

Audio

FORUM
— Heyser & Curl

\$1.25

THE AUTHORITATIVE MAGAZINE ABOUT

SEPTEMBER 1979

47425 

UP IN THE AIR ABOUT METAL TAPE ?????

WE TEST FOUR CASSETTES

Roberson: Dolby- Tape-

...NG ...TANCE OF ...ker ...tivity

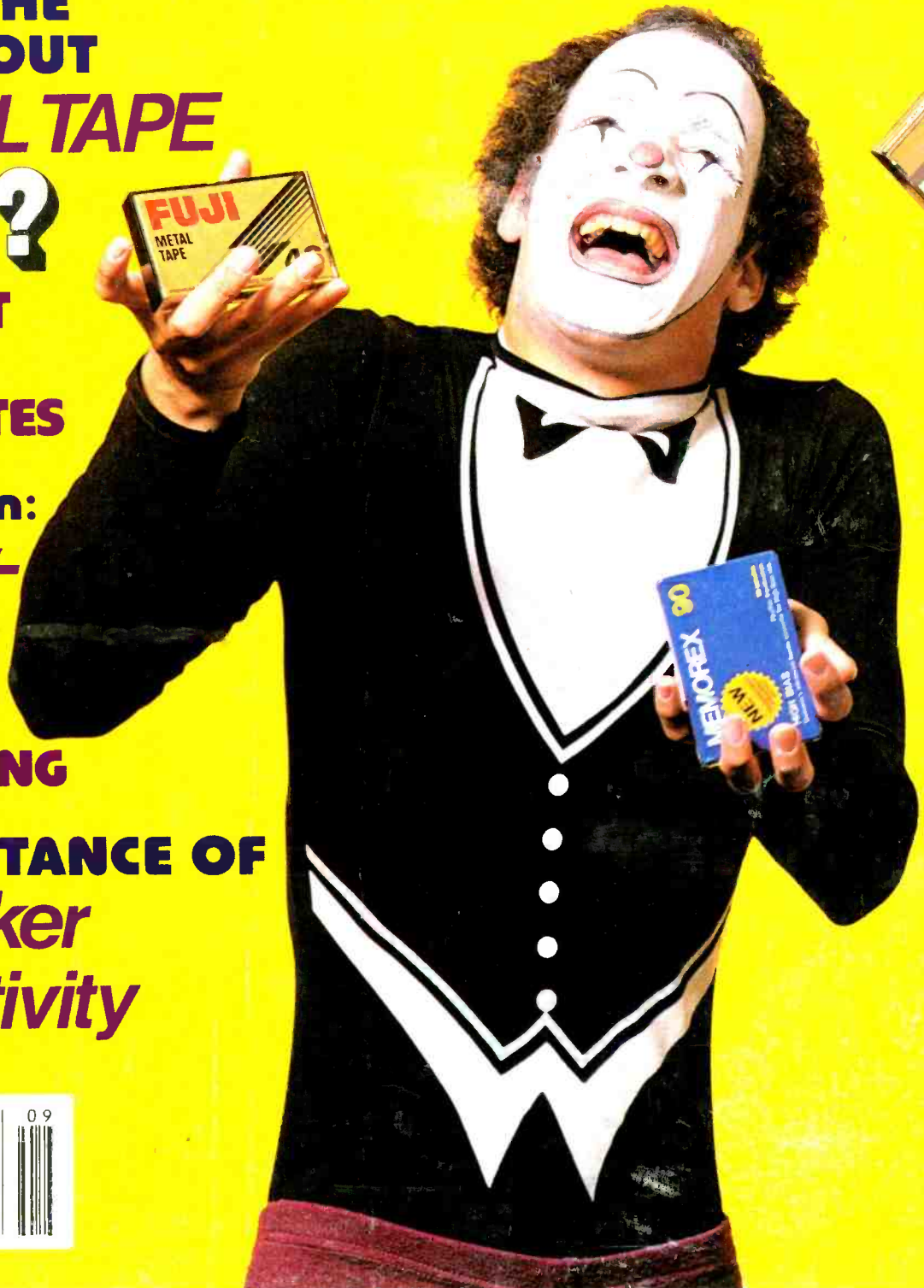

U0296146 1085 90515031P7202232
WILLIAM W KAYSER
147 W BAYVIEW BLVD
NORFOLK VA 23503



THE RIGHT WAY.



when combined with lower audible frequencies.

Most of our competitors use a standard high band filter to cancel out this signal. Unfortunately, it also cancels out some of the music.

Pioneer created a special integrated circuit that eliminates this pilot signal without affecting the music.

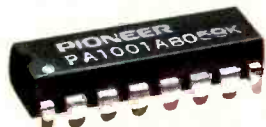

A pilot signal canceling circuit that lets you hear only music and nothing more.

Which means that you're assured of hearing everything the musicians had intended you to hear. Nothing more. And nothing less.

Obviously, the SX-780 is the

only receiver that gives you this feature in this price range. The others give you the noise.



An accurate picture of what you're listening to.

WATTAGE METERS THAT LET YOU SEE WHAT YOU'RE HEARING.

When a receiver has wattage meters, it lets

you see exactly how much power is going through your speakers. So that it not only helps prevent unnecessary damage due to overloading, it helps you make cleaner FM recordings.

Of course, the SX-780 has other virtues conspicuously absent from our competitors' models. Like a built-in wood grain cabinet. Which is something others give you the option of paying extra for.

But what really separates Pioneer's SX-780 from others is more than just a matter of wood cabinets, wattage meters, metal bottoms, DC power, or even price.

It's our commitment to giving you a quality hi-fi receiver, no matter how much, or how little, you plan to spend.

So if you're planning to spend less than \$400, you couldn't ask for more than the SX-780.

PIONEER
We bring it back alive.

POWER: 45 watts per channel min. at 8 ohms from 20-20,000 hertz with no more than .05% total harmonic distortion.
FM SENSITIVITY: Stereo: 37.0 dBf

S/N RATIO: Stereo: 72 dBf
CAPTURE RATIO: 1.0 dBf
POWER METERS: 2
SPEAKERS: A, B, AB
TONE CONTROLS: Dual
TAPE MONITORS: 2

PIONEER DID IT

INTRODUCING THE SX-780.

It seems that our competitors think they've mastered the art of building a moderately priced receiver.

Unfortunately, most of them appear to be the work of cost reduction engineers, rather than high fidelity engineers. People whose jobs depend on the cost of what goes into a receiver, not the sound that comes out of it.

At Pioneer, on the other hand, we build a receiver that sells for under \$400 with the same care given to a receiver that sells for over \$1000.

A perfect example is the SX-780.

It offers the kind of features, value and sound you won't find in any other comparably priced receiver.

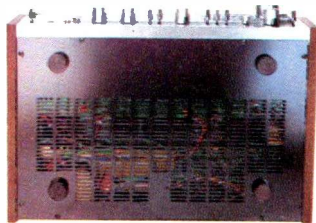

Metal shields our SX-780 from spurious noise.

It offers the kind of features, value and sound you won't find in any other comparably priced receiver. It's designed to shield the tuning section from spurious noise and keep CB interference from getting in the way of your music.

Equally important is the fact that our bottom has a special ventilating system that allows air to circulate freely around the heat sinks. This not only reduces FM drift due to overheated tuning elements, but increases the life expectancy of the circuitry.

A DC AMPLIFIER WITH THE POWER TO ELIMINATE DISTORTION.

The SX-780 features the same DC power configuration found in today's most expensive receivers.



DC power supply found on the most expensive receivers.

A STRONG CASE FOR THE METAL BOTTOM.

If you turn over our SX-780, for instance, you'll notice the bottom is made of heavy gauge metal.

It provides cleaner sound and richer, more natural bass because it eliminates feedback and something called TIM (transient intermodulation). Transient intermodulation is a form of distortion that can keep you from hearing the subtle overtones in your music.

Which interestingly enough is why receivers with a conventional power amplifier might possibly be able to match the specs of the SX-780, but never the sound.

A PILOT SIGNAL CANCELING SYSTEM THAT'S UNHEARD OF IN THIS PRICE RANGE.

All stereo FM stations in America broadcast their music over a pilot signal of 19,000 hertz.

If not eliminated, this signal tends to create an extremely high pitched sound



**THERE ARE A LOT
OF WAYS TO BUILD
A RECEIVER THAT SELLS
FOR UNDER \$400.**

YOU CAN
LEAVE OUT
DUAL WATTAGE
METERS LIKE
MARANTZ DID.



YOU CAN INSTALL
AN INEXPENSIVE
PRESS BOARD BOTTOM
LIKE TECHNICS DID.
INSTEAD OF
A METAL ONE.

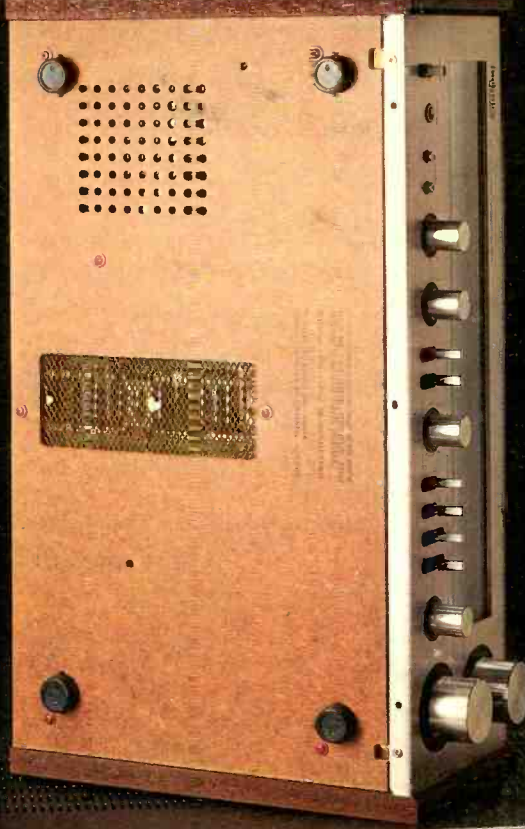

YOU CAN USE
A CONVENTIONAL POWER
AMPLIFIER LIKE
KENWOOD DID.
INSTEAD OF
AN ADVANCED
DC AMPLIFIER.



YOU
CAN USE
STANDARD
HIGH BAND
FILTERS LIKE
YAMAHA DID.
INSTEAD OF SPECIAL
INTEGRATED CIRCUITS TO CANCEL
THE UNWANTED FM PILOT SIGNAL.

Audio

"Successor to **RADIO**, Est. 1917"

Feature Articles

The Importance of Speaker Directivity	37	Dan Queen
Tape-to-Deck Matching For Best Dolby Tracking	44	Howard A. Roberson
Up in the Air About Metal Tape?	50	Howard A. Roberson

Equipment Profiles

Rotel RT-2100 FM Tuner	58	Leonard Feldman
Warp Out Record Weight	64	Bert Whyte
Empire EDR.9 Phono Cartridge	66	B.V. Pisha
McKay Dymek DR-33		
All-Wave Receiver	70	Leonard Feldman

Record Reviews

The Column	80	Michael Tearson & Jon Tiven
Jazz & Blues	90	
Top of the Pile	97	
Classical	98	Edward Tatnall Canby
Folk Bag	102	

Audio in General

Audioclinic	6	Herman Burstein
Audio ETC	8	Edward Tatnall Canby
The Forum	18	Richard C. Heyser, John J. Curl
Tape Guide	26	Joseph Giovanelli
Behind the Scenes	30	Bert Whyte
Dear Editor	35	
The Bookshelf	74	
Classified Advertising	106	
Free Information Service	114	

About the Cover: You may start juggling for joy when you find out how good metal-particle cassettes are in Howard Roberson's articles. Photo: Photographic Illustrations, Philadelphia. Model: Jay Levan.



Audio Publishing, Editorial, Subscription, and Advertising Production offices, North American Building, 401 No. Broad St., Philadelphia, Penna. 19108. Telephone 215/574-9600. Postmaster: Send Form 3579 to above address.

The **DISCWASHER**®

Perfect Path Concept

DiscLeads™

Headshell Connectors



Single forged metal strips/clips of a special hi-conductivity alloy. Heavy gold plating optimizes skin transfer of electrons. DiscLeads pass cartridge output to headshell without signal-destroying wire crimps or solder joints.

Gold-ens™

Perfectionist Audio Cables



Tips have the same gold alloy used in the highest quality aerospace contacts. Unique cable is flexible, low capacitance, and is locked into each metal tip with an exclusive molded nylon core.

SMOG-LIFTERS™ II

Proprietary Coaxial Speaker Cable



160 strands of pure copper conductors. Ultra-low resistance, capacitance and phase coherency allow amplifiers to "relate" to speakers with safety and audible improvement. Tip sections are sealed until hookup for better contact.

The Perfect Path

From Discwasher dealers, who are actively preserving your musical experience.



discwasher, inc.
1407 N. Providence Rd.
Columbia, Missouri 65201

Professional Sound Systems Start With The Stanton 881S

Stanton Magnetics presents the new 881S Professional Calibration Standard Cartridge. It's the cartridge preferred by recording engineers worldwide and it assures a new standard for home audiophiles desiring the very best in recorded sound. Its patented, low mass Stereohedron™ stylus

tip makes possible the flawless reproduction of high velocity modulations present on today's finest recordings.

The Stanton 881S... where great sound begins. Stanton Magnetics, Terminal Drive, Plainview, NY 11803



STANTON

THE CHOICE OF THE PROFESSIONALS™

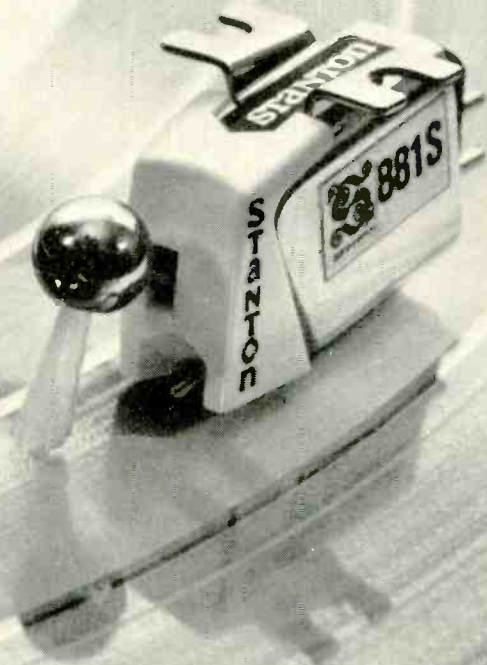

Enter No. 30 on Reader Service Card

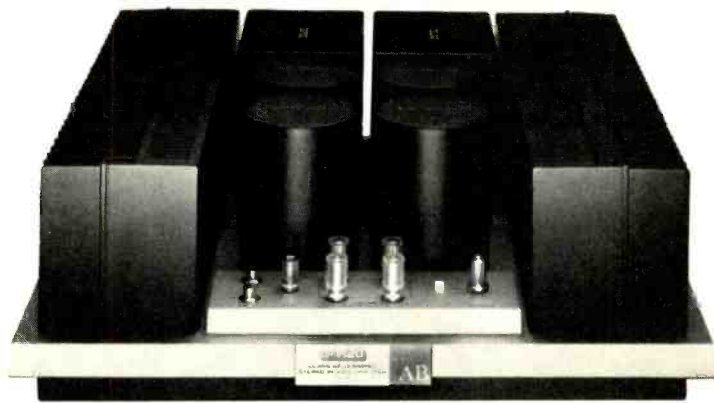

series20

IT TAKES GUTS TO BE MORE EXPENSIVE THAN McINTOSH

McIntosh might be considered an expensive extravagance by the average high fidelity consumer. However the true audiophile perceives reliability, proven engineering and classic styling as necessities rather than luxuries.

The true audiophile also appreciates outstanding specs and the state of the art technology that distinguishes Series 20 from the field.

Consider the Ring Emitter Transistor out-put stage in the Series 20 M-25 Class AB Power Amplifier that provides incredible high frequency performance.

Consider the Series 20 F-26 FM Tuner's parallel balanced linear detector that delivers the lowest distortion available.

When you realize how exceptional Series 20 is, you'll marvel at how inexpensive expensive can be.



20 Jewell Street, Moonachie, N. J. 07074

AVAILABLE AT THESE FINE DEALERS

- | | | | |
|---------------------------|--------------------|-----------------------------|----------------------|
| American Audiophile | Valley Stream, NY | Garehime Music Company | Las Vegas, NV |
| American T.V. & Appliance | Madison, WI | Hi Fi Haven | New Brunswick, NJ |
| Another World Electronics | Ft. Lauderdale, FL | Innovative Audio Products | Brooklyn, NY |
| Appletree Stereo | De Kalb, IL | Jonas Miller Sound | Beverly Hills, CA |
| Appletree Stereo | Springfield, IL | Lafayette Radio Electronics | Rapid City, SD |
| Appletree Stereo | Naperville, IL | Listen Up | Denver, CO |
| Appletree Stereo | Elgin, IL | Listen Up | Evergreen, CO |
| Appletree Stereo | Rockford, IL | Metex International | Laredo, TX |
| Appletree Stereo | Normal, IL | Music & Sound | Woodland Hills, CA |
| Appletree Stereo | Peoria, IL | Natural Hi Fi | New Philadelphia, OH |
| Appletree Stereo | Champaign, IL | Natural Sound | Framingham, MA |
| Audio Advice | Raleigh, NC | Park Avenue Audio | New York, NY |
| Audio Dimensions | San Diego, CA | Powerhouse Electronics | Red Bluff, CA |
| Audio Professionals | Overland Park, KS | Pro Audio | Sioux Falls, SD |
| Audio Professionals | Omaha, NE | PUD's | Albany, CA |
| Audio Professionals | Lincoln, NE | Sights & Sounds | Chicago Heights, IL |
| Audio Video Concepts | Winston-Salem, NC | Sights & Sounds | Oak Lawn, IL |
| Back Door Stereo | Atlanta, GA | The Sound Company | Minden, LA |
| DKL Sound Laboratory | Silver Springs, MD | Spaceways Sound | Annapolis, MD |
| Esoteric Audio | Wayzata, MN | The Stereo Shop | Martinez, GA |
| Executive Audio | Santa Monica, CA | Summit Sights & Sounds | Jefferson City, MO |
| Fred Locke Stereo | Berlin, CT | Team Electronics | Sioux City, IA |
| Fred Locke Stereo | New Haven, CT | Tin Ear Sound Company | Reno, NV |
| Fred Locke Stereo | Wethersfield, CT | Tri-State Electrical Supply | Michigan City, MN |

Enter No. 32 on Reader Service Card

If you would like full information on Series 20, please send us the coupon below.

To: Series 20
Dept A9
20 Jewell Street
Moonachie, New Jersey 07074

Please send me the specs for the following circled Series 20 components.

M-22 Class A-Stereo Power Amplifier	D-23 Multi-AMP Elec. Crossover Netwk	M-25 Class AB Stereo Power Amplifier	C-21 Stereo Preamplifier
F-26 Advanced Quartz FM Tuner	A-27 Class AB Integrated Stereo Amplifier	F-28 Quartz FM Tuner	
PLC-590 Quartz PLL Servo- Controlled Turntable	PA-1000 Carbon Fiber Tone Arm	U-24 Program Source Selector	

Name _____
Street _____
City _____
State _____ Zip _____

Audio

Editor
Eugene Pitts III

Assistant Editor
Kay Blumenthal

Design
Frank Moore

Design Assistants
Barbara D'Aprile
Mark Collins

Production Manager
Margaret Zibelman

Associate Editors:
Edward Tatnall Canby, Bert Whyte

Senior Editors:
Richard C. Heyser, B. V. Pisha
Howard A. Roberson

Contributing Editors:
Tom Bingham, Herman Burstein,
Geoffrey T. Cook, John Diliberto,
Leonard Feldman, Joseph Giovanelli,
Edward M. Long, C. G. McProud,
George Pontis, Jon Sank,
Donald M. Spoto, Michael Tearson,
George W. Tillett, Jon Tiven

Vice President/Publisher
Jay L. Butler



AUDIO is published monthly by North American Publishing Company, Irvin J. Borowsky, Founder and President
Frank L. Nemeyer, Vice President/General Manager
Joseph Florentine, Chief Financial Officer
R. Kenneth Baxter, Vice President/Manufacturing
Vijay Chowdhry, Production Director
Jack Maxson, Promotion Director
Betty Brodsky, Subscription Promotion Director
Mary Claffey, Vice President
S. O. (Shap) Shapiro, Circulation Consultant
Jean Davis, Circulation Manager
Dorothy Yockey, Subscription Fulfillment Manager

ADVERTISING SALES

Jay Butler, Vice President/Publisher,
545 Madison Ave., New York, NY 10022
Telephone (212) 371-4100

East Coast Sales Office: Laurel Carr, 545 Madison Ave., New York, NY 10022 Telephone (212) 371-4100

West Coast Sales Office: Jay Martin, 17000 Ventura Blvd., Encino, CA 91316. Telephone (213) 788-9900.

Classified Advertising: Carolyn Sumner,
401 North Broad St., Philadelphia, Pa 19108
Telephone (215) 574-9600

Continental European Representative: V. B. Sanders,
International Publishers Advertising Service,
Raadhuisstraat 24, P.O. Box 25, Graat-De Ryp, Holland.
Telephone, 02997-1303

England: The Paul Singer-Lawrence Media Group,
54 Burton Court, London SW 3 5YA, England. Phone,
01-730-3592

©1979, North American Publishing Co. Established 1917. ALL RIGHTS RESERVED.

World Library Congress Number ISSN0004-752X

Dewey Decimal Number 621.381 or 778.5

Editorial Contributions are welcomed but should be accompanied by return postage. Submissions will be handled with reasonable care, but the publisher assumes no responsibility for return or safety of manuscripts, photographs, or artwork.

Printed in U.S.A. at Columbus, Ohio. Second-class postage paid at Philadelphia, PA and additional mailing offices. USPS Number 036-960

U.S. Subscription Rates: 1 year \$12.00, 2 years \$22.00, 3 years \$30.00.

Other Countries: 1 year \$18.00, 2 years \$34.00, 3 years \$49.00.

Back issues, when available, \$5.00 postpaid.

Audio Publishing, Editorial, Subscription, and Advertising Production offices, North American Building, 401 North Broad St., Philadelphia, PA 19108.

Telephone: (215) 574-9600.

Postmaster: Send Form 3579 to above address.

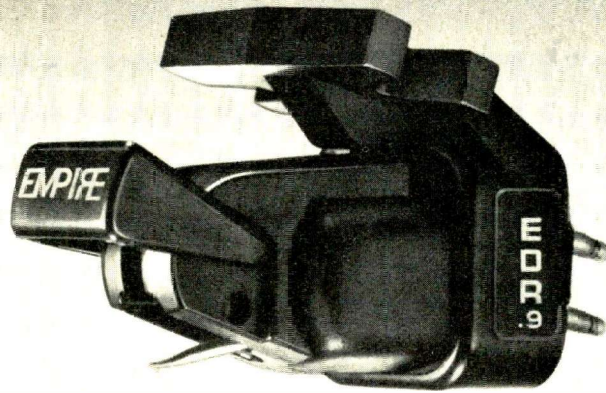

INTRODUCING THE EMPIRE EDR.9 PHONO CARTRIDGE. IT SOUNDS AS GOOD ON A RECORD AS IT DOES ON PAPER.

It was inevitable . . .

With all the rapid developments being made in today's high fidelity technology, the tremendous advance in audible performance in Empire's new EDR.9 phono cartridge was bound to happen. And bound to come from Empire, as we have been designing and manufacturing the finest phono cartridges for over 18 years.

Until now, all phono cartridges were designed in the lab to achieve certain engineering characteristics and requirements. These lab characteristics and requirements took priority over actual listening tests because it was considered more important that the cartridges "measure right" or "test right"—so almost everyone was satisfied.

Empire's EDR.9 (for Extended Dynamic Response) has broken with this tradition, and is the first phono cartridge that not only meets the highest technological

and design specifications—but also our demanding listening tests—on an equal basis. In effect, it bridges the gap between the ideal blueprint and the actual sound.

The EDR.9 utilizes an L. A. C. (Large Area Contact) 0.9 stylus based upon—and named after—E. I. A. Standard RS-238B. This new design, resulting in a smaller radius and larger contact area, has a pressure index of 0.9, an improvement of almost six times the typical elliptical stylus and four times over the newest designs recently introduced by several other cartridge manufacturers. The result is that less pressure is applied to the vulnerable record groove, at the same time extending the bandwidth—including the important overtones and harmonic details.

In addition, Empire's exclusive, patented 3-Element Double Damped stylus assembly acts as an equalizer. This eliminates the high "Q" mechanical resonances typical of other stylus assemblies, producing a flatter response, and lessening wear

Enter No. 13 on Reader Service Card

and tear on the record groove.

We could go into more technical detail, describing pole rods that are laminated, rather than just one piece, so as to reduce losses in the magnetic structure, resulting in flatter high frequency response with less distortion. Or how the EDR.9 weighs one gram less than previous Empire phono cartridges, making it a perfect match for today's advance, low mass tonearms.

But more important, as the EDR.9 cartridge represents a new approach to cartridge design, we ask that you consider it in a slightly different way as well. Send for our free technical brochure on the EDR.9, and then visit your audio dealer and listen. Don't go by specs alone.

That's because the new Empire EDR.9 is the first phono cartridge that not only meets the highest technological and design specifications—but also our demanding listening tests.

Empire Scientific Corp.
Garden City, N.Y. 11530

EMPIRE

Audioclinic

Joseph Giovanelli

Recording Engineering Schools

Q. I recently graduated from high school and have become very interested in the recording engineering field. Can you give me a list of institutes that offer courses in this field? — M. Kuc, Vancouver, B.C., Canada.

A. The Institute of Audio Research, 64 University Place, New York, N.Y. 10003, offers advanced courses dealing with recording and related fields. You might also look into: (1) Cleveland Institute of Electronics, 1776 East 17th Street, Cleveland, Ohio 44114; (2) Bell & Howell Education Group, National Offices, 2201 West Howard, Evanston, Ill. 60202; (3) Technical Center Institute, 320 West 31st Street, New York, N.Y. 10001; (4) Teccart Institute, Montreal, Canada; (5) Eastman School of Music, Rochester, N.Y. 14604; (6) Loyola University, Montreal, Quebec, Canada, and (7) Brigham Young University, Provo, Utah 94602.

Billboard magazine, 1515 Broadway, New York, N.Y. 10036, has an "International Directory of Recording Studios" for sale. You might also get helpful information from such journals as *db*, 1120 Old Country Road, Plainview, N.Y. 11803 and *Recording Engineer/Producer*, P.O. Box 2449, Hollywood, Cal. 90028.

Measuring an Unknown Frequency

Q. I should like to find out the frequency of an unknown audio signal. How can I hook up the unknown signal and a calibrated signal generator, sweep until I hear a beat or null, and then take my reading from the calibrated generator? — F. Alexander, Maspeth, N.Y.

A. The simplest way by which one can determine a frequency generated by an uncalibrated source is to obtain a frequency counter. Certainly if you plan to do much along these lines, the investment in a counter is justified. The uncalibrated source is fed directly into the input of the counter. If its output level is too low for the counter to handle, an appropriate preamplifier must be used. The frequency of the unknown signal is read directly on the counter's display.

Another method for determining the frequency of the unknown signal source is more like the system mentioned in your question. In this ar-

rangement the unknown signal is compared to a signal of known frequency. The two signals are adjusted to produce equal audio outputs. Each signal is fed to the input of a two-position mixer, whose output is connected to an amplifier and loudspeaker system.

Perhaps the best procedure is to listen to the unknown and then attempt to match that sound fairly closely to that of the known generator, by alternating listening to one or the other of the signals while you adjust the known to equal the frequency of the unknown source.

When you think they are reasonably close in frequency, listen to the two signals together. You probably will hear them, plus a third signal set up by interaction between the two signals. Adjust the known signal till this third sound disappears. What you will then hear is a variation of the amplitude of what appears to be one signal. Carefully adjust the frequency of the calibrated source until even this effect vanishes. You will then have the two signal sources running at the same frequency. Therefore, the frequency of the unknown source can be read as though it were the known source. The accuracy of your results will depend on the accuracy of the known signal generator's calibration.

If the frequency of the unknown signal is above the range of audibility, the same basic procedure can be used, although it would be subject to error. In this instance you would sweep the calibrated source until you hear a signal. This signal represents the beat tone created by the known and unknown signals which are close enough in frequency to produce an audible beat. Unfortunately, rather than obtaining a true beat between the known and uncalibrated signals, it is possible that the harmonics of the signal of known frequency can beat with the fundamental frequency of the unknown or vice versa. Thus, when you adjust for the absence of such a beat, your reading of the known signal frequency may reflect a reading created by harmonics rather than the fundamental frequencies involved. Therefore, be sure to sweep the known signal's frequency over a sufficient range to pick up more than one beat. The beat which is the strongest will

represent the beating of the two fundamental frequencies.

Where supersonic frequencies are not involved, a third procedure is possible. Instead of combining the signals, feed each of them into a stereo amplifier channel. Make the same tests while listening to the output of that amplifier with headphones.

Matching Headphone To Amplifiers

Q. I have headphones rated at 250 ohms which I would like to use with my amplifier's front panel headphone jack. Do I just install resistors in series with the jack, and what value should I use? The jack is rated at 8 ohms. — Steve Anderson, Santa Ana, Cal.

A. A source rated for a low impedance (8 ohms) load can drive one of higher impedance (250 ohms) easily. The reverse is not true, however. Matching them in this case will make no improvement in sound, but would lower the signal input into the phones because your amplifier already has resistors in series with its output. These are required to keep from feeding the amplifier's entire output to the phones and blowing them out (and hurting your ears).

Degrading of Electrolytic Capacitors

Q. Is it true that electrolytic capacitors wear out gradually if left in a non-operating condition? Such could easily be the case with consumer-type electronic audio gear which may not be operated for extended periods of time. How insidious for an amplifier to wear out just sitting there—say, perhaps, in storage for a considerable length of time! — Steven Heinisch, Prior Lake, Minn.

A. When an electrolytic capacitor is not used, most of the time its capacitance does not change much. Its voltage breakdown point, however, will gradually fall. This fact can cause trouble when a piece of equipment has not been operated for long periods. In some instances, the capacitance may also decrease. A

If you have a problem or question about audio, write to Mr. Joseph Giovanelli at AUDIO Magazine, 401 North Broad Street, Philadelphia, PA 19108. All letters are answered. Please enclose a stamped, self-addressed envelope.

AUDIO • September 1979

Technics SILVER EDITION

When you consider the prices of many metal-tape cassette decks, it's hard to consider them at all. But consider this: With Technics RS-M63 you not only get metal tape recording, you also get three heads and double Dolby† for only \$450.

That means you'll get a lot of performance, too. Take the RS-M63's extended frequency response. With standard CrO₂ tape it's incredibly high; with metal tape it's simply incredible.

Wow and Flutter	Frequency Response	S/N
0.05% WRMS	20Hz-20kHz (metal) 20Hz-18kHz (FeCr/CrO ₂) 20Hz-17kHz (normal)	67 dB Dolby in

The RS-M63's separate HPF record and playback heads not only result in a very wide frequency response, they also work together so you can check the quality of your tape while recording it. There's also a sinter/ferrite erase head, powerful enough to erase highly resistant metal tape.

When it comes to Dolby NR, the RS-M63 offers plenty of versatility. Because there are separate Dolby circuits for recording and playback. And that means you can monitor your tapes with the benefits of Dolby Noise Reduction.

To help you make recordings with plenty of dynamic range, the RS-M63 adds fluorescent (FL) bar-graph meters. They're completely electronic and extremely fast with a device attack time of just five millionths of a second. They're also accurate. So accurate that deviation from the 0 VU level is no more than 0.1dB. And that means the recording levels you see are the recording levels you get.

The RS-M63 also has separate three-position bias and EQ selectors for normal, chrome and ferrichrome tapes. A separate metal tape selector. Fine bias adjustment. And memory features including auto rewind, auto play and rewind auto play.

The RS-M63. The only deck to consider when you consider its performance and its price.

*Technics recommended price, but actual retail price will be set by dealers.

†Dolby is a trademark of Dolby Laboratories.

Everyone's talking about metal tape recording, 3 heads and double Dolby. Technics lets you hear it all for \$450.*

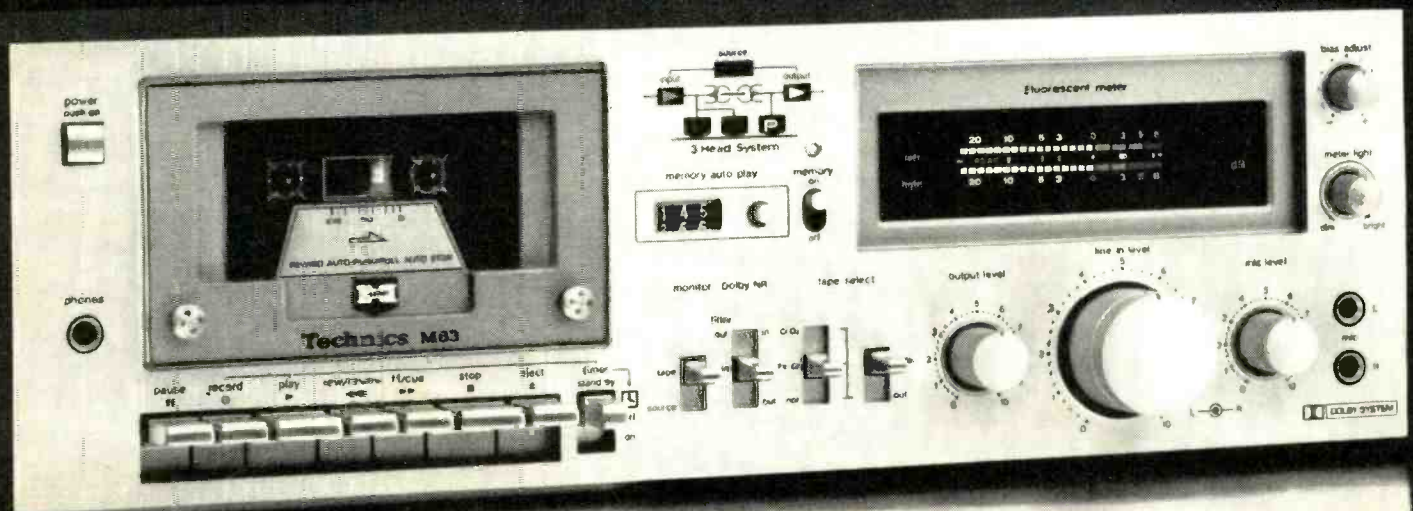

Enter No. 44 on Reader Service Card

Audio etc.

Edward Tatnall Canby

Sometimes the simplest ideas are the brightest. Often, too, it takes a big company to produce a really simple, basic idea. I don't necessarily mean in technology — I mean in *concept*. To make one say, why didn't I think of that? Clears away the underbrush, cleans up the confusion, points the direct way, makes things easy. Like, say, the safety pin.

It looks as though, maybe, Philips has launched a modern safety pin for us in audio. It's called the Compact Disc and the analogy with Philips' Compact Cassette is deliberate. Very different product but much the same thinking.

Need you guess? This is a digital disc. Need you guess again? It's for everything and everybody, the cheapest and the fanciest alike. And I'll give you three: It is NOT a picture disc. Pure audio, and blind as a bat. The only picture this one will ever show might be a title in little red letters. Do you need a fourth guess? It's SMALL. Compact is hardly the word; this is the Subcompact of the Future. And if I have my wish, it will at last spark that audio miniaturization which, with all our transistors, ICs, and chips, is still barely beginning. I've yelled miniaturization for years. Now, maybe, compact fi to match Disc? About time! Some safety pin!

Philips' well-matured cassette, of course, took a long time to get going, and no doubt the Compact Disc will also take a while. Philips expects so. This is just the beginning. When the cassette first appeared there was nothing very much of interest in it for the hi-fi man; it was put out basically as a "people's tape" and I often wonder whether Philips really had any idea of its future quality potential. No matter! It did have that potential, which is what counts. Things move faster now



and the Compact Disc has much more than mere quality potential. Remember — it's digital. The quality is already there. But the thinking goes the same as before. Back then, Philips took a basic tape problem in hand — how could we use tape at its maximum potential for an inexpensive, automated consumer recorder/player with no threading, no-touch, no bulky reels, all push-button? The Philips solution was so radical, such a complete break, that it has kept us busy every since, and never more than at present with metal tape ready for another quantum jump in cassette performance. Yet the cassette is still a basic "cheapie" mass-sales system today whenever you want it to be. That was the idea. That is the Philips approach.

True, there was plenty of competition in automated tape. But Philips is big and, shall we say, obstinate. It kept its cassette exactly the way it wanted. We should note, after the fact, that unbridled modifications of the format

might well have confused and splintered the consumer market beyond repair. Many of us have chafed at these design limitations, but I think we now admit that the rigid interchangeability of all cassette tapes and players has been a good thing and perhaps the biggest factor in the present cassette success. We know all too well what happens when interchangeability goes down the drain. (*Compatibility* is something else again, primarily between the old and the new in transition of formats.)

Ah, for the good old days again. Remember 1948, when Columbia offered the LP disc to all comers for practically nothing? RCA demurred, but came around, and vice versa. Now here we go again. If Philips is wise, I think it will (a) stick to its technical guns as to specs for its Compact

Disc, as with the cassette, and (b) license out its new system *liberally*, persuasively — low impedance, high power. It's a likely bet and Philips can easily afford it as the best way to discourage rival systems.

Like Father, . . .

Let me paraphrase, then, the aims of this new Compact Disc as of its predecessor the cassette. How can we use the digital disc potential for an automated consumer disc record system that will be truly basic, practical for use all the way from the lowest "cheapie" right up to the top, at lowest possible cost and highest efficiency? Same idea, you see. But now there are differences. To make digital cheap is a mountainous proposition. Curiously, an even bigger problem is digital quality — there's *too much*. Just the opposite from the cassette. There, you started low and gradually worked upward through improvements. Now, with digital, we start in the strato-

WHICH NEW HIGH BIAS TAPE WINS WITH MAHLER'S FOURTH SYMPHONY?

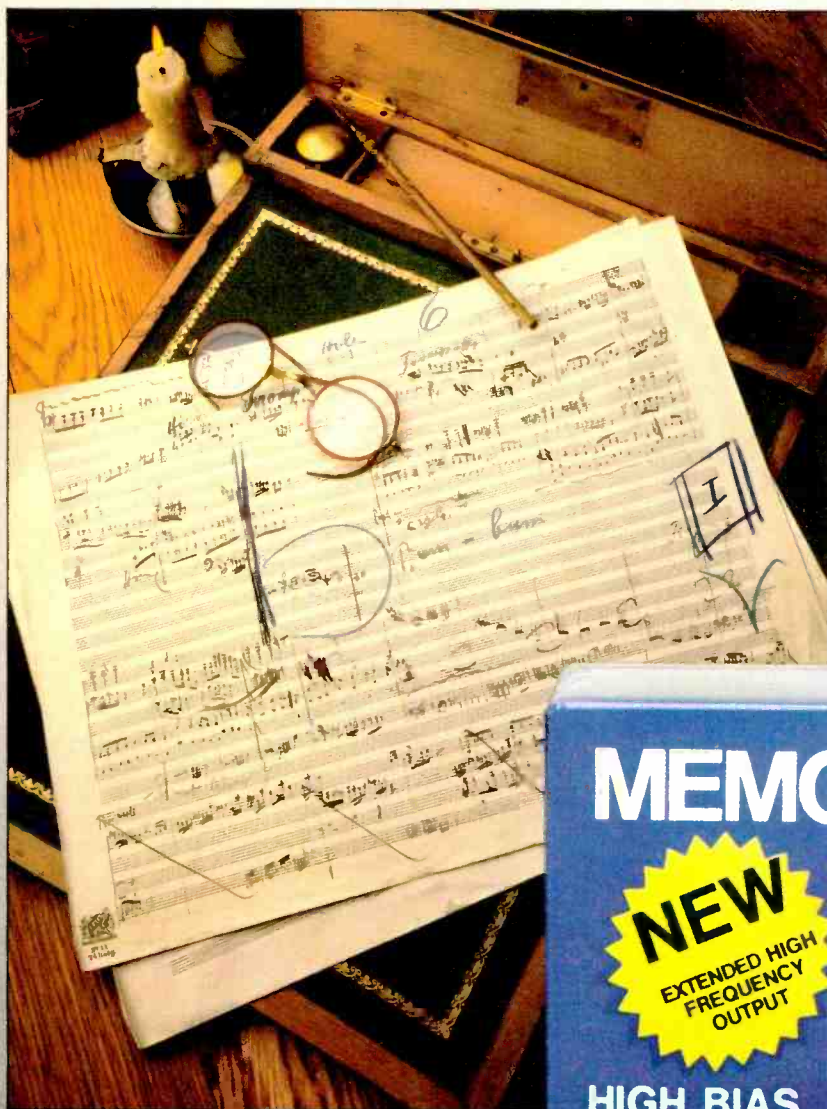

Original manuscript sketch for the first movement of Gustav Mahler's Fourth Symphony. Courtesy of The Newberry Library, Chicago.

Choose eight measures of Mahler's Fourth that are really rich in the high frequencies. The type of passage that high bias tapes are designed for.

Record it on your favorite high bias cassette, using the Chrome/CrO₂ setting. Then again on new MEMOREX HIGH BIAS.

Now play back the tapes.

We're convinced you'll have a new favorite.

New MEMOREX HIGH BIAS is made with an exclusive ferrite crystal oxide formulation. No high bias tape delivers greater high frequency fidelity with less noise, plus truer response across the entire frequency range.

In short, you can't find a high bias cassette that gives you truer reproduction.

MEMOREX

Recording Tape and Accessories.
Is it live, or is it Memorex?



sphere and try like the dickens to bring things down to earth in a practical way. Crazy.

In engineering terms there is virtually NO limit to the audio potential of the digital disc. If a vinyl platter of standard 12-in. size can already, right now, produce an hour of acceptable home color TV, then the same can give you days and days of super audio in a similar configuration. *Who wants it?* As I noted facetiously a few months ago, the audio version of JVC's joint audio/video 12-in. disc is probably still playing — they haven't finished timing it yet. Too much! For the same, you

could have quadra-quadraphonic in 16 channels plus perfume cues and still have too much. *At too much cost.*

Now all this has made a good many of us increasingly uneasy. The tie-up between pictures-with-sound and plain audio is technically solid and just a matter of bandwidth, but in terms of use, it seems increasingly to be unnatural and unfortunate. Audio, sound for sound's sake, is always going to be at the short end — not too little quality but too much. Wasteful. Hence — expensive.

It's like having to hire a 747 to take your family for a modest weekend in

the country. Or buying a gallon of Coke to take one swallow. Suppose Coke came only in gallon jugs?

So we in audio, we who like music, all kinds, music on its own, sound on its own, are beginning to understand that disc digital sound can co-exist commercially, and reach a normal development in its own terms, *only on its own disc, minus picture requirements.*

There isn't even a software compatibility between TV-style pictures-with-sound and audio by itself. We have known this for years. In spite of groans galore, in spite of noble efforts to improve, and all those worthy simulcasts in FM stereo, the basic television sound, whether broadcast, cabled or recorded, remains largely indifferent (to be polite) — *and it is not merely to save on costs.* For the big commercial run of TV-type pictures, sound quality is not really important to the message. Like the telephone. If you understand the words, there's communication. That is what matters. Good audio is merely an added frill. Go to any bar on a baseball night, or visit your own living room! You should have heard the sound on Philips' own TV tape blurb for its new disc. Phew!

Yes, there is televised opera, ballet, concert, and there the sound is important. But this is not the mainstream, alas. As the mainstream goes, so must the medium. A picture disc can do a lot better for these specialties and surely will, since digital allows for it. Even so — audio by itself is still going to suffer, from too much quality at too high expense. If it ties itself to this medium. Restrictions. Small market. Specialty. Premium price.

So on this precise basis, Philips has taken the big and logical step. An optimum *pure audio* digital disc, un-wasteful of space, money *and* quality. This combined with the typical Philips broad-sales-spectrum "Compact" thinking — it must be inexpensive enough to cover all markets and purposes. I was wrong when I said there would never be another purely audio disc. Not ever again an analog system, to be sure. But I forgot the safety pin. Now why didn't I think of this one?

If you have been following recent digital developments you can give a good guess as to the details of the Compact Disc without reading any further. Its operating principles are already familiar in other digital disc prototypes. Laser beam tracking of billions of tiny reflecting pits in close spirals, replacing the contact grooves of the past. There is, of course, the new size — remember, we are now free of picture requirements, and we can scale down the parameters for optimum au-



HOW ABOUT PUTTING HALF A KILOWATT OF STEREO POWER IN YOUR CAR OR VAN?

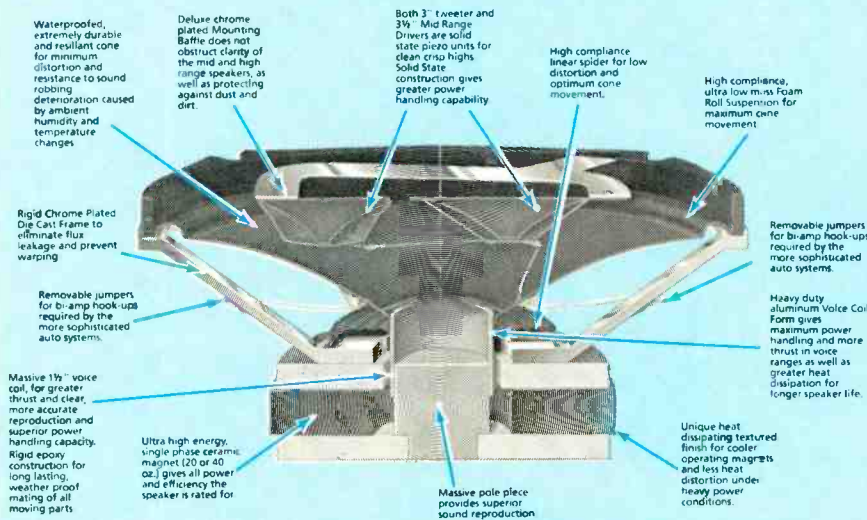

That's right! If you dare, you can actually install a TRUSONIC auto speaker system capable of handling 500 watts of peak power. That's the kind of power your favorite groups use. All you need is a good quality amplifier rated at 120 watts RMS per channel, or slightly more, and four TRUSONIC power speakers. We can assure you that your system will rival the performance found only in very costly home systems.

TRUSONIC is the only manufacturer of auto sound speakers having many unique features that make this possible. For example, we use solid state tweeters and mid-ranges that will handle all of the power your equipment is designed to deliver. Our massive 40 ounce magnet and 1 1/2" voice coil ensure the power rating and we back it up with a 5 YEAR LIMITED WARRANTY. Our chrome plated die cast construction prevents warping which results in distorted sound. THERE'S MORE TOO...

Write to us at address above, or circle Reader number below.

ALL TRUSONIC CAR STEREO, MUSICAL INSTRUMENT, AND HI-FI SPEAKERS, ARE MANUFACTURED IN U.S.A.

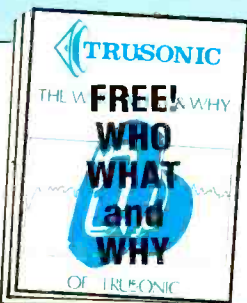

Enter No. 45 on Reader Service Card

AUDIO • September 1979

There are many reasons for owning the new Sansui SC-3300.



Metal is just one.

Metal particle tape could be the most exciting thing that's happened to tape recording in years. But to get the full benefits of metal, you need a special cassette deck — like the new Sansui metal-compatible SC-3300.

The great thing about the SC-3300, though, is that even if you're not sure about metal or are wary of the software expense, this deck still makes a great deal of sense. Here's why:

SOUND QUALITY IS

SUPERB. The SC-3300 is designed to get the most out of any tape, including the newest pure metal formulations. We're using a special alloy record/play head that's particularly immune to saturation from the high bias currents needed for metal recording; and it's much more wear-resistant than even the strongest conventional heads.

The erase head, too, is special — a double-gap ferrite design that produces a 70dB erasure factor for beautiful low-noise recordings. Our new Roller Back holdback tension mechanism further improves sound quality by suppressing frequency-modulated distortion and reducing wow and flutter to a mere 0.04%.

OPERATION IS EFFORTLESS. The feather-touch controls of the SC-3300 are monitored by an LSIC logic chip tied to high precision solenoids. So you get the freedom you need to concentrate on the music you're making or taping. It's so foolproof that no matter how fast you push the buttons, the tape will

never jam or stretch.

The unusually versatile tape selector system provides separate switches for bias and equalization, with numerical indications of the optimum levels for normal, chrome and metal tapes.

And our 16-segment/channel LED peak-level indicators make it easy to set just the right levels for maximum signal and minimum noise. They're calibrated in dB and indicate red if a signal is too strong.

ALL THE EXTRAS, TOO. For added convenience, you can connect the SC-3300 to a timer, and the logic circuits will start recording or playing any time you want. Sansui's exclusive Tape Lead-In feature automatically skips over the unusable leader and beginning portion of each tape. And of course there's Dolby™ noise reduction, memory re-wind, variable output and a computer-assisted pause control.

The brushed aluminum face and simulated rosewood cabinet of the SC-3300 perfectly complement our new Double-Digital receivers. We also have a complete line of matte-black finish metal-compatible models that come equipped with rack-mounting handles.

So, whether you're a strong believer in metal or just looking for a new cassette deck, visit your authorized Sansui dealer to see the best.

Dolby™ is a registered trademark of Dolby Labs Inc.

SANSUI ELECTRONICS CORP.

Lyndhurst, New Jersey 07071 • Gardena, Ca. 90247
 Sansui Electric Co., Ltd., Tokyo, Japan
 Sansui Audio Europe S.A., Antwerp, Belgium
 In Canada, Electronic Distributors

Sansui



Enter No. 41 on Reader Service Card

At last a moving coil cartridge you can recommend to your best friend!

New AT30E
Stereo Phono Cartridge
with Vector-Aligned™
Dual Moving MicroCoils™
and user-replaceable Stylus



The subtle, yet unique characteristics of moving coil cartridges have had their admirers for years. A top-quality moving coil cartridge exhibits remarkable sonic clarity and transparency. This performance can be attributed to the very low mass, and low inductance of the tiny coils used to sense the stylus motion.

But until now, moving coil cartridge popularity has been limited by three major problems which seemed almost inherent to moving coil designs.

1) It seemed impossible to make a user-replaceable stylus assembly without compromising performance; 2) most moving coil cartridges exhibited relatively low tracking ability due to rather stiff cantilever mounting systems; and 3) output of the cartridge was below the level needed for commonly available amplifier inputs.

Introducing the new Audio-Technica AT30E and the end to all three problems! Our design approach is simple and direct. Rather than locate the coils in the cartridge body, they are integral with the stylus assembly. If the stylus becomes worn or damaged, the *entire* moving system, coils and all, is simply unplugged and replaced, just like a moving magnet cartridge. Large, gold-plated connectors insure loss-free connections so vital at the low voltages generated by a good moving coil cartridge. The result is easy field replacement with no penalty in terms of performance.

Careful research indicated that good tracking and moving coil design were indeed compatible. By controlling effective mass and utilizing a radial damping system similar to our famed Dual Magnet™ cartridges, we have achieved excellent tracking ability

throughout the audio range. Compliance is individually controlled during manufacture of each assembly to optimize performance. This extra step, impossible with most other designs, coupled with our unique radial damping ring, insures excellent tracking of the high-energy modulation found in many of the top-quality recordings now available.

Each coil is located in the ideal geometric relationship to reproduce "its" side of the record groove. This Vector-Aligned™ design assures excellent stereo separation, minimum moving mass, and the highest possible efficiency. It's a design concept which is exclusive to Audio-Technica, and is a major contributor to the outstanding performance of the AT30E.

We can't take credit for solving the low output problem. The AT30E output is similar to many other fine moving coil cartridges. But an increasing number of amplifiers and receivers are featuring built-in "pre-amplifiers" or "head amplifiers" to accommodate moving coil cartridges directly. Thus the new systems buyer can make a cartridge choice based on sonic characteristics rather than on input compatibility. In addition, Audio-Technica offers the Model AT630 Transformer for matching to conventional amplifier inputs.

The new Audio-Technica AT30E Dual Moving Micro-Coil Stereo Phono Cartridge. With the introduction of this remarkable new design, every important barrier

to full enjoyment of the moving coil listening experience has been removed. Progress in sound reproduction from Audio-Technica... a leader in advanced technology.

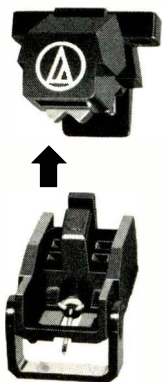

 **audio-technica**
INNOVATION □ PRECISION □ INTEGRITY

AUDIO-TECHNICA U.S., INC., Dept 99A-1, 33 Shawassee Avenue, Fairlawn, Ohio 44313

Enter No. 3 on Reader Service Card

dio alone. And — clever idea! — the Philips is variable speed, from 500 to 215 rpm, inside out. That makes the small-diameter inner grooves playable. Constant velocity as the laser sees it, very much like tape itself. (Now would you have thought of that safety pin?)

But what size? And what quality? Follow me a bit further. You could, I suppose, put a ring of digital sound around the outside of a 12-in. platter, a half inch or so, and accommodate, disc for disc, all our existing LP software. Why bother. Very wasteful. Or could you bond a ring or band of vinyl onto a cheap 12-in. substrate? Clumsy. Better to reduce the size. Ten-inch? Still far too big and wasteful of digital potential. Eight-in.? Maybe 7-in.? For at least some compatibility in the packaging and pressing departments during changeover? Is there any useful compatibility?

Tiny & Very Long

The Philips answer is an unequivocal NO. Except for one vital thing: Philips puts the entire playback system inside its tiny player unit and comes out with a standard stereo signal, ready to feed anything you want. That's an excellent sort of compatibility both for retail and manufacturing: Nothing to buy except the single player unit and its complete miniature electronics and laser system.

What, then, is the size of the disc? Hold onto your bonnets. The Philips choice is a whopping 4½ inches of feather-weight vinyl. It comes in a handy jacket, very much like an LP (with the same cover art). The whole thing fits into the palm of your hand.

Inside the jacket are all the notes, texts, bios you want, neatly bound like a little book. Great improvement over the information-scanty cassette. Only the spine is unprinted, at least in the prototype; but an LP-like spine could easily be added for better filing, and probably will be.

What does this little dandy do? It's digital, remember. It plays *one full hour* of stereo on a single side. That's the contents of a standard LP, *both* sides.

The second side is blank, for a start. Who needs it? But somebody in authority at the initial demonstration last June allowed as how there could be a double-side disc any time it might be useful. That would make two hours of play on a single 4½-in. mini-disc. See what I mean by the technological gap that has been building up between the standard LP and the new digital potential.

Imagine it. A whole five-hour Wagner opera on three tiny discs, five

AUDIO • September 1979

LUX 5K50



LUX 5K50 STEREO CASSETTE DECK

REDEFINING THE ART OF CASSETTE PERFORMANCE

For over half a century, the name Lux has meant advanced technology and sophisticated designs—qualities sought by dedicated music lovers around the world. And now Lux's audiophile/engineers have focused their attention on the cassette format.

Some of the special features of the new 5K50: Real-time process DC amplifiers for both record and playback; a unique modular tape-transport system featuring three motors and separate three-head configuration; Lux's dual Plasma record level meter, and most significant, Lux's recently developed BRBS Variable Bias Control System.

Real-time processing DC circuits bring Lux quality amplification to the cassette format for extended bandwidth, low distortion and exceptional signal-to-noise ratios.

The highly sophisticated tape transport extracts the best possible performance from any cassette... and there's further improvement when Lux cassettes are used. Each of the three heads is precisely designed for its special task, as are the three motors that provide the separate drives for the dual capstans and reel hubs. The capstan drive motor is a quartz-referenced phase-locked loop direct-drive unit, while coreless motors for the reels provide total stability with the precise torque and tension required for an effective dual-capstan transport system.

When a Lux cassette tape is loaded, an electronic digital counter provides the exact minute and second of tape use. The

electronic counter functions normally for standard cassettes. A plasma fluorescent display indicates peak levels from -40 to +6 dB per channel with a special +10 dB scale for metal-particle tapes.

To eliminate the distortion inherent in conventional tape-bias circuitry, Lux developed the Bridge Recording Bias System. These special circuits enable the user to adjust the recorder for best possible response with any tape, while eliminating those transient distortion and phase shift.

And there is so much more: Electronic IC logic control with feather-touch pushbuttons replaces mechanical operation and its attendant noise and wear problems. Human engineered control clusters; record-head azimuth adjustment with built-in indicators for optimum setting for any tape; signal-to-noise ratios up to 69 dB and frequency response from 30 to 20,000 Hz, depending of course, on the tape used.

The expense of the Lux 5K50 cassette deck is fully justified, not only by what Lux puts into it, but the performance the user can get out of it. Also look into the other Lux cassette decks, Models K-12, K-10 and K-5A, ranging in price from \$495 to \$2,000... each an embodiment of Lux quality.

To experience the Lux lineup of high-performance cassette decks, see your local Lux dealer or write to Mr. Robert Bowman, Vice President of Sales at Lux Audio of America Ltd.



LUX K-10



LUX K-5A



LUX K-12



LUX AUDIO OF AMERICA, LTD.
160 Dupont Street, Plainview, NY 11803
In Canada: Lux Audio of Canada, Ltd., Ontario

Because music is mostly transients.



Our 282-e cartridge.

From the attack of an organ note to the bite of a plucked string, music is mostly transients: sudden bursts of sound at all frequencies. On a stereorecord, transient signals define the characteristic attack and decay of musical sounds, differentiating one instrument from another.

Until Micro-Acoustics' direct-coupled design (U.S. Pat. No. 3952171), all high-fidelity cartridges concentrated on *tracking ability*: maintaining contact between stylus and groove at low forces, for minimum record/stylus wear. This reduces *transient ability*, because under-damped moving assemblies tend to remain in motion, impairing clarity and definition. On the other hand, earlier cartridges with stiffer stylus assemblies had better transient ability, but greater wear.

Unlike these single-pivot cartridges, which maximize one ability, Micro-Acoustics' 282-e has twin pivots optimized for *both* abilities. Resulting in superior transient and tracking performance from *one* cartridge on *all* records, including warped discs. Performance totally independent of tonearm cable capacity or preamp input impedance.

Visit your MA dealer and let your ears convince you. Or use our unique test record for evaluating and comparing cartridge tracking and transient ability. Just send \$5.00 for a postpaid copy, or write for free information. Micro-Acoustics Corporation, 8 Westchester Plaza, Elmsford, N.Y. 10523. In Canada, H. Roy Gray Ltd., Markham, Ont.

ma

Micro-Acoustics

"Because good tracking isn't enough."

© 1977, Micro Acoustics Corporation.

sides, or Mahler symphonies or complete musical shows. And yet all of the present LP flexibility and variety is preserved and all present LP material can be reissued, disc for disc (one sided) or 2 for one (double sided) for playing in the new format. Whole shelves of your present LP items will file away, record for record, in a small cardboard box.

How about sound quality, for this super-miniaturization? You should not be surprised. Yet Philips is cagey. The specs for the Compact Disc are not quite up to top professional standards — that is, digital standards. Philips is thinking consumer. Most professional digital tape now uses a 16-bit coding, for the ultimate in "headroom." Philips has made a mild cut back, from 16-bit to 14-bit coding. This allows for a system useable in the very lowest, cheapest popular equipment on a mass basis. But is it a serious compromise from the audio viewpoint?

Well, not exactly. Merely from the astronomical to the semi-astronomical. As we are aware, the digital system does not "read" noise of the all-too-familiar analog sort, on either disc or tape. To be sure, S/N in the Compact Disc system is not quite up to professional digital tape. Instead of an incredible 90 dB down for the noise level, it is reduced to a mere 85 dB.

Please note that the very best an LP can do, in theory, is around 60 dB signal to noise, and we'll say nothing about the average disc. And look at the S/N specs for your hi-fi circuitry, where the noise is purely electronic. This little disc matches the fanciest. Its available dynamic range, to match is also 85 dB — check that against cassette and LP.

Stereo separation? Because the two stereo channels are read out in separate digital "words" the separation is, well, not quite infinite. The finest stereo cartridges edge up towards a 40-dB channel separation and anything in the mid-30s is very OK for the better models. The Compact Disc figure: 80 dB.

Need I say more about audio quality? It is sensational, and that is that. And yet still, in the end, this disc is potentially inexpensive enough to go into the cheapest of popular mini-players. It has that potential, like its cassette sibling.

Subtitles?

The prototype reproducer unit looks like a miniature LP player, around 8-in. wide and maybe 3-in. high. The entire laser-beam pickup system and all its (chip) electronics are housed in the bottom of this little box; there is nothing else. It can be built into a small

"portable" system just as easily as the cassette. Or plugged into the fanciest hi-fi set-up. There is a "fast forward and reverse," so to speak, and you can start anywhere (they say) though the first demo left a lot to be desired in this respect, most of the music fading in after the beginning. (You can't do that to Beethoven!) Temporary, if a problem at all. There's a visual readout, centimeters or something and — very neat — you can indeed encode a printed message right in the recording which will appear at the right moment. Titles and such. (And let's hope it's not an ad.) How long they didn't say. I suspect that the String Quartet No. 29 in A Major, Opus 371 No. 2, "Springtime" by Karl Ditters von Dittersdorf will appear simply as DIT. Strictly telegraphese. Visible message or not, the little disc spins merrily and visibly under the top cover, and you can put it on and take it off like any LP via a slightly larger center hole. Or play automatic.

The record is really unflappable. Those billions of tiny pits are imprinted and sealed below a transparent layer of protective plastic, reflecting the laser beam via a metallic coating. The laser tracks without physical contact via the now familiar lightwave feedback circuitry, correcting itself for both vertical and sidewise irregularities in the record. There is the usual coding redundancy to correct for any errors or drop-outs in the digital signal. Since it is sharply focused by a tiny lens, the laser reads only the pits and "sees" surface scratches and dust only as a blur, completely ignoring same. Short of maybe chocolate sauce or a splatter of paint, nothing is going to bother this system and the record will not ever "wear" until the plastic collapses. Or the dog chews it up. Whether it will play upside down, I do not know — we weren't allowed to touch.

Oh, yes — WHEN? Keep cool. Philips, ever the radical conservative, says "early 1980s" and expects the good old LP to last another 10 years before the Compact Disc drives it out. No rush. Philips can wait. It has theumph.

Meanwhile there are the vital circuit chips — not yet in being. At the demo they had to use a two-foot pile of ordinary macro-electronics. And there are a few minor (!) competitive problems coming up, like patents, licenses, whole rival systems. Again, Philips is tough and unhurried. Negotiations will proceed. Power will be applied. It's a good disc though. And I do hope Philips will carry its big stick and talk very softly, until it persuades our market and the world's. Better than bulldozing, any time. ▲

Introducing TDK metal. The Music Mirror.



The era of metal particle tape has arrived. Metal-ready cassette decks are already in the stores, and more are on their way. There are also a number of metal cassettes on the market, and all of them have a high coercivity and remanence — their magnetic energy is roughly four times that of the best oxide tapes. But that does not mean that all metal cassettes are alike. Not by a long shot.

TDK's metal cassette, MA-R, looks, feels and performs like no other cassette. That's why we call it "The Music Mirror." We've used advanced manufacturing technology to solve the problems inherent in metal tape. If left untreated, metal particles oxidize upon contact with water vapor and oxygen in the atmosphere — they actually "rust." TDK has developed a unique way to coat each and every particle with a process that protects them from the atmosphere, even at the critical exposed edge of the tape. The result is a tape that is resistant to oxidation. In fact, the overall stability of MA-R is well within the limits that have been set for conventional cassettes. But superior tape is only

part of MA-R's story. TDK's new Reference Standard Mechanism is so revolutionary in design and performance, that its influence will be felt for years to come.

For starters, there's the one-piece, die-cast metal main-frame. Metal is far more resistant to warpage than plastic, and unibody construction eliminates performance differences between the A and B sides. The frame and mechanism are sandwiched between two clear covers held in place by six computer-torqued, double-threaded locking screws that will not slip because of vibration.

MA-R's amazing mechanism is visible for all to see, thanks to a transparent slip sheet. Our unique double hub-clamp is an integral part of a strong and circular tape storage system. (MA-R's two clamps are color-coded red and black, as a visual reference).

Our newly-designed, seamless, water-wheel-type rollers rotate around stainless steel pins, which are micro-polished for circularity. Our new dual-spring pressure pad assembly allows for more flexibility, yet provides more hor-

izontal support for uniform tape to head contact. MA-R even includes removable, replaceable erase-prevention lugs, a new standard in protection and flexibility.

Ask your TDK dealer to show you the new MA-R cassette. Hold it in your hands and feel its weight. Look at the ingenuity and precision of the shell and mechanism. Then listen to it perform in one of the new metal decks. All your senses will tell you that this isn't just another new cassette — it's one of the memorable audio products of our time. TDK Electronics Corp., Garden City, N. Y. 11530.

© 1979 TDK Electronics Corp.



TDK.MA-R

The machine for your machine.

Enter No. 42 on Reader Service Card

The forum

Polarity Convention

In keeping with the spirit of the audio Rosetta Stone [1], I propose that from this point forward the entire audio industry take a basic step which is capable of improving the quality of the listening experience from the present and future product without adding any cost to that product. I propose that the polarity convention of every part of the audio chain be identified and this information made available to establish the net polarity of the reproduced sound relative to the original performance. In those cases where the original performance does not arise as an acoustic sound field, such as computer or synthesized signals, and in which the performer or composer considers polarity to be artistically important, I suggest that the score or software include this information.

In natural sounds there is a definite physical relationship between sound pressure and the mechanical displacement of air molecules which gave rise to that pressure. There is also a definite physical relationship between the pressure wave impinging on a boundary and the resultant sound pressure wave reflected from that boundary, as well as the seismic or acoustic wave which continues past the boundary. For several decades there has been evidence that the human perception of sound includes this relationship as a subtle cue. The subtlety of this effect has, until quite recently, been more than masked by other aberrations in the recording and reproduction of sound. But, with the constant improvement in audio systems, we have now reached the state where many persons can readily perceive the coloration caused by improper polarity in the reproduced sound. We must now recognize this and set our house in order.

Accountability of polarity should include, but not be limited to:

- Groove wall direction of displacement for positive sound pressure increase at the microphone for all phonograph records, including those of the direct-to-disc type.
- FM transmitter direction of carrier deviation and of stereo multiplexing for positive sound pressure increase at

tion relative to voltage or current applied at the reproducer terminals.

In the great majority of cases, a record producer, particularly those producing direct-to-disc records, has maintained a *de facto* convention for their own product. Measuring this convention and supplying the information on the record jacket of new releases can allow us to adjust the polarity of speaker leads for increased accuracy from those records which we now own from those companies, as well as the record so marked.

There is truly no aspect of the audio industry that lies apart from this first step into providing information relating to better sound. Sound reinforcement in the performing arts should be included, as well as in motion pictures and television. At

this time I am asking for a book-keeping tally which we can use to gain a small but important increase in the enjoyment of sound from the existing product. If portions of the audio industry enter into the spirit of this self analysis, I suspect that we will begin an inexorable move to improve the end product. I see no way in which this can hurt the industry, and there are many obvious benefits that can come from cleaning up our act. Eventually it must lead to industry standardization.

In those circumstances where it is not easy to quantify polarity or phase as a function of frequency, I suggest that recourse be made to a simple audio Rosetta Stone. A handclap can establish gross polarity through quite complicated networks. It can also reveal those all-too-frequent cases where a magnetic tape playback is out of phase with the line feed into the recorder. If such a signal, either electronically generated or produced by physical means, is included on a leader, tapes shared by various broadcast

the microphone for all live broadcasts, and for groove wall direction of displacement and magnetic tape flux change for reproduced program material.

- FM receiver demodulated polarity of output voltage for upward carrier deviation of the received signal and for demultiplexed signals.

- Phonograph cartridge voltage polarity as related to direction of groove wall displacement.

- All electronic equipment polarity convention, whether inverting or non-inverting between input and output, for all combinations of terminals and control switching which a user may utilize in normal operation.

- Polarity convention for individual microphones relating increase of sound pressure (or increase of particle velocity) to direction of voltage or current for which the microphone is designed.

- Sound reproducer polarity of sound pressure at the listener's loca-



BEFORE YOU THROW OUT A GOOD TURNTABLE OR SPEAKER SYSTEM, CONNECT WITH A GREAT AMPLIFIER. THE PHASE 400 SERIES TWO.

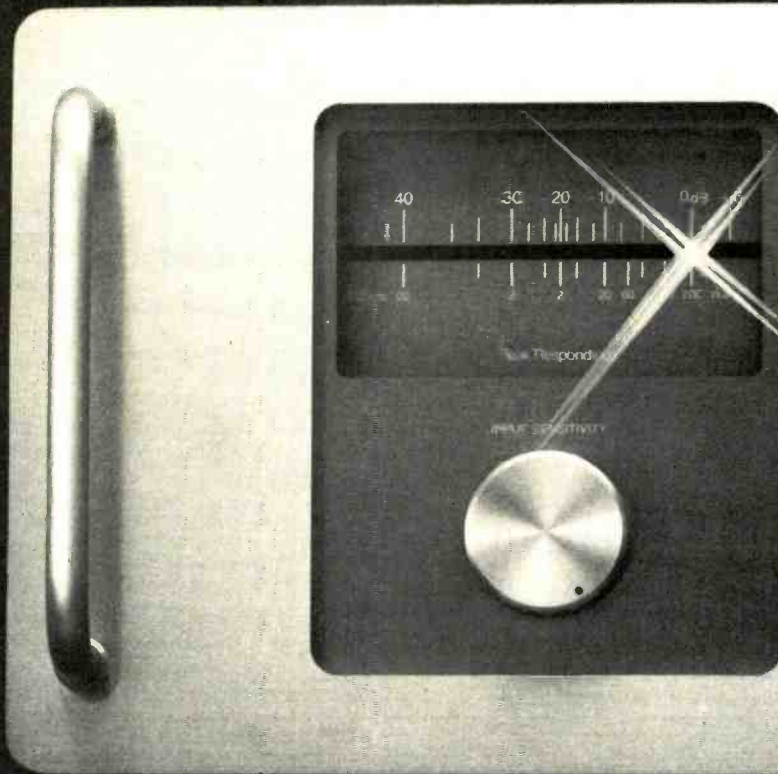

Phase Linear

Model 400 Series Two
Audio Standard Amplifier

Some speakers sound fine, until you hit a low passage. Then they turn to mud, or rumble at you like a cheap turntable. Chances are, that muddy, distorted sound is in fact, the result of an inadequate amplifier stretched to its limits. Clipping!

To improve your sound, you need plenty of reserve power. The Phase 400 Series Two delivers the tremendous power reserve you need for sonic accuracy over the audible frequency spectrum. To accurately reproduce low frequencies without clipping, your speakers require up to 10 times the minimum power requirement of the mid-range frequencies. With the Phase 400 Series Two, when you listen to the 1812 Overture, you hear the blast of the cannon with awesome clarity. Even the deepest notes are clearly distinguishable.

ACCURACY YOU CAN HEAR

To improve accuracy, the new 400 Series Two utilizes an advanced BI-FET input stage. This integrated

circuit keeps the output virtually identical to the input. Distortion and noise are reduced to virtually inaudible levels. Beautiful music in, beautiful music out.

ACCURACY YOU CAN SEE

You might have some questions about the 400's instantaneous LED output meters. Conventional-style VU meters are slow in comparison because they have to move the mass of the needle. The LED's

move at lightning speed, accurately monitoring the output voltage, with scales for 8 and 4-ohm impedances. For accuracy, the meter contains 32 graduations, plus 4 fixed flashers to alert you to clipping. You have a visual safeguard, in addition to the Electronic Energy Limiters to prevent damage from overloads.

See your Phase dealer about the Phase 400 Series Two. We think you'll recognize accuracy when you hear it. And when you see it.

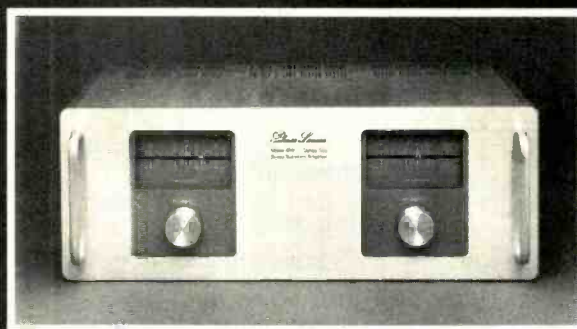

SPECIFICATIONS: OUTPUT POWER: 210 WATTS, MIN RMS PER CHANNEL 20Hz-20kHz INTO 8 OHMS, WITH NO MORE THAN 0.09% TOTAL HARMONIC DISTORTION. Continuous power per channel at 1000Hz with no more than 0.09% total harmonic distortion 8 ohms—260 watts, 4 ohms—360 watts, Inter-modulation Distortion: 0.09% Max (60Hz: 7kHz—4:1), Damping Factor: 1000; Residual Noise: 120uV (IHF "A"), 1 Min, Signal to Noise Ratio: 110dB (IHF "A"), Weight: 35 lbs. (16 kgs.), Dimension: 19"x7"x10" (48.3cm x 17.8cm x 25.4cm). Optional Accessories: Solid Oak or Walnut side panels.

Phase Linear
THE POWERFUL DIFFERENCE

PHASE LINEAR CORPORATION, 20121 48TH AVENUE WEST, LYNNWOOD, WASHINGTON 98036
MADE IN USA. DISTRIBUTED IN CANADA BY H. ROY GRAY LTD. AND IN AUSTRALIA BY MEGASOUND PTY. LTD.

Enter No. 29 on Reader Service Card

agencies, possibly subjected to indeterminate rerecordings, can be readily verified for polarity. While not normally intended for broadcast, such signals could be transmitted for listener verification and setup, much as Dolby tones are now transmitted prior to playback of encoded programs.

Aware of the distinct audibility of polarity, and, in my own experiments, the limited audibility of phase shifts other than zero or 180°, I have, since 1974, measured and provided a standard for the phase reference of loudspeaker reproduction, the so-called absolute phase. Every loudspeaker which reviews in these pages has its absolute phase identified in the continuum of angles from in-

phase through phase reversal as a function of frequency. I suggest that this voltage-to-listener position sound-pressure convention be adopted for polarity determination of loudspeaker reproduction, taking into account phase shift as a function of frequency, as we do in our *Audio* reviews.

Leaders in the audio field, such as Hansen and Madsen [2], have pointed out the audible difference caused by improper polarity, and recently Moncrieff [3] has taken the important step of alerting a segment of the listening public to this effect and has identified a number of amplifiers which invert signal polarity. I now publicly call upon the entire audio industry, from

computer composer through loudspeaker and headphone manufacturer, to acknowledge polarity as a psychoacoustic parameter and identify either the polarity or phase convention of their product.

Richard C. Heyser
Senior Editor
Audio Magazine

References

1. R.C. Heyser, "Acoustic Rosetta Stone," *Audio*, Jan., 1979, p. 66.
2. V. Hansen and E.R. Madsen, "On Aural Phase Detection," *J. Audio Eng. Soc.*, Vol. 22, p. 10 (Part I) and p. 783 (Part II), Jan. & Dec., Nos. 1 & 10.
3. J.P. Moncrieff, "Phase Inversion," *Int. Audio Review*, No. 4 (1978).

Omitted Factors in Audio Design

I want to share with you some thoughts on and data affecting the current state of audio design, some of which appeared in the IEEE TIM Conference Proceedings, Tulsa, 1978.

Given the resources and talent invested in audio design today, it seems to me that products should have emerged that would be entirely sonically acceptable until a radically new technology offers advantages currently impossible with present design techniques. The reason this has not happened is, I think, because designers have not yet considered all of the factors necessary to a successful design. I would like to discuss some of these factors and attempt to show what must be done in the future to more completely define the audio design process. I have divided audio design factors into three major areas:

1. Standard specifications;
2. New distortion measurement methods, and
3. "X" factors, ones relating to the incompletely understood hearing process or psychoacoustics.

Standard specifications have been with us for many years. They are found listed in typical sales brochures and are often the major criteria the consumer uses to select the product. Some examples are frequency response, harmonic and IM distortion, maximum output power or voltage, damping factor, wow and flutter, Each of these is important, but often other factors are disregarded to make them as impressive as possible. Usually these specifications are so excellent that it is difficult to understand how further improvement could possibly be audible under any circumstance.

New distortion measurement methods have been developed in recent years to help the designer further op-

imize a design. Some of these measurements are:

1. TIM or SID (transient intermodulation distortion, slew induced distortion),
2. IIM (interface intermodulation distortion),
3. ED (envelope distortion),
4. Distortion related to the input impedance of the phono preamplifier, and
5. Resonance problems related to phono turntable, tonearm, and cartridge.

TIM or SID distortion is related to the slew rate of a particular amplifier circuit. It has been brought to the attention of audio designers through the research of Dr. Matti Ojala of Finland, and the recent series in *Audio* by Jung, Stephens, and Todd focused on this type of distortion. It is essentially the measure of the ability of an amplifier to respond to a rapid change in amplitude of the input signal. A good many designers currently feel that a slew rate of 50 V/ μ S in a 100-watt power amplifier and 5 V/ μ S in a phono preamp is necessary to pass all possible inputs without TIM or SID [1].

IIM, discussed for the first time only a year ago [2], is essentially related to the interaction between the amplifier and the loudspeaker. The theory states that under some circumstances, negative feedback can reduce the performance of an amplifier when driving a real loudspeaker as a load. This discussion also covers some of the virtues of the triode vacuum tube as opposed to the pentode in power amplifiers, as well as some of the problems with bass performance in some vacuum-tube circuits.

ED, recently discussed by two engineers from Sansui (3), is related to the interaction of the various stages of an amplifier (or sometimes between

channels), which can be very significant with changing amplitude levels. They developed a test signal which more closely simulates actual musical signals than do continuous tones for the testing of power amplifiers. The results confirm the knowledge of many designers that power supply regulation is quite important in a quality design.

Input-Impedance Distortion related to the phono input stage has been discussed recently by Yamaha (4), who say that this is essentially undetected by conventional test measurements. Essentially, they say that we must test a circuit with realistic input impedances, which can be greater than 10,000 ohms, to give a realistic assessment of the distortion contribution of the input stage.

Phono System Resonances and related problems are now receiving more attention in various circles. While not directly related to electronic design, this is nonetheless an important area where work can be done to improve high-fidelity reproduction. Much thought is going into the new cartridge designs, particularly in the cantilevers, into tonearms and their mountings, into bases and suspensions, and into platter mats. This last was the subject of articles by Stockton in the June, 1979, issue of *Audio* and by Jean Hiraga in the April, 1978, issue of the British publication *Hi-Fi News and Record Review*. An understanding of these distortions, even though measurement techniques have not yet been standardized, gives designers significantly greater insight into the design of circuitry which will be successful. However, one further area remains, one which is important to a successful design and involves factors yet to be measured in any comprehensive manner or understood fully. This area is the subjective response of an

**Super-Dome[™]
high
performance
tweeter
to match
a high
performance
speaker
system.**

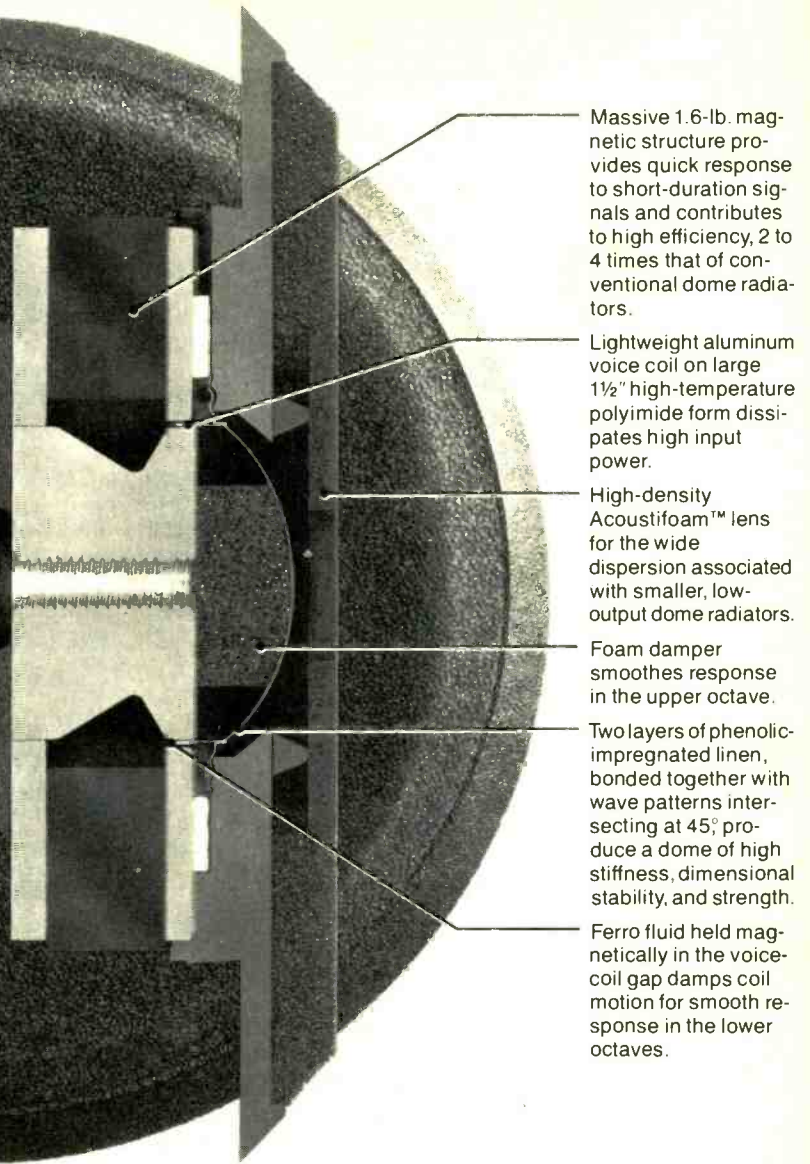

- Massive 1.6-lb. magnetic structure provides quick response to short-duration signals and contributes to high efficiency, 2 to 4 times that of conventional dome radiators.
- Lightweight aluminum voice coil on large 1½" high-temperature polyimide form dissipates high input power.
- High-density Acoustifoam[™] lens for the wide dispersion associated with smaller, low-output dome radiators.
- Foam damper smoothes response in the upper octave.
- Two layers of phenolic-impregnated linen, bonded together with wave patterns intersecting at 45°, produce a dome of high stiffness, dimensional stability, and strength.
- Ferro fluid held magnetically in the voice-coil gap damps coil motion for smooth response in the lower octaves.

The Super-Dome[™] tweeter in the new generation of Interface speakers represents an extraordinary development in speaker design. Electro-Voice engineers have developed the first high-performance tweeter capable of matching the high efficiency and extended bass response found in our optimally vented, computer designed Interface: A. Super-Dome has the sonic excellence normally associated with a dome tweeter and the efficiency heretofore found only in cone tweeters – two to four times that found in a standard dome. Plus, its voice coil will withstand a full 25 watts power input long term. That's *five times* the power handling capacity of other standard dome or cone tweeters.

While the angle of dispersion narrows at high frequencies with conventional tweeters, the high-density Acoustifoam[™] lens in Super-Dome helps keep dispersion constant in the upper octaves. Acoustically transparent at lower tweeter frequencies, the lens becomes opaque at higher frequencies, reducing the effective diameter of the radiating surface, thus increasing the angle of dispersion.



Interface: A Series III

Enter No. 12 on Reader Service Card

The result is the wide, uniform high-frequency dispersion necessary for precise localization of sound, both lateral and front-to-back.

Super-Dome is found in six of seven speakers in the new third-generation Interface line. No matter which model you decide to buy, you are assured of outstanding performance and model-to-model sonic integrity. Our goal remains the same as it was in 1973 when we introduced the first Interface speaker – to offer you a speaker that sounds like music.

EV **Electro-Voice[®]**
a gulton company
600 Cecil Street, Buchanan, Michigan 49107

interface[®]

experienced individual to a design, and I call this "X" factor. Efforts to bring these "X" factors into a coherent scheme are being made by Richard Heyser [6] and by Michael Gerzon [7] of Oxford University, as well as several others, who are attempting to more accurately characterize the listening process in mathematical terms. Just how these things relate to major measurement areas 1 and 2 is not clear, but it is important that a designer take all three areas into consideration, as a lack of attention to any one of them can make an otherwise good design less than successful in the final analysis.

Out-of-Band Signals

I would like now to turn to some work I have been doing on phono cartridge measurements and how some unexpected data affects designs.

SMPTÉ intermodulation and harmonic distortion measurements utilizing a 20 Hz to 20 KHz bandwidth, even using commercial test equipment with a resolution of 0.001 percent, do not fully predict the sonic characteristics of audio amplifiers because, I feel, of

their lack of consideration of the sub-sonic and supersonic components of the actual signals and how they affect the signal as it is finally audible. One of the major assumptions of TIM theory has been the existence of sufficient supersonic information to provoke this form of distortion [1, 8]. Critics of the TIM concept usually rely on linear assumptions of what should be possible from conventional sources such as musical instruments, disc cutting systems, and phono cartridges [9]. However, linear assumptions do not fully predict the actual measurements of many phono cartridges, particularly the moving-coil types.

I would like therefore to present the results of measurements of the supersonic component of the spectrum of several phono cartridges in an effort to ascertain the magnitude of this spectrum portion as well as its subsequent effect on later stages. [10]. For this research, a Tektronix 7L5 spectrum analyzer was used to detect information to 200 kHz, and it was found that certain moving-coil cartridges have significant output even at 160 kHz. While the absolute level of the individual

spectra decreases with frequency, the overall envelope of the spectrum closely simulates the TIM (30,30) waveform (see Fig. 1). (Editor's Note: These graphs were reduced from 'scope photos.)

There are notable deviations from "worst case," as shown by the spectra of the moving-magnet cartridges. Here, the low mechanical resonance (20 kHz) and high series inductance (720 mH), together with the recommended termination capacitance (400 pF), significantly filter the spectrum above 40 kHz (see Figs. 2 and 3). This filtering effect contrasts with the output of the Denon 103S, with its Shibata stylus, and the GAS Sleeping Beauty (conical stylus), both of which are moving-coil types and have significant energy to 160 kHz (see Figs. 4 and 5). A comparison between square-wave rise time and sine-wave mistracking implies that in many cases cartridge mistracking is a major factor in creating "worst case" dv/dt (see Figs. 6 and 7).

Virtually all difficult material from records, such as cymbal crashes, brass ensembles, and special effects, contributes significant output to the

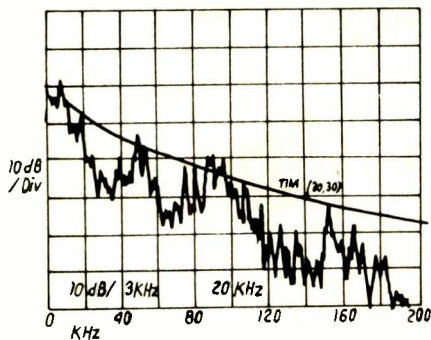

Fig. 1—TIM (30,30) spectrum superimposed on the spectrum of a cymbal crash from the GAS moving-coil cartridge playing *The Perfect Song*, Sheffield Vol. 3, Lab 1.

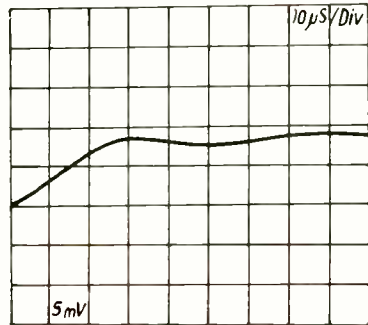

Fig. 3—The rise time of the Shure M91ED playing a 1kHz square wave from the CBS STR-112 test record.

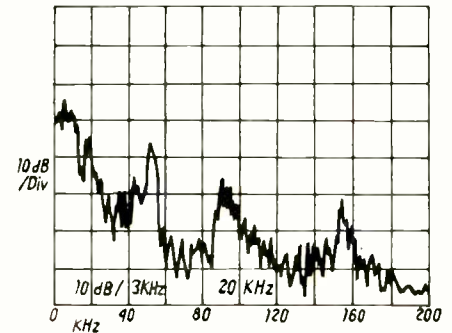

Fig. 5—The GAS cartridge with conical stylus, playing the same cymbal crash as in Fig. 1.

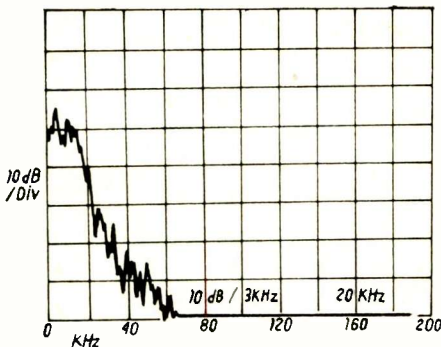

Fig. 2—The spectrum of a Shure M91ED moving-magnet cartridge playing a cymbal crash; same source as in Fig. 1.

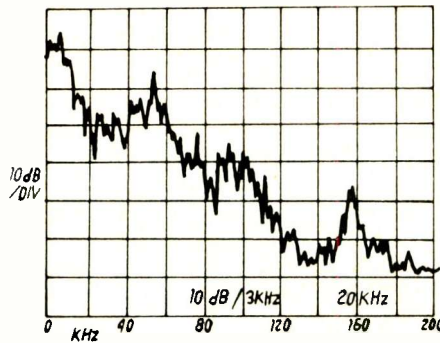

Fig. 4—The spectrum of the Denon 103S moving-coil cartridge playing the same cymbal crash as in Fig. 1.

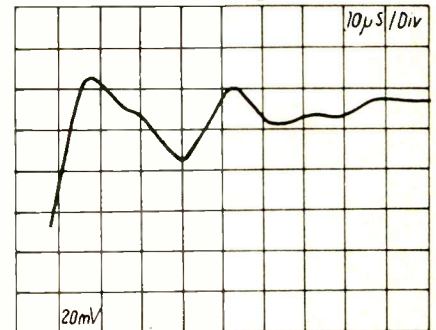

Fig. 6—Rise time of the Ortofon MC20 moving-coil cartridge playing the 1-kHz square wave on the CBS STR-112 test record.



An acknowledged world leader in loudspeaker design and engineering, KEF has developed a monitor-standard speaker system that is both small — only ¼-cubic foot in size—and truly “high” fidelity. While these objectives are not new, the Reference Series Model 101 speaker system represents the first time that both are available in one product.

The Model 101 is, therefore, ideal for use in locations where an accurate small speaker is required in keeping with the rest of a high quality audio system.

System Design

Despite all the ingenious ideas that have been proposed by various speaker manufacturers over the years, the three basic parameters of Enclosure Volume, Bass Response and Efficiency are still related by unchanged physical laws. What is different is the thorough manner in which KEF engineers have, with the use of advanced technology, optimized the relationships between these parameters.

Starting with the premise that prospective Model 101 users will have substantial amplification available, KEF engineers achieved a response from this small enclosure of 90Hz–30kHz ±2dB (–10dB at 47Hz).

KEF's leadership in computer-aided digital analysis techniques enabled them to optimize the design of the drivers, crossover network and enclosure to achieve a Target Acoustic Response without repetitious trial and error experimentation. Much of this technology, which did not previously exist, has been applied to the design and production of a small high fidelity speaker system for the first time in the Model 101.

Once the desired prototype was completed, KEF applied the same unique computer-aided techniques developed for the production of the critically acclaimed Model 105, so that the sound quality originally achieved in the laboratory prototype will be available to every user.

In addition, the high standards of the computer-aided production and assembly procedures enable precision-matched pairs of stereo loudspeakers to now be offered. For example: every Model 101 driver is tested and matched to tolerances of better than 0.5dB, and crossover networks to tolerances of 0.1dB; each pair of drive units is matched not only to each other, but to the other components in the system as well.

Loudspeaker Protection

The major problem with small, relatively less efficient loudspeakers is thermal overloading of the voice coils. KEF engineers have developed a unique self-powered electronic overload protection circuit, S-STOP (Steady State and Transient Overload Protector).

Musical peaks are generally of short duration, so tweeters can handle far in excess of their normal program rating. A similar situation exists with low frequencies and their effect on the bass unit. Consequently any form of fuse protection can reasonably limit the instantaneous peak handling ability of the system, yet fail to protect the system against a very high average power level. KEF's solution is to incorporate a protection circuit which takes into account the instantaneous power applied to each drive unit and also computes the length of time the signal is applied. The law under which it operates resembles very closely the temperature rise within the voice coil. A potentially damaging signal is immediately attenuated by about 30dB, and the full signal is automatically reconnected when it is safe to do so.

As a result, the Model 101, although only ¼-cubic foot in size, is fully protected against fault conditions when used with amplifiers of up to 100 watts per channel.

The Model 101 is obviously not your average “miniature” speaker system where the quality of sound or power handling capacity is compromised by the small size of the enclosure. Nor is it inexpensive. If you require a speaker system that

is both small and truly high fidelity, visit your authorized KEF dealer for a thorough demonstration. For his name, write: KEF Electronics, Ltd., c/o Intratec, P.O. Box 17414, Dulles International Airport, Washington, DC 20041.



KEF Reference Series Model 101:

Accurate, Small, Protected.

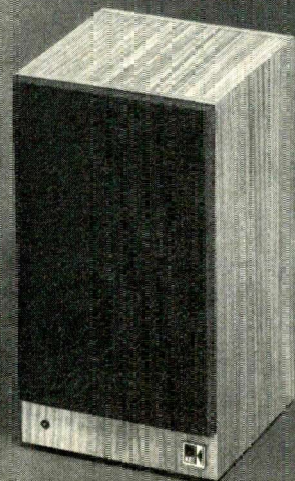

Enter No. 18 on Reader Service Card

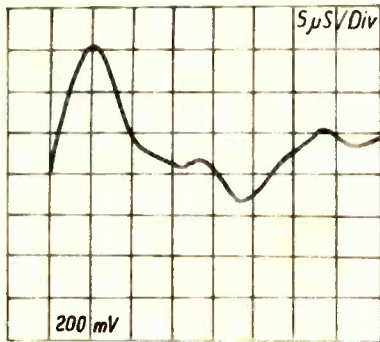

Fig. 7—The rise time of the Ortofon MC20 mistracking a 1 kHz sine wave on the B&K 2010 test record

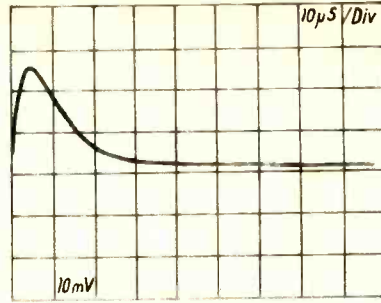

Fig. 8—The TIM (30,30) waveform, without 15 kHz. This is composed of a 3.18-kHz square wave and a 15-kHz sine wave with a peak-to-peak amplitude ratio of 4:1. It is filtered by a single-pole filter at 30 kHz (-3 dB), then inverse-RIAA equalized by a passive network, and further filtered by a second single-pole, 30-kHz filter.

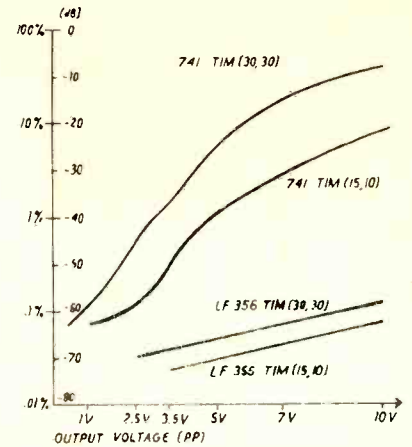

Fig. 9—Peak-to-peak output voltage vs. TIM (30,30) and TIM (15-10) distortion for 741 and LF 356 op amps.

supersonic spectrum. Applying the TIM (30, 30) waveform (see Fig. 8) to a phono preamplifier using a UA741 op amp with a slew rate of 0.6 V/μS showed measureable distortion, even at moderate levels. Other IC op amps with higher slew rates and greater gain-bandwidth products showed essentially unmeasureable distortion in the same circuit at moderate levels (see Fig. 9).

Other Distortion Sources

Besides the distortion created by slew-rate difficulties, non-linear elements, such as ceramic capacitors, can create distortion if used as low-pass filters or lead networks. In many instances, conventional 20 Hz to 20 kHz measurements fail to assess the actual distortion because at the usual audio frequencies, the capacitors are usually sufficiently decoupled. However, with increased spectral bandwidth, such as might be energized with some of the cartridges discussed above, the distortion from these capacitors can dominate an other-

Table I—SMPTE IM distortion of a low-pass filter using a ceramic capacitor.

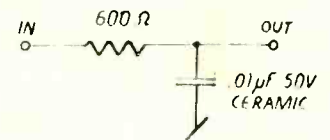

f (-3dB) = 25 kHz	
Volts (rms)	SMPTE IM
15V	0.12%
10V	0.082%
3V	0.028%
1V	0.008%
0.5V	0.003%
residual	0.001%

wise low-distortion design (see Table I).

The last generally neglected factor I would like to discuss is the spurious subsonic information created by record warps and by tonearm-cartridge mechanical resonances. This has been well documented by other sources [11, 12]

Table II—Harmonic distortion of a tantalum capacitor used as a high-pass filter.

Freq., Hz	Single Cap.		Paralleled Caps.	
	V rms	% dist.	V rms	% dist.
1k	0.155		0.08	
500	0.31	0.0065	0.16	
300	0.51	0.016	0.27	
200	0.75	0.038	0.4	0.003
100	1.4	0.125	0.78	0.009
50	2.2	0.32	1.44	0.035
30	2.6	0.53	2.0	0.06
20	3.0	0.7	2.5	0.12
10	3.2	1.0	3.0	0.26

One consequence of this subsonic information is the distortion caused by electrolytic capacitors when coupling between stages with zero d.c. potential across the terminals. Back-to-back coupling or nonpolar tantalums will reduce this distortion, but will not eliminate it completely. One effective compromise is to place two tantalum capacitors side by side in reverse phase. This doubles the capacitance while effecting a first-order cancellation of the distortion in the capacitors. (see Table II).

I hope, then, that some of this data will be useful to other designers, as I have found it a too common assumption that only those signals and distortions within the 20 Hz to 20 kHz band are worth worrying about. I hope too

that I have shown that conventional audio measurements do not fully characterize the distortion of a particular audio stage in real-life applications and that measurement of supersonic and subsonic spectra should be considered in a full description of actual circuit performance.

John J. Curl
Berkeley, Calif.

References

1. E. Leinonen, M. Ojala & J. Curl, "A Method for Measuring Transient Intermodulation Distortion," *J. Audio Eng. Soc.*, Vol. 25, No. 4, April, 1977, p. 107.
2. M. Ojala & J. Lammasniemi, "Intermodulation Distortion in the Loudspeaker-Amplifier Interface," presented at the 59th Convention of the Audio Eng. Soc., Hamburg, 1978, Preprint No. 1336.
3. S. Takahashi & S. Funada, "Envelope Distortion in Audio Amplifiers," presented at the 60th Convention of the Audio Eng. Soc., Los Angeles, 1978, Preprint No. 1344.
4. "Technical Information," Yamaha C-2 owner's manual.
5. J. Hiraga, "How Turntable Mats Influence Sound Quality" *Hi-Fi News and Record Review*, Vol. 23, No. 4, p. 57, April, 1978.
6. R. C. Heyser, "Perspectives in Audio Analysis: Changing the Frame of Reference, Parts I and II," *J. Audio Eng. Soc.*, Vol. 24, Nos. 8 & 9, pp. 660 & 742, Oct. & Nov., 1976.
7. M. Gerzon, "Mathematics and Sound Perception," *Jour. Audio Eng. Soc.*, Vol. 26, No. 1, p. 46, Jan.-Feb., 1978.
8. M. Ojala & E. Leinonen, "Theory of Transient Intermodulation Distortion," *Trans. Acous., Speech, & Signal Processing*, Vol. ASSP-25, No. 1, Feb., 1977.
9. M. Davis, "Letters to the Editor," *The Audio Critic*, Vol. 1, No. 4, p. 10, Sept., 1977.
10. D. Hadaway, *BAS Speaker*, Vol. 5, p. 13, Feb., 1977.
11. L. Happ & F. Karlov, "Record Warp and System Playback Performance," *Jour. Audio Eng. Soc.*, Vol. 24, No. 8, p. 620, Oct., 1976.
12. T. Holman, "Dynamic Range Requirements of Photograph Preamplifiers," *Audio*, Vol. 62, No. 7, p. 72, July, 1977.



If you don't clean and preserve your records with Sound Guard, you're only scratching the surface.

Have you ever considered what it would cost to replace your record collection at today's prices? With that kind of investment at stake, it's no wonder that many music lovers have become more aware of record care. Regular cleaning of your records is important and necessary, but cleaning alone won't prevent them from wearing out. To protect your investment you need more than cleaning. You need both Sound Guard Cleaner and Sound Guard Preservative.

Sound Guard Record Preservative is a revolutionary dry lubricant which virtually eliminates record wear without affecting the fidelity of the record. And when you drag the hardest

substance found in nature—diamond—through the soft, intricate vinyl canyons of a phonograph record at phenomenal rates of acceleration, it doesn't matter how light you're tracking. Something's got to give, and that's the vinyl. But with a Sound Guard-treated record, even after 100 plays, there is no audible degradation of performance.*

Before and after you preserve your records, be sure to use our superior cleaner to remove the dust and oily films that can further mar

performance. (The cleaner will not remove the preservative's protective coating.)

Sound Guard offers the only complete program of record preservation and maintenance. It requires a little more time and effort than just cleaning. But how much did you say it would cost you to replace your record collection?

Sound Guard. Everything else is a lot of noise.



Sound Guard™

Sound Guard preservative—Sound Guard™ cleaner. Sound Guard™ Total Record Care System. Sound Guard is Ball Corporation's registered trademark. Copyright © Ball Corporation, 1979, Muncie, IN 47302.



*We have the test results to prove it—write us and we'll send them to you

The Watts Parastat

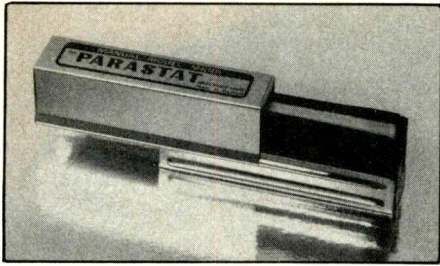

**In 15 seconds
your records are
clean, dry,
and ready to play.**

With some systems you pour liquid on your records (and rub it into the grooves), while with others you brush the dirt around (and rub it into the grooves). The Watts Parastat is neither of these.

By placing a plush velvet pad on either side of a soft nylon brush and adding a drop or two of Parastatik® fluid, a remarkably efficient system is created.

The brush bristles lift the rubbish to the surface. The pads collect and remove it. And the Parastatik® fluid supplies just the right degree of humidity to relax dust collecting static without leaving any kind of film or deposit behind.

No other system does so much for your records in so little time.

So when you want the best, ask for the original. The Parastat, by Cecil Watts.

Cecil & Watts Ltd

Watts products are distributed exclusively in the U.S. by: Empire Scientific Corp., Garden City, NY 11530

Enter No. 46 on Reader Service Card

Herman Burstein

Tape guide

Cassette Deck Pros and Cons

Q. I have had an open-reel tape deck for a number of years. While it has provided good results, it now needs a variety of repairs and replacements, costing an estimated \$200. My question is whether to repair this deck or put the money into a cassette deck of good quality, because I take my hi-fi sound seriously.—C.S. Hoffman, Allentown, Pa.

A. A current high-quality cassette deck will, overall, provide quality of performance about as good or better than that of an older open-reel deck.

The advantages of a tape deck are: Possibly a higher signal-to-noise ratio with Dolby N/R, lightness and portability, and compact storage of recorded material. Additionally, a cassette deck will afford greater ease when loading the tape, since you can reverse the cassette or put in a different cassette in a split second whereas an open-reel deck may cause you to lose precious seconds during a recording session if you become fumble-fingered under pressure.

The disadvantages of a cassette deck are: Less rugged; less headroom in recording (the tape is more likely to be saturated on high frequencies unless you back down on the recording level); less extended treble response (quite possibly not needed or audible); higher wow and flutter (quite possibly not audible); inability to record four mono tracks (quite possibly you don't care to do so), and greater susceptibility to tape dropouts because of the narrower tracks (quite possibly not noticeable because of the high-quality cassette tapes now available).

Most cassette decks do not permit simultaneous record and play. If this feature is important, you can find some cassette decks that provide it, but at a substantially higher cost.

Open-Reel Tape Deck Problems

Q. I have a problem with my open-reel tape deck. The machine slips and wobbles at random. — Ernest Snow, Brooklyn, N.Y.

A. You should carefully clean all the parts contacted by the tape, particularly the pressure roller and the capstan. If, by chance, you have lubricant on

the roller or capstan, this could account for the problem. You might try a back-coated tape; its rough backing should enable the capstan and pressure roller to get a better grip on the tape, resulting in steadier tape motion.

Claims for Bulk Erasers

Q. A manufacturer claims that its bulk eraser is capable of erasing a recorded tape so well that the tape hiss and related noises will be lower than before the tape was used. Is this possible? If so, wouldn't it make sense to use the bulk eraser on tapes before recording? Or does the bulk eraser take away some of the recording qualities of tapes? — Vernon Franklin, APO New York

A. A powerful bulk eraser might bring tape hiss to a level below that of virgin tape. However, I doubt that you would hear the results of this. The principal forms of tape noise are those due to distortion in the bias waveform and to irregularities in the backing and magnetic coating of the tape. Such sources of noise would not be affected by bulk erasure.

While a bulk eraser ordinarily does a better job than an erase head, particularly on heavily saturated tape, usually a good-quality head serves very satisfactorily. In fact, an erase head has the advantage that it can erase one track at a time (or two at a time, depending on the deck in question), whereas a bulk eraser necessarily erases the entire width of the tape.

Some persons have recommended trying the following for the most noise-free recording: Use a bulk eraser to erase the tape and then record, placing a very smooth material (such as teflon or celluloid) between the erase head and the tape to prevent this head from contacting the tape. This is necessary because the erase head may be a source of noise owing to the large amount of bias current flowing through it, and it is this current that powers the head. A

If you have a problem or question on tape recording, write to Mr. Herman Burstein at AUDIO, 401 N. Broad Street, Philadelphia, PA 19108. All letters are answered. Please enclose a stamped, self-addressed envelope.

AUDIO • September 1979

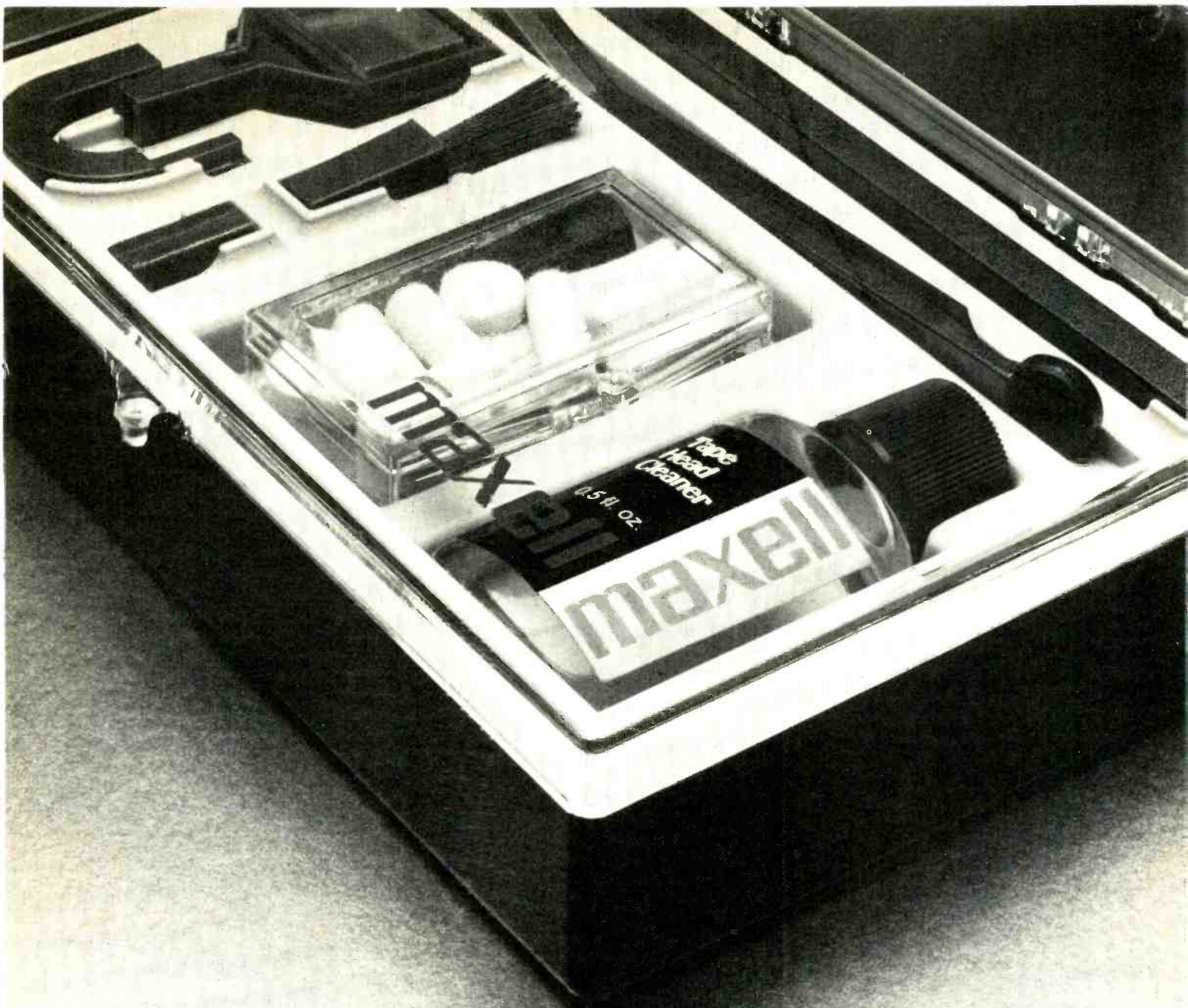

People who aren't using our new tape care kit should have their heads examined.

After every ten hours of recording or twenty hours of play back, you should spend a few minutes cleaning your tape heads.

Because in that period of time enough dust and residue accumulate on your tape heads to significantly affect the sound that comes out of

your tape deck.

So at Maxell, we've developed a tape care kit to help you get the cleanest possible sound out of your recordings.

In addition to liquid head cleaner, it has special curved probes, swabs, a brush and a mirror to help you

keep even areas you can't see spotless. All of which means you'll be getting maximum performance out of your machine. Year after year.

And if that doesn't sound like a good idea, maybe you need to have more than your tape heads examined.

maxell

Enter No. 21 on Reader Service Card

Maxell Corporation of America, 60 Oxford Drive, Moonachie, N.J. 07074

Mitsubishi Pre-empt's the Receiver.

Introducing the docking tuner/preamplifier and amplifier. Exclusively Mitsubishi.

It is not a receiver. It is what receivers try to be.

It is two components. Tuner and preamplifier on one chassis. That docks with our dual monaural power amplifier.

It has The DM Factor.

Dual Monaural construction. Exclusively Mitsubishi.

It means more than mere stereo. It means inside our stereo tuner/preamplifier are two perfectly matched mono preamplifiers. Just like our component preamplifiers. But not like any receiver.

Because it is not a receiver.

It is a tuner with THD in stereo at 0.08%. With signal to noise in stereo at 75dB. With switchable selectivity for uncompromising reception.

With incredible clarity and

definition. Ten violins sound like ten violins, not one big mushy solo.

It is a dual monaural pre-

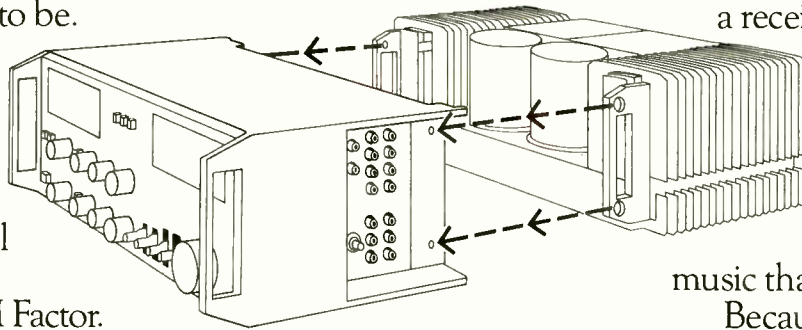

amplifier with interchannel separation at better than 80 dB at 20kHz. Far better than any receiver. With THD at less than 0.002%. For effective elimination of leaks, crosstalk, or any influence able to distort the stereo image.

With the ability to handle the moving coil cartridge. For signal to noise at -77dB (0.1mV input). Previously unheard of in any preamplifier.

It is a tuner/preamplifier that docks with a dual monaural power amplifier. 100 watts or 150 watts. With max RMS output power into 8 ohms from 15Hz to 30kHz.

With THD at no more than 0.05% at rated output.

It is a single, uncluttered unit with the convenience of a receiver. But the integrity

of the exclusive DM Factor. The prime factor in making sure our equipment doesn't fictionalize any

music that it plays.

Because the equipment is Mitsubishi. And Mitsubishi has a standard: what comes out must be as real as everything that went in.

Listen to the most expensive receiver you can. Then hear our DA-C20 dual monaural tuner/preamplifier and self-docking amplifier.

Hear what our standard really sounds like.

And, believe us, it doesn't sound like any receiver in the world.

 **MITSUBISHI**
AUDIO SYSTEMS

For more information write Melco Sales, Inc. Dept. 40, 3030 East Victoria Street, Compton, California 90221.

Enter No. 25 on Reader Service Card



Behind the scenes

Bert Whyte

This year, the annual Los Angeles convention of the Audio Engineering Society was later in May than usual, and the CES in Chicago was earlier in June than usual . . . resulting in overlapping reports which I hope doesn't cause too much confusion. Herewith the second part of the 63rd AES convention report . . . the CES report will follow. I've fairly well covered the digital doings at the 63rd, and while it is all very exciting and glamorous, a tour of the exhibits and demonstration rooms was convincing evidence that the audio industry is still firmly entrenched in the world of analog.

It has become a cliché to report that new mixing consoles were shown by

trolling capstan and reel motors for constant tape tension. The MTR-90 features fast wind modes in which the capstan remains engaged, which is said to produce a very smooth tape pack. Tape speeds are 15 and 30 ips, with wow and flutter at 30 ips of less than 0.03 percent (DIN 45 507) while S/N ratio on the 24-channel version at 30 ips is rated at better than 62 dB. Frequency response at 30 ips is listed as ± 2 dB from 50 Hz to 20 kHz. Remote control is available, as is an auto locator for search and cue. Bias record frequency is a comparatively high 246 kHz, and headroom is rated at +24 dB. Price for the 24-channel MTR-90 is around \$32,000.

inch) and depth, stores the information in a memory, and a servo system executes the commands of the computer-generated motional profile for maximum groove packing density on the record. (This is a very simplistic explanation of a highly complex process.) The system is claimed to be self-analyzing on turn-on for all operational parameters. A display panel shows time elapsed for individual bands as well as cumulative for the entire side, and has an indicator of groove depth and another to indicate pitch. The "Compudisk" system has built-in half-speed cutting ability. The system can be retro-fitted to all older models of Scully and Neumann lathes.

Clay Barclay of Barclay Analytical Systems, Wynnewood, Pa., was justly proud of the first production models of his Badap 1 audio micro-computer. The functions of this unit are myriad and much too complex to fully discuss here. A few of the features are the displays which are multi-colored on a nine-in., single-gun color picture tube. All labels and graticules are synthesized by the computer and, with the standard NTSC color output provided, can thus be also displayed on larger screens including projection types. This also permits videotaping of the display data input. The Badap 1 has many applications, among them, realtime analysis, peak-versus-average mixdown control display, tape-to-disc transfer, tape recorder alignment, and cartridge and tonearm alignment. One of the programs now available is automatic computation of RT/60 reverberation time. In conjunction with this, the unit will perform chromatic spectral analysis, another form of room reverberation measurement, where instead of measuring a single third-octave band at a time, all 31 bands are analyzed simultaneously. The Badap 1 is a most versatile instrument, with many unusual capabilities, and after its long gestation period, it is good to see it reach production status.

Speaking of products a long time aborning, Sansui finally made its entry into the professional audio field with the introduction of their B-1 power amplifier, E-1 disc pre-amplifier, and P-1 parametric equalizer. Sansui took a group of ye audio critics to the West-

AUDIO • September 1979



those specialist firms, which inevitably, at every AES convention, show new mixing consoles. But there they were, new offerings from the likes of Neve, Quad Eight, Automated Processes, Solid State, MCI, etc., in all their awesome complexity. I recently did a mix on a 30-input board (a modest unit these days) and can readily testify that when the Good Lord gave us 10 fingers, He didn't reckon with modern mixing consoles.

Analog tape recorders are very much with us, as witness the latest models from such stalwarts as Ampex, Studer, MCI, etc. New to the professional ranks, however, was the Otari MTR-90, a 16- or 24-channel recorder using standard two-inch tape. This unit does not employ a pinch-roller with its direct-drive capstan, with a phase-locked, closed-loop servo system con-

Computer Cutter

It is always interesting to see new disc-cutting equipment, since it is comparatively rare. The new lightweight Cybersonics disc-cutting lathe, which I reported on at the last Los Angeles AES convention, has now reached the production stage with five systems said to be available. The lathe displayed was fitted with the Ortofon cutter head. The Sontec Company of Cockeysville, Md., attracted a great deal of interest with their new "Compudisk" CD-80 digital lathe control system. Essentially, it is a device for automatic groove pitch and depth control, operating in the digital domain. Using programs of slope analysis and phase analysis, the system uses a high sampling rate to analyze the modulation envelope and computes optimum groove pitch (lines per

Step up to Realistic quality and we'll save you \$310

Now through Sept. 25th we're taking 35% off this audio system. Because we want to be your hi-fi store and we want Realistic to be your hi-fi brand



LAB-250 Turntable. Belt drive. Automatic arm return and shutoff. With base, dust cover, \$24.95-value cartridge. No extras to buy.

STA-95 Receiver. 45 watts/channel, min. RMS, 8 ohms, 20-20,000 Hz, with no more than 0.08% THD.

Two T-100 "Tower" Speakers. Two 8" woofers, 3" tweeter. Finished on all 4 sides in genuine walnut (not vinyl) veneer. 35½" tall.

Reg. Separate Items \$889.80

\$579*

Realistic is Radio Shack design and engineering

The same engineering know-how behind the world's first mass-produced personal computer, the "breakthrough" Radio Shack TRS-80,[™] is behind our Realistic audio line. What other retailer/audio manufacturer can boast technology like that?

Realistic is Radio Shack manufacturing muscle

We own and operate 21 factories in 5 countries, including 17 in the USA. Realistic components are

either manufactured by us or contract-made to our specifications. This helps us keep costs down and quality high.

Realistic is Radio Shack service after the sale

Our warranties are meaningful — service and factory parts are available through our 7300 locations in 40 countries. Over 100 company operated repair centers service only our own brands. Think about that before you buy any audio brand from anybody.

Realistic is Radio Shack value and 59 years of earning your trust

We've been specializing in electronics since 1921 and have earned over 25,000,000 active customers — more than any other electronics chain in the world. We invite you to come in and discover the Quality + Value audio line — Realistic. Sold only at Radio Shack, the Nationwide Supermarket of Sound.[®]

REALISTIC[®] IS

Radio Shack[®]

A DIVISION OF TANDY CORPORATION
FORT WORTH, TEXAS 76102

*Retail prices may vary at individual stores and dealers.

lake studio in Hollywood where the new equipment was demonstrated. The amplifier is a 250-watt-per-channel brute with the rather astonishing specs of a 300 volts-per-microsecond slew rate and rise time of half a microsecond, all, of course, in the interest of minimum TIM. Their special "diamond-differential, direct-coupled" circuit is said to be responsible for these impressive figures. I hope I'm not counted as an "old curmudgeon," but frankly, with my antipathy to screaming rock music and the harsh, "tizzy," peaky sound typical of most studio monitor speakers, which is how the units were demonstrated, honest evaluation was impossible. All the Sansui

equipment looked very professional and imposing, and their human engineering aspects well executed. I expect good things of this equipment when I get a chance to hear it under my own controlled listening conditions.

Speaker Systems

That there is an alternative to the "colored," raucous sound of most studio monitor speakers was amply demonstrated by the ACD John Meyer Studio Standard Reference Monitor. John Meyer is a very bright young engineer, who particularly espouses a purist philosophy in his audio designs. John has designed and built much of the specialized input equipment for the

direct-disc recordings of Crystal Clear Records. He has acted as systems engineer on the direct-disc recordings I made with Virgil Fox, the Boston Pops, and the London Philharmonic Orchestra. John's approach to studio monitor speaker design is of the "no-holds-barred," "no compromise" variety, and the system consists of two speaker cabinets, each 21½ x 15 x 30½ inches, with specially configured horns and 12-in. cone woofers. A separate control unit houses four power amplifiers, electronics crossovers, and amplitude- and phase-correction networks. Each speaker weighs just under 100 pounds. The systems are bi-amplified, and the design is partially a result of research by John at the Institute for High-Fidelity Studies at Montreux, Switzerland. The speakers are, in fact, manufactured in Switzerland. To complete the system, there are the 400 ES subwoofers driven by a special two-channel amplifier. As you have guessed by now, the complete system is on the large side! The monitor speakers alone have a claimed frequency response of ±3 dB from 27 Hz to 18 kHz. A rise and settling time of 500 nanoseconds is claimed to eliminate transient smearing, and the power handling is prodigious . . . a continuous 115 dB with no thermal losses. Below the crossover point of 100 Hz, the subwoofers will put out a staggering 8 acoustic watts continuously! Now if you can imagine that kind of output, with a sound that is neutral and uncolored, with no low frequency "boominess," you'll understand why this system created such a stir of interest with many engineers. Count among those impressed Stan Ricker of the JVC Cutting Center, Dr. Tom Stockham, and yours truly. Unfortunately, such all-out engineering is expensive. The complete ACD John Meyer system will make you \$11,000 poorer. Of course, that includes all the power amps, crossovers, etc. On the other hand, some of our high-end audiophile speakers, with appropriate electronics, are in that same rarefied area. As you can readily understand, speakers like this are unlikely to be on display at your local high fidelity emporium. For information on them, you can contact John at Meyer Sound Laboratories, Inc., 2194 Edison Ave., San Leandro, Calif. 94577. The phone is 415/569-2866.

For some reason, this AES convention had lots of activity in loudspeakers. Bob Fulton's FMI company was attending their first AES and showing the Fulton "Premiere" speaker. This is an evolutionary concept derived from the Fulton "J" series, and it now must be rated one of the most outstanding audiophile speakers on the market.

AUDIO • September 1979

**sweet
sixteen**

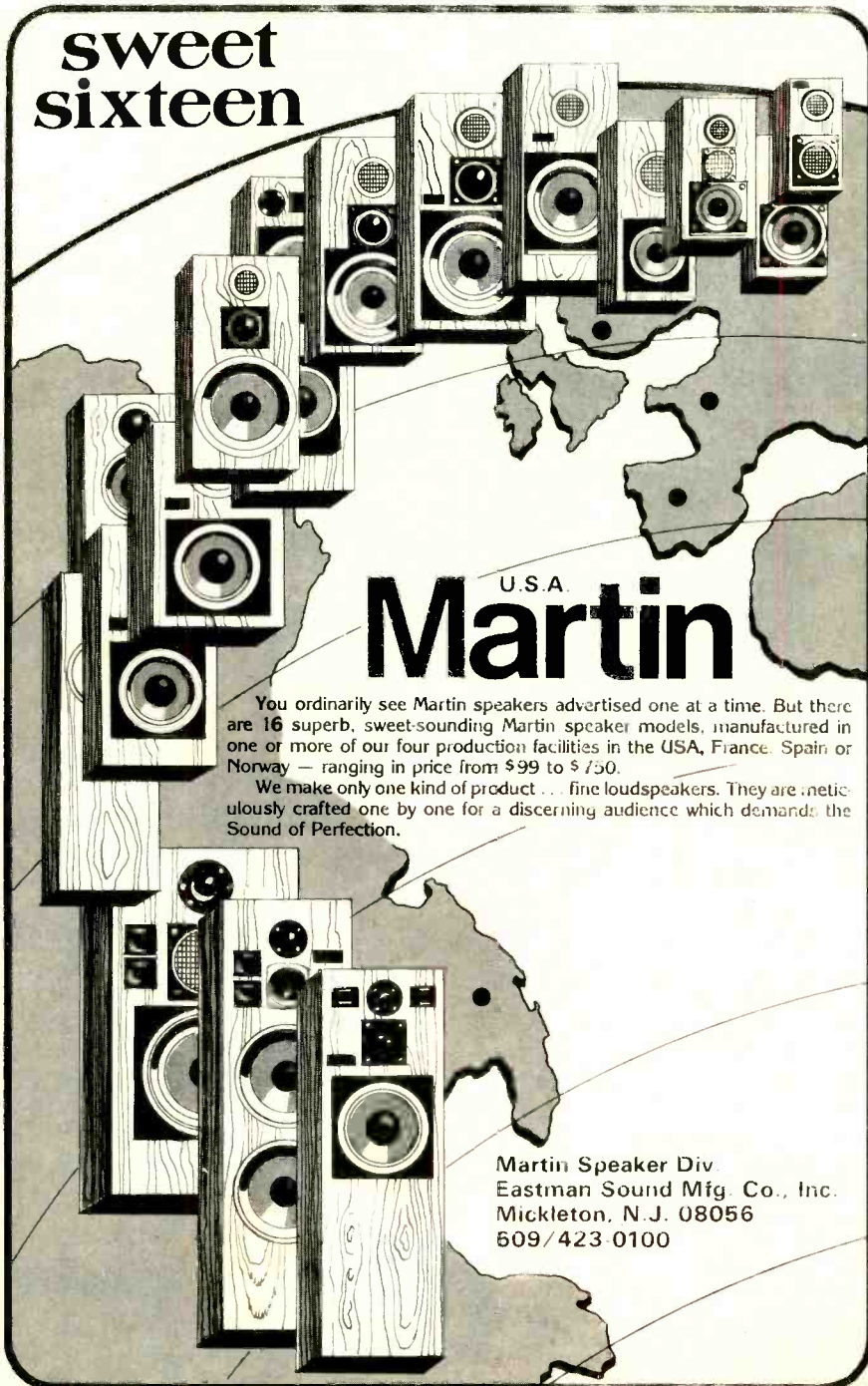

You ordinarily see Martin speakers advertised one at a time. But there are 16 superb, sweet-sounding Martin speaker models, manufactured in one or more of our four production facilities in the USA, France, Spain or Norway — ranging in price from \$99 to \$750.

We make only one kind of product . . . fine loudspeakers. They are meticulously crafted one by one for a discerning audience which demands the Sound of Perfection.

Martin Speaker Div.
Eastman Sound Mfg. Co., Inc.
Mickleton, N.J. 08056
609/423-0100

Restore the impact of "live" ...easy as 1-2-3.

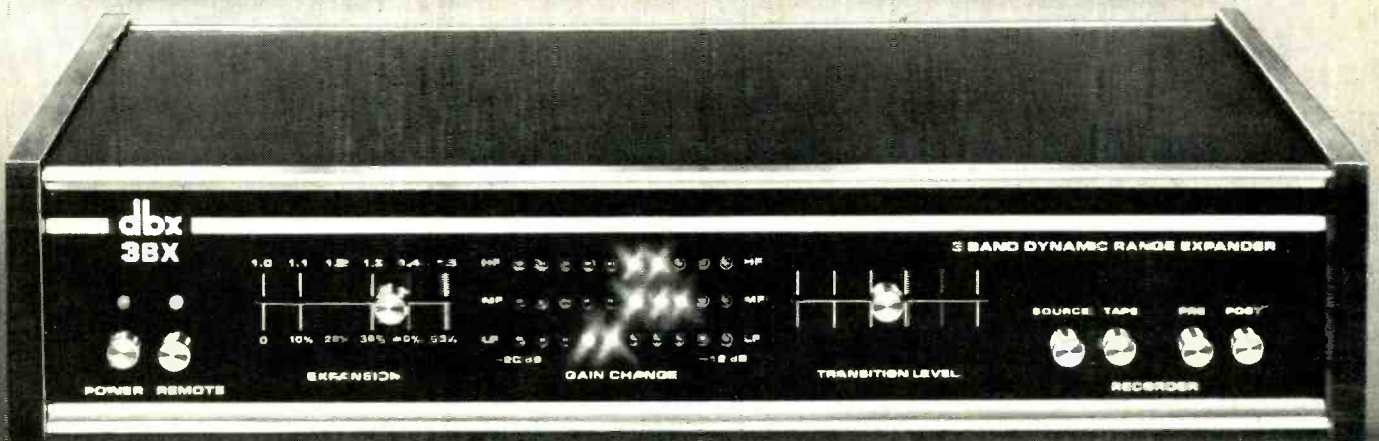

No matter how accurate your stereo system is, it's only as good as the records and tapes you play on it—and they leave much to be desired. The recording process does some terrible things to live music, and one of the worst is robbing it of dynamic range, the key element which gives music its impact.

Fortunately dbx has developed a whole line of linear dynamic range expanders which can restore lost dynamic range.

1BX. The 1BX is the most sophisticated one-band expander on the market. Its RMS level detector incorporates an infrasonic filter to prevent mis-tracking caused by turntable rumble and record warp.

2BX. The 2BX divides the frequency spectrum into two bands and expands each separately. It doesn't allow the bass to influence the vocals or mid-range instruments, and in strongly percussive music, that's important.

3BX. The 3BX is the state-of-the-art, but with the introduction of the 3BX-R Remote Control option, it's more flexible and more fun than ever. The 3BX divides music into three frequency bands. Low bass will not influence the midrange. And midrange crescendi will not boost low level highs, so operation is virtually inaudible. For complex musical material, the 3BX is the best way to restore dynamic range.

All dbx expanders have design features in common. All utilize true RMS level detection. All feature a program-dependent release time, for natural, life-like sound. All are true stereo expanders that maintain rock-solid stereo imaging. And all dbx linear expanders have a pleasant benefit—up to 20 dB of noise reduction.

The 3BX is still the standard. But now there is a family of dbx expanders designed to bring any system one step closer to "live."

dbx
UNLOCK YOUR EARS.

dbx, Incorporated, 71 Chapel Street, Newton, MA 02195 (617) 964-3210.

Enter No. 10 on Reader Service Card

Which is More Accurate?

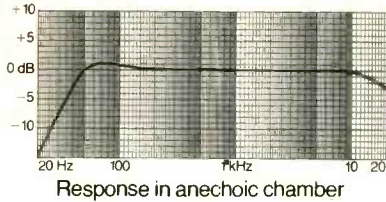

SPEAKER A

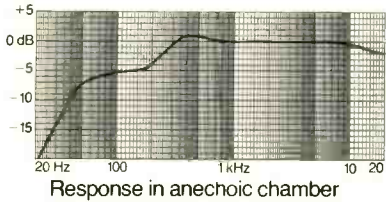
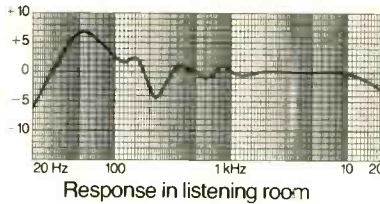

SPEAKER B

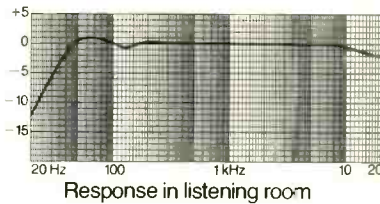

Speaker A is an idealized version of any one of a number of fine loudspeaker systems of conventional design. It performs very well in an anechoic test chamber, but in a real living room the reflected impedance from the room boundaries changes its power output drastically. In practical use its response is far from flat.

Speaker B is an Allison® Room-Matched™ loudspeaker system with

Stabilized Radiation Loading, designed for flat power output in the only environment that really matters: your listening room.

Which speaker really is more accurate? And which would you prefer?

Descriptive literature, including complete specifications and a statement of Full Warranty for Five Years, is available on request.

ALLISON ACOUSTICS INC.

7 Tech Circle, Natick, Massachusetts 01760

Enter No. 7 on Reader Service Card

HEADPHONES THAT PUT THE MOST EXPENSIVE SPEAKER SYSTEMS TO SHAME.

When you listen to Sony headphones, you'll share an intimacy with the music you've probably never experienced before; you'll hear subtleties you've missed with most speakers.

Admittedly, this may sound rather extraordinary. But then, so do our headphones.

SONY

We've never put our name on anything that wasn't the best.



Poor Bob Fulton wasn't around to show off his triumph, being laid low in Minneapolis with a 104 degree fever. However, I saw Bob later at the CES and heard more of the "Premiere"; I'll go into details in the CES report.

For the last of AES speaker news, we visit the Cerwin-Vega room, quite deliberately isolated from the main area of the convention, for therein holds forth genial Gene Czerwinski, "High Priest of High Levels." Gene has always been noted for manufacturing speakers with high output, and, as you can imagine in this era of "disco sound," he has been particularly addressing himself to this market. Gene uses various kinds of horn-loading in his systems to generate high-efficiency bass. Coupled with monster 18- and 24-inch woofers are speakers Gene calls "Stokers." He places pairs of these units "nose to nose" . . . woofers facing woofers . . . on the front left and right of his fairly large room, adds high efficiency mid-ranges and tweeters, and bi-amps the whole array with some 4000 watts of power! Using some of his own Sony PCM digital recordings for super-quiet source material, he turns this decibel demon loose! My Gawd! Have you ever experienced 30 to 40 Hz frequencies at sound pressure levels over 130 dB? The wave fronts literally flap your trouser legs for a free dry-cleaning. Your chest and head feel compressed. To me, exposure for more than a few seconds is unthinkable, yet the 'disco devotees apparently soak this up by the hour. The amazing thing is that in spite of this awesome output, the signal is clean. Gene had his demo room partitioned, and in the front part, his speaker design philosophy executes a 180-degree turn. There he was playing his highly sophisticated audiophile speaker, a line source, with an array of spiral-on-thin film transducers, some 76 of them, plus sub-woofers. Since I also checked this out at the CES, I'll give details later.

As usual at the AES, there were many other items, but space won't permit. Before we wrap up the 63rd AES, however, it is worth noting that for the first time, the cocktail party preceding the banquet was held outside in the pool-side patio of the Hilton, with a Mexican mariachi band, no less! I had a ringside table, and when you heard the sound of the trumpet, two fiddles, and three guitars, with all its power, dynamics, and emotional impact, you realized that with all of the glittering panoply of sophisticated audio equipment in the exhibit upstairs, we are still quite a long way from capturing the true essence of the live musical experience!

Dear editor

Aural Fatigue on Planes

Dear Sir:

In the May issue of *Audio*, correspondent Joel Tall wonders, "Why is it that airplane designers are not aware that the noise inside the 'usual' plane destroys hearing?"

Lest readers of *Audio* become alarmed by this reference to hearing damage from riding in airplanes, I'd like to report the results of my findings of several years ago, when I, too, became concerned about possible hearing damage from extended exposure to airline travel.

For about three months, I took a Scott 450 instrumentation-grade sound level meter with me on all flights, covering in the process a variety of seating positions in all the models of commercial jets then flying. As you would expect, the highest noise readings I got were in window seats toward the rear of the aircraft and during METO conditions (take-off and shortly after).

While I observed many broad-band (C-weighted) readings in the mid-eighties, the highest A-weighted reading I got in any commercial airliner was 79 dB SPL, well below the level at which hearing damage can occur.

Aural fatigue as mentioned by writer Tall is quite another matter from hearing damage, and in this I agree with Tall. I certainly would not like to do a recording session within a day after a transatlantic flight, or even a domestic flight for that matter. But it should be noted that jetliner fatigue, while an inconvenience, is not a hearing health hazard, and it should not be characterized as damaging to the aural facility.

Bruce Mallon
Stoneham, Mass.

More on Ear Fatigue

Dear Editor:

Following up the letter in the May issue of *Audio* on air travel and its effects on hearing, I was once a student of aviation. Back when I took flight instruction, I was informed that the low frequency waves, a.k.a. "the vibratory jet noise penetrating the cabin" can and does cause deafness in pilots. To pilots, it is something to be reckoned with.

Don Rima, II
Tamassee, S.C.

Audio Evolution

Dear Sir:

William A. Manly's article "Phase, Time, Ears, and Tape" in the April, 1979, issue of *Audio* was both important and timely.

Frequency response, as we now think of it and as we now graph it, was not "discovered" until the 1920s (see Bostwick, "Acoustic Considerations Involved in Steady-State Loud Speaker Measurements," *Bell System Technical Journal* 8:1, p. 135, Jan., 1929). Fifty years later all the wrinkles are still not fully understood (see Bordone-Sacerdote, "Round Robin Measurements on Loudspeaker Systems" *Acustica*, 38:5, pp. 297-312, Nov., 1971).

In the same way, phase response has been "discovered" in the 1970s. We have come to realize that phase response must be under control (if not ruler flat) at every step . . . in the microphone, throughout the recording channel (as Mr. Manly describes), through all the processing equipment, and out through the loudspeaker. We will fully understand phase response at about the same time we fully understand frequency response . . . maybe some time in the next century, maybe never.

Ted Uzzle
Cambridge, Mass.

Birth of a New Spec?

Dear Editor:

Mr. Wilson's comments regarding his rear-end crash published in the April issue could well lead to a new FCC spec, "Crash Absorption, Foot-Pounds Per Channel." Just what we need—more government regulations, perhaps with a minimum "capable of withstanding a 55 m.p.h. rear-end crash with no more than 0.2 percent damage."

Possibly Professor I. Lirpa can integrate this sturdy specification in his new four-wheel drive VDRS.

Edward T. Dwyer
Manahawkin, N.J.

Shower Singer Seeks Advice

Dear Sir:

Playing a live "shower record" I made while using the Lirpa Shower Mike (reviewed in the April issue), I heard a horrible "iss" sound.

Is this sound due to:

- a) Deficient circuitry in the mike, or
- b) The noise of the water coming from the shower?

If the latter is the cause, is Professor I. Lirpa currently working on a noise reduction invention for home showers?

Your reply is very important to me, a shower singer lover.

J. C. Picarra
Sao Paulo, Brazil

Since there is no circuitry in the microphone, we can rule out the hypothesis proffered in "a." Therefore, assuming "b" is correct, we can get round the horrible "iss" by eliminating the water from the shower head which will contribute mightily to the mike's reliability, as per Figs. 5 and 6 in the original review. —E.P.

Classical Tapes Offered

Dear Sir:

My late husband had, in the last 13 years, amassed a collection of classical tapes which I am interested in selling in its entirety.

The collection is completely catalogued. It is on reel-to-reel tape, recorded from Chicago's WFMT classical music station, on an Ampex tape deck. The collection includes Bach; Beethoven; Berlioz; Britten; Bruckner; Delius; Donizetti; English orchestral and folk songs; Franck; French art songs; German lieder; Haydn; Ives; Janacek; Mahler; Mozart; Poulenc; Purcell; various Russian, Spanish, Scandinavian, and Polish music; Schubert; Schumann; Schoenberg; Shostakovich; Stravinsky, and others. There are approximately 1,300 tapes of excellent quality in the collection.

Interested individuals may write to me at the below address.

Kathleen M. Disselhorst
10525 South Hale
Chicago, Ill. 60643

Audio Pen Pal Sought

Dear Sir:

I am a 20-year-old Czech student, with a passionate interest in music and hi-fi. I would like to correspond with readers of similar interests and possibly exchange records.

Vaclav Jerabek
Kodanska 29
101 00 Praha 10
Czechoslovakia

Soundcraftsmen's NEW "SCAN-ALYZER"/EQUALIZER



MADE IN U.S.A.

\$499

Model AE 2420-R
Including Case.

THE MOST ACCURATE ANALYZER/EQUALIZER—0.1 dB READOUT!

The Patent-Pending DIFFERENTIAL COMPARATOR circuitry of the "SCAN-ALYZER"/EQUALIZER IS THE KEY TO HIGH PRECISION ACCURATE EQ analysis. The basic simplicity of the DIFFERENTIAL COMPARATOR circuitry makes it possible for even a novice to accurately EQ his room and his system, yet that same circuitry is so highly accurate it can actually be used for 0.1 dB laboratory measurements of EQ analysis. This combination of equalizer and analyzer creates a functional component that should be an integral part of every high quality home stereo system. The "SCAN-ALYZER"/EQUALIZER with its accompanying COMPUTONE CHARTS, can be used in a home stereo system for many important functions—for example... To establish a room EQ curve using its own EQ or external EQ... To

establish a curve for taping so that each tape recording is pre-compensated for any variance in the recording tape's or in the tape recorder's frequency response characteristic... To establish a curve for any specific cartridge in use... To establish a curve for given sets of room conditions, i.e.: a crowded room, a room with drapes closed and doors closed, an empty room, a room with drapes open and doors open, furniture changes, etc... To establish the performance characteristics of any new component to be added to the system... To verify the continued accuracy of performance of the entire system or of any individual component in the system, such as a tape deck, turntable, cartridge, amplifier, preamplifier, speakers etc... and many more applications too numerous to list!

5 EQUALIZERS from \$249 to \$550



(Also available in silver, SE450-S)



2 PRE-AMP EQUALIZERS from \$549 to \$699

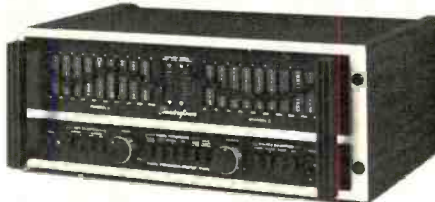
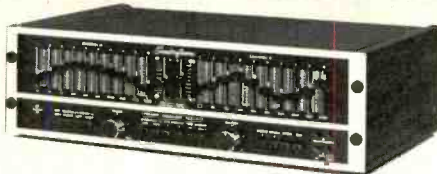

3 CLASS "H" AMPLIFIERS from \$649 to \$949

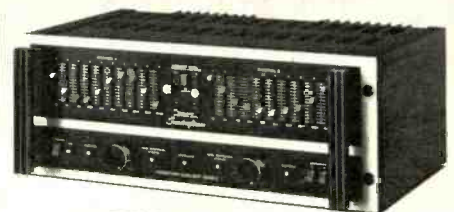

(Also available, Basic Power Amp Model PA5001)



FREE! 16-page Full-Color Brochure

WHYS and HOWS OF EQUALIZATION

Includes TEST REPORTS, complete specifications, Class "H" amplifier ENGINEERING REPORT, EQ COMPARISON CHART, and the "WHY'S & HOW'S" of equalization—an easy-to-understand explanation of the relationship of acoustics to your environment. Also contains many unique IDEAS on "How the Soundcraftsmen Equalizer can measurably enhance your listening pleasures," "How typical room problems can be eliminated by Equalization," and a 10-POINT "DO-IT-YOURSELF" EQ evaluation checklist so you can FIND OUT FOR YOURSELF WHAT EQ CAN DO FOR YOU!

SEND \$6.00 FOR EQUALIZER-EVALUATION KIT: 1—12" LP RECORD, 1 SET CHARTS, 1 CONNECTOR, 1 INSTRUCTION FOLDER
SOUNDCRAFTSMEN INC., • 2200 South Ritchey • Santa Ana, CA 92705 U.S.A.

Enter No. 37 on Reader Service Card

AmericanRadioHistory.Com

THE IMPORTANCE OF SPEAKER DIRECTIVITY

Dan Queen

Phase, time-delay, coherence, dispersion — these have been some of the watchwords in loudspeaker debates over the past few years. The “omnidirectional versus directional” argument is also gaining a place with the “tubes versus transistors” and “triodes versus pentodes” controversies of years back.

All these arguments reflect upon our knowledge of how we hear music and on what things in the sound wave produced at the recording site are important enough to be reproduced accurately in the listening room.

Seldom in such discussions are those two very important factors — the recording site and the listening room — brought into an evaluation of the merits of a loudspeaker design. Yet, it may be the interaction of the loudspeaker with characteristics of the two rooms, particularly those of the listening room, that have more to do with the sound quality of a given loudspeaker than any traditional measurements.

There are many ways to describe the rooms in which music may respectively be recorded and reproduced: The dimensions of the rooms may be stated; the shapes of the rooms may be stated or the materials of which they are constructed may be described. Important to acousticians are the sound fields which build up in the rooms. These sound fields are described in terms of an interaction of room acoustics and characteristics of human hearing (or psychoacoustics).

When a sound source in a room emits a sound, it will first travel directly from the source to the listener. However, the sound will also travel in other directions, striking walls, and ultimately reflecting back to the listener. There is obviously a shorter time required for a sound to travel directly to the listener from the loudspeaker than via a reflection to the listener, and these differences in

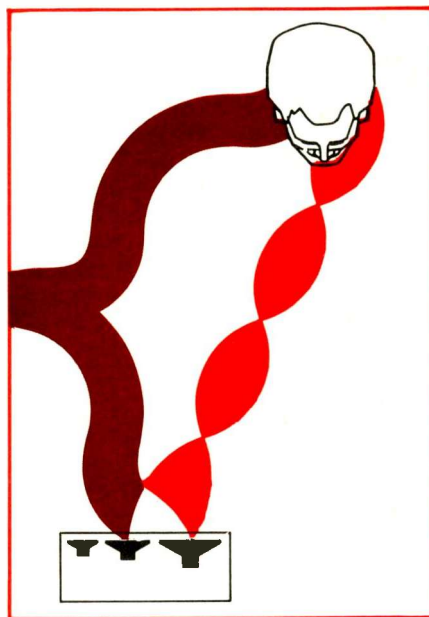

In systems where two drivers cover the same tones, cancellations can cause different perceived locations for fundamentals and overtones.

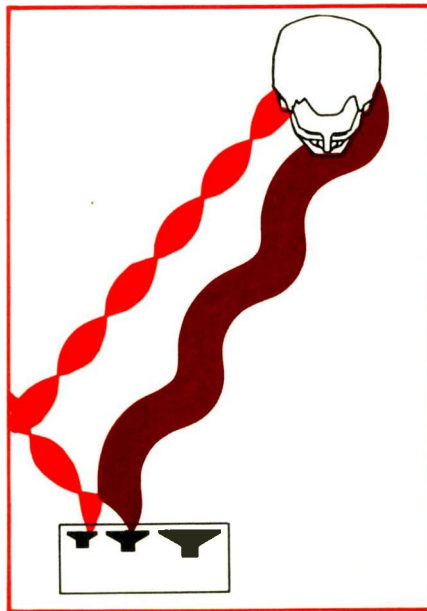

time are small enough to be measured in milliseconds.

Sound travels about three tenths of a meter (or about one foot) every millisecond. Because our hearing sense has evolved in bounded areas, such as caves and dense forests, it is natural that we would have developed some means of using the sense for discriminating between direct sound and its reflections. This discrimination, in fact, gives us much of our ability to determine the direction from which a source has come, that is, our ability to localize a sound.

Part of this ability depends on some of these reflections fusing themselves with the direct sound. A voice sounds louder in a room at a distance of a few feet than it does outside at the same distance. Reflections have added loudness to the sound which reaches us. However, this ability of the ear to “add” the reflections to the direct sound is limited by time, so after a few tens of milliseconds, later arriving sounds no longer fuse with the direct sound but begin to be heard as echoes or, when there are many such late reflections, as reverberation. Thus, acousticians define three fields in a room. The first is the direct sound; the second, the early reflections, and the third, the late sound or reverberation.

Home listening rooms seldom *sound* reverberant. The majority of the sound goes into the direct sound and early reflections. In fact, early reflections predominate in a home listening room. On the other hand, in a concert hall or large studio, there is generally considerable reverberation and relatively few early reflections. This is because sound has to travel so much greater distances to reach reflecting surfaces and return to the listener. By the time it does return to the listener, most of it will be in the category of late sound.

Distance is the key. Because of the distances involved, it is very difficult to

37



Bravo!

That's the Jensen R430 Car Stereo Receiver. That's the thrill of being there.

Bravo indeed for the superlative performance of the 60 watt Jensen R430 Car Stereo Receiver. The top-of-the-line of six receivers that boast a compliment of features found only on better home receivers.

Features like a separate trunk-mounted Power Amplifier unit as well as a twin amplifier section in the main unit.

The advanced Bi-Amp capability of the R430 makes it possible to selectively send high frequency power information to a car's front speakers, and low frequency info through the Power Amp to the rear speakers. This bi-amplification allows for greater volume and less distortion.

Jensen has refined the R430 with other unique features like feather-touch electronic switches. And an automatic tape alarm.

Dolby® Noise Reduction processes out tape hiss and improves the dynamic range of Dolby-encoded tapes and FM broadcasts.

A Fader control adjusts levels front to back; separate Balance control adjusts left to right. There's even a Loudness Compensation function and for the extra-sensitive FM tuner, Interstation Muting.

But all the features in the world don't mean a thing if they don't combine to do one thing a receiver is built to do... recapture and deliver to you all the power and intensity that went into the original performance.

That's the thrill of being there.

That's the Jensen R430 Car Stereo Receiver.

JENSEN

The thrill of being there.

For more information, write Jensen Sound Laboratories, Division of Pemcor, Inc., 4136 N. United Parkway, Schiller Park, Illinois 60176.

® "Dolby" and "Dolby System" are registered trademarks of Dolby Laboratories, Inc.



make a home listening room sound anything like a concert hall. To produce concert-hall sound, it is necessary that some late sound be on the recording. Nevertheless, use of time-delay circuitry and logic to try to favor the late sound, delay it, and radiate it into the room from directions other than the front, can be effective in simulating the concert hall in the room.

However, in doing so, it is necessary that the loudspeaker used does not introduce some distortion of the natural sound fields because of peculiarities in its own characteristics. And those loudspeaker characteristics most important to the placement of sound in the listening room are the directivity characteristics.

Experimenters in the field of psychoacoustics have found that the hearing mechanism can be fooled, using two sound sources, such as stereo headphones, into thinking that a sound source is actually between the headphones. They find that we are fooled into thinking the source is centered when the signals are identical. As one signal becomes softer than the other, the sound seems to move toward the louder earphone. Also, if one sound is delayed relative to the other, the sound seems to move toward the undelayed earphone.

Using earphones in this manner, a delay of only one millisecond will make equal amplitude sounds appear to be entirely at one side of the head. However, this phenomenon appears to hold true mainly when most of the sound is at low frequencies. When the sound is at high frequencies, the intensity cue seems to be most important. Remarkably, under the artificial conditions set up by earphones and synthesized signals, one can even produce two images, one controlled by the intensity and the other by the time delay.

Fortunately, when one places two loudspeakers in a room at the usual locations for stereo reproduction, both ears are receiving signals from both loudspeakers with very small time differences at the two ears. Nevertheless, the amplitude differences continue to appear. An amplitude difference of 10 decibels seems sufficient to shift the sound completely to the louder loudspeaker (10 decibels represents a doubling of perceived "loudness"). This means that amplitude differences of less than 10 dB tend to cause a sound to be located between the loudspeakers. This, of course, is the basis of stereophonic imaging. But, when one places the loudspeakers in a room, such as a residential living room, there can be more than one thousand

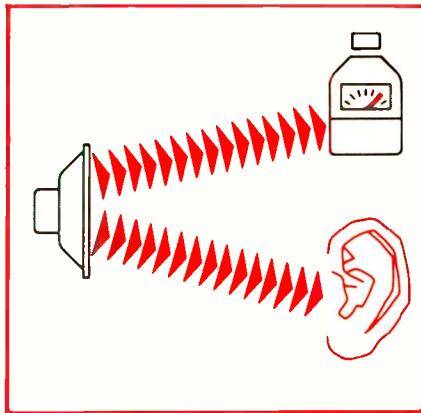

The human ear, unlike a sound level meter, can easily detect subtle differences between steady-state and pulsating tones.

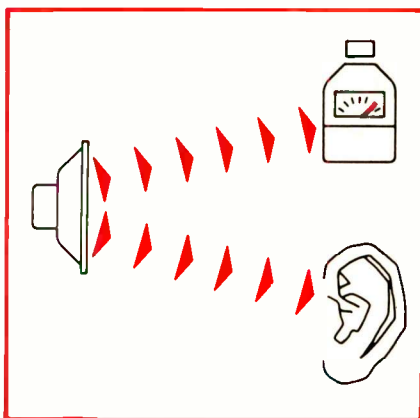

reflections from room surfaces that are within 10 dB in level of the sound coming directly from the loudspeaker. How, then, is it possible to obtain a stereophonic image in a real room?

One apparent answer is that each of the reflections acts, in effect, like another loudspeaker, and each of the new reflection-speakers has the same relationship to the original loudspeaker as each of the new reflection-speakers has with any other. To make things clearer, let's look at a diagram in which we see a sound moving directly to a listener and another reaching the listener via a wall reflection. The listener places the source at a point between the loudspeaker and the reflection, but, because the loudspeaker should be louder, closer to the loudspeaker.

Each subsequent reflection will itself again shift the image in one direction or another — eventually averaging out in a final position. If a loudspeaker produces a lot of reflections from a wall to the side of it, it is very possible that the perceived direction will be closer to that wall than to the loudspeaker. Thus, it is possible for a

pair of stereo loudspeakers to produce an image which is wider than the actual distance between the loudspeakers.

But all is not as well as it seems. The hypothetical loudspeaker we have been describing may well emit sound as efficiently in the direction of the wall as in the direction of the listener. In reality, most loudspeakers have outputs which vary with direction.

It can be argued that if the loudspeaker projects most of its sound toward the listener and much less toward the walls, a better stereo image should be obtained. This would probably be true if it were physically possible to produce a loudspeaker that has the same directional pattern at all frequencies. When the directional pattern varies with frequency, one could easily find the fundamental of a musical instrument appearing to come from one direction while its overtones come from another direction.

The radiation patterns of two drivers show us why this is so. If you drop one pebble in a pool of water, waves will radiate smoothly out in all directions from the point of impact. However, if you drop two pebbles, the two sets of waves will interact. In some directions, the waves will add on top of one another, while in other directions, the wave from one stone will tend to cancel the wave from the other stone. Where the cancellation and addition actually take place depends on the distance between the crests of the wave.

For waves of sound in air, the distance between the crests determines the frequency of the sound. Thus, the waves of the overtones from an instrument, being higher in frequency, will have different cancellation patterns than the waves of the fundamental.

A listener may find himself sitting at a point where, at the fundamental, the waves coming direct to him from the loudspeaker are adding, while the waves heading toward the wall or reflecting surfaces are cancelling. The fundamental will then appear to come directly from the loudspeaker. On the other hand, at the first overtone, the situation can easily reverse itself, moving the overtone in the direction of the reflective surface.

The result is the hazy, unclear sound which is characteristic of many loudspeaker systems. It is sometimes mistakenly called poor transient response, which is not true in the pure electrical sense, although it may be considered so in terms of spatial acoustics. In any case, it is not a problem which will make itself known by the measurement of tone bursts in an anechoic chamber

The property of the ear which enables it to average the direction of a sound from its origin and its reflections operates only in the first tens of milliseconds after the direct sound. Furthermore, in actual listening rooms of the sizes found in residences, most of the reflections which are within 10 dB of the level of the original sound, occur in the first 10 milliseconds or so. While the exact time at which the ear is no longer able to fuse the reflections and begins hearing them as echoes and reverberation seems to vary due to many factors, it is generally agreed that it happens at a time greater than 20 milliseconds and shorter than 100 milliseconds.

This means that problems due to loudspeaker directivity which occur in the home listening room may not occur in a large hall — where very few reflections arrive at the listener during the time immediately after the direct sound. On the contrary, most of the reflections in the large hall are heard as echoes and reverberation. This is why a loudspeaker that sounds excellent in a large hall may be virtually unlistenable in a small room — and vice versa.

Furthermore, before any discussion of the relative merits of directional versus omnidirectional loudspeakers can take place, one must consider whether or not the speakers are truly directional or truly omnidirectional. We have seen wave interference as illustrated by dropping two stones in a pool of water.

In loudspeaker systems, the two-stone analogy applies in the crossover

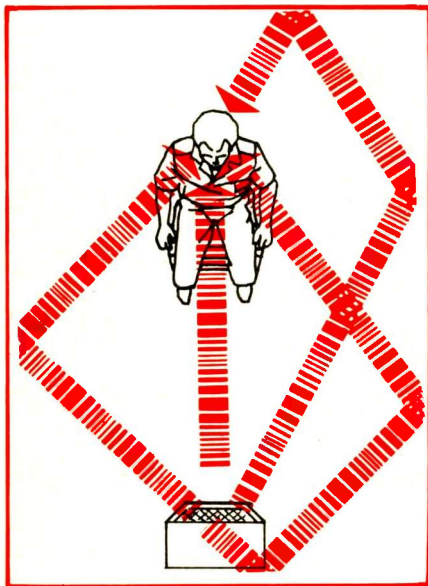

To a listener, the "sound" of a speaker is a combination of the direct and reflected sound.

region of the loudspeakers as well as in loudspeaker systems which have more than one source radiating the same frequencies.

Nevertheless, even when only one driver is radiating the same frequencies, similar interference occurs. It can be illustrated by dropping a straight rod into that same pool of water. Even if that rod is dropped parallel to the water surface, the wave front started from one end will tend to interfere with the wave front from the other end.

In fact, the only way that one can get the smooth, circular "omnidirectional" ripples is to use a single very small pebble. This, moreover, is true with sound waves. A perfect omnidirectional pattern can be obtained only with an infinitely small source — or, at least, one that is very small compared to the smallest wave one wishes to produce.

However, the smaller the pebble, the smaller the size of the waves that can be produced. The same is true in generating sound waves. While one would like a small "pebble" to produce uniform response, one needs the larger "rod" to produce sufficient sound power. The task in loudspeaker design is to solve this dilemma. Merely placing loudspeakers around a cabinet does not produce true omnidirectionality. It is like dropping pebbles in a circle. The wave interference is still there and is still strong.

A possible solution is illustrated by dropping the rod vertically into the water. One can make the waves go out evenly around the rod — but if there were, in effect, a "vertical water" there would still be wave interference. Nevertheless, it is possible, using devices such as "radial horns" — which are horns that open in a circle — and some types of electrostatic full cylinders, to obtain a relatively uniform omnidirectional pattern, that is one nearly perfect in the horizontal plane.

In rooms of the size of residential listening rooms, it makes some difference if one achieves uniform directionality in a directional speaker or an omnidirectional speaker. The omnidirectional speaker will have to be more efficient because it will be radiating towards all surfaces, which means that it may be subject to "absorption" in some surfaces more than a directional radiator will be. However, at present, it is not possible to make a directional radiator which has a uniform pattern with frequency.

Reflected sound acts like a ball bouncing off the cushions of a billiard table. If the cushions are springy, the ball loses only a little energy each time

it hits. However, as the cushions become old, they start to "absorb" a good deal of energy from the ball each time it hits. In the room, hard plaster walls absorb little, while carpets, drapes, upholstery, acoustic tile, and people absorb more. But the absorption varies with frequency, aggravating the effects of uneven loudspeaker directivity.

Uneven absorption could also create problems with a "perfect" direc-

A system with 360-degree horizontal dispersion would have no shifting images due to cancellation effects.

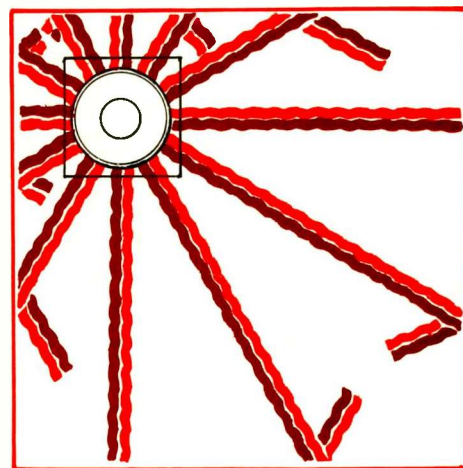

tional speaker, since some of its sound output will produce reflections which eventually get to the listener. Because the directional loudspeaker favors only the surfaces in front of it, rather than all the variegated surfaces of the room, it cannot average out the room differences as well as an omnidirectional speaker. In contrast, the sound of a truly omnidirectional speaker will hardly vary as one moves about the listening room.

Furthermore, the ability of the omnidirectional speaker to even out room differences allows the effective use of equalizers to smooth the response of the speaker-room combination. Thus, ideally, the combination of a loudspeaker that directs its sound only to listener locations, with a room which reflects all frequencies equally from all directions, should provide the most realistic sound. Unfortunately, such a loudspeaker is not technically feasible, and such a room would have to exclude furniture, decor, and — most significantly — people, making the omnidirectional speaker the better choice from the directivity standpoint.

**Your deck isn't ready for
the ultimate cassette tape.**



Introducing the first line of decks that are.



25-18,000 Hz \pm 3dB at -20VU with metal tape, 70dB signal-to-noise ratio. 6dB hotter output than ferrichrome.

The reason we can offer you SIX metal tape-compatible decks with specs like these, is all in the heads. Sen-Alloy heads. With better high frequency characteristics than the Sen-Dust most of our competitors use, Sen-Alloy just happens to record and erase metal tape perfectly.

So while our competitors have had to struggle with little problems like designing heads that could handle metal tape, we've had a head start towards packing our metal decks with more state-of-the-art features.

Our new "X-cut" Sen-Alloy record head extends bass response to lower than your woofers may go: 25Hz!

Our unique double-gap Sen-Alloy erase head gets 60dB erasure on metal tape at the critical 400 Hz level.

Our B.E.S.T. computer automatically finetunes deck bias, equalization and

sensitivity to tape in less than 30 seconds.

Spectro-Peak and Multi-Peak L.E.D. indicators react 100 times faster than meters so you can make perfect, undistorted recordings.

How much does it cost to replace the weak link in your system with a JVC metal deck?

As little as \$299, and no more than \$750, suggested retail price.

After all, now that your ears are ready for metal tape, your pocket-book ought to be too.

For the name of your nearest JVC dealer, call

800-221-7502 toll-free (in NY State, 212-476-8300). Or write to US JVC Corp., 58-75 Queens Midtown Expressway, Maspeth, NY 11378.



The B.E.S.T. computer system



The Double-Gap Sen-Alloy erase head and X-cut Sen-Alloy record/play head.

Shown: KD-A8, 2hd, 2mot, MPI L.E.D.'s, B.E.S.T., X-cut SA rec/play head, SA erase head, solenoid controls, Super-ANRS. Freq. resp., 25-17K*; S/N, 60dB**; w&f, 0.035%. **KD-A5**, 2hd, 2mot, MPI L.E.D.'s, SA rec. erase hds, sol cont., Super-ANRS, freq. resp. 30-16K*; S/N, -60dB**; w&f 0.04%. **KD-A6** 2hd, 2mot, X-cut SA Rec/play & SA erase hds 2 x 10. MPI L.E.D.'s; Super-ANRS, pitch cont. 25-17K* freq. resp.; S/N, -60dB**, w&f 0.04%. **Not Shown:** KD-77, 3 SA hds, 2mot, sol contr., Super-ANRS; KD-A7, 2hd, 2mot, X-cut SA rec/play & SA erase hds, sol cont., 2-clr fluores. 10-band SpectroPeak mtrs., Super-ANRS; KD-A3, 2hd, 2mot, MPI L.E.D.'s, SA rec. erase hds, Super-ANRS.

* \pm 3dB @ -20VU.

**Without noise reduction. (ANRS adds 10dB @ 5kHz)

JVC[®]
US JVC CORP.

Now you're ready for JVC.

Enter No. 17 on Reader Service Card

Tape-to-Deck MATCHING For Best Dolby Tracking

Howard A. Roberson

The inclusion of Dolby noise reduction has certainly been a major factor in the success of the cassette format. Unfortunately, performance in this mode has been unsatisfactory in too many cases because of poor matching between the tape formulation and the Dolby circuit adjustments in a particular deck. A good part of the problem is the fact that most manufacturers do not inform the owners as to what specific tapes were used for set-up.

Let's take a look at the elements essential to Dolby NR calibration. Figure 1 shows the blocks of important parts, as they appear in a few decks. What is shown is for purposes of illustration, such as separate record and play heads

and the built-in test oscillator; many other circuit elements, including some switching to the meter, are not shown. The Dolby encoder and decoder perform correctly when fed specific voltages. The output of the decoder should be at a certain voltage at the Dolby level reference, the manufacturer may make an internal adjustment if necessary, and then *Meter Cal* is adjusted for such an indication. Now, when a standard Dolby-level tape (200 nWb/m at 400 Hz) is played on the deck, *Play Cal* is adjusted for the same indication. At this point, playback and metering are calibrated; in other words, metering and decoding are properly referenced to Dolby level.

The critical level points, as indicated in the figure, are at the input of the decoder (which is set with *Play Cal*) and the output of the encoder. To set up the encoder, the manufacturer uses signals specified by Dolby and makes any adjustments necessary, all of which are points inaccessible to the user. If there is a built-in test oscillator, it must be set (usually internally) for the correct drive level, but this is not an adjustment of the encoding function. Between the two points defined as "critical" in the figure, we have some amplifiers, the record and playback heads, the tape path, the introduction of bias and EQ. In general, we can say, and we do rely on the fact,

Fig. 1 — Essential elements in Dolby N/R loop calibration.

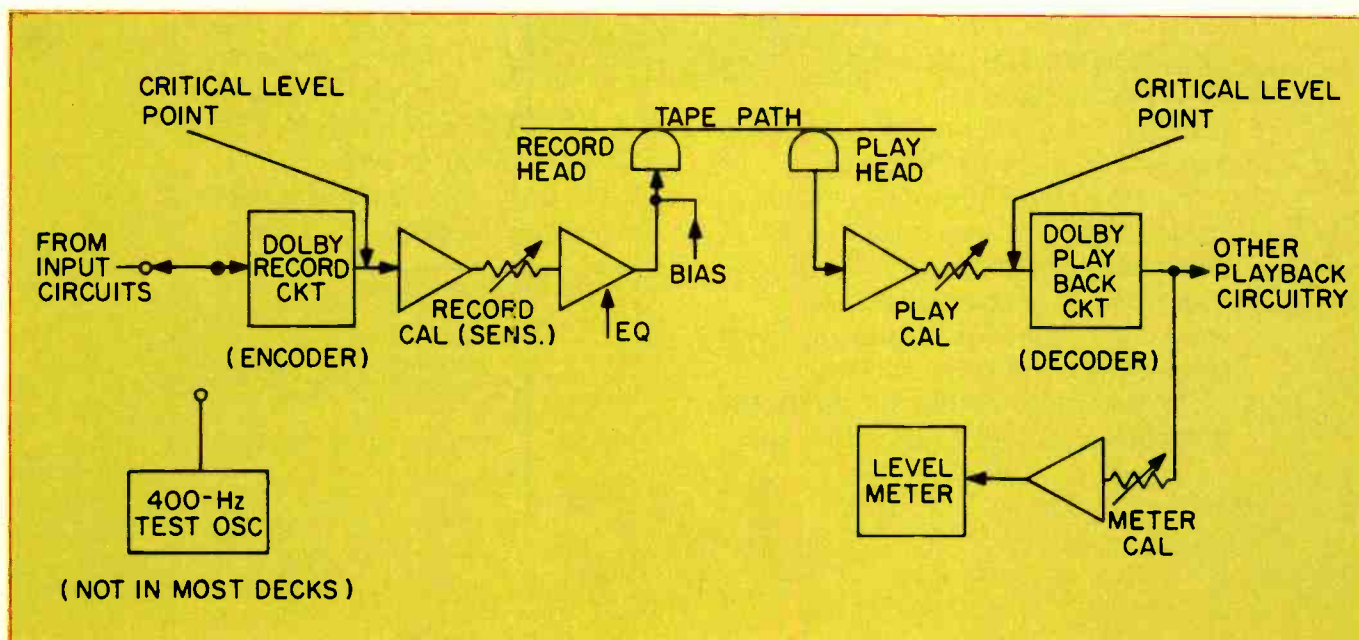

INSIDE EVERY RECEIVER OWNER IS A SPECTRO ACOUSTICS BUYER



What do you do when the old receiver's lost its zip? When your ear's improved, but the sound still hasn't? When you've outgrown the basic bass, treble and occasional mid? What do you do when hifi's lost its high?

Well, if you really want to put the fun back in your system, you'll take a good, hard look and listen at Spectro Acoustics.

Here's a line of high quality stereo components that's built for enjoyment—and priced that way too. Fact is, you can get a complete Spectro Acoustics component system for about the same price as that receiver you were thinking of.

And you'll get a lot more for your money. Such as a dramatic-looking FM stereo tuner—newest addition to the Spectro line—featuring digital readout of station frequency, our exclusive new pinpoint tuning system and astonishing sensitivity.

You'll also have a power amp—we make 4 of them, at two different wattage levels—built to deliver dependable performance with plenty of reserve power. A straight-line preamp featuring adjustable cartridge loading. And a graphic equalizer—choose from 2—that gives you 10 divisions of frequency control per channel, instead of a receiver's 2 or 3.

In short, you'll get more versatility, flexibility and control over your system than any receiver can provide.

You'll also get peace-of-mind with Spectro Acoustics. We build all of our components almost 100% by hand, and subject every one of them to continuous quality control.

We don't hurry through production, so our components don't hurry into the repair shop. That's why Spectro Acoustics owners keep coming back when it's time to add on or trade up. Our careful, limited production means you may have to look a little harder, or wait a little longer for Spectro Acoustics components. But when you do get yours, you can bet they're good ones.

**SPECTRO
ACOUSTICS** 
Built for enjoyment™

All Spectro Acoustics components are
manufactured in the U.S.A.
4500 150th Avenue, N.E.
Redmond, Washington 98052



Enter No. 38 on Reader Service Card

Empire's revolutionary cleaning method peels off every trace of dirt, dust and oil from deep down in your record's grooves.



Write for your free brochure on all fine record care products by Audio Groome. Empire Scientific Corp., Dept. AG, Garden City, New York 11530

EMPIRE

Enter No. 47 on Reader Service Card

Fig. 2 — How various bias and record sensitivities affect frequency response. A, responses with bias and record sensitivity matched to tape. B, responses with excessive bias.

C, responses with correct bias with sensitivity set 3 dB too low. D, responses with bias causing 2-dB drop in Normal and record sensitivity set 2 dB low.

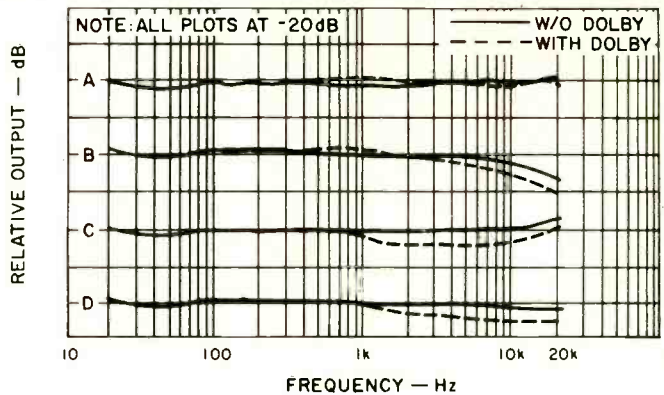

that the amplifiers have stable gain. What does change, however, is tape type with corresponding changes in record sensitivity and EQ and bias requirements.

When the manufacturer sets up the deck, he uses a series of adjustments for each tape for best frequency response and to maintain the level relationship between the two critical points. These same requirements apply to a two-head machine with the single record-play head, where the head and Dolby-circuit functions are switched for playback. If the user of the deck knows what the manufacturer utilized for set-up, he will probably get the best results with the same formulations (or ones very close in characteristics).

If another formulation is used, however, the results may be quite disappointing if bias requirements and/or record sensitivity are different. In Fig. 2, the swept-frequency response plots from 20 Hz to 20 kHz illustrate how this can happen. In the top set of plots, the Dolby response is almost exactly the same as that without noise reduction. For the second set, bias was purposely increased to cause a drop of 3 dB at 15 kHz without Dolby NR. As the dashed plot shows, the response with Dolby is poorer, having about twice as much droop above 3 kHz.

For the third group, bias was returned to the original setting, and record level calibration was set 3 dB too low (at 400 Hz). Here the result is a shelving action with a 2-dB reduction in level, with Dolby, from 2 to 10 kHz. For the bottom plots, bias was set for a 2-dB reduction at 15 kHz, and 400-Hz record sensitivity was set 2-dB low. Here we have a $-1\frac{1}{2}$ to -2-dB shelf with Dolby NR with a general fall-off as the frequency is increased. Changes in the sound when switching in Dolby are

most evident in the last two cases: There is a definite loss in presence, and most music sounds quite dull.

So, what can you the owner do to minimize such effects? First of all, if you have a deck which includes facilities for checking and adjusting bias, EQ, play calibration or record calibration, you can use what adjustments you have to aid in verifying the performance with Dolby N/R. Proceed cautiously, however, and keep track of any changes made. You may determine that you can get a better match with another tape type. Don't forget that if you want to check play calibration, a Dolby-level test tape is needed. Checking for unwanted shifts in response when switching to Dolby is easiest at 20 to 25 dB below Dolby level. Mistracking should be obvious, and the signal level well above noise. Use music and FM interstation noise, if you do not have test sources.

It's tougher to get to the solution if your deck does not have such adjustments on the front panel. If you're lucky, the manufacturer stated exactly which tapes are best. If there are more than a very few tapes listed, the list is suspect. Unfortunately, most manufacturers hesitate to state exactly which formulations are used for set-up, a reluctance they should overcome. By referring to the two figures and reviewing the discussion above, the reader may correctly conclude that using a tape that plays 400 Hz back at the same indicated level as in record is a matching of record sensitivity. (Check position of output pot, etc.) With a number of tapes that pass this test, record/listen tests with music should pinpoint the best bias/EQ match without Dolby. The tapes surviving these tests should give you good frequency response as well as low noise when in Dolby mode. Δ

Unboxed Sound. Reduced.



Introducing the Avid Model 110 Minimum Diffraction Loudspeaker.

The New Reference Standard Under \$150.

Utilizing the innovative design techniques which have made our revolutionary line of loudspeakers so popular, Avid introduces a compact Minimum Diffraction Loudspeaker™ for less than \$150.

Its performance characteristics are so superior for the price, that the Model 110 establishes a reference standard that challenges comparison.

Overall system response (48 Hz to 20 kHz \pm 3 dB) is truly exceptional for a speaker in this price range, and few loudspeakers in its class offer 88 dB efficiency along with 100-watt power handling capability.

Avid builds its own drivers to meet the specific design objectives of each system, and the Model 110 is no exception.

Power handling of the 1-inch soft dome tweeter is achieved with a design incorporating magnetic fluids and a high-temperature voice coil. Avid's proprietary cone treatment techniques enable the 8-inch woofer to roll off mechanically, eliminating the need for an electronic crossover.

The Model 110 is a totally integrated design yielding a level of performance usually found only in the most expensive loudspeaker systems.

Audition the Model 110 and other Avid Minimum Diffraction Loudspeakers™ at your Avid dealer.



AVID

The careful integration of special engineered Optimum Dispersion Couplers™ and solid front grill panels with rolled edge design significantly reduces unwanted cabinet diffraction effects.

**Unboxed
Sound**

Avid Corporation
Department 110A, 10 Tripps Lane
East Providence, R.I. 02914

Please send me complete technical information on the new Model 110 Minimum Diffraction Loudspeaker™

Name

Street

City

State Zip

Enter No. 6 on Reader Service Card

TAPE SPEED

1 7/8 3 3/4



INPUT LEVEL

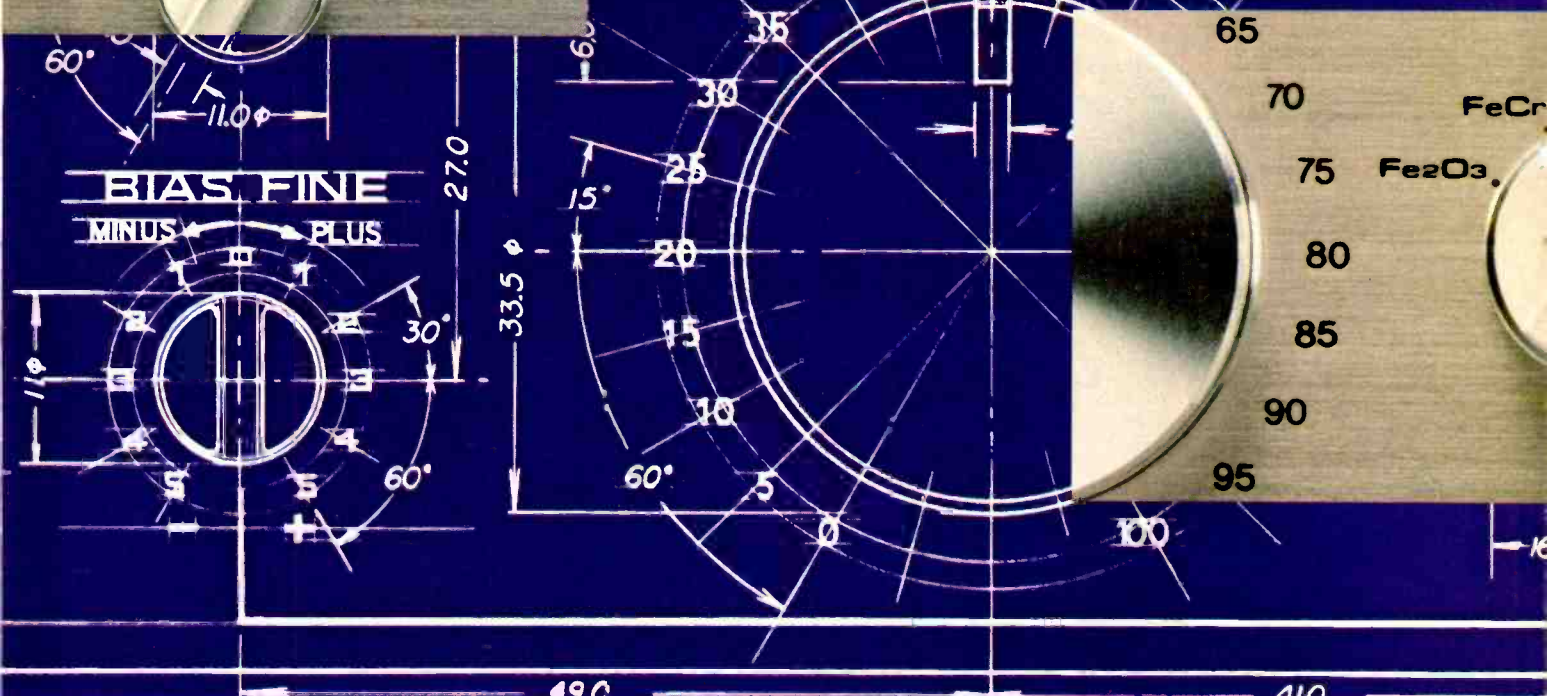

THIS REMARKABLE
CASSETTE DECK
COULD ONLY
COME FROM
THE NEW FISHER.

Recent developments have revolutionized tape technology. The new Fisher CR4029 cassette deck, with an array of features you thought were still in the future, can now make recordings in your home that rival the product of professional studios. Equally important, the CR4029 offers a wide range of choices that, until now, were unavailable. Some of the new cassette decks offer one or two of these technological innovations—Fisher offers them all in one integrated package.

TWO SPEED OPERATION.

You can use the CR4029 at the standard 1 7/8 ips speed and you'll have outstanding recordings. But that's just the beginning. Switch to the new high-speed 3 3/4 ips and the CR4029 delivers an incredible 30Hz-20kHz ± 3 dB frequency response (using normal tape). What's more, recording at high speed drastically reduces wow and flutter and tape dropout. Off-the-air and off-the-disc recordings will astound you, and even surprise your friends who own reel to reel recorders. (Since a C90 cassette will record a full album at 3 3/4 ips, high speed recording is still economical.) But—there's more

METAL TAPE. Another of the marvelous innovations is metal tape. Why has it become so important? Our chart shows why. Metal tape demonstrably improves frequency response. Combine it with the new high speed and you'll get a hard-to-believe 30Hz-25kHz ± 3 dB frequency response with virtual freedom from distortion. You'll also be able to record at higher levels. (With normal tape and standard speed, you have to record at lower levels to prevent tape saturation and consequent distortion.)

CR4029 FREQUENCY RESPONSE

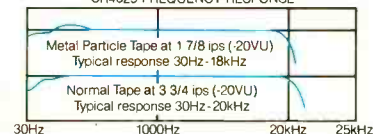

THREE VHT / SENDUST HEADS WITH DUAL PROCESS DOLBY. All this new technology requires new recording, playback and erase heads. So Fisher engineers came up with our new VHT heads. Made of a special micro-fine, high density particle formulation, they bring out the best potential of metal tape and high speed. Because the

TAPE SELECT BIAS EQUALIZE TAPE MONITOR LIMITER INPUT

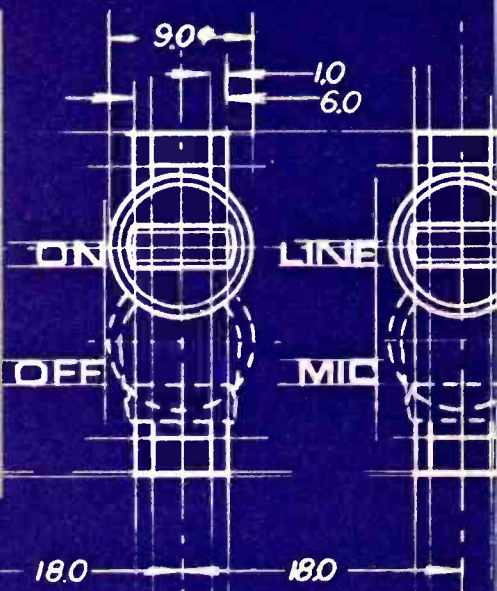
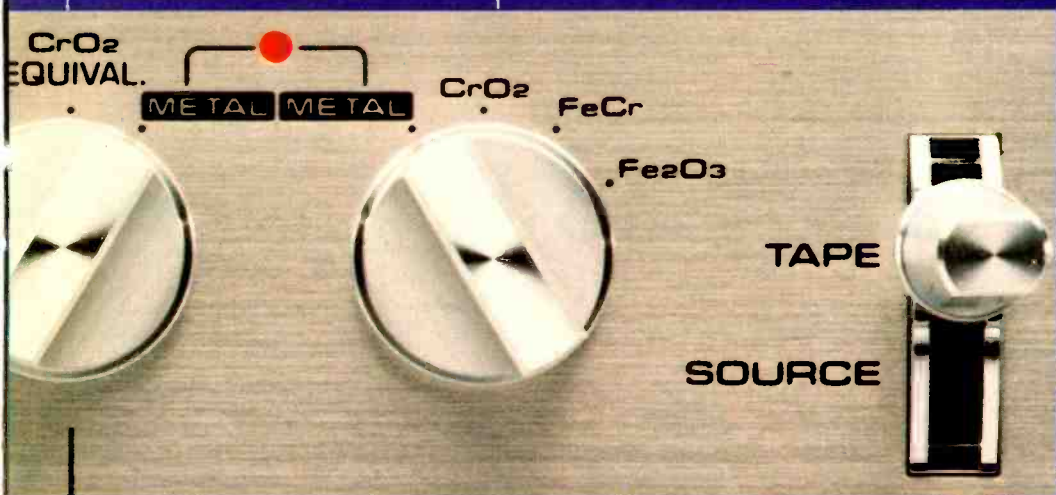

THREE HEAD SYSTEM WITH DUAL PROCESS DOLBY

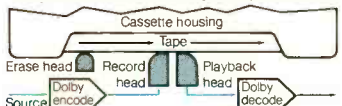

The separate playback head lets you listen to the actual recording already on the tape—as you record.

CR4029 is a three-head design, each head can be optimized for a specific function. There's a wide 4 μ m gap VHT record head for the best possible signal-to-noise ratio. A narrow 1 μ m gap VHT playback head improves frequency response. And a Sendust alloy erase head overcomes the problem of hard-to-erase metal tape. The separate record and playback heads allow you to monitor as you record—an absolute must for serious record-

VHT RECORD AND PLAYBACK HEADS



ing. And Dual Process Dolby gives you the advantage of Dolby noise reduction in both the record/playback and off-the-tape monitoring mode.

THE CR4029 HAS ALL THE OPTIONS. Why have only part of the new tape technology when you can have all of it? Using the CR4029 three head system you can use metal tape at the standard 1 $\frac{7}{8}$ ips speed, combining high performance with long play. Or use normal tape at the new 3 $\frac{3}{4}$ ips speed for both economy and superior performance. Or choose the ultimate: metal tape at high speed 3 $\frac{3}{4}$ ips, and exceed the expectations of the most critical enthusiasts.

IT'S WHAT YOU'D EXPECT FROM THE NEW FISHER. We invented High Fidelity over 40 years ago. We've never stopped moving ahead. The CR4029 is a perfect example. Part of the new Fisher. Where the only thing about us that's old is our tradition of quality and craftsmanship. See the new CR4029 at your Fisher dealer. Everything you'd want in a technologically advanced cassette deck, and at an under \$500 price.

New guide for buying high fidelity equipment. Send \$2.00 with name and address for Fisher Handbook to: Fisher Corporation, Department H, 21314 Lassen Street, Chatsworth, California 91311.

© Fisher Corp. 1979.



SPECIFICATIONS:

Motor	(1) DC-Servo	Frequency Response 1 $\frac{7}{8}$ ips
Drive System	(1) Capstan	FeCr Tape (\pm 3dB) 30Hz-16kHz
Number of Heads	3	Metal Tape (\pm 3dB) 30Hz-18kHz
Head Material	VHT/Sendust	Frequency Response 3 $\frac{3}{4}$ ips
Wow and Flutter		Normal Tape (\pm 3dB) 30Hz-20kHz
1 $\frac{7}{8}$ ips	0.06% WRMS	CrO ₂ Tape (\pm 3dB) 30Hz-22kHz
3 $\frac{3}{4}$ ips	0.05% WRMS	FeCr Tape (\pm 3dB) 30Hz-22kHz
Signal-to-Noise Ratio (CCIR Weighted)		Metal Tape (\pm 3dB) 30Hz-25kHz
(Dolby Off)	52dB	Total Harmonic Distortion at OVU
(Dolby On)	62dB	1 $\frac{7}{8}$ ips 1.5%
Frequency Response 1 $\frac{7}{8}$ ips		3 $\frac{3}{4}$ ips 1.2%
Normal Tape (\pm 3dB)	30Hz-14kHz	Tape Selector Switch Norm., CrO ₂ , FeCr, Metal
CrO ₂ Tape (\pm 3dB)	30Hz-16kHz	Bias Fine Adjustment \pm 20%

Dolby is a registered trademark of Dolby Laboratories.

the New **FISHER**
The first name in high fidelity.®

For the audiophile who has been using cassette recorders, there have been tremendous changes in the performance in this format in relatively few years. It wasn't that long ago (1965) Philips brought out its Cassette-corder, which was strictly for fun, family gatherings, and other low-fidelity purposes. A stereo recorder did appear the following year, but its performance was ho-hum rather than hi-fi. In this same period, of course, there was the start and growth of the software (tape) manufacturers. Ten years ago, development became more rapid, including such new products as TDK's SD (Super Dynamic) tape.

At this time, there was the need for and the practice of greater cooperation between the manufacturers of the recorders and the tape makers. The inherent nature of the magnetic interfaces made this essential: An improved tape needed improved record, play and even erase heads, and improved head designs could benefit from better tapes. It was a great year for the cassette format: In 1970 significant improvements were made in extending frequency response and lowering noise with the introduction of CrO₂ tape and the Dolby B system. Some started using the expression "high fidelity," but "for a cassette" was usually added. The appearance of the Nakamichi 1000 in 1973 impressed many with its one-grand price, but many more were impressed with the sonic results. This was a time of conversion for many skeptics who had concluded that tape speed and width precluded any possibility of acceptable playback.

The next couple of years saw a great expansion in the generation of well-performing cassettes decks and new tape formulations. Some of these were not successful, including early FeCr versions which were not stable and cobalt-doped ferrics which had their own sort of erratic behaviour. TDK brought SA on the market in 1974, and its ion-absorption approach enabled the use of the desirable cobalt. The improvement in straight ferric tapes was continuing all during this period, and continues at this moment. Many other excellent tapes were introduced by Maxell, Scotch, BASF, Fuji, Memorex, and others. The introduction of metal-particle tapes is significant, but it is part of this relatively short history which has included a number of important changes.

Up in the Air About Metal Tape?

Howard A. Roberson



Before we get into a discussion of the history of the metal-particle tapes and their magnetic properties, we should review some of the basic characteristics of tape formulations. The reader will note that there are three hysteresis loops in Fig. 1, one for a gamma ferric oxide such as Maxell UD, one for Nakamichi SX (or another similar cobalt-modified ferric), and one for Nakamichi ZX metal-particle tape. Let's make a trip around the loop; follow any one of the three, for the basic story is the same. We also assume that the magnetic material has gone through the loop prior to our discussion, so we are not building up from zero magnetization.

As the coercivity increases in the positive direction, the retentivity also increases, very sharply at first. These steep slopes are desirable and are a goal of the designer, because this shows that the flux in the material is responding well to the magnetizing force. Alas, the material reaches a point where magnetic saturation takes place, and increasing the magnetizing force does not increase the flux in the material. With the lowering of the applied field, when coercivity has been

reduced to zero, a certain flux level is retained. This is called retentivity which is the number of flux lines per cm² of the tape coating cross-section. This is flux density with the units, gauss, and the area determined by the tape width and the thickness of the coating. This is a fundamental measure of the magnetic performance of the particles, but there is a bit more to this part of the story.

Tape performance is determined by the actual number of lines of flux induced, not just the density. Remanence is the actual signal retention in total lines of flux (in Maxwells), contributed by the tape coating thickness and width. As we recognize that the highest frequencies would not penetrate a thick coating, we can see that the choice of coating thickness facilitates matching low- and high-frequency record sensitivities. Once again, note that retentivity (flux density) goes with the properties of the particles and the remanence (actual lines of flux) goes with the tape product. Squareness ratio is the decimal fraction of flux at zero coercivity to the flux at saturation.

So far in our trip around the loop, we have succeeded in magnetizing the material, but what's required to demagnetize it? If a magnetizing field is applied in the reverse direction, the flux in the particles will be reduced down to zero along the lines in the second quadrant. For the other direction of induced flux, we would travel the other half of the total loop. Let's restrict our attention, however, to the important second quadrant of the figure and make some comparisons among the tapes. Note that there are two dashed lines showing the 5-kHz and 20-kHz demagnetization loss line. These are based upon those appearing in Vogelgesang's article in *Audio* just a year ago.

For the particular tapes shown, the retentivity increases from 1050, to 1550 to about 3500 gauss. There is no doubt about the significant increase in possible flux levels, especially at the low frequencies. Vogelgesang points out, however, that this high flux capacity is needed for good high-frequency performance, along with high coercivity. For this property, the tapes show values of about 300, 550 and 1000 oersteds, showing increasing resistance to erasure. The demagnetization loss lines indicate the much lower likelihood of self-erasure with the metal particle tape. Consider also that with the much higher retentivity, the tape designer has a bit more flexibility in the choice of coating thickness to achieve the best combination of extended response and high record level. The high coercivity is a mixed blessing in that it places much higher demands on the erase and record heads — a definite challenge to the head designer. Later on we'll take a look at some test results with both old and new machines.

Metal-Particle Tapes Arrive

The 3M Company has been working on the technology of a tape coated with pure-metal particles since 1965, which is when cassettes themselves started, though the basic work on the particle began two decades earlier. In the last couple of years, the activity in this area accelerated greatly and produced many rumors. Most of the printed discussion of problems of pure-metal particles talked about the need to prevent the actual rusting or oxidizing of the particles. There were some stories about extra fast oxidation, also known as burning, of the material. (Now, that would be a hot tape!) 3M and others, however, were solving the processing problems, and samples began to appear more regularly in early 1978. Scotch will probably gain some

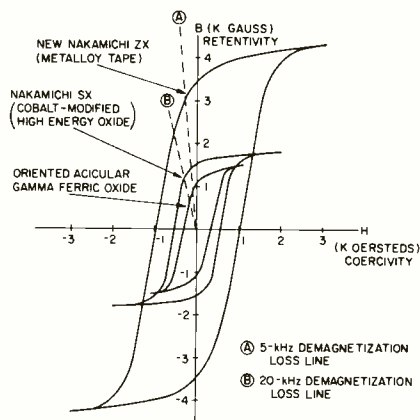

Fig. 1 — Hysteresis loop characteristics of three cassette tape formulations.



Fig. 2 — Particles used in TDK SA tape.



Fig. 3 — Particles used in TDK metal-particle tape.

points with the use of "metafine" as the name of their metal-particle tape. TDK is using "MA," and Nakamichi has "ZX," but Fuji so far says just "metal." Maxell, BASF, Memorex and Ampex have announced intentions to manufacture metal-particle tapes, but no specific information had been received at the time of this writing. Tests on the first-mentioned tapes, which are reported later, used a Nakamichi 582 deck. Other units compatible with these challenging tapes are being offered by Tandberg, Pioneer, JVC, Aiwa, Lux, TEAC, Sanyo, BIC/Avnet, Technics, Eumig, and others I expect, by the time this appears in print.

The various manufacturers have been gearing up the advertising departments, as well as the production lines, for output of metal-particle tape. Some of the manufacturers have supplied technical data, but some of the "standards" used are not the same. TDK, for example, makes comparison to TDK SA and refers to a TDK standard tape, while Scotch uses DIN references. TDK data shows the possibility of using a bias level 3.5 to 5.0 dB higher than SA bias. Increased headroom at the higher frequencies is listed as 5 to 7 dB greater. Figures 2 and 3 are photomicrographs for the particles used in TDK SA and MA (metal-particle) tapes, respectively. The thinner elements in the MA tape are actually small balls strung together, somewhat like a pearl necklace. Each little ball is about 300 Angstroms in diameter. The SA particles are not in the shape of a chain, but are needlelike, about 0.5 microns in length (5,000 Angstroms). TDK states that the coating thickness of the metal-particle tape is about 4 microns.

Bias for Scotch Metafine is shown as +6.5 dB, but this is referred to DIN ferric bias, so it is not so far removed from the bias for TDK MA as it seems at first. Scotch claims that Metafine has output twice as great as chrome tapes at low frequencies and three times as great at the high frequencies. The manufacturer states that, overall, "this results in 5 to 10 dB greater output over chrome." Additional data on Metafine and TDK MA is given in the tape-tests report in this same issue.

One concept that has received a fair amount of attention lately is the rating of magnetic tape performance by determining its signal capacity. With their extension of high-frequency response, metal-particle tapes have been touted by some as "greatly superior" because of the indicated increase in such signal capabilities. In the next section, consideration is given to this

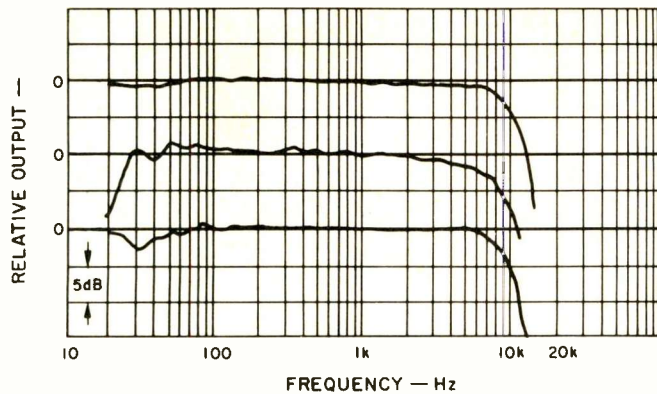

Fig. 4 — Frequency responses at Dolby level obtained using TDK SA ferri-cobalt tape in three recorders: Top, Nakamichi 582; middle, Technics RS-9900US, and bottom, Harman-Kardon HK1000.

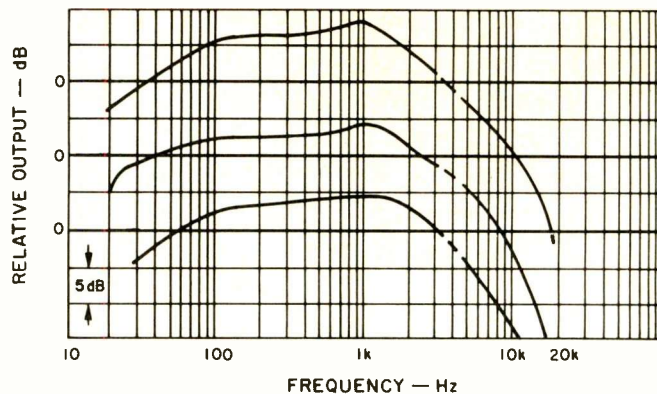

Fig. 5 — Three-percent distortion limit for TDK SA tape in three recorders: Top, Nakamichi 582; middle, Technics RS-9900US, and bottom, Harman-Kardon HK-1000. Zero reference is Dolby level.

and other ways of assessing the improvements with metal-particle tapes.

Performance Improvements: Tape or Machine?

In the process of evaluating the Nakamichi 582, the reviewer was struck by the fact that its performance with FeCo tapes was superior to the majority of machines tested in the past. Further, a review of all the data revealed two interesting things. First, although the results with the metal-particle tapes were superior, there was not as much of a difference as expected. Second, the figures that have been used to indicate the expected improvement were much closer to the difference between the Nakamichi deck with the metal-particle tape and older recorders with chrome-type formulations.

To gain some understanding on the inter-relationships, TDK SA was used for record/playback responses at Dolby level and for maximum-record-level tests. Three recorders were used, the Nakamichi 582, the Technics RS-9900US, and the older Harman-Kardon HK1000. The bias on the first two machines was adjusted to match SA; the HK 1000 had been aligned to SA previously. The maximum record levels were determined with HDL₃=3 percent from 20 Hz to 3 kHz and twin-tone IM distortion = 3 percent from 5 kHz to the upper frequency limit. Figure 4 shows that all three responses are quite good at Dolby level; the Harman-Kardon is quite impressive, considering its vintage. When the comparison is made among the machines for the distortion limit (Fig. 5), the Nakamichi has superior headroom across the entire band. The same cassette was used for the three decks, so the differences are machine related, although small shifts in bias could bring some changes.

It might be noted that the 3 percent distortion-limit curves have a slope of about -6 dB per octave and cross zero dB around 2 kHz. With the slope of much music on the order of -3 dB/octave, however, the distortion may reach the stated limit at lower frequencies first. The ability to record a wider, undistorted bandwidth with the Nakamichi comes from greater headroom at both ends of the band.

Nakamichi ZX metal-particle tape was exercised in the same way with the same three recorders, but there

were some changes. First of all, no attempt was made to adjust the Harman-Kardon deck bias to match this tape. The results would show what to expect from using such tapes in a deck actually set up for a tape similar to TDK SA. Bias was adjusted on the Nakamichi and Technics decks to match the ZX tape, using pink-noise at -20 dB. The RTA display was as expected with slight under-bias for 400 Hz with the 582 as shown in Fig. 6. Note that the highest frequencies curve upward, as they should under this condition. With slight under-bias with the Technics, however, the rise in the highest frequencies is very mild, indicative of possible self-erasure effects from the high bias (+3.8 dB re: CrO₂ zero bias). Figure 8 shows the frequency response plots, with the expected low level and high-frequency peaking on the HK1000 with the severe under-bias condition.

For the great majority of the band (see Fig. 9.), the headroom on the 582 is superior, particularly at the frequency extremes. Note, however, that the Technics has a higher limit from 5 to a little over 10 kHz. To help put a handle on some of the comparisons that can be made, Fig. 10 shows the increase in distortion limit (or headroom) across the band for two cases. The first one examines the improvement by going from the Technics RS-9900US with TDK SA to the Nakamichi 582 with Nakamichi ZX tape. There is an advantage of about 5 dB for most of the band with a rapid increase above 14 kHz. In the second case, just the 582 was used, and the differences between TDK SA and Nakamichi ZX were measured. The average improvement is about 2.5 dB which is worthwhile and nice to have, but certainly less than many of the claims that have appeared. We will get back to look at

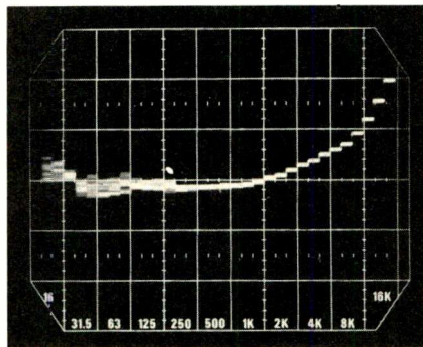
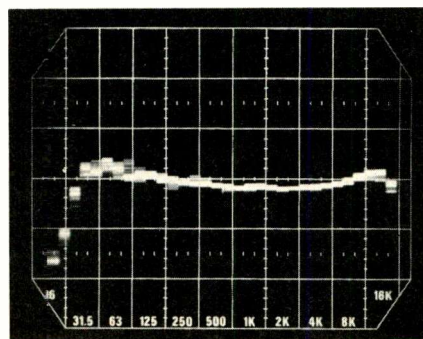

Fig. 6 — Pink-noise response with ZX tape on Nakamichi 582 with 0.5 dB under-bias at 400 Hz.

Fig. 7 — Pink-noise response with ZX tape on Technics RS-9900US with 0.5 dB under-bias at 400 Hz.



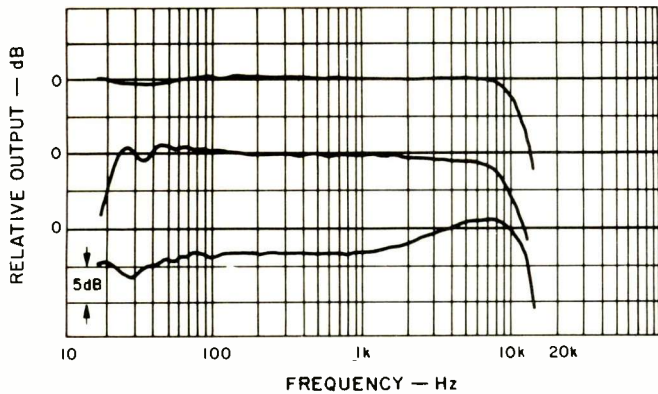

Fig. 8 — Frequency response at Dolby level with ZX tape on three recorders: Top, Nakamichi 582; middle, Technics RS-9900US, and bottom, Harman-Kardon HK-1000.

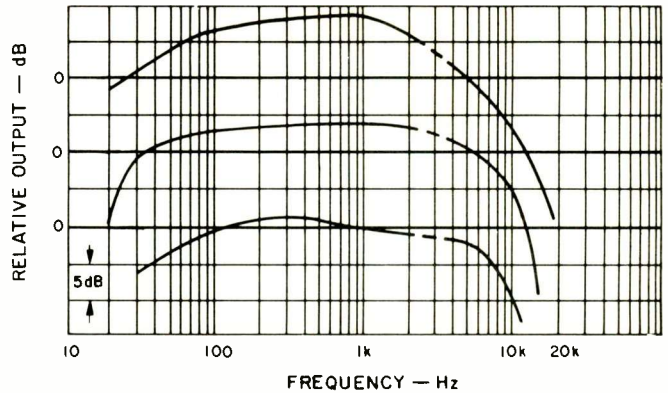

Fig. 9 — Three-percent distortion limit using ZX tape on three recorders: Top, Nakamichi 582; middle, Technics RS-9900US, and bottom, Harman-Kardon HK-1000. Zero reference is Dolby level.

these relationships from another perspective after discussing another facet of rating tape performance.

Mention was made earlier of rating tape formulations by their signal capacity. As we have just seen, the performance of a particular tape can vary a great deal from one machine to the other. One has to be very careful, then, about firm conclusions about a tape without being certain of the effects from the machine. If we refer to Fig. 10 again, we could say that there is a great increase in signal capacity if we look at the top plot, or just a useful increase if we use the bottom plot. For analog recording, forecasts of improvements in total performance based upon the increases in signal capacity can be misleading. Some of the formulas being used treat each Hz of bandwidth as equally important. A response or distortion-limit plot on this basis would have linear frequency, such as 2 kHz for each of ten divisions. With noticeable increases in head-room between 10 and 20kHz, there's a great increase in signal capacity. Before you get bowled over by numbers derived in this way, remind yourself of a couple facts. First of all, there is no way that the 10-kHz band from 10 to 20 kHz will ever be as important as the 10-kHz band from zero to 10 kHz for analog recording. Second, the levels of the harmonics keep dropping with frequency, except in rare cases. The gains with this type of recording should be assessed with frequency on a log basis. If we consider digital recording, however, the gains in signal capacity with high-end improvements can be directly helpful, they could be essential for a digital system using the cassette format.

There are some other machine-tape relationships which merit discussion. Scotch states that an erasing field of

3000 oersteds is required, and all manufacturers have commented on the problems of adequate erasure with decks not designed for metal-particle tapes, even if they have the bias capability for record purposes. A few tests confirmed that the problem is real. The Nakamichi 582 was the only one of the three used for the previous tests that was able to erase greater than 60 dB across the audio band. In most places, erasure was greater than 70 dB. On the other hand, the Technics deck had erasure of only 40 dB at lower frequencies with metal-particle tapes. Nakamichi had stated that its deck was able to do a better job than many bulk erasers. I had discounted this claim until I found that I had to use the 582 deck to do what my bulk eraser could not.

The severe challenge to using metal-particle tape in a present deck thus includes many factors. Even if the unit can generate enough bias drive to the record head for the mid-frequencies, limitations in head design could cause

a drastic self-demagnetization of the higher frequencies. The user may also have to face the problem of being unable to erase what was put on the tape. Further, he is likely to find out that his bulk eraser can't hack it either. Mine looks impressive, and it says "professional" on it, but it didn't do the job.

Is Metal-Particle Tape Worth It?

The new metal-particle tapes do provide worthwhile improvements in total sonic performance when used with a well-designed deck. It should be clear from the previous discussion that using such tape is not a simple case of throwing another cassette into your present machine. It is quite probable that the new tapes will stick to the 70- μ S EQ, which would allow playing pre-recorded tapes with such formulations on existing machines. There are certain to be some hobbyists who will make modifications to their present machines, but the challenges

Fig. 10 — Increase in distortion limit vs. frequency for Nakamichi ZX tape over TDK SA tape. Top, results with ZX tape on Nakamichi 582 deck and SA on Technics RS-9900US deck. Bottom, results with both tapes on Nakamichi 582. See text.

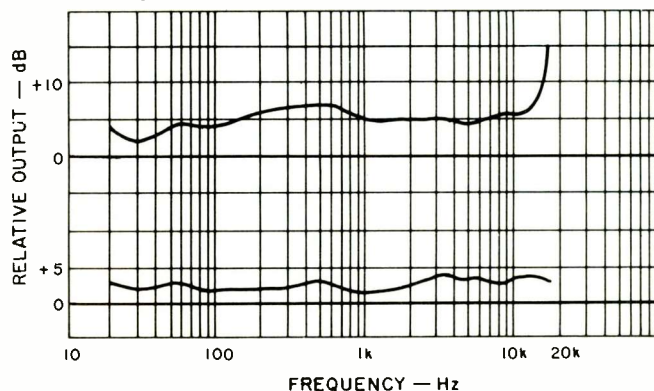

are many, and this approach cannot be given a general recommendation.

There will be an increasing number of new decks that will have the basic capability to utilize metal-particle tapes. As the text above showed, the requirements for record and erase heads are very severe and a great challenge to the designer. Some will obviously be more successful than others.

Specific points to check when contemplating purchase include the following: (1) erasure, particularly at low frequencies, (2) headroom across the entire audio band, and, (3) the means of setting and checking bias for best response. The combination of a deck, well designed in these and other respects, and metal-particle tape could very well be a most worthwhile

change for many owners of present decks. It is also possible that other new decks will offer improved performance with all formulations, as evidenced with the Nakamichi 582.

The Future

It is to be expected that the metal-particle tapes will continue to improve; the results reported else-

METAL CASSETTE TESTS

Howard A. Roberson

Sample cassettes of the new metal-particle tape formulations have become available just in time for this issue. There has been great anticipation of their appearance, and the results provide evidence of truly significant improvement in most performance parameters. With the limited number of samples available, it was not possible to obtain our usual three samples of each length, which number facilitates checking consistency and determining what is typical. Cassettes were received from Fuji, Nakamichi, Scotch and TDK.

Manufacturer's Specifications

Technical data sheets were provided by some of the manufacturers, but there was quite a range in the amount of information delivered. The entries shown in Table I do not cover all the details, but much essential data is shown. Take especial note of the values for coercivity and retentivity for the various formulations. Note there is about a 2:1 increase in coercivity going from high-bias tapes to the metal-particle tapes, approximately 600 to 1000 or more oersteds. We would expect to find improving high-frequency performance



where in this issue used early-run samples. Perhaps the prices will be quite close to those for FeCo and CrO₂ tapes. And, we should expect to see improvement in performance because of up-dating in the deck designs, particularly the heads. In other words, we will see greater headroom and wider response in the future, with contributions from both types of manufactur-

ers. Areas worthy of particular attention by the engineers are improved consistency, lower modulation noise and lower distortion at the frequency extremes. Perhaps there will be standards established for bias to minimize the possible spread in tape bias requirements without such a guideline.

Refinements should be expected to continue with ferric, FeCo and CrO₂

formulations, upgrading their performance. Du Pont states that CrO₂ still has considerable undeveloped potential for audio cassettes. The FeCr tapes and their future is problematical: There are only three formulations, so deck makers may not want to keep such a switch position with the metal-particle tapes on the scene — and they are here to stay. A

Table I — Manufacturer's Specifications

BRAND OR MAKER	TAPE NAME	COER. Oer.	RET. Gau.	REM. Max.	SQU. RAT.	SENS. dB	BIAS dB
Fuji	Metal						
Nakamichi	ZX						
Scotch	Metafine	1000	3400	0.51		+3.0	6.5
TDK	MA-R	1050	3000		0.80	0.0	

Notes: "COER." and "Oer." are coercivity and oersteds respectively. "RET ." and "Gau." are retentivity and Gauss respectively. "REM." and "Max." are remanence and Maxwells respectively. "SQU. RAT." is squareness ratio. "SENS." is sensitivity at 333 Hz.

with these changes. As for retentivity, there is a jump of about 2:1 in going to the metal-particle formulations, so we should find measurable improvements in maximum record levels. There are a number of inter-related factors which are discussed more fully in the separate article on metal tape characteristics.

Tests Performed

As in the previous tests on cassettes, bias of the test recorder was adjusted to show each formulation at its best. There was no so-called standard tape, which would make others look poorer in comparison. The metal-particle cassettes were evaluated on the Nakamichi 582, which has the requisite capabilities for recording and erasing these high-coercivity tapes. Because there are no industry standards as of this date, record sensitivity was referenced to Nakamichi ZX. As there was no bias-current monitor, an indication of the bias needs for each of these tapes was gained, in a relative sense, by changing bias from optimum to that for Nakamichi ZX and noting the change in response at 15 kHz. The reference level used for all tests was a fluxivity of 200 nWb/m at 400 Hz, which is Dolby level for cassette tapes. The reference record level, then, was that which obtained this flux level. Record/playback responses were run at Dolby level and 20 dB below that. For each tape, adjustments to bias and

the record-head azimuth were made just before sweeping. The Crown RTA-2 was used for the pink-noise source and the 1/3-octave real-time display, which greatly facilitated these adjustments.

The source for the swept plots was an Exact 128 function generator with portions of a UREI 200 plotting system feeding an MFE X-Y recorder. A Sound Technology 1701A was used for a signal source, level monitoring and to measure distortion at 100 Hz, 400 Hz, 1 kHz and 2 kHz. A Ferrograph RTS-1 was used as the second signal source for twin-tone IM tests, with the tones 1 kHz apart. Data was taken for HDL₃ = 3 percent for the single tones and also 3 percent for the (2f₁-f₂) distortion product for the twin-tone tests. Two checks were made, with the lower frequency, f₁, equal to 5 kHz and 10 kHz. A Hewlett-Packard 3580A spectrum analyzer showed the levels of both fundamentals and upper and lower sidebands. It should be understood that this twin-tone IM distortion limit is more restrictive than a simple saturation test. The signal-to-noise ratios were referred to the 3 percent distortion limit for 400 Hz and used IEC "A" weighting. A Nakamichi T-100 secured the dBA figures, and was also used as the bias level monitor for the Technics RS-9900US, as well as for some brief flutter checks. Past experience had shown that the great majority of cassettes are quite similar as far as flutter

performance is concerned. Most of them give a variation in readings just from stopping and starting, reinserting, etc. A few are consistently better than most, and there's the occasional dog that is much worse.

Modulation noise was measured by recording a 1-kHz tone at reference level, rewinding and playing it back. A UREI 560 feedback suppressor notched out the tone, and band limiting was introduced at 500 Hz and 1500 Hz with a Gen. Rad. 1952 filter set. The checks on amplitude stability and drop-outs were made with the H-P 3580A in zero scan mode tuned to the 3 kHz tone that was recorded. A sweep rate of 2S per division showed the slower variations, and the sweep rate of 50 mS/div. showed slower detail on drop-outs.

The consistency from cassette to cassette among the samples supplied was verified primarily with the Crown RTA-2. Adjustments, such as bias and head azimuth, were made with one cassette. Then, all other samples were tried with these same settings. Bias or skew differences immediately appeared as a roll-off at the highest frequencies. Sensitivity variations were revealed with checks with the test oscillators built into each test recorder.

Test Results

There were a total of four metal-particle cassettes tested, including ones from Fuji, Nakamichi, Scotch, and TDK. They have, of course, generated

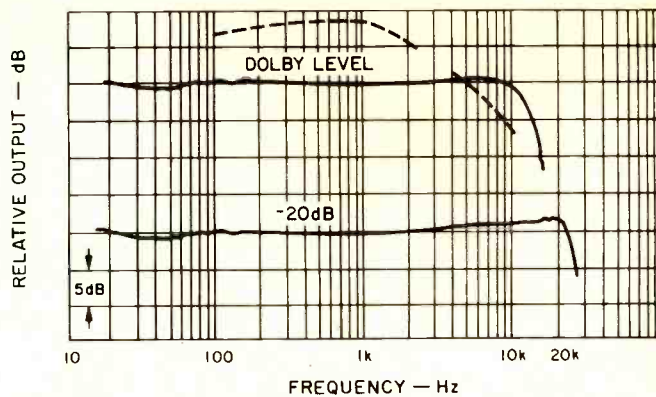
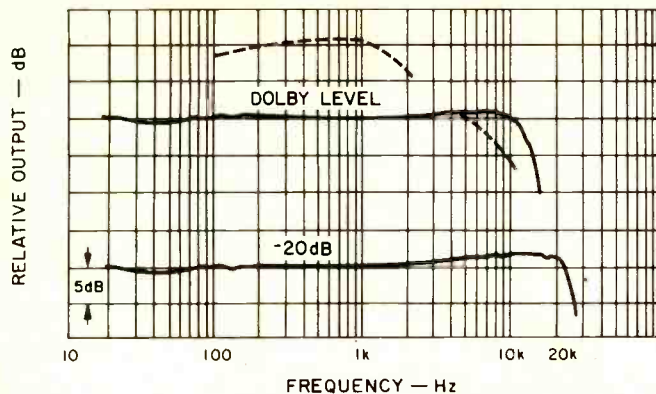

Fig. 1 — Frequency responses and three-percent distortion limit (dashed line) for Fuji metal-particle tape.

Fig. 2 — Frequency responses and three-percent distortion limit (dashed line) for Nakamichi ZX tape.

a good deal of interest, particularly among the technical community.

Now, we get to the highlight of this report: How well *did* the metal-particle tapes do? It has become somewhat common practice to refer to these formulations as "metal" tape, but we hope our readers know that the base of the 0.150-in. wide tape is still Mylar. The particles on the base may be pure, non-oxidized metal, but we do not have a solid metal ribbon. When comparing the results in Table II with the text below, remember that further insight into a number of the inter-related factors is provided in the accompanying article on metal-particle tape.

Fuji Metal: Reference To Table I will show that this formulation offers the highest headroom at low and mid frequencies, up to +10.6 dB (!), and the highest signal/noise ratio in this category. The responses are extended at both 0 dB and at -20 dB, particularly in comparison with the other types of tape in the table. C-60s were consistent in all respects, as were the C-46 samples received. There was very little amplitude variation with time, perhaps 0.1 dB. There were rare, unimportant drop-outs.

Nakamichi ZX: This tape had headroom of +9.0 dB at 1 kHz and wide responses similar to the Fuji tape. The sensitivity and bias settings for this tape were used as reference points for the other tapes. Insufficient samples were on hand to check for consistency. There were some random amplitude variations, usually less than 0.25 dB. There were occasional drop-outs of a minor nature.

Scotch Metafine: If nothing else, Scotch ought to get a few points for naming their formulation "Metafine." In the actual performance, this tape had the most extended responses, better-than-average headroom across the band and better-than-most signal/noise ratio. The headroom at 5 and 10 kHz was the best of the group. The modulation noise, however, was the highest of the category. The C-46 samples were generally consistent for sensitivity, skew and bias needs, but there was a skew change with turning cassettes over. Some earlier C-60 samples were actually very similar in all respects. There was a general variation of 0.3 dB in amplitude that was quite continuous. There were a few minor drop-outs shown on the analyzer,

which were not detectable in listening. **TDK MA-R:** This entry into the metal-particle sweepstakes had responses very close to Scotch Metafine and the lowest modulation noise. The headroom was a bit less than the others at the lower frequencies, but quite close over the rest of the range. The C-60 samples were exactly consistent in sensitivity, bias and skew, including turning the cassettes over. This could very well have been aided by the refined cassette "mechanism" used by TDK. The amplitude was generally very steady and smooth, with just an occasional variation of 0.2 dB. There were rare, medium drop-outs which were not detectable in listening.

Summary

There is no doubt that this new category of tape has more to offer than any of the others. Improvements are evident in frequency response, headroom all across the band, and signal-to-noise ratio. The modulation noise did not show the same improvement, however, nor was consistency better than a number of older tapes. This is the beginning of production though, and it is to be expected that there are

Table II — Test results.

BRAND OR MAKER	DESIGNATION TYPE	RESPONSE AT		MAXIMUM RECORD LEVEL						S/N RATIO dBA	MOD NOISE -dB	400-Hz SENS dB	BIAS dB
		0 dB Level	-20 dB Level	HDL ₃ = 3%				TT IM = 3%					
				100	400	1k	2k	5k	10k				
Fuji	Metal Particle	12.8	24.6	+9.0	+10.6	+10.6	+7.1	0.0	-5.8	62.5	49.7	+0.5*	+1.2**
Nakamichi	ZX (Mtl. Part.)	12.7	24.7	+7.2	+8.8	+9.0	+6.1	0.0	-6.0	60.0	50.3	Ref.	Ref.
Scotch	Metafine	13.3	25.5	+8.2	+9.1	+8.7	+7.0	+0.2	-4.6	61.6	47.0	+1.2*	-5**
TDK	MA-R (Mtl. Part.)	13.0	25.0	+5.7	+7.2	+7.9	+6.6	-0.5	-6.3	60.3	52.7	-0.5*	0.0**

* The record sensitivities shown are those relative to the sensitivity of Nakamichi ZX.

** The figures shown for bias for the metal-particle tapes are not actual bias values. Listed for each of the tapes is the change in its response at 15 kHz when shifting bias to that for Nakamichi ZX tape. See text.

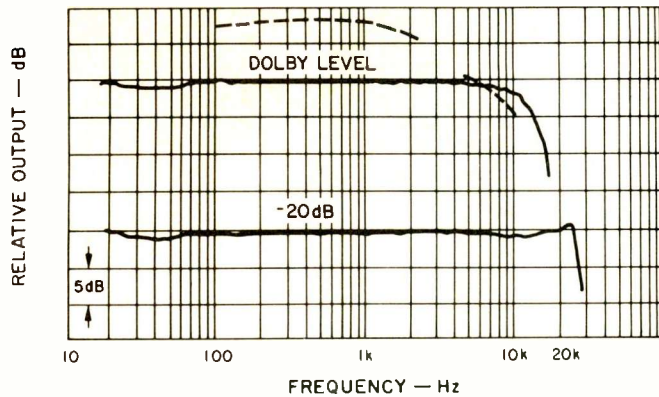

Fig. 3 — Frequency responses and three-percent distortion limit (dashed line) for Scotch Metafine tape.

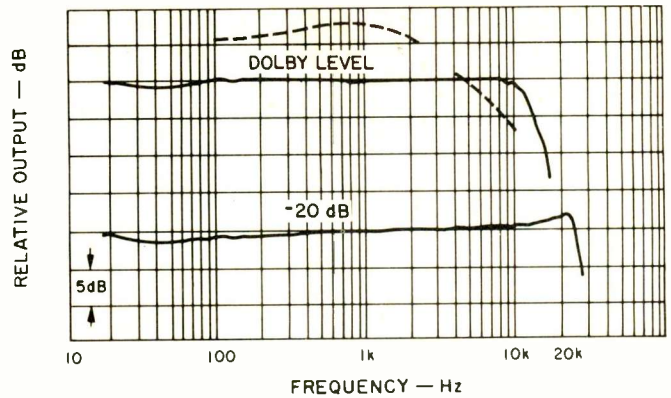

Fig. 4 — Frequency responses and three-percent distortion limit (dashed line) for TDK MA-R tape.

more advances to be made with the new materials. There are a number of things to be standardized for the metal-particle tapes, and there must be standard test tapes for everyone to refer to. Along with that there may be a standard bias established. In the results reported here, note that the Scotch Metafine would be down 5 dB at 15 kHz with Nakamichi ZX bias, or the Nakamichi ZX would be up about 5 dB with Metafine bias. Competition

is intense in the tape area, and we can expect to see continuing improvement from all of the manufacturers.

Can I Use Metal-Particle Tape?

The results given here were obtained with a Nakamichi 582, which was designed to use metal-particle tape. The performance figures given go with those tapes tested and the particular machine. With further

changes, it is possible (read probable) that the data will be even closer to open-reel results. Using a metal-particle tape on a machine not designed for it could actually be quite disappointing, with both recording and erasing problems. Such use is not recommended. Reference should be made to the accompanying article which includes coverage of such facets. It could aid in any evaluation of a deck offering metal-particle-tape compatibility. **A**

Signet dealers are a breed apart.

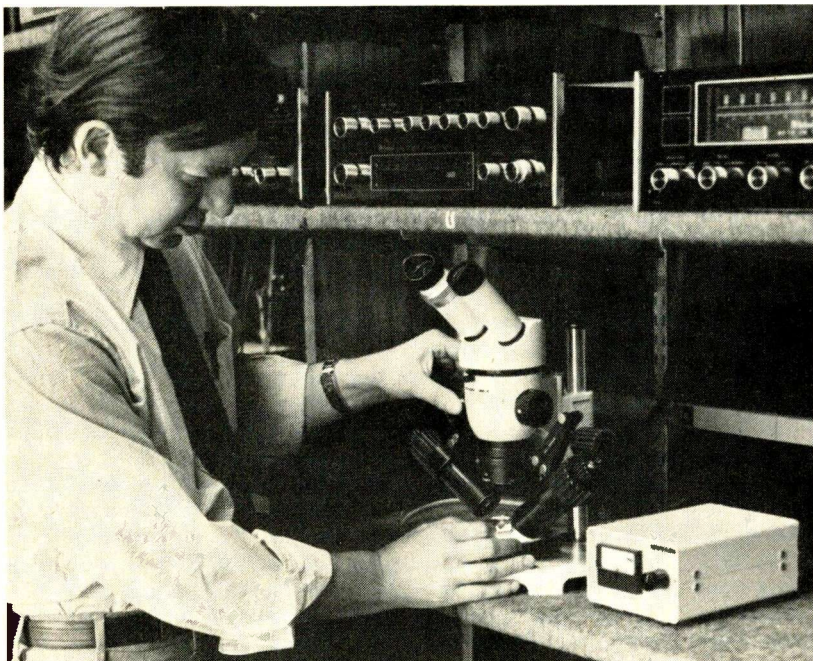

Simon Zreczny, Pres., *Audio Consultants*, Libertyville and Evanston, IL

They don't just sell merchandise. They get involved. In the how and why of sound reproduction. And they don't take anything for granted.

For instance, to hold a Signet franchise, each dealer must have—and know how to use—a powerful microscope. Like the \$5,500 Wild-Heerbrugg stereo Model AT-M5A we helped to develop. It reveals in intimate 3-dimensional detail the construction and condition of any phono stylus.

We think it's important that your dealer be able to check your stylus for wear, tip geometry, tip polish, damage or dirt. Signet dealers agree.

But they also use their microscope to take a critical look at new cartridge products—ours and others. To see for themselves the quality of this critical component. We wouldn't have it any other way.

If your audio standards are high, your Signet dealer is worth seeking out. Write us and we'll introduce you to him and our current Signet products. We honestly believe you'll appreciate the difference.

SIGNET DIVISION, A.T.U.S., Inc., Dept. 99A-2, 33 Shiawassee Avenue, Fairlawn, Ohio 44313

Equipment profiles

Rotel RT-2100 Stereo FM Tuner

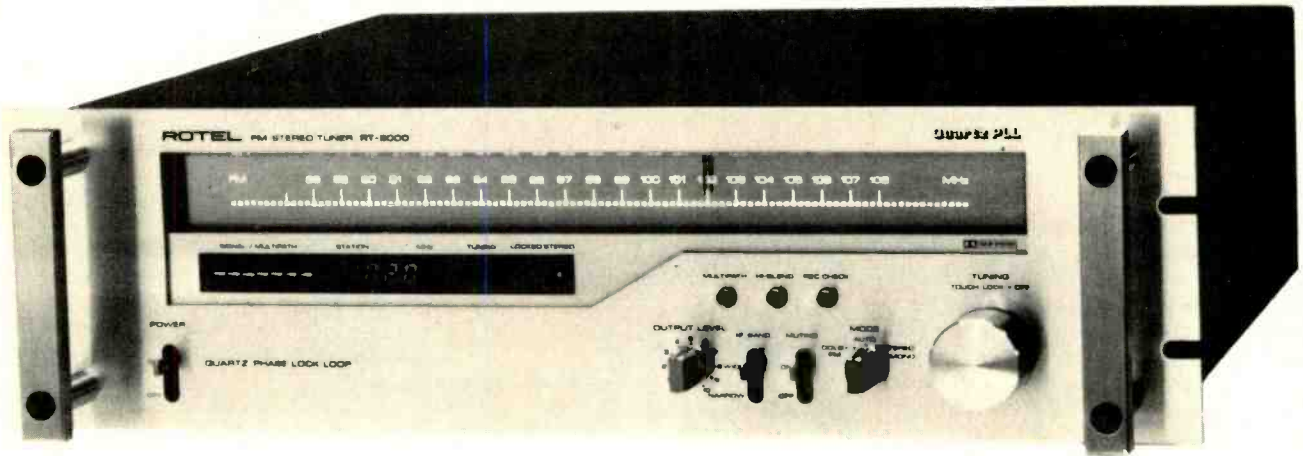

58

MANUFACTURER'S SPECIFICATIONS

Usable Sensitivity: Mono, 9.3 dBf (1.6 μ V, 300 ohms).

50-dB Quieting: Mono, 14.7 dBf (3 μ V); stereo, 36 dBf (35 μ V).

S/N: Mono, 80 dB; stereo, 75 dB.

THD, 100 Hz, 1 kHz and 6 kHz: Mono, 0.05 percent wide, 0.15 percent narrow; stereo, 0.07 percent wide, 0.2 percent narrow.

Frequency Response: 30 Hz to 15 kHz, +0.3 dB, -1.0 dB.

Capture Ratio: 1.0 dB.

Selectivity: 45 dB wide; 80 dB narrow.

Image and I.F. Rejection: 115 dB.

Spurious Response Rejection: 90 dB.

AM Suppression: 65 dB.

Muting Threshold: 15 μ V (28.7 dBf).

Stereo Separation: Wide, 45 dB @ 1 kHz, 40 dB @ 100 Hz and 10 kHz; narrow, 45 dB @ 1 kHz, 40 dB @ 100 Hz and 10 kHz.

Sub-Carrier Rejection: 65 dB.

SCA Rejection: 70 dB.

Output Level: 0.775 V fixed; 0 to 1.5 V variable.

General Specifications

Power Requirements: 120 V, 50/60 Hz, 25 watts.

Dimensions: 19 in. (45.25 cm) W x 5 $\frac{1}{8}$ in. (14.23 cm) H x 12 $\frac{3}{8}$ in. (32.7 cm) D.

Weight: 16 $\frac{1}{2}$ lbs (7.5 kg).

Price: \$600.00

Whether on the test bench or installed in a hi-fi system, Rotel's top-of-the-line RT-2100 stereo FM tuner turns out to be a rather fine performer. While we could quibble with the owner's manual describing this unit as having an AM section — there is none — this really is pretty minor. In any case, the front panel is sized for standard rack mounting and is complete with properly spaced screw-notches at each end and a pair of rugged looking handles. The dial area is pan-handled in shape, carrying over an asymmetrical style that has become identified with other Rotel products, such as their amplifiers and receivers. In this instance, the irregularly shaped cutout serves a definite purpose. The "deep" portion of the cutout at the left incorporates the combination LED signal-strength metering system/multipath indicator, a four-digit digital readout of tuned-to frequencies, "tuning" and "locked" LED indicators (about which more in a moment), and a stereo indicator light. Running the full length of the cutout is a linearly calibrated FM frequency scale, with each MHz divided into four marked increments (250 kHz each?), and a conventional moving dial pointer.

The power On-Off toggle switch is at the lower left, while at the lower right are a rotary output level control, an i.f. bandwidth switch (with "Wide" and "Narrow" settings), muting On/Off switch, a mode selector switch (with posi-

tions for *Auto-FM*, *Mono*, *Dolby FM*, and *Stereo Only*, and the flywheel-coupled rotary tuning knob. Three small push-buttons just under the dial opening in this area of the panel are used for altering the signal-strength LED display to a multipath indicator, introducing a high-blend filter (for weak-signal stereo reception), and activating a built-in 400-Hz record-calibration tone.

To the right and left of the aforementioned "tuning" indicator LED (which is colored green) are a pair of red arrows which tell the user which way to tune to attain optimum tuning. The touch-lock tuning system of the unit is by now familiar to most readers, since this approach has been used by several tuner and receiver manufacturers. So long as you grip the tuning knob, the built-in, quartz-referenced, phase-lock-loop type of AFC is deactivated. Once you have tuned to a station (as indicated by the red and green LED combination of indicators) and release the knob, this sophisticated form of AFC "locks" onto the signal and counteracts any drift or compensates for slight detuning. Releasing the tuning knob causes the "locked" light to come on, giving the user the visual assurance that, indeed, optimum tuning has been achieved and will be maintained. Though the owner's manual does not indicate it, this ultra-sophisticated circuit can be deactivated by turning off the muting switch, and we used

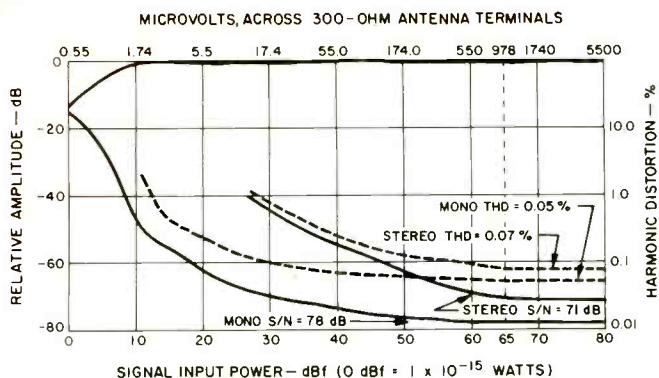

Fig. 1—Mono and stereo quieting and distortion characteristics of the Rotel RT-2100 in "wide" i.f. mode, 1 kHz, 100 percent modulation.

this setting for our distortion measurements to get around a slight misalignment in the auto-lock circuit of this sample. As we will see later, this manual tuning resulted in truly magnificent distortion figures obtained in our bench tests.

The rear panel is equipped with 300-ohm and 75-ohm antenna terminals, the latter being available either as a terminal or in the form of a coaxial connector. In addition to the pairs of fixed and variable-level output jacks, there is a detector output jack for possible use if and when four-channel stereo FM broadcasting is approved.

No information regarding circuit configuration is provided in the multi-lingual owner's manual, but an examination of the internal layout of the chassis disclosed a five-gang tuning

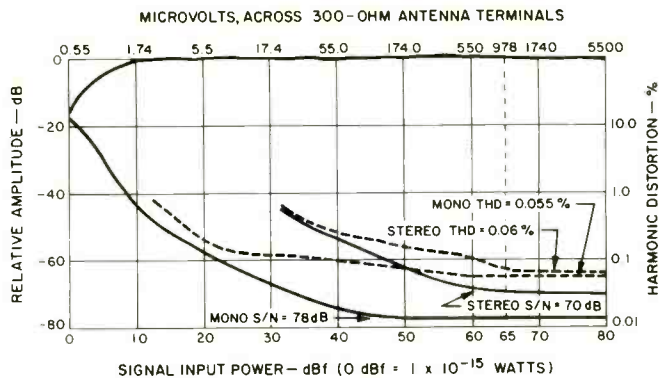
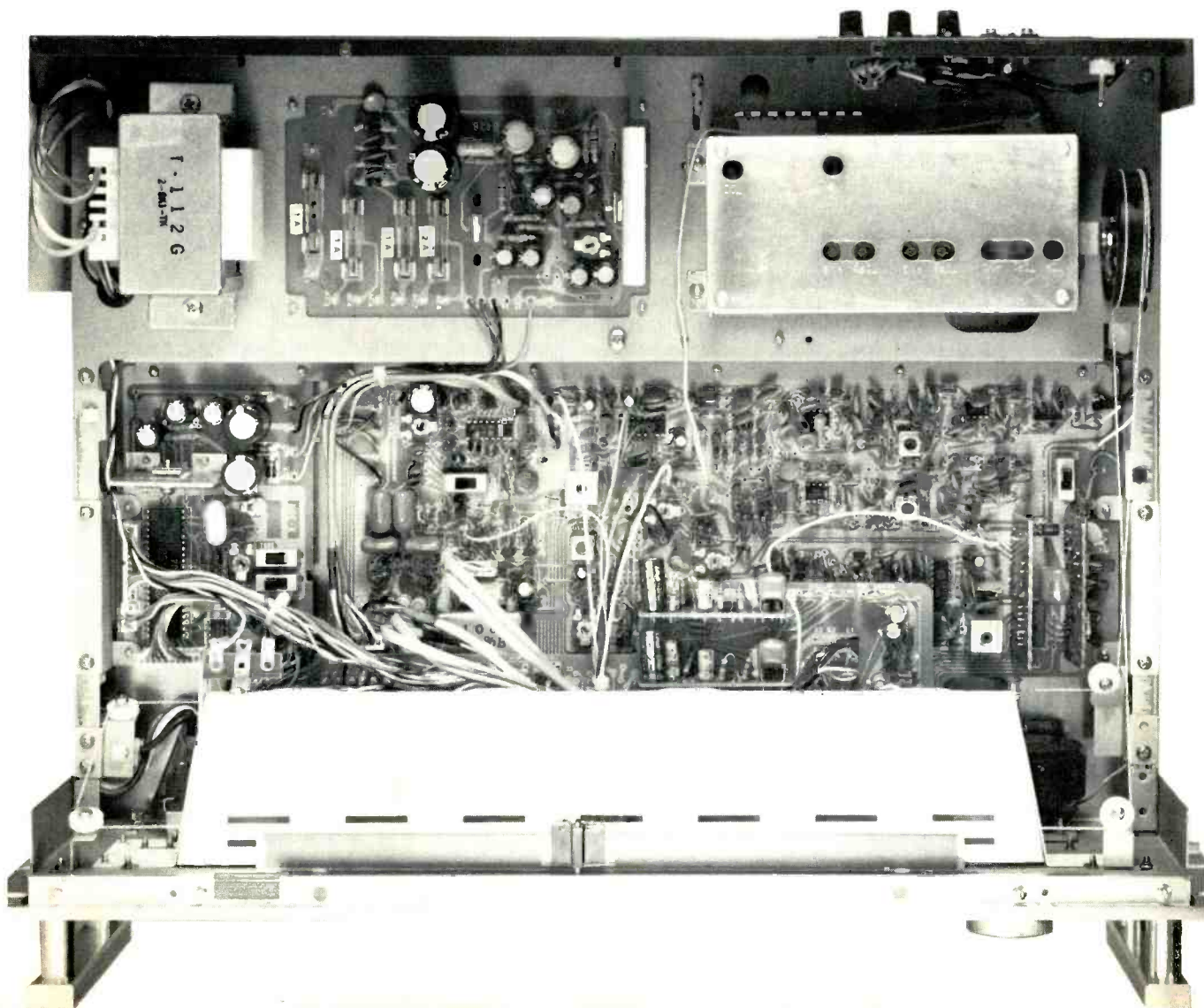

Fig. 2—Mono and stereo quieting and distortion characteristics in "narrow" i.f. mode, 1 kHz, 100 percent modulation.

capacitor, a well-shielded front-end and i.f. section, and generally neat and orderly layout of the major and minor circuit boards. The well-marked adjustment points (all in English, this time) would make servicing and alignment of this unit fairly easy to accomplish, and we were tempted to "touch up" the auto-lock circuitry but refrained from tampering with the factory settings.

Laboratory Measurements

Two sets of measurements of most parameters were required for this report; one for the "wide" i.f. mode, the other for the "narrow" mode. In the "wide" setting, usable sensitivity in mono was 10.7 dBf (1.9 μ V), while signal strength for



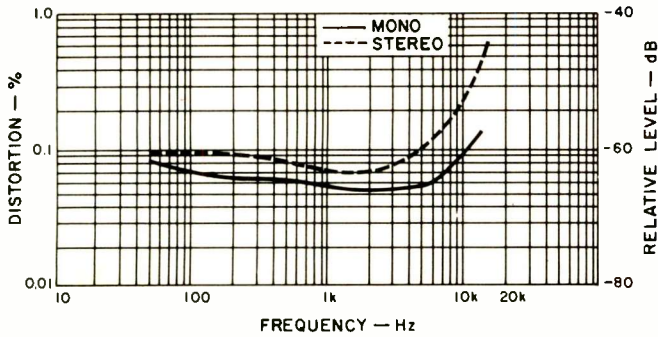

Fig. 3—THD vs. frequency in the "wide" i.f. mode.

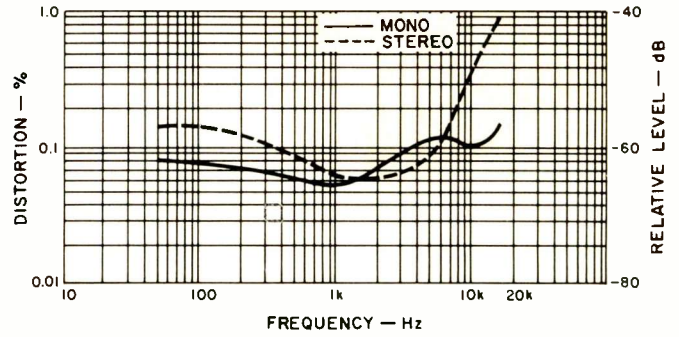

Fig. 4—THD vs. frequency in the "narrow" i.f. mode.

50-dB quieting measured an incredibly low 10.3 dBf (1.8 μ V) in mono and an also impressively low 34.7 dBf (30.0 μ V) in stereo. Signal-to-noise ratio at 65 dBf in mono was 78 dB, decreasing to 71 dB in stereo; both figures are a little poorer than claimed but certainly more than simply adequate. For a 1-kHz signal, THD measured 0.05 percent in mono and almost as good 0.07 percent in stereo. These quieting and distortion characteristics are plotted as a function of input signal strength in Fig. 1.

Figure 2 is a plot of the same characteristics, this time for the "narrow" i.f. setting. The mono 50-dB quieting point was a bit poorer this time, with readings of 2.5 μ V (13.2 dBf), though ultimate S/N remained the same for mono, decreasing slightly to 70 dB for stereo. An unusual thing about this setting was that the THD for 1kHz was just about as good as it had been in the "wide" setting, measuring 0.055 percent in mono and 0.06 percent in stereo, the latter figure actually a shade better than in the "wide" mode. As can be seen from Figs. 3 and 4, there is a moderate improvement in distortion when using the "wide" i.f. setting as far as the frequency extremes are concerned. Thus, in the "wide" mode, THD at 100 Hz and 6 kHz measured 0.07 percent and 0.095 percent in mono respectively and 0.09 percent and 0.11 percent in stereo, while for the "narrow" mode, THD in mono at 100 Hz and 6 kHz measured 0.075 percent and 0.13 percent, and for stereo the readings were 0.15 percent and 0.1 percent. Based on the all-around excellence of these distortion measurements alone, one could not totally justify the added expense of providing the two i.f. bandwidth selections, what with the level of performance attained by the "narrow" section.

In the case of stereo separation, however, the availability of these two modes proved to be of somewhat greater significance, as can be observed in Figs. 5 and 6. The lower trace of Fig. 5 is a plot of cross-talk, or output in the right channel when a left-only signal is used to modulate the carrier. Separation at the three key test frequencies of 1 kHz, 100 Hz, and 10 kHz measured 49 dB, 43 dB, and 47 dB. The middle trace in Fig. 5 shows what happens to separation when the high-blend filter is introduced to reduce noise from weak-signal stereo signals. Figure 6 shows separation versus frequency using the "narrow" i.f. mode. Separation decreased to 43 dB at 1 kHz, 44 dB at 100 Hz, and 37 dB at 10 kHz. Vertical calibration in the 'scope photos of Figs. 5 and 6 is, as usual, 10 dB per vertical division.

Discerning readers may note that the meter-read separation figures just quoted do not always agree with the observed cross-talk in our frequency-sweep spectrum analyzer 'scope photos. That is because a single-meter reading of cross-talk includes output products in addition to the fundamental modulating frequency fed to the other channel. Figure 7 illustrates this point and was taken with a 5-kHz signal applied to the left channel (tall spike at left) and using a linear sweep of the analyzer (5 kHz per horizontal division). Storing the 5-kHz spike, a sweep was then made of the right channel output. Contained within the tall original 5-kHz spike is the 5-kHz true cross-talk component, but to the right of it can be seen second- and third-order distortion components and, further to the right, we see the 19-kHz, 38-kHz, and other unrelated output components.

Capture ratio in the "narrow" setting measured 1.2 dB, improving to the claimed 1.0 dB in the "wide" setting. Selectivity in the "narrow" position was 80 dB, as claimed. Spurious, image, and i.f. rejection all measured in excess of 100 dB, while AM suppression measured 63 dB. The Rotel RT-2100 has built-in Dolby decoding circuitry and, in Fig. 8, we see how the Dolby circuit acts at decreasing modulation levels. The upper trace corresponds to 50 percent modulation or Dolby calibration level.

The IHF Tuner Measurement Standards call for an IM distortion measurement commonly known as CCIF-IM. In this

60

Fig. 5—Stereo FM frequency response (upper trace) separation (lower trace), and separation with MPX filter (middle trace) in the "wide" i.f. mode.

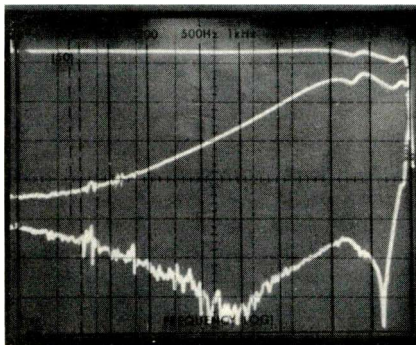
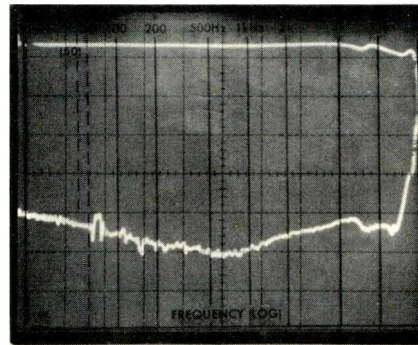

Fig. 6—Stereo FM response (upper trace) and separation in the "narrow" i.f. mode.



The best-sounding headphones



are also the most comfortable.

The Sennheiser HD 430's are so light you'll soon forget you're wearing them. But you'll never forget the sound. You'll hear, on your audio system, sound qualities you didn't know you had. Brilliant trebles, accurate mid-range notes. And the bass! Because of the unique Sennheiser Open-Aire® design, the bass notes come through with all the authority you'd expect to hear from the best concert seat in the house.

The HD 430's are only one of a complete line of

Sennheiser Open-Aire headphones — each designed to give you the best possible sound for your particular requirements. They're available at quality dealers across the country — just drop us a postcard for the name of the one nearest you.

 **SENNHEISER**

...the one the dealers take home, themselves.

SENNHEISER ELECTRONIC CORPORATION: 10 West 37th Street, New York, N.Y. 10018, (212) 239-0190
Manufacturing Plant: Bissendorf/Hannover, West Germany

Fig. 7—Cross-talk and distortion components in unmodulated channel, referenced to full modulation of a 5-kHz signal in the opposite channel, in the "wide" i.f. mode.

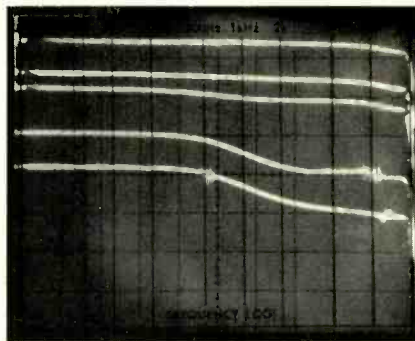
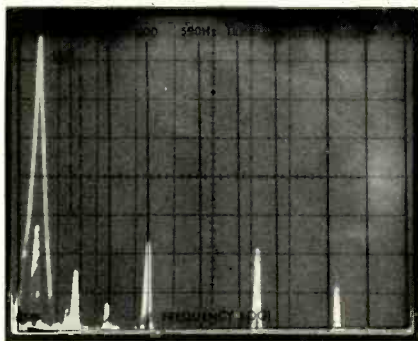

Fig. 8—Action of FM Dolby decoding circuitry at various levels of modulation.

measurement, two tones (14 kHz and 15 kHz) are used to modulate the generator to peaks of 100 percent modulation, and the resultant "beat frequency" of 1 kHz appearing at the output is expressed as an IM distortion percentage. Our lab is now equipped to make this measurement, and these measurements were made both with manual tuning and using the AFC feature. Results are as follows:

In the "wide" i.f. mode IM in mono measured 0.016 percent when manual tuning was used and 0.16 percent when relying upon the PLL auto-lock circuit. For stereo, manual tuning brought the IM down to 0.04 percent, while 0.067 percent was obtained with the auto-lock system. The measurements were repeated for the "narrow" i.f. setting. This time, manual tuning in mono resulted in an IM reading of 0.02 percent which increased to 0.14 percent when the automatic tuning system was activated, while for stereo the readings were 0.026 percent for manual tuning and 0.058 percent for "auto tune."

To further illustrate this technique, we plotted the output of the tuner on our spectrum analyzer with the two test tones applied. Fig. 9 shows the 14-kHz and 15-kHz test tones at the extreme right of the "scope photo, while near the center we see the (approximately) 1-kHz "difference" component. To emphasize the effect, the plots were taken with the tuner in the "auto tune" setting, where we knew that the IM components would be higher.

Interestingly, in stereo, the 1-kHz component observed (at the center of Fig. 10) is actually much lower than it was for mono, confirming the meter readings obtained earlier. However, in Fig. 10 we also see several products arising at the higher frequencies caused by different combinations of beats between multiples of the 14-kHz and 15-kHz frequencies. The CCIF IM method does not call for inclusion of these components in the final IHF-IM reading. However, in the new IHF Amplifier Measurement Standards, such components are to be included in the IHF-IM measurement and, where applicable, we will attempt to report such IM mea-

surements in future amplifier test reports which we are called upon to prepare for *Audio*.

Muting threshold as well as stereo switching threshold were both set at $16 \mu\text{V}$ (29.3 dBf) on our sample, a little high in view of the excellent quieting and low distortion characteristics of the tuner. Of course, the muting is defeatable should the user wish to search for distant, weaker signals.

Listening and Use Tests

For all our criticism of some of the test results obtained for this sample, we must admit that the tuner performed extremely well during the listening tests that followed. In our closed-circuit tests (wherein we "transmit" our own program sources via our r.f. generator to the tuner under test), A-B tests between directly amplified reproduction of some of our favorite direct-to-disc recordings and "off-the-air" pickup of the same program material disclosed little, if any, audible differences. By the same token, we could also detect no difference in sound quality when switching from the "wide" to the "narrow" i.f. modes. In real off-the-air tests, the tuner was able to pick up every station which we normally receive in our test location with excellent quieting. The multi-path indicator works well and is a true aid in proper antenna orientation, and the same LEDs, when used to determine signal strength of an incoming signal, are intelligently calibrated so that wide ranges of signal strength can be clearly interpreted. Closed-circuit tests of the Dolby circuitry confirmed that Dolby calibration was just about perfect and, at weak signal levels, the improvement in S/N with Dolby FM is so impressive that we wonder why more stations do not avail themselves of this broadcast system, which requires no special approval by the FCC and may be adopted by any FM station in the United States.

All in all, then, here is a tuner which is well engineered and delivers quality FM reception to those who may be fortunate enough to live in an area where quality FM is in fact broadcast.

Leonard Feldman

Enter No. 90 on Reader Service Card

Fig. 9—IM distortion, mono, in auto-tune mode.

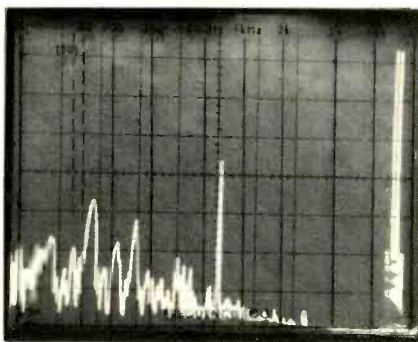
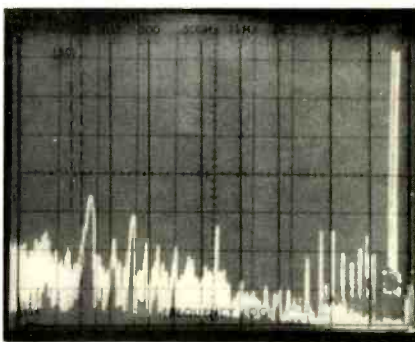
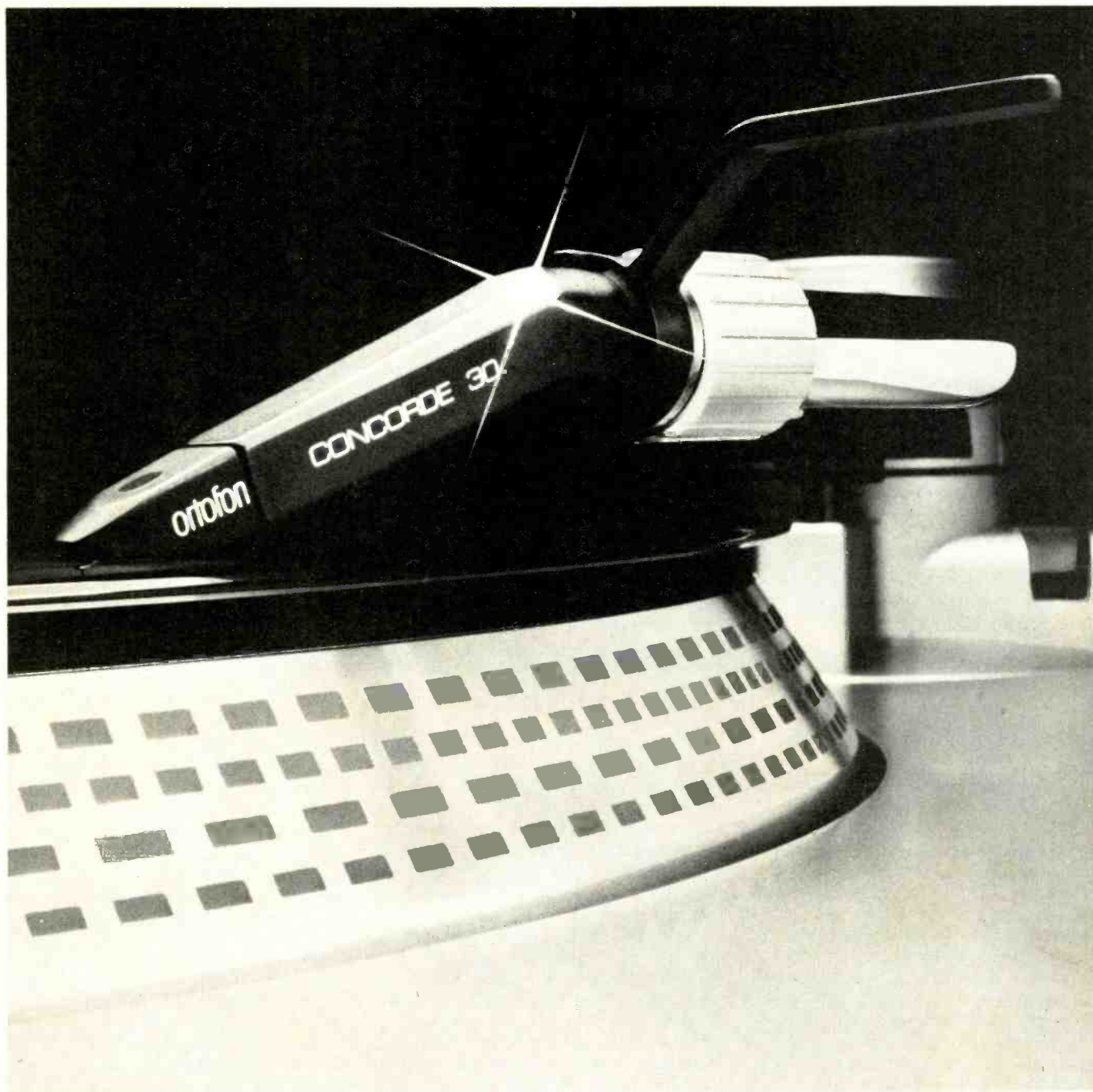

Fig. 10—IM distortion, stereo, in auto-tune mode.





LAUNCHING A NEW ERA IN THE REPRODUCTION OF MUSIC FROM RECORDS.

A strong claim, but true. The Concorde combines a cartridge and headshell in a single form, but weighs less than most headshells alone. The reduction in record wear and distortion, and the ability to track accurately despite warpage, pay incalculable dividends to music lovers.

Ortofon dealers are now ready to demonstrate the Concorde. It's worth a visit just to see and hear this remarkable cartridge that stands at the very frontier of music reproduction technology. For complete information write: Ortofon, 122 Dupont Street, Plainview, New York 11803.

ortofon 

Enter No. 27 on Reader Service Card



64 Warp Out Record Weight

\$15.00.

The existence of a product such as Warp Out is a sad but accurate commentary on the pressing quality of many records being sold to the public. As many of you are all too painfully aware, records displaying various types of warpage are becoming the rule, rather than the exception. Seeking recourse from a dealer merely becomes a process of exchanging your warped record for another in similar condition. It would be interesting to know how much business is lost when people give up in sheer frustration their search for a good copy and forego purchasing a particular recording.

Of all the warps that records are subject to, that of "pinch" or "edge" warp is most common. While some of the best phono arms can cope to a very limited degree with some of the minor pinch warps encountered, in severe cases, even if an arm could track the warp, it would be putting out potentially destructive amounts of sub-sonic energy. If you don't believe me, take a look at the violent excursions of your woofer cone during playback of a warped record.

Warp Out is a black, zinc ring, fabricated so that it is slightly larger than a standard 12-in. record, but with a "lip" that is meant to be positioned on the periphery of the record. On the inner walls of the ring are a number of

spring retaining clips to help secure the ring to the edge of the disc. In use, the idea is that when the ring is placed over the record, with the "lip" of the ring covering the edge of the record by approximately an eighth of an inch, the weight of the ring will compress any pinch warps that are present, thus making the record playable.

Does this device work? The answer has to be a qualified "yes." In my opinion, there is too much "play" in the ring, in that the inner diameter is slightly too large so that the spring clips don't perform enough clamping function. At least not on the records and turntables I used to test this unit. Because of this play, the ring must be carefully positioned on the record so that the "lip" covers a uniform area and is not "lopsided." Depending on the weight, thickness and resiliency of the vinyl in the record, and, of course, the severity of the pinch warp, this Warp Out made many records playable, but unfortunately could not alleviate the warpage of some severely warped records.

Some turntable platters have beveled edges rather than straight sides, and the device won't work optimally with them. To cope with this, Warp Out sent a prototype Iso Mat, a quarter-inch thick plastic "sub-platter" with straight sides, which is placed on the turntable platter and then the turntable mat placed on top of the

sub-platter. This gives additional vertical clearance. They do supply a clearance gauge. The Warp Out device would work better if it didn't have to contend with the "groove-guard" raised edge of the records. As it is, depending on the clearance between the stylus cantilever and the underside of the phono cartridge body, some cartridges are difficult to position on the lead-in grooves without contacting the steel ring. This is on a manual turntable. On turntables with automatic arm function, I would urge caution when using this device the first few times to observe the stylus "set-down" point in relation to the ring.

Because "dish warp" on records is also extremely common, even when the Warp Out succeeds in eliminating pinch warp, the dish warp can still cause tracking problems. Ideally, the Warp Out should be used in conjunction with the turntable spindle weights such as those made by Keith Monks and Audio-Technica. These record weights flatten out the dish warps and make the task of the Warp Out easier. It seems ridiculous to employ such extremes in order to make a record playable, but such is the nature of pressings these days. In summation, Warp Out is not a panacea for all record warpage, but it certainly makes many records playable, instead of becoming frisbees!

Bert Whyte

Enter No. 91 on Reader Service Card

The Nikko NR-1219 state-of-the-art AM/FM Stereo Receiver gives you the features, performance and versatility of separates plus all the convenience of a receiver.

Lots of Sock

100 watts minimum per channel both channels driven into 8 ohms, 20 to 20,000 Hz with no more than 0.03% total harmonic distortion. That's more than enough — even for rock concert levels. And distortion is so low you'll never hear it.

T-Locked Tuning

Once you place the tuning indicator close to an FM station, all you have to do is take your hand off the tuning knob. The Nikko T-Locked circuit automatically locks onto the exact center of the FM frequency. Perfectly. Every time.

DC Power Amplification — Less Distortion, Wider Bandwidth

The latest word in power amplifiers. DC (direct coupling) means that input and output capacitors have been eliminated. The output transistors are, in effect, coupled directly to your loudspeakers. The phase distortion and bass limitations of conventional amplifiers have been eliminated.

The NR-1219 amplifier section gives you bass response right down to the theoretical limit: 0 Hz, or dc (direct current).

LED Power Readouts

Nikko peak-holding LEDs display power directly in watts and in decibels for each channel. LEDs are more accurate, easier to read and faster than any meter mechanism.

There's More Yet

□ 12-dB per octave subsonic filtering eliminates distortion due to turntable rumble or warped records □ a 20-dB muting switch lets you lower volume temporarily and return to the exact original setting □ two-position tape dubbing with full monitoring and copying from either deck □ pre/main terminals for optional external signal processors □ 25 μ S Dolby* FM de-emphasis □ exclusive Nikko fully electronic protection circuitry □ wood veneered side panels.

Don't Just Take Our Word For It

Write for complete information and specifications, or call toll-free (800) 423-2994 for the name of your nearest Nikko dealer. Compare features. Compare performance. Compare price.

*Dolby is the trademark of Dolby Laboratories, Inc.

Nikko NR-1219: Anything Less Is Just A Good Receiver.



Nikko Audio

For those who take their stereo seriously.

Nikko Electric Corp. of America, 16270 Raymer St., Van Nuys, Calif. 91406 (213) 988-0105 • 320 Oser Ave., Hauppauge, N. Y. 11787 (516) 231-8181 © Nikko Audio 1979
Enter No. 26 on Reader Service Card

Empire EDR.9 Magnetic Phono Cartridge

Manufacturer's Specifications

Frequency Response: 10 — 50,000 Hz; 20 — 35,000 Hz \pm 1.75 dB.

Recommended Tracking Force: 0.75 to 1.25 grams.

Separation: 20 Hz to 500 Hz, 20 dB; 500 Hz to 15 kHz, 30 dB, and 15 kHz to 20 kHz, 20 dB.

IM Distortion: 0.08 percent, 2 kHz to 20 kHz at 3.54 cm/sec.

Stylus: L.A.C. radii, 0.3 x 3.0 mil.

Effective Tip Mass: 0.30 mG.



Compliance: 28×10^{-6} cm/dyne.

Tracking Ability: 38 cm/sec at 1 kHz at 0.9 grams.

Channel Balance: 0.75 dB at 1 kHz.

Inductance: 250 mH.

D.C. Resistance: 650 Ohms.

Input Load: 47 kilohms.

Total Capacitance: 100 pF.

Output: 4.5 mV at 5 cm/sec.

Vertical Tracking Angle: 20 degrees.

Type of Cartridge: Moving iron, variable reluctance.

Weight: 5.2 grams.

Stylus Replacement: \$5000.

Price: \$200.00.

Empire Scientific recently introduced a totally new phono cartridge, the EDR.9, which is the new top of their phono cartridge line. Its design incorporates an L.A.C. (Large Area Contact) stylus which is said to have a smaller radius and larger contact area than any other cartridge. The 0.3x3.0-mil stylus radii does fit comfortably within the high frequency portion of the record groove and has a very large, low-pressure contact area between the stylus and groove, and thus should give remarkably good record wear. A recent EIA paper, RS-238B, on stylus pressure index calculation, shows that higher indexes should give better tracking, lower distortion, and a lighter tracking pressure unit area for good wear. The EDR.9 rates high in this regard, and the diamond stylus is polished and mounted "nude" to further reduce tip mass.

The hollow aluminum cantilever, which is tapered from base to tip, thus achieving greater rigidity while decreasing tip mass, contains a miniature iron bar that behaves like a tuning fork, moving only in a specific range of frequencies and operating as an inertial damper of the high frequency response peak that usually appears due to elastomer-cantilever resonance. This inertially dampened "tuned stylus" system thus acts as a sort of mechanical equalizer to eliminate the elastomer-cantilever resonance.

To reduce the mass of the stylus assembly and, hence, improve transient performance and tracking, the EDR.9 design is of the variable reluctance type, utilizing a lightweight, hollow ferrous tube, rather than relatively heavy magnets, attached to its cantilever. The electrical elements of the EDR.9 have been designed to remain unaffected by any normal variation in load capacitance. The name EDR.9 is derived from "Extended Dynamic Response" and the ".9" indicates the pressure index of the stylus.

Measurements

The Empire EDR.9 phono cartridge was mounted on a Technics lightweight, aluminum alloy, die-cast head shell which contains a vibration-proof viscous-elastic material to provide non-resonant performance. The head shell total weight is 9.5 grams. The mounted cartridge was used with the Technics EPA-100 universal tonearm, mounted on the Technics SP-10 Mk2 turntable.

To obtain near-perfect cartridge/stylus lateral alignment (to better than 0.003") and optimum tracing of the record groove, we oriented the Empire EDR.9 cartridge in its shell and tonearm using our latest tool, the Dennesen Geometric Soundtractor (Box 51, Beverly, Mass. 01915). This stylus alignment tool compensates for any errors made in the tonearm design and manufacture, automatically setting the appropriate overhang for any pivoted tonearm effective length.

The cartridge was loaded with 47 kilohms resistance in parallel with 100 pF capacitance for all measurements. The measurements were made at a tracking force of 1.25 grams. Dur-

ing the test period, the average temperature was 76°F (24.44°C) and the relative humidity 68 percent \pm 3 percent.

Frequency response, using the Columbia STR-170 test record, is flat from 40 Hz to 20 kHz within +0.33 dB to -1.6 dB. Specifically, the response is within +0.33 dB from 40 Hz to 9 kHz, then slowly descends to -1.6 dB from 14 to 20 kHz. Separation is 25.6 dB at 1 kHz, 27 dB at 10 kHz, 23.5 dB at 15 kHz, and 22 dB at 20 kHz. The separation between 10 and 20 kHz is excellent, a good deal better than that found in most cartridges.

The response to a 1-kHz square wave shows a moderate overshoot followed by ringing that decays moderately fast, with a stylus resonance at about 38 kHz. The cartridge-arm low-frequency resonance was of 1.25 dB amplitude at 7.5 Hz and of 1 dB amplitude at 8.5 Hz. When utilizing the dynamic damping system present on the Technics EPA-100 universal tonearm, the cartridge-arm low-frequency resonance was at 7.5 Hz and of 0.75 dB amplitude, and at 8.75 Hz with an amplitude of 0.5 dB.

The following test records were used in making the reported measurements: Micro-Acoustics TT-2002; Shure TTR-103, TTR-109, TTR-110, TTR-115; Columbia STR-170, STR-100, STR-112, SQT-1100; Deutsches HiFi No. 2, and the Nippon Columbia Audio Technical Record (PCM) XL-7004.

Wt. 5.2 gm; d.c. resistance 663 ohms; inductance 276 mH; tracking force 1.25 grams; opt. anti-skating force 1.5 grams; output 0.99 mV/cm/sec; IM distortion (4:1) + 9 dB lateral, 200/4000 1.9 percent, + 6 dB vertical, 200/4000 6.4 percent; crosstalk (using Shure TTR-109) greater than 30 dB; channel balance within 1 dB; trackability: high freq. (10.8 kHz pulsed) 24 cm/sec, mid-freq. (1000 + 1500 Hz, lat. cut) 31.5 cm/sec, low freq. (400 + 4000 Hz, lat. cut) 24 cm/sec; Deutsches HiFi

Fig. 1 — Frequency and separation using the CBS STR-170 test disc.

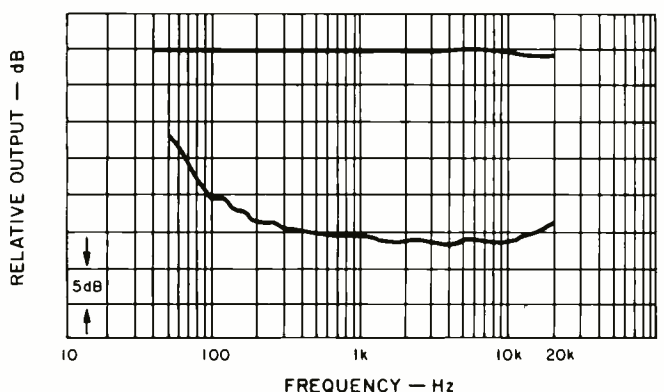

ADC has four Sound Shaper® frequency equalizers that will improve your sound system. No matter how good it is. And at a cost that's lots less than trading in your components.

ADC Sound Shapers will improve your speakers. By extending mid bass hump while simultaneously extending the true bass response.

ADC Sound Shapers will improve the relationship between your cartridge and speakers. From one of partial incompatibility to total compatibility.

They'll also eliminate rumble (low frequency overload), tape hiss and record scratches.

And that only scratches the surface of what ADC Sound Shapers can do. For instance, the walls, carpeting and furniture of your listening room physically bounce sound around so that some spots have less sound than other spots.

Lots less. ADC Sound Shapers will bring these "dead" spots to life.

Perhaps best of all, though, is a Sound Shaper's ability to let you re-equalize what a recording engineer mixed. If a horn section is overwhelming a piccolo, for example, you just slide the appropriate frequency lever. Presto, more piccolo. You can also vanquish a voice. Or boost a tuba.

Sound Shapers segment the entire spectrum of sound. To let you re-shape a sound track to your personal musical preferences. It's all the control you've ever dreamed of but never dreamed possible.

To get into equalizers, start with our Sound Shaper One which operates in five frequency ranges. Or our Sound Shaper One Ten which gives you greater control by operating in ten frequency ranges.

For more professional equalizers, there's our Sound Shaper

Two Mk II which functions in twelve frequency ranges with a two-channel LED meter. And there's our new Sound Shaper Three Paragrophic™ Equalizer.

It combines all the advantages of a graphic equalizer with all the advantages of a parametric equalizer. Twelve primary frequency controls per channel. Plus twenty-four ancillary control positions per channel. The Sound Shaper Three is the ultimate in controlling and creating with your stereo system.

Take the ultimate step up in sound, without trading in a thing.

ADC Professional Products, a division of BSR Consumer Products Group, Route 303, Blauvelt, NY 10913. Distributed in Canada by BSR (Canada) Ltd., Ontario. *Sound Shaper is a registered trademark of Audio Dynamics Corporation.

HOW TO TRADE UP YOUR RECEIVER, TUNER, AMP, TURNTABLE, CARTRIDGE AND SPEAKERS WITHOUT TRADING IN A THING.

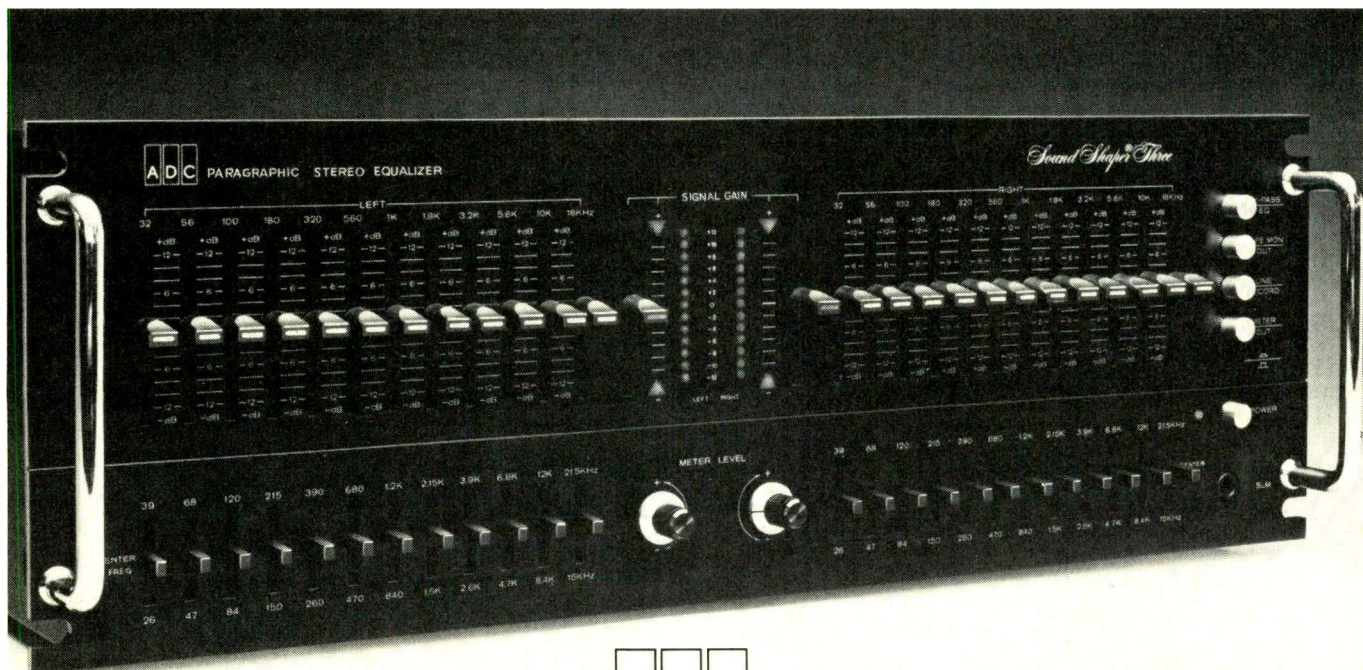

ADC SOUND SHAPERS
A BSR Company

Enter No. 9 on Reader Service Card

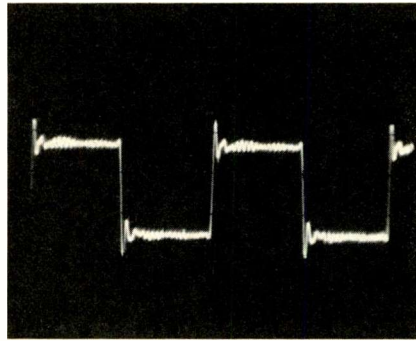

Fig. 2 — Response to a 1-kHz square wave.

No. 2 300-Hz test band was tracked cleanly to 86 microns (0.0086 cm), lateral at 16.20 cm/sec at +9.66 dB and 32.6 microns (0.00326 cm), vertical at 6.17 cm/sec and +1.19 dB.

The Empire EDR.9 cartridge was able to play all the tracking and transient ability bands of the Micro-Acoustics TT-2002 musical test record without difficulty. All instruments were easily localized without any smearing of position. Applause definition was very good. The Shure Obstacle Course — Era III test record was played without difficulty except towards the end of band 5 of the violin test where a very slight mistracking was heard. With the newer Shure Obstacle Course — Era IV test record's orchestral bell test, level 5, the cartridge just started to mistrack on the initial transients. Level 5 of the harp-and-flute test had a hint of mistracking in the difference tones, while level 5 of the flute and orchestral bells test sounded muddled in the difference tones. Only

very rarely is a cartridge capable of playing all levels of these test records without mistracking one or more of the high level bands.

Listening and Use Tests

As is our practice, extensive listening tests were performed both before and after laboratory testing of the Empire EDR.9 phono cartridge. While listening to the wide variety of records listed below, we specially noted the excellent sonic clarity and lack of detectable coloration, particularly when reproducing the high recorded levels present on most current direct-to-disc recordings, such as those listed below. The Empire EDR.9 is truly a "musical" cartridge, and it is very pleasing to the ear when playing music. In conclusion, this new top-of-the-line phono cartridge should be considered as an excellent choice for most every music system. *B.V. Pisha*

Enter No. 92 on Reader Service Card

Evaluation Equipment and Records

A rigorous listening evaluation was performed on the EDR.9 using the following equipment and the specific records listed below. The equipment included the Technics SP-10 Mk 2 turntable fitted with their EPA-100 universal tonearm, Crown IC-150A preamplifier, a pair of Crown DC-300A amplifiers used in monophonic mode, a pair of stacked Duntech DL-15 speakers in each channel, and a Columbia SQL-400A SQ decoder. Each pair of speakers were connected to the amplifiers with Polk SoundCables using the Polk RC terminating networks at the speaker end of each cable. The turntable was equipped with the Hiraoko Disc-SE22 turntable mat. The following records were used to aurally evaluate the performance of the Empire EDR.9 phono cartridge:

Stereo

Pink Floyd: *The Dark Side of the Moon* — Mobile Fidelity Sound Lab MFSL 1-017.

Puccini: *Prelude Sinfonico, Capriccio Sinfonico*, Edgar: *Preludio, Mercadante: Sinfonia*, Boito: *Sinfonia en la Mineur*, Verdi: *La Battaglia di Legnano*, Scimone, Orchestre National de L'Opera de Monte-Carlo — Erato on RCA STU 71040.

Ormandy conducts Wagner (excerpts) Vol. 2: *Parsifal, Tristan and Isolde, The Flying Dutchman*, The Philadelphia Orchestra — RCA ARL1-2528.

Mehta conducts Schubert: *Symphonies No. 4 (Tragic) and No. 8 (Unfinished)*, The Israel Philharmonic Orchestra — London CS 7067.

Montemezzi: *L'Amore dei Tre Re* (Moffo and Domingo), Santi, London Symphony Orchestra — RCA ARL2, 1945.

Direct to Disc

Gould Conducts Gould: *Spirituals for Orchestra and Foster Gallery*, The London Philharmonic Orchestra — Crystal Clear Records CCS 7005.

Walter Susskind Conducting the London Philharmonic Orchestra — Crystal Clear Records CCS 7006.

George Wright Plays the Chicago Theatre Organ, Vol. 2 — Century Records CR 1061.

P114h 315,110 1061.

Robert Wagner Chorale: *Encore* — M & K Realtme Records RT 110.

Dixie Direct featuring Rosie O'Grady's Good Time Jazz Band — Direct Disk Records DD103.

Nostalgia Suite, Roger Kellaway and the Cello Quintet — Discwasher Recordings DR 003 DD.

This is Creation Studio Live in Direct-to-Disc Recording — Express (Toshiba-EMI Ltd) ELF-95024.

Pulse Code Modulation (PCM)

Bizet: *L'Arlesienne Suite, Carmen Suite*, Miedel, Yomiuri Nippon Symphony Orchestra — Denon OX-7153-ND (Denon records are distributed by American Audioport, Inc.).

Midnight Over Memphis, John Stubblefield — Denon YX-7546-ND.

Together, Tommy Flanagan & Kenny Barron — Denon YX-7544-ND.

Fantasia, Hilton Ruiz — Denon YX-7548-ND.

The 24th Street Band — Denon YX-7547-ND.

Joplin: "Bethena" and other Ragtime Music — Denon OX-7158-ND.

Dvorak: *String Quartet No. 12(6) in F Major, Quintet in A Major for Piano and Strings*, Smetana Quartet — Denon OX-7152-ND.

Concert pour Ensemble de Koto — Debussy et Ravel, Keiko Nosaka et son ecole — Denon OX-7155-ND.

Digital to Analog

New Year's in Vienna, Boskovsky, The Vienna Philharmonic — London Digital Recording LDR 10001-2.

Shostakovich: *Festive Overture*, Ravel: *Bolero*, Ginastera: *Estancia Ballet Suite*, Weinberger: *Polka and Fugue from "Schwanda"*, Gould, London Symphony Orchestra — Chalfonte SDG 301.

Macho Marches, Fennell, The Cleveland Symphonic Winds — Telarc DG-10043.

Quadraphonic — SQ

Rated Extraordinaire, Johnnie Taylor — Columbia PCQ 34401.

The Miracles, Love Crazy — Columbia PCQ 34460.

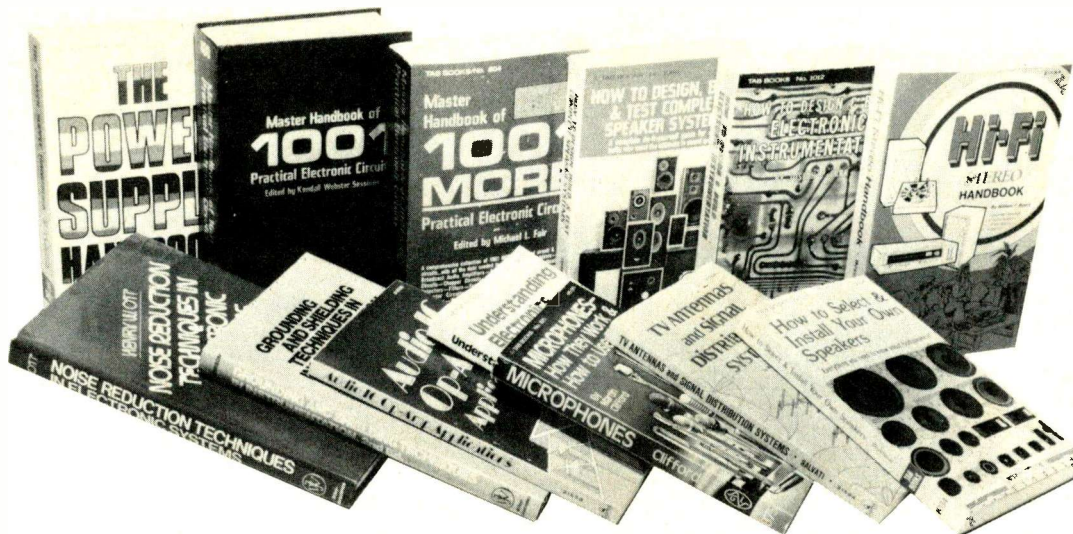

Audio BOOK STORE

Your Best Source to Build a Worthwhile Library

No. 752—Design, Build & Test Speaker Systems. Do it yourself guide shows beginner and expert how to get the most from a speaker. 6.95

No. 751—Microphones. Complete manual shows how to record—anything. Special section tells how to interpret spec sheets. 5.95

No. 759—Audio IC OP-AMP Applications. Newly revised 2nd edition includes many new high performance circuits. 7.95

No. 520—1001 MORE Practical Electronic Circuits. A comprehensive collection of 1001 more integrated circuit & transistor circuits, with the data needed to put them to work. 12.95

No. 516—Understanding Electronics. All about electronic circuits—what they are, how to build them, what they do. 4.95

No. 517—The Power Supply Handbook. A broad and varied collection of ready to build power sources for electronics hobbyists and engineers. 7.95

No. 518—Grounding and Shielding Techniques in Instrumentation, 2nd Ed. All you need to know about grounding and shielding electronic equipment. 17.50

No. 519—Noise Reduction Techniques in Electronic Systems. Topics include: shielding and grounding, protection of switching contacts, passive and active device noise sources, much more. 25.50

No. 447—Hi-Fi Stereo Handbook. Complete coverage of Audio Systems from Source to Sound. All the differences of monophonic, stereophonic and four channel sound explained and much more. 11.95

No. 792—How To Design & Build Electronic Instrumentation. Ready to use, practical circuits for hobbyists, technicians, hams and engineers. 9.95

No. 796—TV Antennas and Signal Distribution Systems. An invaluable aid to help you select and install TV antenna and signal distribution systems. 9.95

No. 794—Select and Install Your Own Speakers. From autos to auditorium, here's how to get the best reproduction from any audio system. 5.95

No. 793—Master Handbook of 1001 Practical Electronic Circuits. A collection of 1001 circuits and the peripheral information needed to put the circuits to work. 12.95

To order, use coupon below or write AUDIO, Book and Learning Systems Division, Dept. JA79, North American Publishing Company, North American Building, 401 North Broad St., Philadelphia, PA 19108

- 752 DESIGN, BUILD & TEST SPEAKER SYSTEMS 6.95
- 751 MICROPHONES 5.95
- 759 AUDIO IC OP-AMP APPLICATIONS 7.95
- 520 1001 MORE PRACTICAL ELECTRONIC CIRCUITS 12.95
- 516 UNDERSTANDING ELECTRONICS 4.95
- 517 THE POWER SUPPLY HANDBOOK 7.95
- 518 GROUNDING AND SHIELDING TECHNIQUES 17.50
- 519 NOISE REDUCTION TECHNIQUES IN ELECTRONIC SYSTEMS 25.50
- 447 HI-FI STEREO HANDBOOK. 11.95
- 792 HOW TO DESIGN & BUILD ELECTRONIC INSTRUMENTATION 9.95
- 796 TV ANTENNAS AND SIGNAL DISTRIBUTION SYSTEMS 9.95
- 794 SELECT AND INSTALL YOUR OWN SPEAKERS 5.95
- 793 MASTER HANDBOOK OF 1001 PRACTICAL ELECTRONIC CIRCUITS 12.95

Please send me the book(s) I have checked. **A99**

Enclosed is my proper remittance for \$_____.

I understand if I am not fully satisfied I may return my selection(s) in undamaged condition within 10 days for a full refund.

Name (please print) _____

Address _____

City/State/Zip _____

Please allow 4-6 weeks for delivery.

YOU MAY PAY FOR YOUR BOOK(S) ON YOUR CREDIT CARD

CREDIT CARD NO. _____

VISA AMERICAN EXPRESS DINERS CLUB

MASTER CHARGE _____ M/C BANK NO.

NUMBER MUST APPEAR _____

IF USING MASTER CHARGE _____

EXP. DATE _____

Audio

Book and Learning Systems Division Dept. JA79
North American Publishing Company, North American Building
401 N. Broad Street, Philadelphia, PA 19108



Audio Magazine is published by North American Publishing Company, leaders in editorial excellence.

McKay Dymek Model DR-33 All-Wave AM/SSB/CW Receiver

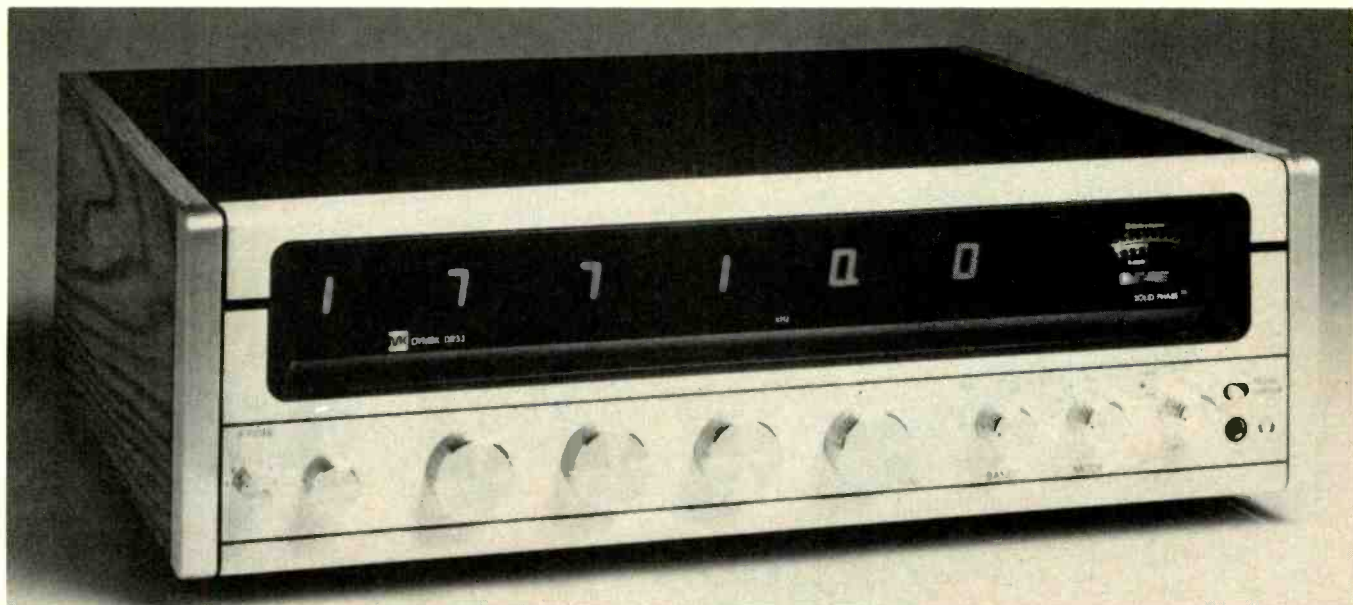

MANUFACTURER'S SPECIFICATIONS

Frequency Range (Coverage): 50 kHz to 29.7 MHz.

Sensitivity for 10 dB (S+N)/N: AM, 1.0 μ V from 400 kHz to 20 MHz, 1.5 μ V from 20 MHz to 29.7 MHz; SSB, 0.5 μ V from 400 kHz to 20 MHz, 0.75 μ V from 20 MHz to 29.7 MHz; CW, 0.25 μ V from 400 kHz to 20 MHz, 0.35 μ V from 20 MHz to 29.7 MHz.

Frequency Stability: \pm 40 Hz, after 30 minute warm-up.

Image Rejection: 70 dB.

R.F. Blocking: 100 dB to 1 μ V.

Cross Modulation: 65 dB to 1 μ V.

Intermodulation: 65 dB to 1 μ V.

R.F. Bandwidth: 4 or 8 kHz for -6 dB on AM.

Audio Notch Filter: More than 25 dB at 5 kHz.

Hum and Noise: 55 dB re: full output, 1 mV input, 8-kHz bandwidth, 90 percent 1-kHz modulation.

THD: 0.6 percent for 50-percent modulation, 1.0 percent for 80-percent modulation, 1.5 percent for 90-percent

modulation; AM, 1-MHz, 1-kHz modulation, 1-mV r.f. input, 8-kHz bandwidth.

Audio Output: 2 watts at 4 ohms, plus 1.0 V rms into 5-kilohms external output.

Power Requirements: 110-120/220-240 V a.c., 50/60 Hz, switch selectable; 30 watts.

Dimensions: 17.5 in. (44.45 cm) W x 5.1 in. (12.95 cm) H x 15 in. (38.1 cm) D.

Net Weight: 16 lbs. (2.7 kg).

Price: \$1500.00.

We suspect that many readers of *Audio* magazine, in addition to their interest in high-fidelity audio equipment, are also interested in quality reception of programs on the other broadcast bands, that is in AM and short-wave, both continuous wave and single sideband. Few, if any, FM stereo tuners are equipped with anything but the most minimal kind of broadcast-band AM circuitry, let alone facilities for tuning to short-wave frequencies. McKay Dymek's Model DR-33 receiver provides the means, for those who can afford it, to hook in a truly remarkable AM tuner which is one of the very finest all-wave receivers ever made available to general consumers.

The McKay Dymek DR-33 is a fully synthesized, solid-state, triple-conversion general coverage receiver intended for the reception of AM, single sideband or continuous wave (CW) signals in the frequency range from 50 kHz to 29.7 MHz. It offers extreme accuracy and convenience of tuning, with the tuned-to frequencies displayed in large electronic-readout digits spread across the upper half of the front panel. The receiver is designed for use either as a self-contained unit with its internal speaker or for connection to an external speaker or a hi-fi system or tape recorder.

The second through fifth larger knobs on the lower left section of the panel are used for precise frequency selection. These knobs select frequencies in 10 MHz, 1 MHz and 100 kHz steps, with the fourth knob of this group selecting frequencies in 5 kHz increments and controlling the last two digits of the LED readout. A fine-tune knob, beyond those mentioned, covers a range of 5 kHz and is a multi-turn control for increased tuning ease and resolution when receiving SSB or CW signals. A "band" control to the right of the knobs

just described has five settings: 0.05-29.7 MHz Preamp (the "normal" setting for people in favorable or average listening areas), 0.05-29.7 MHz (when only moderate sensitivity is required), "Local" (with sensitivity reduced some 30 dB), and 2.5-29.7 MHz (in which a filter is introduced to reduce interference from strong local stations, when only short-wave listening is desired).

The mode switch and the i.f. filter switch knob at the extreme left of the panel are usually used together. The former has settings for AM, SSB, CW or RTTY (Radio Teletype signals). The six-position i.f. control determines the upper limit of the audio frequency output of the receiver. It includes 4-kHz and 8-kHz positions for AM listening, "L" and "U" settings for upper and lower sidebands during SSB reception, and "A" and "B" positions which allow for addition of optionally available mechanical filters having bandwidths of 400 Hz (CW), 1200 Hz (RTTY) and 2500 Hz (for narrow AM reception.).

The i.f. gain and volume/on-off controls are concentrically mounted below the "S" meter of the receiver, at the lower right of the panel, while nearby is a noise-limiter switch which, when turned on, helps to eliminate impulse noise and other interference while receiving in the various modes. A stereo-type headphone jack is located below the noise limiter switch and, although reception via this jack will obviously be monophonic, headphones used with the receiver should be equipped with a stereo phone plug (ring, tip, sleeve contacts) for proper operation.

The rear panel of the DR-33 has a recessed line voltage switch, an internal speaker on-off switch, a tuner level control (which adjusts level at the tuner output jack, also located

Reintroducing A World Standard...

CBS Laboratories' STR Professional Test Records



For over ten years, the original series of these high-precision test records set a standard for the audio industry. Now the new series sets an even higher standard. It's been revised, recut and expanded.

The new series consists of eight records for professionals and one for non-professional audiophiles.

Each record contains a complete series of easy-to-use tests to help you rapidly and accurately evaluate components and systems. Even one of these records can eliminate the need for costly, additional equipment. Each will find productive use and save you hours in the laboratory, on the production line and in field testing.

Take a look at what this essential testing series contains:

SEVEN STEPS TO BETTER LISTENING—For only \$6.98, you can improve your system with CBS Laboratories' "Seven Steps to Better Listening." This high-precision test record enables you to make sure that your equipment functions properly . . . to tune your system to your ears and your room acoustics. Included is a detailed 16-page booklet by Audio's Edward Tatnall Canby explaining how to use the record to improve the performance of your system. With the record you can perform the following "ears alone" tests: left-right identification, phasing, loudspeaker balance, tone control setting, alternate phasing, buzz and rattle elimination, lateral tracking, and vertical tracking.

★ **STEREOPHONIC FREQUENCY TEST RECORD STR 100** Designed for the evaluation of pickups and systems. Provides a constant amplitude characteristic below 500 Hz and a constant velocity characteristic above 500 Hz. Tests include: Sweep Frequency—with the sweep rate synchronized for use with a graphic level recorder; Spot Frequency—with voice announcements; Channel Separation; Wavelength Loss and Stylus Wear—to pinpoint oversize or worn-out styli, and excessive pickup tracking force; Compliance; Phasing; Vertical and Lateral Tracking; Tone Arm Resonance—to check system performance at low and subaudible frequencies and thus reveal undamped resonance which may cause equipment overloading.

★ **SQUARE WAVE, TRACKING AND INTERMODULATION TEST RECORD STR 112** Enables detailed study of tracking capabilities of stereophonic phonograph pickups. The square wave modulation allows a rapid appraisal of stylus-tip mass, damping, and tracking. Low frequency compliance and tracking are determined by means of 300-Hz bands of progressively increasing amplitude. Intermodulation distortion measurements are made possible by graduated 200-Hz intermodulation test bands. The Str 112 has been cut with vertical angle approximating 15°, which is representative of current recording practice.

★ **BROADCAST TEST RECORD STR 151** Developed especially to meet the needs of broadcast engineers, audiophiles, and other professionals seeking a convenient signal source for the testing and adjustment of all audio equipment. Tests include: phonograph pickup response and separation, speed accuracy at 33 1/3 and 45 rpm, wow and flutter, rumble and hum detection, ballistic test of V.U. meters and many others."

★ **RIAA FREQUENCY RESPONSE TEST RECORD STR 130** Provides RIAA frequency characteristics for the calibration of professional recording equipment and for testing the response of professional and consumer record reproduction equipment. This record is suitable for use with a graphic level recorder to provide permanent, visible records for precise evaluation. Spot frequency bands for use without automatic equipment are included.

★ **318 MICROSECOND FREQUENCY RESPONSE TEST RECORD STR 170** Provides pickup designers and recording studios with a high-level, easily-equalized signal for frequency response and channel separation measurements. The STR 170 employs a 318 microsecond characteristic corresponding to the "test" or "flat" mode common to most disc recording equipment. Constant amplitude recording is employed in the region below 500 Hz with constant velocity recording in the region above. The transition is smooth, in contrast with the STR 100 which employs a sharp breakpoint at 500 Hz. The record is suitable for use with a graphic level recorder to provide permanent, visible records for precise evaluation.

★ **WIDE RANGE PICKUP RESPONSE TEST RECORD STR 120** Makes possible the measurement of pickup response at frequencies far beyond the audible range, where elusive distortion elements can cause audible distortion. The low-frequency range includes glide-tones at twice normal level for the detection and elimination of arm resonance, loudspeaker cone and cabinet rattles. Other tests include: silent grooves for measuring rumble and surface noise characteristics; and standard level bands at 0 dB for overall system S/N measurements. This record is suitable for use with a graphic level recorder to provide permanent, visible records for precise evaluation.

★ **QUADRAPHONIC TEST RECORD SQT 1100** Designed for calibration, verification, and adjustment of SQ™ decoding equipment. The record provides test bands for pickup measurements, for adjustment of decoder electronics and for channel identification and balance. Each band is described in terms of recorded characteristics and its intended use.

★ **RIAA PINK NOISE ACOUSTICAL TEST RECORD STR 140** Designed for acoustical testing of systems and loudspeakers and for psychoacoustic tests on reproduction equipment. With the STR 140 it becomes possible to test loudspeakers in the room in which they will be used. Spot frequency tones with voice announcements facilitate the testing procedure. Continuous glide-tones in 1/3-octave bands cover the frequency range from 30 to 15,000 Hz and are synchronized with a graphic level recorder.

The original series has been unavailable for many years. Quantities of the new and improved series are also limited. So make sure you have perfect copies on hand for years to come by ordering duplicates. Fill out and mail the coupon now for immediate action.

SQ is a Trademark of CBS Inc.

Only a limited quantity are available. Be sure to order enough for many years of use.

Send me the following test records:

- Seven Steps to Better Listening (STR 101) \$6.98 each. Quantity _____
- Stereophonic Frequency (STR 100) \$10.00 each. Quantity _____
- Square Wave, Tracking and Intermodulation (STR 112) \$15.00 each. Quantity _____
- Wide Range Pickup Response (STR 120) \$15.00 each. Quantity _____
- RIAA Frequency Response (STR 130) \$15.00 each. Quantity _____
- RIAA Pink Noise Acoustical (STR 140) \$15.00 each. Quantity _____
- Broadcast test (STR 151) \$15.00 each. Quantity _____
- 318 Microsecond Frequency Response (STR 170) \$15.00 each. Quantity _____
- Quadraphonic Test (SQT 1100) \$15.00 each. Quantity _____

SEND TO:
AUDIO TEST RECORDS
401 N. Broad Street
Philadelphia, Pa. 19108

AU9

Amount Enclosed \$ _____
(Payment must accompany order)

Name _____

Address _____

City _____

State _____ Zip _____

on the rear panel), an i.f. output jack (which makes available the 455-kHz i.f. signal, and a "mute" jack (useful when using the receiver along with a transmitter) which comes equipped with a shorting plug for signal continuity. Antenna connections may be made by means of a transmission line terminated in a phono-tip plug or by means of terminals which accept the stripped ends of antenna and ground lines. Nominal input impedance is 50 ohms.

Circuit Description

Fig. 1 is a block diagram of the DR-33 receiver. Beginning at the antenna, the signal proceeds through a 30-MHz low-pass filter. A broad-band r.f. amplifier comes next, and a switch (not shown) on the "Band" control allows for by-passing this stage, while another position on that switch introduces 30 dB of attenuation ahead of the mixer stage. Also not shown is the high-pass filter setting of the "Band" switch, mentioned earlier, which blocks out all signals below 2.5 MHz.

The double-balanced mixer has two inputs; one contains the incoming signals, while the other is the first local oscillator frequency selected by the four programming switches described earlier. The oscillator operates 30 MHz higher than the tuned-to frequency. The first i.f. section, therefore, operates at a high 30 MHz. A 40.7-MHz crystal-controlled second local oscillator signal, along with the 30-MHz i.f. signal, is then applied to the second mixer to produce a 10.7-MHz signal which is again amplified. The output of the 10.7-MHz amplifier is applied to a third mixer together with the output of a crystal-controlled third local oscillator to produce the

final difference i.f. frequency of 455 kHz, which signal is then amplified by yet another stage. This signal is then applied to one of the two detectors, depending upon the setting of the "Mode" control.

In the AM setting, an envelope detector, using a Class-D transistor rectifier and r.f. filter, is used to recover desired audio, while in the SSB mode, signals are recovered by means of a product detector. Since short-wave signals may be assigned frequencies only 5 kHz apart, a notch filter tuned to 5 kHz is included in the DR-33 to eliminate possible beats between adjacent short-wave channels. At the output of this filter, audio signals branch to the tuner output through a rear panel level control and, via the front panel volume control, to an audio amplifier which delivers 2 watts of audio power to the internal speaker or to a connected external speaker. A rear panel switch disables the internal speaker when an external speaker is used or if the tuner output is fed to an associated high-fidelity component system.

Measurements and Listening Tests

My lab is not equipped to measure all the capabilities of a receiver such as the McKay Dymek DR-33, still, even with my vintage 1950 AM generator, I was able to verify sensitivities on the broadcast band of — are you ready for this? — 0.7 microvolts for 20 dB (S+N)/N_s, referenced to 30 percent modulation. As for frequency response, Fig. 2 tells the story. It is a spectrum analyzer sweep from 20 Hz to 20 kHz and shows response for the 4-kHz and 8-kHz bandwidth positions of the i.f. filter switch. Note that in the case of the

Fig. 1 — Block diagram.

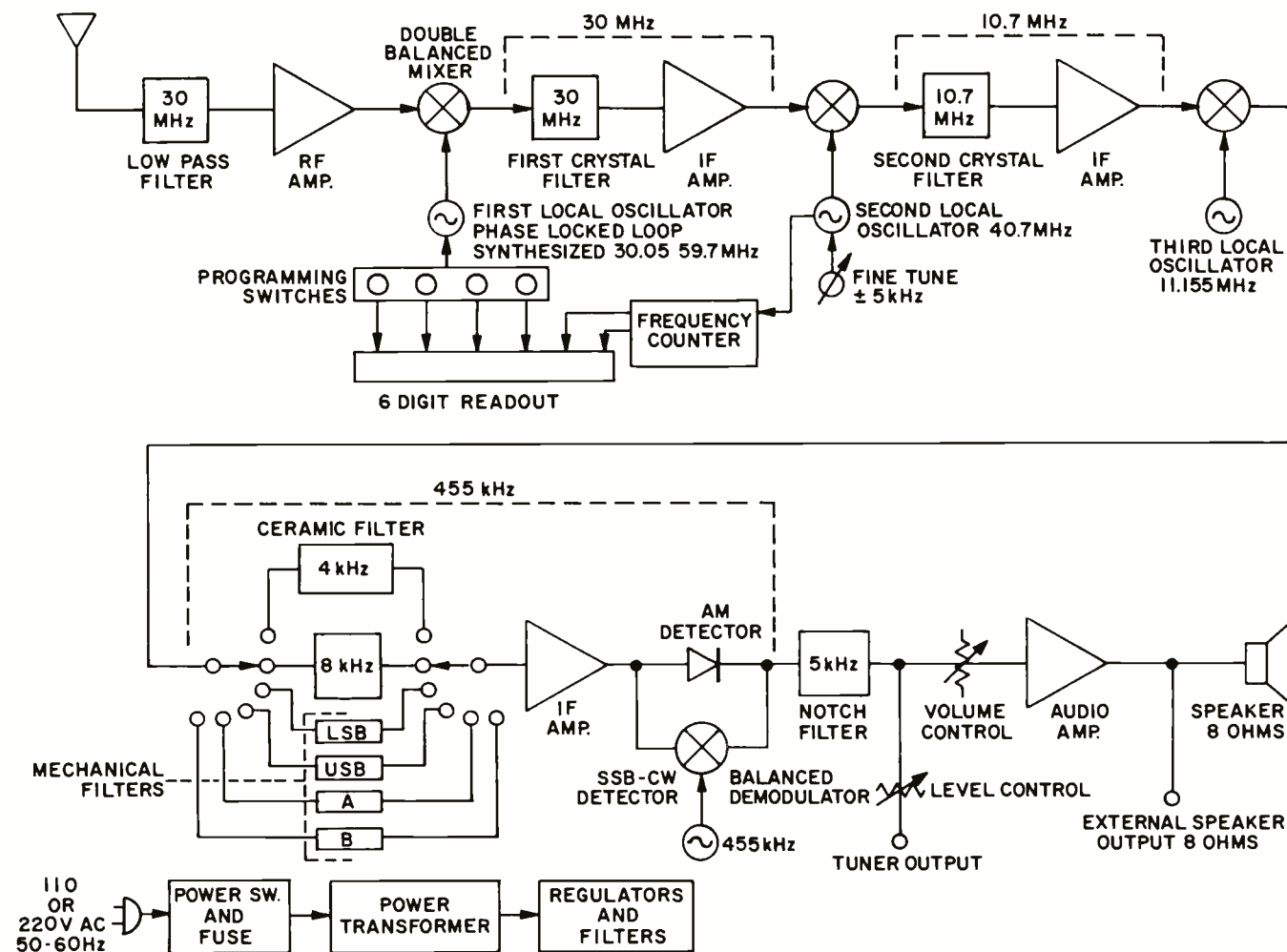

Fig. 2 — Frequency response of tuner output. Wider response, with 8-kHz i.f. setting, shows effect of 5-kHz notch filter.

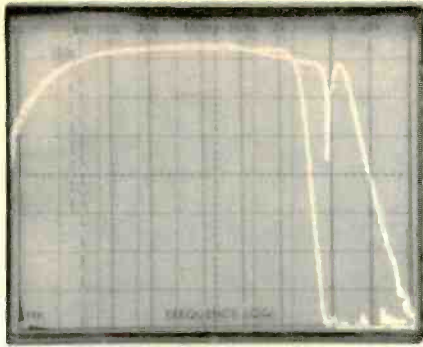
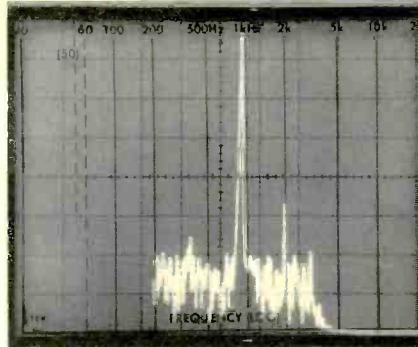

Fig. 3 — One-kHz output (tall spike) shows a relatively small 2nd harmonic distortion component at 2 kHz, which is some 47 dB below reference level.



better of the two curves, the notch filter pulls out any 5-kHz beats, but then the response jumps right up again, rolling off finally at around 7 kHz.

Figure 3 shows the harmonic distortion components for a 50 percent modulated AM signal fed to the antenna terminals at an intensity of 1 millivolt. The fundamental (center spike) is 1 kHz and scope vertical sensitivity is 10 dB per division, as usual, so that the 2nd harmonic contribution is down some 47 dB from the fundamental. That works out to a distortion percentage of 0.45 percent. Try comparing with that figure with the AM tuner section of any super-fi stereo receiver.

Tuning accuracy is, of course, as precise as can be read on my digital frequency counter — and that's more precise than you can imagine. Anyone who has tried to tune to and hold onto some of those elusive overseas short-wave broadcasts using conventional all-band receivers will immediately appreciate being able to tune to within 0.1 kHz of a desired frequency from 50 kHz to 29.7 MHz.

My only criticism of the McKay Dymek sample I have in

my lab is that listening to the hundreds — no, thousands — of transmissions of all kinds that constantly permeate our atmosphere has proven to be so fascinating that I haven't been able to turn my attention to more urgent testing projects that are waiting to be finished. Happily, McKay Dymek was kind enough to send along their Model DA-100 all-wave receiving antenna, a two-part omnidirectional antenna consisting of an external module (mounted outdoors) and an internal module which contains power supply, attenuator, and impedance switch. Combined with the DR-33 receiver, one can obtain short-wave and AM broadcast reception that is truly beyond belief.

While I was unable to measure some of the more subtle performance specifications of the receiver, I have no doubt that they are met or exceeded, judging by the few measurements I was able to make. And now, if you'll excuse me, I have to run — I think I hear Australia coming in over the DR-33 which is still on the test bench in the next room!

Leonard Feldman

Enter No. 93 on Reader Service Card

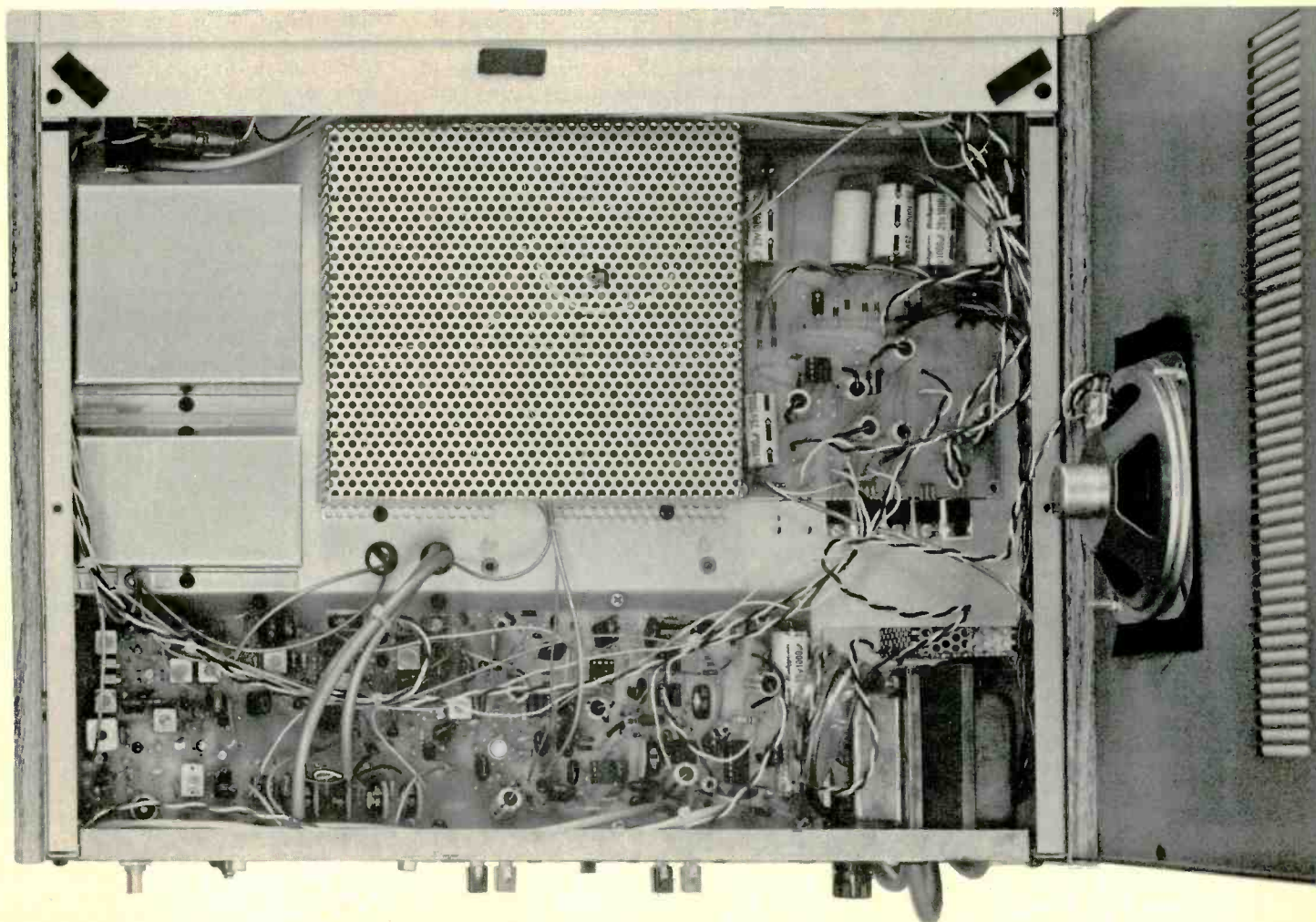

The bookshelf

Audio IC Op-Amp Applications, Second Edition by Walter G. Jung. Howard W. Sams, 1978, 208 pp., \$7.95.

In the three years since the first edition of this book, there have been significant changes in the audio IC op amps available and their possible applications. Mr. Jung provides much new material that is of importance. The first chapter is a general introduction, including right-to-the-point lists of IC op amps acceptable for various levels of audio performance. Chapter 2 is a fascinating 60 pages on the op amp parameters that are important for audio uses. There is the expected discussion on open-loop gain, the gain-bandwidth product and compensation. The coverage on slew rate and slew-induced distortion, however, is very extensive, and will tie together many loose ends for the reader. Included are correlation curves for TIM, two-tone IM and THD, complete descriptions for a THD test series, and the results for a number of op-amp types. The author also includes valuable coverage on noise and its measurement.

A short chapter discusses basic op amp configurations translated as necessary for audio applications. The last three chapters, totalling about 100 pages, provide information on many practical circuits. The first of these chapters has information on voltage amps, increasing power output, various types of preamps, power amps, and a headphone amplifier. The next chapter covers a number of equalizer types and many filter circuits, including those for rumble, notch, bi-quad, state-variable and multiple-feedback filters. The final applications chapter discusses summing amps, impedance matching, driving lines with and without transformers, sine-wave oscillators, function generators, and other nice things.

The two appendices have a set of data sheets for the 5534 IC and addresses and device lists for a number of manufacturers, to aid in writing for the sheets you need. The index has good detail, and there is very good

cross referencing. The book is very readable, not only because of the excellent writing, but because of a good type face and excellent illustrations. The author includes extensive references for each chapter, an impressive total of 166 for the volume. This second edition is highly recommended to all audio engineers and technicians, including those who already have the first edition. *Howard A. Roberson*

Noise Reduction Techniques in Electronic Systems by Henry W. Ott. John Wiley, 1976, 294 pp., \$22.75.

The author states that this text has been written "for the practicing engineer for the design of electronic equipment . . . with the emphasis on low and mid frequencies," and a very worthwhile addition to the literature it is. The first chapter considers the general interference problem with a look at the methods of noise coupling. Chapter 2 on the shielding of conductors and Chapter 3 on grounding detail many facets of capacitive and inductive coupling, shielding, cable construction, safety and signal grounds, isolation, and neutralization. The next chapter presents other techniques including power supply decoupling and controlling system bandwidth.

There is a close look at the possible contributions from passive components, capacitors, inductors, ferrite beads, even conductors. The 36-page chapter on shielding by metallic sheets will provide clarification for many in this area; other authors have touched the subject, but lightly. Next, Mr. Ott covers the protection of contacts to promote longer life, but also to reduce noise being radiated or introduced directly into circuits.

The final two chapters cover sources of intrinsic noise and the noise from active devices. This portion of the book gets across the essentials of thermal noise, equivalent noise bandwidth, measurement of random noise, noise factor, optimizing the source resistance, models for noise current and voltage, etc. Five appen-

dices are included: (A) The decibel, including information on telephone industry weighting functions; (B) a summary of noise reduction approaches; (C) Reflections of magnetic fields in thin shields; (D) 50 problems, a good collection, and (E) the answers. The index has good detail with good cross-referencing.

This text made a very favorable impression on this reviewer: The copy is lucid, accompanied by excellent illustrations. At the end of each chapter there is a bibliography and a helpful chapter summary, listing both the effects that might be encountered and the applicable approaches. The volume would be a worthwhile addition to the bookshelf of audio/electronic design engineers and technicians who need to keep noise under control, from small devices up to complete systems and studios. *Howard A. Roberson*

Grounding and Shielding Techniques in Instrumentation, Second Edition by Ralph Morrison. John Wiley, 1977, 146 pp., \$16.50.

The first two chapters cover electrostatics, capacitance and energy storage. There is discussion of the fundamentals of charges, fields, and self and mutual capacitance, which the author notes "exist physically, but are never on a parts list." Then, there is a brief chapter on the application of electrostatics to practical processes. The particulars of electrostatic shielding are introduced, and the characteristics of the earth plane are examined.

The next three chapters cover subjects of interest to the users and designers of audio equipment: amplifier shielding, signal entrances, transformer shielding, differential amplifiers, and common mode and its rejection. Of particular interest is the material on single and balanced inputs, on floating and grounded systems, and the best choice between them. There is a short chapter on the shielding of a resistance-bridge system. A longer chapter on magnetic elements and applications includes the essential instruction,

Introducing the ADC 1700DD turntable. The quality begins with the tonearm...



...and keeps on going.

The tonearm you'll find on the ADC 1700DD reduces mass and resonance to new lows. So the music you hear comes out pure and clean.

Our engineers have combined the latest advancements of audio technology to create the amazing 1700DD, the first low mass, low resonance turntable.

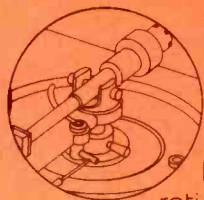

The famous LMF carbon fibre tonearm was the model for the sleek black anodized aluminum tonearm found on the ADC 1700DD. The headshell is molded carbon fibre, long known for its low mass to high tensile strength ratio. The viscous cueing is a gentle 4mm/sec., and the tempered spring anti-skate adjustment is infinitely variable to 3.5 grams. The pivot system uses stainless steel instrument bearings, which are hand-picked and perfectly matched to both the outer and inner races for virtually frictionless movement. All this makes it the best tonearm found on an integrated turntable.

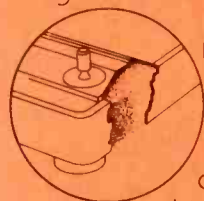

The base on the ADC 1700DD turntable is constructed of a highly dense structural foam which absorbs and neutralizes resonance and feedback. The speed selection control is an electronic microswitch which will respond to your lightest touch.

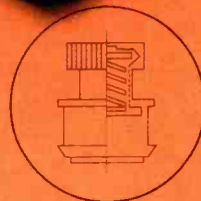

Supporting this resonance-cancelling base are energy absorbing, resonance-tuned rubber suspension feet. These suspension feet help to stabilize the base while controlling resonance.

The motor in the ADC 1700DD is also present standard of excellence: Direct Drive Quartz Phase-Locked Loop.

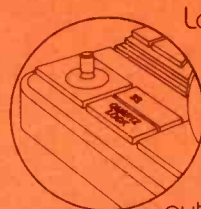

A quartz crystal is used in the reference oscillator of the motor. An electronic phase comparator constantly monitors any variance in the speed, making instantaneous corrections. Even when out of the Quartz-Locked mode, the optical scanning system keeps drift at below 0.2%. Wow and flutter are less than .03%. Rumble is an incredible -70dB Din B.

The result of all these breakthroughs is pure, uninterrupted enjoyment.

We invite you to a demonstration of this and the other remarkable ADC turntables at your nearest franchised dealer.

Or write for further information to: ADC Professional Products, a division of BSR Consumer Products Group, Route 303, Blauvelt, N.Y. 10913. Distributed in Canada by BSR (Canada) Ltd., Ontario.



ADC. We build breakthroughs.

A BSR Company

Yamaha, the industry

When we set out to improve on our industry-acclaimed receivers, we knew we had a tough task ahead of us. How do you top being the first in such precedent-setting developments as built-in moving coil head amps, negative feedback MPX demodulators, pilot signal cancellation circuits, and the same amazingly low distortion throughout our entire line? After much continuing research, effort and unique care in design, we have the answer. It's called the CR-2040, the first in Yamaha's new line of receivers that does what only Yamaha could do. Outdo ourselves.

Unique continuously variable turnover tone controls. The unique Yamaha innovation gives you the tonal tailoring characteristics of both a parametric and a graphic equalizer. Without the added expense of having to purchase either. For instance, in addition to boosting or cutting the bass control ± 10 dB, you can also vary the turnover frequencies between 100 & 500 Hz to compensate for speaker deficiencies, room anomalies, etc., for unparalleled tonal tailoring flexibility. The same is true for the presence and treble controls.

Built-in moving coil head amp. More and more listeners are discovering the beautiful experience of music reproduced with a moving coil cartridge, such as Yamaha's newly introduced MC-1X and MC-1S. Discover this exquisite pleasure for yourself with the CR-2040's built-in moving coil head amp. This ultra-low noise head amp provides an ultra-clean 86dB S/N ratio

Continuously variable loudness contour.

This control compensates for the ear's decreased sensitivity to bass and treble tones at low volume levels. And you're not just limited to compensation at only one specific volume setting as with other manufacturers' on/off-type loudness switches. The Yamaha continuously variable loudness contour assures you of full, accurate fidelity at any volume setting you choose. Another Yamaha exclusive.

Automatic operation. Without a doubt, the Yamaha CR-2040 is one of the most automatic receivers in audio history. Instead of fiddling with dials and meters, you can sit back and let the automatic circuits do the work. Or, if you choose, manually override the circuits. Take the AUTO-DX circuit, for instance. We developed IF bandwidth switching for our world-acclaimed CT-2000 tuner. Now we've gone even further by improving this circuit so the receiver automatically chooses the correct bandwidth (local or DX) for the least noise. Working with this circuit is the AUTO BLEND circuit which eliminates annoying FM hiss to



to assure you of capturing all the high-end detail and imaging the MC experience affords. All you'll miss is the extra expense and added noise of an outboard head amp or step-up transformer.

Independent input and record out selectors. If you're a tape recording enthusiast, this feature is something you won't want to be without. It lets you select the signal from one program source to send to the REC OUT terminals for recording while you listen through your speakers to an entirely different program chosen on the INPUT selector. You can also dub from one tape to another even while listening to an entirely different program. It's another example of why Yamaha is the industry leader. We build in what the others can't even figure out.

make previously unlistenable stations more clearly audible. All without your lifting a finger. And Yamaha's exclusive OTS (Optimum Tuning System) automatically locks in and holds the desired station when you release the tuning knob.

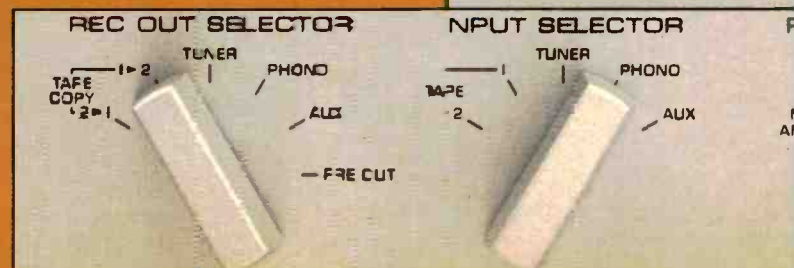
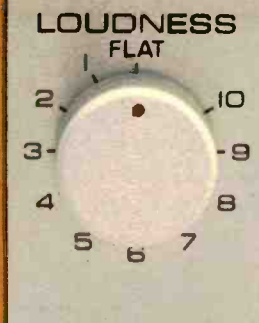

leader...leads again!

Advanced circuitry. All these advanced features are backed by the most advanced internal circuitry imaginable. Like the auto tracking pilot signal canceller, Yamaha invented pilot signal cancellation and now we've improved it further. A special circuit not only senses the incoming 19kHz pilot signal (which is a part of FM broadcasts), it also automatically tracks any signal fluctuation which might occur. This assures you of complete pilot signal cancellation for interference-free FM listening. Yamaha does it again!

The all DC power amp section puts out a massive 120 watts per channel, both channels driven into 8 ohms, from 20Hz to 20kHz, with THD and I.M. an astronomically low 0.02%. That's a new low, even for Yamaha. And to keep tabs on all this pure power there's a twin LED power-monitoring system—green to indicate half power, red to indicate an overload condition.

The tuner section has a Yamaha-exclusive Direct Current-Negative Feedback—PLL MPX IC providing excellent phasing of the high frequencies for superb stereo separation and clearer sound. Our efforts to bring you the finest sound possible know no limits.

Human engineering. As incredibly advanced and complex as the CR-2040 is, it is incredibly simple to operate. The front panel is arranged in a clean and logical manner with the larger primary operational controls located on the central forward panel, and the smaller tone-tailoring controls located on the lower panel. It takes a minimum of effort to set up the CR-2040 for maximum listening pleasure.

The functionally beautiful front panel is complemented by a real wood cabinet with simulated ebony finish—the perfect finishing touch to the extraordinary CR-2040.

And the CR-2040 is just one of a whole new line of receivers from Yamaha. Each one offers, in its class, the ultimate in features, performance and pure musical pleasure. Visit your local Yamaha Audio Specialty Dealer and see and hear for yourself how we've outdone ourselves. He's listed in the Yellow Pages. Or write us: Yamaha, Audio Division, P.O. Box 6600, Buena Park, CA 90622.

From Yamaha, naturally.

0.02% THD



YAMAHA

Yamaha, Audio Division, P.O. Box 6600, Buena Park, CA 90622

PHONO SELECTOR
33kΩ 47kΩ 88kΩ MM
MC AMP 100kΩ

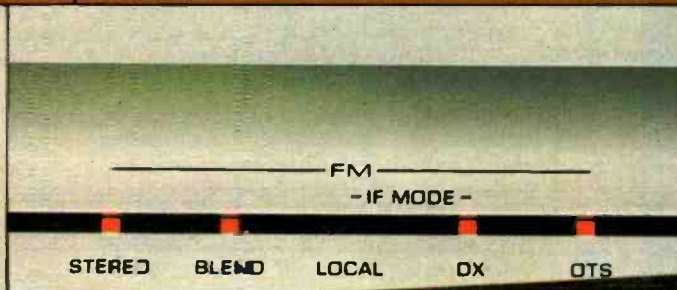

SME SERIES III

*The best pick-up arm in the world*Design Council
Award 1978

Exclusive distributors for the U.S.: Shure Brothers Incorporated, 222 Hartrey Avenue, Evanston, Illinois 60204
and in Canada: A. C. Simmonds and Sons Ltd, 975 Dillingham Road, Pickering, Ontario, L1W 3B2

Informed opinion

Few products in the hi-fidelity world have received such favourable comments from knowledgeable experts as the Series III precision pick-up arm.

They are too numerous to quote here, so we have prepared a special presentation of them which we will gladly send on request. Please indicate whether or not you require details of the arm as well.

Write to Dept 1452
SME Limited · Steyning · Sussex · BN4 3GY · England

"minimize the loop areas." The final two chapters are on r.f. processes in instrumentation and the earth plane. There is discussion of problems in these areas and the possible solutions. The index is fairly good with adequate cross-referencing. The emphasis in the book is on grounding/shielding for instrumentation, but there is helpful information for audio equipment/system design. This second edition is more of a refinement of the first edition, with relatively little new material.

Howard A. Roberson

The Complete Handbook of Public Address Systems by F. Alton Everest. Tab Books, 1978, \$7.95.

The author states that the text is directed to non-technical persons who must understand PA/SR systems, but its usefulness is broader than that. The first three chapters cover elements of basic acoustics, including room effects, propagation, and hearing. Some confusion was generated by figures 3-3 and 3-4 being interchanged and in non-standard orientation. The next chapter on types of SR systems has good coverage of some facets too often ignored, but it seemed odd to find emphasis on special mike usage, with little on what is more likely. Chapter 5 tells how to evaluate an existing system and provides specific information on conducting articulation tests in a church — one of the best features of the book.

The next four chapters are on equipment characteristics and usage, microphones, amplifiers and signal processing, loudspeakers, and the elements of audio control. There is a great deal of information contained, perhaps too detailed for some non-technical readers. The discussions of criteria for multiple-mike usage and loudspeaker location and pointing are particularly noteworthy. More information would have been desirable on control, mixers, and system interconnections.

Chapters 10 to 12 concern room acoustics and EQ, fold-back systems for platform/choir areas, and the problems in multipurpose halls. There is a lot of good information, though 70-V systems are not even mentioned, a curious omission. The next chapter gives examples of relatively advanced SR systems. More applicable would be the detailing of simpler installations, complete with interconnection diagrams. The brief final two chapters contain essential points on dealing with a sound contractor and suggestions for new construction.

The appendix contains instructions for articulation tests. The glossary has

well-chosen entries with good definitions. The index is quite abbreviated, especially when compared to the amount of material in the preceding 260 pages. By the author's own definition, this text is really more of a handbook for sound reinforcement than for public address. It's filled with helpful and pertinent up-to-date discussion of most areas, although systems considerations are not covered to the same level.

Howard A. Roberson

The Face of Rock & Roll by Bruce Pollock & John Wagman. Holt, Rinehart & Winston, 1978, paperback, \$12.95.

This newest collection of album cover art takes the form of a retrospective of rock & roll trends with a text that takes the vantage point of a fan who grew up in the '60s.

There are serious problems with this volume all down the line. Wagman's design is static. Most right-hand pages have full-page reproductions while the left have one of four different layouts which range from the rare full-page illustration to six illustrations of one-ninth page each and a column of text. Most curiously, nowhere in the book does a single gatefold cover appear folded out even when the design obviously cries out for such treatment, as with the cover of the first King Crimson album. Additionally, without explanation, Wagman sees fit to duplicate himself by repeating some covers several times, sometimes to good effect (facing full-page covers of Debbie Reynolds and Olivia Newton-John looking for all the world like time-warped clones), but more often purely gratuitously (including Kiss' *Love Gun* cover as a full page twice and only 35 pages apart).

On a technical level, the reproduction quality is erratic at best. The full pages are, for the most part, embarrassingly grainy. The color reproduction is wildly uneven. The repeated Kiss covers' color varies almost to the point of being unrecognizable.

Pollock's text is breathlessly autobiographical and sketchy. To be sure, he makes his occasional points, but slogging through the cuteness to find them is a large bother. Better to leave the fan's fantasies aside and observe the art.

On top of it all is a steep \$12.95 list price, \$2.00 more than *The Album Cover Album* edited by Roger Dean and Hipgnosis. That one, released over a year ago, was one of the first books of album cover art and, after about a half-dozen challengers, is still the definitive one. Get it instead.

Michael Tearson

TELARC DIGITAL RECORDING:

**It spells
enchantment,
intoxication,
and your utter
involvement in
the music.**

Stravinsky's Firebird is a challenge. In 1910 it dared listeners to embrace new tonalities, and it has remained fresh and alive ever since. It is a formidable test of the resources and musicianship of the orchestra. And it makes fantastic demands of the art of recording.

Even the finest conventional tape recorders have been unable to capture the full dynamic range and complex sonorities of this remarkable composition. Digital recording techniques are likewise put to a significant test in capturing the full impact of this performance. That this unique digital effort has succeeded will be immediately apparent with the opening notes. And the benefits of the digital process will persist to the final echo.

Briefly, this Telarc recording uses Dr. Thomas Stockham's Soundstream digital recording system which converts the original electronic signal from the recording console into a series of digital numbers... a new number every 1/50,000 of a second! Each of these "samples" uses a 16-bit binary code to describe the signal more precisely than



you can hear it. These numbers are stored on tape, with quartz-locked accuracy, then recalled later without loss to make the master disc recording.

While digital techniques lower distortion, increase signal-to-noise ratio, and eliminate speed problems which limit most recording quality, it is just the first step to an outstanding disc. Half-speed mastering and the finest of European pressing also contribute to the high standards this disc achieves.

This impressive technology does more than simply reveal the impressive performance of Robert Shaw and the Atlanta Symphony Orchestra and Chorus. Uninhibited by artificial

restrictions of dynamics, the interpretation of the Firebird Suite is memorable. Borodin's Prince Igor is no less spirited.

Indeed, digital recording completely removes many of the long-standing barriers between musician and listener. Enjoy this new freedom at your Audio-Technica dealer, where the finest digital, direct-to-disc, and high technology recordings are sold.



If not available locally, write for complete current catalog and ordering information.



audio-technica
INNOVATION □ PRECISION □ INTEGRITY

AUDIO-TECHNICA U.S., INC., Dept. 99A-3, 33 Shiloh Avenue, Fairlawn, Ohio 44131

Enter No. 4 on Reader Service Card

Jon Tiven

Michael Tearson

The column



With the Naked Eye: The Greg Kihn Band.

Beserkley BZ-10063, stereo, \$7.98.

With his fourth album, Greg Kihn seems finally poised to rise above the remarkably poor luck that has prevented the previous three discs from reaching the audience they deserve. Though he has always recorded on Beserkley, because of the often byzantine politics of the record biz, each album has been distributed by some different firm, first Playboy Records (now defunct), then CBS, then Janus (now defunct), and now Elektra/Asylum which would seem to be a perfect choice of a label sympathetic to his music.

Put aside the politics. Greg Kihn is an engaging, beguiling, charming rocker/troubador with '60s roots and genuine "song sense," one who has gained strength and savvy each time out. Perhaps because of not "making it" instantaneously, the group is stronger than if "success" had caught them sooner. Now they are a confident, sure-handed unit that really shines on **With the Naked Eye**.

Again Greg has turned in a cluster of bright originals complemented by a

couple of inspired covers. One of the covers opens the album, a previously unrecorded Bruce Springsteen song *Rendezvous* which Bruce gave Greg as a present for his inspired version of *For You* two albums ago. It is a tune that should be a radio staple for Summer '79, great cruising music. Speaking of cruising music, there is a thunderous open throttle version of Jonathan Richman's epic-proportioned *Roadrunner* to which Greg brings a perfect mixture of restlessness and excitement.

Among the originals a couple stand out for clever lyrical play, namely *Beside Myself*, with its great refrain line "I'm beside myself/But I want to be next to you," and *Can't Have the Highs (Without the Lows)*. There is *Fallen Idol*, a go at the old theme of the newly defeated and now sinking ex-champ; it could have been maudlin or trite, but it isn't. *Another Lonely Saturday Night* is another beautifully written song set in a softer tone with echoes of Buddy Holly's classic *Everyday*. The album's title track has a particularly effective and finely honed nasty edge.

Greg's band — Larry Lynch, Stevie

Wright, Dave Carpender and Kihn himself — revels in the empathy that their several years of work together have developed. They play catchy riffs and ear-tweaking nuances, largely '60s style, with great verve and wit. The production is spare yet carefully detailed and all the while absolutely unpretentious.

Absolutely unpretentious. That's what makes The Greg Kihn Band special. They waste no energy on their own sense of self-importance. What you get is a terrific spirit of fun amid some great rock and roll.

Great songs. Great playing. Sympathetic production. **With the Naked Eye** has it all. If it's not a hit, I promise to eat a whole album cover. M.T.

Sound: B

Performance: A

The Wonderful World of Wreckless Eric

Stiff SEEZ 9, stereo, \$7.98 (import).

Stiff Records has been getting a lot of press lately due to a simultaneous release of five albums by five near-unknowns. The record company is

AUDIO • September 1979

HIGH SPEED RECEIVERS: FASTER RESPONSE MEANS MORE ACCURATE SOUND.

The new Kenwood receivers actually outperform all other receivers, as well as our competitors' separate amplifiers and tuners in transient response.

The reason is Kenwood's exclusive technical breakthrough: Hi-Speed. It allows our receivers to react more quickly to musical changes. So what comes out of your receiver matches precisely what went in.

You'll hear the difference as dramatically accurate, open sound with superior imaging and detail. Like hearing an individual singer in a vocal group.

Hi-Speed is available in four models, all DC-amplified for clean bass response. Each one also has switchable wide and narrow IF bands for low-distortion FM reception, plus dual power meters.

And each Hi-Speed receiver has unique individual features that make a real difference in the tonal quality of music. Like dual power supplies that eliminate crosstalk distortion. Or a pulse count detector that digitally reduces FM distortion by half

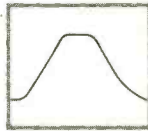

Distorted waveform response produced by conventional receiver.

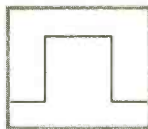

Square waveform response of Hi-Speed receiver.

while significantly reducing background noise. Or a built-in equalizer with ten turnover frequencies for full acoustic control.

Whichever model you choose, you'll be getting the most advanced receiver technology and performance available today. Advances far beyond the competition.

Your Kenwood dealer will be happy to demonstrate Hi-Speed, now.

HI-SPEED™

Hear the future of high fidelity



KENWOOD®

For the Kenwood dealer nearest you, see your Yellow Pages, or write Kenwood, P.O. Box 6213, Carson, CA 90749
In Canada: Magnasonic Canada, Ltd.

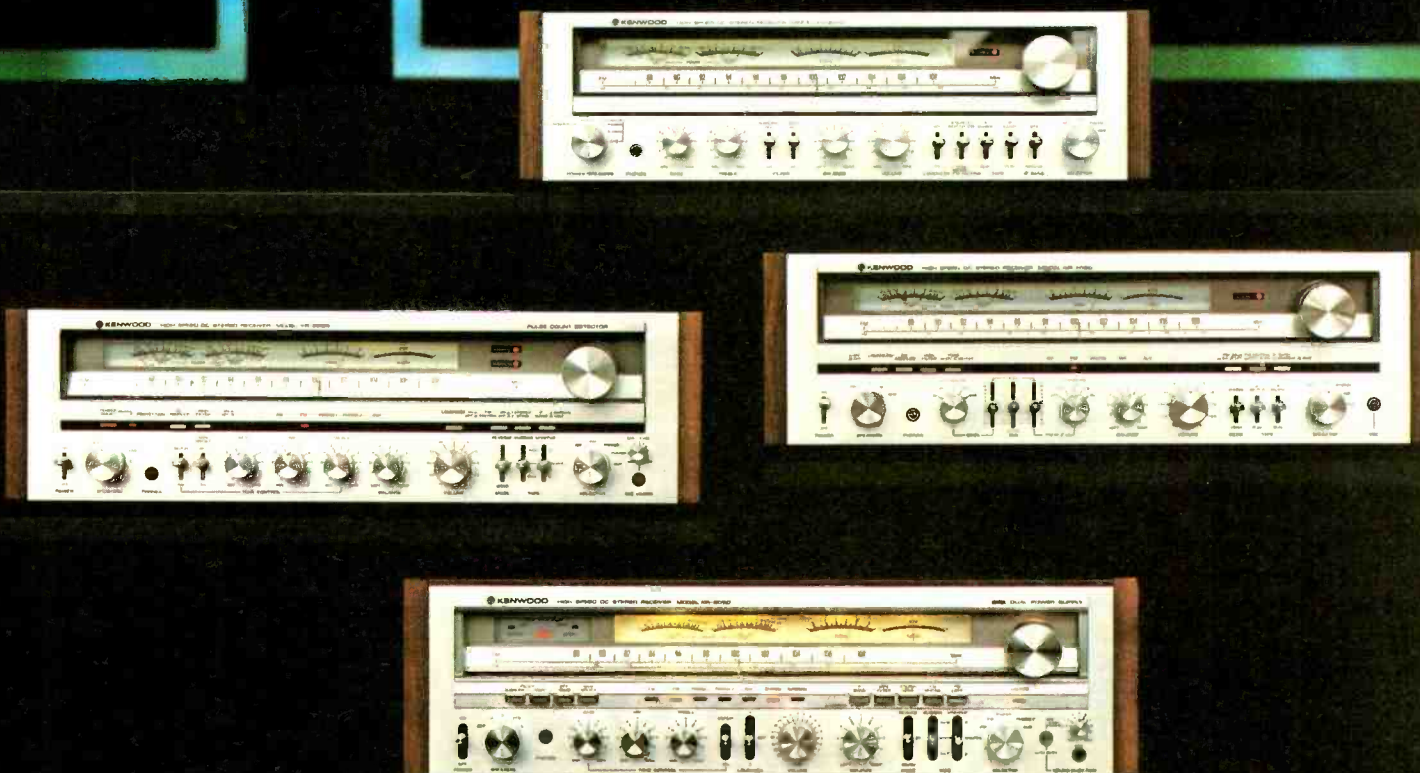

Enter No. 19 on Reader Service Card

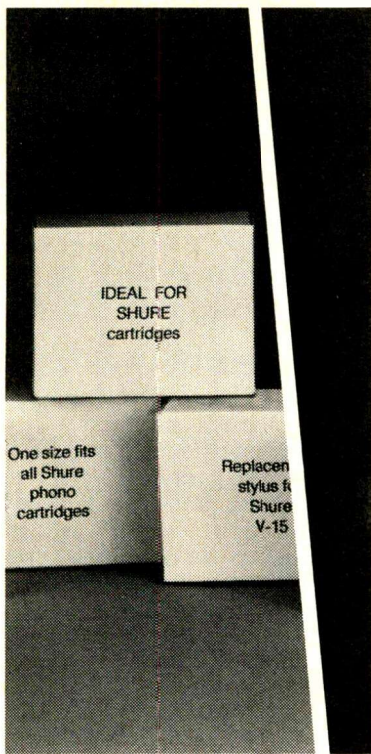

Needle in the hi-fi haystack

Even we were astounded at how difficult it is to find an adequate other-brand replacement stylus for a Shure cartridge. We recently purchased 241 random styli that were not manufactured by Shure, but were being sold as replacements for our cartridges. Only ONE of these 241 styli could pass the same basic production line performance tests that ALL genuine Shure styli must pass. But don't simply accept what we say here. Send for the documented test results we've compiled for you in data booklet # AL548. Insist on a genuine Shure stylus so that your cartridge will retain its original performance capability—and at the same time protect your records.

Shure Brothers Inc.
222 Hartrey Ave., Evanston, IL 60204
In Canada: A.C. Sir-monds & Sons Limited

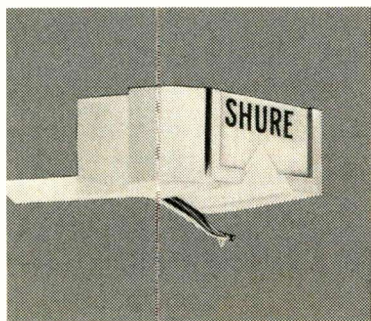

Manufacturers of high fidelity components, microphones, sound systems and related circuitry.

Enter No. 34 on Reader Service Card

known for their clever packaging, New Wave-leaning, sense of humour, and appeal to music critics' tastes. What's more, they have made quite a success of themselves with the likes of Elvis Costello and Nick Lowe (both of whom having moved to another record label over a year ago) and Ian Dury, giving them the funds to live out their wildest music industry fantasies. Of their five latest releases, the only one to my liking is this, mainly because it seems to have a certain amount of artistic integrity (the others are second-hand versions of other artists, if you get my drift). Wreckless Eric is an amusing musical personality, whose earliest single *Whole Wide World* showed an amazing amount of promise in a perverted bubblegum sort of way. In fact, when Elvis left Stiff, the president of the company made a statement that El Costellos' were a dime a dozen, referring to Wreckless as being one of the ten cents in waiting, and I expected the next Wreckless Eric album to be every bit as captivating as *My Aim Is True*.

Unfortunately, some goon matched him up with a producer named Larry Wallis who had as much of a bead on Wreckless Eric as Squeaky Fromme had on Gerald Ford, the result being a sloppy, undecipherable album of no use to anyone. For his current offering, his mentor is Pete Solley (a keyboardist whose previous bands have been known only to a privileged few), and at least this time we have a record that is vaguely musical. Most of side one is, in fact, listenable despite the fact that Mr. Eric's British accent is laid on a bit thick as to impress us Americans with his origins. His trademark is a simple song punctuated by rhythm guitar eighth notes (*Walking on the Surface of the Moon* and *I Wish It Would Rain* being the most typical), although his cover version of Buddy Holly's *Crying, Waiting, Hoping* is equally effective and entertaining. The record has its accent on personality, which isn't to say that Wreckless Eric cannot sing — but face it, Rod Stewart he is not.

What is so distressing about this album is that one cannot tell really how good an artist Eric is, as the songs are camped up so much that appreciating them for anything beyond personality is no less difficult than trying to make out the words on a Plastic Bertrand album. Perhaps a lyric sheet (with American translation) could have been included to help us out, but I feel that despite Mr. Eric's talent, he's going to have a difficult time breaking out of the cult business. J.T.

Sound: B- Performance: B

50 Million Elvis Fans Can't Be Wrong: Elvis Costello & The Attractions **Slipped Disc EL 5000**, stereo, \$14.98.
Anyone Can Play: The Yardbirds **Slipped Disc YB 1965**, stereo, \$7.98.
Tearjerker: Tom Petty & The Heartbreakers **Slipped Disc TPH 1AB**, stereo, \$7.98.

Bootleg discs have always been the thorn in any record company's side, regarded as a detraction from their artist's sales and unfair competition. This is true in the case of records which are virtually identical to the ones released by the major labels. But in these examples of boots, I would argue that not only is the legger providing a service to the public, but to the artist besides. In all three cases, the unofficial discs are even superior performance-wise to the officially released albums.

Take Elvis Costello & The Attractions album, which is in itself a fine argument against recording studios, record producers, and the whole machinery. Contained herein are song demos made on a home two-track, featuring the guitar and voice of Elvis unaccompanied by anything but a slight hiss. The performances of songs like *You Belong To Me*, *Radio Radio*, and *Alison* are every bit as musically compelling as the versions on **This Year's Model**, possibly even more so. There's also a demo with The Attractions working out *Lip Service* which makes the album version pale by comparison, and an outtake of *Red Shoes* which is more human and real than the seemingly faultless version on **My Aim Is True**. The rest of the album is a live show from the first week of Elvis' American tour of 1977, and, although the sound quality seems a bit muddled, the power of the performances is unlike anything that's been heard on record by this man before. His guitar playing is exciting and unbridled, the band is on fire, and his vocals breathe with an intensity that lives up to the hype. Without a doubt, this is Elvis Costello at his best. Precision is lacking in a few places, but it's more than made up for by the obvious conviction in the delivery.

Anyone Can Play is by a defunct group from which no albums have been released in over ten years, although The Yardbirds were perhaps one of the best guitar improvisation groups of all time. Jimmy Page, Jeff Beck, and Eric Clapton — one of whom is practically anybody's favorite guitarist — did their first stepping out with this pop-blues outfit during the mid-Sixties, and it is absolutely a crime that only their hits are still available on record when their misses are far more

fact: there's a Shure cartridge that's correct for your system —and your checkbook:



V15 Type IV—The perfectionist's pickup—overcomes such ever-present problems as warp, static electricity, and dust. Ultra-flat response. Reduced distortion. Unprecedented trackability. $\frac{3}{4}$ to 1½ grams tracking. Premium-priced.



V15 Type III—Second only to the Type IV. Ultra-flat, wide range response. Super trackability. $\frac{3}{4}$ to 1½ grams tracking. Best-buy pricing.



M95HE—New mid-priced cartridge with distortion-reducing Hyperelliptical stylus. Flat response. $\frac{3}{4}$ to 1½ grams tracking.



M95EJ—Superb performance for heavier tracking (1½ to 3 grams) systems. Biradial (Elliptical) stylus. Moderately priced.

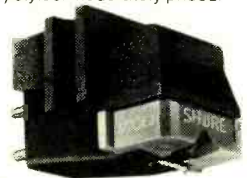

M70 Series—Modestly priced cartridges with truly noteworthy performance. 1½ to 3 grams tracking. Biradial or Spherical styli.

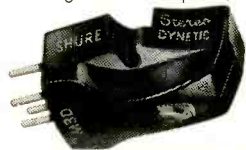

M3D—The low-cost cartridge that began it all nearly two decades ago! 3 to 6 grams tracking. Replacement styli still available, as they are for virtually all Shure stereo cartridges ever made.



Manufacturers of high fidelity components, microphones, sound systems and related circuitry.

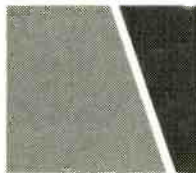

**fact:
the phono
cartridge
is the
heart of
hi-fi...**

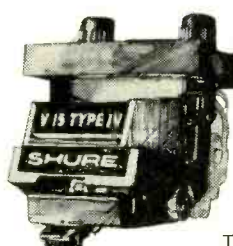

The hi-fi phono cartridge functions as the *source of sound* (the point at which the recording is linked with the balance of the hi-fi system)—therefore, its role in high fidelity is absolutely critical. Just as the camera can be no better than its lens, not even the finest hi-fi system in the world can transcend the limitations of an inferior cartridge. The cartridge represents a relatively modest investment which can audibly upgrade the sound of your entire record playback system.

Consult with your nearby Shure dealer who will help you select the Shure phono cartridge that is correct for your system and your checkbook. We especially recommend that you audition the Shure V15 Type IV. Discriminating critics throughout the world praise this cartridge as the new standard for faithful sound re-creation. It overcomes such ever-present problems as dust, static electricity, "hot" signals, and record warp that cause "clicks" or "pops," and distorted record reproduction. May we send you our brochure?

Shure Brothers Inc., 222 Hartrey Ave., Evanston, IL 60204
In Canada: A.C. Simmonds & Sons Limited



Enter No. 33 on Reader Service Card

interesting and plentiful (at least on tape). The bootleggers have, in this instance, again provided the public with an album that makes the commercially released documents obsolete. **Anyone Can Play** contains almost an entire side of live Yardbirds tracks featuring James Page at his most agile, half a dozen live rave-ups with Jeff Beck wailing frenetically, and two rare studio tracks with Mr. Clapton, if I'm not mistaken. This is the group that recent bands like Aerosmith and Nazareth try to emulate, but **Anyone Can Play** will reaffirm your faith that there is no equal to the original heavy-metal dynamism of The Yardbirds.

Tom Petty & The Heartbreakers are an excellent band but have never been

properly captured on record — their first album was intermittently successful at displaying their essence; their second (which took ages to record) was not much better. **Tearjerker**, a live radio broadcast recorded and mixed in one night, seems to have the energy and fire that Tom Petty's fans want from his albums and only receive in concert. Superbly recorded chestnuts that have never found their way onto record, like *Route 66* and *Jaguar & The Thunderbird*, appear here in fine form, as well as previously unrecorded Petty originals like *Surrender* and *Dog on the Run*. If this album were actually available through the normal channels, Tom Petty's sales might quickly jump from gold to platinum; as is, the

fans can get their taste of where the band genuinely is at.

All three of these records are pressed in what I would term a highly professional manner, and the only time the mastering volume isn't high enough is when the records have eight songs or so per side. I would strongly recommend them to any serious record collector who wants to hear what his favorite bands *really* sound like. In twenty years, when people look back and want to find out what this generation's rock & roll was all about, I hope someone has these albums lying around. J.T.

Sound: A

Performance: A

Thanks I'll Eat It Here: Lowell George Warner Brothers BSK 3194, stereo, \$7.98.

If, when this solo album was promised, you expected a big harvest of all the Lowell George songs that have been conspicuously absent from recent Little Feat records, you might be surprised now that it has been released. But I doubt you'll be disappointed, for George's **Thanks I'll Eat It**

Here is just fine — whether or not it's what you anticipated.

Side one has four songs, 1½ of them originals: The nasty *Honest Man* and a version of *Two Trains* that is very different from the one on Little Feat's **Feats Don't Fail Me Now**. These are framed well by a smash pair of covers. The side opens with a sleek and funky go with Allen Toussaint's *What Do You Want the Girl to Do?* and closes

On June 29, Lowell George died from a heart attack in Arlington, Va. He had been about to mix the final Little Feat album when he got off tour. Lowell was one of the most passionate and individual players and singers in rock, and the sense of loss is overwhelming. I already miss him dearly. M.T.

with a sly run through Ann Peebles' *I Can't Stand the Rain*, an offbeat choice that is a honey. Side one is the rockin' side.

Side two is something else, the crazy side. *Cheek to Cheek* is a collaboration between George and that classic zany Warner Bros. eccentric and inspiration Van Dyke Parks. *Cheek* is an especially quirky, herky-jerky thing that combines Caribbean, Mexican, and other rhythms. Next is Rickie Lee Jones' *Easy Money* about city hooker schlockers done to a bluesy shuffle. *Twenty Million Things* is Lowell's. It is in the tradition of *Trouble* from Feat's **Sailin' Shoes**, a "what have I done now?" song. Fred Tackett, who wrote the equally wistful *Find a River*, earlier wrote *Fool Yourself* which is on Feat's **Dixie Chicken**. The finale is a weirdo Jimmy Webb song called *Himmeler's Ring* played as a cabaret number all the way down to a trombone horse-laugh.

It's a short album, barely 31 minutes, but it is all dandy material. Nothing too heavy but with slants. The album plays like the "should be over the hill" pitcher who has lost his velocity, but has learned to do it with off-speed stuff, smarts and desire, and who can still pull a 20-win season seemingly at will. M.T.

Sound: B

Performance: A-

Lowell George, seated, with Little Feat



Wornell Jones**Paradise PAK 3308**, stereo, \$7.98.**Heart of Fire**: Mary Russell**Paradise PAK 3292**, stereo, \$7.98.**Bustin' Out of L Seven**: Rick James**Gordy G7-984R1**, stereo, \$7.98.

Disco music is a retrogression to the days when a producer would drag some geek off the street, tell him to sing when he snapped his fingers, sell the master to a record company, and get most of the money himself with the artist pretty much left in the dirt. They're the kind of records where people know the name of the tune, but nobody remembers the name of the artist, so when the next record by him comes out, it has only a slightly better chance of being a hit than the last one, rather than being an automatic smash.

But there is a Black Music happening today that has nothing to do with predictable white producers, financial cons, and music business jive. It started years ago when Motown started giving acts like Stevie Wonder, Marvin Gaye, and Smokey Robinson autonomy, and they proved that they could make good use of the producer's chair themselves. Nowadays even fairly unknown artists can get to produce themselves, and in these cases they have proved wholly refreshing.

Wornell Jones is probably best known for his Nils Lofgren work (particularly his stunning bass guitar on **Cry Tough**) although he's also worked with members of the Motown stable, and his first album under his own monicker is 100 percent successful. In feel, it's very similar to early Seventies Stevie Wonder, although with a song like *Lay It On The Line* he proves he can rock out energetically. Using instrumental support from his former Lofgren cohorts Andy Newmark and Reverend Patrick Henderson, Stan Lynch (drummer in Tom Petty & The Heartbreakers) and various studio musicians, Wornell makes a music



which is every bit as fine and immediate as the Motown greats. Obviously the guy is going to be successful as all heck, so all I can say is go out and buy the record 'cause it's great.

Mary Russell (wife of Leon) sings extremely well, writes very commercial songs (with the help of the Kim Fowley publishing roster), and has a very danceable album called **Heart of Fire**. Being a vocally oriented album, it's not quite as subtle as Wornell's (although Wornell plays extremely strong bass guitar on it, and has even written the title track) but every bit as consistent. Unlike the disco records with three songs per side, there are 10 excellent tracks here, any one of which could be her single.

Rick James is slightly more *avant-garde*, playing a stone funk unlike any of his predecessors and has himself one weird album. Of course, he's already had his share of singles success so he is allowed as many of his excesses as he cares to deliver. Believe me, this is one bizarre guy, but as talented as you're likely to find and, besides, this is one of the most way-out records ever to be released on the Mo-

town label. It's a little too intense to listen to the entire thing in one sitting, but if you're on your feet dancing, it might be totally suitable for your purposes. In any case, Black Music is alive and well if you look past your Chic and Taste of Honey records and score any/all of the above. Just 'cause you can dance doesn't mean you can't think — at last, we have danceable records which don't insult your intelligence while you boogie! J.T.

Sound: B to B- Performance: A to A-

85

Fool Around: Rachel Sweet
Stiff SEEZ 12, stereo, \$7.98 (import).

Why are today's "girl" singers so boring? Is it because they try to be pleasing — either sexy or cute — rather than genuinely expressive? In the '50s and '60s soul singers like Aretha Franklin and girl groups like the Ronettes and the Crystals managed to convey aspects of their personalities other than a standardized sexuality that the audience is said to expect: Even though respectively sexy and cute, they expressed real emotion

Simple Makes Perfect

The PPA-1 pre-preamplifier is a simple battery-operated step-up device for moving-coil cartridges. The simple Class A circuit has no TIM, no SID, zero feedback, and is hand-matched to 1% tolerances in a simple dual mono design. The styling is simple elegance with 16 ga. steel wrapped in heavy aluminum. And the sound... simply amazing. If you haven't heard the PPA-1, you haven't heard your moving-coil... it's as simple as that.

Marcof Electronics 7509 Big Bend Blvd., Webster Groves, MO 63119 Exclusive Canadian distributor: **Trans Audio Marketing**

McIntosh

"A Technological Masterpiece ..."



McIntosh C 32

"More Than a Preamplifier"

McIntosh has received peerless acclaim from prominent product testing laboratories and outstanding international recognition! You can learn why the "more than a preamplifier" C 32 has been selected for these unique honors.

Send us your name and address and we'll send you the complete product reviews and data on all McIntosh products, copies of the international awards, and a North American FM directory. You will understand why McIntosh product research and development always has the appearance and technological look to the future.

Keep up to date.
Send now - - -

McIntosh Laboratory Inc.
Box 96 East Side Station
Binghamton, NY 13904

Name _____
Address _____
City _____ State _____ Zip _____

If you are in a hurry for your catalog please send the coupon to McIntosh. For non-rush service send the Reader Service Card to the magazine.

Enter No. 22 on Reader Service Card

through their "oh yeah's" and "do-wah's." Rachel Sweet, a young caucasian chanteuse, had the right idea when she chose these two singing traditions to model her vocals upon — I mean, at least she doesn't attempt a Blondie or Ronstadt delivery in the hopes of making her debut album sound familiar and therefore buyable to the unadventurous ears of the slowly educated listening public. So we have Sweet, a mere sixteen year old with a powerful and liberally ranged voice, performing songs by her producer Liam Sternberg in the 50s girl-group idiom on the album, **Fool Around**.

The reason that Sweet has been recorded at all is the same reason she's allowed artistic freedom on her first LP: Stiff Records is geared to new artists and doesn't seem to have tampered much with Sweet's original ideas for each song. Hence the patchy and misproduced quality of an album that's in a word, uncommercial, a shame indeed because Sweet's selling potential is definitely in the six-digit bracket. She's closer to MOR than New Wave, her tunes feature considerable orchestration and a lot of whiney/perky/longing vocals guaranteed to attract the sing-along record consumers.

The weakest part of this record is the second and more experimental side. *It's So Different Here* and *Cuckoo* have disjointed rhythms and lyrics that belie a kindergartenish imagination: They're more annoying than a bad Blondie song because the instrumentation is all but absent. Conversely, *Stay Awhile* is the most effective tune. It's a Spectroesque song with horns, strings, and ooh-ah backing vocals that provide a dynamic background for Sweet's enthusiastic crooning.

Desolation Angels: Bad Company
Swan Song SS 8506, stereo, \$8.98.

Foreigner, Toto, and a string of other gruff-voiced artists have used Paul Rodgers' last group Free as a reference point from which to catapult toward fame, and on Bad Company's first album it looked like they were destined to be one of the all-time great groups. It's been downhill ever since, with the only decent tracks either covers (*Youngblood*) or steals (*Good Lovin' Gone Bad*). My feelings are that too much was expected of Paul Rodgers, whose talents are undeniable as a performer but minimal as a composer; the Free songs were always coauthored with Andy Fraser when they were any good, and Mr. Fraser's solo career has been artistically fruitful although hampered by business mistakes. The



Sweet's voice is as her name suggests — wistful and yearning, closer to soul than the sleazy drone of Debby Harry.

Definitely one of Stiff's more talented artists, Sweet could be great if she adopted a more rocking approach to her music. **Fool Around** has most of the basics — decent songs, good singing, the Beat most of the time — but it's hampered by dull arrangements and instrumentals unnoticeable if not off-key. Luckily for Sweet, time is on her side: Maybe she'll have a happening act in time to perform at her own high school prom. *Sally Young*

Sound: B -

Performance: B+

Paul Rodgers Voice has no rival in terms of delivering a tune or improvising over a fadeout, but lately he hasn't had much to work with. Mick Ralphs' songwriting has been a major disappointment, for when one considers that *Can't Get Enough* and *Ready For Love* were actually written while Mick was still in Mott The Hoople, one realizes that Ralphs really hasn't come up with anything, except maybe *Movin' On*, in half a decade.

The latest album is no major improvement, and it actually displays how weak Ralphs and Rodgers are as songwriters, since the two best tunes on **Desolation Angels** are the ones written by the rhythm section, Boz Burrell's r&b-ish *Gone, Gone, Gone* and Simon Kirke's ode to himself, (*I'm A*) *Rhythm Machine*. Neither of these

AUDIO • September 1979

ORIGINAL MASTER RECORDING™

PINK FLOYD!!

The Dark Side Of The Moon

Limited Edition
Stereodisc

**Available from select audio
and record stores coast to coast.**

Mobile Fidelity Sound Lab
P. O. Box 919
Chatsworth, CA 91311
(213) 993-4945



Imported Super Vinyl Pressings • Half-Speed Mastered • Special Protective Packaging

Enter No. 14 on Reader Service Card

tunes is great, but at least Rodgers sings them well and they aren't rehashes of *Can't Get Enough* like *Lonely For Your Love* is.

Now it's almost a certainty that Bad Company's next album will be a live one so they can at least get some air-play again with a new version of their greatest hit, but I'd like to offer the group several alternatives. They can get Andy Fraser to write some songs for them, they can get Roy Thomas Baker to produce them, or they can do an album of Free's best songs. Otherwise, why don't Paul Rodgers and Simon Kirke join up with Jimmy Page (another Swan Song artist) and show the world that there can be a super-group in 1980? Certainly I can't be the only one tired of this stuff. *J.T.*

Sound: C+

Performance: C

Wild Places: Duncan Browne
Sire SRK 6065, stereo, \$7.98.

This is one time that the cover art is a good hint of what is inside. From the ice cream suit he's wearing to the flame-haired, wasp-waisted girl in the leopard leotard and the color negative back cover, Duncan Browne has obviously taken his graphics lessons from the Roxy Music school of design.

The music inside is very arty and very British. It is very much a continuation of the music of Metro, the now-

defunct band that Browne last surfaced as part of. The opening title track is excellent, a yearning melody matched to desperately yearning words. *Roman Vecu* with its repeated line "you don't live in Paris..." expands the theme into haunting territory, leading directly to the ambitious and extensive instrumental tableau *Camino Real*.

Side two opens and closes with songs left over from Metro, the slugging *Samurai* and the mystical *Planet Earth*. In between are the sensuous

Kisarazu—The Touch and *The Crash* which is an up-tempo song to an unattainable lady.

Wild Places features a big wash of sound. Browne, who self-produced, uses echo on his voice for mystique and a Genesis/10 cc school instrumentation with emphasis on strings and synthesizers (arranged by Tony Hymas) for depth. **Wild Places** has its real strong moments alongside the adequate ones; side one is stronger. *M.T.*

Sound: B

Performance: B-



Remote Control: The Tubes
A&M SP-4751, stereo, \$7.98.

Whoever's idea it was to engage techno-wiz Todd Rundgren to produce The Tubes must have thought it was a master stroke. After all, more than most, The Tubes have had serious problems translating their incredible stage show to vinyl. Todd, combining his well-known and superb song sense with his studio mastery, would be perfect for The Tubes, right?

Well, not quite right. **Remote Control** as it finally appears is thoroughly Rundgrenized, fully homogenized until it sounds more like a Todd album

played by other people. The Tubes' distinct personalities are fully obscured behind their producer. Then their continuing difficulties with material that works live but doesn't as pure vinyl. What is here is average at best, most of the time simply forgettable.

Surprisingly, the sound Todd has crafted for The Tubes is compressed smaller than life, not bigger. Alas, **Remote Control** is not the big step forward hoped for. It is really no step at all. *M.T.*

Sound: C-

Performance: D+



Hiding: Albert Lee
A&M SP-4750, stereo, \$7.98.

Most recently Albert Lee has spent a couple years in Emmylou Harris' Hot Band after James Burton left. Before that the Englishman played in many bands. Legend has it that Albert was Eric Clapton's original guitar hero. Whatever the truth of this, Eric has added Albert to the touring band for his 1979 World Tour. **Hiding** is Albert's first solo project. Produced by Brian Ahern, Emmylou's producer and husband, it has more verve and life than Brian's work usually has, without losing any of the polish.

Each side opens with a hot rocker, Albert's own *Country Boy* and *Setting Me Up*, which is the first Dire Straits song to be covered. These two are the most energetic of the album. Each side also has a standout weeper with Rodney Crowell's beautiful *On a Real Good Night* and the aching, sad title song. The opening guitar riff in *Now and Then It's Gonna Rain* is a steal from The Everly Brothers' *Bye Bye Love*, probably no surprise since Don Everly sings superb Brothers-type har-



monies with Albert on three numbers, including *Setting Me Up* and *Hiding*.

The album is surprisingly well recorded. As noted earlier, as a whole it sounds brighter than most of what Ahern has produced to date — from the slow, sad ones to the rockers. Albert Lee's *Hiding* is one of the sleepers of 1979. M.T.

Sound: B+

Performance: A-

Power: John Hall
ARC/Columbia JC 35790, stereo, \$7.98.

Power is a very stylish elpee, from the neon guitar art to the disc inside. It is the first solo album John Hall has done that sounds really comfortable (he made four albums with Orleans).

Hall recorded producing himself with friends at Bearsville studios, just past Woodstock. *Home at Last* would seem the obvious bid to the charts, a sleek pop rocker opening the set. *Power*, Hall's anti-nuclear energy song, features James Taylor and Carly Simon singing along. It is a strong and obviously heartfelt song. So is similar to *Fame* by David Bowie and John Lennon (currently missing in action) placed in a slightly reggae figure. The second side sports more of a jazzy feel with side opener *Run Away with Me* and the instrumental *Arms* which segues neatly into *Half Moon*, the song Hall wrote for Janis Joplin's *Pearl*.

Production and performance are equally crisp. Like I said at the top, John Hall's **Power** is a class act. M.T.

Sound: B+

Performance: B+

Ambient #1/Music for Airports: Brian Eno
Ambient/PVC 7908, stereo, \$7.98.

Music for Airports introduces yet another fascinating concept from the prolific Brian Eno. "Ambient Music" is meant to be background music, to fill spaces environmentally. In his notes Eno says it is "intended to induce calm and a space to think." Further he adds, "It must be as ignorable as it is interesting," and this is the key.

Music for Airports (wonderful title, that) is undoubtedly a success. It does

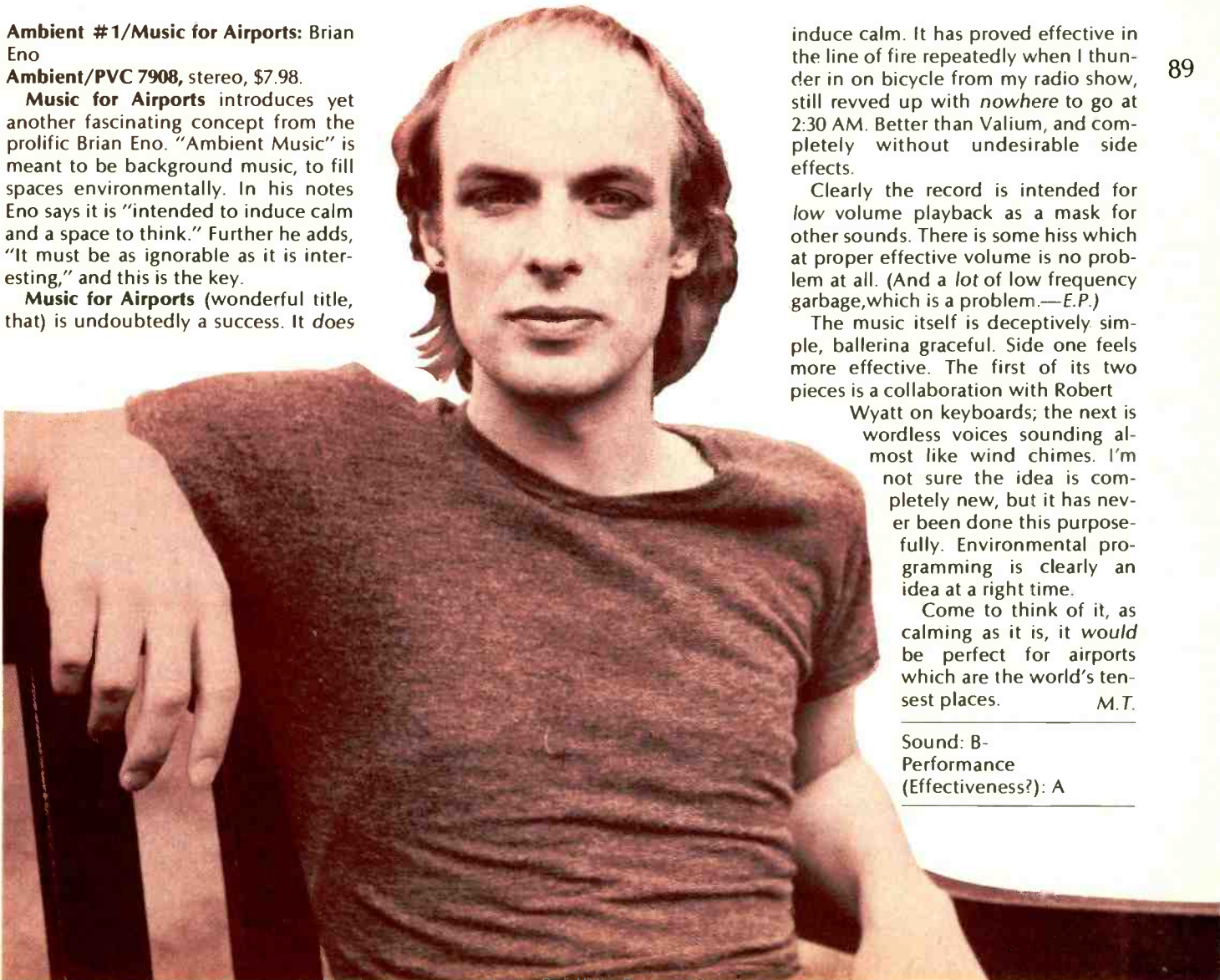

induce calm. It has proved effective in the line of fire repeatedly when I thunder in on bicycle from my radio show, still revved up with *nowhere* to go at 2:30 AM. Better than Valium, and completely without undesirable side effects.

Clearly the record is intended for low volume playback as a mask for other sounds. There is some hiss which at proper effective volume is no problem at all. (And a lot of low frequency garbage, which is a problem.—E.P.)

The music itself is deceptively simple, ballerina graceful. Side one feels more effective. The first of its two pieces is a collaboration with Robert

Wyatt on keyboards; the next is wordless voices sounding almost like wind chimes. I'm not sure the idea is completely new, but it has never been done this purposefully. Environmental programming is clearly an idea at a right time.

Come to think of it, as calming as it is, it would be perfect for airports which are the world's ten-est places. M.T.

Sound: B-
Performance
(Effectiveness?): A

Jazz & blues



Opus De Bop: Stan Getz
Savoy SJL 1105, mono, \$6.98.

Stan Getz Gold

Inner City 1040, stereo, \$7.98.

The Peacocks: Stan Getz and Jimmy Rowles

Columbia JC 34873, stereo, \$7.98.

Stan Getz began his career as a devotee of Lester Young's light-toned, translucent style of tenor saxophone. As the years went by, Getz acquired a firmer tone, developing a commanding attack and an authoritative style that few of his contemporaries could match.

Getz's early years are the subject of the single LP Savoy reissue, titled **Opus De Bop**, which encompasses three sessions that preceded and directly followed Getz's fruitful stint in the Four Brothers sax section of the Woody Herman Second Herd. The first Savoy session, a 1945 Kai Winding date featuring an 18-year-old Getz, Shorty Rogers on trumpet, and Shelley Manne on drums, focuses on a kind of transition bop-to-cool jazz sound. Getz and Winding work well together, and their clean, firm solo work encompasses concepts that were still partially rooted in Swing. (Getz, the year before, had spent time in the Benny Goodman

band.) The second session, which includes the title track, is an out-and-out 1946 bebop date which features pianist Hank Jones and drummer Max Roach. Here one can hear Getz's efforts to incorporate the sound of his idol Lester Young with the harmonic approach of the bebop master Charlie Parker. There are times when Getz's cool, drifting sound becomes so languid that many of his solos bog down for lack of momentum. The sound of these mid-'40s Savoy 78 rpm discs was fuzzy and murky, and the transfer to LP does nothing to improve their sonics. The much-better-recorded 1949 Savoy date features Getz in an Al Cohn-arranged sax ensemble (which also included Zoot Sims). Appearing with Getz, Cohn and Sims, is ex-Hermanite guitarist Jimmy Raney. The Cohn charts offer the cool, resonant, fluid sound of the Herman Second Herd, and the playing is brisk and breezy.

Stan Getz Gold, the Inner City release, is one of Getz's most potent jazz albums in some years. Recorded late in January, 1977, at the Club Montmartre in Copenhagen, Denmark, during the week of Stan's 50th birthday, the two-disc set presents Getz in

magnificent form. His rich, warm feeling for ballads can be heard on the lyrical *Lush Life* and *Morning Star*. On such uptempo numbers as Wayne Shorter's *Lester Left Town* and *Stan's Blues*, Getz wings nimbly through the changes, plotting a dramatic course for his solos, gradually intensifying his choruses and building them into a swirling climax. Getz has uncovered a fine young pianist, Joanne Brackeen who demonstrates a sparkling right hand on Alec Wilder's *Lady Sings the Blues*, *Eiderhorn*, and *Blues For Dorte*. The remarkable Danish bassist, Neils-Henning Orsted Pedersen, is also present, and his pulsing, probing accompaniment, and solo statements are not to be missed. The vigorous, razor-sharp teamwork of the Getz rhythm section — Pedersen, pianist Brackeen, and drummer Billy Hart — is another plus. This live Copenhagen recording offers a clear, bright, natural sound.

The Columbia **Peacocks**, released some months ago, was conceived as an album that featured pianist Jimmy Rowles with Getz behind the studio glass as producer. But according to the album liner notes, the music was so compelling that Getz was carried away

and joined in. The saxophonist is a good producer, a good host, and a stimulating participant. The idea of the album was to introduce, to a wider audience, the little-known but highly regarded veteran pianist. Rowles plays solo piano, clowns a bit, and even sings on three numbers — *I'll Never Be the Same*, *My Buddy*, and *This is All I Ask*. His scratchy vocals are the kind you'd expect to hear from an aspiring song writer working his way through the Brill building. Rowles' lush duets with Getz on *Peacocks* and on Ellington's *What Am I Here For*, shimmer with a warm rapport; they are models of elegant repartee between two consummate musicians. On his *Body & Soul* solo, Rowles restates and re-embellishes the standard with melodic elan and with flecks of Tatum filagree. On Hoagy Carmichael's *Skylark*, Getz cruises gracefully, his singing tone interfacing with Rowles' sympathetic accompaniment. *Lester Left Town* features a splendid quartet consisting of Getz, Rowles, drummer Elvin Jones, and bassist Buster Williams playing at a bristling tempo. Columbia is to be congratulated for this album which provides 58 minutes of perfect sound and music.

John Lissner

Opus De Bop

Sound: B-	Performance: B+
<hr/>	
Stan Getz Gold	
<hr/>	
Sound: A	Performance: A+
<hr/>	
The Peacocks	
<hr/>	
Sound: A+	Performance: A+

Beauvais Cathedral: Kent Carter
Emanem 3306, stereo, \$6.98.

Cello /bassist Kent Carter occupies the nether region where the European classical tradition and American improvisational music intersect. Carter's techniques, textural concepts, and lack of overt emotionalism, as well as the overall "feel" of his music, might lead jazz observers to classify him with the classical *avant-garde*. However, the improvised nature of most of his work, not to mention his past associations with such artists as Steve Lacy, will probably stamp him as a jazz performer among the classical audience. Categories are more hindrance than help when discussing visionary individualists, and Kent Carter is an individualist of the first order.

Beauvais Cathedral is split between solo improvisations and overdubbed ensemble pieces. *Cello Solo 1: Pinch* is a stunning, powerful work which Carter describes as "a study of the use of dynamics and rhythm to produce

the feeling of more than one player." Carter is uncommonly modest, omitting any mention of the mind-boggling virtuoso bowing and plucking by which he achieves his multiple-cello illusion. *Pinch* is so rich in musical and sonic ideas, 11 minutes pass by all too quickly. *Cello Solo 2: Beginnings* is a display of sustained dissonances, developing slowly and logically to a harsh climax before retreating back to the point of origin. *Bass Time For Max* is a 55-second, Mingus-rooted bass solo, while *Other Fingers* (also a bass solo) is suggestive of *Pinch* in that it sounds deceptively like a duet. *Bass Suite No. 1: Fingers* is, at 11:45, the album's longest piece, a bass raga of sorts in which Carter very deliberately unfolds intricate plucking patterns.

The ensemble works are influenced by Expressionist chamber music to varying degrees. *Dance Two: Rhapsody* is a compact, Webern-reminiscent miniature in which two cellos skirt blithely around a bounding, free-jazz bass. *Chateau de Maignelay* is similar, though employing bowed bass, the slightest hint of jazz rhythm, and perhaps a touch of Bartok. One must acknowledge the close rapport between Carter and second cellist Phillip Pochon on this piece. *Stretch* is a fascinating aural exploration for melodica, two cellos, and bass. The melodica reappears on the album's most outwardly humorous track, *Michala Dance* (with Michala Marcus on flute), which might be called free-metered chamber-bop.

Play Time finds Carter responding contrapuntally to the twisting of a radio dial; the results are closer to a duo interaction than to a Cage-ian simultaneity. The album's masterpiece, though, may well be the spellbinding title track, an eerie, extended crescendo in which the radio provides a backdrop of noise over which the rest of the instruments (piano strings, bass, five cellos) are layered to give a ghostly, quasi-electronic aura.

The solo pieces are poorly recorded, with a hollow, faraway sound. The overdubbed tracks are much more convincing, the individual parts being notably clearer, while the remix is generally very effective. Surface noise and static intrude. (Emanem Records, P.O. Box 805, Hillburn, NY 10931.)

Tom Bingham

Sound: D+	Performance: A
-----------	----------------

New Wine In Old Bottles: Jackie McLean
Inner City IC 6029, stereo, \$7.98.

Anytime you put Jackie McLean, Ron Carter, Tony Williams, and Hank

ADVANCING The State of the Art in automatic percussion units



the PROGRAMMABLE DRUM SET

features: Score Editing, Bridges, Intro's, External sync. to sequencers or foot controls, Memory save switch and much more!

Enter scores in seconds - No Programming Knowledge Required! High Fidelity describes the kit as "an easy project... fun to do and yields delightful results... an excellent educational tool and versatile aid to the musician who can't afford a live rhythm section."

Programmable Drum Set Kit \$84.95
Programmable Drum Set Assembled \$149.95
(plus \$3 shipping)

FIDELITY ELECTRONICS 1020 W. WILSHIRE BLVD., OKLA CITY, OK 73116

- () Programmable Drum Set Kit \$84.95
- () Programmable Drum Set Assembled \$149.95
plus shipping enclosed.
- () SEND FREE CATALOG

NAME _____
ADDRESS _____
CITY _____ STATE _____ ZIP _____

FIDELITY ELECTRONICS, DEPT. 9A, 1020 W. WILSHIRE, OKLAHOMA CITY, OK 73116

Without The Audio Critic, you'll never know.

Which \$3000-plus speaker system produces sheer garbage instead of the true sound of music? And, on the other hand, which \$400 stereo power amplifier is almost as good as the world's best, regardless of price? What's wrong with nearly every phono cartridge and tone arm on the market today?

Without The Audio Critic, you'll never know. Other audio publications must kowtow to advertisers or, if they're noncommercial like The Audio Critic, their scientific grasp of the subject and their listening criteria are generally on the audio-store cowboy level. Only The Audio Critic has 100% respect for the laws of physics, combined with a complete, in-house laboratory facility plus a \$25,000 reference system for listening to new components under test.

Seven issues have been published so far; the last four are still in print. You may want to start your subscription with Number 6, which is a cumulative reference work with over 150 reviews. Send \$30 for 6 consecutive issues by first-class mail (no Canadian dollars, \$6 extra for overseas airmail) to The Audio Critic, Box 392, Bronxville, New York 10708.

Enter No. 28 on Reader Service Card

Jones on a record of standards, you can believe that there will be some new wine flowing. Recorded in April of '78, this record captures everyone at the top of their form. The rhythm section of Ron Carter and Tony Williams is a classic one, even if both men have abused their reputations to a certain degree. For this date they leave their stylistic clichés at home. Carter's warmth and full-bodied tone are sometimes so potent that they obscure

former here is Jackie McLean, whose alto sax has been a personal and individual voice through many phases of the music. His solos on such cookers as his own *Appointment In Ghana Again* and Bird's *Confirmation* are tumultuous whips of sound that take off from the heads and develop a centrifugal force of generated power. On the ballads he comes in for carefully conceived statements that are like sculptures in worn rock.

porate. By the mid-50s he was scuffling on the West Coast with pick-up bands. He died in 1959 in his Hollywood apartment apparently from a fire that was caused by a carelessly lit cigarette.

The Joyce McIntyre collection is divided into a World War II broadcast to steelworkers and a later 1946 date at Frank Dailey's Meadowbrook, the famous showcase for big bands. There are some particularly spirited swing pieces on the Meadowbrook date such as *Scarlet and Amber* and *Push it Off* plus some good vocals from the Sinatra-like singer Frankie Lester. Nancy Reed is adequate on *I Don't Know Why*, a number which also features a fine solo by McIntyre's limpid alto and a rich, throaty chorus by tenor saxman Dave Matthews. *Swanee River* spotlights gorgeous trombone section work, a languid alto chorus by McIntyre, some exotic Ellingtonian ensemble texture, and an excellent but unidentified trumpet player (Les Elgart?). The 1943 steelworkers broadcast offers some World War II jive like *Shoo, Shoo Baby*. On both broadcasts the band is impeccably rehearsed, and the rhythm, provided by bassist Eddie Safranski, drummer Ralph Tipken, and guitarist Barry Galbraith, drives it along in spirited fashion. The recorded sound is clean if a bit thin. Sort of reminds me of the sound that came out of the Emerson bedside radio I used to listen to late at night when I caught those big band remotes in the early 40s.

The Joyce label has a distribution limited to jazz collectors' shops that specialize in the "nostalgia jazz" of the 30s and 40s such as Rose's Discount Records in Chicago or Ray Avery's Rare Records in Glendale, California. Joyce also sells by mail order; Joyce Music Corp., Box 1707, Zephyrhills, FL 33599. *John Lissner*

Sound: C-

Performance: A

Black Octopus: Paul Jackson
East Wind EWLF-98006, stereo, direct-to-disc, \$15.95.

I don't understand why they made this album, let alone doing it direct-to-disc. **Black Octopus** features Herbie Hancock's current touring unit, except bassist Paul Jackson is the leader. Unlike Hancock, Jackson has not mastered the factory production sound of disco and funk. With the exception of a headlong attempt at free improvisation at the opening of the album, **Black Octopus** is an album of stock funk rhythms with a few perfunctory solos thrown in to surround Jackson's choked-back, stylized vocals.



the fact that he's one of the most accurate navigators around. Tony Williams may have had some trouble getting his chops together with VSOP, but here his drumming is crisp and energized, with a riveting pulse that pushes the soloists.

Hank Jones plays off this rhythm section with deft forays that dance around Carter's bass. But the main per-

New Wine In Old Bottles is a captivating and charged performance by people from whom you should expect no less. The sound of this album only heightens its immediacy. All the instruments are clearly defined in the mix with an incredible three dimensional punch. *John Diliberto*

Sound: A-

Performance: A

One Night Stand: Hal McIntyre
Joyce 7006, mono, \$6.98.

The splendid Ellington-influenced Hal McIntyre orchestra of the early and mid-40s is all but forgotten, but this Joyce album is one of several releases by big band collectors' labels that rescue the talented McIntyre from near oblivion. This LP is made up of

two privately recorded broadcasts taken off the air in 1943 and 1946. In 1943, financially backed by his ex-boss Glenn Miller, McIntyre was shifting into high gear, and his band was enjoying some commercial success. By 1946, Swing's moment had passed, and McIntyre drifted into a slow decline, seeing his playing opportunities eva-

But even if the tunes were top-notch disco and the performances inspired, it's completely counter to R and B aesthetics to record this way. Disco requires sleek, glistening production, instruments should leap out at you with exaggerated presence. All kinds of sound-expanders, reverb units, and phase-shifters are used to get that bigger-than-life sound that is the disco ideal. By disco standards this album is flat and lifeless. By direct-to-disc standards it's still pretty weak. The sound lacks any crispness or brilliance. The explosive drums of Alphonse Mouzon lack resonance, the horns lack definition, and the vocals are under-mixed. The recording and surfaces are crystal clear, but clarity alone does not make either good music or good recordings.

There are two philosophies in operation on this record, and in the act of accommodation, both lost out. **Black Octopus** is available through Audio-Technica, 33 Shiawassee Ave., Fairlawn, Ohio 44313. *John Diliberto*

Sound: B- Performance: C-

Bechet In Philadelphia, Volume 2: Sidney Bechet
Jazz Archives JA-37, mono, \$6.98.

The bulk of this album is derived from a concert at Philadelphia's Academy of Music in February, 1950, with the rest from return Philly engagements over the next three months.

Bechet is in exceedingly high spirits throughout, performing at a peak which he would rarely approach during the rest of his last decade. It's virtually impossible to choose highlights from among his solos, since his always inventive and fluent soprano sax is at such a constantly high level on every track. Six of the nine cuts are in a "dixieland" format, while Bechet also reprises his two most fabled quartet specialties (*Dear Old Southland* and *Summertime*) in strong, confident renditions.

The February concert features trumpeter Max Kaminsky and trombonist Wilbur DeParis as Bechet's front-line mates. Kaminsky is rather bland and cliché ridden on *Jazz Me Blues*, though he's his characteristic swinging self on *Sweet Georgia Brown* and *Royal Garden Blues*. DeParis could be garish at times (as on *Sweet Georgia Brown*), but by and large carries his weight.

Pianist Bob Feugeeze acquits himself well in his Teddy Wilson-inspired turn on *Sweet Georgia Brown* but is far less secure on *Jazz Me Blues*. Bassist

Charlie Traeger does a commendable job without rising to any great heights. Veteran small-combo drummer Arthur Trappier stomps out a la Gene Krupa (listen under Kaminsky's trumpet solos in particular), making up in propulsive drive what he lacks in imagination.

I Found A New Baby and *After You've Gone*, from March, 1950, feature a looser ensemble built around a lineup of Bechet, Wild Bill Davison on trumpet, Cutty Cutshall on trombone, and an unknown clarinetist. The latter has a nasal, straining tone, and a penchant for long-winded runs that are high on verbosity and low on taste. Davison has often been erratic elsewhere, though here he justifies the high regard in which many hard-core traditionalists hold him. Cutshall is witty and infectious. Aside from Bechet, however, the best solos come from raggy-stride pianist Ralph Sutton. Too bad you have to strain to hear him on *After You've Gone*.

The final track is a nasty grind on Ellington's *The Mooche*, with Bechet acting as a straight man to Vic Dickenson's lascivious trombone growls.

In case you're wondering, there is no **Bechet In Philadelphia, Vol. 1**. The volume designation refers to the fact that other selections from the February concert served to fill out an earlier Jazz Archives album by Bechet and Wingy Manone.

The sound is constricted, with intermittent rumble in the rhythm section, and a fair share of scratches, bumps, and the like. As private acetates go, though, it's quite acceptable, except on rare occasions such as the opening moments of *Royal Garden Blues*. Jazz Archives Recordings, P.O. Box 194, Plainview, NY 11803. *Tom Bingham*

Sound: C Performance: B+

I Don't Want My Blues Colored Bright: Sonny Rhodes
Advent 2808, stereo, \$7.98.

Perhaps the best aspect of reviewing blues albums is periodically being bowled over by bluesmen whose considerable talents are exceeded only by their regrettable obscurity. **I Don't Want My Blues Colored Bright** marks the emergence of Oakland's Sonny Rhodes as a mature contemporary bluesman who'll undoubtedly be heard from again and, I hope, often.

Backed by a compact, supple ensemble of local club mates, Rhodes displays electric guitar work that draws heavily on T-Bone Walker. As in the case with Chicago's Fenton Robinson, Walker's fluid lines are merely a point of departure for a refreshing style combining the timeless elements of

**BIGGEST SAVINGS—
SAME DAY DELIVERY**

Call TOLL FREE 800-638-8806
or, if busy, 301-488-9600



- We have more of the components and manufacturers you are looking for.
- Our prices are the lowest you'll find anywhere.
- Your phone order is shipped the same day you call.
- In most cases you'll enjoy your equipment within 72 hours.
- We stand behind everything we sell with a "No Lemon" guarantee and a trained customer service department.
- Our Audio Advisors will help you select the right equipment at the best prices for the quickest delivery.

Call TOLL FREE 800-638-8806, or, if busy, 301-488-9600 for information on equipment, prices and ordering, or send for free brochure, tips on buying hi-fi equipment by mail, test reports and a \$2.00 merchandise certificate.

International Hi-Fi Distributors
Moravia Center
Industrial Park, Dept. A9
Baltimore, Maryland 21206

Enter No. 16 on Reader Service Card

HELP!

Anytime you have a question about your Audio subscription, please include a mailing label to insure prompt service on your inquiry.

AFFIX
LABEL
HERE

**CHANGE
OF ADDRESS**

If you're about to move, please let us know approximately four weeks before the move comes about. Or, if there is anything wrong with your current mailing label, please let us know on this form also. Simply affix your present label here, and carefully print the updated information below.

**PLEASE HELP US TO SERVE
YOU BETTER**

AUDIO MAGAZINE

401 N. Broad Street • Phila., Pa. 19108

Name _____ (Please Print)
Company _____
Address _____
City _____ State _____ Zip _____

latter-day electric blues with an invigorating dose of r'n'b. Rhodes' smooth but husky vocals, which evoke blues balladeers Junior Parker and Percy Mayfield, cut right to the heart of his strong original material.

Harp player Gary Smith, a talented local band leader in his own right, joins Rhodes and crew for a suitably stinging *Take The Bitter With The Sweet*, and a few other numbers cast along the lines of Chicago blues. Smith is replaced by a punchy brass section on such rhythmically strutting cuts as *One More Drink* and *Stranded*. J. J. Malone, a long time friend of Rhodes, sits in on piano on most tracks and takes the spotlight for two vocals. Neither is bad, but both are out of place on this disc, as Malone is just as distinctive a stylist as Rhodes.

This disc was originally produced by Rhodes and members of his band for Sweden's Amigo Records, and generally compares favorably to records being issued by small domestic labels. The production of this set is questionable at times, and some of the arrangements are threadbare, but such faults pale into insignificance when faced with as striking a debut album as **I Don't Want My Blues Colored Bright**.

Roy Greenberg

Sound: C Performance B+

Three Day Moon: Barre Phillips
ECM ECM-1-1123, stereo, \$7.98.

The Touchstone: Azimuth
ECM ECM-1-1130, stereo, \$7.98.

The Touchstone and **Three Day Moon** contain music that doesn't fall easily into the hybrid categories normally associated with ECM. Neither LP really nods to any specific jazz tradition, be it European or American, but both do depend on improvisation and a synthesis of several musical styles.

Bass player Barre Phillips himself embodies several traditions, having played both *avant-garde* and straight classical music, as well as jazz, with the likes of John Surman, Albert Mangelsdorf, and Dave Holland. His recordings have ranged from "free" jazz excursions through an album of solo bass improvisations (**Journal Violine** on Opus One Records) to his first ECM record **Mountainscapes** which delivered on the promises of fusion music. It featured dense and involved compositions with amazing solo work from John Surman and John Abercrombie.

Three Day Moon shows an expansion on the concepts of **Mountainscapes**. Phillips retains only Dieter Feichtner's synthesizer from the previous record. In addition to the German

Feichtner, he has Norwegian space guitarist Terje Rypdal, himself an over-looked ECM regular, and Indian percussionist Trilok Gurtu. **Three Day Moon** is everything this international blend intimates and more. Phillips' compositions range from primal, rhythmic forays into the atmosphere to ethereal settings for the bass.

Feichtner and Gurtu are environmental musicians who envelop you in an electronic gossamer mist punctuated by the subliminal pulse of tablas and shimmering glimpses of percussion and cymbals. On the more rhythmic pieces Phillips adds to the pulse with an earthy pizzicato bass. He weaves his singing solo lines on arco bass between Rypdal's mind-searing fuzzed guitar. Their textural complexity is so rich that once emerged, you might never find a way out. Feichtner also steps out for some surprisingly supple and responsive leads. At one point on *S.C. and W. (Space, Country, and Western)* he emulates the whining, twisting lines of Indian violinists like L. Shankar, the violinist with John McLaughlin.

The Touchstone shares the unusual instrumentation and spacial, atmospheric sound with **Three Day Moon**, but there the similarities end. While Phillips' sound has moments of liquid density, Azimuth is always light and airy. Azimuth tends towards a Western classicism with only a slight hint of the minimalism that pervaded their first album. Based around the organ, piano, and compositions of John Taylor, Azimuth contains the wordless vocals of Norma Winstone and Kenny Wheeler's trumpet and flugelhorn.

Taylor's compositions are built upon simple melodic patterns which are maintained in the keyboard figures and augmented by voice and horn. With this small palette of colors to draw from, Taylor creates music that is both sublime and stimulating. Winstone's warm voice is a perfect sounding board for Wheeler's open-ended horns. Even though he's a virtuoso on his instrument, Wheeler exhibits spartan restraint in his constructions. Azimuth makes music which exists apart from the word, as if floating in timeless space.

The clean recording sound of ECM is an essential aspect of these recordings which depend so much on sonic purity as a means of sculpting sound. They are also studio albums in the sense that they use overdubbing and sound placement techniques that are not available in live performance. The switch of ECM from Polydor to Warner Brothers label has also resulted in much improved pressings, which to

my ear rival the German pressings for clarity and surface noise.

John Diliberto

Barre Phillips

Sound:A- Performance:A+

Azimuth

Sound:A- Performance:A-

Spectrum Suite: Steve Halpern
SRI Records SRI-770; stereo, \$6.98.

Zodiac Suite: Steve Halpern
SRI Records SRI-771; stereo, \$6.98.

Starborn Suite: Steve Halpern
SRI Records SRI-780; stereo, \$6.98.

Steve Halpern calls his records "soundscapes." They are designed as acoustic environments for people who wish to reach a state of tranquility and peace in their mind and bodies. Using a combination of psychology, acoustic research, music, and New Age mysticism, Halpern has arrived at a soothing, resonant flow of sounds which, unlike the "Environment Series" put out by the Acoustic Research group or the "Sounds From The Womb," also exists as music.

Each album explores a different aspect of sound and its effect when combined with spiritual and psychological archetypes. **Spectrum Suite** is seven pieces based on the concept that there are seven major tones and seven basic colors. Meditation on these tones and their effect on specific parts of the body is supposed to let you visualize its corresponding color. The combination of sound and color will then have a "meditative and relaxation effect." **Zodiac Suite** uses the same principle but in combination with the zodiac. **Starborn Suite** uses a less specific approach to reconnect us with our cosmic origins.

The suite sides of these albums use little instrumentation. **Spectrum** employs only an electric piano upon which Halpern extracts notes like crystalline drops on a smooth pond. Each note resonates with those clean electronic overtones. **Starborn** adds a polyphonic string ensemble to bathe the keyboard tones in a celestial glow. **Zodiac** evokes the strongest images with the addition of electric violin, flutes, zithers, chimes, and a synthesizer. All these are used in sparing ways to create images of glistening lights, velvet rains, and oriental serenity.

The second sides of all these albums are the most enjoyable, perhaps because they weren't designed to have a specific effect on the body harmony. **Zodiac Suite** was particularly stimulating, with exotic tunes entitled *Blues for Arcturus* and *Sky Boat Theme*.

Tony Selvage's electric violin soars through the tremulous overtones like a soul lost in time. The second side of **Spectrum** was also illuminating with the addition of organ, guitar, and electric flute. Here Halpern has the approach of psychic explorers like Klaus Schulze or Coltrane. Rather than simply providing a soothing environment, they are also exploring their vibrational origins.

Halpern's music is somewhat one dimensional, however, in that it allows you to reach a point of meditation but seems to ignore the ideas of transcendence and elevation that so much powerful music can give you. His calculated methods are pleasing, but also irrelevant. When he interacts with himself and especially other musicians, he utilizes more facets of his being with the result of more provoking and meaningful music.

In keeping with his harmonious directions, Halpern has recorded his records in ways which enhance their sonic purity. Most of the electric instruments he uses are recorded with ample reverb to exaggerate their overtones and create a suspended, floating effect. Even the acoustic piano of **Starborn Suite** is produced to increase its full tonal sound. Unfortunately the pressings of SRI Records leave much to be desired. The surfaces have a degree of hiss and crackle which might be acceptable on most recordings, but with music that is so low keyed and uses so much silence, it is annoying, though not intolerable. (SRI Records are available from Spectrum Research Institute, P.O. Box 720, Palo Alto, Cal. 94302.)

John Diliberto

Sound: B- Performance: B

People In Me: Abbey Lincoln
Inner City IC 6040, stereo, \$7.98.

Abbey Lincoln's voice, with its mature body tempered by an edge of vulnerability, has been too long absent from American records. Though her highly political and social lyrics have appeared on several albums, including those under her own name and with others, not one of her records remains in print in the U.S. She hasn't made a new record since the mid-60s. Even this recording was done in '73 and is only now being made available here.

People In Me places Lincoln in a contemporary jazz context which does not compromise her. Her lyrics are less political now, and her social outlook has turned romantic. But Abbey Lincoln is so passionate that it doesn't matter what she sings, but how she sings it. The songs run the gamut from

the title track, a children's chant about the unity of man, to the powerful **Africa**, cowritten with John Coltrane. Though the lyrics are somewhat trite, Lincoln builds them to an emotional high.

Her performance succeeds when she maintains a mood throughout a song or gradually increases her intensity. **Dorian** is a mystic song with rolling, ritualistic drums and Dave Liebman's exotic soprano underpinning her moody reading. But in other tunes, such as **Koh-Joh-No-Tsuki** she establishes a dark, somber mood, then, with no previous build-up, shifts the song into an up-tempo snappy jazz groove. This technique tends to trivialize her songs which are not helped by Liebman's often perfunctory and uninvolved reed decorations.

The rhythm section of Hiromasa Suzuki (piano), Kunimitsu Inaba (bass), and Al Foster (drums) keeps the pieces moving. Ultimately, Abbey Lincoln's voice is a power and beauty unto itself.

This record is excellently recorded. The rhythm section is so crisp I had to look around occasionally to be sure no one was playing drums in the room. Though flawed, this album should spark a renewed interest in Abbey Lincoln for all those who have forgotten or have never heard her impassioned performances.

John Diliberto

Sound: A- Performance: B

Bonobo: Hans Reichel
FMP 0280, stereo, \$6.50.

If I'm interpreting it correctly, the German subtitle of **Bonobo** translates into "11 unexpected small pieces for guitar by Hans Reichel." There's something vaguely evasive about that designation. While "unexpected" may be something of an understatement, to refer to Reichel's unorthodox instrument as a "guitar" is downright deceptive.

Judging by the cartoons which take the place of liner notes, Reichel saws the necks off two guitars, discards the bodies, and connects the necks into one long, 12-stringed stick, which is then electrified with bass-heavy amplification. The final result is far from a guitar, though it does bear a visual resemblance to a Chapman Stick. So, let's call this a "Reichel Stick."

What does it sound like? Like any number of things actually. On **Gier I**, it sounds like a cross between an amplified harpsichord and a zither. On **Peter Zweifel**, it's reminiscent of one of Sun Ra's strangely named electric keyboard instruments. If one were able to beat an autoharp like a

AM Comes Alive!

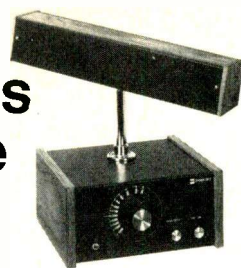

The McKay Dymek DA 5 shielded ferrite loop AM antenna has a solid state preamp with tuning and sensitivity controls.

Overcomes the two most common AM reception problems: strong local stations "hiding" weaker distant stations close on the dial, and interference from TV and electrical sources.

Improves inherent long range capabilities of AM — programs listenable from over a thousand miles.

Increases signal strength 4 to 8 times — really sharpens up AM performance in typical hi-fi receivers and tuners.

Factory direct, 30-day money back guarantee. Exclusive rent/own plan available. For more information call toll free:

Nationwide 800/854-7769
California 800/472-1783



McKay Dymek Co.
111 South College Ave.
P.O. Box 5000
Claremont, CA 91711

Enter No. 23 on Reader Service Card

J&R

THE ONE-STOP MUSIC SHOP AT WHOLESALE PRICES

MINIMUM ORDER 12 TAPES 100% GUARANTEED		REEL-TO-REEL	
BLANK TAPES		Maxell UD 36-90 1800 ft. CALL	CALL
CASSETTE TAPES		Maxell UDXL 95-905 1800 ft. CALL	CALL
AmpeX Grand Master II C-90	\$3.11	Maxell UD 36-180 3600 ft.	CALL
AmpeX Grand Master I C-90	\$2.79	TDK L-1800 1800 ft.	\$6.22
BASF Studio C-90	\$2.69	Scotch 212 1800 ft.	\$4.35
BASF Professional II or III C-90	\$2.99	Scotch 207 1800 ft.	\$6.19
Maxell UD C-90	CALL	TDK L-500 (2 Hour)	\$13.95
Maxell UDXL I or II C-90	CALL	AmpeX L-500 (2 Hour)	\$12.95
Maxell UDXL I or II C-90	CALL	VIDEO TAPES	
Scotch low noise/Dynarange C-90 1/2 inch	\$4.99 for 3	BETA FORMAT	
Scotch Master I C-90	\$2.84	MTK L-500 (2 Hour)	\$13.75
Scotch Master II or III C-90	\$3.29	Sony L-750 (3 Hour)	\$18.85
Sony Fw4rhrome C-90	\$3.58	Sony L-500 (2 Hour)	\$13.95
TDK D C-60	\$1.20	Scotch L-500 (2 Hour)	\$13.50
TDK D C-90	\$1.68	Zenith L-500 (2 Hour)	\$13.95
TDK D C-120	\$2.10	AmpeX L-500 (2 Hour)	\$12.95
TDK D C-180	\$2.99	VHS FORMAT	
TDK AD C-60	\$1.79	Scotch VK-250 (4 Hour)	\$17.95
TDK AD C-90	\$2.52	JVC T-120 (4 Hour)	\$18.75
TDK SA C-60	\$2.22	TDK T-120 (4 Hour)	\$17.95
TDK SA C-90	\$3.18	RCA VK-250 (4 Hour)	\$18.95
		RCA VK-125 (2 Hour)	\$14.95
		Panasonic NVT-120 (2 Hour)	\$18.95
		Panasonic NVT-60 (4 Hour)	\$14.95

Call or write for super low prices on Maxell tapes.

CARTRIDGES

audio-technica

AT-20 SS	\$129.50	M5SHE	\$34.95
AT-15 SS	\$89.90	V15 TYPE IV	\$89.90
AT-14 SA	\$48.95	V15 TYPE III	\$64.95
AT-12 SA	\$49.90	V15 TYPE II	\$39.95
AT-10	\$12.00	M91ED	\$21.00
8815	\$72.50	M44E	\$13.80
681EE-S	\$55.00	M70EJ	\$9.90
681EE	\$42.50		
680EE	\$24.90		
500E	\$12.60		

EMPIRE

2000	\$59.90	XSV/3000	\$49.95
2001	\$74.80	XV15/1200E	\$39.95
2000EII	\$19.50	XV15/50E	\$22.50
4000DI	\$19.50	XV15/625E	\$25.77
4000DI	\$29.90	XV15/400E	\$22.45

HEADPHONES

SENNHEISER

HD-420	\$50.88	PRO 4AA	\$39.90
HD-430	\$74.40	PRO 4 AAA	\$48.00
HD-400	\$26.28	HV1I	\$29.97
HD-414	\$44.88	HV1L/C	\$35.97
HD-424	\$65.28	K/6A	\$19.97

HOW TO ORDER: For shipment within 48 hours, send money order or certified check. Two weeks delay on personal checks. Please add \$3.50 per order for shipping & handling. (\$5.50 for orders outside U.S.). N.Y.S. residents add tax. No C.O.D.'s. All merchandise 100% guaranteed, brand new & factory fresh.

J&R MUSIC WORLD

33 PARK ROW, DEPT. AD, NEW YORK, N.Y. 10038
ORDER TOLL FREE (800) 221-8180
CALL OR WRITE FOR FREE 120 PAGE CATALOG

Enter No. 48 on Reader Service Card

95

AmericanRadioHistory.Com

The Second Ten at 45 rpm

10 albums introduced the series. And the acceptance is as spectacular as the sound itself.

With ears still enraptured by the sonic excellences of Holst and Wagner, Ravel, Stravinsky and Respighi, the second ten albums are now announced.



SS-45004 SS-45006
 SS-45010 SS-45013
 SS-45015 SS-45014
 SS-45020 SS-45017
 SS-45018 SS-45016

As before, these performances are illustrative examples of sonically stunning orchestral effect. 45 rpm reveals new clarity for the full spectrum of sound heard in these ageless favorites.

Audiophile and casual listener alike will rejoice in the new dynamic width of frequency range showcased in this new series of Angel recordings.



Enter No. 2 on Reader Service Card

hammered dulcimer, the results might sound similar to *Toeni*, while on *Moor*, one is reminded of a gigantic electric Appalachian dulcimer. *Bonobo I* sounds like a trio of blues-rock guitars, a monster harpsichord, and electric bass. On *Mariahilf*, Reichel manages to mimic a church bell. And you could swear *Gier II* was being performed on a synthesizer.

Reichel's abstract melodic and constructive concepts are as farsighted as his versatile stick. *Gier I* and *Gier II* are improvisations on a theme built on the repetition principle of Terry Riley. *Peter Zweifel* and *Moor*, with their open form, hesitant pacing, and spacey melodic turns, could serve very handily as a sound track for a particularly imaginative robot movie. On *Lurch*, Reichel investigates harmonic, timbral, and rhythmic possibilities around a reiterated tone. *Des Jagers Klage* gradually unfolds like a Javanese gamelan composition. The brief *Nicht Sand, Sondern Popel Im Getriebe* apparently has its origins in British progressive-rock (Led Zeppelin perhaps).

All cuts are performed solo except for *Bonobo II*, which utilizes "three or four tracks" for a textural survey of kaleidoscopically bizarre, non-musical sounds and percussive techniques.

Bonobo is a fascinating, surprisingly accessible, thoroughly innovative record by a unique artist who, I suspect, has far from exhausted the improvisational potentialities of his unparalleled instrument.

The recording has a luxuriously full-bodied sound, rich in surging bass resonances, gurgling trebles, and clearly focused sliding tones. Surface noise rarely rears its ugly head.

FMP (Free Music Production) is a Berlin-based label distributed in the U.S. by Innovative Records Co., P.O. Box 518, Hempstead, NY 11550.

Tom Bingham

Sound: A

Performance: A

Esoteric Funk: Hubert Eaves
Inner City IC 6012, stereo, \$7.98.

Hubert Eaves is a facile session pianist who has backed many fine players in both the mainstream jazz and funk genres. Left to his own devices, he is capable of producing listenable melodies and a smooth, funky rhythm. But it never rises above the level of background music. He works within his modest skills as a composer and metes out only one or two ideas per tune. He could survive this if he had a soloist who could take it out for him. Even with such session heavies as Reggie

Lucas, John Lee, and Mtume, and avant-garde stowaways like Rene McLean and Malachi Thompson, they rarely get beyond perfunctory doodling.

Like most funk records this one is cleanly recorded with a mix that doesn't make the rhythm section overbearing. "Derivative Funk" would have been a more apt title for this LP.

John Diliberto

Sound: B+

Performance: C-

Survival Themes: Reggie Lucas
Inner City IC 6010, stereo, \$7.98.

Over the years of listening to records I've developed a strong bias against LPs by studio musicians. Countless recordings have shown that when directed by truly creative artists they can be tapped for incredible power. However, when left to their own devices they invariably flounder on pointless displays of technique, mundane writing, poor leadership, and the commercial interests of their producer. Reggie Lucas's solo debut looked to be at least an exception to this rule, but instead, it is only further evidence to support my conviction.

As a long-time session player, guitarist Lucas earned quite a reputation playing behind pop and R and B dates. When given the challenge of playing with Miles Davis in '74 though, Lucas wailed. A listen to the Japanese recording *Pangaea* will convince you that not only was this one of Mile's hottest units, but that Reggie Lucas and coguitarist Pete Cosey were the next progression from Jimi Hendrix.

Survival Themes will do much to dispell this last belief. On side one Lucas falls into all the traps listed above, with three poorly written tunes given a perfunctory funk performance. Normally when I hear one entire side of completely vapid music, I don't flip the record over. But for some reason I listened to side two.

Side two contains a suite of four pieces under the heading *Survival Themes*. His own multi-tracked guitar accompanied only by percussionist Mtume, Lucas performs an empty display of creativity and virtuosity. His tunes take the form of a late-60s psychedelic jam, but he never finds any ideas to ignite his sparse structures. Instead we are treated to phase-shifted, fuzzed guitar runs and sophomoric stereo panning techniques with no context or content to give them meaning. Like so many other players, Lucas can play, but he doesn't have anything to say.

John Diliberto

Sound: B-

Performance: C-

Top of the pile

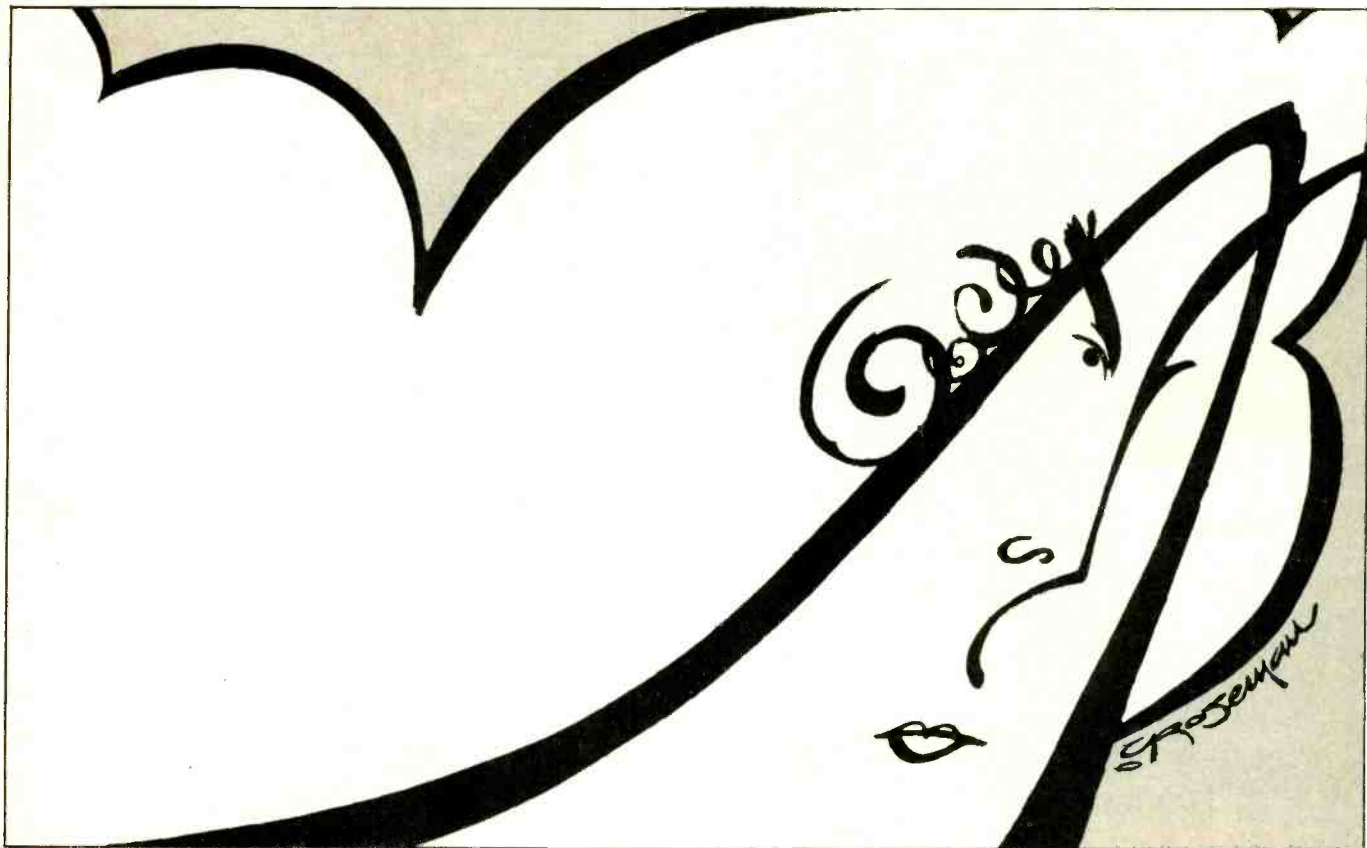

97

G. F. Handel: *Messiah*. With Elly Ameling, soprano; Anna Reynolds, contralto; Phillip Langridge, tenor, and Gwynne Howell, bass. The Academy and Chorus of St. Martin-in-the-Fields, Neville Marriner, cond.

ARGO/Barclay-Crocker ARG V D18D3, two reels, \$25.95.

Perhaps one of the most difficult tasks facing a recording team is when they set out to capture a major opera or oratorio on tape. The human voice, whether singly or in groups as a chorus, is a very elusive beast and not easily found in its natural state. This is due, in part, to its wide dynamic range, its harmonic structure, and the fact that Mother Nature, in her infinite wisdom, has made our ears to be the most sensitive in the frequency range to those tones covered by the normal voice. Any distortion or coloration is quickly detected.

The recording team for ARGO, however, seems to have the problem well in hand, as this new recording of Handel's *Messiah* will attest. This is the finest recording of this popular work

I've heard to date. The balances between the orchestral and vocal forces are, in a word, superb. The excellent soloists have just the right combination of presence and ambience. The chorus of men and boys sounds like a chorus, not like a group of individuals as is so often the case.

For this recording, conductor Neville Marriner has chosen to use the new Christopher Hogwood edition, which recreates as nearly as possible the first London performance of the work in 1743. After that first performance, the many changes made by Handel to accommodate the abilities of subsequent performers, along with the many changes incorporated by succeeding generations of musicians has led to the version we know today. Mr. Hogwood's changes (described in great detail in the booklet included with the tapes) are sometimes subtle, with only a bar or two being modified, and at other times very obvious, with completely unfamiliar melodies and/or meter. This recording also includes many sections that are not usually per-

formed in concert or included in other recorded performances. If you are familiar with the more traditional versions of *Messiah*, this ARGO recording will hold many new delights.

Barclay-Crocker has done more than their usual excellent job of duplication. The sonic qualities of these tapes are far superior than any discs could be with a work of this sort. The limitations of the disc process, especially at inner grooves, are such that no disc could ever match these fine tapes. If you are somewhat skeptical of my statements, listen to the final Amen chorus on any disc version of *Messiah* (including the disc version of this ARGO recording), and then to the Barclay-Crocker tape. The complex waveforms generated by the sound of the full chorus, orchestra, D trumpets, and tympani simply cannot be reproduced in inner disc grooves by any current cutting or playback equipment. Open-reel tape is the clear winner here.

(Available from Barclay-Crocker Tapes, 11 Broadway, New York, N.Y. 10004.)

Charles P. Repka

Classical reviews

Edward Tatnall Canby

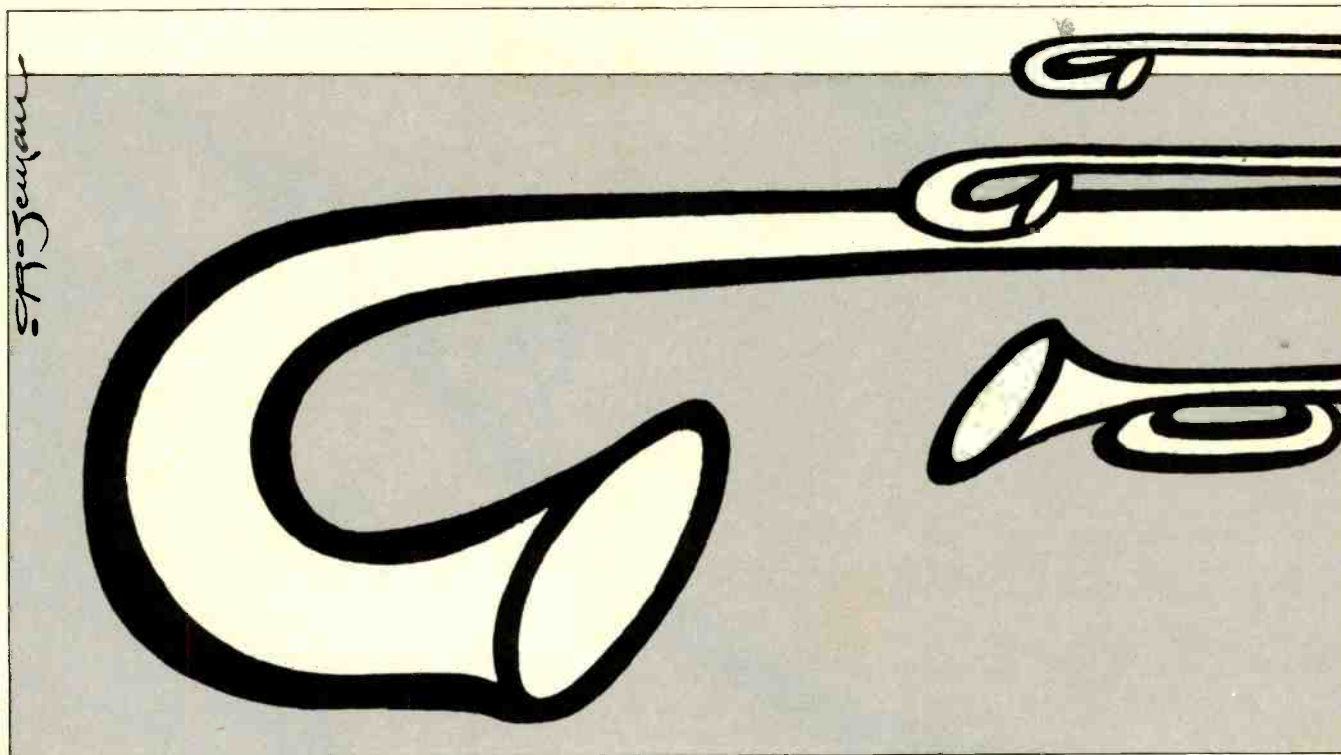

98

Brass Etcetera. (Husa: *Landscapes*. Haufrecht: *Symphony for Brass and Timpani*. Mourant: *Aria for Orchestra*.) Western Brass Quintet; Brass Ensemble Society of N.Y.; Hamburg Symphony Orch.

CRI SD 192(78), stereo, \$7.95.

Keep your eye on CRI. And your ears too. Composers Recordings is not-for-profit and has tax-exempt status, operating primarily for composers. In this case, oddly enough, this seems to be no bar to good audio. Here's an example, as of side one. The etcetera of the title goes on side two.

Side two, it seems, is a re-issue in stereo of an early CRI disc with the same catalogue number, here compressed neatly on one side — the Haufrecht *Symphony* and the Mourant *Aria*. That leaves a whole side free for something else. To match the Haufrecht brass, they offer more and newer brass — the Husa *Landscapes* for brass quintet on side one and, wow, what a recording! Right up in the digital and d-to-d area in terms of sheer sound. And ultra-quiet pressing.

This is something you really ought to hear.

If you are an audiophile, you'll like the music. It is "modern" all right, in a dissonant and highly professional way, but also expressive and sonically colorful as well as potent. Never heard such unusual brass sounds — but not merely to be different. The first movement ("Northern Woods") is loud and dissonantly, fanfare-clear. The second ("Northern Lakes") is utterly mysterious; far away, legato, making use of some remarkable microtonal effects, out of tune. The last ("Voyageurs") begins with a sort of fugue that sounds like a flock of tropical birds twittering, and then it grows to an amazing brass climax, almost like jazz. I could hear no profound relationship between these astonishing brass sounds and the titles — which is quite OK with me. Titles must be for local consumption, up in the Great Lakes country — something about the majesty of nature embellished by geese and spaceships. (I might have heard the geese, but I missed the spaceships.) What matters

is that nature is embellished by superb brass recording (and playing), extremely clean and clear with a very wide dynamic range, a sharpness of brassy, breathy transients and, remarkably, scarcely a trace of groove pre-echo or post-echo. And all this imposed upon a glassy-smooth surface without ticks and almost free of any sense of turning turntable, which allows for magical effects in the slow movement in particular. Very high-quality pressing.

So if you want super-fi at half price (by current standards), try this for side one. That pays for the perfectly OK but not remarkable side two, which also benefits from the excellent pressing. Dare I say it, I *think* this is an American pressing, too. Yes, it can be done!

(Side 1)

Sound: A Recording: A- Surfaces: A-

Rimsky-Korsakov: "Christmas Eve" Suite No. 2; Overture on Russian

Themes; Skazka (Fairy Tale). Bochum Symphony, Maga. **Vox Turnabout QTV 34736**, stereo/quad (QS), \$4.98.

Much is neatly summed up in this recording, many of the features and problems of music via the audio medium. You may want to try it out of sheer curiosity, at the bargain price.

First, the music. Everybody knows old Rimsky-K. But what listener has heard *these* works? What big-name orchestra ever features them in its regular repertory? No matter — they will please you.

Almost anything Rimsky writes is going to be sweet and melodious and full of orchestral color, apt for recording. These are all of that, with some added attractions. The "Christmas Eve" music, its only recording to date (London has Suite No. 1 I think) is lovely, peaceful, quiet music, then moving on to a peasant-like celebration with sounds that remarkably suggest "Petrouchka." Maybe Stravinsky knew this music? The early *Overture on Russian Themes* is a surprise, the themes or tunes in question being ultra-familiar in other composers' works — Tchaikovsky, Moussorgsky, et al. Interesting to hear them in an entirely new (though actually older) variation treatment.

Only the last work, *Skazka*, sort of goes on & on, as Rimsky can do all too often.

The Bochum Orchestra? Sounds like so much hokum and a local-yokel outfit at best. It is indeed provincial and not too expert, but these people really try and I'd give them top grades for getting the music over to us, in spite of some blats and unevenness and out-of-tune chords. You'll probably never notice them. Better this, I say, than the polished name-brand sound of some overworked and over-bored big-time orchestra! As Shakespeare would have put it, "all is not gold that glistens" out of Public Relations.

Next, the recording. Curious. The instant I put stylus to disc a superb concert ambience jumped out at me. Splendid. Combination of excellent mike placement and fine hall acoustics, very perceptively accomplished. But what happened next was somebody else's doing. Gross compression. So I heard it. The side opens with soft music, as with so many works of a concert nature. And it ends with very loud music, also typical of concert music, as we know all too well. Bad for recording; but we can do better than this record does. Somebody, somewhere in the processing, must have blown up the beginning music and/or pulled down the ending; the two are *the same in volume*. Sounds to me like a

AUDIO • September 1979

Sumiko presents

SUPEX

The FIRST FAMILY
of Moving Coil Cartridges

Available from Supex Dealers

ALL NEW from Sumiko, Inc.
P.O. Box 5046, Berkeley, California 94705

Enter No. 39 on Reader Service Card

See What You've Been Missing... Read Audio's Classified

99

To get the most from your cassette you need a clear head.



If your cassettes don't sound as good as when you first recorded them, it may be because you haven't cleaned your cassette deck heads in a while. TDK makes an ingenious and easy-to-use Head Cleaning Kit that contains everything you need to do the job, safely and thoroughly.

There's an angled mirror to inspect the heads and a non-abrasive brush to dust away loose dirt. A specially-formulated cleaning fluid is applied by a

cleaning probe with disposable tips. It all fits neatly in a standard cassette box to store conveniently wherever you keep your cassettes.

When you think how many dollars your tape deck cost, the TDK Head Cleaning Kit makes a lot of sense.

TDK
The machine for your machine

© 1979 TDK Electronics Corp., Garden City, New York 11530.

Enter No. 43 on Reader Service Card

THE B&W DM2/II. A CLASSIC IN EVOLUTION.



Despite the almost daily claims of revolutionary breakthroughs, loudspeaker design is basically an evolutionary process.

Consider the new B&W DM2/II, for example. When its predecessor, the original DM2, was introduced several years ago, it was widely acclaimed as a classic of impeccable design and outstanding performance.

In pursuit of excellence.

Since that time, however, B&W's unparalleled research and development program has yielded new and fascinating insights into virtually every aspect of speaker design and performance.

From these uniquely innovative studies has emerged a completely new design of surpassing accuracy, the B&W DM2/II.

Each driver of the DM2/II has been designed for exceptionally smooth response over its entire operating range. The crossover is a computer calculated nineteen element network employing true third order Butterworth filters that result in significantly lower intermodulation distortion and exceptional phase and amplitude characteristics.

Listening. The final proof.

Listening to the B&W DM2/II is, quite simply, a revelation. It produces completely natural, uncolored sound of extraordinary clarity and depth. Moreover, its modest size and elegant appearance permit advantageous placement in almost any listening area.

As with all B&W loudspeakers, each DM2/II is individually tested and shipped with its own proof of performance chart recording.

However, the ultimate proof of performance is in the listening. Your B&W dealer invites you to audition this classic contribution to the evolution of speaker technology and decide for yourself.

For additional information write: Anglo-American Audio Co., Inc., P.O. Box 653, Buffalo, N.Y. 14240. In Canada: Remcron Electronics Ltd.

B&W Loudspeakers. The next step up.

hand job, but it could be a compression circuit, set to maximum. The effect is like something out of the 1940s, or the first batch of Dynagrooved discs from you-know-who. A real distortion of the musical sense, quite intolerable in these times.

You can help yourself simply by monitoring. Start with the volume control way down, then when the orchestra begins to work harder, turn it up. You might practice, then make a copy onto cassette with your corrections neatly built in. Note also that an expander circuit might be the answer. An excellent chance to see what yours can do for an extreme case. Hey, dbx, better grab this one for some tough lab testing.

Finally — here we have still one more QS-encoded recording. They keep coming out. (If only CBS had been as casual about its SQ coding, minus all the extra-price hoopla and the gold labels, we might still be getting new material in that form too.)

With these complications I'm having trouble assigning letter ratings. Chalk the compression under sound — the basic recording pickup remains very fine.

Sound: B- Recording: A Surfaces: B+

Alicia De Larrocha, piano:

Granados, Albeniz, Turina, Soler, de Falla. Vox Box SVBX 5801, three discs, stereo, \$11.95.

Manuel de Falla. Turnabout TV 34742, stereo, \$4.98.

Mozart, Mendelssohn, Tchaikovsky, Chopin, Debussy, Liszt, Schubert, Beethoven, Couperin, Paderewski, Faure, Weber, de Falla. Vox Box 5800, three discs, stereo, \$11.95.

In two minutes you will know that here, recorded, is one of our greatest living pianists, notably for her own Spanish music. Astonishing how quickly a recording can hit you in this way.

On stage, the big show biz musicians have an advantage; on records, they sometimes bang and pound. Too close for comfort. Sight unseen, the recording pianist is down to basics — only the audible music counts, and neither the visible personality nor the big publicity helps. Publicity doesn't make musical noises.

The first of these albums is the place to begin, an absolutely splendid collection of easy, graciously Spanish pieces of an elevated cocktail-lounge sort, perfect for light listening. Many another pianist makes these sound banal

and pedestrian; when De Larrocha plays them they are magic. You get that curious feeling that the music is playing *her* — the piano, even the composer himself. The fingers are simply pulled along, the pianist a mere vehicle! It is the same when, in ballet, the human body seems to take off into the air as though lifted from above.

Next, you go on the harder, more acid and telling music of de Falla in the same Spanish tradition. Again, superb. Perfection! I have never heard greater pianism, finer musicianship. Again, the piano *is* the composer, De Larrocha a sort of passive medium, as though all the musical energy came out of the instrument itself. Only the very greatest pianists achieve this effect.

I was almost reluctant to try the "general-purpose" De Larrocha album, an array of standard and mostly familiar works. Such a Spanish specialist could hardly play all this other music equally well? I was wrong. True, the Mozart and Beethoven were slightly peculiar and Debussy sounded much more Spanish than French. But Schubert was lovely, and her Chopin, far from an ordinary styling, was extraordinary indeed. Revivified, brought back of life! After so many tired and powerhouse performances by ordinary skilled pianists, I wouldn't have believed it. The great artist again.

The original Hispavox recording, presumably out of Spain, is a natural and easy piano sound, especially lovely in De Larrocha's delicate *pianissimo* passages. Some gentle hiss in the background. The "general-purpose" album is more uneven, made up of assorted recordings, early and late, with varying piano sounds. One piano twangs like a demented harpsichord or, more precisely, as did the early 19th century piano on which some of these physically powerful works were first heard. I didn't much like the variety of sound but accepted it as inevitable for this type of piano collection.

Sound: B+ to B- Recording: B to B+ Surfaces: B-

Calliope, A Renaissance Band. Music of 16th Century Italy. Calliope 101. (Mail order: \$6.95, Hamlen Management, 125 East 85th St., New York, N.Y. 10024.)

Here, on its own label, is a first-rate and up-to-date Renaissance band, four performers and 24 instruments among them (no voices), nicely taken down in an old New York church of excellent acoustic quality. This now popular

type of music has come a very long way since, in the same city, the old Pro Musica first set out guidelines. This group not only plays with impeccable expertise but also plays musically, with good phrasing and expression — thank heavens! Too often in the past the music has been merely pounded and banged and twanged, shapelessly. In particular, the slower works here are really beautifully phrased out, with a fine legato and tension. The faster dances have a certain telltale American foot-tapping to them and tend to fall into the same tempo a bit too often, but this is minor criticism.

As must be pointed out again and again, even the tiniest record label today may boast top-quality sound in its product — indeed, the smaller labels generally equal or surpass the sheer audio and recording quality of the big major labels, from the microphoning right through to the pressing itself. To date, the Calliope “label” includes exactly one record — this one. It is a very worthy start.

Sound: B+ Recording: A- Surfaces: B+

R. Strauss: Don Quixote, Don Juan. Tibor Machula, cello; Concertgebouw Orch., Haitink. **Philips 9500 440**, stereo, \$8.98.

While this recent Philips recording of the two Strauss “Dons” was playing, I took a look at another LP which hangs in a place of honor on my living room wall: a plastic platter produced by RCA Victor (LM-144) around 1933 which contains only about half of *Don Quixote* on its two short sides. It was by the N.Y. Philharmonic (Philharmonic-Symphony) under Sir Thomas Beecham, with Alfred Wallenstein (of the Wallenstein Sinfonietta on pre-war WOR) as the solo cellist. I tried this one on my table — what an incredible barrage of noise, all but drowning out the faint but excellent music in the background! Even the right stylus wouldn’t help much. Technically we’ve come a long way from the first home LPs.

This new Philips can cope with the large-scale music as the old system could not, but it is, alas, no model recording. I like the quite distant sound, though it tends to lack presence and seems not loud enough. The levels are indeed low, no doubt because of the length of the work. The solo cello is nicely balanced, not too obtrusive against the orchestra. (Alfred Wallenstein is closer and relatively louder in the pre-war style of micro-

phoning.) But the Philips disc itself has more than a few ticks and, worse, a lot of stuck-on gunk, bits of cardboard or whatever, that repeatedly threw my stylus out of the groove. Not so creditable, especially at the price.

Don Quixote is the most literal-minded of the Strauss tone paintings, what with the Don himself (cello), Sancho Panza, bleating sheep, windmills, and so on. As music it is episodic and slow moving; you really have to follow the “story line” to make much enjoyment of it. Old Sir Thomas

Beecham knew how to get the most out of this slack musical writing; two generations later, Bernard Haitink lets it amble along at its own pace. Pleasant but not very compelling.

I found, too, that his *Don Juan* ambles or shuffles the same way, lacking the razor-edge passion and the anticlimax frustration of the Don’s musical lovemaking. Sir Thomas would have done wonders with *that* music — if the RCA LP had allowed it.

Sound: B+ Recording: B Surfaces: C+

THE FUJI CHALLENGE

Try the others. Then try ours.

When it comes to choosing the best tape, a minute of *listening* will tell you more than hours of specs. Because the best tape for *you* depends solely on the sound *you* like and the response of *your* deck.

At Fuji, we make the most advanced magnetic tape in the world — for video as well as audio. We’ll match our specs against anyone else’s, but we respectfully suggest you stop reading and start *listening*. Once you compare Fuji FX-I or II to any other premium tape, there’s nothing more to say. We have confidence in your ears.

FUJI

Magnetic Tape Division
of Fuji Photo Film U.S.A., Inc.
350 Fifth Avenue,
New York, New York 10001



Folk bag



102

Roots of Reggae:

Jolly Boys
Lyrichord LLST 7314,
stereo, \$7.98

Calypso-Rock Songs of Jamaica:
Horace Johnson & The Eagle Star
Folkways FTS 31308, stereo, \$7.98.

The increasing popularity of reggae in the U.S. has encouraged new interest in earlier forms of Jamaican folk and popular music. These two albums present two different approaches to *mento*, a native Jamaican idiom analogous to Trinidadian calypso.

It's hardly accurate to refer to this music as "the roots" of reggae, since reggae derives in large measure from the collision of a number of Jamaican religious cult musics with American R&B. Nonetheless, mento-like melodies are often encountered in some of the more tradition-conscious reggae.

But the interchange goes both ways. Several tracks on Donald Davidson and The Jolly Boys' album are clearly influenced by reggae and its predecessors, ska and rocksteady, though The Jolly Boys perform them in a vastly more archaic style. Their version of Toots and The Maytals' *Pomp and Pride* affords a rare opportunity to contrast reggae and mento approaches

to a familiar song. Despite The Jolly Boys' experience as tourist-club entertainers, their rendition is infinitely more primitive, with loose, earthy singing which betrays neither professional polish nor outside influences. Moreover, they employ traditional instruments — four string banjo, acoustic guitar, maracas, the Rasta "repeater" drum, and a bass instrument known as the "rumba-box" (a sort of oversized thumb-piano; alas, the instrument is virtually inaudible on this album).

Alongside a couple obviously reggae-oriented Davidson originals (*Build On the Rock, Thousands of Children*), The Jolly Boys also do several "purer" mento songs, such as Fritz Ramus' *Sarah* and *Fat Wife*. These are generally (not always) slower than calypso, with a jerkier beat. Despite the rather amateurish, imperfectly balanced recording and the misleading, pseudo-hip liner notes, **Roots of Reggae** is a highly entertaining album with great appeal.

The Horace Johnson album is much more tourist-oriented, despite instrumentation similar to The Jolly Boys (minus the repeater drum). Tourists expect to hear Harry Belafonte songs when they travel to Jamaica, so that's

what Johnson gives them. Although he calls his music "calypso-rock," I hear next to no rock influence here. Rather, he combines easy-listening Caribbean pop, calypso and diluted upbeat mento. The Eagle Star is a considerably more proficient, professional outfit than The Jolly Boys, but I personally prefer the latter group's cruder sound. It's worth noting that the recording (which sounds like mono to me) is clear enough so that the rumba-box can be plainly heard. Enjoyable, but try The Jolly Boys first. *Tom Bingham*

Jolly Boys

Sound: C- Performance: B

Johnson

Sound: B- Performance: B+

Reunion: Johnnie Lee Wills
Flying Fish FF 069, stereo, \$7.98.

Johnnie Lee Wills has always lived in the shadow of his older brother Bob, in whose band he began his career in the mid-1930s. But Johnnie Lee was and, when his health permits, still is a highly respected Western-Swing band-leader in his own right. In fact, one of

his original compositions, a playful and unaccountably memorable little ditty called *Rag Mop*, entered the popular mainstream in the early '50s and is still with us.

Rag Mop is one of 14 Wills Brothers favorites reprised on this top-notch reunion of some of Western Swing's greatest exponents. Johnny Gimble, Joe Holley, Eldon Shamblin, Gene Crownover, Glenn Rhees, Wayne Johnson, and Alex Brashear are just a few of the fabled names present. To hear them on this session, you'd swear it was still 1949 and they were playing a dance at Cain's Academy in Tulsa. Bob's old business manager, O.W. Mayo, even puts in a cameo appearance to introduce *Rag Mop*. The back-cover photo shows a lot of gray hair and lined faces (not to mention an out-of-place Oak Ridge Boys T-shirt!), but this is the real thing in all its glory, with a magical air of spontaneity that's missing from the Original Texas Playboys' glossier Capitol albums.

And look at that lineup of songs — *Silver Bells*, *Four Or Five Times*, *Rosetta*, *South*, *Milk Cow Blues*, *Whose Heart Are You Breaking Now*, *La Golondrina* — all done in first-rate arrangements for three or four fiddles, three horns, and a full rhythm complement. Moreover, the singing, by Johnnie Lee, son John Thomas Wills, Curly Lewis, and Joe Holley, is mighty easy on the ears.

The album is so musically exemplary I hate to make any negative comments for fear I might turn away prospective customers. But, alas, the production is grossly flawed. Some of the ensemble lines (horns in particular) are buried in the mix, while Shamblin's second guitar comping is much too prominent. Instead, several of the horn solos and a few fiddle obbligatos should have been brought forward. In addition, many of the vocals have too much reverb, and there's an overall tubbiness to the sound. With more than one listen, one can compensate for these deficiencies, but there shouldn't be any reason for them in the first place.

The music transcends any complaints, however. This is one record no self-respecting Western Swing fan will want to be without. *Tom Bingham*

Sound: C- Performance: A

Pace Yourself: P.T. Gazell

Sugar Hill SH 3703, stereo, \$7.98.

Phil Gazell has risen to semi-prominence as Johnny Paycheck's harp blower. On his debut album as featured instrumentalist (and adequate singer on one track, *Hold the Wood-*

pile Down), Gazell is backed by an eclectic string band featuring Boone Creek's Ricky Scaggs and Jerry Douglas.

Gazell's repertoire encompasses old-time fiddle tunes (*Billy In the Low Ground*), sentimental country standards (*Miss the Mississippi & You*, with appropriately laid-back guitar and mandolin), bluegrass (*Roanoke*), and hot-jazz (*The Flintstones*). Rather surprisingly, there's a high percentage of Anglo-Irish material (*Off to California*, *Red Haired Boy*, *British Isles Medley*, and a Gazell original *Susan's Cable Stitch*), on which his primarily, though not exclusively, linear (i.e., one note at a time) harmonica style is sometimes reminiscent of a one-handed concertina. No matter what the origin of his tunes, Gazell plays them with sensitivity, seamless dexterity, a fluent rhythmic sense, and an admirable talent for finding the right tone, tempo, and approach to fit each song.

Mention should also be made of Tony Williamson, whose flatpicked guitar breaks and bass runs add much to the excitement of the uptempo cuts. **Pace Yourself** is one of the most skillful, varied, and enjoyable harmonica albums I've ever heard. (Sugar Hill Records, P.O. Box 4040, Duke Station, Durham, NC 27706.) *Tom Bingham*

Sound: B+ Performance: A

Dream Dancer: Light Rain
Magi 001, stereo, \$7.00.

Light Rain is an instrumental ensemble whose name derives from an earlier album by singer-composer Doug Adams. **Dream Dancer** is an unparalleled fusion of Western folk- and chamber-music instrumental concepts with rhythms and melodies inspired by Middle Eastern belly-dance music.

Each side of the album is conceived as a complete dance routine, though Adams' impressionistic, dream-like compositions and arrangements are perfectly suited for concentrated listening as well as dancing. Adams varies his instrumentation from track to track, drawing from a 12-member lineup which includes a string quartet, bamboo flute, oboe, mandolin doubling banjo, bass, and Arabic and Latin percussion, along with Adams himself on solo violin, plucked dulcimer, recorder, wordless vocals, and percussion instruments.

Consequently, each segment of the two routines has its own identity and set of influences. For example, *City of Dreams* and the two *Firewoods* are (instrumentation aside) almost purely Arabic in style. *The Sword Dance* recasts a traditional violin *taqsim* in a

sea of vocal drones, leading into an erotic slow-dance of pizzicato violins and mandolin. *Women of the Well* borrows from South American Indian music, whereas *Dervish* sounds like a baroque concerto given an Egyptian beat. *Rabekin* (composed by Rusty Gauthier, the only section not written by Adams) takes the five-string banjo on a camel caravan, in a manner not unreminiscent of early Sandy Bull.

Thanks to Adams' thorough understanding of his diverse sources and his highly developed flair for combining them in ways that are fresh and experimental, yet which show the highest respect for their original contexts, the heterogeneous elements of **Dream Dancer** coalesce into a fully unified whole. There's little of the "pastiche" character which so often mars less substantial attempts at cultural fusion. Rather, there's a very natural flow to these colors, textures, and rhythms, which gives the album a relaxing, refreshing ambience. It works on so many levels — dance music, entertainment, artistic innovation, and soul-cleansing — that it should charm and captivate listeners from an unusually wide variety of musical backgrounds.

My only reservation is the album's unsatisfying conclusion. After all the compositional skill Adams demonstrates throughout the album, why does he suddenly let it die at the end? But this is a minor quibble which hardly detracts from an otherwise blemish-free masterpiece. (Dream Dancer, P.O. Box 356, Larkspur, CA 94939.) *Tom Bingham*

Sound: B Performance: A+

Nowell Sing We Clear, A Pageant of Midwinter Carols: John Roberts & Tony Barrand
Front Hall FHR-013, stereo, \$7.98.

This is a Christmas record with a real difference. Rather than going to the standard treasuries of 19th century carols, John Roberts and Tony Barrand, two English folklorists now living in Vermont, have gone back to medieval and Renaissance songbooks, back to when the "carol" was a round-dance as well as a song. With the able assistance of Fred Breunig, a dance-caller and fiddler, and Steve Woodruff, who plays button accordion, Anglo concertina, and pennywhistle, Roberts and Barrand have managed to recreate a true English Christmas celebration with a lilting bounce and a fresh, gentle gaiety that stands out in marked contrast to the massed chorales and over-orchestrated walls of driven slush that pass for Christmas music in your neighborhood supermarket.

The liner notes stress the pagan origins of much of this music, thinly Christianized magic-invoking attempts to ensure that the long English winter would pass over and the sun return to the leaden sky. This mixture of old and new religions results in highly civilized paganism in Roberts and Barrand's interpretations of the jolly season, and may indeed give a fresh impetus to people looking for something better than *Little Drummer Boy* or *Rudolph the Red Nosed Reindeer* to trim a tree by. There are too many good songs here to pick favorites, though, so just go ahead and run it all the way through; then toast Father Christmas in your own wassail and run the carols round again. That's the spirit to enjoy this sweet, unusual album in. (Write Front Hall Records, RD 1, Wormer Rd., Voorheesville, NY 12186.)

John McLaughlin

Sound: B Performance: B+

The Complete Guitarist: Davy Graham **Kicking Mule KM 138**, stereo, \$7.98

Stefan Grossman started Kicking Mule Records as a guitar instruction label offering tablature booklets for each of their albums, a practice they continue. Recently they've released some exquisite albums by artists well known in England where Grossman lives. These include: Bert Jansch, Ralph McTell, and a duet set by Grossman and John Renbourn. All of these artists readily acknowledge Davy Graham as their prime inspiration.

As far as I can tell, this is Graham's first album in a decade or better. Totally instrumental, it ranges freely from traditional airs and jigs, to J.S. Bach and Ralph Vaughan Williams, to blues, to a jazz classic in Horace Silver's *Sarah*. Most remarkable is the consistency of Graham's playing whatever the genre. As he is an acknowledged master of the British folk set, any release is an event, and *The Complete Guitarist* is no let-down. The only aspect of his playing unrepresented is Eastern style music, an intentional omission since Graham is presently mastering sarod, bouzouki, and Moroccan lute in order to present these forms as authentically as possible.

Davy Graham is truly an outstanding guitarist. His taste is exquisite, paradoxically displaying flourishes and economy. This new album is at least as good as any he has done to date. Technically it is par for Kicking Mule's high standards.

Michael Tearson

Sound: B Performance: A+

Sanctified Singing with Traditional Jazz Accompaniment: Rev. D. C. Rice **Herwin 212**, mono, \$6.98.

Gospel music as we know it today dates back to the 1930s. One of its most significant, yet little-known forebears was the uninhibited, highly rhythmic "sanctified music" of the Pentecostal or "Holiness" churches. This collection, recorded in Chicago between 1928 and 1930, is the latest in an exceptional series of reissues of pre-gospel black religious music on the Herwin label.

Rev. Rice had a distinctively adenoideal, yet far from heavy voice with what might be termed a friendly demeanor, which keeps his singing from becoming too "preachy." The responses and unison leads sung by his congregation were rather pinched and primitive, but they had a contagious spirit and spontaneity that added greatly to the music's irresistible dance beat. Several of the tracks open with brief sermons or scriptural readings by Rice; while a three-minute 78 hardly allowed time for a fully-developed sermon plus song, these spoken segments provide a tantalizing glimpse at what an old-time Holiness service might have been like.

The advertised "traditional jazz accompaniment" is primarily limited to six cuts. These feature a tailgating trombonist who adds pointed commentary through boisterous New Orleans licks. He's joined by an ornamenting trumpeter on four of the six cuts. On most of the 12 additional tracks, though, a rollicking pianist adds a raggy/jazzy bounce which helps justify the album's title. Moreover, the mandolinist on the first two tracks on each side sounds like a refugee from a jug band.

The songs come from the same racially interactive Pentecostal tradition — part black spiritual, part rural white hymn — that gave rise to songs like *When the Saints Go Marching In* (to give a familiar example). The performances, though, are indisputably Afro-American in rhythm, vocal approach, and call-and-response patterns. On the other hand, there are a couple of real curiosities — *Sin Is To Blame* sounds like a German beerhall singalong-waltz, an impression reinforced by the tuba puffing away on the first beat of every measure. *When I Take My Vacation in Heaven* is also a waltz, but with more of an old-time country flavor.

The original engineers emphasized the vocals at the expense of the instrumental combo. Volume levels are inconsistent, with instruments suddenly breaking out of the background

at odd times. The condition of the 78s used for transfer is, with a couple exceptions, above average. Herwin Records, Inc., Box 306, Glen Cove, NY 11542.

Tom Bingham

Sound: C Performance: A-

Zydeco A La Mode: Queen Ida and the Bon Temps Band

GNP Crescendo GNPS 2112, stereo, \$7.98.

Here's a pleasant surprise—a nationally distributed zydeco album by someone other than Clifton Chenier!

Queen Ida Guillory and company hail from the San Francisco area, home of the greatest concentration of Cajuns outside the Louisiana Bayou/Texas Gulf Coast region. Queen Ida's music is lighter, less intense, more country-rock oriented than Chenier's stomping boogie-r&b. While I personally lean toward the Chenier approach, there's no denying the infectious enthusiasm of **Zydeco A La Mode**.

Singer-guitarist Al Lewis (Queen Ida's brother) has a strong Cajun-country voice and an instantly likeable manner. He also writes immediately appealing songs (in both French and English) without a trace of affectation. The rhythm section keeps them jumping along at a persuasively foot-tapping pace, while guest fiddler Steamin' Freeman adds a down-home touch to four cuts.

What really gives the band its special identity, though, is Queen Ida's buoyant accordion. She plays a three-row button model with quick responses and full chords. Her readily identifiable, light-textured sound is quite different from both the reedy wheeze of the traditional Cajun melodeon and Chenier's dense, electrified piano-accordion. Ida's style is especially suited to catchy country-rock-flavored tunes, but she easily adjusts to the bluesier boogie of *Moi Tit Feye O'Paradis*.

Ida's band is well-named. This is real *bon-temps* (good-time) music which only the most sour-pussed traditionalist would want to resist. Aside from an occasional distortion and lost fiddle line, the recording is quite good.

Tom Bingham

Sound: B- Performance: B+

Master Fiddler: Eck Robertson **Sonyatone STR-201**, mono, \$6.98.

The recorded history of American country and folk music began in New York on June 30, 1922, when a 34-year-old Texas fiddler, Alexander "Eck" Robertson, and an elderly Oklahoman,

Henry Gilliland, stood before Victor's acoustic recording horn and bowed out brisk breakdown versions of *Arkansas Traveller* and *Turkey in the Straw*. Those two performances, as well as all other existing Robertson recordings made between 1922 and 1929 (his unissued takes are apparently lost forever), are finally available in chronological order on this important reissue album.

Robertson was not only the first country fiddler to record, he was arguably one of the best, with a downright uncanny sense of timing. Hear in particular his unaccompanied masterwork, *Sallie Goodin* — his old-fashioned, multi-stopped bowing was so immensely developed that he vigorously whipped out one rapid, driving variation after another, all the while maintaining a steady drone underneath. He also laid the groundwork for Benny Thomasson's influential swing-inclined "Texas-style" fiddling, with an undulating rhythmic lilt that was simultaneously straight-ahead and pliable (hear, for example, *Ragtime Annie* and *Done Gone*, the latter hemmed in slightly by a stiff, monotonous studio pianist).

Following his 1922 sessions, Robertson had to wait seven years for another chance to record. By this time he was heading the Robertson Family, alongside his wife and daughter, who kept time on guitars, and Eck, Jr., who was a speedy tenor banjo strummer. Their *Texas Wagoner*, *Run Boy Run*, and *Great Big Taters in Sandyland* strike me as localized Texas attempts to capture the rollicking Southeastern stringband style of the Skillet Lickers et al. *Amarillo Waltz* is somewhat lackluster, though this tune and the two-part *Brown Kelley Waltz* suggest that Bob Wills (who battled Robertson at regional fiddle contests) owed a good measure of his waltz style to this older competitor.

Rounding out the album are Robertson's best-known recording, *Brilliant Medley*, which is still a showpiece for old-time fiddlers; his only issued vocal (though several others were recorded), a ballad called *The Island Unknown*, sung with his wife Nettie, and a 1965 home-recorded version of his former *Radio Theme Song*. The latter piece, though revealing the ravages of time on both his singing and fiddling, shows the old man still had a lot of spunk during his brief "comeback" in the '60s.

The record comes with an informative booklet containing a short biography (though Robertson's birth date should read 1887, not '97), a discography, and notes on each track. To histo-

rians, of course, this album is essential, but it can be just as easily recommended to anyone who loves traditional fiddling and stringband music. (Sonyatone Records, P.O. Box 567, Santa Barbara, Cal. 93102.)

Tom Bingham

Performance: B to A

Fred Pike & the Flat Top Guitar Revonah RS-929, stereo, \$5.98.

Fred Pike is a veteran Connecticut flatpicker who is credited as a major influence by no less than Jimmy Gaudeau.

After hearing this all-instrumental album, I can only wonder why I've never heard of Pike before. Even his fastest licks are clean, fluid, inventive, and always tasteful. His touch is light yet exact. His pick ripples across the strings with a distinctively soft-focused tone which is unmatched in subtlety and resonance by even such giants of the flatpick as Doc Watson and Dan Crary.

Pike shares the spotlight with Perley Curtis, a very promising young dobro player whose melodic approach is rooted in Buck Graves, but open to more modern styles, and banjoist Fred Lantz, who's a bit stiff on *Old Joe Clark*, but blends perfectly with Pike elsewhere. Dave Dalton (rhythm guitar), Bob Denoncourt (bass), and Pike himself (overdubbing rhythm guitar and mandolin) add strong rhythm support throughout.

There's occasional distortion in the bass and in the guitar's lower register, and I'd have preferred a less cluttered middle channel. (Revonah Records, Box 217, Ferndale, NY 12734).

Tom Bingham

Sound: B- Performance: A-

Gypsy Folk Songs From Hungary Hungaroton SLPX 18028-29, stereo, two records, \$15.96.

When you think of Hungarian gypsy music, you naturally conjure up images of tearfully romantic violins, chiming *cimbaloms* (the Hungarian hammered dulcimer), and round-toned, broken-chord clarinets (sometimes replaced by nasal, double-reed *tarogatos*).

That type of Hungarian music, although performed by professional gypsy musicians, is largely directed toward a non-gypsy audience. As entertaining and artistic as it may be, it's far from representative of "real" gypsy music. **Gypsy Folk Songs From Hungary**, a collection of 1975 field recordings by Rudolf Vig, introduces an even more fascinating species of Hungarian

gypsy music, the a cappella folk songs of peasants scattered in small, isolated villages.

One can hear little audible connection between these traditional gypsy songs and the familiar orchestrated variety. The slow songs, sung solo, are quite arhythmic and have a definite (though difficult to exactly pinpoint) Asian melodic flavor. However, the expressive tremolos in the singing lack the stunning melismatic ornamentation heard in most Eastern vocal music. A profound feeling of weary melancholia pervades these songs, giving them an intrinsic poignancy which transcends both language and cultural barriers.

The uptempo tracks are as joyous as the slow songs are sad. These infectious, spirited, wonderfully discordant dance tunes sound so indescribably bizarre to the uninitiated ear, one could be forgiven for laughing on first hearing. The lower class gypsies, too poor to afford musical instruments (aside from the percussive use of household utensils), developed an oral technique known as "double bassing." This consists of an incredible array of syncopated vocal/guttural noises which dance and weave around each other in a blissfully cacophonous polyphony of nonsense syllables. In groups of four or five singers, they set up complex, exciting polyrhythms, sung, grunted, shouted, mumbled, and barked (to use a number of words which don't rightfully apply) with little regard for "proper" pitch and tonality.

The closest American equivalents to these weird vocal sounds I can think of are that strange Appalachian phenomenon called "eefing" (like blowing into a non-existent jug while hyperventilating) or, at times, John Hartford's assemblage of off-the-wall vocal utterances. But these, of course, aren't layered into polyrhythmic configurations. Moreover, they're novelties and are regarded as such, rather than being the common dance music of their culture.

The sound quality is generally above average, though several cuts suffer from flutter, bumps, and other distortions. The surface is considerably below Qualiton/Hungaroton's usual standards, often intruding on the solo vocals. Pass this set by, though, and you'll be missing a rare opportunity to sample what must be the most unique (though, alas, rapidly disappearing) traditional music in all of Europe. (Qualiton Records, Ltd., 65-37 Austin St., Rego Park, NY 11374).

Tom Bingham

Sound: C- to B- Performance: A

Classified

FOR SALE

Classified Advertising Rates

BUSINESS ADS- For Sale, Help Wanted, Services, Business Opportunities, Tape Recordings, etc. etc. \$5.25 per line. First line set in bold face type at no extra charge. Extra lines \$9.60 per line. One point ruled box, extra charge \$8.00. Full payment must accompany order.

NON BUSINESS ADS- Situations Wanted, used equipment for sale by private individuals \$3.50 per line. First line set in bold face type at no extra charge. Extra lines set in bold face type \$7.00 per line. Full payment must accompany order.

FREQUENCY DISCOUNT- 3 times, less 10%. 6 times, less 15%. 12 times, less 20%. (line copy ads only)

DEADLINE- 1st of two preceding months. (Dec. 1 for Feb. issue).

BLIND ADS- Box numbers may be used at \$5.00 extra for handling and postage.

MAIL ORDER AND DISPLAY CLASSIFIED RATE

1 col x 1"	\$150
1 col x 2"	\$225
1 col x 3"	\$300
2 col x 1"	\$225
2 col x 2"	\$395

Advertiser must supply complete film negative ready for printing for display ads.

Carolynn F. Sumner
Classified Advertising Manager

AUDIO Magazine
401 North Broad Street
Philadelphia, Penna 19108

HOW TO ANSWER BOX NUMBER ADS

When replying to an Audio Box Number Ad, please use this address Box No. — c/o Audio, 401 No. Broad Street, Philadelphia, Pa. 19108

ABSOLUTE LOWEST PRICES ON OVER 80 BRANDS OF STEREO GEAR. Our unique plan saves you money over the best of the mail order houses. Huge inventory, fast service. Send \$1 for catalog and consultants rap sheet to: Discount Audio Services, 1078 Clearfield Rd., Nazareth, PA 18064. YOU WILL BE GLAD YOU DID! 11-9

FOR SALE

ACCURATE, QUALITY AUDIO EQUIPMENT DISCOUNTED! Low prices on quality Car and Home Hi Fi Components. Send SASE, call for quotes and literature. Denco Audio, P.O. Box 6104-U, El Monte, CA 91734. (213) 444-9978 evenings, wknd. 9-9

AFFORDABLE ESOTERICA

Central N.Y. State
Audionics Apt-Holman Dahlquist Denon
Spectro-Acoustics Crystal Clear
Citation Grace Ortofon Cizek
B&O McIntosh Crown KEF
STELLAR STEREO
384 Elmira Rd. Ithaca N.Y. 14850 607 272 2644

AKG, BURWEN, DBX, EV, JBL, HARTLEY, PHASELINEAR, TAPCO, TECHNICS PRO + MORE. NEW BURNEN DNF 1201, \$289; NEW JBL 4315 \$699; NEW JBL 6233, 700 WATT AMP, \$999. GOLD SOUND, P.O. Box 141, ENGLEWOOD, CO. 80151. 9-9

AMBIENCE DECODER FOR REAR CHANNELS, \$149.95. Literature 50c. Huntington Electronics, Box 2009-A, Huntington, Conn. 06484

AMPEX TAPE—NEW 1800 on 7" reel 12 for \$18 POSTPAID, 1200' 12 for \$13 POSTPAID—free list—WIDE RESPONSE, 6114A, SANTA MONICA BLVD., HOLLYWOOD, CA 90038 TF

A NEW SERVICE — THE AUDIO BROKER Computerized matching of Buyers & Sellers Used Equip. Send Mfg., Model, Price, Condition together with \$1 for each item for 12 months listing to Box 1, Tennent, NJ 07763. 9-9

ANNOUNCING — PHOENIX, AZ AREA

Hafner, Quatre, Marcof, Audiocraft, AGI, Denon, Supex, Grace, etc. Audiophile headquarters at The Listening Post (602) 967-1250 by appointment. 9-9

ANTI-SKATING for AR TURNTABLES!! Proven counterweight design of nickels steel & aluminum construction. Install yourself in minutes. \$7.95 postpaid. (Dealer inquiries invited.) AUDIO INNOVATIONAL PRODUCTS, P.O. Box 1607, Portsmouth, N.H. 03801.

ADVERTISING IN EUROPE?

Advertising expert, situated in Germany, of German nationality, can handle your audio advertising matters in Europe. Write to Alphon Advertising, Koenigsteiner Str. 47, 6232 Bad Soden, W.-Germany.

FOR SALE

AMERICAN AUDIOPHILE

PROUDLY PRESENTS
A STARTLING ADVANCEMENT
IN SPEAKER TECHNOLOGY
THE

IMPULSE MODEL 1 RIBBON SPEAKER SYSTEM

- FAST, UNIFORM TRANSIENT RESPONSE
- NO CROSS-OVER ABOVE 200 Hz.
- DEEP, POWERFUL, QUICK, DISTORTION FREE BASS RESPONSE. (down 2 db at 30 Hz.)
- BI-POLAR RADIATOR (from 200 to 20,000 Hz. ± 2db.)
- LINE SOURCE (the ribbon is only 3/8" wide)
- NO ENCLOSURE INDUCED SOUNDS (double thick walls; 1-1/2"; and acoustic foam are used)
- VAST POWER HANDLING ABILITY (500 peak; speech/music)
- THE RIBBON DRIVER (from 200 to Over 20,000 Hz., the IMPULSE ribbon driver is one of the fastest, least colored drivers made)
- Minimum Phase Response Above 200 Hz.

AMERICAN AUDIOPHILE

716 Madison Ave, New York, NY 10021
(212) 751-9733

5 Sunrise Plaza, Valley Stream, NY 11581
(516) 561-7114

ALL SHIPMENTS PREPAID AND INSURED
FREE THROUGHOUT CONTINENTAL U.S.
MASTER CHARGE & VISA ACCEPTED

ANOTHER AUDIOPHILE PUBLICATION?

AUDIO UPDATE is published ON TIME. This bi-monthly includes modifications construction projects, improvement methods, data available nowhere else. It's provocative, informative, and a MUST if you enjoy audio. Annual: \$12.00 USA/Canada, \$14.00 elsewhere. MasterCharge/Visa welcome. AUDIO DIMENSIONS, 8888 Clairmont Mesa Blvd., San Diego, CA 92123. (714) 278-3310. TF

ANOTHER NEW YORK CITY HIGH END AUDIO STORE?

Not really. Instead of rush A/B comparisons, electronics B.S., flashy switching systems, or high pressure salesmanship, we offer honest advice, audiophile to audiophile, and an open invitation to audition, at your leisure the finest components available in a comfortable homelike setting on Manhattan's upper east side.

Linn-Sondek, Linn Isobarik, Naim, Marcoff PPA-I, Meridian, Michaelson & Austin TVA-I, Spondor, Fried, Mor-daunt-Short, Precedent Audio, Spatial Coherence, Van Alstine, Strelloff Systems, STD, Connoisseur, Rega, Plana, Grace, Supex, Signet, Micro-Acoustics, NAD, AGI, Hadcock, CPU Micro-Tuner, Berningft-10 and many others.

SOUND BY SINGER AN ALTERNATIVE

For information or an appointment call (212) 929-2356 (10:00 AM-10:00 PM) We ship anywhere. 5-9

SPEAKER SYSTEMS

Beveridge • Rogers L35A • JR Rogers 149
DCM • Snell Acoustics • Dahlquist • ADS
Allison • Mitsubishi • BW • Janis

Audiocom HIGH TECHNOLOGY AUDIO

177 Sound Beach Ave Old Greenwich CT
Phone (203) 637-3621

THE SENSIBLE SOUND

NEW
ISSUE #7

403 DARWIN, SNYDER, NY 14226
REQUIRED READING BEFORE
MAKING ANY PURCHASE

New findings based on channel phase differences have been added to our cartridge reviews which include: NAGATRON 360 CEX, SUPEX SD-901 (high output), ACUTEX M320/III, SHURE V-15 IVG (spherical) and Type III, ADC ZLM, SIGNET TK7E, SONUS BLUE, PICKERING XSV-3000, STANTON 881S. Preamps include APT/HOLMAN, SERIES 20 C-21, JSH LABS MODEL T, SPECTRO ACOUSTICS 217, MARCOFF PPA-1, EPOCH IOU-4000, ADI modified PARAGON E1. We look at following turntables & tonearms: B&O 4004 & 3400, SME III, DENON DP-790, MITCHELL FOCUS ONE, SOUNOAIDS TONEARM MOD. Loudspeakers cover the field with the (NEW) DCM TIME WINDOWS, ROGERS COMPACT MONITORS, LIVE PERFORMANCE MODEL ONE, GRAPHYX SP6, BASSMINT 10/24, MONITOR AUDIO MA4, EPICURE 14, RTR 800D and the FRIED H/2 & T. Also, the HAN-D-MAG, GRT Products, QUIETONE, STATI-BRUSH and SPECTRA MAT. We review over 30 recommended records (half on budget labels), tell which speakers break the laws of physics and acoustics, look at loudspeakers and "real world" power rating, phono capacitance loading and wet record play considerations—plus much more—PLEASE JOIN US \$12 (4 issues), \$14 1st class mail & Canada, \$17 Foreign air mail—VERY SENSIBLE.

FOR SALE

APT/HOLMAN AMPLIFIER NOW AVAILABLE

Tom Holman's amplifier — The APT/Model 1 The Stereo Power Amplifier you've been waiting for! 6db Dynamic Headroom so it stays incredibly clean when it gets incredibly loud. The Model 1 eliminates Speaker/Amplifier interaction so it's stable into any speakers you use. 100 watts rms/channel. ONLY \$625. Shipped insured anywhere in the cont. U.S.A. Designatron Stereo Store, 260 Old Country Rd., Hicksville, NY 11801. (516) 822-5277. Mastercharge/VISA. 9-9

APT HOLMAN \$400 Nakamichi 620 \$525 Gale GS401 \$800 pr. Kenwood Scope KC6060 \$150. 318-276-4576, Box 650, Jeanette, LA 70544. 9-9

AT CUSTOM SOUND, we've spent more than two years developing the very best designed cabinet for housing stereo components. Before you invest in a rack or cabinet send 25¢ (stamps O.K.) for our color brochure. Custom Sound, 8460 Marsh Road, Algonac, Mich. 48001. (313) 794-5400.

AUDIONICS -BERNING

We have in stock the CC-2, the NEW IMPROVED BT-2 and the INCREDIBLE BERNING BA-150. Free shipping. Visa & M.C. honored. By appt. OXFORD AUDIO CONSULTANTS, P.O. Box 145, Oxford, OH 45056. 513-523-3985.

AT LAST! H-END AUDIO AT LOW LOW PRICES!

Thru a unique mail order arrangement, DIRECT DISCOUNTS LTD., can now offer you many of the finest audio components at unbelievable prices. We feature ACCUTRAC, ADC, AIWA, ALLISON, ALTEC, AUDIO PULSE, BOSE, CIZEK, CM LABS, DBX, DUAL, ESS, HAFNER, H/K (incl. Citation series), KOSS, LUXMAN, MICRO SEIKI, SAE, TECHNICS PRO, VISONIK, and many more! We also handle several esoteric lines that we can't mention by name. However, we can quote prices over the phone. In car stereo we feature BLAUPUNKT, EPI, FOSGATE, and the new JENSEN car receivers. And, of course, direct to disk and digital recordings to complement any fine system. Although our prices speak for themselves, we look forward to discussing your individual audio needs. Please call us at 212-254-3125 or send \$2.00 for our brochure (refund from 1st purchase) to: DIRECT DISCOUNTS LTD., P.O. Box 841, COOPER STATION, NY 10003. For your convenience we accept most major credit cards and generally ship w/in 48 hours. TF

AT PARAGON OF SOUND: New and superb Conrad-Johnson tube amp and Berning FT10 tube-transistor and the Precision Fidelity C-4 preamps. In speakers: the new Snell Acoustic, the MZ MOD3, Rogers LS3/5A, and Acoustic Concept AC-24; M & K and Fundamental Research Subwoofers. Armstrong 624 FM Tuner; Berning Stereo 20 amp. S.T.D. Turntable, Hadcock tonearm. Denon, Grace, Supex, and Dynavector products. Call 301-229-2676 (Bethesda, MD) or write P.O. Box 189, Cabin John, MD. 20731 7-9

AT 15Sa, New in box, \$78. 516-623-3059. 9-9

AUDIO ALTERNATIVE — A unique Specialty Shop Prompt, knowledgeable, friendly, reliable service. SASE mail inquiries welcome for product profile and advantageous prices. Pre-paid shipping Cont. USA Mastercharge - Visa. Audio Alternative, 1124 East Elizabeth, Fort Collins, Colorado 80524. 10-9

The SYN-AUD-CON PT-1

At long last an effective, economical absolute polarity tester for those who know the difference between polarity and phase. Tests both acoustical transducers and electronic circuits.

The type of fundamental problem solver you would expect from SYN-AUD-CON. Full instructions each unit \$250 each.

Synergetic Audio Concepts
P.O. Box 1134
Tustin, CA 92680
(714) 838-2288

FOR SALE

ATTENTION DCM TIME WINDOW OWNERS

We now offer a convenient and attractive way to improve the sound of your speakers. The DCM Time Window, when raised 9 inches off the ground, has an arier and tighter sound: the image is raised and standing waves reduced.

THE DCM TIME WINDOW PEDESTALS are made of heavy duty wrought iron and suit the shape and appearance of the Time Window perfectly. They sell for \$65. per pair. If there is no dealer nearby, order postpaid (Master Charge & Visa accepted) from

R. S. PARK AUDIO ASSOCIATES
5 SUNRISE PLAZA, VALLEY STREAM, NY 11581
(516) 561-7555
DEALER INQUIRIES INVITED

ATTENTION PRECISION FIDELITY OWNERS: Have your C4 updated to a C4-A by the designer of the circuit. \$70 exclusive of shipping. Phone 408-255-8585 for scheduling. 9-9

Audio and TV tubes factory boxed, speakers, semiconductors—low prices, free price list. Transisletronic Inc., 1365-39th St. Brooklyn, N.Y. 11218 212-633-2800 TF

AUDIO BARGAINS — FREE LIST. Closeout/bankruptcy specials. SCC, Box 8014 (A-79), Canton, Ohio 44711. TF

AUDIO CAN MAKE MONEY FOR YOU! Sell Equipment at your college. No investment; experienced saleshelp and incentive programs provided. Audio Outlet, Inc., 10 Commerce Ct., Newark, NJ 07102. 201-622-3250.

FOR SALE

AUDIO DEN AND POLK AUDIO

The Audio Den is proud to have on display and demonstration the amazing Polk Audio Monitor Series. Our customers say "Fantastic! Compares with the finest loudspeakers I have heard. Probably the best value in the history of Audio!!!" Audiogram®, from the Audio Advisor said, "We were so impressed that we could not believe the prices . . . Other \$200 speakers simply do not come close to the standards set by the Model 10 . . . And at their price, they are simply a steal." Come in for an audition or write us for information on Polk or our other state-of-the-art products. Polk is shipped free in the continental U.S. Audio Den Ltd. 1320-34 Stony Brook Rd., Stony Brook L.I., N.Y. 11790, 516-751-3350. TF

AUDIO RESEARCH SP-3B, \$470 Mod. to ARC SP3A-1 by ARC. Near SP-6 performance with tone controls. Perfect. \$800 Firm. (612) 388-4683. 9-9

The *only* place
in the country
where you can buy

KOSS
Model II ELS

**eakin
audio**

6403 Roosevelt Way NE
Seattle, WA 98115
(206) 525-0200

BRING THE BEAST OUT OF YOUR SYSTEM

MONSTER CABLE™

HEAR THE DIFFERENCE
at better audio specialists
everywhere

- Improves damping factor for tighter bass
- Extends dynamic range
- Increases clarity and definition
- Safe with all amplifiers and receivers

MONSTER CABLE is available
in convenient pre-cut and
terminated stereo pairs or
custom cut to your
requirements.



Over 500 strands of copper in a unique rope-laid configuration. Low resistance, low capacitance, low inductance. Extremely fine stranding for reduced "skin effect."

MADE IN U.S.A.

THE MONSTER CABLE CO. 101 Townsend St. San Francisco, Ca 94107 (415)777-1355

FOR SALE

AUDIO DEN LTD.

Long Island's leading audio store has on demonstration,

THE STATE OF THE ART

AUDIO RESEARCH ELECTRONICS

(THE NEW SP6 TUBE PREAMP)

THE NEW ACOUSTAT MONITORS

EMT & GREADO SIGNATURE CARTRIDGES

(AUDIO CRAFT) ULTRA CRAFT UNI-PIVOT TONEARM

We also have the following lines, B&O, Chartwell and new Chartwell woofer, CM, Denon, Fulton, Grace, Koss, Luxman, Magneplaner (including Tympani series), M&K woofers, Nakamichi, Polk, (Quad ESL and electronics), Rappaport, Rogers, RTR, Sonus, Thorens, Yamaha, largest selection of direct discs on Long Island.

FREE INSTALLATION IN NEW YORK AREA

WITH IVIE SPECTRUM ANALYZER.

ALL GOODS SHIPPED PREPAID AND INSURED — COME SEE THE WORLD'S FINEST RECORD CLEANING MACHINE BY KEITH MONKS.

AUDIO DEN LTD.

1320-34 Stony Brook Road

Stony Brook, New York 11790

516-751-3350

TF

FOR SALE

AUDIO HOUSE — FLINT MICHIGAN

Mordant - Short Sound Concepts Watson Labs

Audionics Rogers Symmetry

Linn Sondek Conrad-Johnson Theta

Bryston Marcof M & K

Keith Monks Record Sleeves 100 for \$20. Sample \$1.00.

4304 Brayan Dr., Swartz Creek, Michigan 48473 313-732-

4670 by Appointment. TF

AUDIO LTD

In Central Illinois

Bringing you the finest in stereo components:

Audio Research KEF Quad

David Hafler GAS Grace

Chartwell IMF Marcof

Symmetry SME Rogers

Supex DB Tangent

and more. 115 N. Walnut, Champaign 61820

(359-3774)

11-0

AUDIOPHILES! Direct-Disc, Digital, Mobil Fidelity-All labels-
Low Prices Fast Service. Write for free catalog. Direct Disc
Discounters, 2245 New Hope Church Rd., Raleigh, NC
27604. 9-9

AUDIOPHILES' HIGH FIDELITY COMPONENTS!

Bose, Tandberg, Revox, Nakamichi, Yamaha, ADS,
Denon, Allison, Hafler, B&O, Ohm, GAS, Genesis, Rog-
ers, Crown, Lux, Infinity, Advent, SAE, Nikko, others.
Low, Low Prices! **AUDIO AMERICA** (Virginia) 804-793-
3820. Hours: 10 am - 6 pm. Call today for Low Prices!

AUDIO PULSE ONE — \$450.00 — will take 24" or 18"
Hartley as part trade — TEAC — 860 Deck — \$900.00,
Marantz 3600 + 250 amp. Offers (616) 457-5149 between 2
and 8 pm. Grand Rapids, MI. 9-9

AUDIO REPORT

STAN WHITE Glasacone™ Speaker

AUDIO Magazine (Germany 2/78) reports on Stan White
SHOTGLASS loudspeaker, "Er klingt so als ob ein im
Halbdunkel spielendes Orchester poltlich von starken
SCHEINWERFERN beleuchtet wurde, so dass jeder Mann
mit seinen Instrument poltlich sichtbar wird." For further in-
formation write TACHYON, P.O. Box 204, Bloomingdale, Ill.
60109 Sole U.S.A. distributor. 312-529-9468.

FOR SALE

AUDIO RESEARCH D-110 \$1850.00 702-293-4795. 10-7

BEAUTIFUL MOPED MOTOR-BIKE In crate to-you. BIG SAV-
INGS. E.J. Sales, Box AM 3084, Centerline, Michigan 48015.

BEVERIDGE 2SW-1 electrostatic system, mint condition, 6
months old-\$5000/Mark Levinson JC-2 with A, A3, & D pho-
no cards, ML-1 pwr supply filter, oak cabinet, mint - \$550/
Call 912-746-0037 between 6 & 11 pm EST (GA). 10-9

**BIASED — THE ONLY UNDERGROUND HI-FI MAGA-
ZINE THAT WILL ACCEPT BRIBES** (and admits it). Is-
sue 2 is now ready. Send a self addressed stamped en-
velope for your FREE copy. In this issue: the new small Linn
Isobarik Speaker, new electronics from Maim, a no-cost
improvement to your system, a list of all the manufactur-
ers that have offered us bribes, a list of the ones we
accepted, and more, including the second annual FUBAR
award for overly creative advertising. **AUDIOPHILE SYS-
TEMS**, 5750 RYMARK COURT, INDIANAPOLIS, IN
46250. 11-9

BIG, SAFE, TWISTED #12 GAUGE SPEAKER WIRE 40¢
per FT. COD O.K. Free Shipping 100 Ft. or more. Keith Monks
Record Sleeves 100 for \$20. Samples \$1.00. Audio House,
4304 Brayan Dr., Swartz Creek, Mich. 48473 313-732-4670.
TF

B & O USES "ANY" CARTRIDGE with standard mounting
centers after our modification kit or at factory. Effective mass
2.5 grams. Adjustable silicone damping. \$199.00 with money
back guarantee. JML Company, 39,000 Highway 128, Clover-
dale, CA 95425. TF

BURWEN DNF 1201. Mint. \$250. (415) 341-3075. 9-9

CARTRIDGES UP TO 70% OFF!!

DIRECT DISCOUNTS LTD. is now fully stocked with top-rated
phono cartridges at unbelievable prices. We feature ACUTEX,
ADC, DYNVECTOR, EMPIRE, GRADO, MICRO ACOUSTICS,
ORTOFON, PICKERING, SHURE, SONUS, STANTON, et al.
Specials this month include: ADC XLM Mk. III-49.95; DYNA-
VECTOR 10X-89.95; GRADO F3E+27.95; SONUS BLUE
(gold) -89.95. All fact. fresh w/manuf. warranty. We also han-
dle several esoteric pick-ups at competitive prices. Please call
us at 212-254-3125 for more information or write to: **DIRECT
DISCOUNTS LTD.**, P.O. Box 841, COOPER STATION, NY
10003. TF

**CASH IN ON DISCO: BEAT INFLATION START YOUR OWN
BUSINESS NOW! CONVERT AN OLD BAR/RESTAURANT
INTO A DISCO. SEND \$12.50 FOR COMPLETE, INDEPTH
MANUAL EXPLAINING DISCO SOUND AND LIGHTING SYS-
TEMS TO L'AVENTURE DISCOTHEQUE, UNION STATION,
P.O. BOX 702, DEPT. A1, ENDICOTT, NY 13760. tf**

CHARLOTTE, NC

AUDIO SALON: Audio sales in a real environment.

PS Audio Hafler

Decca SME

Thorens VA Systems

Fried Speakers

227 Greenway Ave., 28204; (704) 377-6590.

By appointment only. Shipped pre-paid.

NEW ENGLAND AUDIOPHILES Goodwin's Inc. is
unique in the audio field, offering a few select products
which are acknowledged to be the finest. These prod-
ucts are properly set-up, and may be auditioned in a
comfortable, relaxed, living room environment.

Our reference is the Mark Levinson HQD system, with
30ips master tapes played on a Mark Levinson Studer
A-80. The degree to which this system approaches the
sound of live music is literally breathtaking.

Goodwin's represents: Mark Levinson, Quad, Linn Son-
dek, Syrinx, Verion, Draco, Symdex, Precedent Audio,
Fidelity Research, Pedersen Acoustics, and Win Labs.

If you would like to avoid the planned obsolescence of
most stereo components, and are interested in the finest
music reproduction, please call Goodwin's for an
appointment.

Goodwin's Inc.
(617) 266-0608

33 Newbury St.
Boston, MA 02116

... vintage COOK

Certain of the landmark rec-
ords are being re-mastered by
Emory Cook himself, straight & un-
processed, from the original tapes,
on new, in-house designed electron-
ics. The result is great and historic
sound. Write for list. Your sugges-
tions of preference will be welcome.

COOK LABORATORIES, INC.
P.O. Box 529, Norwalk, CT 06954

SUPERIOR AUDIO COMPONENTS: Audio Pulse; Audio Research SP-6 tube preamp and D-110
amp; Badap 1; Celestion; Cizek; Crown Distinction Series DL-2, SA-2, and EQ-2; Dayton Wright;
dbx; Decca; Denon; Dynavector; EMT; Formula 4; Grace; Hafler kits; KEF; Kenwood Purist; Lux
LRS; Magneplanar; Mitsubishi; Mobile Fidelity records; Nakamichi; Plasmatronics; Polk; RTR;
Verion; Watson speakers.



233 East Lancaster Avenue, Wynnewood, Pa. 19096.
(215) 667-3048 or 649-2965.



GARLAND AUDIO, INC.

**WHERE ONLY THE FINEST
IS GOOD ENOUGH**

**AUDIO RESEARCH
MAGNEPLANAR
LUXMAN
DENON
GALE
F.M.I.**

**B & W
ROGERS
NAKAMICHI
MITCH COTTER
FIDELITY RESEARCH
R.H. LABORATORY**

**MARK LEVINSON
SEQUERRA
QUATRE
GRACE
QUAD
G.A.S.**

Call or write for a **FREE** subscription to our quarterly newsletter!

GARLAND AUDIO

2960 Stevens Creek Blvd. • San Jose • (408) 244-6724

Tues/Thurs, 11-8 — Wed/Fri, 11-6 — Sat, 10-5 — and by appointment—

FOR SALE

TURN-ON THUMPS AND NOISE? Send 50¢ for literature on our Suppressor. Huntington Electronics, Box 2009-A, Huntington, Conn. 06484.

U.S. AUDIOPHILES REJOICE! The KOETSU moving coil cartridge is now available. For more information write: Sumiko, Inc., P.O. Box 5046 Berkeley, CA 94705. 12-9

VACUUM TUBES, tube-peculiar parts. All kits/parts for circuits described in our 230+ page Modification Manual. Write for list to AUDIO DIMENSIONS, 8888 Clairemont Mesa Blvd., San Diego, CA 92123. (714) 278-3310. 9-0

Wisconsin Has: Audionics, Denon, Luxman, Hafler, Polk, Mayware, STAX, Micro-Acoustics, Connoisseur, Nagatronics, Aiwa, Hitachi, Kenwood. Lit. and prices on request: The Sound Seller, 1706 Main St., Marinette, WI 54143 715-735-9002.

"With our Acoustic Suspension Design portfolio anyone can design professional grade woofer systems, easily, without guesswork, and accurately! Any woofer can be used. Sample designs of a subwoofer, mini monitor, and bookshelf speaker system included. Only \$12.95. It could save you hundreds. . . ."

Light and Sound Design

90 Riverside Drive
New York, NY 10024"

10-9

WORLD AUDIO WESTCHESTER, INC.

Westchester's finest audio sales and service dealer is proud to announce the addition of:

Fried Loudspeakers

to the already fine lines of AR, AKG, ADC, Pro-Accutrac, Quanta, CM Labs, Celestion, Decca, Direct-Disc, Discwasher, J.V.C., J.V.C. Pro., Kos, Lux, L.S.S., Maxell, Panasonite, Pickering, Qysonic Array, Rotel, Scott, Sennheiser, Soundcraftsman, Sound Source, Stanton, Supex, Thoren, Tandberg, TDK. Shipping is free in continental U.S.

WORLD AUDIO WESTCHESTER, INC.

211 North Avenue
New Rochelle, NY 10801
914-576-3230

2-0

YAMAHA CR — 2020, FULL FACTORY WARRANTY, 5 MONTHS OLD, PERFECT CONDITION, \$650. (202) 483-3436 AFTER 7 PM. 9-9

YAMAHA CR2020 STEREO RECEIVER \$650. Mint Condition. Call 717-961-0882 5 to 7 pm EST. Ask for Dave. 9-9

YAMAHA C-2 PREAMP MINT CONDITION. \$395. (614) 451-1890 or (614) 261-2446.

YOUR SONG professionally recorded Vegas artists. Girl plus three. Send lead sheet, \$30. Vegas Demos, Dept. A, Box 1321, Las Vegas, NV 89101.

3600' New L/N Scotch or Ampex tape, 10½" metal reels 5 for \$38.00 12 New Ampex 42 min. 8 Tracks \$9.00. 6 New Ampex 370 C-60 cassettes in Stackette \$5.50. C-90 \$6.50. Sound, Peachtree DeKalb Airport, Chamblee, Ga. 30341

TUBES — GENALEX, TELEFUNKEN, — for audiophiles who demand premium quality European replacements for Audio Research, Conrad-Johnson, Dyna, LUX, Paragon, Marantz, McIntosh and other tubed preamps, amps and tuners.

Just a few popular types include:

	Matched Pcs.	Each
GENALEX: KT88/6550	\$67.00	\$29.50
TELEFUNKEN: ECC83/12AX7		\$4.95
ECC82/12AU7		\$4.95
EL34/6CA7	\$23.95	\$10.95

Quotes provided on request for other than advertised tubes. Save 10% and get a complete Retube Kit for any specific unit. Now! HARTLEY 7", 10", 18", 24" drivers and complete systems. Send orders and inquiries to: SOUND SERVICES, Lake Walton Road, Wappingers Falls, NY, 12590. Telephone: 914-226-5414. TF

CROWN DISCOA AMP, IC 150 PREAMP. Mint. Original boxes, Manuals. \$550 for both. Walnut cases \$50. 9-9



Tune in to:

AUDIO CLASSIFIED

No Static

No Distortion

Plenty of Results

109

CHARTWELL THE SPEAKERS THAT LOOK AS GOOD AS THEY SOUND

Introducing the FIRST full range of Monitor Speakers Featuring Polypropylene cones.

ADVANTAGES OF THESE CONES:

- Less Coloration
- Less Distortion
- Smoother Frequency Response
- Lower Mass - Improving Transients
- More Efficient
- Consistent Acoustic Performance

Add all these benefits together with careful design and the result is . . . Pure Music

Don't take our word for it, hear the full range yourself, from the mini to the professional studio monitor.

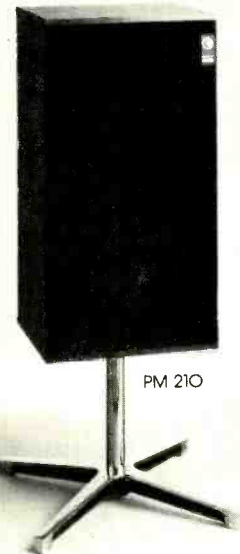

Reference Monitor Int. Inc., 2380 "C" Camino Vida Roble, Carlsbad, CA 92008

FOR SALE

CIRCUIT BOARDS AND PARTS for M. Leach's Low TIM 3 Amplifier; FET Wide Bandwidth Phono, Tape, or Microphone Preamplifiers; Moving Coil Pickup Pre-Preamp; and Amplifier Strapping Circuit. Send stamped envelope for prices. Custom Components, P.O. Box 33193, Decatur, GA 30033. 11-9

CITATION 16 \$410, CITATION 11 \$210, AR-5 spkrs. & MA-1 twtrs. \$250, Dynaco FM-5 \$50. 302-368-9854. 9-9

CLASSICAL EQUIPMENT SALE

McIntosh A116's, C8's, Marantz 1's Fisher 50A's, SA 300, H.H. Scott 250's, 290, 265A, 122, 121, 299D, Langevin 101D's, Altec Theater Amps, Karg, Quad, Radiocraftsman, Ampex spkr/amps, J.B.L. SA 600, H-K Cit A, Mattes SSP 200. More. 213-784-3904 after 7 p.m. 9-9

the audio advocate

SME
POLK
LS35A
SHURE
DECCA
CIZEK
DENON
ONKYO
QUATRE
ADVENT
ARISTON
ACOUSTAT
MAGNEPAN
FORMULA-4
NAKAMICHI
AUDIO RESEARCH

505 Millburn Avenue Millburn, NJ
(201) 467-8988

FOR SALE

COLLEGE STUDENTS nationwide interested in selling Hi-Fi on campus for a significant profit and would desire a reliable stereo wholesale supplier and further pertinent information should contact: The Sound Outlet, 35 Whitfield Road, Somerville, Mass. 02144 for immediate response. 9-9

COMPLETE SET AUDIO OR WILL CONTRIBUTE to library for T/L. Also complete High Fidelity. Box c/o Audio, 401 N. Broad St., Phila., PA 19108. 9-9

CONNECTICUT: A.D.S., Advent, A.P.T. Holman Audio Pulse, B&O, B.I.C., Carver, Citation, Dahlquist, D.C.M. Time Windows Epicure, Hafler Harman/Kardon, J.B.L., Mitsubishi, Nakamichi, Ortofon, Phase Linear, Micro-Acoustics, N.A.D., Stax, Tandberg, Yamaha, Cizek, Sonus. Will ship prepaid. Sounds Incredible, 39 Federal Road, Brookfield, CT., 06804, (203) 775-1122—phone quotes only. TF

CONNOISSEUR BD1 TURNTABLE Belt Drive, 37 logged hours. w/mtg hole for Grace 707. \$75 408-279-1425, 259-9648.

CRITICAL LISTENERS AGREE FULTON MOVING-COIL CARTRIDGE

is closest to the musical experience. Ultimate care in design and manufacture. Write for tech papers and review reprints on complete FULTON line. MEDWIN AUDIO 11400 Rochester Ave. (W) Los Angeles, CA 9-9

FORMULA 4 MC-2C MOVING COIL CARTRIDGE The best transducer only \$85 incl. Airmail. Literature \$1 Bill. Dealer Enquiries invited. Mayware Ltd., 15 Heather Walk, Edgeware, Middx. England. 2-0

FOR SALE

DAVID HAFLER IS BACK!

The man behind the original Dynakit is back with his own company and a new state-of-the-art preamplifier at a bargain price! Available as a KIT or CUSTOM ASSEMBLED by expertly trained wireers — each performance certified. For further details write or call AUDIOKIT—260 Old Country Road, Hicksville, N.Y. 11801 (516) 822-5749

DAVID HAFLER PREAMP

Now available at Audio Ltd.
115 N. Walnut, Champaign, IL 61820 (217) 359-3774

4-9

DCM TIME WINDOWS \$495 pair; Audio Research SP4A preamp \$450; Nakamichi 430 Tuner w/case \$350; Tandberg 6000X tape deck \$225. E. Church, 9010 Harford Rd., Baltimore, MD 21234. 9-9

DEALER COST: Visonik Sub-1 subwoofer, pair Visonik David 502's, & pair Audioanalyst Phase Matrix M6's. Call (704) 377-6590. 9-9

DEMO AND TRADE-IN CLEARANCE. DEMO units (new warranty): Threshold NS-10 preamp \$675; GAS Thalia \$299, Thoebe \$399, Thaedra II \$679, GAS Bridge \$85; Pioneer TX-6700 tuner \$150; Nakamichi 420 power amp \$265; Cizek II speakers (new version) \$240/pr.; Fried Q speakers \$210/pr. TRADE-ins (30 day warranty): DB preamp w/power supply \$300; Threshold NS-10 preamp \$650. Freight and ins. prepaid within cont. U.S. Audio Concepts, 2200 Southwest Freeway, Houston, TX., 77098. (713) 527-0774. 11-9

DESIGN ACOUSTICS DEMONSTRATED NEW YORK AND NEW JERSEY

All Models in Stock
Phone your "MUSIC MAN" for demo appointment
212-463-1208 OR 516-621-2126
Custom Audio Systems Designed and Installed

DIAMOND NEEDLES and Stereo Cartridges at Discount prices for Shure, Pickering, Stanton, Empire, Grado, Audio Technica and ADC. Send for free catalog. LYLE CARTRIDGES, Dept. A, Box 69, Kensington Station, Brooklyn New York 11218. For fast service call toll free 800-221-0906. TF

Does your cartridge have TQA? The Supex SD-900/E+ Super and SD-901/E+ Super moving coil cartridges do. If your cartridge does not have TQA you may be paying too much for too little. What is TQA? Total Quality Assurance and each and every Supex moving coil cartridge has it. For complete information on TQA and Supex moving coil cartridges, see your local Supex dealer or write to: Sumiko, Inc., P. O. Box 5046, Berkeley, CA 94705.

DOLBY ENCODER/DECODER now available assembled, or as kit. Comprehensive review. AGA INTEGREGX, Box 747, Havertown, PA 19083 9-9

Don't Buy Video Cassettes - Rent! Free details: Video A, Box 2046, NY 10017. 9-9

SALE SALE SALE SALE SALE SALE

Here is a tremendous opportunity for the audiophile to obtain SOTA components at great savings. All items have new warranties and are sold fob Oxford. Bracketed prices are list. DEMO: Audionics BT-2 (444) 330, Denon DP-3000 (415) 300, Lecson AC-1 (595) 400, Lecson AP-3 (595) 400. NEW: Denon DP-3500 (600) 450. OXFORD AUDIO CONSULTANTS, Box 145, Oxford, OH 45056 513-523-3895. Open eve. & weekends too.



Audio Res'ch	Grace	Platter Pad
Advent	Grado Sig.	Polk Audio
ADS	Hafler	Quatre
Denon	Hiroka Mat	Rega
Dynavector	Kenwood	Revox
Electro Res'ch	LinnSondek	Rogers
E.M.T.	Magneplanar	Setton
FMI (Fulton)	Milch Cotter	Shure/SME
G.A.S.	Nakamichi	Signet
		Sonus
		Stax
		Technics
		Ulfracraft
		Wintec

2858 W. Market St., Akron, Ohio 44313 Phone (216) 864-4411

AMERICAN AUDIOPHILE FOR

- FINEST STATE OF THE ART AUDIO COMPONENTS
- PRIVATE DEMONSTRATIONS
- INTIMATE ATMOSPHERE

WE FEATURE:

AUDIONICS
AUDIO INNOVATIONS
AUDIO STANDARDS
AUDIO TECHNOLOGY

AXIOM
BEDINI
CIZEK
DCM
DECCA
DENON
HADCOCK
HAFLER
H.A.P.I.
IMPULSE
IVIE
JANIS
LUSTRE

MARCOF
NAD
NEXUS
PRECISION FIDELITY
PREMIER
RAPPAPORT
SERIES 20
SHURE
SIGNET
SME
STAX
STD
SUPEX
TANGENT
VANDERSTEEN
VPI
WIN LABORATORIES

REFERENCE AUDIOPHILE RECORDINGS

AMERICAN AUDIOPHILE

5 Sunrise Plaza
Valley Stream, NY 11581
(516) 561-7114

716 Madison Ave.
New York, NY 10021
(212) 751-9733

ALL SHIPMENTS PREPAID AND INSURED
FREE THROUGHOUT CONTINENTAL U.S.



MASTER CHARGE & VISA ACCEPTED



FOR SALE

DYNA ST70	\$125
PR. RTR ESL 6 TWT.	\$250
DYNA 400 AMP	\$400
SERIES 20 D23 XOVER	\$500
SERIES 20 M22 AMP	\$400
SOUND CONCEPTS SD550	\$500
TIME DELAY APT PREAMP	\$425
PR. CUSTOM TRANSLINE B-139 WOOFERS	\$300
DAVIS BRINTON PREAMP	\$125
617-254-0697	9-9

ELECTRONIC CROSSOVERS — ALL TYPES Updated definitive booklet describes applications, how to improve speaker systems; \$5.00 postpaid, credited to first purchase. Huntington Electronics, Box 2009-A Huntington, Conn. 06484.

ELECTROSTATIC TRANSLATORS ARE HERE

Come and audition this fine new line of electrostatic loudspeakers along with: Audire, Audio Technology, Celestion, Clarke, Decca, Grado, Braun Satellites and subwoofer etc. . . .

PERSONALIZED AUDIO

723 Bound Brook Rd., Dunellen, NJ 08812
Appointments available call 201-752-3883

EQUALIZATION TEST RECORD Octave bands of pink noise on 7" EP. \$2.00 postpaid. Crosswind Records, Shrewsbury, Pa. 17361

ESOTERIC DOES DISCOUNT! Virtually every type of high-end equipment, incl. British speakers, European turntables, Am. & Japanese amps, preamps, & cart. At prices substantially below retail. Audio World, 616-241-2994. Ship anywhere. Visa & Mastercharge. 9-9

FANTASTIC SAVINGS! ON "ELECTRO-VOICE" DRIVERS & SYSTEMS. WRITE FOR LISTING — SAS. SYST. Box 536 SILVER LAKE WIS. 53170. 11-9

HAFLER: PREAMP, HEAD AMP, AMP & ACCESSORIES

We have in stock the DH-101K \$199.95, DH-101A \$295.95, DH-102 head amp \$74.95, DH-103 black knobs \$19.95, DH-104 rack mount kit \$24.95, DH-105 preamp cabinet \$24.95 & DH-101A with DH-102 installed \$375. We anticipate having the DH-200K \$299.95 & DH-200A \$399.95 amps by June 15, 1979. World-wide shipping. Free shipping in the US. Visa and M.C. honored. Demo. by appt. OXFORD AUDIO CONSULTANTS, POBox 145, Oxford, OH 45056, 513-523-3895. Also open evenings & weekends.

DUAL MONO TUBE PREAMPLIFIER. From the designer of the Precision Fidelity and Paragon preamps comes the latest in tube technology. For more information on this amazing product write to: Audio Illusions, P.O. Box 8707, San Jose, CA 95155. 9-9

DYNACO/DYNAKIT: SCA-80Q/K, \$97; PAT-5/A, \$177; ST-80/K, \$67; PAT 4/K, \$64. POSTPAID (U.S. only). Certified check/mo, SCC, Box 8014, Canton, Ohio 44711. TF

Syn-Aud-Con PZM System

Send \$1 for Syn-Aud-Con's illustrated bulletin on Pressure Zone Microphony (PZM™). The technical bulletin describes the available models and discusses the fundamental principles behind the performance of these exceptional microphones.

PZM is believed to be the first major improvement in the classical microphone since the directional pattern principle was discovered in the 1930's. PZM is judged by their users to be without a peer for piano, orchestra, opera and other recording tasks where microphone coloration is not desired.

Synergetic Audio Concepts
P O Box 1134
Tustin, CA 92680
(714) 838-2288

FOR SALE

FREE SHIPPING & THE LOWEST PRICES

12 MAXELL UDXL I or II C-90 TAPES @ \$3.39 each (\$40.68 per carton)
10 TDK SA-90 tapes @ \$2.99 each (\$29.90 per carton)
DISCWASHER Brush & Fluid \$9.95
DISKIT - Includes brush, fluid, zerostat, SG1 Stylus cleaner and organizer \$32.75

This is just a sample of our extensive line of audiophile equipment . . . at prices everyone can afford. To place an order, send CERTIFIED CHECK OR MONEY ORDER and add NOTHING for shipping, handling and insurance to anywhere in the Continental United States. All tapes sold in cartons only. To obtain a brochure in our line of high end, name brands, and economic audio systems, just send your name and address to:

AUDIO SYSTEMS II
200 West 57th Street, Suite 1004
New York, N.Y. 10019

FRANK VAN ALSTINE MODIFICATIONS for Dynaco, Audio Research, Dahlquist, Paragon, and other audio components can be the most cost effective way for you to achieve State of the Art audio performance. Our FET-5 MARK 5 mod for the PAT-5 & PAT-5 BIFET will equal the performance of any preamp in existence. The DOUBLE 400 SERIES 2 is all new with vastly improved sound. It's new life for your St-400 or St-416. FREE MOD PLANS for the Dyna ST-70 and PAS with a large stamped envelope. Low cost updates for any units we have modified in the past. New power supply mods for the ARC SP3A.

Read the esoteric magazines, our mods work.
JENSENS STEREO SHOP 2202 RIVER HILLS DRIVE
BURNSVILLE, MINNESOTA 55337 612-890-3517 1-0

CONRAC FLEETWOOD 900 TV CHASSIS Magnecorder
6PT6 JAH Tape Deck. Best offer. 212-367-5472. 9-9

FOR SALE

FAMOUS 511B HORNS COPIED IN HEAVY NON-RESONANT PLASTIC. Better than aluminium horns. Excellent high definition midrange for disco or home use. Only \$69 UPS prepaid. 100 watt Rockwell drivers for horns \$69 UPS prepaid. Info and chatter \$2.00. Daily Mfg. Co., Rockwell, NC 28138. 10-9

FIDELITY RESEARCH: The Ultimate Phono reproducers!
S.Baird/Records Box 17947, Memphis, TN 38117. 11-9

G-B ELECTRONICS

Audition: Snell Acoustics, Symdex, Spondor, J. R., Threshold, Conrad-Johnson, Leach, Promethean, Denon, Grace, Hadcock, Linn-Sondek, S.T.D., Patter Pad, Audio Source, K. Monks, Weathers and others. Call for audition appointment (201) 427-8885. Serving Northern New Jersey Since 1945. Write: Box 385, Hawthorne, NJ 07507. 10-9

STEREO COMPONENT Video Tape Equipment

**AKAI • B-I-C • Harman Kardon
Phase Linear • ALTEC • Kenwood •
TEAC • Marantz • Sony • Technics •
Sanyo • JVC • JBL • Pioneer • Dual •
RCA** Photographic Equipment Too!
TO ORDER CALL TOLL FREE

(800) 421-8537

Henry's

CAMERA • HI-FI • VIDEO
516 W. 8th St. Downtown L.A., Ca. 90014 Tel. 488-0341

The transient perfect crossover!

Symmetry ACS-1

designed by John Curl

The only active crossover that has:

- ★ perfect phase response
- ★ continuously variable frequency 45-4500 HZ
- ★ unique Bessel/Butterworth filter design

Symmetry is proud to announce these recent additions to its dealer network:

Audio Lab
2204 Ingersoll
Des Moines, Iowa 50312

Golden Gramophone
2858 W. Market
Akron, OH 44313

Natural Sound
401 Worchester Rd.
Framingham, MA. 01701

Paragon Sound
4543 Monroe
Toledo, OH 43613

The Stereo Shoppe
805 N. Orchard
Boise, ID. 83704

Tin Ear
704 Symons
Richland, WA. 99352

For a complete dealer list and product information contact:

Symmetry

101 Townsend St., San Francisco, CA 94107 (415) 777-1113

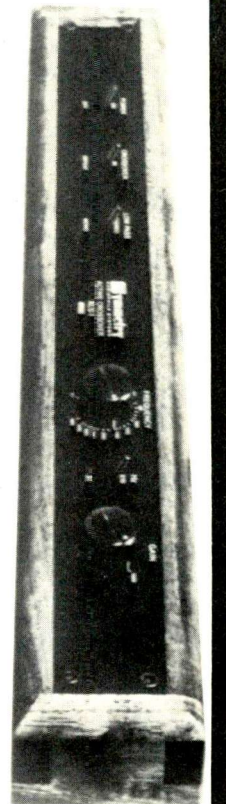

FOR SALE

WITH TRANSCENDENTAL AUDIO'S advanced raw speakers. Bextrene cone magnet, v.c. layer & lgth. options for most. D. tweeters, low mass alum. cone & ribbon sup. as, a fascinating new driver w/1.3 gms. moving mass that "traces" signal detail like the best electrostatic headphones, will definitely spoil you. Design & application assistance from our lab available to help you realize the dream system you are planning. Your inquiries & orders receive prompt attention. Send \$1 for literature to Transcendental Audio, 6550 Indiana St., Golden, CO. 80401. Innovative components & designs in high-end audio. 303/420/7356 Polydax, Decca, Jordan, Hartke, Sonic Developments. 11-9

GET INTO BROADCASTING! Learn how to receive free records, tapes, get an FCC broadcast license, start your own station. Free details. "Broadcasting", Box 130-N5, Paradise, CA 95969.

GRAPHIC EQUALIZER KIT FOR ONLY \$100 PPD. Twelve bands/channel, 100dB S/N. Free info or send \$2.50 for instruction manual with Len Feldman's review and copy of May 1978 Radio-Electronics cover story (Refundable with purchase). Symmetric Sound Systems, 1608 S. Douglas, Loveland, CO 80537.

HAFLER: AMP AND PREAMP
Audio Ltd 115 N. Walnut Champaign Il 61820 217-359-3774. 11-0

HAFLER HEADQUARTERS IN CANTON, OHIO - The Listening Room, 1807 Cleveland Ave. NW. (216) 452-6332. TF

HAFLER IN THE SOUTH!
In stock, the superb Hafler DH-101 preamp. Kit \$199, factory assembled \$299. New:DH-200 amp. Immediate free shipping. Also Fried, Audionics, more. READ BROS. STEREO, 593 King St., Charleston, S.C. 29403 (803) 723-7276. 7-9

FOR SALE

HAFLER DH-101 PREAMP
We expect to be in stock on this exciting new preamp by Dec. 12th. Kit price is \$199.95. Custom wired and tested, \$299.95. Immediate prepaid shipment by UPS. THE AUDIBLE DIFFERENCE, 435 Tasso, Palo Alto, California 94301. (415) 328-1081. TF

HAFLER PREAMP CABINETS. Literature. GEOMETRIX, Box 612, Mexico, MO 65265 7-9

HAFLER: PREAMP, HEAD AMP, AMP & ACCESSORIES
We have in stock the DH-101K \$199.95, DH-101A \$295.95, DH-102 head amp \$74.95, DH-103 black knobs \$19.95, DH-104 rack mount kit \$24.95, DH-105 preamp cabinet \$24.95 & DH-101A with DH-102 installed \$375. We anticipate having the DH-200K \$299.95 & DH-200A \$399.95 amps by June 15, 1979. World-wide shipping. Free shipping in the US. Visa and M.C. honored. Demo. by appt. OXFORD AUDIO CONSULTANTS, POBox 145, Oxford, OH 45056, 513-523-3895. Also open evenings & weekends.

HAFLER SCORES WITH 101!
David Hafler's triumphant return with his state-of-the-art DH 101. Available now in kit or assembled form at:
PERSONALIZED AUDIO
723 Bound Brook Road. Dunellen, New Jersey 08812 (201) 752-3883 4-9

HARTLEY 24 with 14 foot folded transmission line. (206) 857-6635.

HAVE AN AFFAIR

Listen to the PRECISION FIDELITY C7 tube preamplifier with innovative cascode circuitry. The real David against all the Goliaths. Let your ears as well as your pocketbook relax. State of the art affair at \$499.
PRECISION FIDELITY, 1169 E. CHESS DR., FOSTER CITY, CA, 94404 6-0

SCOTT 499, McIntosh MPX 5. 4 CH Integrated Amplifier. Resident 1365 North Avenue, New Rochelle, NY 10804.

TECHNICALLY PERFECT
on the test bench
MUSICALLY PERFECT
in your system

Introducing the remarkable
APT/HOLMAN preamplifier at
● **Audiocom**
177 Sound Beach Ave Greenwich, CT
(203) 637-3621

FOR SALE

HEATHKIT TV CABINET, GRA-602-25 for GR-2000 or 2001 TV's. \$150. NO SCRATCHES. 408-279-1425 day. 408-259-9648, evs.

HIFI ENTHUSIASTS WANTED!!! Earn more than just spare money in your spare time. We need campus representatives to sell name brand stereo components at discount prices in your area. No investment required. Serious inquiries only please. Contact: Mail Order Dept., K&L Sound Services Co., 75 N. Beacon St., Watertown, Mass. 02172 TF

HIGH-END AUDIO AT LOW LOW PRICES! Arwa, Allison, Audio Pulse, Bose, DBX, Cizek, ESS, Luxman, Micro Seiki, SAE, Technics Pro and many more! All factory fresh with full warranty. For discount price call 212-254-3125. Or send \$2.00 for our catalogue and price list to DIRECT DISCOUNTS LTD, P. O. Box 841, N.Y., NY 10003.

HIGHEST QUALITY USED EQUIPMENT: Nakamichi 700 II, \$800; Luxman 4000 amp, \$1000; Yamaha CR 2020, \$640; Nakamichi 410 preamp, \$250; Ortofon SL 15Emk II, cart., \$69; Lux CL 35 preamp, \$595; IMF Monitor mkIII \$700 ea; McIntosh MC 2100, \$450; McIntosh C28, \$425; Yamaha C2 preamp \$450, McIntosh C 26, \$280; Yamaha CR 3020, \$1100; AR 14 spkrs, \$100 ea, McIntosh MLC spkrs, \$250 ea., Yamaha NS 1000 M spkrs, \$850 pr.; Infinity 4000 spkrs, \$115 ea, JR 149 spkrs, \$150 ea.; Pioneer SX 950, \$300; ESS AMT Monitors, \$270 ea.; JBL L100, \$185 ea.; McIntosh MC 2505, \$330; McIntosh MA 6100, \$450; Audio Research SP3, \$360; Quad 303 pre-amp, \$175; Genesis III spkr, \$360 pr. Genesis II oak spkrs, \$220 pr; Luxman L 100 Amp, \$550; Thorens TD 145II tt, \$200; Audio Pulse Model 1, \$500; SAE MK VI B Tuner, \$650; Harman/Kardon Citation 11, \$200, AR Receiver, \$200; Marantz 3300 preamp, \$200; Marantz 3600 preamp, \$270; Marantz 4300 rcvr, \$365; Luxman PD 272 turntable, \$250; B&O 3000 tt.210.
All used equipment guaranteed 90 days parts & labor. Audio Consultants, Inc. 517 Davis St., Evanston, IL. 60201, (312) 864-9565. 9-9

How is it that the inefficient, noisy, distortion prone, archaic vacuum tube can retain any acceptance among serious audiophiles? Why do manufacturers, large & small still expend enormous creative energy in designing and making tube equipment? Who cares? We do . . . MR. AUDIO'S BIMONTHLY expounds the gospel of tube equipment but not at the exclusion of all else. We concede to permit solid state MC head amps, xovers, bass amps & the like in a music system. The tenacity with which tubes cling in spite of advanced solid state technology is a mystery to some — but not to us. MR. AUDIO'S BIMONTHLY — 6 issues 1st class \$15. Overseas \$18 — P.O. Box 3022, Monterey, Ca. 93940.

STOCK CLEARANCE

REVOX. OTARI, TECHNICS & OTHER—Recorders, Mixers, Headphones, Mics, Pre & Power Amps, Speakers, etc. Lists from ENTERTAINMENT SOUND SERVICES INC., P.O. Box 66, Madison, Alabama, 35758, (205) 772-0251.

112

**Go, Screw & Save
YES, KITS!**

Choose from The World's Finest Selection of Speaker Kits including **FRIED, DALESFORD EXPORT, JANSZEN ELECTROSTATS & SEAS.**

Here's just one example:

DALESFORD EXPORT SYSTEM 210 H

\$185 each
complete kit
(\$275 ea. if pre-assembled)



Dalesford low-coloration Bextrene drivers are world-renowned and used in many highly praised systems. The System 210 H uses the Dalesford 10" Bextrene bass/mid unit combined with the famous 1" Audax low mass soft dome tweeter. Response is ±3 dB from 40 Hz to 20 KHz. An advanced multi-element compensating crossover is used and the specially-designed enclosure is damped with bituminous felt and Australian long-fiber wool. Power handling: 20-100 Watts RMS/Ch. Specs & Prices subject to change without notice.

No matter how good your other components, you won't hear high definition sound if your speakers can't reproduce it!

FREE MINI-CATALOG—OR SEND \$1.50 FOR NEW SPEAKER MANUAL/COMPLETE CATALOG
(\$1.50 Refunded with Purchase)

SoniKit "The Speaker Specialists" 1173V -65th Street Oakland, CA 94608

Please send me my free mini-catalog
 Here's my \$1.50 check—send my Spkr Manual/Catalog A14

Name _____
Address _____
City _____ State _____ Zip _____

In today's ever changing field of audio there exists a storm of hype and confusion. By adhering to certain guidelines we have clearly found our calm in the eye of the storm. Honesty, integrity, and expertise have helped us to create a unique audio environment that is indeed professional in the true sense of the word. The lines we represent speak for themselves

- Audio Research
- Vandersteen
- Linn Sondek
- Theta
- Dahlquist
- Audire
- B & W
- KEF
- Dayton Wright
- Denon
- Grace
- Grado Signature



- Pyramid
- Promethean
- GAS
- Dynavector
- EMT
- Marcof
- Nakamichi
- Luxman
- Bang & Olufsen
- RH Labs
- Yamaha
- Advent

We ship prepaid throughout the U.S. (714) 897-0166
15102 Bolsa Chica Suite A Huntington Beach, CA. 92649
Store Hours - Mon. thru Fri. 1:00-9:00 Sat. 10:30-5:00 Sun. 12:30-5:00

FOR SALE

HAVING TROUBLE FINDING DIRECT-TO-DISC AND SOTA RECORDINGS? WE HAVE THEM ALL. SEND FOR FREE CATALOGUE. KNOT SO CHEAP RECORDS, 705 BIG BEND, DEPT. AM12, WEBSTER GROVES, MO 63119.

INSIDERS know that **AUDIO FORUM MAGAZINE** provides the most extensive coverage of the esoteric audio market ... Do YOU!? Audio Professionals know how AFM helps them to keep in touch with the ever-changing audio market with vital information often exclusive, always first, months before the others. Audiophiles like the first reports on new equipment, ways to improve their systems, and increasing their understanding of some of audio's most complex and controversial topics. You should subscribe today. Send \$18 (1st class) or \$22 U.S. (overseas air) for six bi-monthly issues to AFM, Box 22544 A-5, Portland OR 97222. BAC/MC honored. Full **MON- EY BACK GUARANTEE** if not satisfied.

INVISIBLE HANGERS for ADS, Braun, Visonik/David speakers. Pair \$12.00, \$1.00 postage. Plexiforms, 1016 1/2 Gilbert Court, Iowa City, IA. 52240

JBL AND GAUSS SPEAKER WARRANTY CENTER. Full lines stocked. Instant Recone Service, compression driver **DI-APHRAMS FOR IMMEDIATE SHIPMENT.** Newcome Sound, 4684 Indianola Avenue, Columbus, Ohio 43214, (614) 268-5605.

JC-2 upd. to ML-1 (ML-1 pp3, A3 & A4, line drivers & p.s. filter) \$795. (805) 484-9544. 9-9

KENWOOD KA 2002 INT AMP \$35. 412-781-5248. 9-9

KENWOOD KX-1030 CASSETTE DECK, \$320 EXCELLENT CONDITION. (216) 793-6235. 9-9

KENWOOD LD 7C AND (2) L07 Ms, 9 mos. old; Kenwood 9100 integ. amp, 5 mos. old; Tandberg 10XD, used for four hours; 10x, excellent; L200C's 6 mos. old; H-K rabco ST-7, factory record.; Denon AU-320, DL-103D, 6 mos. old excellent; SAE 5000: Everything as new or excellent, original boxes. Best offer on any or all: 717-424-5077, eve. or J. Ray, 43 Washington ST., E. Stbg., PA 18301. 11-9

KOETSU is here. The legendary handmade moving coil cartridge is now available in the U.S. For the complete story, write: Sumiko, Inc., Box 5046, Berkeley, CA 94705.

LAUGH AND THINK. The Hi-Fi Game: A board game of fun and thought. \$11.95 from Penjon Games, Box 2129, Martinez, CA 94553. Dealer inquiries welcome, too.

LEVINSON JC-1DC HEAD AMP \$55. 901-754-3010 before 3 pm C.D.T. 9-9

LONG HAIR WOOL carded — cleaned for stuffing speakers, \$7/lb incl. ship. J. Ebbert, 770 Holly Rd., Wayne, PA 19087 (215) 687-3609

LOWEST POSSIBLE PRICES! Most stereo brands! Request quotes only! Allegheny, Box 1029-U3, Johnstown, PA 15907. 7-9

FOR SALE

LOWEST DISCOUNT PRICES ANYWHERE on audio equipment. All major brands discounted. Write for quotes, K&L Sound Services, 75 N. Beacon St., Watertown, Mass. 02172. TF

L.A. — SOUTHERN CALIFORNIA

LINN ASAK CARTRIDGE: The makers of the finest turntable have brought us the finest cartridge. This moving coil tracks excellently in most fixed pivot tonearms. The cartridge does the same thing as the table, less trash and hash, more music. \$350

SERIES 20 PA1000: This incredible tonearm is the perfect match for the Linn cartridge or any other cartridge regardless of compliance (1 or 2 exceptions). \$150

MUSIC FIDELITY BB1: This battery powered preamp is the clearest, tightest, most natural available. Its only competition is a certain transformer (causes some smearing compared to the BB1) at twice the price. \$225

MICHAELSON & AUSTIN: All three pieces from this company are among the finest values ever offered in audio. The TVP-1 preamp at \$750 is a tube unit with resolution and a 50/50 watt tube amp with high resolution and detail you probably never heard before. The TVA-10 is the big brute, at 75 lbs. this amp has the muscle to fill the room with the largest and yet most detailed sound stage.

WE CARRY: Linn Sondek, Denon, Michaelson & Austin, Series 20, Professional Systems Engineering (PSE), Rogers, Tangent, Koss ESL, Satterberg, Spatial, Theta, Peterson, Hafler, Lentek, Stax, SAEC, Audionics, Decca and Osawa.

EXECUTIVE AUDIO

BY APPOINTMENT ONLY (213)394-6463
2210 Wilshire #207 Santa Monica, CA 90403

TA (Time Align), PRP (Pressure Recording Process), PZM (Pressure Zone Microphones), TDS (Time Delay Spectrometry), ETC (Energy Time Curve), SBA (Signal Biasing Amplification), LEDE (Live End Dead End).

New ideas to you? That is what SYN-AUD-CON is all about. Plan to join us this Fall for a Syn-Aud-Con 3-day sound engineering seminar. Write us for a schedule and a list of cities where we will hold seminars this Fall.

Synergetic Audio Concepts

P O Box 1134
Tustin, CA 92680
(714) 838-2288

FOR SALE

LOWEST PRICES ON STEREO-ESOTERIC COMPONENTS & Tapes. Over 150 brands. Send #10 SASE for quotes. Audio Unlimited, 401 Reynolds Circle, San Jose, CA 95112 (408) 289-8875 1-6 Monday thru Thursday.

Magneplanar Tympani 1-D. White, perfect. Best Offer over \$900. (415) 383-6418. 11-9

SOUND ADVICE AND POLK AUDIO LOUD-SPEAKERS We have the incredible Polk Audio Monitor Series loudspeakers in stock. The Polk's are definitely the best performance per dollar value ever offered in a truly accurate inexpensive loudspeaker. We ship freight prepaid anywhere in the U.S. within 24 hours upon receipt of order. Write or call for information on the Polk Audio Monitor Loudspeakers.

SOUND ADVICE

Village Plaza Ruston, LA 71270
(318) 255-8000

AUDIOWORKS DESIGN LTD.

The AWX-1 power amplifier kit is a major advance in cost-effective performance—indeed a radical improvement over most existing state-of-the-art designs, regardless of cost. AWX-1 features a huge power supply, zero signal feedback, very large dynamic range, wide bandwidth with filtered input, high slew rate, clipping indication, solid state switch-on, built-in calibration circuitry, top quality pre-tested parts, matched semiconductors, and the most complete and informative instruction book ever supplied with a kit. Current capacity: 20 A/ch stereo, 40 A mono peak. Power: 65 W/ch at 8 ohms, 130 W/ch at 4 ohms, 260 W/ch at 2 ohms, 260 W mono at 8 ohms, 520 W mono at 4 ohms, .1 Hz—100 kHz. This Andy Rappaport-designed kit is suitable for novice assembly. Price is \$395 prepaid. Bridging pkg. \$40. UPS insured shipping charges collect. Penna. residents add sales tax. Assembly manual, \$10 credited on amp kit purchase. Available only directly from manufacturer: Audioworks Design, Ltd., P.O. Box 4314, Harrisburg, PA 17111 (717) 652-6996.

AT SOUND COMPONENTS, INC. WE'VE GOT IT ALL

Audionics Bang & Olufsen Beveridge Cylindrical Bryston
. . . . DCM Denon Dynavector Fidelity Research Fulton . . .
Grace Great American Sound Hafler H.Q.D. Reference System
. . . . Janis KEF Kenwood Purist Linn Sondek Magnepan . . .
Mark Levinson Paragon Pyramid Metronome Quad Rega
. . . . Rogers Sonex Spendor Stax Verion Yamaha . . .

Master Charge & Visa accepted

We ship prepaid within U.S.

SOUND COMPONENTS, INC.
2710 Ponce de Leon Blvd., Coral Gables, Fla. 33134
(305) 446-1659

Free information service

To AUDIO readers... from AUDIO advertisers

- Look over the below list of advertisers and select those from whom you want more product information.
- Write the numbers on the Reader Inquiry Card and fill in all the information. We will rush your request to each company.

Advertiser	Page	Advertiser	Page	Advertiser	Page
Acusta Craft Speaker Kits Write Direct to Advertiser	124	Barclay Electronics Hi-Fi Components Write Direct to Advertiser	108	EMS, Inc. Speakers Write Direct to Advertiser	122
ADC Hi-Fi Equipment Enter No. 1 on Reader Service Card	75	B5R Hi-Fi Equipment Enter No. 9 on Reader Service Card	67	Etco Quad Record Demodulator Write Direct to Advertiser	126
Allison Acoustics Hi-Fi Equipment Enter No. 7 on Reader Service Card	34	B&W DM2/II Speakers Write Direct to Advertiser	100	Fisher Cassette Deck Write Direct to Advertiser	48, 49
American Audiophile Audio Components Write Direct to Advertiser	110	Carston Studios Stereo Receiver Write Direct to Advertiser	123	Fuji Hi-Fi Equipment Enter No. 15 on Reader Service Card	101
Angel Records Ten New Albums Enter No. 2 on Reader Service Card	96	Chestnut Hill Audio Audio Store Write Direct to Advertiser	126	Garland Audio Audio Store Write Direct to Advertiser	108
Apt Corporation Apt/Holman Preamplifier Write Direct to Advertiser	120	Cook Laboratories Records Write Direct to Advertiser	108	Golden Gramophone Audio Store Write Direct to Advertiser	110
Audio Concepts Hi-Fi Components Write Direct to Advertiser	123, 124	dbx Hi-Fi Equipment Enter No. 10 on Reader Service Card	33	Goodwin, Inc. Stereo Components Write Direct to Advertiser	108
Audiocom Hi-Fi Components Write Direct to Advertiser	106, 112, 121	DeCoursey Engineering Electronic Crossovers Write Direct to Advertiser	125	Havens & Hardesty Audio Components Write Direct to Advertiser	112
Audio Critic Publication Write Direct to Advertiser	91	Digital Meter Research Digital Decible Meter Write Direct to Advertiser	125	Henry's Camera Hi-Fi Components Write Direct to Advertiser	111
Audio Excellence Hi-Fi Components Write Direct to Advertiser	125	Discwasher Hi-Fi Equipment Write Direct to Advertiser	2, Cover IV	International Hi-Fi Hi-Fi Equipment Enter No. 16 on Reader Service Card	93
Audio Horizons Publication Write Direct to Advertiser	124	Eakin Audio Headphones Write Direct to Advertiser	107	Itone Audio Stereo Equipment Write Direct to Advertiser	122
Audio Insight Stereo Equipment Write Direct to Advertiser	121	Eastman Hi-Fi Equipment Enter No. 11 on Reader Service Card	32	Jensen Car Stereo Receiver Write Direct to Advertiser	38, 39
Audio Technica Hi-Fi Equipment Enter No. 3 on Reader Service Card Telarc Digital Recording Enter No. 4 on Reader Service Card	14, 79	Electro-Voice Interface Speakers Enter No. 12 on Reader Service Card	21	J&R Audio Mail Order Enter No. 48 on Reader Service Card	95
Avid Minimum Defraction Loudspeaker Enter No. 6 on Reader Service Card	47	Empire Hi-Fi Equipment Enter No. 13 on Reader Service Card Hi-Fi Equipment Enter No. 47 on Reader Service Card	5, 46	JVC Cassette Decks Enter No. 17 on Reader Service Card	42, 43
Ball Sound Guard Write Direct to Advertiser	25			KEF Speakers Enter No. 18 on Reader Service Card	23
				Kenwood Hi-Fi Equipment Enter No. 19 on Reader Service Card	81

114

Free information service

To AUDIO readers... from AUDIO advertisers

- Look over the below list of advertisers and select those from whom you want more product information.
- Write the numbers on the Reader Inquiry Card and fill in all the information. We will rush your request to each company.

Advertiser	Page	Advertiser	Page	Advertiser	Page
Larksong Stereo Components Write Direct to Advertiser	123	Phase Linear Hi-Fi Equipment Enter No. 29 on Reader Service Card	19	Soundcraftsmen Hi-Fi Equipment Enter No. 37 on Reader Service Card	36
L. T. Sound Hi-Fi Components Write Direct to Advertiser	120	Pioneer SX-780 Receiver Enter No. 31 on Reader Service Card	Cover II, 1	Speakerlab Speaker Kit Write Direct to Advertiser	124
Lux 5K50 Cassette Deck Write Direct to Advertiser	15	Radio Shack Realistic Equipment Write Direct to Advertiser	31	The Speakerworks Speaker Kits Write Direct to Advertiser	121
Marcof Hi-Fi Equipment Enter No. 20 on Reader Service Card	85	Reference Monitor International Speakers Write Direct to Advertiser	109	Spectro Acoustics Hi-Fi Equipment Enter No. 38 on Reader Service Card	45
Maxell Tape Care Kit Enter No. 21 on Reader Service Card	27	R. G. Dynamics Dynamic Processor Write Direct to Advertiser	120, 121	Stanton Magnetics 881S Cartridge Enter No. 30 on Reader Service Card	3
McIntosh C 32 Preamplifier Enter No. 22 on Reader Service Card	86	Sansui SC-3300 Cassette Deck Enter No. 41 on Reader Service Card	13	Sumiko Moving Coil Cartridges Enter No. 39 on Reader Service Card	99
McKay Dymek DA 5 AM Antenna Enter No. 23 on Reader Service Card	95	Saxitone Tapes & Tape Recordings Write Direct to Advertiser	126	Symmetry Stereo Equipment Write Direct to Advertiser	111
Memorex Hi-Fi Equipment Enter No. 24 on Reader Service Card	11	Sennheiser Headphones Write Direct to Advertiser	61	Take 5 Hi-Fi Components Write Direct to Advertiser	123
Microacoustics Hi-Fi Equipment Write Direct to Advertiser	16	Sensible Sound Publication Write Direct to Advertiser	106	Tapeworld Blank Tapes, etc Write Direct to Advertiser	126
Mitsubishi Tuner/Preamplifier Enter No. 25 on Reader Service Card	28, 29	Series 20 Hi-Fi Equipment Enter No. 32 on Reader Service Card	4	TDK Hi-Fi Equipment Enter No. 42 on Reader Service Card Head Cleaning Kit Enter No. 43 on Reader Service Card	17, 99
Mobile Fidelity Hi-Fi Equipment Enter No. 14 on Reader Service Card	87	Shure Hi-Fi Equipment Enter No. 34 on Reader Service Card Phono Cartridge Enter No. 33 on Reader Service Card	82, 83	Teac Tape Recorders Write Direct to Advertiser	Cover III
Monster Cable Stereo Equipment Write Direct to Advertiser	107	Signet Signet Dealers Enter No. 40 on Reader Service Card	57	Technics RS-M63 Cassette Deck Enter No. 44 on Reader Service Card	7
Nikko Hi-Fi Equipment Enter No. 26 on Reader Service Card	65	SME Hi-Fi Equipment Enter No. 35 on Reader Service Card	78	Trusonic Hi-Fi Equipment Enter No. 45 on Reader Service Card	12
Ortofon Hi-Fi Equipment Enter No. 27 on Reader Service Card	63	Sonikit Speaker Kits Write Direct to Advertiser		Watts Hi-Fi Equipment Enter No. 46 on Reader Service Card	26
Ovation Audio Audio Components Write Direct to Advertiser	126	Sony Hi-Fi Equipment Enter No. 36 on Reader Service Card	34	Yamaha Hi-Fi Equipment Write Direct to Advertiser	76, 77
PAIA Hi-Fi Equipment Enter No. 28 on Reader Service Card	91	Sound Advice Used Stereo Equipment Write Direct to Advertiser	125		

119

FOR SALE

MAGNEPLANAR TYMPANI 1-D, white, mint \$900 + shipping; Audio Research D52B, new, \$900 or B/O; Ariston RD115, \$200. 919-449-6912. 9-9

MARK LEVINSON DEMO SALE

ML-1 Preamp w/ A, D5 & D6 cards \$995; LNC-2 Crossovers either 100Hz or 7 KHz \$879; oak cases \$54; Camac cables ½ off. All mint w/ warranty. Prices Firm. Call day time only. MC & VISA.

Perfectionist Audio, Ltd.
P.O. Box 250
Pleasant Gap, Penna. 16823
(814)-359-3007

10-9

Mark Levinson MC-1 Preamplifier, the latest version of this reference standard. Excellent condition. \$1400. without adaptors. (415) 777-1811. 9-9

METRO-NEW YORK CITY

G.A.S., FR, Dahlquist, B&O, Lux, Linn Sondek, AVID, Janis, Baure & Wilkens, Grace, Tangent, R.H. Labs, Direct Discs, Grado, many others. All issues of Absolute Sound.

UNIVERSITY STEREO-Ridgewood, N.J.,
57 E. Ridgewood Ave. (201) 447-5700

20 minutes from G.W. Bridge

12-9

A SINGER'S DREAM!



REMOVES VOCAL FROM MOST STEREO DISCS
The Thompson Vocal Eliminator can actually remove most or all of a solo vocalist from a standard stereo record and yet leave the background music virtually untouched! Not an equalizer! We can prove it works over the phone. Write for a brochure and demo record below. COST: \$195.00

ECHO Ambiance

We do it **BETTER** for **LESS**
Whether your interest is in using ambiance for a concert hall effect or as an echo chamber for studio recording use, we manufacture a broad line of sophisticated analog delay Echo and Reverberation devices at prices which only direct sales make possible. Prices range from \$159 to \$495.

Write for a brochure and demo record. Include \$1 to cover costs (refundable with order.)

Write to: **LT Sound**, Dept AU, P.O. Box 1061,
Decatur, GA 30031 (404) 284-5155

FOR SALE

McIntosh 2105 Amp. 110 Watts — C28 Preamp. Mint, Walnut Cabinets, Original Cartons. Asking \$1100. Will sell separately. (201) 735-4847. 9-9

MILWAUKEE! The Audio Emporium: Audio Perfection cables, Audiopulse, Audio Research, B&O, Connoisseur, Dahlquist, Denon, Genesis, Grace, Grado, Grafyx, GAS, Hafler, Linn, Lux, Magnepan, Marcof, M&K, New Acoustic Dimension, Polk Audio, RH Labs, Revox, Rogers, Sonus, Sumo, Technics. We have many direct discs and the Keith Monks record cleaning machine. 6900 W. Brown Deer Rd. Open Tues. thru Sat. 10-6, (414) 354-5082. TF

MILWAUKEE & WISCONSIN'S ONLY TRUE AUDIOPHILE DEALER

Specialists in components by; G.A.S., Yamaha, KEF, Tandberg, Dahlquist, DCM, Fried, Quatre, Stax, SAE, Connoisseur, Transcriptors, Grace, Nakamichi, Infinity, Dynaco, Crown, Ortofon, Sonus, ADC, Hafler, DBX, Akai, Teac, Revox, MXR, Technics and many many more. Featuring a very unique switching system for instant component comparisons. Also, one of the largest tape recorder displays in the country, with over 130 machines on display. WACK ELECTRONICS, INC. 5722 W. NORTH AVE. MILWAUKEE, WI. 53208. PHONE: 414-442-3441 TF

MIXER made especially for tape duplication. Will produce enhanced high quality second generation tapes. KUHN ELECTRONICS, 1801 Mills Ave., Norwood, OH 45212. TF

MONTANA AUDIOPHILES

DISCOVER ROCKY MOUNTAIN HI FI

DAHLQUIST	NAKAMICHI	MAGNEPLANAR
ACOUSTAT	GAS/AMPZILLA	SONUS
BEVERIDGE	AUDIONICS	GRACE
DCM TIME WINDOW	SONY	HEGEMAN
FULTON/FMI	STAX	POLK
R. H. LABS	N.A.D.	B&W

812 Central Ave., Great Falls, Montana 59401
Phone (406) 761-8683

MULTI-TRACK AND SEMI-PROFESSIONAL AUDIO EQUIPMENT: BEST PRICES! Prompt Delivery! DBX, TEAC/Tascam, Sound Workshop, AKG, Delta-Lab, Phase-Linear, Uni-Sync, Others. Dept. AD, WDI, P.O. Box 340, Cary, NC 27511. 919-467-8122.

FOR SALE

NAKAMICHI 500 Cassette Deck in excellent condition w/factory installed new head. \$195. D. Wilson, 112 Public Square, Berryville, AR 72616. 9-9

NAKAMICHI 410 PREAMP — \$220. (414) 682-1882.

NEW AMPEX MASTERING TAPE 406 (7") 2.25, 407 (7") 3.25 New Scotch or Ampex LN-HO 1200x7 1.50, 1800x7 2.25, 4000x10 5.00 min. 20 pp. all boxed. New type 10" metal Reels Boxed \$4 min. 10 pp. other tapes Avail. Large SASE for Details. MJS, 2514 Seaboard Ave., SJ, CA 95131 408-262-8793.

NOISE REDUCTION

For tapes, records, & broadcasts — Playback or record.
8800 DYNAMIC NOISE FILTER by LOGICAL SYSTEMS
3314 H St., Vancouver, WA 98663. 206 694 7905. 9-9

NORTHERN CALIFORNIANS

It is our goal to make the joy of music possible for everyone. At any price we offer solid value, superior performance, and traditional service.

We operate on the theory that you as our customer will achieve the greatest long term satisfaction only through a careful analysis of your audio requirements. We strive to offer sober, highly cost effective solutions to meet your specific needs. Please stop in for a refreshing experience with music.

OUR SELECTION INCLUDES:

Magnepan	Audios	Dahlquist
Tandberg	Threshold	Chartwell
Onkyo	Audire	B&W
JVC	Hafler	Cizek
AKG	P.S.E.	AVID
Denon	Lux	Stanton
Micro	Grado Sig.	AIWA
Connoisseur	Sonus	M&K
Soundcraftsmen	Grace	Rogers

HIGH FIDELITY SHOPPE
1511 North Main Street
Walnut Creek, Calif. 94596
(415) 932-2242

"WE BUILD BETTER SYSTEMS FOR YOU"

Northern N.J.'s finest store-Lux, Mod DQ-10, Grace, B&W, G.A.S. Sleeping Beauty, FR, B&O, Linn, Sondek, Janis, Tangent, R.H. Labs, Grado, AVID and more. University Stereo, 57 E. Ridgewood Ave., Ridgewood, N.J. 07450. 20 minutes from the G.W. Bridge. 201-447-5700. TF

OHM-F, The amazing Walsh driver in beautiful rosewood finish at ½ price. \$900/pr. (415) 777-1811. 9-9

ONLY \$8.95 EACH! DIRECT-TO-TAPE RECORDINGS
#DTR 7901, "Lynn Binstock Plays Flute" (w/piano, violin, viola, cello); #DTR 7907, "Annette DiMedio Plays Piano." TAPES ONLY—DUPLICATED AT PLAYING SPEED! No outrageous ticks and pops or direct discs. Specify cassette, cartridge, or reel (4 or 2 track, optional dolby or dbx II). Shipping \$1.00 per order. Add NJ sales tax if applicable. Direct-to-Tape Recording Company, 14 Station Ave., Haddon Heights, NJ 08035.

MARANTZ SLT-12V TURNTABLES -2. Mint Condition. Brian Appleman, 604 Kenwood Ave., Dayton, OH 45406. 9-9

McIntosh C-28 Preamp with walnut cabinet, mint. 1-919-8924315 days. 1-919-8975222 nights & weekends. Don Wood, PO Box 270, Dunn, NC 28334.

MORDAUNT-SHORT SPEAKERS at **BARGAIN PRICES** Pageant Series 2 in factory sealed cartons. List \$495/pair. Now only \$290/pair. Mainland freight prepaid, NY residents add sales tax. Entertainment Sound Services Inc. 78 North Franklin Street, Hempstead, New York 11550.

FREE! HARDWOOD VENEERS & LUMBER CATALOG

96 varieties world's rarest veneers and lumber at reasonable prices. Simplified veneering instructions plus full color wood selector included. Send for free catalog now and get special bonus starter offers. **SAVE 25% Hurry!**

BOB MORGAN WOOD, Dept. Alk9
1123 Bardstown Rd., Louisville, Ky. 40204



TRANSPARENT



The lowest distortion of any expander available.

For information write: RG Dynamics
4448 W. Howard St. Skokie IL 60076

THE RG PRO-20W DYNAMIC PROCESSOR

The Apt/Holman Preamplifier

For literature, the name of your local dealer, and ordering information, please check the box.

For a collection of five technical papers by Tom Holman, please check the box and send \$2.00.



Name _____

Address _____

Apt Corporation Box 512 Cambridge, Massachusetts 02139

FOR SALE

PAMPERED AUDIO NEEDS GOOD HOME . . . Phase Linear 4000 pre-amp w/cabinet, 1 pr. Advent Large Speakers — walnut cabinets, 1 pr. Micro Acoustics MS-1 add-on tweeters, JVC SEA-50 Equalizer. No reasonable offer refused. Satisfaction guaranteed. Member SAC. Call John (616) 651-4606 evenings & wknds. 9-9

PERFECTIONISTS PREFER DYNAKITS

Before Purchase You Owe Yourself Our Quote Mainline IIa, 971 Fronheiser, Johnstown, PA 15902 TF

PERSPECTIVE SPEAKER SYSTEM

plus Rappaport Electronics and S-O-T-A phono system available for audition now exclusively at AUDIOWORKS. A most advanced and accurate audio system. By appointment only. Audioworks, Box 4314, Harrisburg, PA 17111, (717) 652-6996. 9-9

PHASE LINEAR — Phase III Speaker System 6-mo. old \$900.00. 717-285-4150.

POINT SOURCE SPEAKER SYSTEM

by Auditor of France — extremely fine sound at affordable cost — exclusively at AUDIOWORKS, Box 4314, Harrisburg, PA 17111, (717) 652-6996. 9-9

POLYDAX (AUDAX) Bextrenes, soft domes etc., Decca Ribbon tweeters Leach Amplifiers. Catalog: TA Box 97A, W. Cornwall CT. 06796. Postage now 40c, please help with stamps. 9-8

PROFESSIONAL Noise Reduction at an affordable Price. 8800 DYNAMIC NOISE FILTER by LOGICAL SYSTEMS 3314 H St., Vancouver, WA 98663. 206 694 7905. 9-9

PROPER TONEARM GEOMETRY!! Optimum offset angle, overhang, vertical pivot height and angle. Resonance damping construction. Jewelled pivots. Height adjustable while playing records. Effective mass 2.5 grams. Damped cueing. Anti-skate bias. TA-3A with silicone damping, \$249.00, "Universal" nylon hardware, \$1.00; alignment protractor, \$3.00. Prices include postage and money-back guarantee. JML Company, 39,000 Highway 128, Cloverdale, CA 95425 TF

PROTECT YOUR LPs. POLY SLEEVES FOR JACKET 10", ROUND BOTTOM INNER SLEEVES 9", SQUARE BOTTOMS 6", POLY LINED PAPER SLEEVES 15", white jackets 35", POSTAGE \$1.50. HOUSE OF RECORDS, HILLBURN, NEW YORK, 10931. TF

PUT PHILLIPS AND AUDAX IN YOUR CAR and you'll want to spend lunch hours in the company parking lot. For a buck (refundable) we'll show you how. MADISOUND SPEAKER COMPONENTS, 537 Holly Ave., Madison, Wis. 53711, (608) 238-1517 or 256-7337

QUALITY VACUUM TUBE ELECTRONICS from conrad-johnson design. The conrad-johnson stereo preamplifier and the new conrad-johnson power amplifier offer breathtaking impact, clarity, harmonic structure of live music. Highest quality materials and workmanship assure lasting beauty and performance. Preamplifier \$585, power amplifier \$985, at selected dealers. For information, write to: conrad-johnson design, inc., 1474 Pathfinder Lane, McLean, VA 22101. 10-9

Tired of trying to erase cassette box labeling liners when you re-record? New liners on heavy index card stock 12 for \$2.00 Postpaid. R. Peeler, Box 51, Essex Fells, NJ 07021.

TURNTABLES

Denon • Visonic • Supex • Linn Sondek Transcriber • SAEC • Grace • Sleeping Beauty AKG • Formula 4 • Dynavector • Mitsubishi

Audiocom HIGH TECHNOLOGY AUDIO
177 Sound Beach Ave Old Greenwich CT
Phone (203) 637-3621

FOR SALE

QUICKEST AIRMAIL DIRECT FROM TOKYO: All brands of Cartridges & Arms of Japan. Ask for latest Quotations with \$1 for postage. JAPAN AUDIO TRADING CO., LTD. Saikaen Bldg., 4-33-21, Kamimeguro, Meguro-Ku, Tokyo 153 Japan 2-0

RECORDS/TAPES. Major labels, top names at distributor prices. All categories. Complete set of catalogs \$1.00 (refundable) Box 1111, Chatsworth, Calif. 91311.

Records you own can sound like the master tapes that made them! Our perfectly machined disc resonance damper will allow you to hear imaging, depth and detail you never knew existed on your discs. Hearing is believing! Just \$33.00 and \$2.00 shipping. V.P.I. Industries, Box 159, Ozon Park, NY 11417. 8-9

RENOUCE ROTTEN RECORDINGS! Read selected British reviews in the bi-monthly EURO-DISC GAZETTE, then order these European discs judged the finest in technical and musical excellence. Selections mainly classical. Send for free sample issue. No obligation. EURO-DISC GAZETTE, PO Box 337-A, Peterborough, NH 03458. TF

RH Labs sub woofer, Excellent condition \$250. (415) 777-1811 9-9

SALE!!!!

TWO FOR LESS THAN THE PRICE OF ONE. Now you can buy two fine RCA (Japan) direct to disc records, Beethoven's passionata and Lew Tabackin quartet's trackin' for only \$11.95 including postage. That's right. Two records for \$11.95! Rated as reference recordings in the Absolute Sound & Stereophile, these records retail for \$30 for both. Hurry, supply limited. Send check or money order to: Specs Corp., 130 Fallen Leaf Drive, Hillsborough, Calif. 94010 CA residents add Sales tax. 2-0

Sansui TV — 9900 Tuner, Sansui BA/CA 2000 Power Pre-Amp, Pioneer HPM 1500 Speakers, Sansui Au 11000 Amp. E. Teringer, 1212 Laredo Ave., Chatt., TN 37412 (615) 867-7103. Excellent condition. Low prices!

LUX 4000, \$850; 1000, \$550; Accuphase preamp, \$295; Marantz IT + 15, exc. cond., \$375; Harbeth spkrs, \$475; Grace 840, new, \$100. S. Wallen, 5295 E. Sunset Rd., Knoxville, TN 37914. 9-9

FOR SALE

SAVE UP TO 40% ON DIRECT DISCS

Select from over 250 different direct discs, PCM, and Japanese Audiophile records. Over 30 labels to choose from. Send \$1 for complete list and prices. (\$2 outside U.S.) Dynamic Discs, P.O. Box 0, Tarzana, CA 91356. 1-0

SAVE UP TO 69% ON OVER 100 TOP BRAND AUDIO COMPONENTS FROM CARSTON STUDIOS. NEW ENGLAND'S AUDIO SUPERMARKET ONE OF THE OLDEST MAIL ORDER FIRMS (EST 1952) AND CERTAINLY ONE OF THE MOST RELIABLE. ALL ORDERS SHIPPED FROM STOCKED WAREHOUSE. SEND FOR PRICE QUOTE AND PRICE LIST. CARSTON STUDIOS, OLD BROOKFIELD ROAD, DANBURY, CONN. 06810. TF

SEAS SPEAKER COMPONENTS. Raw Drivers, crossover networks, speaker kits and more! Drivers and plans for mini kit and subwoofer kit. For information and literature send \$1 refundable upon purchase to:

The Speaker Works
Dept A
Box 303
Canaan, NH
03741

ALL SPEAKER KITS ARE FUN TO BUILD, BUT...

SEAS
SPEAKER KITS SOUND BEST!

SEAS SPEAKER KITS FROM SCANDINAVIA OFFER THE MOST COMPLETE AND BEST ENGINEERED LINE OF LOUDSPEAKER KITS TO DATE. SEAS LOUDSPEAKER KITS ARE THREE-WAY BOOKSHELF DESIGNS UTILIZING HIGH QUALITY COMPONENTS OF THEIR OWN DESIGN AND MANUFACTURE IN COMPUTER-MATCHED ENCLOSURES OF OPTIMAL SIZE. SEAS SPEAKER KITS ARE AVAILABLE FROM \$89. FULL MONEY BACK GUARANTEE. FOR LITERATURE AND INFORMATION, SEND \$1 REFUNDABLE UPON PURCHASE TO:



THE SPEAKER WORKS
P. O. BOX 303
CANAAN, N. H. 03741

SPATIAL



Exclusive patented circuitry optimizes stereo image.

For information write: RG Dynamics
4448 W. Howard St., Skokie, IL 60076

THE RG PRO-16B DYNAMIC PROCESSOR

Now in Fort Lauderdale...
State of the art components for the audio perfectionist and serious listener.

Audio Research • Acoustat • Denon • B & W • Armstrong • Chartwell • Lux Tangent • Polk • GAS • Conrad Johnson • Audire • Ariston • Connoisseur ADC • Grace • Supex • Grado • Goldring • DB Systems • Quatre • Stax Theta • Plasmatrix • Transcriptors • Dynavector • Vandersteen
Complete selection of direct to disc recordings.

AUDIO INSIGHT
The Promenade at Bay Colony
6286 N. Federal Hwy., Ft. Lauderdale, FL 33308 • 305/491-7677



FOR SALE

SIEMENS, TELEFUNKEN, GENALEX AND AMPEREX and other top quality audio tubes available at very competitive prices. Contact Jim Wallace at 1203 Success St., Pittsburg, PA 15212 or (412) 322-4706 TF

SOTA TANGENT RS2 \$519/pr PPD, DCM Time Window \$680/pr PPD, WOODBURN SOUND STUDIO 400 Highland Court, Iowa City, Iowa 52240. 9-9

WOOFERS • MIDRANGES • TWEETER ZERO PHASE ERROR CROSSOVERS

High power handling 5 1/4" midrange unit • One hundred watt 6", 8", 10" & 12" woofers with 4.7 lb. or 7.6 lb. magnet structures • High quality 1" cloth dome tweeter with 3 lb. magnet structure • Wide dispersion, low distortion piezoelectric tweeter handling 150 watts r.m.s. • Revolutionary new ZERO PHASE ERROR CROSSOVERS built on glass epoxy printed circuit boards for 2, 3 & 4-way systems • Crossovers are matched to system utilizing our drivers or systems utilizing the high quality POLYDAX units mfg. by AUDAX in France • Large inventory of nonpolar capacitors, non-inductive wire wound resistors & air-core coils. Custom crossovers designed to your specifications.

SEND \$3.00 for prices & CATALOG of complete engineering data, application notes and simplified procedures for measuring Theile and Small's parameters, refundable with order.

EMS, inc. 615/546-7374
2727 Magnolia Ave.
Knoxville, TN 37914

FOR SALE

SOUND COMPONENTS INC.
EXCLUSIVE SOUTHEAST
DEALER FOR THE
INCOMPARABLE
MARK LEVINSON H.Q.D.
REFERENCE SYSTEM

The H.Q.D. reference playback system consists of the following components:

- 2 Hartley 24 in sub-woofers
- 4 Quad ESL loudspeakers
- 2 Decca ribbon tweeters (modified)
- 2 Levinson LNC-2 Crossovers (100 Hz & 7 KHz)
- 1 Levinson ML-1 (LEMO) preamp
- 6 Levinson ML-2 amplifiers
- 1pr. Hand-crafted oak or ash trestle stands (for Quads & Decca)

THE H.Q.D. SYSTEM WITH GOOD SOURCE MATERIAL, WILL REPRODUCE A MUSICAL EVENT BETTER THAN ANY SYSTEM WE KNOW OF.

For more information, please write or call:

SOUND COMPONENTS
2710 Ponce de Leon Boulevard
Coral Gables, Florida, 33134
305-446-1659

TWX 812-848-7627 tf

LINN SONDEK—LINN NAIM—LINN MODIFICATIONS

We offer the remarkable Linn Sondek LP12. Hear it in an A-B demonstration and make your own decision! We also offer the superb Linn Naim head amp, Linn Asak MC cartridge, 45 rpm adapter & friction hinged dust cover for the LP12 and Linn Mods for the Grace 707 Mk2. By appt. Free shipping. OXFORD AUDIO CONSULTANTS, Box 145, Oxford, OH 45056, 513-523-3895.

Threshold CAS-1 cascode amplifier, 150 watts. \$600. (415) 777-1811. 9-9

FOR SALE

STATE OF THE ART IN N. CALIFORNIA

is now on demonstration at The Audible Difference. Hear the superb Threshold NS-10 preamp/400A power amp through Dick Sequerra's stunning Metronome loudspeakers. Audition Peter Snell's superb Snell Acoustics Type A loudspeaker system with Threshold's new medium power CAS-1 amplifier. For the ultimate in high-power amplification, audition the Threshold 8000A mono amplifiers. Hear how good a bi-amp system can be with John Curl's new transient perfect crossover from Symmetry, the ACS-1, plus Paragon's 125 watt solid state bass amp. Experience the beautiful new Paragon 12A preamp, plus Thaedra II from G.A.S.

Hear the ultimate direct drive turntable, the Denon DP-6000, plus the audiophile reference Linn Sondek with Linn-modified Grace 707 tonearm. Examine the precisely machined bearing of the new glass platter, belt drive Planar tables from Rega Research. Hear the ultra-musical Paragon System E preamp, plus the new high performance, moderate cost Thalia/grandson combination from G.A.S. Audition a new generation of compact high performance loudspeakers from Polk and Cizek, plus BBC minimonitors from Spondor and Rogers. For the music listener who demands the best, we offer the Breuer Dynamic Tonearm, plus the EMT cartridge with Verion transformer.

For that extra measure of sonic purity so important to the critical audiophile, we recommend and stock Polk Sound Cables; Mogami wire; the anti-resonant Platter Pad, \$24.95; Audio Perfection audio interconnect low capacitance cables, \$15/pr; plus the Stylift at \$19.95 and a wide selection of audiophile quality recordings including Gale Maximum, Fidelity and Denon PCM.

We ship all products prepaid throughout the United States.

THE AUDIBLE DIFFERENCE
435 Tasso, Palo Alto, CA 94301
(415) 328-1081

TF

STAX DA300 class A power amp, \$2000. Bob Duca, P.O. Box 93, Beverly, NJ 08010, (609) 386-7041. 9-9

STELLAMASTER with large reel attachment, power supply, switchable head block. Also Sennheiser mikes. Paoli amps. Call days 201-592-2355, eves. 201-567-5062.

STEREO REPRESENTATIVES NEEDED!!!

Sell 100 brands!! Lowest Possible Prices!! Krasco—REP DEPT.—998 Orange Ave. West Haven, Conn. 06516 TF

SUPEX - ORTOFON - DENON - OTHER MOVING-COIL CARTRIDGE OWNERS Send 50¢ for literature on our Micro-Preamplifier. Superb Performance at \$129.95. Huntington Electronics, Box 2009-A, Huntington, Conn. 06484.

TANDBERG TCD 330, \$675.00, SAE 2900, \$275.00, Tandberg 2025 \$275.00 Advent 300, \$175.00; R. Shannon, 1839 Fernwood Rd., Belmar, New Jersey, 07719. 9-9

TANDBERG 10XD with remote control. Mint condition in original carton. New \$1600 sell for \$975. Roger Russell, 7 Normandy Court, Binghamton, NY 13903. 9-9

TANDBERG 10X2 HALF-TRACK STEREO RECORDER 3 1/2, 7 1/2, 15 IPS, 10 1/2 inch reel capacity. In excellent condition with handle and plexiglass cover for portable use. \$800. Phone 704-693-9794. 9-9

TEN DYNACO MK VI AMPLIFIER kits all or part \$260 each plus freight. Rt. 1, Box 104, Del Mar, CA 92014. 11-9

TRADE UP to the MICRO CPU 100 fm tuner

It may have been out of the question at \$2000, but the new retail is \$995. Subtract even more for your trade-in and this magnificent tuner can be yours at a surprisingly low price. We offer very generous trade-in allowances on your old tuner or other audio equipment. A rare chance to own the best at a reasonable price (see Audio, Nov. '77). Write us for a quote, or better yet, phone after business hours and we can discuss your trade-in: (617) 874-0706, mon.-fri., 6-8 pm. (ask for Dick)

AUDIO CALIBRATION, box 250, Westminster, MASS 01473. TF

TAPE HEAD REFINISHING - Precision method full frequency response. \$15.00 ea. One day service. E. Maher, 5 Evans Place, Orinda, CA 94563.

LOWER LOUDSPEAKER DISTORTION

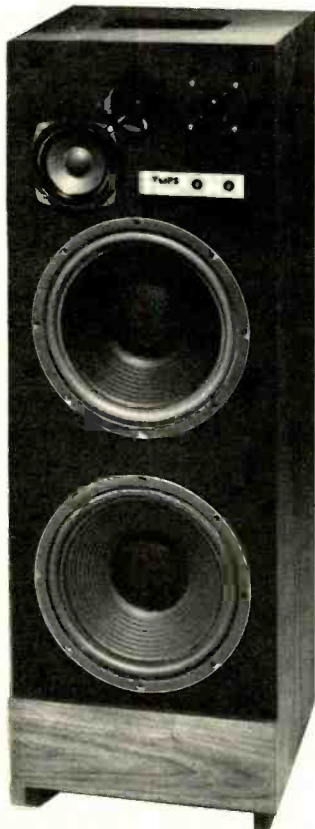

VMPS Tower II speaker system, \$549 ea. (kit \$369 ea.)

The VMPS Tower II speaker system, with its unique multi-band bass technique—flat to 22 Hz—and aperiodic enclosure design generates **three times less** harmonic distortion (0.7% THD 22Hz - 20 kHz/1W input) than the best and costliest competitors.

Its output is completely minimum phase over the full musical range.

Efficiency (103dB/1W/1m), power handling (300W rms), maximum undistorted output (126 dB/1m with rated max input) and dynamic range are enormous.

Linearity and neutrality are the equal of the finest audiophile monitors.

Its periphonic dispersion pattern (bottom-firing slot-loaded subwoofer, top-firing supertweeter) is nearly ideal in any listening room.

The Tower II can be biamped **without** an external crossover, or operated full range from as little as 20W/ch.

Its cost is \$549ea. (optional with dealer) fully assembled, or \$369ea. in easy-to-assemble kit form.

We think this is the loudspeaker you've been waiting for.

There are nine VMPS speaker systems priced from \$72 to \$1499 each, including the Mini-Tower II (\$249ea. kit, \$389ea. assembled), the Super Tower (\$499ea. kit, \$799 ea. assembled), and the fabulous 7ft. tall Super Tower II (\$799ea. kit, \$1299ea. assembled theater black, \$1499 in finishes). Kit prices plus shipping, 5 year warranty. Details: ITONE AUDIO, 7301 ROCKWAY, EL CERRITO, CAL. 94530 (415) 526-7084. Dealer and rep inquiries invited.

FOR SALE

THE AUDIOGRAM, a pithy independent newsletter now in its third year, provides timely, money saving reports on the latest products and techniques. Our critical integrity and realistic sense of proportion fill the gap between the commercial magazines and the neurotic underground press. Our latest issue of number 12 contains reviews of:

- The best moving magnet cartridge
- The best headamps
- The best turntable mat
- The best tube preamp
- Ultracraft AC300 Mark II

A review of tonearms by Paul Messenger.

\$10/4 issues/1 year. **AUDIOGRAM**, Box 27406, St. Louis, MO 63141.

THE CRITICAL RECORD REVIEW

Issue 2 is ready. We offer sound reviews of SOTA and D-D discs in bimonthly newsletters, \$6 per vol., 6 issues. P.O. Box 8766, Jacksonville, FL 32211

The Listening Room Loves

POLK AUDIO MONITORS

The golden ear of Marcel Wittman has established the Listening Room as one of the nation's premier audio salons. Not only do we have the finest esoteric audio equipment costing well into the five figures price range, we have the Polk Audio Monitor Series Loudspeakers beginning at just \$99.95 each, and easily worth many times their price in sound value. Come in to listen, write them for full literature, or give us a call. Shipped free anywhere in the U.S.

Listening Room
590 Central Park Avenue
Scarsdale, N.Y. 10583
(914) 472-4558

THE LISTENING ROOM INC.

590 Central Park Avenue
Scarsdale, N.Y. 10583
(914) 472-4558

Cordially invites you to audition our fine line of equipment. THRESHOLD · BRYSTON · SPATIAL · PYRAMID METRONOME 2+2 · PLASMATRONIC · SPEAKER · DAYTON WRIGHT ESL · QUAD ESL · SNELL ACOUSTICS · DAHLQUIST · KEF 105 · DYNAVECTOR · DENON · YAMAHA · TANDBERG · POLK AUDIO · GRACE · NAKAMICHI · STAX · R.H. LAB · S3/5A BBC MINI MONITOR BY CHARTWELL · KEITH MONK · SEQUERRA · HAFLER · JANIS · FONTEK HEADPHONES · AUDIO PUSLE · LINN SONDEK · OASIS · GREAT AMERICAN SOUND · EMT · HADCOCK · SRATHCLYDE · PSE · OBELISK · MARCOFF · ULTRACRAFT TONE ARM · AUDIO STANDARD · GRADO SIGNATURE III · IMPULSE · FIDELITY RESEARCH · TANGENT · DIRECT TO DISK RECORDS ·

Visit our private studios. We ship free anywhere in the Continental U.S. We invite Inquiries. TF

ATTENTION UPSTATE NEW YORK AUDIOPHILES! House of Hi-Fi is now open with Hafler, D.C.M. Time Windows, Ampzilla (G.A.S.) Polk Audio Monitors, KEF, Harmon Kardon STB, Sleeping Beauty, Audionics, N.A.D., Mayware formula 4 tonearm, Signet moving coils, AKG cartridges, Toshiba, Sony, and Aiwa. For Info. call 518-793-6639 Mon. to Fri. 11-9 Sat. 10-6. House of Hi-Fi, 50 Miller Rd. (Rt. 9), Glens Falls, NY 12801.

Buy with confidence

Send for Quotes & Price List on JVC & Over 60 Other Famous Brands

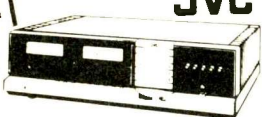

JVC
JVC-JRS-201
AM/FM STEREO RECEIVER

35 watts per channel, RMS at 8 ohms, from 20-20,000 Hz with less than .03 percent Total Harmonic Distortion.

Mon.-Fri. 9:00-5:30
Sat. 9:00-3:00
ARSTON
148 Old Brookfield Road, Danbury Conn. 06810
(203) 744-6421 (212) 369-6212

FOR SALE

THE MONITOR SERIES FROM POLK AUDIO

AUDIO BREAKTHROUGHS now has on demonstration the remarkable new Polk loudspeakers priced from less than \$200 per pair. Compare them to the finest loudspeakers in the world. All Polk Audio Monitors utilize high definition polymer laminate bass-midrange drivers, wide dispersion soft dome tweeters and fluid coupled sub-bass radiators. They are capable of reproducing a highly defined phase accurate three dimensional sonic image which rivals the thousand dollar super speakers. They sound great with a small receiver, yet reveal the fine subtleties of state of the art electronics. Shipped free in U.S. Send for free brochures on Polk or our other fine lines. **AUDIO BREAKTHROUGHS**, 1534 Northern Blvd., Manhasset, LI, NY 11030 (516) 627-7333 TF

THE NEW YORK AUDIO SOCIETY, INC. is a non-profit member-supported Hi-Fi Club. Come and hobnob with others like yourself to widen your knowledge of Audio Products and Systems and make new acquaintances. Informative monthly meetings feature new product demonstrations, lectures on latest Hi-Fi developments and exchange of information. All Audiophiles are invited to attend one session as our guest. Details about meetings and membership available. Write Box 125 Whitestone Sta., Flushing, N.Y. 11357 or call (516) 593-6538.

THORENS TD 124 with TP 16 Arm Mint \$275. J. John Dilworth, FP 55. Costalo, Levittown Lakes, P.R. 00632. (809) 784-7675. 9.9

SOUND CONCEPTS DELAY MINT 414-542-8361. 10.9

FOR SALE

THOUSANDS OF LIKE NEW LP's and prerecorded tapes. Catalogue—\$2.00. House of Records, Hillburn, New York 10931. TF

SOUTH CAROLINA'S ONLY HIGH-END STORE the finest audiophile equipment: British American Sound, P.O. Box 1247 186 King Street, Charleston, SC 29402 6.9

TONEARMS-CARTRIDGES-TURNABLES at lowest prices. Most brands available, including MC. Send #10 SASE for quotes. Audio Unlimited, 401 Reynolds Circle, San Jose, CA 95112.

get with the Audio Pros
 select from top quality brands
 Franchised Dealers For: AR BOSE, DAHLQUIST, AVID, ADS/NAKAMICHI, MYR, YAMAHA, ONKYO, OPTONICA, PHASE LINEAR, TANDBERG, DBY, WIN LABS, SONUS, MICRO ACOUSTICS, HARMON KARDON, AUDIO, PULSE, VISONIK, STAX, DENON, HAFLER, G.A.S., QYSONIC, SAE, ESS, CONNOISSEUR, OTHERS.
AUDIO CONCEPTS
 (213) 445-3663
 (800) 423-4170
 1127 W. HUNTINGTON
 ARCADIA, CA 91008

Connecticut's Progressive Audio Store

Over 350 Titles of Direct-Disc
• Keith Monks Record Cleaning • 5 Listening Rooms

M-W 10-7, TH-F 10-8, S 10-5
All shipments, pre-paid & insured.
Master Charge/Visa/American Express

Acoustat • Apt Holman • Audionics • Bryston
• Cizek • Cotter • Cybele • DAC • DCM Time Window • Denon • Grace • Grado • Hafler • JR • Levitation • KMAL • LS-3/5A • M&K • NAD • Pyramid • Quatre • Rappaport • Signet • Sounds Concepts • Supex • Symdex • Tangent • Yamaha • Audiophile Accessories.

TAKE 5 AUDIO 105 Whitney Ave., New Haven, CT 06511 (203) 777-1750

You can pay \$5.00 for an advanced state-of-the-art 60 minute cassette.

Why? Larksong will sell you one for \$1.30 or less.*

- * Pure Micro-Acicular Ferric Oxide
- * Fully Bias and Equalization Compatible
- * Five Screw Case
- * Outstanding Signal to Noise Ratio
- * Lifetime Guaranteed

Treat your hungry power-packed tape machine to a Larksong cassette and get a lot more entertainment for your money. No longer does its thirst for quality cassettes need to be limited by your lean budget. Now you afford the best — **Larksong**. One top line of exceptional cassettes available in two styles of boxes. *** Dollar Special** — Your first Larksong C-60 cassette with complete tape specifications and postage-free order blank for only \$1. Limit one per customer. Larksong puts it all together so you get more music out. Larksong, Dept. IC, 10 Scott St., Point Arena, CA 95468.

Larksong WHOLESALE INQUIRIES INVITED
The Real tape breakthrough you've waited for.

FOR SALE

MARANTZ 7C, 9, MCINTOSH C22, MC275, MC240. J. Fong, 1238 Green St., San Fran., CA 94109. (415) 885-0596. 7-0

THE SOUNDING BOARD, INC.

75 Franklin Ave.
Ridgewood, NJ
(201) 445-5006

Come to listen at northern N.J.'s brand new audio salon. We carry quality products such as:

DAHLQUIST, D.B. SYSTEMS, VAN ALSTINE, I.M.F., OBELISK, SERIES 20

LINN SONDEK, CIZEK, TANDBERG, MITSUBISHI, QYSONIC, AVID, WINTEK, DUAL, CONNOISSEUR, GRADO SIGNATURE, GRADO DECCA, STAX, and more.

SpeakerGuts.

The absolute latest in advanced speaker technology. *Wave Aperature™* Drivers, the Patented *Nestrovic Woofer System™*, raw speaker components selected for their excellence. Horns, crossovers, subwoofers, woofers, midranges, horn and dome tweeters. Over 30 in all. Build your own speaker system and we'll provide top quality speakers and design information. Send for FREE 48 page color catalog from the largest, most experienced speaker kit manufacturer in the world. **DON'T DELAY. Write today!**

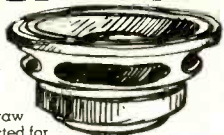

Speakerlab®
Dept. A-AD, 735 N. Northlake Way
Seattle, Washington 98103

FOR SALE

SPENDORS ARE SPLENDID!

See OAC for the Spendor SA-1's, BC-1's & BC-3's. Free shipping. Visa & Master Charge honored. Demo. by appt. OXFORD AUDIO CONSULTANTS, P.O. Box 145, Oxford, OH 45056. 513-523-3895. Also open evenings & weekends.

AT LAST — AN AFFORDABLE OPTION!

NOISE REDUCTION for tapes, records, & Broadcasts.
8800 DYNAMIC NOISE FILTER. Ask your dealer or write:
LOGICAL SYSTEMS, 3314 H St., Vancouver, WA 98663,
206 694 7905. 9-9

TOP-RATED CARTRIDGES UP TO 70% OFF!! We feature Acutex, ADC, Nagatron, Ortofon, Sonus, Stanton, et. al. Unbelievable prices! Call 212-254-3125 for prices, or write to DIRECT DISCOUNTS LTD., P.O. Box 841, N.Y., NY 10003.

TOURING SOUND SYSTEMS, 2, 4 and 8 Track Studios. Disco Sound, Cerwin Vega BGW, Altec, Shure, AKG, Tapco, Dyna, Revox, EV, Beyer, Cetec, etc. K & L Sound Service, 75 North Beacon At., Watertown, Mass. 02172. (617) 787-4072. Att: Ken Berger. TF

Sound Concepts 550 time delay system. \$400. Smooth, quiet, incredibly realistic. (415) 777-1811 9-9

TRS-80 MICRO COMPUTERS By Radio Shack at 15% discount! Also have software for business systems. Micro Management Systems, Cairo, GA 31728. (912) 377-7120. 9-9

ROGERS REFERENCE MONITOR SYSTEM

This is a biampified system designed by Rogers using the incredible LS3/5a's. Hear this system as well as the Rogers Monitor II's, Compact Monitor's. LS3/5a's, A75 amp and T75 tuner at OXFORD AUDIO CONSULTANTS, P.O. Box 145, Oxford, OH 45056. By appt. Free shipping. 513-523-3895.

PHOTOGRAPHY

1979 PHOTOGRAPHER'S MARKET LISTS 1600 buyers Only \$12.95. Fletcher Book Sales, Box 460, Milton, VT 05468. 9-9

PUBLICATIONS

TERRIFIC SWAP OFFERS NATIONWIDE

Rcvrs., amps, TTs, Audio, Ham Gear, Etc. 5 issues \$2! "Electronic Trader." Box 73-A, Folly Beach, SC 29439. T.F.

SERVICES

CB RADIO OPERATORS—Send your name, handle and license number. We will inscribe this information attesting to your status as a CB operator on a handsome scroll, suitable for framing. Send information printed or typed together with check or money order for \$2.95 to Larry Bergman, P.O. Box 281, Cedarhurst, NY 11516. 9-9

CUSTOM RECORDING SERVICE, Tapes, discs, and cassettes. Stereo and mono. Live and copies. Editing, Masters and pressings. High quality at reasonable rates. Joseph Giovanelli, Audio-Tech Laboratories, 2819 Newkirk Ave., Brooklyn, N.Y. IN9-7134 TF

JBL SPEAKER WARRANTY STATION RCI, 8550 2nd Avenue, Silver Spring, Md. 20910. Mail orders Welcome.

NASHVILLE RECORD PRODUCTIONS WILL PRESS HIGH QUALITY PURE VINYL RECORDS FROM YOUR TAPES. SEND FOR SAMPLE RECORD AND PRICE LIST. ALSO FINEST DISC MASTERING. 469 CHESTNUT ST., NASHVILLE TENNESSEE 37203 TF

STARTLING REVELATIONS! Your true character and future explicitly revealed. Send \$5.00 with signature sample and birthdate to: SCIENTEL, BOX 720, Adelaide St., Toronto, Canada M5C 2J8.

MISCELLANEOUS

COLLEGE STUDENTS! Improve your grades. Send \$1.00 for 356-page, collegiate research papers catalog. 10,250 available. RESEARCH ASSISTANCE, Box 25918AD, Los Angeles, California, 90025. (213) 477-8226. 9-0

SUPER GAS SAVER: (U.S. Patent 3118435) automatically corrects over rich gas mixture, makes engine burn 15 gals. of air to every gal. of gas. Gas Prices are going up. **ORDER NOW;** \$15.95 postpaid, 2 for \$24.95. **SATISFACTION GUARANTEED OR MONEY REFUNDED. OR SEND \$2.50 FOR DETAILS.** H&H ENTERPRISES, BOX 1275, Bismark, ND 58501. 9-9

YELLOW PAGES OF AUDIO—\$3.95

Sourcebook to 1,100 periodicals. 250 books, 7,500 products! Future Publications, 137 Valley Park S. Bethlehem, PA 18018 1-9

16mm Films, Videotapes. SAVINGS on reels, equipment. Big list. Urbanski, 8142 Kenneth, Chicago, IL 60652. 10-9

RECORDS

AUDIOPHILE SUPER-FI RECORDS!

All types, labels; quick, personalized service; huge catalog only \$1.00 Try us! Cosmic Chords PO Box 4873 Boulder Colo 80306

DIRECT TO DISC AND DIGITAL RECORDINGS: All labels at low prices. Telearc, Discwasher, Audio-Technica, Sheffield, Denon PCM, Crystal Clear, Mobile Fidelity Labs. . . WE HAVE THEM ALL!! (and more!!) Send for FREE price list and Newsletter or \$2.00 for descriptive catalogue DISConnection, P.O. Box 10705 Tampa FL 33679.

FREE SOUNDTRACKS & CASTS CATALOG! Personalities! ST/OC Valuebook: \$4. RTSA 711 W. 17th G-1 Costa Mesa, CA 92627. TF

RARE OUT-OF-PRINT LP's. Factory Sealed — 99c to \$3.99 ea. Over 25,000 in stock. List — \$1.00 Record Warehouse, Box 4617, Dept. AO, Rochester, New York 14613.

Houston and the Gulf Coast

Mark Levinson/Threshold/G.A.S./Apt/Holman/Hafner/Advent/Nakamichi/Dahlquist/Magneplanar/KEF/Acoustat/KM Systems/DCM Time Window/Cizek/Snell/Denon/Klipsch/Fidelity Research/Grace/Signet/Cotter/Ivie Analyzers

AudioConcepts

2200 SW Freeway at Greenbriar Houston, Texas 77098 713/527-0774
Credit Cards Accepted Freight Prepaid in Continental USA

AUDIO HORIZONS

P.O. BOX 10973
St. Louis, MO 63135

Issue #3 contains reviews of the AUDIO STANDARDS MX-10A pre-preamplifier, the THETA preamplifier, the DENON PCC-1000 phono crosstalk canceller, plus PART II of the phono cartridge survey, which includes the KOETSU MC-ONE, the SUPEX SDX-1000 and SD-900E, Super II, the GRADO Signature III, the FIDELITY RESEARCH FR-1 MK3F, the FULTON RS, the PRECISION FIDELITY, the WIN LABS Lab Standard, and the ELECTRO-RESEARCH EK-1. Issue #3 also features reviews of several high-grade pickup arms, which include the FIDELITY RESEARCH FR-6As, the LUSTRE GST-1, the GRACE G-707 MKII, G-704, G-714, the DENON DA-307, the MA YWARE PLSA/D1 Formula 4 Series III, the SME 3009 Series III, the JH AUDIO LABS, the DYNAVECTOR DV-505, the HADDOCK GH-228 Super, the BREUER DYNAMIC 5A, the JML TA-3A, the INFINITY "Black Widow" GF, the STAX UA-7c-m, the new SLMIKO, the MISSION 77A, the SERIES 20 PA-1000, the MICRO-SEIKI MA-505X and MA-707X, and the ULTRACRAFT AC-3000MC.

Subscription rates to AUDIO HORIZONS™ for six issues are: U.S.A. - \$18; Canada and Mexico - \$20, and outside North America - \$26 (sent Air Mail). Sample copies of any issue are available for \$4.50 each (U.S.A., Canada, and Mexico), and \$6.00 each (outside North America). U.S. DOLLARS ONLY.



The UNKITS!

- They don't LOOK like kits!
- They don't SOUND like kits!
- They just SAVE like kits!

Build your own speakers — Save 50% or more... No soldering required!

☐ **FREE KIT BROCHURE** — I'm interested — send me your free 8-page Brochure (kits from \$55.00 each).

☐ **\$1.00 Catalog/Manual** — Give me all the details — send me your comprehensive manual on speaker kits, crossovers, basic components and engineering data with "How-to-do-it" article by noted speaker designer John Hoge. \$1.00 enclosed.

Acusta Craft

Dept. AU P.O. Box 12030 • Shawnee Mission, Ks. 66212

Acusta Craft®

RECORDS

MILWAUKEE! The Audio Emporium: we have over 100 direct discs and other high quality LPs, most labels and constantly new releases. We also have the Keith Monks record cleaning machine. 6900 W. Brown Deer Rd. Open Tues. thru Sat. 10-6, (414) 354-5082. TF

"**RECORD JACKETS.** Replace old, torn, LP jackets with clean, glossy, pure white or black jackets. Plastic lined inner sleeves, 78 sleeves, opera boxes. Free catalog. CABCO A6, Box 8212, Columbus, Ohio 43201." TF

RECORDSAVERS, POLY-LINED INNER SLEEVES TEN CENTS EACH, POSTPAID, MINIMUM 100. DEO, INC., BOX 452D, GLENVIEW, IL 60025. 6-0

RECORDS, RECORDS, RECORDS

Old, New & Direct Disc too! Send \$1. for Complete Info, S.E.O.J., 519 Wheat, Johnstown, PA 15902. 4-9

SOUZA RECORDS. Free catalog upon request. Stanford. Box 36163, Grosse Pointe, Mich. 48236. 1-0

SUPERIOR ENGLISH RECORDS, including the new Philadelphia Orchestra EMI releases and the Decca Digitals. Send SASE for price list. S. Baird/Records, Box 17947, Memphis, TN 38117. 9-9

WHILE YOU WERE LOOKING for out-of-print records, you should've been looking for us. DISContinued. 444 S. Victory Blvd., Burbank, Ca. 91502 TF

SPEAKERS

VENEER SPEAKER CABINETS Hardwood Walnut Speaker Cabinets with grill. Routed or unrouted, front baffles, or complete **SPEAKER KITS.** Send self-addressed stamped envelope for complete brochure. **KUSTOMIZED SPEAKER SYSTEMS, 260-A GLENN CIRCLE, POWELL, TN 37849.**

WANTED TO BUY OR TRADE

JBL HARTS-FIELD 1 or Pr. 313-229-7378. 2-9

McINTOSH, Late 2300 amplifier Pasiecznik 52 Crest, Murray Hill, NJ 07974. 9-9

McINTOSH OR MARANTZ any kind of tube amps: Pay top dollar (213) 278-3430, 8633 Airdrome St., LA, Calif. 90035.

OPEN REEL pre-recorded tapes. Rock, folk, jazz, classical stereo, quad (8 - track quad also). A few of each for sale too. SASE. Ray, 1293 French Ave., Lakewood, Ohio 44107. 11-9

SONY TC-650 REMOTE CONTROL (MOD. rm-16)/P. KLEIN, 215 5th, PROVIDENCE, RI 02906. 9-9

"**WANTED — AUDIO RESEARCH D-57, D-76 A, D-750.** State price and condition. J. Wachter, Seidenweg CH — 3012 Bern Schwitz." 9-9

WANTED: Quad AM3. McIntosh MC-75. Western Electric amps and speakers: 555, 594, 728B, 91D, 86, 87, any other. WE-300, 252, 205, 284 triodes. WE-171 transformer. A. Lal, 117 E. 37th St., New York, NY 10016. 9-9

Bob Heenan Sells Great Used Equipment

Tel: 617-734-2727
Sound Advice
Box 782
Brookline Village
MA 02147

AR	Marantz (Tubes)	SAE
DB	Magneplanar	Sony
EPI	McIntosh	Stax
Bose	Levinson	Quad
B & W	LS 3/5A	Revox
Crown	H - K	Yamaha
Advent	Linn	Thorens
Dahlquist	GAS	Tandberg
Dyna (Tubes)	JBL	Nakamichi
Audio Research	Lux	Phase Linear

Money Back Guarantee

Sound Advice, Box 782,

Brookline Village, MA 02147

Equipment bought, sold, traded & brokered.

WANTED TO BUY OR TRADE

WANTED: MARANTZ & McINTOSH TUBE EQUIPMENT. Sam Aberst, P.O. Box 480436, L.A., Calif. 90048 (213) 276-6727. 9-9

WANTED: Recording gear of all ages and variety. Microphones, outboard gear, etc. Dan Alexander, 6026 Bernhard, Richmond, CA 94805, (415) 232-7933.

WANTED — Wharfedale W60 E or W70 E (Pr.) (302) 654-9370, DE. 9-9

PLANS & KITS

AR TURNTABLE IMPROVEMENT KIT. \$2.50 postpaid. AUDIO PLEASURE, P.O. Box 498, Croton-on-Hudson, NY 10520. 9-9

SAVE MONEY - building your own 19" rack-mounting equipment. Rack cases available for 10 or 12 band stereo equalizers, LED VU meters, preamps, patchbays, etc. (schematic included). Send \$1 for details and prices. Home Grown Music, P.O. Box 1084, Decatur, AL 35602. 10-9

TOP QUALITY SPEAKERS, NO SECONDS. Free plans with each woofer purchase. Super selection including full line of car speakers and equipment. Send 50¢ to: Speaker Warehouse 809 N. State Rd. 7 Hollywood, FL 33021.

BUSINESS OPPORTUNITIES

Beat the Races! "Lifetime Income From Racing-flats, trots." Elias, Box 47AA, Brooklyn, New York 11219

CABLE FM BROADCAST STATION. Unique no investment/experience business makes money! Others work for you! Free Details "CAFM," Box 130-N4, Paradise, CA 95969

BUSINESS OPPORTUNITIES

CAMPUS REPRESENTATIVES — Earn big money selling hi-fi as a QSI Campus Rep! For info. contact Quadraphonic Studios International, 9320 Keeler Ave., Skokie, IL 60076

CAMPUS REPS - High Performance Loudspeakers, Box 18009, Seattle, WN 98118 TF

ACTIVE ELECTRONIC CROSSOVERS

Plug-in Butterworth (maximally flat) filters in 6 db., 12 db., or 18 db., per octave attenuation, any frequency specified. Filters flat beyond 100 KHz.

Complete crossover in attractive metal cabinet with all terminations and regulated power supply;

STEREO BI-AMP \$139

Tri-amp, quad-amp, and monaural types available at comparable prices. Other available features: Summer for "single woofer" systems, Subsonic noise elimination filters supplied with or without bass boost, level controls.

FOR OEM'S AND HOME ASSEMBLERS

500 Series dual filters and/or plug-in filters, regulated power supplies.

FREE CATALOG & PRICE SHEET

Write to:

DeCoursey ENGINEERING LABORATORY
1182B Jefferson Bl. • Culver City, CA 90230
Phone: (213) 397-9668

DIGITAL DECIBEL METER

Features of the DMR100

- 0.1 dB resolution
- 120 dB range
- True RMS response
- ± 99.9 Vdc scale also
- Variable zero reference
- Analog and Compressed signal outputs



\$250.00

DIGITAL METER RESEARCH Box 28 Arlington Hts, MA 02175

Audio Excellence

A UNIQUE STEREO SHOWROOM DEDICATED TO THE PERFECTIONIST

Presenting Components from the Prestigious Companies of

AUDIONICS	DENON	GRADO	SIG.	SIGNET
BEVERIDGE	SNELL	MAGNAPAN	HAFLER	
THRESHOLD	DCM	CONRAD J.	ROGERS	
PLASMATRONICS	PSE	OBELISK	BRYSTON	

SHIPPED PREPAID THROUGHOUT THE U.S.

584 Washington Street, San Francisco 94111 415-433-1335

BUSINESS OPPORTUNITIES

MAKE REAL ESTATE PROFITS Without Investment. Complete Course \$10. PRA, Box 891, Auburn, WA 98002. 9-9

PIANO TUNING LEARNED QUICKLY AT HOME! Free information. Empire School, Box 450327, Miami 33145.

Want money? Hate hard work? Lazy way to big money. Cleaver plan \$2.00 (Refundable) Noble, Box 10033, Houston, TX. 77206.

\$500/THOUSAND Stuffing envelopes. Send stamped addressed envelope. Messerer Enterprise, Rt. 2A, Hawkeye, Iowa 52147. 1-0

\$600/THOUSAND PROFIT!!! Guaranteed Earnings, stuffing envelopes, RX, DGWING, Box 311, Novato, California 94947

HELP WANTED

AUSTRALIA—NEW ZEALAND WANT YOU!! 50,000 Jobs! Big Pay! Reports \$2.00. AUSTCO, Box 2069-K, La Puente, CA 91746 1-0

ELECTRONICS ENGINEER: National Public Radio seeks an individual with experience in servicing audio equipment, tape recorders, receivers, turntables, amplifiers, etc. Excellent company benefits and salary. Interested persons should submit resume including salary history/requirements to: DeNise Johnson, NPR, 2025 M St. NW, Washington, DC 20036. AA/EOE. 9-9

RADIO-TV Jobs... Stations hiring nationwide! Free details: "Job Leads," 1680-PH Vine Hollywood, CA 90028

Western Pennsylvania's Quality Audio Dealer

Mark Levinson	Grace
Bryston	Janis Woofers
Dayton-Wright	M&K Woofers
Watson Labs	Denon
DCM Speakers	Ariston
Snell Acoustics	Connoisseur
Linn-Sondek	Thorens
Rogers LS3/5A	Fidelity Research
Van Alstine	Supex
Symmetry	Formula 4
Hafler	Decca
Marcoff	dbx
Threshold	Cotter
AIWA	Nikko
Dahlquist	SAE
Infinity	Armstrong
Marantz	Visionik
Technics-Pro	AEI

plus much more...

Direct-To-Disc Recordings

SHIPPED PREPAID & INSURED

Ovation Audio

6019 Broad St. Mall
Pittsburgh, Pa. 15206
(412) 441-4550

TAPE RECORDINGS

BIG BANDS radio broadcasts on reel/cassettes \$1 refundable for catalog. P.O. Box 5101, Riverside, CA 92507. 9-9

ON OPEN REEL from master tapes. Argo, Telefunken, Vanguard, Unicorn, MHS. Catalogue \$1.00. Barclay-Crocker, Room 1470-A, 11 Broadway, NYC, 10004. TF

RADIO PROGRAMS

GOLDEN AGE RADIO. Your best source for radio tapes, reels or cassettes. Box 25215-D, Portland, Oregon 97225. 9-0

RENT RADIO SHOWS: Make your own copies or just listen. Great way to build your collection reasonably. Catalog \$1 refundable. OTR Rental, Box 1146, Livermore, Ca. 94550 TF

YESTERDAYS RADIO ON TAPE. Reels-Cassettes. Quality Sound. Reliable Service. Giant catalog \$1.00 refundable with first order. ADVENTURES, Box 4822-A, Inglewood, California 90302. TF

1930-1962 RADIO PROGRAMS. Beats television!! Tapes. \$1.00 hour! Established esteemed dealer, informative 200 page catalog \$1.25. Cassette samples \$2.00. AM Treasures, Box 192AU, Babylon, N.Y. 11702 TF

INSTRUCTION & EDUCATION

CERTIFIED AUDIO CONSULTANTS home study Hi Fi course available. Send \$5.00 for information. Includes AUDIO TECHNICAL YEARBOOK with 29 sample lessons and applications for membership in Society of Audio Consultants. Write SAC, P.O. Box 552 Department A, Beverly Hills, Calif. 90213.

"PASS FCC EXAM" over 1200 questions, answers, discussions, illustrations. 3rd, 2nd, 1st, phone, radar, broadcast, endorsements. \$14.95. SPECIFIC SKILLS INTERNATIONAL Inc., P.O. Box 1233, Cocoa, Florida 32922. Mastercharge/VISA. 2-0

POPULAR ORGAN STYLES plus free chord chart and lesson. Cassette-8 track \$10. Christie-1972 Union SE Minerva, Ohio 44657. 9-9

SPECIAL PURCHASE!



Sansui

Model QC-04 CD4 Four-Channel QUAD RECORD DEMODULATOR!

12⁹⁵ EA.

Sensational Factory Surplus purchase! A goldmine of parts and circuitry! 1500 in stock. With schematic. (5 lb.) 025H P088.

\$9.95 ea., lots of 3.

\$8.95 ea., lots of 100.

FREE! EXCITING CATALOG! Hundreds of surplus & unusual items — Write today!

ETCO ELECTRONICS

Dept. 044,
NORTH COUNTRY SHOPPING CENTER
PLATTSBURGH, N.Y. 12901

TAPE AND TAPE RECORDERS

CASSETTES — SUPER FERRO DYNAMIC
Equal or better than Maxell UDXL, TDK-SA etc. Eight cassettes with FREE Add'n Stac storage module (\$1.95 value): C-45's \$16.00; C-60's \$18.00; C-90's \$22.00 including postage or send \$2.00 for a sample C-60. Save money, Get Great Quality! Use check, moneyorder, Visa or Mastercharge. Moneyback Guarantee! ED HELVEY ASSOCIATES, Box 1507A, Annapolis, MD 21404.

CUSTOMIZED TAPES. Jazz, Big-Band. Over 900 standard tracks. 80 minute cassettes or 8-tracks, \$8.00. Open reel, \$10.00, catalog \$1.00 (refundable). Tapes Unlimited Box 163 Portsmouth RI 02871 TF

FREE SAMPLE — Custom Video cassette case. \$4 value. Send \$1 for postage & handling. VIDEO CASE, 237 W. 54th St., New York, NY 10019, Dept. 1A1. Include make & model of recorder. 11-9

VIENNESE LIGHT MUSIC SOCIETY — Waltzes, Polkas, Overtures on imported Dolby cassettes. Most non-Schwann. K.C. Company, Box 793, Augusta, Maine 04330. 7-9

NAME-BRAND RECORDING TAPE, custom loaded. Available in cassettes, reels, cartridges. Huge savings from manufacturer. Also low everyday prices on Maxell, TDK, Ampex, Scotch, BASF, etc. New catalogue now available. MJS, 2514 Seaboard Ave., San Jose, CA 95131. (408) 262-8793.

SAVE UP TO 70% ON MAXELL LN CASSETTES! Bulk packaging (No box or Label) saves you money. C-60: \$1.09, C-90: \$1.57, C-120: \$2.65 Satisfaction Guaranteed. Send order with check or M.O. to Starship Audio, P.O. Box 217, Great Falls, Va 22066. 9-9

VIDEO RECORDER OWNERS!
Watch your films or slides on TV! No need to set up projector and screen. No reel changing or turning off lights. Up to 1000 ft. of super or regular 8 recorded on a VHS or Beta II cassette — \$32. 400 2X2 slides also \$32. Includes cassette and shipping. Or send \$2 for complete details, price list and padded film/slide mailer. VIDEO TAPE SERVICE, 1329E Carson, Barstow, CA 92311. 9-9

BLANK TAPE SALE

TDK SA-C90	3 05	AMPEX GRANDMASTER I-90	2 69
TDK AD-C90	2 45	AMPEX GRANDMASTER II 90	3 09
TDK D-C90	1 59	Scotch 212-7R-1800	3 99
TDK SA-C60	2 15	Soundguard Record Pres Kit	4 59
BASF PRO I C-90	2 79	TDK L-1800	5 13
BASF PRO II or III-C-90	2 89	TDK LB-1800	6 31
BASF Studio I or II-C-90	2 59	AMPEX Grandmaster 1800 ft Reel	5 95
SCOTCH Master II or III-C-90	3 15	SCOTCH 207-7R-1800	5 09
SCOTCH Master IC-90	2 69	BASF Studio 1800 ft Reel	6 49

All tapes can be assorted. No minimum order. Shipping 3.00 per order. Or write for free catalog of over 250 products including lowest prices on all Maxell products. All tapes 100% guaranteed. Free gift with every order. 412-283-8621 M-Th 9-4
TAPE WORLD 220 Spring St Butler PA 16001

SAVE up to 80% BY MAIL on: SCOTCH, TDK, BASF, MAXELL, MEMOREX, CAPITOL MUSIC TAPE, CERTRON (over 180 different reel & cassette tapes to choose from); top brand recorders; America's largest collection of taping accessories, too. Same day service. **FREE catalog.**

America's Recording Tape Specialists

SAXITONE TAPE SALES

1776 a Columbia Rd., Washington, D.C. 20009
(202) 462-0800

LEGENDARY.

Mark Levinson. Threshold. Grado. Audionics. Janis. Pyramid. Grace. Spendor. Rogers. DCM. Quad. F.R. Bryston. Snell. Linn-Sondek. B & W. Prebend. Cotter. Symdex. Revox. All these legends at Chestnut Hill Audio, 2302 Lombard Street, Philadelphia, Pa. 19146. (215) KI6-6178.

CHESTNUT HILL AUDIO.

YOU CAN'T TAKE ANY MACHINE AT FACE VALUE.

Every tape recorder is a machine by definition. Pretty faces, knobs and buttons are incidental to the recorder's fundamental responsibility. To move tape. And that is where a TEAC shines.

Twenty-five years of specialization has taught us that balance is the critical factor in determining how accurately and for how long a tape recorder will move tape.

Balance means no part stands alone. It also means delicate physical relationships. Good drive motors produce tremendous energies, magnified in fast modes. The slightest imbalance will cause vibration and audible deterioration.

Our hysteresis torque motors, one on each reel, maintain the delicate balance between start-up, back torque and running torque to prevent tape stretch and breaking. Precise tape-to-head contact is maintained to pre-

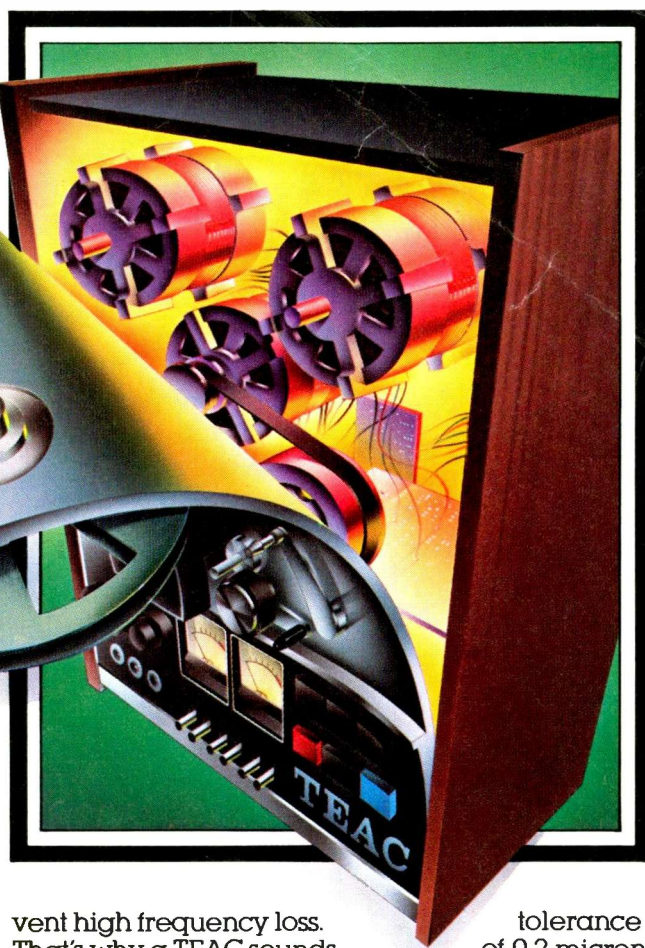

vent high frequency loss. That's why a TEAC sounds better initially and maintains its sonic integrity after years of use.

The most important part of any drive system is the capstan assembly, where balance, again, is crucial. For accurate tape speed, the size and roundness of the capstan shaft are of utmost importance. So we use automated lathes to form each shaft. Then micro-grind each one to a

tolerance of 0.2 micron (0.000008 inch).

Our hysteresis synchronous capstan motor is specifically designed for speed accuracy. Deviations (wow & flutter) are kept to the absolute minimum. Our massive flywheel is dynamically-balanced and coupled to the drive mechanism with belts that are tested under the most severe temperature, humidity and

atmospheric conditions to assure dimensional stability for years to come.

For fast action and positive feel, we use highly responsive micro-switch transport controls. They activate solenoids almost twice as powerful as those in other machines. You can even hear the distinctive sound of a TEAC mechanism in action.

Our erase, record and playback heads are secured to a steel mounting plate — itself a product of over 20 years of design refinement — then aligned in the three critical planes.

Finally, we mount everything to a ¼-inch high density duralumin base plate. Physical relationships must remain constant. Especially in the tape world of micro-tolerances.

To us, it's a matter of craftsmanship. To you, a matter of decision. That's why we invite you to look beyond mere face value. Peel away the cosmetics and you'll find the real measure of any tape recorder. Especially ours.

For more information, see your TEAC Audio Specialist dealer or write us at Dept. A0-9.

TEAC®

Feedback Causes:



Feedback Cure:



DISCWASHER®

DiscFoot™

Hi-Technology Turntable Isolation System

- Works in combination with existing feet for dramatic reduction of feedback.
- Isolates better than original or "replacement" feet.

Home environments can "upset" a turntable by feeding back both speaker and footfall vibrations. Acoustic isolation of a turntable involves the complex variables of turntable weight, room/floor conditions and audio system placement. The Discwasher DiscFoot has been specifically designed to successfully isolate most turntables in the home environment.

The "Material" Solution

The major components of the Discwasher DiscFoot System are new, "totally engineered" chemical complexes that behave radically different than other plastic, rubber or spring systems. These proprietary compounds are durable and precise in behavior, although difficult and expensive to synthesize. Laboratory and real-world tests justify the use of these unusual materials in the DiscFoot System.

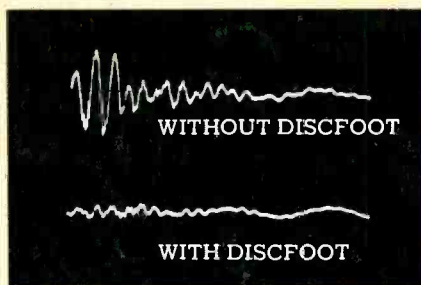

The Telling Test

The oscilloscope photo shows the output of two identical audio systems on the same shelf with their styli contacting the platters. The shelf is being struck by a rubber mallet. The top trace shows a turntable with absorptive "replacement" feet. The lower trace shows a DiscFoot System operating in conjunction with the existing turntable feet. Note the dramatic (tenfold) improvement in shock and feedback isolation.

The DiscFoot System contains four isolation feet, four platform caps, four furniture-protecting sheets and four special damping pads (to adapt DiscFoot units to certain turntables.) Additional single DiscFoot units are available for turntables weighing over 22 lbs. The system costs \$22.

 **DiscFoot™**

Discwasher DiscFoot can be found at audio dealers interested in preserving your music.

 **discwasher, inc.**
1407 N. Providence Rd.
Columbia, Missouri 65201