

Audio

THE AUTHORITATIVE MAGAZINE ABOUT HIGH FIDELITY

Jung
On SID/TIM

\$1.25

JUNE 1979

47425



**TWEAKING
YOUR
TURNTABLE**

**DO
TURNTABLE
MATS
WORK?
YOU
BET!**

**FIRST
TEST**

**YAMAHA
CR-2040
RECEIVER**



06
00295170 1055 90515031P720225
WILLIAM W KAYSER
147 W BAYVIEW BLVD
DORFJLK MA 23503

**AND IT'S WHAT GOES
INTO HPM SPEAKERS THAT
MAKES THEM SOUND GREAT ON
EVERY PART OF THE MUSIC.**



HPM 60

HPM 100

HPM 150

HPM 40

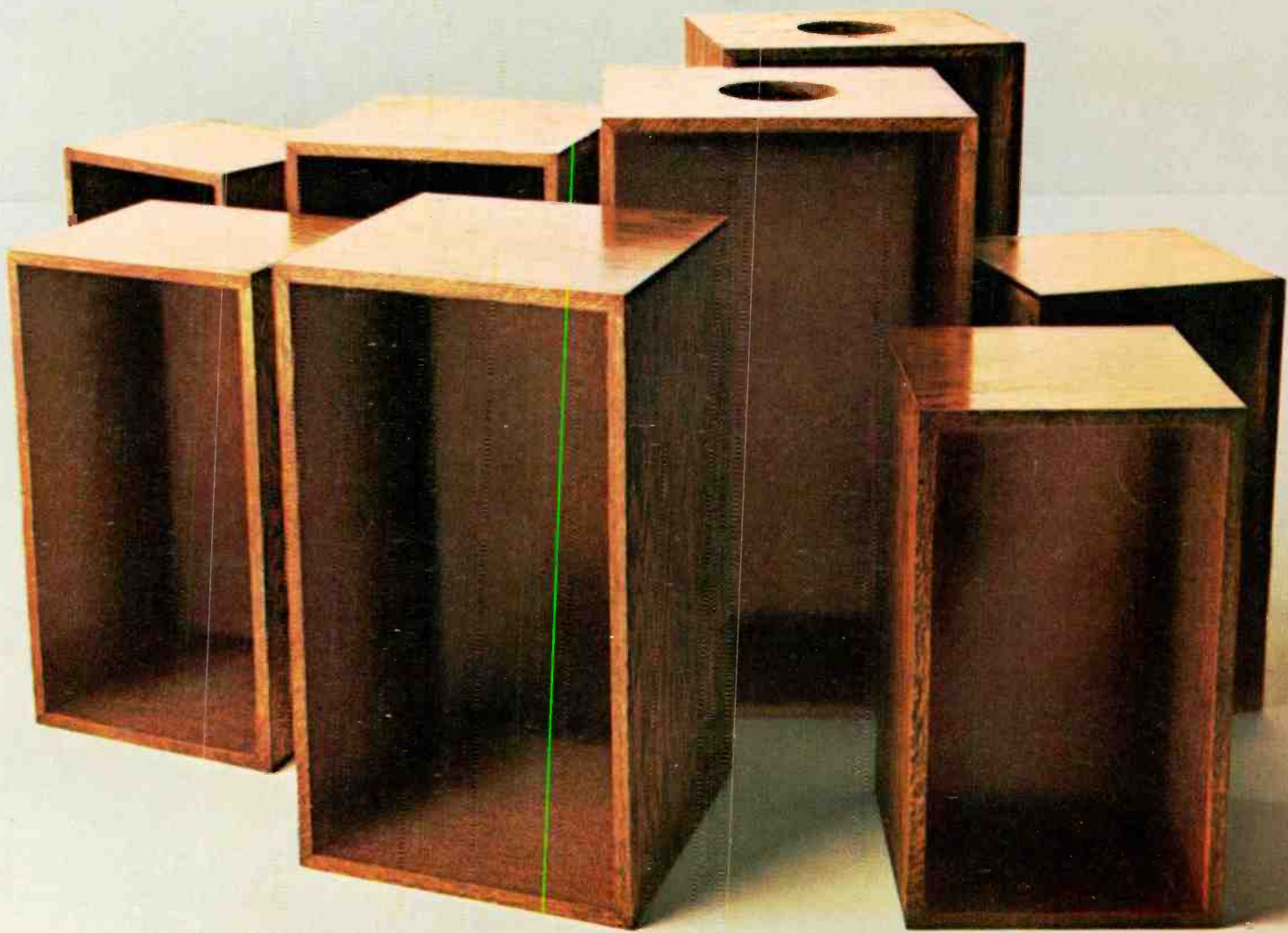

Most speaker companies try to impress you by describing the "wonderful" sound that comes out of their speakers.

At Pioneer, we think the most believable way to describe how good HPM speakers are is to tell you what went into them.

THE HPM SUPERTWEETER: SPEAKER TECHNOLOGY RISES TO NEW HIGHS.

In many speakers, you'll find that the upper end of the audio spectrum is reproduced by an ordinary tweeter.

In HPM speakers, you'll find that the high frequencies are reproduced by a unique *supertweeter*.

It works by using a single piece of High Polymer Molecular film, (hence the name HPM) that converts electrical impulses into sound waves without a magnet, voice coil, cone, or dome.

And because the HPM supertweeter doesn't need any of these mechanical parts, it can reproduce highs with an accuracy and definition that surpasses even the finest conventional tweeter.

As an added advantage, the HPM film is curved for maximum sound dispersion. So unlike other speakers, you don't have to plant yourself in front of an HPM speaker to enjoy all the sound it can produce.

MID-RANGE THAT ISN'T MUDDLED.

For years, speaker manufacturers have labored over mid-range driver cones that are light enough to give you quick response, yet rigid enough not to distort.

Pioneer solved this problem by creating special cones that handle more power, and combine lower mass with greater rigidity. So our HPM drivers provide you with cleaner, and crisper mid-range. Which means you'll hear music, and not distortion.

WOOFERS THAT TOP EVERY OTHER BOTTOM.

Conventional woofers are still made

Enter No. 49 on Reader Service Card

with the same materials that were being used in 1945.

Every woofer in the HPM series, however, is made with a special carbon fiber blend that's allowed us to decrease the weight of the cone, yet increase the strength needed for clarity. So you'll hear the deepest notes exactly the way the musician recorded them.

And because every HPM woofer also has an oversized magnet and long throw voice coil, they can handle more power without distorting.

OTHER FEATURES YOU RARELY HEAR OF

Every HPM speaker has cast aluminum frames, instead of the usual flimsy stamped out metal kind. So that even when you push our speakers to their limit, you only hear the music and never the frames. In fact, our competitors were so impressed, they started making what look like die cast frames, but aren't.

HPM speaker cabinets are made of specially compressed board that has better acoustic properties than ordinary wood.

Their speakers have level controls that let you adjust the sound of the music to your living room. And these features are not just found in our most expensive HPM speaker, but in every speaker in the HPM series.

All of which begins to explain why, unlike speakers that sound great on only part of the music, HPM speakers sound great on all of it.

At this point, we suggest you take your favorite record into any Pioneer Dealer and audition a pair of HPM speakers in person.

If you think what went into them sounds impressive, wait till you hear what comes out of them.

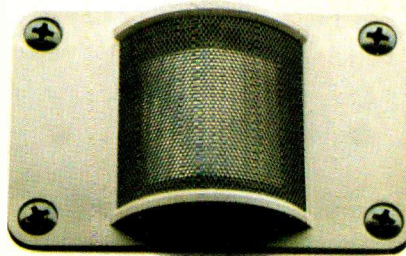

The High Polymer Molecular Supertweeter. So incredible, we named a whole line of speakers after it.

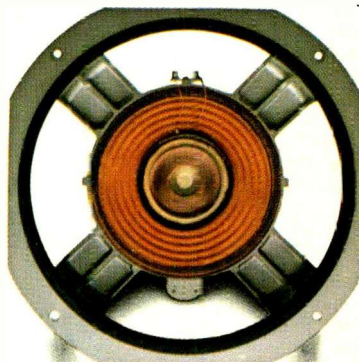

You'll never hear a sound out of these die cast aluminum speaker frames.



Level controls that let you adjust the sound to your listening area.

PIONEER
We bring it back alive.

**WHAT COMES OUT
OF A SPEAKER IS ONLY
AS IMPRESSIVE AS
WHAT GOES INTO IT.**

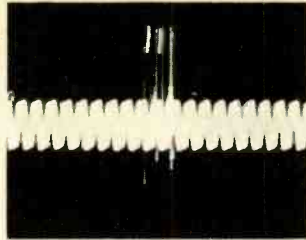

Actual, unretouched photo of an oscillograph test.

The oscillograph you see is an actual photo of a high-quality audio system "playing" a fingerprint.

You're hearing fingerprints now through your speaker system. Instead of the sound your precious discs are capable of. And no vacuum record cleaner, brush-arm or treated cloth will remove them. None.

The sound of your fingerprint

But Discwasher® — with new **D3** fluid — removes fingerprints completely. Along with dust. And manufacturing lubricants (added to make pressing faster) that can act like groove-blocking fingerprints. All this cleaning without pulling polymer stabilizers from your vinyl discs.

Discwasher™. The only safe, effective way to silence the printed finger. At Audio specialists world wide.



Discwasher, Inc.
Columbia, Mo. 65201



June 1979

Vol. 63, No. 6

Audio

"Successor to **RADIO** Est. 1917"

Feature Articles

Do Turntable Mats Work? You Bet!	42	Robert Stockton
Aphex—Tool of Hit Record Makers	46	Paul Laurence & George Pontis
The Fine Art of Tweaking Your Turntable	52	Bob Gary
An Overview of SID & TIM	59	Walter G. Jung, Mark L. Stephens, & Craig C. Todd

Equipment Profiles

Yamaha CR-2040 Receiver	74	Leonard Feldman
Technics RS-M85 Cassette Deck	87	Howard A. Roberson
ReVox B790 Turntable	92	George W. Tillett
Realistic SCT-30 Cassette Deck	94	George W. Tillett
ADS 10 Digital Time Delay System	98	Leonard Feldman
Akai Gx 267D Tape Deck	106	Howard A. Roberson

Record Reviews

Top of the Pile	108	
The Column	111	Michael Tearson Jon Tiven
Jazz & Blues	115	
Classical Records	124	Edward Tatnall Canby
Folk Bag	129	Tom Bingham
European Records	131	John S. Wright

Audio in General

Audioclinic	6	Joseph Giovanelli
Behind The Scenes	8	Bert Whyte
Videoscenes	16	Bert Whyte
Tape Guide	22	Herman Burstein
Audio ETC	26	Edward Tatnall Canby
What's New in Audio	36	
Dear Editor	40	
Classified Advertising	135	
Advertising Index	146	

About the Cover: You can get the sound of the future by using a good mat and other "tweaks" discussed in Robert Stockton's and Bob Gary's articles. Model: Sue Greco. Costume by Capri-corn, Philadelphia. Photo by Photographic Illustrations, Philadelphia.



Audio Publishing, Editorial, Subscription, and Advertising Production offices, North American Building, 401 No. Broad St., Philadelphia, Penna. 19108. Telephone: 215/574-9600.
Postmaster: Send Form 3579 to above address.

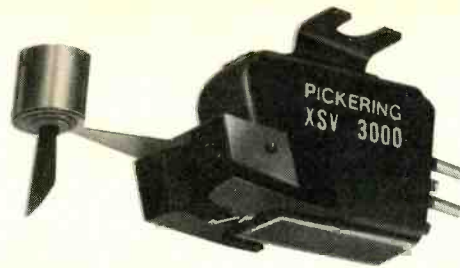

The XSV/3000 is the source of perfection in stereo sound!

Four big features ... all Pickering innovations over the past 20 years ... have made it happen.

1976: Stereohedron® This patented Stylus tip assures super traceAbility™, and its larger bearing radius offers the least record wear and longest stylus life so far achievable.

1975: High Energy Rare Earth Magnet Another Pickering innovation, enabling complete miniaturization of the stylus assembly and tip mass through utilization of this type of magnet.

1968: Dustamatic® Brush This Pickering patented invention dynamically stabilizes the cartridge-arm system by damping low frequency resonance. It improves low frequency tracking while playing irregular or warped records. Best of all, it provides record protection by cleaning in front of the stylus.

1959: Record Static Neutralizer The patented V-Guard Record Static Neutralizer has been a feature of all Pickering cartridges since 1959. It eliminates electrostatic dust attraction at the stylus and discharges record static harmlessly into the grounded playback system.

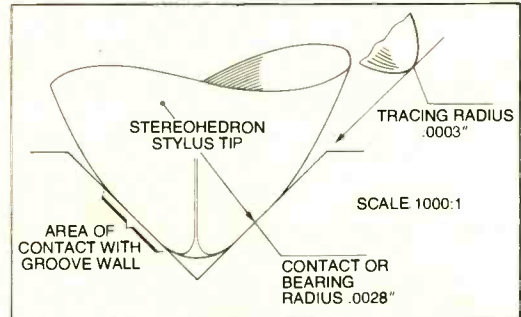

1. Technical drawing of the Stereohedron shape.

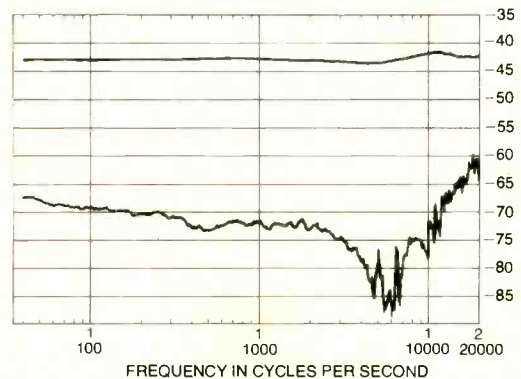

2. Typical frequency response and channel separation curves of the XSV/3000.

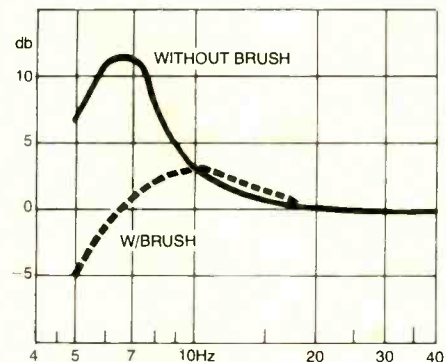

3. Damping effect on tonearm resonance.

4. V-Guard Static Neutralizer, "Where the Stylus meets the groove."



For further information write to Pickering & Co., Inc., Dept. A, 101 Sunnyside Blvd., Plainview, N.Y. 11803

© Pickering & Co. Inc., 1978

Enter No. 48 on Reader Service Card



INTRODUCING THE EMPIRE EDR.9 PHONO CARTRIDGE. IT SOUNDS AS GOOD ON A RECORD AS IT DOES ON PAPER.

It was inevitable . . .

With all the rapid developments being made in today's high fidelity technology, the tremendous advance in audible performance in Empire's new EDR.9 phono cartridge was bound to happen. And bound to come from Empire, as we have been designing and manufacturing the finest phono cartridges for over 18 years.

Until now, all phono cartridges were designed in the lab to achieve certain engineering characteristics and requirements. These lab characteristics and requirements took priority over actual listening tests because it was considered more important that the cartridges "measure right" or "test right"—so almost everyone was satisfied.

Empire's EDR.9 (for Extended Dynamic Response) has broken with this tradition, and is the first phono cartridge that not only meets the highest technological and design specifications—but also our

demanding listening tests—on an equal basis. In effect, it bridges the gap between the ideal blueprint and the actual sound.

The EDR.9 utilizes an L. A. C. (Large Area Contact) 0.9 stylus based upon—and named after—E. I. A. Standard RS-238B. This new design, resulting in a smaller radius and larger contact area, has a pressure index of 0.9, an improvement of almost six times the typical elliptical stylus and four times over the newest designs recently introduced by several other cartridge manufacturers. The result is that less pressure is applied to the vulnerable record groove, at the same time extending the bandwidth—including the important overtones and harmonic details.

In addition, Empire's exclusive, patented 3-Element Double Damped stylus assembly acts as an equalizer. This eliminates the high "Q" mechanical resonances typical of other stylus assemblies, producing a flatter response, and lessening wear and tear on the record groove.

We could go into more technical detail, describing pole rods that are laminated, rather than just one piece, so as to reduce losses in the magnetic structure, resulting in flatter high frequency response with less distortion. Or how the EDR.9 weighs one gram less than previous Empire phono cartridges, making it a perfect match for today's advanced low mass tonearms.

But more important, as the EDR.9 cartridge represents a new approach to cartridge design, we ask that you consider it in a slightly different way as well. Send for our free technical brochure on the EDR.9, and then visit your audio dealer and listen. Don't go by specs alone.

That's because the new Empire EDR.9 is the first phono cartridge that not only meets the highest technological and design specifications—but also our demanding listening tests.

Empire Scientific Corp. **EMPIRE**
Garden City, N.Y. 11530

Enter No. 19 on Reader Service Card

Audioclinic

Joseph Giovanelli

Turntable Hum

Q. I'm having difficulty in eliminating a loud hum from my turntable which is connected to the receiver. My receiver is grounded to the wall outlet and the ground lead on the turntable is connected to the receiver ground. I have a timer plugged into one outlet, and my receiver is also plugged into a clock. What can be done to remedy this hum? — O.B. Madenwald, Hines, Or.

A. The interconnecting cable between the turntable and the receiver must be short and direct and not run near a.c. lines. If you have harnessed this line among many other cables, including a.c. lines, hum is sure to occur.

The location of the turntable itself is somewhat critical. Components having coils or power transformers must be kept well away from the phono cartridge. Is the receiver or tape deck mounted directly above or below the turntable? If so, you will likely have hum. The hum may vary as the phono cartridge is moved over the surface of the disc. When this occurs, you will know that the cartridge is picking up stray magnetic fields, and it must be moved away from the presence of such fields.

Your timer also has a motor which must be kept away from the turntable as it is not shielded and is certain to radiate stray hum fields.

Turntable Drive Systems

Q. Much is mentioned in audio literature about the design parameters used in turntables. Manufacturers are always boasting about either their belt- or direct-drive systems. Can you elaborate, specifically, on the drive system/rotor assembly? — Thomas Maguire, Bronx, N.Y.

A. Motor rotors must be kept well balanced if vibration is to be kept to a minimum. This is true regardless of other considerations such as belt drive or direct drive. There is always vibration from a motor, especially when that motor must turn at a relatively high speed, as with a belt-driven motor. However, if the motor is properly shock-mounted, then the belt itself serves as a good isolator between the motor shaft and the turntable. The shaft must be as "true" as possible, otherwise it will cause the belt to vi-

brate and this vibration will be transmitted to the turntable and then into the phono cartridge as rumble. The flywheel action of the platter will prevent these shaft eccentricities from producing "flutter." Properly designed and manufactured, belt-driven turntables are excellent.

Direct-drive turntables are more complicated in their design, as the motors used with them must turn at the same speed as the platter. In this design, precautions must be taken to avoid having the motor hesitate between successive magnetic poles. This hesitation, if transmitted to the platter, takes the form of flutter and rumble. Because of the slow rotational speed of such motors, vibration is very low; and this is essential because of the direct coupling between the motor and the platter. When properly constructed, these turntables function very well indeed.

Pre-Preamp Uses

Q. Do pre-preamplifiers and/or step-up transformers have other uses besides their applications with moving-coil cartridges? — S. Campanile, Pleasant Hills, Cal.

A. The only other possible use for either a pre-preamplifier or a step-up transformer is to boost the signal on experimental ribbon microphones, whose impedance is also very low.

Outdoor Antenna Noise

Q. In the metropolitan area where I live there are many FM stations and nearby hills cause multipath interference on some stations and block reception on others. I am using a directional outdoor FM antenna mounted 25 feet above ground level connected to my receiver with a coaxial cable. However, when using the outdoor antenna, I hear a crackling noise on medium strength and weak stations. Switching to a simple, indoor dipole usually eliminates the crackling, but increases background hiss. What causes the crackling noise? What kind of lead-in cable is best, coaxial or shielded twin-lead? Would raising the antenna higher help? — Bill Hatchell, Hayward, Cal.

A. Some improvement can be obtained by stacking antennas. You may be able to use two or perhaps four

directional antennas to make the directional pattern sharper, minimizing the pickup of reflections from directions other than those from the desired signal.

It sometimes works out that by pointing the antenna in a direction other than that of the desired signal, you can pick up a reflection of the desired signal better and with less multipath distortion, rather than pointing the antenna directly at the transmitting tower.

In severe multipath problems the use of a coaxial cable is better than a shielded twin-lead. The shielding of the coaxial cable is more effective, thereby eliminating signal pickup by the cable itself.

There is a chance that the noise you hear is the result of your antenna being located too close to a power line or some industrial plant. The indoor antenna is, perhaps, further away from the power line, hence, less likely to pick up interference from it.

Raising the antenna might allow it to clear power lines, thus lessening the crackling noise and possibly helping to reduce multipath distortion. Also, moving the antenna to a new location can help. Just a small change in antenna position can often produce a situation where reflections are less, with an attendant reduction in multipath distortion.

Low-Impedance Loads

Q. My amplifier is rated at 30 W per channel, and my two pairs of speakers (one rated at 8 ohms and the other at 4 ohms) are connected to the main and remote speaker terminals. The sound, this way, is better than with either pair alone. I figure that the total impedance is 2.5 ohms. Does this constitute a danger to the amplifier? — Albert Sadler, San Diego, Cal.

A. If the amplifier manufacturer states that you can run it with loads of less than 4 ohms, then there will be no danger to your amplifier. However, if the instructions do not state this, then you run the danger of damaging your amplifier.

If you have a problem or question about audio, write to Mr. Joseph Giovanelli at AUDIO Magazine, 401 North Broad Street, Philadelphia, PA 19108. All letters are answered. Please enclose a stamped, self-addressed envelope.

You're looking at three ways Technics pursues the one ideal. Waveform fidelity.



Waveform fidelity. It should be the objective of any professional component. Because perfect waveform fidelity would mean an output signal that's a mirror image of the input signal.

How do our engineers pursue this elusive goal? To begin with, they use two automatically switchable IF bands in the ST-9030 FM tuner. A narrow band for extra-sharp selectivity. And a wide band for extra-high S/N and extra-low distortion. But just as significant is a pilot-cancel circuit which Technics developed for high-frequency waveform fidelity. Even the basic tuning function in the ST-9030 is unique. Like an 8-ganged tuning capacitor for outstanding reception.

The engineering in the SU-9070 DC preamp is similarly impressive. There's a moving coil preamp with -157 dBV noise voltage. A moving magnet preamp with an extremely high S/N of 100 dB (10 mV input). Direct-coupled circuitry to keep distortion at a minimum of 0.003% (rated THD). What's more, the SU-9070 has inputs for three tape decks.

Finally there's Technics SE-9060 amp. It's DC like our preamp. Has a frequency response of 0-100 kHz (+0, -1 dB). And a "strapped" circuit for more than

double the power in a multi-amp system. Compare specifications and prices. We think you'll agree. There's no comparison for these Technics components.

ST-9030. THD (stereo, 1 kHz): Wide—0.08%. Narrow—0.3%. S/N (mono): 80 dB. S/N (stereo): 73 dB. FREQUENCY RESPONSE: 20 Hz—18 kHz +0.1, -0.5 dB. SELECTIVITY: Narrow—90 dB. CAPTURE RATIO: Wide—0.8 dB. IF, IMAGE and SPURIOUS RESPONSE REJECTIONS (98 mHz): 135 dB. STEREO SEPARATION (1 kHz): Wide—50 dB.

SU-9070. PHONO MAX. INPUT VOLTAGE (1 kHz RMS): MM—380 mV. MC—9 mV. S/N MM—100 dB (10 mV input). MC—72 dB (60 μ V). FREQUENCY RESPONSE: Phono 20 Hz—20 kHz (RIAA \pm 0.2 dB).

SE-9060. POWER OUTPUT: 70 watts per channel (stereo), 180 watts (mono) min. RMS into 8 ohms from 20 Hz to 20 kHz with no more than 0.02% total harmonic distortion. S/N: 120 dB.

Technics. A rare combination of audio technology. A rare standard of audio excellence.

Technics

Professional Series

Enter No. 67 on Reader Service Card

Behind the scenes

Bert Whyte

Recently I was rummaging through some old papers looking for an article, and I ran across a 1951 hi-fi catalog. I got quite a kick browsing through it and recalling many of the components, which in their day were considered quite advanced. Magnetic phonograph cartridges were relative newcomers to the market and were a significant improvement over the crystal and ceramic piezoelectric types. Listed as the General Electric variable-reluctance magnetic cartridge, selling for \$5.95! Obviously, back in those good old days, inflation was something you did to automobile tires.

Shortly thereafter I had the pleasure of visiting Joe Grado at his home. As I am sure many of you are aware, Joe Grado is one of the pioneers in manufacture of magnetic phono cartridges, and his products have occupied their special niche in the hi-fi components market for over 25 years. I was talking to Joe about that old catalog and the \$5.95 GE cartridge, and he pointed out that now, 28 years later, his F-1 magnetic cartridge sells for just \$9. It is, of course, a far more sophisticated design, light years ahead in performance than the old GE unit, and just another example of why hi-fi components are still considered the best value among current products.

Joe Grado is no stranger to the pages of *Audio*. His interesting and provocative articles on turntables, suspensions, and shock mounting have elicited much favorable comment. Joe is quite an iconoclast, and many of his ideas and techniques are considered both unorthodox and controversial. While Grado Laboratories has grown and prospered over the years, Joe is the first to admit that it is a small operation compared to the giants in the field. And that is the way Joe wants it. As his own man, free of any managerial constraint, he is able to pursue any

line of experimentation that he finds of interest. Joe is an inveterate and indefatigable experimenter in his own field and in allied audio interests. In fact, this activity has caused some tongue-in-cheek comments about him, such as . . . "If you bought this Model X cartridge on Monday, come back on Friday, and you can buy the revised, updated Model X, Mark Two." Among other attainments, Joe is an operatic bari-tenor who is good enough to have sung lead roles with some opera companies here and abroad. He has tremendous output, and when he belts out an aria from "Otello," believe me, your ears will ring! His singing and his abiding love of music have helped to develop his keenly analytical ear for sound quality.

All the Grado phonograph cartridges, with one exception, are manufactured at the Grado Laboratories' factory in Brooklyn, N.Y. The exception is the "Joseph Grado Signature Three" model, which is hand made in a small laboratory in Joe's home. I spent most of a day in Joe's home lab where he showed me the fascinating process of how he personally makes and tests his Signature Three phono cartridge. During that time, Joe discussed some of his theories with me and explained the rationale of some of the design features of his cartridge. At this point, I should note that Joe Grado is in the unique position of manufacturing the least expensive magnetic cartridge in the field, the F-1 at \$9,

and the most expensive, the Signature Three, at a rather breathtaking \$750!

High-Priced Parts

It must be admitted that high-end audio components have been getting very high indeed of late. With Infinity, Beveridge, and Plasmatronic speakers priced between \$6000 to \$7000 a pair, the new Infinity amplifier at \$4000, the GAS Godzilla at \$3500, and a pair of mono Mark Levinson ML-2 amplifiers at \$4200, those are pretty rarified prices! In relative terms, the \$750 Signature Three cartridge would appear to fall right in with this group. Unquestionably, many of the owners of this exotic equipment do use the Signature Three. However, because a phono cartridge is such a small component and because no other cartridge has ever been priced this high, many audiophiles are outraged at what they consider a "rip-off!" The Signature Three has become the "darling" and "in" cartridge of the underground "audiophile" publications, and while they are lavish in their accolades for this cartridge, they also moan and groan about the price.

The Signature Three is a magnetic cartridge of the moving-iron type. You would think that in a cartridge in this price range, the cantilever would be made of some exotic material like beryllium or titanium. Joe stated he had researched these and other materials, and they exhibited resonances which he found unacceptable. If anything can be said to characterize Joe's designs, it is his almost fanatic quest for the reduction of spurious resonances. Joe feels that resonances are often the hidden culprits in the creation of sound coloration, which diminishes the cleanliness or flaws the illusion of reality of the sound. In light of this, Joe uses a hardened, tapered aluminum cantilever, which is internally coated with a special damping compound to reduce resonances. The coils in the cartridge's magnetic circuit are wound on precision machined bobbins, using a very fine wire, and, be-

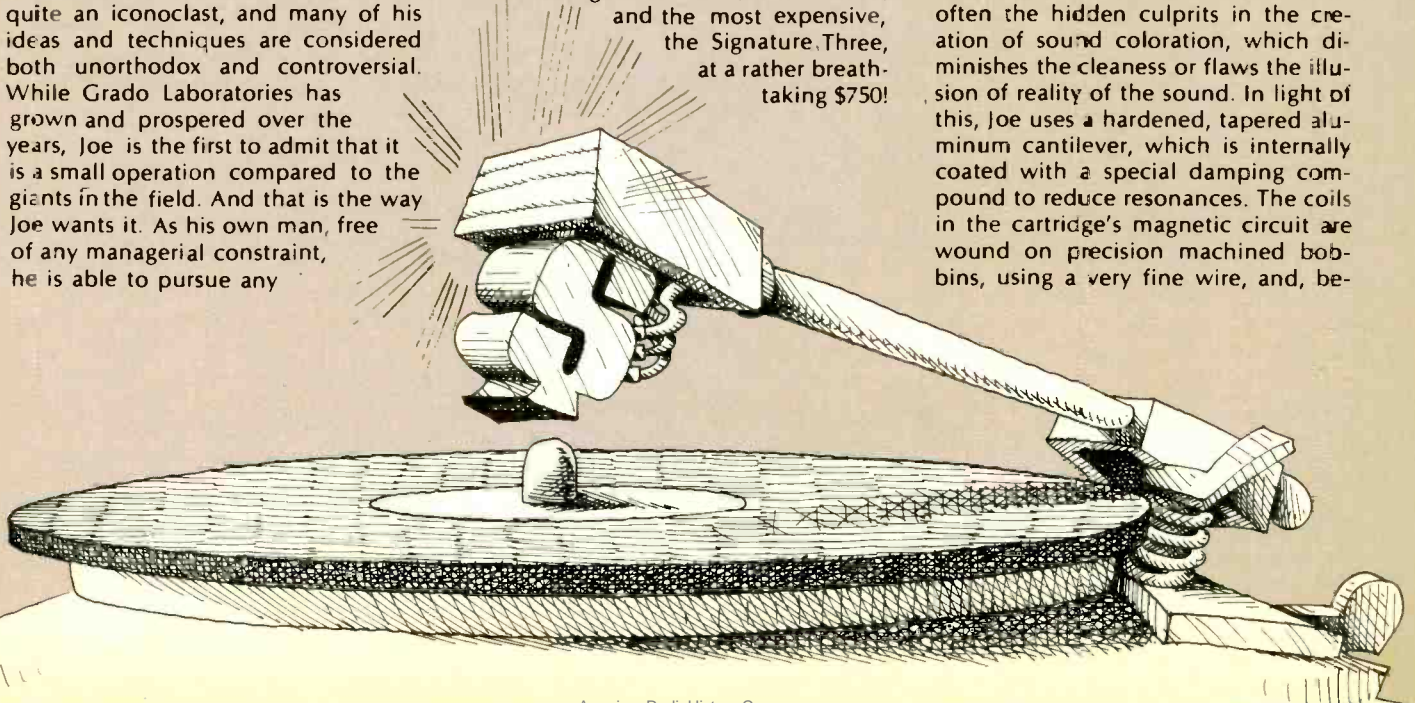

WHICH NEW HIGH BIAS TAPE WINS WITH MAHLER'S FOURTH SYMPHONY?

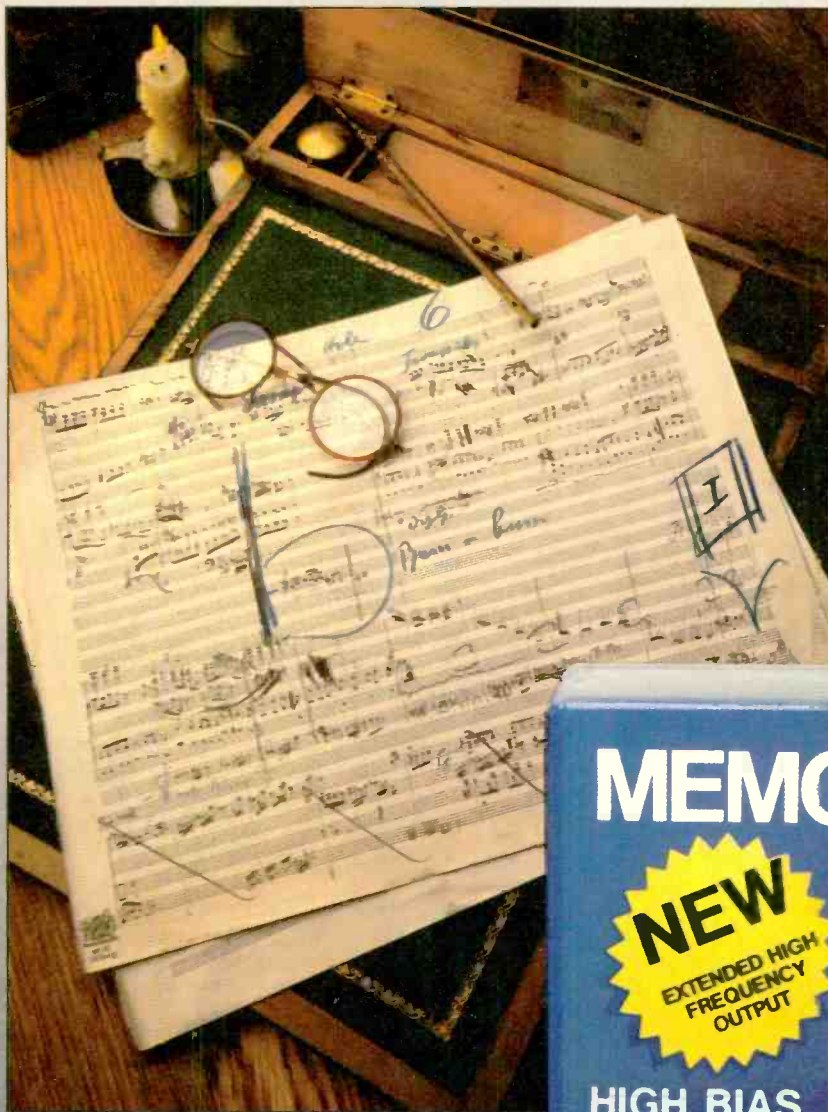

Original manuscript sketch for the first movement of Gustav Mahler's Fourth Symphony. Courtesy of The Newberry Library, Chicago.

Choose eight measures of Mahler's Fourth that are really rich in the high frequencies. The type of passage that high bias tapes are designed for.

Record it on your favorite high bias cassette, using the Chrome/CrO₂ setting. Then again on new MEMOREX HIGH BIAS.

Now play back the tapes.

We're convinced you'll have a new favorite.

New MEMOREX HIGH BIAS is made with an exclusive ferrite crystal oxide formulation. No high bias tape delivers greater high frequency fidelity with less noise, plus truer response across the entire frequency range.

In short, you can't find a high bias cassette that gives you truer reproduction.

MEMOREX

Recording Tape and Accessories.
Is it live, or Is it Memorex?



cause of the design, use a minimum number of turns of wire. This results in a cartridge of very low inductance and raises the resonant peak far above the audio range.

There are four separate and independent magnetic gaps, and I watched Joe, working with a high-powered magnifier, precisely position the cantilever in the center of the four gaps and cement it in place with a tiny spot of epoxy he had melted in a small laboratory furnace. At the base of the cantilever there is a tiny ring of a very special "pure" iron, which exhibits very low hysteresis effects and has the

property of being magnetized very rapidly and, conversely, of equally rapid demagnetization. The motion imparted to the cantilever by the undulations of the recorded signal moves the tiny iron ring in the center of the four gaps, increasing and decreasing the intensity of the magnetic flux in the four independent gaps.

The result is a balanced magnetic circuit of high efficiency, and, unlike most cartridges, it does not require heavy mu-metal shielding. The stylus Joe uses is what he calls the "twin-tip," which is, in essence, a twin spherical tip. If you imagine a screwdriver

blade in the record groove, with the shoulders of the tip ground off to spherical shape, you'll get the idea. Joe states that this affords less mass and better tracking than the typical "long line contact" types. He also says that this design does not exhibit vertical angle changes, and as a consequence "stick-slip" is greatly reduced.

Stylus-Groove Friction

Stick-slip is a function of the friction between the diamond of the stylus and the vinyl of the record. Although one thinks of the stylus "gliding" along a record groove, as the vinyl passes underneath the stylus, friction tends to "pull" and slightly deform the vinyl up to the point where there is finally a "catastrophic" release of the vinyl . . . and then the process begins all over again. All this causes what might be termed a subtle or, in bad cases, an extreme groove "chatter," with subsequent physical damage to the record groove.

Engineers are aware of this phenomenon, and, at present, there is work going on to produce a satisfactory groove lubricant, which will neither leave a residue nor degrade the record either physically or sonically. As a matter of fact, I recently heard a record treated with an experimental lubricant, and there was no question that the reduction of stick-slip definitely gave cleaner, better-defined, high-frequency response.

Grado also put a piece of a temperature-stable elastomer in the cantilever structure, not for damping, as is the usual case, but to maintain the pivot center of the assembly. Joe claims that his Signature Three cartridge has the lowest effective tip mass of any existing cartridge and says optimum performance of his cartridge is via a damped, medium-mass arm. He is, in fact, working on a radically new type of arm, which he claims will literally "couple" the arm/cartridge to the record groove. It may be introduced this fall.

There are also a number of very critical adjustments Joe performs on his cartridge, in conjunction with exhaustive tests on his lab bench. The cartridge is fitted into the special Technics EPA-100 tonearm which is only sold as part of the SL-1000 turntable with its beautiful 37-pound lava rock and epoxy black base. For testing, Joe uses a General Radio frequency response tracer, a Hewlett Packard spectrum analyzer with various test records to check harmonic distortion and intermodulation distortion, special pulse tests for transient accuracy, and others. To show the consistency and accuracy

The Interaudio® I. It shows the European appreciation for performance in a compact size.

The Interaudio® I speaker has been one of the best-selling speakers in Europe. Why?

Because Europeans truly appreciate the speaker's outstanding performance, as well as its very compact size.

The Interaudio I fits just about anywhere. On a small bookshelf, the wall or in your van. But no matter where you put it, the Interaudio I delivers a deep, powerful bass and crisp clean highs.

The key to this tremendous sound in such a small speaker is the careful integration of woofer, tweeter, and crossover by the same engineers who developed the famous Bose® 901® Direct/Reflecting® speakers.

Not every stereo dealer carries the Interaudio® I. But then again, you can't buy a BMW at every car lot, either.

Interaudio®

Bose Corporation
Framingham, Massachusetts



BMW 320i courtesy of Auto Engineering, Inc.

THE JVC CASSETTE DECK.

It gives you more of what the others wish they could.

Cassette recording takes a giant step forward with the new series of JVC cassette decks. Each is designed to give you everything you need to get the most out of any tape. And there are totally new features to help you make better-sounding cassettes.

Exclusive Spectro Peak Indicator System.

With almost recording studio vigilance, 25 instant-responding LED indicators offer fail-safe protection against distortion produced by tape over-saturation. For the first time, you can constantly visually monitor the levels of five low-to-high musical frequency ranges. Then, on playback, the Spectro Peak Indicator actually lets you see how accurately the deck has performed.

Expanded Dynamic Range and Better Noise Reduction.

Our Super ANRS circuitry applies compression in recording and expansion in playback to improve dynamic range at higher frequencies. So distortion is eliminated in sudden high peaks of any musical

program. Super ANRS also reduces tape hiss by boosting the deck's signal-to-noise ratio by as much as 10dB over 5000Hz.

New Head Design.

Our refined Sen-Alloy head gives you the sensitive performance of permalloy head construction, combined with the extreme longevity of ferrite, for bright, full-sounding recordings.

Get the most out of any tape

Because whichever type you select, you'll extract the most from it with our special recording equalizer circuit that lets you "fine tune" the high frequency response of the deck to the exact requirements of the tape. These innovations alone set JVC cassette decks apart from all the others. Then, when you consider our other refinements, like precision-ground capstans, gear/oil-damped cassette doors, multi-peak LED indicators, independent drive mechanisms, plus top performance specifications, you can understand why we say that JVC gives you more of what other decks wish they could. Visit your JVC dealer and you'll hear why.

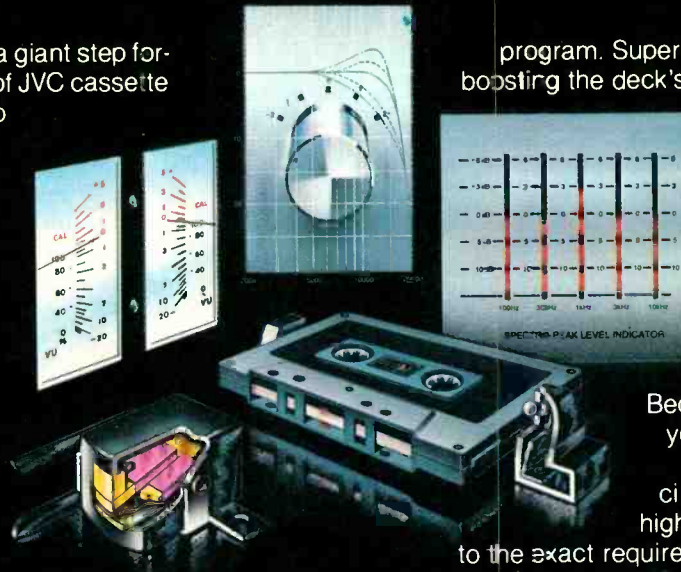

Top: KD-65, KD-55, KD-25. Bottom: KD-10, KD-1770 II, KD-1636 II. Not shown: KD-2, KD-3030, KD-S201.

JVC



JVC High Fidelity Division, US JVC Corp., 58-75 Queens Midtown Expy., Maspeth, N.Y. 11378. Canada: JVC Electronics of Canada, Ltd., Ont.

Enter No. 31 on Reader Service Card

HOW THE MODEL 100 BRINGS A WHOLE NEW FEELING TO YOUR MUSIC

In recent months, we've received rave comments from all kinds of music lovers about our new Model 100 Subharmonic Synthesizer. "I can't believe what sounds I've been missing;" "It adds fullness to the bass that you normally only hear and feel in a live concert;" "It adds presence and impact to disco music although I use it most of the time with classical records;" "I have a whole new record collection now;" and so on.

But besides these great comments, most new Model 100 owners also wanted to know just how it improves the low-frequency performance of their music systems. So, we're happy to oblige.

As the block diagram below shows, the music signal from your preamplifier (usually taken from the tape monitor output jacks) is fed directly into the Model 100. Its circuits send the full frequency range of this signal straight through. Simultaneously, the Model 100 selects the lowest notes in the signal (between 50 and 100 Hz), creates a companion signal an octave lower, and mixes it back with the original musical signal. A front panel control allows you to vary the level of the added subharmonic signal, and there's a special output for use with subwoofer systems too.

What happens is that you literally achieve a sense of "being there" —with more excitement from your music than ever before—no matter whether you're listening to disco, rock, or classical music.

Now that you know how the Model 100 works, we suggest that you experience the full impact of this unique electronic component at your dbx dealer. The dbx Model 100: just one of our keys to unlocking your ears.

dbx, Incorporated, 71 Chapel St., Newton, MA 02195, (617) 964-3210.

dbx
UNLOCK
YOUR EARS

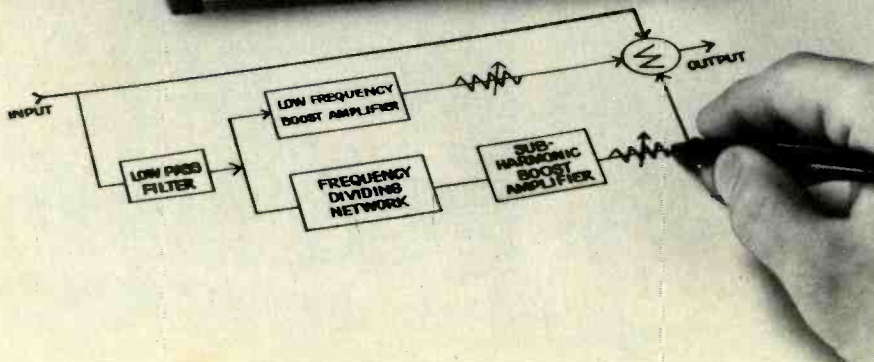

of his Signature Three cartridges, Joe ran through about 15 different cartridges playing back some high-quality music recordings, and for all practical purposes, the sound was the same for all units.

Cost Consciousness

Now for the all important question... can one justify \$750 for a phono cartridge? Is it worth the money? First off, there are many fine cartridges on the market, far lower in price, and for many people they do a good job. It must be said that many of these people either do not have systems of requisite high quality or are aurally incapable of discerning sonic differences between the cartridges. Still others have listening situations with so many variables in speaker response, preamps, room acoustics, etc. that they might be misled in any comparison tests. For example, a moving-coil cartridge with a "peaky" or sizzly top end might sound good by virtue of a speaker that has a compensating rolloff in its high frequency response.

No, the Signature Three is not a cartridge for everyone. It has qualities that demand it be played on the very best equipment. There are those audiophiles who favor the sound of moving-coil cartridges over moving-iron or moving-magnet types, and vice versa. In the purest sense this shouldn't be a factor, as ideally, the best cartridge will not have a "distinctive" sound at all. If it does, coloration of some sort is lurking somewhere. It must be acknowledged that many people like these "colorations," either because they correct sonic faults not readily evident elsewhere in the listener's system or they just find them to produce a sound they *think* is accurate and realistic.

I have listened to many fine cartridges of all types, but in overall smoothness of sound, for outstanding resolution of inner detail, for transparency and the perception of depth, for clean, solid, well-defined bass, and, above all, for lightning-fast transient response, the Grado Signature Three is in a class by itself. I hasten to add that the very highest quality recordings are necessary to find out what this cartridge can do. The quality of information that can be extracted from the best of the direct-disc and digital recordings is truly impressive and gratifying. It would be nasty to say that you "gets what you pays for" and there are plenty of other cartridges that you can live with, but if your Aunt Fanny leaves you a small remembrance, you should listen to this exceptional phono cartridge. 

AUDIO • June 1979

Enter No. 16 on Reader Service Card

When you Test-drive the best speakers from Britain you'll drive home with real sound.

You're a confirmed audiophile and nobody can fool you with a lot of promises.

You're ready for the ultimate test and only your ear will be convinced.

When you test-drive the best from Britain we know we'll have your ear and maybe a lot more.

When you're ready, take a variety of recorded music into your dealers. (Use direct disc recordings so you can put our speakers to the real test.)

We know you'll be amazed at the accuracy.

And we'll have turned another confirmed audiophile into a dedicated Anglophile.

We've been convincing lovers of sound in Britain for over half a century. And we've earned our reputation as the leader by not compromising.

We don't rely on gimmicks. Every speaker in our completely new line of systems is based on sound engineering principles and tested thoroughly.

As you know, with everything in audio, it's the end result that counts, not the means to get there.

But we don't neglect the means either. To get your ear, we use our English craftsman's pride in carefully putting together the right components for delivering a broad range of sound smoothly and uniformly so you get the flattest response possible.

When you take a look at the specs you'll see what we mean.

We've shown the Ditton 662, but all three new Ditton speakers, besides being technologically superb and precision engineered, are beautifully styled and assembled in the fine English cabinet-making tradition, to fit into any decor.

And we've used a completely different design concept for each of them to satisfy your individual taste and budget.

So now that you've grown up to real sound, you can test-drive your choice of the best sound from Britain.

But you won't be able to find them at just any dealer. For our select list of shopkeepers who carry Celestion, simply drop us the coupon and we'll send you the list by return post.

But don't delay, the traffic may be heavy.



First we'll start with the Ditton 442—made for the music lover, who wants full bass sound.

Large presentation for hi-power system.

Sealed box design—inside, a second sealed infinite transmission line enclosure for the mid-range unit.

Drive units: FC 121, 330 mm bass unit with 46 mm voice coil.

FC 61, 130 mm mid-range with 25 mm voice coil.

HF 2001 treble unit with 19 mm voice coil.

Controlled by 14 element dividing network with fuse protection for the treble unit.

What you get is less restriction, overall balance openness with no coloration.



Then move up to the Ditton 551

For outstanding dispersion—tight sound. A vented box design with improved bass response from a smaller bass unit.

Drive units: PC 101, 290 mm bass unit with 50 mm voice coil.

MD 701 mid-range with 46 mm voice coil.

HF 2001 treble unit with 19 mm voice coil.

Controlled by 15 element network with fuse protection and failure light for the treble unit.

Also level controls for treble and mid-range up to 2 dB boost and 6 dB cut.



And finally, the top of the line, the Ditton 662.

Our passive radiator (ABR) system gives solid bass, smooth response and dispersion, and stereo imaging. Use with all power amplifiers.

Has 3 active drive units and passive radiator.

Drive units: FC 122 bass unit, 330 mm passive with double suspension for pure axial movement.

MD 501 mid-range with 52 mm voice coil.

HF 2001 treble unit with 19 mm voice coil.

Controlled by 14 element network with fuse protection for treble unit.

Mail to:
Celestion Industries, Inc., Dept. A-69
Kuniholm Drive
Holliston, Ma. 01746

Gentlemen: I'm ready to test drive the best speakers from Britain. Please send me more information on:
 Ditton 662 Ditton 551 Ditton 442
 Name of nearest Celestion dealer

Name _____
Address _____
City _____ State _____ Zip _____
Name of speakers you currently own _____

Celestion.
Nobody sounds better than the British.

Enter No. 12 on Reader Service Card

Video scenes

Bert Whyte

This column was initiated because of the ever-growing ties between video and audio in the ongoing "home entertainment revolution." We have been concerning ourselves with every aspect of the booming video scene . . . video cassette recorders for the home, portable VCRs with both black and white and new lower cost color cameras, projection video systems, the various video disc systems, video software, etc. These various elements of the video scene are all part of a vital and exciting new industry that will become an ever more important contributor to the national economy. However, the rosy prospects of this industry are currently being threatened by a legal action which began near the end of January in Los Angeles.

Of all things, Walt Disney Productions and MCA, Inc., the parent company of Universal Pictures, are suing Sony Corporation of America, Sony-Japan, Sony's American advertising agency, and four VCR retailers. They claim that the manufacture and sale of the Sony VCR Betamax is a threat to their business, because home taping of their films is a breach of their copyright protection. They are asking for damages and, more importantly, an injunction against Sony restraining them from future alleged violations. In other words, if Disney and MCA were to win this suit, the sale and use of VCR units in this country would come to a screeching halt! Needless to say, the arguments are flying thick and fast, and, as far as I am concerned, most of the allegations made by Disney/MCA are specious, bordering on the absurd,

and display an incredible naivete in respect to the realities of the American home entertainment market. I'll go into some of the claims and contentions shortly, but first let us look at Sony's basic defense. They state that the use of the Betamax in the home is within the "fair use" stipulation in the national copyright law, and, with that proviso, they are not in violation of the law.

Sony has an important precedent on their side. If home videotaping is illegal, then so is audio taping. Recording is recording, whether it is "off the air" or "off TV" or from records or tapes or whatever. From a strictly legal viewpoint, audio taping has never been fully resolved. Which is why there is the "fair use" clause in the copyright act. Implicit in it is the "opinion" and "understanding" that as long as the audio material recorded is for the private use of the individual and is not subsequently offered for sale, the copyright law has not been violated. There is absolutely no reason, legally, technically or morally to categorize home video recording as a "special circumstance" different from the home audio recording practices of private individuals. Every day, millions of audio recordings are made of copyrighted material from radio broadcasts and from commercial recordings within the "ground rules" of the "fair use" stipulation, and you don't see the broadcasters or the recording companies rushing out to sue the manufac-

turers of audio tape recorders for loss of revenue!

I remember very vividly a somewhat similar situation to this present imbroglio in 1965. Some executives of RCA and several other record companies were screaming loudly that so many tape recorders were in the hands of the public, and so much blank tape was being sold, that "off the air" recording was rampant and this would seriously reduce the sales of their recordings. Nothing of the sort happened, and, of course, there has been a tremendous increase in the sales of cassette recorders and blank tape, accompanied by a vast expansion of the record market, to the extent that at some three and a half billion dollars per year, it has surpassed the movie industry in revenues. As is well known, a very common practice is that consumers buy recordings and transfer them to cassettes. Allowing that there is some interchange of these recordings between friends, this still constitutes a sizable market. On top of that, prerecorded cassettes sell very well, another indication that "off the air" recording does not significantly cut into record company sales.

In the Los Angeles trial before U.S. District Court Judge Warren J. Ferguson, Donn Tatum, Chairman of the Board of Disney, stated he would rather have a viewer miss a televised Disney program in its regular broadcast time slot than see it later via a videotaping of the program. He went on to say that as a result of videotaping the program, they would not have time for other Disney activities such as

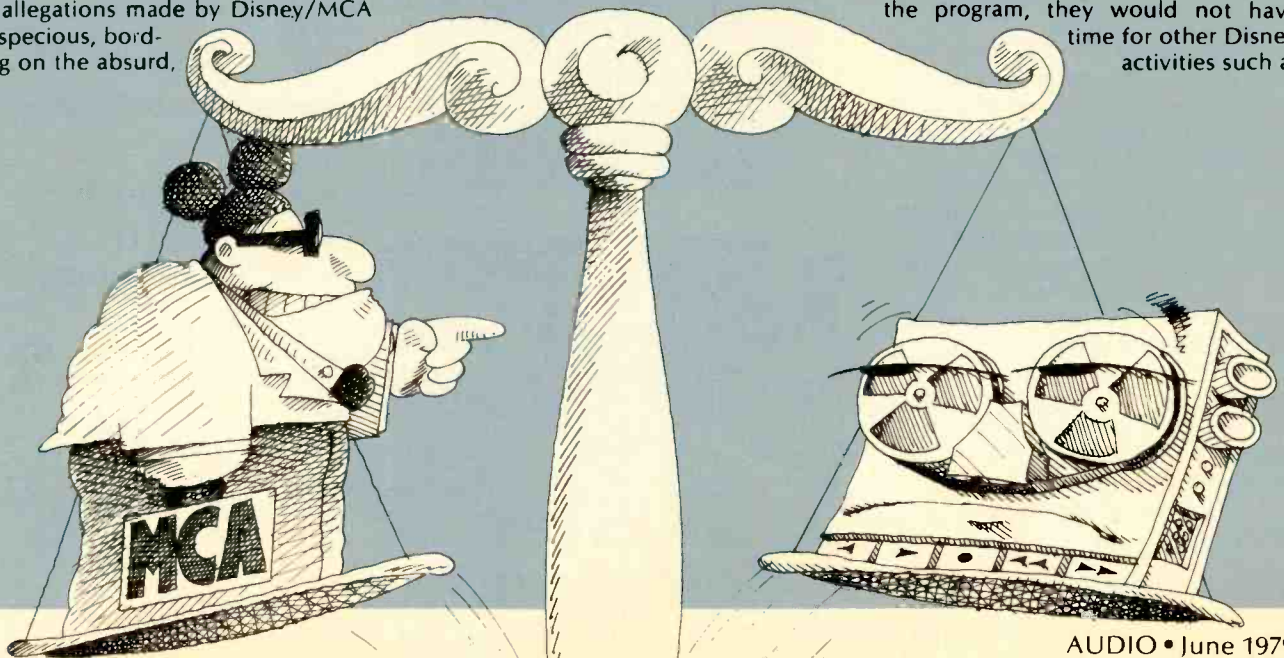

AUDIO • June 1979

16

The Bose® 901® Series IV: A new approach to room acoustics creates a major advance in performance.

It's well known that living room acoustics are a major factor in how any speaker will sound in your home. Recently, an ambitious Bose research program analyzed speaker performance in dozens of actual home listening rooms. The study showed that, while rooms vary greatly, their prin-

cipal effects can be isolated to specific types of frequency unbalances.

Based on this research, the electronic Active Equalizer of the new Bose 901® Series IV speaker system has been totally redesigned. New controls allow greater capability for adjustment of room factors

than conventional electronics, and make possible superb performance in almost any home listening room.

These new room controls also let us develop a basic equalization curve with no compromises for room effects, allowing still more accurate tonal balance. In addition, an important improvement in the design of the 901 driver makes possible even greater efficiency and virtually unlimited power handling.

These innovations combine with proven Bose concepts to create a dramatic advance in performance: in practically any listening room, with virtually any amplifier, large or small, the 901 Series IV sets a new standard for the open, spacious, life-like reproduction of sound that has distinguished Bose Direct/Reflecting® speakers since the first 901.

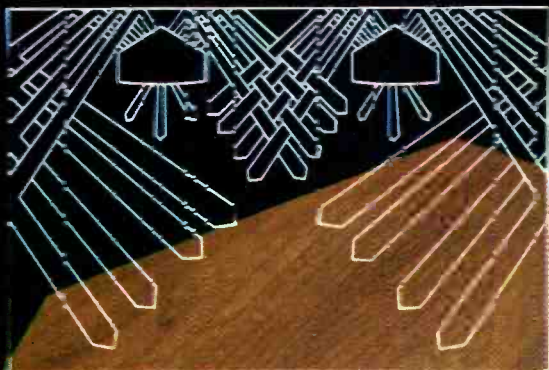

The 901 Series IV Direct/Reflecting speaker creates a life-like balance of reflected and direct sound.

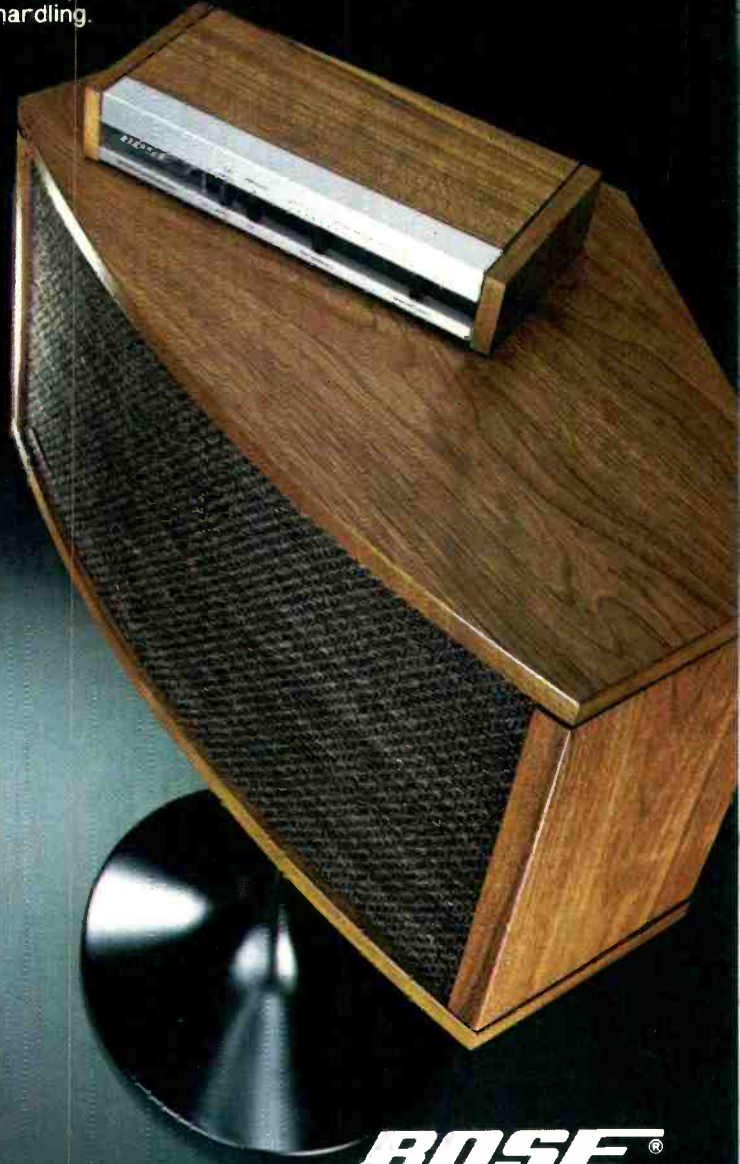
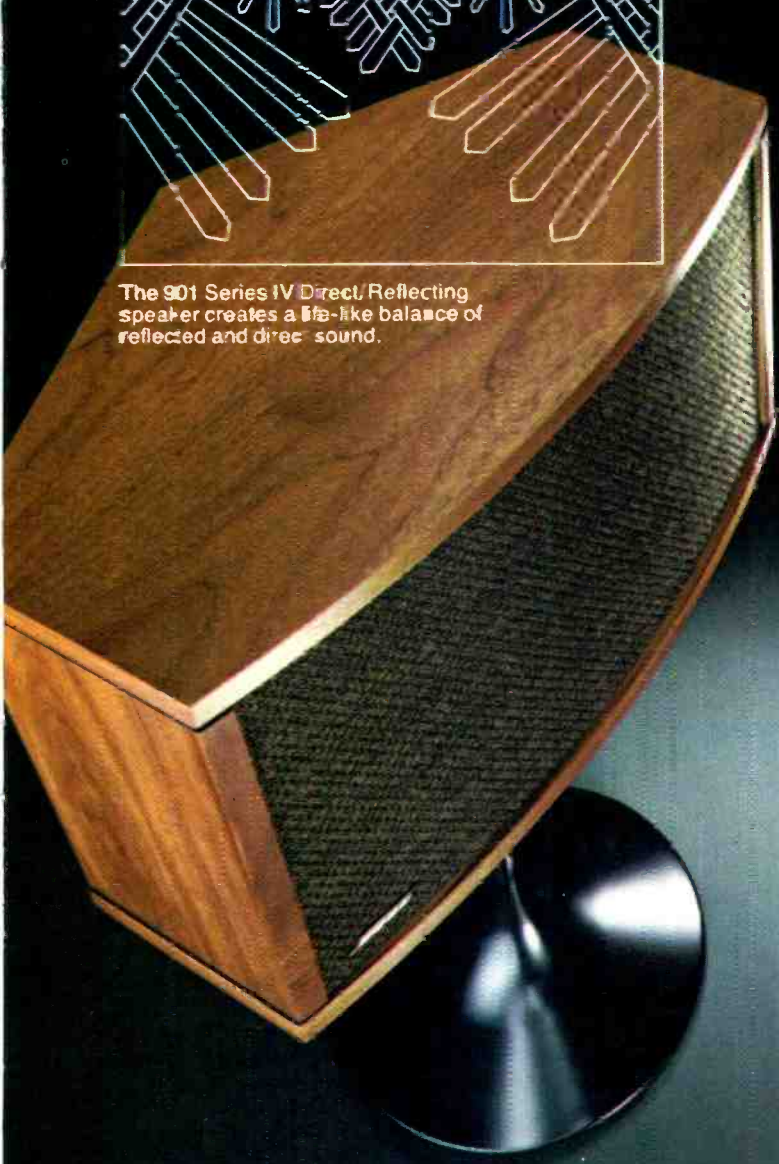

BOSE®
The Mountain, Framingham,
Mass. 01701

Covered by patent rights issued and pending.

Never has one speaker system incorporated so many aspects of the state of the art.

The Infinity Reference Standard 4.5



This is a system of breathtaking clarity and detail, yet capable of the awesome punch and power demanded by the finest contemporary digital and direct-to-disc recordings.

The Reference Standard 4.5 frees the intimate warmth of the human voice, the robust sheen of the strings, the fiery attack of the brass, the stab and snap of the bass. The speakers seem to disappear, revealing a concert stage breathing life, delicacy and fury. You hear the musicians, not the speakers.

How does the 4.5 work its musical miracles? The profoundly accurate bass and midbass are partly the result of a remarkable new cone material, polypropylene. It has dramatically less mass, yet significantly greater internal damping than paper cones or other exotic materials. Our polypropylene piston, combined with our exclusive Infinity/Watkins dual-voice-coil woofer principle creates bass frequencies with the snap and definition of the finest dipoles, yet retains the ultra-low frequency response (flat to 23 Hz) that has made Infinity famous.

The transparent crystalline treble issues from our world-acclaimed EMIT™ tweeters in dipole array. Midrange warmth, smoothness and unprecedented definition are the progeny of our lustrous new dipole EMIM™ Electromagnetic Induction Midranges. Like the EMITs, they employ powerful magnets of rare-earth samarium cobalt and etched voice-coils on low-mass diaphragms.



A separate electronic crossover/equalization unit allows you control over variable source material and room anomalies, either in single or bi-amp mode.

A remarkable technological story. And like all great stories, this one ends where it began: with the music. Which is the real reason you should spend \$3000* on the Infinity state-of-the-art Reference Standard 4.5.

 **Infinity™**

We get you back to what it's all about. Music.

For the nearest dealer's name and address, phone toll-free 800-423-5244, or, from California, 800-382-3372.

Enter No. 27 on Reader Service Card

*Suggested system retail price, optional with dealer.

© 1979 by Infinity Systems, Inc.

attending theaters where Disney films are showing. Well, now, Mr. Tatum . . . that is quite a display of pretentious, self-serving pique! Mr. Tatum then compounds his gaffe by acknowledging that video games cut into the time viewers may otherwise have spent seeing Disney films at a movie house. In other words, Mr. Tatum is annoyed with any leisure-time activity of the public that pre-empts the viewing of Disney films. Can you imagine how he feels about someone who — dare I say it? — reads a book instead of viewing his films? Mr. Tatum summed up his attitude by stating that “with a Betamax anyone can have an unauthorized copy of one of our productions that we can’t control.”

MCA attorney Stephen Kroft made a particular point of condemning the use of the “pause” and “fast forward” controls of VCRs because it enabled viewers to neglect or reject commercials to the detriment of the sponsors. He went on to state that the Betamax encouraged a viewer to make “unauthorized recordings of copyrighted programs and build a tape library of selected TV programs.” In having this library, subsequent reruns of the programs recorded would not be viewed, again allegedly damaging to the sponsors. Come on, fellas! You are treading the dangerous mine-fields of public opinion . . . you are trying to tell people how to regulate their lives on your time schedules. Don’t you realize one of the main reasons people like and buy VCRs is that they are a time-shift device that frees them from the tyranny of rigid “prime time” programming? The networks surely know this, and they are spending a great deal of time trying to cope with this fact, and at the same time figure out how to take advantage of the new revenue possibilities this affords.

For the benefit of the Disney and MCA people, they should be aware that, for the most part, VCR owners do comparatively little recording of a program they are watching. Far more common is that they are watching one program, while recording another program on a different channel because of time conflicts. Needless to say, the viewer does not have use of the “pause” control on the conflicting program he is recording, so the commercials are duly recorded. On subsequent replay of the recording, the viewer may or may not elect to mute the commercial; he will still see the visual presentation of the commercial. Remember, there are actually some commercials people want to see and hear . . . some for the message, and some because they are clever and

entertaining. Also a prime use of the VCR is unattended or timer control recording. People do go out . . . to parties, sporting events, to see Disney or Universal films (I enjoy them too) etc., and they set up their VCRs to record programs they otherwise would have missed by their absence. Again, the commercials are recorded.

As to that business of building up a tape library . . . pray tell a library of what programs? First of all, Disney and MCA should be aware that videocassettes are a relatively expensive item. Unless some one is inordinately enamored of a particular film or program, most video recordings go through one or two replays, and then they are used to record entirely new program material. If one has the interest and the wherewithal to build a library of the magnificent Shakespearean plays on PBC or a cooking buff saves Julia Child programs, that’s understandable, and most certainly this does not damage Disney or MCA in any manner. And what about the viewer who pays a fee for “Home Box Office” programs, which may include Disney or MCA films? This certainly should enable him to record those programs without arousing your ire. There is no question that by and large most programs that are videotaped are of a very impermanent nature, to be enjoyed by a private individual and his family, and then the cassette recorded anew. This certainly falls within the purview of the “fair use” stipulation of the copyright act.

From another viewpoint, one assumes that like “Gone With The Wind,” blockbuster films of the nature of “Star Wars” will eventually be shown on TV. No doubt it would be videotaped by a great many people, and no doubt many of the kids would want to see it three or four times before it is erased. On the other hand, this would stimulate interest in any release of such a film. Clearly, there simply is no comparison between viewing “Star Wars” on the very best big screen TV with mono sound versus the staggering visual and sonic impact of it on 70mm film on a huge wide-aspect-ratio movie screen with Dolby stereo surround sound. The same holds true for virtually every film of this nature. People videotape old films “off TV” (after all, except for some “made for TV” films, there are no new films on TV) for casual and temporary entertainment, not to build libraries. New movies, obviously including Disney and MCA releases, are seen in movie houses. People still go to movies, for their obvious technical superiority, and will continue to do so, even

Listen,

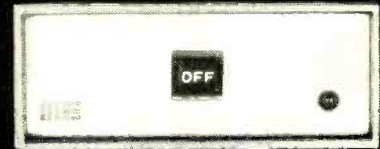

If you haven't heard the PPA-1, you haven't heard your moving-coil cartridge. Audition the Marcof PPA-1 Pre-preamplifier at one of these fine audio dealers.

Absolute Audio, Santa Ana, CA
 American Audiophile, Valley Stream, NY
 Audible Difference, Palo Alto, CA
 Audio Alternative, Fort Collins, CO
 Audio Alternative, Portland, OR
 Audio Cage, Sacramento, CA
 Audio Climax, Metairie, LA
 Audiocom, Old Greenwich, CT
 Audio Connection, Muskegon, MI
 Audio Consultants, Evanston, IL
 Audio Directions, San Diego, CA
 Audio Emporium, Milwaukee, WI
 Audio Excellence, Longwood, FL
 Audio Excellence, San Francisco, CA
 Audio Forum, Watertown, MA
 Audio House, Swartz Creek, MI
 Audio Ltd., Champaign, IL
 Audio Odyssey, Davenport, IA
 Audio Perfection, Bloomington, MN
 Audio Vision, Dallas, TX
 Audioworks, Harrisburg, PA
 Chestnut Hill Audio, Philadelphia, PA
 CSA, Fairfield, NJ
 Creative Audio, Columbia, MO
 David Beatty, Kansas City, MO
 Ear drum, Nanuet, NY
 Ecologic Ear, Des Moines, IA
 Golden Gramophone, Akron, OH
 Golden Ear, Black Hawk, CO
 Harbor Sound, New London, CT
 Havens & Hardesty, Huntington Beach, CA
 Hi-Fi Express, Miami Beach, FL
 Hi-Fi Haven, Brunswick, NJ
 House of Stereo, Jacksonville, FL
 Innovative Audio, Brooklyn, NY
 Kief's Gramophone Shop, Lawrence, KS
 Linear Sound, New York, NY
 Listening Post, Tempe, AR
 Listening Room, Scarsdale, NY
 Listen Up! Audiosystems, Denver, CO
 Music & Sound, Woodlawn Hills, CA
 Myer TV & Audio, Edwardsville, IL
 Natural Sound, Framingham, MA
 Needle In A Haystack, Washington, D.C.
 Ovation Audio, Pittsburgh, PA
 Paragon of Sound, Bethesda, MD
 Paul Heath Audio, Rochester, NY
 Perfectionist Audio, Pleasant Gap, PA
 Reference Audio, Gardena, CA
 Sights & Sounds, Chicago Heights, IL
 S K Audio, No. Lindenhurst, NY
 Sound by Singer, New York, NY
 Speaker Craft, Webster Groves, MO
 Stereo Shoppe, Boise, ID
 Wilson Audio, New Orleans, LA

Exclusive Canadian distributor:
Trans Audio Marketing

**Marcof
 Electronics**

7509 Big Bend Blvd.,
 Webster Groves, MO 63119

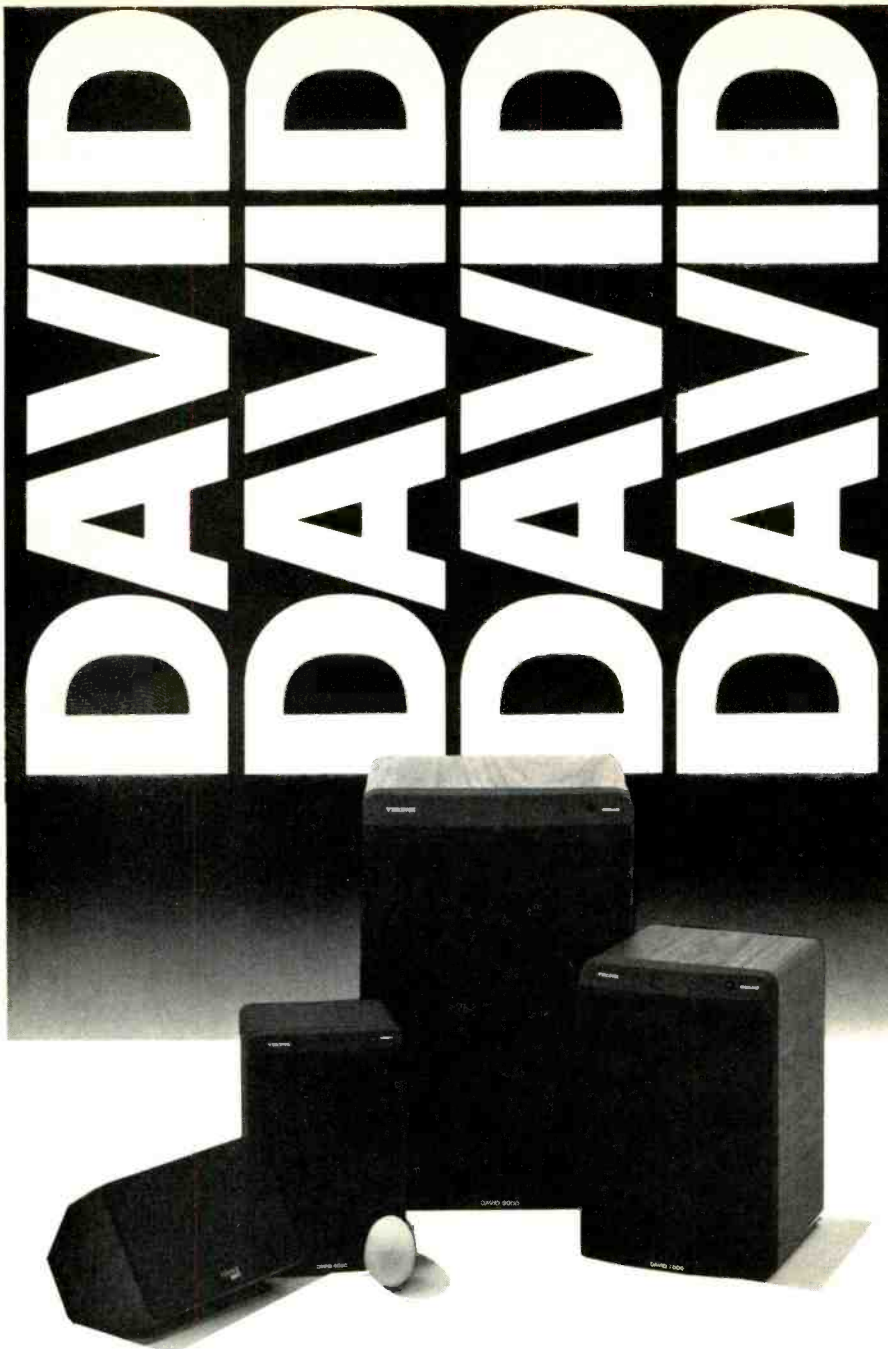

DAVID®—from Visonik® Made with German precision for the most demanding American listeners.

And now the newest DAVIDs, four incredibly small loudspeakers that do everything large speakers do—and more. Each has been recognized for full, rich, accurate sound reproduction.

These newest DAVIDs feature improved efficiency and power handling than did earlier DAVIDs, while still maintaining the sound quality that has made the DAVIDs famous. And the unique grill design of these new DAVIDs improves the dispersion. The 6000, 7000 and 9000 have a prominent LED indicator to signal overload risk in the tweeters.

The smallest of the DAVIDs is the two-way 5000, perfectly made for easy placement within your home, or even car or van (with the optional B-5 mounting bracket). Commensurately fuller sound and greater power handling capacity are achieved with the 6000, 7000 and 9000 studio monitor.

Whatever DAVID you choose, you can be sure you will own a loudspeaker whose size makes it possible to have the best sound wherever you want it.

VISONIK® HIFI

You'll hear more from us.™

Visonik of America, Inc./1177 65th Street/Oakland, CA 94608/(415) 653-9711

© 1979 Visonik of America, ® Registered Trademark, Visonik KG

Enter No. 68 on Reader Service Card

if VCR units purchased are numbered in the millions.

As we go to press, the trial ended March 7th. In six weeks of testimony, many witnesses for both sides appeared and put forth some cogent, but mostly inane questions, from what I read of the trial. One of Sony's main defenses was that Disney and MCA had known about the development of Betamax since the early 1960s, yet made no objections until recently. One of the more absurd ideas came up when the plaintiffs tried to introduce testimony from an engineer who was supposed to explain how TV signals could be "jammed" to prevent videotaping of copyrighted programs. Judge Ferguson quite rightly wouldn't hear this testimony. Such tampering with TV signals would have to be approved by the FCC, and broadcasters would have to alter their transmitters at their expense to accomplish this nonsense. In the highly unlikely event this would ever happen, don't Disney and MCA realize the outraged owners of VCRs would clamp an immediate boycott on all their products? Needless to say, any other hare-brained attempt to prevent taping copyrighted material by in any way adding any "black box" type of device or altering either the TV receiver or video recorder is foredoomed to immediate castigation and failure.

As to the outcome of the trial . . . it was predictable. No decision by the judge, and the case will be referred to the 9th Court of Appeals and likely to the Supreme Court.

I must make it clear that I am not against copyright protection per se, most especially where it concerns the products of our best creative minds. Composers and artists need that kind of protection, and as this protection is presently constituted, it works fine. However, I find most artists have little or no objection to the "fair use" clause of the copyright law, especially as it applies to home recording. Perhaps one of these days, something along the lines of what is done in Germany could be instituted, which is that at time of sale or from date of manufacture, a stipulated modest fee be charged on a one-time basis on all tape recorders and on each reel or cassette of blank tape, the proceeds to be divided equally among representative artist's organizations.

In the meanwhile, I think the Disney/MCA suit should be dismissed, and I can practically guarantee that, just like the audio cassette recording fracas back in 1965, the Disney/MCA people will not only not suffer any reduction in revenues, but if they will grow with this vital new industry, they will benefit mightily. A

BEFORE YOU THROW OUT A GOOD TURNTABLE OR SPEAKER SYSTEM, CONNECT WITH A GREAT AMPLIFIER. THE PHASE 400 SERIES TWO.

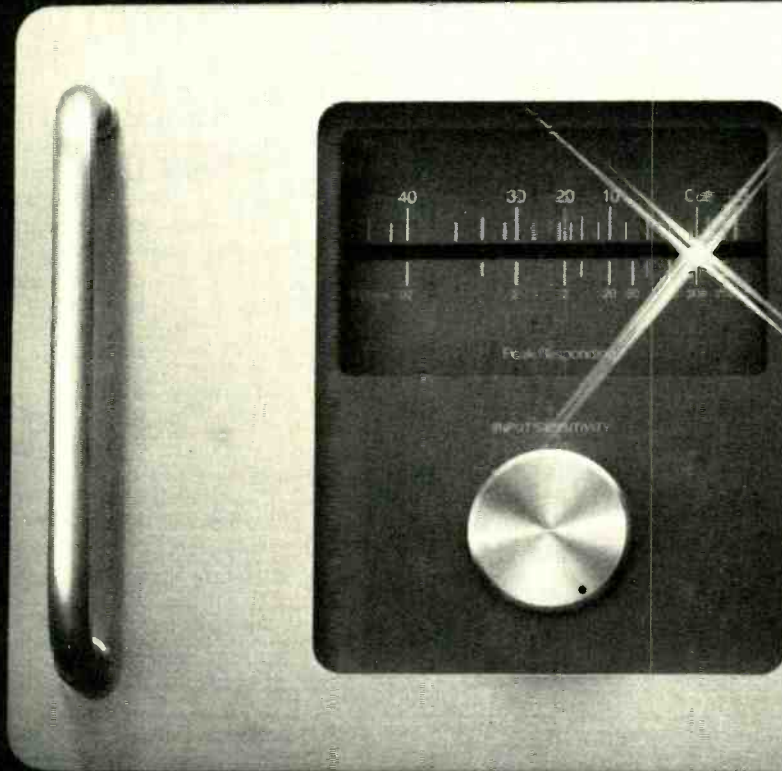

Phase Linear

Model 400 Series Two
Audio Standard Amplifier

Some speakers sound fine, until you hit a low passage. Then they turn to mud, or rumble at you like a cheap turntable. Chances are, that muddy, distorted sound is in fact, the result of an inadequate amplifier stretched to its limits. Clipping!

To improve your sound, you need plenty of reserve power. The Phase 400 Series Two delivers the tremendous power reserve you need for sonic accuracy over the audible frequency spectrum. To accurately reproduce low frequencies without clipping, your speakers require up to 10 times the minimum power requirement of the mid-range frequencies. With the Phase 400 Series Two when you listen to the 1812 Overture, you hear the blast of the cannon with awesome clarity. Even the deepest notes are clearly distinguishable.

ACCURACY YOU CAN HEAR

To improve accuracy, the new 400 Series Two utilizes an advanced BI-FET input stage. This integrated

circuit keeps the output virtually identical to the input. Distortion and noise are reduced to virtually inaudible levels. Beautiful music in, beautiful music out.

ACCURACY YOU CAN SEE

You might have some questions about the 400's instantaneous LED output meters. Conventional-style VU meters are slow in comparison because they have to move the mass of the needle. The LED's

move at lightning speed, accurately monitoring the output voltage, with scales for 8 and 4-ohm impedances. For accuracy, the meter contains 32 graduations, plus 4 fixed flashers to alert you to clipping. You have a visual safeguard, in addition to the Electronic Energy Limiters to prevent damage from overloads.

See your Phase dealer about the Phase 400 Series Two. We think you'll recognize accuracy when you hear it. And when you see it.

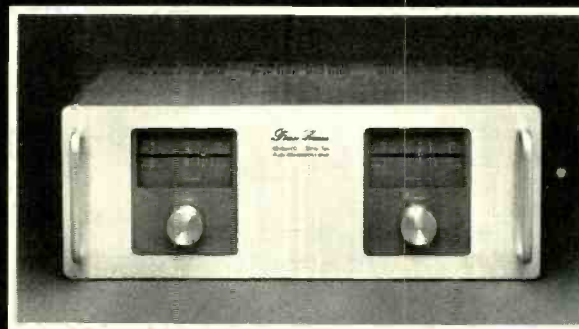

SPECIFICATIONS: OUTPUT POWER: 210 WATTS, MIN RMS PER CHANNEL 20Hz-20kHz INTO 8 OHMS, WITH NO MORE THAN 0.09% TOTAL HARMONIC DISTORTION. Continuous power per channel at 1000Hz with no more than 0.09% total harmonic distortion 8 ohms—260 watts, 4 ohms—360 watts. Intermodulation Distortion: 0.09% Max (60Hz: 7kHz—4:1, Damping Factor: 1000; Residual Noise: 120µV (IHF 'A'), 1 Min. Signal to Noise Ratio: 110dB (IHF 'A'), Weight: 35 lbs. (16 kgs.), Dimension: 19" x 7" x 10" (48.3cm x 17.8cm x 25.4cm). Optional Accessories: Solid Oak or Walnut side panels.

Phase Linear[®]
THE POWERFUL DIFFERENCE

PHASE LINEAR CORPORATION, 20121 48TH AVENUE WEST, LYNNWOOD, WASHINGTON 98036
MADE IN USA. DISTRIBUTED IN CANADA BY H. ROY GRAY LTD. AND IN AUSTRALIA BY MEGASOUND PTY. LTD

Enter No. 47 on Reader Service Card



**We build
a speaker
that sounds
like music**

It can accurately reproduce the 120+ dB peaks that are found in some live music. That's more than just being able to play music loud. It can accurately reproduce the music bandwidth—from below 25Hz to 20kHz. And the Interface:D's vented midrange speaker reproduces midrange sounds with the clarity and purity that allows precise localization of sound sources—both lateral and front-to-back.

The Interface:D is the only commercially available speaker we know of that can meet these criteria. Audition them at your Interface dealer.



Electro-Voice®
a gulton company

600 Cecil Street
Buchanan, Michigan 49107

Interface:D™

Herman Burstein

Tape guide

Dolby Calibration

Q. How do I go about setting the playback calibration on my Dolby noise reduction unit for operation at 7½ ips without a 7½-ips playback level tape? — Hugh Reaves, New Smyrna Beach, Fla.

A. To the best of my knowledge, accurate playback calibration of a Dolby noise reduction unit requires a playback calibration tape.

TV Taping

Q. I have a tube TV connected to my receiver by means of shielded cable coming from the TV volume control. I make tape recordings of the TV sound via the receiver. However, these tape recordings have a very audible attenuation of the higher frequencies, even though I get very satisfactory results when recording from other sources. Do you have any suggestions? — Frederick Berlingen, Chicago, Ill.

A. The problem may be due to excessive treble de-emphasis employed after the sound discriminator circuit of the TV set, quite possibly to balance out the sound (to compensate for the bass deficiency of the small speaker). Capacitance of the cable leading from the TV to the receiver may be excessive; you should use as short a lead of microphone cable as possible with a low capacitance (about 25 pF per foot).

To remedy this situation, the de-emphasis circuit could be changed to produce less treble cut, but, unless you are technically oriented, you will need a service technician to make the change. Another remedy might be to make judicious use of the treble control when playing tapes recorded from TV.

Head Comparison

Q. Is there a significant difference between ferrite tape heads and hyperbolic heads? — Richard Wahl, APO, San Francisco

A. Ferrite refers to the material from which the head is made. Such a head is claimed to have a longer life than one made of permalloy by a factor of 10:1 or more. Hyperbolic refers to the shape of the head. Its purpose is to

have the tape approach and leave the head in such a fashion as to ensure very close tape-to-head contact for good treble response and to minimize the peaks and dips in the bass response owing to the contour effect, where the entire head tends to respond to the signals on the tape, instead of only the gap responding.

Response Differences

Q. What is the difference between record/playback response and playback response? Why does the record/playback response always cover a wider frequency range in all reports I have read on open-reel decks? — Jeffrey Pratter, Brooklyn, N.Y.

A. Playback response is based on a test tape and such tapes, ordinarily, do not go beyond 10 or 15 kHz, even though the particular deck may be capable of a wider response. The record/playback response is measured without reference to a test tape; signals of equal amplitude covering the audio range are recorded on the deck being reviewed, and their relative amplitudes are measured in playback. Consequently, one may measure record/playback response out to whatever frequencies the deck is capable of reproducing, 20 kHz or more.

Playback Parameters

Q. I have a collection of cassette tapes made on a high-quality deck, and I would like to know if there would be any detrimental effect if they were played on a relatively inexpensive portable cassette deck? — Martin Herbstman, New York, N.Y.

A. You will probably not damage your cassettes by playing them on an inexpensive deck, assuming that it is not a toy. A very cheap deck might put undue tension on the tape and possibly deform it or it might cause the tape to jam and snarl. If the deck you have in mind treats other cassettes carefully, it should do the same to yours.

One thing you might watch out for is magnetized heads and tape guides. Such magnetization would increase noise and reduce the treble response. It would be a wise precaution to demagnetize the heads and guides of the portable deck before playing your valuable cassettes on it.

AUDIO • June 1979

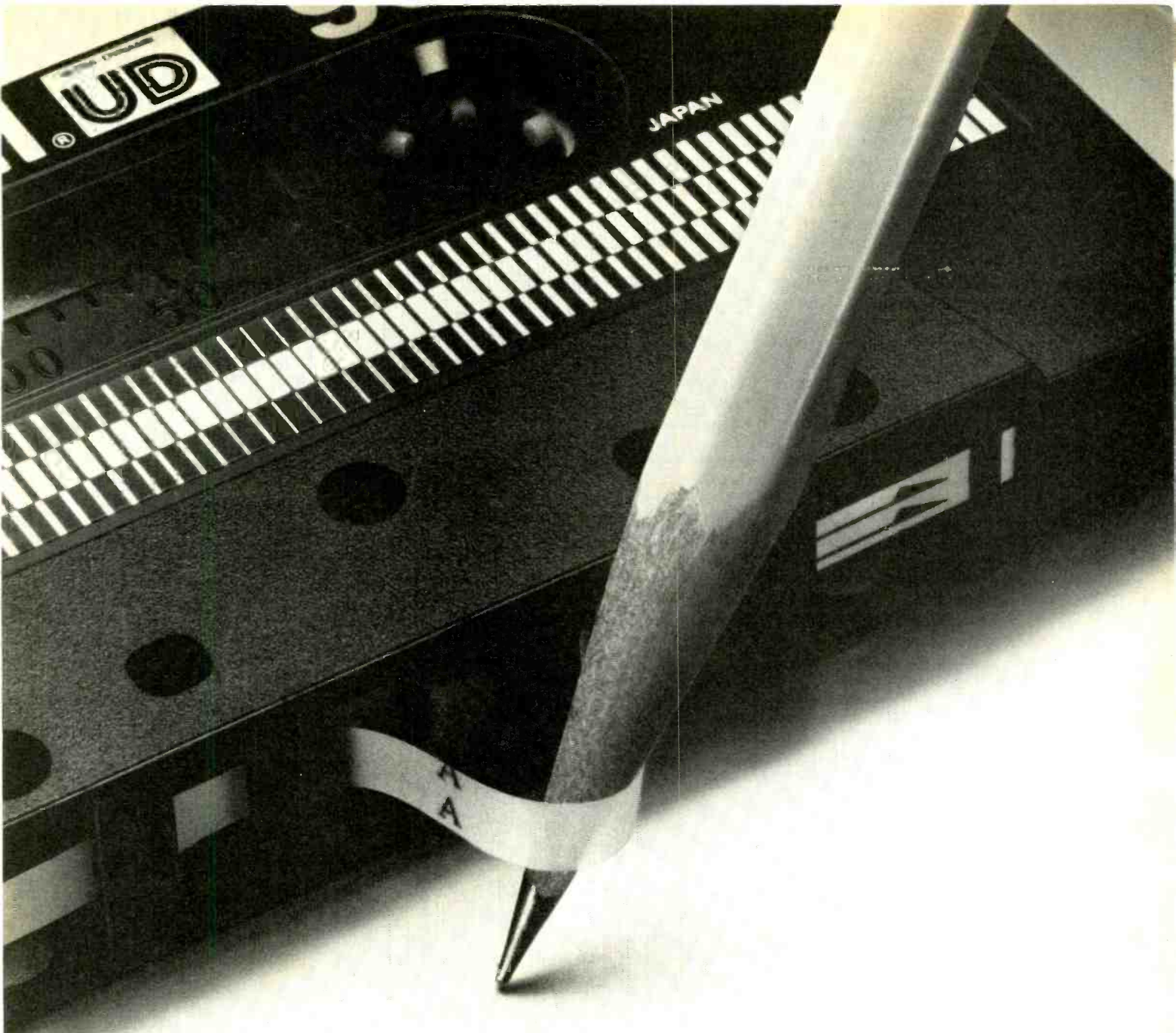

We put more thought into our leader than most manufacturers put into their tape.

One of the reasons Maxell has such a great following is because of our leader.

It has a built-in non-abrasive head cleaner designed to remove the oxide residue other tapes leave behind, without damaging your tape heads.

It also points out what side of the tape you're on (A or B) as well as which direction the tape is traveling. So it's almost impossible to make a mistake.

It even gives you a five second cueing mark, so you can set your recording

levels without wasting tape. Or time.

Obviously, all the thought that went into our leader was designed to help you get more out of our tape.

So if you think our leader sounds impressive, wait till you hear what follows it.

maxell



Maxell Corporation of America, 60 Oxford Drive, Moonachie, N.J. 07074

Enter No. 37 on Reader Service Card

Taping Interference

Q. When recording an FM broadcast a burst of static is audible through the monitors as well as on the tape playback. All interference stops when the tape deck is off, also, no interference occurs when recording through the phono circuit of my receiver. What could be wrong? — Patrick Grealy, Stratford, Conn.

A. The problem seems to be interference between the 19-kHz pilot signal of stereo broadcasts and the tape oscillator frequency, or between the tuner's oscillator and the tape machine's oscillator. If the latter is the cause, then moving the tuner and tape

deck further apart might help. If the former is the cause, you need a 19-kHz filter at the output of your tuner, or at the input of your tape deck. Inquire at your local audio store about a suitable filter.

Distortion Figures

Q. Can you tell me why the intermodulation distortion of even the best tape decks ranges from 5 to 15 percent? — Anson Reynolds, Sierra Vista, Ariz.

A. The subject of IM distortion in tape decks has been given much less public attention than that of harmonic distortion (THD), quite possibly be-

cause most audiophiles would be alarmed by specifications in the range of something like 5 to 15 percent. But they are less apt to be unnerved by the THD figures of 1 to 3 percent generally published. On the other hand, listening tests correspond more nearly with the THD, rather than the IM figures in the case of most tape decks.

I can only speculate as to why IM of, say, 5 to 10 percent is more acceptable to the ear in the case of a tape deck than in the case of an amplifier. Part of the reason may be the limited frequency response of tape machines so that not all the distortion products are audible. Furthermore (and this is true of all components), it has been observed on mixed tones, such as we generally listen to, that it takes much greater amount of distortion to be discernible to the ear than in the case of pure tones. IM of 5 percent or more is often undiscernible on mixed tones, whereas as little as about 0.5 percent or less, may be discernible on single tones.

Finally, IM of 5 percent or more is experienced in the vicinity of the peak recording level, while most of the audio signal is 10 to 20 dB below the peak signal. Therefore, most material has IM well below the 5 to 10 percent range.

Setting Bias

Q. What is the proper procedure for setting bias in an open-reel tape deck? B.E. Herring, Goldsberg, N.C.

A. There are various ways to set bias and the recommendations vary among different manufacturers. Some advise setting bias so that a prescribed voltage (given in the service manual) is obtained at a certain point, for example across the record head. Others recommend that the bias be set low, then gradually increased until maximum audio output is obtained for both record and playback at a specified frequency, usually in the range of 500 to 2000 Hz. Some manufacturers add that you should further increase bias until the audio output drops 0.5 dB to make the treble less susceptible to variations owing to slight changes in bias. Other manufacturers advise touching up bias to obtain the best compromise between low distortion and extended treble response. However, it is always wisest to follow the bias adjustment instructions, given in the service manual, for your specific tape deck. Δ

If you have a problem or question on tape recording, write to Mr. Herman Burstein at AUDIO, 401 N. Broad Street, Philadelphia, PA 19108. All letters are answered. Please enclose a stamped, self-addressed envelope.

AUDIO • June 1979

WITH PERFORMANCE/SPECIFICATIONS ABOVE ALL—
at a price the budget-conscious pro can afford.

FEATURES

- 42 bands total: (15-band $\frac{1}{3}$ octave EQ each channel, plus 6-band alternate $\frac{1}{3}$ octave EQ each channel)
- Zero-gain level controls
- L.E.D. indication of unity-gain in/out level balancing
- System 1/line equalization—either channel
- System 2/tape equalization—either channel
- Sub-Sonic filter—3dB @ 15 Hz
- EQ defeat—separate (each channel)
- 600 ohm balanced or unbalanced operation
- Zero Insertion loss
- Stereo operation
- Mono operation—each channel separately
- Tape monitor circuit

SPECIFICATIONS

- Total Harmonic Distortion: .01% @ 2V RMS
- IM Distortion: 0.1% @ 2V RMS
- Signal-To-Noise: 114dB-10V RMS output—100dB-2V RMS output
- Input Capability: Maximum 10V RMS-22dBm
- Output Capability: 10V-22dBm
- Input Impedance: 47K—balanced or unbalanced
- Output Impedance: 600 ohms—balanced—300 ohms—unbalanced
- ISO Center Frequencies (Hz): ($\frac{1}{3}$ Octaves) 40, 50, 63, 80, 100, 125, 160, 200, 250, 315, 400, 500, 630, 800, 1K. (Alternate $\frac{1}{3}$ Octaves) 1.6K, 2.5K, 4K, 6.3K, 10K, 16K
- Boost/Cut Individual Controls: \pm 22dB (all other controls at max); \pm 15dB (all other controls at zero)

NEW BASIC EQUALIZER \$249

WITH 9 ESSENTIAL EQ FEATURES:

- 1—Environmental EQ Test Record and Computone charts
- 2—EQ Tape Recording
- 3—Tape Monitor
- 4—Two Master Output Level
- 5—EQ defeat
- 6— \pm 16dB-12dB EQ/octave
- 7—S/N-105dB
- 8—Cabinet included as shown
- 9—THD less than 0.01% @ 2V.

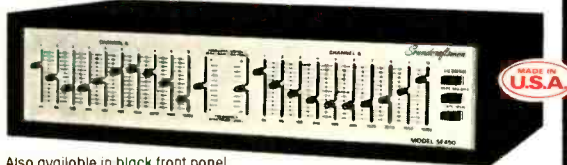

Also available in black front panel

FREE! 16-page Full-Color Brochure

Includes TEST REPORTS, complete specifications, Class "H" amplifier ENGINEERING REPORT, EQ COMPARISON CHART, and the "WHY'S & HOW'S" of equalization—an easy-to-understand explanation of the relationship of acoustics to your environment. Also contains many unique IDEAS on "How the Soundcraftsmen Equalizer can measurably enhance your listening pleasures!" "How typical room problems can be eliminated by Equalization," and a 10-POINT "DO-IT-YOURSELF" EQ evaluation checklist so you can

FIND OUT FOR YOURSELF WHAT EQ CAN DO FOR YOU—

SEND \$6.00 FOR EQUALIZER-EVALUATION KIT: 1-12" LP TEST RECORD,

1 SET OF COMPUTONE CHARTS, 1 COMPARISON CONNECTOR, 1 INSTRUCTION FOLDER

SOUNDCRAFTSMEN, 2200 S. RITCHEY, SANTA ANA, CA 92705 • Canada: ESS AUDIO LTD., Ontario

Enter No. 62 on Reader Service Card

THE B&W DM2/II. A CLASSIC IN EVOLUTION.

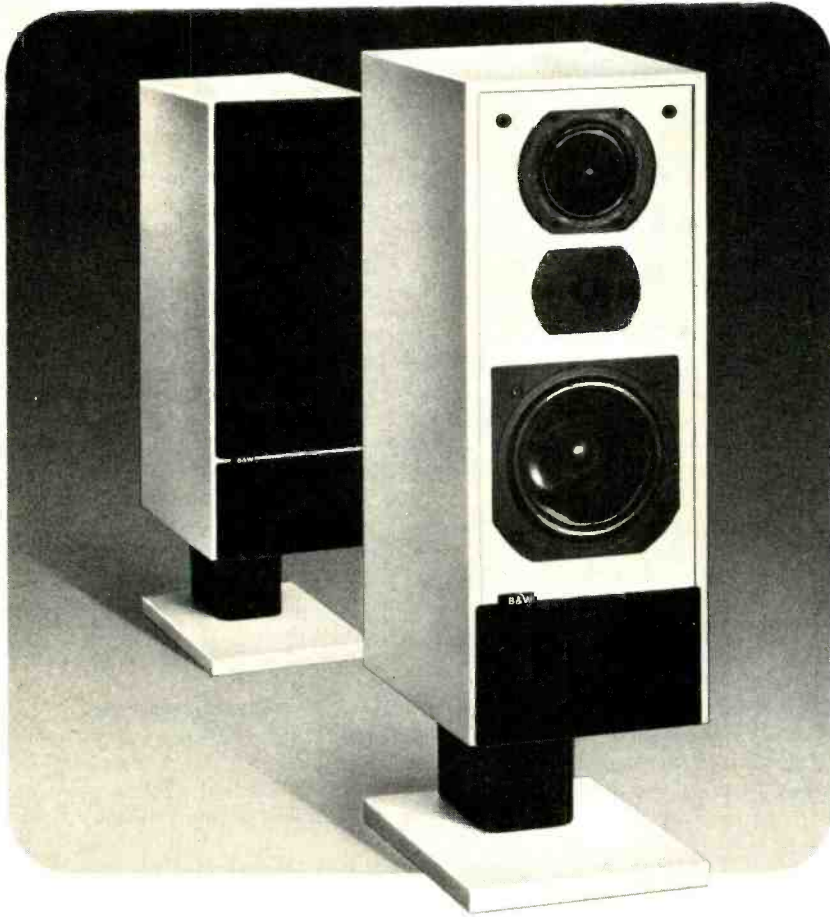

Despite the almost daily claims of revolutionary breakthroughs, loudspeaker design is basically an evolutionary process. A systematic, step by step exploration of new ideas, materials and measurement techniques.

Consider the new B&W DM2/II, for example. When its predecessor, the original DM2, was introduced several years ago, it was widely acclaimed as a classic of impeccable design and outstanding performance.

In pursuit of excellence.

Since that time, however, B&W's unparalleled research and development program has yielded new and fascinating insights into virtually

every aspect of speaker design and performance.

From these uniquely innovative studies has emerged a completely new design of surpassing accuracy, the B&W DM2/II.

Each driver of the DM2/II has been designed for exceptionally smooth response over its entire operating range. The crossover is a computer calculated nineteen element network employing true third order Butterworth filters that result in significantly lower intermodulation distortion and exceptional phase and amplitude characteristics. Indeed, the DM2/II comes very close to attaining that most illusive of all speaker qualities, an apparently seamless transition from driver to driver.

Listening. The final proof.

Listening to the B&W DM2/II is, quite simply, a revelation. It produces completely natural, uncolored sound of extraordinary clarity and depth. Moreover, its modest size and elegant appearance permit advantageous placement in almost any listening area.

As with all B&W loudspeakers, each DM2/II is individually tested and shipped with its own proof of performance chart recording.

However, the ultimate proof of performance is in the listening. Your B&W dealer invites you to audition this classic contribution to the evolution of speaker technology and decide for yourself.

For additional information write: Anglo-American Audio Co., Inc., P.O. Box 653, Buffalo, N.Y. 14240. In Canada: Remcron Electronics Ltd.

B&W Loudspeakers. The next step up.

Audio etc.

Edward Tatnall Canby

Time delay! It's the latest thing in listening, though it's been around ever since our recording engineers and broadcasters discovered ambience, via the new microphone, back in the earliest 1930s. Now, delay is digital and for home consumption, direct and to choice, which makes things much more interesting and up to date.

Several years back I reacted with great vigor, as they say, to my first all-out experience with this new kind of home facility, the Audio Pulse system — not only for what it could do to astonish the ear via perfectly normal recordings of familiar sorts, but because it also so clearly implied an important change in recording (and broadcast) technique, whereby the producer could no longer control the effects of space and size and ambience in which his music was to be heard in the home.

Since Audio Pulse, there has been the ADS 10 system, which supplies you with everything from built-in 100-watt amps to a second pair of speakers. I've been chafing to try this big system for

more than a year but meanwhile, that sober and highly innovative firm, Advent Corporation, has produced a more basic digital delay unit for home listening, and it is that one which now adorns my living room, if not quite in the manner Advent intended, as you will shortly see.

Maybe you thought that by this time I must have reverted from four channels back to a solid stereo pair, like almost everybody around. Not so, and I wouldn't actually need the extra gear that ADS so conveniently supplies. A while back, in fact, I beefed up my system by setting out pairs of speakers for each channel, matched, right around the room. Now, prompted by Advent, I've brought in even more — six channels. Everything I had before plus Advent too. Works like a charm. After all, if Advent and the others require an upgrade from two to four, then why not from four to six? It took me awhile, I'll admit, to reach that staggering conclusion. But it turned out to be a good answer.

Speaker Saver

As a matter of fact, in case you are one of those who hang on to your old speakes instead of trading them in (how I wish I hadn't sold my Model A Ford for \$200 about 1935...), I just made a count and discover that I have no less than 17 speaker systems right now in my living room, and 10 of them actually working. Not to mention the tube-type Motorola AM radio on the table. The silent ones are oldies, dead-heading, serving out their time as convenient tables and stands here and there. Most of them could be fired up in an emergency if needed. Nothing very fancy here, you understand — but there's safety in numbers. Just look at the high-priced speaker spreads, all full of multiple woofs and tweets in a single expensive package. Same with me, only separate.

The reason I can still walk around is that these units are stacked up in vertical columns a' la AR 9, two active speakers, one above the other, and sitting on a third, a silent support, old

26

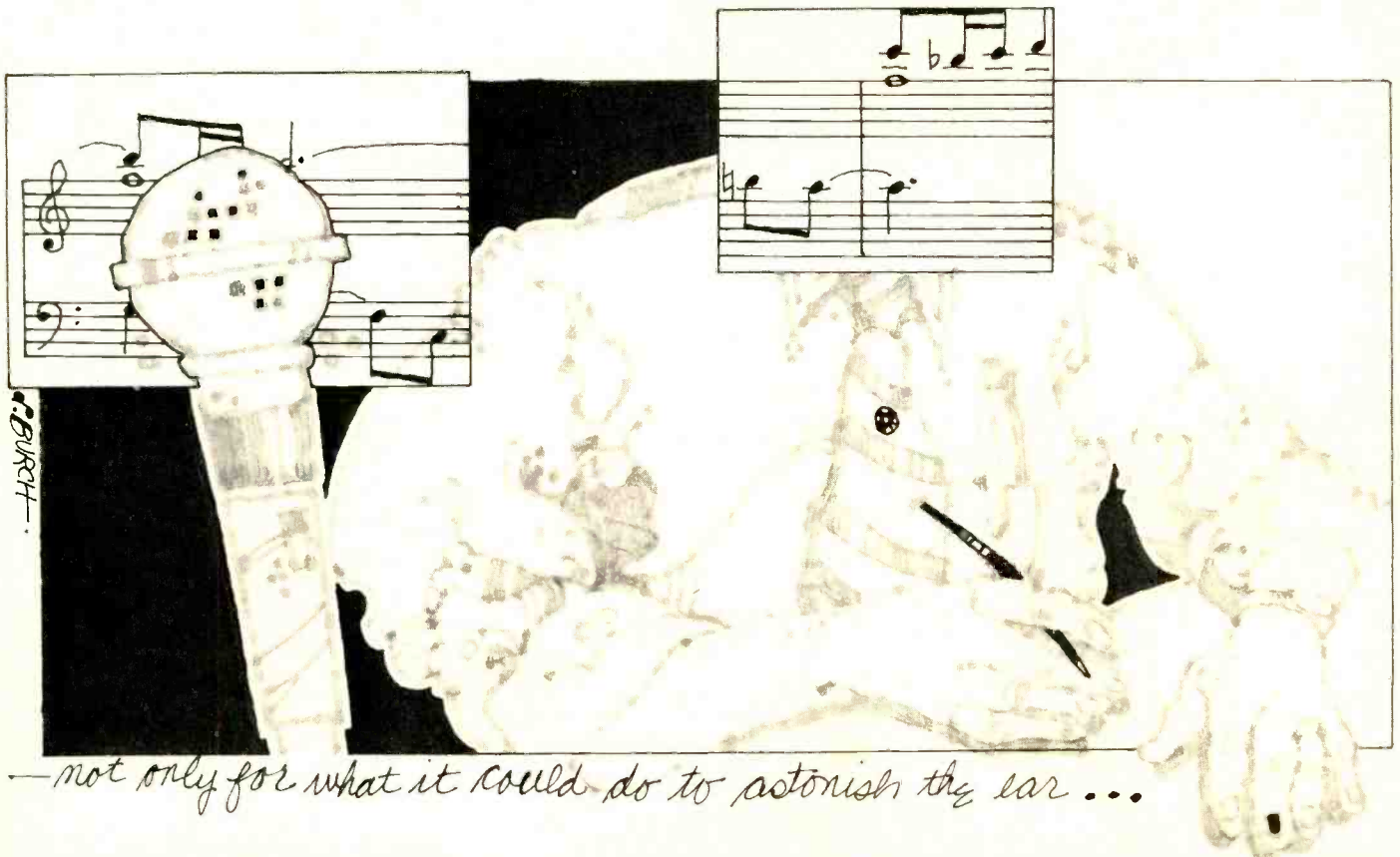

—not only for what it could do to astonish the ear...



The first choice of those who refuse to settle for second-best.

The true audio perfectionists are those who demand state-of-the-art performance from every part of their system. For these trend setters, second-best just won't do.

At TDK we consider ourselves perfectionists, too, so it's gratifying to know that TDK SA is the number one selling cassette to these critical listeners.

Perfectionists demand the best possible sound quality. SA is the high bias reference standard; most quality manufacturers set up their decks in the factory to sound best with SA.

© 1979 TDK Electronics

Perfectionists appreciate technological superiority. SA's advanced cobalt-adsorbed gamma-ferric oxide particle formulation made it the world's first non-chrome high bias cassette. And many parts of its super precision mechanism, such as its double hub clamp and bubble surface liner sheet have yet to be equalled.

Perfectionists insist on reliability, and they know that TDK was first with a full lifetime warranty*—more than 10 years ago.

You may not be an audio perfectionist; you may not be able to afford

an ultimate, cost-no-object stereo system. But it's comforting to know you can get better performance from your present system by using the tape you'd buy even if you had a million to spend—TDK SA. TDK Electronics Corp., Garden City, New York 11530.

* In the unlikely event that any TDK cassette ever fails to perform due to a defect in materials or workmanship, simply return it to your local dealer or to TDK for a free replacement.

 **TDK**
The machine for your machine.

Enter No. 65 on Reader Service Card



Kevin Cronin listened to us.

He writes, sings and produces with REO Speedwagon.

He listened to the group's latest recording on our new System B.

The System B is a vented 4 way, 5 driver loudspeaker system.

Here's what he said.

"I know exactly what's on the record so if there's anything missing, if there's anything these speakers weren't producing, I'd be the first one to fall off my chair. But I hear everything"

That's because we've gone to great lengths to minimize distortion. The System B reproduces the highest and the lowest frequencies of music with amazing accuracy and clarity.

To minimize distortion, we have painstakingly designed each individual mid and high frequency driver so that greater clarity is possible.

What's more, we've carefully selected each crossover frequency to subjugate driver resonance below critical crossover points. That completely eliminates distortion in the crossover regions.

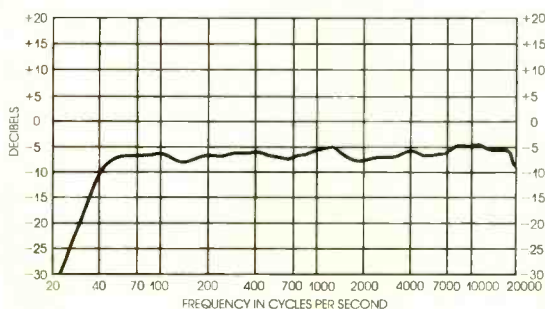

The graph shows the acoustic power output of the System B. As you can see, the System B has an incredibly uniform acoustic power output. The result is music that is clearly defined and accurate.

And it doesn't take a high powered

amplifier to bring a loud-as-life performance of your favorite artists, either.

That's because System B blends extremely efficient drivers with a vented enclosure. This makes it possible to produce relatively high levels of music with minimal power input.

At the same time, System B has the power handling capability to produce an incredible 115 dB of sound pressure at its 150 watt rating.

We can't go into all the details of this amazing sound system in this ad.

That's why you should go to your audio dealer for a demonstration.

Your ears are the ultimate test.

But here's one more observation by Kevin Cronin, a professional musician and producer.

"I spent six months making this record, so as far as it being on the vinyl it is there and I hear everything through the speakers"

Listen to our speakers in person. Kevin Cronin did.

Listen with the professionals.



Listen to JENSEN speakers.

JENSEN SOUND LABORATORIES
Division of Pemcor, Inc., Schiller Park, IL 60176.

to astonish the ear...

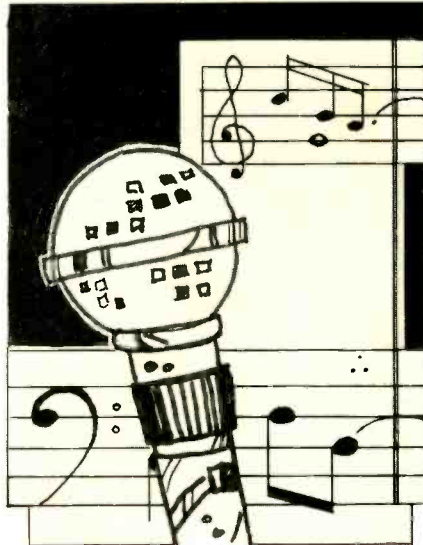

but sturdy. You'd be surprised how easily these tall, thinnish columns blend into the interior landscape, especially the newer active speakers with those inconspicuous black grilles. Very great economy of space, I can tell you.

In the back corners, wide apart, I have two of these columns, reaching high so they shoot over my head as I listen. Corner placement helps bass. Up front are two more identical columns in stereo position, these without the deadhead support and lower down. Floor helps bass. That's 10 units, eight of them active and playing four channels. Now I've added channels 5 and 6, an *ad hoc* arrangement that just might become permanent. At left middle is another slim column of three speakers, only the top one active, and across the room to the right is its mate standing on top of my equipment cabinet at the same height. All in all, this addition has removed about one more square foot of living room space.

All of these speakers, you must note, are either in matched pairs, or fours. Necessary if you want sonic stability, whether in six channels or two.

Now about these six channels. When the Advent Sound Space Control arrived I began with the thought of setting it up just as indicated, two stereo speakers in front and two more for the delay somewhere between the sides and the back, for best effect. The unit passes the "front" signal straight through and adds its subtly variable delay processing to the second set of speakers to make a surround effect. The back (or side) channels, then, contain all the digitized information in two basic parameters, the length of delay, translating into simulated room size, and the "die-away" or reverb time, which simulates the degree of liveness or deadness in the synthesized space. Both, of course, are abundantly and usefully variable via the controls, as is the volume level of the delayed signals in respect to the front.

Since I had my four channels all set up already, my first thought was simply to disconnect my enhance/logic equipment and reconnect my four channels to Advent's specs. What else? So I did. And I was in business, technically speaking.

But here the argument became confused. Now *wait-a-minut*, I muttered, this isn't right. I am *not* comparing the sound of a stereo system to the same with Advent added, which is obviously the intention. Instead, I am comparing two quite radically different means for making use of a full four channels already *in situ*, installed and

operable. Interesting, but— More-over, there was no way I could figure to make even this comparison in AB form. In order to install Advent I had to remove the other stuff. So it would be a four-way memory comparison at best — how does this new synthesized digital delay ambience compare with the variable decode-with-logic sound I have been hearing through the selfsame amps and the same four channels of speakers?

Distribution Differences

I think it is important to get straight right here the really profound difference between these two approaches to the same thing. The decode/enhance logic system, via any of the various matrices and the differing logic circuits, once or still available, distributes sound differently to each of the four channels with more or less directional sensitivity, according to clues, mostly phasing and volume differences, that are built into the recording itself. Whether these are controlled by deliberate coding or are casual and random — the delayed reflections of actual room sound and placement as captured in stereo — the principle is the same. The decoders, all decoders, tend to separate the delayed ambience reflections from the direct signals and variably to distribute these around your speaker array, both front and back. There are many formulas for this and, as we remember, even more heated arguments as to which is right and best — no matter. (If you have a choice, you are in the clear.) The principle remains good and useful today. Those random decoded differences between your four channels, or the deliberately coded differences, do indeed provide a very real and natural sense of room or hall space, not at all unrelated to the original.

LEIGH SPEAKERS ARE AVAILABLE FROM THESE DISTRIBUTORS.

JACK ABRAM CO.

1055 West Third
Columbus, Ohio 43212
(614) 294-3356

TERRITORY:

Ohio, W. Virginia, Western Pennsylvania.

CARDINAL SALES

6225 Coffman Road
Indianapolis, Ind. 46268
(317) 298-9650

TERRITORY:

Indiana, Kentucky.

JIM DWYER ASSOCIATES

West Newbury,
Massachusetts 01985
(617) 363-5466

TERRITORY:

Massachusetts, Connecticut, Rhode Island, Maine, New Hampshire, Vermont.

ELLINGER SALES CORP.

6580 Northwest Hwy.
Chicago, Illinois 60631
(313) 763-1570

TERRITORY:

Illinois, Wisconsin, Minnesota.

ESTERSOHN ASSOC. INC.

541 Davisville Road
P.O. Box 516
Willow Grove, PA 19090
(215) 657-1414

TERRITORY:

Delaware, Maryland, Eastern Pennsylvania, Southern N.J., District of Columbia.

STEVE FISHER SALES CORP.

221 Degraw Avenue, Box 438
Teaneck, N.J. 07666
(201) 837-1200

TERRITORY:

Northern N.J. (as far south as Trenton) and Metro New York City (including Nassau, Westchester, Suffolk and Rockland counties).

H.J.S. ENTERPRISES

351 Lynwood Avenue
Buffalo, N.Y. 14209
(716) 881-1831

TERRITORY:

Upper New York State

DAVE JOYNER & ASSOC.

2251 Perimeter Park
Suite 3, P.O. Box 43804
Atlanta, Georgia 30336
(404) 691-5593

TERRITORY:

Georgia, Florida, Alabama, Mississippi, N. Carolina, S. Carolina, Tennessee, Virginia, Maryland (Allegany and Garrett counties).

RIDDERHOFF & ASSOCIATES

2201 Zenia, P.O. Box 1233
Troy, Michigan 48099
(313) 589-2722

TERRITORY:

Michigan

LEIGH

**"WHAT WE LEAVE IN
IS MORE IMPORTANT THAN
WHAT WE LEAVE OUT"**

That's why we've eliminated redundant tone controls, needless L.E.D.'s, and useless cosmetics, providing you with better quality drivers. These drivers were specifically designed and built by Leigh to give maximum system performance. Results? The most accurate sound available for your dollar.

The Leigh 802 provides natural bass and flat frequency response in a compact, low cost enclosure. Features include a high-power 8" woofer, flared dome tweeter, with a 6dB/octave cross over @ 2,500Hz.

The Leigh 1002, has a 10" woofer for increased low frequency response and expanded dynamic range. A flared dome tweeter with a 6dB/octave cross over delivers sparkling highs. Air suspension design allows for a low Q tight bass response.

The Leigh 1203 three-way system consists of a 12" woofer, 5" mid-range and a high-power flared dome tweeter crossed over at 6dB/octave, @ 800 Hz and 5,000Hz respectively.

For further information contact:
LEIGH INSTRUMENTS LIMITED
350 Weber Street North, Waterloo,
Ontario, Canada N2J 3H6
Tel: (519) 884-4510, Telex: 069-55440

"EARS AHEAD"

LEIGH

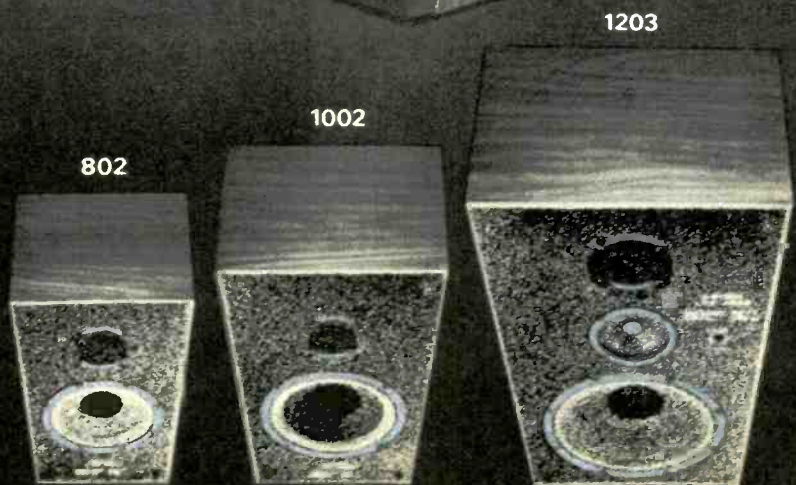
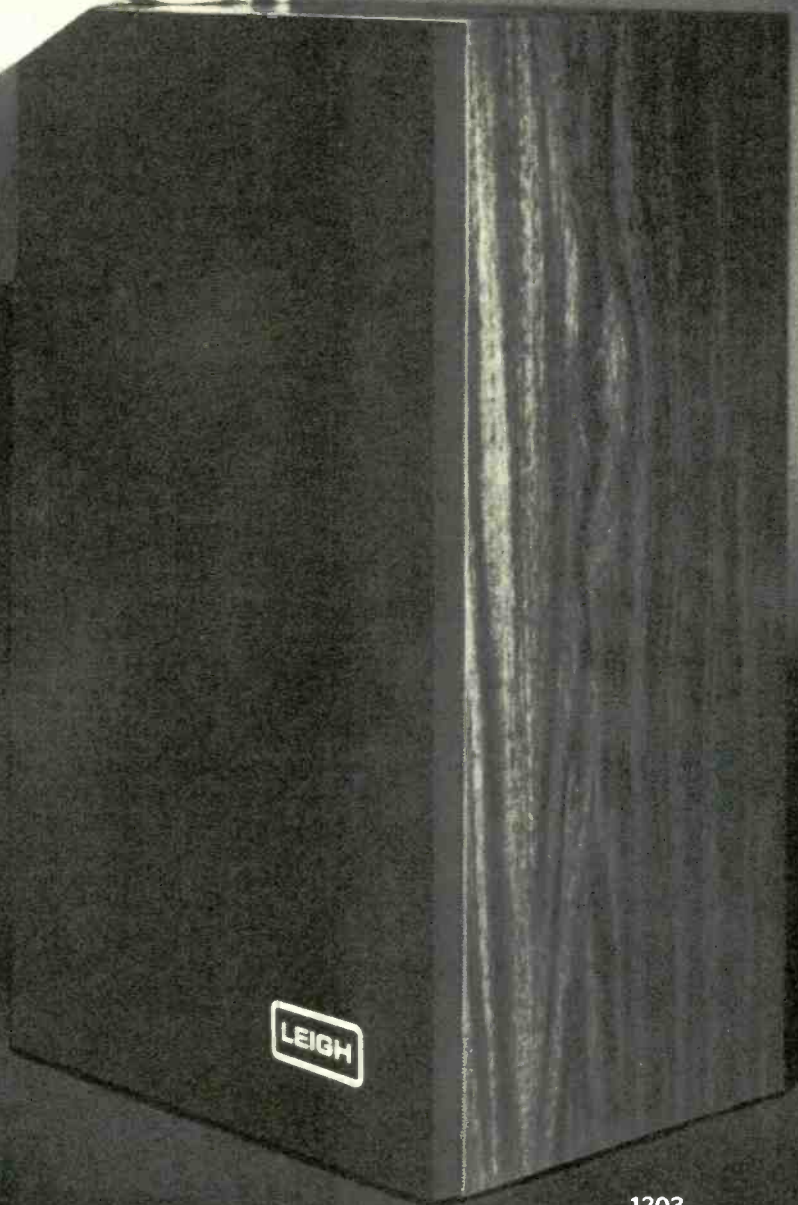

Should You Have Subwoofers?

At \$145.00 per channel, the answer may be yes.



"Full-range" speaker systems (even the best ones) are made to have falling response in the octave from 40 to 20 Hz. This is the result of a compromise required to achieve reasonable cabinet size and efficiency.

It is a good compromise, because there isn't much music in that range. And what *is* there is often lost in the recording process.

Despite this, some people go to extraordinary lengths to achieve bottom-octave reproduction. A pair of subwoofer systems, with an electronic crossover and the extra power amplifier to drive them, can easily cost over \$2,000 and will occupy a lot of space.

Most sensible people would agree that flat response in the bottom octave is

worth something, but probably not that much. Now there is an alternative choice: The Electronic Subwoofer™ filter and bass equalizer system.

Some full-range speaker systems, including those made by Allison, have woofers with as much cone area and as much linear excursion capability as a subwoofer. With the proper equalization these systems can produce flat power output down to 20 Hz. The Electronic Subwoofer system provides that equalization, and it also provides cut-off filters operating at 18 dB per octave below 20 Hz and above 20 kHz. Its price (\$290) and size (14½ by 4½ by 1¾ inches) make it a uniquely practical investment in lowest-octave bass restoration.

Complete descriptions and specifications for Allison® loudspeaker systems and The Electronic Subwoofer system are available on request.

ALLISON ACOUSTICS INC.

7 Tech Circle, Natick, Massachusetts 01760

Enter No. 3 on Reader Service Card

The digital delay principle also distributes carefully chosen "reflections" and randomized die-away reverb to your surrounding speakers, for a similar effect of room space and liveness. But here the idea is altogether different. The delays do not occur at the point of recording — they are created in your living room, out of the whole signal in its stereo form. Thanks to the sophistication — and complication — of current digital circuitry you have very sophisticated controls over the effect, changeable at will. Unlike that of the decode/enhance space, this one can be radically altered in an arbitrary manner. But you are leaving the recording technician out of the picture! Or you can, if you wish to, ignore him. You can create a grotesque cathedral sound where the producer had thought of a modest concert hall. Should you? No law against it, of course.

Synthetic Space

What I noticed in my earlier experience with Audio Pulse — not in my own living room — was just this extraordinary versatility, fooling the ears into hearing spaces that were totally synthetic. Crazy! Wonderful. Often grotesque. (That system was operating in six channels as I listened.) With the more circumspect Advent machinery, set up in the very familiar circumstances of my home living room, I noticed right away that here you must be careful. This is NOT a natural ambience. Yet it must not sound synthetic — not, at least, for any sort of extended listening. The built-in ambience of the recording, remember, is still a part of the signal. The recording has its own intended space, large or small, near or distant, live or dead. Out of this, we are building something further. It must be done with reasonable thought, unless we want pure stunt sound. I am quite sure that this is Advent's philosophy and, in the long run, it is good.

On the Advent unit there are indeed a brace of well-mannered controls for the synthesizing. A large variation in the delay time, from 0 to 99 milliseconds in bright red display numbers. You flip a switch and the numbers race forward or back as the apparent room size gets bigger or smaller. Oddly, always one millisecond too low (as if that could matter to you and me!): the maximum is 100 milliseconds at 99 on the display. Decay time, i.e. reverberation time, is controlled by a simple volume-type knob, short to long, making your synthesized space either deadish or liveish as though 20 tons of sound padding were being put down

May we satisfy your curiosity about the new Thorens TD-110C and TD-115C turntables?

You may have heard some talk about Thorens coming out with some revolutionary turntables.

It's more than talk.

The new Thorens TD-110C manual and TD-115C semi-automatic turntables introduce some real breakthroughs in turntable technology.

For example: They are the first turntables to be entirely unaffected by external vibrations. That's because of the new and radical "Ortho-Inertial Suspension." Now heavy-footed Sam in the apartment next door can clump across the floor without messing up your sound.

You might have to go a bit out of your way to hear TD-110C/115C turntables. You won't find a Thorens dealer on every street corner—for the same reason there are fewer Rolls Royce dealers than Chevy agencies. So we will send you the name of the nearest Thorens retailer along with the exciting specification of the newest Thorens



Thorens TD-110C
about \$330.00

turntables. Write Elpa Marketing Industries, Thorens and Atlantic Aves., New Hyde Park, N.Y. 11040.

THORENS®

always a
sound investment

Enter No. 20 on Reader Service Card

AUDIO • June 1979

WHAT PRODUCT:

1. Prevents "record chatter" on your turntable?
2. Looks unimpressive?
3. Is very thin and gray?
4. Is more anti-static than similar products*?

*according to tests by the Swedish National Test Institute.

ANSWER

D'STAT[®]-II by Discwasher[®]

(A turntable mat for overlay or replacement on your existing equipment.)

D'STAT[®]-II works; costs only \$7.95; and never wears out.

Give **D'STAT[®]-II** a spin.

At Discwasher dealers nationwide.



 **discwasher[®], inc.**
1407 N. Providence Rd.
Columbia, Missouri 65201

McIntosh

"A Technological Masterpiece..."



McIntosh C 32

"More Than a Preamplifier"

McIntosh has received peerless acclaim from prominent product testing laboratories and outstanding international recognition! You can learn why the "more than a preamplifier" C 32 has been selected for these unique honors.

Send us your name and address and we'll send you the complete product reviews and data on all McIntosh products, copies of the international awards, and a North American FM directory. You will understand why McIntosh product research and development always has the appearance and technological look to the future.

Keep up to date.
Send now - - -

McIntosh Laboratory Inc.
Box 96 East Side Station
Binghamton, NY 13904

Name _____

Address _____

City _____ State _____ Zip _____

If you are in a hurry for your catalog please send the coupon to McIntosh. For non-rush service send the Reader Service Card to the magazine.

Enter No. 38 on Reader Service Card

or removed with two fingers. You can also set what I might call the degree of obtrusiveness via a back-channels volume control, which I found vital. Too much is too much when it is overly loud. You can get an optimum balance via a "direct" position, no processing, the same signals in front and in the added speakers, and Advent's directions here are excellent in detail. You can monitor at three choices of input sensitivity via flashing level and overload signals for each delayed channel. (They indicate a considerable and, no doubt, carefully randomized cross-channel digitalization, an important aid to naturalness.)

And yet — I floundered. At first I got all sorts of unpleasant and artificial twangs and buzzes and metallic surges out of the delay speakers. And there was that nasty "doorspring" effect, right out of the early and relatively crude spring-actuated mechanical delay units! I was pushing too hard. (I had at least to try the stunt aspect.) No go. This Advent, emphatically, is not a stunt machine. It was several days before I got over this initial discouragement, for even my first comparisons with a more sober approach were not favorable. I missed the solid, if less controllable, ambience of my regular decode/enhance arrangements, minus all doorsprings.

Hang on! I'm not finished yet. When you change brands of car, doesn't the new one often seem pretty cranky, until you get the hang of it? What I learned is, I think, fundamental. In this synthesizing business we need not only moderation but respect. We do have an already built-in and intended effect of delayed sound on every record. Advent can profitably enhance that effect, if you will just listen first, and act accordingly.

To convert a dead studio sound into a cathedral roar is fun but silly. It sounds fake. The Advent really won't take it, though it tries. The machine under this provocation goes into twangs and buzzes at the slightest pop or click or sudden transient and the doorspring sound is always just around the corner. Avoid it! When used properly, all this disappears and the Advent is docile as a lamb. In a word, you enhance what is on your record, you do not change it into something it isn't.

Added Ambience

As soon as this dawned on me I knew what to do and Advent's instructions backed me up. Switch the delay channels to DIRECT, or to OFF. And listen to the recording as it is. Get the producer's intention. Then flip back

and adjust delay and reverb to suit what you have heard, maybe adding just a bit of extra size and ambience. There is flexibility, if you understand. Fairly intimate chamber music (or jazz and pop the same) will not take more than 30 or 40 milliseconds on the delay readout. Most concert music does well from 50 to 75. Reverb (decay time) to taste, but usually no more than half-way to maximum. And the whole at a lowish, unobtrusive volume — this is room sound, not the main direct message. Some of the more spectacular recordings, big orchestra and chorus, organ recital, will take up to 90 milliseconds and more — not many! Mostly you must cleave to the original, whatever, and interpret it. That's the whole idea.

Six channels? One night I started thinking. Advent doesn't operate on the regular front channels, the normal stereo sound. So why not hook up both systems simultaneously, taking advantage of an Advent tip that the best place for delay speakers is often at the sides rather than in back. Perfect! Feed the Advent delay into a fifth and sixth channel set up just that way, at the sides. Use the stereo feed-through, or the second main output on my versatile preamp control unit, to feed the decode/enhance equipment as before and so on into the original four channels front and back. The rest is merely switching. Next day the whole thing was done in minutes.

Now I have the advantages of both approaches combined. More than that, I can make any "A-B" test comparison you could possibly want at the push of a button or flip of a toggle. For instance — flip off Advent's delay and you have my old four-way system exactly as it was. Then push "2 CH" on the decode/enhance unit and there's straight two-channel stereo in front only. Flip Advent back on again and I have Advent-only sound, exactly as recommended by the manufacturer, via front and side speakers. Finally, push any of the three decode/enhance buttons and I get full six-channel sound, combining both systems, with variables to taste and all over the place. As they said in the sixties, it's a gas.

I find that in the six-way mode Advent works just as it does in four, to widen and open out the matrix-decoded ambience already in the recording and so further enhance the recorded message. Same rules apply, and this is as it should be. All in all, this thin black box with the red flashing number is a very useful, high-level gadget to have around. 

PLAY IT LIKE IT IS.

THE OSAWA HIGH PERFORMANCE PHONO GROUP.

Nobody can improve the basic sound quality of a record as you buy it or as it is in your record collection. Neither you, nor we. But what you can do is to make certain that all the components of your record playing system—the phono cartridge, tonearm and turntable—perform with maximum accuracy and an absolute minimum of noise. With Osawa's High Performance Phono Group, you'll hear all the music on the record, clearly and with nothing added.

Start with one of six **SATIN MOVING COIL CARTRIDGES**, intended for the most discriminating listeners. In addition to the brilliant clarity and exceptional sensitivity to every part of the groove, Satin MC cartridges offer you two special bonuses. Unlike many MC's, Satin cartridges work without a pre-pre-amplifier or transformer which can degrade sound quality. And the stylus is user-replaceable.

The new **OSAWA HIGH PERFORMANCE SERIES CARTRIDGES** are uniquely constructed with

extremely low mass and the most precise tracking possible for excellent reproduction.

At a more modest price are Osawa's unique new **MP MOVING PERMALLOY CARTRIDGES**. Each is factory hand-adjusted with an alignment screw, so every cartridge and stylus match perfectly for optimum performance.

There is an Osawa cartridge for every budget. And you can even buy your cartridge conveniently pre-mounted in an Osawa Headshell for instant plug-in installation.

To bring out the best performance in any cartridge, you need a precision tonearm. Winner of the

Consumer Electronics Design and Engineering Award and the Japan Audio Award, the Osawa **ULTRA-CRAFT TONEARM** features interchangeable arm stems (lowering effective mass), single-point suspension (minimizing bearing friction) and a tunable damping system (optimizing the match with cartridge compliance), and comes in silver or black anodized brass.

And for top turntable performance, you can't beat the Scottish-built **ARISTON RD11S** from Osawa. Outstandingly designed for precision operation, it offers a remarkably quiet -80dB rumble rating, with wow and flutter less than 0.05%. Mounted in a handsome teak or walnut cabinet, the RD11S is specially isolated from floor shocks by a unique silicone-damped suspension system.

Finally, to improve the performance of any turntable, Osawa offers the critically-acclaimed **DISKMAT**. Designed to replace existing turntable mats, the Diskmat provides optimally-contoured record support, while its high-mass, high-density construction immunizes your records from the vibrations that can muddy bass, and lessens wow, flutter and feedback.

Visit your nearest Osawa dealer today and bring along your favorite record. When you listen with Osawa's High Performance Phono Group, you'll hear music you never knew was there.



OSAWA HIGH PERFORMANCE CARTRIDGE



OSAWA

OSAWA & CO. (USA) INC.
521 Fifth Avenue, New York, NY 10017
(212) 687-5535-9/ TELEX: 236593

Enter No. 45 on Reader Service Card

What's new



The Bib Electronic 3000 eliminates record static "like a miracle."

That's what professional reviewer John Borwick claims in the June issue of Gramophone. Here's why.

The Bib Groov-Stat Electronic 3000 emits only positive ions. And that's very important because positive ions completely neutralize the negative static charge on records.

All other anti-static devices emit both positive and negative ions even though record static is mostly a negative charge. So don't be fooled by demonstration gimmicks that "prove the superiority" of trigger-type devices.

The 3000 has a smoother, slower effect that keeps the record static-free longer. And the continuous emission of ions from the 3000 immerses the record in a bath of ions unlike the irregular flow emitted from trigger-type devices.

Simple to operate, the battery-operated 3000 has a double-checking system that includes a neon light and a high-pitched tone.

Ask for the Bib 3000. See for yourself why it works "like a miracle."



Bib

The Audiophile Edition by Bib. The Finest Record and Tape Accessories in the World.

Bib Hi-Fi Accessories, Inc.
3363 Garden Brook Drive, Dallas, Texas, 75234

Enter No. 10 on Reader Service Card

Jensen Speaker System

The System B is a four-way, five-driver vented speaker system with a frequency response from 37 Hz to 21 kHz, +2, -4 dB. It has a 12-in. woofer, a 6-in. lower midrange, and 1¼-in. upper midrange, a 1-in. tweeter, and a 2-in. rear-firing tweeter. The system impedance is 8-ohms, with a 5-ohm minimum, and the recommended amp power ranges from 9 to 150 watts. Price: 490.00.

Enter No. 100 on Reader Service Card

JBL Control Monitor

The Model 4313 monitor loudspeaker is a three-way system with a 10-in. woofer, a 5-in. midrange, and a 1-in. dome tweeter. The crossover networks have individual adjustments for the midrange and high-frequency outputs. Measuring 22¼ in. x 14¼ in. x 10 in., the speaker weighs 42.5 lbs. Price: 369.00.

Enter No. 101 on Reader Service Card

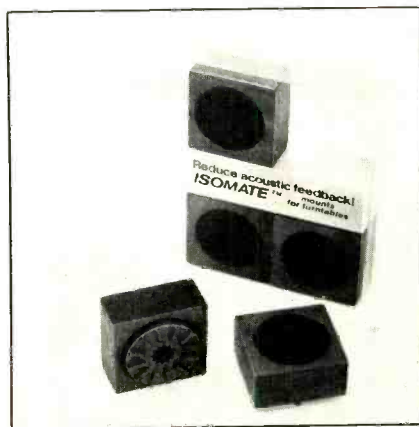

Enid Turntable Mounts

Isomate turntable mounts reduce acoustic feedback by providing an extra stage of vibration isolation. The four mounts, featuring elastomeric suspensions in walnut blocks, are guaranteed to allow 10 dB higher power levels without distortion due to structure-borne sound. The mounts also provide turntable stability against outside vibration. Price: \$16.95.

Enter No. 102 on Reader Service Card

Precision Fidelity Preamp

The Model C4 is a dual-cascade, vacuum tube preamplifier with a gain of 42 dB at 1 kHz in the phono stage,

THD of less than 0.01 percent, and an S/N ratio of 70 dB. The unit employs localized feedback in addition to a main a.c. and d.c. feedback loop, and the slew rate is four times quicker than in previous tube preamps. Price: \$1095.00.

Enter No. 103 on Reader Service Card

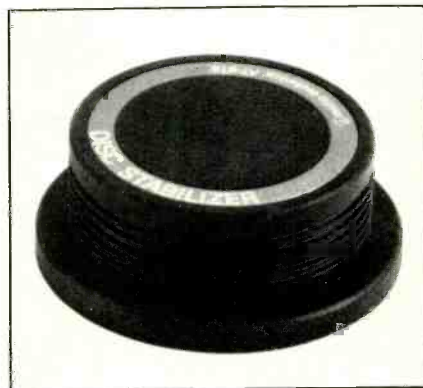

Audio-Technica Stabilizer

The Disc Stabilizer helps flatten out warped records which can color the sound of music played on sophisticated hi-fi systems. A compact, solid-brass disc in a rubber jacket, the stabilizer exerts a pressure upon the record label to damp sound coloring resonances that develop during record play. Price: \$19.95.

Enter No. 104 on Reader Service Card

Monitor Audio Speaker

The MA1 Series II is a three-way speaker system with a frequency response of 45 Hz to 19 kHz, ±3.5 dB, and an 8-ohm impedance. The 13-by-9-in. passive bass radiator is acoustically coupled to the 8-in. woofer and operates in-phase below 45 Hz. The midrange driver is made of bextrene plastic and the tweeter is a polycarbonate dome. Price: \$429.00.

Enter No. 105 on Reader Service Card

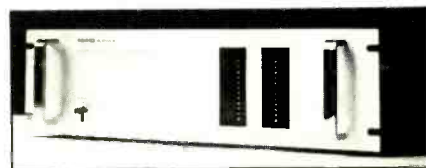

Nikko Amplifier

The Model Alpha III is a power amplifier, using power-MOS-FETs,

rated at 80 watts rms per channel into 8 ohms, has a frequency response from 20 Hz to 20 kHz, a THD of 0.006 percent, a 115-dB A-weighted S/N ratio, and is rack mountable. Price: \$479.95.

Enter No. 106 on Reader Service Card



TDK Kit

The Head Cleaner Kit contains a mirror, brushes, pads, and liquid essential for proper head care, all packed within a cassette storage box. Price: \$6.00.

Enter No. 113 on Reader Service Card

Gusdorf Component Furniture

The Model 1435 electronics furniture has four interior shelves adjustable in two-inch increments to accommodate almost any component available. Two storage cabinets feature removable record dividers, and feet on the unit are adjustable for precise leveling. Measuring 48-in. H x 23 $\frac{3}{4}$ -in. W x 17-in. D, the unit features access holes to conceal wiring. Price: \$144.00.

Enter No. 107 on Reader Service Card



American Scientific Analyzer

The Model 910 Audio Analyzer contains a "pink noise" generator and signal analysis circuitry combined with a multi-function CRT display to aid the audio enthusiast in room equalization, speaker comparison, FM reception and tuner performance, basic tests of audio components, acoustic setup of halls and auditoriums, and testing the validity of audio specifications. The unit has four operating modes: *Analyzer* for spectral analysis, *Oscilloscope* for signal response observation, *FM Multipath* for optimizing FM performance, and *Audio* for optimizing stereo performance and antenna tuning. Price with calibrated condenser mike: \$895.00.

Enter No. 108 on Reader Service Card

Kustom Acoustics Speaker

The Labyrinth is a four-way system with a frequency response of 16 Hz to 40 kHz, ± 6 dB, and crossover frequencies at 175 Hz, 2.5 and 7.5 kHz. Requiring a minimum of 15 watts power, the unit can handle up to 200 W (music peak) and comes standard for bi-amp or tri-amplification. Price: \$899.00 each.

Enter No. 109 on Reader Service Card

Crown Amp/Preamp

The Straight Line One preamplifier and the Power Line One amplifier are designed to be companion units that emphasize ease of operation. The Straight Line One has a frequency response of 10 Hz to 20 kHz, ± 0.1 dB, S/N of 101 dB "A" weighted, THD at less

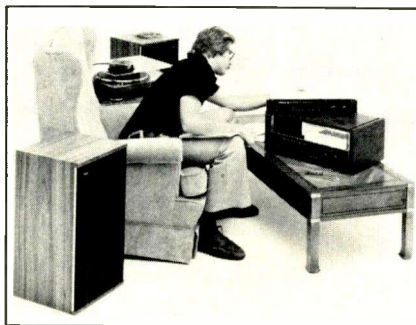

than 0.0009 percent and IMD at less than 0.00055 percent. The Power Line One has a rated output of 50 watts, a frequency response of 20 Hz to 20 kHz, ± 0.1 dB, a S/N ratio of 115 dB "A" weighted, THD at less than 0.05 percent, and IMD at less than 0.00095 percent at rated output. Price: preamp, \$549.00; amplifier, \$479.00.

Enter No. 110 on Reader Service Card

Audio-Technica Phono Cartridge

The Model AT30E moving-coil phono cartridge overcomes two drawbacks usually associated with this type cartridge: It has an unusually low price and the stylus is user replaceable. An optional AT630 transformer is also available, making it usable with standard phono inputs. Price: \$100.00, transformer: \$95.00.

Enter No. 111 on Reader Service Card

Scott Speaker

The Model 166 is a two-way, controlled-impedance loudspeaker, rated at 8 ohms and never dropping below 7 ohms. The frequency response is 55 Hz to 20 kHz, ± 4 dB, with an output level of 92.5 dB SPL at 1 meter for 1 watt pink noise input. Capable of handling amplifiers from 10 to 100 watts, the 1-in. textile-dome tweeter is protected against burn out. Price: 119.95

Enter No. 112 on Reader Service Card

Bib has all the angles for cleaning your tape heads at \$10⁵⁰

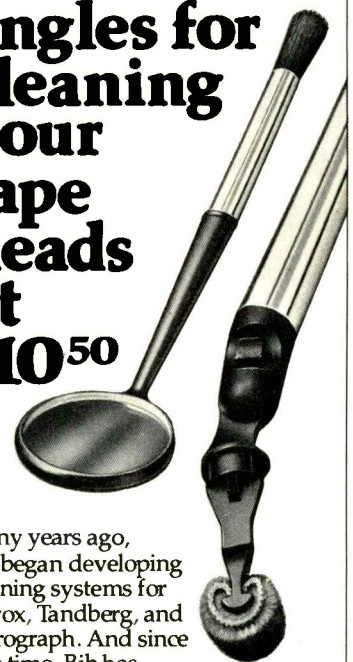

Many years ago, Bib began developing cleaning systems for Revox, Tandberg, and Ferrograph. And since that time, Bib has sought a satisfactory answer to the problem of dirty tape heads and pinch rollers.

As a consequence of its diligent research, Bib has created the Tape Head Cleaner—a totally unique and completely effective instrument that can be used on any brand or style of tape deck.

Because the head rotates around 280° and locks into any position desired, the tool can reach the heads whatever their position. And the tip of the tool is made from a soft synthetic fiber that does not shed, unlike cotton pads or similar devices.

The kit includes an inspection mirror, fluffy brush, head cleaning fluid, and 3 extra snap-on tips. And it comes in a velvet-lined hard plastic case.

The next time you're at your favorite stereo shop, ask for the Bib Tape Head Cleaner. It has the angle you need for proper tape head maintenance.



Bib

The Audiophile Edition by Bib. The Finest Record and Tape Accessories in the World.

Bib Hi-Fi Accessories, Inc.
3363 Garden Brook Drive, Dallas, Texas, 75234

Enter No. 11 on Reader Service Card

LOW TIM MAKES THE LISTENING DIFFERENT.

COMPARABLE AMPLIFIERS DO SOUND DIFFERENT

Choosing the best amplifier for your audio system involves comparing specs, features and, of course, price. But ultimately, if you love music, you should base your decision on the way an amplifier sounds when reproducing music.

Two amplifiers may have identical power ratings and virtually no total harmonic distortion, yet sound very different: one clean and clear, the other harsh and metallic. The difference you hear is transient intermodulation distortion (TIM, for short). The real effects of TIM on music, however, have only recently been recognized, since TIM does not show up in even the most accurate traditional laboratory measurements.

Measurements for THD are made with smooth, repetitive signals (sine waves). Music, on the other hand, presents an amplifier with a series of non-repeating, pulsive, "transient" signals, as illustrated below.

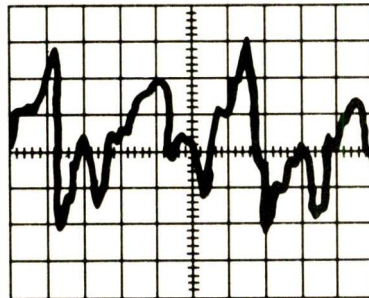
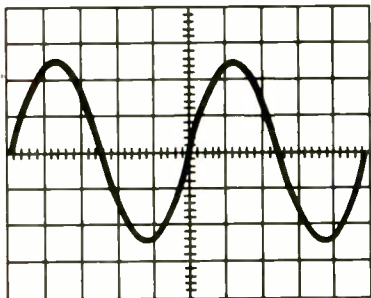

An amplifier that cannot faithfully follow the sharp transients demanded by music may have very low THD, but very high TIM.

WHAT CAUSES TIM?

It has been discovered that TIM distortion in an amplifier is caused by an insufficient slew rate — the engineer's term for an amplifier's ability to handle the high power, high frequency signals a musical transient presents. Poor slew rate in con-

ventional amplifiers is most often caused by the very mechanism used to reduce THD, namely, the addition of negative feedback. Put more simply, in conventionally-designed power amplifiers, the more negative feedback you use, the lower will be the THD (which is good), but the higher will be the TIM (which is not so good).

It took Sansui, and a whole new approach to amplifier design, to solve the high-



AU-919 DD/DC AMPLIFIER

frequency slew-rate problems of TIM without compromising our superbly low THD specifications.

THE SANSUI SOLUTION

The most important step in the solution was to "speed up" (increase the frequency response of) the basic amplifier — even before negative feedback is applied — by using Sansui's own patent-pending DD/DC (Diamond Differential/Direct Coupled) circuit. The DD/DC circuitry includes a sophisticated "lag + lag/lead" dual compensation system, more often found in instrumentation amplifiers than hi-fi products, which maintains stability without decreasing frequency response. With DD/DC, the amplifier can instantly supply the enormous negative feedback current demanded by transients, without restricting the slew rate, and so without introducing TIM.

How well our unique circuitry succeeds in

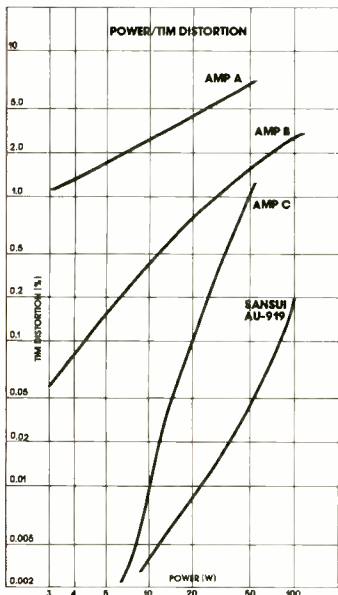

Power output vs. TIM distortion curves for the Sansui AU-919 and competitive amplifiers. Derived using the TIM measurement method described in a paper presented at the 63rd Convention of the AES May, 1979.

eliminating TIM, while maintaining extraordinarily-low levels of THD is shown in these comparative curves. The Sansui AU-919 amplifier (bottom curve) is rated at 110 watts per channel, min. RMS, both channels into 8 ohms from 10Hz to 20,000Hz, with no more than 0.008% total harmonic distortion.

AT LAST, A NUMBER

Transient intermodulation distortion is now recognized to be an audibly significant problem. But finding the best way to measure it proved an engineering challenge — a

challenge to which Sansui has once again risen. Earlier methods either simply observed the TIM process on an oscilloscope, but couldn't measure it; or required a multitude of laborious computations and/or the use of ultrasonic signals that

might actually damage some amplifiers.

Sansui's proposed methods of TIM measurement, presented at the 63rd Convention of the Audio Engineering Society (May 1979), utilize a 20kHz sawtooth waveform whose direction is reversed at an audio rate. A high-pass filter eliminates the ultrasonic components, and a low-pass filter eliminates the switching products, so that what remains is composed of actual TIM products within the audible spectrum. By simply comparing the amplitude of the peak-to-peak signals before and after the filtering (shown below), the percentage of TIM can be directly calculated facilitating both significant listening tests and improved circuits. A copy of the Sansui paper, more fully describing the procedure, is obtainable from Sansui on request.

LET YOUR EARS BE THE JUDGE

Instruments and circuit-design analysis are fine in their place, which is the laboratory. But you listen to music in your home; and we're confident that you will hear the difference in musical clarity that a Sansui amplifier makes. Your local Sansui authorized dealer can demonstrate all the convincing reasons for choosing Sansui.

SANSUI ELECTRONICS CORP.

Lyndhurst, New Jersey 07071 • Gardena, Ca. 90247
SANSUI ELECTRIC CO., LTD., Tokyo, Japan
SANSUI AUDIO EUROPE S.A., Antwerp, Belgium
In Canada: Electronic Distributors

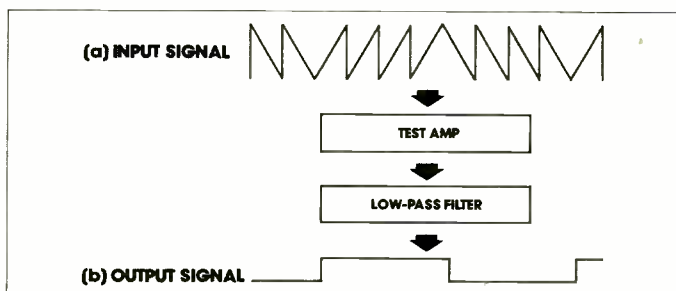

Input test signals passed through the AU-919 amplifier and the low-pass filter, resulting in the DC-shifted signals which indicate the TIM.

Enter No. 54 on Reader Service Card



Dear editor

Author Sought

Dear Sir:

I would like to get in contact with Rolf Rennwald who wrote an article in the June, 1963, issue of *Audio* entitled: "A Full-Range Electrostatic Speaker."

I am hoping that either he or one of his friends in Germany will see this letter and help me in this matter.

Michael J. Kelly
17416 S.E. 262nd St.
Kent, WA 98031

Sounds *au naturel*

Dear Sir:

The recording of environmental sounds (bird songs in particular) is an avocation shared by a number of people. I'm sure that those who have listened, for example, to the Environments releases by Syntonic Research and other nature recordings can understand why.

I am presently organizing an association called Essence, which, I hope, will attract the ideas of people who are interested in recording the sounds of

wildlife we are still lucky enough to have.

Ideas concerning recording techniques will be especially useful and we hope to set manufacturers of portable recording equipment in the right direction, since the quest for true fidelity in this unexplored field has only just begun.

Those interested are invited to write to me.

M. Mark Swan
308½ South First
Dekalb, IL 60115

Lucky Find

Dear Sir:

In reply to the letter by Mr. K.O. Johnson in your January, 1979, "Dear Editor" column, it is unlikely that he will be able to locate any commercial sources for purchasing Emory Cook's stereo/binaural records of the 1950s. If he can find a private collector willing to part with them, he will be very lucky indeed.

Most of Cook's recordings were son-

ic dynamite, and the binaural discs with entirely separate channels, both laterally cut, avoided the problems of vertical cutting inherent in 45/45 stereo cuts.

Admirers and worshippers of the "old master" will be pleased to hear that he is once again producing records, reissuing his stunning records of the '50s in the regular stereo format. We have recently made comparison between these issues and our collection of the original discs (lovingly preserved for equipment testing purposes) and, incredibly enough, they sound even better.

Anyone interested in hearing these sonic blockbusters of the "glorious" 50s may contact Mr. Cook at the following address: Cook Laboratories, Inc., 375 Ely Ave., Norwalk, CT 06854.

Lionel A. Seemungal
Celian B. Yip
Edward R. McDowell
Newtown, Port of Spain
Trinidad, W.I.

The new Meteor Vamp1 sinfully satisfies two senses with 100 watts of audio and 1500 watts of lighting

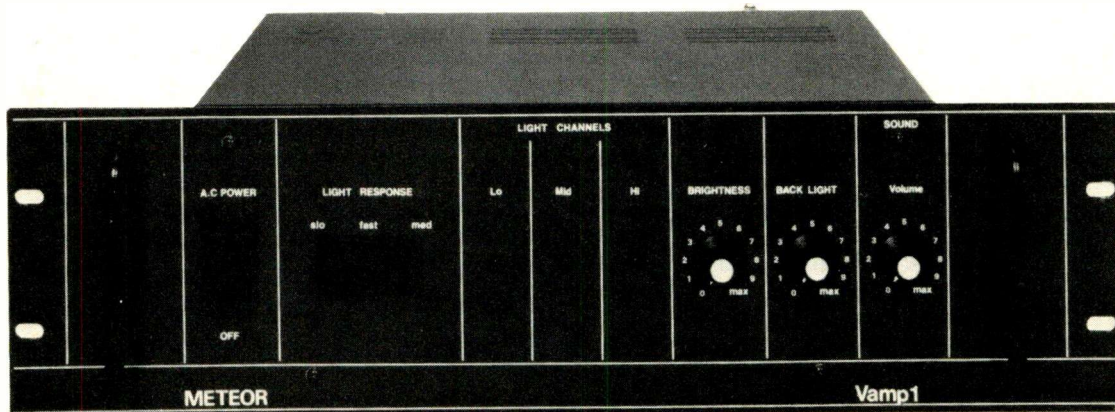

Vamp 1 - an ultra low distortion power amplifier with a big difference - built in lighting. **Vamp 1** features unique sound to light translation-circuits that cater for all musical tastes. Coupled to three light channels using red, green and blue elements, **Vamp 1** can follow the delicate rolling color changes that enhance classical works or switch swiftly to the beat of rock or disco dance music.

Just connect any line audio source from your preamp, mixer, receiver, tape unit or tuner, and professional sound to light translation is yours.

Visual and aural satisfaction from one single unit. See **Vamp 1** at selected audio dealers or complete the coupon for further details.

METEOR LIGHT and SOUND COMPANY

155 Michael Drive, Syosset, New York 11791
Telephone (516) 364-1900. Telex 96-1396

A member of the Hammond Industries Group.
West Coast Telephone (213) 846-0500
Canada (416) 677-0544, England (Byfleet) 51051

METEOR LIGHT and SOUND COMPANY		
155 Michael Dr, Syosset, NY 11791		
Please send information on		
<input type="checkbox"/> Projectors	<input type="checkbox"/> Loudspeakers	<input type="checkbox"/> Disco Walls
<input type="checkbox"/> Strobes	<input type="checkbox"/> Lighting Controllers	<input type="checkbox"/> Disco Floors
<input type="checkbox"/> Effects	<input type="checkbox"/> Mobile Installations	<input type="checkbox"/> Disco Ceilings
<input type="checkbox"/> Mixers	<input type="checkbox"/> Fixed Installations	
<input type="checkbox"/> Amplifiers		
Name _____		
Address _____		
City _____ State _____ Zip _____		

Enter No. 24 on Reader Service Card



“In its price class, the Dual 819 has some formidable competitors, and one has the right to expect first-class performance from any cassette deck selling for more than \$400.

Nevertheless, even in such distinguished company, the 819 stands out.”

Hirsch-Houck Labs in Stereo Review, December 1978.

We shall be pleased to send you the complete Hirsch-Houck report if you write to us directly. If you'd rather not wait, here are some additional key excerpts:

“...the extremely low flutter, flat frequency response and low noise level of the 819, combined with its superbly accurate and useful meters, make this one of the more attractive values in a high-quality cassette deck. Such features as the fade/edit system and the bidirectional memory can be considered simply as bonuses.

“The Maxell UD-XL-I tape provided a very flat record-playback response (at -20dB) within ± 0.75 dB from 30 to 15,000 Hz... the response with Sony Ferrichrome was flat within ± 1 dB from 33 to 15,000 Hz... the Dolby tracking was among the best we have measured... with a weighted rms reading the flutter was an amazing 0.035 percent. It is clear that in all aspects of its design and performance, the Dual 819 is a first-class unit.”

One final comment of our own. As you know, Dual's reputation for quality, precision and reliability has been based upon the performance of our turntables. When we introduced our first cassette decks, we knew they must establish a reputation of their own. And it is evident that they are doing just that.



United Audio
120 So. Columbus Ave.
Mt. Vernon, NY 10053

Enter No. 17 on Reader Service Card

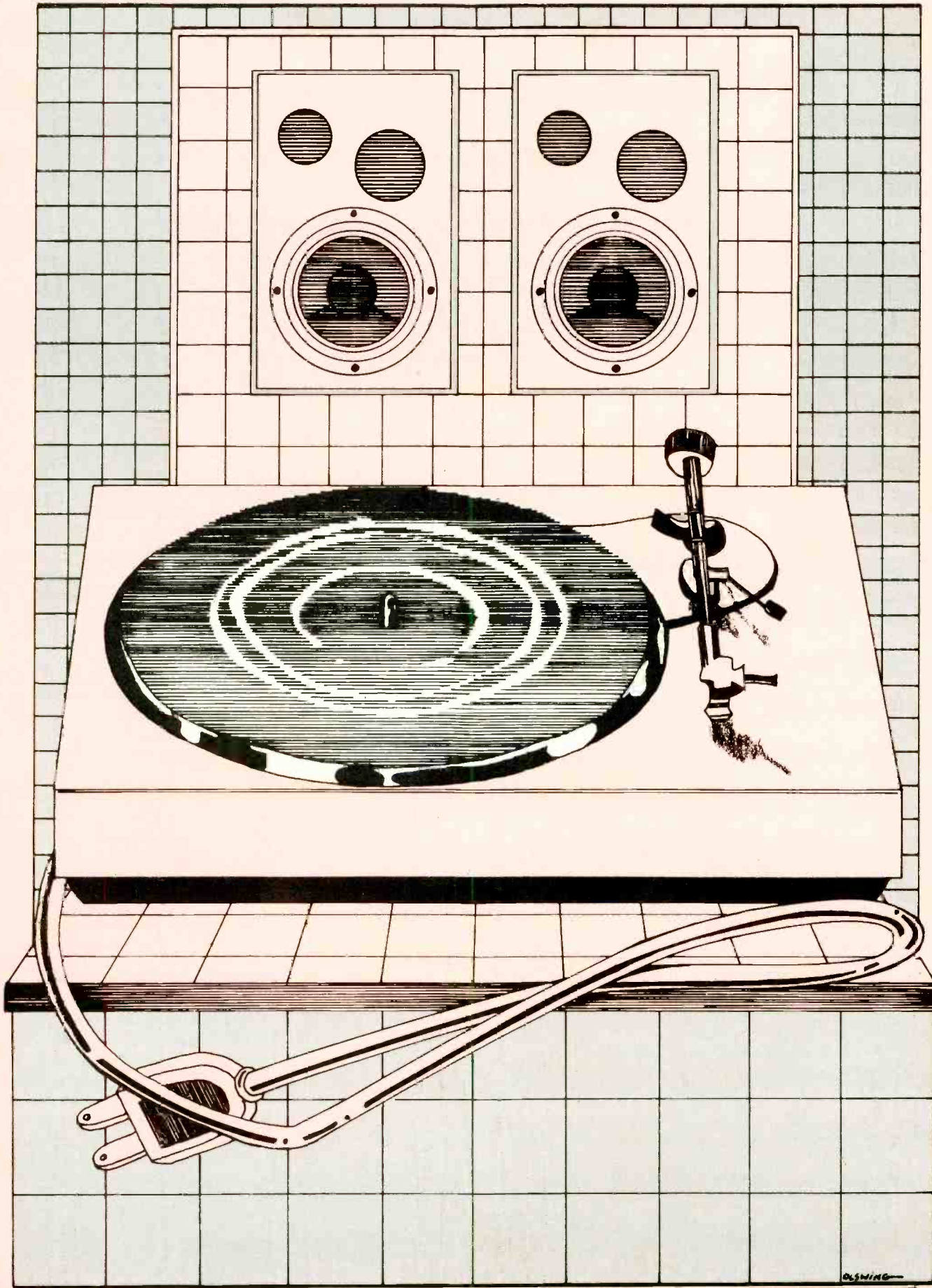

OLWING

As audiophile-grade hi-fi systems have become more revealing, and therefore less likely to contain subtle types of coloration and distortion, more and more seemingly minor factors have been found to relate to the audible characteristics of these same music systems. In the past few years, it has become clear that the effects of tonearm and cartridge mass resonance, friction,¹ and even arm tube and headshell rigidity can all color the sound of a high performance system.

A number of organizations studying the electrical and mechanical characteristics of record discs have found that the physical properties of the turntable mat upon which the disc rides can have consequences which are both audible and significant. These studies have focused on two phenomena which had previously been rather poorly understood: The nature of static formation, neutralization and discharge, and the occurrence of vibration and resonance in the record itself.

Conventional records, being composed primarily of PVC, represent a highly insulating dielectric. The vinyl compounds are very easily charged, particularly in dry climatic conditions, and store extremely high static voltages. These charges can be easily formed, in many cases, just by removing the record from its inner sleeve. A recent paper on the subject, prepared by Shure Brothers,² notes that static charges of as high as 30,000 volts were commonly measured during their tests. Experiments performed by Dr. D. W. Swan of 3M Technical Laboratory (England)³ found equally high static charges. Dr. Swan notes that since the breakdown voltage of air at normal humidity is about 30,000 volts, any "snap" which is heard as the record is removed from the jacket or handled indicates that a static charge of such magnitude is present. Most records, in addition to easily acquiring static voltages, have substantial charges molded into the plastic during the pressing process. These voltages render them intrinsically charged, much like the diaphragm of an electret microphone.

Static Problems

Although static charges themselves are very rarely amplified by the system, and are therefore not usually directly audible, they do cause a plethora of other problems in various indirect ways. These problems include:

1) *Attraction of Dust* — Dust and larger particles commonly have charges of their own which tend, in the majority of cases, to attract them

DO TURNTABLE MATS WORK?

to record discs. According to the Shure studies, the charge on a record is generally negative; most dust particles, apparently, have positive charges, which factors generate a classic case of electrostatic attraction. In addition, Dr. Swan of 3M describes, in detail, the behavior of complex electrostatic forces which may generate attraction of even uncharged particles. It is generally accepted that the primary mechanism of dust collection on record surfaces is static related and not the product of particles simply falling onto the disc. Once attracted, dust becomes extremely difficult to remove without some neutralizing activity and virtually impossible to adequately pick up with simply dry record brushes.

2) *Electrostatic Attraction of Cartridge* — The phono cartridge itself is attracted to a statically charged disc for reasons similar to those responsible for dust attraction. A number of studies^{2,3} indicate an addition to the measured tracking force of 0.375 to 0.500 grams may occur under reasonably typical conditions (a charge of about 4,000 volts with the record on the turntable). The cartridge or arm may also be attracted to the unplayed records in a changer stack and, in some

cases, even to the closed dust cover of the turntable.⁴ These various attractions change not only the tracking force but also many other dynamic parameters. As a result, stereo imaging and tracking properties of the system may be affected.

3) *Modulation of Cartridge Output* — Since static charges are not uniformly distributed on the record surface, it is possible for tracking force, anti-skate settings, vertical tracking angle, and channel balance to be altered enormously on a momentary basis as the cartridge passes over heavily charged regions of the record surface (static "hot spots"). This may have the effect of modulating the output of the cartridge in one or both channels.

4) *Cueing "Snaps" or Transients* — Occasionally, as a tonearm is cued to the disc, a static discharge will be coupled through the cartridge or input leads to the amplifier and reproduced by the audio system as a loud snap. This is annoying, but more significantly, a transient of this type is of very high level and can damage both the amplifier and speakers.

The audio marketplace offers a wide variety of devices and methodology to reduce static charges. These range from fluid and film applications (with no generally used substance which performs this function without interfering with some other aspect of the playback process) to polonium-strip emitters (Staticmaster) which are essentially positive-only Alpha emitters. Air-ionizing devices (Zerostat and others) can bring static charges to zero, but such neutralization lasts only about one hour. One other practical solution lies in creating a conductive path from the record surface to ground, and this can be done locally via a conductive fiber brush or generally via an electrically conductive turntable mat.

The conductive mats, such as the Discwasher D'Stat II, eliminate static charges in two separate and distinct ways: 1) by conduction of the charge to ground, where the charge passes through electrically conductive fibers woven into the mat which spread out local charge concentrations and act as a low resistance path to the turntable ground through the metal platter or spindle; and 2) by ionic neutralization, a phenomenon in which ions of opposite polarity to the charged record surface travel from ground (which may be viewed as an infinite "bank" of both positive and negative ions) onto the conductive fibers of the mat to the fiber points which store charges as

YOU BET!

Robert Stockton

"point electrodes." When sufficient ionic potential has gathered at the fiber points, the ions transfer to the disc and effectively neutralize the static charge present there. See Fig. 1. Thus, when the record is first placed on the turntable, an ionically active mat will require several seconds to eliminate the static field. Some mats accomplish the "conductive" function but few the ionic neutralization.

Both conduction and neutralization of charges take place on the "bottom" of the record, and, at first glance, this seems to have little beneficial effect upon the upper tracking surface. Interestingly enough, however, a high degree of conductivity in the mat will cause a migration of the charge between the upper and lower disc surfaces. This migration reduces, in large measure, the field on the upper surface. Alternatively, the record might be flipped to the "play" side after resting on the mat for several seconds, though this is tedious.

Studies on Mats

The National Swedish Authority for Testing, Inspection, and Metrology has performed a number of studies on conductive mats,⁵ comparing the effectiveness of different types. Their findings indicate that both the number of conductive fibers and the diameter of the fiber points (which determines the effectiveness of the fiber as an electrode) are of great importance. In a comparative test of three mats which had front-to-back resistances of 5 megohms, 100 megohms, and greater, respectively, it was demonstrated that the lower resistance type (e.g. D'Stat) was almost totally effective in eliminating charges of 4,600 volts and more by reducing the static charge on the record to about 500 volts, a relatively negligible figure. The higher resistance devices accomplished much less reduction of static charge, from 4600 volts down to 3900 and 4000. These tests establish that the electrical ion donor properties of conductive mats must fall within a fairly specific range in order to yield effective results.

Other recent studies have examined

another rather interesting concept: The turntable mat performs another crucial function in isolating or damping. A number of different types of vibration may generate resonances and motion within the record itself, and there are, apparently, several sources of vibration which may affect the disc.

The best documented of these sources is the turntable drive mechanism, primarily the drive motor and/or the main bearing on which the platter rotates.^{6,7} Depending upon the drive system and the suspension used to support these elements, rumble, primarily in the form of vertical motion of the record surface, may be transmitted to the stylus and through the system. This transmission path is the predominant source of rumble in modern turntables; very little vibration is transmitted through the tonearm structure to the stylus. Contrary to popular belief, the frequency spectrum of rumble from conventional turntables is quite broad and includes a substantial amount of output above 50 Hz (in the audible range), as well as frequency components down to as low as a few Hertz. A paper by Bauer details a number of rumble spectra and comments on the origins of various frequency components.⁷

Platter-transmitted rumble, if reproduced by the system, has a number of ultimate sonic effects: 1) Modulation of the mid-bass information on the record by the higher frequency portions of the rumble; 2) a reduction in the usable power output of the amplifier and increased bass-driver distortion (this occurs because the low frequency portions of the rumble are amplified to very high levels, given the disc equalization curve of the preamp stage, and thus "use up" a substantial amount of both the power available from the amplifier and the usable excursion of the bass driver); and 3) excitation of the fundamental arm-cartridge resonance, with all of its well-documented impact upon tracking ability and deep bass performance.^{8,9}

The Japanese firm, Denon, and their importer, American Audioport, have done tests on another source of reso-

nance in record discs — vibration excited directly by the loudspeaker. Denon has carried out experiments which confirm that midrange frequencies at fairly typical listening levels can set the record in motion and, consequently, add midrange coloration to the music. In their tests, a conventional phonograph record was photographed by laser holography, while a loudspeaker reproduced a wide range of frequencies at 103 dB SPL (measured adjacent to the record). A major resonance at 932 Hz and lesser resonances at other frequencies were observed (see Fig. 2). The peak displacement of the record surface was about 0.02 mm, which translates to an amplitude of several dB when reproduced by a typical system. In related experiments, engineers at American Audioport were able to induce ringing at even higher frequencies in records placed on radially ribbed or other edge-supportive platters. Records on such platters could be made to microphonically reproduce through an audio system the sound of a technician shouting at the record! Taken in perspective these findings do not seem surprising. Architectural acousticians regularly find much larger objects — chandeliers, framed paintings, etc. — which have pronounced resonant modes. Indeed, it would be more surprising if an unsupported vinyl disc did not vibrate in a room with music being played at concert hall levels.

Disc Vibration

A third source of disc excitation has been investigated privately by an English engineer, G. Holliman.¹⁰ In the magazine, *Hi-Fi Answers*, Holliman describes a phenomenon in which the record plays the stylus, as well as the reverse: "When the groove moves the stylus to reproduce a signal, the groove itself is slightly deformed and radiates waves on the record surface like ripples in a pond. These waves travel across the record surface, reflect from the curved edge, and return to the stylus, where they are corrected each time they pass, to further sound pulses (like an echo plate)." He goes

Fig. 1 — Illustration of cross section of the record, mat, and platter, showing the static discharge process.

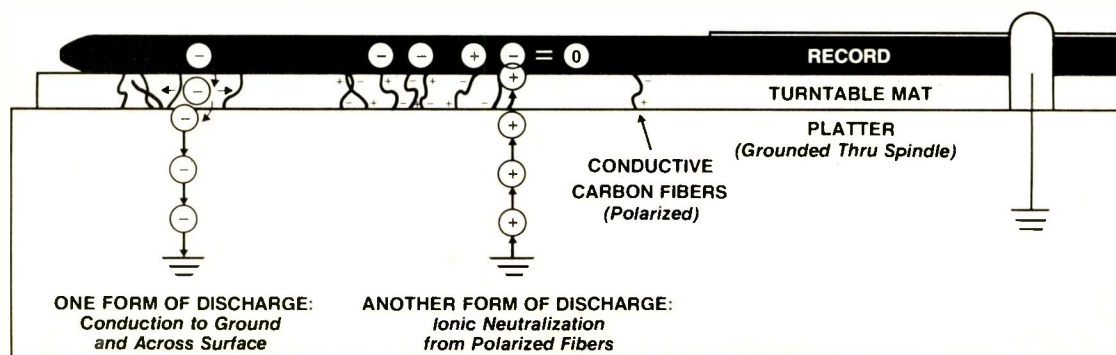



A.

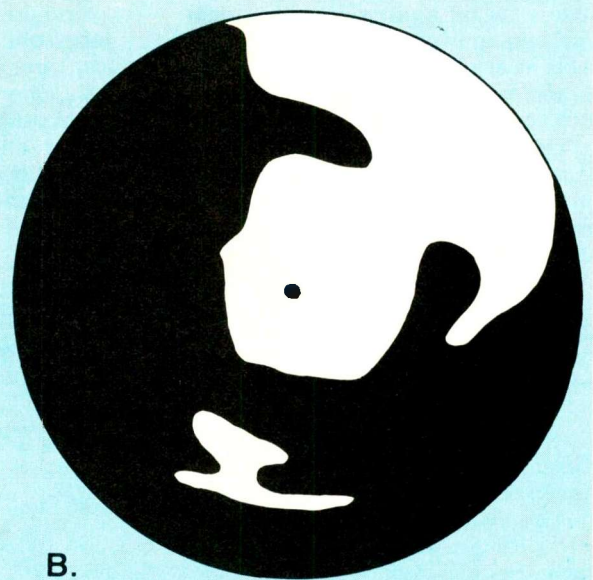

B.

Fig. 2 — Laser interferometry tracing of a record on turntable mats: A) resonance pattern of record on standard ribbed turntable mat, and B) resonance pattern of record on a

specially designed butyl rubber mat (10 mm thick). The circular islands and holes show resonance while the large spaces show stability of the record disc.

on to give a detailed explanation of the audible effects of this wavelike vibration, describing the result as resembling the exaggerated reverberant effect of a large hall. Holliman also suggests an interesting experiment as one means of verifying its sonic effects. Suspend a record above the turntable platter on a stack of large washers such that only the labeled portion of the disc is supported, and compare the sound of the disc played in that position with the same disc played under normal circumstances. Although Holliman's work is not backed by the same degree of experimental data as the studies of other disc vibration phenomena, it seems to be theoretically accurate. At least two cartridge manufacturers have noted similar occurrences under laboratory conditions, and audiophile groups have reported repeatedly on the sonic "flavor" it adds to certain records.^{11,12}

Support and damping for the record disc, or lack of them, seem to be the primary factors in determining the degree of record susceptibility to vibration. The Denon tests involved two different types of mats — a conventional ribbed synthetic rubber mat and a heavy 10 mm thick butyl rubber unit. The results indicate that mechanical damping was critical to the mat's effectiveness. Rubber and plastic units damp out vibration visco-elastically by dissipating the mechanical energy of motion in the process of "stretching" a

lossy, elastic medium (the rubber compound). Felted or fibrous materials, by contrast, perform the same dissipation of vibrational energy in the process of separate fibers rubbing together, causing friction and energy conversion to heat. This fibrous energy conversion is somewhat more effective over a wide range of vibrational frequencies and has the additional advantage of being able to incorporate conductive elements. The findings of other tests support this contention. In the American Audioport experiments, the harmful vibrational effects of the edge-supportive and ribbed platters could not be duplicated when felted or heavy rubber mats were used. The Holliman article notes that the reverberant character of sound vanished when a heavy pad was substituted for the washer stack.

Important in the selection of mats is the thickness of the mat as it relates to cartridge tracking angle. A thin mat will change the cartridge angle less than 0.7° (much less than warp angle), whereas the 3/16-in. thickness of some "over mats" can change the tracking angle as much as 2.5°. Tonearms that can be vertically adjusted are essential to compensate for such increased pad thickness.

Replacing a conventional turntable mat with an anti-static, anti-resonant type will not radically alter the sound of an audio system, for the effect of such a change is to provide an aware-

ness of musical nuance. Such subtle enhancement is true of any improvement which does not replace the major components of the system. Nuance, however, is what separates the excellent from that which is merely satisfactory. **A**

References

1. John J. Bubbers, "An Evaluation of the Forces Required to Move a Tonearm," *Journal of the Audio Engineering Society*, October, 1970.
2. C. Roger Anderson, et al., "Phonograph Reproduction—1978," *Audio* May, June, 1978.
3. Staff Report, "Audio Accessories — Supplement," *Hi-fi News and Record Review*, December, 1977.
4. M. P. Hide, et al., "Electrostatic Forces on Pickups" (Letters) *Wireless World*, May, June, August, September, and December, 1974.
5. National Swedish Institute for Testing, Inspection, and Metrology Test No. 77100-33, Spring, 1978.
6. K. Clunis & M. Kelly, "Overcoming Record Warps and Low Frequency Turntable Rumble in Phonographs," *Journal of the Audio Engineering Society*, July-August, 1975.
7. Benjamin B. Bauer, "On the Measurement of Rumble in Phonograph Reproduction," *Journal of the Audio Engineering Society*, April, 1967.
8. Gary T. Nakai, "Dynamic Damping of Stylus Compliance/Tonearm Resonance," *Journal of the Audio Engineering Society*, September, 1973.
9. Benjamin B. Bauer, "On the Damping of Phonograph Arms," *Journal of the Audio Engineering Society*, July, 1963.
10. G. Holliman, "Belt Drive Versus Direct Drive," *Hi-fi Answers*, November, 1976.
11. Arthur Pfeffer, "Further Thoughts — The Dust Bug," *The Absolute Sound*.
12. Art Scott, "Skinny Discs and Platter Pads," *The Boston Audio Society Speaker*, July, 1978.

but not totally — that of equalization. You can offset the equalizing function by EQing your send *inversely* relative to your return (that is, cut highs) and still derive some benefit, still get some of the "Aphex Effect." Also unlike EQ, only a slight amount of actual level is added, and the disparity between what is heard and what can be measured with machines is so great that the remainder must be chalked up to psychoacoustics. The complicated auditory circuitry of the listener's brain is triggered — "excited" — into perceiving the sound as it does.

By itself the Aphex return sounds godawful. Strident, brittle . . . nothing like the way you'd want a recording to sound. It only really happens when it's mixed in with everything else. What the Aural Exciter contributes to the recording is most commonly referred to as presence, (which unfortunately tells us very little. Though presence is generally considered a good thing to have, there is not much agreement about just what it is. There is perhaps no other word in the audio vocabulary whose meaning is so personalized. Some producers and engineers use it to mean distance, bigness, airiness, liveliness, naturalness. Others use it to mean just the opposite — in referring to direct recording, say, which gives you a smaller and more concise focal field and a distinctly unnatural perspective on the given sound source. For many, presence can be achieved merely by boosting the high end — anything above 5 kHz.) "Air" is probably the next most-often-used term for what the device adds. People also talk about qualities like shine, gloss, smoothness, sheen, and silkiness. Also fullness, crispness, brightness, articulation, and clarity.

And there are some spatial ramifications as well. One hears of an Aphexed instrument "popping out" or moving closer to the listener. There is an "opening up" — a left-right broadening of an Aphexed instrument's focal field — and, of course, the Aphex return being behind the straight signal

(more a reflection of being lower in level than later in time) will tend to pull the image back along the front-back axis as well. Others have noticed that the recording as a whole seems larger — specifically a broadening of the entire side-to-side axis, where some of the high frequencies in particular seem to emanate from beyond the speakers.

The Aphex Aural Exciter — the current model is the solid-state 602 — does the following:

1) It filters. A high-pass (shelving) filter removes almost all sub-1 kHz information. In so doing, it . . .



2) Shifts the phase, in a frequency-dependent manner. For example, all 1 k information is shifted 36 degrees, at 7 k it's 126 degrees, ascending all the way to 170 degrees out of phase at 20 k. As a result of and concurrent with the phase-shifting, it . . .

3) Delays ever so slightly. It delays the maximum where it (effectively) begins — at 1 k it's 100 microseconds, 50 microseconds at 7 k, tapering off to 24 microseconds at 20 kHz.

4) Generates additional harmonics from the fundamental tones of the sound, dependent upon amplitude. It seems that "fragile ambient information" (like overtones, reflections, and room ambience) is often buried by the main signal or otherwise lost during

the recording and processing. The Aphex resurrects this fragile information (bringing out the second and fourth harmonics in particular), making whatever it is more like the way our ears would have heard it live.

5) It compresses (in a level-dependent manner), which lends a greater degree of control over the harmonic generation.

6) Lastly, it adds intermodulation distortion, simulating that which occurs naturally in the non-multitrack recording situation.

The Aphex Aural Exciter is a discrete stereo unit having two inputs and two outputs. Patched — again — like reverb, it can be used in conjunction with any foldback network. Most people use "cue," but it can also be driven with "echo," "monitor," or the busses. Whichever is chosen, situations where panning is available are to be desired, as the Aphex is true stereo and will maintain your send panning. (Incidentally, a given instrument's Aphex send is usually panned to the same point along the left-right axis as the instrument itself. Panning them otherwise seems to adulterate the effect.) And, of course, the two Aphex outputs are patched back into the console and brought up on two faders. There they can be treated like any other channels of information. Most people using it though, prefer to leave them pretty much alone — full-spread, unechoed, and at a level usually 15-20 dB below the rest of the program.

The Aphex Aural Exciter 602 features the identical controls for each of its two channels:

Input controls level of master send into the unit.

Meter controls what is registering on the VU meter, the master send ("In"), the output of the unit ("Out"), or the "AUX," which gives you just the Aphexed signal output for when the unit is being employed to mix both straight and Aphexed signals.

Output controls the output level.

Aphex Input is essentially a sensitivity control; that is it notes when too little or too much signal is going into the circuitry. At -12 VU, a green LED lights; at +2, a red LED lights.

Aphex Mike enables you to blend straight and Aphexed signals where the unit has to serve as its own foldback — where no return channels are available.

Additionally, there is a gated filter (whose center is at 5k) for controlling sibilance. It is not often needed — mostly for PA work — and affects only the Aphexed information. There are three controls in this "De-esser" sibilance-killing circuitry:



DT 440

MADE FOR EACH OTHER.

Earphones are made for ears. Yours. That's why the Beyer DT 440 has sound so natural and is so light and comfortable you don't even know it's there, even after many hours.

At 9.6 ounces, it is one of the lightest headphones available. And its weight is evenly distributed among the sponge-padded ear-cups and air-filled headband.

There's no great weight suspended from your head, and your ears never get squeezed.

Some people complain about the isolation of headphones that close them off from the world. So we built the DT 440 with a high velocity open design, to allow a natural mixture of recorded music and environmental sound.

How does it sound? Most

people say "spectacular." A great combination of impact and intimacy. The overall sound is wonderfully smooth and transparent. With clean, rich bass response. Powerful, lifelike midrange. Crystal-clear, undistorted highs. And perfect stereo imaging.

For sound — and for comfort — nothing beats a Beyer. We'd like to make one for you.

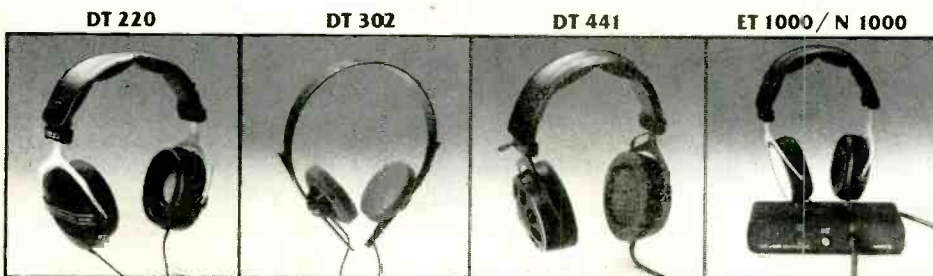

Beyer 
Dynamic

BURNS AUDIOTRONICS, INC.
5-05 Burns Avenue, Hicksville, NY 11801
(516) 935-8000

Curt Knoppel with his baby, the Aphex Aural Exciter, and Marvin Caesar, President of Aphex.



nately a modern development, lending a similarly "modern" sound and a certain "slickness" as well. So, anytime you want to add modernness or slickness, use the Aphex. And conversely, with a production you want true to the sound or spirit of an earlier era or where you want a "rough-hewn," "funky," or similar sound, then these conditions would indicate not using the Aphex. From a purely aesthetic point of view, you'll want to employ the Aural Exciter in situations where you desire any of the previously mentioned qualities of presence, air, etc. in the particular way the Aphex handles them.

At one time or another, the Aphex has probably been used on every single instrument, though it is said to be best with acoustic instruments because they are so rich in overtones. Engineer Brad Hartman (Emmylou Harris, Willie Nelson, The Band) likes it on vocals, toms, guitars, and especially acoustic piano. He finds that it helps the piano cut through — gives the instrument that "bite" — without making it harsh. He Aphexed the piano solo at the time of recording on Emmylou's *Two More Bottles of Wine*. Every cut on that album, **Quarter Moon in a Ten-Cent Town**, had the Aural Exciter save *One Paper Kid*.

Greg Ladanyi, engineer for Jackson Browne, Andrew Gold, and Warren Zevon, uses the Aphex on guitars, piano, drums, and percussion. Unlike many people, he does not Aphex either strings or vocals. For his taste, it adds not only too much sibilance to vocals but a silkiness as well, so that they tend to get lost in the mix. He finds that the lightly harder, harsher un-Aphexed sound works better for a vocal against a silky Aphexed track.

The Aural Exciter, like any tool, should be used with discretion, even more so with instruments that have a lot of highs, such as cymbals; with instruments that are mostly lows, since the Aphex has no lows, or with vocals where the sibilance can get out of hand. The unit is really only considered unworkable in two situations, with an out-of-tune instrument, which the Aphex makes even more obnoxious, and with a noisy track as it makes the noise more apparent. "Aphex is a very dumb instrument," says Curt Knoppel. "It simply doesn't know that noise isn't beautiful."

There is, of course, the temptation to go overboard with the Aphex. One's ears can easily be acclimated to hearing it, rendering all things un-Aphexed dull and listless by comparison. And it become a very real problem when you get to mastering. Too much Aphex return on a tape adds a lot of physical energy, enhancing the transients and creating more complex waveforms, all of which make the disc more difficult, if not impossible to cut.

The Aphex Exciter has been used for mastering, in a "blanket" fashion, processing the entire two-track mix. This calls for discretion as well, as you are not able to control any of your send levels which makes the possibility of over-Aphexing any one instrument a distinct possibility.

One of the safest opinions on this tool comes from Greg Ladanyi, "The Aphex is not something that will make a record better — or worse — you know. . . . The Aphex is something that is used as a very fine subtlety in terms of a piece of outboard equipment. If you know how to use it correctly, you can make it work for you, but it's not gonna make the record great." **A**

Threshold by which you establish the level at which the filter is activated.
Notch Filter by which you regulate how many dB you're filtering.
Filter Trigger Indicator is an LED that lights up when the "De-esser" is functioning.

And lastly, on the back there is a phase-reversal switch ("Phase Reverse") for each channel. Though the Aphex return is never in phase with the rest of the program, care must be taken to see that the two sides are in phase with one another, lest they cancel each other out when the recording is heard in mono.

Aphex Applied

Where, then, should the Aphex be applied? First from a philosophical and historical vantage point, having emerged in 1976, the Aural Exciter is defi-

The world's fastest power amplifier

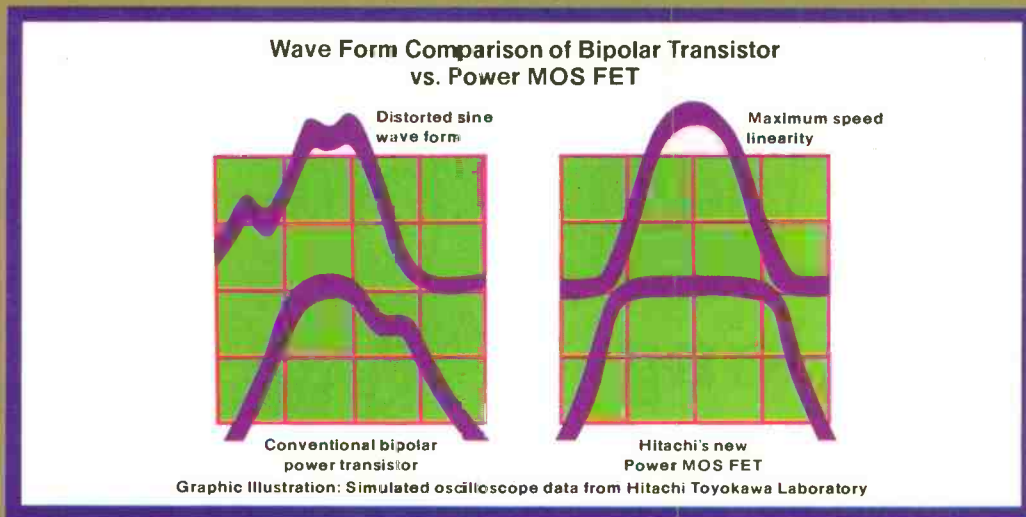

Hitachi Power MOS FET

Hitachi's HMA-6500 Stereo Power Amplifier with the incredible Power MOS FET offers ultra-high switching speed to dramatically reduce output and frequency distortion. At 50 watts output from 20 Hz to 20 kHz, there's no more than 0.02% total harmonic distortion. And the HMA-6500 has such wide linearity

that it refuses to distort even when confronted with the most intense dynamic peaks. Frequency response is ruler flat from DC to 100 kHz, with no crossover distortion.

Add the performance-matched HCA-6500 Stereo Control Amplifier and the FT-8000 Digital Synthesizer Tuner. Both are sleek and stylish performers. The HCA-6500 gives you total control without adding any audible noise or distortion. The FT-8000 is nothing short of an electronic miracle, with digital frequency readout, all-electronic front end, clock function and six station memory.

The HMA-6500, HCA-6500 and FT-8000 – the fastest and the finest from Hitachi.



HITACHI
The New Leader in Audio Technology

Audio Component Division Hitachi Sales Corp. of America, 401 West Artesia Boulevard, Compton, CA 90220, (213) 537-8383, Extension 228

Enter No. 26 on Reader Service Card

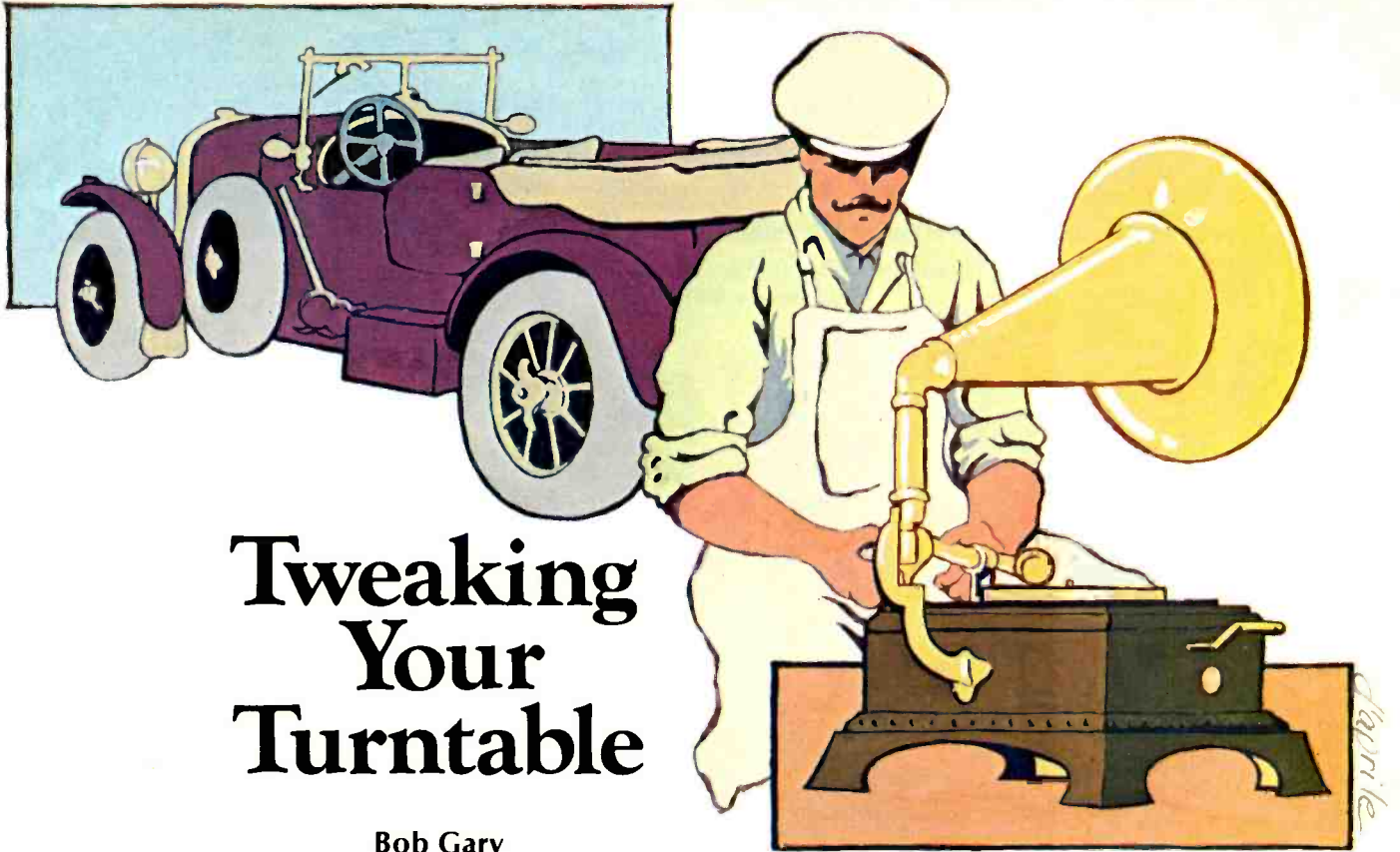

Tweaking Your Turntable

Bob Gary

In the '20s, one of the winningest racing cars around was the classic Bentley 4½ liter, an incredible 22 feet of car fitted with two spare tires, three huge tool boxes, and seating for five. To most observers today, the Bentley seems more truck than sports car; yet it scored the first British victory at Le Mans and countless other racing triumphs. Obviously, the old 4½ would not be much of a competitor in contemporary racing, as the cars have been improved, aerodynamics, suspension geometry, and a host of other factors have become increasingly important, to the extent that, now, even the shape of the side mirrors affects a car's performance.

A similar phenomenon has occurred in the field of audio design; factors which at one time were inconsequential, masked by larger faults in other parts of the equipment, are now of critical importance, given the improved sonic definition of modern music systems. The clearest example of this is in the turntable-cartridge combination which serves as the primary music source in most systems. A series of developments since World War II have vastly improved the ability of a turntable to extract musical information from records: magnetic cartridges, the offset tonearm, and standardization of tracking angle. Yet the record

playing system remains a very weak link in the audio chain and one most easily affected. The positioning of the cartridge in the arm, the construction of the headshell, the length and type of connecting cable, and even the mounting screws used, all have a real and audible effect upon the ultimate listening qualities of the system. More than any other component, the turntable-cartridge combination requires a process of testing and adjustment, of "tuning," as it were, to realize optimum performance.

Among the most common problems affecting turntable-cartridge combinations is that of the "arm-cartridge resonance" engendering bass coloration and distortion. All tonearm and cartridge combinations have a resonance or range of tones which will be accentuated by the mechanical properties of the combination. The frequency range in which this accentuation occurs is determined by the compliance, or degree of looseness, of the stylus assembly (which is in turn ordinarily determined by the rubber collar which holds the stylus) and by the dynamic or moving mass of the arm (which is controlled primarily by the location and physical weight of the headshell and cartridge). If this resonance occurs at too high a frequency, say about 20 Hz, the deep bass information in the

music will be muddled by the bass accentuation. If it occurs at too low a frequency, the effects of motor rumble and record warps will be greatly increased, and bass articulation will again be reduced. This is because the cartridge and preamplifier will interpret the warp and rumble information as music, and due to the accentuation caused by the arm-cartridge resonance, reproduce these subsonic tones at very high level, overloading the power amplifier and loudspeakers. In one case, Advent and Apt Engineer Tomlinson Holman found that a particularly poorly matched tonearm and cartridge were actually overloading the input of a tape recorder so severely that the unit was shutting itself off. In most cases, the effects are not that marked, but many systems suffer from arm-cartridge resonance problems to the extent that more of the amplifier's total power is being used to reproduce the warp and rumble than to play back the music itself.

To test for resonance problems in your system, first put a record which has proven itself difficult to track on the turntable, and play the first track. If the entire arm moves up and down over the warps, without any independent wiggling of the stylus, the arm-cartridge resonance is probably neither too high nor too low, but in

the proper middle region. If the stylus itself wiggles up and down as it moves over the warp, while the arm remains stationary, the resonance is at too low a frequency. Resonance at too high a frequency is rare, particularly given the current crop of high-compliance cartridges. It may be tested for by putting a penny on top of the headshell, and listening to a bass-oriented selection a number of times, with and without the penny. If the presence of the penny seems to reduce artificial mid-bass warmth, substitute a small headshell weight, available from your dealer. The new Shure TTR-115 test record also contains a band designed to check for arm-cartridge resonance problems.

There are two general methods of solving the more prevalent problem of too low a resonance: One is to arrange for the resonance to occur at a frequency above the problem frequency region; most engineers view 10 to 12 Hz as the ideal resonance frequency region. Since the compliance of the cartridge cannot be changed, the only practical means of raising the resonance frequency into this proper range is to reduce the moving mass of the arm, by removing relatively unneeded parts, such as fingerlifts and stylus guards, or by reducing the mass of those parts which must remain, using nylon, rather than steel, mounting screws (these are available at many hobby stores), and, in severe cases, by trimming away unnecessary parts of the headshell or replacing it entirely with one of lighter weight.

The other method, particularly in cases where mass reduction proves ineffective, is to damp out the resonance so that it introduces very little, if any, accentuation, and is therefore inaudible. A number of firms make de-

vices for this purpose; Shure has one as an integral part of their V-15 Type IV phono cartridge and Discwasher makes a unit, the "Disctraker," which is usable with any tonearm. Depending upon the design of the pivot bearings, some arm-cartridge combinations may be damped by the injection of a silicone gel (10,000 centistoke viscosity is about right, for those who would like to experiment) into the vertical pivot, though this can also introduce undesirable side effects. A few home brew audiophiles² and at least one manufacturer³ have developed systems which use open pools of liquid and paddles to reduce resonant motion.

Another major variable is that of the loading presented to the phono cartridge by the connective cables and the preamplifier. All cartridge manufacturers design their products to operate with a certain "load," or set of conditions inside the first stage of the preamplifier, which will assure flat response. The load is composed of two properties: A resistance, which for modern cartridges has been standardized at 47,000 ohms, and a capacitance, which is not standard and may, in fact, be specified for different cartridges over a wide range of values. If the capacitance provided by the preamp and cables is different from the value recommended by the manufacturer, the response of the system will not be flat in the mid and upper treble. This usually has the audible effect of exaggerating surface noise and record "pops" and may also make the system sound somewhat harsh or metallic on brass instruments and voice, in particular. In the early days of hi fi, these effects were masked by the poor treble response of most loudspeakers. In modern systems, however, where an enormous amount of research has

gone into achieving linear response in the amplifier and loudspeakers, a 3-dB variation in treble response represents a serious defect in performance. At least one design engineer, Tom Holman, has advanced the theory that the differences heard between high quality preamplifiers and integrated amplifiers are caused by variations in frequency response because of capacitive effects, rather than by reasonable levels of distortion products.⁴

Because different preamps and turntable connecting cables supply different quantities of capacitance, for years the only practical way to match up the turntable, amp, and cartridge for flat response was to take the whole shebang to an audio service shop, have the system tested, and then add the amount of capacitance needed, either in a minibox or by soldering the necessary components directly into the circuit. This was, of course, a fairly expensive operation.

Recently, however, a number of manufacturers have introduced preamps which incorporate selectable input capacitance. Another solution for the average system owner is the development by Discwasher, db Systems, and Berkshire of capacitance adaptor systems compatible with any amplifier and turntable, which are connected between the turntable cables and the input jacks. Discwasher includes a comprehensive chart, which cross references amp, turntable, and cartridge characteristics, for selection of the precise value for flat response.

A series of small adjustments also have surprisingly large effects upon the sound quality of a system: Even slight inaccuracies in the geometry of cartridge mounting will substantially increase tracking error distortion. It is consequently very important to align

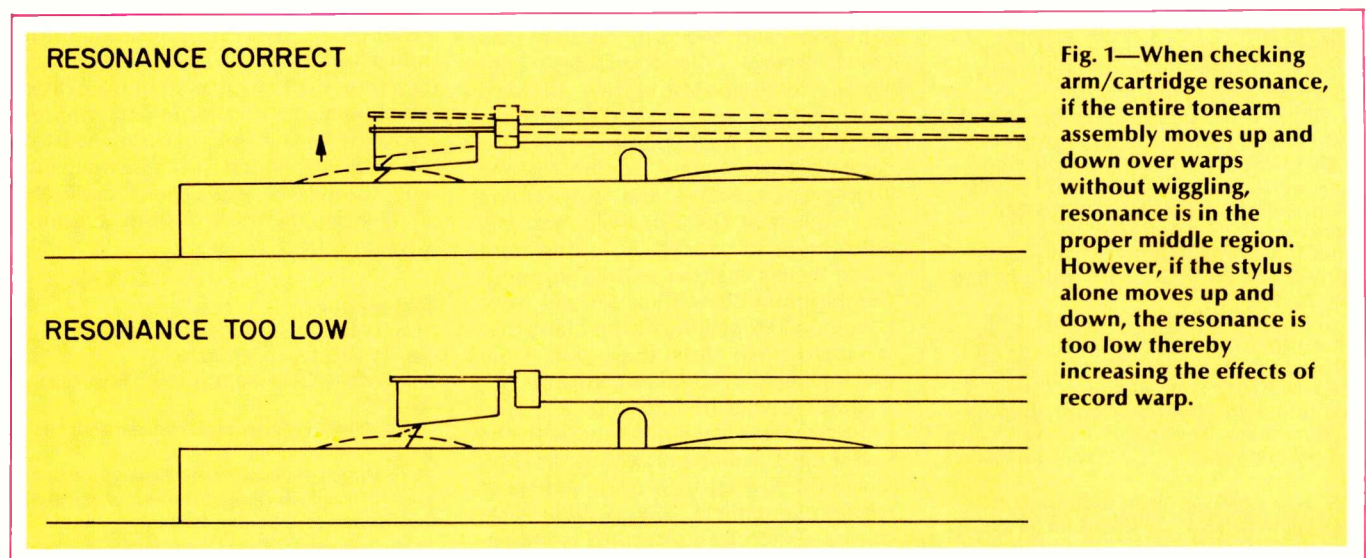

Unique New SONIC TONIC™ Vibration Damping Compound from Audio-Technica

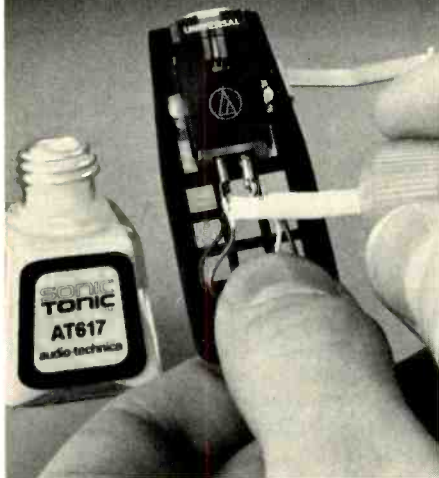

54

Liquid touch-up for the golden ear!

Sonic Tonic is a viscous damping material created to control and subdue small resonances in your system. It stops the tiny vibrations which may spoil an otherwise clean-sounding signal.

For instance, at low recorded levels your phono may sound fine. But at high levels perhaps an unsupported tone arm lead vibrates ever so slightly, adding a "sonic haze" to everything you hear.

Simply add a thin coating of Sonic Tonic. It goes on white, and dries in minutes to a clear yet always resilient coating. Sonic Tonic adds almost no mass, but—because it never fully hardens—it soaks up small vibrations like a sponge soaks up water.

Sonic Tonic can be applied almost anywhere to metal and most plastic surfaces. Use it on speaker voice coil wires, cartridge leads, tone arm shells and fingerlifts, turntable springs or wherever subtle control is needed. Sonic Tonic withstands normal handling, yet peels off readily if you change your mind.

If you're seeking perfection, Sonic Tonic is a helpful new finishing touch. Just \$6.95 for a bottle of AT617 Sonic Tonic, complete with applicator cap. At your Audio-Technica dealer's today.



 **audio-technica**®
INNOVATION □ PRECISION □ INTEGRITY

AUDIO-TECHNICA U.S., INC.
Dept. 69A-233 Shiawassee Avenue
Fairlawn, Ohio 44313
In Canada: Superior Electronics, Inc.

Enter No. 8 on Reader Service Card

the cartridge with the mounting guide or template with extreme care, even though the process may take 20 minutes or so. A British author, J.K. Stevenson, has calculated that a 0.2-in. or two degree error in mounting position will double the harmonic distortion figure of a typical turntable cartridge combination, to almost 2 percent.⁵ This level of distortion is about one hundred times larger than that of the best current amplifiers, so this step is certainly worth the effort.

Both tracking force and anti-skate settings are worthy of careful adjustment, too. The fashion in tracking-force settings today is to utilize the smallest force necessary to keep the stylus in the groove. Very low tracking forces are generally inadvisable for two reasons. Most importantly, low tracking forces generally do not eliminate record wear, but actually increase it due to mistracking. Also, distortion caused by mistracking is enormously reduced as the tracking force is increased. In fact, the published distortion figures for most cartridges are usually measured with tracking forces from the upper end of the manufacturers' recommendations. The optimal tracking force, from the standpoint of both wear and distortion, is in the middle of the cartridge manufacturers' range of recommended forces, very rarely below 1.5 grams.

Anti-skating settings are at best an approximation, since the forces which draw the arm inward are constantly changing, but certain steps can be taken to achieve a more precise adjustment. For this an unmodulated disc (one which has a totally blank, grooveless section) is required. Shure presently makes one, and some dealers may still have an old Garrard unmodulated disc lying about. To make the adjustment, the disc is put on the turntable, and the arm cued to the blank section. The turntables' anti-skating force control is then adjusted such that the arm remains motionless as it tracks the blank portion. This indicates that the inward skating force is counterbalanced by the anti-skating mechanism of the turntable, and the adjustment is correct. An adjustment made in this manner will be at about the minimum level since skating force developed by playing of the blank disc is substantially less than that from playing heavily modulated grooves.

Other points of importance in the tuning process are concerned with the signal path from turntable to preamp. Given the low intrinsic noise figures of modern amplifiers, any audible hum or hiss while playing records is indicative of something gone awry, usually

in the signal path. Hum or noise could be the result of loose, corroded, or defective cables or jacks or a loose or broken ground lead. Connectors may be cleaned with an abrasive pen eraser. When cables are internally defective, quality molded replacements are in order. If all of these possibilities are checked and the problem still persists, the system may be suffering from some sort of ground loop. Experiment with connecting the receiver's ground lug to a solid-earth ground (the center screw of a wall outlet, for instance) or try disconnecting the turntable's ground lead from the receiver. Any arrangement which eliminates the hum is acceptable. In certain instances, a turntable cable in close proximity to a line cord may induce hum; check to be sure that cables are kept separate. With low-output moving-coil cartridges or when cables must be placed close together, it is sometimes effective to wrap each cable in aluminum foil.

Feedback from the loudspeakers to the turntable may introduce bass coloration. The best test for this is to tap the turntable surface while playing a record with the volume level as high as you ever use. There will, almost certainly, be a "thump" from the loudspeaker, but if the thump is accompanied by any ringing or shriek, the system is susceptible to feedback troubles. Moving the turntable to a place less affected by the bass information in the music is the simplest solution, though in certain stubborn cases it may be necessary to mount the turntable on a separate platform or on anti-resonant feet, such as those made by Audio-Technica.

Audio hobbyists, like the people who race cars, are continually seeking just a bit more performance from their equipment. Sometimes the price of excellence is very high; the point of diminishing returns is a concept that enters into most music system purchases. But it is also true that remarkable improvements in sonic performance can often be obtained just by matching and tuning the equipment. Even the ol' Bentley benefitted from a tuning now and then. ▲

References

- 1) Tomlinson Holman, "New Tests for Preamplifiers," *Audio*, February, 1977.
- 2) J. Brinton, "Tonearm Damping," *High Fidelity*, July, 1975.
- 3) SME/Shure 3009 Series III tonearm with "fluid bath."
- 4) Tomlinson Holman, "New Factors in Phono-graph Preamplifier Design," *Journal of the Audio Engineering Society*, May, 1976.
- 5) J.K. Stevenson, "Pickup Arm Design—I," *Wireless World*, May, 1966.

AUDIO • June 1979

LUX K-12



SUPERIORITY BY LUX...

A FUNCTION OF CONSTANT ATTENTION TO INFINITE DETAIL

For those who consider adequacy enough, there are many manufacturers able to meet that audio standard. Superiority, however, is another story.

Superiority demands imagination translated into production. It requires thorough dedication to quality without compromise. And most of all, it takes constant attention to infinite detail.

These are the factors that have made Lux audio systems recognizably superior to the select group appreciating such detail and willing to pay the price.

The Lux K-12 Stereo Cassette Deck reflects Lux's focus on perfection with a number of new and exclusive features devoted to producing the ultimate in audio fidelity and user convenience.

The first of these is "real-time processing," a standard set by computer manufacturers to eliminate the most minimal time lag in dealing with electronic signals during record or playback.

Because any meter is too slow to match real-time processing, Lux provides their Plasma Peak Indicator with peak hold function for instantaneous response to signals by means of a fluorescent tube display scaled in dB for each channel. You can see real-time processing in action.

Dual DC Amplification

As a pioneer in the development of DC amplifiers, Lux refuses to compromise and introduces the K-12, the first cassette deck with two DC amplifiers, one for recording and the other for playback.

Manufacturers—even of expensive equipment—are satisfied with mixed amplification systems, one AC amplifier and one DC amplifier. Most decks available are AC amplifiers only.

Minutes and Seconds

Still another exclusive when used with Lux's unique

cassette tape, featuring SKEW adjustment for optimum tape to head and wide pad and holding mechanism for stable frequency response, is the ultimate precision found in the Electronic Digital Tape Counter. Lux engineers designed and built an electronic counter working off a specially designed tape motion sensor. As you record or playback, this elapsed time is shown on a 4-digit LED display in terms of minutes and seconds.

Dedicated to Superiority

Lux's K-12 pure sendust alloy heads are capable of handling any tape, including the new metal particle tapes.

Dual drive motors are part of the tape transport system, with one motor driving the capstan and another the reel. Thus, torque vibration is virtually eliminated and back tension is always maintained at the optimum.

In addition, with IC logic circuitry, the slightest touch on human engineered controls fulfills your commands... instantaneously.

Additional features include Dolby* NR system, recording mute device, mike mixing circuit, separate 3-way bias and equalization and just about everything you would want or expect—on audio equipment bearing the Lux name.

Specifications are among the best available...

Frequency Response of 30-20,000Hz \pm 3dB (metal tape), S/N ratio better than 69dB (Dolby on, metal tape) and Wow & Flutter no more than 0.04% (WRMS). But, in the final analysis, your own hearing has to be the judge. See the K-12 and test the unique cassette tape at your Lux dealer. Try it... hear it... and focus on perfection as only Lux can provide.

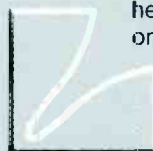

LUX AUDIO OF AMERICA, LTD.

160 Dupont Street Plainview, NY 11803

In Canada: LUX AUDIO OF CANADA, LTD., Scarborough, Ontario

*Dolby is a trademark of Dolby Laboratories, Inc.



Introducing the Bose® Spatial Control™ Receiver.
The first and only receiver to let you control the spatial image of sound.



The Importance of Spatial Properties of Sound

Imagine you are at a live performance. The music which reaches your ears comes not only directly from each instrument, but from every surface which reflects the sound. This combination of reflected and direct sound creates the spatial image of sound; it provides the ambience that makes music sound lifelike.

The Bose® Spatial Control™ Receiver is the first and only receiver that creates, in your living room, a variable spatial distribution of sound, allowing you to adjust the spatial image for different kinds of music.

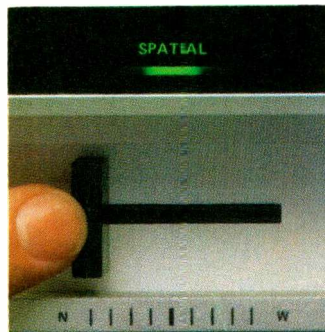

Controlling the Spatial Image

When you are listening to orchestral music, move the spatial slide control to the wide position. Special circuitry directs middle and high frequencies to the rear outside drivers and the front drivers of the Bose 901® Series III or IV loudspeakers. This creates a broad, dispersed pattern of reflections. You experience the breadth and spaciousness of a symphony orchestra.



Should you be listening to a soloist or small group, slide the control toward the narrow position. Now more sound energy is directed to the inside rear drivers to create the focused sound image you associate with intimate performances.

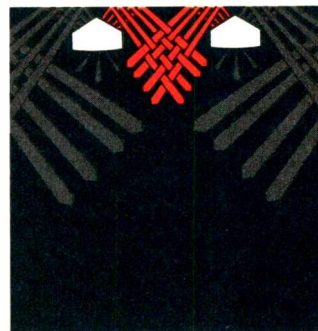

Built-in Bose 901 Equalizer

The Bose 901 Series IV equalizer, built into the Spatial Control™ Receiver, gives you substantial savings when purchasing 901 loudspeakers since you don't need to buy a separate equalizer.

The third speaker connection terminal on each Bose 901 Series III or IV loudspeaker makes it possible to control different sets of drivers independently. It is the key to varying the spatial properties of sound.

The Spatial Control™ Receiver is a complex combination of a stereo preamplifier and equalizer, switching circuits, compensation circuits, and four main power amplifiers. Bose-developed logic circuitry, using CMOS components, controls the complex interconnections among these elements, for ease of operation and great versatility.

Simply program the receiver for your speakers by setting the switches on the rear panel; the rest happens automatically as you operate front panel switches. Programmability gives you several options. For example, the spatial slide controls can also be used as a balance control between two sets of speakers, one equalized and the other unequalized.

Six Power Amplifiers Offer Extraordinary Versatility

Four Direct-Coupled Fully Complementary power amplifiers drive the different arrays of 901 drivers when the receiver is in the spatial mode. Two fully independent power amplifiers drive the headphones with an unequalized signal, regardless of the speakers in use. Each amplifier is individually accessible; you can, for example, enhance the realism of your system with a time delay accessory, without adding a separate amplifier.

Source and Room Compensation Controls Give More Accurate Overall Frequency Response

Bose has made precise measurements of the acoustic properties of different rooms and recording techniques and found that conventional tone controls are simply inadequate to compensate for the problems that occur in typical listening environments. The unique Source and Room Compensation Controls found on the Spatial Control Receiver approach the effectiveness of a more complicated graphic or parametric equalizer but are as easy to use as standard tone controls.

The Source and Room Compensation Controls embody the basic characteristics of the 901 Series IV equalizer controls and extend their range of control to lower frequencies. In acoustically "dead" rooms, they help restore brilliance and clarity to the high frequencies. They can also largely eliminate boominess in poorly mixed records without affecting bass fundamentals and they can restore much of the fullness lost when room surfaces absorb excessive sound energy.

The Result: Unparalleled Performance and Versatility

The Bose Spatial Control™ Receiver offers discriminating listeners an unequalled system for the realistic reproduction of sound. No other receiver lets you control the spatial aspects of recorded music. No other receiver has been designed to take full advantage of the unique sound-producing characteristics of the world-renowned Bose 901 loudspeaker system. And no other receiver gives you such extensive control over the acoustic variables found in widely different room environments and recordings.

No other receiver offers the total listening experience of the Bose Spatial Control™ Receiver.

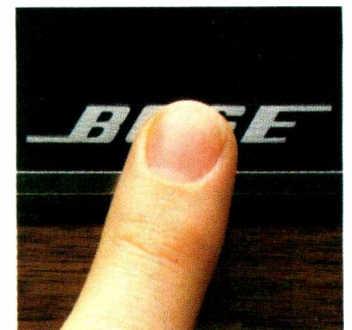

BOSE
100 The Mountain, Framingham, MA 01701

A NEW DIMENSION IN SONIC CLARITY

Now, SONUS flashes forward with a new dimension in clarity. For the first time, phono reproduction goes beyond conventional measurements into a realm of hyaline purity that exceeds all previous limitations. SONUS reveals a "seventh sense"—a heightened perception from all records that defies laboratory techniques yet is instantly apparent to the listener. Crafted by the most advanced tooling and assembly methods in the United States, no other component can make such a significant improvement for so little cost.

WARNING: BEFORE YOU CHANGE ANY OTHER COMPONENT, REPLACE YOUR PRESENT CARTRIDGE WITH A SONUS!

SONUS®

Sonic Research, Inc., 27 Sugar Hollow Rd.
Danbury, CT 06810 (203) 792-8822

Enter No. 60 on Reader Service Card

An Overview of SID and TIM

Walter G. Jung, Mark L. Stephens, and Craig C. Todd

PART I

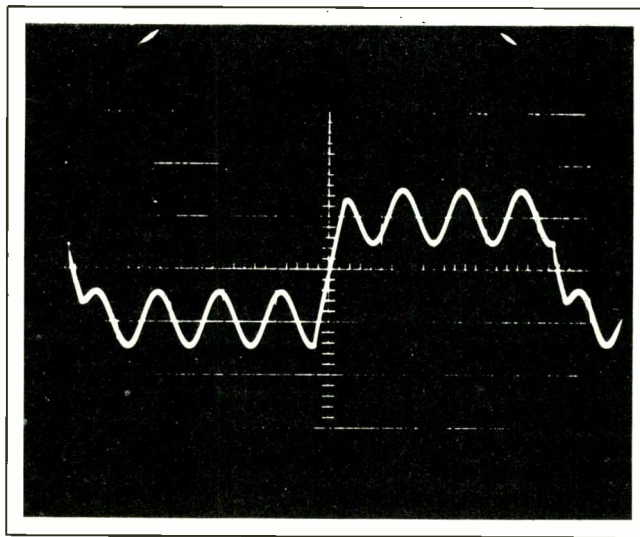

In this series of articles we hope to shed useful light on the high-frequency performance of amplifiers. Modern operational amplifiers and circuits of similar topology have an inherent Slew Rate (SR) limit, and they will produce distortion as the output Signal Slope (SS) approaches this limit. We refer to this distortion as Slew Induced Distortion (SID). If an amplifier is driven into slew-rate limiting gross distortion will be produced. This is analogous to driving an amplifier into amplitude clipping, which also produces gross distortion. The distortion produced by driving an amplifier towards slew-rate limiting has also been described as Transient Intermodulation distortion (TIM) [3,8,9,17,18,51,56].

Until recently [33,34] there has not been a thorough study of this distortion. Therefore, this series is intended to be a comprehensive overview and explanation of SID. We will explain how and when SID is produced by an amplifier, and measurement techniques for and typical measurements of this distortion will be described. The results of a listening test for SID will be discussed, and the results of a theoretical calculation of SID in a 741 op amp will be shown and compared with measurements. Some reasonable design criteria will also be reviewed. Above all, we will attempt to give a good overall perspective of this subject so that the reader will be able to judge its relevance to his or her own situation.

Before discussing how SID occurs within amplifiers, it is necessary and appropriate to first consider how the slew rate itself is related to an audio signal. A sine-wave audio signal has definite and measurable parameters, namely its amplitude and frequency. However, a somewhat more subtle parameter (and one germane to this issue) is the *slope* of the signal, as is determined by its amplitude and frequency. A simple relationship which defines the signal slope (SS) of a sine wave is the equation

$$SS = 2\pi V_p f \quad (1)$$

where V_p is the peak signal voltage, and f its frequency.

Portions of this article are adapted from "Slewing Induced Distortion in Audio Amplifiers" by the authors in *The Audio Amateur*, Feb., 1977 (P.O. Box 176, Peterborough, N.H. 03458), part of an article series which is available in book form. Portions were also adapted from the authors' article "Slewing Induced Distortion — Its Effect on Audio Amplifier Performance, with Correlated Listening Results," Audio Engineering Society Preprint No. 1252 from the May, 1977, convention. (See bibliography references nos. 33 and 34.) © Copyright 1979 by Walter G. Jung, Mark L. Stephens, and Craig C. Todd.

Sometimes this equation may be seen written in terms of slew rate (SR) [20,21,22,29,30,54], however we wish to clarify the point here that signals *in themselves* have no inherent slew limit, or maximum allowable slope, as do amplifiers. Therefore, we will use the terminology of SS to describe the slope of a sine-wave (or other) signal and SR to describe the slew rate of an amplifier. Note that this is an important distinction, as an

amplifier has a defined SR, which is (by very definition) its maximum output-voltage rate of change, or slope, as set by its design. It is a defining performance limit for that amplifier, just as power output is (or any other basic performance parameter, for that matter).

The reader should note that this equation may be manipulated into an expression in terms of a frequency (f), for a given signal slope and peak voltage; for instance:

$$f = SS / 2\pi V_p \quad (2)$$

When the relation is thus used, and the particular SS under discussion is the slew rate limit of a given amplifier and V_p its peak output voltage, it would appear as

$$f_p = SR / 2\pi V_p \quad (3)$$

This expression yields a power bandwidth, f_p , which is determined by the amplifier SR and the peak output voltage, V_p . Generally, f_p is understood to be the bandwidth for a 1 percent THD limit. Note that f_p is directly proportional to SR and inversely proportional to V_p . The practical significance of this is that high output-voltage amplifiers require more SR to maintain a given distortionless bandwidth.

Also, an important distinction to be made is that power bandwidth defines an entirely different form of bandwidth than does the more familiar small-signal bandwidth, and the two terms should *never* be confused. Exceeding the power bandwidth of an amplifier causes gross distortion; exceeding its small-signal bandwidth results only in a frequency response rolloff [37].

SID and TIM Which is Which and What Do They Mean?

Unfortunately, many of the popular explanations serve to confuse rather than clarify the issue, and this short preparatory discussion will, we hope, clarify some of these points to the reader.

"TIM" stands, of course, for *transient intermodulation distortion*, sometimes called simply "transient distortion." If this name is taken in a literal sense, it implies a distortion

Fig. 1 — Mixed square/sine output from amplifiers with and without TIM. General conditions: 5-kHz square wave and 40-kHz sine wave. Fig. 1a — Strong TIM, sine wave missing on waveform transitions, slewing evident. (Scale: 10 V/div.) Fig. 1b — Little or no TIM, waveform is a linear sum of sine and square waves. (Scale: 1 V/div.)

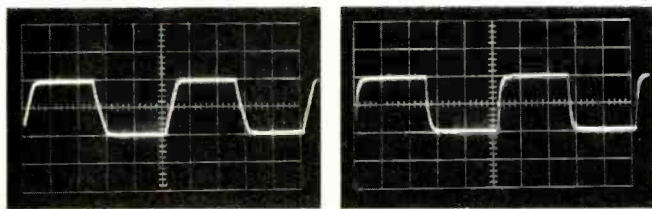
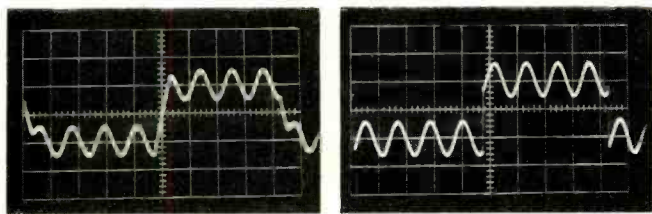

Fig. 2 — Amplifier square-wave responses with and without slew limiting. Fig. 2a — Slew limiting (10 kHz, 10 V p-p). Fig. 2b — No slew limiting (10 kHz, 1 V p-p).

mechanism which produces intermodulation when subjected to transients. A point to be noted is that if the term were understood literally, this would imply transients of both high and low frequencies and/or high or low operating levels. In other words, all transients.

In actual practice, however, transient IM occurs only for signals with simultaneous high level and high frequencies — not lower levels or lower frequencies. The key parameter of such signals is that they are characterized by high signal slopes, not just high frequencies or high levels. Neither high frequencies nor high levels in themselves necessarily result in distortion, unless their combination is such that a high effective SS is produced.

High SS waveforms are not confined solely to transient waveforms. It just so happens that musical signals which exhibit high signal slopes more often are transient in nature —

Fig. 3 — Inter-relationship of amplifier response, feedback, and SID. f_c is the small signal bandwidth which varies for different gains. f_p is amplifier full-power bandwidth which is independent of gain (for a given output level).

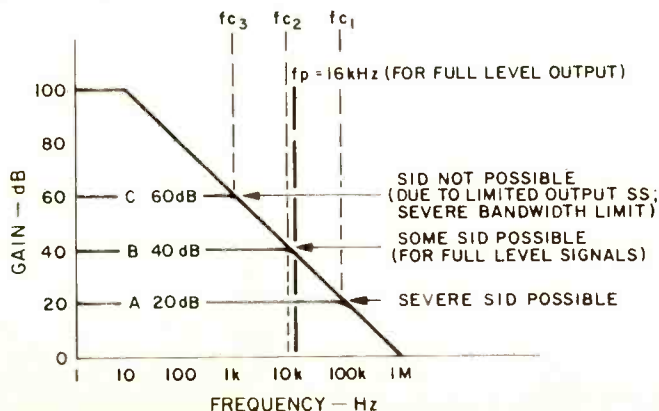

a fortissimo cymbal clash, for instance. Thus, TIM is probably a descriptive term for the distortion as it occurs on musical waveforms, but the term is not totally descriptive of the distortion mechanism itself [33,34,44,52].

TIM is actually generated when the SS approaches or exceeds the amplifier SR. Thus, a more easily understood term as to what actually happens would be one which relates both to SS and SR. In an amplifier, distortion is produced when the output voltage SS approaches or attempts to exceed the SR, as the amplifier limits (clips) for such a circumstance. This can happen for either transient or steady-state signals [33, 34, 52] if they have a sufficiently high SS. Thus we feel a more descriptive term to describe the mechanism is Slew Induced Distortion [33, 58] as it is distortion induced either by the onset of or actual slewing. Other descriptive variations of this terminology are seen in print, such as "slew rate distortion" and "slewing distortion," and mean essentially the same thing [11].

Effect of Excessive Signal Slope On Amplifier Performance

A demonstration of the sensitivity of amplifiers to SS is contained in the two waveform photos of Fig. 1. Figure 1a shows a mixed square/sine wave signal combination, where the level and risetime of the square wave are such that the SS is greater than the amplifier SR. For this particular output voltage, then, slew limiting is produced on the square-wave edges, causing the momentary disappearance of the sine wave. Note in particular the square wave transition in the center of the screen. This is, of course, a strong case of TIM, which is induced by the condition of slewing.

In 1b, the same signal is shown at a reduced level, and, as can be noted, the slew limiting is gone, as the waveform indicates simply a linear sum of the sine and square wave. The point being made here is that the distortion is not being caused so much by the transient as it is by the high SS (in Fig. 1a). Thus, it should be appreciated (in a qualitative sense) that SID (or TIM) is a distortion which is level sensitive in terms of both amplitude and frequency (since both affect SS).

This factor is demonstrated in another way by the square-wave response photos of Fig. 2. In Fig. 2a, a 10V p-p square wave is shown, and, as can be noted, the amplifier is slewing, as evident by the linear rising and falling waveform edges. In 2b, the waveform is at a lower level, and here the square wave is reproduced without slew limiting. This is evident by the exponential shape of the waveform edges, which is an indicator that the amplifier is operating linearly [15,36,37]. It is in actuality operating as a low-pass filter, as is defined by its small signal bandwidth, f_c .

A square wave passed through a single-pole filter will exhibit the general waveform shape of Fig. 2b, and such a waveform at the output of an amplifier is a qualitative indicator that no slew limiting is present. At progressively higher voltage-output levels, slew limiting may set in (as in 2a), and the waveform then takes on the ramp-like slopes [15,37,50,63].

This is incidentally an excellent check to make on an amplifier if possible, increasing output square waves. If the exponential waveshape holds true for increases in level up to the rated output, the amplifier is behaving optimally, as it cannot be made to slew for any realistic signal conditions [11,43]. For this to be true, the power bandwidth must be greater than the small-signal bandwidth [45] which in turn says that the amplifier is guaranteed free from internal overload due to excessive SS. An amplifier can be designed for a defined small-signal bandwidth either by use of an input low-pass filter or appropriate feedback connections to constrain output SS below the SR. Further details of this from a

The New ADS L810-II

“radical improvements
wouldn't have been possible...”*

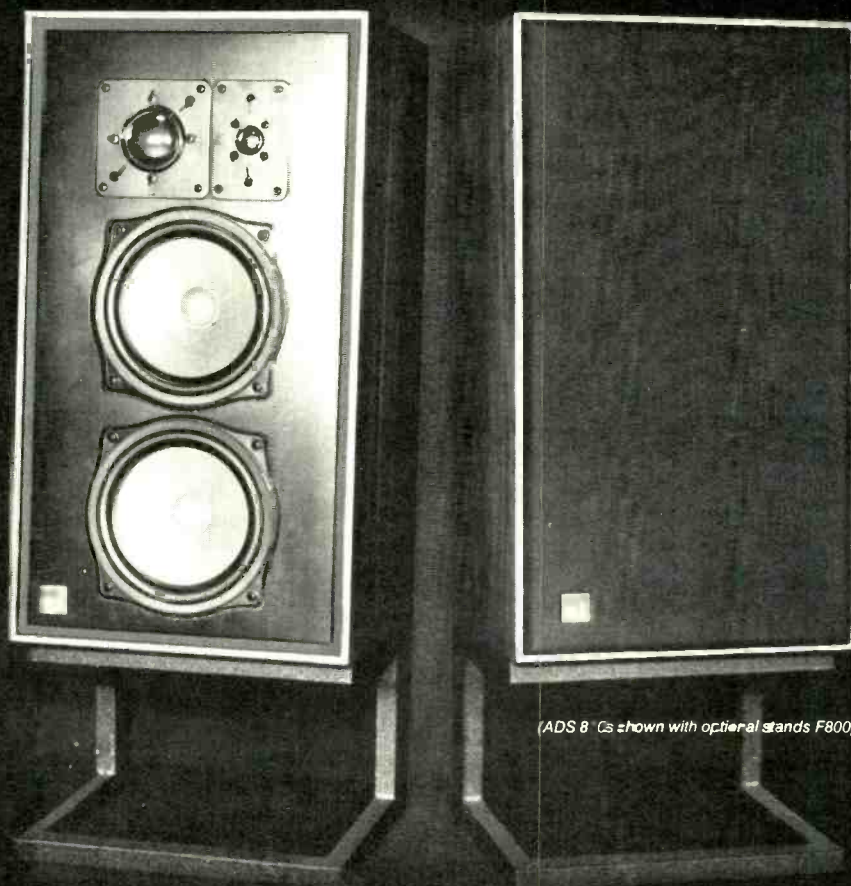

(ADS 8" Cs shown with optional stands F800)

“ADS Series II speakers are subtly improved over the original versions — radical improvements wouldn't have been possible considering the high quality of the originals. The 810 was highly respected for its extreme clarity, and for the natural, tight bass response it exhibited. The Series II continues to offer these attributes, will handle more power, and have better high end dispersion. A fine speaker has been made better, and we recommend it highly.”*

*As quoted from the May 1979 Complete Buyer's Guide To Stereo/Hi-Fi Equipment.

ADS has indeed spared nothing in the quest for perfection.

Less than \$375 apiece the ADS L810 is accurate enough for the professional recording engineer and affordable enough for the lover of good music at home.

Discover the best today. Discover the ADS L810-II. There is a selected ADS dealer near you.

For more information, write ADS, Dept. AU5, or call 1-800-824-7888 (California 1-800-852-7777) toll free and ask for Operator 483.



Where technology serves music

ADS, Analog & Digital Systems, Inc. One Progress Way Wilmington, MA 01897 (517) 658-5100

Fig. 4 — Relative relationship of f_c and f_p , and the resulting effect on SID. General conditions: 5 kHz square wave, 20 V p-p.

**Fig. 4a — $f_c > f_p$;
slewing evident.**

**Fig. 4b — $f_c = f_p$;
some slewing on highest SS.**

**Fig. 4c — $f_c < f_p$;
no slewing evident.**

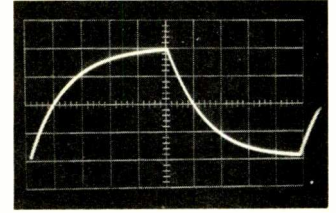
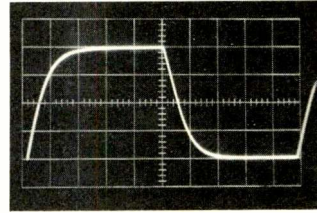
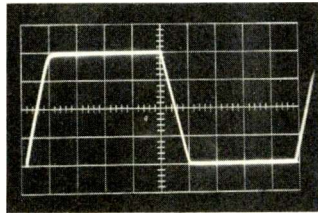

design standpoint are contained in several references [11,43,45] and are also discussed later on.

The Effect of Feedback on SID

One of the popular explanations for the cause of TIM and SID is said to be excessive negative feedback used around audio amplifiers [3,4,6,7,8,9,10,13,48]. In fact, this appears to be one of the more volatile parts of the issue, even to the extreme that already there have appeared statements in the literature calling for maximum feedback factors on the order of 12 dB and amplifiers advertised as having “zero feedback.” The general argument advanced is that increasing negative feedback increases the susceptibility to TIM, and optimum feedback factors are said to be on the order of 30 to 40 dB.

It is interesting to consider how changes in feedback will affect the performance of an amplifier. There are certain aspects of the “less feedback is better” school of thought which have definite merit, but the *entire* situation must be considered for a true and complete perspective.

Consider a fixed gain-bandwidth amplifier open-loop response, as illustrated in Fig. 3. This amplifier has a unity-gain frequency of 1 MHz (such as a 741) and a full-power bandwidth of 10 kHz (at full output). Suppose we examine its susceptibility to SID for gains of 20, 40, and 60 dB, and at full output level. The small signal bandwidth (f_c) for these three conditions will be 100 kHz, 10 kHz and 1 kHz, respectively [30]. However, for each condition of feedback, the full-power frequency (f_p) remains at 10 kHz. Then, for the 20-dB (heavy feedback) gain condition SID is definitely possible, for output frequencies of 10 to 100 kHz. For 40 dB of gain, f_c is equal to f_p , and slight SID is possible. For 60 dB of gain, f_c is less than f_p , so SID is not possible.

A demonstration of this is contained in the photos of Fig. 4, taken from an IC op amp operating fairly close to the conditions of Fig. 3. For this device f_p is 17 kHz, and Fig. 4a shows a square wave for the condition where f_c is greater than f_p ; slewing is evident. In 4b, f_c is equal to f_p , and some slewing is noticeable at the *initial* rise of the square wave where SS is highest. In 4c, f_c is less than f_p and no slewing is evident. In all three instances, the experiment follows what the Bode diagram predicts.

The reason that slewing is not evident for the high-gain, low-feedback condition is because the amplifier output SS is severely curtailed, due to the very low small-signal bandwidth. This is another demonstration of the point made above that slewing can be prevented by making f_c less than f_p . For a fixed gain-bandwidth amplifier, as just demonstrated, this generally says that less feedback can prevent or reduce susceptibility to TIM or SID, as it reduces f_c in relation to f_p , or lowers the output SS in relation to amplifier SR. This is however hardly the *optimum* manner to arrive at this objective, as it will most certainly result in a generally noisier and more distorted amplifier, as well as possibly insufficient bandwidth. If f_c is to be maintained less than f_p , it should be done by another method, obviously.

Another view on the “less feedback is better” argument is to consider an amplifier which is compensated (optimally)

for a higher gain (less feedback) condition. Due to fundamental feedback stability criteria, such an amplifier will have proportionally *less* compensation capacitance necessary. The smaller capacitance for less feedback then allows a higher SR to be realized by the amplifier, and so it is less susceptible to TIM or SID, as it can now handle greater SS waveforms linearly. In this case, the improvement is an indirect result of less feedback, a point which should be appreciated fully — *it also results because the SR is raised.*

These points are somewhat subtle, and we do appreciate that a fair amount of semantics are involved in the discussion which accompanies this issue. There are, however, several key points which are clear and should be made.

Since the limited SR is the cause of the distortion, it follows that design means which improve amplifier SR will lower distortion as a general result. (While this is generally true, there are notable exceptions, such as slew enhanced devices, which will be discussed later.) Feedback is certainly involved in the overall issue, but intimations that there is a fixed magical upper limit to feedback factors have no sound engineering basis to our knowledge. Given sufficient SR (and an otherwise linear amplifier), there is no inherent reason why 60 to 80 dB of feedback is not allowable [33,45,47,52]. The ultimate stability limit will, in practice, confine it to less than this as a natural consequence of usable gain-bandwidths, at least at audio frequencies.

Another part of the semantics issue comes to play with the argument that less feedback in combination with a more linear open-loop characteristic is desirable towards prevention of TIM. Essentially this is true, because without a high degree of overall feedback, less compensation (if any) is needed, and SR goes up as a result. However, *local* feedback around a stage *is still feedback*, and if bipolar transistors are used, it hardly seems possible to get truly excellent open-loop linearity *without* a lot of feedback, since their voltage transfer is basically exponential. So the argument should perhaps be oriented towards a closer definition of *what kind of feedback*, as well as its degree.

To get back to the more conventional amplifier, the point has been made that it is SR which is the fundamental predictor of SID (and/or TIM), and amplifier improvements which increase SR generally lower SID (and TIM).

The remaining low TIM criteria, wide open-loop amplifier bandwidth, involves semantics also. Taken literally, an open-loop bandwidth of 20 kHz (as commonly specified) [1,2,3,4,6,7,8,10,14] will be interpreted to mean 20 kHz *small signal bandwidth*. What is *really* important is a 20 kHz (or more) *power bandwidth*, which will minimize or eliminate slew limiting [33,34,39,45,52].

Amplifiers can be designed for 20 kHz (or more) open-loop bandwidths, but often with a severe penalty of low-frequency linearity and gain accuracy [40,45]. By results from several different forms of tests, there appears to be no fundamental necessity for a wide open-loop small-signal bandwidth, given a power bandwidth sufficient to eliminate slew limiting. Several specific test results discussed later on clearly demonstrate this point.

real to reel...

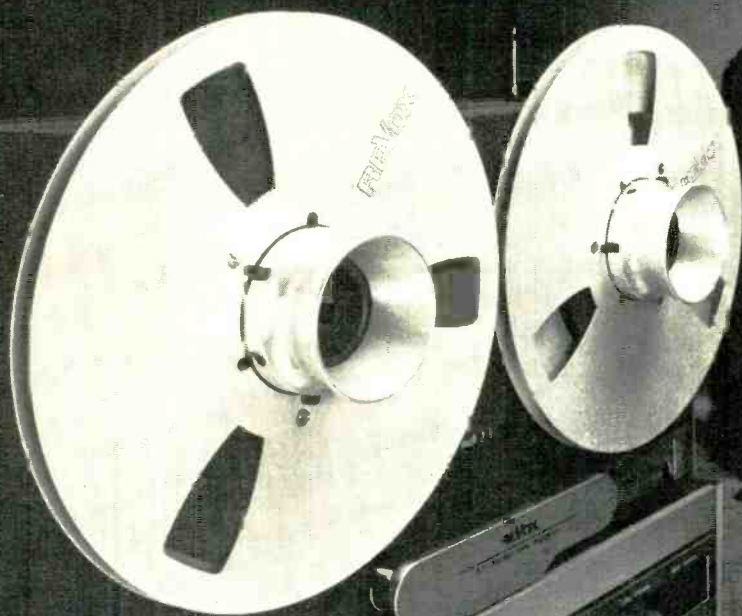

sounds best on ReVox B77

Real to reel means live performance recording, and that's where the ReVox B77 dramatically demonstrates its superiority over other tape recorders. Only the B77 has the wide dynamic range and generous record headroom you need to capture without compromise the full detail and dimension of live music.

Only the B77 delivers the "ruler-flat" frequency response you get from Willi Studer's legendary head design. Only the B77 combines the convenience of push-button digital logic control of tape motion, professional VU meters with built-in peak level indicators, and a self-contained tape cutter/splicer.

If you're thinking of upgrading your real to reel performance, try the ReVox B77. It's available in half or quarter track, 3 $\frac{3}{4}$ -7 $\frac{1}{2}$ or 7 $\frac{1}{2}$ -15 IPS. For complete information and list of demonstrating dealers, circle reader service number or contact us at the address shown below.

REVOX

Studer Revox America, Inc., 1819 Broadway, Nashville, Tennessee 37203 / (615) 329-9576 • In Canada: Studer Revox Canada, Ltd.

Enter No. 63 on Reader Service Card

AmericanRadioHistory.com

Fig. 5a — Amplifier model.

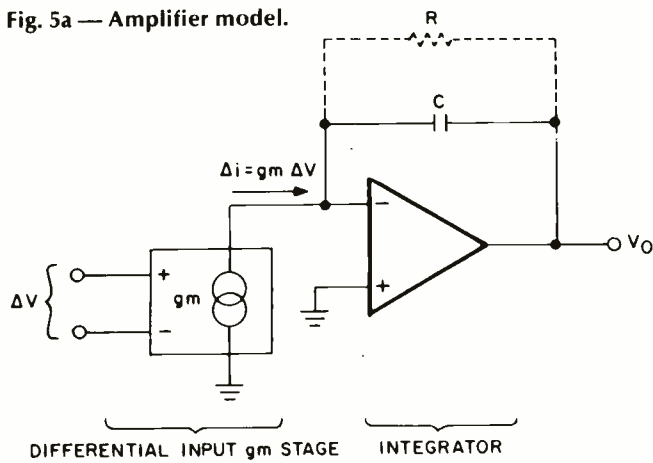
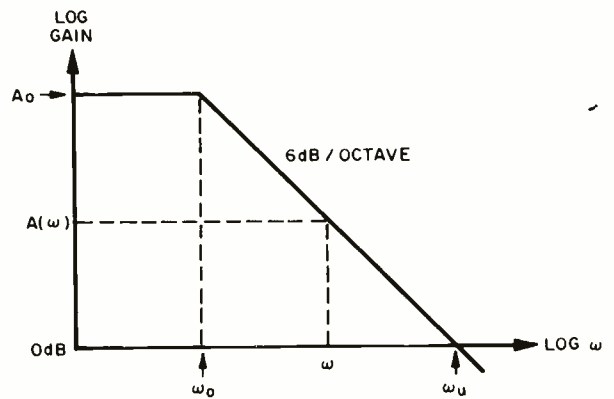

Fig. 5b — Amplifier frequency response.



Analysis of The Slew-Induced Distortion Mechanism

It is of fundamental importance to understand the various distortion sources in amplifiers, such as the SID mechanism of interest here. In this discussion we will mostly deal with operational amplifier circuits, but since many present-day power amps are of similar topology and are subject to similar physical laws, the discussion and data will be relevant to them as well.

Figures 5a is an idealized model of a typical operational amplifier [20,21,22,24]. Its input stage is a voltage-to-current converter or transconductance stage, characterized by the parameter g_m . The output current of this stage (Δi) is simply

$$\Delta i_{(t)} = g_m \Delta V_{(t)} \tag{4}$$

64 The second stage of the amplifier is an integrator, with an output voltage (V_o)

$$V_{o(t)} = \frac{g_m}{C} \int \Delta V_{(t)} dt \tag{5}$$

The resistor R is responsible for the finite d.c. gain of the amplifier. At low frequencies the open-loop gain is

$$A_o = g_m R \tag{6}$$

The open-loop frequency response begins dropping (Fig. 5b) at a frequency

$$\omega_o = 1/RC \tag{7}$$

Since for audio circuits we have no great interest in the amplifier gain at d.c., it is much more convenient to neglect R (as in equation 5) and work with the unity gain bandwidth

(ω_u) which, due to the integrator's -6 dB/octave response, is equal to the gain bandwidth product.

$$\begin{aligned} \omega_u &= A_o \omega_o \\ &= A_o g_m / C \end{aligned} \tag{8}$$

Referring to equation 5, we have

$$V_{o(t)} = \omega_u \int \Delta V_{(t)} dt \tag{9}$$

Thus, for an amplifier with a six dB/octave frequency response, the amplifier can be characterized simply by its unity-gain bandwidth or gain-bandwidth product. Our next step is to examine the differential input voltage as a function of the output voltage. Differentiating equation 9 we have

$$\Delta V_{(t)} = \frac{1}{\omega_u} \frac{dV_{o(t)}}{dt} \tag{10}$$

This highly important result clearly shows us that the instantaneous differential input voltage of an amplifier is directly proportional to the slope of the output voltage, with $1/\omega_u$ as the constant of proportionality.

If we now look at an actual amplifier, we will understand what SID really is. Figure 6a is a very simple real amplifier which will serve to demonstrate this. Q_1 and Q_2 are the differential input pair, and Q_3 - Q_4 form a current mirror. This Q_1 - Q_4 stage is our transconductance amplifier with a transconductance of

$$g_m = I_K / 2V_1 \tag{11}$$

where $V_1 = K_1/q$ (26 mV at room temperature). Q_5 , with its current source load I_A , forms our integrator, in concert with C . We will neglect the finite d.c. gain produced by R ,

Fig. 6a — Real amplifier.

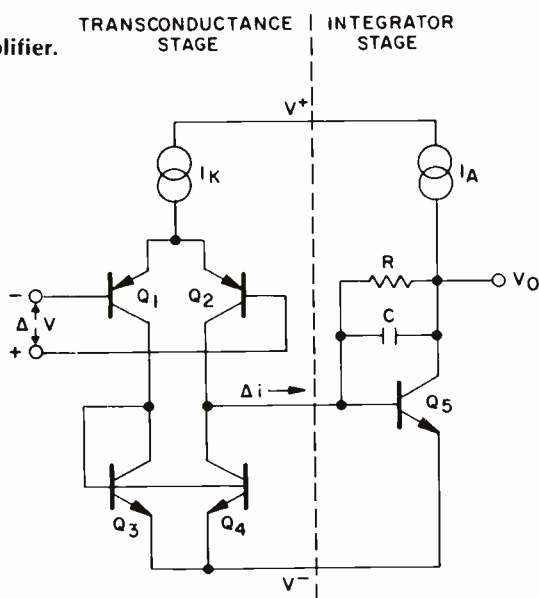
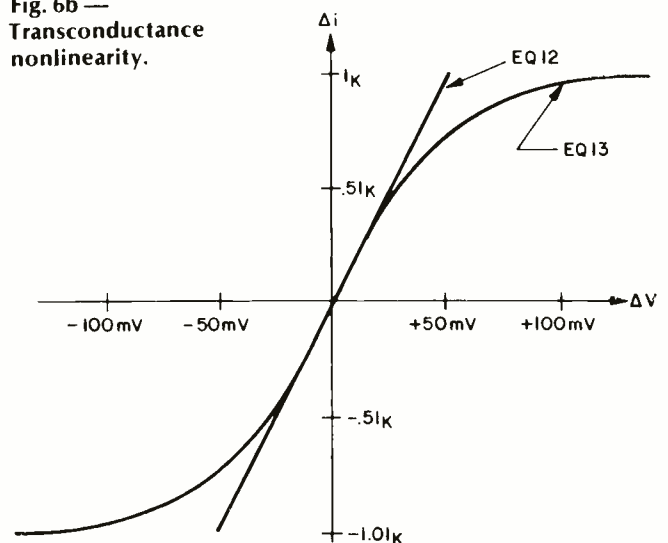
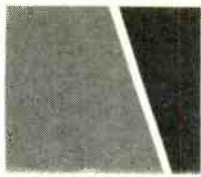

Fig. 6b — Transconductance nonlinearity.





fact: viscous-damping straightens out all your records



your favorite record may be a tangle of warps

Your phono cartridge "sees" such records as twisted, heaving surfaces, jolting up and down 0.5 to 8 times a second. Even records that look flat have warps, and a warped record can change the cartridge-to-record distance, the tracking force, and the vertical tracking angle. Warps produce frequency "wow" and distortion, and can dangerously overload speakers and amplifiers.

What's more, somewhere between 5 and 15 Hz, every tone arm-cartridge system has a resonance frequency—a frequency at which a warp will produce an exaggerated response that may result in mistracking and in extreme cases, cause serious damage to both the record and stylus.

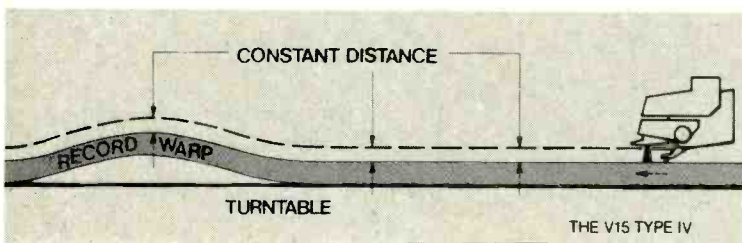
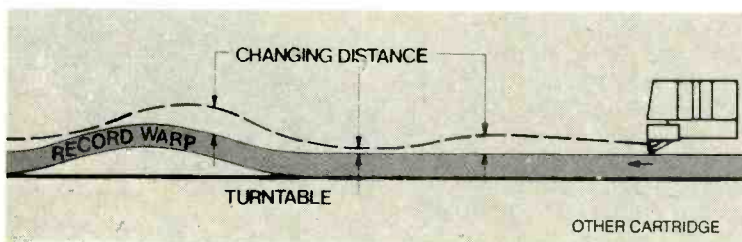

The Shure V15 Type IV is the first cartridge in the world to incorporate effectively the principles of viscous damping. The Dynamic Stabilizer acts something like a "shock absorber," carrying the cartridge over surface irregularities without distortion, without bottoming out, and without risk of damage to records or stylus. It even protects the stylus should it be dropped accidentally onto the record.

the role of the Dynamic Stabilizer:

The V15 Type IV's Dynamic Stabilizer makes certain you hear the recorded information, not the warps. The viscous-damping system of the Dynamic Stabilizer resists rapid changes in the cartridge-to-record distance. This remarkable Shure innovation eases the stylus over warps without affecting the tracking force on warped or unwarped portions of the record. And the tone arm-cartridge resonance is attenuated to a subaudible level. As a further bonus, the Dynamic Stabilizer cushions the stylus from accidental impacts.

Get the straight talk today at your dealer's showroom. Ask for a free demonstration of the V15 Type IV.

V15 Type IV
the viscous-damped cartridge by...



Shure Brothers Inc., 222 Hartrey Ave., Evanston, IL 60204, In Canada: A. C. Simmonds & Sons Limited
Manufacturers of high fidelity components, microphones, sound systems and related circuitry.

Enter No. 58 on Reader Service Card

THE RATIONAL AMPLIFIER, FROM CROWN.

Sound reproduction systems of the 1980's will include "smart" components—components that react to their environment, that know how to protect themselves, and know how to keep functioning in that environment. They belong in your future.

The Crown Distinction SA2 stereo power amplifier is a rational amplifier. It analyzes its own behavior in terms of its immediate environment. It protects itself. It keeps on driving your speakers with power reserves that may amaze you. It's available now.

The SA2 has four on-board computers that constantly monitor and control the performance of the amp. The SA2 knows when it can use its full power capabilities, and when it has to cut back in order to prevent damage to itself.

The SA2 is sonically so accurate that its distortion and response levels require highly sophisticated test instruments to measure. However you measure them, the SA2 translates into beautiful music.

The SA2 incorporates new system engineering concepts that won't easily be duplicated. It is unique.

SOA—it's important!

The safe operating area (SOA) of a power transistor is defined by the internal temperature of the transistor. That temperature must be kept

below a critical level or the transistor will be damaged, an expensive and bothersome event.

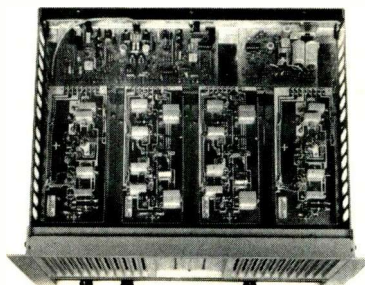

Audio circuit designers have always known that SOA is difficult to measure, since it varies widely depending on what the transistor is being asked to do. Designers have had to estimate arbitrary limits for output voltage or current in order to protect output transistors, leaving much of the capability of the power transistor unused. Such designs are not as efficient as the SA2 has proven to be.

SOA measured by Crown.

Crown's engineers several years ago developed a special test instrument to accurately measure the changing SOA of power transistors under varying loads. To the best of our knowledge, it's still the only such test equipment in the audio industry.

From the work done on this instrument, Crown developed the mathematics of output device behavior needed to design the computer-controlled protection system of the SA2 amplifier. That system makes it possible, for the first time, to utilize fully the capabilities of power transistors in an audio amplifier.

On-board computing.

The SA2 protected-power system starts with the output transistor data developed by Crown, which is now in computer memory at Crown. Analog computer circuits built into the SA2 are programmed from data about the SOA of the output devices. The on-board computers obtain real-time input from sensing devices which report current, voltage and thermal behavior of the output transistors. The computers then describe, in real time, what the transistors have been doing, what they are being asked to do, and compute whether the result of all that could drive them outside their SOA.

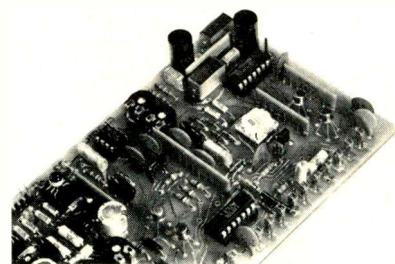

If the on-board computers predict operation outside the SOA, the output is limited automatically and immediately. The computers also limit output only to the degree necessary, so that output power is always at the maximum safe level for the existing environment. The limiting is self-correcting, and full output power is automatically restored as soon as the demands on the output devices no longer threaten their SOA limits. All this happens in micro-second time, with the output devices being constantly checked.

Continuing safe output.

Output power is never, in the Crown SA2 system, limited arbitrarily. Your

SPECIFICATIONS

Stereo Output Power:

220 WATTS PER CHANNEL MINIMUM RMS (BOTH CHANNELS OPERATING) INTO AN 8 OHM LOAD, 20Hz-20KHz AT A RATED RMS SUM TOTAL HARMONIC DISTORTION OF 0.05% OF THE FUNDAMENTAL OUTPUT VOLTAGE.

350 WATTS PER CHANNEL MINIMUM RMS (BOTH CHANNELS OPERATING) INTO A 4 OHM LOAD, 20Hz-20KHz AT A RATED RMS SUM TOTAL HARMONIC DISTORTION OF 0.08% OF THE FUNDAMENTAL OUTPUT VOLTAGE.

600 watts per channel minimum RMS (both channels operating) into a 2 ohm load, at 1KHz; rated RMS sum total harmonic distortion of 1.0% of the fundamental output voltage.

Monaural Output Power:

700 WATTS MINIMUM RMS INTO AN 8 OHM LOAD, 20Hz-20KHz AT A RATED RMS SUM TOTAL HARMONIC DISTORTION OF 0.12% OF THE FUNDAMENTAL OUTPUT VOLTAGE.

440 watts minimum RMS into a 16 ohm load, 20Hz-20KHz, at a rated RMS sum total harmonic distortion of 0.08% of the fundamental output voltage.

1200 watts at 1KHz into a 4 ohm load, at a rated sum total harmonic distortion of 1.0% of the fundamental output voltage.

Stereo Hum and Noise:

115dB below rated output, "A" weighted.

Stereo IM Distortion:

Less than 0.01% from 0.25 watts to 220 watts into 8 ohms per channel.

Stereo Slewing Rate:

Greater than 30 volts per microsecond.

Stereo Frequency Response:

+0, -1.5dB, DC- 80KHz.

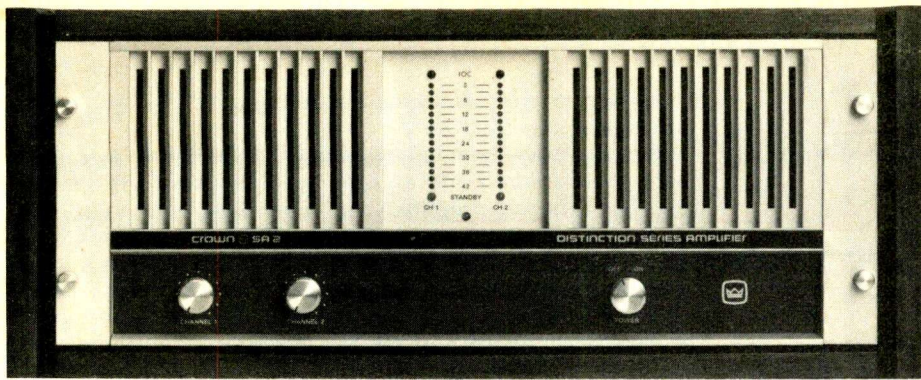

SA2 continues at full power as long as output transistor safe operating area is not violated. Where other amps would simply thermal out and shut down, the sensing and protection concepts employed in the SA2 keep the maximum safe power flowing to your speakers under any and all conditions.

Unique heat sink design.

The Crown SA2 heat sinks may be new to most home audio system owners. The finned aluminum channels in these Crown-made heat sinks are much more efficient than castings because they rapidly dissipate large amounts of heat to keep the SA2 at its most efficient thermal level. In addition, a rear-mounted fan keeps a gentle flow of air moving through the amp. If the chassis should heat up, the fan automatically shifts to a higher speed until the amp returns to a cooler operating level.

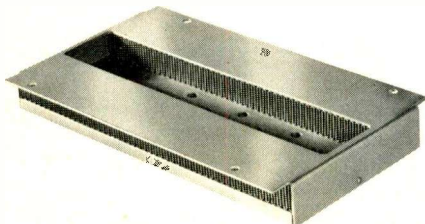

And much more.

When we designed our rational amplifier, we didn't stop with the innovative protection system. The SA2 is built around a carefully thought out circuit design that contributes to immeasurably low distortion. For instance, a junction field-effect transistor (J-FET) input is incorporated into a multiple feed-back design to reduce noise and distortion while offering perfectly controlled transient response.

The main power supplies and transformers for each channel are separate. The SA2 mechanical design emphasizes sensible weight distribution and easy handling. The Crown IOC distortion indicating system notifies you about deviations in output waveform before any kind of distortion becomes audible. Sub-

audio speaker protection is provided by monitoring the output and turning off the affected channel if necessary.

Indicating dynamic range.

You will be pleased at the elegant concept of reporting music peaks in the Crown SA2. The vertical LED meters on the front panel actually display two values for each channel. The top light will always be a peak-hold display with a four second delay. The other light, which may be coincident with the peak-hold indication, but is usually below it, is a running peak indication. The differences between those two will enable you to evaluate the dynamic range available in the music source.

Built by Crown.

The SA2 is a Crown product. If you're new to high-quality audio systems that may not mean much, so we suggest you ask an experienced friend about us. He will tell you about the Crown reputation for reliability, for sonic excellence, for service. We're proud of that reputation, so we work very hard to uphold it.

Crown Care.

Every SA2 is thoroughly tested at

the factory, and a certified proof-of-performance report is attached, detailing the measured specifications for your SA2, which are often better than the published specifications. Every SA2 is also covered by the full Crown warranty, by which Crown guarantees, at no cost to the current owner, repair or replacement of any SA2 which does not perform to original, published specifications for a period of up to three years from date of original purchase. This warranty also covers *round-trip* shipping for the unit. We believe that this protection for your investment is the finest available anywhere.

We think the SA2 is quite simply the finest audio power amplifier you can buy, one which will expand your musical horizons. But before you make up your mind, you may want more information. You can examine the SA2, and the product manual, at your nearest Crown Distinction dealer, or you can send us five dollars with the coupon and we'll send you an SA2 manual. If you return the manual, we'll return the five dollars.

Listen to the Crown SA2. It's a rational decision.

To: **Crown International**
1718 W. Mishawaka Road
Elkhart, IN 46514

Please send:

An SA2 manual. My five dollars is enclosed.

A free brochure.

Name _____

Address _____

City _____

State _____ Zip _____

Phone _____



1718 W. Mishawaka Road, Elkhart, Indiana 46514

Innovation. High technology. American. That's Crown.

Fig. 7 — Amplifier with feedback.

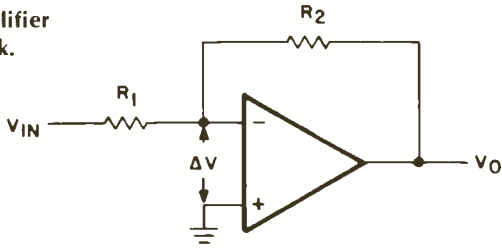

inasmuch as it has no bearing on ωu (see above). Ideally the g_m stage output current (Δi) is

$$\Delta i_{(i)} = g_m \Delta V_{(i)} = I_k (\Delta V_{(i)}) / 2V_{T1} \quad (12)$$

However, this is only true when ΔV is small. The exact transfer expression for this input stage is [23].

$$\Delta i_{(i)} = I_k \tanh (\Delta V_{(i)} / 2V_{T1}) \quad (13)$$

As this expression shows, the transconductance stage is linear only for small signals, and thus will produce distortion for high output currents, when ΔV is large. Equations 12 and 13 are plotted in Fig. 6b and illustrate this point more clearly.

The maximum output current (limit) from our input stage is I_k . This determines the maximum rate of change of V_o , which is the slew rate of our amplifier. This is simply

$$SR = I_k / C. \quad (14)$$

How close we are working to the SR is

$$SS_{\text{output}} / SR = \Delta i / I_k. \quad (15)$$

This relation is one important and useful, as will be seen. The ratio SS / SR we will here define as the *slew rate ratio* (SR ratio), which relates the output SS to the amplifier SR.

This ratio is easily measurable from outside the amplifier with a differentiator,

$$\Delta i / I_k = (1 / SR) (dV_o / dt). \quad (16)$$

Figure 6b graphically tells us that operating with a SR ratio > 0.25 (or $\Delta i > 0.25 I_k$) will produce some obvious distortion. This is equivalent to saying that operation at greater than 25 percent of the amplifier's SR will produce distortion. This distortion depends solely on the SS of the output, hence our use of the term "Slew Induced Distortion." The amplifier is

producing distortion by being forced towards its SR limit; the distortion is slew induced.

So far we have been talking only of the amplifier with no mention of feedback and we have been discussing the open-loop performance. Amplifiers are rarely used open loop, so we must turn our attention to the effects of feedback on amplifier performance. An important point to keep in mind as we discuss feedback is that feedback networks are placed around an amplifier and have no direct effect on its *internal* performance. Feedback alone will not effect the validity of any of the equations developed above. It will, however, under certain signal conditions, cause these relationships to be taxed, creating a SID-producing situation. This statement will become more clear with subsequent discussions (if not already so from the preliminary discussion).

As is well known, feedback reduces distortion. Let's take a qualitative look at how this happens. A simple feedback network has been placed around our amplifier in Fig. 7. The differential input voltage is

$$\Delta V = (V_{in} R_2 + V_o R_1) / (R_1 + R_2). \quad (17)$$

This is the error voltage which we would like to be zero, but it will be non-zero if V_o contains a gain or phase error, or distortion. If we operate the amplifier near its slew limit, we know that the amplifier transfer characteristic is very non-linear (see 6b). The feedback will reduce this non-linearity from V_{in} to V_{out} , but it will necessarily still exist from ΔV to V_{out} . If the feedback is doing its job and producing a relatively clean signal at V_{out} , then it follows that the signal ΔV must be distorted. The distortion of ΔV must be of the proper magnitude and phase to compensate for the amplifier's internal nonlinearity, if it is in reality reducing distortion. A qualitative insight of this is contained in the waveforms shown in Fig. 8. These are pictures of the performance of a 748 op amp, compensated to unity gain by 30 pF and operated as shown in Fig. 7. The amplifier had the following performance (measured before the experiment):

$$\begin{aligned} f_t &= \omega_c / 2\pi \\ &= 1.5 \text{ MHz} \\ SR &= +0.97, -0.91 \text{ V} / \mu\text{S}. \end{aligned}$$

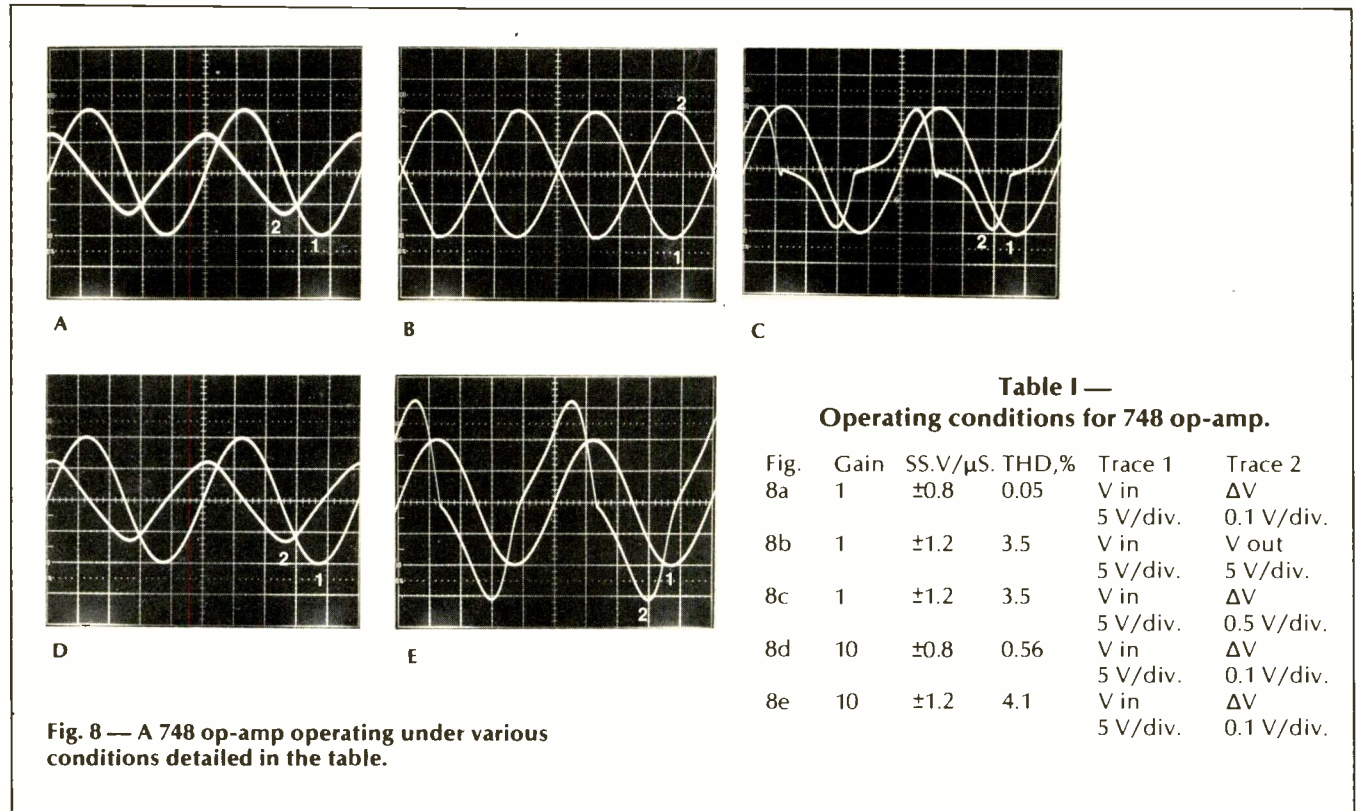

Table I — Operating conditions for 748 op-amp.

Fig.	Gain	SS.V/ μ S.	THD,%	Trace 1	Trace 2
8a	1	± 0.8	0.05	V in	ΔV
				5 V/div.	0.1 V/div.
8b	1	± 1.2	3.5	V in	V out
				5 V/div.	5 V/div.
8c	1	± 1.2	3.5	V in	ΔV
				5 V/div.	0.5 V/div.
8d	10	± 0.8	0.56	V in	ΔV
				5 V/div.	0.1 V/div.
8e	10	± 1.2	4.1	V in	ΔV
				5 V/div.	0.1 V/div.

Fig. 8 — A 748 op-amp operating under various conditions detailed in the table.

The sound is familiar. The PRICE is the SURPRISE!

REALISTIC® Minimus-7

This amazing little hi-fi speaker costs only about a third as much as some mini speakers, but we think they compare very favorably. How could they? Well, we gave ours a heavy-magnet large-excursion 4" woofer, a soft-dome wide-dispersion 1" tweeter, a precise L-C cross-over network, and a diecast aluminum enclosure. The result is astonishing bass and crisp highs from a 7-1/6" tall system that fits on any bookshelf. Audio response is 50-20,000 Hz and power capacity is 40 watts RMS. All for only 49.95* each.



Now listen to this! Just 14.95* buys you a pair of the fully adjustable mounting brackets pictured here, so

you can install two Minimus®-7s in your car. Or van or pickup or RV. Discover Minimus -7, the mini-size, maxi-value speaker for home or mobile use. Sold only at Radio Shack.

*Retail prices may vary at individual stores and dealers.

These two cards honored
at most Radio Shack stores



Radio Shack®

A Division of Tandy Corporation • Fort Worth, Texas 76102
Over 7000 Locations in Nine Countries

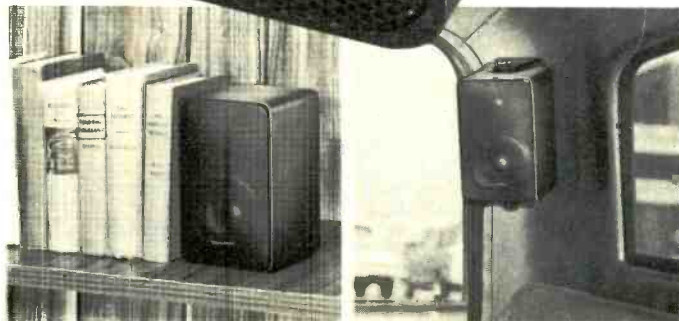

Use 'em on a shelf

Use 'em in your vehicle

The amplifier was operated at its full rated output swing of 20 V p-p. Two test frequencies were used, 12.7 kHz and 19.1 kHz. At 20V p-p (10V peak) these frequencies produced signal slopes of $\pm 0.8 \text{ V}/\mu\text{S}$ and $\pm 1.2 \text{ V}/\mu\text{S}$ respectively. These two frequencies were applied to the closed-loop amplifier, for signal gains of 1 and 10. For either gain condition, the output was a visibly clean sine wave for the 12.7 kHz, $\pm 0.8 \text{ V}/\mu\text{S}$ signal (not shown). However, the 19.1 kHz, $\pm 1.2 \text{ V}/\mu\text{S}$ signal drove the amplifier into slew limiting, and this is shown in Fig. 8b. The output slewing waveform was visibly the same for either gain. Table I summarizes and identifies the conditions and results shown.

The important point to note from this is that the op-amp input, ΔV , becomes highly distorted in an attempt to linearize the response of the closed-loop amplifier. In 8a and 8d, for example, ΔV is just beginning to become non-linear, but is still relatively low in level. As the maximum slew rate is exceeded, this process breaks down and the error voltage abruptly increases, as can be noted in 8c and 8e (note the different scale factors for ΔV). Operation at the lower gains (more feedback) yields lower distortion operation, and allows low-distortion operation closer to the slew rate limit.

There is nothing particularly unique about SID in audio amplifiers. It can be measured, calculated, and improved upon by using standard techniques that have been available for some time [57]. The only elusive aspect of this form of distortion is that rather than occurring on a peak magnitude (like clipping), it occurs on the rising or falling edge of the waveform, when the SS approaches or exceeds the amplifier SR. This is due to the fact that the dominant non-linearity in the circuit, the transconductance of the input stage, is followed by an integrating stage. Thus in Fig. 5, if the transconductance stage were overloaded and producing clipped square waves of current output, the integrating stage would

transform these square waves into triangle waves at the output. The triangle wave is the ultimate example of gross slewing distortion, and its presence is a visible verification that the amplifier is operating open loop during the slew interval(s).

Although slew limiting is most often encountered in amplifiers due to internal IC relations, such as have been just described, it can also occur due to output-current/load-capacitance rate limiting, with the end effect being similar [33,34]. This type of slew limiting can occur for example in RIAA-equalized preamps which cannot adequately charge frequency-shaping capacitors [33,41] or power amplifiers which cannot drive capacitive loads due to protection circuitry [33].

The distortion products produced by SID are measurable either by methods of THD [16], two-tone high-frequency IM, or TIM [14,33,34,51], and in all cases they become significant as the amplifier's inherent SR is approached by the output signal slope.

Representative results from these test methods are discussed in Part II of this series. In this next installment, sample data from different types of distortion tests are presented consisting of total harmonic distortion (THD), two-tone-difference intermodulation distortion (IM), and the recently proposed test for TIM [18]. Some of the relative merits of these measurement techniques will be discussed, and it will be seen that while they are all useful to the detection of this distortion, there are differences in sensitivity and practicality between them. Generally speaking, low-frequency distortion tests such as 1-kHz THD, or 60-Hz/7-kHz (SMPTE) IM tests are useless for detecting SID, since the signal slope is not sufficiently high. An interesting outcome is that IC op amps, long viewed with suspicion by many, are actually capable of truly superlative performance when properly operated below their slew-rate (SR) limit.

References

- Daugherty, D.G., "Design Considerations for Linear Transistor Audio Amplifiers," Ph.D. dissertation, Univ. Wisconsin, 1964.
- Daugherty, D.G.; Greiner, R.A., "Some Design Objectives for Audio Power Amplifiers," *IEEE Transactions on Audio and Electroacoustics*, Vol. AU-14, No. 1, March, 1966.
- Otala, M., "Transient Distortion in Transistorized Audio Power Amplifiers," *IEEE Transactions on Audio and Electroacoustics*, Vol. AU-18, No. 3, September, 1970.
- Otala, M., "Circuit Design Modifications for Minimizing Transient Intermodulation Distortion in Audio Amplifiers," *J. Audio Eng. Soc.*, Vol. 20, No. 5, June, 1972.
- Hamm, R.O., "Tubes vs. Transistors — Is There An Audible Difference?" *J. Audio Eng. Soc.*, Vol. 21, No. 4, May, 1973.
- Stuart, J.R., "An Approach to Audio Amplifier Design," Parts 1, 2, 3, *Wireless World*, Aug., Sept., Oct., 1973.
- Lohstroh, J.; Otala, M., "An Audio Power Amplifier for Ultimate Quality Requirements," *IEEE Transactions on Audio and Electroacoustics*, Vol. AU-21, No. 6, Dec., 1973.
- Otala, M.; Ensomaa, R., "Transient Intermodulation Distortion in Commercial Audio Amplifiers," *J. Audio Eng. Soc.*, Vol. 22, No. 4, May, 1974.
- Leach, W.M., "Transient IM Distortion In Power Amplifiers," *Audio*, Feb., 1975.
- Leach, W.M., "Build a Low TIM Amplifier," *Audio*, Feb., 1976.
- Leach, W.M., "Suppression of Slew Rate and Transient IM Distortions in Audio Power Amplifiers," *J. Audio Eng. Soc.* Vol. 25, Nos. 7/8, July/Aug., 1977.
- Leach, W.M., "Design Considerations for Feedback Amplifiers," TIM Session, ICASSP (IEEE), Tulsa, OK, April, 1978.
- Schrock, C., "The Tektronix Cookbook of Standard Audio Tests," Feb., 1975.
- Thomsen, C.; Moller, H., "Swept Electroacoustic Measurements of Harmonic Distortion, Difference-Frequency and Intermodulation Distortion," AES Preprint No. 1068, AES New York Convention, Nov., 1975.
- Jung, W.G., "Let's Put Function Generators to the Test," *Broadcast Engineering*, Dec., 1975.
- Jelsing, T., "Causes and Elimination of TID," AES Preprint No. A-5, AES Zurich Convention, March, 1976.
- Holman, T., "New Factors in Phonograph Preamp Design," *J. Audio Eng. Soc.*, Vol. 24, No. 4, May, 1976.
- Leinonen, E.; Otala, M.; Curl, J., "Method for Measuring Transient Intermodulation Distortion (TIM)," *J. Audio Eng. Soc.*, Vol. 25, No. 4, April, 1977.
- McClain, F.F., Jr., "Intermodulation Distortion Produced by Out-of-Band Program Components," *J. Audio Eng. Soc.*, Vol. 24, No. 2, Mar., 1976.
- Hearn, W.E., "Fast Slewing Monolithic Operational Amplifier," *IEEE Journal of Solid-State Circuits*, Vol. SC-6, No. 1, Feb., 1971.
- Soloman, J.E., "The Monolithic Op Amp: A Tutorial Study," *IEEE Journal of Solid-State Circuits*, Vol. SC-9, No. 6, Dec., 1974.
- Gray, P.R.; Meyer, R.G., "Recent Advances in Monolithic Operational Amplifier Design," *IEEE TCS*, Vol. CAS-21, No. 3, May, 1974.
- Schmoock, J., "An Input Stage Transconductance Reduction Technique for High SR Op Amps," *IEEE JSSC*, Vol. SC-10, No. 6, Dec., 1975.
- Solomon, J.E.; Davis, W.R.; Lee, P.F., "A Self-Compensated Monolithic Operational Amplifier with Low Input Current and High Slew Rate," *IEEE ISSCC Digest Tech. Papers*, Feb., 1969.
- Kesner, D., "A Simple Technique for Extending Op Amp Power Bandwidth," *Motorola AN-459*, May, 1971.
- Jung, W.G., "New IC Approach to Audio Power," *Broadcast Engineering*, Oct., 1972.
- Jung, W.G., "Optimizing IC Op Amp Speed," *db, The Sound Engineering Magazine*, Jan., 1973.
- Jung, W.G., "Improve Op Amp Audio Circuits," *Electronic Design*, Sept. 27, 1973.
- Jung, W.G., "The Pitfalls of the General Purpose IC Operational Amplifier As Applied to Audio Signal Processing," *J. Audio Eng. Soc.*, Vol. 21, No. 9, Nov., 1973.
- Jung, W.G., *IC Op Amp Cookbook*, Howard W. Sams & Co., Indianapolis, 1974.
- Jung, W.G., *Audio IC Op Amp Applications*, 2nd Edition, Howard W. Sams & Co., Indianapolis, 1978.
- Jung, W.G., "IC Op Amps for Audio," Parts I, II, *The Audio Amateur*, issues 2/73, 1/74, 2/74.
- Jung, W.G.; Stephens, M.L.; Todd, C.C., "Slewing Induced Distortion in Audio Amplifiers," Four part article series, February, 1977, *The Audio Amateur* (Peterborough, N.H., available as reprint in book form).
- Jung, W.G.; Stephens, M.L.; Todd, C.C., "Slewing Induced Distortion and its Effect on Audio Amplifier Performance — With Correlated Measurement/Listening Results," AES Preprint No. 1252, AES Los Angeles Convention, May, 1977.

Quartz lock meets linear drive.

When Fisher introduced our radically new linear drive turntable two years ago, it was hailed as the most important advance in turntables since direct drive.

But now we've taken linear drive to a new level of performance, by combining it with a sophisticated quartz-locked speed control. Presenting the MT6250 Studio Standard turntable—we think the world's finest.

The MT6250 uses the same 120-pole linear motor direct drive system that has been thoroughly proven in other Fisher turntables. This system uses three precisely phased drive coils to propel a 120-pole magnetic strip encircling the turntable platter. And it is so elegantly simple and smooth that it would be difficult to improve upon. The overlapping drive pulses and large number of poles (compared with 12 or 16 in conventional direct drive systems) assure almost perfect smoothness,



freedom from "cogging," and lower wow & flutter.

For speed stability, Fisher engineered a unique, quartz crystal-controlled, phase locked loop speed servo. The servo electronically monitors the rotation of the platter thousands of times every minute, and keeps it locked in perfect sync with the crystal oscillator. This system is so stable that speed variation of the MT6250 is practically zero.

Of course, the rest of the MT6250 lives up to the perform-

ance standards set by its drive system. The fully-counterbalanced tonearm easily handles virtually any cartridge, and provides the convenience of automatic return and shutoff at end of record, or when reject is actuated. Built into the beautifully finished base are adjustable leveling feet and a bubble level which doubles as a stylus overhang gauge.

If you want the best performing turntable money can buy, see and hear the Fisher MT6250 at \$300.*

Quartz lock meets linear drive now at selected audio dealers or the audio department of your favorite department store. Don't miss the action.

*Manufacturer's suggested retail value. Actual selling price determined solely by the individual Fisher dealer.

New guide to buying high fidelity equipment. Send \$2 for Fisher Handbook, with name and address to Fisher Corp., Dept. H, 21314 Lassen St., Chatsworth, CA 91311.

The first name in high fidelity.®



MT6250

35. Jung, W.G., "Slew Rate Important for Audio Amps?" *Electronic Design*, May 24, 1977.

36. Jung, W.G., "Slew Rate Tests for Distortion in Audio Circuits," *Broadcast Engineering*, Aug., 1977.

37. Jung, W.G., "Slewing Induced Distortion," *Hi-Fi News and Record Review*, Nov., 1977.

38. Jung, W.G., "Audio Performance Tests for IC Op Amps," *The Audio Amateur*, issue 2/78.

39. Jung, W.G.; Grenier, R.A., "Dear Editor (letters)," *Audio*, March, 1978.

40. Markwalter, J.L.; Jung, W.G., letters, *Electronic Design*, Apr. 12, 1978, p. 7; July 19, 1978, p. 7.

41. Jung, W.G., letters, *Wireless World*, Sept., 1977, p. 62.

42. Jung, W.G.; Todd, C.C.; Stephens, M.L., "Slew Induced Distortion," Invited presentation, TIM session ICASSP (IEEE) Tulsa, OK, Apr., 1978.

43. Linsley-Hood, J.; Jung, W.G., letters, *Hi-Fi News and Record Review*, Jan., 1978, pp. 81-82; May, 1978, p. 87.

44. Jung, W.G., "Unraveling the Complexities of SID and TIM," *The Absolute Sound*, Vol. 3, No. 12, June, 1978.

45. Olsson, B., "Critical Review of the TIM Theory," AES Preprint No. 1200, AES Paris Convention, March, 1977.

46. King, G., "Three Amplifier Obscurities," *Hi-Fi News and Record Review*, Feb., 1976.

47. Cherry, E.M., "Three Audio Amplifier Dragons," *Monitor-Proc. IREE*, Vol. 37, No. 12, Dec., 1976.

48. Ojala, M., "Non-Linear Distortion in Audio Amplifiers," *Wireless World*, Jan., 1977.

49. Leinonen, E.; Ojala, M., "Correlation of Audio Specifications," *J. Audio Eng. Soc.*, Vol. 26, Nos. 1/2, Jan./Feb., 1978.

50. Zuch, G.; Knitter, J., "High-Speed Op Amps — They're in a Class by Themselves," *EDN*, Sept. 5, 1977.

51. Moller, H., "Multi-Dimensional Audio," AES Preprint No. 1296, AES New York Convention, Nov., 1977.

52. Greiner, R.A., "Amp Design and Overload," *Audio*, Nov., 1977.

53. Baxandall, P.J., "Audio Power Amplifier Design," *Wireless World*, Jan., 1978.

54. Vanderkooi, M., "Predicting Op Amp Slew Rate Limited Response," National Semiconductor LB-19, Aug., 1972.

55. Ashley, J.R.; Gage, D.S., "The Theory of Distortion in Audio Amplifiers," TIM session ICASSP (IEEE), Tulsa, OK, April, 1978.

56. Ojala, M.; Leinonen, E., "The Theory of Transient Intermodulation Distortion," *Monitor-Proc. IREE*, Vol. 37, Mar., 1976. (Sydney, Australia).

57. Naryanan, S., "Transistor Distortion Analysis Using Volterra Series Representation," *Bell System Technical Journal*, Vol. 46, pp. 999-1024, May/June, 1967.

58. Allen, P.E., "Slew Induced Distortion in Operational Amplifiers," *IEEE J. Solid State Circuits*, Vol. SC-12, No. 1, Feb., 1977.

59. Sundqvist, B., "Transient Intermodulation In Amplifiers," *Wireless World*, Feb., 1977.

60. Stanley, G.; McLaughlin, D., "Transient Intermodulation Distortion and Measurement," AES Preprint No. 1308, AES New York Convention, Nov., 1977.

61. Jung, W.G.; White, D.M., "The PAT-5/WJ-1," *The Audio Amateur*, issue 1/78.

62. Petri-Larmi, M.; Ojala, M.; Leinonen, E.; Lammasniemi, J., "Audibility of Transient Intermodulation Distortion," TIM Session, ICASSP (IEEE) Tulsa, OK, April, 1978.

63. Weigand, D.M., "Boost Op Amp Bandwidths and Slew Rates," *Electronic Design*, July 20, 1972.

64. Cooper, G.F., "Series Feedback," *Audio*, Dec., 1962.

65. Roddam, T., "Calculating Transient Response," *Wireless World*, Aug., 1952.

66. Garde, P.; Leach, Wm., "Letters," *J. Audio Eng. Soc.*, Vol. 26, No. 6, June, 1978.

67. Garde, P., "Transient Distortion in Feedback Amplifiers," *Monitor — Proceedings of IREE (Australia)*, Vol. 38, No. 10, Oct., 1977. Reprinted in *J. Audio Eng. Soc.*, Vol. 26, No. 5, May, 1978.

68. Garde, P., "Slope Distortion and Amplifier Design," *Monitor — Proceedings of the IREE (Australia)*, Vol. 38, No. 12, Dec., 1977. Reprinted in *J. Audio Eng. Soc.*, Vol. 26, No. 9, Sept., 1978.

69. Takahashi, S.; Chikashige, T., "Design and Construction of High Slew Rate Amplifiers," AES Preprint No. 1348, AES Los Angeles Convention, May, 1978.

70. W. Marshall Leach, "Relationship between Amplifier Bandwidth, Slew Rate Requirements, and Phase Distortion," AES Preprint No. 1415, AES New York Convention, Nov., 1978.

71. Palouda, H., "75W Hi-Fi Audio Amplifier with Low Transient Intermodulation Distortion," Fairchild Semiconductor Application Note 336, July, 1977.

72. "Model CC-2 Power Amplifier," Audionics, Beaverton, Ore.

73. Jung, W.G., "IC Op Amps for Audio Applications," *Electronic Products*, Nov., 1978.

WHY NOT THE BEST?

"Polk Audio is a small Maryland-based company whose speakers enjoy an enviable reputation among audiophiles who would prefer to own such exotica as the Beveridge System 2SW-1 or Pyramid Metronome but don't have the golden wallets to match their golden ears."

THE COMPLETE BUYER'S GUIDE TO Stereo/Hi-Fi Equipment

The Beveridge System 2SW-1 sells for \$7000 per pair.

The Pyramid Metronome sells for \$4990 per pair.

The Polk Audio Monitor Series starts at less than \$200 per pair.



polk audio
Monitor Series Loudspeakers

Polk Audio products are available at the world's finest hi-fi stores. Write us for complete information on our products and the location of the Polk Audio dealer nearest you.

Polk Audio, Inc. 1205 S. Carey St., Baltimore, Md. 21230 Dept. B4



**Until now, you had to buy a Lamborghini
to hear an Alpine car audio.**

In
tro-
ducing
Alpine:
the car
audio that
Lamborghini se-
lected to be stan-
dard equipment on
their \$85,000 sports ma-
chine. Alpine audio sys-
tems are pure-bred, high-
technology designs for the car
listening environment. The new
Alpine systems offer more features,
and more combinations of features,
than ever before available on in-dash car
audio. Features like memory logic elec-
tronics, music sensor, Dolby® key-off eject, cas-
sette glide, loudness contour and a CrO₂-FeCr
switch. These systems also offer high power—20
watts-per-channel RMS—along with low distortion and
unbelievably low wow and flutter (.09% on many models).

ALPINE

At
the
heart of
Alpine's
line there
are two types
of "master" units:
the Integral Compo-
nent and the Micro In-
tegral. Each type houses
an FM/AM Stereo Tuner
and Cassette Deck. The Micro
Integral models also feature an
amplifier and are completely self-
contained. Alpine accessory equip-
ment includes Digital Time Delay (for
concert hall-like ambience) and Graphic
Equalizers. And Alpine offers Loudspeakers
which handle the enormous clean power of
Alpine car audio systems. Consult your Alpine
dealer for professional planning to suit your
particular needs. Alpine: We're new, and every-
thing we do is new. Alpine Electronics of America, Inc.

Dolby is a registered trademark of Dolby Laboratories, Inc.

Enter No. 4 on Reader Service Card

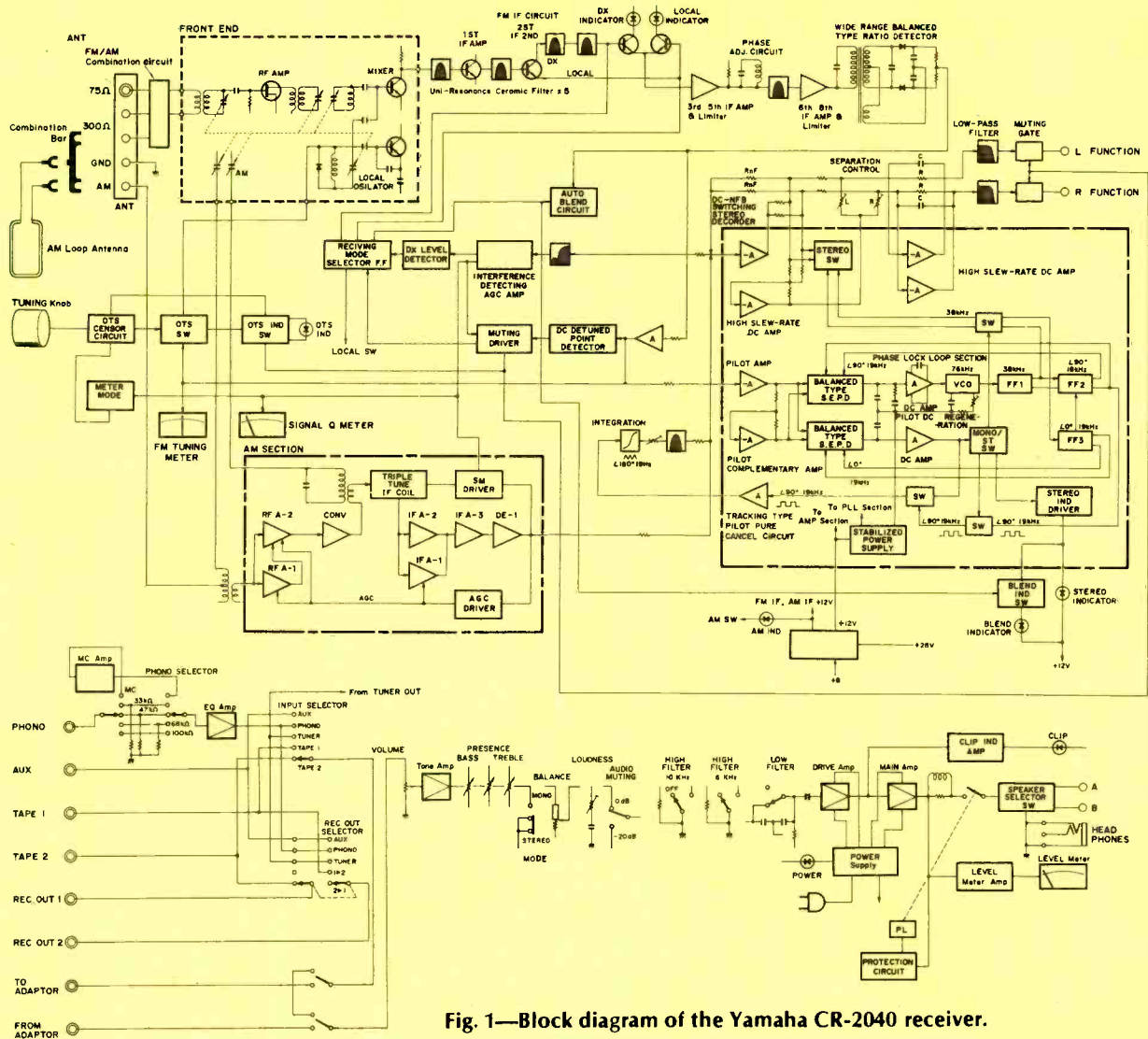

Fig. 1—Block diagram of the Yamaha CR-2040 receiver.

up with a couple of novel alternatives. In areas where AM signal strength is high, a shorting bar connects the AM antenna terminals to the FM antenna terminals and the FM antenna (indoor or outdoor) serves as an AM antenna as well.

Alternatively, Yamaha supplies a completely separate loop antenna for AM. This loop antenna is rectangular in shape, measuring around 5½ in. by 2¾ in. and comes equipped with a bracket which has an adhesive coating on its back surface. Twin leads with spade lugs are intended for connection to the external AM and ground terminals on the rear panel of the receiver, and since the lead length supplied is some 20 in. long, the antenna loop can be affixed to the rear panel of the receiver or mounted to a wall behind or near the receiver for optimum AM reception. The loop itself can be oriented in any direction by rotating it within the bracket holder. Yamaha contends that this loop is a far more sensitive AM antenna than the usual stick supplied with most tuners and receivers. Certainly, this arrangement is more flexible than the ferrite bar normally supplied.

Internal Layout and Circuit Highlights

As can be seen from the photo of the internal construction of the chassis, a large portion of the internal volume of the chassis is given over the fin-type heat-sink structures which

house the output transistors. Flexible cables operate several of the switches (such as the phono-selector switch) which are actually mounted very close to the circuits with which they are associated, rather than to the front panel. The power amplifier section is a d.c.-configured circuit, whose first stage is a current-mirror differential amplifier using a low-noise dual transistor. The second stage is a Darlington-connected constant-current-loaded pre-driver stage. The output stages are three-stage, Darlington-connected, complementary parallel, push-pull configured circuitry.

Tone control circuits combine low noise ICs with simulated LC circuits which are immune to magnetic induction (so-called gyrator circuits). The phono equalizer section uses five low-noise transistors and features a constant-current-loaded first stage and a single-ended push-pull output stage. Resistors in the negative feedback circuit which determines RIAA equalization have a 1 percent tolerance, while capacitors were chosen with a 2 percent tolerance. The pre-preamplifier for the MC phono input employs an extra low-noise IC.

The FM tuner section front end uses a wide-gap, four-gang tuning capacitor in conjunction with a J-FET r.f. stage. The i.f. section operates in one of two modes, making use of three uniresonance ceramic filters, one transistor amplifier stage, and a six-stage differential IC amplifier with current limiter in

Anybody who does this has rocks in his turntable.

You have to be a little crazy to place a turntable directly on a speaker. Because vibration can cause acoustical feedback and uncontrolled howling.

We did it here to make a point about our new direct-drive, fully automatic KD-5070.

You see, the unique-looking white base is made of actual *resin concrete*. To virtually eliminate vibration and keep things steady as a rock.

And while we always recommend separating a turntable from a speaker, you should know that the KD-5070 will stand up to all sorts of inter-

ference without any hops, skips, or jumps from the tone arm.

We used an extra-heavy platter to improve speed accuracy. And reduced wow and flutter to a mere 0.025% (WRMS). Even the DIN-weighted rumble is better than -73dB.

At last, you can get the specs and features of an esoteric manual turntable with the convenience and record-care advantages of a full-automatic.

At \$285.00* it just might be the smartest move you can make.

 **KENWOOD®**

For the dealer nearest you, see your Yellow Pages, or write Kenwood, P. O. Box 6213, Carson, CA 90749.

*Nationally advertised value. Actual prices are established by Kenwood dealers. Cartridge optional. Dust cover included.

In Canada: Magnasonic Canada, LTD.



Make your system sound hundreds of dollars better with new M&K RealTime Direct-to-Disc Records

We'll prove it with a special \$5.00 Super Sampler Album

The Super Sampler features cuts from each of our 11 RealTime Direct-to-Disc albums. It is designed to give you a demonstration of what your ears have been missing.

Because if you've got the system, we've got the program material. Eleven brilliantly recorded and performed discs in the widest choice of fine music available on any direct-to-disc label.

Music for every taste, on the best-sounding records yet. But don't take our word. Here's what some of the critics have said already:

"Performance: Exquisite. Recording: Superior . . . I advise you to get your copy fast." **STEREO REVIEW**

"(For Duke is) one of the best of all Ellington collections . . ." **SWING JOURNAL**

"Dynamic range unheard of in traditional recordings." **AUDIO**

"For Duke is technically the most perfect jazz disc I have ever seen or heard." **JAZZ MAGAZINE**

". . . a superlative series." **ABSOLUTE SOUND**

"So they've caught a big one direct-to-disc (Earl 'Fatha' Hines)." **JAZZ JOURNAL INTERNATIONAL**

The RealTime Recording Process raises direct-to-disc recording to its ultimate in realism. The use of tape, compression, limiting and transformers are totally eliminated. Out go hiss, wow and flutter and distortion.

On location and in RealTime Records' own direct-to-disc studio, live sound passes unscathed through specially modified transformless condenser microphones and state-of-the-art D.C. coupled electronics to the 600-watt per channel cutter driving stage of our highly modified lathe. So music goes straight onto the

lacquer master in realtime — simultaneous with its live performance. Then, the lacquers are flown directly to West Germany for plating and pressing on the finest pure virgin vinyl.

The results are recordings that literally mirror the original performance, with all their dynamic range, detail, steep transients, stereo imaging, tonal balance and ambiance preserved intact for your repeated enjoyment. On pressings totally free from pops and clicks so you hear realism you never realized your audio system could reproduce.

Get your \$5.00 Super Sampler and other M&K RealTime records at these dealers:

ALABAMA
Ingram Audio
Florence
Lawrance Stereo
Birmingham

ARIZONA
HIFI Sales
Mesa
Jerry's Audio Exchange
Flagstaff
Phoenix
Tucson

CALIFORNIA
Audio Directions
San Diego
Audio Vision
Santa Barbara

Big Ben
All Locations
The Eardrum
Los Angeles
Havens & Hardesty
Audio Systems
Huntington Beach
Henry Radio
Anaheim
Jonas Miller Sound
Los Angeles
Licorice Pizza
All Locations
Music Plus
All Locations

Northridge
Audio Center
Northridge
Pilot Stereo Center
Santa Monica
Sound Center
Woodland Hills
Stereo HIFI Center
Gardena
Torrance
Culver City
Stereo Showcase
Vallejo
Sacramento
Tower Records
All Locations
Warehouse
All Locations
Woodland Stereo
Woodland Hills

COLORADO
A.D.L. Sound
Boulder

K & H Enterprises
Fort Collins
Listen-Up
Denver
DISTRICT OF COLUMBIA
Needle in a Haystack
Washington D.C.

FLORIDA
House of Stereo
Jacksonville

GEORGIA
Audio Outlet
Savannah
HIFI Buys
Atlanta
High Fidelity SSS
Atlanta

ILLINOIS
Rose Records
Chicago
Sounds Deluxe
Westmont

Spin Shop
Decatur
Victor's Stereo
Chicago
Morton Grove

INDIANA
Peaches Records & Tapes
Indianapolis

Slatewood
Ft. Wayne
W. Lafayette

Vons
W. Lafayette

KENTUCKY
Disc Jockey
Lexington
The Wax Works
Owensboro

LOUISIANA
Brut Force Audio
Lafayette

MARYLAND
DKL
Silver Springs
House of Sound
Baltimore

MASSACHUSETTS
Sound & Music
Northampton

MICHIGAN
Absolute Sound
Detroit
Royal Oak
Ann Arbor
Almas Hi Fi
Dearborn
Birmingham

Audio House
Flint

Audio Tech
Warren
Pecars
Detroit
Roger's
Grand Rapids
Lansing
Sound Room
Benton Harbor
Grand Rapids
Kalamazoo
South Bend

Stereoland
Livonia
Royal Oak
Southgate

MISSISSIPPI
Entertainment Electronics
Jackson
Vicksburg

M&K
REALTime
RECORDS

SUPER SAMPLER

One exciting cut from each of our 11 RealTime Direct-to-Disc albums

SUPER SAMPLER ALBUM OFFER!!
You can hear a selection from each of our direct-to-disc records.
Get your copy for just \$5.00 from any participating RealTime dealer.

The Super Sampler is from our ultra-high-fidelity back-up master tapes and cut on our RealTime direct-to-disc cutting equipment. Get your Super Sampler – and a free RealTime catalog at your RealTime dealer today.

M&K MILLER & KREISEL SOUND CORP.
8719 Wilshire Blvd., Beverly Hills, California 90211
Creators of the RealTime Direct-to-Disc Recording Process

MISSOURI
Speaker Craft, Inc.
St. Louis

MONTANA
Team Electronics
Great Falls

NEVADA
Interior Systems
Las Vegas

NEW JERSEY
Franklin Lakes
Franklin Lakes
University Stereo
Ridgewood

NEW MEXICO
HIFI House
Albuquerque
Sound Ideas
Albuquerque

NEW YORK
Alltronics Stereo, Inc.
Amhurst

Arnee Audio
Wappinger Falls
Audio, Audio
Staten Island
Audio Breakthroughs
Manhasset
Huntington
Audio Den
Stoney Brook
Eardrum Stereo
Nanuet
Harmony House, Inc.
New York City
Harvey Sound
New York City
King Karol Records
New York City
Liberty Music
New York City
Listening Room
Scarsdale

Lyric HiFi
New York City
White Plains
Metro Electronics
New York City
Park Avenue Audio
New York City
Sam Goody Dist.
All Locations
NORTH CAROLINA
Audio Advice
New York City
Stereo Station
High Point
Stereo Village
Burlington

OHIO
Audio Craft
Akron
Cleveland
Westlake

Custom Stereo
Electronics
Columbus
Golden Gramophone
Akron
Sound Associates
Bowling Green
Toledo
Findlay
OREGON
Hawthorne Stereo
Portland
Napier Audio
Eugene
Rising Sun Records
Salem
PENNSYLVANIA
Sound Plus
Jenkintown
TENNESSEE
College HiFi
Chattanooga

D & F -
Underground Sound
Memphis
Nicholson's HiFi
Nashville
Sound Concept
Bristol
Johnson City
Kingsport
Watkin's Stereo
Kingsport
TEXAS
Arnold & Morgan
Dallas
Garland
Audiocraft
Houston
Audio Trends
Houston
Bjorn Stereo
San Antonio
Hillcrest HiFi
Dallas

UTAH
Arrow Audio
St. George
VIRGINIA
Audio Arts
Richmond
Audio Associates
Falls Church
Giant Music
Falls Church
WASHINGTON
QC Stereo
Bellingham
Mt. Vernon
WISCONSIN
Audio Emporium
Milwaukee
Nutcracker Sweet
Madison

CANADA
A & B Sound
Vancouver
Ava T.V.
Toronto
S.W. Ontario
Bay Bloor Radio
Toronto
K & W Audio
Calgary
London Audio
London
Miller's Sound
Vancouver
Sam the Record Man
Ontario
Sound Lovers
Winnipeg
Stereo City
Edmonton

Enter No. 42 on Reader Service Card

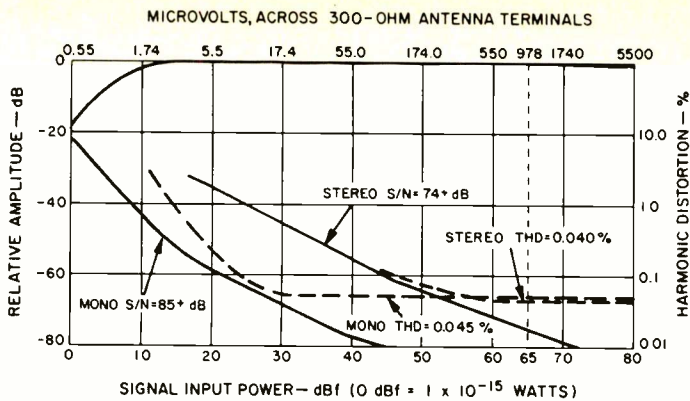

Fig. 2—Mono and stereo quieting and distortion characteristics in the FM mode.

the Local mode. When operated in the DX (narrow) mode, two additional ceramic filters and a differential IC amplifier are added to the signal path.

Yamaha's Auto-DX circuit automatically switches the operating mode of the i.f. section between Local and DX by electronically detecting the amount of noise and interference present in the received signal. This Auto-DX circuit is electrically linked with the Blend circuit. Whenever the tuner is tuned to a station whose signal strength is very low or one which is interfered with by a strong adjacent signal, the Blend circuit is switched in automatically to reduce noise, albeit at the expense of stereo separation. The built-in AFC circuitry is automatically defeated when the used searches for a signal. Once the station is accurately tuned in, the system locks the frequency of the local oscillator to the tuned frequency. The OTS switch is linked with the muting switch to eliminate interstation noise when tuning for weak signals.

Yamaha's multiplex demodulator consists of a d.c. negative-feedback switching circuit based on a d.c. amplifier with a high slew rate, a subcarrier generator using an anti-interference, phase-locked-loop system, and a tracking-type pilot-canceller circuit which cancels any residual 19-kHz signal before it reaches the switching demodulator circuit. This canceller even takes into account the slight differences in pilot-signal level, which may vary from station to station, tracking both the level and phase of the incoming pilot signal. A complete block diagram of this receiver is shown in Fig. 1.

FM Performance Measurements

Usable mono sensitivity of the FM tuner section measured just under $2.0 \mu\text{V}$ (11.3 dBf), while stereo usable sensitivity was a very low $4.2 \mu\text{V}$ (17.7 dBf). The 50-dB quieting point was reached with input signals of $2.4 \mu\text{V}$ (12.8 dBf) and $33.0 \mu\text{V}$ (35.6 dBf) in stereo, both values being considerably better than those claimed by Yamaha.

As indicated in Fig. 2, the best signal-to-noise ratio we could measure in mono was 85 dB. However, we know that our own FM signal generator cannot give reliable readings in

Fig. 3—FM mono and stereo harmonic distortion vs. frequency.

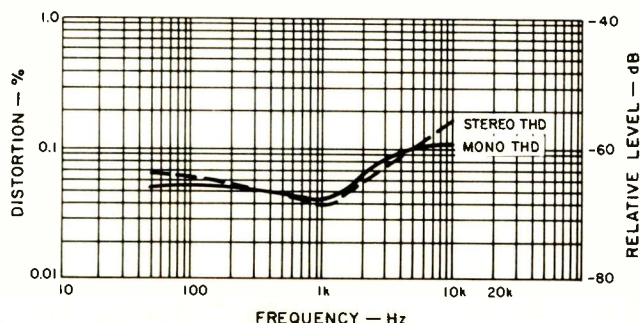

excess of that figure and, therefore, have no reason to doubt Yamaha's claim of 90 dB. As for stereo S/N, our figure of 75 dB, excellent as it is, applies to a 65-dBf level. Yamaha quotes 84 dB for a 75-dBf level which, though not in conformance with IHF Measurement Standards, is probably true (again, our FM generator cannot do much better than 75 dB of S/N in stereo). Amazingly, harmonic distortion for both mono and stereo, at a 65-dBf level using a 1-kHz modulating frequency at 100 percent modulation, was down at around 0.04 percent. Since IHF Measurement Standards call for all THD measurements to be made at 65 dBf, it was not possible to determine what the distortion would be if the tuner section were operating in the "DX" (narrow i.f.) mode, since that mode only comes into play automatically at low input signal levels.

We measured a capture ratio of 1.3 dB, a bit better than claimed, and alternate channel selectivity (again, in the auto-

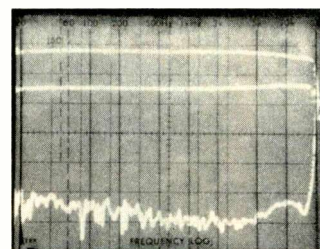

Fig. 4—Frequency response and stereo FM separation. With the "blend" circuit activated, separation decreases uniformly (middle trace) for reduced noise in stereo FM.

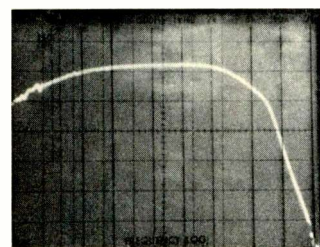

Fig. 5—Frequency response in the AM tuner section.

atically selected "local" or wide position of the i.f. system) measured exactly 82 dB as claimed. The i.f. and spurious rejection were both in excess of 100 dB, while image rejection was 81 dB. The curves shown in Fig. 3 depict distortion vs. frequency for mono and stereo FM signals at a level of 65 dBf. Figure 4 is a scope photo of successive frequency sweeps made with a spectrum analyzer, and the upper trace represents frequency response of the FM tuner section from 20 Hz to 20 kHz. The scale is 10 dB per vertical division. The lower trace represents separation or crosstalk in stereo FM and indicates separation figures of 53 dB at 100 Hz, 57 dB at 1 kHz, and 47 dB at 10 kHz. The middle trace shows the much reduced but uniform separation characteristics obtained when the "blend" circuit is introduced to reduce background noise for weak-signal stereo reception.

Muting threshold was measured as $5 \mu\text{V}$ (19.2 dBf), while stereo switching threshold occurred at signal input levels of $3 \mu\text{V}$ (14.7 dBf). The tuner switches automatically into the "DX" (narrow) mode when signals are equal to or less than $12 \mu\text{V}$ (26.8 dBf). Calibration was extremely accurate over the entire FM frequency range, with a maximum error of only 0.1 MHz up at 108 MHz.

AM Performance Measurements

Despite the fact that the AM circuitry of the Yamaha CR-2040 utilizes only a two-gang tuning system in its front end, sensitivity (via the direct antenna input) was a satisfactory $20 \mu\text{V}$ and best signal-to-noise ratio (at 1 mV input) measured 50 dB as claimed. THD for a 30 percent modulation

EYE FIDELITY.

Any audio professional will tell you. The fidelity of your recording depends on the quality of your recording level meter.

That's why Sony Audio created the fastest, most accurate, most versatile, most reliable, brightest, and easiest-to-read recording level display meter in tape deck history. Period.

Our Liquid Crystal Peak Program Meter IC responds in an incredible 1 millisecond. That gives you the quickest measurement possible, even on the most sudden transient signals.

To demonstrate, clap your hands in front of a microphone. Watch any ordinary VU meter as it tries to respond. Not very much will happen. Now try the same thing with our LCD meter and you'll see that total burst of sound completely displayed.

And speaking of displays, you get a Double Indication System which displays peak levels in two ways: Auto mode, which holds peak levels for approximately 1.7 seconds, or Manual mode, which maintains peak level readings over the entire length of your recording.

Unlike other displays, our LCD meter gives you 33-step accuracy over a wide -40 to +5dB range. It changes color above 0dB, so you never miss an overload reading. And it even has an element life span of more than 50,000 hours.

Finally, the tremendous brightness and logical design of the LCD meter make precise comparisons between left and right channels easier. In any kind of light.

But not only does Sony Audio have the LCD meter. We've got the cassette deck to deserve it. The TC-K60.



With our own hesitation-free brushless/slotless BSL motor, our own newly developed Dolby* IC, our own Ferrite-and-Ferrite head, and our own microprocessor-controlled Automatic Music Sensor that lets you preselect any of up to nine recorded program segments.

Enough talk. The TC-K60 with Liquid Crystal Peak Program Meter is one Sony Audio product you've got to see for yourself.

So look. Then listen.

You'll never be satisfied with anything less.



SONY® AUDIO

*TM Dolby Laboratories Inc.

© Sony Industries, 9 West 57th Street, N.Y., N.Y. 10019.
Sony is a registered trademark of Sony Corporation.

Enter No. 61 on Reader Service Card

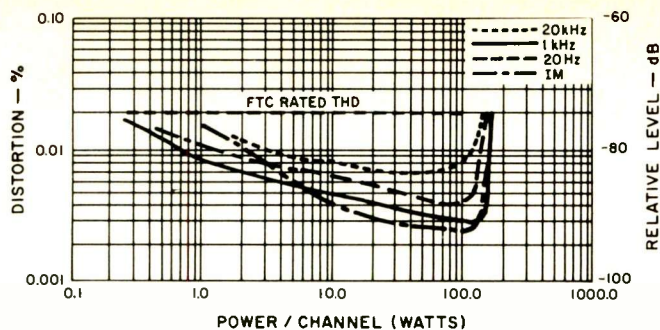

Fig. 6—Distortion vs. power with 8-ohm loads.

level measured 0.5 percent. Frequency response of the AM section is depicted in the frequency-sweep 'scope photo of Fig. 5 with the -6 dB points at 60 Hz and 5 kHz.

Power Amplifier Performance Measurements

Figure 6 depicts the distortion vs. power output characteristics of the amplifier section at three key frequencies (20 Hz, 1 kHz, and 20 kHz) as well as the IM distortion (SMPTE method) vs. power output, referred to 8-ohm loads. Power output for rated THD (0.02 percent) was 145.3 watts for a 1-kHz signal, 140 watts at 20 Hz, and 135 watts at 20 kHz. IM distortion reached rated 0.02 percent for 148.7 equivalent watts output. At the receiver's rated output of 120 watts per channel, THD measured 0.0045 percent at 20 Hz and a barely measurable 0.0029 percent and 0.0025 percent at 1 kHz and 20 kHz, levels rarely encountered in receivers or amps! IMD at the same output level was 0.01 percent. Based upon these measurements, FTC power rating for 8-ohm operation might well have been stated as 140 watts instead of 120 watts. Full rated power output of 120 watts per channel across 8-ohm loads was obtainable at rated distortion over a frequency range from 10 Hz to 40 kHz. Damping factor, measured at 50 Hz, was 50, referred to 8 ohms.

Since Yamaha rates the amplifier section of the CR-2040 for 4-ohm, as well as 8-ohm, operation, we measured power output vs. distortion for this lower load impedance value as well. The amplifier delivered 205 watts per channel into 4-ohm loads, with a 1-kHz test signal, for rated THD of 0.02 percent and 225 watts per channel for the same level of IM distortion. Graphic plots of power output vs. 1-kHz THD and IM are shown in Fig. 7. Distortion vs. frequency at rated output (120 watts per channel) with 8-ohm loads is shown in the graph of Fig. 8.

Preamplifier and Control Section Measurements

Phono input sensitivity for 1-watt output measured 0.19 millivolts for the moving-magnet phono input setting and 9.2 microvolts for the moving-coil cartridge setting. RIAA equalization was accurate from 20 Hz to 20 kHz, +0, -0.2 dB. Phono overload for the moving-magnet cartridge mode measured a superbly high 275 millivolts, while for the moving-coil setting it was 33 millivolts. Signal-to-noise ratio for the MM phono input, referred to 5 millivolts input and volume control adjusted for 1-watt output, measured 81.5 dB ("A"

Fig. 7—Distortion vs. power with 4-ohm loads.

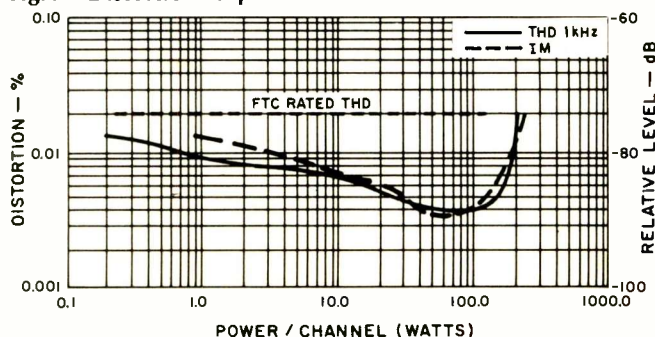

weighted), while in the case of the moving-coil phono setting it was 73 dB referred to 1-watt output and 0.5-millivolts input. Frequency response for the high level inputs extended from 4.5 Hz to 35 kHz, ± 1 dB, while the -3 dB rolloff points occurred at 3.5 Hz and 80 kHz. Signal-to-noise for the high-level inputs, referred to 0.5-volts input and 1-watt output, measured 83 dB. Note that our signal-to-noise measurements are made in accordance with the new IHF Amplifier Measurement Standards and results are therefore not readily comparable with Yamaha's published figures. For readers not accustomed to these new reference input and output levels, we should note that the figures obtained are extremely good, especially for an all-in-one receiver.

Figure 9 shows the composite range of action of the variable turnover bass and treble controls. Three settings of turnover frequency were used in tracing these response curves for both the bass control and the treble control, a midsetting and the two extreme settings. Of course, any number of additional curves could have been plotted to show the extreme versatility of these controls.

Much the same procedure was used in plotting the maximum boost and cut characteristics of the midrange or presence control, as shown in Fig. 10. As we said earlier, the degree of flexibility afforded by these three controls renders the tone system of the Yamaha CR-2040 very close to that of a parametric three-band equalizer.

The low-cut filter on the receiver is essentially a subsonic filter, beginning its attenuation at around 25 Hz at a rate of 12 dB per octave. Since our spectrum analyzer sweeps frequencies within the audio range (20 Hz to 20 kHz), the action of this low-cut filter could not be depicted in the 'scope photo of Fig. 11. However, the action of the two high-cut filters (whose slope is a more gradual 6 dB/octave) is shown in this photo and, by selecting both high filter cutoff positions simultaneously, a third curve is obtained. We would have preferred to see a greater slope rate for these filters since, in their present configuration, they accomplish little more than could be done with the aid of the treble control (compare Fig. 11 with Fig. 9).

The action of the separate loudness control is depicted in the composite sweep-frequency photo of Fig. 12. This secondary control covers a range of approximately 20 dB (at midfrequencies) so that by setting the main volume control to "loud-as-life" levels for any program source, one can reduce listening levels by up to 20 dB with the aid of this secondary control and achieve near-perfect Fletcher-Munson loudness compensation at any lowered listening level within that range. This is one of the few valid and truly adjustable loudness compensation arrangements we have seen on an integrated receiver.

Listening and Use Tests

Without a doubt, the Yamaha CR-2040 is the most intelligently engineered receiver that that company has yet produced, and that's no small feat, since Yamaha products have,

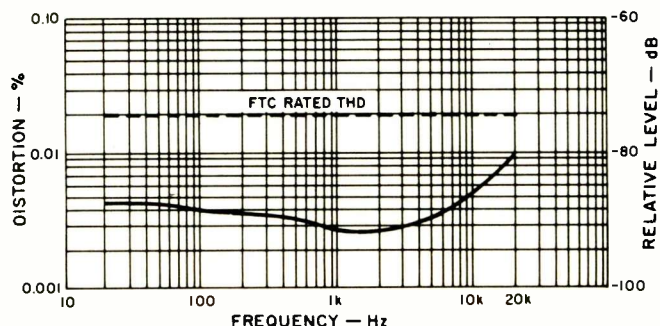

Fig. 8—Distortion vs. frequency at rated output (120 W/ch) into 8-ohm loads.

ONKYO'S Exclusive Accu-Bias



BECAUSE ALL TAPES AREN'T CREATED EQUAL

You see, all tapes aren't created equal. All manufacturers' tapes require slightly different bias than the average 3-position setting for optimum performance, i.e., widest and flattest frequency response and lowest harmonic distortion. Even the same type of tape from the same manufacturer varies in its bias requirements. Batches differ. Processing has its ups and downs.

The newest, hottest audio tape is metal particle. It can give performance level equal to or better than open reel tapes. But, it's so new that bias standards aren't set. When they are, who's to say that the same manufacturer to manufacturer variability will not apply to the metal particle tape?

That's why Onkyo invented automatic ACCU-BIAS.

Onkyo's automatic ACCU-BIAS uses logic circuitry centered around built-in reference generators to determine the optimal settings for bias for any tape you use...every time you use it.

And it's all automatic. With Onkyo's automatic ACCU-BIAS you just tell the logic circuits the kind of tape you're using... Metal, High or Normal. Push the automatic ACCU-BIAS button, engage play and record. Within seconds the automatic ACCU-BIAS computer determines and sets the exact bias,

stops, rewinds and is ready for you to make a perfect recording.

That's not an average setting. Nor a compromise setting. But the precise setting for any cassette you use every time you record. So, unless you want a factory technician to make your decisions for you, there's only one way to go.

Onkyo's TA-2080 with automatic ACCU-BIAS.

What kind of performance can you expect with ACCU-BIAS and metal particle tape? Frequency response of 20-20,000Hz. And a S/N ratio of 62dB with Dolby* out.

Other features that add to the flexibility are 2 sendust alloy heads, plus a special laminated erase head for new metal tapes, feather touch solenoid transport, PLL DC servo motor drive, dual capstans, line mic mixer and 10 segmented peak level LED in columnar array between VU meters.

Another feature is the "Fadeout" which gradually erases portion of the tape during playback while you listen for those times when the tape runs out before the music...easing and simplifying editing chores.

Overall specifications and features make Onkyo's TA-2080 something special. Automatic ACCU-BIAS makes it even more. Check it out at your Onkyo dealer and see what it means by Onkyo's motto of being a step ahead of state-of-the-art.

*Dolby is a trademark of Dolby Laboratories, Inc

Artistry in Sound

ONKYO

Eastern Office: 42-07 20th Avenue, Long Island City, NY 11105 (212) 728-4639

Midwestern Office: 935 Sivert Drive, Wood Dale, IL 60191 (312) 595-2970

West Coast Distribution Center: Darnik Industries, Inc., 20600 Nordhoff Street, Chatsworth, CA 91311 (213) 998-6501

Canada: Sole Distributor, Tri-Tel Industries, Ltd., Ontario, Canada

Enter No. 44 on Reader Service Card

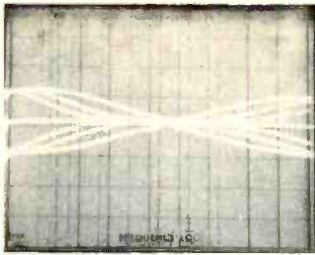

Fig. 9—Action of bass and treble controls with various settings of continuously variable turnover controls.

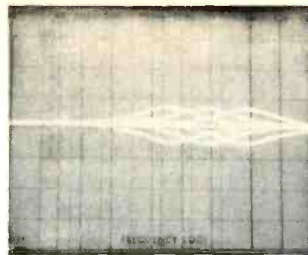

Fig. 10—Action of "presence" (midrange) control with the maximum, minimum, and midsetting of the center-frequency control.

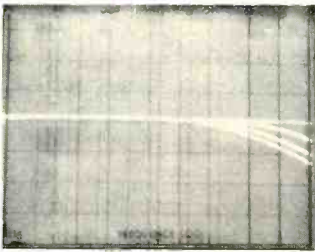

Fig. 11—Action of the high-cut filters with either or both (lower trace) filter switches activated.

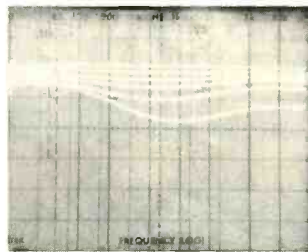

Fig. 12 — The separate loudness control is continuously variable over a range of 20 dB.

over the last few years, shown a degree of sophistication, human engineering, and audio engineering expertise which has set them apart from run-of-the-mill receivers. Not only has Yamaha managed to come up with internal circuit improvements such as a fully d.c. configured power amplifier, an excellent FM tuner section which almost defies the user to mistune it, and preamplifier features such as a built-in preamp and superb cartridge matching facilities, but for all the control features included in the CR-2040, it remains an elegant looking and easy-to-use receiver. As for the sound quality of this unit, we would match it against virtually any other receiver in its price category and against a large number of integrated amplifier or separate preamp/amp combina-

tions as well. Transient response, especially in the phono mode, was excellent with not a hint of dynamic intermodulation distortion or dynamic overload so long as power levels are maintained below maximum output ratings. As for the output capability, we feel that the CR-2040 delivers just about as much power as an all-in-one receiver has any reason for doing. Rather than opting for a dB or two of extra output (dynamic headroom in any case, was 1.2 dB above rated continuous power), Yamaha has concentrated on top sound quality, control features that are useful and usable, and packaging that looks as good as it sounds. The receiver-oriented audiophile and many dyed-in-the-wool separates users will find the CR-2040 difficult to resist, once it is seen and heard.

HOW TO INSTALL DAHLQUISTS IN YOUR CAR.



Dahlquist DQ-10 loudspeakers will never fit in an automobile, but the new Dahlquist ALS 3 Auto/Home Loudspeakers fit beautifully. And they deliver the kind of clarity and definition that earned the DQ-10 its legendary reputation.

The new ALS 3 is an example of Dahlquist's forward-thinking approach to design—a three-way system with the drivers mounted on a special anti-diffraction baffle plate; switchable EQ to optimize either auto or home use; and a mass-loaded woofer for deeper, cleaner bass. (The ALS 3 tweeter is the identical unit used in the DQ-10.)

The ALS 3's are furnished in black, heat-resistant, pressure-cast aluminum cases, with removable 90° rotatable mounting brackets, and no-solder connecting cables—at a price below anything approaching their quality.

Don't be impressed by anyone comparing their car speakers to their home speakers until you find out how good their home speakers are.

THIS BORDER IS THE SIZE OF AN ALS 3.

FOR FREE ALS 3 MANUAL WRITE TO: **DAHLQUIST**
601 Old Willets Path, Hauppauge, N.Y. 11787

The revolutionary new AIWA AD-6700 puts metal-particle tape through its paces.

Now there's a cassette deck designed to realize all the potential sound improvement that metal-particle tape can offer: the revolutionary new AIWA AD-6700. With the impressively broader frequency response and increased dynamic range that rival even today's most advanced reel-to-reels.

AIWA designed it that way to make a breathtaking difference in the way you listen. There's a Sendust Guard Head with extended 1.3 micron gap for optimum recording, AIWA's double-gap Ferrite erase head and an improved erase circuit to meet the increased power demands of metal-particle tape.

But the extraordinary performance of the AIWA AD-6700 doesn't stop with just metal-particle tape. AIWA's own precision Bias Fine Adjustment System lets you select the proper bias for every tape formulation available today with just a twist of the dial. So every tape you play gives a flat response.

The AIWA AD-6700 makes distortion-free recording a cinch, with an amazingly accurate system of sensitive LEDs that instantly respond to peak signal

*Dolby is a Trademark of Dolby Laboratories, Inc.

levels. AIWA's system boasts a highly visible three-color display to help you record a safe level every time. A Peak Hold facility is also included.

For carefree listening, there's a convenient Auto/Repeat with Memory Switch that lets you replay the complete side of a tape—or just the portion of it you most want to hear.

And with AIWA's exclusive "3 Minute Warning" Remaining Tape Time Meter you'll never worry again about running out of tape. All you do is check the left meter.

Wow and flutter have been reduced to an outstanding 0.04% (WRMS). And there's Dolby NR with MPX Filter.

As a special limited introductory offer, every AIWA AD-6700 comes with one free cassette of Scotch® Metafine® Pure Metal Tape. Now whatever metal-particle tape can do, the new AIWA AD-6700 makes it do better.



With full-function wireless remote control.

Advanced feather-touch logic controls make the AIWA AD-6700 a pleasure to operate. Plus it's the first cassette deck in the world with full-function wireless remote control that includes the extra freedom of Cue and Review—even from across the room! So anything the AIWA AD-6700 does, you can do in the palm of your hand.

Upgrade to **AIWA**

Distributed in the U.S. by: AIWA AMERICA INC., 35 Oxford Drive, Moonachie, New Jersey 07074.
Distributed in Canada by: SHIRO (CANADA) LTD.

Enter No. 2 on Reader Service Card

How Audio History is made.



A lot of speakers claim to be audio breakthroughs. Our new Model 14 really is. In fact, it's so unique, that before we could create it, we first had to invent a whole new family of components.

We began with a new type of horn. The Mantaray.^{™*} It's the first "constant directivity" horn ever created. Conventional horns,

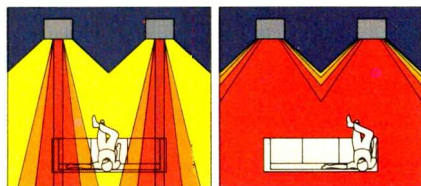

Conventional beaming narrows listening area. Mantaray expands listening sweet spot.

cones and domes (including so-called omnidirectional and reflective speakers) tend to "beam," that is, narrow their angle of sound radiation at higher frequencies. This effect causes the stereo image to lose strength off the center axis and to actually wander.

Mantaray, on the other hand, delivers a clearly-defined sound wedge that keeps its strength regardless of the music's changing frequencies. You get the full spectrum of sound and the most solid three-dimensional stereo image you've ever heard. And since the sound doesn't diminish off center axis, the

Model 14 enlarges your listening area, your "stereo sweet spot."

As an extra benefit, Mantaray's precise sound focusing means your music goes in your ears—not in your drapes, walls and ceilings. Consequently, it's more likely than other speakers to sound the same in your home as it does in your dealer's showroom.



Power Control

Then to give you even higher highs, we developed the first radial phase plug, the Tangerine.^{®**} In contrast to conventional phase plugs with two equidistant circular slots that block some frequencies, the Tangerine's tapered slots permit a free flow of high frequencies to beyond 20 KHz.

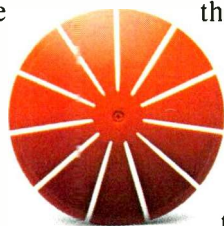

Tangerine

Equally important to all this is our new Automatic Power Control System.

Unlike fuse-type devices or circuit breakers, the system keeps track of the power pumped into the speaker, lets you know with a blinking light when power exceeds safe limits, and then reduces overloads automatically,

but without shutting the speaker off. It's quite a system.

In addition, the Model 14 offers you super-efficiency, high-power handling capacity and exceptional dynamic range, plus a new vented enclosure with a 12-inch bass driver for a tighter, crisper low end. So that's how audio history is made. And it's all yours at a price that means the best sound value available for your home today.

For a free brochure and the name of your local dealer, write: Altec Lansing International, 1515 South Manchester Avenue, Anaheim, CA 92803.



* U.S. and foreign patents pending
**U.S. Patent No. 4050541

Technics Model RS-M85 Stereo Cassette Deck

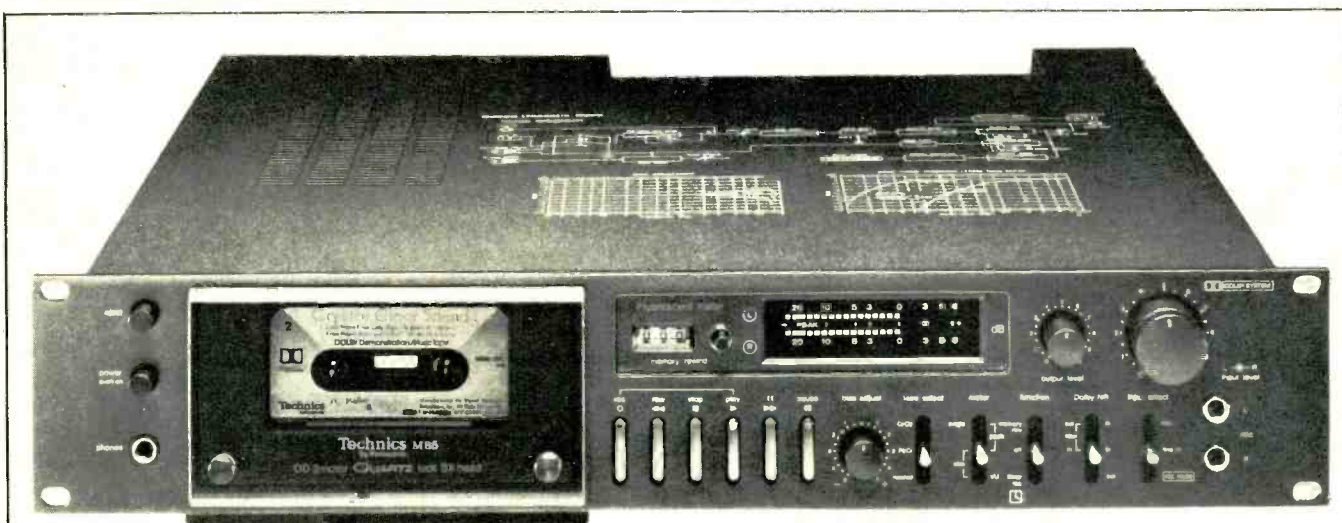

MANUFACTURER'S SPECIFICATIONS

Frequency Response: 30 Hz to 14 kHz, 30 Hz to 16 kHz with FeCr and CrO₂ tapes.

S/N Ratio: 59 dB, 69 dB with Dolby NR.

Input Sensitivity: Mike, 0.25 mV; Line, 60 mV.

Output Level: Line, 700 mV; Head-
phone, 140 mV into 8 ohms.

Flutter: 0.035 percent W rms.

Wind Times: 80 seconds for C-60.

Dimensions: 19-in. (48.3 cm) W x 3 7/8-
in. (9.7 cm) H x 15 7/8-in. (40.3 cm) D.

Weight: 23.1 lbs. (10.5 kg).

Price: \$650.00.

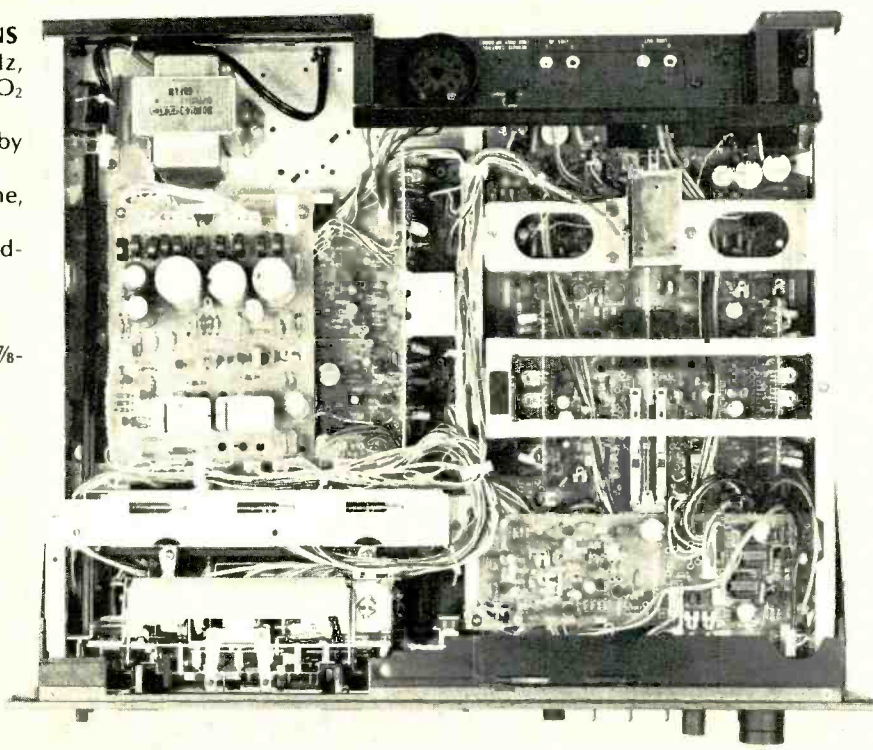

The Technics RS-M85 cassette deck delivers excellent performance in all respects for a medium-high price. The unit is made for rack-mounting, and the front panel is a standard 3 1/2-in. high. Portions of the bottom, however, project below the front panel, so some clearance would be needed from the next piece of equipment below. The deck can be placed on a table or cabinet as it is supplied with feet, but the 16-in. depth would prevent its placement on most shelves. The *Eject* button caused the cassette carrier and its clear cover to move out and tilt, facilitating insertion and removal of tapes. Taking off the cover (two thumb screws) gave excellent accessibility for maintenance tasks.

Tape motion control is with light-touch, logic-controlled switches with narrow bars for actuation. Switching between modes can be accomplished in any order, except that *Record* cannot be added while in *Play*, an odd omission. There are

white status indicators in the tops of the *Play* and *Pause* switch bars and a red one in *Rec*. Five three-position lever switches provide these selections: *Bias/EQ* for the three tape types, VU or peak response for the meter with a choice of higher brightness for peak, memory-on/ memory-off/timer record, off/on/on-with-filter for Dolby NR, and input selection of mike, line or *Rec Mute*. In the third position of the meter switch, the brightness of the fluorescent bar display can be set with a rear-panel pot. The maximum increase in brightness was not great, but there was some improvement in seeing short transients. With *Timer Rec*, the deck will normally start in record mode. It will start in *Play* if, and only if, the safety tab has been removed from the cassette. All of these spring-loaded switches snapped positively from position to position, though I prefer a record-mute switch to be momentary contact to prevent an inadvertent no-record situ-

ation. Associated with the tape selector switch is a bias adjust pot with center detent. This is an important feature, which was used to get the excellent responses reported below.

Just to the right of the counter and its reset button are the fluorescent-bar level displays. The segments cover from -20 to +8, and, as mentioned above, the responses can be set for VU or peak dynamics. The increments from one bar threshold to the next appeared to be a bit large, but this was judged to be more of a problem in testing than in actual use, as detailed later. The dual-concentric, input-level pots were somewhat difficult to adjust at times because the knobs are smooth, of the same diameter, and had slightly high friction. The smaller diameter output level pot has the same style smooth knob with groove and red dot indices. The headphone jack is at the left end of the front panel and the microphone jacks are at the right. The gold lettering on the dark brown panel looks nice, but labels are hard to read except in good light.

Angle support brackets connect from the front rack-mounting panel to the bottom of the main chassis. On the top cover is imprinted a block diagram, curves showing the effects on response with bias adjustments, and peak and VU meter dynamic responses. The line in/out phono jacks are on the rear panel with the remote-control socket and the peak meter brightness pot. With the removal of top and side cover, several PCBs were revealed, all with excellent soldering. All parts were identified, and adjustments were labeled and accessible. Inter-board connections were made with multipin cabling. The drive motors of the quartz-locked servo system were mounted within a support frame, and thus not easily examined.

88

Performance

Playback responses with BASF and TDK test tapes were within 2 dB at all frequencies for both EQs, and usually much closer than that. Playback of a Dolby-level tape showed that meter indications were about a dB low. Tape play speed was measured to be less than 0.1 percent fast, much closer than the great majority of decks. The tapes supplied with the deck were Maxell UD XL I, Sony FeCr, and TDK SA, and these cassettes were used for all of the detailed testing. Fast checks with pink noise and the 1/3-octave RTA showed that similar responses were possible with many tapes with the aid of the adjustable bias (See Table I).

The headroom at Dolby level (200 nWb/m at 400 Hz) was very good with the Maxell and TDK tapes, with responses to about 9 to 10 kHz. All record/playback responses were excellent at -20 dB with very minor head-contour effects and deviations limited to ± 1 dB from 30 Hz to over 16 kHz. Please note that these figures are those obtained with Dolby NR. All too often, stated frequency responses are based upon the

Fig. 1—Frequency response with Maxell UD XL I tape.

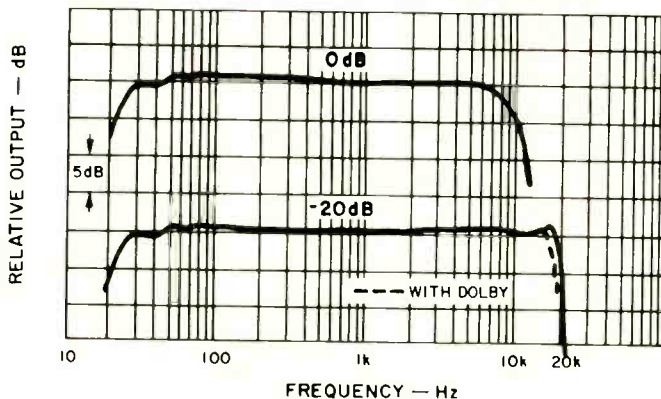

Table I—Record/playback responses (-3 dB limits).

Tape Type	With Dolby NR				Without Dolby NR			
	Dolby Lv1		-20dB		Dolby Lv1		-20dB	
	Hz	kHz	Hz	kHz	Hz	kHz	Hz	kHz
Maxell UD XL I	25	8.8	23	17.5	25	8.8	23	19.0
Sony FeCr	23	5.2	23	17.8	25	8.8	23	18.3
TDK SA	24	9.0	23	18.8	24	9.7	23	20.0

Table II—Signal/noise ratios with IEC A and CCIR/ARM weightings.

Tape Type	IEC A WTD (dBA)				CCIR/ARM (dB)			
	W/Dolby NR		Without NR		W/Dolby NR		Without NR	
	@ DL	HD=3%	@ DL	HD=3%	@ DL	HD=3%	@ DL	HD=3%
Maxell UD XL I	59.7	65.2	51.3	56.0	57.6	63.1	48.6	53.3
Sony FeCr	62.5	65.9	56.1	58.8	61.0	64.4	51.4	54.1
TDK SA	62.2	64.2	54.8	55.9	60.5	62.5	51.8	52.9

results secured without Dolby NR, and the deviations resulting when it is switched in are ignored. The plotted figures show that the Dolby tracking is superb with minor, inconsequential changes at the very highest frequencies. All of this data was run with the bias adjustment at "-3." The effect of shifting the setting to "+5" is shown on the TDK SA plot. The phase jitter in the playback of a recorded 10-kHz tone was just 20 degrees, equal to the best ever measured on a cassette deck. The 37-dB notch of the multiplex filter was centered almost exactly on 19 kHz. Bias in the output during recording was very low.

With a test frequency of 1 kHz, HDL₃ was measured as a function of record level with Dolby NR, as well as without NR. At the higher levels, the figures increased from Maxell UD XL I to Sony FeCr to TDK SA, but at -10 dB (re: Dolby Level) they were almost exactly the same 0.1 percent. HDL₃ vs. frequency was run at -10 dB with the Maxell tape with very good results overall. HDL₂ was low in most cases, and HDL₅ was even lower. Without NR, distortion figures were about 40 percent higher.

The signal-to-noise ratios secured with the three tapes at Dolby level and at the HDL₃ = 3 percent point are shown in Table II. The results are very good, and there is little to fault them even though the best figure of 65.9 dBA is lower than the specified 69 dBA. It was noted that the reduction in distortion with a "0" bias setting resulted in a smaller discrepancy, but the frequency response suffered some. Separation between tracks was a very good 46 dB, and erasure and cross-talk were both down at least 80 dB, excellent figures.

Mike input sensitivity was 0.25 mV, and input overload was a high 57 mV. Line input sensitivity was 56 mV, and input

Fig. 2—Frequency response with TDK SA tape.

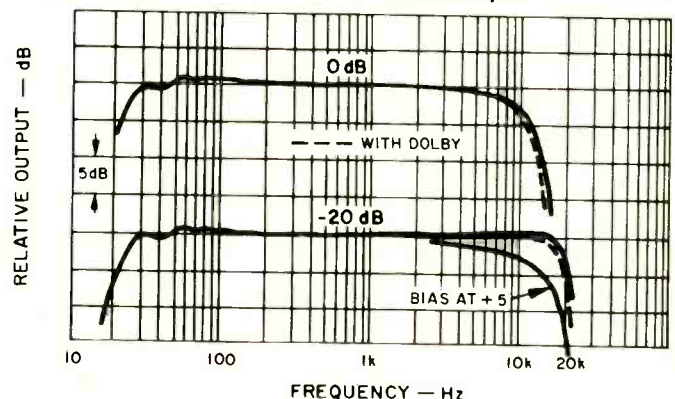

See It. Feel It. Just About Taste It.

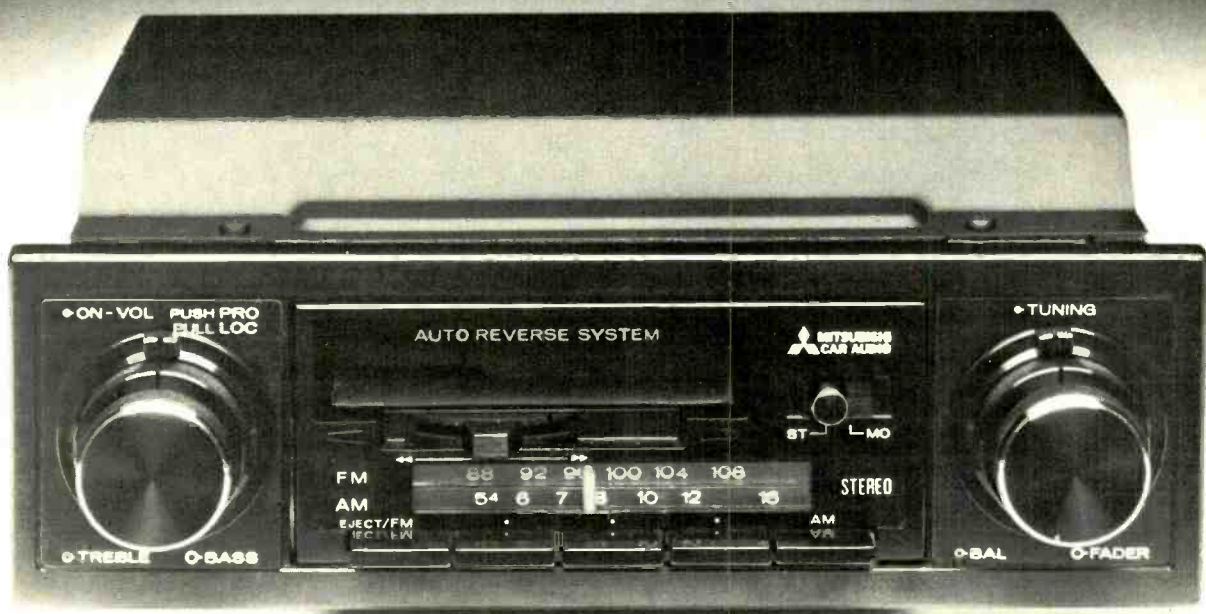

Above All, Hear It.

Car audio has come of age. And Mitsubishi has applied its respected audio technology and experience to its new line of car audio products. There is no compromise. Reliable. Rugged. Well designed. But the proof is in the listening. That's where they shine.

Be it the RX-69 or RX-7 In-Dash AM/FM Auto-Reverse Cassettes or the RS-67 AM/FM 3-track, Mitsubishi is miles ahead in car audio. In addition, three

Under-Dash Cassettes, one Under-Dash 8-track, and an ambitious array of quality car hi-fi speakers complete the line. Mitsubishi transcends the ordinary. Ready to extend your limits? Look into the entire line of car audio component separates. Get a taste of Mitsubishi Car Audio...

But, above all, hear it.



MITSUBISHI
CAR AUDIO
SOUND US OUT

©1979 Meico Sales, Inc., 7045 N. Ridgeway Ave., Lincolnwood, Ill. 60645. 800-323-4216 (Outside Ill.)

312-973-2000 (Within Ill.)

Enter No. 41 on Reader Service Card

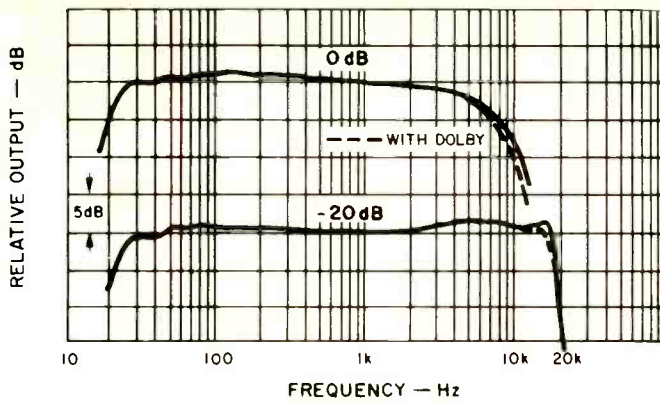

Fig. 3—Frequency response with Sony FeCr tape.

Fig. 4—Third harmonic distortion (HDL₃) vs. level in the Dolby NR mode with Maxell UD XL I, Sony FeCr, and TDK SA tapes.

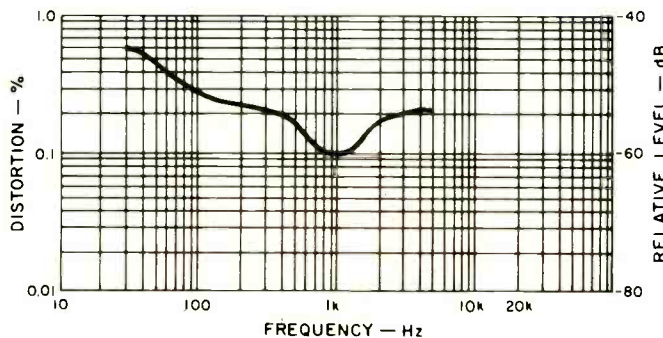
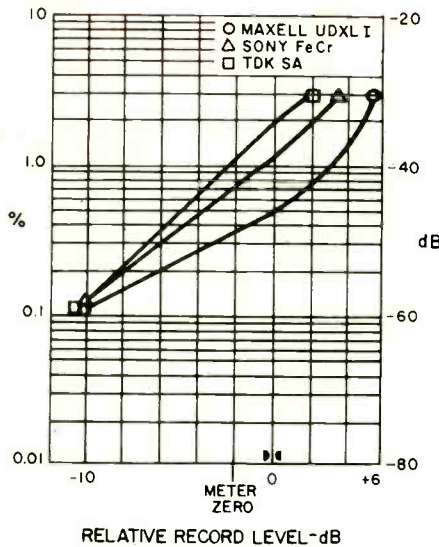
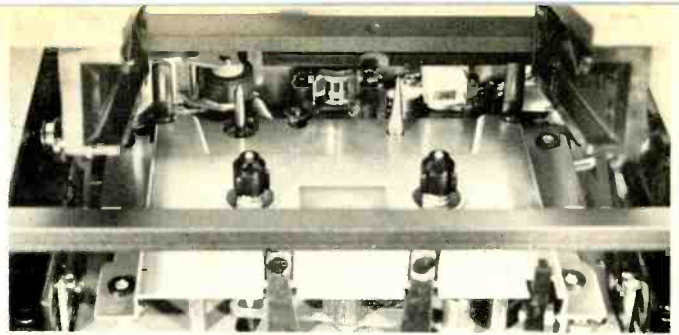
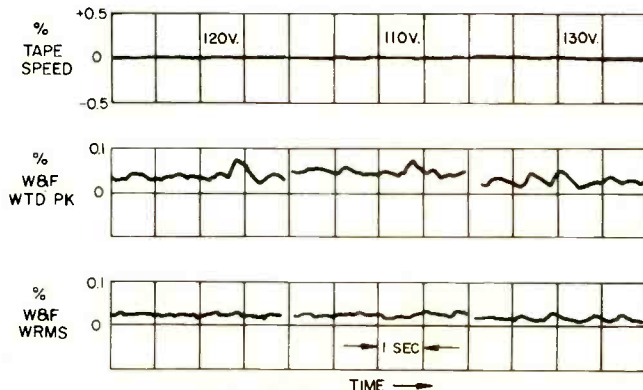

Fig. 5—HDL₃ vs frequency in NR Dolby mode at 10 dB below Dolby level with Maxell UD XL I tape.

Fig. 6—Wow & flutter (three trials) and tape play speed vs. line voltage.



overload clipping appeared at over 10 V, although some flattening first appeared at about 2 V. Output clipping occurred at a level equivalent to +17 dB relative to meter zero. The input level pot sections tracked within a dB from maximum down 60 dB. The line output level was 635 mV, slightly below spec. The 150-mV output at headphones to 8-ohm loads was sufficient to drive all phones tried to a high level. The output level pot sections tracked within a dB for 40 dB down from maximum.

At first look, the fluorescent level meters appear to have many segments and associated thresholds. In fact, two segments turn on at a time from -20 up to zero, and then single ones for +1, +3, +5, and +8. The thresholds were within 0.2 dB with the exception that -20 was at -23 dB, and +8 at +9.2 dB. Frequency response was from 18 Hz to 25.6 kHz. Dynamic responses were to VU standards with that setting, and to the curves on the top cover in peak, about twice as fast as peak program meters to the British standard. In peak, the indications were just 3 dB down with 4 mS bursts. The Technics deck had the best tape-speed characteristics ever measured on a cassette deck. Earlier data had shown tape speed to be perhaps 0.07 percent fast. The flutter was only 0.025 percent W rms and just 0.045 percent Wtd Peak — superlative results. Within the limits of the instrumentation, there were no tape speed variations in playback with time or with changes in line voltage, the best ever seen. The wind times were 79 seconds. Changing wind direction or switching from wind to play required a small fraction of a second.

Listening and Use Tests

Cassette loading and unloading was smooth and easy to do. All controls and switches operated with complete reliability during the testing, which included a determined effort to defeat the tape-motion control logic. Mention was made before of lack of flying-start recording and of spring return for the record-mute switch. Levels were set very readily with the use of the meters in either VU or peak. Although there had been some question on the coarseness of the fluorescent-bar segments in earlier tests, the display was very readable with music inputs. For one thing, the intensity of a flashing segment was indicative of how far above that threshold the peak was. The 12-page instruction manual has excellent text and illustrations. The discussion on setting bias using FM interstation noise is right on the nose. There are very helpful notes and cautions in light-gray blocks, another feature of this outstanding guide for owners.

Records and FM broadcasts and interstation noise were used for the listening tests and all of the results were just fine. Was there really a slight loss in impact with Sony FeCr? One thing was certain: There was no jump in character between Dolby NR and without, and there was no need to explain drooping or peaking with Dolby, because there wasn't any. Record, pause, and stop noises were undetectable with the exception of a soft "clunk" just out of tape noise with stop. The Technics RS-M85 does not have mike/line mixing, and it does not have a couple other things mentioned above. What this deck does have is excellent performance in every important area.

Howard A. Roberson

Enter No. 91 on Reader Service Card

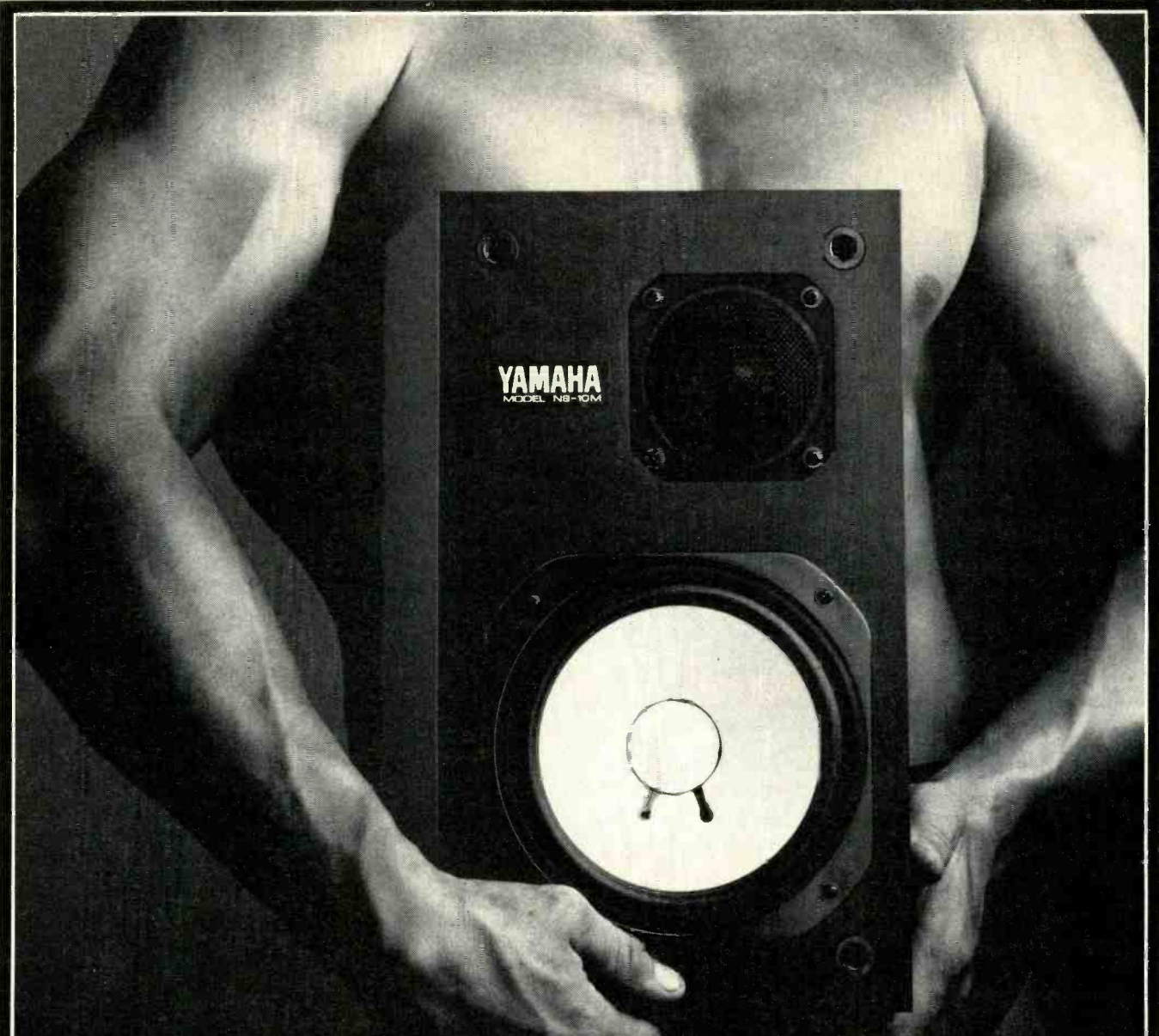

Incredibly smooth, well-defined, powerful. Yet small.

Presenting Yamaha's new NS-10M Mini-Monitor. With wide, even dispersion, high sensitivity and accuracy, the sound is distinctly Yamaha: a rich, solid sound with a tight, firm bass that respects every nuance of tonal shading.

What you're going to wonder, is where it's all coming from. Because for the sound, the Mini-Monitor is amazingly small. Weighing in at 13 lbs., the speaker measures only 15.4" high, 3.5" wide. Inside, a 7" cone woofer and a 1.5" dome tweeter produce 90 dB SPL with 1 watt at 1 meter.

The Mini-Monitor was made in the image of the NS-1000. It has an identical finish, and like its bigger brother, is sold in mirror-image matched pairs. At low volume levels the sound is virtually the same. It's a primary monitor with the NS-1000 look and sound for places the NS-1000 won't fit.

Our new Mini-Monitor with the powerhouse sound is currently contending with the heavyweights at your Yamaha Audio Specialty Dealer. And holding its own, thank you.



Audio Division, P.O. Box 6600, Buena Park, CA 90622

If you can't find your nearest Yamaha Audio Specialty Dealer in the Yellow Pages, just drop us a line.



Revox Model B 790 Turntable

MANUFACTURER'S SPECIFICATIONS

Drive: Quartz-controlled, direct.

Speeds: 33 and 45 rpm.

Speed Accuracy: Better than 0.01 percent (DIN 45 507).

Manual Speed Variation: ± 7 percent.

Speed Indication: Four-digit LED readout.

Wow & Flutter: Better than 0.05 percent (DIN 45 507).

Braking Time: Better than 1.5 seconds.

Rumble: Better than 68 dB (DIN B).

Dimensions: 18-in. (45.7 cm) W x 15-in. (38.1 cm) D x 5½-in. (14 cm) H.

Price: \$899.00.

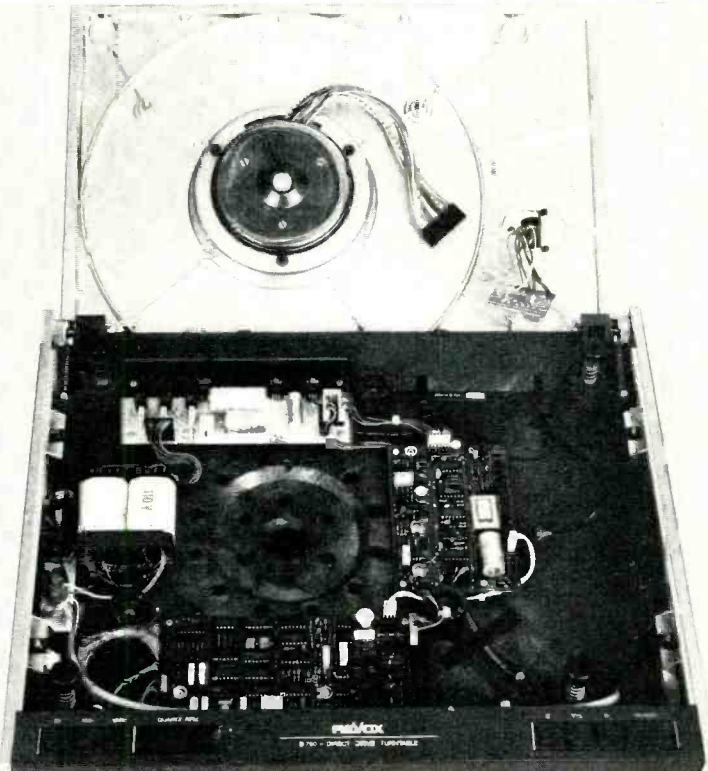

As I'm sure most of our readers know — when a master record is made the cutter head travels across the lacquer in a straight line; it doesn't move in an arc like most tonearms and introduce a tracking error. However, by careful design, the use of an optimum-length tonearm, offset headshell mounting, etc., this tracking error can be reduced to almost the vanishing point. Even so, the potential for improvement, however microscopic, has proved a challenge for design engineers who have come up with various means to duplicate the original cutting motion.

In the past we have seen complex articulated twin arms from Burne-James and Garrard, as well as straight-line carrier models from Marantz, B&O, Schlumberger, and Rabco, all with varying degrees of success. It is known that Sony has a sophisticated model in the lab stage, and now Revox has entered the arena with the B 790, a nicely styled unit made with typical Swiss precision. The turntable measures 18-in. long by 15-in. deep by 5½-in. high, while the motor is a quartz-controlled, direct-drive model with speed correction signals generated by a 200-cog pulse wheel and Hall-effect devices. The tonearm carrier consists of an assembly measuring 7¼-in. long which swings radially over the record to be played. The phono cartridge is mounted on a small arm, less than 2-in. in length, which slides along a metal bar on the assembly. Tracking is controlled by a photo-optical sensor and servo-operated d.c. motor. The arm lowering system is electronically controlled by pneumatic damping, and the muting circuit is switched off as soon as the stylus touches the record.

All controls are located in the front and are accessible even when the dustcover is closed — a design trend which is becoming more popular. On the extreme left of the turntable, there is a group of three rectangular pushbuttons; two for speed change, while the third, marked *Variable*, disconnects the reference frequency control and allows the speed variation of ± 7 percent. The speed control is in the form of a thumbwheel mounted next to a digital display to the right of the pushbuttons, and it should be mentioned that the quartz-lock mechanism is always operative. On the right-hand side of the unit is another group of pushbuttons: Two operate a motor which sends the phono cartridge right-to-left or left-to-right (yes, the cartridge is automatically lifted from the record) and number three is the cue control. Finally, a large button at the end is the power *On/Off* switch.

The unit is nicely finished in a combination of charcoal black, gray, and silver (matching other Revox products) and stands upon four solid feet. The motor and tonearm are mounted to a heavy, diecast top plate which is spring isolated from the base to prevent acoustic feedback.

Measurements

Our sample came fitted with an Ortofon M20E phono cartridge but, as Revox states, the unit is also available without a cartridge and, of course, mounting instructions will be supplied. Stylus force is controlled by a small screw, and the quoted range is from 0.5 to 2.0 grams. Because of the small clearance between the stylus and the turntable, it wasn't easy to use a gauge to measure the actual force being applied, but it appeared that the force setting on the unit supplied was just over 1 gram. However, a stylus force gauge is supplied with the phono cartridge kit to allow the proper mounting of any cartridge, with the possible exception of the older, larger moving-coil cartridges, in the tonearm. There is no anti-skating control to adjust — one of the advantages of tangential tracking.

Wow and flutter were measured first and the combined figure was an excellent 0.04 percent (DIN 45 507). Rumble was -63 dB (ARLL) which is better than average. Variable speed control gave a range of +6.5 percent to -7.5 percent, more than adequate.

Listening and Use Tests

In operation, the record is placed on the turntable and the tonearm assembly is swung over it — the stylus passing over a brush on the way to the disc. The motor is switched on automatically and as soon as the *Cue* button is depressed, the stylus is gently lowered to the record. If desired, one of the transit buttons can be pressed and the cartridge will move to another position. At the end of the record, the tonearm returns to its "up" position above the run-in groove and the motor is switched off. When the tonearm carrier is swung away from the record, the cue-control system is disconnected so there is no chance of accidentally damaging the stylus.

The main problem with straight-line or tangential tracking has to do with the maintenance of accurate groove positioning, and the Revox B 790 uses an ingenious method to solve

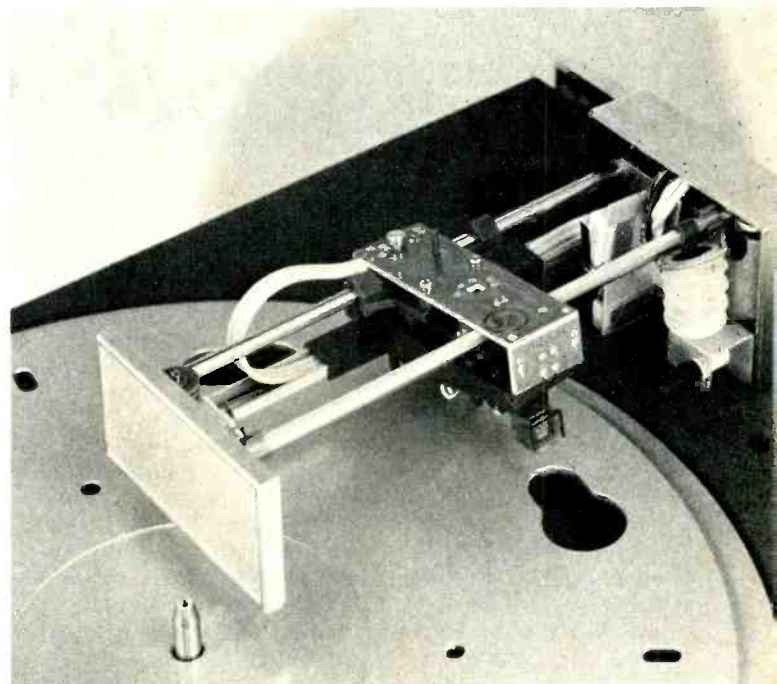

it. Two photo diodes receive infrared light from an LED through a slot in the tonearm. If the arm is displaced, even slightly, to one side, the photo diodes receive an asymmetrical amount of light, and the resulting signals are passed onto the servo system which controls the regulating d.c. motor driving the tonearm cradle. I must say that this system works very well, and Revox is to be congratulated.

How did the turntable system sound? (Yes, the turntable can affect sound.) Well, in this case the results are governed by the phono cartridge, and the M 20E supplied is certainly not the best choice in the Ortofon line. In my opinion, the MC 30 moving-coil model would have been more suitable. Even so, the M 20E gave a good account of itself tracking all bands of the Shure ERA III test record with no difficulty. The impressive 36 Hz drum in the Telarc recording of Holst's *Suite Number 1* (Telarc digital 5038) was also reproduced with no groove jumping or distortion — quite a severe test.

The unit seemed reasonably free from acoustic feedback problems due to the efficient suspension system. The only possibility for vibration might be from the top plate caused by airborne sound if the turntable is placed too close to the loudspeakers.

Overall, the unit is well designed and constructed, and it should give many years of faithful service. The only problems would seem to be the smaller than usual cartridge clearance which could cause problems with warped records — not mis-tracking, but a thumping or scraping noise. *George W. Tillett*

Enter No. 92 on Reader Service Card

Realistic Model SCT-30 Cassette Deck

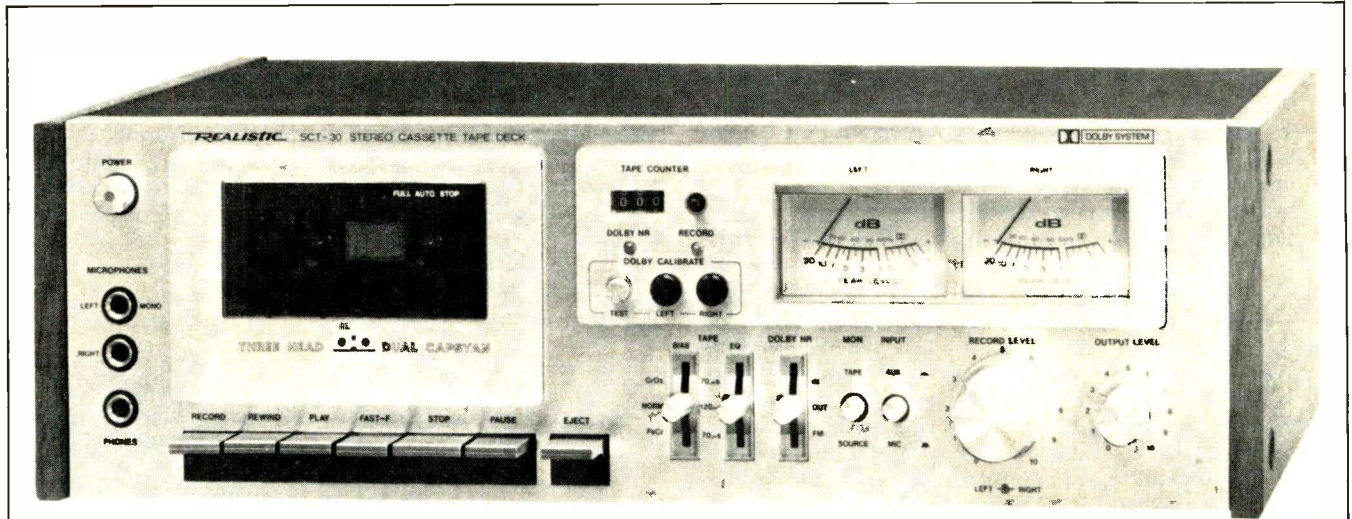

MANUFACTURER'S SPECIFICATIONS

Frequency Response: 30 Hz to 15 kHz ± 3 dB, Normal; 30 Hz to 16 kHz, CrO₂; and 30 Hz to 15.5 kHz, ± 3 dB, FeCr.

S/N Ratio: 61 dB (weighted).

Wow & Flutter: Less than 0.06 percent W rms.

Distortion at 0 VU: Less than 0.9%.

Dimensions: 18 in. (45.7 cm) L x 10 1/8 in. (25.7 cm) D x 5 1/2 in. (14 cm) H.
Price: \$399.95

94

Radio Shack's Realistic SCT-30 is the top-line cassette deck for this enterprising company. It is a three-head machine with monitoring facilities, plus some other interesting features such as a variable-bias control and a built-in 400-Hz generator for accurate Dolby NR calibration. The cassette compartment is located on the left with the usual array of tape transport keys situated underneath. Next to them is another lever key for *Eject*. Then comes a group of three lever switches; the first two are three-position switches for *Bias* and *Equalization*, while the third is the *Dolby NR* switch. These are followed by two pushbuttons for *Tape-Source* monitor and *AUX-Mike* input selection. Over to the right are two rotary controls; one controls the recording level, while the other is the output control. The recording control is a dual-concentric type permitting the user individual channel adjustment.

The two VU meters are located at the top of a subpanel and a peak LED indicator is situated between them. Also on the same panel is a digital counter, *Record* and *Dolby* indicators, as well as the Dolby calibration controls with a switch for the internal generator. The *On/Off* switch is way over on the extreme left along with the standard 1/4-in. sockets for microphones and headphones. At the rear of the deck are

two Dolby calibration controls for FM recording, along with the various input/output sockets, including a DIN jack.

The record/playback heads are encapsulated into one assembly, thus preventing alignment problems. A single d.c. motor with a twin-capstan drive is used. The case is plastic while the steel cover is finished in black contrasting with the two wooden end pieces. The panel itself is made of heavy-gauge aluminum with a satin-brushed finish.

Measurements

The frequency response, measured with a standard playback test tape, was within ± 1.5 dB from 40 Hz to 12 kHz as shown in Fig. 1. As the deck came with a Radio Shack premium quality Supertape Gold cassette tape, this was used for the initial record/replay measurements with the results shown in Fig. 2; the upper -3 dB frequency was at 15.6 kHz. Next, a Maxell UDXL-1 tape was tested and the response was extended to 16 kHz. Tape number three was a Fuji FX-II chrome-substitute tape, and the high frequency response was almost identical to the Supertape Gold (see Fig. 4). Finally a FeCr cassette was checked, a Scotch Master III, and, as expected, the high end was excellent although it only beat the Maxell UDXL-1 tape by a small margin — 16.4 kHz against

Fig. 1—Playback response with a standard test tape.

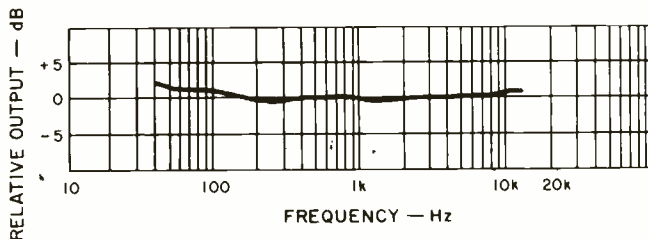
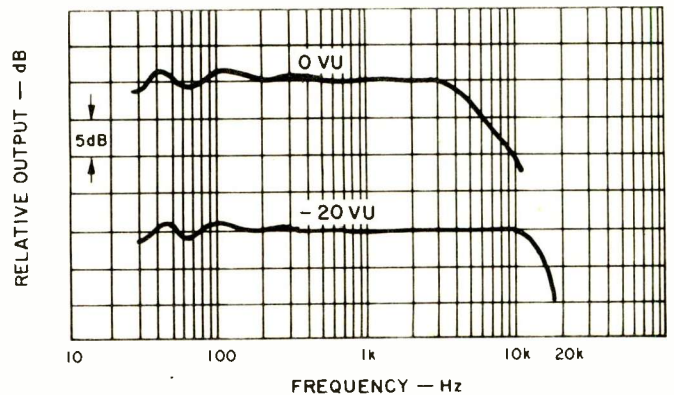

Fig. 2—Frequency response with Radio Shack Supertape Gold.



How can equipment designed for an average listening room perform optimally in your environment?

There's nothing particularly wrong with your stereo system. It's just that different rooms have different acoustics.

Of course, you could build a room specifically designed around the needs of your speakers, and you could rebuild it every time you upgrade your system. But we have an easier way; an MXR Graphic Equalizer that enables you to achieve maximum performance from *your* system, in *your* room...without moving walls.

Our equalizers allow you to critically adjust the frequency balance throughout the entire musical spectrum. They can help to correct certain audible inconsistencies common in many of today's records and tape recordings. You can choose the MXR equalizer that best suits your needs. We make three models that differ in flexibility and precision/sophistication, but each is built to the same exacting specifications and all three share MXR's reputation, in the professional field, for reliability and integrity.

Our popular ten band stereo EQ has one band per octave. Our stereo fifteen band model allows even greater control with two-thirds octave per slider; and for the true audiophile, the MXR thirty-one band equalizer provides ultimate control with one-third octave per slider.

Each of the MXR Graphic Equalizers can help you get the most from your stereo system by working with your room, not against it.

Your MXR dealer can help you choose the MXR equalizer that best suits your needs.

MXR Innovations, Inc., 247 N. Goodman Street,
Rochester, New York 14607, (716) 442-5320



**Consumer
Products Group**

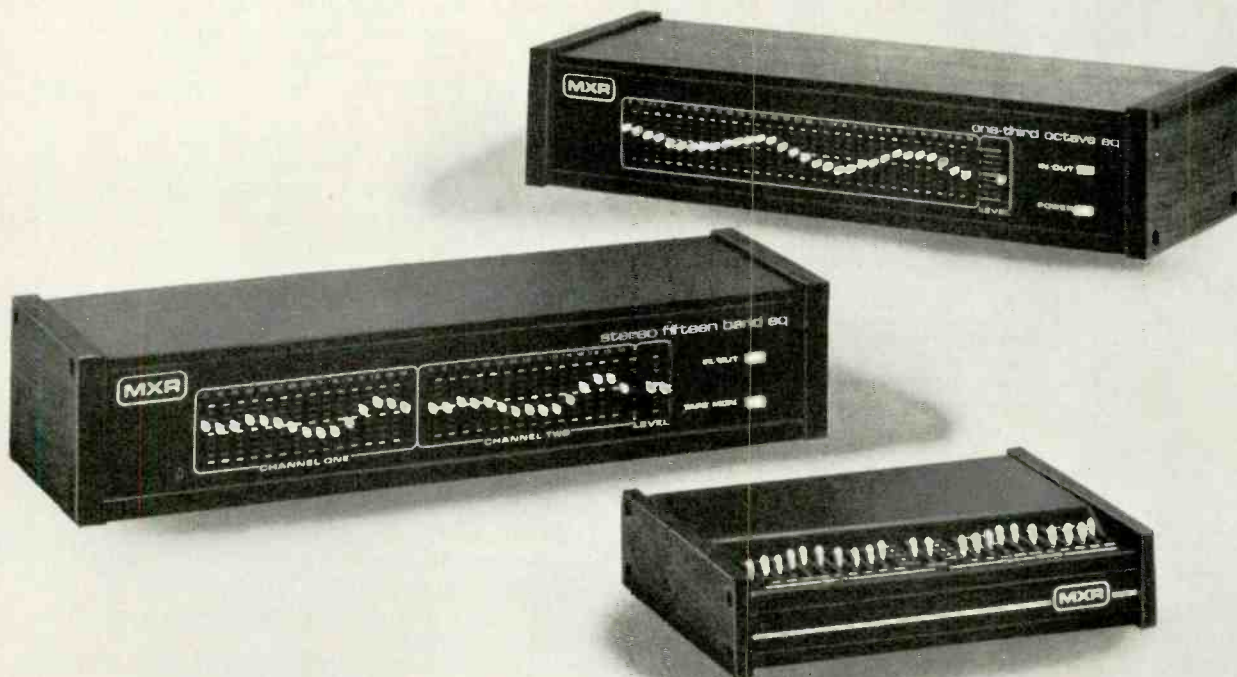

Enter No. 43 on Reader Service Card

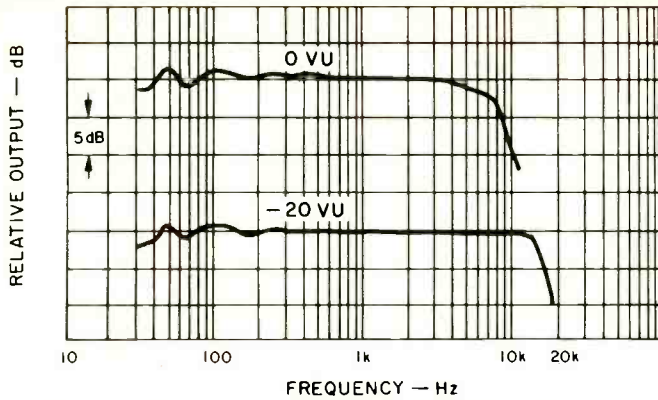

Fig. 3—Frequency response with Maxell UDXL-I tape.

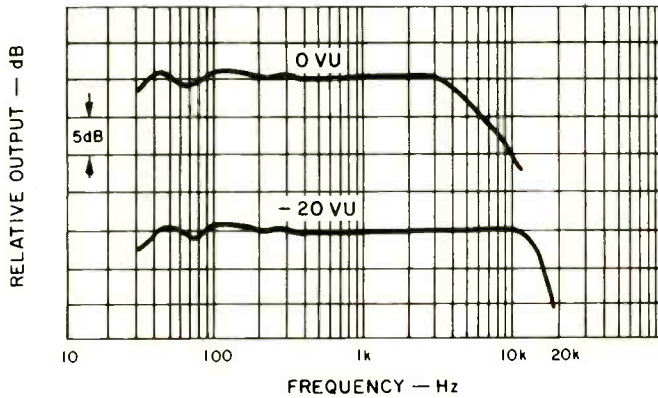

Fig. 4—Frequency response with Fuji FX-II tape.

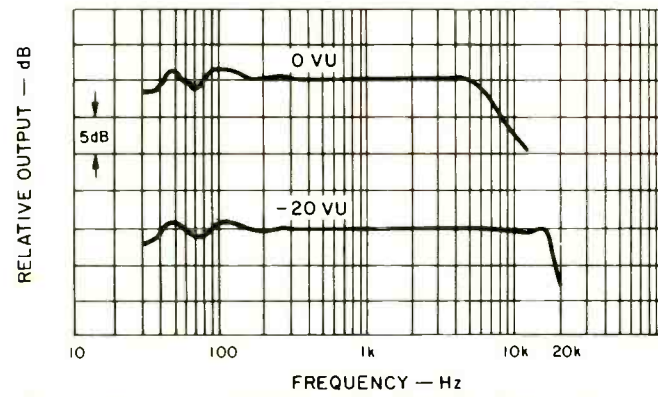

Fig. 5—Frequency response with Scotch Master III FeCr tape.

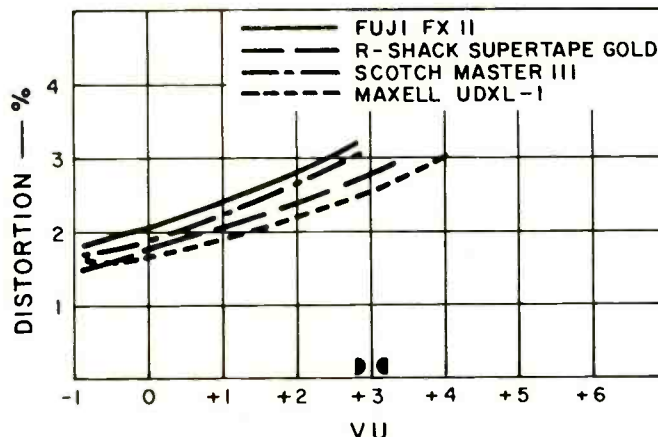

Fig. 6—Distortion and headroom at 1 kHz.

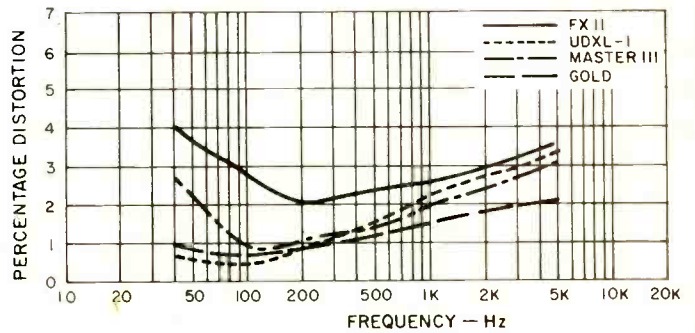

Fig. 7—Distortion vs. frequency.

16 kHz. The falling output at 0 VU for all four tapes is partly due to tape saturation, but the curves are somewhat steeper than usual.

How about bias control? Well, it was initially adjusted for optimum results with Supertape Gold, but it needed only a slight touch for optimum use with the other three tapes.

Figure 6 shows the distortion and headroom at 1 kHz, while Fig. 7 indicates distortion vs. frequency. Headroom before the 3-percent THD point is between 3 and 4 dB for all the four tapes tested with the best performance from the two standard 120 μ S cassettes — Maxell UDXL-I and Supertape Gold. In terms of signal-to-noise ratio, using "A" weighting and 3 percent THD, the Maxell UDXL-I and Supertape Gold measured 55 dB, while the Scotch Master III and the Fuji FX-II were marginally superior at 56.5 dB. Switching in the Dolby NR increased these figures 9 to 10 dB.

The input required for 0 VU was 80 mV line and 0.4 mV for microphones, the output then being 700 to 800 mV depending upon the tape used. Maximum signal handling capacity for the microphone input stage was 23 mV, and the signal-to-noise ratio decreased by 12 dB with the input control in its maximum position.

The Dolby system tracked very accurately, and the margin of error was within 1.5 dB down to -40 dB. Erase efficiency was over 70 dB. Wow & Flutter measured 0.05 percent (DIN 45 507), and the tape speed was less than 0.1 percent slow. Rewind time for a C-90 cassette was 135 seconds.

Listening and Use Tests

As can be seen from the foregoing measurements, the SCT-30 more than meets its specifications and is well up to the high standards for a three-head cassette deck. The dual-capstan drive helps provide a smooth tape transport, while the special attention paid to the Dolby NR requirements, such as the internal calibration generator, will appeal to many.

Those who want optimum results from various kinds of tape will certainly appreciate the variable bias facility — even though adjustments would be easier if the built-in generator could also be switched to 8 kHz or thereabouts. However, it must be said that the method recommended by Radio Shack, using FM interstation noise as a reference, worked out to be surprisingly accurate.

Overall, the Realistic SCT-30 cassette deck combines simplicity of use with enough versatility to appeal to amateur and audiophile alike, a very good value for the money.

George W. Tillett

Enter No. 93 on Reader Service Card

Cleaning your records is only half the battle.

What do you suppose happens when the hardest substance found in nature—diamond—is dragged through the soft, intricate vinyl canyons of a phonograph record at a force which produces acceleration that exceeds 1000 G's!

Friction and wear.

From the very first time you play a record, a process of decay takes place. The delicate high frequency sounds are the first to be impaired. Then the midrange. With every play details are lost and noise becomes more pronounced, eventually rising to a hailstorm often punctuated sharply by clicks and pops. And

the better your equipment, the more annoying the disturbance.

Regular cleaning of your records is important and necessary—to remove the dust and oily films that can further mar performance—but it's simply not enough. The best way to preserve the music on your records is Sound Guard[®] Record Preservative.

Sound Guard is a revolutionary dry lubricant that virtually eliminates record wear. It's so thin that it will not affect the sound of a new record. It's so effective that a treated record may be played 100 times with no audible degradation of per-

formance or increase in surface noise.* A built-in anti-static property helps keep dust off your records between cleanings.

It's true that it requires a little extra effort and expense to protect your records with Sound Guard. But when you add up the investment you've made in your stereo system and record collection, you really can't afford not to do it.

Sound Guard. Everything else is a lot of noise.



Sound Guard preservative-Sound Guard[®] cleaner-Sound Guard[™] Total Record Care System
Sound Guard is Ball Corporation's registered trademark.
Copyright © Ball Corporation, 1979, Muncie, IN 47302



*We have the test results to prove it—write us and we'll send them to you.

ADS Model 10 Digital Time Delay System

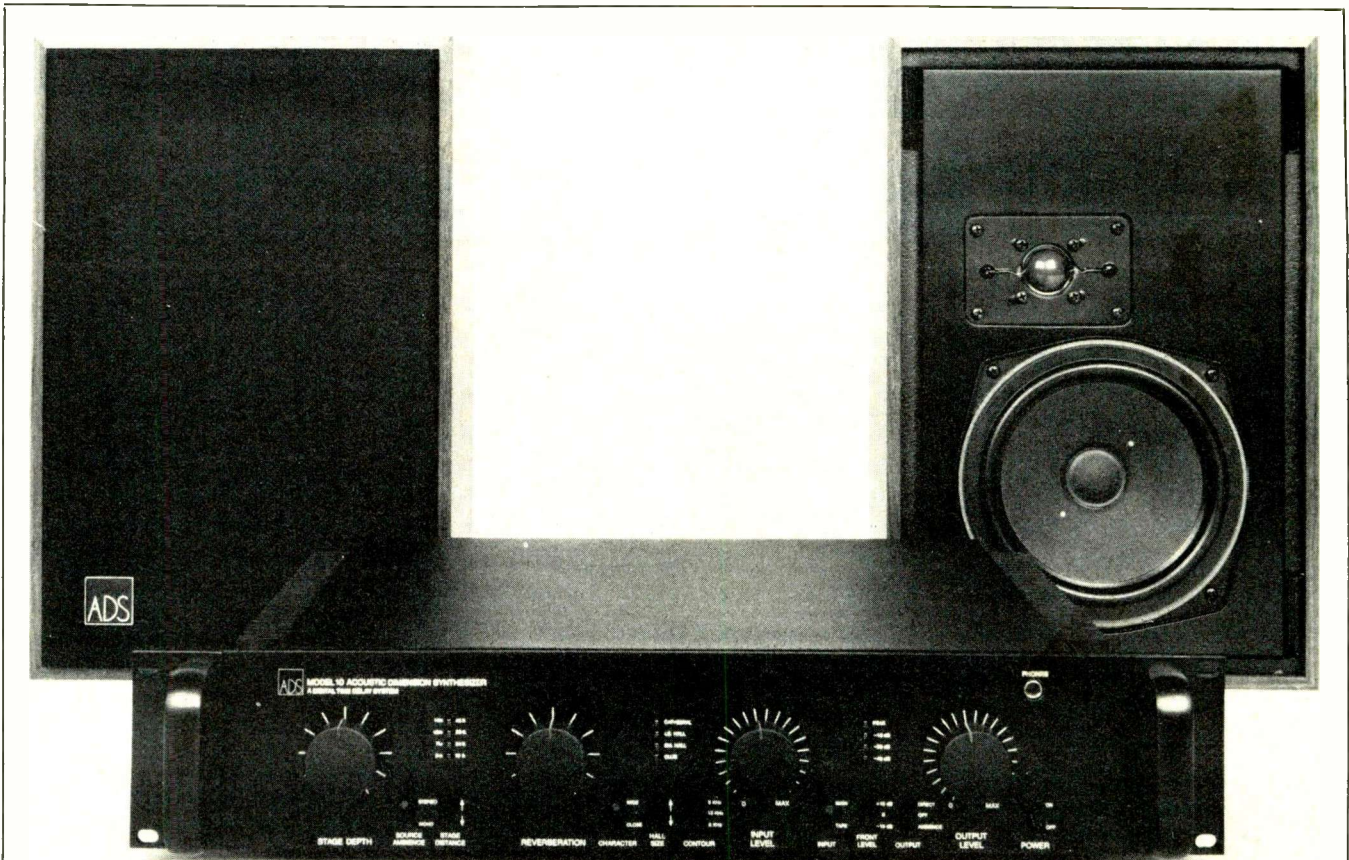

98

MANUFACTURER'S SPECIFICATIONS

Delay Specifications

Method of Delay: Digital pulse storage.
Number of Initial Delays: Three.
Length of First Delay: 10 to 40 mS.
Length of Longest Initial Delay: Up to 100 mS before recycling.
Reverberation Decay Time: 0 to 1.6 sec.
Echo Density: Converges to 4 mS.
Digital Memory Capacity: 24.5k bit.
Memory Cycle Time: 4.1 μ S.

Audio Specifications (Front out/Ambience out)

Input Impedance: 40 kilohms/40 kilohms.
Input Sensitivity for 0 dB at 1 kHz: 0.75 V/0.75 V.
Maximum Input Level: 3 V/frequency dependent (3 dB above 0 dB peak-level indication).
Output Impedance: 2.2 kilohm/2.2 kilohm.

Maximum Output Level: 3 V at 0 dB front level, 6 V at +15 dB, 0.5 V at -15 dB/3 V.
Dynamic Range: 90 dB/80 dB.
Frequency Response: 20 Hz to 20 kHz, ± 0.3 dB; 30 Hz to 13 kHz, +1, -3 dB.
THD Plus Noise: 0.005 percent at 2 V/0.3 percent at 0 dB peak level; less than 1 percent at -40 dB.

Power Amplifier Specifications

Power Output: 100 W/channel into 4 ohms, 20 Hz to 20 kHz.
Rated THD: 0.1 percent.
SMPT E IMD: 0.1 percent.
Dynamic Headroom: 1.0 dB.
Frequency Response: 30 Hz to 20 kHz, ± 0.5 dB.
S/N Ratio: 94 dB, "A" weighted, re: full output.
Input Impedance: 22 kilohms.
Damping Factor: 50 at 1 kHz or 50 Hz.

General Specifications

Power Requirements: 120 V 50/60 Hz, 3 amperes maximum.
Dimensions: 15.75-in. (40 cm) W (19-in. with optional rack mount brackets) x 3.5-in. (8.9 cm) H x 12-in. (30.5 cm) D.
Weight: 23.5 lbs. (10.7 kg).

Loudspeaker Specifications

Driver Complement: One 7-in. woofer and one 1-in. soft-dome, acoustic-suspension tweeter.
Efficiency: 90 dB/watt.
Power Rating: 50 watts (100 watts peak).
Frequency Response: 48 Hz to 18 kHz, ± 3 dB.
Dimensions: 9.75-in. (24.8 cm) W x 15-in. (38.1 cm) H x 6.5-in. (16.5 cm) D.
Weight: 12.5 lbs. (5.7 kg).
Price: \$1000.00.

ADS calls their Model 10 Acoustic Dimension Synthesizer "a complete third-generation, digital time-delay system," which they say means the unit has 99.5 percent non-coherent output, very high echo density, normal placement of both mono and stereo sources, and an additional octave of frequency response for simulation of the small hall. For our part, we certainly grant that the system in "complete," in that time-delay circuitry has been combined on a single chassis with a powerful 100-watt-per-channel amplifier which can either be

used for powering the two compact ADS "ambience" speakers also supplied or, if your present amplifier is less powerful, can be used to drive your main stereo speakers with your present amplifier taking care of the "ambience" channels.

A detailed examination of the front panel of the system will give some idea of the versatility and flexibility of this unit. Controls on the right side of the panel select and adjust the input and output signals of the ADS 10, while those at the left are used to adjust the character and quality of the

Others don't stack up against the books from Audio

No. 607, This volume is a handbook on the broad aspects of the practice and principles of multitrack recording.

No. 618, Covers both the advantages and disadvantages of each enclosure type.

No. 617, This is a thorough learning manual about microphones and how they work.

No. 622, Directed toward both the theory and the practical applications of audio circuits.

No. 619, The book attempts to address the considerations in applying the IC op-amp with maximum effectiveness in a wide variety of circuits.

No. 620, This book explains the operation of unique IC op-amp applications.

No. 608, Here is the whole event-filled story of the phonograph's first century.

No. 903, This new modern publication discusses the audio-system as a whole.

No. 609, This book has become a bible for serious scholars of the technical and legal aspects of the development of the audio-visual industry.

No. 623, This text tells and shows practically and authoritatively the uses of the microphone.

No. 621, The book discusses all types of timers, using representative industry standard devices as examples.

No. 612, This extensive survey of sound should be required reading for every recording engineer and audiophile.

No. 616, This book presents important information for those who want to, and should understand the performance characteristics of the room itself.

No. 613, This is the most up-to-date, complete, and accurate single volume on the development of television and radio now available.

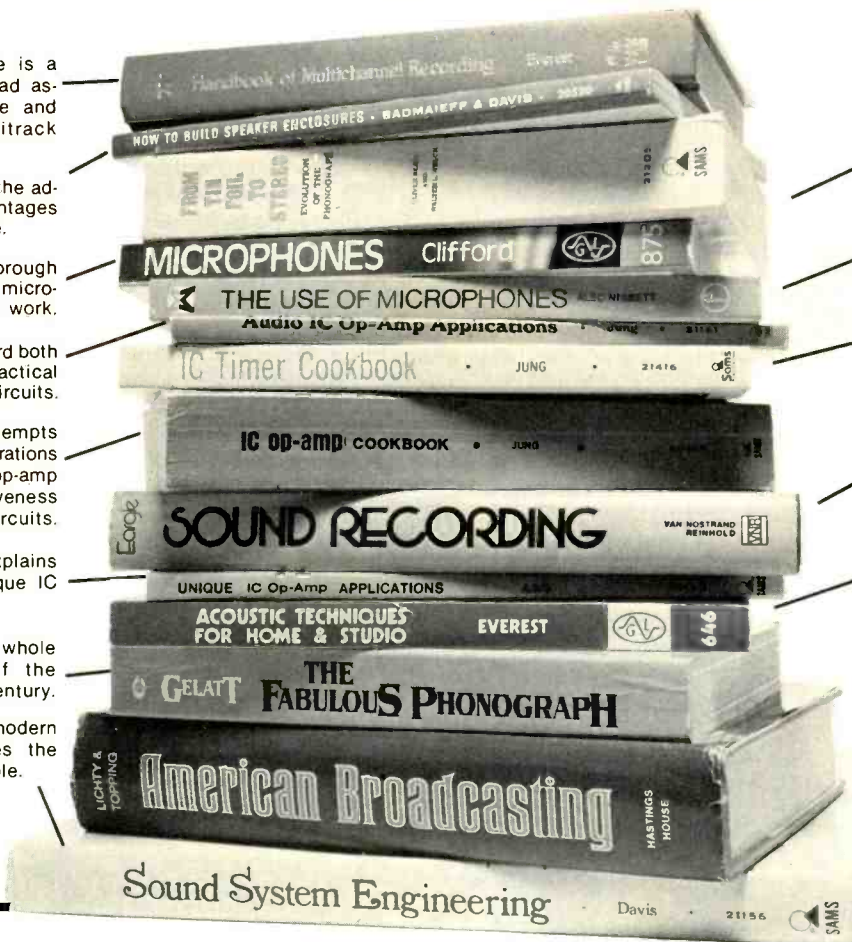

Please send me the book(s) I have checked.
Enclosed is my proper remittance for \$ _____.
I understand if I am not fully satisfied I may return my selection(s) in undamaged condition within 10 days for a full refund.

- 607, HANDBOOK OF MULTICHANNEL RECORDING, \$10.95
- 608, THE FABULOUS PHONOGRAPH, 1877-1977, (softback) \$6.95
- 609, FROM TIN FOIL TO STEREO, (softback) \$9.95
- 612, SOUND RECORDING, \$16.95
- 613, AMERICAN BROADCASTING, \$26.50
- 616, ACOUSTIC TECHNIQUES FOR HOME AND STUDIO, \$8.95
- 617, MICROPHONES—How They Work and How to Use Them, \$8.95
- 618, HOW TO BUILD SPEAKER ENCLOSURES, (softback) \$4.95

- 619, IC op-amp COOKBOOK, (softback) \$12.95
- 620, UNIQUE IC op-amp APPLICATION, (softback) \$4.95
- 621, IC TIMER COOKBOOK, (softback) \$9.95
- 622, AUDIO IC op-amp APPLICATIONS, (softback) \$4.95
- 623, THE USE OF MICROPHONES, (softback) \$6.95
- 903, SOUND SYSTEM ENGINEERING, \$19.95

Name (please print) _____

Address _____

City/State _____ Zip _____

Please allow 4-6 weeks for delivery

Audio

Book and Learning Systems Division

North American Publishing Company, North American Building, 401 N. Broad Street, Philadelphia, PA 19108

Audio Magazine is published by North American Publishing Company, leaders in editorial excellence.

AAM6

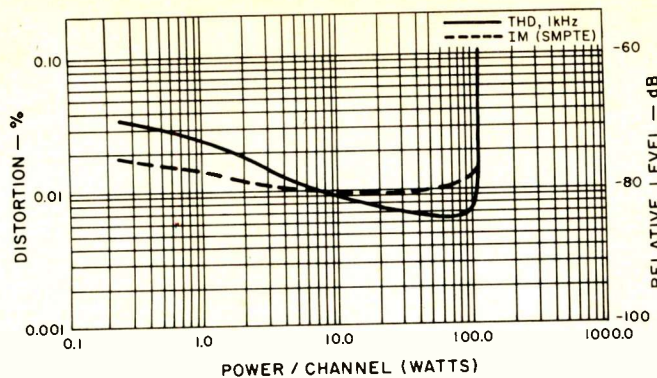

Fig. 2 — Distortion vs. power output with the power amp section.

signal path line) is first fed to a mixer where the stage depth control may be used to add delayed ambience or reverberation to the front stereo signals.

The signal from the input level control is also fed to the source ambience selector circuit. In the mono position, the signal is unaltered, but in the stereo position, the mono component of the stereo signal is selectively diminished while the stereo-difference component is enhanced. Time-delayed signals are mixed with input signals by means of the reverberation control. The signal is filtered by one stage of a two-part filter controlled by the front-panel contour switch. The other part of the filter is in the Delay-1 out signal path. The primary purpose of the input half of the filter is to eliminate ultrasonic energy which might cause interference in the digital encoder circuits. Wider than most other units, bandwidth rolls off steeply above 13 kHz, and a modest amount of pre-emphasis or treble boost is applied prior to A/D conversion. According to ADS, the A/D converter used in the ADS-10 is a new, proprietary design developed for this application. The encoder is able to delay a 13-kHz bandwidth signal for up to 100 milliseconds with over 80 dB of dynamic range using 25,000 bits of digital memory.

A simplified description of how the encoder works is offered in the owner's manual, from which the following description is paraphrased: Every four microseconds, the audio signal is examined, and the instantaneous signal voltage is compared with a reference voltage. If the voltage is higher than the reference, the encoder generates a "one" or "on" pulse; if lower than the reference voltage, a "0" or "off" is generated. At each sampling, the reference voltage itself is altered, depending upon the pulse generated. Thus, the encoder continuously derives corrective instructions for its reference voltage and that voltage "tracks" the incoming signal voltage.

Fig. 3 — Distortion vs. frequency with the power amp section.

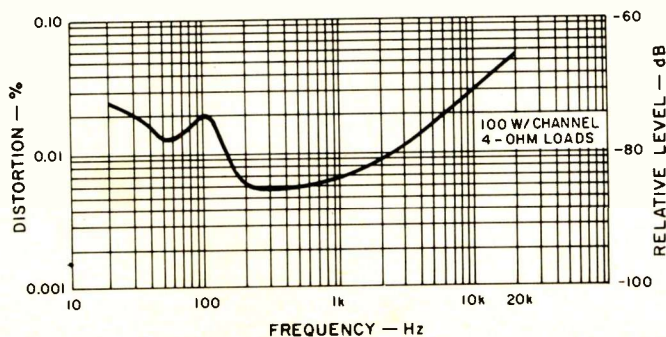

The 1 and 0 logic pulses are fed to the digital memory at a rate of 250,000 per second. The storage memory consists of 25,000 "shift registers" wired in a continuous series. The pulses emerge from the last cell of the memory after a delay which is equal to the number of calls traversed multiplied by the storage time in each cell. In order to produce various time delays, the memory bank is tapped at 12 places along the string (three groups of four taps each). Three time delays are obtained, each of which can be set to four lengths. The shortest delay length is selected by the *Stage Distance* control. The two longer delays are ganged together and are jointly controlled by the *Hall Size* control.

Each delayed pulse train is fed to a separate D/A converter so that three time-delayed replicas of the input signal are produced. Each is then subjected to a mild treble cut to counter the pre-emphasis applied before encoding, for some noise reduction. The three recovered signals are combined in a mixer, with relative strengths controlled by the *Character* switch. At the user's option, the three delayed signals can be sent back to the input, in varying amounts determined by the reverberation control. By rerouting these signals through the delay circuitry, a sustained pattern of many delays is achieved, which we identify as reverberation.

The shortest delayed signal may be mixed with the front stereo signal at a level determined by the *Stage Depth* control. The delayed signals pass through a proprietary circuit which makes them more nearly incoherent, so that they will not appear to be localized. Real concert hall ambience is known to be omni-directional. If the delayed signals were coherent, having identical phase and delay in each channel, they would tend to be localized by the listener as a quasi-monophonic mass of sound at the center of the rear wall of the listening room.

The *Output* switch selects either ambience or direct signals. The second stage of the bandwidth filter comes next (controlled by the *Contour* switch). The signal at the Delay 2 output is obtained from one of the two longer time delays but is not redundant to Delay 1, since it doesn't receive a mix of early delays and reverberation signals applied to it occur in a different order. Front-out and Delay-1 signals are also mixed and fed to the headphone amplifier to drive the phone jack.

Amplifier Test Measurements

It was difficult to take the amp's harmonic distortion readings via the *Main Inputs* because a finite amount of noise is generated by the connected delay circuits and contributes to the readings in the *Direct* mode. In an effort to measure this amp as if it were being used to power the front channels, distortion measurements were made by disconnecting the jumpers that, as supplied, connect the *Delay 1* outputs and the *Power Amp In* jacks and applying our test signal inputs to these normally "jumped" terminals. Figure 2 is a plot of 1-kHz power output vs. distortion, using 4-ohm loads, under which condition the amplifier was able to deliver 112 watts per channel for rated THD of 0.1 percent. Using an 8-ohm load, the amplifier put out 72.6 watts per channel for the same level of THD. Harmonic distortion vs. frequency, at rated output, using 4-ohm loads is plotted in the graph of Fig. 3. Using the new IHF Measurement Standards for amplifiers, dynamic headroom measured 1.4 dB, while damping factor (referred to 4 ohms) measured 46 at 50 Hz. Frequency response was flat to within 0.5 dB from 24 Hz to 50 kHz, while power bandwidth extended from 10 Hz to 28 kHz. FTC rated power measured 106 watts (the power level at which the amplifier produced rated THD at the frequency extremes to 20 Hz and 20 kHz). With both input and output level controls set for maximum gain, sensitivity for 1-watt output measured 25 millivolts. Signal-to-noise ratio, measured in ac-

YOU'VE SEEN ALL THE CASSETTE ADS... NOW GO HEAR THE PROOF.



The Proof is a pre-recorded demonstration of sounds you've never heard. Sounds made possible because of BASF Professional Series cassettes.

The Proof is proof that BASF, the inventor of recording tape, has once again gone one step ahead in sound.

New, highly advanced, second generation coatings make BASF Pro-Series the most sensitive recording tapes.

Pro-I's (normal bias) maximum output level is unsurpassed among ferric cassettes.

Pro-II's (chrome high bias) incredibly advanced chrome formulation enables it to

perform up to reel-to-reel specifications.

Pro-III's (ferrichrome) formulation gives superb results on all recorders, especially car stereo cassette players.

In the past, we've proven our superiority with our Chrome, Studio and Performance Series cassettes. And now all BASF cassettes also have a patented Security Mechanism™ for jam-proof performance.

Sensitivity is impossible to prove on paper. But easy to prove by simply going to your audio dealer and asking for The Proof. Or, you can send for it. Either way, once you hear it we're sure you'll believe it.

TO HEAR IT IS TO BELIEVE IT™



GIVE ME THE PROOF.

Send \$3.50 with this coupon to: The Proof, Box 18367, Boston, MA 02118. We'll send you The Proof (Professional II C-90, \$4.99 value). Or, for a free demonstration of The Proof, bring this coupon to your audio dealer.

Name _____

Address _____

City _____ State _____ Zip _____



BASF

THE INVENTOR OF RECORDING TAPE.

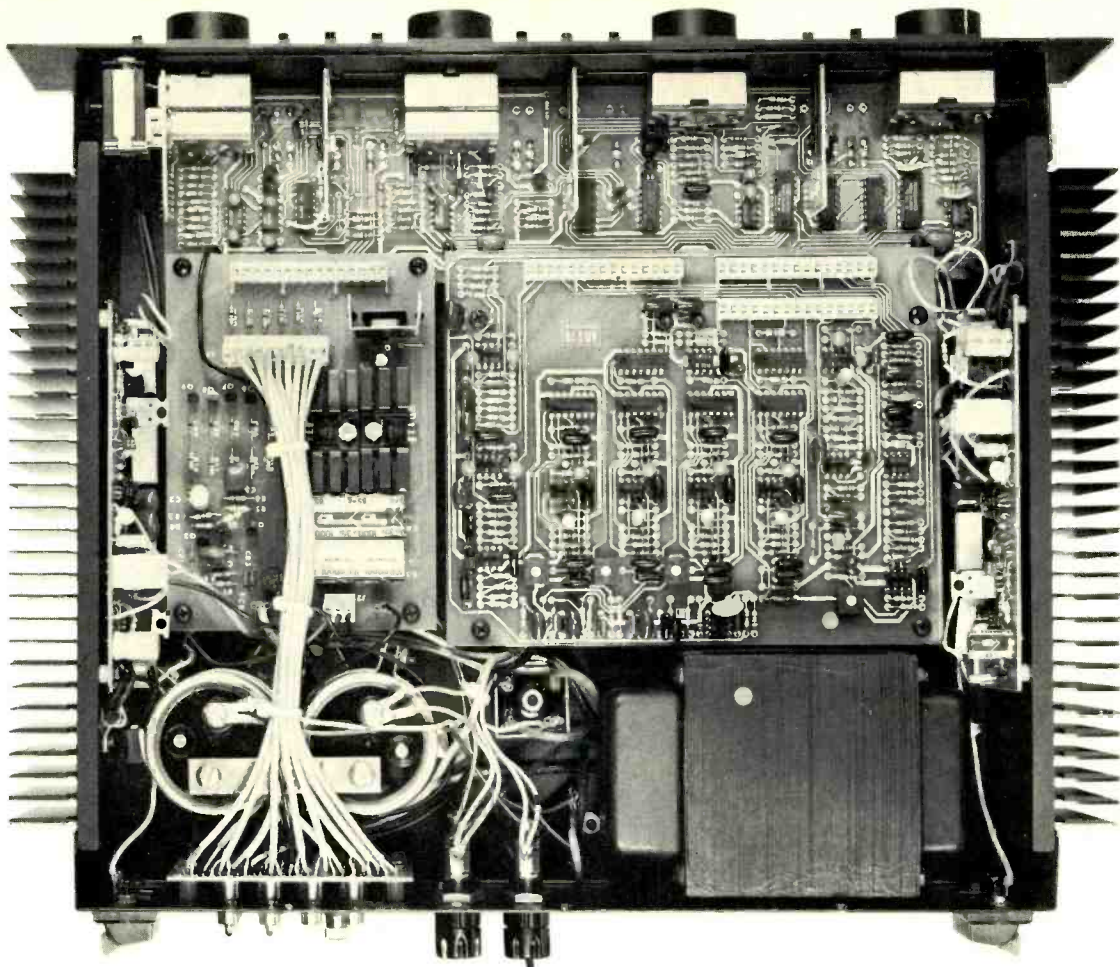

cordance with the new IHF Standards, depended upon the setting of the two gain controls. Since S/N must be measured with 0.5-volts input and 1-watt output as reference levels, it is possible to achieve this output by an almost infinite combination of settings of the input and output level controls. Worst case was obtained with the output level control at maximum, where S/N (re: 1-watt output for 0.5-volt input) measured 66 dB, "A" weighted. Best results were obtained with the input level control at maximum and the output control adjusted for the 1-watt-output reference (still with 0.5 volts input), under which condition the S/N measured 84 dB, "A" weighted.

Time-Delay Measurements

Our earlier experiences with audio time delay units have taught us that very few meaningful static measurements can be made concerning the performance of such units. Judg-

ment as to their effectiveness in recreating the ambience of enlarged listening spaces must be largely subjective. Only the most basic parameters of electronic-digital-time-delay units can be gleaned from bench measurements.

For example, it is impossible to measure frequency response of the delayed channel using single tones. Sine-wave analysis of any time-delay system, like that of a real acoustic environment, will show response notches due to "comb filter" effect of multiple delays, occurring at frequencies dependent upon delay path lengths. This effect is clearly discernible in the 'scope photo of Fig. 4, in which we can see, in the sweep from 20 Hz to 20 kHz a succession of closely spaced notches in "response," particularly at the low frequency end of the audio spectrum. The experiment was conducted more for the purpose of observing bandwidth range of the delay circuits than for evaluating "flatness" of response of the ambience channel. In that connection, we first

Fig. 4 — Frequency sweep from 20 Hz to 20 kHz through delayed channel illustrates the comb-filter effect and bandwidth range.

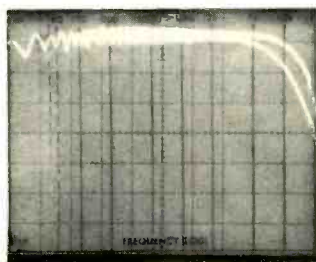

Fig. 5 — Output of delayed channels (lower trace) with tone burst applied to input (upper trace) and controls set for minimum stage distance and hall size.

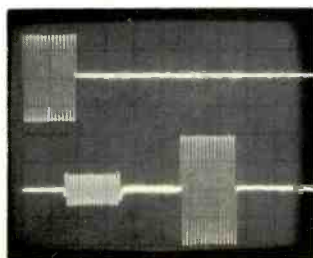

Fig. 6 — With same input signal as Fig. 5, but controls now set for maximum stage distance and hall size.

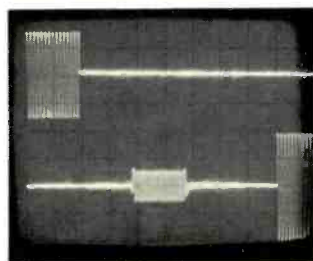
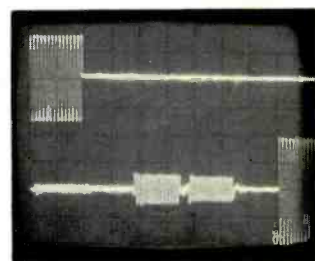

Fig. 7 — Conditions as in Fig. 6, but with maximum reverberation added.



set the contour control for 13 kHz (maximum bandwidth) and then for minimum (5 kHz) bandwidth, and the differences in rolloff at the high end are clearly visible.

We were able to accurately measure the "lengths" of the various time delays by using a tone-burst signal (upper trace in Figs. 5, 6, and 7). Following ADS's recommendations, the Stage Distance and Hall Size controls were adjusted first for their minimum values (10 feet and "club" hall size). Sweep rate was adjusted so that one trace traverses the 'scope face in 100 milliseconds.

In Fig. 5 we see a short delay (1st delay) of approximately 10 mS with the second, longer delay displaced by about 50 mS, and the third delay (much diminished in amplitude) some 30 milliseconds removed in time from the input signal. The controls were then adjusted for maximum delay (stage distance of 45 feet and hall size "cathedral") with results shown in Fig. 6. All of the output signals (first, second, and third delay) have been appropriately shifted to the right (delayed) as might be expected.

The results shown in Figs. 5 and 6 were obtained with no recirculating reverberation added. With the controls still positioned as in the case of Fig. 6, reverberation was now added, and additional, highly random, lower amplitude signals have developed at the output signals (lower trace) in Fig. 7.

Listening & Use Tests

Our initial listening experiments were all conducted using ADS L-10 speakers for the ambience channels. These units, happily, are small enough to be placed almost anywhere, though we found above ear level positioning to be rather helpful in realizing the desired effect. Simply put, if you can hear the ambience channel speakers you are either feeding them with too much delayed/reverberant signal or they are too close to you and beaming at your ears. A fair amount of

experimenting, both with speaker placement and with front and ambience levels, is required to achieve the desired effect, but once achieved, the effect is really quite wonderful. I found the range of control to be greater than I would consciously want. Specifically, I could find no program source which actually required the maximum settings of first and later delays plus maximum reverb, so I must chalk up the provision of these extreme settings to the fact that, despite ADS's warnings regarding the need for subtlety with time delay devices, overkill, particularly on the showroom floor, helps to sell.

Properly adjusted for a variety of program sources and "room sizes," the thing that struck me most favorably about the ADS-10 was the lack of modulation noise or "quantizing" noise which I had detected when listening to some early generations of time-delay systems. ADS has certainly made a valiant and largely successful attempt at total incoherency of the time-delayed channel, with their success most noted when the shorter or medium first time delays are used and when moderate amounts of reverberation are added. When one opts for the spaciousness of a "large hall" or "cathedral" effect, a small degree of artificiality is discerned which tends to somewhat distract the listener and negate the overall illusion of "true space." I would add that by using the Delay 2 outputs and a third pair of speakers with the ADS-10 (powered by a 50-watt-per-channel amplifier that happened to be in the lab at the time we tested the unit), an additional degree of realism was obtained, though the additional improvement is not nearly as startling or impressive as the improvement obtained when the ADS-10 is used with only its Delay 1 outputs to augment our standard stereo setup.

Be that as it may, the ADS-10 stacks up as one of the best and perhaps the most carefully executed ambience recovery and time delay system that I have yet heard. *Leonard Feldman*

Enter No. 94 on Reader Service Card

CORELLI, CALINDA AND CANTATA

Each of these popular loudspeakers is an excellent example of the KEF total system design approach, whereby the drive units, the cabinets and the electronic circuits are developed together, using the computerised digital analysis techniques which KEF pioneered. The Corelli, designed for shelf mounting, offers remarkable bass performance and surprisingly high power handling from such a compact system. The Calinda and Cantata are tall, elegant floor-standing loudspeakers with a special arrangement of the drive units which give a truer frequency response, greater clarity and a sharper stereo image than any previous speakers of comparable size.

And because we make all our own drive units, we can offer a consistency in manufacture and performance which is unrivalled in the Hi-Fi industry.

Write for literature and the name of your nearest dealer.

KEF Electronics Ltd., US Distributors Intratec,
PO Box 17414, Dulles International Airport,
Washington DC 20041.

KEF
The Speaker Engineers



Enter No. 32 on Reader Service Card

Akai Model GX 267D Open-Reel Tape Deck

MANUFACTURER'S SPECIFICATIONS

Frequency Response: 30 Hz to 26 kHz at 7½ ips, 30 Hz to 20 kHz at 3¾ ips.

Harmonic Distortion: 0.5 percent.

S/N Ratio: 56 dB.

Erasure: 70 dB.

Input Sensitivity: Mike, 0.25 mV; Line, 70 mV.

Output Level: Line, 0.775 V; Headphone, 100 mV at 8 ohms.

Flutter: 0.06 percent W rms at 7½ ips, 0.09 percent at 3¾ ips.

Speed: ±0.5 percent.

Wind Times: 90 seconds for 1200 ft.

Dimensions: 17.3 in. (44 cm) W x 18.5 in. (47 cm) H x 9.8 in. (25 cm) D.

Weight: 45.5 lbs. (20.6 kg).

Price: \$850.00.



The Akai GX 267D ¼-track open-reel deck includes many features of interest to audiophiles and has very good performance overall. The front panel is obviously different from most because of the large, centrally located pinch roller, an essential part of the six-head, auto-reverse system. That's right: There are three heads for each record/play direction for off-the-tape monitoring during the record process. A three-position switch selects forward only; forward, reverse, and stop, and forward and reverse continuously (play only). The tape foil that causes the reverse in direction is detected by sensing poles in the left tape guide and in the right tension arm. The Rec Mute switch stops recording on the tape, but the signal continues to appear on the meters, with the monitor switch on Source. A light next to the mute switch flashes every second. This is a great aid if timing is required. The use of Pause automatically removes mute upon release — good thinking, Akai!

Tape motion switches are large, light-touch pushbuttons with complete logic control and status lights for forward,

reverse, and record. Any mode can be chosen while in any other mode, including flying-start recording, changing direction while recording, etc. The two level meters are of large size with scales expanded above "0" and have bright illumination. There are two sets of dual, concentric input-level pots, both with handy marker rings. Mike and line mixing is, therefore, a simple task, aided by the smoothness of the pots. The phone jacks for mikes are just below. There are individual record switches for the two channels, allowing operation in monaural or stereo as desired. Pushbutton switches select tape speed, 7½ or 3¾ ips, and bias for *Low Noise* or *Wide Range*. There is also a timer start switch, an output-level pot, a headphone phone jack, and a counter, which last is positioned above and between the two reel turntables.

The line in/out phono jacks are on the back panel. With the pane's removal, examination showed that soldering was excellent with most circuitry on two, large PCBs. Intercard connections were made with wire-wrap, multi-pin plugs, and direct wiring. All parts were identified by number, and acces-

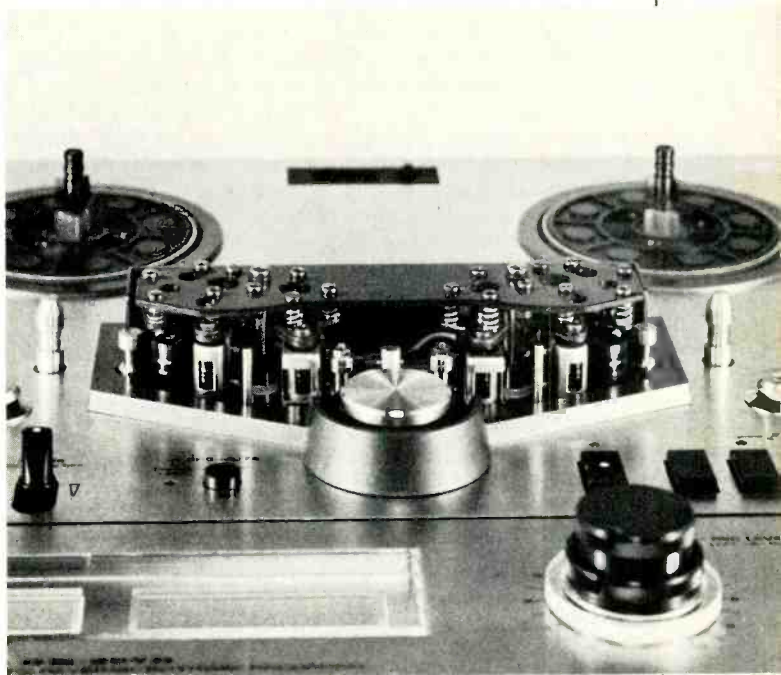
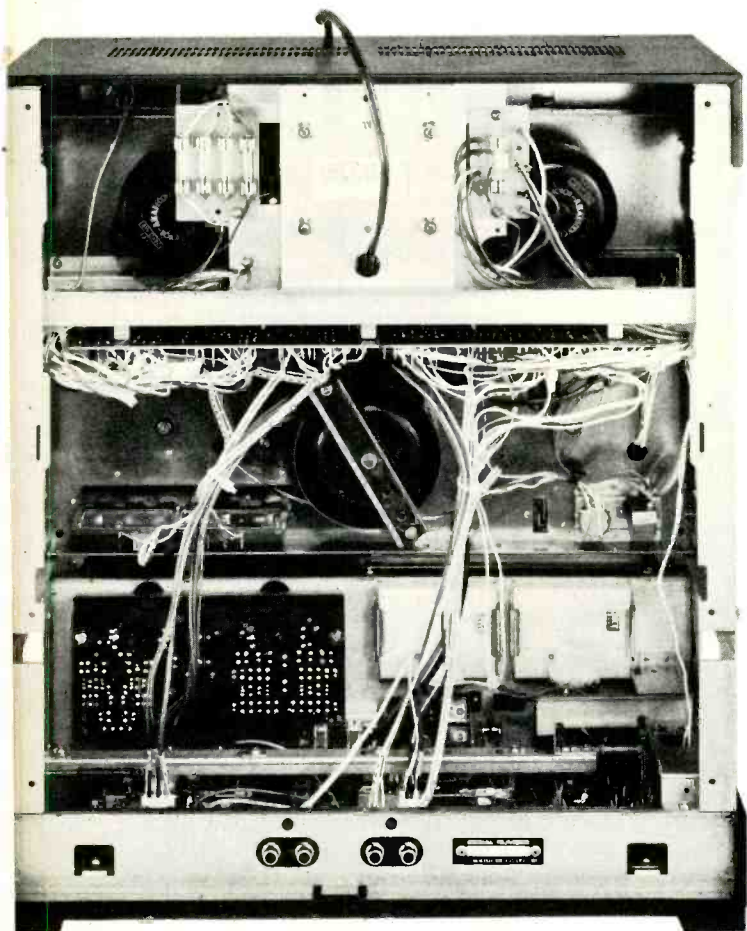

sibility to adjustment was good. Rigid support was provided for the three, outside-rotor, eddy-current motors. There were five internal fuses, all in clips.

Performance

The playback responses with standard tapes were generally quite good for both speeds, with the exception of being 2 dB low at 40 Hz with 3¾ ips. Meter indications were almost exact for the specified 185 nWb/m 0 VU. Tape speeds were within 0.5 percent in all cases, and reverse was slightly slower than forward. Responses in record/playback were very good for a number of tapes, and Scotch 250, TDK Audua, and Memorex Quantum were used for more detailed testing. Reference record level was that for 200nWb/m in playback at 1000 Hz. The best results were obtained with the *Wide Range* bias setting in most cases, as there was too much of a peak around 20 kHz with these tapes when set to *Low Noise*. The results are shown in the plotted figures and in Table I. As shown with TDK Audua, the response even at 10 dB above

Table I—Record/playback responses (-3 dB limits).

Tape Type	AT 7½ IPS				AT 3¾ IPS			
	Ref. Level		-20 dB		Ref. Level		-20 dB	
	Hz	kHz	Hz	kHz	Hz	kHz	Hz	kHz
Scotch 250	23	20.0	22	31.3	33	11.0	32	21.7
TDK Audua—								
Forward	22	21.7	23	32.4				
Reverse	24	23.6	25	33.2				
Memorex								
Quantum	23	19.2	23	30.0	35	10.5	35	21.5

Table II—Signal/noise ratios.

Tape Type	IEC A WTD (dBA)				CCIR/ARM (dB)			
	AT 7½ IPS		AT 3¾ IPS		AT 7½ IPS		AT 3¾ IPS	
	Q Lvl	HD=3%	Q Lvl	HD=3%	Q Lvl	HD=3%	Q Lvl	HD=3%
Scotch 250	60.3	67.0	56.0	61.6	57.8	64.5	52.7	58.3
TDK Audua	57.8	65.8	55.3	60.7	55.2	63.2	51.9	57.3
Memorex								
Quantum	59.3	68.7	58.8	66.5	55.8	65.2	55.3	63.0

(Continued on P. 133)

Top of the pile

For Duke: Bill Berry and his Ellington All-Stars

M & K RealTime Records RT 101, stereo, direct-to-disc, \$15.00.

It is no news to relate that direct-to-disc recordings provide some superb sonic and musical experiences. My feeling has always been that super-fidelity of poor performances is no bargain, however good the sound is. Unless the music is "happening," it's got to be ultimately uninteresting.

Happily, **For Duke** is one of those rare occasions where the sounds and sound come together for something really special. Bill Berry has gathered some great players, all steeped in the Ellington experience. Berry, Britt Woodman, and Marshall Royal are all former members of the Ellington organization. The great Ray Brown recorded a superb piano/bass duet album with Duke (**This One's For Blanton**, Pablo 2310-721) only six months before Duke passed on. Fleshing out the band are veterans Frankie Capp and Nat Pierce and young Scott Hamilton whose tenor sax solo in *Take the "A" Train* quoting *Bewitched, Bewildered and Bewildered* is gorgeous.

The whole program is devoted to favorites from the Ellington books. There are standards like the signature piece *Take the "A" Train*, the immortal *Mood Indigo*, and *Satin Doll*. And favorites like *Things Ain't What They Used To Be* and *I Got It Bad (And That Ain't Good)*. Also things that aren't played much anymore like Juan Tizol's theme *Perdido*, Duke's *Cotton Tail* and *I Let a Song Go Out of My Heart*. Berry and the band set up a groove, first comfortable and then ever more swinging and fun. The playing is at a high standard with eloquent, thoughtful soloing. Nat Pierce's piano is the main strut with Ray Brown's bass playing great bottom. Pierce and Brown are superbly recorded. The direct-to-disc system here is perfect for the music which clearly works best in live performance, precisely what the system emphasizes most. As a result, excellent clarity is achieved with marvelous presence.

I only have one real bitch with **For Duke**. It is so much fun to listen to that the sides end much too quickly. This has to have been one of those

sessions that everyone, musician and technician alike, had a ball doing, and it shows. *Michael Tearson*

Sound: A Pressing: A
Performance: A-

Acoustic Guitar: Stefan Grossman with John Renbourn

EMI/East Wind EWLF-98001, stereo, direct-to-disc, \$15.95.

This direct-disc recording was made by Stefan Grossman during a 1978 tour of Japan. On the final selection of each side, Grossman is joined by the superb John Renbourn, the former guitarist with Bert Jansch in *Pentangle*. Only recently Renbourn and Grossman cut a duo album for Grossman's *Kicking Mule* label.

Stefan's solo numbers are blues and rags, personal old favorites, familiar ones with little new added this time through. When Renbourn joins in to close the sides the musical sparks start to fly, for the interaction between the two is what really is extraordinary about the album's music.

That said, on to the direct-disc recording itself. Yes, the album has an obviously great dynamic range, dramatically better than such an excellent example of acoustic guitar sound on a "conventional" album such as *Happy Traum's American Stranger* on *Kicking Mule* (US, KM-301; UK, SNKF-142). Unfortunately, along with the added presence is what appears to me to be excessive room ambience and a boomy guitar sound. From the album's back cover photo, these effects might be the result of odd microphone placement. I find the problem more distracting on Grossman's solo numbers than on the duets where, frankly, more is going on. According to the notes, one side had to be recut when some noise was made while switching guitars, so the mike placement might be the result of the special requirements for switching instruments.

The notes also relate how during the first few tries, the performances were static and stiff, induced by the pressure of the session's special nature perhaps. This is both the beauty and greatest limitation of the format. What happens once is what you get, warts and all. From listening to the album,

the only really relaxed moments were the duets, particularly the jazzy *Spirit Levels*.

The process does make exceptional sound a reality, but it can't insure exceptional performances.

Michael Tearson

Sound: B Pressing: A+
Performance: C+

Copland: Appalachian Spring Suite (original instrumentation).

Ives: Three Places in New England. St. Paul Chamber Orch., Dennis R. Davies, cond. **Sound 80 Digital Recording S80-DLR-101**, stereo, \$12.50 (2709 E. 25th St., Minneapolis, Minn. 55406).

This new recording from Sound 80, a Minneapolis-based recording studio that has gone into the record business *a la* Sheffield, gives us our first opportunity to hear the digital recording system developed jointly by 3M and the BBC. 3M, the first major U.S. company in the digital audio equipment market, was faced with meeting the high standards set by Dr. Stockham's Soundstream process and the PCM techniques developed by Denon. Based on what I hear on this record, I would say that they have succeeded admirably. My ears tell me that this recording is as noise free and has as wide a dynamic range as the best available. The pressing (by Wakefield Manufacturing) is equal to the best German and Japanese efforts with quiet, pop- and tick-free surfaces. In fact, Wakefield is developing a growing reputation as the U.S. equivalent of Teldec. Who said high-quality pressings couldn't be made in the U.S.?

The recording uses a multi-mike approach and was made in a medium-size recording studio rather than a concert hall, which necessitated the use of a fair amount of artificial reverberation. I would have preferred the real thing, although the over-all effect here is quite natural. The balances are generally good except for the piano, which I felt was a bit too prominent in places.

This digital approach was not to be used originally because the plans were for this record to be a direct-disc, with the 3M equipment used for backup

only. However, everyone was so pleased with the results of the digital recording, it was decided to produce records from the tapes alone. These circumstances, and the fact that 3M had not yet completely developed its editing system at the time of the sessions, explain why both the Copland and Ives works are presented in "single take" performances.

The "live" recording circumstances posed no handicap to the musicians, who play the complex rhythms and tonalities of the Ives with apparent ease. The Copland *Suite* uses the original scoring for 13 instruments which means that each player must be a virtual soloist. Compared to the Ives, the Copland *sounds* deceptively simple, but it requires a virtuosity of a different sort. With both works, I always felt that I was listening to a performance (and an excellent one), rather than an edited recording, although this could be partly because I was aware that no editing could be done. In any event, an excellent beginning for Sound 80 and 3M with respect to both music and sound.

We now have records available to us recorded via three different (and incompatible) digital systems, with a fourth (by Ampex and incompatible with the other three) to be introduced shortly. Only time will tell which system (if any) will prevail. And we can't forget about direct-to-disc recordings and the new metal tapes. What is more important, however, is that all these technical innovations have shown that it is possible to produce recordings for the home that are several orders of magnitude better than was thought possible a few years ago and, what's more, that we can make those recordings available in commercial quantities. What is still needed is a more consistent level of musicianship, but that too will come in time. Which system will prevail? Frankly, that doesn't really concern me. As long as the end result is up to the high standards we now know are possible.

Charles P. Repka

Recording: A Pressing: A
Performance: A

Naima: "Hannibal" Marvin Peterson
East World EWLF-98004, direct-to-disc,
\$15.95.

One of my principal reservations about direct-to-disc recording and its application to jazz has been its technical limitations in handling spontaneous music. The cutting phase of the process is so delicate that an unexpected jump in volume will cause the

AUDIO • June 1979

Q • How close can hi-fi get to an authentic musical experience?

A • Slip on new Audio-Technica Stereophones and hear for yourself.

If you want to find out how good the new Audio-Technica Stereophones really are, don't just compare them with other headphones. Put them up against the very finest *speaker* systems. But don't just listen to the equipment. Listen to the *music*. And be ready for a surprise!

Judged on the basis of flatness of response, freedom from distortion, transient response, sensitivity, and independence from room acoustics, these new dynamic and electret condenser models are perceptibly better sounding than speaker systems costing hundreds of dollars more.

And if you think that great performance can only come from heavy, bulky stereophones, get ready for another surprise. Our heaviest model is less than 7½ ozs. and our lightest is an incredible 4¾ ounces light. Comfort that lasts an entire opera if you wish.

For all the facts, send for our catalog. But for the revealing truth about stereophone performance, listen and compare at your nearby Audio-Technica showroom. It will be a great *musical* experience.



Model ATH-7
Our finest Electret Condenser
with LED peak level indicators
\$149.95

Model ATH-1
The moving coil dynamic stereo-
phone that weighs just 4¾ oz.
\$29.95



audio-technica
INNOVATION □ PRECISION □ INTEGRITY

AUDIO-TECHNICA U.S., INC., Dept. 69A-1, 33 Shiwawsee Avenue, Fairlawn, Ohio 44313
Available in Canada from Superior Electronics

Enter No. 7 on Reader Service Card

MOR part of the music biz with clients like Barbra Streisand, Cheryl Ladd, Liv Taylor, Helen Reddy, and lots more, I expected a pretty mushy record.

It is Collins' first album in several without a single original composition. However, the content is suited — perhaps I should say tailored — nigh on perfectly to her. She dips into the Stephen Sondheim songbag, where she was so successful with *Send in the Clowns*, for *I Remember Sky*, another difficult but beautiful song. New discovery Hugh Prestwood wrote the title song and *Dorothy*. Randy Newman's *Marie*, a difficult song for a woman, also comes off very well as does the Rodgers & Hart chestnut *Where or*

When. The only piece I seriously quarrel with is the Eagles song *Desperado*, not for the performance, but because it simply has been recorded too often for Judy to make it her own.

Collins' voice, always a formidable instrument, is in excellent shape as it lovingly wraps itself around the songs and arrangements. And Gary Klein's production is smooth without becoming slick.

The pressing I received unfortunately was a somewhat noisy one which was distracting in some of the quieter passages. M.T.

Sound: C

Performance: B

tunes (Jonathan Richman's *Roadrunner*, *Johnny B. Goode*, *Rock Around the Clock* and more) as well as an orchestral *God Save the Queen* and the original mix of *Anarchy*. Side two is slightly more recent material, with a few covers again (The Monkees' *Step-pin Stone* and The Who's *Substitute*), Steve Jones' excellent solo spot *Lonely Boy*, and Sid Vicious' finest moment on record, Eddie Cochran's *Something Else*. The third side has a French *Anarchy*, which is good for about one listen; a live and studio version of *Belsen Was a Gas* (which was scheduled to be the next Pistols' single the week before the group broke up) and a bunch of filler. The final side has one great track in the title song, but the rest — Malcolm McLaren's *You Need Hands*, the group's *Friggin In the Riggin*, a mediocre Sid Vicious rendition of another Eddie Cochran tune *C'mon Everybody*, and an orchestral *EMI* — are easily disposable.

I mean to say that I enjoy quite a lot of this album, and I'm amused by a medley of all the Sex Pistols' tunes done in disco style, but I'm sure I'll hear it in the movie, so why bother stuffing it in the soundtrack? Why not provide some additional live Pistols' cuts instead? There's about an album's worth of energetic stuff here, and with all the material left in the can, I'm sure they could have produced something more cohesive a statement than this — but perhaps this is all part of the Swindle here.

As far as swindles go, however, Mr. Johnny Rotten steals the show in his debut with his new outfit, Public Image, Ltd. The song which bears the same monicker as the group is good (not great), but the rest of the album is one of the most self-righteous pieces of nonsense ever to be recorded, never mind released. I'm sure he's very much aware of this and did it to prove a point, much the same as Lou Reed did with *Metal Machine Music*, but it's a good waste of money when there are plenty of starving artists around who don't get the chance to record so easily. I wouldn't write Johnny off yet, but this backwards progression has got to be halted before long, as he must have some talent locked inside his head. Unfortunately, it's hardly to be found on **Public Image**, and although I hate to join the critics' consensus, I feel an inherent duty to pan this one. J.T.

TGRnRS

Sound: C

Performance: B-(spotty)

PI

Sound: D-

Performance: D



The Great Rock 'n' Roll Swindle: Sex Pistols
Virgin VD2510, stereo, two discs, \$12.98

Public Image: Public Image
Virgin V2114, stereo, \$7.98.

If someone wanted to write the greatest horror story of the Seventies, a farewell to the decadent age of rock complete with murder, suicide, sex, and drugs, they'd be hard-pressed to come up with a piece of fiction as sensational as the collective adventures of Johnny Rotten, Malcolm McLaren, Sid Vicious, Steve Jones, Paul Cook, and Glen Matlock collectively known as the Sex Pistols. The film of this rock 'n' roll Frankenstein has yet to be released, but the clips I've seen indicate that the movie "The Great Rock 'n' Roll Swindle" could be the best

rock film since "The Girl Can't Help It." Nevertheless, this human being finds it very difficult to applaud a group responsible for two deaths (Sid Vicious & Nancy Spungen), particularly when there was no actual goal in mind other than chaos. The Sex Pistols don't exactly rate as a *cause celebre*, although if they actually stood for something, one doubts whether they could have accomplished what they did.

Regardless of the historical date, the Sex Pistols had their musical moments, and many of them are chronicled on "The Great Rock 'n' Roll Swindle," which certainly stands as a better value for money than the first Pistols' album. Side one has the gall to feature Johnny Rotten and Co. running through a bunch of other peoples'

Electricando Linda: Linda Leida
TR 134X, stereo, \$7.98.

Singer Linda Leida, a protege of the great bandleader Tito Puente, has the makings of a salsa superstar. She has a dark, husky voice, with a smoldering undercurrent of eroticism. Her phrasing is open and distinctive, and her sense of timing is sure and strong.

Electricando Linda opens with a fast-moving *guaguanco*, *Yo Soy La Rumba*, propelled by a syncopated Andy Gonzalez bass line and a driving Sonny Bravo piano riff. The percussion gets a workout in the mambo section, while Leida's extemporizations in the *montuno* (the climactic section of a *guaguanco*, a combination of horn, coro or vocal chorus, and rhythm riffs over which the singer or an instrumentalist improvise) are brisk and well-formed. But her lusty Latin sensuality is perhaps better suited to boleros like *Deuda De Amor* and *Amar Y Querer*, which allow her to more ardently express her soulful romanticism. The marvelous *Dame Tu Corazon* crosses a bolero-style song with a piquant *montuno*, spotlighting a dramatic trumpet solo over the coro's vocal riff.

Para Mi Gente is in the increasingly fashionable *bom bon* rhythm, a jagged 6/8 which apparently derives from a West African drum pattern (as evidenced by the Afro-flavored percussion on this cut). Leida also does an exciting rendition of Adalberto Santiago's popular *guaguanco*, *A Puerto Rico*, and an irresistible merengue, *Maricusa Esta Hecha*, with hot, bubbling polyrhythms in the percussion.

The horn section (three trumpets, one trombone) is tight, precise, and closely harmonized. Though the jazz elements which help set salsa apart from earlier Caribbean-Latin dance idioms are relatively underplayed here, the music is shot through with unmistakable jazz touches. The horn interlude on *Me Gusta Compartir La Idea* and the trumpet shakes on *Dame Tu Corazon* illustrate how subtly jazz influences are woven in the Latin fabric.

The recording is clean and well-defined with biting brass and colorful percussion. The mix, by Puente and Bernie Fox, pays exceptional attention to small, yet significant details. The brass packs an extra punch thanks to the manner in which they're spread between the left and right channels. The doubling of Bravo's piano riffs by Nelson Gonzalez on tres is emphasized by placing the tres in the middle. Playing time is only 26 minutes. TR's address is 747 10th Ave., New York, NY 10019.

Tom Bingham

Sound: A-

Performance: A

Fine tune your living room.

Drapes
muffle lows.

Rugs
soak up lows.

Wood floors
bounce highs.

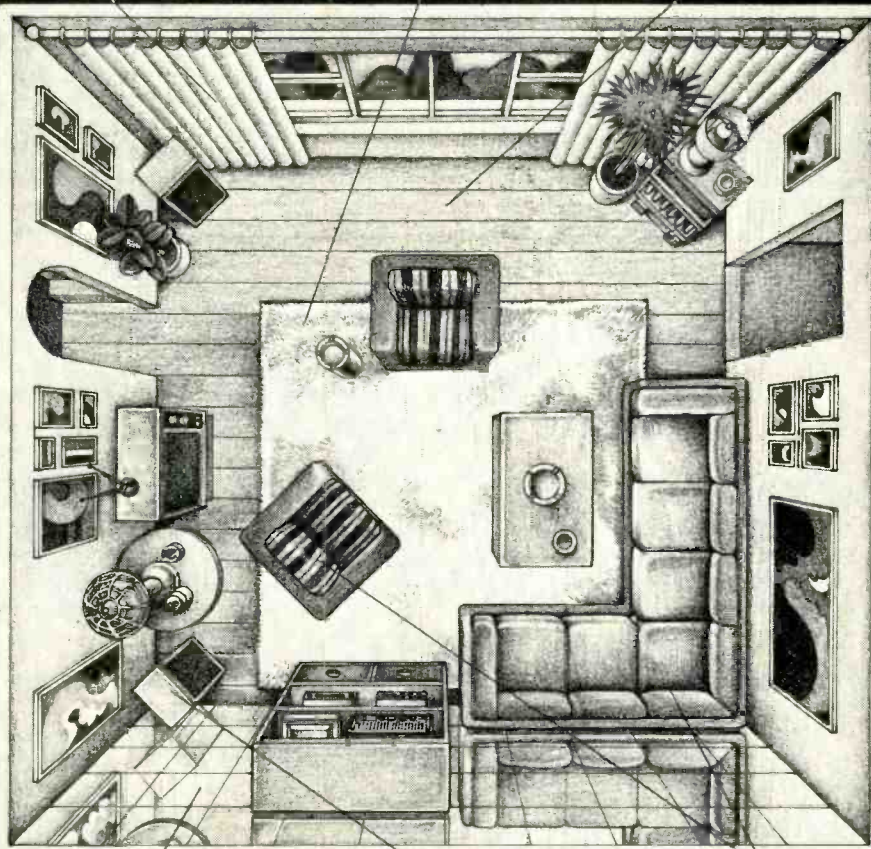

Mirrors
reflect highs.

Poorly placed speakers,
poor sound.

Upholstery
soaks up lows.

Your stereo probably doesn't have the sound you thought you bought. Because you first heard it in a sound room. Unfortunately, most stereos are set up in rooms designed for living. Not listening.

That's why you need a Sound Shaper® One or Two. The frequency equalizers that re-shape music to fit your ears. And your living room.

Sound Shaper One has ten frequency controls, five for each stereo channel. And beautiful styling. But if your system is more sophisticated, you'll want Sound Shaper Two Mk1 with twenty-four frequency controls (twelve for each stereo channel). Plus, internal switching and monitoring. So highlight the vocal. Suppress the bass. Wipe out the flute entirely. And if you want the professional touch, get the new SLM-2 Sound Level Meter. With it, sound levels can be read directly on the Sound Shaper Two, so no longer will you have to run back and forth between the listening area and the equalizer.

Without redesigning your living room, turn it into a listening room.

Sound Shaper® One and Two

ADC PROFESSIONAL PRODUCTS
A Division of BSR Consumer Products Group
Route 3C3, Blauvelt, N.Y. 10913
A BSP COMPANY

Distributed in Canada by BSR (Canada) Ltd., Rexdale, Ont. • Sound Shaper is a registered trademark of Audio Dynamics Corporation.



SME SERIES III

The best pick-up arm in the world

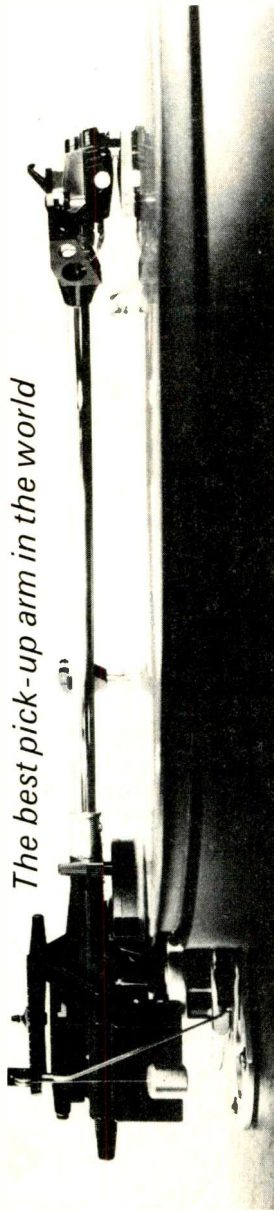
Design Council
Award 1978

Exclusive distributors for the U.S.: Shure Brothers Incorporated, 222 Hartrey Avenue, Evanston, Illinois 60204
and in Canada: A. C. Simmonds and Sons Ltd., 975 Dillingham Road, Pickering, Ontario, L1W 3B2

Informed opinion

Few products in the hi-fidelity world have received such favourable comments from knowledgeable experts as the Series III precision pick-up arm.

They are too numerous to quote here, so we have prepared a special presentation of them which we will gladly send on request. Please indicate whether or not you require details of the arm as well.

Write to Dept 1452

SME Limited · Steyning · Sussex · BN4 3GY · England

Jackson was a feature artist on the label's sampler **No Wave** (A&M SP-4738).

Look Sharp! has a compact rock band feel, basic like Police or Greg Kihn's excellent band or a more electric Dire Straits. His songs are mostly comments on boy/girl situations much like those on Costello's first album **My Aim is True**. Like Costello, Jackson can draw blood. *Sunday Papers*, a dandy white reggae song strong in its way as Costello's *Watching the Detectives*, is terrific. The mileage Joe gets out of the one word "suckers" is more than many guys get out of a whole album side.

Is She Really Going Out With Him? is a throwback to the innocent pop sound of the 60s British invasion. *Baby, Stick Around* has a rhythm sound cribbed right off of those old yellow Sun Records plus a great line in "Somebody's stepping on my plastic sandals." Each side ends with a scorcher, *Throw it Away* and *Got the Time*.

Sound and production are nothing extraordinary. It is muddy, sometimes dense, but exciting. Like Costello's records, sometimes it's hard to get the words, but that makes you listen harder. M.T.

Sound: C+ Performance: B+

Down on the Drag: Joe Ely
MCA 3080, stereo, \$7.98.

Joy Ely comes from the hard rockin' honky-tonk side of country music. His newest is much more of a rocker than last year's excellent, but overlooked **Honky Tonk Masquerade** (MCA 2333).

Side One is the stronger. *Fools Fall in Love* is not the Frankie Lyman oldie, rather it's one of four strong Butch Hancock songs on the album. (Remember that name Butch Hancock. He's a comer.) Incidentally Ely did several Hancock songs last time out, too. *Standin' at the Big Hotel* (another Hancock song) and Ely's own *Crazy Lemon* uphold the promise.

Bob Johnston's production is reminiscent of some of his gutsiest work with Johnny Cash or Dylan, especially **Blonde on Blonde** where Nashville's cream met rock head-on and everyone won.

Possibly irreverent but worth noting, for the more than a two-month period opening 1979, I was telling friends, associates, anyone who asked, that the only '79 releases had really impressed me to the core were Joe Ely's **Down on the Drag** and Elvis Costello's **Armed Forces**. M.T.

Sound: B- Performance: B+

No Wave: Various Artists
A&M SP-4738, stereo, \$7.98.

First off, if you want to be picky, the title is misleading because **No Wave** refers to a school of thought in New York that applies to groups who can't sing or play, and a few of the groups on this anthology can. The Police are quite entertaining on one song (*Roxanne*) but fairly mediocre on their other (*Next to You*). Joe Jackson shows potential but has to outgrow his Elvis Costello infatuation, and U.K. Squeeze could be a good progressive rock band if they stopped trying to be New/No Wave as they don't have what it takes to make it as a low-budget Devo. The Dickies are a second-rate Ramones, Klark Kent is a dull poseur, The Secret are indescribably ignorable, and The Stranglers are an OK keyboard combo but their vocals are obnoxious. However, the album is pressed on blue-tint transparent plastic which means if you can find it for a dollar or less, you're getting your money's worth — strictly an ignorable piece of cult junk. J.T.

Sound: C- Performance: D+

Framed: Dave Lambert
Polydor PD-1-6193, stereo, \$7.98.

Ex-Strawb Dave Lambert's first solo album comes after several years playing in that arty English band, and his album actually sounds more deliciously Strawb-like than the last several Strawbs albums. Indeed, Lambert's voice here sounds more like main Strawb Dave Cousins than Cousins often does. What's more, with the tight band sound that Lambert has gotten, **Framed** sounds tougher and more driving than the Strawbs have lately. His players include the Who's John Entwistle, alternating with The Section's Leland Sklar on bass, and ex-Wings drummer Danny Seiwell, plus Tom Hensley on keyboards and Richard Bennett on guitars.

Lambert's songs are dramatically set pieces. At the start of the album *Take a Little Bit of My Life* drives right into *Framed*, a courtroom saga. *Dorian* seems inspired by Mr. Gray's portrait. Themes of upbeat optimism following personal changes of direction permeate **Framed**, as if Lambert is a revitalized man with new vistas. So *Lucky* and *Welcome to My Dream* are fine examples.

Well recorded, strongly and stylishly played, Dave Lambert's **Framed** is a muscular fresh start. M.T.

Sound: B+ Performance: B

JAZZ & blues



117

An Evening With Herbie Hancock and Chick Corea: Herbie Hancock/Chick Corea

Columbia PC2 35663, two discs, stereo, \$13.98.

An album and tour of acoustic piano duets is one of the last things you would expect from these purveyors of slick commercial funk and fusion. Hancock and Corea have a jazz history as rich as anyone, and both are well schooled in the classical traditions and experimentation of their instrument. For this album, culled from their 1978 tour, they were able to leave the funk at home. They also leave behind that penchant for cheap virtuosity that so frequently pervades their music, particularly Corea's.

On *An Evening With . . .*, Corea and Hancock concentrate on developing empathetic improvisations that exhibit restraint and thought. Rather than clutter up a lot of air with four-handed pianistics, they supply each other with space in which each can create complementary patterns of crystalline sound. Or one might lay back and simply provide a few reference points for the other's solo.

The album spans their musical backgrounds. It opens with a tribute to a common teacher, Miles Davis, *Someday My Prince Will Come*, a Miles classic. Their playing is sentimental without being schlocky. *Button Up*, in spite of its funky title, borders on modern classicism. Sharp, angular lines set off delicate explorations of sustained notes and chords. At one point they telegraph to each other by muting the strings with their hands and playing the keyboard. The third side is composed of a Hancock solo of meditative beauty. The album concludes with a back-to-back reading of the Hancock standard, *Maiden Voyage* and Corea's *La Fiesta*. The *Voyage* is pleasant but not as convincing as previous performances. *La Fiesta* is the most histrionic piece in the album. With all its flash, it wears thin very quickly.

Hancock and Corea are kindred spirits whose careers have run parallel for many years, so it's not surprising that they would be such sympathetic performers. *An Evening With . . .* is in marked contrast to that other duet of piano giants, Cecil Taylor and Mary Lou Williams . . . wherein the artists

had diametrically opposed philosophies of music and it showed in their concert. The only time Hancock and Corea fall down is when they try to create tension by trading exchanges. This results in the most trite and clichéd aspects of the performance.

An Evening With . . . is well recorded with the pianos having a rich and deep resonance throughout the dynamic spectrum. Yet, through careful miking and mixing, the two keyboards never run into each other and are cleanly split into the left and right channels. Though they use Sony's PCM digital mastering equipment, they did not avoid a degree of surface noise. The pressings, though clean by normal standards, could have been cleaner still and are especially noisy on the Hancock solo where most of the music is coming from one side.

There's nothing new or brilliant on this record. No one says anything that they haven't said before. But it's nice to know that even if you can't go home again, you can at least pay a visit.

John Diliberto

Sound: B+

Performance: B+

Scotch® Recording Tape... it sounds like money well spent.



Scotch® Recording Tape. The truth comes out.

Enter No. 34 on Reader Service Card

If you can find a receiver that does more.

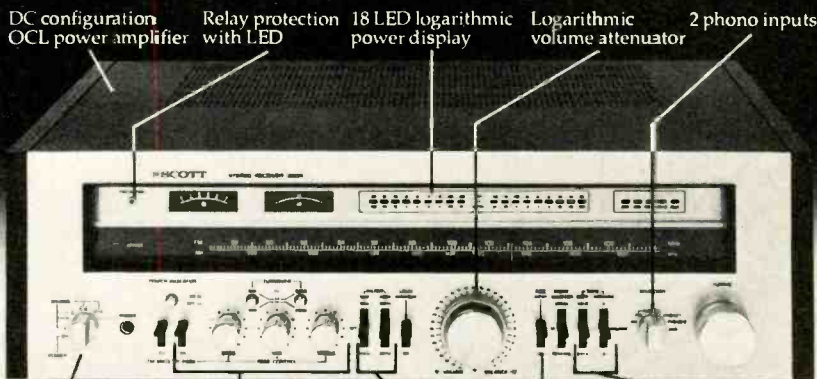

DC configuration OCL power amplifier Relay protection with LED 18 LED logarithmic power display Logarithmic volume attenuator 2 phono inputs

Connections for 3 pair of speakers Bass/midrange/treble tone controls with variable turn-over frequencies and by-pass Twin position active subsonic and high filters Front panel accessory switch 2 tape monitors with full tape copy capability

Scott's new 390R is perhaps the most complete receiver ever made.

A professional control center for your entire sound system, the 390R delivers a full 120 watts per channel min. RMS, at 8 ohms from 20-20,000 Hz with no more than 0.03% THD. And it offers more options, features and flexibility than you'll find on most separates.

Compare the Scott 390R with any other receiver on the market today. If you can find one that does more... buy it.

Buy it.

For specifications on our complete line of audio components, contact your nearest Scott dealer, or write H.H. Scott, Inc., 20 Commerce Way, Dept. JR, Wobum, MA 01801.

 **SCOTT**
The Name to listen to.
Makers of high quality high fidelity equipment since 1947.

Enter No. 55 on Reader Service Card

Hannibal In Antibes: Marvin "Hannibal" Peterson

Inner City IC 3020, stereo, \$7.98.

Hannibal is the trumpeter to watch. Though he's only put out four albums in as many years, plus work with Gil Evans among others, his improvisational abilities are self-evident. His solo's are impassioned declarations of pyrotechnical dexterity and searing emotion. The presence of Hannibal on a session immediately indicates a hot level of intensity.

For this July, 1977, date recorded in Antibes, he has gathered together musicians who can not only withstand the force of his assault, but add to its power. Both bassist Steve Neil and drummer Makaya Ntshoko play in a rough muscular style that gives Hannibal's rhythms a throbbing ebb and flow effect. On top of this, Diedre Murray serves the dual purpose of a third soloist and a dark texturalist. Her arco cello is an electric undercurrent throughout the music until she steps out for solos of twin convoluted lines. Sharing the front line with her and Hannibal is powerhouse George Adams on tenor and flute. His tenor is a turbulent stream of ideas, while his flute has no trouble cutting through with a swath of clarity.

Hannibal In Antibes is made of two tunes that sound like they were edited out from a longer set. The first side is a Hannibal piece called *Ro*. It features a loping rhythm played against a series of solos that gather in ferocity as each musician is fueled from the ideas of the previous solo. The second side is a stormy rave-up on *Swing Low Sweet Chariot*.

The album is hindered, however, in every phase of the recording process. The mikes are poorly placed so that soloists often sound like they're playing from the back of the stage. Poor editing begins both pieces in the middle of solos. The transfer from tape to disc is sloppily executed with a discernible wow going into the opening cymbal flurry of *Ro*. The bottom is murky, and the high end lacks the brilliance needed to highlight Hannibal's trumpet. But the performance is an emotionally exhilarating monster.

John Diliberto

Sound: C-

Performance: A

Second Nature—The Savoy Sessions: Milt Jackson

Savoy SJL 2204, mono, \$6.98.

Vibist Milt Jackson, currently enjoying a renaissance within the jazz revival, is playing today at the top of his form. This double-set reissue of some

of his classic mid-50s Savoy sessions is most welcome. The music is vibrant and stimulating, and the 23 years that have elapsed (the original recordings were made in 1956) have not diminished their appeal. Saxophonist Lucky Thompson, one of the most talented of the modern tenormen who segued from Swing to Bop, was at the height of his powers when he joined Bags for these sessions. Thompson's playing is so strong here, it almost overshadows Jackson's efforts; his impassioned improvisations on *The Lady is a Tramp* and *Lover* are two highlights of this collection. Thompson's very personal sound — a blend of Coleman Hawkins' rich, intense attack, Lester Young's lyricism, and Stan Getz's light, floating style — should have brought him the kind of attention accorded Getz, but his antagonism to the seamer aspects of the jazz nightclub business and his years of expatriate living in Paris and Copenhagen have kept him out of the limelight.

The rhythm section behind Thompson and Jackson is tastefully supportive; pianist Hank Jones comps impeccably, Wendall Marshall is firm and solid on bass, and Kenny Clarke combines delicate brushwork with a rock-steady beat that is never obtrusive, yet constantly stimulates and pushes the soloists. Jackson's solos demonstrate his mastery of seamless, inventive bluesy improvisation. The vividly recorded 1956 mono sound survives intact on the remastering. Milt Jackson's *Second Nature* is solid, high caliber modern jazz; basic jazz repertoire stuff.

John Lissner

Sound: B Performance: A-

Kings of Mali: Chico Freeman
India Navigation IN 1035, stereo, \$7.98.

New York's normally active *avant-garde* scene has certainly not been hurt by the recent influx of musicians from the Association for the Advancement of Creative Musicians of Chicago or the Black Artists Group of St. Louis. The communion of all these musicians with New York's eclecticism has resulted in a new focus. Chico Freeman's *Kings of Mali* is a product of this focus. Along with Freeman is fellow AACM member Famoudou Don Moye of the Art Ensemble of Chicago. They are combined with a formidable New York assemblage including veterans Cecil McBee on bass, Anthony Davis on piano, and Jay Hoggard, a vibraphonist whom I've never heard before, but who sounds like he's been playing for years.

Freeman has crafted an album of vi-

AUDIO • June 1979

Quality. Uncompromised.

ROTEL

from the 2000 Series:
The Basic Threesome—for very high standard music control center

THE HEART AND SOUL OF SOUND

RT-2100 FM Stereo Tuner
with Quartz PLL tuning and
built-in Dolby FM.

RC-2000
FM Stereo DC Control
Amplifier with built-in
MC headamp.

RB-2000
Stereo Class AB/DC
Power Amplifier.
120 watts per
channel at 8Ω,
20 to 20,000
Hz with
< 0.01%
THD.

Dolby is a trade
mark of Dolby
Laboratories, Inc.

ROTEL OF AMERICA, INC.
1055 SAW MILL RIVER ROAD,
ARDSLEY, NEW YORK 10502
(in Canada—WHITE ELECTRONICS, Malton, Ontario)

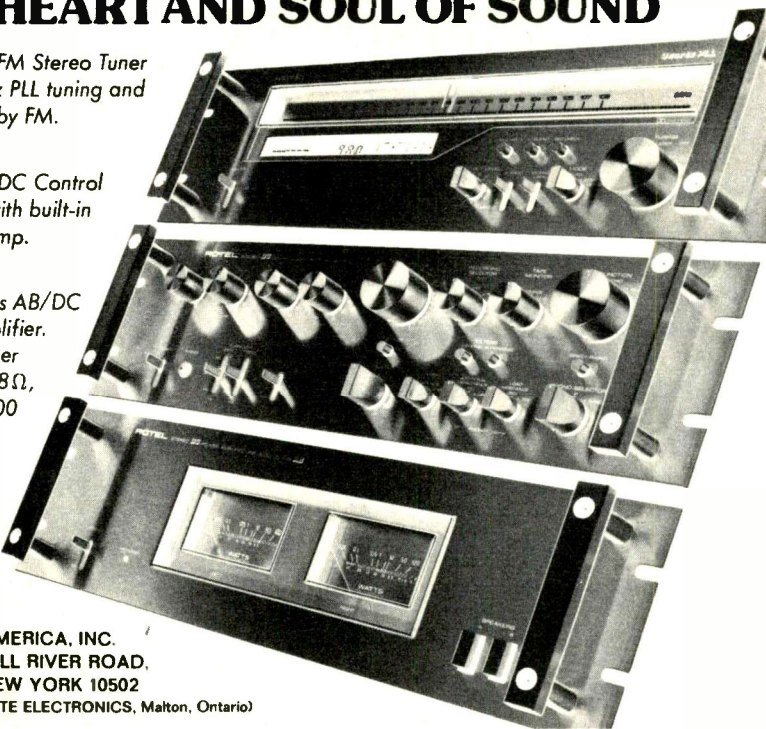

Enter No. 52 on Reader Service Card

119

THE ONE-STOP MUSIC SHOP AT WHOLESALE PRICES

J&R

BLANK TAPES	REEL-TO-REEL
CASSETTE TAPES	Maxell UD 35-90 1800 ft. \$5.49
Amplex Grand Master I C-90 \$2.14	Maxell UDXL 35-900 1800 ft \$6.75
Amplex Grand Master I C-90 \$2.79	Maxell UD 35-180 3600 ft. \$4.95
BASF Studio C-90 \$1.99	Scotch 212 1800 ft. \$15.30
BASF Professional II or III C-90 \$2.99	Scotch 207 1800 ft. \$5.19
Maxell UD C-90 \$1.92	TDK L-1800 1800 ft. \$5.22
Maxell UD C-90 \$2.85	
Maxell UDXL I or II C-90 \$2.50	VIDEO TAPES
Maxell UDXL I or II C-90 \$3.47	BETA FORMAT
Scotch, low noise/Dynaflex C-90 / 3 pk. \$4.99 for 3	Sony L-750 (2 Hour) \$18.95
Scotch Master I C-90 \$2.84	Sony L-800 (2 Hour) \$13.95
Scotch Master II or III C-90 \$3.29	Scotch L-500 (2 Hour) \$13.50
Sony Ferrichrome C-90 \$3.58	Zanrite L-500 (2 Hour) \$13.95
TDK D C-60 \$1.20	Amplex L-500 (2 Hour) \$12.95
TDK D C-90 \$1.88	
TDK D C-120 \$2.10	VHS FORMAT
TDK D C-180 \$2.99	JVC T-120 (4 Hour) \$18.75
TDK AD C-90 \$1.79	TDK T-120 (4 Hour) \$18.50
TDK AD C-90 \$2.62	Fuji T-120 (4 Hour) \$17.95
TDK SA C-60 \$2.22	RCA VK-230 (4 Hour) \$18.95
TDK SA C-90 \$3.18	RCA VK-125 (2 Hour) \$14.95
	Panasonic NVT-120 (4 Hour) \$18.95
	Panasonic NVT-80 (2 Hour) \$14.95

Minimum Order 12 Tapes — 100% Guaranteed.

CARTRIDGES
audio-technica

AT-20 SLA \$118.00	SHURE
AT-15 SA \$85.90	V15 TYPE IV \$89.90
AT-14 SA \$48.95	V15 TYPE III \$64.95
AT-12 SA \$42.90	M5ED \$29.75
AT-10 \$12.00	M44E \$13.80
STANTON	M70E \$9.90
881S \$72.50	PICKERING
681EE S \$55.00	XSV/3000 \$49.95
681EE \$42.50	XV15/200E \$39.95
680EE \$24.90	XV15/150E \$32.50
50E \$12.60	XV15/825E \$25.77
	XV15/400E \$22.45

HEADPHONES

HEINHEIMER	KOSS
HD-44 \$23.88	PRO 4AA \$39.90
HD-400 \$28.28	XV15/50E \$48.00
HD-414 \$44.88	HV/1 \$29.97
HD-424 \$65.29	HV/LC \$35.97
	K16A \$18.97

HOW TO ORDER: For shipment within 48 hours, send money order or certified check. Two weeks delay on personal checks. Please add \$3.50 per order for shipping & handling. (\$6.50 for orders outside U.S.). N.Y.S. residents add tax. No C.O.D.'s. All merchandise 100% guaranteed, brand new & factory fresh.

J&R MUSIC WORLD

Dept. A, 33 Park Row, N.Y.C., 10038 (212) 732-8600
ORDER TOLL FREE (800) 221-8180
CALL OR WRITE FOR FREE 96 PAGE CATALOG

Enter No. 30 on Reader Service Card

8-AD

name _____

address _____

city _____ state _____

zip _____

MAIL THIS COUPON AND WE'LL SEND YOU THE BEST SPEAKER CATALOG YOU EVER READ!

No kidding. Speakerlab's catalog took longer to write than some of our competitors have been in business. In fact, we created an industry by "building great kits so you can afford great speakers." Our catalog is an invaluable manual of speaker function and design. And, it will introduce you to the finest speaker kits made anywhere...with the strongest money-back guarantee. Find out for yourself...FREE. FREE, that is. Mail the coupon now.



Speakerlab

Dept. 6-AD, 735 N. Northlake Way
Seattle, WA 98103

brant immediacy and turbulent depths. Its immediacy is derived from Moye, whose kaleidoscopic drums and "sun percussion" color the insistent rhythms with shifting accents and dynamo energy. Freeman also has a penchant for infectious melodies which carry you through the wildest forays and linger long after the song is finished. But **Mali's** power comes from an intense level of individual and collective improvisation between the musicians. Anchored by Moye and McBee, Hoggard and Davis extrapolate the melodies into a fluctuating textural sheet around which they build solos. Davis plays a lyrically percussive piano that can counterpoint both Hoggard's vibes and Moye's drums. Hoggard himself follows the tradition of vibist Walt Dickerson and plays with a force that belies the delicacy of his axe. Freeman feeds off all these energies for his own solos for winding soprano runs on *Look Up* and a furious tenor on *Minstrels Sun Dance*.

Kings of Mali is Chico Freeman's most cohesive effort to date. It moves naturally through dreamy landscapes, as at the end of the title tune, and precision ensemble runs, as on *Sun Dance* with its marching intro that drummers have been jamming on since Baby Dodds hit the skins. India Navigation has made an uncharacteristic move into the studios for this one with a subsequent improvement in sound. But they still manage to maintain a live ambience that obscures some of the finer points. Available from India Navigation Company, P. O. Box 559, Nyack, N.Y. 10960. *John Diliberto*

Sound: B Performance: A-

Descent Into The Maelstrom: Lennie Tristano

Inner City IC 6002, Mono, \$7.98.

More than any musician from his era, Lennie Tristano epitomized the "cool" school of jazz. Tristano himself had a

legendary conceptualization of "cool" which found followers in people like Lee Konitz, Warne Marsh, and Peter Ind. Long after Tristano dropped out of the performing scene, his influence was still felt by people such as Anthony Braxton. But as cool as he was, Tristano played with a burning cerebral passion in a format that allowed him totally free expression.

Maelstrom presents rare Tristano recordings culled from self-recorded dates and studio performances spanning from 1952 to 1966. Side one is all solo piano and opens with *Descent Into The Maelstrom*, an accurate title for a piece that moves in a psychotic swirl of twisting piano lines and rumbling overtones. Though it's hard to discern through the quality of the recording, it seems that Tristano might have been over-dubbing onto his own tracks as early as 1953. *Dream: Paris 1965* and *Image: Paris 1965* are variations on familiar themes which find Tristano in a slightly romantic and wistful mood. The side closes with three recording date rehearsals from '61. Here Tristano employs a free walking-bass line, while he rifles off fast and cool melodic improvisations on the right hand.

Side two places Tristano in different trio settings. There are two cuts with Peter Ind and Roy Haynes and two with Sonny Dallas and Nick Stabulas playing bass and drums, respectively. The Ind/Haynes pieces are much more typical of the Tristano style, as the rhythm section is muted with the drummer using brushes for a soft background pulse, while the bass does a slow supple walk. This made Tristano the focus and allowed him roam at will. The Dallas/Stabulas sets are much hotter as the rhythm section moves to the fore with a more gusty sound. Tristano plays a heavier and denser style here than he's usually noted for.

The passing of Lennie Tristano last

year left us with very few recordings of his legacy. **Descent Into The Maelstrom**, originally available only as a high-priced import on Japan's East Wind label, is an excellent document of Tristano, no matter how poorly recorded. Tristano did the engineering on all but three tunes and it shows. There's a minimal dynamic range for a music that required the subtleties of dynamics. Tape hiss and other recording annoyances abound. But in this case, you take what you can get.

John Diliberto

Sound: D+ Performance: A-

Orchestra, Duo, Septet: Hamiet Bluiett **Chiaroscuro CR 182, stereo, \$7.98.**

Hamiet Bluiett is the newest voice of the baritone saxophone. He has already asserted his virtuosity on the big horn and his mastery of its history on his excellent solo sax recording **Birthright**. For this new album he seeks to stretch the boundaries of his music by incorporating several Middle Eastern instruments. He doesn't entirely succeed. *Glory (Symphony For World Peace)*, the only cut to use the full 11-piece orchestra, is a gospel-flavored tune with insistent high-hat rhythms from Michael Carvin and a exotic percussive flavor from the use of a bata, balafo, diembe, and kora. But the piece tends to meander with soloists rarely stepping to the front to give any direction.

The side-long *Oasis — The Well* works much better with a septet ensemble. After a few clarion-call honks from Bluiett, the piece moves into a rollicking, spirited groove over a steady pulse from the percussionists, Chief Bey and Ladji Camara. Bluiett moves in and out of the piece with scrawling roars, while Don Pullen leaves shattered and skewed runs across his piano. Unfortunately the mix does not take into account the delicacy of Ahmend Abdul-Malik's

DYNAMITE

DIMENSION

LAB SERIES
MINI SPEAKERS

MKII

With the amazing success of the MKIA, Dimensions has just introduced their new MKII incorporating a dome tweeter to further enhance the high frequencies. Their solid walnut construction and totally advanced speaker suspension employs heavy-duty voice coils and a bass boost cross-over network. Its attractive styling blends beautifully with any decor for home, boat, R.V., plane or auto use.



Custom Craft

819 S. Kraemer Blvd. / Placentia, CA 92670 / (714) 630-5440
DEALER INQUIRIES WELCOME

oud. You can hear him buzzing around but he is never focussed on. The album's rounded out by a tender duet between Pullen and Bluiett.

John Diliberto

Sound: C+

Performance: B-

Musique Mechanique: The Carla Bley Band

Watt 9, stereo, \$7.98.

Carla Bley is an enigmatic composer and performer. While enjoying a strong reputation in the jazz world, she somehow manages to exist apart from it. She writes tunes which are by turns subtle, dark, quirky, or simply goofy, but ones that are like nothing else being written in jazz. They are recorded by musicians as diverse as Art Farmer, Gary Burton, and George Russell because they are such fertile vehicles for improvisation. Unlike many artists who are criticized when they move outside of their acknowledged musical territory, Carla Bley has jumped from rock, jazz, funk, and classical, creating synthesis, collages, juxtapositions, and fusions of one form to another. Each move has been applauded more than the last because Carla Bley has a musical identity that doesn't transcend categories, but exists outside them.

Like her last few outings, **Musique Mechanique** takes a few listenings to grow on you. A cursory listening reveals debauched marches, drunken waltzes, and Spanish fanfares. Within these slightly twisted forms Bley builds her structures of off-center rhythms and odd horn voicings.

The album opens with an unobtrusive dance track that could be the opening for a TV adventure series. Though it's the least interesting tune, it features the most solos. Bley takes an interesting Ramsey Lewis-style run from the early 60s, backed by a solo from Gary Windo, who plays an energized variation on the theme, followed by a more sustained rendition from altoist Alan Braufman. After a brief interjection from Bley, trombonist Roswell Rudd and French horn player John Clark take solos following the same pattern.

Do you remember Herb Alpert and the Tijuana Brass? *Jesus Maria and Other Spanish Strains* features Carla Bley and her Hot Enchiladas. *Jesus Maria* is based around a languid dirge with different Spanish motifs separating the solo settings. Charlie Haden plays a moody bass solo over Eugene Chadbourne's walkie-talkies. Chadbourne's scratching electric guitar also provides a basis for Mike Mantler's

lonely trumpet cry. This gives way to an ominous marching rhythm with Roswell Rudd growling out his trombone like a killer desperado only to be broken up by a toreador fanfare.

The centerpiece of the album is the three-part *Musique Mechanique* which stutters open and repeats to its conclusion like a scratched record. In between, Bley takes an antique dance out of "The Godfather" wedding scene and with some quirky changes builds it to a drunken frenzy until advanced inebriation slowly eliminates the participants.

Part two is one of the most bizarre pieces she's done since *Escalator Over The Hill*. Subtitled *At Midnight*, Bley fabricates an aural Max Escher drawing with a lyric auditory illusion that keeps turning back on itself as the music rises behind it with insistent rhythms, sustained organ drones, and nightmare dissonances.

The final section centers around a call and response pattern between Windo and the rest of the horns over a menacingly stalking rhythm. Solos by Windo and Braufman evolve into ensemble passages where Bley scores a

Choose your car stereo as carefully as you choose your home system.



If you have a quality stereo component system in your home, you shouldn't settle for anything less in your car.

The Compo car stereo from Fujitsu Ten is a true separates system, not just a booster. Choose between two different power amplifiers for 40 or 80 RMS watts of power. The auto-reverse cassette deck with Dolby* has a special playback head for great frequency response. The AM/FM/MPX tuner features motor-driven automatic search, along with FET front end and PLL/IC for stable reception. Even a six-function remote control amplifier.



And our 2-way hermetically-sealed speaker system is designed to accurately reproduce every note under difficult acoustic conditions.

We suggest you compare Compo spec for spec against the competition the same way you'd compare an amplifier or tuner for your home system. You'll discover how 25 years of making car stereos leads to making the best.

Write for additional information on Compo and our complete car stereo and speaker line, plus the dealer nearest you.

Compo™: The best separates on wheels.

*Dolby is the trademark of Dolby Laboratories, Inc.



FUJITSU TEN CORP. OF AMERICA
1135 East Janis Street, Carson, CA 90746.

Enter No. 22 on Reader Service Card

SURPLUS IS YOUR BEST BUY
BIG NAME 4-WAY SPEAKER SYSTEM \$99.88/Pr.



Super Cabinet, 8" woofer/mid-range, passive radiator, 2 1/2" super horn, Piezo Tweeter, terminal grill cloth, wires, acoustic dampening material, hardware, & instructions etc. Freq. resp. is 30 Hz TO 25,000 Hz., 60 watts max. power. Sh. Wt. 98 Lbs. (3 pks.)

Use this great speaker system for big band speakers, monitor speakers, all ground music speakers or with "DISCO" systems. Don't delay. These will go fast! Seconds, Nicks, Chips, Cab. Structurally sound - you finish & save!
 9110123 \$99.88/pr. \$1,698.88/20 pr.

\$298.88 pair
PRES-4 STUDIO SYSTEM KIT



Freq. Resp. 28 HZ TO 25 KHZ, power min) (10/100) x-over freq. (1000 HZ), woofer (10" dia., 2" voice coil, mag. Wt. 40 oz., foam edge), F.S., 25 HZ, Passive radiator (12" foam edge), Mid-range (5" dia., 1" voice coil, mag. wt. 9 oz., Ferro Fluid Damped, F.S. 550 HZ), tweeter, 3" Super Horn Piezo 3 KHZ TO 25 HZ, grill, (foam) dimensions: 42" hg. X 15" X 15 1/2" Dp. Sh. Wt. 75 Lbs each.
 9310105 \$298.88/pr. \$1,588.88/doz.

NO NAME SPEAKERS
 SAVE 50% off LIST THEN BUY
SECOND SPEAKER FOR \$1



Handles most amplifiers. "Presence control" fine tunes each system to its environ. 50W RMS power capacity. 10" woofer, 5" midrange, 4" fluid damped tweeter, ducted port. Freq. resp. 30-22,000 Hz. 12 1/2" deep x 10 1/2" high.
 8Y0478 \$149/each \$150/pair

SPECTRUM Q SPEAKERS

ORD. NO.	F.A.R.F.R.	MAG.	PoW	Dia.	V.C.	COST	/Pair
Y0541	1.3K	22K	9	50	4	3/4	6.88 11.88
70203	2K	22K	9	100	4	1	11.88 21.88
*30248		40K				3/2	7.88 14.88
30331		40K				2X6	14.88 27.88
70449	3K	15K	4	5	1 5/8	9/16"	3.00 5.00
**B0111W	5K	11K	9	70	5	1"	10.38 18.88
**0540	5K	12K	9	70	5	1"	10.38 18.88
5MRS	8K	12K	3	35	5	9/16"	8.88 15.88
B0110W	26	31	10	75	8	1 1/2"	22.88 33.88
Y0006	35	7K	12	60	8	1 1/2"	16.88 29.88
B0114	27	2K	40	100	10	2"	32.88 59.88
B0115	24	2K	20	75	10	1 1/2"	17.88 33.88
B0116	20	2K	40	100	12	2"	34.88 67.88
B0124	21	2K	26	90	12	2"	29.88 56.88
B0117	34	2K	12	60	12	1 1/2"	17.88 33.88
B0118		Passive Radiator					12.88 23.88
B0119							8.88 15.88
B0120							6.88 11.88

*Piezo Tweeters **Ferro Fluid Damped

B&F ENTERPRISES DEPT. 10% A-6
 119 Foster Street Peabody, Mass. 01960
 Phone Orders. Charge!!! (617) 531-774 MC, Visa

TERMS: Add Postage. VISIT OUR NEW STORE!
 NO C.O.D.'s please. So. Willow St. (near Woolco) the "TOWNE DUMPE"
 Manchester, N.H.

SEND FOR OUR FREE CATALOG
 Say "Audio" & Get 10% Off These Items.

Enter No. 9 on Reader Service Card

8 IMPORTANT REASONS WHY MORE PEOPLE BUY TOP QUALITY EQUIPMENT FROM INTERNATIONAL HI-FI THAN ANY OTHER MAIL ORDER COMPANY

MORE THAN 80,000 CUSTOMERS NATIONWIDE

1. Guaranteed lowest price... you pay same price many dealers pay.
2. No-risk, no-deposit... phone orders shipped C.O.D. or Credit Card.
3. Same day shipping when ordered by 1 p.m.
4. Seven audio advisors provide professional help for the inexperienced buyer.
5. Fully insured shipments plus full manufacturers' warranty.
6. Exclusive "no lemon" guarantee.
7. Fully staffed customer service department.
8. Over 70 top name brands... equipment most mail order and discount dealers can't supply.



CALL NOW
(301) 488-9600
 Mon.-Fri. 9-9, Sat. 9-4

Write for: • Brochure with prices and lines
 • Tips on buying by mail

International Hi-Fi Distributors
 Moravia Center
 Industrial Park, Dept. A6
 Baltimore, Maryland 21206

Enter No. 29 on Reader Service Card

record skip effect. Just as you move to lift the tonearm, Windo and Braufman break out, in turn, with frenzied solos.

Musique Mechanique is an interesting compositional exercise for Bley, but it seems to lack the force of her earlier works. Most of the soloists in her new band give perfunctory readings at best. The light-hearted air which she imparts to her music lately on both record and in live performance tends to lessen their importance in the minds of both performers and listeners.

Bley's production has improved with each self-produced record she's made. **Musique Mechanique** features sharp definition on the horns and percussion with a dynamic balance between the loud ensemble passages and the delicate effects occasionally interspersed between them. Steve Swallow's amazing bass guitar technique is lost in the bottom mix and the noise of the pressing, however. The final enigma of Carla Bley is that she genuinely doesn't care what any of us think.

Watt records are available through JCOA/New Music Distribution Service, 6 West 95th St., New York, NY 10025.
 John Diliberto

Sound: C Performance: B-

So Many Roads: Otis Rush
Delmark DS-643, stereo, \$7.98.

Otis Rush hasn't profited much from his near legendary status as a bluesman. Despite a rare unanimity among Chicago's blues guitarists that he's one of the best in their ranks, until recently Rush has been a virtual exile from the recording studio. Of necessity, his considerable reputation rests on his considerate performances, which have long been inconsistent.

So Many Roads, recorded live at a stop along Rush's recent Japanese tour, captures him on two good nights, which is to say that blues fans will find much of the album stunning. **So Many Roads** is the Chicago blues as they're meant to be played by one of its giants. Mr. Rush is not a flashy guitarist nor much of a showman. He is, however, a superbly eloquent musician who structures soaring, inventive solos of awesome power. The album is not for casual listening; Rush's guitar work is laced with a commanding, agonizing tension, and at its best moments provides a catharsis for both Rush and listener alike. His vocals, if relatively unpolished, convey deeply felt emotions, rendering greater technique superfluous.

The album's tracks are all staples of the bluesman's sets, but compare favorably with earlier versions of the

songs. Rush delivers his oldest material with a vigor that belies the numbing overfamiliarity that almost inevitably sets in after 20-odd years of club performances. The oft-copied guitar licks of his *All Your Love I Miss Loving* still move a listener as effectively as they did back in 1958 when the tune was first released. Further, Rush is able to breathe not merely life, but fire, into an overworked warhorse such as *Every Day I Have The Blues* with hard-edged guitar lines and an explosive opening break.

So Many Roads is the definitive Otis Rush album. It would seem that this blues master's best years are in front of him.
 Roy Greenberg

Sound: B- Performance: A

Another Time/Another Place: Barry Altschul

Muse MR 51 6, stereo, \$7.98.
 To call Barry Altschul a drummer or percussionist is to miss the whole point of his concept. Altschul's deft, melodic percussion has been subtle enough for pianist Paul Bley's cerebral explorations and fiery and responsive enough for Sam Rivers' spontaneous compositions. When he's seated within his percussion module of traps, bells, chimes, and devices both ancient and homemade, his movements are those of an ecstatic dervish. Altschul is a melodic improviser who never has to take a back seat to traditional front-line soloists.

For his second solo outing Altschul has decided to show us just how vast his conception can be. All the tunes have different and sometimes unique settings which span several facets of contemporary jazz. The first tune fits into the recently coined category of "avant-bop." Arranged by the pianist of the date, Anthony Davis, *Crepes-cule: Suite for Monk* takes three Thelonius Monk tunes and uses them as launching pads for some fierce improvisations both in and out of time. As they did in their straight Bop context, Monk's tunes prove to be fertile vehicles for soloists. Everyone seems to smoke here, beginning with Ray Anderson's funnel of energy on trombone. Davis and alto-saxophonist Arthur Blythe also take off in tightly controlled, but wide-ranging solos. But throughout all the changes Altschul maintains a rein on the pulse with colorful shadings and drive.

Chael doesn't fare as well, as the influence of Altschul's tenure with Anthony Braxton surfaces. Using just a trio of Davis and Abdul Wadud on cello, Altschul emulates Braxton's Euro-

pean *avant-garde* leanings with clusters of sound, stop/start patterns, and general dislocation. While technically precise, it contains none of the cerebral emotion and humor that allows Braxton to pull off such pieces. Altschul again goes to European traditions for *Pentacle*, using various combinations of two basses, Dave Holland and Brian Smith, and two cellos, Abdul Wadud and Peter Warren, plus himself on percussion. *Pentacle* moves in dark droning colors and intertwining lines suspended around Altschul's liquid percussives.

The title cut closes out the album with rhythms that sound like out-of-sync marches and solos that stretch from Anderson's New Orleans plunger to Davis' skewed piano. Rounding out the album is *Traps*, a piece that I hesitate to call a drum solo because it's so musical.

Another Time/Another Place is an ambitious project that tries to establish Altschul as a composer as well as a musician. His only failing is that he hasn't distilled all of his composing influences into a personal and coherent style as he has with his drumming.

The album is cleanly though not brilliantly recorded. He's paid special attention to sound placement of instruments in the mix. But he has also elevated his own percussion and allowed the horns to lose some of their punch.

John Diliberto

Sound: B

Performance: B+

Terje Rypdal/Miroslav Vitous/Jack DeJohnette

ECM-1-1125, stereo, \$7.98.

This new trio grouping on ECM has made some stately and spacy music, fascinating stuff. In addition, the sound is a treat, even for ECM's high standards.

Each musician has contributed material. Guitarist Terje Rypdal wrote *Sunrise* and the contemplative *Den Forste Sne*, while Vitous supplied the strong *Will* and the more introspective *Believer*. The remaining two, the spacy *Flight* and the finale *Seasons* are group compositions and largely improvised. The album breaks down naturally into a melodic and stately Side One and a more "out there" Side Two.

Stimulating, relaxing, soaring, strange. And other things, too. This is a superb example of the music that the ECM label stands for. *Michael Tearson*

Sound: A

Performance: A-

AUDIO • June 1979

The Final Formula: R + D = R + D

Research and development equals realism and detail... that's what ultimate performance from a moving-coil cartridge is all about. Marcof has applied years of research to developing a step-up device capable of extracting unequalled realism and detail... and that's what music is all about! Hear your moving-coil cartridge. Audition the Marcof PPA-1 Pre-preamplifier at fine audio dealers everywhere.



Enter No. 36 on Reader Service Card

See What You've Been Missing... Read Audio's Classified

123

ROTEL OF AMERICA, INC.
1055 SAW MILL RIVER ROAD,
ARDSLEY, NEW YORK 10502
(in Canada—WHITE
ELECTRONICS, Malton,
Ontario)

Dolby is a trade mark of Dolby Laboratories, Inc.

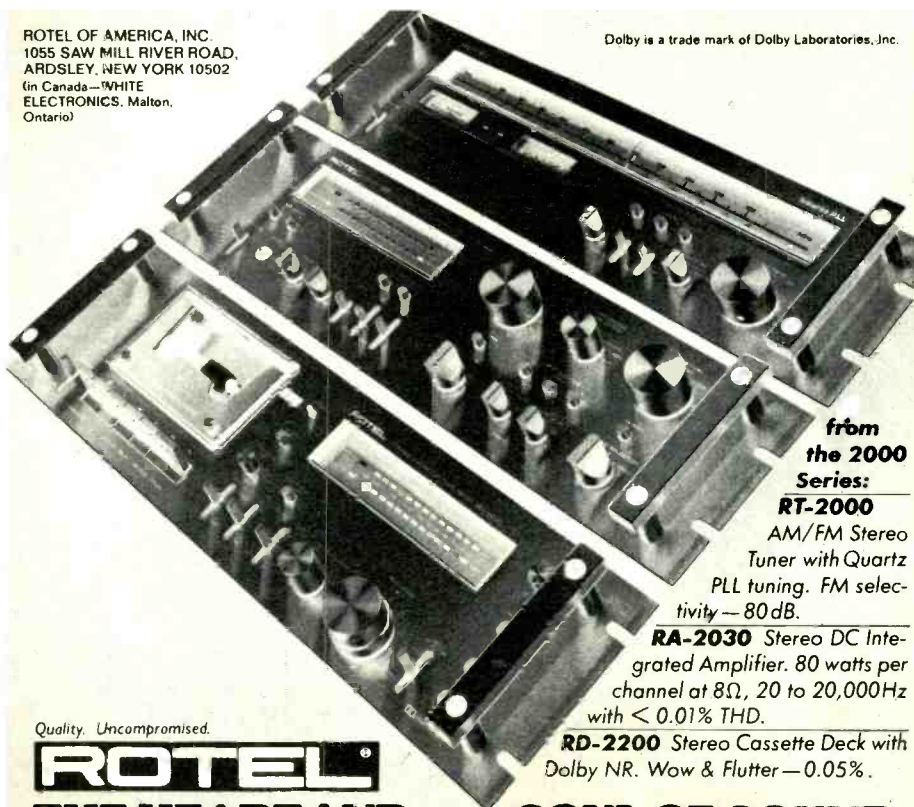

from
the 2000
Series:

RT-2000
AM/FM Stereo
Tuner with Quartz
PLL tuning. FM selectivity—80 dB.

RA-2030 Stereo DC Integrated Amplifier. 80 watts per channel at 8Ω, 20 to 20,000Hz with < 0.01% THD.

RD-2200 Stereo Cassette Deck with Dolby NR. Wow & Flutter—0.05%.

Quality. Uncompromised.

ROTEL

THE HEART AND

SOUL OF SOUND

Enter No. 53 on Reader Service Card

Classical reviews

Edward Tatnall Canby



124

Note — Disc Surface Ratings

After considerable experiment, I have worked out a useful guide for assigning letter grades to the surfaces of the current discs reviewed. Review copies of records tend to be better than the average store-bought copy — hence a good many B ratings and higher (this is because they are from the early part of the pressing cycle).

A disc that a) has a few, very few ticks or pops, widely spaced, and b) only a faint rhythmic rustle or rumble, barely noticeable in unmodulated grooves, rates B. If there is some slight rustle or rumble, but NO ticks or pops, the grade is B+.

Those few superb records which have no ticks or pops, but also *no perceptible turning rhythm* in the unmodulated grooves, almost complete silence, rate a full A. It does happen . . . it should. E.T.C.

Monteverdi: Madrigali, Libro 7. (Madrigals, Book 7). Soloists, John Alldis Choir, Engl. Chamber Orch., Leppard. **Philips 6747 416**, 3 discs, stereo, \$26.94.

Monteverdi is one of the Big Names in Western music, the father of opera and almost anything else you can think of, back around 1600 and on. Is he listenable today for the average audio fan? It all depends.

He was one of the earliest composers actually to specify which instruments he wanted for each line of music, at least in some of his works. So we have a clear idea as to what his sound was like. We can — if we want to — infer equally well what his solo voices sounded like. Just from the way the music is written. But all this was before the era of our modern instruments and their earlier counterparts in the 18th century. To play Monteverdi via a modern orchestra is NOT the same as for Bach and Handel, a century later. Monteverdi's sound was utterly different. So what to do?

One school of thought says restore the earlier sounds, instruments and voices, as ingeniously and imaginative-

ly and authoritatively as possible. The other school says make it sound well with present-day musical forces. That's what we have on this record. Though the result, in spite of dedicated and able performers, is for my particular ear anathema — I could not play the whole thing — the sounds may indeed be quite OK for you, and rightly so. These performers are musically top notch. But they make most of the music sound like Verdi and Puccini, in spite of some old instruments, like harpsichord and recorder. Most of the music is for duets and trios of voices, with minimum accompaniment. And so the voices are what must decide you. They are standard operatic, loud, rich, full of vibrato, and tiring on the ears — just like most opera. But they do sing the right notes in the right places, with fervor. There you have it.

Madrigali? You are right; madrigals were sophisticated little pieces for voices, first in Italy but soon transferred to England in the late Elizabethan period. Monteverdi turned music inside out, over many years, by publishing eight books of "Madrigals" that began, when he was in his teens, with

"regular" madrigals (superb music) and then went onward, more and more elaborate and revolutionary, until with the last two books he was in effect writing whole opera scenes, cantatas, with solos, chorus, and orchestra. For symmetry, and maybe because there weren't yet any other names, he still called them madrigals. Hence this Book 7, and the large array of forces required for the recording.

Note that there are numerous performances of this composer that restore at least a good deal of the original Monteverdi sound, via old instruments and even via a revised vocal technique that fits the obvious needs of the music as the modern opera voice does not. Some parts of these restorations are no less than magnificent. Ask your dealer.

Sound: B+ Recording: B Surfaces: B+

Louis Moreau Gottschalk: Four-hand piano music. David and Deborah Apter. **Musical Heritage MHS 3430**, stereo, (Mail order only: 1710 Highway 35, Oakhurst, N.J. 07755).

A curious thing happened to my original copy of this excellent recording; after one play, it split neatly in half. Some sort of pressing stress, I suppose. Eventually I got them to send another. It hasn't split.

Gottschalk was the only really accomplished pianist/composer of the early American scene — a man whose training was European and who knew many of the greats over there, yet whose music is, even so, unmistakably American, whether of the South or the North. He was surely the first to get into the Latin American idiom and to apply it to European "classical" pianism — he ended up down in the Islands. His overall style, though, is very much of the period before our Civil War, full of elaborate and highly tinkling arrangements of assorted opera and "folk" tunes, done to a turn like Liszt but much less pretentious. With four hands, the man really went to town — it sounds like a hugely enlarged music box repertory. If you don't play too much at a time, you'll find this tinkly stuff delightful — but you have to set it aside now and then ... too much alike.

The Apters, who look like born comedians to me in their cover picture, do an uplifting and airy job on the music, technically top level but never overly serious where entertainment is the intent. And this even though occasionally they come close to string busting — it's vigorous music, all right! Excellent sound and recording, surfaces

AUDIO • June 1979

pretty good, too, and the only fault is maybe inevitable in such music — a few pre-echoes, before the violently loudest chords.

Sound: A- Recording: A- Surfaces: B to B-

Moving Pictures. Michael William Gilbert. **Gibex Music, Riverglade 104, Amherst, MA 01002.**

"Dear Music Reviewer. I am a young composer of contemporary music. The enclosed record ... is my first release. It is on my own independent label

and, as a result, the promotion and distribution aspects are being handled directly by myself." Thus do we get down to basics, and the address (no price is given) you will find above. How can one do less than admire the energy and forcefulness of those who take on the entire production of a disc in person, even unto the selling, and do so at the age of 25? Things like this keep the big companies on their toes, more or less — or should. Right?

All that remains is to review the record. I do hate to say so, but I found it rather conventional and old fash-

It takes \$700 – \$800 to put together a good satellite-subwoofer system.

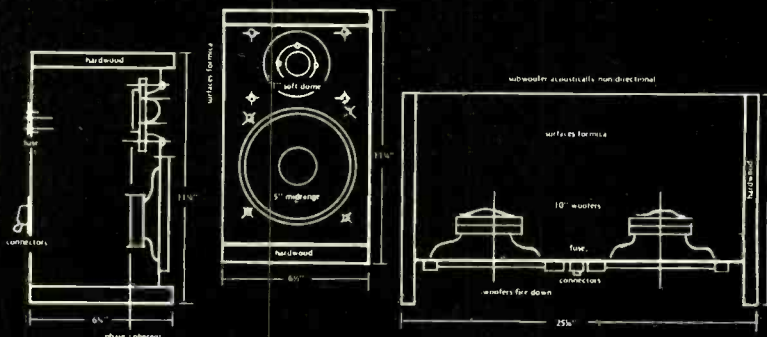

It takes \$395 to buy one.

A TRUE 2-CHANNEL 3-WAY SYSTEM:

- Satellites are phase coherent; house a 1" soft dome tweeter and 5" midrange.
- Subwoofer has two 10" down-firing drivers with response down to 20 Hz (± 3 db). Subwoofer has formica top and sides; doubles as an end or coffee table.
- Min. power required 25 watts; max. 200 watts. Maximum SPL is 110 db; frequency response is a true 20 Hz-20 kHz.

point 3 systems



ANOTHER GREAT WHITE WHALE PRODUCT

Enter No. 23 on Reader Service Card

**PROTECTS YOUR PRECIOUS SPEAKERS!
DRIVES LOW INPUT SPEAKERS SAFELY WITH
A HIGH OUTPUT AMP!**

BELCO  SYSTEM
E-120 (PAT. P.)

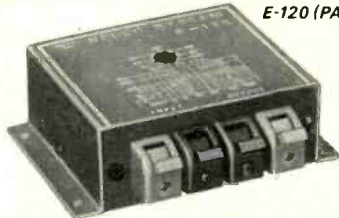

An overinput applied to the speaker immediately actuates the Belco System to limit the overcurrent and protect the speaker against burning out of the voice coil, distortion of the cone paper, and other troubles. The Belco System has absolutely no affect on tonal quality or amplifier operation.
*All range protection. *Woofer, mid range, tweeter range protection. *B speaker protection at A speaker system high input, B speaker system low input. *Extremely simple to install.

SPECIFICATIONS

- * Maximum allowable input: 200W (program source)
- * Applicable speakers: 10W~120W (program source)
- * Dimensions: 75(H) x 86(W) x 25(D) m/m
- * Weight: 100g

• For detailed information, please contact:

TAISEI ELECTRONICS CO., LTD.

C.P.O. Box 847, Tokyo, Japan.

Phone: 03-256-9054 Telex: J24788 SIGMARON

Enter No. 64 on Reader Service Card

ioned, as electronic music goes (with "instrumental music" and "musique concrète"). It all seems good, in the words the man uses, and I would be happy to go along with the idea of a synthesis of electronic, "concrète" (that is, recorded real sounds, altered by tape tricks), and "instrumental," i.e. plain, unaltered (maybe non-synthetic sounds. Grand idea. But the record itself left me, at least, pretty much unmoved. The sound is flat — that is the best word. Even through six channels and decode/digital spreading, it just sits there up in front, like mono. No excitement. The effect is as of early tape music, much slow moaning, long-drawn-out pitches, not very much sonic color, and very weak high end from the color viewpoint. Also, very much in the key of A minor, from beginning to end of several items.

I would be ever so happy to be proved wrong! You have the address — why not try for yourself?

Durufle: Requiem: Danse lente. Kiri Te Kanawa, Siegmund Nimsgern, Ambrosian Singers, Desborough School Choir, New Philharmonia, Andrew Davis. **Columbia M 34547**, stereo/quad, \$7.98.

This excellent recording, released early last year, was one of the final items offered, ever so inconspicuously, in the compatible SQ format. You'll find that indication down in one small corner of the rear. It sounds just fine in stereo — as any SQ-encoded record should. And it has extra value in case you still can "enhance" via more than two channels of home sound. This, one might say, is the final and best application of built-in surround ambience, as part of the recording itself, before the advent (no pun intended) of synthesized surround sound, created by digital-delay-type home circuitry.

The Requiem is a curious work, very much patterned on the more familiar and much beloved Faure' Requiem, yet composed no less than 60 years later, in 1947. You would scarcely know it as "modern" if somebody didn't tell you. Even so, it is genuinely expressive, well constructed, and easily made very effective, as it is in this big recording by predominantly English forces — except for the vocal solos. The British have always been able to do French music in rather grand style, very French sounding, which seems hard to believe; Sir Thomas Beecham, of Beecham's Pills and Brylcreem, was one of the best of the British Frenchifiers and his tradition still goes on — Andrew Davis (not the same as Colin Davis!) knows exactly how to achieve the

In today's ever changing field of audio there exists a storm of hype and confusion. By adhering to certain guidelines we have clearly found our calm in the eye of the storm.

Honesty, integrity, and expertise have helped us to create a unique audio environment that is indeed professional in the true sense of the word.

The lines we represent speak for themselves.

Audio Research B & W
Vandersteen KEF
Linn Sodek Dayton Wright
Theta Denon
Dahlquist Grace
Audire Grado Signature



Pyramid
Promethean
GAS
Dynavector
EMT
Marcof
Nakamichi
Luxman
Bang & Olufsen
RH Labs
Yamaha
Advent

We ship prepaid throughout the U.S. (714) 897-0166
15102 Bolsa Chica Suite A Huntington Beach, CA. 92649
Store Hours - Mon. thru Fri. 1:00-9:00 Sat. 10:30-5:00 Sun. 12:30-5:00

Enter No. 25 on Reader Service Card

Audio Transformers

The SESCOM "MI-Series" Audio Transformers are specifically designed for broadcast and recording applications.

FEATURES

1. Low distortion < .2% @ 30 Hz
2. Broad frequency response ± 1 db 20-20KHz
3. Electro-static shielding
4. Six power levels: -40, -30, -10, +4, +18 and +30 dBm
5. Various primary and secondary impedances
6. Double and single mu-metal shields
7. Both shielded and open versions.



Shielded Terminals



Open Frame



Plug-In



Plug-In



Wire Leads

SEND FOR YOUR FREE COPY OF OUR NEW CATALOG

We also manufacture direct boxes, Mic-splitters, snakes and audio modules



SESCOM, INC. P.O. Box 590,
12931 Budlong Ave.,
Gardena, CA 90247 U.S.A.
(213) 770-3510, (800) 421-1828
TWX (910) 346-7023

"Quality Engineered Sound Products"

Enter No. 57 on Reader Service Card



SAVE!

AUDIO

Custom designed Library Cases will protect your magazine copies. These files are rugged and made with a rich Kivar cover. Shipped postage paid. Prices: \$7.50 each; 3 for \$20; 6 for \$37. Return the order form below with your payment.

Please send me _____ library cases.
Prices: \$7.50 each; 3 for \$20; 6 for \$37. My check or money order is enclosed.

My Name _____
Company _____
Address _____
City _____ State _____ Zip _____

Mail to: Audio,
401 N. Broad Street
Philadelphia, Pa. 19108

Allow four weeks for delivery. AU 6/79

mystical, reverent Catholic atmosphere of this work.

Sound: B Recording: A- Surfaces: B

Steve Reich: Music for 18 Musicians.
ECM-1-1129 \$7.98.

Surely you have heard of Steve Reich? If not, then you ought to.

Big minds, big people, show their size in any area, no matter how zany. Reich is one of them. And this is his most significant work to date—for here he takes what were strictly and typically electronic techniques and transfers them, incredibly, to live instruments. Like throwing out the computer in favor of a batch of accountants—and getting away with it.

My first contact with this man was absolutely typical. He did an electronic transformation, lasting a whole LP side, on a brief spoken statement, "IT'S GONNA RAIN," repeated a million times and gradually transformed, by who knows what phase and envelope and frequency changes, until it was utterly different—all with a steady beat, never stopping for an instant, totally monotonous, and yet always changing! I was appalled at the folly of it. And also fascinated. Big man.

Now, this man has had the incredible idea of translating that sort of music (or organized sound) to the live medium. He does it! His dedicated group of 18 real, live, functioning musicians, playing old-fashioned, real, live, mechanical music instruments, actually come out with a complex texture of electronic-like sounds that has the same hypnotically complex effect of gradual micro-change that his earlier electronic works provided.

You don't have to call it music. Maybe it isn't. But whatever it is, this is important and persuasively powerful organized sound. Do try. You'll be the better for it.

Sound: A- Recording: ?? Surface: B+

Vytautas Smetona Plays Chopin, Liszt, Rachmaninoff. Sirius 1001, stereo,
(28001 Chagrin Blvd., Cleveland, Ohio 44122).

There are folk sayings that cover it—where there's a will there's a way, nature abhors a vacuum, and so on: A thousand and one superbly talented young people now pour themselves into the piano biz because, as another fable goes, it is there. Fame, exposure, and prize money! What else? This resolute-looking young gent (see cover) is 20 and the son of the last President of Lithuania as an independent

state, a native of Cleveland and his training was there... pure American.

Yes, fantastic technique and better than that, a big concept of his music, very much the soul of Neo-Romanticism, but not at all moony and blurry, like some. He has excellent rhythmic sense and a fine ear and mind for small details, which are concisely worked out. He plays a lot of staccato, short, jabby notes, and he puts much into inner voices and such, which he probably learned from his older teachers—they used to do it that way. He has an excellent sense for the drama of *ff* and *pp*, loud and soft. He often gets really carried away, to the point in these performances where he makes a lot of stumbles and recoveries—but after all, these are concert performances on disc, and no repeat takes.

And yet—this is a 20 year old, as anybody can hear in moments. Especially in the long and extremely touchy Liszt *B Minor Sonata* on Side 1, a work that few pianists in the world can hold together over its enormous length. The good parts, here, are the fiery segments—terrific, especially the ending. The less-worthy parts are, of course, those that are deeply, maturely contemplative. It takes a 70 year old really to do them up right. Smetona is more in his element in the shorter Rachmaninoff and Chopin, and if he is any good, he will in due time grow into the longer pieces.

Sound: A- Recording: B- Surfaces: A-

The Mozart Family—Three Generations. (Leopold, Wolfgang Amadeus, Franz Xaver). S. Lautenbacher, E. Wichmann, M. Dosse, W. Holy, Pro Musica Orch. Lubeck, Kuntzsch; Mainz Chamber Orch., Faerber. **Vox Turnabout QTX 34684, stereo/quad (QS), \$4.98.**

A good idea here and a brave try, one of Vox's typical conglomerations of assorted local European performances—but this one is a minor disaster on a number of counts.

First, though the four solos, violin, flute, piano and trumpet, are good, the two orchestras are distinctly and audibly second rate, playing sloppily, plodding, even out of tune. Only the solo flute, Ernst Wichmann, seems to galvanize these players into some action.

Second, the music. Franz Xaver, Mozart's youngest son, born the year the composer died, 1791, became a concert pianist and toured Europe under the name of Wolfgang Amadeus Mozart, Jr.—which tells all. He is a pale shadow of his father, at least in

the early student-type piano concerto featured here. (He did write some respectably Romantic music later on.) This one is simply farcical, a genial tissue of outdated conventionalities, awkwardly and clumsily assembled—a hundred unknowns of that fabulous piano era did better! So much for side 1. Papa Mozart, the didactic Leopold, is represented by the usual, the *Trumpet Concerto* that is already on records a dozen or so times. Nicely played—but nobody tells us whether this is really a clarino (without valves) or not. They didn't have valves in

Primo

A NEW WEAPON FOR THE WORLD OF SOUND!
Electret Condenser Microphone
Model PC-20

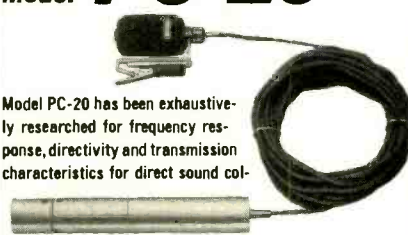

Model PC-20 has been exhaustively researched for frequency response, directivity and transmission characteristics for direct sound collection of string instruments in a concert hall. Clip it to any string instrument.

FEATURES

- Supercardioid characteristic and wide frequency response specially designed to match the directivity pattern of string instruments provide a sound quality boasting excellent reverberation of the middle and low regions.
- Microphone employs a clip type mounting system with freely adjustable angle. Can be mounted to the instrument with one touch. All mounting parts have a soft construction to prevent damaging precious instruments.

RATINGS

- Sensitivity: -74 dB \pm 2 dB
- Directivity: Supercardioid characteristic
- Output impedance: 250 Ω
- Frequency response: 50 to 20,000 Hz
- Noise: 22 dB SPL or less
- Maximum input sound pressure: 120 dB SPL or greater
- Power requirement: 1.5 V (UM-5) and 48 V phantom
- Battery life: 2 months or more of continuous use
- Output connector: XLR-3-12C equivalent
- Cable: 3 m
- Weight: Microphone 25g, power supply 160g

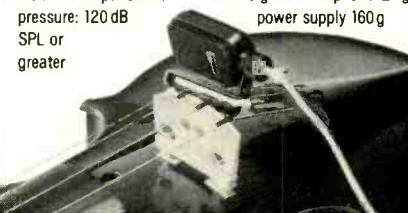

• For more information write or call us today.

PRIMO MICROPHONES, INC.
2468 DELTA LANE, ELK GROVE VILLAGE,
ILLINOIS 60007, U.S.A. TEL: 312-595-1022
TELEX: 28-3474 PRIMO MUS ELGR

PRIMO MICROPHONES SINGAPORE (PTE) LTD.
24B-27B BLOCK 3, KALLANG WAY, SINGAPORE 13
TEL: 803586 TELEX: 26131

PRIMO COMPANY LIMITED TOKYO, JAPAN
6-25-1 MURE, MITAKA-SHI, TOKYO, JAPAN
TEL: 0422-43-3121-9 TELEX: 2822-326 PRIMO J

127

This month the Institute of Audio Research celebrates 10 successful years of teaching professional Multi- track Recording Technology.

Complete the 405 hour MRT program in one year, or earn credit toward the B.S. Degree in MUSIC TECHNOLOGY via the joint Institute of Audio Research-NYU program.

Accelerated Summer '79 Quarter
July 9th-August 31st
Fall '79 Quarter
October 2nd-December 21st

For further information call or write:

Institute of Audio Research
64 University Place
Greenwich Village, New York 10003
(212) 677-7580

Licensed by New York State Department of Education

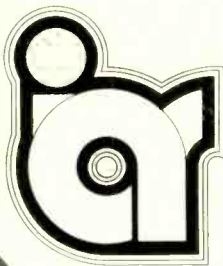

Enter No. 28 on Reader Service Card

COMPARE PRICES

\$41

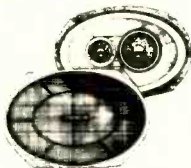

TS 695
6"x9" 3-way speakers



PIONEER

\$141



KP8005
Car Stereo

\$344



SA 8800
Amplifier



**CAR
STEREO**

We carry the full line of Pioneer,
Sanyo, Clarion, Marantz, and more.

CALL

Weekdays 9-6
Saturdays 9-5

WDS
WISCONSIN DISCOUNT
STEREO

2517 whalen lane madison, wisconsin 53713

Over 60 Brands like:

Technics	Maxell	Sony	Cerwin
Pioneer	Empire	Teac	Vega
Marantz	Altec	Akai	JBL
Kenwood	Sharp	Dual	Audio
Sansui	Sanyo	Koss	Technica
Jensen	Shure	TDK	

TOLL FREE

800-356-9514

Enter No. 69 on Reader Service Card

Leopold's day. Might have found something more enterprising than this little bit.

As for the Mozart, side 2 is filled out by two familiar isolated movements for solo and orchestra, violin and flute (K. 373, 315), both of which, again, have been recorded many times in high places. Scarcely worth the trouble to listen, I'd say.

Helen and Karl Ulrich Schnabel, One Piano, Four Hands. (Mozart, Schubert, Weber, Mendelssohn, Bizet, Dvorak, Brahms.) Town Hall S-19 (2 discs), stereo, \$13.96.

Those who remember and revere the great name of Artur Schnabel (who recorded the very first complete set of Beethoven piano sonatas, on 78s back in the early thirties) will jump to acquire this superb album, right in the Schnabel tradition, played by his son and Helen Schnabel on one piano, four hands, for broadcast in Canada. Alas, it can never happen again—Helen Schnabel has since died. It was a case where the two artists were even better together than separate. They specialized in this type of performance.

This is an optimum broadcast recording, made close enough to capture the big piano's most enormous sounds yet with enough spaciousness to avoid any suggestion of deadness or radio studio. I could find no fault except perhaps an occasional thump in the bigger low bass notes, no doubt due to the particular mike placement.

As for the playing, it is simply beyond compare. The marvelous sense of phrasing, of innate musical tension and drama, of wonderfully flowing rhythm, all the best of the Schnabel tradition, are right here in this recording and most notably in the Mozart and Schubert items. But to offset the Viennese, we have a whole set of little Bizet pieces from France (*Jeux d' Enfants*) and two of the familiar Brahms *Hungarian Dances*, not to mention Mendelssohn and Dvorak at their most persuasive. It's a great literature, this for a single piano with four hands at work.

Music for two separate pianos is, of course, much better to look at on the stage! A pair of performers squashed onto a single piano bench is not usually an edifying sight for a concert audience. The music wasn't meant as concert music; it was for the home and the private music room—and now we hear it appropriately in our own music rooms.

Sound: B Recording: B+ Surface: B+

Folk bag



129

Early Hawaiian Classics: Kalama's Quartette
Folklyric 9022, mono, \$7.98.

This collection of 14 tracks recorded between 1927 and 1930 reintroduces one of the finest groups of the "Golden Age" of Hawaiian music. Kalama's Quartette is all but forgotten today, but this album proves their music is long overdue for the same posthumous recognition now being given to Sol Hoopii, Jim & Bob, et al.

The Quartette's vocal harmonies are especially spellbinding. Their voices cover an incredibly wide melodic range, striking all sorts of unexpected, yet seductive chord formations, laced with emotional vibratos. Each singer had his own individualistic personality, but when they sang together, Mike Hanapi's lovely, delicate, yet hearty falsetto; Bob Nawahine's throaty, sharp-toned, stentorian bass, and the hardly less memorable voices of William Kalama (tenor) and Dave Munson (baritone) merged into an exceptionally rich, concordant blend.

The group was no less distinguished instrumentally. Especially noteworthy are the double-steel tracks, in which Hanapi and Bob Matsu (who, it would

seem, turned the Quartette into a "quintette") play independent, yet totally sympathetic steel lines. On *No Moku Eha* and *Lei Ana Ika Mokihana*, one acoustic steel guitar plays a jaunty melody, while the other one dances over it in a euphonious obbligato. Savor also their elegant harmony interludes on the beautiful *Ua Like No A Like*, their "hot" counterpoint on *Hano Hano Hanalei*, and the harmonic "chimes" over the lead steel on *Hoomau A Hoomau*. The other members (Kalama, ukulele; Munson, guitar, and Nawahine, on the then-popular harp-guitar) fill in with proficient string textures and relaxed rhythms. Also noteworthy is the archaic hula, *Heeia*, in which the vocals and Hanapi's steel are accompanied by native percussion instruments.

If forced to choose highlights, I'd single out *Mama E*, that old standby *On the Beach at Waikiki* (sung in barely recognizable English), and most of all the magnificent *Hoo-Hihi Oe Ke Ike Mai*, for their supreme integration of voices and instruments. But virtually every cut is a highlight in one way or another.

If you've developed a taste for 20s-

style Hawaiian music, this record's a must. And if you've never given Hawaiian music a second thought, think about this album. It could very well convert you after just one hearing.

Tom Bingham

Performance: A+

The Real Bahamas, Volume 2
Nonesuch Explorer Series H-72078, \$4.98.

For years now **The Real Bahamas** (Nonesuch H-72013) has been an evangelical personal favorite. Taken from 1965 field recordings made by Peter Siegel and Jody Stecher, it is one of the purest of delights in all of Nonesuch's wonderful Explorer series of native musics of the world. It includes marvelous performances by the Swin family and the Pindar family with the legendary and nearly unbelievable guitarist/singer Joseph Spencer. I still recommend it whole-heartedly.

With it I can now direct attention to **Volume 2** which is a further dip into the 1965 tapes. There is more of Spencer, the Pindars and the Swins as well

The most valuable issue of The Audio Critic yet.

In its forthcoming issue (Vol. 2, No. 1), The Audio Critic breaks new ground. For the first time, its test reports find a number of newly introduced *medium-priced* components to be just a small notch below State of the Art, a rating that would have been unimaginable as recently as a year ago.

Another first, possibly of even greater value to audiophiles, is the partial transcript of a unique all-day seminar on audio design, featuring the uncensored views of some of today's most highly respected technologists.

The Audio Critic is the only audiophile review that combines (1) no advertising by either manufacturers or dealers, (2) technical sophistication above and beyond the "underground" cultist level, (3) advanced laboratory facilities and test programs, and (4) in-depth listening evaluations.

You may want to start your subscription with the previous issue (Vol. 1, No. 6), which is a cumulative reference work with over 150 reviews. Send \$30 for 6 issues by first-class mail (no Canadian dollars, \$6 extra for overseas airmail) to The Audio Critic, Box 392, Bronxville, NY 10708.

132

String Synthesizers

Can Be: Just strings...

....But when designed by Marvin Jones they have:



violins/cello/piano, variable chorusing, keyboard split, synthesizer interface, variable sustain controls, jacks for foot controls, dual violin/cello mixers, separate mixable piano output, stereo string & computer interface options.

Stringz 'n' Thingz

just \$295 kit \$600 assembled
from **RAIA** You're gonna love it!

TELL ME MORE

- () Send Assembly & Using Manual \$5 refundable upon purchase Stringz 'n' Thingz.
- () SEND FREE CATALOG

name: _____

Address: _____

City: _____ State: _____ Zip: _____

RAIA ELECTRONICS Dept. 6-A
1020 W. Wilshire Blvd., Oklahoma City, OK 73116 (405) 843-9626

Enter No. 46 on Reader Service Card

gebouw recording of Dvorak's *New World Symphony No. 9* (9500 511). I must say though that in this latter case the performance completely won me over.

As previously mentioned, Bernard Haitink celebrates his half century, and much of his career has been based upon the reputation he gained for conducting the Concertgebouw Orchestra of Amsterdam. Over the period of the last 10 years he has been engaged intermittently in recording all the Mahler symphonies, and Philips has now chosen to remaster these at an extremely reasonable price as a 16-record box set (6788 021). I really do not wish to enter into the lengthy dissertation that this deserves except to say that in my opinion his insight into the composer deepened as the series progressed and that the recording quality (while never deliberately spectacular) also shows a gradual rise in standards. In all, the technical approach avoids listening fatigue but misses the sheer impact of a live performance. However, as I have stated before, the day I heard Mahler reproduced as it sounds in the concert hall will be the day I quit bothering about developments in audio.

Equally, and *ad nauseam*, I tend to complain how poorly opera is handled on records and nearly always find that the contrived approach of Decca ends up as being the most plausible. In this respect I notice that their new recording of *Hansel and Gretel* with the Vienna Philharmonic conducted by Sir Georg Solti (on D 131D) has already won an award. Of course, such fairy tale music is unlikely to be harmed by an even trivial recording approach, and the engineers here have made much use of special effects with a good sense of distance and movement. In all this is a treat, incorporating all the tricks of the trade, and if you are thinking of buying it, I would give it a definite "yes." Vocal music of a much more serene nature comes on a recording by L'Oiseau-Lyre of choral music by Michael Tippett (DSLO 25). This is engineered by John Dunkerley and David Frost and is clear, crisp, and ambient. Only some very low frequency rumble, almost too slight to mention, mars the pressing and the music incorporates the unaccompanied negro spiritual from Tippett's oratorio *A Child of Our Time*.

John Dunkerley is also the engineer behind yet another superb Philip Jones Brass Ensemble recording entitled *Easy Winners* (ZRG 895). Musically this is rather a change for the Brass Ensemble incorporating sparkling arrangements of Scott Joplin rags and a delightful version of Mozart's *Eine*

Kleine Nachtmusik, etc. Being perhaps more than usually exaggerated in lateral positioning across the stereo stage, this is nevertheless quite outstanding, not the least for its convincing brass quality, and is bound to end up as a demonstration record.

In a previous issue I spent considerable time discussing the various recent recordings of Berlioz's *Symphonie Fantastique* and the approaches taken. I quote: "the Solti recording (SXL 6571) ... makes great sonic impact." This quarter we have yet another contender, being that of the London Symphony Orchestra conducted by Andre Previn, balanced and recorded by Christopher Parker and Christopher Bishop (respectively) on ASD 3496. This coupling of forces results, not surprisingly, in a weighty recording of an impressive and analytical type, yet with the veracity and lack of pander that one might expect from Previn. Christopher Parker is also the engineer in EMI's release by the same artists of Prokofiev's "Classical" *Symphony No. 7* (ASD 3556). The similar bass is complemented in more lighter moments by an almost ideal blend, more towards lightness than lushness. I have noticed this tendency before with records produced by Suvi Raj Grubb and I approve of it.

However, being almost lush to the extreme, is a concert of **English Chamber Music** on CBS Master Works 76719. This recording approach, together with the extremely popular — maybe even hackneyed — selection of music, makes the record ideal for background music. Works include Vaughan-Williams' *Greensleeves*, *Arrival of the Queen of Sheba*, *Chanson de Matin*, *Capriol Suite*, and the like. Lastly, also on the CBS label and the final record to be reviewed this quarter, is a version of Saint-Saens' *Carnival of the Animals*, played by the piano soloists Philippe Entremont and Gaby Casadesu on 76735. In the June '78 column, I gave a rave review of EMI's recording (ASD 3448) which is sheer extravaganza and fun, but probably not to everybody's taste. This version is straight-laced, being meticulously accurate and, by comparison, taking the spirit out of the work. However, thank-goodness all people do not think the same, and the sedate quality of the recording balance respectfully reflects the intended purpose.

Next quarter I shall be discussing the advent of digital recording techniques and reviewing the first British disc to be made from digital master tape — the New Year's Day concert in Vienna (D147D 2) — recorded live with Willi Boskovsky conducting the Vienna Philharmonic Orchestra. **A**

AKAI-GX 267D

Continued From P. 107

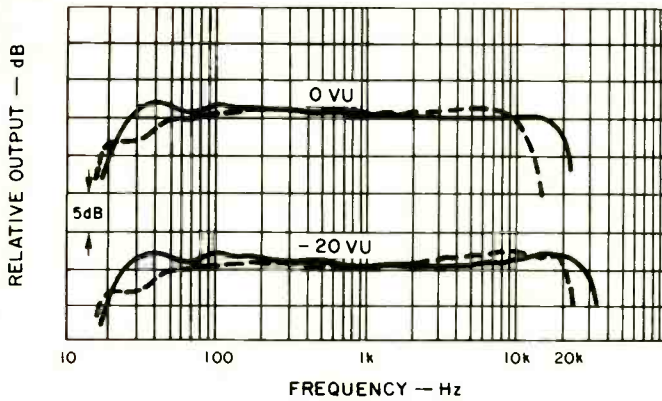

Fig 1—Frequency response with Scotch 250 tape (dashed line is 3¾ ips).

200 nWb/m (at 1 kHz) extends to 8 kHz. In general, the low-end response was flatter in reverse, but the high end was more peaked. At 3¾ ips, the responses drooped below 40 Hz. The phase jitter in the playback of a 10-kHz tone was about 45 degrees in forward at 7½ ips; it was less than that in reverse, but greater than that at 3¾ ips. Phase errors between tracks averaged 25 degrees at 7½ ips and 45 degrees at 3¾ ips. These figures are fairly good, and the discrepancies could be indicative of the challenge of properly aligning the six heads. The response with a 1-kHz square wave was quite good, albeit with some ringing on the leading edges, more so at 3¾ ips. Bias in the output during recording was 10 mV rms, slightly high.

Data was taken on HDL₃ vs. record level with Scotch 250 at 7½ ips and with Memorex Quantum at both speeds. The results with Memorex tape at the higher speed do not have quite the linearity expected, but the figures are outstanding — very close to the best results ever obtained previously. HDL₂ and HDL₅ were admirably low at all levels. HDL₃ vs. frequency at the two speeds was run at reference level with Memorex Quantum. The distortion levels were as expected, with those above 2 kHz a little on the high side. All the results discussed above were secured in forward. Checks in reverse revealed somewhat higher distortion, perhaps related to the greater peaking in reverse and less bias (?). In the process of taking some of this data, it was noted that the level of HDL₃ was rising and falling at a regular rate. It was determined that there were ¼-dB cyclic variations in the level of the fundamental at a 10-Hz rate at 7½ ips, at a 5-Hz rate at

the lower speed. In reverse, variations were doubled. Calculation and physical measurement pinpointed the source as runout in the capstan shaft. More on this later.

The signal-to-noise ratios with both IEC A and CCIR/ARM weightings are shown in Table II. "0 Lvl" in the table is 200 nWb/m at 1000 Hz, which corresponded to +2.5 on the meters. The results are certainly very good, and much better than the specification. Separation between channels was 75 dB and erasure was greater than 80 dB, both excellent figures. Crosstalk between adjacent tracks of opposite play direction was 78 dB down, also very good.

Mike input sensitivity was 0.28 mV, and line input sensitivity was 75 mV. Both figures are above specification, but the discrepancies are less than a dB. The input overload points were 57 mV for mike and over 10 V for line, both very good. Output clipping appeared at a level equivalent to +13 dB relative to meter zero. The sections of the dual, concentric input pots tracked fairly well, within a dB over 35 dB for line and within a dB over 45 dB for mike. Rotation of all pots and slipping one section relative to the other were always very smooth. Output levels were 890 mV for line and 120 mV into 8 ohms for headphones, which generated high levels in all headphones tried. The output-level pot, which also controls headphone level, had channel tracking within a dB to 40 dB down from maximum. Channel levels and meter indications were very well matched. The frequency response of the VU-type meters was from 29 Hz to 36.4 kHz. Accuracy of the indications was excellent from -10 to +3, and the scales are expanded above zero. Illumination was bright and even, facilitating the reading. In the dynamic test with a 300-mS tone burst, there was an overshoot of about a dB.

The flutter at 7½ ips was 0.038 percent W rms and 0.065 percent Wtd Pk, for both forward and reverse. These are excellent results, and there is nothing to fault them. At 3¾ ips, flutter in forward was 0.065 percent W rms and 0.09 percent Wtd Pk. In reverse, the figures were about 50 percent higher, and variations with time were greater. Tape play speeds were acceptably accurate in all modes with the standard 120-V line power, though changes in voltage caused speed shifts up to 0.25 percent. This error fits within the speed specification of ± 0.5 percent, but this characteristic could cause minor pitch or timing problems in some areas. Wind times were 70 seconds or less for 1200-foot reels, much lower than the 90-second spec, and yet the winding was smooth and quiet. Run-out at the end of the reel initiated braking very quickly with very little tape-end whipping. Switching between wind modes appeared to be immediate. Wind-to-play in any combination and reversing play/record direction required three seconds. At first, this seemed a bit on the slow side, but the logic stored any command, so it was not necessary to hold in buttons until execution.

133

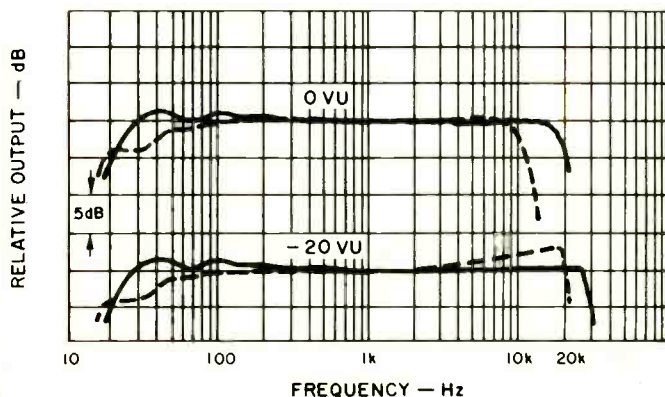

Fig. 2—Frequency response with Memorex Quantum at 7½ ips (WR bias) and 3¾ ips (LN bias is dashed line).

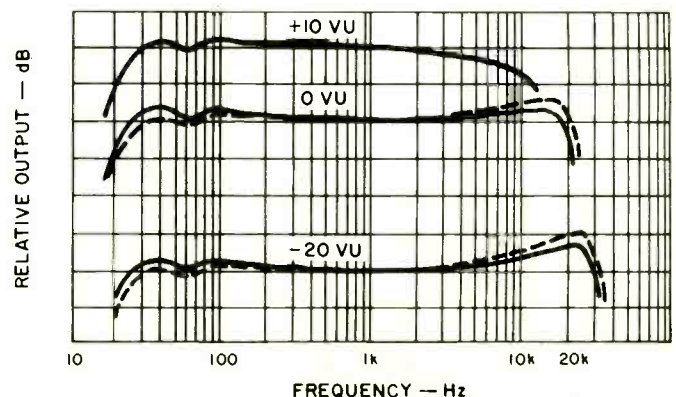

Fig. 3—Frequency response with TDK Audua at 7½ ips (dashed line is Reverse).

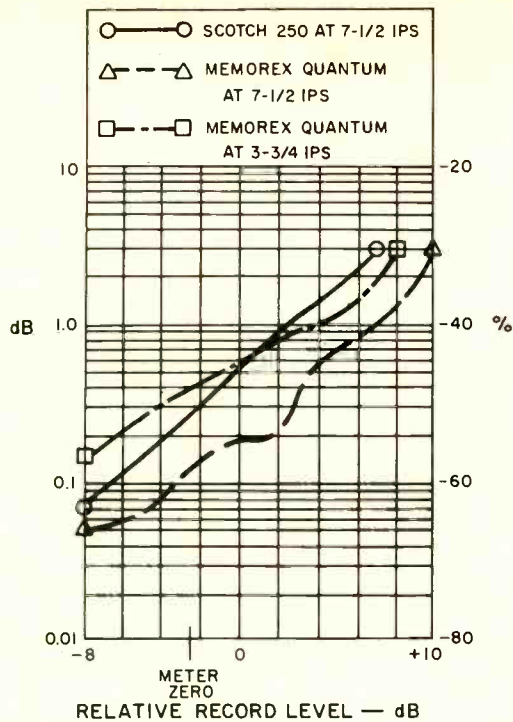

Fig. 4—Third harmonic distortion (HDL_3) vs. relative record level of 1-kHz signal. (Zero reference level is 200 nWb/m.)

134

Fig. 5—Playback of 1-kHz square wave at 7½ ips (top) and 3¾ ips (bottom).

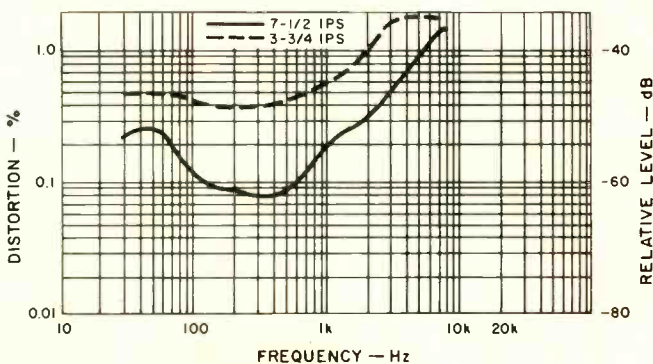
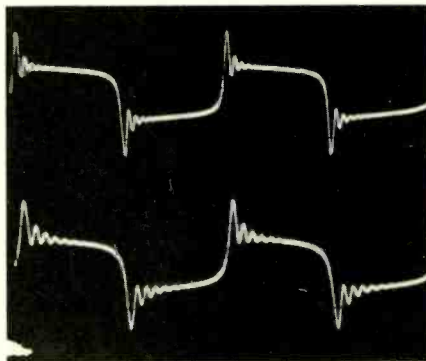

Fig. 6—Third harmonic distortion (HDL_3) vs. frequency with Memorex Quantum at a constant record level (200 nWb/m in playback at 1 kHz). Dashed line is 3¾ ips.

Listening and Use Tests

Tape threading was easily accomplished, even though it looked a bit challenging with guide posts, tension arms, and the six heads. Access for maintenance was excellent with the head-assembly cover removed. All controls and switches were completely reliable during the testing, which included attempts to confuse the tape-motion logic. The input-level pots were especially nice to use; the just-right friction coupling allowed adjusting both channels individually with one hand. Timer start, pause, and record mute all worked as expected; the one-second flasher with mute aided in some copy work. The meters seemed a little sluggish with music inputs, probably associated with the overshoot measured before.

The 24-page instruction book has excellent text and illustrations, with considerable detail presented lucidly. Akai should also get a pat on the back for showing the use of a tape splicer. That's the way it ought to be, but a surprising number of instruction books show the use of scissors (ugh!). Various sources were recorded while set up for monitoring the playback. Some attention was directed to ascertaining whether it was possible to detect the small amplitude variations that had appeared when using test tones. As expected, no such effect was detected in the playback of recorded music. The sound was very close to the original in most every case. There was a slight loss in the lowest bass at 3¾ ips, and added presence at times with both speeds. A recording of a consort of violas sounded better in playback (to me) because of this effect. Record, pause, and stop noises were all very low, barely detectable by meter or ear. The Akai GX267D open-reel deck has many features, including off-the-tape monitoring for both forward and reverse, and attractive performance parameters for its moderate price.

Howard A. Roberson

Enter No. 95 on Reader Service Card

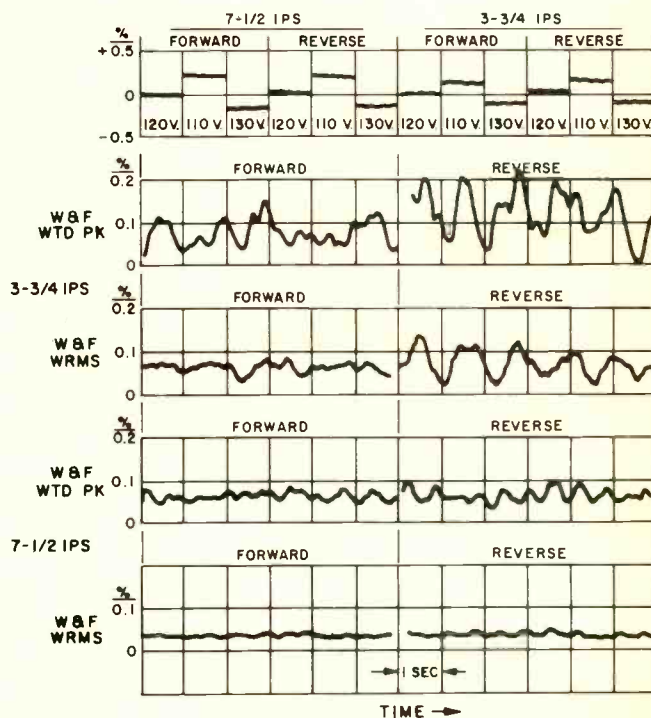

Fig. 7—Tape speed and wow and flutter, each wtd. peak and W rms, for 3¾ ips and 7½ ips in both forward and reverse.

Classified

CLASSIFIED ADVERTISING RATES

BUSINESS ADS- For Sale. Help Wanted. Services. Business Opportunities. Tape Recordings, etc. etc. \$4.80 per line. First line set in bold face type at no extra charge. Extra lines \$9.60 per line. One point ruled box, extra charge \$8.00. Full payment must accompany order.

NON BUSINESS ADS- Situations Wanted, used equipment for sale by private individuals \$2.80 per line. First line set in bold face type at no extra charge. Extra lines set in bold face type \$5.60 per line. Full payment must accompany order.

FREQUENCY DISCOUNT- 3 times, less 10%. 6 times, less 15%. 12 times, less 20%. (line copy ads only)

DEADLINE- 1st of two preceding months. (Dec. 1 for Feb. issue).

BLIND ADS- Box numbers may be used at \$5.00 extra for handling and postage.

MAIL ORDER AND DISPLAY CLASSIFIED RATE

1 col x 1"	\$125
1 col x 2"	\$180
1 col x 3"	\$250
2 col x 1"	\$180
2 col x 2"	\$320

Advertiser must supply complete film negative ready for printing for display ads.

AUDIO Magazine
401 North Broad Street
Philadelphia, Penna 19108

HOW TO ANSWER BOX NUMBER ADS

When replying to an Audio Box Number Ad, please use this address Box No. — c/o Audio, 401 No. Broad Street, Philadelphia, Pa. 19108

FOR SALE

SUPER BASS!!

AMAZING COMPUTER DESIGNED SUBWOOFER THAT CAN QUICKLY BE BUILT BY YOU! ADD IT TO YOUR SYSTEM FOR TRULY EARTHSHAKING 20 Hz RESPONSE. IT CAN BE BUILT FOR UNDER \$90. • COMPUTER GENERATED FREQUENCY RESPONSE CURVES. • SIMPLE STEPWISE INSTRUCTIONS. • PASSIVE & ACTIVE X-OVER PLANS. • COMPLETE ILLUSTRATIONS. • REASONABLE SIZE. ONLY \$9.95 SEND CHECK OR MONEY ORDER TO:

BUCELLA LABORATORIES P.O. BOX 288 BUFFALO N.Y. 14205

FOR SALE

ABSOLUTE LOWEST PRICES ON OVER 80 BRANDS OF STEREO GEAR. OUR UNIQUE PLAN SAVES YOU MONEY OVER THE BEST OF THE MAIL ORDER HOUSES. HUGE INVENTORY, FAST SERVICE. SEND \$1. FOR CATALOG AND CONSULTANTS RAP SHEET TO: DISCOUNT AUDIO SERVICES, 1078 CLEARFIELD ROAD, NAZARETH, PA 18064. YOU WILL BE GLAD YOU DID.

ACCURATE, QUALITY AUDIO EQUIPMENT DISCOUNTED! Low prices on quality Car and Home Hi-Fi Components. Send SASE, call for quotes and literature. Denco Audio, P.O. Box 6104-U, El Monte, CA 91734. (213) 444-9978 evenings, wknd.

ACCUTRAC 4000 I.K. new \$250. Scott digit, synth. tuner w/ cards # 433, perf. \$250. Transcripator skeleton T.T. w/arm \$250. Both I.K. new. Pioneer SD1100 stereo display scope, mint \$300. Pioneer RT707 new \$370. Micro Seiki DQX1000 \$350, mint. 212-377-7282.

AFFORDABLE ESOTERICA

Central N.Y. State
Audionics Apt-Holman Dahlquist Denon
Spectro-Acoustics Crystal Clear
Citation Grace Ortofon Cizek
B&O McIntosh Crown KEF

STELLAR STEREO

384 Elmira Rd. Ithaca N.Y. 14850 607 272 2644

A FREE 40 PG. ELECTRONIC PARTS CATALOG

Precision Metal Film Resistors as low as .15¢ each. 1% and 5% Wirewound Power Resistors. Potentiometers of all types Multi-turn, Multi-gang, Slide and Miniature. Capacitors Mil-Spec, Mica, Polystyrene, Mylar, Ceramic, Electrolytic. Over 10,000 Discrete Semiconductors - Sanken Hybrid Audio Power Amplifiers - I.C.'s Write today for your free copy.

HANIFIN ELECTRONICS CORP. — DEPT. A-1

P.O. Box 188, BRIDGEPORT, PA. 19405

AGI S11A, Bryston 3B JVC KD-85C, Sounder Craftsman RP-2215R, Yamaha CT 600, Denon DP-1000, with Infinity Black Widow and MA 2002E. 1-207-247-6438.

ALAN HILL'S PLASMA SPEAKERS, acclaimed the most superior in the world. \$7000 FOB, Albuquerque. Custom installation - air fare only. Call or write for consultation. Hi-Fi House, 3011 Monte Vista N.E. 87106. 505-255-1694.

ALBUQUERQUE - HI-FI HOUSE - 30 YEARS serving audio needs with care. Advent, Acoustat, Acutec, BGW, Apt-Holman, Grace, Ampex, Alan Hills' Plasma Speakers, Audio-Pulse, JBL, JUC, KEF, DBX, McIntosh, Maxell, NAD, Teac, Tascam, Sennheiser, Yamaha, Urei, etc. Custom home and commercial installations. 505-255-1694, 3011 Monte Vista N.E., 87106.

FOR SALE

AMBIENCE DECODER FOR REAR CHANNELS, \$149.95. Literature 50c. Huntington Electronics, Box 2009-A, Huntington, Conn. 06484

AMPEX TAPE—NEW 1800 on 7" reel 12 for \$18 POST-PAID, 1200' 12 for \$13 POST-PAID—free list—WIDE RESPONSE. 6114A, SANTA MONICA BLVD., HOLLYWOOD, CA 90038 TF

ANOTHER AUDIOPHILE PUBLICATION? All issues of AUDIO UPDATE have been published ON TIME. Update Seven featured an explanation of "supercables," with reasons why some cables operate better than others. Update Nine offered a complete technical and user report on the Rogers LS3/5a, with a computer-assisted analysis of the crossover and a guide to the use of this remarkable speaker system. In each issue, you'll find modifications to perfectionist equipment . . . look for the Marantz Nine, the Lux MB 3045 and others . . . includes step-by-step procedures. If your library doesn't include this bi-monthly publication, your system is not performing as well as it could. Annual subscription \$12. U.S.A. and Canada (add \$1.50 for first class mail), \$14. other countries (add \$4.38 for airmail). AUDIO DIMENSIONS, 8898 Clairemont Mesa Blvd., San Diego, CA 92123. (714) 278-3310. TF

ANTI-SKATING for AR TURNTABLES!! Proven counter-weight design of nickels steel & aluminum construction. Install yourself in minutes. \$7.95 postpaid. (Dealer inquiries invited.) AUDIO INNOVATIONAL PRODUCTS, P.O. Box 1607, Portsmouth, N.H. 03801.

ARC-SP3A1, D76 Natural Finish, Both mint, 975.00 For pair or Best offer. 301-526-6738.

ARC SP-3 pre amp \$400 in good working condition, can be rebuilt to a SP-6. Karl (415) 854-1171.

ARIZONA AUDIOPHILES

Dahlquist, S.A.E., Revox, Rabco, Nakamichi, Yamaha, Crown, Grace, Stax, Tandberg, Sonab, Supex, Gale, Klipsch, Phase Linear, Uher, Burwen, J.B.L., Harmon-Kardon Citation, A.D.S., Spectro Acoustics, Beveridge, Sennheiser, Teac, Thorens, Stanton, Aiwa, Stax, Micro-Seiki, Fidelity-Research, Genesis, Optonica, R.T.R., B&W, Toshiba, DBX, Signet, Mitsubishi and Mitsubishi V.S.S.

JERRY'S AUDIO EXCHANGE

PHOENIX—334 E. Cambridge Rd. (602) 263-9410
TEMPE—130 E. University Dr. (602) 968-3491
TUCSON—5750 E. Broadway. (602) 622-7407
MAIL ORDER HOT LINE—MR. WOZ (602) 265-7841 TF

AT CUSTOM SOUND, we've spent more than two years developing the very best designed cabinet for housing stereo components. Before you invest in a rack or cabinet send 25¢ (stamps O.K.) for our color brochure. Custom Sound, 8460 Marsh Road, Algonac, Mich. 48001. (313) 794-5400.

ATTENTION SOUTHERN AUDIOPHILES! Acoustat, Audionics, Apt-Holman, DCM Time Window, Yamaha, Lux, Stax, Gale, Denon, Grace, Sonus, Mitsubishi, B&O, Advent. Available at AUDIO SYSTEMS, INC. Suite L, 3302 Johnston St., Lafayette, Louisiana 70503 (318) 984-7007.

SEAS

SEAS loudspeaker kits are the result of an extensive research and development program. No effort has been spared in developing what is one of the most advanced range of speaker systems on the market today.

SEAS FABRIKKER A/S, one of Europe's largest and most up to date speaker manufacturers, ensures the quality of this range of loudspeakers, to guarantee you the utmost in listening pleasure.

For SEAS Catalogue, send \$1 (refundable) to:

SpeakerKit

P O BOX 12A
MENOMONIE, WI 54751

GA GARLAND AUDIO, INC.

WHERE ONLY THE FINEST IS GOOD ENOUGH

AUDIO RESEARCH
MAGNEPAN
LUXMAN
DENON
GALE
F.M.I.

B & W
ROGERS
NAKAMICHI
MITCH COTTER
FIDELITY RESEARCH
R.H. LABORATORY

MARK LEVINSON
SEQUERRA
QUATRE
GRACE
QUAD
G.A.S.

Call or write for a FREE subscription to our quarterly newsletter!

GARLAND AUDIO
2960 Stevens Creek Blvd. • San Jose • (408) 244-6724

Tues/Thurs, 11-8 — Wed/Fri, 11-6 — Sat, 10-5 — and by appointment —

FOR SALE

AMERICAN AUDIOPHILE

HOME OF

AUDIONICS
AUDIO GENERAL
AUDIO STANDARDS
AUDIO TECHNOLOGY
CIZEK
DCM
DECCA
DENON
HADCOCK
HAFLER
H.A.P.I.
HITACHI
HI-TECH
IMPULES
IVIE
JANIS

LUSTRE
MARCOF
NEXUS
PRECISION FIDELITY
PREMIERE
RAPPAPORT
SERIES 20
SHURE
SIGNET
SME
STAX
STD
SUPEX
SYMDEX
TANGENT
VANDERSTEEN

AMERICAN AUDIOPHILE

5 Sunrise Plaza
Valley Stream, NY 11581
(516) 561-7114

716 Madison Ave.
New York, NY 10021
(212)751-9733

ALL SHIPMENTS PREPAID AND INSURED
FREE THROUGHOUT CONTINENTAL U.S.
MASTER CHARGE & VISA ACCEPTED

AT PARAGON OF SOUND: New and superb Conrad-Johnson tube amp and Berning FT10 tube-transistor and the Precision Fidelity C-4 preamps. In speakers: the new Snell Acoustic, the MZ MOD3, Rogers LS3/5A, and Acoustic Concept AC-24; M & K and Fundamental Research Subwoofers. Armstrong 624 FM Tuner; Berning Stereo 20 amp. S.T.D. Turntable, Hadcock tonearm, Denon, Grace, Supex, and Dynavector products. Call 301-229-2676 (Bethesda, MD) or write P.O. Box 189, Cabin John, MD. 20731 7-9

AT LAST! THE ULTIMATE CABINET DESIGN FOR HOUSING STEREO COMPONENTS - THE CUSTOM SOUND MODULAR EQUIPMENT CABINET. EARLY TWO YEARS IN DEVELOPMENT FEATURING:

- Flexible modular design expandable to suit any size installation.
- Accommodate any size components including the largest.
- Totally enclosed design with locks prevents dust buildup, tampering, or theft of valuable equipment.
- Bottom casters for mobility and rear door for easy rear access.
- High grade furniture design and construction.
- Very attractively priced.

Before you invest in a rack, call or write for our free illustrated information. Custom Sound Service, 8460 Marsh Road, Algona, Michigan 48001. (313) 794-5400. 11-8

Audio and TV tubes factory boxed, speakers, semiconductors—low prices, free price list. Transisleteronic Inc., 1365-39th St. Brooklyn, N.Y. 11218 212-633-2800 TF

Buy Gold & Silver Scrap

Available everywhere. Big profit. Experience, Investment unnecessary! Write for FREE INFORMATION:

L. C. Meredith

P.O. Box 11216 Reno, NV 89510

FOR SALE

ATTENTION ADVENT/AR OWNERS, the revolutionary HARTKE TWEETERS can extend the high frequency response, and improve dispersion with almost all cone type speakers.

The added open sound of these tweeters will shock your senses.

These extremely well constructed add-on, in their own walnut cabinet, come complete with built-in crossover and level adjustments. \$175 per pr.

PREPAID AND INSURED
AUDIO DEN

HEARING IS BELIEVING

1320-34 Stony Brook Road, Stony Brook, N.Y. 11790
(516) 751-3350.

ATTENTION AUDIOPHILES! We have the guaranteed lowest prices on an enormous selection of fine Audio and Video equipment. Many esoteric brands available, all are discounted. Brand new, factory sealed merchandise with full manufacturer's warranty. Defective exchange, Prompt Service. Write TODAY for a computerized price quotation! Stellar Sound, 6260 Melody Ln., Suite 1024, Dallas, TX 75231 (214)368-7197.

ATTENTION SOUTHERN AUDIOPHILES

Yamaha	Great American Sound
Dahlquist	
Polk Audio	Denon
Bang & Olufsen	Klipsch
Advent	Technics
M & K	Visionik
Aiwa	Sonus
Philips	Maxell

Available at Sound Advice

Village Plaza Ruston LA. 71270 (318) 255-8000. 9-9

ATTENTION UPSTATE NEW YORK AUDIOPHILES! House of Hi-Fi is now open with Hafler, D.C.M., Time Windows, Ampzilla (G.A.S.) Polk Audio Monitors, KEF, Harmon, Kardon STB, Sleeping Beauty, Audionics, N.A.D., Mayware formula 4 tonearm, Signet moving coils, AKG cartridges, Toshiba, Sony, and Aiwa. For Info. call 518-793-6639 Mon. to Fri. 11-9 Sat. 10-6. House of Hi-Fi, 50 Miller Rd. (Rt. 9), Glens Falls, NY 12801.

AUDIO ALTERNATIVE, A UNIQUE SPECIALTY AUDIO SHOPPE

Featuring Grado, Promethean, Signet, Supex, Win, Nagatronics, SME, Hadcock, Audiocraft, Mitchell Focus, Thorens, Micro-Seiki, Grace, Denon, ADC, Hafler, Audionics, Sumo, NAD, Conrad-Johnson, TVA-1 Marcoff, RG, Sound Concepts, Rogers, Shahinian, J.R. 149, Thiel, Mordaunt-Short, Swallow, Allison. Mail inquiries and orders promptly and courteously answered. 1124 East Elizabeth, Fort Collins, Colorado 80524.

AUDIO HOUSE - FLINT MICHIGAN

Mordaunt-Short	Marcof	Watson Lab
Audionics	Sound Concepts	Linn Isogarikis
Linn Sondek	Rogers	Setton
Bryston	Conrad-Johnson	M&K

GONZA wire is big, safe, twisted #12 Gauge speaker wire. 40' per ft. Sample \$1.00. 5232 Sagamore Dr., Swartz Creek, Mich. 48473 (313) 732-4670 by appointment. TF

Western Pennsylvania's Quality Audio Dealer

Mark Levinson	Grace
Bryston	Janis Woofers
Dayton- Wright	M&K Woofers
Watson Labs	Denon
DCM Speakers	Ariston
Snell Acoustics	Connoisseur
Linn- Sondek	Thorens
Rogers LS3/5A	Fidelity Research
Van Alstine	Supex
Hegman	Formula 4
Hafler	Decca
Magneplahn	dbx
Polk Audio	Verion
AIWA	Nikko
Dahlquist	SAE
Infinity	Armstrong
Marantz	AR
Visionik	AEI
Threshold	Technics-Pro

plus much more...

Direct -To- Disc Recordings

SHIPPED PREPAID & INSURED

OVATION AUDIO

6019 Broad St. Mall
Pittsburgh, Pa. 15206

(412) 441-4550

The transient perfect crossover!

The only active crossover that has:

- *perfect phase response
- *continuously variable frequency 45-4500 HZ
- *unique Bessel/Butterworth filter design



SYMMETRY ACS-1

design by John Curl

For dealer information:

101 Townsend Street

San Francisco, California 94107 • (415) 777-1113

FOR SALE

AUDIO CAN MAKE MONEY FOR YOU! Sell Equipment at your college. No investment; experienced saleshelp and incentive programs provided. Audio Outlet, Inc., 10 Commerce Ct., Newark, NJ 07102. 201-622-3250.

AUDIO DEN AND POLK AUDIO

The Audio Den is proud to have on display and demonstration the amazing Polk Audio Monitor Series. Our customers say "Fantastic! Compares with the finest loudspeakers I have heard. Probably the best value in the history of Audio!!!" Audiogram®, from the Audio Advisor said, "We were so impressed that we could not believe the prices . . . Other \$200 speakers simply do not come close to the standards set by the Model 10 . . . And at their price, they are simply a steal." Come in for an audition or write us for information on Polk or our other state-of-the-art products. Polk is shipped free in the continental U.S. Audio Den Ltd. 1320-34 Stony Brook Rd., Stony Brook L.I., N.Y. 11790, 516-751-3350. TF

AUDIO DEN LTD.

Long Island's leading audio store has on demonstration, THE STATE OF THE ART AUDIO RESEARCH ELECTRONICS (THE NEW SP6 TUBE PREAMP) THE NEW ACOUSTAT MONITORS EMT & GREADD SIGNATURE CARTRIDGES (AUDIO CRAFT) ULTRA CRAFT UNI-PIVOT TONEARM

We also have the following lines, B&O, Chartwell and new Chartwell woofer, CM, Denon, Fulton, Grace, Koss, Luxman, Magneplaner (including Tympani series), M&K woofers, Nakamichi, Polk, (Quad ESL and electronics), Rappaport, Rogers, RTR, Sonus, Thorens, Yamaha, largest selection of direct discs on Long Island.

FREE INSTALLATION IN NEW YORK AREA WITH IVIE SPECTRUM ANALYZER.

ALL GOODS SHIPPED PREPAID AND INSURED — COME SEE THE WORLD'S FINEST RECORD CLEANING MACHINE BY KEITH MONKS.

AUDIO DEN LTD.
1320-34 Stony Brook Road
Stony Brook, New York 11790
516-751-3350

TF

AUDIO LTD

in central Illinois

is bringing you the finest in components from

Audio Research	KEF
GAS-Ampzilla	Quad
David Hafler	Grace
Supex	Rogers
IMF	Tangent

and others. 115 N. Walnut, Champaign 61820

AUDIO REPORT

STAN WHITE Glasscote™ Speaker

AUDIO Magazine (Germany 2/78) reports on Stan White SHOTGLASS loudspeaker. "Er klingt so als ob ein im Halbdunkel spielendes Orchester poltzlich von starken SCHEINWERFERN beleuchtet wurde, so dass jeder Mann mit seinem Instrument poltzlich sichtbar wird." For further information write TACHYON, P.O. Box 204, Bloomington, Ill. 60109 Sole U.S.A. distributor. 312-529-9468.

STEREO COMPONENT Video Tape Equipment

**AKAI • B-I-C • Harman Kardon
Phase Linear • ALTEC • Kenwood •
TEAC • Marantz • Sony • Technics •
Sanyo • JVC • JBL • Pioneer • Dual •
RCA** Photographic Equipment Too!
**TO ORDER CALL TOLL FREE
(800) 421-8537**

Henry's

CAMERA HI-FI VIDEO
516 W. 8th St. Downtown L.A., Ca. 90014 Tel. 488-0341

FOR SALE

AUDIO MODIFICATION MANUAL 200+ pages of priceless information. Step-by-step procedures for many common components, general information applicable to almost anything you own. Emphasis on tube circuitry. AUDIO: "... a wealth of ideas . . ." STEREOPLUS: "easy to read, entertaining . . . a painless education . . ." HIGH FIDELITY: "chock full of goodies . . ." This unique book provides information available nowhere else. Includes one year's free consultation service. \$25. U.S.A. and Canada \$27. elsewhere. California residents add \$1.50 tax. Overseas customers provide \$7.00 for Insured Air Parcel Post. M/C, Visa orders accepted: (714) 278-3310. AUDIO DIMENSIONS, 8898 Clairemont Mesa Blvd., San Diego, Calif. 92123. TF

AUDIOPHILE QUALITY OLD RADIO. Dolby, DBX pre-recorded tapes of vintage drama, Jazz, opera, etc. Catalog \$1. Esoteric Vintage Sound, 414 Assembly Dr., Bolingbrook, Ill. 60439.

AUDIOPHILES' HIGH FIDELITY COMPONENTS!

Bose, Tandberg, Revox, Nakamichi, Yamaha, ADS, Denon, Allison, Hafler, B&O, Ohm, GAS, Genesis, Rogers, Crown, Lux, Infinity, Advent, SAE, Nikko, others. Low, Low Prices! **AUDIO AMERICA** (Virginia) 804-793-3820. Hours: 10 am - 6 pm. Call today for literature and Low Prices!

AUDIO PULSE MODEL ONE \$475, Phase Linear Speakers \$850, Pioneer Spec II. \$475, Kenwood KD-500 and Grace 707 with warranty cards \$315. All post paid. (919) 967-6087 after 6 p.m.

AUDIO RESEARCH D-100, Mint, \$850.00; TECHNICS SE-9060 (2), both for \$595.00 sealed boxes; ADS L200 minisprks. (pair) \$145.00; Marantz 250 amp (USA model) Mint \$195.00 406-282-7673.

FOR SALE

AUDIO RESEARCH SP4A, McP1-\$950.00, D350-\$2250.00, TID's \$1095.00 Lux Quartz locked direct drive, Stax Carbon Fiber & Emt, complete for \$995.00. Yamaha CT7000-\$600.00. Nakamichi DS200-\$130.00, McIntosh 2300-\$1200.00. Total \$7,220.00, or make offer for total package. T.R. Wulff, Suite 400, Century Bldg. Paducah, Ky. 42001. 502-442-7611. 7-9

Audio research D51, D76, D75A (319) 323-6567.

AUDIO RESEARCH D-100A MINT \$800.00 1-317-547-7574 (Power Amp.)

BEST OFFER (mostly) new w/full warranty: Preamps — AEA-520, ARC SP-4, Technics 9070; Power amps — ARC D-100, Onkyo M-505, Technics 9060; Speakers — Dahlquist DQ-10, IMF pro monitor mkIV; Turntable & arms — Micro Seiki DQX-500 w/MA-707, Teach TN-400 (rare magnetic float D-D) w/Grace 704; Tape deck — Teac A-3300SX; Tuner — Technics 9030; Mic — Sony C-37p; several Yamaha; Norman Lab Switcher. Allen (607) 272-8941.

BLACK WIDOW I, \$85; VAN ALSTINE/DYNA 150X \$345; Dyna PAS 3x (new tubes) \$65. All used, superb cond. (914-234-9515) eves.

ELECTRONICS

GAS • Nakamichi • Mitsubishi • AGI
Spectro Acoustics • APT • Audiopulse • ADS
Burwen • Audionics • Denon • Setton

AUDICOM HIGH TECHNOLOGY AUDIO

177 Sound Beach Ave. Old Greenwich, CT
Phone: (203) 637-3621

137



DESIGN FEATURES & BENEFITS:

ELECTRONIC CROSSOVER for reduced harmonic distortion and accurate integration of low and high frequency speakers. Not found with passive units.

BI AMPLIFICATION reduces IM distortion and improves dynamics.

CROSSOVER FREQUENCY AND SHAPE
Complex design utilizing 1st and 3rd order slopes at optimum frequency eliminating minor LS 3/5a resonances in the 70 Hz region. Coloration reduced and phase response maintained due to correct crossover shape.

MID RANGE DETAIL AND DEFINITION of LS 3/5a improved with addition of woofer system.

HIGH POWER HANDLING CAPACITY
Continuous program levels of 150-170w.

TWO BASS ENCLOSURES imperative for correct stereo imaging.

**THE ONLY WOOFER SYSTEM
TECHNICALLY CORRECT FOR THE LS3/5a**



The Reference Monitor System
Musically Superior

Rogers
BRITISH HIGH FIDELITY
Reference Monitor Int. Inc., 2380 "C" Camino Vida Roble, Carlsbad, CA 92008

FOR SALE

DAVID HAFLER REAMP DH-101
Kits \$199.95, Custom wired and tested \$299.95, Custom wired and Tested with Perfectionist Mod. \$399, Pre-reamp \$75 or \$90 installed. Pro-Perfectionist \$444.
PERFECTIONIST AUDIO LTD.
P.O. BOX 250
Pleasant Gap, Penna. 16823
(814) 359-3007

DAVID HAFLER IS BACK!

The man behind the original Dynakit is back with his own company and a new state-of-the-art preamplifier at a bargain price! Available as a KIT or CUSTOM ASSEMBLED by expertly trained wireers—each performance certified. Power Amp Kit coming this summer. Place your order now. Preamp Headamp now available. For further details write or call AUDIOKIT—260 Old Country Road, Hicksville, N.Y. 11801 (516)822-5749

DAYTON-WRIGHT XG-8 MKIII Series 3, rosewood & wheat with stands, Threshold mods, several months old / Grace 714 tonearm / Call 912-746-0037 between 6 & 12PM EST (GA).

DB SYSTEMS PRE AMP NAKAMICHI Studio Monitor Speakers, JBL HEARTSFIELD SPEAKER, McIntosh MC 60 Tube Amps. All Mint Best Offer (406) 761-8683 or 727-4115

DB-1A preamp \$400. Sae MK 31B amp \$200. Both for \$550. (816) 931-0257 after 6 PM Ask for Marty.

DISCO: MOBILE OR FIXED = CASH
START YOUR OWN DISCO BUSINESS. Complete 25 page start-up manual explaining sound and lighting systems installation written by Professional Disco DJ's and Designers. \$10.00 J.C. ENTERPRISES P.O. Box 243, Apalachin, NY 13732. TF

the audio advocate

SME
POLK
LS35A
SHURE
DECCA
CIZEK
DENON
ONKYO
QUATRE
ADVENT
ARISTON
ACOUSTAT
MAGNEPAN
FORMULA-4
NAKAMICHI
AUDIO RESEARCH

505 Millburn Avenue Millburn, NJ
(201) 467-8988

FOR SALE

DELUX power amp. LUXMAN M1500. Two switchable inputs and outputs. Subsonic filter. Peak reading meters. Rosewood case. Asking \$450. 814-234-6881.

DESIGN ACOUSTICS DEMONSTRATED NEW YORK AND NEW JERSEY

All Models in Stock
Phone your "MUSIC MAN" for demo appointment
212-463-1208 OR 516-621-2126
Custom Audio Systems Designed and Installed

DIAMOND NEEDLES and Stereo Cartridges at Discount prices for Shure, Pickering, Stanton, Empire, Grado, Audio Technica and ADC. Send for free catalog. **LYLE CARTRIDGES**, Dept. A, Box 69, Kensington Station, Brooklyn New York 11213. For fast service call toll free 800-221-0906.

DIRECT TO DISC RECORDINGS: All labels at low prices. Sheffield, Crystal Clear, Mobile Fidelity, Century. Send \$2.00 for descriptive catalog. DISConnection, P.O. Box 10705, Tampa FL 33679.

DISCOUNT STEREO - 8 warehouses now combine to offer you 188 brands at huge discounts. Stereo, high-end, car stereo, TV, video, more. Free consultation, full service & repairs. Call or write for big sale packet. AAV, 224 Winding Way, Moorestown, NJ 08057 (609) 234-3655 ext. RS.

Does your cartridge have TQA? The Supex SD-900/E+ Super and SD-901/E+ Super moving coil cartridges do. If your cartridge does not have TQA you may be paying too much for too little. What is TQA? Total Quality Assurance and each and every Supex moving coil cartridge has it. For complete information on TQA and Supex moving coil cartridges, see your local Supex dealer or write to: Sumiko, Inc., P.O. Box 5046, Berkeley, CA 94705.

DYNACO TRANSISTOR/TUBE COMPONENTS — FREE LIST. SCC, BOX 8014, CANTON, OHIO 44711

DYNACO WALNUT CABINETS (for all "faceplate" models): CAB-1D (Single), \$19.95; CAB-2D (Double), \$24.95. Greatly improves Dynakit appearance! "Quadaptor: QD-1/Kit, \$9.95; QD-1/Wired, \$24.95. Postpaid. SCC, Box 8014, Canton, OH 44711. 5-9

ELECTRONIC CROSSOVERS — ALL TYPES Updated definitive booklet describes applications, how to improve speaker systems; \$5.00 postpaid, credited to first purchase. Huntington Electronics, Box 2009-A Huntington, Conn. 06484.

ELECTROSTATIC TRANSLATORS ARE HERE

Come and audition this fine new line of electrostatic loudspeakers along with: Audire, Audio Technology, Celestion, Clarke, Decca, Grado, Braun Satellites and subwoofer etc. . . .

PERSONALIZED AUDIO

723 Bound Brook Rd., Dunellen, NJ 08812
Appointments available call 201-752-3883

FOR SALE

EQUALIZATION TEST RECORD Octave bands of pink noise on 7" EP. \$2.00 postpaid. Crosswind Records, Shrewsbury, Pa. 17361

ERC D-76A + ARC fan base! Retubed and spec'd 1-75 \$900. SA6A \$1000 and SP3A2, \$550. Phone: 408-738-3310.

**FASTER THAN A
SPEEDING BULLET
MORE POWERFUL
THAN A
LOCOMOTIVE
ABLE TO PASS
PULSES IN A
SINGLE BURST**

IS IT A BIRD?

IS IT A PLANE?

**NO! IT'S THE INCREDIBLE
VANDERSTEEN
MODEL II
SPEAKER SYSTEM**

Exclusively at

AMERICAN AUDIOPHILE

716 Madison Ave., New York, NY 10021

(212) 751-9733

5 Sunrise Plaza, Valley Stream, NY 11581

(516) 561-7114

**ALL SHIPMENTS PREPAID AND INSURED
FREE THROUGHOUT CONTINENTAL U.S.A.
MASTER CHARGE & VISA ACCEPTED**

Fine Raw Speakers, woofers, bextrenes, soft domes, ribbon tweeters w/data, x'over parts, dual power supply amps. \$1 for literature. TA Box 927, W. Cornwall, CT 06796.

FLINT — Michigan Mordaunt-Short, Audionics, Linn Sondek, M&K Subwoofers, Bryston, Sound Components, Watson Labs, Roger, Visonik-David, Conrad-Johnson, Spectro, Acoustics, Sopex, Grace. Gonza wire is big safe # 12 gauge speaker wire! 40¢ per ft. Rice paper record covers 25 for \$7.50. Samples \$1.00 Audio House, 5232 Sagamore Dr., Swartz Creek, Mich. 48473 (313) 732-4670 by appoint. only.

FOR SALE: KOSS MODEL 1A SPEAKERS \$1850. ORTOFON MC-10 CARTRIDGE \$55. (212) 454-3205.

FOR SALE OR TRADE: QUAD 405, AIWA 6900 cassette
SME 3, 1-713-729-1658.

"For Sale. Six Used Polaroid Land ID System Cameras with Laminator for Photoidentification cards. Contact Greer at Commercial National Bank, Little Rock, Arkansas, (501) 378-3399."

FRANK VAN ALSTINE MODIFICATIONS for Dynaco, Audio Research, Dahlquist, Paragon, and other audio components can be the most cost effective way for you to achieve State of the Art audio performance. Our FET-5 MARK 5 mod for the PAT-5 & PAT-5 BIFET will equal the performance of any preamp in existence. The DOUBLE 400 SERIES 2 is all new with vastly improved sound. It's new life for your St-400 or St-416. **FREE MOD PLANS** for the Dyna ST-70 and PAS with a large stamped envelope. Low cost updates for any units we have modified in the past. New power supply mods for the ARC SP3A.

Read the esoteric magazines, our mods work.
JENSENS STEREO SHOP 2202 RIVER HILLS DRIVE
BURNSVILLE, MINNESOTA 55337 612-890-3517 1-0

FULTON PREMIERE SPEAKERS, mint, \$2500 delivered; Paoli 60 Me amplifiers, better sound than D76a, \$500; (617) 648-4191.

AUDIO RESEARCH • JANIS • GALE • BREUER
• TECHNICS •
Audio Reference Systems • MAGNEPAN •
808 • 732-3303 • Kahala Office Center
Suite 201 • Honolulu, Hawaii 96816
• ROGERS • GREAT AMERICAN SOUND • SONEX

AT SOUND COMPONENTS, INC. WE'VE GOT IT ALL

Audionics Bang & Olufsen Beveridge Cylindrical Bryston
. . . . DCM. . . . Denon Dynavector Fidelity Research Fulton . . .
Grace Great American Sound Hafler H.Q.D. Reference System
. . . . Janis KEF Kenwood Purist Linn Sondek Magnepan . . .
Mark Levinson Paragon Pyramid Metronome Quad Rega
. . . . Rogers Sonex Spondor Stax Verion Yamaha . . .

Master Charge & Visa accepted

We ship prepaid within U.S.

SOUND COMPONENTS, INC.
2710 Ponce de Leon Blvd., Coral Gables, Fla. 33134
(305) 446-1659

Audio's Book Store...

Your Best Source to Build a Worthwhile Library for these Reasons:

Audio Editors are Always Searching for Worthwhile Books and Manuals for Our Readers.

Audio Editors Review these Books and Manuals, and Choose the Ones that Offer the Most Up-to-Date Information and Technical Knowledge for Audio Readers.



No. 759—Audio IC Op-Amp Applications. Newly revised 2nd edition includes many new high-performance audio circuits.

No. 755—Direct Current Motors. Understand the most-basic electric motor of all. Includes testing and maintenance section.

No. 750—Japanese Servicing Manual. Fix-it data with schematics on Hitachi, Realistic, Sanyo, Sharp, Soundesign, Superscope, and more.

No. 751. Microphones. Complete manual shows how to record anything. Special section tells how to interpret spec sheets.

No. 756—Home Audio Systems, Vol. 1. Most up-to-date service/schematic manual for Capehart and Zenith.

No. 757—Home Audio Systems, Vol. 2. Latest service data for Channel Master, Hitachi, and Coronado. Includes schematics.

No. 758—Home Audio Systems, Vol. 3. Repair Admiral, Automatic Radio, Midland, and Sharp with this complete service manual.

No. 754—Photo Guide to AM/FM Stereo Repair. Step-by-step troubleshooting guide shows what parts break down and how to replace them.

No. 753—Antenna Construction Handbook. CB, ham, and SW listeners can build high performance antennas for their custom rig.

No. 752—Design, Build & Test Speaker Systems. Do-it-yourself guide shows beginner and expert how to get the best from a speaker.

- 759, AUDIO IC OP-AMP APPLICATIONS, \$4.95
- 755, DIRECT CURRENT MOTORS CHARACTERISTICS & APPLICATIONS, \$14.95
- 750, JAPANESE RADIO, RECORD & TAPE PLAYER SCHEMATIC SERVICE MANUAL, \$7.95
- 751, MICROPHONES—HOW THEY WORK & HOW TO USE THEM, \$5.95
- 756, HOME AUDIO SYSTEMS/SERVICE MANUAL VOL 1, \$5.95
- 757, HOME AUDIO SYSTEMS/SERVICE MANUAL VOL 2, \$5.95
- 758, HOME AUDIO SYSTEMS/SERVICE MANUAL VOL 3, \$5.95
- 754, PHOTO GUIDE TO AM/FM STEREO REPAIR, \$6.95
- 753, THE ANTENNA CONSTRUCTION HANDBOOK FOR HAM, CB & SWL, \$5.95
- 752, HOW TO DESIGN, BUILD AND TEST COMPLETE SPEAKER SYSTEMS, \$6.95

Please send me the book(s) I have checked.

AAM6

Enclosed is my proper remittance for \$ _____

I understand if I am not fully satisfied I may return my selection(s) in undamaged condition within 10 days for a full refund.

Name (please print) _____

Address _____

City/State/Zip _____

Please allow 4-6 weeks for delivery.

YOU MAY PAY FOR YOUR BOOK(S) ON YOUR CREDIT CARD

CREDIT CARD NO. _____

VISA AMERICAN EXPRESS DINERS CLUB

MASTER CHARGE _____ M/C BANK NO. _____

NUMBER MUST APPEAR

IF USING MASTER CHARGE

EXP. DATE _____

Audio

Book and Learning Systems Division

North American Publishing Company, North American Building,
401 N. Broad Street, Philadelphia, PA 19108

FOR SALE

AUDIO TECHNOLOGY L.E.D. READOUTS MODEL 510. \$109.95 each plus \$3.00 postage and handling. C.O.D.'s if desired. PA res. add 6% tax. E & A Associates, 501 North St., Marion Heights, PA 17832 or call (717) 373-1470 or (717) 339-3243 after 5:30 P.M.

"A-1 SOLUTION FO MC CART. /PREAMP INTERFACE Consider the MCT-1, a passive device with twin transformers in mu-metal containers. band-width: 0, -1db 10Hz, to 22.5 volts out. \$299 Amer. \$340 Can. RWR Audio Ltd., Box 3080, Station D, Ottawa, Canada K1P 6H6 Or send for literature."

BRAND ELECTRONICS Florida's heading Crown Dealers is honored to now have the amazing DL-2 Distinction pre-amplifier in stock. Designed to be State-of-the-Art. Years from now using computer technology. Treat your ears now to the Crown DL-2 at Brand Electronics - from Jacksonville to Miami. Brand Electronics, 3550 N.W. 77th St., Miami, Fl. 33122.

BRYSTON AMPLIFIERS USED SIX MONTHS. Five year warranty transferable, original owner, 2B, \$350 - 3B, \$550 - 4B, \$900. Also, THRESHOLD N510, as above, \$650. Contact Mark or Todd, 713-527-0774.

FOR SALE

"BONGIORNO IS BACK"

After more than 1 1/2 yrs of absence we are proud to announce the new Sumo Amplifier. It is different in every way - and consistent with the advancements of designs by James Bongiorno.

In the past, Mr. Bongiorno has designed the Dynaco 400, the entire line of S.A.E. amps, and more recently the products from G.A.S. These were and still are great products. But time moves on and new progress and new ideas must be born.

The new Sumo amplifier will be at your dealer soon along with the Sumo preamp. They will also have features that are new and original, but at prices that can be afforded, in the Bongiorno tradition.

The Sumo cartridge
The Sumo Bridge
The Very Clever Little Crossover
The Sumo Preamp
The Sumo Amplifier

See Them Soon
SUMO ELECTRIC CO. LTD.
1230 N. Horn Ave.
W. Hollywood, CA 90069
(213) 659-4370

BOULDER SOUND GALLERY, LTD. The Rocky Mountain region's audio dealer with a point of view. We carry LUX/LUX L.R.S., B & W, Mark Levinson, Spondor, Denon, Dahlquist, Stax, Polk, ADC tone-arms, Signet, Van Alstine, Quad, the K-M System, Janis, R.H. Labs, JSH Labs, N.A.D., Revox, Conrad-Johnson, Chartwell LS-3/5-A, etc. If your goal is to get from the source material back into the air with the least possible change, we can help.

B & O 4002 TURNTABLE, EC \$375 (616) 375-3478.

BLANK TAPE: PREMIUM SCREW CASSETTES loaded with AGFA PROFESSIONAL I: C60 \$1.25; C90 \$1.60; C120 \$2.50. If you like Maxell, try these! DuPont Crolyn C90 \$2.40. Min order 10 cassettes. REEL: NEW AMPEX 642 LN/HO: 3600' pancakes 6/\$35.76 or respoiled 1800' reels (boxed) 10/\$37.80. Shipping \$2.00 per tape order. AIWA CASSETTE DECKS: new, custom adjusted for Agfa tapes: 6300 \$205; 6600 \$405; 6900 \$765. Shipping \$4/deck. NJ residents add 5% sales tax to orders. Direct-to-Tape Recording Co., 14 Station Ave., Haddon Hts., NJ 08035.

B&W BM 7's Rosewood McIntosh MC60 Tube Amps Nakamichi 630 Tuner preamp SAE Mark IDVM Amp All mint Best Offer (406) 761-8683 or 727-4115.

CAMPUS REPRESENTATIVES — Earn big money selling hi-fi as a QSI Campus Rep! For info. contact Quadrasonic Studios International, 9320 Keeler Ave., Skokie, IL 60076

FOR SALE

BRYSTON 2B \$400., Kamaha T-2 \$500., Rappaport Pre-1 \$425. 215-535-8928.

Circuit boards and parts for builders of M. Leach's revises Low TIM 3 Amplifier, new FET Wide Bandwidth Preamplifier, Push-Pull Pre-amplifier, and Strapping Circuit. Send stamped envelope for price list. Custom Components, P.O. Box 33193, Decatur, GA 33033.

COMMUNICATIONS CO.-REAL TIME ANALYZER Model 411 (uses 24 VU meters) w/scope display adapt./carrying case. Excellent operating Cond. \$1000. + shipping. Specialized Audio, Inc., RD # 5, Rt. 50 & Hutchins Rd., Saratoga Springs, NY 12866. (518) 885-8966.

CONCRETE TURNTABLES BY MAIL

You won't get any feedback with Kenwood Concrete Resin Direct Drive turntables. Available "armed and armless" from Designatron. New Quartz-lock models available also. 260 Old Country Road, Hicksville, NY 11801. In stock. U.P.S. to continental U.S.A. Write for quote or call (516) 822-5277.

CONNECTICUT: A.D.S., Advent, A.P.T. Holman Audio Pulse, B&O, B.I.C., Citation, Dahlquist, D.C.M. Time Windows Epicure, Hafler Harman/Kardon, J.B.L., Mitsubishi, Nakamichi, Ortofon, Phase Linear, Micro-Acoustics, N.A.D., Stax, Tandberg, Yamaha, Cizek, Sonus. Will ship prepaid. Sounds Incredible, 39 Federal Road, Brookfield, CT, 06804. (203) 748-3889—phone quotes only. TF

CONNOISSEUR BD1 TURNTABLE Belt Drive. 37 logged hours. w/mtg hole for Grace 707. \$75 408-279-1425, 259-9648.

CROWN SX724, tape counter, pro hubs. Excellent condition, \$700 firm. (303) 481-2758.

DAHLQUIST DQ-10 OWNERS UPGRADE YOUR SPEAKERS TO THE LATEST PRODUCTION MODELS. MYLAR CAP AND MIRROR IMAGE MODS DONE IN YOUR HOME (NYC VICINITY) (212) 454-3205.

DALLAS / FORT WORTH

Magnepan	Acoustat
Denon	GAS
Dahlquist	Audio Standards
Advent	Cizek
Stax	Grace
HK	Bic

Keith Monks Record Cleaning Machine

AUDIO VISION, in Carillon Plaza

13601 Preston at Alpha, Dallas, 233-8513

DB PRE-AMP 200. VAN ALSTINE Md. 1 pre-amp 200. Jerry Schade, Box 31071, Omaha, Neb. 68131 (402) 553-1553.

NEW ENGLAND AUDIOPHILES Goodwin's Inc. is unique in the audio field, offering a few select products which are acknowledged to be the finest. These products are properly set-up, and may be auditioned in a comfortable, relaxed, living room environment.

Our reference is the Mark Levinson HQD system, with 30ips master tapes played on a Mark Levinson Studer A-80. The degree to which this system approaches the sound of live music is literally breathtaking.

Goodwin's represents: Mark Levinson, Quad, Linn Sondek, Syrinx, Verion, Draco, Symdex, Precedent Audio, Fidelity Research, Pedersen Acoustics, and Win Labs.

If you would like to avoid the planned obsolescence of most stereo components, and are interested in the finest music reproduction, please call Goodwin's for an appointment.

Goodwin's Inc.
(617) 266-0608

33 Newbury St.
Boston, MA 02116

TURNTABLES

Denon • Vlsonic • Supex • Linn Sondek
Transcriber • SAEC • Grace • Steeping Beauty
AKG • Formula 4 • Dynavector • Mitsubishi

Audiocom HIGH TECHNOLOGY AUDIO
177 Sound Beach Ave. Old Greenwich CT
Phone: (203) 637-3621

140



THE AUDIO ALTERNATIVE

FINE AUDIO COMPONENTS
FOR THE
DISCRIMINATING LISTENER

CSA AUDIO

Designs featured by CSA:

Beveridge
SUPEX

dw
DAYTON
WRIGHT

KEF
FRIED

J
Loudspeakers:

QUATRE
cb

LABS

Grace

sound
concepts

Linn Sondek

MERIDIAN

van alstine

GRADO SIGNATURE
RADFORD

ARISTON
AUDIO

THIEL

after

Stax



CONTEMPORARY
SOUND
ASSOCIATES

PRIVATE LISTENING
AUDITIONS BY APPOINTMENT

10 min from G.W. Bridge Route 46W to
Passaic Ave. and left, then first right
before overpass.

35 LITTLE FALLS ROAD, FAIRFIELD, N. J. 07006 201/575-1135

FOR SALE

FREE SHIPPING & THE LOWEST PRICES

12 MAXELL UDXL I or II C-90 TAPES @ \$3.39 each (\$40.68 per carton)

10 TDK SA-90 tapes @ \$2.99 each (\$29.90 per carton)

DISCWASHER Brush & Fluid \$9.95

DISKIT - Includes brush, fluid, zerostat, SG1 Stylus cleaner and organizer \$32.75

This is just a sample of our extensive line of audiophile equipment . . . at prices everyone can afford. To place an order, send CERTIFIED CHECK OR MONEY ORDER and add NOTHING for shipping, handling and insurance to anywhere in the Continental United States. All tapes sold in cartons only. To obtain a brochure in our line of high end, name brands, and economic audio systems, just send your name and address to:

AUDIO SYSTEMS II
200 West 57th Street, Suite 1004
New York, N.Y. 10019

GAS THOEBE preamp-\$295. Recently recalibrated by GAS. (507) 288-9006 mornings.

G-B ELECTRONICS

Audio sales and laboratory service in northern New Jersey since 1945. We offer: Snell Acoustics, Spondor, Symdex, JR, Gale, Threshold, Conrad-Johnson, Rappaport, AGI, Leach, Denon Electronics, Denon Turntables, Linn-Sondek, Linn-Naim, Connoisseur, Grace, Hadcock, Promethean, Decca Products, Platter Pad, Audio Source, Sheffield, Crystal Clear & Levinson discs and others. G-B Electronics, Box 385, Hawthorne, N.J. 07507 (201) 427-8885 for appointment. We welcome mail orders, free shipping.

GET INTO BROADCASTING! Learn how to receive free records, tapes, get an FCC broadcast license, start your own station. Free details. "Broadcasting", Box 130-N5, Paradise, CA 95969.

GRAMOPHONE CLASSICAL CATALOG (June, '79 issue). Pre-publ. price: \$5.25 postpaid. Reserve now. Baird Records, Box 17947, Memphis, TN 38117.

GREAT GRACE & SUPER SUPEX

We have in stock the Grace 707 MK2, 704, F-8L, F-9L, Linn mods for the 707 MK1 & MK2 & the Supex SD-900/E+ Super. Free shipping in the U.S. Visa & M.C. honored. Demo. by appt. OXFORD AUDIO CONSULTANTS, Box 145, Oxford, OH 45056, 513-523-3895. Eve. & weekends too.

G.A.S. AMPZILLA II, Fulton RTR electrostatic tweeters, 'rare' Fulton Mono-Amps. Call (414) 647-6530 evenings.

HAFLER DH-101 PREAMP

We expect to be in stock on this exciting new preamp by Dec. 12th. Kit price is \$199.95. Custom wired and tested, \$299.95. Immediate prepaid shipment shipment via UPS. THE AUDIBLE DIFFERENCE, 435 Tasso, Palo Alto, California 94301. (415) 328-1081. TF

HAFLER: PREAMP, HEAD AMP, AMP & ACCESSORIES

We have in stock the DH-101K \$199.95, DH-101A \$295.95, DH-102 head amp \$74.95, DH-103 black knobs \$19.95, DH-104 rack mount kit \$24.95, DH-105 preamp cabinet \$24.95 & DH-101A with DH-102 installed \$375. We anticipate having the DH-200K \$299.95 & DH-200A \$399.95 amps by June 15, 1979. World-wide shipping. Free shipping in the U.S. Visa and M.C. honored. Demo. by appt. OXFORD AUDIO CONSULTANTS, POBox 145, Oxford, OH 45056, 513-523-3895. Also open evenings & weekends.

HAVING TROUBLE FINDING DIRECT-TO-DISC AND SOTA RECORDINGS? WE HAVE THEM ALL. SEND FOR FREE CATALOGUE. KNOT SO CHEAP RECORDS, 705 BIG BEND, DEPT. AM12, WEBSTER GROVES, MO 63119.

SPEAKER SYSTEMS

Beveridge • Rogers L35A • JR Rogers 149
DCM • Snell Acoustics • Dahlquist • ADS
Allison • Mitsubishi • BW • Janis

AUDIOCOM HIGH TECHNOLOGY AUDIO
177 Sound Beach Ave. Old Greenwich, CT
Phone: (203) 637-3621

FOR SALE

HAFLER PREAMP CABINETS. Literature. GEOMETRIX, Box 612, Mexico, MO 65265 7-9

HARTLEY LOUDSPEAKERS—New improved 24" super-woofer chassis now with the Equalized Flux Module magnet design: \$400. Complete 24" super-woofer system with enclosure and crossover, \$990. Also, 18" chassis: \$350; or complete system \$625. HARTLEY full range systems from \$192 to \$3450. Orders shipped direct from HARTLEY factory. Send orders and inquiries to: SOUND SERVICES, Lake Walton Road, Wappingers Falls, NY 12590. Telephone: 914-226-5414. TF
VISA MASTERCHARGE

HARTLEY 24 with 14 foot folded transmission line. (206) 857-6635.

HEAD AMP HEADQUARTERS

We have the finest head amps available: Denon HA-1000 \$440, Hafler DH-102 \$74.95 (we can tell you how to build an ac supply), Lentek head amp \$160, Linn & PNAG \$300. Free shipping in the U.S. Visa & M.C. honored. Demo. by appt. OXFORD AUDIO CONSULTANTS, P.O. Box 145, Oxford, OH 45056 513-523-3895. Eve. & weekends too!

HEATHKIT TV CABINET, GRA-602-25 for GR-2000 or 2001 TV's. \$150. NO SCRATCHES. 408-279-1425 day. 408-259-9648, evens.

HI-FI ENTHUSIASTS WANTED!!! Earn more than just spare money in your spare time. We need campus representatives to sell name brand stereo components at discount prices in your area. No investment required. Serious inquiries only please. Contact: Mail Order Dept., K&L Sound Services Co., 75 N. Beacon St., Watertown, Mass. 02172 TF

HIGH-END AUDIO AT LOW LOW PRICES! Aiwa, Allison, Audio Pulse, Bose, DBX, Cizek, ESS, Luxman, Micro Seiki, SAE, Technics Pro and many more! All factory fresh with full warranty. For discount price call 212-254-3125. Or send \$2.00 for our catalogue and price list to DIRECT DISCOUNTS LTD, P. O. Box 841, N.Y., NY 10003.

HIGH END DEMO SCRATCH AND DENT SALE

It is time to clear out the demos! All units perform as new, but are soiled, scratched, or dented. AMPS: Quatre Gain Cell DG-250C \$499; AMPS & PREAMPS: ELECTROCOMPANET amp and preamp \$1100; PREAMPS: Analogue Engineering Associates (AEA) 520 \$399, AEA 515 Headamp \$130, Dayton Wright SPL \$250; RECEIVERS: Wintec R-1120 \$395; TURNTABLES: Denon DP-7000 (no base or arm) \$525, Denon DP-7000 w/DK-2000G two arm base \$735, Connoisseur BD-130 (no arm) \$150, Connoisseur BD-103 w/Grace G-707 arm \$250; Cassette; Denon DR-350 \$290; Speakers: Lentek S-4 \$350 pr., Monitor Audio MA-5 Mk. II \$200 pr. \$250 pr., Sonex II \$433 pr., Thiel 01 \$247 pr., Thiel 02 \$122 pr. Thiel 03 \$525 pr., TONEARM: Denon 307 \$157. Prices firm. Call day time only.

PERFECTIONIST AUDIO LTD.
P.O. Box 250
Pleasant Gap, Pennsylvania 16823
(814) 359-3007

FOR SALE

How is it that the inefficient, noisy, distortion prone, archaic vacuum tube can retain any acceptance among serious audiophiles? Why do manufacturers, large & small still expend enormous creative energy in designing and making tube equipment? Who cares? We do . . . MR. AUDIO'S BIMONTHLY expounds the gospel of tube equipment but not at the exclusion of all else. We concede to permit solid state MC head amps, xovers, bass amps & the like in a music system. The tenacity with which tubes cling in spite of advanced solid state technology is a mystery to some — but not to us. MR. AUDIO'S BIMONTHLY — 6 issues 1st class \$15. Overseas \$18 — P.O. Box 3022, Monterey, Ca. 93940.

INSIDERS know that AUDIO FORUM MAGAZINE provides the most extensive coverage of the esoteric audio market . . . Do YOU? Audio Professionals know how AFM helps them to keep in touch with the ever-changing audio market with vital information often exclusive, always first, months before the others. Audiophiles like the first reports on new equipment, ways to improve their systems, and increasing their understanding of some of audio's most complex and controversial topics. You should subscribe today. Send \$18 (1st class) or \$22 U.S. (overseas air) for six bi-monthly issues to AFM, Box 22544 A-5, Portland OR 97222. BAC/MC honored. Full MONEY BACK GUARANTEE if not satisfied.

INVISIBLE HANGERS FOR ADS, Braun, Visonik/David speakers. Pair \$12.00, \$1.00 postage. Plexiforms, 1016½ Gilbert Court, Iowa City, IA. 52240

IVIE ELECTRONICS REAL TIME ANALYZERS, etc. Some very slightly used demonstrators at discount. Full factory warranty. Money-back guarantee. JML Company, 39,000 Highway 128, Cloverdale, CA 95425.

WOOFERS • MIDRANGES • TWEETER ZERO PHASE ERROR CROSSOVERS

High power handling 5 1/4" midrange unit • One hundred watt 6", 8", 10" & 12" woofers with 4.7 lb. or 7.6 lb. magnet structures • High quality 1" cloth dome tweeter with 3 lb. magnet structure • Wide dispersion, low distortion piezoelectric tweeter handling 150 watts r.m.s. • Revolutionary new ZERO PHASE ERROR CROSSOVERS built on glass epoxy printed circuit boards for 2, 3 & 4-way systems • Crossovers are matched to system utilizing our drivers or systems utilizing the high quality POLYDAX units mfg. by AUDAX in France • Large inventory of nonpolar capacitors, non-inductive wire wound resistors & air-core coils. Custom crossovers designed to your specifications.

SEND \$3.00 for prices & CATALOG of complete engineering data, application notes and simplified procedures for measuring Thiele and Small's parameters, refundable with order.

EMS, inc. 615/546-7374
2727 Magnolia Ave.
Knoxville, TN 37914

... they thought our preamp was sensational!



THE BEST IS YET TO COME

in June
DH-200 power amplifier

Advance information on request

The David Hafler Co., 5817 Roosevelt Ave., Pennsauken, N.J. 08109

FOR SALE

IS YOUR PREAMP MERELY "STATE OF THE ART"?
The new Crown DL-2 preamplifier is the result of a totally uncompromised effort to design the quintessential preamp. Only Crown has the engineering expertise to conceive and construct a preamplifier whose sound quality surpasses its superior specifications. Discerning audiophiles know that BARCLAY is also dedicated to satisfying those listeners who strive for the finest musical reproduction attainable. We feature the complete Crown "Distinction Series," including the new SA-2 amplifier (500 watts/4 ohms) and the EQ-2 equalizer (unquestionably the world's best). Visit our showrooms to see and hear the Crown DL-2 preamplifier: tomorrow's "state-of-the-art" preamp available today.
BARCLAY RECORDING & ELECTRONICS
233 East Lancaster Avenue
Wynnewood, Pa. 19096
(215) 649-2965

1-9

JACK THE GIANT KILLER

Among the many megabuck amplifiers we find the humble AUDIONICS CC-2, a modest 70-Watt stereo amplifier (bridgeable for 225 Watts) with the sonic integrity that the giants offer but rarely deliver! The \$489 AUDIONICS CC-2 DELIVERS! Audition the AUDIONICS CC-2, PZ3 & BT2 at

AMERICAN AUDIOPHILE
716 Madison Ave., New York, NY 10021
(212) 751-9733

5 Sunrise Plaza, Valley Stream, NY 11581
(516) 561-7114

ALL SHIPMENTS PREPAID AND INSURED
FREE THROUGHOUT CONTINENTAL U.S.
MASTER CHARGE & VISA ACCEPTED

FOR SALE

JAZZ PATTERNS (Gambino) \$6.95; Substitutions Manual (Minasi) \$3.25; Free Catalog-Sunrise Artistries, Box 125, Maspeth, NY 11378.

KENWOOD AUDIO PURIST (1) L-07C, (2) L-07M's 6 months old 995.00 505-255-5665 N. Mex.

Klipschorns, unfinished, split shipping, \$1195. Denon AU320 trans., \$70. Grace 707 arm, \$70. Pioneer TX-9500 tuner, \$175. DBX 124, \$200. (612) 388-4683.

KOETSU is here. The legendary handmade moving coil cartridge is now available in the U.S. For the complete story, write: Sumiko, Inc., Box 5046, Berkeley, CA 94705.

KOSS PHASE/2 HEADPHONES—\$25. (404) 633-3822.

KUSTOM ACOUSTICS IN OHIO (513) 523-3467.

"K.L.H. 9 Electrostatic Speakers; 4 Panels; Bases; Absolutely Flawless; Cartons, \$1800. Paoli Amps \$350. Offers & Swaps considered. Eves. 914-769-4659.

LONG HAIR WOOL carded — cleaned for stuffing speakers, \$7/lb incl. ship. J. Ebbert, 770 Holly Rd., Wayne, PA 19087 (215) 687-3609

LOWEST DISCOUNT PRICES ANYWHERE on audio equipment. All major brands discounted. Write for quotes, K&L Sound Services, 75 N. Beacon St., Watertown, Mass. 02172. TF

LOWEST POSSIBLE PRICES! Most stereo brands! Request quotes only! Allegheny, Box 1029-U3, Johnstown, PA 15907. 7-9

LOWEST PRICES ON STEREO-ESOTERIC COMPONENTS & Tapes! Over 150 brands. Send #10 SASE for quotes. Audio Unlimited, 401 Reynolds Circle #12-C, San Jose, CA 95112 (408) 289-8875 1-6 Monday-Friday. 5-9

"**LOWEST PRICES: BOSE, SAE, DBX, TANDBERG, ADS, HK, JBL, AND MORE.** DYNAMIC SOUND, Box 168, Starkville, MS 39759. (601) 323-0705. 1 P.M.-9 P.M."

LUXMAN R1120 Receiver. \$700. (913) 776-9045.

FOR SALE

LUX PD-121 \$350; S.A.E. C. WE-308 \$150; Yamaha C-2 pre-amp \$450. All in perfect shape. Call (318) 828-5597

L.A. — SOUTHERN CALIFORNIA

STAX	KOSS ELECTROSTATIC
THETA	SEQUERRA-PYRAMID
DENON	DECCA RIBBON
OSAWA	LINN SONDEK
LENTEK	ULTRACRAFT
ROGERS	SATTERBERG
TANGENT	AUDIONICS
MERIDIAN	SERIES 20

PROFESSIONAL SYSTEMS ENGINEERING (PSE)

There are seven high-end audio stores in Southern California. If you are interested in equipment which is sold on its merit, then it will pay you to find out about what we have to offer.

EXECUTIVE AUDIO

BY APPOINTMENT ONLY (213) 394-6463
2210 Wilshire # 207 Santa Monica, Ca. 90403

MAGEPLANAR Tynpani 1-C, black, mint; \$750. Steve Bruenn, 3609 N.W. 4th Ct., Boca Raton, FL 33431. 305-392-0711 (after 8 PM) 6-9

MAGNEPAN MG II \$485 Harmon Kardon ST-7 \$250 906-485-4174.

MAGNEPLANAR TYMPANI 1-C \$795. Levinson JC-lbc head amp \$65. Sennheiser HD-424 headphones \$45. Sheffield direct disc "The Missing Link" \$85. 901-754-3010 2-3 pm CST

MARANTZ 4400 QUAD RECVR, CD-400 Demod., 115 Tuner, 1070 Amp. Tim Bulgrin, Owen, WI 54460 (715) 229-2146 day, 229-4464 night.

McIntosh -C28 \$425., SME 3009II w/2 extra Head Shells \$90. Call Ron (212) 426-6374.

Metal Film Resistors, RN55, 1%, 75 values from 10 ohms to 1 Meg., 12¢ ea. Send stamped self addressed envelope for list of values. Gold plated panel mount phono jacks, 90¢ ea. Nylon panel insulators for jacks, 10¢ for a \$1.00. Gold plated shielded metal phono plugs, \$1.00 ea. All ppd. Component Systems, 5556 Personality Ct., Indpls., IN 46227.

METRO-NEW YORK CITY

G.A.S., FR, Dahlquist, B&O, Lux, Linn Sondek, AVID, Janis, Baure & Wilkens, Grace, Tangent, R.H. Labs, Direct Discs, Grado, many others. All issues of Absolute Sound.
UNIVERSITY STEREO-Ridgewood, N.J.,
57 E. Ridgewood Ave. (201) 447-5700
20 minutes from G.W. Bridge 12-9

MILWAUKEE! THE AUDIO EMPORIUM—NAD (New Acoustic Dimension) receivers/integrateds, remarkable electronics that are price competitive with masses yet rival top separates, NAD proves receivers can sound good with critical speakers (Polk, Magnepan etc.) Model 7060 (60 w/ch) only \$490. ARC, B&O, Connoisseur, Dahlquist, Decca, Denon, GAS, Genesis, Grace, Grado, Grafyx, Hafler, Lux, M&K, Magnepan, NAD, Polk Audio, RH Labs, Revox, Rogers, Shreve-Rabco, Sonus, Sumo Electric Co, Supex, Technics, Platter Pad, Audio Perfectionist Cables — many direct discs. Open Tues. thru Sat. 10-6, 6900 W. Brown Deer Rd., 354-5082

142

Goo, Screw & Save YES, KITS!

Choose from The World's Largest Selection of Speaker Kits including **FRIED, DALESFORD EXPORT, JANSZEN ELECTROSTATS & SEAS.**

Here's just one example:
DALESFORD EXPORT SYSTEM 110

\$185 each
complete kit
(\$275 ea., if pre-assembled)



Dalesford low-coloration Bextrene drivers are world-renowned and used in many highly praised systems. The System 110 uses the Dalesford 10" Bextrene bass/mid unit combined with the famous 1" Audax low mass soft dome tweeter. Response is ±3 dB from 40Hz to 20Hz. An advanced multi-element compensating crossover is used and the specially-designed enclosure is damped with bituminous felt and Australian long-fiber wool. Power handling: 20-100 Watts RMS/Ch. Specs & Prices subject to change without notice.

No matter how good your other components, you won't hear high definition sound if your speakers can't reproduce it!

FREE MINI-CATALOG—OR SEND \$1 FOR NEW SPEAKER MANUAL/COMPLETE CATALOG
(\$1 Refunded with Purchase)

"The Speaker Specialists"
Sonikit 1173N-65th Street
Oakland, CA 94608

For Free Mini-Catalog, Use Reader Service Number Below.
 Here's my \$1 check—send my Speaker Manual/Catalog.

A11

Name _____

Address _____

City _____

State _____

Zip _____

Reduce acoustic feedback!

12⁹⁵
post. pd.

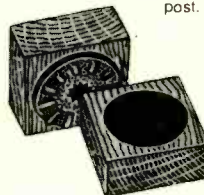

ISOMATE™
mounts
for turntables

10 db more power without distortion, howling, or mistracking from structure-borne sound. Block speaker vibration, shock from your turntable/stylus. 4 isolators in walnut feature high-damping, low resonance, designer styling. Satisfaction guaranteed.

ENID Corp., Box 194-16 Riverside, Ct. 06878

Audio's Growing Edge Now in its tenth year, **Audio Amateur**, a quarterly for the audiophile who wants to know why and how—\$12 for four issues, featuring Jung & White's PAT-5, Nelson Pass' 40W Class A amp, The Mark 1 preamp from Berkeley Space Center's audio group, Audio Research Corp.'s Stereo 70 mod, direct driven electrostatics—plus much more. **W. Marshall Leach says** "...one of the outstanding values for the amateur."

The AUDIO AMATEUR MAGAZINE, P.O. Box 176, Peterborough NH 03458 A19

Send four issues for \$12. Tell me more Charge Card orders include card Nos. and signature

NAME _____

Street _____

Town _____

State _____

ZIP _____

FOR SALE

MICRO-SEIKI DDX 1000 turntable. New in the box. \$385.00 Also, DD-40 turntable with 505 tonearm. \$295.00 Dyna 6T-150. \$145.00 Dyna PAT-5. \$100.00 Both mint w/cabinets (915) 755-9558 MST.

MILWAUKEE & WISCONSIN'S ONLY TRUE AUDIOPHILE DEALER

Specialists in components by; G.A.S., Yamaha, KEF, Tandberg, Dahlquist, DCM, Fried, Quatre, Stax, SAE, Connoisseur, Transcriptors, Grace, Nakamichi, Infinity, Dynaco, Crown, Ortofon, Sonus, ADC, Hafler, DBX, Akai, Teac, Revox, MXR, Technics and many many more. Featuring a very unique switching system for instant component comparisons. Also, one of the largest tape recorder displays in the country, with over 130 machines on display. WACK ELECTRONICS, INC. 5722 W. NORTH AVE. MILWAUKEE, WI. 53208. PHONE: 414-442-3441 TF

MINT CONDITION HI END EQUIPMENT. Mark Levinson ML-1, Oak Case, CA-1 A&D Boards 16 sets Lemo's 1250.— Threshold 400A 1000.— Revox B77 w/Pro Nab Adaptors 1100.— Luxman PD121 350.— Grace G714 200.— Grado 1B 150. (317) 259-1701 Monday-Friday, 8-5.

MIXER made especially for tape duplication. Will produce enhanced high quality second generation tapes. KUHN ELECTRONICS, 1801 Mills Ave., Norwood, OH 45212. TF

MONTANA AUDIOPHILES DISCOVER ROCKY MOUNTAIN HI FI

DAHLQUIST	NAKAMICHI	MAGNEPLANAR
ACOUSTAT	GAS/AMPZILLA	SONUS
BEVERIDGE	AUDIONICS	GRACE
DCM TIME WINDOW		HEGEMAN
STAX		
FULTON/FMI	SONY	POLK
R. H. LABS	N.A.D.	B&W

812 Central Ave., Great Falls, Montana 59401
Phone (406) 761-8683

MUST SELL AMPZILLA, Mod TD II, \$425. Thoebe, \$325. Spectroacoustics equalizer, \$150. Warranties. (208) 529-0093.

MUST SELL — DB1 and DB2 low noise preamp — \$245/offer; Ohm F spkrs — \$695 pr. 802-462-2668 eves.

NAKAMICHI SYSTEM-ONE RACK w/digital clock & timer, models 600 cassette deck, 620 Power amp., 630 preamp & FM tuner-Exc. Cond. \$2000 (203) 848-3318.

Nakamichi 1000 with remote and service manual \$800. Audionics BT-2 preamp \$250. Professionally assembled Heath AJ1510A tuner \$500. Sherwood micro CPU 100 \$800. Micro Seibi DDX 1000 with MA 505 arm \$500. Pioneer Series 20 preamp \$250. Series 20 M-22 Class A amp \$500. Series 20 D-23 crossover \$400. ARC Tympani III A's, \$1,250. C. Smith, 549 Harrington Rd., Wayzata, Minn. 55391. 612-475-1271

NEW AMPEX MASTERING TAPE 406 (7") 2.25, 407 (7") 3.25 New Scotch or Ampex LN-HO 1200x7 1.50, 1800x7 2.25, 4000x10 5.00 min. 20 pp. all boxed. New type 10" metal Reels Boxed \$4 min. 10 pp. other tapes Avail. Large SASE for Details. MJS, 2514 Seaboard Ave., SJ, CA 95131 408-262-8793.

Get QUALITY HI-FI with PROFESSIONAL ADVICE call the Pros at Audio Concepts

Franchised Dealers For:
JBL, AR, TECHNICS PRO, GREAT AMERICAN SOUND, MICRO-SEIKI, BOSE, DAHLQUIST, AVID, ADS/NAKAMICHI, MAXELL, DISCWASHER, MXR, YAMAHA, ONKYO, OPTONICA, SATIN, ADC, ACCUPHASE, PHASE LINEAR, TANDBERG, AKG, DBX, WIN LABS, SONUS, MICRO ACOUSTICS, HARMAN KARDON, AUDIOPULSE, VISONIK, STAX, DENNON, HAFLER, G.A.S., OTHERS.
Free freight on most items.

Call us TOLL FREE. It's worth it!!!

(800) 423-4170

AUDIO CONCEPTS

1127 W. Huntington Dr., Arcadia, CA 91006
(213) 445-3663

FOR SALE

NAKAMICHI 1000 MINT \$1050.00 1-317-574-7574 (CASS).

NORTH CAROLINA

A complete selection of high quality components for the discriminating music lover. For your pleasure, we offer two locations drawing audiophiles from the Blue Ridge to the Atlantic, knowledgeable staff with decades of combined experience, and these fine products:

AVID	ANALOG ENGINEERING ASSOCIATES
STAX	DCM TIME WINDOWS
DENON	MICRO-ACOUSTICS
REVOX	CONNOISSEUR
SONUS	KEITH MONKS
LUXMAN	YAMAHA
VISONIK	HAFLER
ACOUSTAT	FRIED
RAPPORT	CROWN
AUDIONICS	ONKYO
DYNAVECTOR	GRACE
LINN SONDEK	SUPEX
PHASE LINEAR	REGA

PLEASE VISIT ONE OF OUR SHOWROOMS
STEREO SOUND

175 E. Franklin St. Chapel Hill, N.C. 27514 (919) 942-8546	3443 Robinhood Rd. Winston-Salem, N.C. 27106 (919) 768-0150
--	---

PERFECTIONISTS PREFER DYNAKITS

Before Purchase You Owe Yourself Our Quote Mainline 1la, 971 Fronheiser, Johnstown, PA 15902 TF

POINT 3 SPEAKER SYSTEMS, Now Available. These are a unique 3-cabinet design that uses a time-aligned tweeter and mid-range in the upper unit. And 2-10" drivers in the subwoofer. Comes with its own crossover. And has a flat response from 20 to 20kHz. With the ability to handle any power from 20 to 200 watts. And more importantly the sound is very clean, detailed, and open. With no coloration. What is the cost? \$395.00 for the system, PPD. Hard to believe? Write or call: E. Smith, 2941 N. Gransback St., Phila., Penna 19134. Phone: (215) 427-1359. 10 to 10.

FOR SALE

NORTHERN CALIFORNIANS

It is our goal to make the joy of music possible for everyone. At any price we offer solid value, superior performance, and traditional service.

We operate on the theory that you as our customer will achieve the greatest long term satisfaction only through a careful analysis of your audio requirements. We strive to offer sober, highly cost effective solutions to meet your specific needs. Please stop in for a refreshing experience with music.

OUR SELECTION INCLUDES:

Magneplanar	Audioics	Dahlquist
Tandberg	Threshold	Chartwell
Onkyo	Audire	B&W
JVC	Hafler	Cizek
AKG	P.S.E.	AVID
Denon	Lux	Stanton
Micro	Grado Sig.	AIWA
Connoisseur	Sonus	M&K
Soundcraftsmen	Grace	Rogers

HIGH FIDELITY SHOPPE
1511 North Main Street
Walnut Creek, Calif. 94596
(415) 932-2242

"WE BUILD BETTER SYSTEMS FOR YOU"



Audio Res'ch	Grace	Platter Pad
Advent	Grado Sig.	Polk Audio
ADS	Hafler	Quatre
Denon	Hiroka Mat	Rega
Dynavektor	Kenwood	Revox
Electro Res'ch	LinnSondek	Rogers
E.M.T.	Magneplanar	Setton
FMI (Fulton)	Mitch Cotter	Shure/SME
G.A.S.	Nakamichi	Signet
		Sonus
		Stax
		Technics
		Ultracraft
		Wintec

2858 W. Market St., Akron, Ohio 44313 Phone (216) 864-4411

You can pay \$5.00 for an advanced state-of-the-art 60 minute cassette.

Why? Larksong will sell you one for \$1.30 or less.*

- * Pure Micro-Acicular Ferric Oxide
- * Fully Bias and Equalization Compatible
- * Five Screw Case
- * Outstanding Signal to Noise Ratio
- * Lifetime Guaranteed



Treat your hungry power-packed tape machine to a Larksong cassette and get a lot more entertainment for your money. No longer does its thirst for quality cassettes need to be limited by your lean budget. Now you afford the best — Larksong. One top line of exceptional cassettes available in two styles of boxes. *** Dollar Special** — Your first Larksong C-60 cassette with complete tape specifications and postage-free order blank for only \$1. Limit one per customer. Larksong puts it all together so you get more music out. Larksong, Dept. IC, 10 Scott St., Point Arena, CA 95468.

WHOLESALE INQUIRIES INVITED

The Real tape breakthrough you've waited for.

FOR SALE

ATTENTION DCM TIME WINDOW OWNERS

We now offer a convenient and attractive way to improve the sound of your speakers. The DCM Time Window, when raised 9 inches off the ground, has an airier and tighter sound: the image is raised and standing waves reduced.

THE DCM TIME WINDOW PEDESTALS are made of heavy duty wrought iron and suit the shape and appearance of the Time Window perfectly. They sell for \$65. per pair. If there is no dealer nearby, order postpaid (Master Charge & Visa accepted) from

R. S. PARK AUDIO ASSOCIATES
5 SUNRISE PLAZA, VALLEY STREAM, NY 11581
(516) 561-7555
DEALER INQUIRIES INVITED

POLYDAX (AUDAX) Bextrenes, soft domes etc., Decca Ribbon tweeters Leach Amplifiers. Catalog: TA Box 97A, W. Cornwall CT. 06796. Postage now 40¢, please help with stamps. 9-8

Bob Heenan Sells Great Used Equipment

Tel: 617-734-2727
Sound Advice
Box 782
Brookline Village
MA 02147

AR	Marantz (Tubes)	SAE
DB	Magneplanar	Sony
EPI	McIntosh	Stax
Bose	Levinson	Quad
B & W	LS3/5A	Revox
Crown	H-K	Yamaha
Advent	Linn	Thorens
Dahlquist	GAS	Tandberg
Dyna (Tubes)	JBL	Nakamichi
Audio Research	Lux	Phase Linear

Money Back Guarantee
Sound Advice, Box 782,
Brookline Village, MA 02147
Equipment bought, sold, traded & brokered.

FOR SALE

POLYFUSION SYNTHESIZER — STUDIO SERIES 2000. IT IS COMPLETELY MODULAR AND HOUSED IN THREE SEPARATE CABINETS. THEY INCLUDE ALL OF THE FOLLOWING MODULES:

- 3 - VARIABLE FORMAT FILTERS
- 1 - ANALOG SEQUENCER
- 20 - 4 INPUT MIXERS
- 1 - RANDOM SIGNAL GENERATOR
- 4 - DUAL ENVELOPE GENERATORS
- 1 - DUAL SAMPLE HOLD
- 5 - DUAL VOLTAGE CONTROLLED AMP
- 8 - VOLTAGE CONTROLLED OSCILLATORS
- 2 - VOLTAGE CONTROLLED LOW PASS FILTERS
- 1 - DUAL RING GENERATOR
- 1 - VOLTAGE CONTROLLED HIGH PASS FILTER
- 2 - VOLTAGE CONTROLLED REVERBS
- 15 - CONTROLLER OUTPUTS
- 4 - POWER SUPPLIES
- 1 - 2051 KEYBOARD
- 1 - 2052 KEYBOARD

(2 VOICE) (VELOCITY SENSITIVE)

\$10,000 OR BEST OFFER. 6 MONTHS OLD - RETAIL NEW \$19,750. JIM KREUZER, 1428 MAIN RD., CORFU, NY 14036 1-716-762-8472.

PS AUDIO'S PRE-AMP easily surpasses Hafler & APT. The PS pre-amp accepts moving magnet & moving coil cartridges without stepup device and has controls for cartridge resistance & capacitance. The PS model one amp (80 watts) is superb. Both for under \$800. PS electronics are excellent with Visonik's 502's & Visonik sub woofer (SUB-1). Visonik system \$550. DEMONSTRATOR & DISPLAY SALE:

Point Three speaker system (\$400) now \$275
Thornes 110 (\$330) & 115 (\$390) now respectively \$260 & \$310
Spectro Acoustic amp 202c (100 watts (rack) \$375) now \$275

Spectro Acoustic preamp 217R (rack) \$250 now \$200
Spectro Acoustic 210R Eq. ((rack) \$295) now \$230
Audioanalyst M6 speakers (\$558 pair) now \$400
Empire Cartridges 4000 DIII \$75 2000Z \$50
AUDIO SALON 2227 Greenway Ave., Charlotte, NC 28204 (704) 377-5690 by appointment only 3-9 pm daily. Shipped Pre-paid except add \$10 for speaker systems.

FOR SALE

PROTECT YOUR LPs. POLY SLEEVES FOR JACKET 9", ROUND BOTTOM INNER SLEEVES 8", SQUARE BOTTOMS 6", POLY LINED PAPER SLEEVES 15", white jackets 35". POSTAGE \$1.50. HOUSE OF RECORDS, HILLBURN, NEW YORK, 10931. TF

QUICKEST AIRMAIL SERVICE DIRECT FROM TOKYO

CARTRIDGES: Coral 777EX \$103.00, Denon DL-103S \$128.00, DL-103D \$170.00, Entrec EC-1 \$148.00, Grace F-9L \$93.00, F-10L \$210.00, FR FR-1/III \$172.00, Dynavector 15BQ (same as 20B) \$132.00, 20C \$187.00, Satin M-188X \$200.00, JVC MC-1 \$240.00 TONEARMS: Audiocraft AC-300/II \$220.00, Denon DA-307 \$187.00, FR FR-64S \$300.00, FR-66S \$610.00, Grace G-704 \$190.00, G-714 \$195.00, G-945 (Silver) \$230.00, Dynavector DV-505 \$286.00, Stax UA-7CF \$220.00.

All brand new w/full warranty. Ready for prompt shipment. Packing & Air Postage all included. Send order with Cashiers Check. Many other items available - Ask for Quotations with \$1.00 for postage. JAPAN AUDIO TRADING CO., LTD., Saikae Bldg., 4-33-21, Kamimeguro, Meguro-ku, Tokyo 153.

RADIO REUN CASSETTES, 50 shows. FREE Brochure. ASTRO-VIEW, AS box 923, Valley Forge, PA 19481.

RAPPAPORT PRE-1 \$400. THORENS TD125MKII with GRACE 707 arm \$325. All perfect, used less than 8 months. Advent 300 \$175. (215) 382-2503.

RECORDS/TAPES. Major labels, top names at distributor prices. All categories. Complete set of catalogs \$1.00 (refundable) Box 1111, Chatsworth, Calif. 91311.

RENOUNCE ROTTEN RECORDINGS! Read selected British reviews in the bi-monthly EURO-DISC GAZETTE, then order these European discs judged the finest in technical and musical excellence. Selections mainly classical. Send for free sample issue. No obligation. EURO-DISC GAZETTE, PO Box 337-A, Peterborough, NH 03458. TF

ROGERS REFERENCE MONITOR SYSTEM

This is a biamplified system designed by Rogers using the incredible LS3/5a's. Hear this system as well as the Rogers Monitor II's, Compact Monitor's, LS3/5a's, A75 amp and T75 tuner at OXFORD AUDIO CONSULTANTS, P.O. Box 145, Oxford, OH 45056. By appointment. Free shipping. 513-523-3895.

ROGERS REFERENCE MONITOR SYSTEM

This is a biamplified system designed by Rogers using the incredible LS3/5a's. Hear this system as well as the Rogers Monitor II's, Compact Monitor's, LS3/5a's, A75 amp and T75 tuner at OXFORD AUDIO CONSULTANTS, P.O. Box 145, Oxford, OH 45056. By appt. Free shipping. 513-523-3895.

SALE!!!!

TWO FOR LESS THAN THE PRICE OF ONE. Now you can buy two fine RCA (Japan) direct to disc records, Beethoven's appassionata and Lew Tabackin quartet's trackin' for only \$11.95 including postage. That's right. Two records for \$11.95! Rated as reference recordings in the Absolute Sound & Stereophile, these records retail for \$30 for both. Hurry, supply limited. Send check or money order to: Specs Corp., 130 Fallen Leaf Drive, Hillsborough, Calif. 94010 CA residents add Sales tax. 2-0

State-Of-The-Art speaker systems factory direct; fully assembled and kits. Also Decca, Richard Allan, Dalesford, Audax, Kef drive units, crossover components, more. Write for our new catalog: COMMONWEALTH ELECTRONICS, 822 South Victory Boulevard, Burbank, CA 91502. (213) 846-6336.

NOTICE: RECORD RATERS WANTED

(No experience required) Each month you will receive nationally released albums to rate THERE IS NO EXTRA CHARGE for the LP's you receive. You pay a small membership fee which covers all costs of the LP's. We pay postage. In return for your opinion, build your LP collection. "First come basis." For application write: EARS, DEPT ADBox 10245, 5521 Center St., Milwaukee, WI 53210.

LEGENDARY.

Mark Levinson. Threshold. Grado. Audionics. Janis. Pyramid. Grace. Spondor. Rogers. DCM. Quad. F.R. Bryston. Snell. Linn-Sondek. B & W. Precedent. Cotter. Symdex. Revox. All these legends at Chestnut Hill Audio, 2302 Lombard Street, Philadelphia, Pa. 19146. (215) K16-6178.

CHESTNUT HILL AUDIO.

IN CENTRAL MASSACHUSETTS...

MAGNEPAN*	POLK	APT-HOLMAN
HAFLER	G.A.S.	KEF
ADS	DAHLQUIST	B&W
AMBIENT	NAKAMICHI	STAX
D-B SYSTEMS	GRACE	LUXMAN

*Exclusive N.E. dealer for MAGNEPAN MG-I and MG-IIA

Hearingthings

319 Main St.(Mechanics Hall) • Worcester. Mass. 01608 • (617)757-9658

FOR SALE

SAVE UP TO 69% ON OVER 100 TOP BRAND AUDIO COMPONENTS FROM CARSTON STUDIOS. NEW ENGLAND'S AUDIO SUPERMARKET ONE OF THE OLDEST MAIL ORDER FIRMS (EST 1952) AND CERTAINLY ONE OF THE MOST RELIABLE. ALL ORDERS SHIPPED FROM STOCKED WAREHOUSE. SEND FOR PRICE QUOTE AND PRICE LIST. CARSTON STUDIOS, OLD BROOKFIELD ROAD, DANBURY, CONN. 06810. TF

SEAS PROFESSIONAL SOUND

Speaker kits designed for the amateur and the audiophile. Only SEAS speaker kits use the finest quality imported Ccandanavian components.

*Dynamically damped woofers with cast magnesium frames.

*Isolated midrange drivers

*Vacuum formed plasticized dome tweeters

*State of the art crossover networks

SEAS speaker kits are easy to build and are available with or without cabinets from \$59. For free literature on SEAS speaker kits, raw drivers and crossover networks write: **The Speaker Works P.O. BOX 303 Canaan, NH 03741.**

SEMI-PRO AND CONSUMER AUDIO EQUIPMENT: TEAC/ Tascam, Dbx, AKG, Maxell, Delta-Lab, Technics, Others. Best Prices! Prompt Delivery! WDI, P.O. Box 340, Cary, NC 27511. 919-467-8122.

SEQUERRA MODEL 1 FM TUNER #1565 Mint condition, full factory warranty, must sell, make offer. (319) 382-5918.

SIEMENS, TELEFUNKEN, GENALEX AND AMPEREX and other top quality audio tubes available at very competitive prices. Contact Jim Wallace at 1203 Success St., Pittsburg, PA 15212 or (412) 322-4706 TF

SIMPLY INCREDIBLE — the CROWN DL-2 Distinction Series controller pre-amp. In using state of the art digital controls and superior audio circuitry, CROWN has eliminated all extraneous noise to an inaudible minimum, available exclusively, at one of Central P.A.'s finest audio dealers, DS AUDIO

833 PARK ROAD NORTH
WYOMISSING, PA 19610
215-376-4917

SONY 8650 V-FET AMP. MINT \$610.00 (614) 464-0816.

SOUND ADVICE AND POLK AUDIO LOUDSPEAKERS We have the incredible Polk Audio Monitor Series loudspeakers in stock. The Polk's are definitely the best performance per dollar value ever offered in a truly accurate inexpensive loudspeaker. State of the art sound is now available from less than \$200 per pair. We ship freight prepaid anywhere in the U.S. within 24 hours upon receipt of order. Write or call for information on the Polk Audio Monitor Loudspeakers.

SOUND ADVICE

Village Plaza Ruston, LA 71270
(318) 255-8000

9-9

SOUTH CAROLINA'S ONLY HIGH-END STORE the finest audiophile equipment: British American Sound, P.O. Box 1247 186 King Street, Charleston, SC 29402 6-9

The *only* place
in the country
where you can buy

KOSS
Model II ELS

**eakin
audio**

6403 Roosevelt Way NE
Seattle, WA 98115
(206) 525-0200

FOR SALE

SOUND COMPONENTS INC.

EXCLUSIVE SOUTHEAST
DEALER FOR THE
INCOMPARABLE
MARK LEVINSON H.Q.D.
REFERENCE SYSTEM

The H.Q.D. reference playback system consists of the following components:

- 2 Hartley 24 in sub-woofers
- 4 Quad ESL loudspeakers
- 2 Decca ribbon tweeters (modified)
- 2 Levinson LNC-2 Crossovers (100 Hz & 7 KHz)
- 1 Levinson ML-1 (LEMO) preamp
- 6 Levinson ML-2 amplifiers
- 1pr. Hand-crafted oak or ash trestle stands (for Quads & Decca)

THE H.Q.D. SYSTEM WITH GOOD SOURCE MATERIAL, WILL REPRODUCE A MUSICAL EVENT BETTER THAN ANY SYSTEM WE KNOW OF.

For more information, please write or call:
SOUND COMPONENTS

2710 Ponce de Leon Boulevard
Coral Gables, Florida, 33134
305-446-1659

TWX 812-848-7627 tf

SOUSA RECORDS. Free catalog upon request. Stanford. Box 36163, Grosse Pointe, Mich. 48236. 1-0

SPENDORS ARE SPLENDID!

See OAC for the Spendor SA-1's, BC-1's & BC-3's. Free shipping. Visa & Master Charge honored. Demo. by appt. OXFORD AUDIO CONSULTANTS, P.O. Box 145, Oxford, OH 45056. 513-523-3895. Also open evenings & weekends.

STAN WHITE

Latest thoughts on loudspeaker enclosure Geometry OR 'Demise of the Theory of Relativity' Send \$1.00 to: Tachyon™ P.O. Box 204 Bloomingdale, IL 60108.

FOR SALE

SPEAKER DISTORTION BREAKTHROUGH

In place of clever ad copy we offer the best guaranteed performance specifications of any production loudspeakers. Our top-of-the-line includes the 3 most powerful, widest bandwidth, lowest distortion and highest efficiency system available! THE VMPS TOWER II provides max. THD 0.7% 22Hz-20kHz, -3dB at 22 Hz, sensitivity 103dB/1m/1W, max. undistorted output 125dB w/25 OWrms input. Price: \$369 ea. KIT, \$549 ea. assembled. The VMPS SUPER TOWER assures no more than 0.5% THD 22Hz-20kHz, -3dB at 20 Hz, sens. 102dB/1m/1W, max. undistorted output 128dB w/350Wrms input. Price: \$499 ea. KIT \$799 ea. assem. Finally the fabulous 7ft tall SUPER TOWER II has less than 0.25% THD 22Hz-20kHz, -3dB at 17Hz, 132dB output for 500Wrms in. sens. 103dB/1m/1W in. Price: \$899 ea. KIT, \$1299 ea. assem. How it's done: with integral subwoofers & multiband bass, minimum phase response, periphonic dispersion and more. Details: ITONE AUDIO, 7301 Rockway, El Cerito, Cal 94530 (415) 526-7084. DEALER AND REP INQUIRIES INVITED. ED. Prices include shipping free inUSA.

Spendor BC-1's Pr. Walnut, with stands, excellent ent. \$225. 1-717-529-2497

A SINGER'S DREAM!

REMOVES VOCAL FROM MOST STEREO DISCS
The Thompson Vocal Eliminator can actually remove most or all of a solo vocalist from a standard stereo record and yet leave the background music virtually untouched! Not an equalizer! We can prove it works over the phone. Write for a brochure and demo record below. COST: \$195.00

ECHO Ambiance

We do it BETTER for LESS
Whether your interest is in using ambiance for a concert hall effect or as an echo chamber for studio recording use, we manufacture a broad line of sophisticated analog delay Echo and Reverberation devices at prices which only direct sales make possible. Prices range from \$159 to \$495.

Write for a brochure and demo record. Include \$1 to cover costs (refundable with order).

Write to: **LT Sound**, Dept AU, P.O. Box 1061,
Decatur, GA 30031 (404) 284-5155

145

Houston and the Gulf Coast

Mark Levinson/Threshold/G.A.S./Apt/Holman/Hafner/Advent/Nakamichi/Dahlquist/Magneplanar/KEF/Acoustat/KM Systems/DCM Time Window/Cizek/Snell/Denon/Klipsch/Fidelity Research/Grace/Signet/Cotter/Ivie Analyzers

Audio Concepts

2200 SW Freeway at Greenbriar Houston, Texas 77098 713/527-0774

Credit Cards Accepted Freight Prepaid in Continental USA

Audio Excellence

A UNIQUE STEREO SHOWROOM DEDICATED TO THE PERFECTIONIST

Presenting Components from the Prestigious Companies of

AUDIONICS DENON GRADO SIG. SIGNET
BEVERIDGE SNELL MAGNAPAN HAFLER
THRESHOLD DCM CONRAD J. ROGERS
PLASMATRONICS PSE OBELISK BRYSTON

SHIPPED PREPAID THROUGHOUT THE U.S.

584 Washington Street, San Francisco 94111 415-433-1335

Advertising Index

Advertiser	Page	Advertiser	Page	Advertiser	Page
Acustà Craft Speaker Kits Write Direct to Advertiser	152	B & F Audio Mail Order Enter No. 9 on Reader Service Card	122	Electro-Voice Speakers Enter No. 18 on Reader Service Card	22
ADC Equalizers Enter No. 6 on Reader Service Card	113	BCGW Hi-Fi Components Write Direct to Advertiser	99	ELPA Semi-Automatic Turntables Write Direct to Advertiser	32
ADS Series II Speakers Write Direct to Advertiser	61	Bib Anti-Static Device Enter No. 10 on Reader Service Card Tape Head Cleaner Enter No. 11 on Reader Service Card	36, 37	Empire Hi-Fi Equipment Enter No. 19 on Reader Service Card	5
AIWA Hi-Fi Equipment Enter No. 2 on Reader Service Card	85	Bose Spatial Control Receiver Write Direct to Advertiser Hi-Fi Equipment Write Direct to Advertiser	12, 17, 56, 57	E.M.S. Speakers Write Direct to Advertiser	141
Allison Acoustics Subwoofers Enter No. 3 on Reader Service Card	32	Bucella Labs Speaker Kits Write Direct to Advertiser	135	Etco Quad Record Demodulator Write Direct to Advertiser	156
Alpine Car Audio System Enter No. 4 on Reader Service Card	73	B&W Hi-Fi Equipment Write Direct to Advertiser	25	Fisher Turntable Write Direct to Advertiser	71
Altec Lansing Speakers Enter No. 5 on Reader Service Card	86	Celestion Hi-Fi Equipment Enter No. 12 on Reader Service Card	15	Fuji Hi-Fi Equipment Enter No. 21 on Reader Service Card	115
Apt Corporation Holman Preampfier Write Direct to Advertiser	156	Chestnut Hill Audio Audio Store Write Direct to Advertiser	144	Fujitsu Ten Auto Stereo Component System Enter No. 22 on Reader Service Card	121
Audio Advocate Hi-Fi Components Write Direct to Advertiser	138	Crown Hi-Fi Equipment Write Direct to Advertiser	66, 67	Garland Audio, Inc. Audio Store Write Direct to Advertiser	135
Audio Amateur Publication Write Direct to Advertiser	142	CSA Audio Components Write Direct to Advertiser	140	Golden Gramophone Audio Store Write Direct to Advertiser	143
Audiocom Hi-Fi Components Write Direct to Advertiser	137, 140, 141	Custom Craft Mini Speakers Enter No. 14 on Reader Service Card	120	Goodwin, Inc. Stereo Components Write Direct to Advertiser	140
Audio Concepts Hi-Fi Components Write Direct to Advertiser	143, 145	Dahlquist Hi-Fi Equipment Enter No. 15 on Reader Service Card	84	Great White Whale Hi-Fi Equipment Enter No. 23 on Reader Service Card	125
Audio Critic Publication Write Direct to Advertiser	107	DB Systems Preamplifiers Write Direct to Advertiser	155	Hafler Preampfier Write Direct to Advertiser	141
Audio Excellence Hi-Fi Components Write Direct to Advertiser	145	dBX Subharmonic Synthesizer Enter No. 16 on Reader Service Card	14	Hammond Hi-Fi Equipment Enter No. 24 on Reader Service Card	40
Audio Horizons Publication Write Direct to Advertiser	152	DeCoursey Engineering Electronic Crossovers Write Direct to Advertiser	155	Havens & Hardesty Audio Systems Enter No. 25 on Reader Service Card	126
Audio Insight Stereo Equipment Write Direct to Advertiser	154	Diafix Stylus Re-tipping Write Direct to Advertiser	156	Hearingthings Speakers Write Direct to Advertiser	144
Audio Reference Systems Speaker Kits Write Direct to Advertiser	138	Discwasher Turntable Mat Write Direct to Advertiser Discwasher D3 Fluid Write Direct to Advertiser	2, 33	Henry's Camera Hi-Fi Components Write Direct to Advertiser	137
Audio-Technica Stereophones Enter No. 7 on Reader Service Card Vibration Damping Compound Enter No. 8 on Reader Service Card	54, 109	Dual (United Audio) Cassette Decks Enter No. 17 on Reader Service Card	41	Hitachi HMA-6500 Power Amplifier Enter No. 26 on Reader Service Card	51
Barclay Electronics Hi-Fi Components Write Direct to Advertiser	153, 154	Eakin Audio Headphones Write Direct to Advertiser	145	Infinity Speaker System Enter No. 27 on Reader Service Card	18
Ball Record Preservation Kit Write Direct to Advertiser	97	E.A.R.S. Stereo Components Write Direct to Advertiser	144	Institute of Audio Research Music Technology Instruction Enter No. 28 on Reader Service Card	128
BASF Cassette Recording Tape Write Direct to Advertiser	103			International Hi-Fi Mail Order Company Enter No. 29 on Reader Service Card	122

Advertising Index

Advertiser	Page	Advertiser	Page	Advertiser	Page
Jensen Speakers Write Direct to Advertiser	28, 29	Osawa Phono Cartridges, Tone Arms Enter No. 45 on Reader Service Card	35	SME Pick-up Arm Enter No. 59 on Reader Service Card	116
J & R Music World Audio Mail Order Enter No. 30 on Reader Service Card	119	Ovation Audio Audio Components Write Direct to Advertiser	136	Sonic Research Sonus Cartridge Enter No. 60 on Reader Service Card	58
JVC Cassette Decks Enter No. 31 on Reader Service Card	13	Paia Hi-Fi Equipment Enter No. 46 on Reader Service Card	107	Sonikit Speaker Kits Write Direct to Advertiser	148
KEF Hi-Fi Equipment Enter No. 32 on Reader Service Card	105	Phase Linear Amplifier Enter No. 47 on Reader Service Card	21	Sony Recording Level Meter Enter No. 61 on Reader Service Card	81
Kenwood KD-5070 Turntable Write Direct to Advertiser	77	Pickering XSV 3000 Cartridge Enter No. 48 on Reader Service Card	3	Sound Advice Used Stereo Equipment Write Direct to Advertiser	144
Larksong Stereo Components Write Direct to Advertiser	143	Pioneer Speakers Enter No. 49 on Reader Service Card	Cover II, 1	Sound Components Hi-Fi Components Write Direct to Advertiser	138
Leigh Speakers Enter No. 33 on Reader Service Card	30, 31	Polk Audio Hi-Fi Equipment Enter No. 70 on Reader Service Card	72	Soundcraftsmen Equalizers Enter No. 62 on Reader Service Card	24
L.T. Sound Hi-Fi Components Write Direct to Advertiser	145	Primo Electret Condenser Microphone Enter No. 50 on Reader Service Card	127	Speakerkit Loudspeaker Kits Write Direct to Advertiser	135
Lux Hi-Fi Equipment Write Direct to Advertiser	55	Radio Shack Realistic Minimus-7 Speakers Write Direct to Advertiser	69	Speakerlab Speaker Catalog Write Direct to Advertiser	119, 149
3M Scotch Recording Tape Enter No. 34 on Reader Service Card	118	RG Dynamics Dynamic Processor Write Direct to Advertiser	153, 155	Studer Revox Hi-Fi Equipment Enter No. 63 on Reader Service Card	63
Marcof Electronics Pre-amplifier Enter No. 35 on Reader Service Card Moving-Coil Cartridge Enter No. 36 on Reader Service Card	19, 23	Rhoades Audio Components Enter No. 51 on Reader Service Card	130	Symmetry Electronic Crossovers Write Direct to Advertiser	136
Maxell Cassettes Enter No. 37 on Reader Service Card	23	Rogers Speakers Write Direct to Advertiser	137	Taisei Electronics Speaker Protector Enter No. 64 on Reader Service Card	126
McIntosh Preamplifier Enter No. 38 on Reader Service Card	34	Rotel Hi-Fi Equipment Enter No. 52 on Reader Service Card Hi-Fi Equipment Enter No. 53 on Reader Service Card	119, 123	Take 5 Audio Hi-Fi Components Write Direct to Advertiser	152
Memorex Hi-Fi Equipment Enter No. 39 on Reader Service Card	11	Sansui Amplifier, Receiver Enter No. 54 on Reader Service Card	38, 39	Tapeworld Blank Tapes etc. Write Direct to Advertiser	156
Micro-Acoustics Speakers Write Direct to Advertiser	110	Saxitone Tapes & Tape Recorders Write Direct to Advertiser	156	TDK Hi-Fi Equipment Enter No. 65 on Reader Service Card	27
Mitsubishi Audio Components Enter No. 41 on Reader Service Card	89	Scott Hi-Fi Equipment Enter No. 55 on Reader Service Card	118	Teac Cassette Decks Write Direct to Advertiser	Cover III
M&K Sound Sampler Album Offer Enter No. 42 on Reader Service Card	78, 79	The Sensible Sound Hi-Fi Components Write Direct to Advertiser	154	Technics Cassette Decks Enter No. 66 on Reader Service Card Audio Components Enter No. 67 on Reader Service Card	7, Cover IV
MXR MXR Graphic Equalizer Enter No. 43 on Reader Service Card	95	Series 20 Hi-Fi Equipment Enter No. 56 on Reader Service Card	4	Visonik Hi-Fi Equipment Enter No. 68 on Reader Service Card	20
Onkyo Hi-Fi Equipment Enter No. 44 on Reader Service Card	83	Sescom Hi-Fi Equipment Enter No. 57 on Reader Service Card	126	Wisconsin Discount Discount Mail Order Sales Enter No. 69 on Reader Service Card	128
		Shure Cartridge Enter No. 58 on Reader Service Card	65	Yamaha NS-10M Mini-Monitor Write Direct to Advertiser	91

FOR SALE

STAX Preamp. Drive phones direct for best sound. Fact. mods. \$250 or best offer. 814-234-6881.

STEREO REPRESENTATIVES NEEDED!!!

Sell 100 brands!! Lowest Possible Prices!! Krasco—REP DEPT.—998 Orange Ave. West Haven, Conn. 06516 TF

SUB - WOOFERS

\$189.00 & up Hi Fi Sound Sys.
1809 E. McDowell Rd., Phx., AZ. 85006
602-258-8324

SUPER SOUND, FROM PRIVATE collection, excellent condition \$100 ea., Sheffield S-10 AM Biphon QR 7301, 7302, 7303, SR 7501, 7502, Sonar, SR 130, 160, 150, (219) 287-1353.

SUPEX - ORTOFON - DENON - OTHER MOVING-COIL CARTRIDGE OWNERS Send 50¢ for literature on our Micro-Preamp. Superb Performance at \$129.95. Huntington Electronics, Box 2009-A, Huntington, Conn. 06484.

TANBERG 10X: Unused in factory sealed box \$825; SAE MK IX, \$235; New Sansui AX-7 \$185 (208) 237-1189.

TANNOY 15" MONITORS SAE 4cm. amp Lux CL350 preamp Kenwood 3055H. \$1300 Grady 301-667-6173.

TAKE 5 AUDIO

CONN.'S HIGH-END AUDIO SHOP

Bryston	Verion	DCM
Denon	Signet	NAD
Hafler	Symdex	ADC
Pyramid	Rappaport	M & K
Cizek	Watson Lab	AT
Tangent	Promethean	DAC
LS-3/5A	Sound Cable	KMAL
Supex	Platter Pad	JR 149
Cybele	Discwasher	Grado

- * 4 private sound rooms
- * East Coast's largest direct-disc dealer
- * Keith Monk's record cleaning

105 WHITNEY AVE.
NEW HAVEN, CT. 06511
203-777-1750

Take



FOR SALE

STATE OF THE ART IN N. CALIFORNIA

is now on demonstration at The Audible Difference. Hear the superb Threshold NS-10 preamp/400A power amp through Dick Sequerra's stunning Metronome loudspeakers. Audition Peter Snell's superb Snell Acoustics Type A loudspeaker system with Threshold's new medium power CAS-1 amplifier. For the ultimate in high-power amplification, audition the Threshold 8000A mono amplifiers. Hear how good a bi-amp system can be with John Curl's new transient perfect crossover from Symmetry, the ACS-1, plus Paragon's 125 watt solid state bass amp. Experience the beautiful new Paragon 12A preamp, plus Thaedra II from G.A.S.

Hear the ultimate direct drive turntable, the Denon DP-6000, plus the audiophile reference Linn Sondek with Linn-modified Grace 707 tonearm. Examine the precisely machined bearing of the new glass platter, belt drive Planar tables from Rega Research. Hear the ultra-musical Paragon System E preamp, plus the new high performance, moderate cost Thalia/grandson combination from G.A.S. Audition a new generation of compact high performance loudspeakers from Polk and Cizek, plus BBC minimonitors from Spendor and Rogers. For the music listener who demands the best, we offer the Breuer Dynamic Tonearm, plus the EMT cartridge with Verion transformer.

For that extra measure of sonic purity so important to the critical audiophile, we recommend and stock Polk Sound Cables; Mogami wire; the anti-resonant Platter Pad, \$24.95; Audio Perfection audio interconnect low capacitance cables, \$15/pr; plus the Stylift at \$19.95 and a wide selection of audiophile quality recordings including Gale Maximum, Fidelity and Denon PCM.

We ship all products prepaid throughout the United States.

THE AUDIBLE DIFFERENCE
435 Tasso, Palo Alto, CA 94301
(415) 328-1081

TF

TAPCO and ELECTRO-VOICE, mixers, equalizers, amps, mics, and raw loudspeakers. Write for low mail order prices. Sonix Co., P.O. Box 58, Indian Head, MD 20640 8-9

TANBERG 10XD 1/2 TRACK TAPE DECKS (2) with remote and pitch controls, Dolby, (1) has never been opened, mint, \$1,500 (2) mint \$1,100. Write Jim Coker, P.O. Box 1531, Montgomery, Ala. 36102.

THE CRITICAL RECORD REVIEW

Issue 2 is ready. We offer sound reviews of SOTA and D-D discs in bimonthly newsletters. \$6 per vol., 6 issues. P.O. Box 8766, Jacksonville, Fl. 32211

FOR SALE

THE AUDIOGRAM, a pithy independent newsletter now in its third year, provides timely, money saving reports on the latest products and techniques. Our critical integrity and realistic sense of proportion fill the gap between the commercial magazines and the neurotic underground press. Our latest issue of number 12 contains reviews of:

- The best moving magnet cartridge
- The best headamps
- The best turntable mat
- The best tube preamp
- Ultracraft AC300 Mark II

A review of tonearms by Paul Messenger.

\$10/6 issues/1 year. AUDIOGRAM, Box 27406, St. Louis, MO 63141.

THE BASS BOX-A transmission line woofer with electronic crossover-mixer-equalizer that goes lower, plays louder, has better detail and less midrange interference than the other boxes. \$695 plus shipping. Aardvark Quark Audio, Box 55022, Seattle, WA 98155. Dealer inquiries invited.

"THE FINEST BOOKSHELF SPEAKER" The legendary A. Radfords T90 from England. Tremendous overall Reproduction at realistic levels. \$850.00 PR. Now at CSA AUDIO, 35 Little Falls Rd., Fairfield, NJ 07006 201-575-1135 or 575-1528.

The first fifteen issues of **AUDIO UPDATE** were published ON TIME, and proved valuable to the demanding audiophile in optimizing his system. Many modification procedures have already been published, with more to come. Audio Update offers a multitude of provocative new ideas, including reader input. Annual subscriptions: \$12.00 U.S.A. and Canada, \$14.00 elsewhere. M/C and Visa orders welcome. AUDIO DIMENSIONS, 8898 Clairmont Mesa Blvd., San Diego, CA 92123. (714) 278-3310.

The Listening Room Loves

POLK AUDIO MONITORS

The golden ear of Marcel Wittman has established the Listening Room as one of the nation's premier audio salons. Not only do we have the finest esoteric audio equipment costing well into the five figures price range, we have the Polk Audio Monitor Series Loudspeakers beginning at just \$99.95 each, and easily worth many times their price in sound value. Come in to listen, write them for full literature, or give us a call. Shipped free anywhere in the U.S.

Listening Room
590 Central Park Avenue
Scarsdale, N.Y. 10583
(914) 472-4558

9-9

THE LISTENING ROOM INC.

590 Central Park Avenue
Scarsdale, N.Y. 10583
(914) 472-4558

Cordially invites you to audition our fine line of equipment. THRESHOLD • BRYSTON • GREAT AMERICAN SOUND • PYRAMID METRONOME 2 + 2 • DAYTON WRIGHT ESL • QUAD ESL • SNELL ACOUSTICS • DAHLQUIST • DYNAVECTOR • DENON • YAMAHA • TANBERG • POLK AUDIO • LUX REF. • KEF • GRACE • NAKAMICHI • STAX • R.H. LAB • L3/5A BBC MINI MONITOR BY CHARTWELL • SEQUERRA • PHASE MATRIX • HAFLER • JANIS • FONTEK HEADPHONE • AUDIO PULSE • SPATIAL • OASIS • EMT • VERION • DIRECT TO DISK RECORDS • Visit our private studios. We ship free anywhere in the U.S. We invite inquiries. TF

THRESHOLD 800A CLASS A AMPLIFIER. Latest updates and tweaked by Nelson Pass in 7/78. \$1700. Central N.Y. area. George. (315) 437-3357 weekdays

FREE! HARDWOOD VENEERS & LUMBER CATALOG

98 varieties world's rarest veneers and lumber at reasonable prices. Simplified veneering instructions plus full color wood selector included. Send for free catalog now and get special bonus starter offers. **SAVE 25% Hurry!**

BOB MORGAN WOOD, Dept. A11K5

1123 Bardstown Rd., Louisville, Ky. 40204

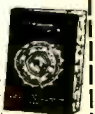

AUDIO HORIZONS

P.O. BOX 10973
St. Louis, Missouri 63135

Our second issue, which is now available, contains reviews of the AGI 511A, STREILOFF SYSTEM DESIGNS DC-1, LINN-SONDEK LP-12, TECHNICS EPA-100, ULTRACRAFT AC-300 MKII, DENON DL 103S, DYNAVECTOR 20B and 20C, GLANZ G-7, GOLD-RING G-900SE, MK2 and G-900E, GRADO G1+ and Signature II, J.V.C. MC-1 and MC-2E, Micro-Acoustics 53DMP, Ortofon MC-20, MC-10, M20E Super, and M20FL Super, SHURE V-15 Types III, IIIc, and IV, SINGNET MK-111E and TK7E, SONUS Gold "Blue" and "Red", SONY XL 55, STAX CP-Y/EC-P-1, and SUPEX SD-900E Super.

Our third issue, now being put together, will contain PART II of our phono cartridge survey, plus a small survey of pickup arms. There will be reviews of arms from BREUER DYNAMIC, DYNAVECTOR, FIDELITY RESEARCH, GRACE, HADCOCK, INFINITY, JML LUSTRE, MAYWARE, SERIES 20, SME, STAX, SYRINX, and ULTRACRAFT.

Subscription rates to AUDIO HORIZONS: for six issues are: U.S.A. \$18 (sent First Class), Canada \$20 (sent First Class) and outside North America \$24 (sent Air Mail). Sample copies of any issue are available for \$4.50 each (U.S.A. and Canada) and \$6.00 each (outside North America). U.S. DOLLARS ONLY.



Acusta Craft

Dept. AU P.O. Box 12030 • Shawnee Mission, Ks. 66212

The UNKITS!

- They don't LOOK like kits!
- They don't SOUND like kits!
- They just SAVE like kits!

Build your own speakers — Save 50% or more... No soldering required!

- **FREE KIT BROCHURE** — I'm interested — send me your free 8-page Brochure (kits from \$55.00 each).
- **\$1.00 Catalog/Manual** — Give me all the details — send me your comprehensive manual on speaker kits, crossovers, basic components and engineering data with "How-to-do-it" article by noted speaker designer John Hoge. \$1.00 enclosed.

Acusta Craft®

FOR SALE

THE MONITOR SERIES FROM POLK AUDIO AUDIO BREAKTHROUGHS now has on demonstration the remarkable new Polk loudspeakers priced from less than \$200 per pair. Compare them to the finest loudspeakers in the world. All Polk Audio Monitors utilize high definition polymer laminate bass-midrange drivers, wide dispersion soft dome tweeters and fluid coupled sub-bass radiators. They are capable of reproducing a highly defined phase accurate three dimensional sonic image which rivals the thousand dollar super speakers. They sound great with a small receiver, yet reveal the fine subtleties of state of the art electronics. Shipped free in U.S. Send for free brochures on Polk or our other fine lines. **AUDIO BREAKTHROUGHS**, 1534 Northern Blvd., Manhasset, LI, NY 11030 (516) 627-7333 TF

THE NEW REFERENCE — CROWN DL-2 fully utilizing the latest technology is the most accurate, flexible system controller available. Sonically unmatched and offering a new level of versatility, the DL-2 may be critically auditioned along with the new SA-2 power amp and EQ-2 Equalizer at Sounds Good To Met 60 Shawnee Ave., Akron, O. 44313.

THE NEW YORK AUDIO SOCIETY, INC. is a non-profit member-supported Hi-Fi Club. Come and hobnob with others like yourself to widen your knowledge of Audio Products and Systems and make new acquaintances. Informative monthly meetings feature new product demonstrations, lectures on latest Hi-Fi developments and exchange of information. All Audiophiles are invited to attend one session as our guest. Details about meetings and membership available. Write Box 125 Whitestone Sta., Flushing, N.Y. 11357 or call (516) 593-6538.

THE RADFORD TT 100 TUBE AMP

"The finest amp we have ever heard" 100 Watt cont. 400 Watt Peaks Plug in Circuit Boards, Solidstate — Tube Design Super Rugged Construction Rated over **AUDIO RESEARCH & THRESHOLD: UPPER RIGHT: CSA SOUND**, 35 Little Falls Rd., Fairfield, NJ 07006 201-575-1135 or 575-1528.

THE SOUNDING BOARD, INC.

75 Franklin Ave.
Ridgewood, NJ
(201) 445-5006

Come to listen at northern N.J.'s brand new audio salon. We carry quality products such as:

DAHLQUIST, D. B. SYSTEMS, VAN ALSTINE, I.M.F., OBELISK, SERIES 20

LINN SONDEK, CIZEK, TANDBERG, MITSUBISHI, QYSONIC, AVID, WINTEK, DUAL, CONNOISSEUR, GRADO SIGNATURE, GRADO DECCA, STAX, and more.

THOUSANDS OF LIKE NEW LP's and prerecorded tapes. Catalogue—\$1.50. House of Records, Hillburn, New York 10931. TF

THRESHOLD

Audition the complete line of Threshold products including their new cascade-class A amplifier and preamplifier. We offer: Model 400-A Cascade, 4000, CAS-1; NS-10 and SL-10; M-1 & M-7 impedance matching modules. G-B Electronics, P.O. Box 385, Hawthorne, N.J. 07507 (201) 427-8885 for appointment.

TONEARMS-CARTRIDGES-TURNABLES at lowest prices. Most brands available, including MC cartridges. Other quality brands available. Send # 10 SASE for quotes. Audio Unlimited, 401 Reynolds Circle # 12-D, San Jose, CA 95112 (408) 289-8875 1-6 M-F. 5-9

TOP-RATED CARTRIDGES UP TO 70% OFF!! We feature Acutex, ADC, Nagatron, Ortofon, Sonus, Stanton, et. al. Unbelievable prices! Call 212-254-3125 for prices, or write to DIRECT DISCOUNTS LTD., P.O. Box 841, N.Y., NY 10003.

TOURING SOUND SYSTEMS, 2, 4 and 8 Track Studios. Disco Sound, Cerwin Vega BGW, Altecc, Shure, AKG, Tapco, Dyna, Revox, EV, Beyer, Cetec, etc. K & L Sound Service, 75 North Beacon At., Watertown, Mass. 02172. (617) 787-4072. Att: Ken Berger. TF

TURN-ON THUMPS AND NOISE? Send 50¢ for literature on our Suppressor. Huntington Electronics, Box 2009-A, Huntington, Conn. 06484.

FOR SALE

TRADE-INS AND DEMOS Revox B77 demo, \$1100. Modified PAT-5, 150. DB Systems 15a preamp-tone control, 500. Sony 3200 F amp, 175. Quatre DG250, 300. Audio Ltd., 115 N. Walnut, Champaign, IL 61820 217-359-3774.

TURNTABLE FEEDBACK ISOLATION

The Mitch Cotter B-2 BASE 40LB. Spring suspended laminated platform, that will make measurable sonic difference and will stop tone arm jumping found with shaky floors. CSA AUDIO, 35 Little Falls Rd., Fairfield, NJ 07006 201-575-1135 or 575-1528.

TUBES — GENALEX, TELEFUNKEN, — for audiophiles who demand premium quality European replacements for Audio Research, Conrad-Johnson, Dyna, LUX, Paragon, Marantz, McIntosh and other tubed preamps, amps and tuners.

Just a few popular types include:

	Matched Prs.	Each
GENALEX: XT88/6550	\$67.00	\$29.50
TELEFUNKEN: ECC83/12AX7		\$4.95
ECC82/12AU7		\$4.95
EL34/6CA7	\$23.95	\$10.95

Quotes provided on request for other than advertised tubes. Save 10% and get a complete Re-tube Kit for any specific unit.

Now! **HARTLEY 7", 10", 18", 24"** drivers and complete systems. Send orders and inquiries to: **SOUND SERVICES**, Lake Walton Road, Wappingers Falls, NY, 12590. Telephone: 914-226-5414. TF

TYMPANI 11A SPEAKER, \$1200. Marantz 500 amp — a classic — \$650. Marantz 510 amp — excellent bass amp \$425. Will consider trades. I'll pay shipping. 614-486-1267, evenings and weekends.

VACUUM TUBES and tube-peculiar parts. We offer a complete inventory of high voltage capacitors, precision resistors and tubes. Kits or separate parts available for building circuits described in our 220+ page Audio Modification Manual. Write for parts list and literature. **AUDIO DIMENSIONS**, 8898 Clairemont Mesa Blvd., San Diego, Calif. 92123. TF

VIDEO CASSETTES — Large selection, Pre-recorded, XXX, PG, R, P, For VHS & Beta. Also Blank Cassettes, L-lots of 10 or more. We accept MC and Visa. Send for free Catalog. Parker Electronics, 123S Dutchess Turnpike, Poughkeepsie, NY 12603.

Wisconsin Has: Audionics, Denon, Luxman, Hafler, Polk, Mayware, STAX, Micro-Acoustics, Connoisseur, Nagatronics, Aiwa, Hitachi, Kenwood. Lit. and prices on request: The Sound Seller, 1706 Main St., Marinette, WI 54143 715-735-9002.

SUPERIOR AUDIO COMPONENTS: Audio Pulse; Audio Research SP-6 tube preamp and D-110 amp; Badap 1; Celestion; Cizek; Crown Distinction Series DL-2, SA-2, and EQ-2; Dayton Wright; dbx; Decca; Denon; Dynavector; EMT; Formula 4; Grace; Hafler kits: KEF: Kenwood Purist: Lux LRS: Magneplanar: Mitsubishi: Mobile Fidelity records: Nakamichi: Plasmatronics: Polk: RTR: Verion: Watson speakers.



Barclay
RECORDING & ELECTRONICS

233 East Lancaster Avenue, Wynnewood, Pa. 19096.
(215) 667-3048 or 649-2965.

FOR SALE

WEST VIRGINIA'S AUDIO PERFECTIONISTS THE CROWN DL-2 DISTINCTION pre-amplifier has arrived and is now on display with the new CROWN SA-2 power amplifier and EQ-2 EQUALIZER, the incredibly detailed sound of these components is receiving international acclaim due to excellence of engineering and state of the art musical accuracy. These components must be critically auditioned to be believed. Now available at West Virginia's Premier Audio Center.

THE SOUND POST

BECKLEY - 325 Neville St 304 252 5369
CHARLESTON - 4120 Mac Corkle Ave SE 304 925 4726
MORGANTOWN - 387 High St 304 292 8464
PRINCETON - 852 Mercer St 304 252 5369

WORLD AUDIO WESTCHESTER, INC.

Westchester's finest audio sales and service dealer is proud to announce the addition of:

Fried Loudspeakers

to the already fine lines of AR, AKG, ADC, Pro-Accutrac, Quanta, CM Labs, Celestion, Decca, Dir.-to-Disc, Discwasher, J.V.C., J.V.C. Pro., Kos, Lux, L.S.S., Maxell, Panasonite, Pickering, Qysonian Array, Rotel, Scott, Sennheiser, Soundcraftsman, Sound Source, Stanton, Supex, Thoren, Tandberg, TDK. Shipping is free in continental U.S.

WORLD AUDIO WESTCHESTER, INC.

211 North Avenue
New Rochelle, NY 10801
914-576-3230

2-0

YAMAHA T-2, call after 6pm (215) JE5-8928.

WRITE US AND WE'LL SEND YOU THE BEST CATALOG YOU EVER READ!

No kidding. Speakerlab's catalog took longer to write than some of our competitors have been in business. In fact, we created an industry by "building great kits so you can afford great speakers." Our catalog is an invaluable manual of speaker function and design. And, it will introduce you to the finest speaker kits made anywhere... with the strongest money-back guarantee. Find out for yourself... FREE, FREE, that is. Write now. Right now.



Speakerlab®
Dept. C-AD, 735 N. Northlake Way
Seattle, WA 98103

153

BREATHLESS



Patented circuitry eliminates pumping and breathing.

For Information write: RG Dynamics
4448 W. Howard St., Skokie, IL 60076



THE RG PRO-16W DYNAMIC PROCESSOR

FOR SALE

YOUR SONG professionally recorded Vegas artists. Girl plus three. Send lead sheet, \$30. Vegas Demos, Dept. A, Box 1321, Las Vegas, NV 89101.

3600' New L/N Scotch or Ampex tape, 10 1/2" metal reels 5 for \$38.00 12 New Ampex 42 min. 8 Tracks \$9.00. 6 New Ampex 370 C-60 cassettes in Stackette \$5.50. C-90 \$6.50. Sound, Peachtree DeKalb Airport, Chamblee, Ga. 30341

4 CHANNEL TAPE DECK AKAI GX 400D SS - 10 1/2". 3 speed remote outboard Dolby, Best offer call day 516-741-5533 after 6 516-374-2711.

Northern N.J.'s finest store-Lux, Mod DQ-10, Grace, B&W, G.A.S. Sleeping Beauty, FR, B&O, Linn, Sondek, Janis, Tangent, R.H. Labs, Grado, AVID and more. University Stereo, 57 E. Ridgewood Ave., Ridgewood, N.J. 07450. 20 minutes from the G.W. Bridge. 201-447-5700. TF

AUDIO AND TV TUBES FACTORY BOXED, speakers, semiconductors—low prices, free price list. Transletronic, 1365 - 39th St., Brooklyn, NY 11218. 212-633-2800.

SEQUERRA METRONOME LOUDSPEAKERS, rosewood, with ribbon tweeters \$3000; IMF Monitor IV loudspeakers \$1800, Rabco ST7 with Sonus Blue \$225. Dr. Sachs, P.O. Box 1719, Ann Arbor, Michigan 48106, (313) 665-9388.

DO YOU KNOW . . .

The truth about "transient intermodulation distortion"?

The real story about speaker-cable construction?

What is audio's "missing link"?

What are the world's best preamp, amp, phono cartridge, speaker, etc.?

Which subwoofer has a flat frequency response to 3 Hz?

What BADAP 1 is and does?

What is the world's finest amp for quadrasonic enthusiasts?

The truth about phase-aligned speakers?

**BARCLAY
RECORDING & ELECTRONICS**
233 East Lancaster Avenue
Ardmore, Pa. 19003

FOR SALE

TRADE UP to the MICRO CPU 100 fm tuner

It may have been out of the question at \$2000, but the new \$995 retail plus a trade-in can put it within reach. We offer very generous trade-in allowances on your old tuner or other audio equipment. A rare chance to own the best at a reasonable price (see Audio, Nov. '77). Write us for a quote, or better yet, phone after business hours and we can discuss your trade-in: (617) 874-0706, m-f, 5-8 pm. (ask for Dick).

AUDIO CALIBRATION, box 250, Westminster, MASS 01473

ALTEC LANSING 729A EQUALIZER, Rack Mountable, w/ sound level meter & tapes. Paid \$1100, sell for \$500. (402) 435-0263 5-9

THE RADFORD TT-100— THE NEXT TUBE LEGEND

Arthur Radford is a legend in British electronic design. He was perfecting the tube amplifier before most audio companies began their existence. The STA series, designed by Arthur in the late 60's, is still being used by Britain's most discerning audio critics as monitor amps. Today—in 1979.

Now comes Arthur's next legend—the TT-100. The logical evolution of 40 years of rigorous, innovative audio experience. Arthur has gone so far as to design and manufacture his own transformers, critical to tube amplifier performance. The result: the subtle benefits of tube design, coupled with the uncanny accuracy of all Radford audio components.

This remarkable amplifier, receiving rave reviews in Britain, is now available in the United States, through Radford of America. Write or call today.

RADFORD OF AMERICA, INC.
PO Box 196
Montclair, NJ 07042
201-526-8774

THIS SPACE FOR SALE! Use the classified section in Audio for shopping & selling.

FOR SALE

ATTENTION AUDIOPHILES: SPECIAL OFFERING OF VERION PRODUCTS

General Resistance, Inc., the ONLY manufacturer of Verion MK1 Stereo Pickup Transformers, Triaxial Audio Cables, and GS1 Ground Strips has been authorized by agreement reached in the New York State Supreme Court to sell their remaining inventory of those products:

MK1 Stereo Pickup Transformers (specify pickup impedance): \$350 each.

Triaxial Audio Cable pairs: \$30 per one meter, plus \$5 each 1/2 meter added to the pair. All Triaxial cables have RCA-type connectors at one end; and either bare leads, RCA-type connectors, or male or female DIN connectors at the other. Be sure to specify length and choice of connector.

GS1 silver-plated 12" solid copper Ground Strips with hardware and grounding pig-tail: \$20 each.

All above carry 5-year manufacturer's warranty.

Quantities are limited since there will be no further production. Send official bank check or postal money order immediately to avoid disappointment. Orders shipped prepaid UPS wherever possible. No telephone orders accepted.

General Resistance, Inc.
130 S. Columbus Ave.
Mt. Vernon, NY 10553

154

NEW—ISSUE #6—WE REVIEW THE FOLLOWING. PLUS MORE!!

THE \$ENSIBLE \$OUND

AGI 511A, Conrad-Johnson, Series 20 (Pioneer C-21, Kenwood L-07C, Grado G1+ and F3E+, Ortofon MC-10 with STM-72, Pickering XUV-4500Q, Stanton 881S, Onkyo T-9 and Yamaha T-1 tuners, Dahlquist DQ-LP1, Audioplate, Allison 3, AR 15, Cizek 2, Fried H/2, Essence 8a, Micro-Acoustics MS-1, Spondor BC-1, Rogers Compact Monitor, ESS 10b, Kustom Impulse and Imp, Isophon DIA-2000, PSU II, Warpknott, Pixoff, Audio Technology 510, Nortronics QM4, Sound Guard, Uni-Sync PMS-1, Setton TS-11, Epicure 14, Denon DP-790, Onkyo T-4, Monitor Audio MA-4. Reviews of over 40 audio-ophile discs, a \$25 product that will improve the sound of your system, and our usual zero cost tips and inside industry info. **SUBSCRIBE TODAY: \$12** (4 issues) 3rd class mail, \$14 first class & Canada, \$17 foreign air mail.

403 DARWIN DR., SNYDER, NY 14226

Now in Fort Lauderdale...
**State of the art components for the
audio perfectionist and serious listener.**

Audio Research • Acoustat • Denon • B & W • Armstrong • Chartwell • Lux
Tangent • Polk • GAS • Conrad Johnson • Audire • Ariston • Connoisseur
ADC • Grace • Supex • Grado • Goldring • DB Systems • Quatre • Stax
Theta • Plasmatrix • Transcriptors • Dynavector • Vandersteen
Complete selection of direct to disc recordings.

AUDIO INSIGHT

The Promenade at Bay Colony

6286 N. Federal Hwy., Ft. Lauderdale, FL 33308 • 305/491-7677



Simply The Best... MOVING COIL CARTRIDGE STEP-UP TRANSFORMER

**MODEL
CST-80**

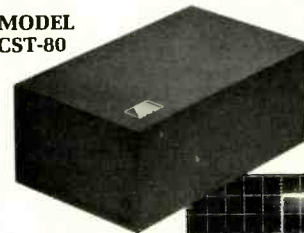

CST-80 Output
Actual Square
Wave Photo:
(50 uS/div. hor., 50 mV/div. vert.)

Provides the necessary gain and impedance matching for connection of any moving coil cartridge to a typical preamplifier phono input. The unit utilizes a pair of ultra-high fidelity transformers exclusively made for us by **JENSEN TRANSFORMERS**. Suggested retail price, \$300.

Please write for complete specifications.
(Dealer Inquiries Invited)

**AUDIO
INTERFACE**
INCORPORATED

P.O. Box 7369/Van Nuys, CA 91409
Phone (213) 998-1082

FOR SALE

ANOTHER NEW YORK CITY HIGH END AUDIO STORE?

Not really. Instead of rush A/B comparisons, electronics B.S., flashy switching systems, or high pressure salesmanship, we offer honest advice, audiophile to audiophile, and an open invitation to audition, at your leisure the finest components available in a comfortable homelike setting on Manhattan's upper east side.

Linn-Sondek, Linn Isobarik, Naim, Marcoff PPA-1, Meridian, Michaelson & Austin TVA-1, Spendor, Fried, Mordaunt-Short, Precedent Audio, Spatial Coherence, Van Alstine, Strelloff Systems, STD, Connoisseur, Rega Planar, Grace, Supex, Signet, Micro-Acoustics, NAD, AGI, Hadcock, CPU Micro-Tuner, Berningft-10 and many others.

SOUND BY SINGER: AN ALTERNATIVE

For information or an appointment call (212) 929-2356 (10:00 AM-10:00 PM). We ship anywhere. 5-9

RADIO PROGRAMS

CATALOGS. Broadcasts, soundtracks. Personalities of Thirties, Forties. Box 225, New York, N.Y. 10028. TF

GOLDEN AGE RADIO. Your best source for radio, tapes — reels or cassettes. Box 25215-DA, Portland, OR 97225. 7-9

YESTERDAYS RADIO ON TAPE. Reels-Cassettes. Quality Sound. Reliable Service. Giant catalog \$1.00 refundable with first order. ADVENTURES, Box 4822-A, Inglewood, California 90302. TF

1930-1962 RADIO PROGRAMS. Beats television!! Tapes. \$1.00 hour! Established esteemed dealer, informative 200 page catalog \$1.25. Cassette samples \$2.00. AM Treasures. Box 192AU, Babylon, N.Y. 11702 TF

OLD RADIO PROGRAMS ON TAPE. Finest sound, competitive prices. Ask for free flyers, BRC OTR DISTRIBUTORS, 17173 Westbrook, Livonia, MI 48152

RENT RADIO SHOWS: Make your own copies or just listen. Great way to build your collection reasonably. Catalog \$1 refundable. OTR Rental, Box 1146, Livermore, Ca. 94550 TF

VINTAGE RADIO: Lowest rates, post free. Traders welcome. Also trading for comics, films, pulps, etc., video tapes, too. SIGNALS, Box 5063, Sta. E. Edmonton, Alta., CANADA. 3-9

FOR SALE

WANTED TO BUY OR TRADE

McINTOSH MI-2, K-107, MI-200, Marantz 7C rack mt. panel, 8B tube cover, JBL SE-460, & any McIntosh, Marantz (tube), or JBL electronics literature. Tube pre-amps & amps manufactured by Acrosound, Brooks, Brociner, Fairchild, Grommes, Langevin, Leak & Rodgers, as well as promo. literature, owner & service manuals for above equipment. State price & condition. Les Gueydan P.O. Box 455, Metairie, La. 70004.

McINTOSH OR MARANTZ any kind of tube amps: Pay top dollar (213) 278-3430, 8633 Airdrome St., LA, Calif. 90035.

OPEN REEL pre-recorded tapes. Rock, folk, jazz, classical stereo, quad (8-track quad also). A few of each for sale too. SASE. Ray, 1293 French Ave., Lakewood, Ohio 44107. 11-9

Wanted: Audio Research D-150, D-76A, SP-3A, J. Wachtler, PF 165, CH-3000 Bern 9 Schweiz.

WANTED: AUDIO RESEARCH SP-6A and D100B. 1-713-729-1658.

WANTED: MAGNEPAN MG I or II's in good condition. Call Barry McHale 302-762-0347, or write 1105 Marsh Road, Wilmington, DE 19803.

WANTED: MCINTOSH MC3500 TUBE AMPS or C22, MC275, MC60, MC75, Marantz 7C & 9, 1-713-729-1658

Wanted: Quad AM3, Radford STA 25, MA25, B&O BM5 mike. Marantz 6 stereo adaptor. Western Electric 594, 4151A, 728B, 40505, 4151S. Westrex cartridge. A. Lal. 117 E. 37th St. N.Y.C. 10016. 532-3995

WANTED: Recording gear of all ages and variety. Microphones, outboard gear, etc. Dan Alexander, 6026 Bernhard, Richmond, CA 94805, (415) 232-7933.

WANTED: 1 ELECTRO-VOICE 15" TRI-AXIAL SPEAKER (15TRX), new or near new. E. Kaplan, 68-55 136 St., Flushing, NY (212) 544-8954.

WANTED TO BUY MCINTOSH MPI-4. Maximum performer indicator—1820 W. Gunn Rd., Rochester Mich. 48063. Mike Tobiasen 313-651-3015.

FOR SALE

WANTED TO BUY OR TRADE

WANTED FISHER-LINCOLN changer, state condition and price in letter or call 212-377-7282. Edward Schenck 1401 Brooklyn, N.Y. 11230.

WANTED: GRAMOPHONE SHOP ENCYCLOPEDIA OF RECORDED MUSIC, in reasonably nice condition. Dr. H.S. Friedman, 6317 Park Heights Ave., Baltimore, Maryland 21215.

DYNACO RACK MOUNT ASSEMBLIES for "face plate" models. Need 3 sets. Dale Stevens, Rt. 4 Box 42 Nichols, S.C. 29581. 803 392-4222.

FOR SALE

ACTIVE ELECTRONIC CROSSOVERS

Plug-in Butterworth (maximally flat) filters in 6 db., 12 db., or 18 db., per octave attenuation, any frequency specified. Filters flat beyond 100 KHz.

Complete crossover in attractive metal cabinet with all terminations and regulated power supply.

STEREO BI-AMP \$139

Tri-amp, quad-amp, and monaural types available at comparable prices. Other available features: Summer for "single woofer" systems, Subsonic noise elimination filters supplied with or without bass boost, level controls.

FOR OEM'S AND HOME ASSEMBLERS

500 Series dual filters and/or plug-in filters, regulated power supplies.

FREE CATALOG & PRICE SHEET

Write to:

DeCoursey ENGINEERING LABORATORY

11828 Jefferson Bl., Culver City, CA 90230
Phone: (213) 397-9668

155

TRANSPARENT



The lowest distortion of any expander available.

For information write: RG Dynamics
4448 W. Howard St. Skokie, IL 60076

THE RG PRO-20W DYNAMIC PROCESSOR

FUJI maxell
Scotch TDK
All tapes guaranteed

FUJI maxell
Scotch TDK
minimum order 12

BLANK TAPES AT WHOLESALE PRICES

Call TOLL FREE or write for LOW PRICES

IN CALIFORNIA NATIONWIDE

800/472-1783 **800/854-7769**



Approved by phone

Mck's TAPE TOWN
111 S. COLLEGE AVE., PO BOX 5000
CLAREMONT CA 91711

ONLY THREE THINGS REALLY MATTER IN A PREAMP'S PERFORMANCE

1. Accuracy of frequency response
2. Low noise
3. Low distortion

The DB Systems DB-1A has...

1. The most accurate phono equalization available (± 0.07 dB 10Hz - 40kHz).
2. Noise as low as any on the market with actual cartridge attached (moving magnet type).
3. The lowest distortion of any preamp available (less than 0.0008%, 20Hz - 20kHz).



DB SYSTEMS • P.O. Box 187 • Jaffrey Center, NH 03454

WANTED TO BUY OR TRADE

BRAZILIAN ROSEWOOD OR WALNUT CABINET for Sequerra Model I Tuner. Contact Barry Tinkoff, Box 590, Fall River, MA 02722; (617) 673-6622.

CASH FOR your unwanted LPs & reel to reel tapes. Records, Box 323, Hillburn, New York 10931. TF

MARANTZ & McIntOSH TUBE EQPT. FUTTERMAN, QUAD and CITATION TUBE EQPT WHEN AVAILABLE CALL COLLECT 617-734-2727. SOUND ADVICE, Box 782, Brookline, MA 02147.

WANTED!

Classified Advertisers For Audio

- it works
- it's inexpensive
- it sells

Send your ad today to:

Audio Classified
401 NORTH BROAD ST.
PHILA., PA 19108

156

FOR SALE

SPECIAL PURCHASE!



Sansui

Model QC-04 CD4 Four-Channel QUAD RECORD DEMODULATOR!

12⁹⁵ EA.

\$9.95 ea., lots of 3.

\$8.95 ea., lots of 100.

Sensational Factory Surplus purchase! A goldmine of parts and circuitry! 1500 in stock. With schematic. (5 lb.) 025HP099.

Hundreds of surplus & unusual items — Write today!

ETCO ELECTRONICS Dept. 044, NORTH COUNTRY SHOPPING CENTER PLATTSBURGH, N.Y. 12901

PLANS & KITS

Delux Audio Equipment Rack. Detailed plans for construction a "Super Audio Rack"! Send \$1.00 for plans and info. Audio box A961, 401 N. Broad St., Phila., PA 19108

TAPE-SLIDE SYNCHRONIZER, multiprojector lap-dissolve plans, \$5.50. With mixer, compressor, preamp schematics, \$8.50. The Millers, 1896 Maywood, S. Euclid, OH 44121. TF

TELEFUNKEN TUBES - A few popular types include: ECC83/12AX7 - \$4.95 ea.; ECC82/12AU7 - \$4.95; EL346CA7 - matched pair \$23.95, each \$10.95. Save 15% with a TELEFUNKEN RETUBE KIT for your amp, preamp or tuner. Quotes on request for other than advertised tubes.

KIMBER KABLE - new high performance, low resistance pure copper braided speaker cable designed by Ray KIMBER. 8 gauge - 87'/ft, 14 gauge - 56'/ft. More information and samples on request. Send orders and inquiries to: SOUND SERVICES, Lake Walton Road, Wappingers Falls, NY 12590. Telephone: 914-226-5414.

VISA MASTERCHARGE

SERVICES

ALL SPEAKERS REPAIRED

FAST SPEAKER RECONING SERVICE ON ALL TYPES OF TRANSDUCERS, FACTORY AUTHORIZED SERVICE FOR JBL, ALTEC, CETEC AND ELECTRO-VOICE, ESS. DEALERS DISCOUNTS AVAILABLE. ANTECH LABS, INC. 8144 BIG BEND ST. LOUIS, MISSOURI 63119 (314) 962-565

CUSTOM RECORDING SERVICE, Tapes, discs, and cassettes. Stereo and mono. Live and copies. Editing. Masters and pressings. High quality at reasonable rates. Joseph Giovanelli, Audio-Tech Laboratories, 2819 Newkirk Ave., Brooklyn, N.Y. IN9-7134 TF

DICTION VIA PHONE: MS, letters, etc. 24 hrs. a day. Rapid transcripts. 215-698-1377.

JBL SPEAKER WARRANTY STATION- RCI, 8550 2nd Avenue, Silver Spring, Md. 20910. Mail orders Welcome.

NASHVILLE RECORD PRODUCTIONS WILL PRESS HIGH QUALITY PURE VINYL RECORDS FROM YOUR TAPES. SEND FOR SAMPLE RECORD AND PRICE LIST. ALSO FINEST DISC MASTERING. 469 Chestnut St., NASHVILLE TENNESSEE 37203 TF

STYLUS RE-TIPPING

FIRST IN COUNTRY

SHIBATA tip in place of spherical or elliptical improves the stylus response-worn records sound better too!

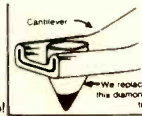

PRICES:

Discs:	As other moving coils	\$45.00		
Fidelity Research	Broken Cartridges	and	\$15.00	
Magnum	All other labor only			
Super	Specialty			
Elite	Shibata	\$10.00		
		\$20.00		

As work 100% guaranteed. See required within 24 hours. Add \$2.00 for shipping and handling. 99 Maple Street, Road, Wappingers Falls, NY 12590

FOR SALE

The Apt/Holman Preamp

For literature, the name of your local dealer, and ordering information, please check the box.

For a collection of five technical papers by Tom Holman, please check the box and send \$2.00.

Name _____
Address _____

Apt Corporation Box 512 Cambridge, Massachusetts 02139

SPEAKERS

HIGH FIDELITY SPEAKERS REPAIRED
AMPRITE SPEAKERS SERVICE
655 Sixth Avenue, New York, N.Y. 10010
212-CH3-4812

TF

VENEER SPEAKER CABINETS Hardwood Walnut Speaker Cabinets with grill. Routed or unrouted, front baffles, or complete **SPEAKER KITS.** Send self-addressed stamped envelope for complete brochure. **KUSTOMIZED SPEAKER SYSTEMS, 260-A GLENN CIRCLE, POWELL, TN 37849.**

MUSICAL INSTRUMENTS

UP TO 60% DISCOUNT. Name brand instruments. Catalog Freeport Music, 114R Mahan St., W. Babylon, N.Y. 11704. TF

TAPE AND TAPE RECORDERS

CASSETTES — SUPER FERRO DYNAMIC

Equal or better than Maxell UDXL, TDK-SA etc. Eight cassettes with FREE Add'n Stac storage module (\$1.95 value): C-45's \$16.00; C-60's \$18.00; C-90's \$22.00 including postage or send \$2.00 for a sample C-60. Save money, Get Great Quality! Use check, moneyorder, Visa or Mastercard. Moneyback Guarantee! ED HELVEY ASSOCIATES, Box 1507A, Annapolis, MD 21404.

CUSTOMIZED TAPES, Jazz, Big-Band. Over 900 standard tracks. 80 minute cassettes or 8-tracks, \$8.00. Open reel, \$10.00, catalog \$1.00 (refundable). Tapes Unlimited Box 163 Portsmouth RI 02871 TF

FREE CATALOG. . . CLASSICAL, Cassettes, Stereo-Dolby . . . Quality Guaranteed . . . Discounted . . . Credit Cards Accepted. . . EKR Classics, GPO Box 1977AB, New York, NY 10001.

MXR's dual 15 and 31 band graphic equalizer, compounder. Discwasher products. Maxell tape. Discounted! N.A.B. AUDIO, Box 7, Ottawa, IL 61350. 4-9

NAME-BRAND RECORDING TAPE, custom loaded. Available in cassettes, reels, cartridges. Huge savings from manufacturer. Also low everyday prices on Maxell, TDK, Ampex, Scotch, BASF, etc. New catalogue now available. MJS, 2514 Seaboard Ave., San Jose, CA 95131. (408) 262-8793.

OLDIES ON OPEN REEL TAPE. Rock n' Roll songs by their year of release. Free Brochure. Rock n' Reel Rental, 38 Fairland Dr., Wethersfield, CT 06109.

TDK, MAXELL, MEMOREX, BASF, cassettes, reels 8-tracks. Lowest prices. New, Guaranteed. FREE CATALOG S&S Audio, P.O. Box 94485, Schaumburg, IL 60194 TF

VIENNESE LIGHT MUSIC SOCIETY — Waltzes, Polkas. Overtures on imported Dolby cassettes. Most non-Schwann. K.C. Company, Box 793, Augusta, Maine 04330. 7-9

SAVE up to 80% BY MAIL on: SCOTCH, TDK, BASF, MAXELL, MEMOREX, CAPITOL MUSIC TAPE, CERTRON (over 180 different reel & cassette tapes to choose from); top brand recorders; America's largest collection of taping accessories, too. Same day service. **FREE catalog.**

America's Recording Tape Specialists

SAXITONE TAPE SALES

1776 a Columbia Rd., Washington, D.C. 20009
(202) 462-0800

BLANK TAPE SALE

TDK SA-C90	3.05	AMPEX GRANDMASTER I-90	2.69
TDK AO-C90	2.45	AMPEX GRANDMASTER II-90	3.09
TDK D-C90	1.59	Discwasher: Complete System	10.49
TDK SA-C60	2.15	Soundguard: Record Pres. Kit	4.59
BASF PRD I C-90	2.79	TDK L-1800	5.13
BASF PRD II or III C-90	2.89	TDK LB-1800	6.31
BASF Studio I or II C-90	2.59	AMPEX GRANDMASTER 1800' Reel	5.95
SCOTCH: Master II or III C-90	3.15	SCOTCH 207-TR-1800	5.09
SCOTCH: Master IC-90	2.69	BASF Studio 1800' Reel	6.49

All tapes can be assorted. No minimum order. Shipping 3.00 per order. Or write for free catalog of over 250 products, including lowest prices in US on complete line of Maxell products. All tapes 100% guaranteed. 412-283-8621.

TAPE WORLD, 220 Spring St., Butler, PA 16001

BUSINESS OPPORTUNITIES

Beat the Races! "Lifetime Income From Racing-flats, trots." Elias, Box 47AA, Brooklyn, New York 11219

CABLE FM BROADCAST STATION. Unique no investment/experience business makes money! Others work for you! Free Details "CAF.M," Box 130-N4, Paradise, CA 95969

CAMPUS REPS - High Performance Loudspeakers, Box 18009, Seattle, WN 98118 TF

PIANO TUNING LEARNED QUICKLY AT HOME! Free information. Empire School, Box 450327, Miami 33145.

Want money? Hate hard work? Lazy way to big money. Cleaver plan \$2.00 (Refundable) Noble, Box 10033, Houston, TX. 77206.

\$1200.00 MONTHLY Correcting Pupil's Lessons!!! Start Immediately. Free Report. Send self-addressed stamped envelope. Home, Box 9201-SLTO, San Diego, CA 92109.

\$400 WEEKLY, Home Mailing Program. Alltime, Box 25131, Tamarac, FL 33320

\$600/THOUSAND PROFIT!!! Guaranteed Earnings, stuffing envelopes, RX, DGWING, Box 311, Novato, California 94947

"1,000% PROFIT AT HOME! NO OBLIGATION. Information. \$1.00 (refundable) Macrame of New York, P.O. Box 87, White Plains, NY 10603"

HELP WANTED

AUSTRALIA—NEW ZEALAND WANT YOU!! 50,000 Jobs! Big Pay! Reports \$2.00. AUSTCO, Box 2069-K, La Puente, CA 91746 1-0

SAN FRANCISCO - PALO ALTO, CALIF. Experienced salespersons & management needed. Salary plus profit sharing. Send resumes to Sound Systems, 546 University Ave., Palo Alto, Ca 94301.

TAPE RECORDINGS

OPEN REEL TAPES. 7½ips, Dolbyized releases from RCA, London, DG, Warner and others. Airline tapes, quad. Catalog and updates, \$1. THE REEL SOCIETY, P.O. Box 9337-A, N. Hollywood, CA 91609. 9-9

UNIQUE RECORD KEEPING FOR YOUR HOME RECORDINGS. SEND SASE FOR FREE SAMPLES. AUDIOCO, DEPT. AU6, 11 CHURCH ST., BOSTON, MASS. 02116.

MISCELLANEOUS

ELECTRONIC BARGAINS, CLOSEOUT, SURPLUS! Parts, equipment, stereo, industrial, educational. Amazing values! Fascinating items unavailable in stores or catalogs anywhere! Unusual FREE catalog. ETCO-008, Box 762, Plattsburgh, N.Y. 12901 TF

TAX REVOLT INFLATION SURVIVAL Information. Free sample: Survival Publications, 500 Esplanade Dr., # 1520A, Oxnard, CA 93030.

YELLOW PAGES OF AUDIO—\$3.95

Sourcebook to 1,100 periodicals. 250 books, 7,500 products! Future Publications, 137 Valley Park S. Bethlehem, PA 18018 1-9

50 DIFF. OLD U.S. Stamps between 1861 and 1939 \$1.00. Ed Roush, 423 Shepard, Mansfield, OH 44907. tf

HELP WANTED

OVERSEAS JOBS — Now hiring all Occupations. High pay. Transportation. Computerized Reports, \$2.00 TRANSWORLD, International Airport. Box 90802-K, Los Angeles 90009 TF

RADIO-TV Jobs. . . Stations hiring nationwide! Free details: "Job Leads," 1680-PH Vine Hollywood, CA 90028

Audio Subscriber Service

When writing about your subscription please attach your mailing label here

and mail form to: **AUDIO**
401 N. Broad St.
Philadelphia, PA 19108

ADDRESS CHANGE?

Just write in your new address below and attach your mailing label above. Please allow 6-8 weeks advance notice.

NEW SUBSCRIPTION?

If you are a new subscriber, check the box below and fill in your name and address. (For gift subscriptions, just attach a separate letter, giving full information.)

RENEWING YOUR SUBSCRIPTION?

First, make sure your mailing address is correct. Check the box below. As you can see, you can send payment, or we will bill you.

Please send

AUDIO

For 1 year, \$12.00

- New subscription Renewal
 Payment enclosed Bill me later

Name (Please Print)

Firm

Title

Address

Apt. No.

City

State

Zip

ENGINEERING WRITER STAFF ENGINEER FIELD-SERVICE ENGINEER

SONY Service Division needs person capable of analyzing state-of-the-art hi-fi circuitry from schematic diagrams, and writing in-depth theory-of-operation about same. Educational background unimportant, ability and knowledge of audio circuitry are. Design experience on commercial hi-fi products desirable but not mandatory. SONY Service Division also needs an East Coast field-service engineer and several staff engineers. Applicants must have servicing backgrounds and be expert in state-of-the-art hi-fi circuitry. Technical people only; no sales or management positions are available. Send resume to: Michael Salvati, SONY CORPORATION OF AMERICA, 47-47 Van Dam Street, Long Island City, NY 11101. We are an equal opportunity employer m/f.

SONY®

RECORDS

DIRECT TO DISC AND DIGITAL RECORDINGS: All labels at low prices. Telearc, Discwasher, Audio-Technica, Sheffield, Denon PCM, Crystal Clear, Mobile Fidelity Labs. . . WE HAVE THEM ALL!! (and more!!) Send for FREE price list and Newsletter or \$2.00 for descriptive cataloge DISConnection, P.O. Box 10705 Tampa FL 33679.

Free Catalog LP's \$2.50 to \$4.00 factory sealed. Modern Design, 1731 N.E. 51st St., Pompano, FL 33064.

FREE SOUNDTRACKS & CASTS CATALOG! Personalities! ST/OC Valuebook: \$4. RTSA 711 W. 17th G-1 Costa Mesa, CA 92627. TF

LP's, Tapes, Imports, Cutouts, Current, Oldie 45's, catalogs \$2; NERT, Box 268-A, Lawrence, Mass. 01842.

MILWAUKEE! — The Audio Emporium-Audio Perfectionist Cables, Audio Research, Bang & Olufsen, Connoisseur, Dahlquist, Decca, Genesis, Grace, Grado, Grafyx, Great American Sound, Hafler, Kenwood Pro, Linn, Lux Magnepan, Polk, Revox, Rogers, Sonus, Supex, Technics, many direct discs, 6900 W. Brown Deer Rd., Open Tues. thru Sat. 10-6. 414-354, 5082. tf

RARE OUT-OF-PRINT LP's. Factory Sealed — 99c to \$3.99 ea. Over 25,000 in stock. List — \$1.00 Record Warehouse, Box 4617, Dept. AO, Rochester, New York 14613.

"RECORD JACKETS. Replace old, torn, LP jackets with clean, glossy, pure white or black jackets. Plastic lined inner sleeves, 78 sleeves, opera boxes. Free catalog. CABCO A6, Box 8212, Columbus, Ohio 43201." TF

RECORDS, RECORDS, RECORDS

Old, New & Direct Disc too! Send \$1. for Complete Info, S.E.O.J., 519 Wheat, Johnstown, PA 15902. 4-9

Soundtrack, Original Cast LP's. Large free catalog. STAR 208, Box 7, Quarryville, PA 17566.

SUPER-FI RECORDS!

All types, labels; quick, personalized service; huge catalog only \$1.00 Try us! Cosmic Chords PO Box 4873 Boulder Colo 80306

WHILE YOU WERE LOOKING for out-of-print records, you should've been looking for us. DISContinued. 444 S. Victory Blvd., Burbank, Ca. 91502 TF

INSTRUCTION & EDUCATION

ADVANCED BASS BOOK. Etudes for the Bass Guitar. A modern method for the skilled bassist. \$5.00. Beyond Help Publications, 311 North St. Coffeyville, KS 67337.

CERTIFIED AUDIO CONSULTANTS home study Hi Fi course available. Send \$5.00 for information. Includes AUDIO TECHNICAL YEARBOOK with 29 sample lessons and applications for membership in Society of Audio Consultants. Write SAC, P.O. Box 552 Department A, Beverly Hills, Calif. 90213.

R.E.I. SCHOOL OF RADIO ANNOUNCING and broadcasting engineering can train you for the exciting field of broadcasting.

F.C.C. 1st Class License in 5 weeks.

Creative commercial production.

Call (813)-955-6922 or write, R.E.I., Inc.

61 N. Pineapple Ave., Sarasota, Fla. 33577.

SHORT INTENSIVE SUMMER COURSES in Recording Techniques, Electronics, Electronic Music, Jazz Improvization, Contemporary Song Writing, Popular and Jazz Harmony, Musical Instrument Repair and Instrumental Workshops in Saxophone, Clarinet, Flute, Trombone, and Percussion, with Allard Oberbrunner, Rascher, Goebel, Purcell and Strohmman. Write or call Frank Stachow, Summer Workshops. (717) 867-4411 Ext. 275, Lebanon Valley College, Annville, Pennsylvania 17003.

This page could change your life

It can turn your old equipment into new money...

Or find just the right piece of new or used equipment for you.

It can fill that opening in your organization...

Or find just the right opening for you.

It can sell your product across the country and around the world...

Or it can bring a world of products to you.

How?

CallCarolynn (215) 574-9600.

Or fill in the attached form
and mail it to:

Carolynn F. Sumner

Classified Advertising Manager

401 North Broad Street

Philadelphia, PA 19108

A Classified Ad.....

It can change your life.

BUSINESS ADS—\$4.80 per line (40 spaces)

For Sale Business Opportunities Instruction
 Help Wanted Services Other _____

NON-BUSINESS ADS—\$2.80 per line (40 spaces)

Situation Wanted Wanted to Buy
 Personals Other _____

COPY (Please Print or Type) _____

PAYMENT MUST ACCOMPANY COPY.

Signature of Advertiser _____ Title _____

Company Name _____

Company Address _____

Phone _____

See front of Classified Section for further information.

EVERY MUSICIAN SHOULD PLAY THIS KEYBOARD.



It controls the TEAC Model 124 Syncaset™. Our first cassette deck that lets you record one track, then overdub the other to get two musical parts in perfect time. Later, you can mix live material with these two tracks and hear all three parts through your home sound system.

With the Model 124, you can accompany yourself or an existing piece of music, and record the result. Rehearse a tune or create one. Sharpen your ear for harmony and phrasing.

And develop your timing and playing skills while you're at it.

*Dolby is a registered trademark of Dolby Laboratories, Inc.

After you've worked on your own music, enjoy the sounds of others. The Model 124 is an outstanding stereo cassette deck. High signal-to-noise performance. Low wow and flutter. Wide, flat frequency response. There's Dolby* NR (disabled in the "Sync" mode). Memory rewind for fast tape checks. And illuminated VU meters for easy level adjustments.

Probably better than anyone, we know the Model 124 can't give you all the multitrack flexibility and open reel performance you want. But at a third the cost of an open reel multitrack recorder, it could be the start-up tool you need. And when you consider the savings on tape alone, you'll find the Syncaset a handy, economical instrument to work with.

So try out the keyboard every musician should play. See your TEAC Multitrack dealer today for a demonstration of the Model 124 Syncaset.™



TEAC®
Multitrack Series

Technics SILVER EDITION

Any tape recording you make is only as accurate as the machine it's made on. That's why you should take a hard look at Technics RS-M44 cassette deck. One of the new cassette decks in Technics Silver Edition.

The first thing you'll notice about the RS-M44 is its fluorescent bar-graph meters. They're completely electronic and extremely fast with a device attack time of just five millionths of a second. They're also accurate. So accurate that deviation from the 0 VU level is no more than 0.1 dB.

What it all adds up to is fast recognition of musical peaks for tight control of dynamic range in your recordings.

For accuracy in the tape transport system, the RS-M44 has an IC-controlled FG servo DC motor. It constantly monitors motor rotation so that speed variations are corrected instantly. Even under fluctuating voltage or load conditions.

Equally accurate is the RS-M44's H₂F head. With it the frequency response is not only wide and flat, it actually exceeds the response of most source material.

When it comes to tape, the RS-M44 has what you need to make the most out of normal, chrome and ferric oxide tape. Like separate three-position bias and EQ selectors as well as a fine-bias adjustment.

The RS-M44 also lets you spend more time listening and less time fidgeting. One reason is the Music Selector. When activated it jumps ahead and plays the next selection, or repeats the present selection. Plus there are other memory features. Including memory auto rewind, auto play, and rewind auto/play.

Still there's really only one way to appreciate all of the new cassette decks in the Silver Edition. Stop reading and start listening.

Technics gives you two ways to look at accuracy. This way. And this way.

Wow and Flutter	Frequency Response	S/N
0.05% WRM ₅	30 Hz - 17 kHz (FeCr/CrO ₂)	67 dB Dolby* in

*Dolby is a trademark of Dolby Laboratories, Inc.



Enter No. 66 on Reader Service Card