

Audio

Mike
Test Update

THE AUTHORITATIVE MAGAZINE ABOUT HIGH FIDELITY • SEPTEMBER 1978 \$1.25

47425

58 Cassette Types Tested

Performance of High-Energy Magnetic Materials for Cassettes

U0803760 0280 70620015P01013111
DOM L HUNTER
2608 CENTRAL BLVD
EUGENE OR 97403

For years, Nakamichi has enjoyed a reputation for building the world's finest cassette deck.

Now Pioneer is introducing something Nakamichi won't enjoy at all: the Pioneer CT-F1000. A cassette deck that offers all the features and performance of Nakamichi's best cassette deck, at less than half the price.

PIONEER VS. NAKAMICHI: THE HEAD TO HEAD COMPETITION.

The \$1,650* Nakamichi 1000II and the \$600* Pioneer CT-F1000 are both honest three headed cassette decks that let you monitor right off the tape as you record.

Both have separate Dolby systems for the playback and recording heads. So when you're making a recording with the Dolby on, you can monitor it exactly the same way.

Both have two motors to insure accurate tape speed.

Both feature solenoid logic controls that let you go from fast forward to reverse, or from play to record without punching the stop button, and without jamming the tape.

And both are filled with convenient items like automatic memories for going back to a selected spot on a tape, multiplex filters for making cleaner FM recordings, separate bias and equalization switches for getting the most out of different kinds of tape, and even a pitch control adjustment that lets you match the pitch of a cassette to the tuning of your guitar or piano.

A \$1,000 GAP IN PRICE; NO GAP IN SOUND.

When we built the CT-F1000, however, we did more than match the Nakamichi's renowned features. We also matched its renowned performance.

Both machines boast totally inaudible total harmonic distortion levels of less than 1.5%.

Both have all but conquered the problem of wow and flutter. (An identical 0.05% for each machine.)

Both offer similarly impressive signal to noise ratios: 64 decibels Pioneer, 65 decibels Nakamichi. (At these levels

It's value.

we dare you to hear any noise at all, let alone any difference.)

And finally, where the CT-F1000 delivers a frequency response of 30 to 17,000 hertz, the Nakamichi deck goes from 35 to 20,000 hertz. (We offer a little more at the bottom; they offer a little more at the top. Either way, the specifications are close enough to be called virtually identical.)

A FEW PIONEER ADVANTAGES THAT AREN'T MONETARY.

To prevent you from making distorted tapes, the CT-F1000 has a peak limiter that the Nakamichi machine lacks.

Our tape heads are made out of a special single crystal ferrite material that's been proven to last longer than the Nakamichi's permalloy variety.

And our Dolby system can be calibrated by hand while the Nakamichi 1000II requires a screwdriver.

Admittedly, the Nakamichi 1000II *does* feature a fancy azimuth control for aligning your heads before every recording session. But we've developed a more accurate way to mount the heads in the first place. So you can spend your time recording, instead of aligning.

A FEW CONCESSIONS TO NAKAMICHI.

Obviously, at almost \$1,000 more, the Nakamichi 1000II must offer some advantages over the CT-F1000.

And we'd be remiss if we didn't point out that their VU meters extend slightly higher than ours.

And that they have extra input for premixed program sources.

And although their signal to noise ratio is hardly different than ours, the Nakamichi 1000II does feature an extra Nakamichi-invented noise reduction system.

Considering the slimness of these advantages, the choice is clear-cut:

You can buy a Nakamichi 1000II and get an incredibly expensive cassette deck.

Or you can buy a CT-F1000. And get one that's simply incredible.

 **PIONEER**[®]
We bring it back alive.



The Pioneer CT-F1000: \$600

The big
difference
between this
cassette deck
and Pioneer's new
CTFF1000
isn't sound.



The Nakamichi 1000II: \$1,650

DISCWASHER

presents

The Clean Truth About Your Naked Stylus

When your stylus plays over one light fingerprint or one tiny "bead" of vinyl stabilizer, the clean naked diamond becomes a glazed, dust-holding abrasive weapon wearing away at your records and masking their true sound. This unseen build-up may actually hold the tracking tip of the diamond out of the record groove.



Accumulated grit on stylus that looks "clean" to the naked eye.

The SC-1 Stylus Cleaner from Discwasher is designed with a brush that is stiff enough to remove harmful accumulation, but gentle enough to avoid damaging delicate cartridge assemblies. Two drops of Discwasher's D3 Fluid add extra cleaning action to the SC-1 without the side-effects of alcohol, which can harden rubber cantilever mountings.



After cleaning with SC-1 and D3 Fluid by Discwasher.

The retractable, walnut-handled SC-1 includes a magnifying mirror for convenient inspection of stylus/cartridge alignment and wiring.

Get the clean truth from your records; get the SC-1.

SC-1 STYLUS CLEANER



discwasher, inc.
1407 N. Providence Rd.
Columbia, MO 65201

Audio

September 1978

Vol. 62, No. 9



"Successor to **RADIO** Est. 1917"

Feature Articles

The Compleat Microphone Review — An Update	35	Jon Sank
58 Cassettes Tested	42	Howard Roberson
Performance of High-Energy Materials in Cassettes	54	Peter Vogelgesang

Equipment Profiles

Pioneer SX-1980 Receiver	70	Leonard Feldman
McIntosh C-27 Preamplifier	78	Leonard Feldman
Studer-ReVox B-77 Open-Reel Tape Recorder	84	Howard Roberson
Nakamichi CM-700 Microphone	90	Jon Sank

Record Reviews

The Column	104	Michael Tearson/Jon Tiven
Theater Music	108	Donald Spoto
European Records	110	John Wright
Classical	112	Edward Tatnall Canby
Jazz & Blues	118	
Folk Bag	122	

Audio In General

Audio ETC	8	Edward Tatnall Canby
Tape Guide	16	Herman Burstein
Dear Editor	18	
What's New In Audio	24	
Audio Clinic	32	Joseph Giovannelli
Classified Advertising	127	
Advertising Index	132	

About The Cover: Beginning on page 42, we present extensive tests of nearly every cassette tape now on the market, but seeing whether the tape has enough signal to light a bulb isn't part of our procedure. Photo by Photographic Illustrations, Philadelphia.

Audio Publishing, Editorial, Subscription, and Advertising Production offices, North American Building, 401 N. Broad St., Philadelphia, Penna. 19108. Telephone: 215/574-9600
Postmaster: Send Form 3579 to above address.

AUDIO • September 1978

Let's set the record straight!

Stanton has had it all for more than 15 years.

The 881S has been acclaimed worldwide as the finest cartridge available. It embodies a unique combination of features developed by Stanton.

After all, it was Stanton who pioneered the first Magnetic Stereo Cartridge — as well as the first CD-4 pickup produced in the United States.



© Stanton Magnetics Inc. 1978

<p>1.</p>	<p>FEATURE</p> <p>Record Static Elimination System</p> <p>Every Stanton cartridge for the last 15 years has featured a patented stylus assembly which neutralizes the atmosphere surrounding the diamond stylus and discharges record static harmlessly into the grounded record playing system.</p>	<p>BENEFITS</p> <ul style="list-style-type: none"> A. Eliminates harmful static electricity at the record. B. Eliminates static clicks and pops at the loudspeaker. C. Enables the brush to do a <i>proper</i> cleaning job. D. Permits the use of an Ungrounded Brush. E. Eliminates electrostatic dust attraction to the stylus tip.
<p>2.</p>	<p>FEATURE</p> <p>"Longhair"® Brush</p> <p>Its independently hinged action does not interfere with the tracking force of the stylus while its tapered nylon bristles clean the grooves in front of the stylus. Stanton developed it in 1966.</p>	<p>BENEFITS</p> <ul style="list-style-type: none"> A. Cleans records efficiently. B. Damps tonearm resonance. C. Improves low frequency tracking. D. Dynamically stabilizes tonearm system. E. Aids in playback of warped records.
<p>3.</p>	<p>FEATURE</p> <p>Stereohedron™ Stylus Tip</p> <p>Patented in 1976, the Stereohedron stylus tip has a far greater bearing radius and more contact area with the groove.</p>	<p>BENEFITS</p> <ul style="list-style-type: none"> A. Exceptional frequency response. B. Superior protection of high frequency signals in the groove. C. Longer record life. D. Longer stylus life. E. Better tracing ability.
<p>4.</p>	<p>FEATURE</p> <p>High Energy Rare Earth Magnet</p> <p>First introduced by Stanton in early 1977, this type of magnet enabled the complete miniaturization of the stylus assembly and tip mass. It is the beginning of a whole new generation of cartridges.</p>	<p>BENEFITS</p> <ul style="list-style-type: none"> A. Outstanding tracking ability. B. Unequaled transient response. C. Higher output with one tenth the mass of ordinary magnets. D. Superior tracing ability.

Add it all up... and you see why Stanton is imitated... but unequaled!

Write today for further information to Stanton Magnetics, Inc., Terminal Drive, Plainview, N.Y. 11803.

... the choice of the professionals™



Enter No. 32 on Reader Service Card

Why now,
more than ever,
we can ask,
"Is it live, or
is it Memorex?"



Quite simply, new MRX₃ is the best cassette Memorex has ever made. Better, even, than our own MRX₂ Oxide cassette. Here's exactly why: MRX₃ is made with a new, high-energy ferric oxide particle to give you the following improvements in sound reproduction.

1) Brighter highs, richer lows.

Higher output at saturation, specifically a 3.0 dB improvement over MRX₂ Oxide at high frequency maximum output level and a 3.0 dB boost at low frequencies.

2) Less distortion.

4.0 dB less distortion than MRX₂ Oxide.

3) Wide dynamic range for broad recording flexibility, the most important indication of tape quality. Boosted MOL and low noise level give you an excellent signal-to-noise ratio and 2.5 dB improvement in dynamic range over MRX₂ Oxide.

In short, new MRX₃ Oxide offers sound reproduction so true that now, more than ever, we can ask, "Is it live, or is it Memorex?"



MEMOREX
Recording Tape.
Is it live, or is it Memorex?

©1978, Memorex Corporation, Santa Clara, California 95052, U.S.A.

Audio

Editor
Eugene Pitts III

Associate Editors:
Edward Tatnall Canby, Bert Whyte

Assistant Editor
Eugene J. Garvin Jr.

Design
Frank Moore

**Advertising Production
& Editorial Assistant**
Gloria Klaiman

Senior Editors:
Richard C. Heyser, B. V. Pisha

Contributing Editors:
Tom Bingham, Herman Burstein,
Geoffrey T. Cook, John Diliberto,
Leonard Feldman, Joseph Giovanelli,
Bascom H. King, C.G. McProud,
Dan Morgenstern, George Pontis,
Howard A. Roberson, Jon Sank,
Donald M. Spoto, Michael Tearson,
Jon Tiven

Vice President/Publisher
Jay L. Butler



AUDIO is published monthly by
North American Publishing Company.
Irvin J. Borowsky, Founder and President

Frank L. Nemeyer, Vice President/General Manager
Harry Feld, Treasurer
Joseph Florentine, Chief Financial Officer
R. Kenneth Baxter, Vice President/Manufacturing
Mary Anderson, Secretary/Production Director
John Nolan, Corporate Art Director
Vic Brody, Promotion Director
Jim Atkins, Subscription Promotion Director
Mary Claffey, Vice President/Circulation
S.O. (Shap) Shapiro, Circulation Consultant
Jean Davis, Subscription Manager

ADVERTISING SALES

Jay Butler, Vice President/Publisher,
545 Madison Ave., New York, NY 10022
Telephone (212) 371-4100.

West Coast Sales Office: Jay Martin, 17000 Ventura Blvd., Encino, CA 91316. Telephone (213) 788-9900.

Continental European Representative: V.B. Sanders, International Publishers Advertising Service, Raadhuisstraat 24, P.O. Box 25, Graft-De Ryp, Holland. Telephone, 02997-1303

England: The Paul Singer-Lawrence Media Group, 54 Burton Court, London SW3 5Y4, England. Phone: 01-730-3592

Title registered in U. S. Patent Office.
Entire contents copyrighted world wide. No portion may be reproduced in any language without written permission.

World Library Congress Number ISSN 0004-752X
Dewey Decimal Number 621.381 or 778.5

Editorial Contributions are welcomed but should be accompanied by return postage. Submissions will be handled with reasonable care, but the publisher assumes no responsibility for return or safety of manuscripts, photographs, or artwork.
Printed in U.S.A. at Columbus, Ohio. Second-class postage paid at Philadelphia, PA and additional mailing offices.

U.S. Subscription Rates: 1 year \$12.00, 2 years \$22.00, 3 years \$30.00.

Other Countries: 1 year \$18.00, 2 years \$34.00, 3 years \$49.00

Back issues, when available, \$5.00 postpaid

Audio Publishing, Editorial, Subscription, and Advertising Production offices, North American Building, 401 No. Broad St., Philadelphia, PA 19108. Telephone: (215) 574-9600.

Postmaster: Send Form 3579 to above address

Enter No. 18 on Reader Service Card

To understand why the Bose® Model 601 sounds so great you have to start at the top.



The Model 601 employs tweeters and woofers, as do conventional speaker systems. But there is where the similarity ends.

Notice how the high-performance Bose drivers are arranged. Each one of the four tweeters and two woofers is precisely positioned within the enclosure to radiate sound in a particular direction. Rearward. Sideways. Upward and forward. To give you the proper balance of reflected and direct sound. Much like you hear during a live performance.

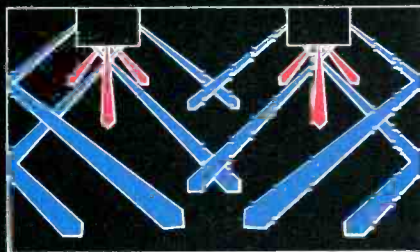

Only a Bose Direct/Reflecting® speaker gives you the spatial realism of live-performance sound. No matter where you sit or stand in your listening room, you hear

accurate stereo balance. Accurate location of each instrument, each note. With a clarity and precision that tells you you're listening to one of the finest speaker systems ever designed.

The Bose Model 601. Hear it at your Bose dealer.

BOSE®
Better sound through research.



How to improve

One of the most frequently-asked questions in high fidelity these days is how well a particular tonearm and cartridge work together. Because tonearm/cartridge compatibility is increasingly recognized as vital to accurate record reproduction.

that of the loudest musical program material.

During the upward motion of the tonearm/cartridge combination, the stylus tends to be pulled out of the groove, reducing tracking force to a fraction of the tonearm setting.

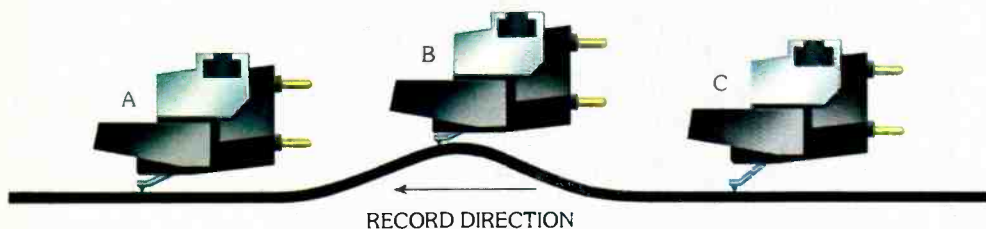

Figure 1. Record warp activates tonearm/cartridge resonance, undesirably reducing and increasing stylus force. (A) Normal position — normal tracking force. (B) Compressed position — increased tracking force. (C) Extended position — decreased tracking force. Record direction is right to left.

At Micro-Acoustics, we have a unique solution: *the first phono cartridge specifically designed to help any tonearm work at its best* — whether that tonearm is straight or S-shaped, low- or high-mass, with low to high cable capacity. We call it the 2002-e . . . and it offers significant advantages over conventional cartridge designs.

Tonearm/cartridge resonance: a critical problem

Record warp, present to some degree on nearly every disc you play, causes the cartridge to move up and down about the stylus (see Figure 1). This low-frequency up-and-down oscillation — called *tonearm/cartridge resonance* — can be considerable, since the amplitude of record warp can actually be *twelve to fifty times*

When this lower tracking force coincides with a loud musical passage, the cartridge mistracks, causing audible distortion and sometimes, groove jumping.

There is a common misconception

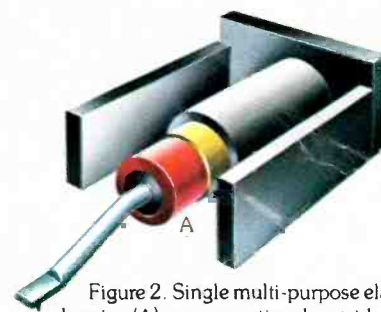
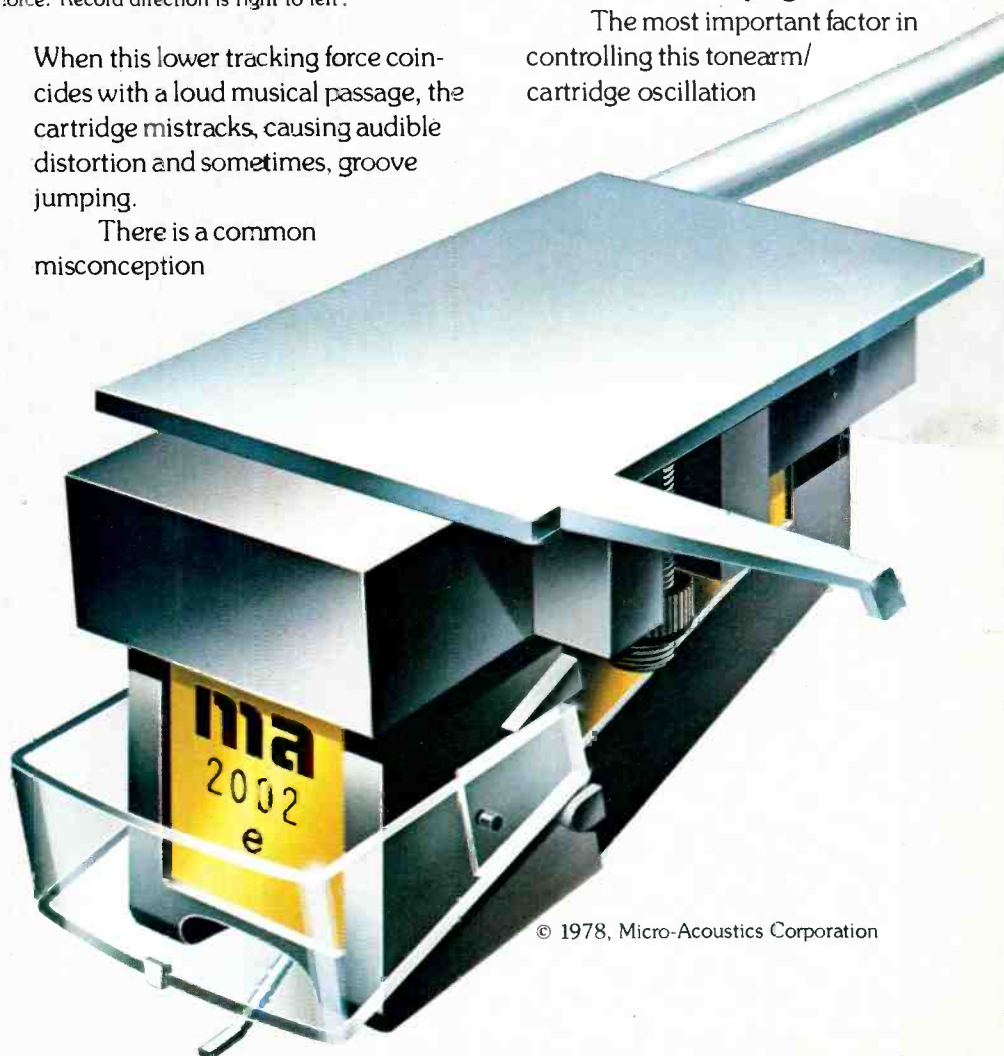

Figure 2. Single multi-purpose elastic bearing (A) on conventional cartridges compromises damping and compliance.

that tonearm/cartridge resonance can be “matched” out of existence. The fact is, it cannot: it must be *controlled* to allow the cartridge to function properly.

Compromised vs. optimized damping

The most important factor in controlling this tonearm/cartridge oscillation



© 1978, Micro-Acoustics Corporation

your tonearm.

is *damping*—a mechanical counterforce precisely applied to suppress resonance. Because the tonearm must be absolutely free to move, virtually all tonearms are totally undamped devices. So *damping must be supplied by the cartridge.*

In conventional cartridges, damping of tonearm/cartridge resonance must be a compromise.

Because it is provided by a single, multi-purpose elastic bearing (see Figure 2) which must trade off maximum compliance for tracking ability (less damping) with maximum suppression of high-frequency stylus resonance and tonearm/cartridge low-frequency resonance (more damping).

In contrast to this, Micro-Acoustics' 2002-e (Figure 3) has a sophisticated *multiple* damping system utilizing *eight* specialized dampers. One pair of these dampers are low-frequency warp stabilizers, *specifically designed* to control tonearm/cartridge resonance. This is the *first* effective warp-control system because it suppresses oscillation *at the cantilever pivot*, where it occurs

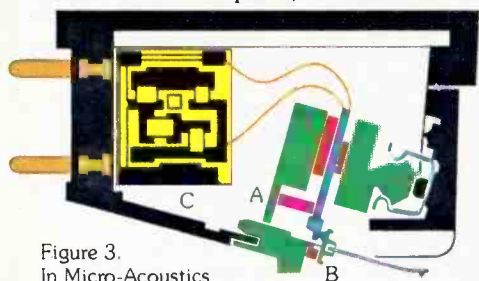

Figure 3. In Micro-Acoustics 2002-e, one pair of dampers—low-frequency warp stabilizers (A)—control tonearm/cartridge resonance. Other dampers optimize other characteristics. Dual bearings (B) provide maximum tracking ability. Microcircuit (C) optimizes cartridge output to any cable capacitance. (Only one channel shown.)

—rather than using an external device that rides ahead of the stylus. The remaining six dampers are optimized for stylus high-frequency damping and other factors, while our exclusive dual-bearing system *independently* optimizes tracking ability. By designing *separate* systems for damping and compliance within the 2002-e, we can precisely control tonearm/cartridge resonance *without compromising any other aspect of cartridge performance.*

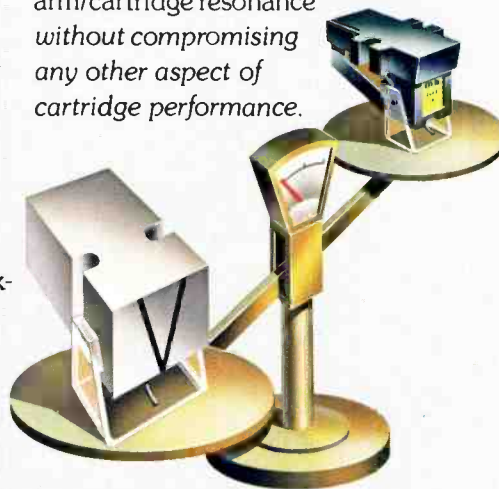

Figure 4. 2002-e is less than half the weight of many other quality cartridges.

High vs. low cartridge body weight

Regardless of the tonearm and damping system utilized, the lower the cartridge body weight, the greater the tonearm's ability to track warped records. This is because lower tonearm/cartridge weight allows damping to more effectively counteract tonearm/cartridge resonance.

At four grams, the Micro-Acoustics 2002-e is half the weight of many other high-quality cartridges, yielding *two or more times* the effective damping (see Figure 4).

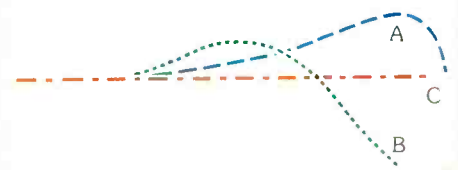

Figure 5. With conventional cartridges (A), low cable capacity causes response to peak; medium-to-high capacity (B) causes high-frequency response to roll off. Response of 2002-e (C) is unaffected.

Cable capacitance capability

Another important limitation of conventional cartridges is their interaction with cable capacity, which causes a deterioration in high-frequency response and transient ability (see Figure 5). In contrast to this, the 2002-e has a passive microcircuit which automatically matches the cartridge output to any tonearm's cable capacity, providing linear high-frequency response and transient accuracy.

Tonearm optimization made easy

If there were no such thing as tonearm/cartridge resonance or cable capacity, any cartridge would match any tonearm. But in the real world, where these problems exist, the only way to get optimum performance from your tonearm is the Micro-Acoustics 2002-e. Or our other direct-coupled cartridges: the moderately-priced 282-e and top-of-the-line 530-mp. All of them offer advantages you can hear today, at your Micro-Acoustics dealer.

Micro-Acoustics Corporation,
8 Westchester Plaza, Elmsford,
NY 10523. 914-592-7627. In Canada
H. Roy Gray Ltd., Markham, Ont.

ma[®]
Micro-Acoustics
Because good tracking isn't enough.[™]

Audio etc.

Edward Tatnall Canby

Well, here it is September already, and summer is beginning to fail. So this month's column is going to have a lot of failings — including some that are of the double-negative sort that come out positive. If summer fails, can fall be far behind? And without fail, year after year, autumn is the time when hi fi falls into place again after the hot weather hiatus.

We use that term "fail" too often, if you ask me. It's getting to be silly. Every single political opponent fails to do or say just about everything imaginable. I just got a snippy postcard concerning my musical broadcast in New York — I "failed to identify" some of the performers. I didn't fail. I did it deliberately, because my subject was the music and its composer, and the performers were performing very well on their own, thanks. So often, you see, we are doing something positive when we "fail." Yes, this evening I failed to drink my usual martini before dinner, I had a Manhattan instead.

A year or so ago in this space you may well remember that I spoke of an honorable old AM-FM tuner, the Fisher Series 80, one of the first "miniaturized" hi-fi components using the then new miniature tubes and taking maximum advantage of their reduced space requirements. (My point, in case you forget, was that the enormously smaller transistor and its relatives plus the IC have led us not to smaller but to larger hi-fi units, a thought that failed to please me.) So shortly thereafter in a letter to *Audio* magazine (June, 1977) Burdick S. Trask of Sherman Oaks, Cal., wrote a fascinating account of his refurbished 1936 Spartan all-wave receiver, complete with bi-amped output into a 15-inch woofer and two tweeters via an electronic crossover . . . for more details see the letter itself. However, before he got into *that*, Mr. Trask took a good humored sideswipe at me and my Fisher. It

seems I "failed to mention" — once again — the broad and narrow band width i.f. switch on the Fisher front panel, the main use of which was to allow reasonable hi fi when an AM station came in wide, clear and, maybe, clear-channel, yet in the narrow-band position reduce the hopeless AM interference, especially at night, when reception was weak and/or distant and the desired station overborne by its neighbors far and near. Selectivity.

Well, with reluctance, the truth must now out. Yes, I failed to mention this

even some rather vital modernizations. My Fisher Series 80 was strictly on its own, never serviced in any way and still (mostly) operating. So there's one positive failure for you.

I'll betcha one of you hounds could fix that Fisher in an hour or two if you got your hands on it. Just call me up and I won't charge you a thing.

Historical Horrors

And speaking of that, our friend Bert Whyte last year in his history of hi-fi shows missed out on (i.e. failed to men-

tion) one of the prime marvels of the first Audio Fairs in the Hotel New Yorker over on 8th Avenue and 34th Street in the Big Apple. That august hotel, vaguely out of the art deco era (1930s?) was indeed furnished with 120 volts of electric potential in each and every room, since it wasn't nearly old enough to boast gas light. But thanks to dear old Thomas A. Edison and his latter day namesake utility, now nicknamed Con Ed, the New Yorker was provided with the very best available electricity in the mid-town area — as we used to put it, 120 volts of

d. c. current. And we picked *that* for a hi-fi show! Maybe nobody realized it until the last minute.

But the show must go on, and the Audio Fairs did indeed. Somebody with a proper electrical background had apparently foreseen the future and the lucrative possibilities in servicing Conventions at the hotel, electronic included. There was a modest local alternator, somewhere down in the basement, which fed a. c. to extra outlets (right among the d. c. outlets) in — well, in some of the rooms. Our earliest hi-fi exhibitors, therefore, had to choose the right socket, and if they did they were rewarded with that splendid cacophony which we now find so familiar in hi-fi shows the world over. It was a brand-new sound, then, and not



useful Fisher feature, out of tact. On my Fisher the FM worked beautifully as I indicated, but the AM was dead.

Well, not *quite*. It did produce several types of interesting hiss and the signal-strength needle moved perceptibly now and then as I wheeled along the AM band. But that wasn't enough for my local weather summary, which was what I was after at the moment. On mature reflection, and since the rest of the tuner worked just fine, I decided to fail to mention the dead AM. After all, it was probably my fault. And time had indeed been passing for many a year — so why not give Fisher the benefit of the advantage? And after all, too, Mr. Trask's Spartan was rebuilt by himself from the bottom upwards with new and revived parts and

To get a superb performance, you need a precision machine.

To command a great performance, a cassette shell and cassette tape must be engineered to the most rigorous standards. Which explains why we get so finicky about details. Consider:

Precision Molded Cassette Shells—are made by continuously monitored injection molding that virtually assures a mirror-image parallel match. That's insurance against signal overlap or channel loss in record or playback from A to B sides. Further insurance: high impact styrene that resists temperature extremes and sudden stress.



Five-Screw Assembly—for practically guaranteed warp-free mating of the cassette halves. Then nothing—no dust or tape snags—can come between the tape and a perfect performance.

An Ingenious Bubble Surface Liner Sheet—commands the tape to follow a consistent running angle with gentle, fingertip-embossed cushions. Costly lubricants forestall drag, shedding, friction, edgewear, and annoying squeal. Checks channel loss and dropouts.

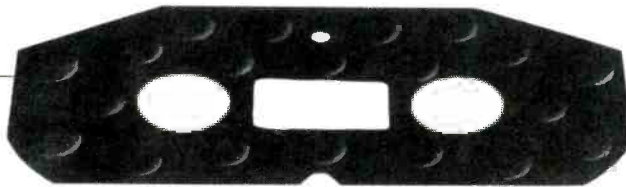

Perfectly Circular Hubs and Double Clamp System—insures there is no deviation from circularity that could result in tape tension variation producing wow and flutter and dropouts. The clamp weds the tape to the hub with a curvature impeccably matched to the hub's perimeter:



Head Cleaning Leader Tape—knocks off foreign matter that might interfere with superior tape performance, and prepares the heads for...

Tapered, Flanged Rollers—direct the tape from the hubs and program it against any up and down movement on its path towards the heads. Stainless steel pins minimize friction and avert wow and flutter, channel loss.

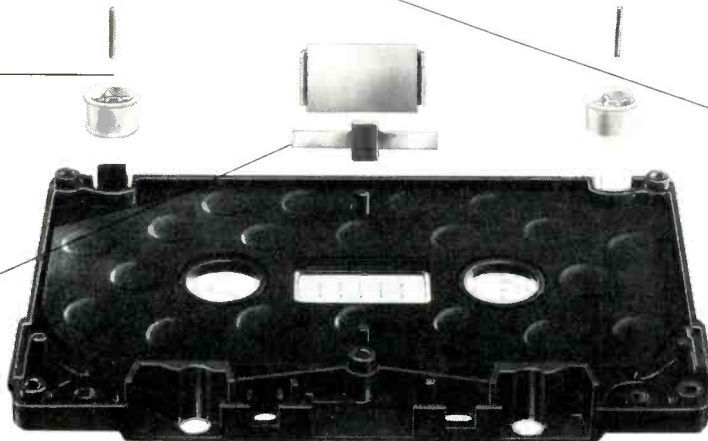

Our famous SA and AD Tape Performance—two of the finest tapes money can procure are securely housed inside our cassette shells. SA (Super Avilyn) is the tape most deck manufacturers use as their reference for the High (CrO₂) bias position. And the new Normal bias AD, the tape with a hot high end, is perfect for any type of music, in any deck. And that extra lift is perfect for noise reduction tracking.

Resilient Pressure Pad and Holding System—spring-mounted felt helps maintain tape contact at dead center on the head gap. Elegant interlocking pins moor the spring to the shell, and resist lateral slipping.

TDK Cassettes—despite all we put into them, we don't ask you to put out a lot for them. Visit your TDK dealer and discover how inexpensive it is to fight dropouts, level variation, channel loss, jamming, and other problems that interfere with musical enjoyment. Our full lifetime warranty* is your assurance that our machine is the

machine for your machine. TDK Electronics Corp., Garden City, N. Y. 11530. Canada: Superior Electronics Ind., Ltd.



TDK
The machine for your machine.

*In the unlikely event that any TDK cassette ever fails to perform due to a defect in materials or workmanship, simply return it to your local dealer or to TDK for a free replacement.

Enter No. 36 on Reader Service Card

nearly as well appreciated as now. If the wrong socket was chosen, in haste or by unfortunate accident, then there was smoke and damage and silence except for that ominous crackling hiss.

That alternator, if I remember correctly, was the handiest closing-time signal you can imagine. Right on the dot, six o'clock or whatever, the a.c. failed, whereupon the constant and excruciating blasts of nonintegrated fi from dozens of superior sources suddenly ceased penetrating every wall into four surrounding rooms and into corridors all over. And we were left in an instant with the loveliest silent d.c. illumination you can

envision. The d.c. kept going — it was from Con Ed. Conversations, continued, in low, hushed tones, and I'd guess there were more hi-fi deals made in those late moments of silence than in all the day's noise.

All that goes back to one of T. Edison's greatest failures — in the midst of his greatest triumph, the integrated electric light system as pioneered right there in New York at the famed Pearl Street power station and distribution system. That system was built on direct current, two-conductor. Very soon after, Edison worked out the three-conductor system but again via d.c. When this idea



was applied to its ultimately right area, the a.c. distribution system, we had modern power — but old Thomas would not go along. He stuck to d.c. and there were horrid stories perpetrated about people being fried via high-voltage a.c. in those newfangled arrangements. This was made even more gory by virtue of the new electric chair, which fried but did not quite kill one of its earliest occupants. Result was that the older Eastern cities, notably Boston and New York (and I would suppose Philadelphia) became entrenched in the d.c. system and stayed that way an astonishing number of years, right on through the 1930s. Of all the vicious impediments to fi, that of d.c. in the home was surely — at that time — the worst. Very nearly insurmountable. I should know; I was there.

Yankee Ingenuity

When I got out of college I moved to New York, right into a d.c. zone. There were plenty left, all over town. Ah, for today's ultra simple transverters, to make up a generic term! I could not exist without a record player, even then. I had a big collection of 78s, which travelled to New York from my college room with hardly more than 5 per cent breakage, a near miracle, thanks to enormous care in the packing of it into my family's Ford.

Naturally, I had rented my lodgings without a thought as to current — and now it was too late. So I went out and bought a perfectly enormous motor-generator thing, which I could just barely lift. Installed in my modest rooming-house corner, it went on with a wham, as the d.c. lights went momentarily dim, and produced a roar of "live" noise that rivalled the sound of the (a.c.) portable phono that it fed. So, heaven protect me, I put it in the back of a deep, deep, old-fashioned clothes closet and covered the entire thing with layers of old blankets and such. The brashness of youth! Somehow, there was no fire.

However, I failed to anticipate a failure to filter. There was a loud, insistent buzzing that came through my speaker whenever I played Beethoven. Was it square-wave or sawtooth? I tend to think the latter. And Beethoven would have rolled

Listen to the music.

PHASE LINEAR 1000



Noise in the form of hiss, hum and rumble—all the things that effectively cloud the clarity of records, tapes and FM broadcasts. Ideally, music should be heard against a silent background. The Phase Linear 1000 achieves just that with two unique systems: AutoCorrelator Noise Reduction and Dynamic Range Recovery. The AutoCorrelator reduces noise by 10 dB without the loss of high frequency music and without pre-encoding. The Dynamic Range Recovery System restores 7.5 dB of the overall dynamic range, without the pumping and

swishing associated with other systems. The Phase Linear 1000 represents the most significant improvement in sound reproduction for the money... more than any other single piece of equipment you could add to your system. It is easily installed to any stereo receiver or preamplifier.

Ask your dealer for an audition, and listen to the music.

Not the noise.

Phase Linear
THE POWERFUL DIFFERENCE

MADE IN U.S.A. DISTRIBUTED IN CANADA BY H. ROY GRAY LTD. AND IN AUSTRALIA BY MEGASOUND PTY LTD.

Soundcraftsmen equalizers

the **NEW**
SE450
\$249⁰⁰
(including cabinet)

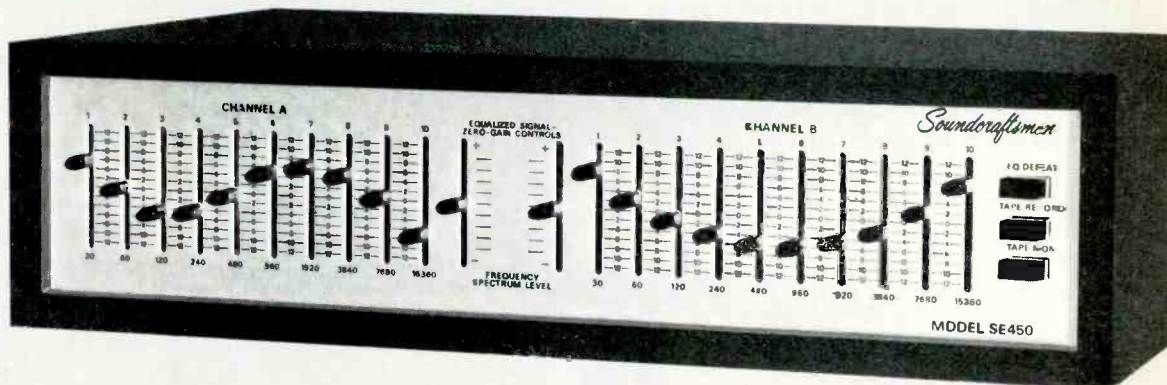

the Best
in EQ is now affordable—and GUARANTEED
to enhance and improve any fine system!

SE450 SPECIFICATIONS

SIGNAL-TO-NOISE:

105dB below full output.

INDIVIDUAL CONTROLS:

32dB total adjustment range.

- a. ± 16 dB each octave (all other octaves set at max.)
- b. ± 12 dB each octave (all other octaves set at zero)

TOTAL GAIN/CUT:

+ 22dB, - 28dB, all controls set at maximum.

THD:

Less than 0.01% at 2V.

THE EQUALIZER YOU BUY SHOULD HAVE THESE FEATURES:

An environmental **do-it-yourself test record** edited and announced by Soundcraftsmen especially for use with the Soundcraftsmen equalizer... **Computone Charts** for making a record of, and resetting in seconds, any desired EQ curve... A full-channel **frequency spectrum level control** on each channel for instant "no distortion" in/out balancing... **Light-emitting diodes** for precise visual signal level balancing... A **graphic display** for each EQ curve.

RP2201-R

\$299⁰⁰

(including cabinet)

Same performance, more features.



RP2215-R

\$370⁰⁰

(Including cabinet)

Spectacular performance, many more features.



Soundcraftsmen's

PERFECT-PAIR

MAKES A

TERRIFIC-TRIO

- 1 A 20-band 2-channel GRAPHIC EQUALIZER
- 2 A PATCH-PANEL PUSHBUTTON PRE-AMP
- 3 A 250-WATT CLASS 'H' AMPLIFIER

1 PE2217-R EQ SECTION

A stereo ten-octave Graphic Equalizer complete with zero-gain level controls, visual level monitoring through L.E.D.'s, the ability to pre-equalize tape recordings, tape monitor facilities, front panel equalizer switching and our exclusive Instructional Test Record and Computone Charts. Signal-to-noise better than 106dB down, ± 12 dB per octave (typ. ± 14 dB), total gain/cut capability + 30dB, -36dB.

2 PE2217-R PRE-AMP SECTION

Two independent discrete phono preamplifiers. Tape dubbing between two or three recorders with optional simultaneous equalizing and monitoring. Front panel tape input-output jacks. Double-dubbing into two recorders simultaneously. Two stereo headphone jacks. 84dB S/N and .01% distortion. Includes walnut-grained sculptured side panels, removable for 19" rack mounting.

3 MA5002 POWER AMP

The new Class "H" Analog logic Vari-Portional circuit with Auto-Crowbar protection circuit, input level controls, adjustable range meters, main and remote speaker selection, clipping indicators, Vari-Portional indicators and speaker protection. 250 watts RMS minimum p/c 20-20KHz @ 8 ohms, less than 0.1% THD. T.I.M. better than 0.02%. Slew rate better than 50V per micro-second.



Manufactured in California, U.S.A. by Soundcraftsmen, 1721 Newport Circle, Santa Ana, CA 92705

Enter No. 30 on Reader Service Card

over for good, because the pitch of everything, as you might guess if you are a Murphy's Law man, was about a half step too high.

Most radios and phonos in those days where a.c./d.c. and these faults, even in commercial manufactured equipment, were all too common. Nasty buzzing. Wrong pitch. The very idea of fixed and stable playback speed, of course, was then relatively recent. The old acoustic machines had a loosely adjustable friction playback speed control, marked Fast and Slow, or just F and S, and you pitched things to taste, with the spring fully wound. As most of us know, the

early acoustic 78s were of many speed variants in the original cutting. Fixed pitch only became really practicable in the electrical area of the 1920s, but it took many long years before the home player could match the large professional cutting table in this extremely vital respect. So—I was brought up on variable pitch, alternating with unstable pitch, as commonly found on virtually all the standard home equipment of the pre-WW II period. That was a real failure, though nobody seemed to be bothered much except for a few of us musicians.

With all of that, you can understand why each time I hear of a new amplifier

that is "flat to d.c." I give a cringe and fail to be properly impressed. In my book, d.c. is an element of hated memory. Is there any U.S. city still providing d.c. for public consumption? If there is, I don't want to hear about it, so please fail to tell me.

Booming Bass

One final item in the positive failure category. A few months back, I went to a fabulous "do" in a late-late New York disco-type place (it was mid-afternoon) to celebrate an ingenious new device for the disco trade (mostly) whereby a low-bass portion of the musical signal is electronically transposed downwards an octave (transpose is the proper musical term) and then fed to the giant woofers via giant power amps. When this thing was operating via the house system, the bench on which I had sat down actually jumped up and down under me on every beat. Overpowering. Fantastic!

The outfit behind this powerhouse bass is, of all people, dbx, a very imaginative firm if there ever was one. The only curious thing, as old readers may agree, is the title—*Boom Box*! Now, not too many years ago, that term was generally derogatory and unfunny, referring to a mistuned home speaker system that produced a resonant, broken-up, false bass, not so much a thump as a *thrrump*. The sound had its place in the old commercial jukeboxes, which often had no highs above 2.5 kHz and made up for it by the famous *basso*, not so *profundo*, that would go right through walls. In a crowded "joint" that was all you got to hear. But when a haphazardly matched home bass-reflex system (speaker and cabinet bought separately) produced a similar *thrrump*, we spoke disparagingly and with disdain of the boom-box sound. We disapproved. Ask Paul Klipsch.

Well, I suppose dbx really didn't know ... or failed to remember. Because they are dealing with superpower public niter and disco-type equipment where the enormously enhanced and improved Big Boom is very much in place and in taste. I liked it! However—dbx did put on a small publicity for their Boom Box as a home device, usable even with systems of very modest power. I'd take that with some d.c. salt, if I were you. The small system won't really get much whorp out of the transposing down an octave. Not enough power and probably not enough bass range in the speakers. But if you have the prevailing super-watt big system, you may find your floor hopping and ditto for the ceiling below. But have a care with the overall level of the system. For while you may well love the effect of the Boom Box, your downstairs neighbors may fail to appreciate the unit quite so much as you do. *A*

IF SOUND COULD CRY.

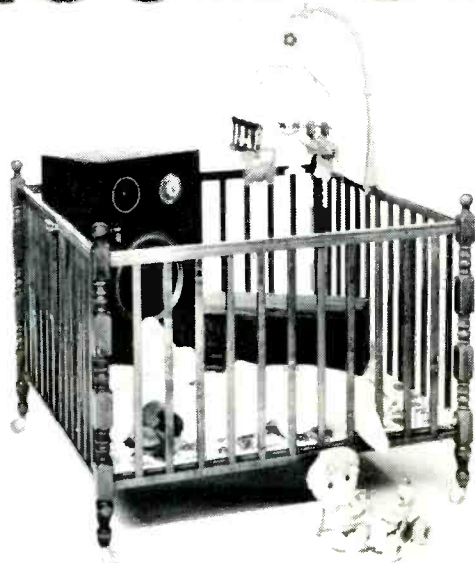

Sound's beauty is best expressed in music. So imagine its frustration when music is destroyed.

Sadly, the destruction is all around us. Most rooms are acoustical nightmares. Muffling. Bouncing. And absorbing musical energy.

If you care, however, your music can be protected. The answer is to equalize your room's frequency response, eliminating acoustical disturbances. Listen around. You'll hear our stereo graphic equalizers making sound, sound better.

Then if sound could cry, its tears would be those of joy.

CANADA:
TC ELECTRONICS
QUEBEC, CANADA

INTERNATIONAL:
FIMC
30 GREENHILL RD.
WESTWOOD, MASS. 02090

SPECTRO ACOUSTICS

DEPT. B
3200 GEORGE WASHINGTON WAY
RICHLAND, WASHINGTON 99352
TELEPHONE (509) 946-9608

AN AMERICAN MANUFACTURER OF HIGH FIDELITY COMPONENTS

“The Sansui AU-717 is a superb amplifier. We like it with no ifs, ands, or buts.” (Julian Hirsch)
It offers “as much circuitry sophistication and control flexibility as any two-piece amplifying system.”



15

Everyone says great things about the new Sansui AU-717, but the experts say it best.

The Sansui AU-717 DC integrated amplifier is "Sansui's finest It incorporates a fully direct-coupled power amplifier section whose frequency response varies less than +0, -3dB from 0Hz (D.C.) to 200 kHz. The amplifier's power rating is 85 watts per channel (min. RMS) from 20 to 20,000Hz into 8-ohm loads, with less than 0.025 per cent total harmonic distortion If any amplifier is free of Transient Intermodulation Distortion (TIM) or any other slew-rate induced distortion, it is this one The slew rate ... was the fastest we have measured on any amplifier, an impressive 60 V/ μ sec.

"The preamplifier section of the AU-717 has very impressive specifications for frequency response, equalization accuracy, and noise levels... The AU-717 has dual power supplies, including separate power transformers, for its two channels ... [and] exceptionally comprehensive tape-recording and monitoring facilities Good human engineering ... separates this unit from some otherwise fine products....

"The Sansui AU-717 is a superb amplifier. We like it with no ifs, ands, or buts." (Reprinted, by permission,

Stereo Review Magazine, Feb. 1978. Julian Hirsch Test Report. Copyright © 1978. Ziff-Davis Publishing Company. All rights reserved.)

"One clear advantage of DC design is apparent. Even at the low 20Hz extreme, the amplifier delivers a full 92 watts – the same value obtained for mid-frequency power – compared with its 85 watt rating into 8 ohms....

"The equalization characteristic of the preamplifier was one of the most precise we have ever measured, with the deviation from the standard RIAA playback curve never exceeding more than 0.1dB....

"Sansui claims that this unit has reduced transient intermodulation distortion – a direct result of the DC design, and, indeed, the model AU-717 delivered sound as transparent and clean as any we have heard from an integrated amplifier....

"... worth serious consideration – even by those who prefer separate amplifiers and preamplifiers." (Reprinted in part from Len Feldman's test report in **Radio-Electronics**, January, 1978.)

Listen to the superb sound of the Sansui AU-717 at your Sansui dealer today. And be sure to ask him for a demonstration of the matching TU-717 super-tuner.

SANSUI ELECTRONICS CORP.

Woodside, New York 11377 • Gardena, California 90247 • SANSUI ELECTRIC CO., LTD., Tokyo, Japan
 SANSUI AUDIO EUROPE S.A., Antwerp, Belgium • In Canada: Electronic Distributors



Enter No. 26 on Reader Service Card



Now
you can hear
the music
you're missing.

You can't hear everything that's in the grooves unless you have an extremely sensitive cartridge. A cartridge that can pick up all the subtle harmonics you are probably now missing. A cartridge like the ZLM by ADC.

The ZLM has the unique ALIPTIC™ stylus. Which combines better stereo reproduction with less wear to your records.

What's more, the frequency response is always ruler flat ± 1 dB to 20kHz and $\pm 1\frac{1}{2}$ dB to 26kHz. It tracks at $\frac{1}{2}$ to $1\frac{1}{4}$ grams.

So listen to the ZLM cartridge. It's like listening to a whole new record collection.



Audio Dynamics Corporation
Pickett District Road
New Milford, Conn. 06776
A BSR COMPANY

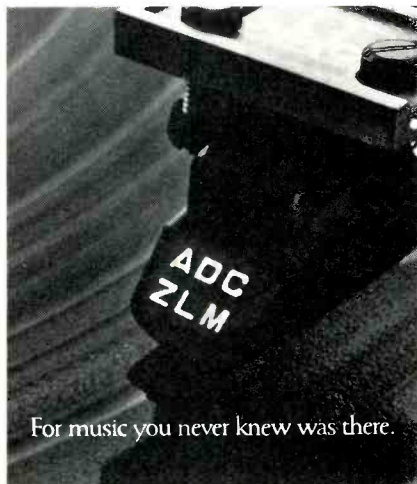

For music you never knew was there.

Enter No. 45 on Reader Service Card

Tape guide

Herman Burstein

Six-Headed Advantages

Q. What are the advantages of a six-headed tape deck? — Larry Weissmann, Butler, N.J.

A. A six-headed machine would be one that records and plays in both directions of tape travel. One set of three heads is for erasing, recording, and playing in one direction, while the other set is for operation in the opposite direction. This eliminates the need to exchange reels when the tape has run out in one direction, and prevents the loss of valuable material in recording.

Retaping Query

Q. I have been doing my taping at 3¾ ips, but now I want to retape these reels at 7½ ips. What I want to know is whether by retaping at 7½ ips I will gain in dynamic range, and by using a Dolby unit at the same time, can I reduce noise on the tapes? — Anthony Mattina, Staten Island, N.Y.

A. Retaping your 3¾ ips tapes at 7½ ips, with or without Dolby, will not improve anything — the noise, frequency response, dynamic range, distortion, etc. Whatever is on the tape will remain there, including the undesirables as noise, etc.

Noise Reduction

Q. Is there any type of hiss filter I can add, or insert, between my amplifier and tape deck to reduce the hiss on my prerecorded tapes? — Nelson Wong, Seattle, Wash.

A. Several noise reduction devices have appeared on the market to deal with noise already on tape (or contained in other program sources such as discs and radio broadcasts). I suggest that you visit your local audio dealers to find out what is available in this respect.

Purchase Preference

Q. I am thinking about purchasing a tape deck. There are two models, with and without Dolby, and I would like to know the advantages and disadvantages of each. Which is preferable? — P. Kramen, Brooklyn, N.Y.

A. In general, if two machines are fully equal in all respects, except for the inclusion of Dolby, I would prefer the one with Dolby, particularly if you are interested in

recording at 3¾ ips, and even more so at 1½ ips. The Dolby accomplishes a worthwhile reduction in noise, particularly at speeds below 7½ ips. The only disadvantage I can think of is the substantial increase in price of the deck, owing to the inclusion of the Dolby unit.

Transferring to Tape

Q. I have several hundred long-play stereo records and I want to put them on tape. I would appreciate any information you could give me to insure that I get the very best results. — William Ure, Hanford, Cal.

A. Yours is a broad question and I think that the best answer lies in the instruction manual for your tape machine. I would suggest that you be careful to avoid recording at too high a level as that will cause excessive distortion. Ordinarily you will obtain good results if you keep the VU meter from going above 0 VU. However, on some program sources, particularly those with sharp transients, it may be necessary to stay below 0 VU. Experience is the best guide. Since you will be taping from records, you can do a bit of experimenting to arrive at the best recording levels, and then erase and re-record those tapes which are unsatisfactory. Make sure that you choose a good quality tape, of a type recommended by the manufacturer of your deck.

Dirty Heads

Q. I have tape "dirt" in one of the gaps of the record head of my tape machine. I've tried alcohol and Q-tips, but cannot remove it. Would you know another way to clean the head since I'm getting a frequency loss in that channel. — Mark Briskie, Wantagh, N.Y.

A. It appears that your record head is seriously worn if you cannot easily remove the dirt on it. Replacement is indicated.

However, I'm not clear as to what you mean by "loss of frequency." Are you referring to treble loss? If so, such loss is usually due to a worn playback head or record-playback head. A

If you have a problem or question on tape recording, write to Mr. Herman Burstein at AUDIO, 401 North Broad Street Philadelphia, Pa. 19108. All letters are answered. Please enclose a stamped, self-addressed envelope.

The best tape decks in the world are only as good as this tape.

While there's a lot of controversy over who makes the world's best tape deck, there's very little over who makes the world's best tape.

Maxell.

Because Maxell gives you the

widest frequency response, the highest signal-to-noise ratio and the lowest distortion of any tape you can buy. In fact, people who own the finest high-performance tape equipment use our

tape more than any other brand.

So why buy one of the world's finest tape decks and get less than the world's best sound.

When you can use Maxell and get everything you paid for.



Maxell Corporation of America, 60 Oxford Drive, Moonachie, N.J. 07074.



Enter No. 16 on Reader Service Card



18

It sounds like music

An incredibly solid 30 Hz low end gives you bass response not found in any other speaker of this size. This is clean bass. It isn't phony. There is no "hump" around 80 Hz to give the impression of bass when there really isn't any. What's on your source material is what you're going to hear - accurately.

There is no sacrifice at the high end either. Both front and rear-firing tweeters give you the uniform total acoustic power output that takes you into a "live-music" environment.

When you buy your next pair of speakers, do yourself a favor - audition the Interface:B's. If your criteria is musical accuracy, the Interface:B's are what you'll buy.



Electro-Voice®

a gulton company
600 Cecil Street
Buchanan, Michigan 49107

Interface:BTM

Enter No. 10 on Reader Service Card

Dear editor

Conservation Connoisseur

Dear Sir:

I read with considerable interest your "Equipment Profile" on the Lirpa Vehicular Disk Reproduction System (VDRS) and look forward to its appearance on the market.

Living in the West as I do and being concerned with our electrical energy crisis, I feel that I will have to defer purchase until Prof. Lirpa introduces a diesel model, which I have no doubt is presently awaiting the EPA test certification.

Woodruff Ogden
Walnut Creek, Cal.

Distraught Discophile

Dear Sir:

The noise problem on records could have ended on May 10, 1977, the day that William K. Heine, of California, demonstrated his laser scanning phonograph record player (Laserphone). This device plays the standard LP record without any ticks or pops, plus it never wears out the record.

It would seem to me that with high-quality and high-priced electronics, there should be some way to play a record without the all too familiar snap, crackle, and pop we always seem to get. The audio industry has produced a few machines to eliminate these ticks and pops, but they only seem to work when the noise has been artificially induced by a

knife across the surface of the disc. But the little ticks and pops you hear in the first two or three minutes of Beethoven's *Moonlight Sonata* are enough to drive you crazy.

I found out recently that TEAC has no present plans to release their digital laser disc player. I, for one, can understand their thinking since the lack of available software during the first two years would destroy their sales.

Let us hope that the audio industry is aware of the fact that the number of higher-priced turntable systems is beginning to drop slightly. The reason for this is the poor quality of the available software. If we can create digital time-delay units, digital PCM recorders, then we can certainly manufacture a patented, proven turntable such as the Laserphone.

Harry L. Foushee
Jacksonville, Fla.

Lamentable Lo Fi

Dear Sir:

I have read numerous letters in *Audio* magazine mentioning the poor quality of many of our popular records and FM radio broadcasts. I have also seen several letters discussing the potentials for better quality AM audio broadcasts. It is unquestionably true that the quality of much of our commercial recording and broadcasting is often far short of the state of the art, as it caters to a mass-market audience of which the audiophile

Errata

Dear Sir:

I have read with interest Mr. Michael Bucci's article on "VTRing" in your July issue of *Audio*.

There are one or two serious errors on the information chart on page 99. Opposite "manufacturer," the JVC Vidstar HR 3300 is listed as being manufactured by Matsushita. This is incorrect. Victor Company of Japan, Ltd. manufactures all of the VCRs marketed in the Vidstar format, as well as 100 percent of our "¾U VCRs." In fact, we also produce O.E.M. ½-in. VHS units for other brands marketing in Asia, North America, and Europe.

Although it is true that Victor is a subsidiary of Matsushita, all of JVC's VCRs

are built in Victor's facilities, by Victor personnel and to our specifications.

In addition (although I am sure it is an oversight), JVC is not even listed in the "Companies Licensed" category. As Mr. Bucci accurately stated in his article, JVC did indeed develop VHS. Quite obviously we should be listed among the host of "licensees."

We are aware that such errors do inadvertently occur. We will appreciate it if you will kindly rectify the above mistakes in your next issue.

R. F. O'Brien
Vice President
U. S. JVC Corp.
Maspeth, N. Y.

AUDIO • September 1978

THERE'S MORE TO FM THAN BEING ON THE RECEIVING END.

Over the past few years numerous hi-fi companies have introduced an array of sophisticated FM tuners. All claim to make a remarkable advancement in FM reception and the claims are justified. Strong reception is an important factor in the reproduction of an FM signal.

Unfortunately, the reception is only the beginning.

As a matter of necessity, most FM stations compress the dynamic range of the musical material prior to transmission in order to make it easier to broadcast. All other tuners regardless of their sophistication simply decode this compressed signal and pass it along to the amplifier. The reception may be excellent, but the dynamic range of the material is still greatly compressed. That's what your amplifier will reproduce. As a result, FM reproduction is generally

regarded as mediocre in comparison to records and tapes.

Until now.

The Phase Linear 5000-Series Two FM Tuner represents a significant sonic improvement in the reproduction of an FM signal. By incorporating a linear signal expansion circuit, the Phase 5000-Series Two successfully compensates for problems associated with signal compression, and is able to restore up to 9 dB of dynamic range. With the Phase 5000-Series Two, FM reproduction exhibits a dynamic range and sonic quality that is audibly superior to other tuners. Regardless of price.

Interested in adding FM to your collection of recorded material? The Phase Linear 5000-Series Two belongs in your library.

SPECIFICATIONS

IHF SENSITIVITY: (mono) 10.8 dBf (1.9 uV)
(stereo) 20.8 dBf (6.0 uV)
USABLE SENSITIVITY:
50 dB Quieting: (mono) 14.8 dBf (3.0 uV)
(stereo) 34.8 dBf (30.0 uV)
SIGNAL: NOISE @ 65 dBf:
(mono) 74 dB
(stereo) 72 dB
TOTAL HARMONIC DISTORTION:
@ 65 dBf: (Narrow Band)
(mono) 0.1%
(stereo) 0.2%
FREQUENCY RESPONSE:
20 Hz-15 kHz \pm 5 dB
CAPTURE RATIO: 1.2 dB
(Narrow Band)
ALTERNATE CHANNEL SELECTIVITY:
75 dB (Narrow Band)
STEREO SEPARATION: 1k 42 dB,
10k 32 dB
SPURIOUS REJECTION: 120 dB
AM SUPPRESSION: 60 dB
IMAGE RESPONSE: 110 dB
DIMENSIONS: 19" X 7" X 10"
(48.3cm X 17.8cm X 25.4cm)
WEIGHT: 17 lbs. (7.7 kgs)
Optional accessories: Solid Oak or Walnut side panels.

• Convenient 300ohm balanced and 75 ohm unbalanced FM Antenna Input connections, including standard lead coaxial connector.

• Fixed Outputs of a nominal 2 volt level can be used for direct taping.

• 75u-second/25u-second de-emphasis for the addition of an outboard Dolby unit, and for use when receiving Dolbyized FM signals.

• Variable Outputs allow precise adjustment of the 5000-Series Two to match that of the turntable.

• Phase Locked Loop (PLL) multiplex decoder.

• Variable Muting Controls lower interstation hiss when tuning.



Phase Linear
THE POWERFUL DIFFERENCE

Phase Linear Corporation/20121-48th Avenue West/Lynnwood, Washington 98036
Made in U.S.A. Distributed in Canada by H. Roy Gray Ltd. and in Australia by Megasound Pty. Ltd.

Q • Where should you start in your search for better sound?

A • At the beginning. With a new Audio-Technica Dual Magnet™ stereo phono cartridge.

Our AT12XE, for instance. Tracking smoothly at 1 to 1-3/4 grams, depending on your record player. Delivers smooth, peak-free response from 15 Hz to 28,000 Hz (better than most speakers available). With a minimum 24 dB of honest stereo separation at important mid frequencies, and 18 dB minimum separation even at the standard high-frequency 10 kHz test point. At just \$65 suggested list price, it's an outstanding value in these days of inflated prices.

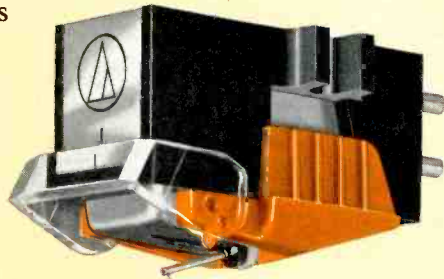

Audio-Technica cartridges have been widely-acclaimed for their great sound, and for good reason. Our unique, patented* Dual Magnet construction provides a *separate* magnetic system for *each* stereo channel. A concept that insures excellent stereo separation, while lowering magnet mass. And the AT12XE features a tiny 0.3 x 0.7-mil nude-mounted elliptical diamond stylus on a thin-wall cantilever to further reduce moving mass where it counts. Each cartridge is individually

assembled and tested to meet or exceed our rigid performance standards. As a result, the AT12XE is one of the great bargains of modern technology ...and a significant head start toward more beautiful sound.

Listen carefully at your Audio-Technica dealer's today.

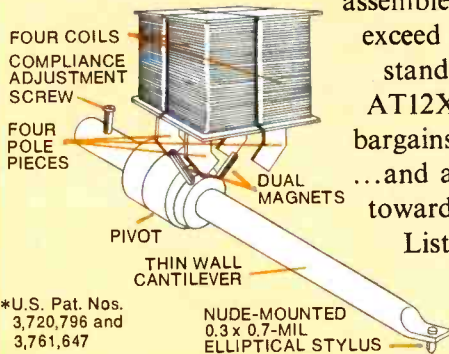

audio-technica
INNOVATION □ PRECISION □ INTEGRITY

AUDIO-TECHNICA U.S., INC., Dept. 98A, 33 Shiawassee Avenue, Fairlawn, Ohio 44313
In Canada: Superior Electronics, Inc.

Enter No. 53 on Reader Service Card

makes up only a very small minority. Most of the general public has very little knowledge or interest in true sound reproduction, and many more are even misled as to what hi fi really is.

Most department store consoles and compact music systems use a device known as "synthetic bass" (David Weems, "The Numbers Game," *Popular Electronics*, Nov., 1970). Since these units are incapable of reproducing frequencies below 100 Hz, or even 200 Hz, they are designed to peak their response by as much as 15 dB from about 250 Hz down to the cut-off point. While this produces an irritating drummy, boomy sound . . . this is the "hi-fi sound" to most people. Synthetic bass is often called "juke-box bass" since they also use this technique.

Secondly, I have walked into many a living room and found both speakers in the stereo system placed together off in one corner of the room well away from the general seating area. Worse yet, I have seen at least one "stereo" console unit in which both speakers are mounted right next to each other in the same cabinet. Obviously, many people have no concept of what stereo sound is or how to realize it, even though they are sold on having it. For this reason I suggest that the makers of low-cost, non-audiophile grade music systems revert back to monophonic reproduction, concentrating the cost of the unit into one decent channel of sound, rather than two mediocre ones. This is not to say that stereo is not useful, for under the right conditions it can do much for the sound of music. Nonetheless, in most living rooms visual aesthetics take precedence over proper speaker placement so that most "stereos" become redundant two-channel "monos."

Even our so-called live performances aren't really live, with very few exceptions. Today most contemporary music performers depend upon P.A. systems and other electronic equipment to convey their sounds to the audience. Worse yet, various forms of distortion are purposely introduced to "gimmick" the sound. Rock music does not even exist as a live acoustic sound, but is actually created through electronics.

Apparently, we live in an electronic jungle of unnatural, distorted, and gimmicked sound reproduction. Except for the audiophile who spends considerable amounts of time, energy, and money attempting to achieve perfection, the public, as a whole, is conditioned into accepting lo-fi reproduction. Unless some campaign can be waged to educate the public at large as to the virtues of hi-fi reproduction, the situation is unlikely to improve.

Michael Kiley
Palos Hghts, Ill.

AUDIO • September 1978

Until the Sound Guard™ record care work pad, one side of your record could take a beating while you were caring for the other.

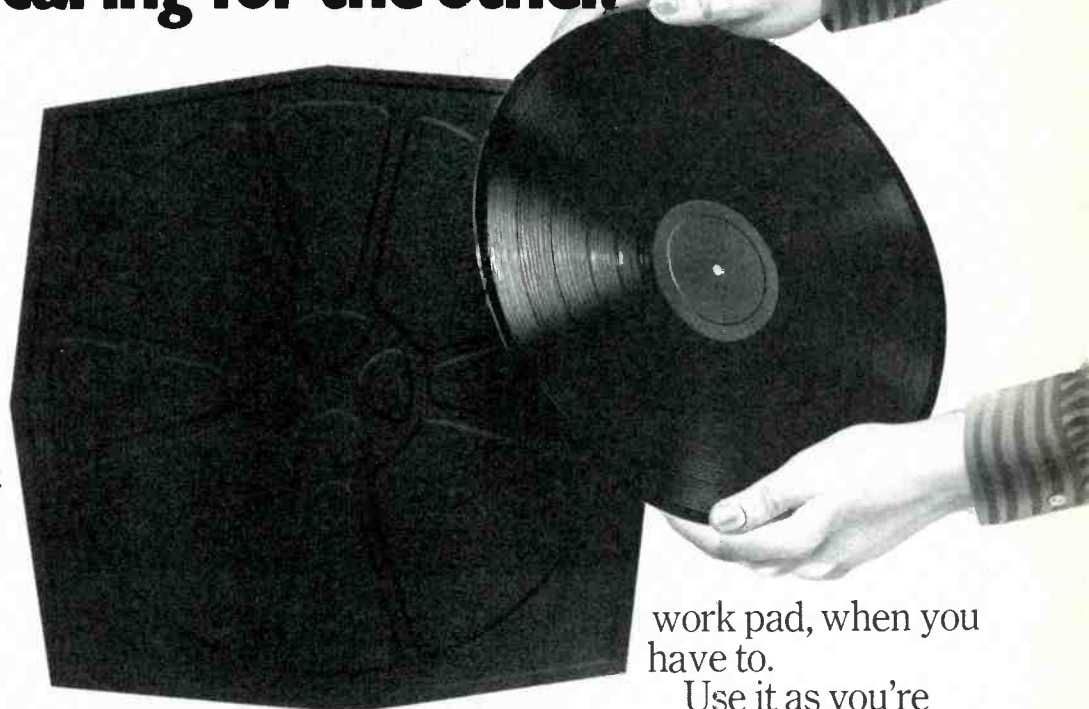

A paper towel that could scratch. A piece of velvet that slips. A cloth of any kind that leaves telltale lint.

Until now, that's all you've had to lay your record on when you wiped, sprayed or buffed it.

Now you've got some-

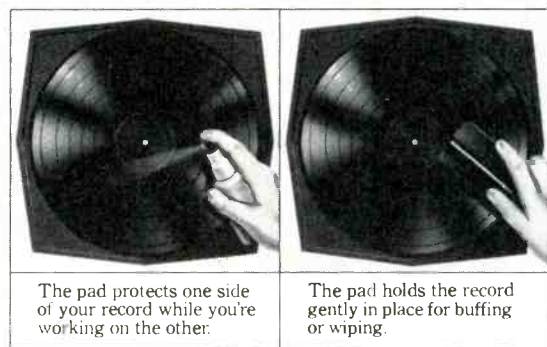

The pad protects one side of your record while you're working on the other.

The pad holds the record gently in place for buffing or wiping.

thing that takes care of one side of your record while you're working on the other side. It's non-conductive to resist picking up particles

from dirty records. It's not a fabric, so it has no lint to spread around. And it's non-abrasive to avoid scratching and slipping when you're buffing.

Its ingenious channels give you another advantage. They collect any excess fluid so it won't run over to the other side of

your record—or onto your furniture.

Wash off your record care

work pad, when you have to.

Use it as you're meant to, and your records will never take another beating.

Like all Sound Guard products, the Sound Guard record care work pad is sold in audio and record outlets.

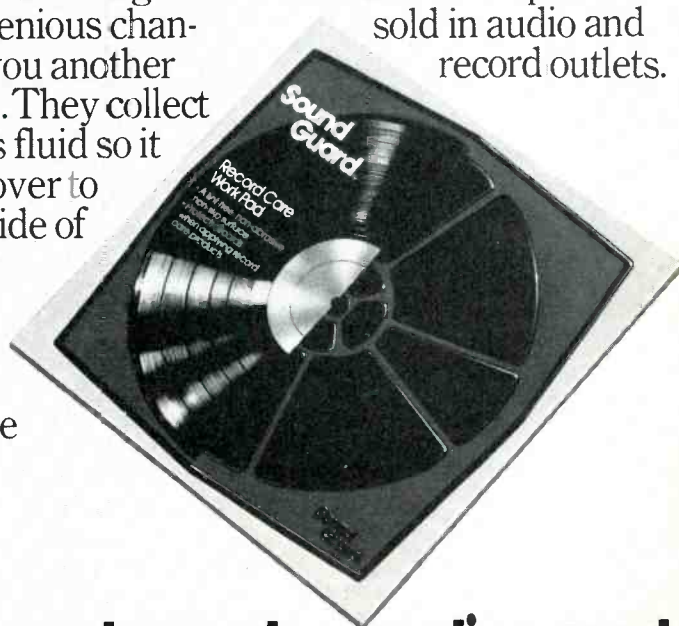

Sound Guard® keeps your good sounds sounding good.



Sound Guard® preservative — Sound Guard™ cleaner — Sound Guard™ Total Record Care System — Sound Guard record care work pad
Sound Guard is Ball Corporation's registered trademark. Copyright © Ball Corporation, 1978. Muncie, IN 47302

The Ditton 44 by Celestion An hermetically sealed three-way system employing a 1" dome super tweeter functioning from the 5 kHz crossover point to well beyond audibility, a 6" cone midrange that functions down to 500 Hz and a 12" bass transducer that is operational down to 30 Hz. Overall frequency response is 30 Hz to 40 kHz. Available in walnut or teak finish. 30" h x 14½" w x 10" d.



**We're not certain
you'll prefer the Ditton 44
over other \$300 speaker systems.
Just reasonably confident.**

We not only know how to make speakers; we know how difficult it is to evaluate them. Especially at dealers, because speakers that you love in the showroom have a habit of sounding different at home.

At Celestion, we make all our own drivers and crossover networks (as we've been doing in England for more than fifty years). So we are reasonably confident of the outcome whenever and wherever our speakers are auditioned and compared with others.

That's why, when we entered the U.S. market in mid-1977, each of our models was introduced together with a select list of competitive systems we considered good values. And also worth your consideration.

Of course, not everyone who made the comparisons chose ours, but enough did to make us feel we were doing the right thing. There are obviously many music lovers who prefer a traditionally-made speaker that produces untraditionally clean, uncolored sound that is as close to the original as we know how to make it.

We don't know how pleased you will be with other speakers when you get home. But from what Celestion owners tell us, ours continue to be satisfying to live with long after the honeymoon is over.

Celestion
Loudspeakers for the perfectionist



Celestion Industries, Inc., Kuriholm Drive, Holliston, MA 01746
In Canada: ROCELCC Inc., Downsview M3J2J7

Enter No. 59 on Reader Service Card

Record Rewrapping

Dear Sir:

To add to your recent discussions on the treatment of records before they reach the consumer, I have an interesting experience to relate.

At a local record store, I was told to go into the back room and ask a certain employe to help me find the record I was looking for. In the back room I was a bit shocked to see a plastic-wrapping machine which was obviously there for the purpose of rewrapping albums that had become unwrapped.

Unfortunately, the sealed plastic doesn't guarantee that the record hasn't been either used or abused.

Leslie Borean
Culver City, Cal.

Recording Blanks

Dear Sir:

I am in possession of a large number of early 1920's or 30's aluminum recording blanks. These are not acetate-coated blanks, but raw, plain aluminum. I would like to use these for recording, obviously not for serious high-fidelity recording, however I am unable to find anyone or any book with information about the recording styli specifications. I have also been unable to find anything as to the composition, size, or shape of the first recording styli that were used for the first so-called instantaneous recordings.

Are there any readers of *Audiomaga-*zine who can either tell me where to obtain such a cutting stylus or what the parameters are so that I might be able to have one reproduced? I would be most grateful for your aid in solving this problem.

Michael Stosich
414 Assembly Drive
Bolingbrook, IL 60439

Quality Consciousness

Dear Sir:

A few months back I purchased a copy of the Crystal Clear Records direct-to-disc recording **San Francisco Ltd.** I had many problems with the record and four times brought it back to the store where it was purchased, trying to either get a refund or a new copy of this recording. Getting no satisfaction whatever from the retailer, I finally wrote directly to Crystal Clear Records asking them if there was something they could do to assist me in this matter. Shortly thereafter I received a brand-new copy of the recording in the mail.

This letter is just to let your readers know that there are still some companies around that respond quickly to complaints from purchasers of their products.

Thomas W. Smith
Franklin Square, N.Y.

AUDIO • September 1978

Technics

Who needs the accuracy of Technics quartz-locked, direct-drive turntables? Professionals do. That's why radio stations use them and discos abuse them.

Now you can get all the accuracy of our professional turntables with the SL-1301 fully automatic and the SL-1401 semi-automatic, our new quartz-locked, direct-drive turntables. Accuracy like wow and flutter of only 0.025% WRMS, rumble of -78 dB (DIN B) and speed drift within 0.002%. That's professional accuracy.

How did our engineers achieve it? They started with a Technics hetero-pole, direct-drive motor. Next, they combined the functions of over 1,100 discrete circuit components into 3 IC chips, the same IC's found in our professional turntables. In one of these IC's you'll find the most reliable speed-reference device ever used in a turntable: A frequency generator quartz oscillator.

To dramatically reduce annoying acoustic feedback, both the SL-1301 and SL-1401 take advantage of Technics unique double isolated suspension system. One suspension damps out vibration from the base while the other absorbs vibrations from the platter and tonearm.

At the same time, Technics computer-analyzed, gimbal suspended S-shaped tonearm reduces friction to a mere 7 mg while it greatly increases tracking sensitivity.

The SL-1301 and the SL-1401. Both give you the accuracy of our professional turntables. With one big difference, the price.

There are few differences between our professional turntables and these quartz-locked turntables. Accuracy isn't one of them.



Enter No. 34 on Reader Service Card

What's new

Audio Technology Peak Reading LED Display

The Model 510 two-channel peak reading LED display has a 45-dB dynamic range with 1-dB resolution either side of the 0 dB point and a display rise time of 50 μ S. The 16 LEDs per channel, calibrated from -39 dB to +6 dB, display the peak value of complex audio waveforms to an accuracy of ± 0.25 dB. It is designed to measure peak line-level signals (preamp output, tuner output, tape recorder input) or peak output from a power amplifier. In the power mode, it measures peak-power amplifier output from 0.00085 watts to 1600 watts, and rear panel switches are provided to set the 0-dB reference to 25, 50, or 100 watts and to select speaker impedances of 4, 8, or 16 ohms. In the line level

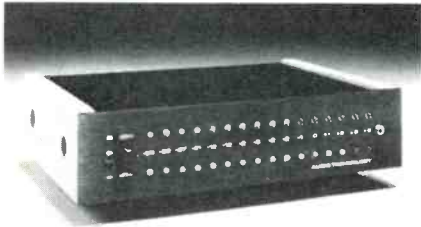

mode, each input is independently and continuously variable over a range of 50 mV to 5 V for a 0-dB indication; a calibration feature is included to balance channels and return the instrument to a 0-dBm reference. Price: \$129.95.

Enter No. 95 on Reader Service Card

Harman Kardon Turntable

The Rabco Model ST-8 straight-line-tracking turntable with zero tracking error, zero skating force, and zero stylus overhang. Features include a 6-gram, low-mass tonearm; belt-drive; automatic speed control; illuminated strobe; automatic arm lift-off; damped cueing; a built-in bubble level; adjustable levelers; touch-sensitive resistance-type switch contacts, and a "Hall effect" d. c., fully servo-controlled motor, which brings the platter from stop to 33 $\frac{1}{3}$ or 45 rpm in less than one revolution. Turntable speeds are adjustable to ± 5.5 percent, rumble is -65 dB, wow and flutter 0.04 percent, and turntable weight is 2.4 lbs. (1.1 kg). Price: \$499.00.

Enter No. 96 on Reader Service Card



Nakamichi Audio Analyzer

The T-100 audio analyzer is a diagnostic instrument combining a number of testing functions in a compact format. Built in is a low distortion oscillator providing 21 frequencies, plus a pink noise generator, from 20 Hz to 20 kHz; a 400-Hz distortion meter for accurate THD readings down to 0.01 percent; switched "A" weighted noise readings down to 10 μ V; FET and d.c. logic controlled switching functions, and plasma-panel, bar-graph displays. The input impedance is 50 kilohms. Price: \$800.00.

Enter No. 97 on Reader Service Card

Yamaha Pre-Preamp

The Model HA-1 pre-preamplifier, for use with moving-coil cartridges, incorporates two pairs of low-noise ICs for each stereo channel and uses metal-film resistors throughout its circuitry. It has an input-equivalent noise level of -157 dBV (RIAA, IHF A Network, inputs shorted), distortion of 0.005 percent for an input of 5 mV, with an overload capacity to 30 mV. Featured is a cartridge output-level switch, which in the low position has an impedance of 10 ohms and a gain of 34 dB, in the high position an input impedance of 100 ohms and a gain of 14 dB, and in the pass position the input and output are directly connected. Price: \$270.00.

Enter No. 98 on Reader Service Card



AUDIO • September 1978
Enter No. 65 on Reader Service Card

Tandberg's New TD 20 A With The Exclusive ACTILINEAR Recording System

Tape recorders can no longer be looked upon as independent units in today's extremely sophisticated sound systems, but rather as components within a total system with performance capability as technically advanced as all other components of that system.

Drawing upon its unequalled 30 year tradition in magnetic recording technology, Tandberg has met this challenge by developing a completely new concept in tape recording known as ACTILINEAR Recording (Patent pending) for their new, advanced open reel and cassette machines.

In conventional recording systems, the summation of record & bias currents in the recording head is done through passive components, leading to inherent compromise solutions. The new ACTILINEAR Recording System is totally free of these compromises, as the passive components have been replaced with an active Transconductance amplifier developed by Tandberg. Just a couple of its many benefits are: up to 20 dB more headroom over any recording system currently available, and the ability to handle the new high coercivity tapes.

In fact, Tandberg's new ACTILINEAR Recording System, when used in conjunction with the soon-to-be-available metal particle tapes now under intense development in the U.S., Japan and Germany, offers performance parameters approaching those of experimental Pulse Code Modulation (PCM) technology, yet is fully compatible for playback on all existing tape recorders. It is literally a machine for the future, with no obsolescence factor, as it can be used with any type of recording tape, available now or in years to come.

Tandberg engineers have mated this new recording system to a logic-controlled, four-motor, solenoidless tape transport of advanced design, which, like the ACTILINEAR concept, is totally unique on the market today.

Other superior features of the TD 20 A include: built-in Sel. Sync. • front panel bias adjustment • front panel 2-position microphone sensitivity switch • frequency-corrected, peak-reading VU meters, with new graphics designed for improved readability • four line inputs + master gain control • a "free" mode + Edit/Cue facilities for easier editing • LED mode indicators • separate power supplies for operational functions and audio functions • rack mount capability • optional wireless, PCM infrared remote control.

Visit your authorized Tandberg dealer for a demonstration of the new TD 20 A deck, and discover how tape recording will be done in the years to come. For your nearest dealer, write: Tandberg of America, Inc., Labriola Court, Armonk, N.Y. 10504; or toll-free 800-431-1506.

TANDBERG

Tandberg Presents the Next Generation



An open and shut case for buying Maxell LN tape.

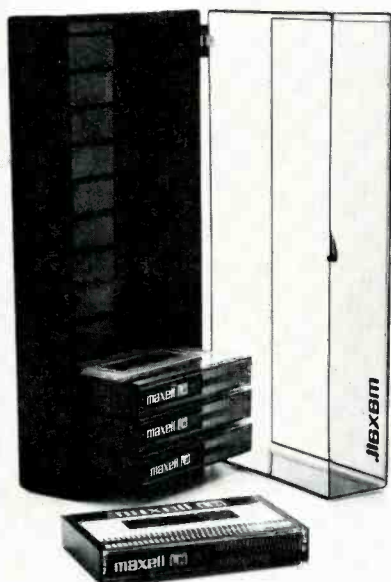

The case in point is this twelve slot cassette storage file.

It's free when you buy this special package of four Maxell Ultra Low-Noise cassettes. Some of the world's finest all purpose tape.

That way you'll not only have recordings that are free of dropouts and noise, you'll have a great place to keep your tapes safe and sound.

Case closed.



*Available at participating dealers.

Enter No. 66 on Reader Service Card

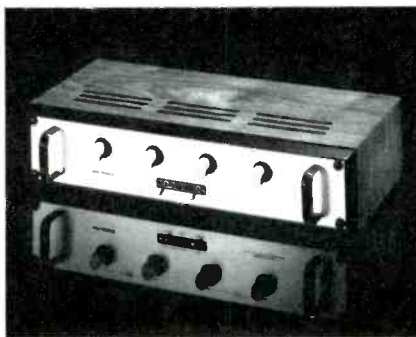

Audio Research Electronic Crossover

The EC-5 is a two-way, fixed-frequency electronic crossover, featuring two switch-selectable crossover slopes, a changeable crossover frequency with optional network parts cards, and variable channel gain. Crossover slopes or rolloff (transfer) characteristics are front-panel switch selectable 6 dB or 18 dB (1st and 3rd order) Butterworth for minimum "summed" channel gain error within the frequency cutoff region. The basic active filter is a multiple-feedback, infinite-gain configuration with relay-selected odd-order feedback network cards which may be changed for various crossover frequency requirements. Frequency response is ± 1 dB, 5 Hz to 30 kHz, -3 dB points 1 Hz and 100 kHz, and harmonic and IM distortion are less than 0.005 per cent at 2 volts rms output (1HF load). Price: \$895.00.

Enter No. 99 on Reader Service Card

BGW Amplifier

The BGW Model 410 amplifier features a 10-segment LED light-metering display; a gain control which allows the amplifier's sensitivity to be lowered from its maximum of 2 volts; a four-position, heavy-duty switch for selecting one or both sets of speakers; a headphone jack for driving medium impedance phones (600 ohms); d. c.-coupled, fully complementary output circuitry; high-speed (15 mHz), high slew rate (50V/ μ S) input circuitry, and relay output protection circuitry. The power output is 200 watts continuous per channel, both channels driven into 8 ohms; frequency response is 20 Hz to 20 kHz, +0, -0.2 dB; slew rate is 40 volts/microsecond; THD is less than 0.07 percent from 20 Hz to 20 kHz; intermodulation distortion and TIM are less than 0.02 percent from 250 milliwatts to 200 watts, and hum and noise (residual) 110 dB below 200 watts.

Enter No. 100 on Reader Service Card

Burwen Remote Equalizer

The remote variable field equalizer has a hand-held unit with six bands per channel over a frequency range of 15-

25,000 Hz, which is joined by a 20-ft. cord to a base power unit. It has a combination of peaking and shelving slide controls operating at 15, 120, 500, 2000, 5000, and 25,000 Hz which offer equalization of ± 32 dB at 15 Hz, ± 7 dB at both 500 and 2000 Hz, and ± 22 dB at 25,000 Hz. Shelving controls provide additional equalization of ± 12 dB at 120 Hz and ± 11 dB at 5000 Hz, giving a maximum equalization of ± 44 dB at 15 Hz and ± 33 dB at 25,000 Hz. Frequency response is flat within 1 dB when controls are set at 0, and THD is 0.03 per cent at 1 kHz, 7.8 V. Price: \$299.00.

Enter No. 101 on Reader Service Card



Robins Headphones

The Model 47-921 headphones have a frequency response of 20-20 kHz, and an 8 ohm impedance. They feature imprinted left/right positioning with individual continuous volume controls, a stereo/mono switch, 3-in. dynamic speakers, and a 9-ft. cord with 1/4-in. phone plus. Price \$20.00.

Enter No. 102 on Reader Service Card

Audio Research Preamp

The Audio Research SP-6 preamplifier has a power supply capable of providing isolated and regulated voltages to each circuit section by utilizing an all solid-state regulator with massive "filtering" at the output to each section, making it possible to increase the bandwidth of the a.c.-coupled vacuum tube design without compromising the circuit stability. The preamp features a close tolerance, segmented gain control with 2-dB steps (guaranteed 1/2 dB tracking, 1/2 dB typical) and rear panel provision to disconnect "common" from the chassis so that rack-mount installations with power amplifiers, etc. may be accomplished without ground-loop induced hum. Frequency response in the high-level section is ± 0.25 dB, 10 Hz to 30 kHz, with -3 dB wider than 5 Hz and 100 kHz; magnetic phono response is ± 1 dB of RIAA from 30 Hz to 15 kHz; harmonic distortion is less than 0.003 percent at 5 V rms output, 20 Hz to 20 kHz; IM distortion is less than 0.008 percent at 5 V rms output; noise in high level is more than 90 dB below 1 V rms input (less than 20 μ V equivalent noise). Price \$1075.00.

Enter No. 103 on Reader Service Card

AUDIO • September 1978

The most important piece of audio equipment you'll ever own.

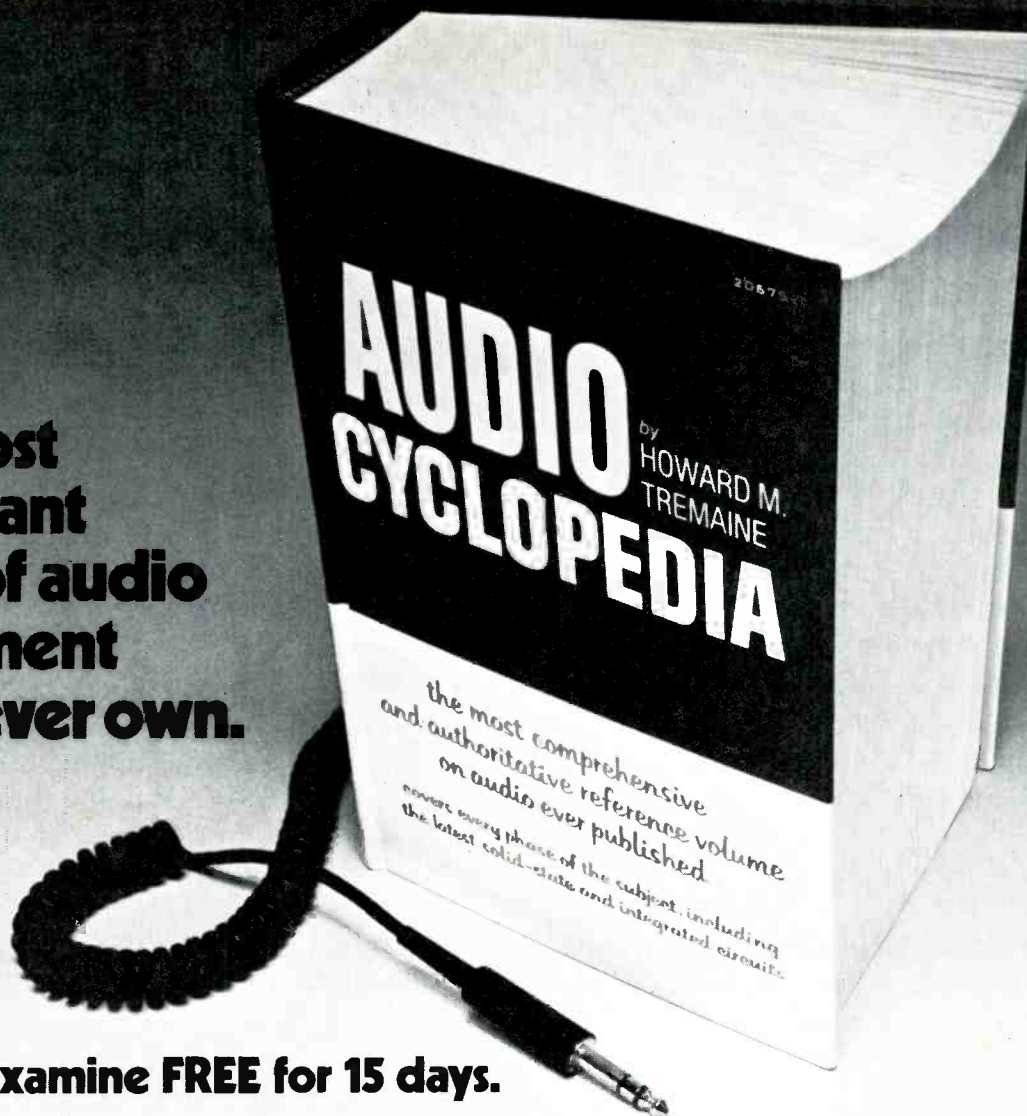

Yours to examine FREE for 15 days.

**25 FACT-FILLED CHAPTERS
ARRANGED IN "EASY-TO-FIND"
QUESTION AND ANSWER FORM**

- Basic Principles of Sound
- Acoustics, Studio techniques, and Equipment
- Constant-Speed Devices, Motors, and Generators
- Microphones
- Attenuators
- Equalizers
- Wave Filters
- Transformers and Coils
- Sound Mixers
- VU and Volume Indicator Meters
- Vacuum Tubes, Transistors, and Diodes
- Audio Amplifiers
- Disc Recording
- Cutting Heads
- Recording and Reproducing Stylis
- Pickups
- Magnetic Recording
- Optical Film Recording
- Motion Picture Projection Equipment
- Loudspeakers, Enclosures, Headphones, and Hearing Aids
- Power Supplies
- Test Equipment
- Audio-Frequency Measurements
- Installation Techniques
- General Information, Charts and Tables

Be our guest. Examine the AUDIO CYCLOPEDIA free for 15 days. You'll find out why it is considered the most comprehensive and authoritative book ever written on the subject. And you'll get a FREE \$3.50 bonus book to keep no matter what!

The AUDIO CYCLOPEDIA is literally a one-book audio library. It has long been considered "the bible" by amateur stereo buffs as well as professional technicians. That's why you'll find it in constant use not only in home workshops and at stereo centers, but also in recording studios, broadcast booths and concert halls.

This giant reference book is over 3" thick,

and packed with 1,757 illustrated pages. It features 3,645 questions and answers and a 50 page "instant-find" index for subject identification. It is truly the big one in audio electronics and it puts all the information you'll ever need right at your fingertips, chapter by chapter.

Send for the AUDIO CYCLOPEDIA today. If you don't agree that it's the most important piece of audio equipment you own, just return it within 15 days. You won't owe a cent. And no matter what you decide, you'll get a free \$3.50 copy of *The ABC's of Tape Recording* to keep just for mailing the coupon.

**FREE-BOOK
FREE-TRIAL COUPON**

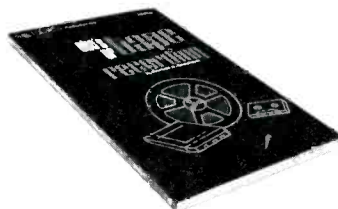

Save postage & handling costs. Full payment enclosed (plus tax where applicable). 15-day return privilege still applies.

Yes, please rush me the AUDIO CYCLOPEDIA (#21455) for my free trial. I understand if not completely satisfied, I may return it within 15 days, and owe nothing. Otherwise, it's mine to keep for only \$39.95 plus postage and handling and local taxes (where applicable).

And, whatever I decide, a copy of "The ABC's of Tape Recording" (valued at \$3.50) is mine free!

Name _____
 Address _____
 City _____
 State _____ Zip _____



Mail to Audel
 4300 W. 62nd Street
 Indianapolis, Indiana 46206
 A Division of Howard W. Sams & Co., Inc. CT45A

Feast Your Ears.

Hear The System.

You'll hear the sound faithfully reproduced. Not artificially manufactured by the equipment. Because the equipment is Mitsubishi.

And Mitsubishi has a standard: what comes out must be as real as what went in.

You'll hear a system where every component has been perfectly matched to every other component. Yet each a precision instrument in its own right.

You'll see new equipment with new capabilities, new features, new designs.

The new amplifier. Not mere stereo, but dual monaural. We call it the DM Factor. For inter-channel separation at 20kHz at better than 80dB. For THD at lower than 0.01% at rated output. For remarkable clarity and definition. Ten violins sound like ten violins

instead of one big mushy solo.

The new preamplifier. With the DM Factor. Exclusively Mitsubishi. For THD of 0.002%. And specially developed to effectively handle the moving coil cartridge. For a signal-to-noise ratio of -77dB. Unheard of in any other preamplifier.

The new frequency synthesizing tuner. With THD in stereo at barely 0.08% at 1 kHz. Conservative, at that. With switched selectivity for uncompromising reception. With digital read-out. With LED's to determine signal strength and precise tuning. With an uncanny ability to zero in on the quietest signal.

The turntable. Our direct drive high torque servometer eliminates gears, belts and pulleys. And with them wow, flutter and noise. Our logic control eliminates unreliable mechanisms in the nerve center. Our high resolution tone arm eliminates virtually all resonance. Everything you never wanted in a turntable.

The loudspeakers. Meticulously constructed. Painstakingly tested. For the exact response that sounds like music, not speaker. The final link in a faultless system.

And not least, the equipment rack. As unique as The System. As clean and uncluttered as the sound.

We could go on reprinting specifications. We could go on employing adjectives. But nothing will tell you more about our audio equipment than your audio equipment.

So hear The System.

See it. Take it apart.

Compare all the possibilities. All Mitsubishi or only a part. You won't settle for anything less than the whole.

Because if we've got you so far, just wait till we get your ears.



DA-F20 Tuner, DA-P20 Preamplifier, DA-A15DC Amplifier, DP-EC1 Turntable, DA-M10 Meters, DS-50CS Loudspeakers, DR-720 Rack.
For more information write Melco Sales, Inc., Dept. HBR, 3030 East Victoria Street, Compton, California 90221.

Enter No. 19 on Reader Service Card



MITSUBISHI
HI-FI
TUNER/AMPLIFIER

MITSUBISHI HI-FI
TUNER/AMPLIFIER

MITSUBISHI HI-FI
TUNER/AMPLIFIER

AMERICAN CO-ORDINATED
SPEAKER SYSTEM

ALLISON: FOUR

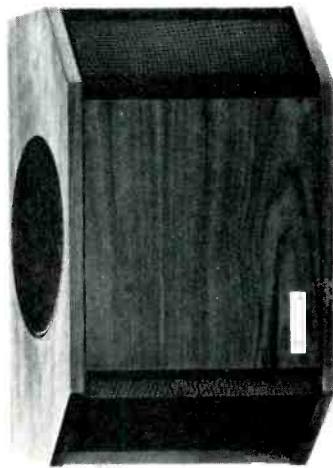

Allison dealers are now demonstrating the ALLISON: FOUR, the first "bookshelf" loudspeaker system with Stabilized Radiation Loading*. This unique design minimizes the large variations in middle-bass power output produced in conventional systems by reflected impedance from room boundaries. In uniformity of bass power delivered to a real listening room, the new model FOUR's only peers are the larger and more expensive Allison three-way systems.

The FOUR is a two-way system with a crossover frequency of 2,000 Hz. But its extreme low-frequency response is the same as that of the ALLISON: TWO, and it is

*Patents pending

**Higher in the South and West because of freight cost.

fully equivalent to other Allison systems in high-frequency range, smoothness, and omni-directional dispersion in the forward hemisphere.

These factors give the ALLISON: FOUR great flexibility in room placement without performance compromise. It can be placed on a table or shelf, or hung on a wall using the wall-mounting hardware supplied with it. A stereo pair can be located on the same wall, on adjacent walls, or even on opposite walls away from the main listening area; there is no requirement that the systems face toward the area.

The ALLISON: FOUR's price is \$195.00**. Descriptive literature, complete specifications, a statement of Full Warranty, and a list of dealers are available on request.

ALLISON ACOUSTICS 7 Tech Circle, Natick, Massachusetts 01760

Audioclinic

Joseph Giovanelli

Neighbors & Sound Systems

Q. I am a tenant in a multi-dwelling apartment complex. I purchased a high-performance stereo system which cannot be used at an adequate listening level without disturbing my neighbors. Are we owners of stereo systems forced to give up the use of our speakers and listen to high fidelity through a pair of headphones? — Michael Tudos, Brooklyn, N.Y.

A. Where an individual's high fidelity listening interferes with his neighbor's rest, peace, right to quiet, etc., the person with the high fidelity system must keep the volume down. Each of us is free to do whatever we like, just as long as this freedom does not, in some manner, interfere with the rights of others.

You would not want to be awakened by a TV set blasting away at 3 a.m., but this is a possibility if one of your neighbors works until midnight. The same holds true for your neighbor if you blast your sound system, or even play it at moderate levels in today's houses. Bass carries, and it is generally the bass which is the disturbing factor in these cases.

It is fortunate that we do have rather good, lightweight stereo headphones available. With the poor acoustic construction of modern apartment buildings, loudspeakers blasting away simply have no place in such apartment buildings.

High Listening Levels

Q. After having read in magazines about people having hearing problems after prolonged exposure to loud music, I've come to you with a question. In the future I would like to be a recording engineer in a studio. I know that I should take good care of my ears and I would like to know what average dB level do you think is a safe listening level? — James Tate, Sharon, Pa.

A. You raise a serious point in terms of hearing problems associated with high level listening, and you are *right* to be concerned about it. Where the sound level is really excessive, it may be a matter of just a year or two before all highs above, perhaps, 5 kHz are lost. I've received some rather sad letters from teenagers who've said that this has already happened to them, and the damage is irreversible.

Today's music places a greater emphasis than before on "feeling" the music as well as hearing it. Apparently, the near painful elements of this experience

are very important to both performers and listeners alike. But with hearing loss, the feathery edge that makes for real immediacy and transparency of sound is gone forever.

It is interesting that you wish to enter the recording field as a studio engineer. If you visit the average recording studio and watch a mixing session, you will hear sound at incredibly high levels, considerably above the conservative 85 dB sound level. I believe that listening at levels above 85 dB is asking for hearing problems, even though there are people who argue that 90 to 95 dB sound level is more realistic.

Given the facts that the ears must last a lifetime and that the ears can and do sustain damage when exposed to high listening levels, you must decide whether work as a studio engineer is really what you wish to do, or if there are other aspects of sound recording work which would be equally satisfying to you. True, the work as a studio engineer is the most well known, but there are other fields such as disc mastering, equipment maintenance, field recording, etc. that are equally challenging and rewarding.

Volume Control

Q. How do you tape a program so that the volume level will be fairly constant, and you don't have to readjust for each selection or station? — Mike Harkley, Lorain, O.

A. Some inexpensive tape machines have an automatic volume control (AVC) so that the recording level doesn't have to be adjusted. However, high-quality machines keep away from this due to distortion and other problems introduced with it. If you want good quality, you have to change recording level when the level of your program source changes. An alternative would be to set the recording gain control on your deck to accommodate the program source with the highest level, e.g. a radio station which comes in strongest. However, weaker incoming signals would then be under-recorded resulting in a drop in the signal-to-noise ratio. If you are using a very fine tape deck with a high S/N ratio (60 dB or better), you may be able to afford the loss of 5 or 6 dB as a result of not turning up the recording gain for the weaker program sources.

If you have a problem or question on tape recording, write to Mr. Herman Burstein at AUDIO, 401 North Broad Street, Philadelphia, Pa. 19108. All letters are answered. Please enclose a stamped, self-addressed envelope.

Others don't stack up against the books from Audio

No. 607, This volume is a handbook on the broad aspects of the practice and principles of multitrack recording.

No. 618, Covers both the advantages and disadvantages of each enclosure type.

No. 617, This is a thorough learning manual about microphones and how they work.

No. 622, Directed toward both the theory and the practical applications of audio circuits.

No. 619, The book attempts to address the considerations in applying the IC op-amp with maximum effectiveness in a wide variety of circuits.

No. 620, This book explains the operation of unique IC op-amp applications.

No. 608, Here is the whole event-filled story of the phonograph's first century.

No. 903, This new modern publication discusses the audio-system as a whole.

No. 609, This book has become a bible for serious scholars of the technical and legal aspects of the development of the audio-visual industry.

No. 623, This text tells and shows practically and authoritatively the uses of the microphone.

No. 621, The book discusses all types of timers, using representative industry standard devices as examples.

No. 612, This extensive survey of sound should be required reading for every recording engineer and audiophile.

No. 616, This book presents important information for those who want to, and should understand the performance characteristics of the room itself.

No. 613, This is the most up-to-date, complete, and accurate single volume on the development of television and radio now available.

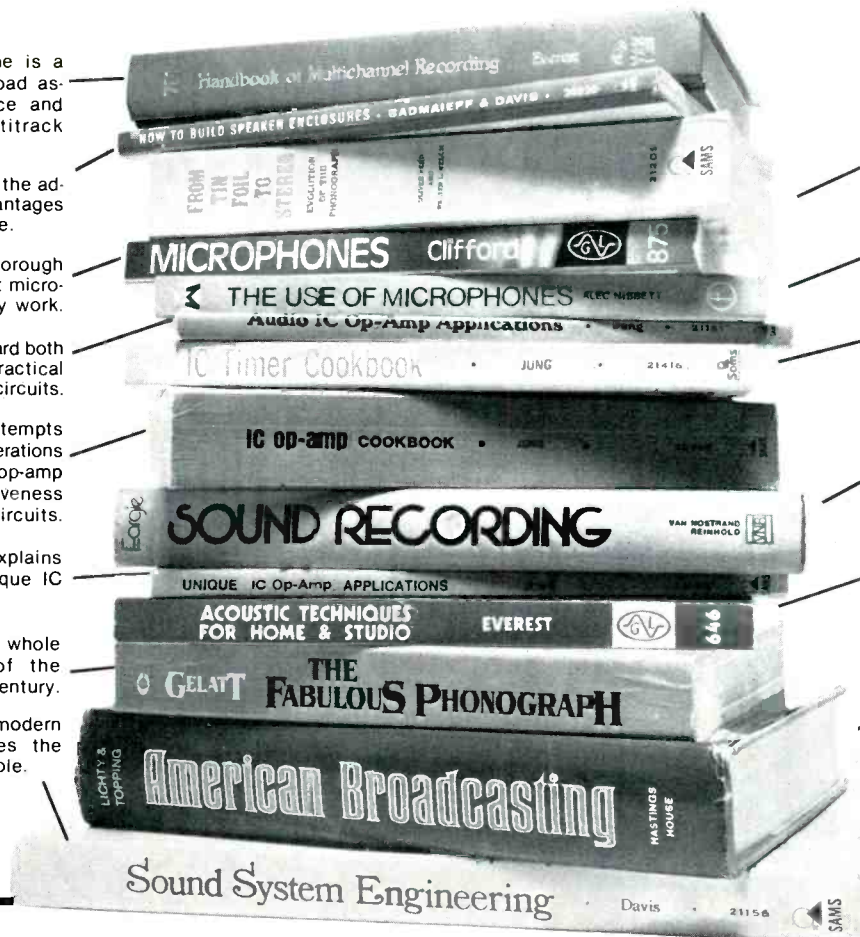

Please send me the book(s) I have checked.
Enclosed is my proper remittance for \$ _____.
I understand if I am not fully satisfied I may return my selection(s) in undamaged condition within 10 days for a full refund.

- 607, HANDBOOK OF MULTICHANNEL RECORDING, \$10.95
- 608, THE FABULOUS PHONOGRAPH, 1877-1977, (softback) \$6.95
- 609, FROM TIN FOIL TO STEREO, (softback) \$9.95
- 612, SOUND RECORDING, \$16.95
- 613, AMERICAN BROADCASTING, \$26.50
- 616, ACOUSTIC TECHNIQUES FOR HOME AND STUDIO, \$8.95
- 617, MICROPHONES—How They Work and How to Use Them, \$8.95
- 618, HOW TO BUILD SPEAKER ENCLOSURES, (softback) \$4.95

- 619, IC op-amp COOKBOOK, (softback) \$12.95
- 620, UNIQUE IC op-amp APPLICATION, (softback) \$4.95
- 621, IC TIMER COOKBOOK, (softback) \$9.95
- 622, AUDIO IC op-amp APPLICATIONS, (softback) \$4.95
- 623, THE USE OF MICROPHONES, (softback) \$6.95
- 903, SOUND SYSTEM ENGINEERING, \$19.95

Name (please print) _____
Address _____
City/State _____ Zip _____

Please allow 4-6 weeks for delivery

Audio

Book and Learning Systems Division

North American Publishing Company, North American Building, 401 N. Broad Street, Philadelphia, PA 19108

Audio Magazine is published by North American Publishing Company, leaders in editorial excellence.

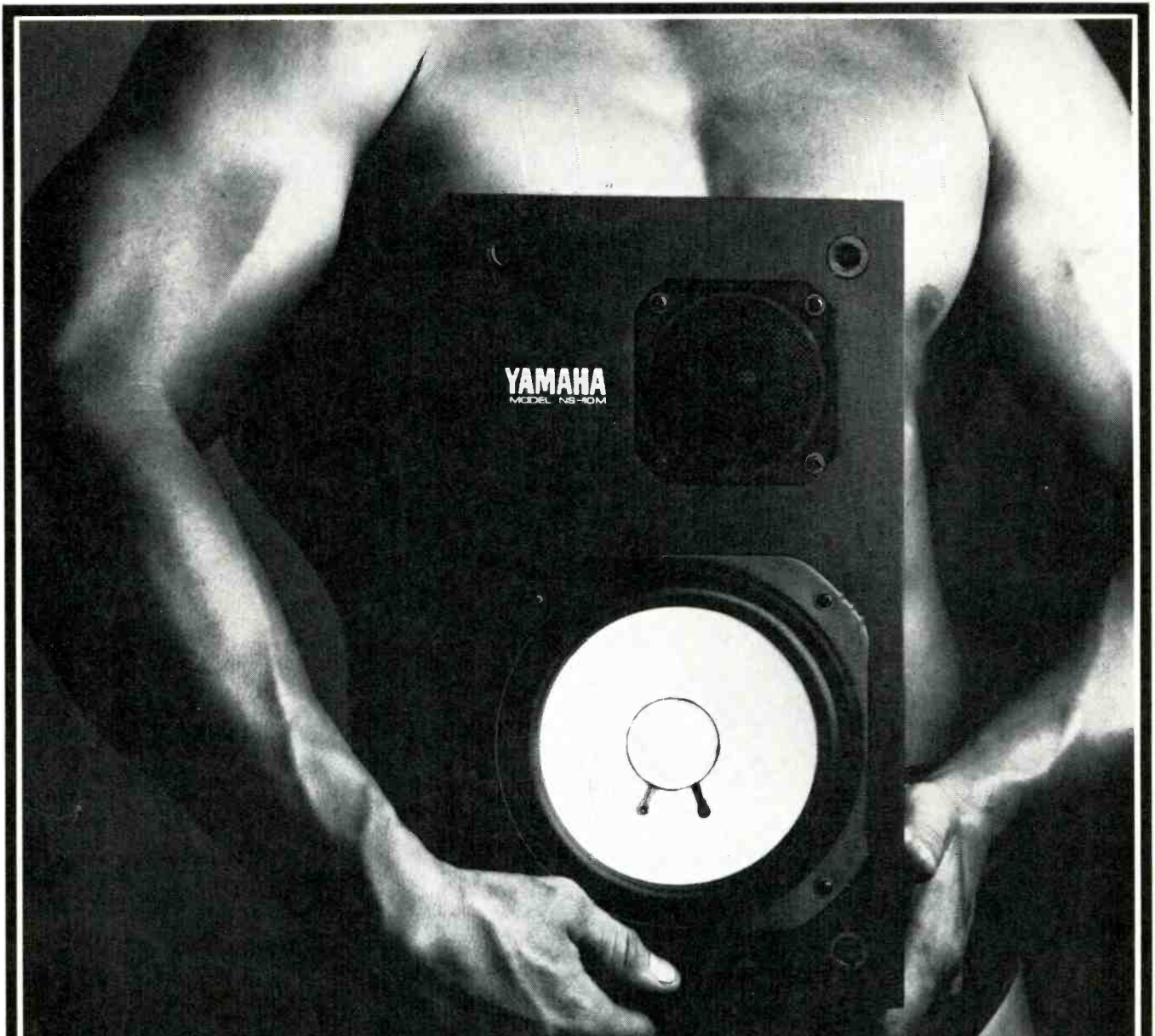

Incredibly smooth, well-defined, powerful. Yet small.

Presenting Yamaha's new NS-10M Mini-Monitor. With wide, even dispersion, high sensitivity and accuracy, the sound is distinctively Yamaha: a rich, solid sound with a tight, firm bass that respects every nuance of tonal shading.

What you're going to wonder, is where it's all coming from. Because for the sound, the Mini-Monitor is amazingly small. Weighing in at 13 lbs., the speaker measures only 15.4" high, 8.5" wide. Inside, a 7" cone woofer and a 1.5" dome tweeter produce 90 dB SPL with 1 watt at 1 meter.

The Mini-Monitor was made in the image of the NS-1000. It has an identical finish, and like its bigger brother, is sold in mirror-image matched pairs. At low volume levels the sound is virtually the same. It's a primary monitor with the NS-1000 look and sound, for places the NS-1000 won't fit.

Our new Mini-Monitor with the powerhouse sound is currently contending with the heavyweights at your Yamaha Audio Specialty Dealer. And holding its own, thank you.



Audio Division, P.O. Box 6500, El Segundo, CA 90622

If you can't find your nearest Yamaha Audio Specialty Dealer in the Yellow Pages, just drop us a line.

Our previous article on microphone testing described methods that we anticipated using for microphone reviews. When we wrote that article we may have had a stereotyped image of a moderately priced dynamic microphone for audiophile use with a cassette recorder.

Instead, we have been privileged to review a number of excellent microphones including ribbon, dynamic, electret and air-condenser types and have been pleasantly surprised to find that these high quality mikes are priced within the reach of audiophiles.

Our goal remains unchanged; we intend to acquire data as complete as time and budget allow, and follow applicable standards as closely as possible. To meet our goal, we are constantly improving our techniques to keep up with advancing technology in microphones.

This update will describe some of our "new wrinkles" in testing. Aspects of two new tests will be described, noise and frequency response testing under plane-wave conditions outdoors, and the setup and procedures that we're using for listening tests.

A recent review (2) showed results of an experimental noise test on an air-condenser microphone. The $\frac{1}{3}$ -octave noise levels of this high quality mike provide good baseline data. The overall measured levels were higher than specs, which inspired us to refine our methods. Our set up was similar to Fig. 1 but employed the same wide-band, solid-state RCA BA-31 preamp used for frequency response testing [Fig. 1]. For noise testing only, we switched to our "standard of quiet," the RCA OP-5 portable amplifier, an old vacuum-tube, remote-broadcast amplifier of high quality, with a step attenuator and classic Weston 4-in. VU meter. The overall noise levels are -129.5 dBm (unweighted) and -131 dBm ("A" weighted) referred to the input. The dBV numbers are the same because the rated input source impedance is 250 ohms [1]. The $\frac{1}{3}$ -octave spectrum of the OP-6 noise is shown in Fig. 3, and the SPL scale is to be disregarded for the present. The 250-ohm impedance rating does not conform to the recent broadcast standard which is 150 ohms, but is ideal for testing today's low impedance microphones which vary from 150 to 600 ohms.

A little mathematics will show why a restricted frequency response amplifier is less noisy than a wide band unit. Random noise is generated by thermal agitation in a resistor or in the resistive component of a complex impedance. The total rms open-circuit voltage e in the frequency band (f_2-f_1) is [4]:

$$e_n = \sqrt{4kTR(f_2-f_1)}$$

Where k is Boltzmann's Constant, T the absolute temperature ($^{\circ}$ K), and R is the resistance value in ohms. If we reduce bandwidth from 150 kHz to 15 kHz, e will be reduced by 10 dB. Failing to band-limit the amplifier can result in a high noise reading that is not related to what you hear. Alternately, we could chill our device to near absolute zero and the noise will be very low, but this is only practical for specialized radio receivers.

If we assume a temperature of 20 degrees C and a bandwidth of 15 kHz, the noise voltage E_n in dB re 1 volt (dBV) is:

$$E_n = \sqrt{-156.2 + 10 \text{ Log}_{10} R}$$

The 250-ohm resistor termination for our OP-6 produces -132.2 dBV of noise according to the equation. Thus the OP-6 adds $-129.5 - (-132.2) = 2.7$ dB to the noise and is said to have a noise figure of 2.7 dB.

The Compleat Microphone Evaluation

35

AN UPDATE

Jon Sank

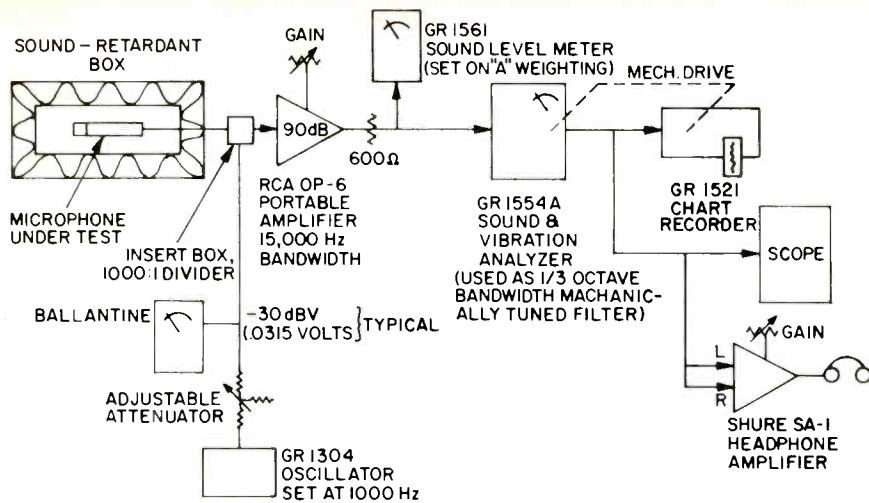

Fig. 1—Test setup for noise measurement.

This is a low N.F. for an audio amplifier, and a limited review of IC Op Amp specifications plus calculations have shown a higher N.F., particularly with unloaded input conditions where the input impedance is five to ten times nominal mike impedance. We would be pleased to receive test data on quiet ICs.

We've only considered the fundamental case of noise generated by a resistance. References 3 and 4 discuss other sources of noise in microphones and amplifiers.

A precision sound level meter (less microphone) is included in our noise test setup to indicate overall levels unweighted (flat response) and "A" weighted (bass rolloff). The "A" weighting is appropriate because microphone noise would be perceived by the ear at a very low sound level where "hiss" is more easily heard than "hum."

European manufacturers specify DIN weighting, but "A" weighting is commonly used in the U.S. for acoustic noise measurements and ratings and is specified by NAB for tape equipment testing. Our noise test equipment conforms to the standards listed in Table I, and these may be consulted for more detailed information.

Our sound-retardant box is made of 3/4-in. plywood, double thickness, braced by 2 x 3 in. boards and lined with several layers of 1-in. acoustical foam. It is purposely non-metallic and non-magnetic because microphone noise properly includes components resulting from ambient magnetic or electric fields. We position the box to minimize hum if it is encountered, because in practice one may so orient a mike. The sound transmission loss (TL) of the box has been measured by exposing it to a high level, calibrated, reverberant sound field. The results are shown in Fig. 2. The loss at low frequencies is remarkably high for an inexpensive box. Room ambient noise generally peaks in the 63 and 125 Hz region due to motors and lamp ballasts, then falls to a low SPL at 1000 Hz and above. This complements the TL curve, and the resulting ambient sound inside the box tends toward a flat spectrum, which minimizes interference to micro-

Fig. 2—Sound transmissions loss of microphone noise testing box.

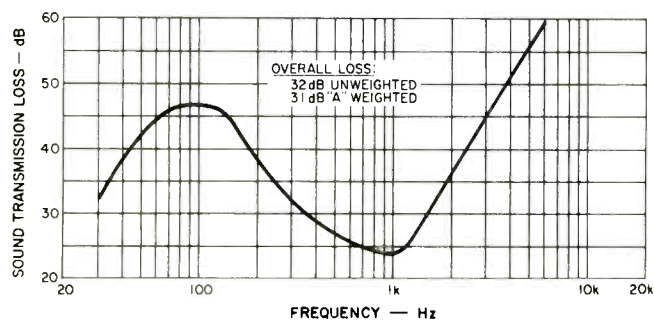

phone tests. Nevertheless, we only make tests when the room is very quiet, and continuously listen for ambient noise from the mike.

We have shown that a simple resistor makes noise, and thus condenser mikes having integral amplifiers are not singular in their ability to generate noise. In fact, all types of mikes make noise. Figure 3 shows some "baseline" data on our lab reference BK-5B ribbon mike. Below 1000 Hz, hum and harmonics predominate above the OP-6 amplifier noise even though the box was oriented to minimize hum. Incidentally, our sound room does not have strong fields, and the BK-5B has low hum sensitivity. Above 1000 Hz, the mike generates no more noise than a resistor. The result is that the noise does not exceed 25 dB unweighted and 19 dB "A" weighted equivalent sound pressure level in dB re 20 microPascals. How is this rating determined? We calibrate our chart paper scale as well as the sound level meter scale in dBV by the insert voltage technique described in Ref. 1. Then we remove this calibrating voltage and measure overall noise levels with the SLM, and record the spectrum on the chart. In order to compare with manufacturer's specifications, the dBV numbers must be converted to equivalent SPL (L_{pn}) as follows:

$$L_{pn} = E_n - R_1 + 94$$

R_1 is the microphone acoustic sensitivity (previously measured) expressed in dBV/Pascal, as described in Ref. 1. Obviously, if E_n is "A" weighted, L_{pn} will be an "A" weighted sound level.

The L_{pn} number may be easily utilized in a practical recording situation. Let's assume we have a rather noisy mike with an "A" weighted L_{pn} of 35 dB and a Nagra IV SD recorder with an ("A" weighted?) S/N of 72 dB (6). In order that the mike noise will be below tape noise, the sound level at the mike must exceed L_{pn} by 72 dB (plus a safety margin). Thus our *minimum* SPL must be an astounding 107 dB! With this mike we can record high-level rock music or pavement breakers but preferably not classical music or normal speech. If we use our BK-5B and OP-6 combination (which is a very quiet system), our minimum SPL is

Fig. 3—One-third-octave band noise spectrum of BK-5B (reference) microphone plus OP-6 amplifier.

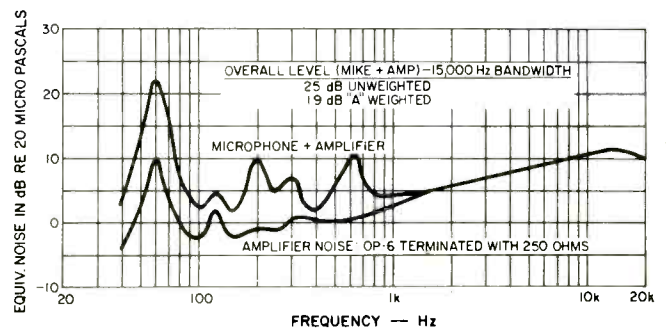

If price alone has kept you from LRS...

Our new Laboratory Standard Series should definitely be of interest.

LUX's new six-component Laboratory Standard Series was developed out of the same commitment to sonic quality that originated our premier component group: the very impressive Laboratory Reference Series.

The new LSS group of components was designed to enable the advanced audiophile to acquire very nearly the LRS level of performance—and at a much more moderate price.

Now, we simply wish to introduce the LSS to you, point out a few high points of the design, and encourage you to get the full story from your LUX dealer.

The tuner features quartz-lock tuning

circuitry, switchable i.f. bandwidth, variable muting threshold, audible multipoint monitoring and an innovative aid to precise tuning: Accutoch. As you turn the knob, any station that exceeds the muting threshold physically locks at the point of lowest distortion.

For amplification, there's a choice of an integrated amplifier, a preamplifier, a stereo power amplifier, and a mono power amplifier—all pure DC and direct-coupled. They use the same special circuits developed by LUX for the LRS. Transient intermodulation distortion is negligible, and problems of DC drift and phase shift are non-existent.

For frequency balance and adjustment, the preamplifier and integrated amplifier include the exclusive LUX L near equalizer.

For additional flexibility, a ten-octave graphic equalizer with active filter components achieves both low distortion and noise-free operation.

If only the necessarily high cost of LRS has been the obstacle between you and its ownership, it is now time to visit your LUX dealer. You'll have the opportunity to audition today's near-ultimate in high-fidelity reproduction. At considerably less than the ultimate in cost.

LUX Audio of America, Ltd.

160 Dupont Street, Plainview, New York 11803 • In Canada: White Electronics Development Corp., Ontario

LSS components as shown, top to bottom: T-12 FM tuner with 10.7 dBf (1.8 μ V) usable sensitivity, 14.1 dBf (2.8 μ V) for 50 dB quieting (IHF), 0.8 dB capture ratio, and 90 dB selectivity. G-11 ten-octave graphic equalizer provides ± 6 or ± 12 dB boost or cut at each octave, $\leq 0.005\%$ THD. The C-12 preamplifier, $\leq 0.005\%$ THD and 0.002% IM distortion, signal-to-noise ≥ 96 dB, 10 mV input (IHF-A weighted), 300 mV phono overload. M-12 stereo power amplifier, 80 watts per channel, both channels driven, into 8 ohms from 20 to 20,000 Hz, $\leq 0.06\%$ THD.



The LRS line of nine separates includes: ST50 frequency-synthesized FM tuner with digital readout and 7-station memory; SC50 preamplifier, DC and fully direct-coupled, THD 0.005%; SG12 12-octave graphic equalizer; SF70 tone control unit; SE24 LED level indicator; SM21 DC direct-coupled power amplifier with meters. Also: SL15 integrated amplifier; ST-0 FM tuner with Accutoch; SM20 power amplifier without meters.

Table 1 — ANSI (American National Standards Institute) and NAB (National Association of Broadcasters) standards related to audio noise measurement.

ANSI 51.11-1966 (R1976) octave, half-octave, and third-octave filter sets, specifications.
ANSI 51.4-1971 (R1976) sound level meters, specifications.
NAB Standard, April 1965 magnetic tape recording and reproducing (reel-to-reel).

$19+72 = 91$ dB. We can record classical music successfully because the recorder gain will be adjusted for 0 VU on the loud passages, which should exceed 91 dB. A high quality, high S/N tape recorder requires a low noise, high sensitivity microphone. The mike preamp in your recorder or mixer can degrade S/N if a low sensitivity or mismatched impedance mike is used or the preamp can be just plain noisy.

Now that we've attracted your attention to microphone noise, we think it only fair to mention a saving grace in realistic audiophile recording sessions and that is ambient acoustical noise. The church in which we record has an ambient noise level of 25 dB "A" weighted, with no people. During a concert, the background sound must obviously be higher. Thus, any mike having a noise rating of less than 25 dB "A" is adequate.

What is the least noisy mike we've measured? It is (surprise!) a condenser. Our RCA MI-10006A varidirectional condenser microphone (7) measures approximately 7 dB unweighted and 0 dB "A" weighted! The MI-10006A was designed for motion picture applications on very quiet sound stages, but surprisingly was not favored because of infrequent "pop" noises which could spoil a long scene. This mike has a lower "threshold of hearing" at low frequencies, than the human ear, and listening to ambient sound with this mike reveals otherwise inaudible noises that sound like distant thunderstorms.

Listening Tests

In our 1977 article in *Audio*, we described the principles of A-B comparisons. We did not show specific methods because of space limitations, but think it a good idea to describe the details, both for the record and for audiophiles who are interested in making more productive listening tests.

Figure 4 shows our test setup. It may appear complicated, but the audiophile could construct a rough equivalent with a pair of mike mixers, a switch, and a headset.

We always use the same reference mike as "A," our BK-5B that we built with T.L.C. about 10 years ago. Periodic checks on the frequency response have shown it to be a stable mike. Since it is a cardioid, it can properly serve only for comparison with cardioid microphones, but these comprise about 80 per cent of mikes reviewed to date.

Each mike is connected to the same load, a balanced, 150-

ohm unloaded input. The step attenuators in each channel are adjusted for equal audio levels as indicated on the VU meter. The difference in attenuator settings in decibels should equal the measured difference in microphone sensitivities. The master attenuator is adjusted so that the overall gain (in the reference "A" channel, at least) is unity, so a ribbon microphone level signal is present at the OP-6 input. The A-B switch is a console-type key switch. It is followed by the matching transformer which presents a balanced circuit to the OP-6 amplifier which functions to boost the signal to a normal program level of +8 VU and provides a large VU meter for indicating levels.

It is important to use headphones which reproduce the entire audio frequency range with low distortion. We have tried a number of high quality phones, but in general, changing phones does not change the conclusions of an A-B comparison of microphones.

We try to follow an orderly and consistent test procedure. First, we position the two mikes close together, make a talk test, balance the levels, and check for correlation of attenuator settings and known differences in sensitivities. This is followed by several comparative tests, some of which are more objective than subjective:

1. Evaluate sound quality of voice.
2. Shake the mike and listen for noises; check operation of on-off or voice-music switches.
3. Tap the stands and mikes and observe outputs.
4. Check sensitivities to breath "pops," with and without accessory windscreens.
5. Orient each mike for maximum output at a specific distance from a coil carrying 60 Hz current, with a field of approximately one gauss, and note relative hum levels.
6. Check clipping level on calibrated scope with loud speech. The voltage value is converted to SPL by calculation using the measured R_1 value.

Pending results from these tests, we set up the microphones in our rectangular listening room which is approximately 400 sq. ft. in volume, with 15-in. studio monitor speakers on one end and 15-in. thick sound absorbing material at the other. Real time analysis at selected locations throughout the room reveals a uniform acoustic response with no need for "room" equalization. The monitor speakers have uniform response from 40 to 15,000 Hz, so that a full range of musical instrument sounds can be reproduced from master tapes of concerts, and this is satisfactory source material for most A-B comparisons of microphones. Then we usually make a quick test using available live instruments, to see if the results correlate.

Further listening tests may be made as circumstances dictate, including stereo taping of live concerts, which necessitates obtaining a second mike. Products for review are submitted in unit quantity, which is usually one microphone. We have not yet attempted A-B comparisons between pairs of microphones.

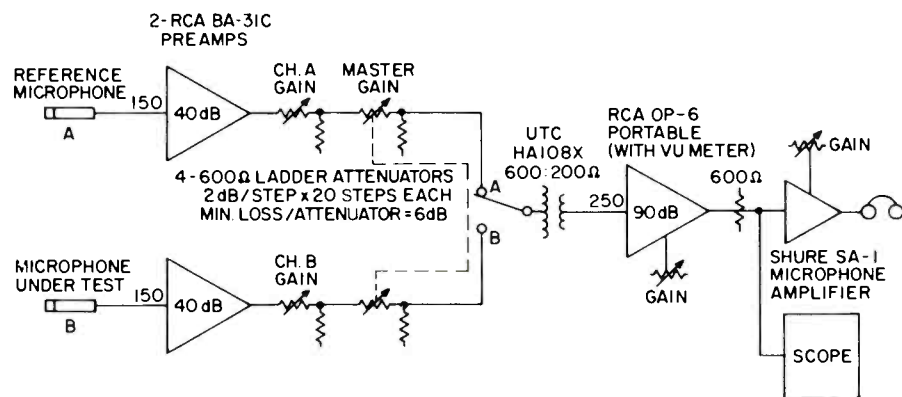
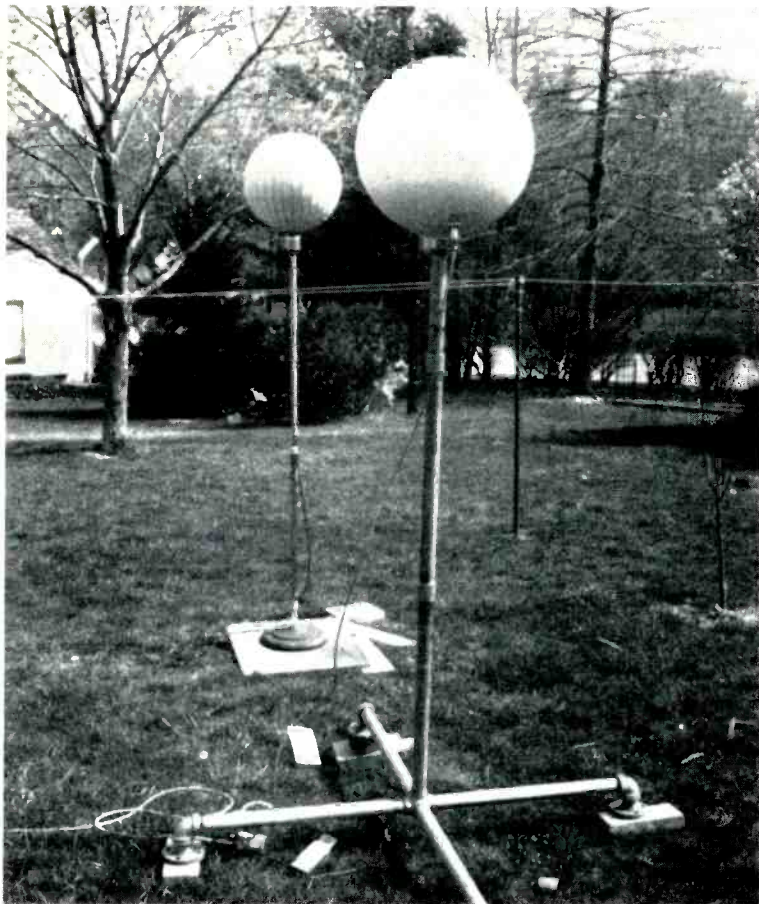

Fig. 4—Equipment setup for comparative listening tests.

Response and Directivity Tests Outdoors

The relevant ANSI and EIA standards (see April, 1977, *Audio* article) require that a plane wave be used for testing frequency response and directional characteristics of microphones. This requirement is essentially met at high frequencies where the microphone is one or more wavelengths from the source. At lower frequencies where the distance is less than about $\frac{1}{2}$ wavelength from the source, pressure-gradient microphones, such as cardioid or figure-eight pattern, exhibit a bass boost or proximity effect as illustrated in Fig. 8 of our 1977 article. A cardioid will exhibit a varying effect depending upon angle of

Fig. 5—The large spherical sound source in the foreground with the SPX ribbon microphone enclosed in a large windscreen.



incidence. The 0-degree response follows the curves of the graph, the 90-degree response is not boosted, and the 180-degree response is boosted more than the 0 degree.

Normally, we measure microphones indoors on the small spherical sound source [1] at distances from 6 in. to 2 ft. These data are published along with the plane wave response which is usually calculated from the 6 and 12 in. curves, using the proximity effect graph. This is fine when you are using a source whose dimension is small compared to the microphone distance, in other words, the mike is in the *far field* of the source. When the mike is closer than twice the source dimension (for this purpose use the diaphragm diameter), the distance to the (effective) point source is undefined, probably varies with frequency, and plane wave response cannot be calculated.

We have discovered that few, if any, manufacturers actually publish low frequency response curves for plane wave condi-

tions. Frequently, the distance to the source is not mentioned, and the source dimension is rarely stated. Most overseas manufacturers use a 1-meter distance. We discovered one overseas company testing at 50 cm, and one domestic company testing at 12 in. (30.5 cm). The latter was using a 12-in. speaker. The 50-cm distance is all right if the source is less than 25 cm in diameter and the data appropriately corrected to plane wave conditions. Testing at 12 in. from a 12-in. speaker is improper unless, of course, you only test omnidirectional (pressure) microphones.

L. J. Anderson (for whom we worked at RCA) is quoted by Ref. 5, stating that essentially plane wave conditions are obtained at a distance d from a (point) source, above a lower limiting frequency f according to $f=350+d$, where d is in ft. and f in Hz.

We have calculated f for the distances mentioned in this article:

d meters	d feet	f Hz
0.15	0.5	700
0.31	1.0	350
0.50	1.6	219
0.61	2.0	175
1.00	3.3	106
1.22	4.0	88
1.82	6.0	58

Strictly speaking, data corrections should be made when the microphone is closer than six ft. from the source.

Our indoor test setup with a small spherical source is satisfactory for omni, cardioid, and figure-8 microphones. The 180-degree response of cardioids at two ft. is a little in doubt below 175 Hz because of uncertain correction factors, but this is a minor difficulty.

Our test procedures had been routine until the Editor (in his infinite wisdom) submitted a shotgun type of ultradirectional microphone. Our extensive experience with this kind of mike has shown that plane wave test conditions are definitely required. It is intuitively evident that a microphone with sound entrances distributed along 40 cm of length should not be tested at, for example, 40 cm from a source, because the SPL at the rear of the mike will be 6 dB less than the SPL at the front. Generally, these mikes are intended to reject reverberant sound that would measure the same SPL at any point in space to be occupied by the mike.

In response to this challenge, we produced our large spherical sound source (Fig. 5), which like the Son of Godzilla, is not smaller than its father, the small spherical sound source! We are sorry to disappoint you with a description of this device, which is in no way as magnificent as its predecessor. The large source consists of a fiberglass sphere, about 18 in. in diameter, $\frac{1}{4}$ -in. thick, coated on the inside with $\frac{1}{4}$ in. of vibration damping compound, and filled with absorbing material. The transducer is a selected ALTEC 755C (8 in.) speaker. Our principal use for this source is for reverberation, response, and sound transmission tests in buildings. Devotees of plumbing will note the stand which is made of 1 $\frac{1}{4}$ -in. pipe and contains an esoteric fitting known as a "side arm cross." This is actually a railing fitting — it's hard to find but is the key ingredient of this very useful portable stand.

Figure 5 may lead you to believe that our beloved SPX laboratory ribbon microphone has had a monstrous offspring, but alas, this is not so. The microphone shown with the source is the SPX enclosed in a large windscreen. This screen is sufficiently good that wind noise from trees is generally heard before the velocity becomes great enough to generate noise in the SPX. The screen is a silver-solderer's masterpiece, made of thin brass rod covered with open-weave fabric. It was made to permit outdoor tests of large horn-type loudspeakers.

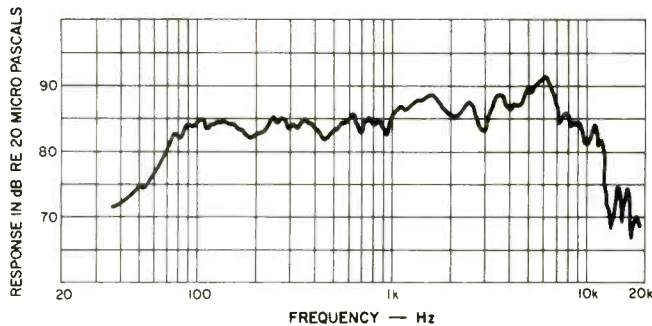

Fig. 6—Calibration of the large spherical sound source.

Those of you who have tried to test loudspeakers outdoors using conventional condenser pressure microphones know that you must either bury the speaker flush with the ground or position it and the mike very high above the ground to avoid wiggles from ground reflections. The ribbon velocity microphone produces accurate, smooth calibration curves of our source with the more practical setup of Fig. 5 where the source is six ft. from the mike, six ft. above grade. The figure-eight directional pattern of the velocity microphone rejects ground reflections, and of course at a six-ft. distance the mike has negligible bass boost due to the proximity effect [8].

It follows that our outdoor setup is best suited to frequency response tests of microphones having a null or at least some significant rejection of sound from the 90-degree direction. These microphones include figure-eight, ultradirectional shotguns, and super cardioids. Of course, most types of mikes, other than the shotgun, can be tested indoors. On high quality cardioids, the outdoor test will show a greater front-to-back ratio, particularly below 200 Hz, than the indoor test.

Figure 6 shows the calibration of the source. The large source is not ideally suited to frequency response tests of microphones having very smooth response, as the reduced data contain wiggles that are not present on curves from indoor tests. Presumably this is because the response of the small sound source is much smoother [1, Fig. 5].

The various schemes of source flattening we described enable more precise tests of microphones using commercial loudspeakers as sources, but it is doubtful that an artificially smoothed cone speaker can even equal the naturally smooth small source in making accurate microphone measurements.

We hope that this explanation of our "new wrinkles" in microphone testing has given you food for thought, both natural and artificial, of course. A

References

1. Sank, "The Compleat Microphone Evaluation," *Audio*, Vol. 61, No. 4; pp. 48-58, (April, 1977).
2. Sank, "Neumann Models 83, 84, & 85 fet-80 Series Microphone System," *Audio*, Vol. 62, No. 1; pp. 80-82, (Jan., 1978).
3. Olson, *Acoustical Engineering*, pp. 335-339, Van Nostrand, 1957.
4. Beranek, *Acoustic Measurements*, pp. 189-192, J. Wiley, 1967.
5. *ibid.*, pp. 642
6. Equipment Directory, *Audio*, Vol. 61, No. 10; pp. 166-168, (Oct., 1977).
7. Tremaine, *Audio Cyclopedia*, pp. 209-210, Howard W. Sams & Co., 1977.
8. Yes, we realize that your test equipment store is fresh out of SPXs. If you have an application (and a budget), we'd like to hear about it.



There WAS
a simpler age in
music reproduction

Today's music reproduction system must be evaluated in uncolored engineering numbers. And generally that has meant testing components in an anechoic chamber - and how many can afford that today?

Well, there is another way! B & K's gated compression system lets you make electroacoustic measurements in ordinary rooms as it pulls the "BOING" out of the measurement to give you free-field data.

The method is explained in Bruel & Kjaer's new Application Note "Combination of Gating and Compression Techniques in Electroacoustic Measurements". If you would like a copy, send us your business card or letterhead and we'll mail you one.

If you are involved in the manufacture of high-quality components for the faithful reproduction of sounds, then why not ask to talk with one of our representatives and discuss B & K techniques to fulfill your measurement requirements.



Combination of Gating and Compression Techniques in Electroacoustic Measurements

Without Compression
With Compression



B&K Instruments, Inc. Established in 1926

Bruel & Kjaer Precision Instruments
5111 W. 164th Street, Cleveland, OH 44142

Nikko. Deadly Accurate for Live Sound.



All audio equipment is simply a means to an end —the accurate recreation of music.

These three components from Nikko Audio's professional series incorporate a level of technology that truly purs the "high" into that "end" of accurate music reproduction.

Gamma V Synthesized Digital Tuner

Nikko's Gamma V FM stereo tuner has PLL twin-stage synthesized tuning circuitry. When the LED readout shows 100.3 MHz, for instance, you've got 100.3 MHz on the button.

You can tune to the station automatically or manually, and then set it (and five others) into the memory bank for instant recall. Accuracy plus convenience!

Alpha III Power MOS-FET DC Amplifier

The Alpha III power MOS-FET DC amplifier oozes accuracy. The power MOS-FET circuitry assures ultra wide frequency response at rated output, while the continuous DC operation from input to output stages assures absolute stability.

An LED power level display provides a direct reading of the power output of each channel. And (here comes the best part) THD is one of the lowest in the industry —0.006% (80

watts RMS per channel, both channels driven into 8 ohms, 20Hz to 20kHz). Unheard-of-accuracy!

EQ 1 Graphic Equalizer

For situations where room acoustics interfere with faithful music reproduction, Nikko's EQ 1 is the solution. With 10 bands per channel providing $\pm 12\text{dB}$ boost or cut, you can adjust your system to precisely recreate the live performance. Active accuracy.

Nikko works hard to stay ahead in technological excellence. But we never forget what it's all about — accurate musical sound for ultimate musical enjoyment. If this is what you want too, call this toll-free number for the name of your nearest Nikko dealer: (1) 800 423-2944.



Gamma V Digital Readout



EQ 1 Gain Control

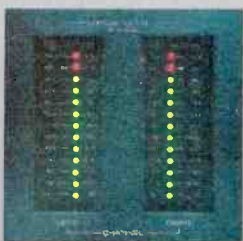

Alpha III LED Display

Nikko Audio

For Those Who Take Their Stereo Seriously

Nikko Electric Corp. of America
16270 Raymer St., Van Nuys, Calif. 91406 (213) 988-0105
218 Sherwood Ave., Farmingdale, N.Y. 11735 (516) 293-2906
In Canada: Superior Electronics, Inc. ©Nikko Audio 1978

Enter No. 41 on Reader Service Card



CASSETTES TESTED

Howard A. Roberson

The goal of this tape survey was to evaluate all cassette formulations currently available, including the bargain-priced ones. Contact was made with all known manufacturers or their representatives. Three samples each were requested of C-90s, the length to receive the greatest attention, and C-60s, plus any other lengths the manufacturer wanted to go through the test process. Three samples were considered the minimum number to make any determination of cassette consistency. Information was requested on each formulation's magnetic properties, features worthy of note, and prices. Unfortunately, technical information was not obtained on the majority of samples, and much of the data actually received was incomplete in one way or another. It was not possible, therefore, to correlate the test results with magnetic properties. Prices were obtained for most of the cassettes, but they were most confusing, what with list price, dealer price, audiophile net, maximum retail price, direct mail order, etc.

The requested samples were received from most of the makers, although fewer than three samples were provided in some cases. A few of the brands were obtained by direct purchase, including the bargain store labels, K-Mart and Zayre. All sources were contacted shortly before the testing started to ensure that the samples being used were representative of current production. The bargain-priced tapes were included so that their actual limitations would be defined and to supply additional information on how improvements in formulations benefit the purchaser.

Manufacturers' Specifications

A total of 58 formulations were tested, and technical data was secured on less than half of these. The table lists the majority of the C-90 magnetic specifications given, but some characteristics of lesser interest are not shown. The *Tape Type* entries were limited to "Fe" for many varieties of ferrics, "FeCr" for ferrichrome, "FeCo" for ferricobalt, and CrO₂. As most of the manufacturers say very little about the exact make-up of the formulations, the listing is undetailed, and there could be some error.

The magnetization curve figure has points of interest labeled for reference. The coercivity, H_{ci} , is the demagnetizing force needed to bring the induced flux to zero, and is expressed in oersteds. The retentivity, B_r , is the number of flux lines per cm² (gauss) of the tape coating cross-section, the width of the tape, and the coating thickness. It is indicative of high-frequency sensitivity. Remanence, is the actual magnetic signal retention in lines of flux (Maxwells) applied to the specific tape. It is the *total flux*, *not* the flux density (gauss). Most manufacturers give values for the 0.150-inch width of the cassettes tapes. Some, however, give values for 1/4-inch widths, and their figures must be multiplied by 0.6 for the smaller width. Remanence affects distortion, sensitivity, and output at the lower frequencies. Squariness ratio is the decimal fraction of the flux remaining relative to the maximum possible at saturation. It is a measure of the "efficiency" of the magnetization process.

Although DIN standards are not true international standards, some of them are used throughout the world. Test tapes made by BASF include a blank section of tape which is used to establish reference levels for sensitivity at 333 Hz and for bias. The manufacturer's figures

for sensitivity and bias give his values in dB relative to the reference tape levels. Sometimes confusion may arise because the bias for CrO₂ tape may be referred to either the standard ferric tape or to the standard CrO₂ tape. If the values are close to zero, the reference is to the standard CrO₂ tape.

Tests Performed

A basic guideline for the testing of each tape type was that each one would be presented at its best, with bias and EQ adjusted for best results. There was no "standard" fixed bias used to match one particular tape, causing other tapes to appear less satisfactory. An important part of the evaluation gear was a Technics RS-9900US 3-head cassette deck. This unit has front-panel continually variable bias and EQ pots, greatly facilitating the test process.

The first step for each tape was examination of the C-90 record playback response with the 1/3-octave RTA with pink noise being recorded at a low level. (A few tapes were available only in C-60.) The record head was adjusted for alignment with the play head, for the skew of the cassette in use. EQ was always started in detent (zero reference), and bias was adjusted for the best response between 1 and 10 kHz, with limits of +1.5/-0.0 dB. EQ was used, if needed, to meet these amplitude limits. Bias was measured on the dB scale of a Heath SM-5238, referenced to standard bias, with a scope monitor. The EQ change was measured by noting the shift in dB at 10 kHz.

The reference record level was established at 400 Hz for Dolby-level indication (200 nWb/m) in playback. Playback of the internal 400-Hz tone gave the data on tape sensitivity. Record/playback responses were run at the reference record level and 20 dB below that. The maximum record level was measured at 100 and 400 Hz, and 3 kHz with an HDL₃ = 3 per cent guideline and at 10 kHz for tape saturation. The signal-to-noise ratio used IEC "A" weighting

Manufacturer's Specifications

BRAND OR MANUFACTURER	TAPE DESIGNATION	TAPE TYPE	COER Oer	RET Gau	REM Max	SQU RAT	SENS dB	BIAS dB	PRICE C-90	Notes on Headings:
Ampex	Plus	Fe	310	1300			0	-0.5	\$2.49	"COER" and "Oer" are "coercivity" and "oersteds" respectively.
Ampex	20 - 20 +	Fe	300	1400			+2.4	-0.5	3.49	
Ampex	Grand Master	Fe	325	1700			+1.5	+2.0	4.29	
AudioMagnetics	High Performance	Fe					+0.5		2.99	
BASF	Performance	Fe	320	1250	0.23	0.79	+1.8	+0.5	3.59	
BASF	Studio	Fe	290	1450	0.20	0.85	+4.0	-1.4	4.49	
BASF	CrO ₂	CrO ₂							4.49	
BASF	Professional I	Fe							4.79	
BASF	Professional II	CrO ₂							4.99	
BASF	Professional III	FeCr							4.99	
Capitol	1	Fe	310	1300	0.25		+1.5	-1.0	1.49	"RET" and "Gau" are "retentivity" and "Gauss" respectively.
Capitol	Music	Fe	310	1300	0.25		+1.5	-1.0	3.69	
Capitol	Music	CrO ₂	510	1600		0.9		+6.0	4.09	"SQU" and "RAT" are "squareness ratio."
Certron	HE	Fe	310	1300		0.82	+0.5	+0.4	2.39	
Columbia	Low Noise	Fe								"SENS" is sensitivity, at 333 Hz.
Comsette	Low Noise	Fe	310	1550		0.88			1.80	
DAK	HEC	Fe							1.91	Prices for C-90s are given as supplied and include all varieties of list, suggested net, direct mail order, suggested retail, etc.
DAK	HEC-SL	Fe							1.78	
Fuji	FL	Fe	320	1210			0.0	-0.2	3.60	
Fuji	FX-I	Fe	345	1520		0.84	+1.5	0.0	5.10	
Fuji	FX-II	Fe	550	1400		0.88	+2.0	+3.8	5.10	
K-Mart		Fe							0.73	
Lafayette	LN	Fe							1.69	
Lafayette	Criterion	Fe							2.19	
Lafayette	XHE	Fe							3.29	
Maxell	LN	Fe								
Maxell	UD	Fe								
Maxell	UDXLI	FeCo	333	1640		0.92	+2.5	0.0		
Maxell	UDXLII	FeCo	548	1542		0.91	+2.0	+0.8		
Memorex	MRX ₃	Fe	350	1525		0.90	+1.7	+1.0	3.99	
Memorex	CrO ₂	CrO ₂								
Nakamichi	EX	Fe							5.80	
Nakamichi	EXII	FeCo							7.00	
Nakamichi	SX	FeCo							7.20	
Realistic	Concertape	Fe							2.99	
Realistic	LN	Fe								
Realistic	Supertape Gold	Fe								
Realistic	CrO ₂	CrO ₂								
Royal	APC/LN	Fe							3.00	
Royal	Ultra Linear	Fe							5.00	
Royal	CrO ₂	CrO ₂							4.50	
Scotch	Highlander	Fe							2.39	
Scotch	Dynarange	Fe	360	1500	0.26		+1.0	-0.5	3.69	
Scotch	Master I	Fe	330	1700	0.33		+2.5	-1.5	4.29	
Scotch	Master II	FeCo	550	1500	0.33		+4.5	+1.3	4.99	
Scotch	Master III	FeCr	370	1500	0.30		+2.5	+1.5	4.99	
Sony	LN	Fe								
Sony	UHF	Fe								
Sony	FeCr	FeCr	320	1500		0.87	+2.0	+0.7		
Sony	CrO ₂	CrO ₂								
Superscope	HF	Fe							1.65	
Superscope	SHF	Fe							2.25	
Superscope	CrO ₂	CrO ₂							3.50	
TDK	Maverick	Fe	330	1200		0.75	0.0		2.39	
TDK	D	Fe	330	1200		0.75	0.0		2.59	
TDK	AD	Fe	390	1500		0.8	0.8		3.99	
TDK	SA	FeCo	540	1500		0.83	+1.5		4.99	
Zayre	Pro Range	Fe							0.70	

with the 400-Hz 3 per cent distortion point as the signal reference level. The Nakamichi T-100 audio analyzer was used to measure levels, signal and noise, and the distortion at 400 Hz. A Tektronix 5L4N spectrum analyzer was used for the 100 Hz and 3 kHz tests. Swept responses utilized an Exact 128 generator with an 80-second sweep, a Gen Rad 1933 SLM as the a.c./d.c. log converter and an MFE 715 X-Y recorder. A Morrey-modified Heath IG-18 generator was the low-distortion source.

Modulation noise was measured with a 1-kHz tone recorded at 0 dB. The 500-to-1500 Hz bandpass was set with a Gen Rad 1952 filter, and the tone was notched out on playback with a UREI 560, with all suppressor filters at 1 kHz. Flutter data was gathered with the Nakamichi T-100. Earlier data had also been taken with a Tandberg TCD-330 feeding a Ferrograph RTS-1. Amplitude stability and drop-outs were measured,

to some extent, with the slow swept-frequency responses. Additional data was gained with a 3-kHz tone feeding the SLM on playback with Fast response, with its output feeding a storage scope.

Consistency of bias and EQ requirements, frequency response, sensitivity, and skew were checked for all samples of each length. Variations in C-60s or C-120s compared to C-90s were also determined, and their record/playback response plotted.

Test Results

The 58 formulations were distributed in five categories as follows: 8 low-bias ferric tapes, 34 normal-bias ferric tapes, 3 ferrichrome tapes, 8 CrO₂ tapes, and 5 high-bias non-CrO₂ tapes. The need for the first category was revealed in the testing as these tapes exhibited common properties. The table shows the results with all of the C-90 tapes, grouped in the categories mentioned. (C-60 results are

shown when that was the only length available.) Listed are the high-frequency 3-dB down points at 0 and -20 dB, the MRL at four frequencies, the S/N ratio in dBA, the modulation noise in (-) dB, and the relative 400-Hz sensitivity and bias, both in dB. The EQ is given in dB change introduced at 10 kHz. The flutter is weighted peak in per cent. Frequency response plots are shown for each of the cassettes, including C-60 and C-120 lengths. Additional comments on each formulation appear with the discussion of the plots below. Cassettes were screw-assembled with regular hard-plastic boxes, unless noted otherwise.

As mentioned earlier, the bias and EQ were adjusted for the best response with each tape, with particular attention to the region between 1 and 10 kHz. Data taken on many tapes showed that a rough guideline could be drawn that for every dB change in bias with a particular tape, there would be a 2-dB change in re-

Table 1: Test Results

BRAND OR MANUFACTURER	DESIGNATION	RESP. -3 dB @ kHz		MRL (dB re 0 dB) AT 4 FREQS.(Hz)				S/N RATIO dBA	MOD. NOISE -dB	400-Hz			W&F WTD PK %
		0 dB Level	-20 dB Level	HDL ₃ =3%		Sat. 10k	SENS. dB			BIAS dB	EQ dB		
				100	400							3k	
DAK	HEC	4.4	14.1	-7.5	-7.0	-4.5	-15.7	48.0	43.7	-2.3	-3.3	0	0.045
K-Mart		4.7	14.0	-3.2	-3.4	-1.7	-14.0	49.2	44.0	+0.2	-3.1	+1	0.10
Lafayette	LN	5.5	15.0	-3.8	-3.4	-1.0	-12.5	48.8	40.3	-0.5	-3.3	+½	0.05
Lafayette	Criterion	5.8	15.4	-4.1	-2.8	-2.6	-11.0	48.9	45.6	0.0	-3.2	0	0.07
Realistic	Concertape	4.2	11.2	-6.1	-8.4	-3.7	-17.5	46.0	43.6	-2.0	-3.2	+2	0.07
Realistic	LN	4.5	13.7	-8.2	-9.0	-7.2	-15.8	46.0	42.3	-2.0	-3.0	-½	0.07
Royal	APC/LN	3.3	8.6	-9.3	-11.1	-7.2	-23.0	46.5	39.3	-2.0	-3.4	+3	0.07
Zayre	Pro Range	4.8	13.6	-9.0	-9.3	-6.8	-16.3	48.8	44.5	-1.8	-3.1	0	0.11
Average values for low-bias ferric tapes		4.6	13.2	-6.4	-6.8	-4.3	-15.7	47.8	42.9	-1.3	-3.2	+¾	0.073
Ampex	Plus	6.0	15.8	+1.0	+2.5	+0.9	-11.2	54.6	48.0	+1.0	+0.1	0	0.055
Ampex	20-20+	5.9	16.0	+2.6	+4.0	+1.4	-10.7	55.3	47.3	+1.6	-0.5	0	0.06
Ampex	Grand Master	7.4	16.9	+5.0	+5.4	+2.7	-8.5	55.8	46.7	+2.8	-0.1	-½	0.075
AudioMagnetics	High Performance	6.8	16.4	+2.5	+3.0	+1.5	-9.8	54.0	43.0	+1.2	-0.1	0	0.075
BASF	Performance	5.8	16.0	-1.2	-1.3	-0.7	-11.3	52.1	42.5	+0.3	-1.6	0	0.065
BASF	Studio	6.4	15.6	+0.9	+1.4	+1.4	-11.7	53.8	47.2	+1.2	-0.1	0	0.06
BASF	Professional I	7.6	15.9	+4.0	+4.8	+2.3	-8.8	56.3	46.7	+1.0	+0.3	-½	0.065
Capitol	1	5.4	14.7	-0.5	+2.1	-0.5	-13.2	55.2	44.8	+1.0	-0.9	0	0.075
Capitol	Music	5.8	15.7	-1.7	-1.0	+0.5	-11.3	51.8	42.9	0.0	-0.6	0	0.055
Certron	HE	6.3	16.2	-0.8	-0.4	-0.3	-10.8	51.2	43.3	+1.5	-1.6	0	0.07
Columbia	Low Noise	5.5	15.6	-0.2	-1.4	-3.4	-11.0	51.4	44.3	+0.7	-1.1	-½	0.07
Comsette	Low Noise	6.6	16.3	+1.0	-1.5	+3.0	-10.6	53.7	41.1	+1.0	-1.0	-½	0.07
DAK	HEC-SL	5.8	15.4	-2.7	-3.5	-2.3	-13.4	48.8	46.2	-1.7	-0.7	-1	0.08
Fuji	FL	6.4	15.7	+0.4	+0.2	-0.8	-10.7	52.5	48.7	-0.8	-1.5	-1	0.065
Fuji	FX-I	7.2	16.4	+1.3	+2.2	-0.3	-8.8	54.5	48.1	+1.0	0.0	-1	0.07
Lafayette	XHE	6.0	15.3	-0.5	+1.0	-0.8	-11.5	52.1	46.5	+0.7	-1.0	0	0.07
Maxell	LN	6.2	15.6	-0.8	-0.6	-2.7	-11.7	52.0	47.7	-0.1	-0.8	-1	0.055
Maxell	UD	7.6	16.5	+3.3	+3.3	-0.5	-8.6	54.8	47.7	+1.7	+0.1	-1	0.042
Maxell	UDXLI	7.1	16.4	+5.4	+5.1	+0.8	-9.7	55.8	47.8	+2.5	+0.1	-½	0.07
Memorex	MRX ₃	6.8	16.0	+4.4	+4.3	+2.2	-9.8	56.2	46.7	+2.0	+0.3	0	0.08
Nakamichi	EX	7.3	16.7	+1.9	+2.6	+0.6	-8.1	53.9	49.8	+0.8	+0.7	-½	0.065
Nakamichi	EXII	7.3	16.3	+4.2	+4.5	+2.8	-9.7	56.4	47.8	+2.7	-0.2	-½	0.065
Realistic	Supertape Gold	7.2	17.2	+6.5	+6.4	+2.7	-7.8	57.5	44.5	+2.0	+0.3	-½	0.075
Royal	Ultra Linear	7.1	16.1	+1.2	+0.7	+0.8	-9.5	52.3	44.0	-1.0	+0.1	-1	0.07

sponse at 10 kHz. Increasing the bias would cause a drop in response, and decreasing it would have the reverse effect. With a particular recorder, changing to a tape requiring less bias could cause an unacceptable loss in highs, or perhaps reduce excessive highs in another case. A tape calling for more bias, of course, would add more response at the high end. From the bias listing in the table, you can tell what to expect in this regard if you do make a change.

Consistency of bias requirements from one length to the other is reported for each formulation so that you will know what to expect. Perhaps you will want to choose a tape which shows the same bias for all lengths. Consistency of sensitivity for the various lengths of one tape, and differences in sensitivity from one tape to the other, is important for best Dolby tracking, particularly if your deck does not have provision for adjusting the record sensitivity. Variations in

tape skew as shown by the need to adjust the record head of the Technics RS-9900US are indicative of changing mechanical alignment of the tape itself. If the tape were made and guided perfectly, the skew problem would disappear. The relative skew from sample to sample for a tape, expressed in dB loss at 10 kHz, is indicative of the mechanical consistency resulting from design, manufacture, and assembly.

Low-Bias Ferric Tapes

The eight tapes in this category all had the best responses with bias 3.0 dB or more below the ferric bias reference. Some of the responses at -20 dB did not seem bad, but most were somewhat poorer at 0 dB. At the bottom of each column for the eight tapes are the average values. Note that the MRLs are below zero at all frequencies; measurable compression had taken place by the time these tapes had been driven hard

enough to get to the reference playback level. All S/N ratios are less than 50 dBA, and the average modulation noise is less than 43 dB down. Most of the tapes had typical flutter figures, but the K-Mart and Zayre tapes were 50 percent higher than most. It had been expected that these two tapes would not be particularly great, but more had been expected from some of the others. No tapes in this category can be recommended for true high fidelity recording, though they can prove adequate for other purposes.

Normal-Bias Ferric Tapes

This category includes 34 tapes, more than half the total. Bias requirements ranged from -1.8 to +0.9 dB, with most figures between -1.0 and +0.4. Discrepancies between the bias specifications and the test settings kept appearing, but these differences were small in many cases. The average results for this large group were markedly

BRAND OR MANUFACTURER	DESIGNATION	RESP. @		MRL (dB re 0 dB) AT 4 FREQS.(Hz)				S/N dBA	MOD. 400-Hz				W&F WTD PK %
		0 dB Level	-20 dB Level	HDL ₃ =3%		Sat.	NOISE -dB		SENS. dB	BIAS dB	EQ dB		
				100	400	3k	10k						
Scotch	Highlander	5.7	15.2	-1.8	-2.0	-2.8	-11.8	50.8	47.0	0.0	-1.8	-1	0.075
Scotch	Dynarange	8.1	16.3	+1.4	+1.8	+0.8	-6.9	54.2	48.5	+0.9	+0.3	-1	0.07
Scotch	Master I	7.8	17.0	+6.2	+6.4	+4.7	-7.0	57.4	46.9	+2.7	0.0	-1	0.08
Sony	LN	6.5	16.0	-1.5	+0.6	-1.4	-10.8	52.9	47.5	-0.9	-1.5	-½	0.08
Sony	UHF	6.2	15.7	-1.0	+0.7	-0.3	-11.4	53.6	47.4	+0.1	-0.1	0	0.045
Superscope	HF	5.3	15.4	-1.8	-0.5	-1.4	-12.9	53.0	45.6	-1.4	-1.2	0	0.08
Superscope	SHF	5.9	15.3	-0.6	-0.8	+0.5	-10.0	53.9	47.8	+0.3	-0.5	-½	0.08
TDK	Maverick	6.4	15.9	-1.7	-1.4	-1.0	-11.0	51.4	47.2	+0.2	-1.1	-½	0.08
TDK	D	6.0	15.5	-2.3	-1.6	-1.0	-11.4	51.0	46.3	-0.1	-1.0	-1	0.07
TDK	AD	7.8	17.1	+2.8	+3.7	+1.6	-7.3	55.7	47.9	+0.7	+0.9	-1	0.07
Average values for normal bias ferric tapes:		6.5	16.0	+1.1	+1.6	+0.3	-10.3	53.7	46.3	+0.8	-0.5	-½	0.069
BASF	Professional III	5.2	22.6	+6.2	+6.0	-4.0	-8.0	61.5	44.4	+1.1	+0.9	-1	0.065
Scotch	Master III	6.1	22.2	+5.0	+5.8	-4.5	-7.4	60.0	47.3	+2.2	-0.5	-2	0.065
Sony	FeCr	4.9	23.0	+4.1	+5.5	-4.8	-7.7	60.4	45.9	+0.5	+0.6	-½	0.085
Average values for ferrichrome tapes:		5.4	22.6	+5.1	+5.8	-4.4	-7.7	60.6	45.9	+1.3	+0.3	-1	0.072
BASF	CrO ₂	5.5	17.2	-4.2	-3.8	-4.6	-10.5	53.8	46.3	-2.3	+0.5	0	0.06
BASF	Professional II	5.6	18.8	+4.2	+3.8	+1.2	-8.5	58.1	48.8	+1.0	+1.2	+½	0.08
Capitol	Music	5.8	17.3	-0.4	+0.4	+2.3	-10.0	55.8	47.4	-2.0	0.0	0	0.07
Memorex	CrO ₂	6.6	18.5	+0.8	0.0	-3.0	-8.8	55.8	48.8	-1.6	+0.1	-½	0.062
Realistic	CrO ₂	6.6	19.0	+0.4	+1.1	-1.0	-7.9	56.7	45.2	0.0	-0.7	0	0.10
Royal	CrO ₂	6.5	18.2	+1.1	-0.4	-3.2	-6.5	56.5	48.8	-0.3	-0.2	-1	0.09
Sony	CrO ₂	6.7	18.1	-0.9	+0.5	-3.1	-8.6	55.9	50.3	-1.2	+0.2	0	0.075
Superscope	CrO ₂	6.1	18.7	0.0	-1.0	-4.2	-9.8	54.5	47.2	-0.7	-0.5	0	0.07
Avg. values for CrO ₂ tapes:		6.2	18.2	+0.1	+0.1	-2.0	-8.8	55.9	47.9	-0.9	+0.1	--	0.067
Fuji	FX-II	6.9	18.6	+1.1	+1.9	-1.4	-7.9	57.3	47.7	+2.8	-0.4	0	0.065
Maxell	UDXLII	8.4	19.3	+3.6	+3.3	-0.2	-6.5	57.6	50.7	+2.1	-1.0	-¼	0.07
Nakamichi	SX	7.3	19.1	+0.9	-0.1	-2.0	-8.0	55.0	49.0	+1.0	-0.4	0	0.085
Scotch	Master II	7.0	20.2	+1.6	+3.5	-0.7	-5.0	58.8	46.2	+2.6	-0.2	+½	0.085
TDK	SA	7.9	18.9	+1.6	+2.4	-0.5	-6.5	56.8	49.6	+1.6	+0.1	-1	0.10
Avg. values for high-bias non-CrO ₂ tapes:		7.5	19.2	+1.8	+2.2	-1.0	-6.8	57.1	48.6	+2.0	-0.4	--	0.081

better than those for the low-bias tapes — high fidelity had been reached. It should be noted, however, that those formulations with bias values from -1.8 to -0.7 were generally not the equal of tapes with higher bias requirements. Once again, keep in mind that a lower-bias tape (say -1.5 dB) would have a high-frequency loss (2 dB at 10 kHz) for more normal bias (say -0.5 dB). There are improvements in every single area over the low-bias (-3 dB) tapes, but some formulations in this category are little better. DAK HEC-SL, for example, has MRLs all below 0 dB and a S/N ratio of less than 50 dBA. There are other tapes with all MRLs below zero dB, and all of these have bias values on the minus side.

On the other hand, Ampex 20-20+ and Grand Master, BASF Professional I, Maxell UD and UDXLI, Memorex MRX₃, Realistic Supertape Gold, Nakamichi EXII, Scotch Master I, and TDK AD all deliver very good frequency response, excellent MRLs, very good S/N ratios, and low modulation noise. The average bias for these tapes was +0.1 dB. Review of the table will allow comparing a tape with any other, and with the averages for the category. Do not put too much weight on minor differences in frequency response. The difference in sound between roll-off at 15.5 and 16.5 kHz is

very subtle, and such a difference can be caused by a small change in the bias. More important is the smoothness from 1 to 10 kHz shown in the plots.

Ferrichrome Tapes

This group of just three tapes showed the best performance in response at -20 dB, MRLs at 100 and 400 Hz, and S/N ratio. Modulation noise was very close to that for the ferric tapes. The MRL at 10 kHz was somewhat better than the average of the better ferric tapes. The responses at 0 dB and the MRLs at 3 kHz were not quite as good, however, and the cause is unclear.

CrO₂ Tapes

The eight tapes in this group showed response limitations similar to the FeCr cassettes at 0 dB, but the rolloff was at a higher frequency. At -20 dB, the high-end limit averaged 18.2 kHz, better than any of the ferrics, although not equal to any of the FeCr tapes. The high-end -3-dB point could have been shifted out very easily with a reduction in bias, but with an increase in a broad peak around 10 kHz, putting it above the +1.5 dB test limit. The S/N ratios were very good, although not up to those of the FeCr cassettes. The average modulation noise was lower than the ferric or FeCr tape averages. With the exception of

BASF Professional II and Realistic CrO₂, the test bias range was +0.5 dB, a small change in requirements from one tape to the other.

High-Bias Non-CrO₂ Tapes

The five tapes in this group had performance that, on the average, was superior in each area compared to the CrO₂ samples. There was some variation within each group, however, and any prospective choice should be compared to the other 12 tapes in the two categories, to say nothing about the FeCr formulations or one of the better ferrics. The flutter was very slightly higher than in any of the other categories.

Low-Bias Ferric Tapes

DAK HE: Generally smooth responses, but limited in extent. Compression across frequency range at zero dB level with roll-off of lows. Continual, rapid variations in sensitivity of 0.5 dB. Skew consistent within 1.5 dB at 10 kHz for C-90s. Skew and bias of C-60s consistent with C-90s. Many medium drop-outs. Sonic-weld cassette, a bit rough.

K-Mart: Generally smooth responses, but limited in extent. Compression across frequency range at 0 dB level. Continual, rapid variations in sensitivity of 0.5 dB or so. Consistent skew and bias. Three medium and nine minor

Low-Bias Ferric Tapes

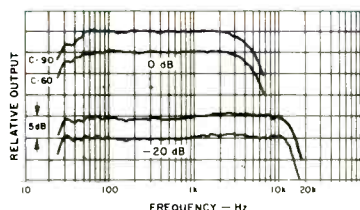

DAK HE

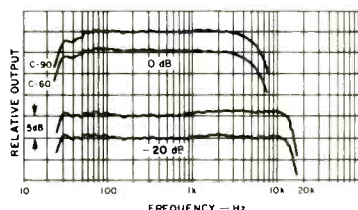

Lafayette Criterion

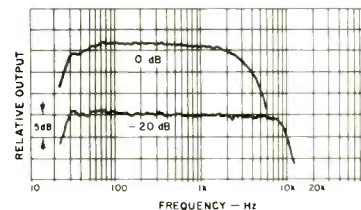

Royal Low Noise (APC), C-90 Only

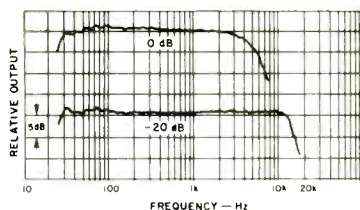

K-Mart, C-60 Only

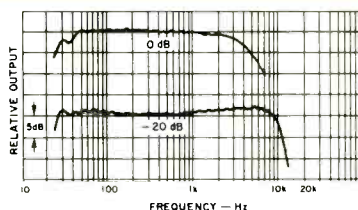

Realistic Concertape, C-60 Only

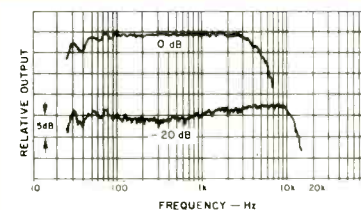

Zayre ProRange, C-60 Only

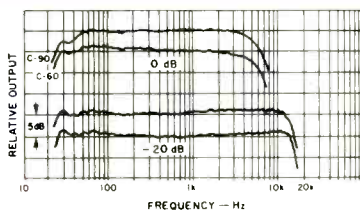

Lafayette LN

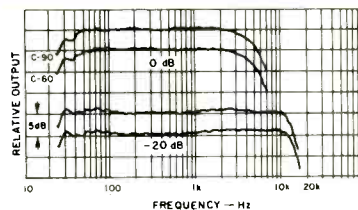

Realistic Low Noise



You know us best for our reputation in audio. In fact, it's audiophiles like you who have made TDK SA the best-selling High bias cassette in America today. But here's something you may not know: the same Super Avilyn engineering principle that revolutionized audio cassettes is in TDK's equally revolutionary new Super Avilyn video cassettes.

No wonder that TDK Super Avilyn is the first 4-hour capability video cassette to be quality approved by the people who know: video cassette recorder engineers. And even less wonder that Super Avilyn makes possible an image so stunning, you will feel as though you are sitting in the broadcast studio.

What's more, TDK's strict quality control works to give you low wear on delicate video heads, virtually non-existent oxide shedding, and no problems with tape stretching, even with repeated playback.

That's because TDK Super Avilyn video cassettes are an actual component of the system, not just an accessory. Our tape is housed in a precision, jam-resistant mechanism, for years of consistent high quality video reproduction. And TDK Super Avilyn VHS video cassettes are compatible with all VHS machines, both those with short-play (2-hour) capability and those with short and long-play (4-hour) options.

TDK Super Avilyn VHS video cassettes: model VA-T60, for one and two-hour recording; model VA-T120, for two and four hour recording. If you like things to look as good as you like them to sound, take a look.

TDK Electronics Corp., Garden City, NY 11530. In Canada: Superior Electronics Ind., Ltd.

 **TDK**[®]
The Machine for your Machine.[®]

Enter No. 70 on Reader Service Card

**What TDK
did for your ears,
it now does
for your eyes.**

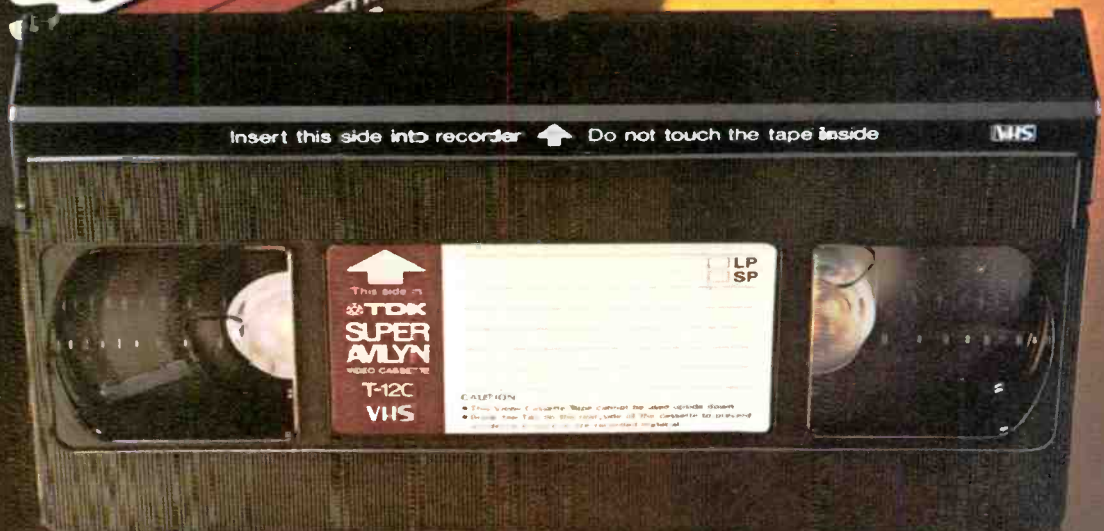
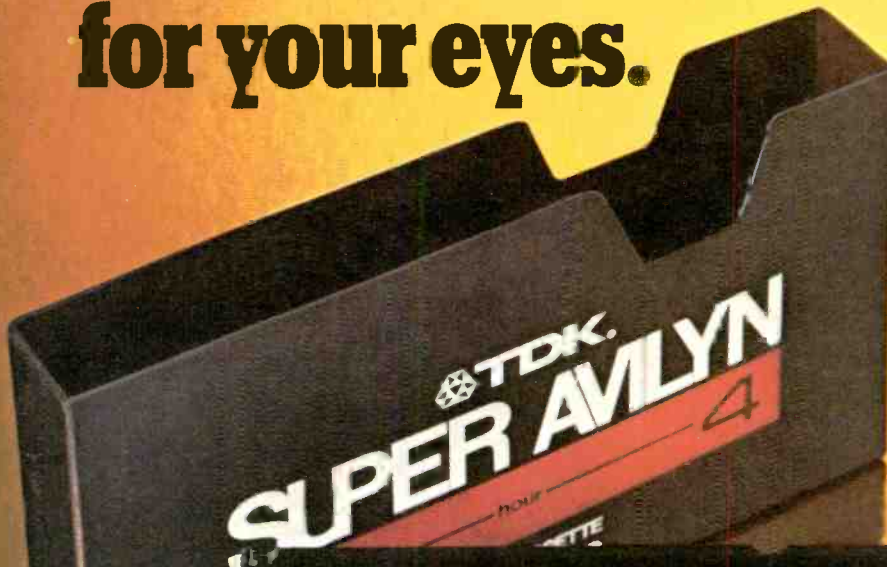

dropouts. Sonic-weld cassette, a bit rough, one of which jammed. Plastic bag. *Lafayette LN*: Generally smooth response, but limited in extent, particularly at 0 dB where compression occurred. Continual variations in sensitivity of 0.5 dB or more. Spread in sensitivity of 2 dB from cassette to cassette. Consistent skew and bias within C-90s. Bias 2.4 dB higher (-0.9 dB) for C-60s. Skew change caused 1.5 dB drop at 10 kHz re C-90s. One C-60 jammed. Five medium drop-outs. Sonic-weld cassette. Soft plastic box.

Lafayette Criterion: Generally smooth response. Overall the best performer in this category. Sensitivity spread of 1 dB. Consistent bias, but one C-90 had change in skew causing 3.5 dB drop at 10 kHz (on the three-head test deck). The C-60s had skew resulting in more than 10 dB drop with C-90 setting. C-60s showed compression at 0 dB. Nine major drop-outs.

Realistic Concertape: Limited frequency response. Compression at 0 dB. Continual, small variations in sensitivity. Consistent bias and skew. Eleven minor drop-outs. Sonic-weld cassette. Plastic bag.

Realistic LN: Limited frequency response. Compression at 0 dB. Amplitude variations generally less than 1/4 dB. One C-90 much different in skew. Skew effects for C-60s showed 3 dB spread at 10 kHz. Three medium and nine minor drop-outs. Sonic-weld cassette.

Royal APC/LN: Very limited frequency response. Heavy compression at 0 dB. Continual, rapid sensitivity variations up to 1 dB. Many major drop-outs. Excessive drag tripped end-of-tape sensor, preventing some tests. Sonic-weld cassette.

Zayre Pro Range: Mediocre response with continual, rapid sensitivity variations up to 1 dB and heavy compression at 0 dB. Sensitivity variations prevented get-

ting data on bias and skew consistency. Seven minor drop-outs. Sonic-weld cassette. Plastic bag.

Normal-Bias Ferric Tapes

Ampex Plus: Good frequency responses, average for this category. One sample showed periodic sensitivity variations of 0.5 dB. Consistent bias and skew for C-90s, and for C-60s, but C-60s 0.7 dB less bias (-0.6 dB) and had different skew. Six minor drop-outs.

Ampex 20-20+: Good, smooth frequency response. Periodic sensitivity variations of 0.3 dB. Bias requirements consistent for both lengths. C-60s skewed slightly relative to C-90s. Four very minor drop-outs.

Ampex Grand Master: Very good, smooth frequency response with excellent headroom across the band. Excellent consistency in sensitivity, skew and bias requirements for all samples of both

Normal-Bias Ferric Tapes

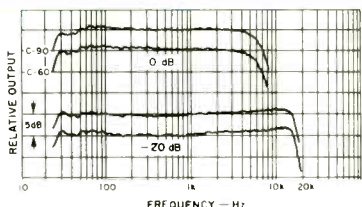

Ampex Plus

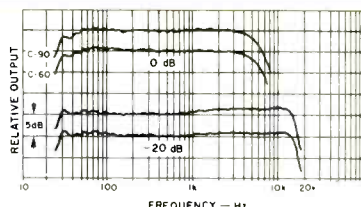

BASF Performance

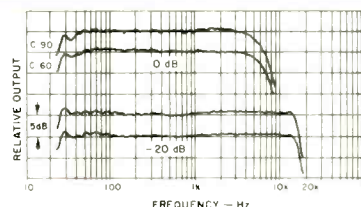

Capitol Music

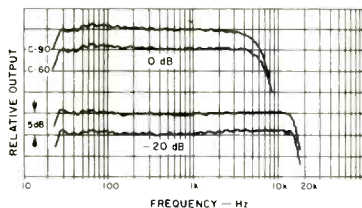

Ampex 20-20+

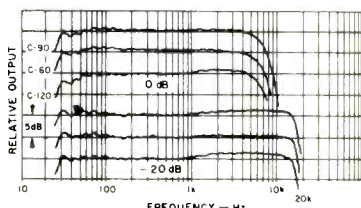

BASF Studio

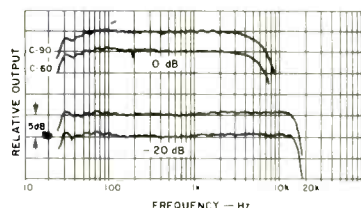

Certron HE

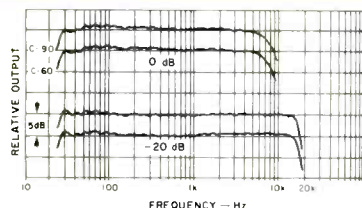

Ampex Grand Master

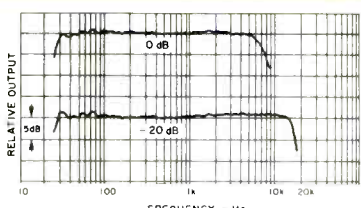

BASF Professional I, C-90 Only

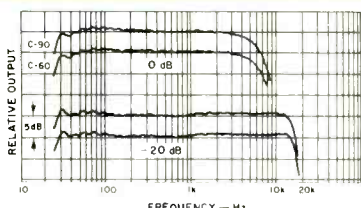

Columbia Low-Noise

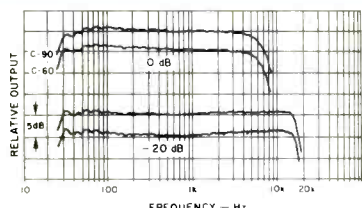

AudioMagnetics High Performance

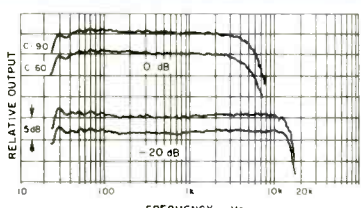

Capitol I

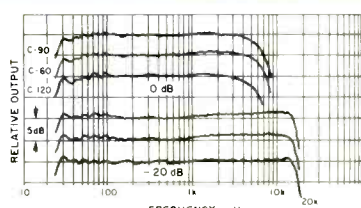

Comsette Low-Noise

lengths. Two medium drop-outs. One of the best ferric tapes.

AudioMagnetics High Performance: Above average frequency responses with good headroom across the band. Sensitivity spread over 1.5 dB plus continual small variations. Skew quite consistent from cassette to cassette, but varied some with time. Ten minor drop-outs.

BASF Performance: About average frequency responses with lower than average headroom across the band. Sensitivity spread 1.2 dB with very minor variations with time. Skew very consistent for all samples. C-60s required 0.3 dB more bias (to -1.3 dB). One medium drop-out.

BASF Studio: Frequency responses, headroom, etc. generally average for this category. Excellent consistency in bias and skew for all samples and all three lengths. Sensitivity consistent for all C-90s and C-60s, but 2.6 dB lower

for C-120s. One major drop-out.

BASF Professional I: Very smooth frequency responses, although not particularly extended at -20 dB. Excellent headroom and S/N ratio. Sensitivity spread 1.6 dB, with very little variation with time. Bias requirement consistent, although shift in skew with one sample was evidenced with 1.5 dB drop at 10 kHz. One medium drop-out.

Capitol 1: Frequency responses generally smooth, but below average, as was the MRL at most points. Sensitivity, bias, and skew were consistent most of the time and for most samples, but a slow amplitude "breathing" in the higher frequencies made assessment difficult. C-60s required 1.8 dB lower bias (to -2.7 dB). One major drop-out. Sonic-welded. Cardboard box.

Capitol Music: Smooth frequency responses, but below average, as was the MRL at most points. Consistent sensitivity, bias, and skew among C-90s

and among C-60s, but C-60s were 1-dB more sensitive, required 0.4dB less bias (-1.0 dB) and showed 2-dB droop before correcting the record head. Three very minor drop-outs.

Certron HE: Average frequency responses. Below average for MRLs and other entries in table. Generally consistent sensitivity, skew, and bias requirements. Periodic small sensitivity variations. Five minor drop-outs.

Columbia Low Noise: Below average in frequency response and other respects. Sensitivity spread of 1.6 dB with minor variations with time. Skew inconsistency, with some samples down 6 dB at 10 kHz compared to most. C-60s required 0.9 dB less bias (-2.0 dB). Five very minor drop-outs. Sonic-welded.

Comsette Low Noise: This formulation provides average performance in all respects, with the exception of higher modulation noise, for a lower-than-average price. Variations in sensitivity of up

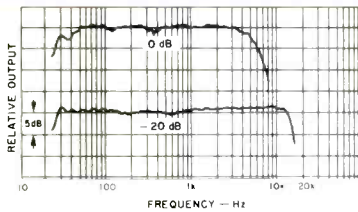

DAK HEC-SL, C-90 Only

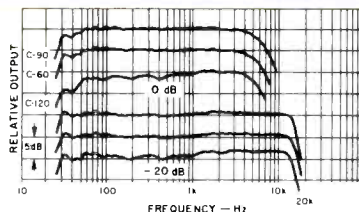

Maxell LN

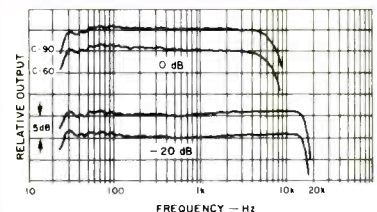

Nakamichi EX

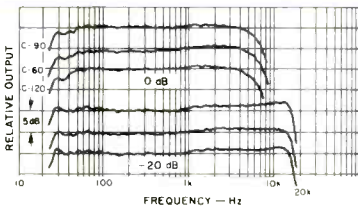

Fuji FL

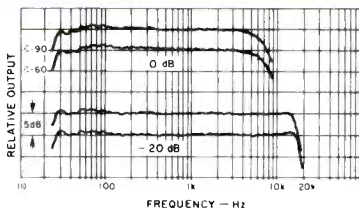

Maxell UD

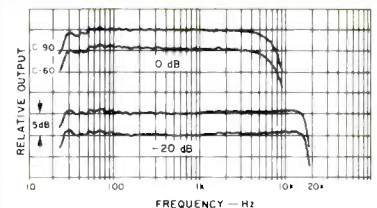

Nakamichi EX-II

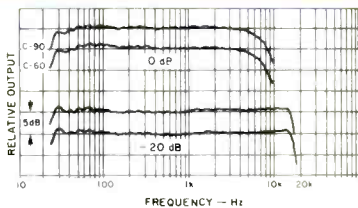

Fuji FX-I

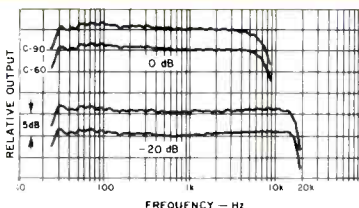

Maxell UD-XL I

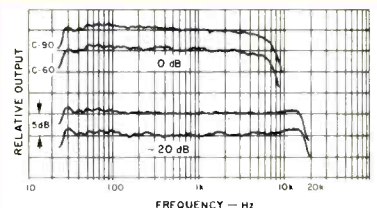

Realistic Supertape Gold

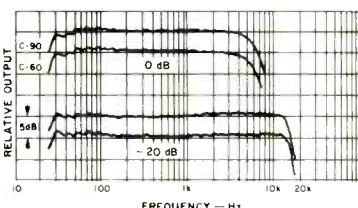

Lafayette XHE

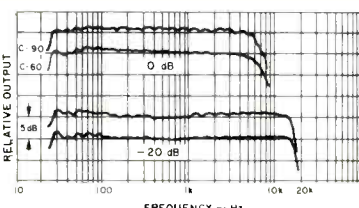

Memorex MRX₃

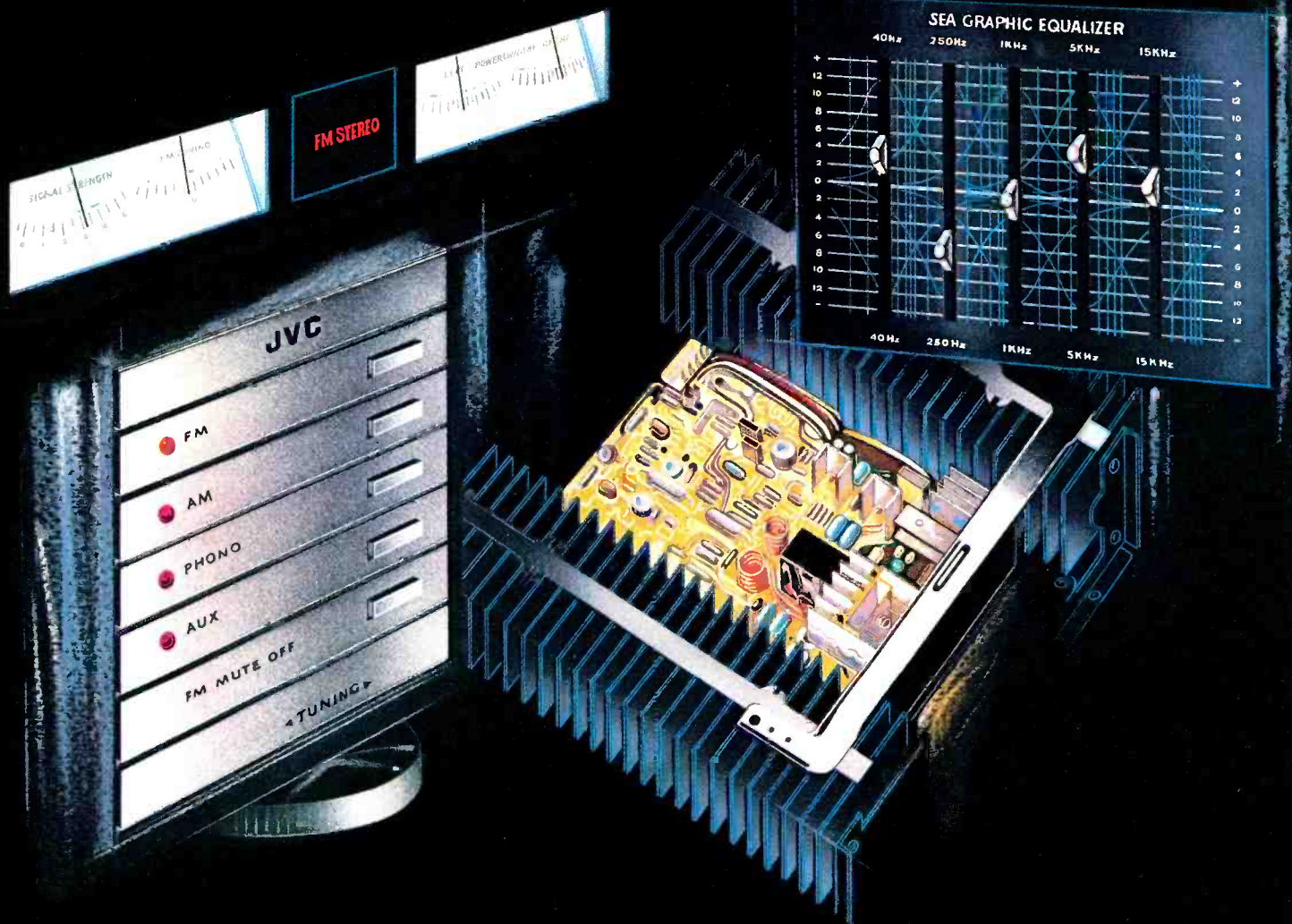

THE JVC RECEIVER.

Every bit as revolutionary as they look, and then some.

In our case, looks are never deceiving. Because all our new DC integrated stereo receivers combine unprecedentedly revolutionary styling with electronic design features that reflect JVC's more than 50 years' experience in audio development and innovation.

DC POWER AMPLIFIER DESIGN

Usually found only in costlier separates, JVC offers DC amplifier circuitry in *all* four of our new receivers. By eliminating distortion-causing capacitors in our interconnecting circuit sections, JVC designers have created an amplifier that offers virtually distortion-free performance (0.03% THD) not only over the entire audio spectrum, but above and below it. As a result, all the sounds you hear are clearer, cleaner and crisper. Moreover, our DC design improves square wave performance and eliminates phase-shift—both factors being of paramount importance in distortion-free music reproduction. In addition, Triple Power Protection circuits and dual power meters give you safety and full indication of receiver operation. There are four new JVC DC integrated receivers, offering your choice of 120, 85, 60 and 35 watts/channel* respectively.

S.E.A.—ALL THE WAY

JVC was the first receiver manufacturer to offer a built-in S.E.A. Graphic Equalizer in a quality receiver, and we continue this tradition by incorporating this convenient feature in our entire new receiver line. Far superior to even triple tone controls, this JVC exclusive gives you complete control over the entire musical spectrum. You can attenuate or accentuate any of five separate bands, covering the entire audible range of music. And as an added feature, we've incorporated a special button

so that the S.E.A. equalizer circuit can also be switched to your tape deck, so you record exactly what you hear.

PUSHBUTTON SOURCE SELECTORS

Unlike conventional receivers, ours incorporate an advanced pushbutton source selection panel. Color-keyed LEDs indicate the program source, and a full-function horizontal pushbutton panel provides total control over all receiver operations. Professional-type slider controls set volume and balance.

SUPERIOR TUNER SECTION

High sensitivity and tuning precision are featured in all four new JVC receivers. Multi-gang FM tuning capacitors, PLL MPX demodulators and other circuit refinements provide optimum frequency response and stereo separation for FM, with maximum sensitivity for AM reception—a feature often neglected in receiver designs. A thumb-control tuning wheel and accurate metering make station location and fine-tuning easy.

Other features include Mode/Loudness/Subsonic Filter switches and provision for connecting two sets of speakers.

Features, styling, innovation and performance: the four main things to look for in a DC integrated stereo receiver. And you'll find them all in a JVC. JVC America Company, Division of US JVC Corp., Maspeth, N.Y. 11378. In Canada, JVC Electronics of Canada, Ltd., Ont.

JVC

We build in what the others
leave out.

JR-S501 (featured at left). Below: JR-S401 (top), JR-S201 (bottom left) & JR-S301 (bottom right)



@ 8 Ohms, both channels driven from 20Hz-20 KHz, with no more than 0.03% THD.

Enter No. 12 on Reader Service Card

to 2.5 dB at a 2 Hz rate appeared at one point. Some samples had noticeably different skew than others. Bias requirements for C-120s matched the C-90s, but the C-60s required 0.7 dB more (-0.3 dB). Seven minor drop-outs. Sonic-welded.

DAK HEC-SL: Low-priced, direct-mail-order cassette was one of the poorest performers in this category, as examination of the table entries will show. Sensitivity was fairly consistent from cassette to cassette, but varied with time. Relative skew reached 1.5 dB at 10 kHz. Six minor drop-outs.

Fuji FL: Frequency responses and other characteristics were average. Sensitivity was very consistent and did not vary with time. Too few samples were received to check C-60 and C-120 consistency. Four very minor drop-outs.

Fuji FX-I: Frequency responses and other results were, in general, above average. This cassette tape was outstanding in its consistency of sensitivity,

skew, and bias requirements for all samples of both lengths. There were minor wiggles in amplitude in the plotting, but there were zero drop-outs.

Lafayette XHE: Average performances were obtained with this tape. Sensitivity, skew, and bias requirements were consistent among all samples of both lengths, with the exception of minor sensitivity differences. Variations with time were very small, and there were six minor drop-outs.

Maxell LN: Frequency responses and other results with this tape were average. Skew was consistent among all of the samples, and bias and sensitivity were consistent for each length. C-60s required 0.9 dB more bias (+0.1 dB) and had the same sensitivity as the C-90s. C-120s required 0.3 dB more bias (-0.5 dB) and were 1.4 dB less sensitive than C-90s. Sensitivity variations with time were very small except for the C-120s, which had a slow, periodic shifting. Two medium drop-outs.

Maxell UD: Very smooth, above average frequency responses with other areas of high performance to match. Excellent consistency of sensitivity, skew, and bias requirements among all samples of both lengths. Small sensitivity variations with 3-second period. Zero drop-outs. Lowest flutter of all tapes.

Maxell UDXLI: Generally smooth, above average frequency responses, but showing periodic sensitivity variations, of perhaps 0.5 dB. A high-performance tape in other areas, listed in the table, and with one exception, all samples consistent in sensitivity, skew, and bias requirements. Zero drop-outs.

Memorex MRX3: This tape formulation can provide performance that is above average in all areas. Bias and skew consistency could not be pinpointed as frequent, random level variations with most samples prevented ascertaining the best settings of the bias pot and the record head. With the best C-90 sample, used for the plotting, there were 1-dB varia-

Normal-Bias Ferric Tapes—continued

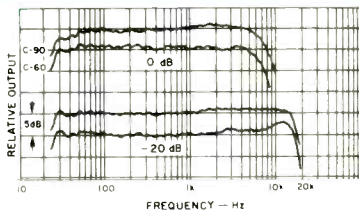

Royal Ultra-Linear

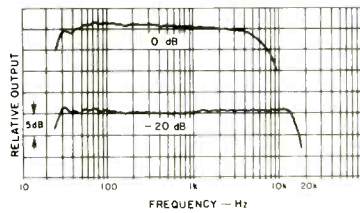

Sony LN, C-60 Only

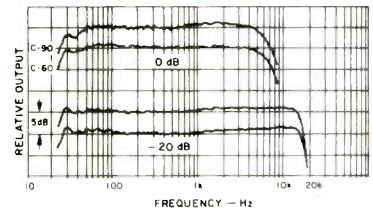

TDK Maverick

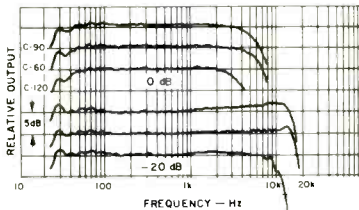

Scotch Highlander

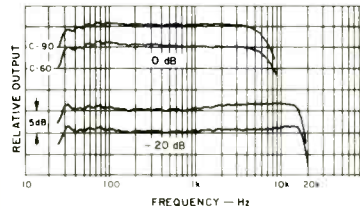

Sony UHF

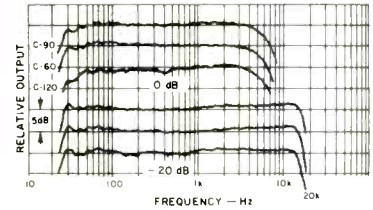

TDK D

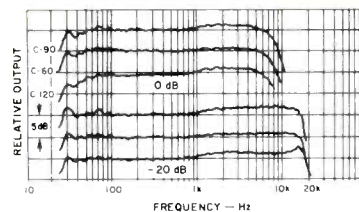

Scotch Dynarange

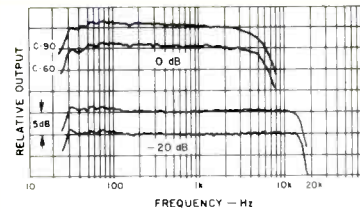

Superscope HF

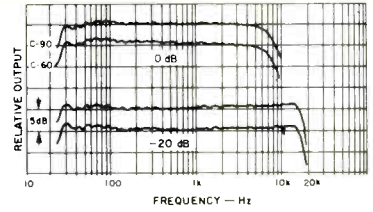

TDK AD

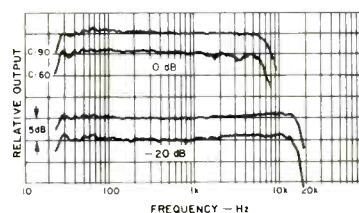

Scotch Master I

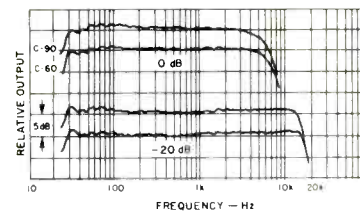

Superscope SHF

FerriChrome Tapes

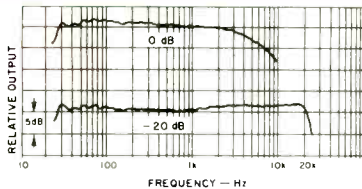

BASF Professional III, C-90 Only

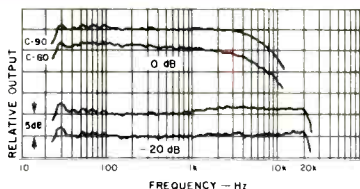

Scotch Master III

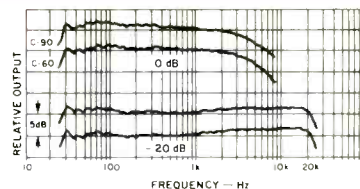

Sony FeCr

tions about every two seconds. Four minor drop-outs. Sonic-welded. Memorex box.

Nakamichi EX: The results were above average and quite similar to Maxell UD. Sensitivity, skew, and bias requirements were consistent among all samples. Amplitude variations were very small, and there were zero dropouts.

Nakamichi EXII: The response plots are above average, similar to Maxell UDXLI, but smoother. Outstanding consistency in sensitivity, skew, and bias requirements. Two medium and four minor drop-outs.

Realistic Supertape Gold: This tape, recently introduced by Radio Shack, had the widest frequency response at -20 dB for the ferrics. It was also one of the best in other areas, particularly MRL and S/N ratio. Sensitivity, skew, and bias requirements were very consistent for all samples of both lengths. There were some

long-period variations in sensitivity of 0.8 dB. There were four medium and 7 minor drop-outs.

Royal Ultra Linear: This formulation had frequency responses and other characteristics that were average, in general. Skew was fairly close among all samples. C-60s were 2 dB more sensitive than C-90s with 1.5 dB less bias (-1.4 dB). Sensitivity variations occurred at times with a shift in level up to 2 dB. Drop-outs were minor.

Scotch Highlander: The frequency responses were below the group average, and the MRLs and the S/N ratios were low. Amplitude "breathing" at the higher frequencies prevented getting valid data on consistency. It appeared that the C-60s were quite close to the C-90s, but the C-120s required 1.6 dB less bias (-3.4 dB) and the sensitivity was 1 dB lower. Six minor drop-outs. Sonic-welded. Slide-in plastic box.

Scotch Dynarange: This tape delivers above average performance in every area, with the best response at 0 dB in this category. The MRLs were very good, with that at 10 kHz the best of all ferrics. Consistency was excellent among all samples and all three lengths. C-120s were exceptions in that they needed 0.5 dB less bias (-0.2 dB) and were 2 dB less sensitive. A few very minor drop-outs. Sonic-welded.

Scotch Master I: One of the best of the ferrics with smooth, wide frequency responses, high MRLs, and S/N ratios. C-90s consistent in all respects, but C-60s exhibited random and cyclic sensitivity variations which made adjustment difficult and interfered with the plotting. Fourteen minor drop-outs.

Sony LN: Average frequency responses, and close to average in other areas. Some variations in sensitivity, skew, and bias needs. Occasional 0.3 dB varia-

Continued on page 100

CrO₂ Tapes

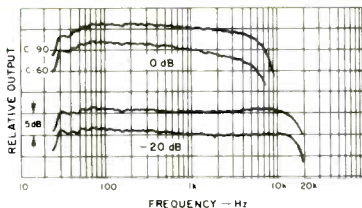

BASF CrO₂

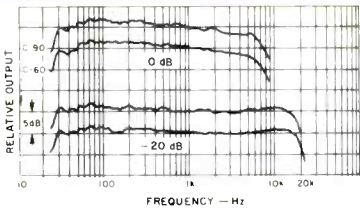

Memorex CrO₂

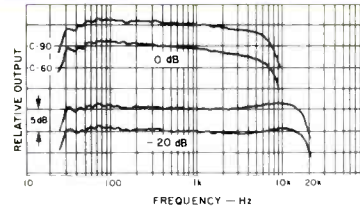

Sony CrO₂

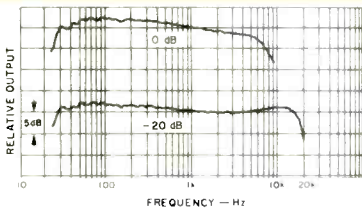

BASF Professional II, C-90 Only

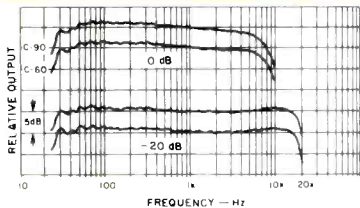

Realistic CrO₂

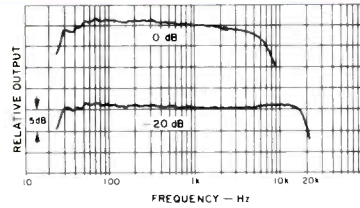

Superscope CrO₂, C-90 Only

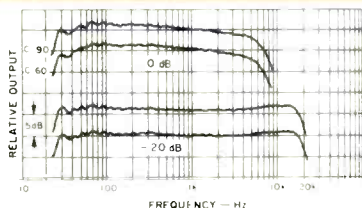

Capitol CrO₂

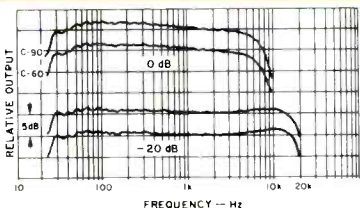

Royal CrO₂



K. S. Gilbert



PERFORMANCE OF HIGH ENERGY MAGNETIC MATERIALS IN AUDIO CASSETTE RECORDING TAPES

Peter Vogelgesang*

The magnetic material which has been used almost exclusively in sound recording tapes for many years is the gamma form of iron oxide, or gamma Fe_2O_3 . This material is a favorite because it is inexpensive, stable, and easily processed for tape manufacturing. Because early tape recording systems were limited in performance by electronic noise, mechanical instabilities, crude magnetic transducers, and by poor physical properties of magnetic tape, little attention was given to improving tapes by employing magnetic materials which had superior magnetic properties.

Today, solid-state electronic amplifiers produce only a small part of total system noise. Precision magnetic transducers can be manufactured of exotic ferrite materials or metallic alloys and have magnetic gaps controlled precisely to a few millionths of an inch. Magnetic tapes are slit to a width accuracy of one-thousandth of an inch, and tape surfaces have a mirror-like smoothness. Capstans, tape guides, and drive motors have been improved commensurately to utilize the improved physical properties of tape. And, a totally new improvement has been added; a preponderance of all magnetic tape manufactured today is enclosed in plastic cartridges or cassettes which protect it from both handling abuse and environmental contaminants.

As a consequence of these gradual improvements, the magnetic recording industry has seen a continued slowing of tape speed over the years. Full range audio recording once required a tape speed of 60 ips, but is now accomplished at the $1\frac{7}{8}$ ips speed of the audio cassette. Limited bandwidth waveforms such as voice and background music are easily recorded at a speed of less than one inch per second.

With so many refinements occurring in related areas of magnetic recording, it was inevitable that improvement in the properties of the magnetic material used in tape would one day be required. Work directed toward this end was underway seriously in industrial laboratories in the early 60s.

* Manager, Advanced Recording Technology
Magnetic Audio/Video Products Division
3M Company, St. Paul, Minn.

AUDIO • September 1978

Today, consumers of audio cassettes have a choice of tapes using materials such as chromium dioxide (CrO_2), cobalt-modified iron oxide, and tapes made with multiple layers of these and other materials in combination. Manufacturers of cassette recorders have equipped their machines with multi-position switches to accommodate the new tapes by changing recording bias level and equalization.

The unique magnetic properties of chromium dioxide and cobalt-modified iron oxide used in these tapes are described by the generic term, "high energy." It is the purpose of this article to describe high energy materials and to show why and how they are used.



Fig. 1—An electron photomicrograph of a typical iron oxide magnetic material was made with a magnification of 45,000. The average length of these particles is about 0.4 microns, and the ratio of length to width is six to one.

Technical Background

Iron oxide magnetic material contained in recording tape consists of tiny, needle shaped or acicular particles which have an average length of 0.4 micron (16 millionths of an inch) See Fig. 1. These particles are mixed as a fine powder with a fluid binder, and the ingredients are milled using a process similar to the manufacturing of paint. The milled material, called a dispersion, is coated onto the surface of polyester film and then oven dried to make recording tape.

Each magnetic particle is an independent miniature permanent magnet. However, it behaves magnetically unlike a large magnetizable bar of iron with which we are all familiar. Because of the small size of the particles, each particle contains only a single magnetic domain. This domain cannot be demagnetized nor can it be made magnetically stronger or weaker. It is forever a permanent magnet of fixed strength, and the only magnetic change it will undergo is a polarity reversal of the magnetic field it produces. Fig. 2 shows how a single particle changes polarity and magnetization when immersed in a magnetic field which is reversing in a sinusoidal manner. A particle will behave in this manner when the direction of the applied field is parallel with the long axis of the particle. A very different characteristic is observed when the field is at right angles to the long axis. In magnetic tape, particles are aligned so that the long axis is parallel with the direction of the recorded tracks. Such orientation is achieved by immersing the coated tape in a strong magnetic

field before the coating is dried, and while the particles are still mobile.

The time required for a single domain particle to reverse polarity, or switch, probably has never been measured (1) and may be considered instantaneous in any practical application of magnetic recording. In numerous laboratory investigations and computer simulations of the recording process, particle switching time has never surfaced as a limitation to the highest frequencies that can be recorded. Thus, designers of recording systems have built video recorders which record frequencies in the tens of megahertz without having to take into account a finite-response time of the magnetic tape.

Due to differences in size, shape, and chemical composition, particles within a bulk quantity of material will have a distribution of magnetic responses. In other words, although each particle within a batch switches at one critical intensity of applied field, the critical intensities of all particles are distributed in a manner which produces a familiar bell-shaped curve. Under the influence of a controlled applied field, a portion of the particles can be switched to one polarity, while the remaining particles stay in the original condition. Because the magnetic field produced by a bulk quantity of particles is the sum of all individual particle fields, the bulk quantity can be weakly or strongly magnetized, or it can be completely demagnetized. This effect is explained with the help of the magnetization curve of Fig. 3.

Coercivity of individual particles is largely responsible for coercivity of the bulk material. However, the density with which particles are packed together also influences the coercivity of a specific quantity of material (2). Coercivity of bulk material is reduced as packing density increases. Saturated remanent magnetization of bulk material also is dependent not only upon remanent magnetization of the particles, but on how closely particles are packed. Since the magnetic field produced by a quantity of material is the sum of the fields produced by individual particles, a greater number of particles in a given volume will produce greater remanent magnetization. Thus, remanent magnetization increases as packing density increases.

This fact has led to the necessity of distinguishing between the intrinsic remanent magnetization of particles and the magnetization of bulk quantities of particles. Intrinsic remanent magnetization essentially defines the remanence of isolated magnetic particles, and is determined by the chemical and physical makeup of the material. Remanent magnetization of a bulk quantity of material is dependent on this intrinsic property, but also upon how densely the particles are packed together. Remanence of a magnetic tape, then, is a function of 1) intrinsic remanence of the magnetic material, 2) density with which the material is packed, and 3) how thickly the material is coated on the tape.

Packing density in magnetic tape is limited by the percentage of polymer binder which must be used to hold particles together in a tough film. Attempts to increase magnetic material content beyond this point result in chalky coatings which will not withstand mechanical abrasion in recording machines. The "energy product" of a magnetic material is obtained by multiplying the values of M and H for a given point on the second quadrant of the major hysteresis curve. For the purpose of defining the performance of a particulate magnetic material used in recording tape, the "energy" of the material can be defined as the area enclosed by the second quadrant. Thus, energy can be increased by increasing either coercivity or remanent magnetization, and remanent magnetization, in turn, can be increased either by changing the intrinsic remanent magnetization of the particle or by increasing packing density of particles. For reasons which are the subject of the remainder of this article, increased remanent magnetization by either means should be accompanied by a corresponding increase in coercivity in order to obtain a maximum possible signal output of tapes used in audio cassette recording or any other kind of very short wavelength recording. The so-called "high energy" magnetic tapes avail-



TRUSONIC

1122 WEST WASHINGTON BOULEVARD, MONTEBELLO, CA 90640

ONLY

ANATOMY OF THE 40 OZ. MAGNET, CHROMED CAST BASKET, 1 1/2" VOICE COIL, 120 WATT, 3-WAY CAR SPEAKER...

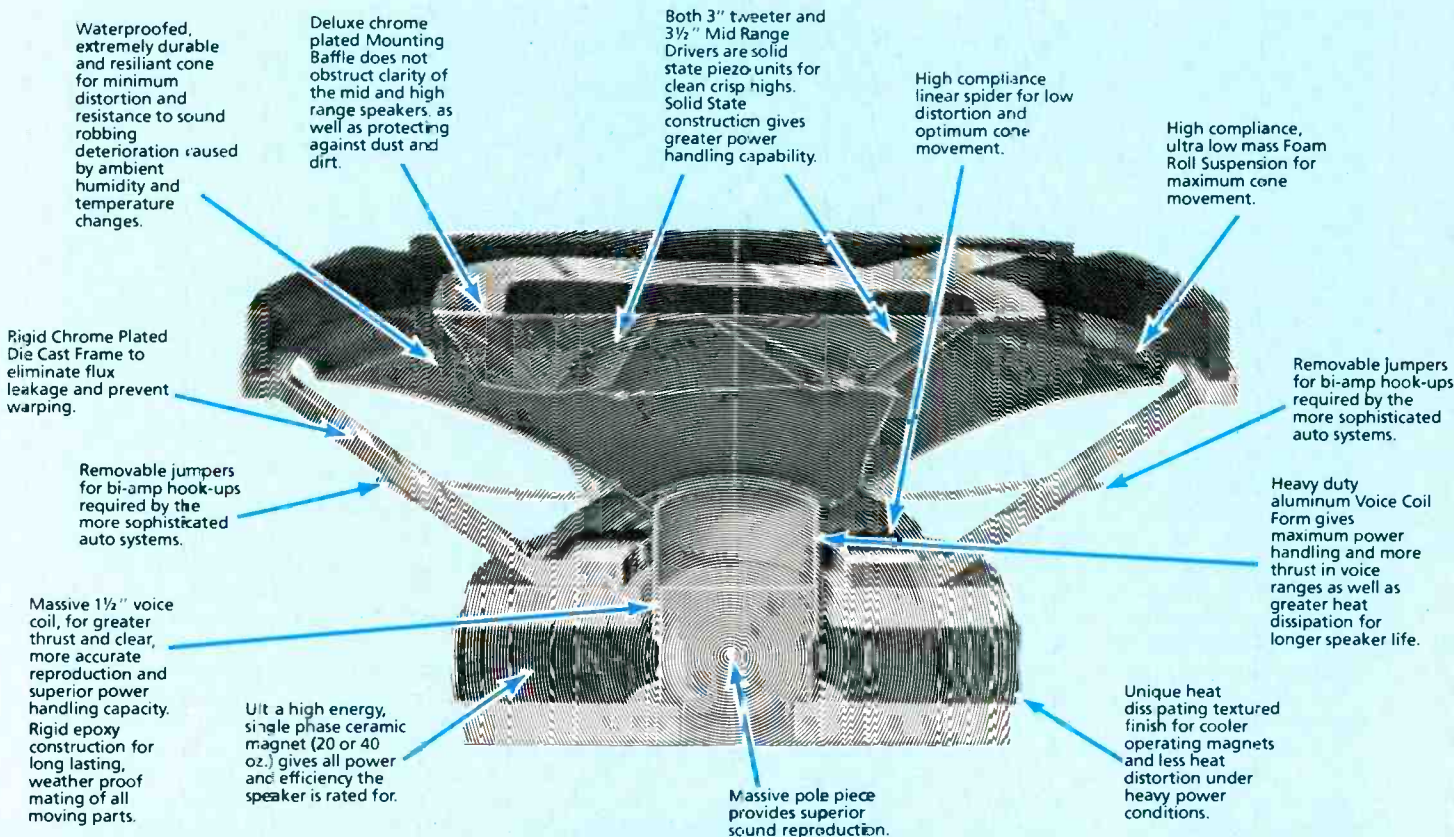

COMPARISON CHART — TRUSONIC VS. COMPETITION

FEATURE	TRUSONIC	WELL KNOWN COMPETITOR	BENEFIT	FEATURE	TRUSONIC	WELL KNOWN COMPETITOR	BENEFIT
Die Cast Frame	Yes	No	Cannot warp or bend due to heat or vibration.	Power *20 oz.	*40 RMS 83 Peak	*30 RMS 60 Peak not made	Heavy magnet structure materials coupled with an over hung voice coil increases linearity at high power levels and enhances the bass frequency reproduction thus minimizing distortion
Chrome Plate	Yes	No	Chrome plating in conjunction with die cast construction prevents rust.	40 oz.	60 RMS 120 Peak		
Bi-Amp Capability	Yes	No	Permits hook up to the newer, more powerful dual output automotive systems being introduced.	Response:			The selection of totally solid state mid-range and tweeter elements produces superior sound in the 2,000 Hz range and beyond. Superior magnets and 50% larger voice coils provide greater low end performance.
Waterproof	Yes	No	Completely waterproof design is necessary for marine and outdoor use	20 oz. 5" x 7" ccax 20 oz. 6" x 9" 3-way 40 oz. 6" x 9" 3-way	40/25,000 Hz 30/25,000 Hz 25/25,000 Hz	50/15,000 Hz 40/20,000 Hz not made	
Voice Coil	1 1/2"	1"	50% larger voice coil handles greater power and reduces distortion.	Warranty	5 Years	1 Year	Superior construction and design insures years of flawless performance without material or sound deterioration.
Unitized Magnet	Yes	No	Offers 1.6 times more energy than stacked magnets. This permits higher efficiency.	Price*	*\$60.00	*\$55.95	

ALL TRUSONIC CAR STEREO, MUSICAL INSTRUMENT, AND HI-FI SPEAKERS, ARE MANUFACTURED IN U.S.A.

Enter No. 67 on Reader Service Card

able today in audio cassettes contain magnetic materials which have higher coercivity than gamma Fe_2O_3 . The term "high energy" is a relative expression which uses iron oxide as the conventional standard.

The Effects of Demagnetization

The magnitude of a long wavelength electrical signal generated in a magnetic transducer during playback of a recorded tape is proportional to the remanent magnetization of the tape. A tape having twice the remanent magnetization of another will produce twice the electrical output. High transducer output is desired in order to obtain a high signal-to-noise ratio in the recording system.

As pointed out previously, remanent magnetization can be increased by 1) increasing the intrinsic remanent magnetization of the particles, 2) increasing the density of the magnetic material by packing more particles into a given volume, and 3) coating the magnetic material more thickly on the tape. At 1 7/8 ips tape speed, none of these approaches to increasing remanent magnetization will produce a corresponding increase of high frequency output. A thicker coating will not increase high frequen-

cy output because short wavelengths are recorded only near the surface of a magnetic tape, and the thicker coating will create only an imbalance in the low and high frequency response of the recording system. The other two approaches to increasing remanent magnetization will not greatly improve high frequency output because of an effect known as "self-demagnetization."

Self-demagnetization in magnetic tape recording causes a loss of high frequency or short wavelength information at peak sound levels where the tape approaches magnetic saturation. Although a magnetic recording system may have an ideally flat frequency response at 20 dB below the maximum operating level (MOL) of the tape, the high frequency end of the audible spectrum becomes suppressed as the MOL is approached. Finally a point is reached where no amount of recording level increase will boost high frequency output, even though low frequencies retain a substantial headroom. Figure 4A shows that a cassette tape constructed with magnetic material having a coercivity of 340 oersteds is only 4 dB down at 19 kHz when the recording level is 20 dB below the MOL. At 0-dB recording level the output is 12 dB down at 10 kHz and is virtually non-existent at 19 kHz.

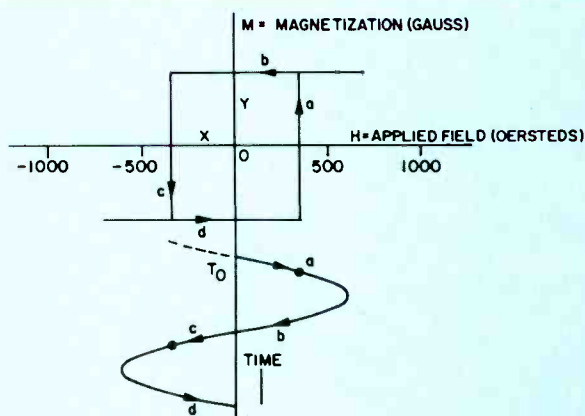

Fig. 2—The switching characteristics of a single-domain particle. The "X" axis represents the polarity and magnitude of a magnetic field, measured in oersteds, applied to a magnetic particle so that the direction of the field is parallel with the long axis of the particle. The sinusoidal waveform shows how the field changes with time. The "Y" axis represents the magnetization (M) of a single domain particle measured in gauss.

Starting at T_0 , the applied field increases in a positive direction, passing through point A, which is equal to the coercivity (H_c) of the single particle, or about 340 oersteds for gamma Fe_2O_3 . At this point, the applied field acts upon the particle to reverse its field virtually instantaneously. The new magnetization of the particle is exactly equal to the previous value, but polarity is reversed, producing a symmetrical figure.

The sinusoidal applied field returns to zero, but the particle remains magnetized in the positive direction. Not until the applied field reaches point C does the particle again switch to its original state. The pattern formed by these two variables is an ideal rectangle having sharp corners due to the instantaneous switching of the particle. This kind of figure is obtained with a single domain particle and will be considerably modified when particles having a wide distribution of coercivities are combined.

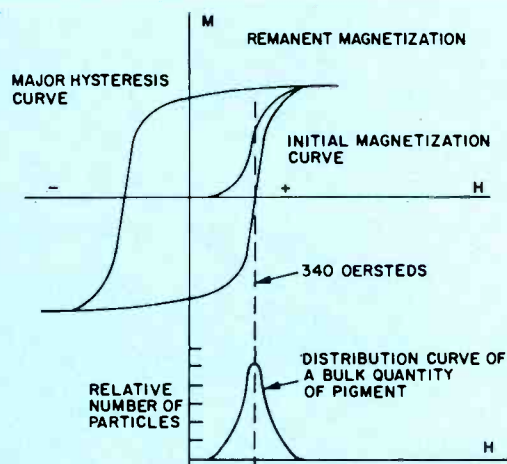

Fig. 3—The magnetization characteristics of a bulk quantity of iron-oxide particles which have a distribution curve in which a preponderance of particles switch at a coercivity of 340 oersteds. A small percentage have lower coercivity, and a similar percentage have higher coercivity, as shown in the figure. The distribution curve is essentially symmetrical. When initially mixed together, it can be assumed that the particles will be oriented in a random manner so that the net magnetic field produced by a bulk quantity is zero. In this state the bulk quantity can be considered demagnetized.

If an applied field is increased in the positive direction, magnetization of the bulk quantity follows an "initial magnetization curve" which is the integral of the distribution curve. The point of steepest slope of the initial magnetization curve coincides with the peak of the distribution curve, and this is the point where a maximum number of particles are switched. When the applied field is said to have reached saturation, and no further increase in applied field will increase magnetization.

Once saturated, the material then changes magnetic state in a manner described by the major hysteresis curve, and magnetization of the material in the absence of an applied field is termed remanent magnetization.

Reintroducing A World Standard...

CBS Laboratories' STR Professional Test Records



For over ten years, the original series of these high-precision test records set a standard for the audio industry. Now the new series sets an even higher standard. It's been revised, recut and expanded.

The new series consists of eight records for professionals and one for non-professional audiophiles.

Each record contains a complete series of easy-to-use tests to help you rapidly and accurately evaluate components and systems. Even one of these records can eliminate the need for costly, additional equipment. Each will find productive use and save you hours in the laboratory, on the production line and in field testing.

Take a look at what this essential testing series contains:

SEVEN STEPS TO BETTER LISTENING—For only \$6.98, you can improve your system with CBS Laboratories' "Seven Steps to Better Listening." This high-precision test record enables you to make sure that your equipment functions properly . . . to tune your system to your ears and your room acoustics. Included is a detailed 16-page booklet by Audio's Edward Tatnall Canby explaining how to use the record to improve the performance of your system. With the record you can perform the following "ears alone" tests: left-right identification, phasing, loudspeaker balance, tone control setting, alternate phasing, buzz and rattle elimination, lateral tracking, and vertical tracking.

★ **STEREOPHONIC FREQUENCY TEST RECORD STR 100** Designed for the evaluation of pickups and systems. Provides a constant amplitude characteristic below 500 Hz and a constant velocity characteristic above 500 Hz. Tests include: Sweep Frequency—with the sweep rate synchronized for use with a graphic level recorder; Spot Frequency—with voice announcements; Channel Separation; Wavelength Loss and Stylus Wear—to pinpoint oversize or worn-out styli, and excessive pickup tracking force; Compliance; Phasing; Vertical and Lateral Tracking; Tone Arm Resonance—to check system performance at low and subaudible frequencies and thus reveal undamped resonance which may cause equipment overloading.

★ **SQUARE WAVE, TRACKING AND INTERMODULATION TEST RECORD STR 112** Enables detailed study of tracking capabilities of stereophonic phonograph pickups. The square wave modulation allows a rapid appraisal of stylus-tip mass, damping, and tracking. Low frequency compliance and tracking are determined by means of 300-Hz bands of progressively increasing amplitude. Intermodulation distortion measurements are made possible by graduated 200-Hz intermodulation test bands. The Str 112 has been cut with vertical angle approximating 15°, which is representative of current recording practice.

★ **BROADCAST TEST RECORD STR 151** Developed especially to meet the needs of broadcast engineers, audiophiles, and other professionals seeking a convenient signal source for the testing and adjustment of all audio equipment. Tests include: phonograph pickup response and separation, speed accuracy at 33 1/3 and 45 rpm, wow and flutter, rumble and hum detection, ballistic test of V. U. meters and many others.

★ **RIAA FREQUENCY RESPONSE TEST RECORD STR 130** Provides RIAA frequency characteristics for the calibration of professional recording equipment and for testing the response of professional and consumer record reproduction equipment. This record is suitable for use with a graphic level recorder to provide permanent, visible records for precise evaluation. Spot frequency bands for use without automatic equipment are included.

★ **318 MICROSECOND FREQUENCY RESPONSE TEST RECORD STR 170** Provides pickup designers and recording studios with a high-level, easily-equalized signal for frequency response and channel separation measurements. The STR 170 employs a 318 microsecond characteristic corresponding to the "test" or "flat" mode common to most disc recording equipment. Constant amplitude recording is employed in the region below 500 Hz with constant velocity recording in the region above. The transition is smooth, in contrast with the STR 100 which employs a sharp breakpoint at 500 Hz. The record is suitable for use with a graphic level recorder to provide permanent, visible records for precise evaluation.

★ **WIDE RANGE PICKUP RESPONSE TEST RECORD STR 120** Makes possible the measurement of pickup response at frequencies far beyond the audible range, where elusive distortion elements can cause audible distortion. The low-frequency range includes glide-tones at twice normal level for the detection and elimination of arm resonance, loudspeaker cone and cabinet rattles. Other tests include: silent grooves for measuring rumble and surface noise characteristics; and standard level bands at 0 dB for overall system S/N measurements. This record is suitable for use with a graphic level recorder to provide permanent, visible records for precise evaluation.

★ **QUADRAPHONIC TEST RECORD SQT 1100** Designed for calibration, verification, and adjustment of SQ™ decoding equipment. The record provides test bands for pickup measurements, for adjustment of decoder electronics and for channel identification and balance. Each band is described in terms of recorded characteristics and its intended use.

★ **RIAA PINK NOISE ACOUSTICAL TEST RECORD STR 140** Designed for acoustical testing of systems and loudspeakers and for psychoacoustic tests on reproduction equipment. With the STR 140 it becomes possible to test loudspeakers in the room in which they will be used. Spot frequency tones with voice announcements facilitate the testing procedure. Continuous glide-tones in 1/3-octave bands cover the frequency range from 30 to 15,000 Hz and are synchronized with a graphic level recorder.

The original series has been unavailable for many years. Quantities of the new and improved series are also limited. So make sure you have perfect copies on hand for years to come by ordering duplicates. Fill out and mail the coupon now for immediate action.

SQ is a Trademark of CBS Inc.

Only a limited quantity are available. Be sure to order enough for many years of use.

Send me the following test records:

- Seven Steps to Better Listening (STR 101) \$6.98 each. Quantity _____
- Stereophonic Frequency (STR 100) \$10.00 each. Quantity _____
- Square Wave, Tracking and Intermodulation (STR 112) \$15.00 each. Quantity _____
- Wide Range Pickup Response (STR 120) \$15.00 each. Quantity _____
- RIAA Frequency Response (STR 130) \$15.00 each. Quantity _____
- RIAA Pink Noise Acoustical (STR 140) \$15.00 each. Quantity _____
- Broadcast test (STR 151) \$15.00 each. Quantity _____
- 318 Microsecond Frequency Response (STR 170) \$15.00 each. Quantity _____
- Quadraphonic Test (SQT 1100) \$15.00 each. Quantity _____

SEND TO:
AUDIO TEST RECORDS
401 N. Broad Street
Philadelphia, Pa. 19108

AU9

Amount Enclosed \$ _____
(Payment must accompany order)

Name _____

Address _____

City _____

State _____ Zip _____

Although many people will not consider a loss of high frequency response at high levels to be a serious listening defect, intermodulation distortion which results from this problem has a profound effect upon the quality of recorded music. With most types of music this intermodulation distortion may be more destructive to good listening quality than harmonic distortion, and it will occur in a magnetic recording system at levels well below the conventionally accepted maximum output level.

Figure 4B contrasts the high frequency performance of a tape which employs a magnetic material having a coercivity of 550 oersteds. The improvement in short wavelength response is attributable to a reduction of self-demagnetization.

Loss of high frequencies due to demagnetization occurs because of the very short wavelengths produced by a tape speed of only 1 7/8 ips. The cassette is most vulnerable to this problem. Demagnetization losses at tape speeds of 15 and 7 1/2 ips are negligible. Let us examine the causes of demagnetization using the familiar example of bar magnets.

Any permanent magnet has both an internal and an external magnetic field. The shape and intensity of both fields are dependent upon the physical shape of the magnet. The ratio of

length to cross-section dimensions of a magnet is called the proportionality factor. That part of the internal field which passes through the body of the magnet has a demagnetizing effect which limits the magnitude of remanent magnetization, that is, it limits the strength of the magnet after the magnet has been withdrawn from a magnetizing field. As shown in Fig. 5, the pole ends of a long permanent magnet are far apart, and much of the internal field extends into air around the magnet. A magnet with this configuration will experience little demagnetization, and therefore it can be magnetized to a fully saturated state. The magnet in Fig. 6 is broad relative to the distance between pole ends. In this case a larger part of the internal magnetic field will exist in the body of the magnet, causing demagnetization. Even though these two magnets may be subjected to the same magnetizing field, the short magnet may have less remanent magnetization when withdrawn.

Demagnetization is resisted by maintaining a certain ratio between remanent magnetization and coercivity. A magnet having relatively low remanent magnetization will not have an intense internal field, and thus will remain saturated even though it may have a corresponding low coercivity. But a high remanence

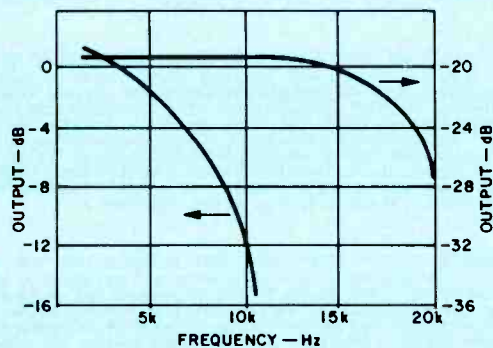

Fig. 4A—Frequency response of a gamma Fe_2O_3 tape at widely separated recording levels. Frequency response of a cassette tape is almost ideally flat when operated at a recording level 20 dB below the maximum operating level, which is generally defined as that level which produces 3 per cent third harmonic distortion in the reproduced signal at a frequency specified by a particular standard. High frequency output is greatly reduced when the tape is operated at the maximum output level, creating intermodulation distortion.

Fig. 4B—Less severe high frequency suppression occurs in a tape made with "high energy" magnetic material having a coercivity of 550 oersteds because of reduced self-demagnetization of the recorded signal.

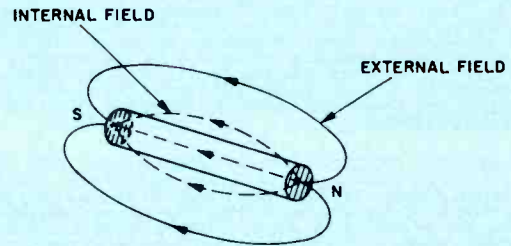
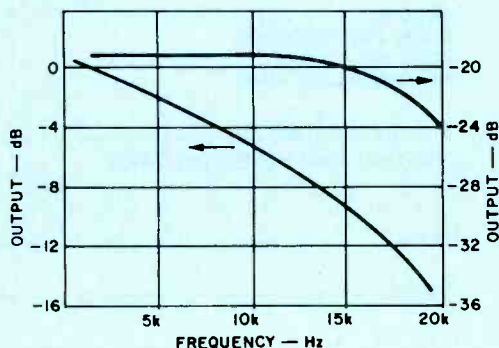
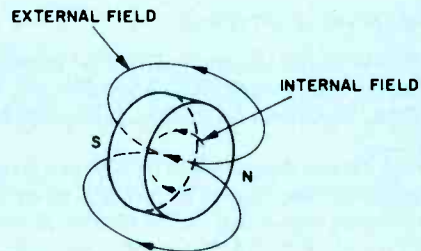

Fig. 5—The internal magnetic field of a long, thin permanent magnet exists largely in the air. This configuration will produce minimum self-demagnetization.

Fig. 6—Most of the internal magnetic field of a short, broad magnet passes through the body of the magnet, increasing self-demagnetization.





You can hear the difference because the difference is right here.

Take a look at what's taking the industry by storm. The Back Electret, another giant step forward from Sony.

Never before has it been possible for thin polyester film to be used in electret condenser microphones. That's because polyester film, acknowledged as the best material for microphone diaphragms, just can't hold a static charge for a long duration.

But Sony's engineers have made the impossible, possible. They've found a way to adhere the electret material directly to the back plate of the microphone. By thus putting the charge on the back plate, we are able to use polyester film in the diaphragm.

The result will be obvious to your ears. Clearly superior sound quality, without particular color-

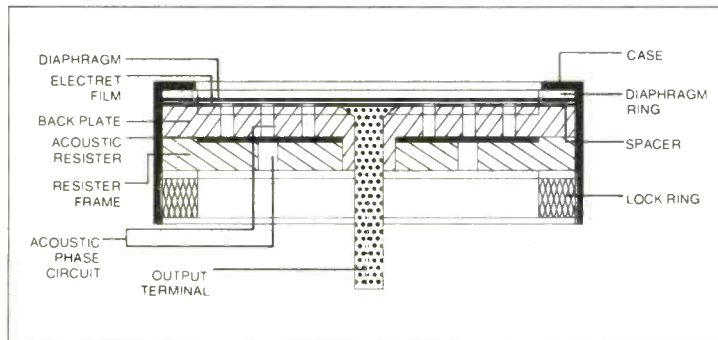

ation in the upper frequency range. The low mass diaphragm means better transient characteristics over the entire frequency range.

You can find the Back Electret in four Sony microphones: ECM-56F, \$220; ECM-65F, \$210; ECM-33F, \$165; and ECM-23F, \$100.

But you don't have to look at Back Electrets to see why Sony is ahead.

NO MATTER WHAT KIND OF MIKE YOU NEED TO GET, WE'VE GOT IT.

Sony's microphone line is thoroughly complete. It ranges from professional condenser to semi-professional to microphones for public address, vocalists, and outdoor use. There's omni and uni-directional. And we think it's big of us to make sophisticated

miniatures.

And all microphones are available with Phantom Power, battery operated, or both.

So if you need something to talk into, it makes a lot of sense to talk to Sony. Write to Sony, 714 Fifth Avenue, Dept. TK, New York, N.Y. 10019.

SONY[®] AUDIO

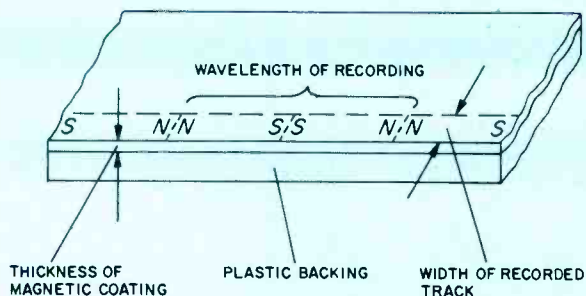

Fig. 7—The thickness of the magnetic coating and the wavelength of the recorded information establishes the proportionality factor of the "magnets" in a long wavelength recording. Even though the magnetic material is continuous, the magnets behave as though they were physically independent. The magnets grow shorter as the recorded frequency increases and will also become thinner at wavelengths shorter than one thousandth of an inch (about 2 kHz) because short wavelengths are recorded only near the surface of the tape.

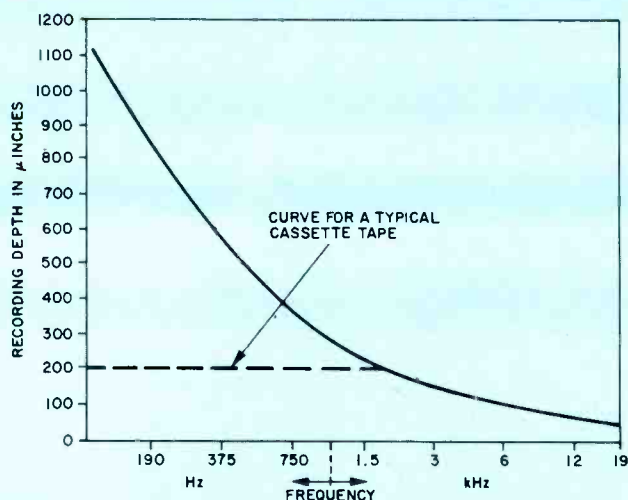

Fig. 8—In this recording depth vs. wavelength curve, the solid curve shows the recording depth that would occur in a thickly-coated magnetic tape moving at 1 7/8 ips. Such a tape would produce far greater relative output at low frequencies than at high frequencies because more magnetic material would be utilized at the longer wavelengths. A typical cassette tape is coated only 200 microns thick, so recording depth below 2 kHz is limited by the physical thickness of the coating.

magnet must also have a high value of coercivity, otherwise the internal field will spontaneously demagnetize the magnet, reducing remanence to a level which the coercivity will sustain.

Permanent magnets are used generally in magnetic "circuits" where magnetic fields are directed through soft iron poles. Examples of such uses are loudspeakers and permanent magnet motors. In these instances the soft iron circuits reduce the internal fields of the magnets, reducing susceptibility to demagnetization.

It is the self-demagnetizing effect that promotes the practice of placing a "keeper" across the pole ends of horseshoe shaped magnets to prevent demagnetization when not in use. The keeper is made of soft iron, and it short circuits the magnetic field to prevent the internal field from causing self-demagnetization.

Because the strength of the total field in and around a magnet is also dependent upon the level of magnetization, a magnetic material which is weakly magnetized will not demagnetize itself even though it may have a very poor proportionality factor. Self-demagnetization occurs primarily when an attempt is made to saturate the magnet or in other words to subject it to an intense magnetizing field which will leave it magnetized to the maximum level it will sustain. Summarizing, self-demagnetization in a saturated magnet is a function of 1) the dimensions of the magnet or proportionality factor, 2) the coercivity of the magnetic material, and 3) the remanent magnetization of the material.

Self-demagnetization induced by a poor proportionality factor is an important cause of loss of high frequency information in magnetic tape when high frequencies are recorded at short wavelengths (slow tape speed). If a square wave is recorded on magnetic tape, the recording signal will magnetize the magnetic layer in a series of end-to-end alternately polarized magnets, as illustrated in Fig. 7. The magnetic intensity of the magnets will be dependent upon the recording level and on the remanent magnetization of the tape. The length of the magnets is established by the frequency being recorded and the speed of the

tape across the recording transducer. At low frequencies (long wavelengths), the proportionality factor of the recorded magnets, which is established by the thickness of the magnetic coating on the tape and the recorded wavelength, is favorable towards preventing self-demagnetization. Consequently, the tape will sustain a high level of magnetization at low frequencies. At very short wavelengths the proportionality factor is poor because the magnets are shorter. The recorded magnets will relax back to less than saturation at the instant they leave the magnetizing field of the recording transducer.

Recalling that self-demagnetization is greatest when an attempt is made to saturate a magnet, it can be seen that a low-level recording (low magnetization) will produce little demagnetization at either long or short wavelengths, and output of the tape is relatively uniform at all frequencies. But at high levels of magnetization, short wavelengths will spontaneously demagnetize as the recorded areas of tape move away from the recording transducer. Under this condition high frequencies will be suppressed relative to low frequencies.

The foregoing analysis of self-demagnetization versus recorded wavelength can be easily visualized in a physical sense. Although a typical magnetic tape may have a coating thickness of about 200 microinches, studies of the recording process (3) have shown that a thickness of only 50 microinches is utilized in recording a wavelength of 0.0001 inch (which is the wavelength generated by 19 kHz at 1 7/8-ips tape speed) (see Fig. 8). Thus the cross-section dimension or thickness of the recorded magnets can be considered to be 50 microinches. The length of a recorded magnet is one-half the recorded wavelength, also about 50 microinches at 19 kHz frequency. The end-to-end magnets at this wavelength are only as long as they are thick, and this proportionality factor of one-to-one gives rise to substantial self-demagnetization.

The second quadrant of the M-H curve of a magnetic material, as shown in Fig. 9, can be analyzed to approximate the effect of self-demagnetization of tape for various wavelengths and val-



What would you do if you saw an orchestra drowning?

Twelve years ago, musicians all over the world were drowning in tape noise. We jumped in and began saving everyone we could, with our professional Dolby noise reduction system. Today, virtually every recording company in the world uses the Dolby system to make quieter master tapes.

Then we made a simpler Dolby system to save orchestras from drowning at home — first on cassettes, now on FM. Just about every manufacturer incorporates our music-saving circuitry in his tape recorders, while there are now more than 80 Dolby equipped FM products. Most recorded cassettes are Dolbyized, as are open-reel tapes. More than 100 stations broadcast Dolby FM.

Now, Dolby is going to the movies. We not only saved R2D2 from drowning — we brought him to you in stereo. Our professional noise reduction system is being put to a new use, as the basis of Dolby Stereo — a practical, economical system for wide-range stereo sound in neighborhood theatres (not just first-run houses).

In fact, we're making just about *everything* sound better. At Dolby Laboratories, we think . . . so that others can swim.

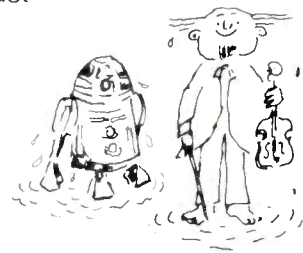

R2D2 appears courtesy of 20th Century Fox.

DD Dolby®

Dolby Laboratories

'Dolby', Dolbyized and the double-D symbol are trademarks of Dolby Laboratories

731 Sansome Street
San Francisco CA 94111
Telephone (415) 392-0300
Telex 34409
Cable Dolbylabs

346 Clapham Road
London SW9
Telephone 01-720 1111
Telex 919109
Cable Dolbylabs London

ues of coercivity and remanence. Remanent magnetization of a tape recorded at very long wavelengths is indicated by the point at which the second quadrant magnetization curve intersects the M axis. This point also corresponds to the saturated output level of the tape at low frequencies, and is determined by the intrinsic remanent magnetization and packing density of the material used in the magnetic coating.

The saturated output level of the tape at high frequency can be determined by using a "demagnetization loss" line drawn through the M-H curve. The angle of this line is dependent upon wavelength, and the angle will rotate counterclockwise as the wavelength becomes shorter (3). At the point where the loss line intersects the M-H curve, a second line is drawn perpendicular to the M axis. The point where this second line intersects the M axis represents the magnetization of the tape for a specified wavelength. Note that remanent magnetization (and output) at 20 kHz is substantially less than that of long wavelengths for a tape having a coercivity of 320 oersteds.

As mentioned earlier, the angle of a demagnetization loss line is a function primarily of wavelength, and will be the same for any tape tested. This angle was determined empirically by testing numerous tapes having widely separated magnetic properties and variable thicknesses. In every case, measured output of the tapes correlated closely to a demagnetization loss line of the same angle for a given wavelength (4).

Figure 10 shows second quadrant magnetization curves for eight tapes which have widely ranging ratios of remanent magnetization to coercivity. The angle of the demagnetization loss line drawn through the tape curves corresponds to 0.1 mil wavelength. If the intersections of this line with the magnetization curves ideally define magnetization of the tapes (and consequently output), then measured outputs of the tapes should all fall on the line of Fig. 11. Note that an excellent correlation is obtained.

This method of predicting demagnetization applies only to the near saturated case, and therefore applies to tape output where the recording level is near the maximum operating level of the tape.

It should be pointed out that, in addition to demagnetization of a recorded signal caused by poor proportionality factor of the recorded "magnets," another type of demagnetization occurs as the result of magnetic interactions of the tape and the record-

ing transducer. This second kind of demagnetization is termed "recording loss," and is included in the total demagnetization predicted by the demagnetization loss line. A definition of recording loss is beyond the scope of this paper.

Numerous conclusions can be drawn from the loss line method of predicting demagnetization losses. First, it can be observed from the curve of tape 2 in Fig. 10 that an increase in remanent magnetization without a corresponding increase in coercivity will not produce a proportional increase in 20-kHz output. The intersection of the 20-kHz demagnetization loss line occurs at a nearly vertical slope in the second quadrant curve, so increasing the height of the curve will produce only a small change in the height of the intersection point. In attempting to develop superior magnetic pigments for short wavelength audio recording, a mere increase in remanent magnetization is of limited value.

Second, remanent magnetization or output of a tape at 20 kHz can be substantially improved without any increase in the intrinsic remanent magnetization of the magnetic material. By increasing coercivity from 320 to 550 oersteds, as shown in Fig. 9, demagnetization at 20 kHz is reduced to half. This result clearly points to the direction of increasing coercivity to obtain improved short wavelength saturated output.

Third, the greatest improvement of short wavelength saturated output is obtained by simultaneously increasing both remanent magnetization and coercivity. High remanent magnetization is needed to produce magnetic fields of high intensity, and coercivity is needed to prevent spontaneous demagnetization that would otherwise occur.

Fourth, and finally, the shape of the magnetization curve can also have a significant effect upon demagnetization. If one imagines a second quadrant curve which has a sharp corner as opposed to a slanted curve, the point of intersection on the demagnetization loss line would be much higher on the M axis (5). Since the shape of the curve is a function of the distribution of coercivities of the magnetic particles, narrow distribution is a quality to be sought. Distribution is made narrow principally by maintaining uniformity in size and shape of the magnetic particles, and by obtaining chemical purity of the material.

The effect of reducing demagnetization by narrowing distribution can also be visualized as an elimination of those low coercivity particles of pigment which are most susceptible to demag-

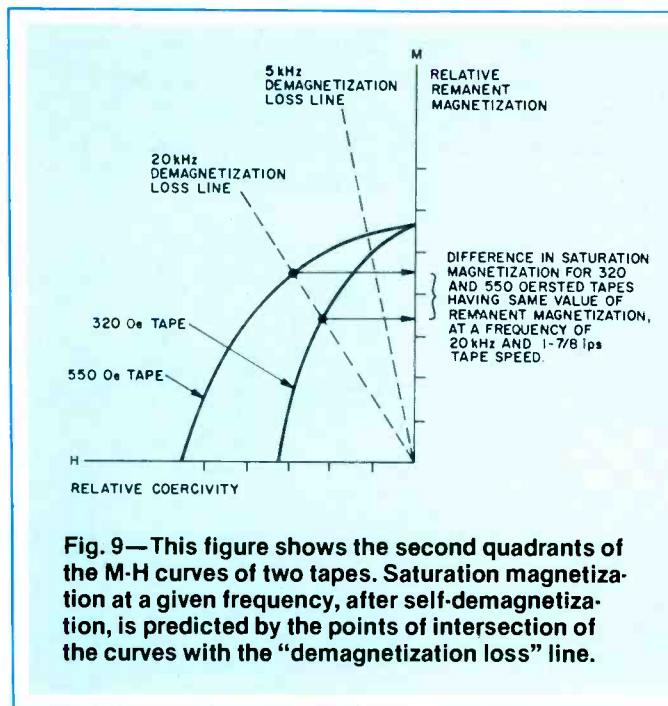
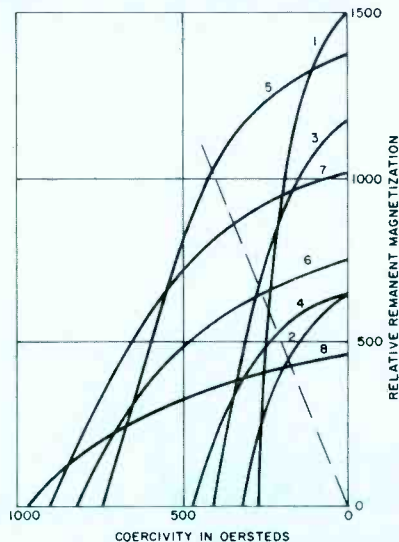

Fig. 9—This figure shows the second quadrants of the M-H curves of two tapes. Saturation magnetization at a given frequency, after self-demagnetization, is predicted by the points of intersection of the curves with the "demagnetization loss" line.

Fig. 10—Second quadrant analysis of eight experimental tapes shows the demagnetization loss line for a recording wavelength of 0.1 mil represented by the dotted line. Note that the predicted output of tape 1 is very much lower than might be anticipated by remanent magnetization alone. This tape provides an extreme example of self-demagnetization.



Before Sound Guard[®], you only played a record in mint condition once.



Magnification shows the record vinyl wearing away.

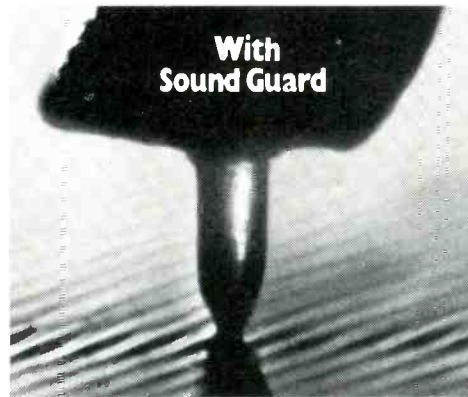

Same magnification shows no record wear.

You can see how the picture has changed.

Independent tests* show that records treated regularly with Sound Guard preservative keep the same full amplitude at all frequencies, the same absence of surface noise and harmonic distortion as records played just once in mint condition.

With its patented dry-lubricant film, Sound Guard

preservative maintains sound fidelity by reducing record wear. And with its built-in, permanent anti-static property, it resists dust accumulation.

And now, two new Sound Guard products:

1. Sound Guard[™] record cleaner, developed from extensive research into record cleaning problems and

methods, removes all common record contaminants—from dust particles to oily fingerprints.

And whether your records need a light cleaning to remove surface dust or a thorough cleaning to remove deep-seated contaminants, Sound Guard record cleaner does both.

2. Sound Guard[™]

Total Record Care System puts Sound Guard record preservative and Sound Guard record cleaner in one package—for the best possible total care for all of your records.

Available in audio and record outlets.

*Tests available on request.



Sound Guard[®] keeps your good sounds sounding good.



Sound Guard preservative—Sound Guard cleaner—Sound Guard Total Record Care System
Sound Guard is Ball Corporation's registered trademark. Copyright © Ball Corporation, 1977. Muncie, IN 47302

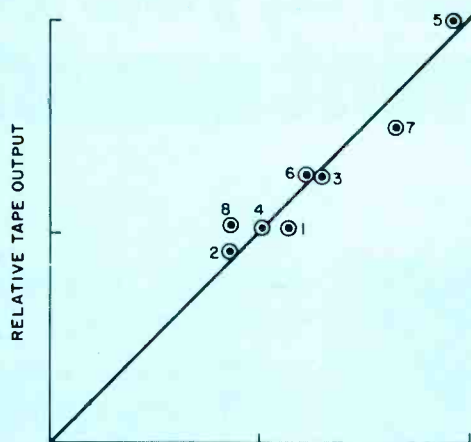

Fig. 11—Measured output of eight experimental tapes. The second quadrant analysis of self-demagnetization would predict that the output of the eight tapes of Fig. 10 would fall on the line.

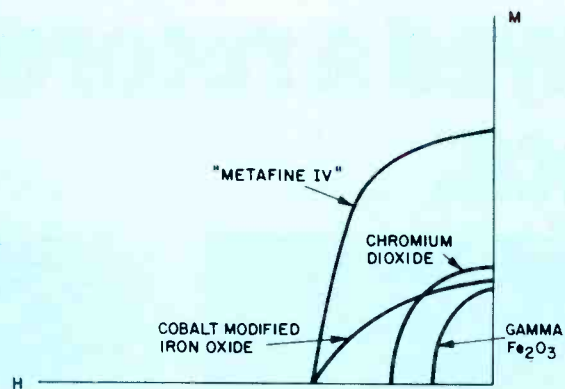

Fig. 12—The relative energies of four magnetic recording pigments. The area enclosed by the second quadrant of the hysteresis curve represents the "energy" of a magnetic material. Coercivity of cobalt-modified iron oxide can be adjusted in the manufacturing process to cover a very broad range, from that of Fe_2O_3 to well beyond the recording capabilities of a magnetic transducer. Metallic magnetic materials are probably the materials of the future since they combine an exceptionally high remanent magnetization with high coercivity.

netization. As remanent magnetization of a pigment is increased, the low coercivity particles will be the first to demagnetize. If these particles represent a large portion of the total material, then demagnetization will be appreciable, even though the value of coercivity represented by the center of the bell-shaped curve is high.

In certain types of short wavelength recording, such as FM video and high density digital recording, a very narrow distribution is highly desired. In fact, a magnetization curve similar to that of a single particle would be ideal. But audio recording is an analog recording process where the instantaneous magnetization of the magnetic material in the tape must be exactly proportional to the instantaneous value of the audio signal. If distribution is too narrow and if the magnetization curve is too steep, sensitivity of the tape becomes too critical to allow proper setting of recording levels. Fortunately this problem is not encountered in particulate magnetic materials because small variations in physical shape and dimensions, as well as variations in chemical composition of particles inherent in the manufacturing process, combine to produce a slope in the magnetization curve which is suitable for analog recording.

The foregoing analysis provides a quantitative means of translating several bulk magnetic properties of materials to performance of a tape, but more importantly, it clearly shows the direction that must be taken in the future development of magnetic materials. All areas of magnetic recording, including television, digital data, and instrumentation recording, are trending toward shorter wavelengths. Advanced materials having higher coercivity and remanence must be developed to meet future needs in all areas.

Material with increased coercivity is the most recent development to find a way into the marketplace. Chromium dioxide and cobalt-modified iron oxide became available in audio cassette tapes several years ago. The coercivity of chromium dioxide is nominally 550 oersteds, as compared to 340 oersteds of gamma Fe_2O_3 . This value of coercivity is determined by the chemical nature of the material and by the size and acicularity of the

magnetic particles. Approximately one-third of the coercivity is attributable to chemical composition and two-thirds to size and shape. A coercivity of 550 oersteds is a fortuitous characteristic of CrO_2 particles, since this value is ideally suited to compensate for demagnetization losses which occur at 1 7/8 ips tape speed. Saturated remanent magnetization of CrO_2 is slightly greater than that of gamma Fe_2O_3 .

Unlike CrO_2 , cobalt-modified iron oxide obtains a high coercivity by combining a small amount of cobalt with the iron oxide crystal. Coercivity can be controlled over a very wide range, up to 2,000 oersteds, by adjusting the amount of cobalt introduced into the iron oxide. This flexibility allows cobalt-modified materials to be adjusted precisely to the application.

Future Limits

If magnetic materials could be tailored to any magnetic properties desired, what are the limits to which remanent magnetization and coercivity could be taken? Certainly many different limits are imposed. Not the least significant is the magnitude of the magnetic field which can be generated by recording transducers. Materials which form the pole piece of transducers become magnetically saturated when attempts are made to record on tape having a coercivity of, say, 1500 oersteds. Even though a tape with this coercivity is highly resistant to self-demagnetization and will provide excellent short wavelength output, no practical method exists for placing a distortionless recording on the tape. Until significant improvements in head materials are made, a coercivity of 1200 oersteds is a practical limit for tape in most applications.

With this limit for coercivity established, it is a simple matter to show by analysis of the second quadrant curve what level of remanent magnetization can be employed before self-demagnetization at short wavelengths occurs. These values of coercivity and remanent magnetization become the goals of future pigments, established by the characteristics of magnetic recording transducers and firmly fixed until advances in transducer materials are forthcoming.

Speaker Systems: Then And Now

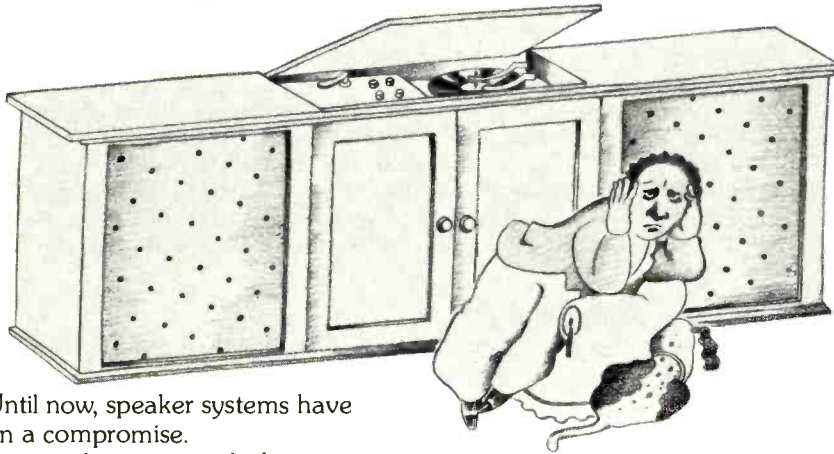

Until now, speaker systems have been a compromise.

But you have to give hi fi engineers credit. They've been doing their best under difficult circumstances.

You see, optimum bass reproduction requires a large enclosure for the bass driver. But then, the mid and high frequency drivers are

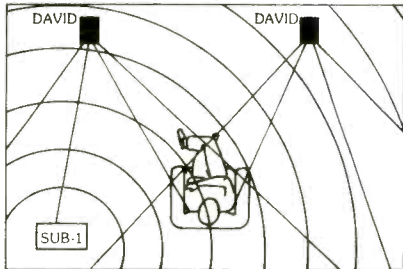

Unique Sound Dispersion Pattern

added to this enclosure. The result is often two bulky, and sometimes unsightly cabinets which are difficult to place for maximum stereo sound reproduction and tasteful interior decoration.

Adding to this dilemma is the knowledge that furniture, carpets, and walls are factors which can cause the bass to sound weak, dull, or false.

Yet, moving the speakers to improve bass response destroys the stereo imaging. So you end up doing what hi fi engineers have been doing. You compromise.

You needn't. Because now, Visonik has a solution. It's called the SUB-1/DAVID® loudspeaker system. Designed to give you uncompromised sound, with uncommon placement flexibility.

The theory behind the SUB-1/DAVID® loudspeaker system is based on the acoustic fact that the human ear cannot detect directionality in low tones, those below approximately 200Hz.

In other words, there's no stereo imaging in the low bass. So why have two bass drivers?

Visonik's three-way SUB-1/DAVID® system utilizes two DAVID® 502 or 602 speakers to reproduce the mid and high range and impart the proper stereo imaging, with a single subwoofer to radiate the low bass throughout the room.

The DAVIDS® reproduce sound with absolute faithfulness and sparkling clarity right up to the highest highs. And their dispersion

characteristics are nothing short of remarkable.

Yet, they are so ultra-compact that integrating the DAVIDS® into your room will be a cinch.

The single sub-woofer brings bass reproduction down to a new low. As low as the lowest lows, but still with a crisp knock-out punch you could only get at a concert.

And the sub-woofer can even be hidden in the room. This produces the astounding effect that the full, rich bass sound seems to come from the DAVIDS®.

With a minimum recommended amplifier power of 50 watts per channel and a maximum of 300 watts per channel, the SUB-1/DAVID®

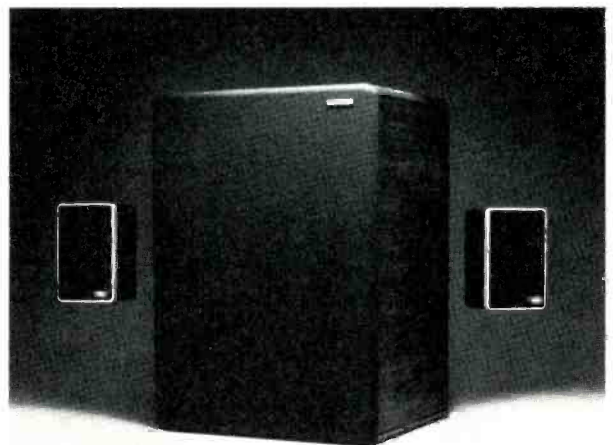

system works well with an unusually large range of amps or receivers.

Visonik's SUB-1/DAVID® system. The one designed for those who won't compromise. Is that you?

Write us or call this toll-free number for the name of your nearest Visonik dealer. (1) 800 423-2355, ext. 606. In California, call (1) 800 232-2175, ext. 606.

VISONIK® HIFI

You'll hear more from us.™

Visonik of America, Inc./1177 65th Street/Oakland, CA 94608

®Registered Trademark, Visonik K. G.™ © 1978, Visonik of America, Inc.

Enter No. 68 on Reader Service Card

The limits of coercivity and remanence established by recording transducers are reached in a new generation of magnetic materials which utilize particles existing in a metallic state. Materials of this type are being developed in several laboratories around the world. One such material, identified by the brand name "Metafine IV," is supplied by the 3M Company. Such particles have an intrinsic remanent magnetization close to the theoretical limit for single domain particles. A comparison of the second quadrant area of the fine iron material and gamma Fe_2O_3 is shown in Fig. 12. As the figure suggests, the output of a tape made with this material is far greater than that of gamma iron oxide tape.

Magnetic materials having very high remanence are difficult to handle in the tape manufacturing process because of a tendency of the particles to cling together in clumps. Magnetic attraction and repulsion between particles in the fluid dispersion causes them to find stable physical relationships wherein opposite poles are locked together, end to end and side by side. This produces chains of particles which appear under a microscope much like the chains of iron filings used to demonstrate magnetic fields. Chained magnetic particles in tape will not behave as individual particles since the switching of one particle will have an influence on neighboring particles. The result of this infectious switching could be poor signal output from the tape.

Clumping or chaining is controlled by dispersing magnetic materials in fluid polymers and binders in which the chemical forces holding particles apart are greater than the magnetic forces pulling them together. The chemistry needed to achieve this equilibrium becomes more difficult as the remanent magnetization of particles is increased. Thus, chemical dispersion technology must be developed in concert with developments in magnetic materials, and advanced magnetic tapes are not made simply by substituting magnetic materials.

The development of advanced magnetic tapes involves much more than simply increasing the energy of magnetic materials.

The magnetic component is only one ingredient in a complex chemical system, and the entire system must be redesigned whenever this component is substituted or modified.

Summary

This paper has explained the effects of demagnetization on short wavelength saturated recording, and has presented an empirically derived method of equating magnetic properties of particles to short wavelength performance of tapes. Although the examples used relate to cassette audio recording systems, the same principles apply to other short wavelength recording systems, and particularly to the whole new generation of video recorders now available to consumers. The trend toward shorter wavelengths, which has been seen in the past, will go on into the future, and refinements of all aspects of recording systems will continue. Development of magnetic materials having increased remanent magnetization, higher coercivity, and narrower distribution will be a large part of this effort.

The author wishes to acknowledge the work of Dr. T. J. Szczech, of the Data Recording Products Division Laboratory of the 3M Company, whose studies of the magnetic recording process are principally responsible for the information contained herein.

A

References

- 1) Jan Smit, "Magnetic Properties of Materials," McGraw-Hill, 1971.
- 2) A. H. Morrish and L.A.K. Watt, "Effect of the Interaction Between Magnetic Particles on the Critical Single-Domain Size," *Physical Review*, Vol. 105, No. 5, March, 1957.
- 3) T. J. Szczech, "Further Studies of Digital Recording," 3M Company Internal Report, November 27, 1968.
- 4) T. J. Szczech and E. F. Wollack, "A Technique for Determining Short Wavelength Output," *IEEE Transactions on Magnetics*, Vol. MAG-10, No. 3, September, 1974, pp. 670-673.
- 5) D. B. Richards and T. J. Szczech, "The Relationship of Switching Distribution to Tape Digital Output," *Journal of Applied Physics*, 1978.

CORELLI, CALINDA AND CANTATA

Each of these popular loudspeakers is an excellent example of the KEF total system design approach, whereby the drive units, the cabinets and the electronic circuits are developed together, using the computerised digital analysis techniques which KEF pioneered. The Corelli, designed for shelf mounting, offers remarkable bass performance and surprisingly high power handling from such a compact system. The Calinda and Cantata are tall, elegant floor-standing loudspeakers with a special arrangement of the drive units which give a truer frequency response, greater clarity and a sharper stereo image than any previous speakers of comparable size.

And because we make all our own drive units, we can offer a consistency in manufacture and performance which is unrivalled in the Hi-Fi industry.

Write for literature and the name of your nearest dealer.

KEF Electronics Ltd., US Distributors Intratec,
PO Box 17414, Dulles International Airport,
Washington DC 20041.

KEF
The Speaker Engineers



Onkyo TA-630D Cassette Deck with the Exclusive Accu-Bias System.

The reason
you waited
to buy one.

With cassette hardware and software changing constantly, a lot of you have been waiting. Holding off for top technology.

You've got it.

Onkyo's TA-630D with our exclusive Accu-Bias is here. And it's the only cassette deck with

adjustable bias in a two-head configuration. Which right there offers lower distortion, better low frequency response and little or no crosstalk. That's a lot, but there's more.

You know how important it is to have optimum bias when you record. Too low a bias signal and you have distortion. Too high a bias signal and you lose high frequency response.

Other cassette decks have adjustable bias and equalization, set at the factory for average conditions. Onkyo doesn't believe in playing averages. And gives you Accu-Bias.



Accu-Bias is Onkyo's exclusive system. It works with a pair of reference signal generators built into the TA-630D. Feed these signals to your tape, and read the reproduction signal on the meters. If bias is off for that cassette tape, you compensate with continuous, variable settings until you get an absolutely flat frequency response. It's that simple...and you get the best high frequency response, least distortion and lowest signal to noise ratio.

You get all that because the bias signal primes your tape as the recording is made, and every manufacturer's tape is different. Even when equalization is correct, if the bias is incorrect, it results in producing peak or losing the high frequency characteristic. Again, this depends on the tape used...all of which respond differently.

Does it work?

After all the effort Onkyo's gone to so you can have the only two-head continuously variable bias control you might expect fantastic sound.

You've got it.

You've got frequency response of 20-15,000 Hz on normal tape; 20-18,000 Hz with FeCr and CrO₂.

S/N ratio with FeCr is 58dB, goint up to 68dB with built-in Dolby* NR System. Wow and Flutter are negligible at 0.055% WRMS by use of a DC servo motor for constant speed.

There's still more, but you'll have to find out from your Onkyo dealer. Be prepared for a stunning cassette listening experience and features found only in higher-priced decks. Listen for the difference Accu-Bias makes and find out what keeps Onkyo a step ahead of state-of-the-art.

**Dolby is a trademark of Dolby Laboratories, Inc.*



ARTISTRY IN SOUND

ONKYO

Eastern Office: 42-07 20th Ave., Long Island City, NY 11105 (212) 728-4639

Midwest Office: 935 Sivert Drive, Wood Dale, ILL. 60191 (312) 595-2970

West Coast Distribution Center: Damark Industries, Inc. 20600 Nordhoff Street, Chatsworth, CA 91311 (213) 998-6501

Canada: Sole Distributor, Tri-Tel Associates, Ltd., Willowdale, Ontario Canada M2H 2S5

Enter No. 20 on Reader Service Card

Equipment profiles

Pioneer Model SX-1980 Stereo AM/FM Receiver



70

MANUFACTURER'S SPECIFICATIONS

FM Tuner Section

Mono Usable Sensitivity: 8.7 dBf (1.5 μ V).

50-dB Quieting: Mono, 11.5 dBf (2.2 μ V); Stereo, 36 dBf (34 μ V).

S/N: Mono, 83 dB, stereo, 74 dB.

THD: Mono, 0.05 per cent @ 100 Hz, 0.07 per cent @ 1 kHz, and 0.2 per cent @ 6 kHz; Stereo, 0.1 per cent @ 100 Hz, and 1 kHz, and 0.2 per cent @ 6 kHz.

Frequency Response: 30 Hz to 15 kHz, +0.2, -0.5 dB.

Capture Ratio: 1.0 dB.

Selectivity: 80 dB.

Image and i.f. Rejection: 120 dB.

When the Pioneer SX-1980 first reached our test laboratory, it had the distinction of being the "world's most powerful receiver." Almost before we could unpack it and get it up on the bench, that title passed on to Technics by Panasonic who now offers a 330-watt-per-channel receiver and, it is entirely possible that by the time you read this, someone will have surpassed that power level in an all-in-one receiver.

If high power alone were all that this receiver boasted, we would probably not be writing and publishing this report. In fact, the Pioneer SX-1980 is an exceedingly well-designed unit that offers just about every conceivable control feature that you might want even if you were shopping for "separates." And, while it is quite large and heavy, the cubic volume it occupies is probably a good deal less than would be the case if you purchased separates that performed as well. In terms of cost, the truism about better cost/performance ratios holds true for this receiver (as compared with separates) despite its huge power output capability.

Major controls along the lower section of the front panel include nine toggle switches and six rotary knobs. Four of these knobs take care of bass and treble settings. As in previous Pioneer receivers, main and sub-bass and treble controls are provided, each pair having different turnover frequencies for an almost limitless combination of tonal settings. A small channel balance control is located at the lower right, next to a large dB-calibrated, step-detented, master volume control. The nine toggle switches are a

power On/Off switch, Tone Defeat, Tape Duplicate and Monitor, Stereo/Mono, Loudness, and Audio Muting.

Above these controls and switches, framed in the large dial area of the panel, are a row of 13 pushbuttons, two rotary switches, a phone jack at the left, and a microphone input jack at the extreme right. The two rotary switches offer variable phono-1 cartridge loading (providing resistive choices from 10 to 100 kilohms and capacitive loading choices from 100 to 400 pF). Three of the pushbuttons choose up to two of the three sets of speakers which can be connected to the receiver. The next two buttons activate the low-and high-cut filters. Three more buttons provide an audible indication of multipath problems, 25 or 75 microsecond de-emphasis, and muting defeat. Five more buttons select desired program source. Of the two phono inputs available, one can be used as an alternate microphone input.

Below the dial scales themselves are four movable "indexing tabs" which can be positioned for easy referencing of favorite stations. Above the linearly calibrated FM dial scale and the AM dial scale are four meters, two for center-of-channel and signal-strength indication and two for monitoring power delivered to the speaker loads. Above the tuning meters are speaker and program-source indicator lights, while to the right are the stereo indicator light, a light that tells the user to "fine tune" the signal, and another light which illuminates when the signal has been properly tuned in and is "quartz locked" by this tuning feature which is associat-

AM Suppression: 60 dB.
Muting Threshold: 19.2 dBf (5 μ V).
Sub-Carrier and SCA Rejection: 65 dB.
Stereo Separation: 50 dB @ 1 kHz;
 40 dB, 30 Hz to 15 kHz.

AM Tuner Section

Sensitivity: 300 μ V/m internal, 15 μ V external antenna.
Selectivity: 26 dB.
S/N: 55 dB.
Image & i.f. Rejection: 55 dB.

Amplifier Section

Power Output: 270 watts per channel, 8 ohms, 20 Hz to 20 kHz.
Rated THD: 0.03 percent.
Rated IMD: 0.03 percent.
DaFping Factor: 40.
Input Sensitivity (for rated output): Phono, 2.5 mV; High Level, 150 mV; Mike, 7.5 mV.
S/N "A" weighted: Phono, 87 dB; High Level, 100 dB.
Tone Control Range: Main Bass, \pm 10 dB @ 100 Hz; Sub-Bass, \pm 5 dB @ 50 Hz; Main Treble, \pm 10 dB @ 10 kHz; Sub Treble \pm 5 dB @ 20 kHz.
Low Filter Cutoff: 15 Hz @ 12 dB/octave.
High Filter Cutoff: 8 kHz @ 12 dB/octave.

General Specifications

Maximum Power Consumption: 1400 W, 120 V, 60 Hz.
Dimensions: 22 $\frac{1}{16}$ in. (56.3 cm) W x 19 $\frac{9}{16}$ in. (49.6 cm) D x 8 $\frac{5}{16}$ in. (21.1 cm) H.
Weight: 78 lbs. (35.4 kg).
Price: \$1250.00.

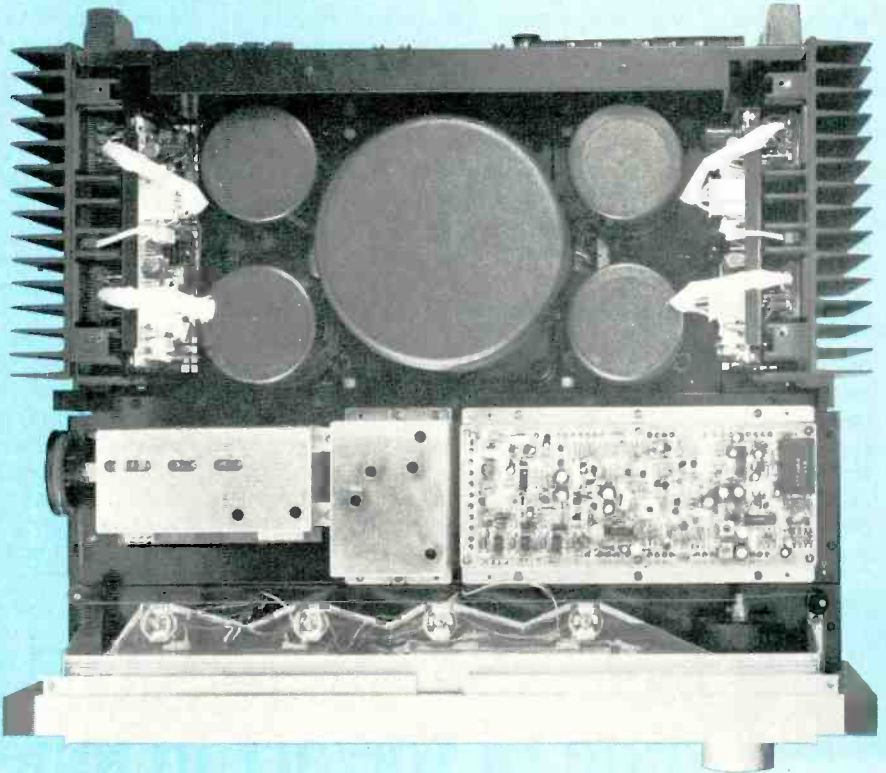
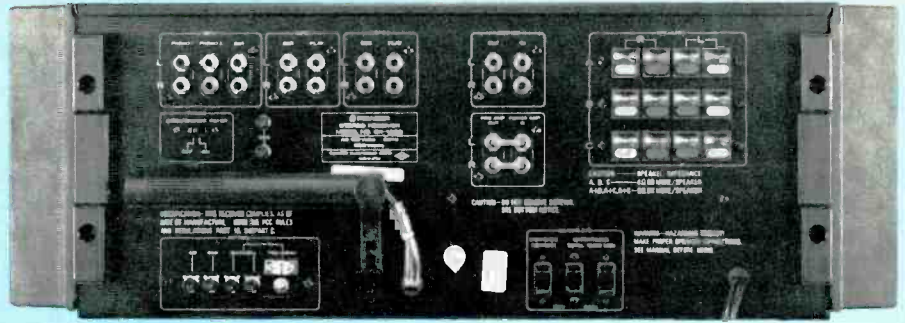

ed with the large tuning knob and activated when the user releases the tuning knob.

The rear panel of the Pioneer SX-1980 has three banks of spring-loaded speaker terminals and, near these, there are preamp-out/main amp-in jacks plus three convenience a.c. receptacles (two unswitched, one switched). Antenna inputs for 300 ohm, 75 ohm coaxial, and external AM are located below the pivotable built-in ferrite bar antenna. Tape-in and tape-out jacks,

phono (two pairs), and AUX jacks are at the upper left of the panel and below the phono inputs is an interference filter switch which can be activated to reduce r.f.i. and other forms of external interference. Additional output and input jacks are located above the preamp-out/main amp-in jacks for possible connection of accessory devices such as a Dolby noise reduction unit, dynamic range expander, graphic equalizer, etc.

Construction and Circuit Highlights

The large, toroidally wound power transformer, visible in the internal view of the SX-1980, has individual secondary windings which supply separate, dual-polarity voltages for each channel's output stages, and 22,000 μ F filter capacitors are used. The power amplifier stage is d.c.-configured, with all capacitors removed from the feedback loop. A single-stage differential-input amplifier is used with low-noise dual transistors, a current-mirror load, and a three-stage Darlington triple single-ended push-pull output stage. The pre-drive amplifier section features a power limiter circuit and an overdrive limiter which control the power output so that the power transistors are protected from damage when excessive loads are applied under high power conditions.

The FM front-end incorporates a two-stage r.f. circuit using a five-gang tuning capacitor and three dual-gate MOS-FETs. The i.f. amplifier section combines five dual-element ceramic filters with four ICs including a quadrature detector. The stereo MPX circuit

Fig. 1 — Mono and stereo quieting and distortion characteristics.

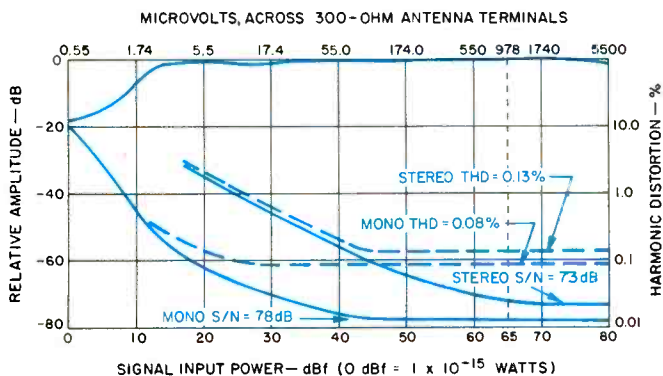

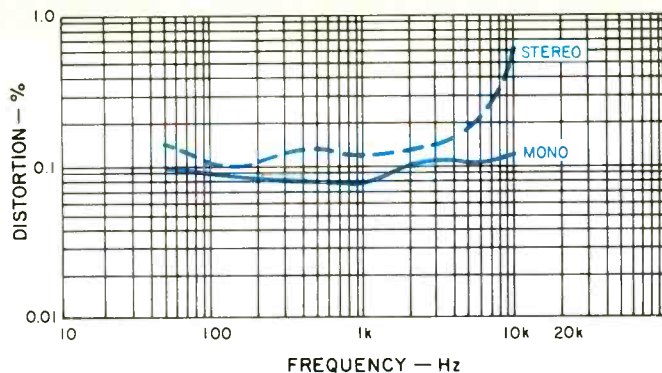

Fig. 2 — Distortion vs. frequency in the FM section.

employs a PLL IC with a self-contained, pilot-cancelling circuit.

The local oscillator is "locked" by means of a reference quartz-crystal oscillator in 100-kHz increments using a circuit that Pioneer has dubbed its APC (Automatic Phase Control) or "touch tuning system."

A dual-FET is used in the first-stage differential amplifier of the phono equalizer circuit while the final stage employs a pure complementary single-ended, push-pull configuration. Equalizer components have been chosen with close tolerances to maintain correct RIAA playback response within 0.2 dB.

FM Tuner Section Measurements

The FM tuner section of the SX-1980 is one of the best we have ever measured on an all-in-one receiver. Usable sensitivity measured 1.5 μV (8.7 dBf) exactly as claimed (and as low as we have ever measured). Usable stereo sensitivity was a low 4.0 μV (17.3 dBf), and 50-dB quieting was obtained with a mono input signal of only 2.0 μV (11.2 dBf) as against 2.2 μV claimed, and 28 μV (34.2 dBf) for stereo as against 36 μV claimed. Best signal-to-noise ratio in mono measured 78 dB, and 73 dB for stereo. For a 1-kHz test modulating signal, THD was 0.08 per cent

in mono and 0.13 per cent in stereo, a bit short of values claimed but, nevertheless, low enough to be insignificant in listening terms. Quieting and THD characteristics as a function of signal input levels are graphed in Fig. 1. Distortion at other frequencies are plotted in Fig. 2 for both mono and stereo modes. At the IHF test frequencies of 100 Hz and 6 kHz, the unit measured 0.09 per cent and 0.12 per cent for mono and 0.15 per cent and 0.2 per cent for stereo. Frequency response, plotted together with separation characteristics in Fig. 3, was flat from 30 Hz to 15 kHz, within +0, -0.5 dB. Stereo separation measured an outstanding 58 dB at mid-frequencies and remained at 55 dB for 100 Hz and 43 dB at 10 kHz. Stereo threshold was measured at 4.0 μV (17.3 dBf), while muting threshold was set at 6.0 μV (20.8 dBf).

Selectivity measured 83 dB, and capture ratio was exactly 1.0 dB as claimed. Image, spurious, and i.f. rejection were all in excess of 100 dB (the limit of our test equipment capability), while AM suppression measured a very high 63 dB. Sub-carrier products were "buried" beneath the noise floor in stereo, as was an SCA test signal.

AM frequency response is plotted in the frequency-sweep display of Fig. 4 and was no better than that observed for most stereo

72

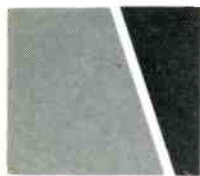

fact: the Shure/SME Series III is the state of the art in tone arms.

new!

Breakthroughs & Improvements.

The Series III is the culmination of research and development extending over more than seven years. It embodies a number of significant breakthroughs as well as evolutionary improvements over its distinguished Shure/SME predecessor.

Notable among these is an exotic nitrogen-hardened titanium tubing arm (with wall thickness only twice the diameter of the average human hair) providing a previously unattainable strength-to-weight ratio. The arm has a soft core annular cross-section with an internal fibrous lining which results in an efficient, natural damping of the vibration fed into the arm by the cartridge.

Cartridge Carrier.

The Series III "cartridge carrier," a combination tone arm and shell in one piece, is removable and interchangeable for multi-cartridge use. Coupling is close to the fulcrum so the carrying arm makes a minimum contribution to the Series III total effective mass (only 5.05 grams measured at 9 inch radius!).

Fluid Damper.

A built-in highly efficient F.D. 200 Fluid Damper gently but effectively resists spurious or potentially damaging stylus forces in both planes, yet does not interfere with normal arm motion.



"The best pickup arm in the world."

Incomparable High Fidelity Performance!



THE SME SERIES III PRECISION PICKUP ARM WITH THE NEW SHURE V15 TYPE IV CARTRIDGE

The combination of the Shure V15 Type IV cartridge and the SME Series III tone arm transcends previous tone arm-cartridge system performance, and sets dramatic new standards in connoisseur-class high fidelity reproduction.

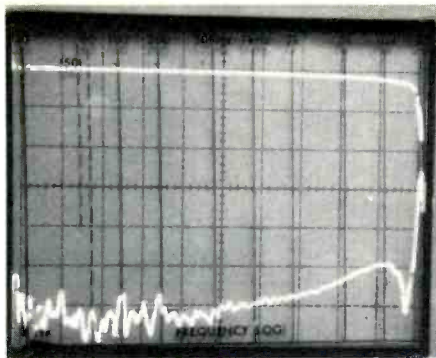

Fig. 3 —
Frequency response and
separation. (Each vertical
division equals 10 dB.)

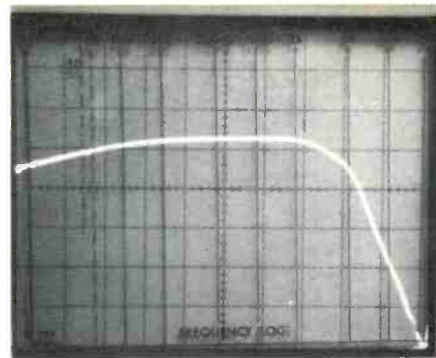

Fig. 4 —
AM frequency response.

receivers, with roll-off beginning at around 2.5 kHz. Sensitivity was good, however, thanks to the three-gang tuning capacitor and separate r.f. stage used in this circuit. Distortion was quite low, with readings of under 0.5 per cent for a 30 per cent modulation level at 1 kHz.

Power Amplifier Section Measurements

As readers of *Audio Magazine* are aware, the IHF (Institute of High Fidelity) has recently approved new Standard Methods of Measurement for Audio Amplifiers (See June, 1978, issue of *Audio*). We are gradually converting our test procedures to comply with these new standards. In order to permit valid comparisons between manufacturer's claimed performance and our test results, however, we will continue to offer "old" and "new" test readings, where applicable, until manufacturers have had an opportunity to convert their specification sheets to the new standards.

As for the power amplifier section of the SX-1980, it delivered 283 watts per channel of average continuous power into 8-ohm loads for the rated THD of 0.03 per cent. For rated IMD (0.03 per cent), equivalent power output was 302 watts per channel. At rated power (270 watts per channel), THD measured a very low

0.006 per cent, while IM (using the SMPTE method) was 0.017 per cent. FTC-rated continuous power measured 276 watts, and power band for rated power extended from 14 Hz to 20 kHz. Low-frequency damping factor (measured at 50 Hz) was 40, as claimed. Dynamic headroom measured 2.3 dB. Power output (for a 1-kHz test signal) versus distortion-plus-noise and IMD is plotted in Fig. 5, while distortion versus frequency at rated output is graphed in Fig. 6.

Preamplifier and Control Section Measurements

RIAA equalization was among the most accurate we have measured for any receiver, remaining within ± 0.1 dB of the prescribed playback curve from 30 Hz to 15 kHz. Phono input overload (for a 1-kHz test signal) measured 330 millivolts. Signal-to-noise referred to actual input sensitivity and full output ("A" weighted) was 87 dB while, using the new IHF method (5-mV in and 1-watt output) with an "A" weighting filter, the S/N became 79 dB. Weighted S/N using rated output as a reference and applying 140 mV with volume control at full measured 107 dB. Using a 0.5-V input and 1-watt output as a reference, the S/N measured 80 dB. Residual hum and noise ("A" weighted) with volume control at minimum,

...other features of the unique SHURE/SME Series III precision pickup arm:

- Unique balance system enables cartridges weighing 0 to 12 grams to be operated under conditions of minimum inertia.
- Interchangeable integral carrying arm replaces conventional tone arm and shell.
- Positive rack and pinion overhang adjustment.
- Main pillar hardened and ground.
- Low friction pivots, vertical axis: high precision fully protected ball races. Horizontal axis: knife edges. Less than .02 gram applied at the stylus will deflect the arm!
- Vertical and horizontal bearing axes intersect at stylus level for minimum warp-wow.
- Precise tracking force up to 2.5 grams can be applied without a tracking force gauge.

- Bias (antiskating) with fine adjustment.
- Longitudinal and lateral balance with fine adjustment.
- Ultra low-distortion geometry.
- Fluid-damped lowering and raising control.
- All electrical contacts heavily gold-plated.
- Superb camera finish throughout.
- 1978 Design Award from the British Design Council.



Send for complete brochure AL579:

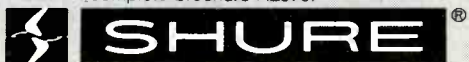

Shure Brothers Inc., 222 Hartrey Ave., Evanston, IL 60204 In Canada: A. C. Simmonds & Sons Limited
 Manufacturers of high fidelity components, microphones, sound systems and related circuitry.

Enter No. 27 on Reader Service Card

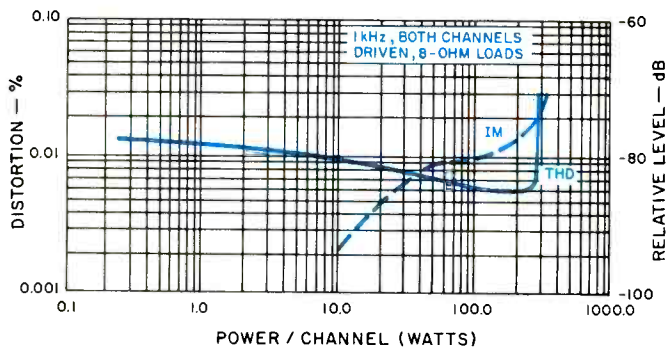

Fig. 5 — Power output vs. distortion.

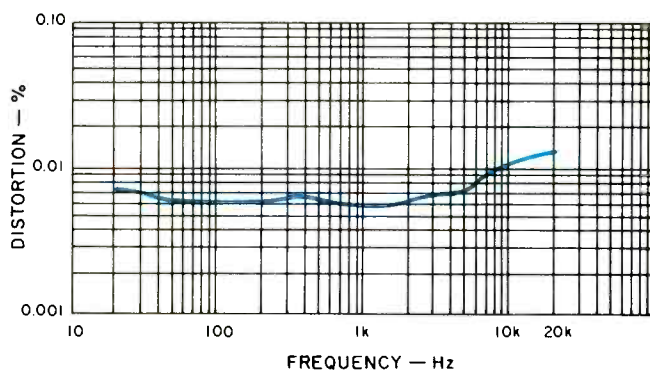

Fig. 6. — Distortion vs. frequency in the amplifier section.

referred to 1 watt, measured 84 dB, corresponding to 108 dB below full rated output. Overall frequency response via the AUX inputs extended from 3.5 Hz to 110 kHz for the -3-dB roll-off points.

Main- and sub-tone control characteristics of the SX-1980 are plotted in the 'scope photos of Figs. 7 and 8. It should be noted that each of these bass and treble controls operates independently, so that combined use of both is not only possible but provides a very great variety of tonal settings to meet acoustic needs of the listening room and to compensate for subtle deficiencies in speaker or other component response. If there is one clear advantage in having the enormous power capabilities of the SX-1980 available, it is the ability to apply as much or as little bass or treble boost as one deems necessary without having to worry about amplifier overload, even when using relatively inefficient speaker systems. Needless to say, however, extreme use of the controls (and especially the "main" treble control) could lead to tweeter failure at high power levels, since most tweeters cannot sustain the kind of power levels deliverable by this receiver.

The sub-sonic filter characteristics are not visible in the sweep-frequency plot of Fig. 9 because the range of sweep on our spectrum analyzer extends from 20 Hz to 20 kHz, whereas the sub-sonic filter begins to act just below the 20-Hz low-frequency extreme. The sharp action of the high-cut filter, however, confirms its 12 dB/octave characteristic and is seen to be optimized at a suitable cutoff frequency to effectively reduce high-frequency hiss without seriously impinging upon musical fundamentals. Nor is the response of this high-cut filter redundant with any of the possible cut positions of either the main or sub-treble controls. Figure 10 is a display of the action of the loudness circuit which is typical of those found in most receivers and of somewhat questionable usefulness, since no means is provided for setting desirable input levels from either the phono or the auxiliary inputs to provide meaningful and correct loudness compensation. Still, for those who prefer this kind of bass and treble boosted lower level listening, there it is.

Use and Listening Tests

Calibration of the FM dial scale was almost perfect, with a maximum error of only 50 kHz observed at the 88 MHz extreme. Station reception was limited only by the quality of the transmission and program material. We found the audible multipath indicator to be extremely effective in reducing this form of interference and insuring proper antenna orientation. Happily, the "quartz lock" feature (unlike some others we have tested) is perfectly aligned with respect to the i.f. and detector system so that it can remain in use (it is defeatable when the muting button is depressed) even for weaker stations and provides tuning which results in lowest measured distortion at all frequencies on the FM dial.

Though Pioneer does not make too much of a point regarding their variable capacitance and resistance selector associated with the phono input, in the course of our listening tests we came to regard this as a very important feature indeed. It is surprising how few people realize the importance of proper cartridge loading for best pickup response and tonal quality. Even those who do seldom bother to add the required amount of capacitance across their phono cartridge terminals. We used several cartridges in our listening tests and, aside from variations in tracking ability, were pleased at how "close" they sounded to each other once we selected the correct cartridge load.

As for overall sound quality of the amplifier/preamplifier combination, it was without serious fault. Transient reproduction was as good as that we have heard on some of the finest separate d.c.-configured power amplifiers and integrated amps. Hum and noise in phono were well below program-source's residual noise, making the dynamic range capability of the receiver awesome to hear. While I can think of few instances in which I would actually require 270-plus watts of continuous power per channel, I can imagine that there are instances in which multiple speaker operation in more than one room (or even stacking double pairs of speakers in a single listening room) might justify such power levels for home listening.

74

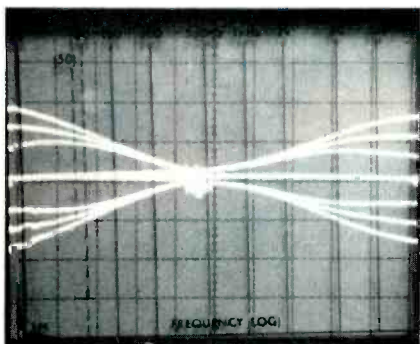

Fig. 7 — Range of main bass and treble controls.

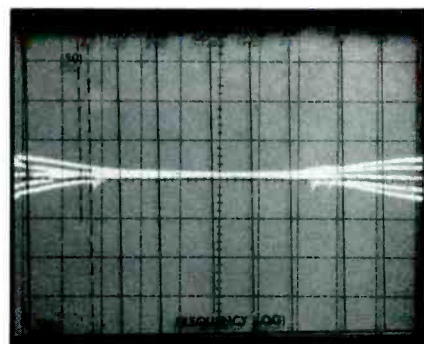

Fig. 8 — Range of secondary bass and treble controls.

THE INSIDE STORY ON HOW TO IMPROVE YOUR HEARING.

AA-1200 AM/FM Stereo Receiver:

Continuous Power Output of 120 Watts/Channel Min. RMS at 8 ohms from 20 to 20,000 Hz with no more than 0.08% Total Harmonic Distortion, Separate Watt Meters with 3 Watt and 100 Watt Ranges (Switchable), 2 Tape Inputs, 1 Phono Input, 3 AC Outlets, Separate Bass, Midrange and Treble Controls, Dual Power Supply for Reduced Transient Crosstalk.

FM Sensitivity (IHF) — 1.7 μ V; FM Selectivity (IHF) — More than 80 dB; Stereo Separation — More than 42 dB at 1 kHz.

AA-1175 AM/FM Stereo Receiver:

Continuous Power Output of 75 Watts/Channel Min. RMS at 8 ohms from 20 to 20,000 Hz with no more than 0.08% Total Harmonic Distortion, 2 Tape Inputs, 1 Phono Input, 3 AC Outlets, Separate Tuning and Signal Strength Meters, High and Low Frequency Filters, Separate Bass, Midrange and Treble Controls, Dual Power Supply for Reduced Transient Crosstalk.

FM Sensitivity (IHF) — 1.7 μ V; FM Selectivity (IHF) — More than 80 dB; Stereo Separation — More than 42 dB at 1 kHz.

AA-1150 AM/FM Stereo Receiver:

Continuous Power Output of 50 Watts/Channel Min. RMS at 8 ohms from 20 to 20,000 Hz with no more than 0.1% Total Harmonic Distortion, 2 Tape Inputs, 1 Phono Input, 2 AC Outlets, High and Low Frequency Filters, Separate Tuning and Signal Strength Meters, Tape Dubbing Facilities and Tape Monitors.

FM Sensitivity (IHF) — 1.8 μ V; FM Selectivity (IHF) — More than 70 dB; Stereo Separation — More than 42 dB at 1 kHz.

AA-1135 AM/FM Stereo Receiver:

Continuous Power Output of 35 Watts/Channel Min. RMS at 8 ohms from 20 to 20,000 Hz with no more than 0.2% Total Harmonic Distortion, 2 Tape Inputs, 1 Phono Input, 2 AC Outlets, Tape Dubbing Facilities and Tape Monitors, FM Mute Switch.

FM Sensitivity (IHF) — 1.8 μ V; FM Selectivity (IHF) — More than 70 dB; Stereo Separation — More than 40 dB at 1 kHz.

AA-1125 AM/FM Stereo Receiver:

Continuous Power Output of 25 Watts/Channel Min. RMS at 8 ohms from 20 to 20,000 Hz with no more than 0.3% Total Harmonic Distortion, 2 Tape Inputs, 1 Phono Input, Phase Lock Loop Multiplex Section.

FM Sensitivity (IHF) — 1.9 μ V; FM Selectivity (IHF) — More than 70 dB; Stereo Separation — More than 40 dB at 1 kHz.

AA-1115 AM/FM Stereo Receiver:

Continuous Power Output of 15 Watts/Channel Min. RMS at 8 ohms from 40 to 20,000 Hz with no more than 0.5% Total Harmonic Distortion, Phase Lock Loop Multiplex Section, Tape Monitor, Speaker Selector Buttons for 2 Sets of Speakers, Tape Dubbing, Loudness Switch, Enumerated Bass and Treble Balance and Volume Controls.

FM Sensitivity (IHF) — 1.9 μ V; FM Selectivity (IHF) — More than 60 dB; Stereo Separation — More than 40 dB at 1 kHz.

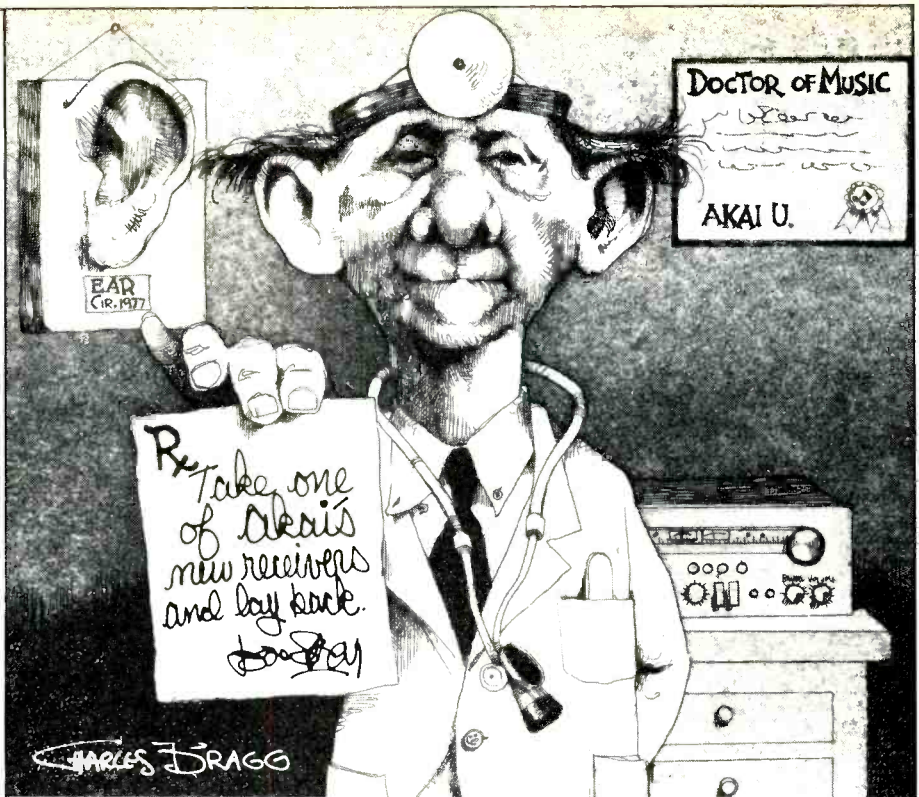

INTRODUCING SIX WAYS TO IMPROVE YOUR HEARING.

75

AKAI introduces just what the doctor ordered to improve your hearing: six great-sounding receivers that put real heart into your system, whether you listen to tape, records or FM.

Choose from six power ranges — 15 to 120 watts per channel — with prices you can afford. So now, no matter what receiver you want — a good basic unit or a unit with all the features an audiophile demands — AKAI's for you. You can feel confident that dollar for dollar, spec for spec, you're getting the true-to-life sound you expect from the name AKAI. And a receiver that delivers better tuner

sensitivity and less distortion at all volume levels is what a good receiver is all about.

Compare performance, features, design and value at your AKAI dealer. And start hearing what you've been missing.

Model	Watts/RMS	OHMS	Power Bandwidth	Total Harmonic Distortion
AA-1115	15	8	40-20,000 Hz	no more than 0.5%
AA-1125	25	8	20-20,000 Hz	no more than 0.3%
AA-1135	35	8	20-20,000 Hz	no more than 0.2%
AA-1150	50	8	20-20,000 Hz	no more than 0.1%
AA-1175	75	8	20-20,000 Hz	no more than 0.08%
AA-1200	120	8	20-20,000 Hz	no more than 0.08%

AKAI

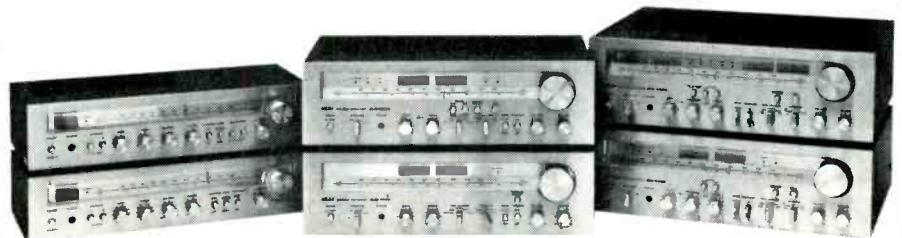

ART COLLECTORS:

For an 18" x 24" reproduction of this Charles Bragg etching suitable for framing, send \$2 to AKAI, Dept. DC, P.O. Box 6010, Compton, CA 90224. ATTN: Doctor.

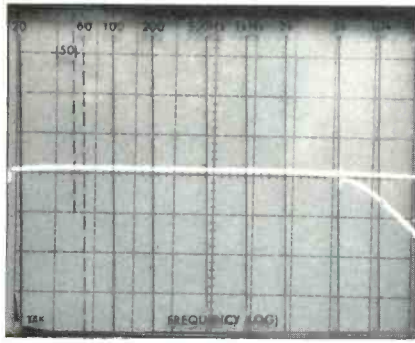

Fig. 9 —
Response of the high-cut filter.

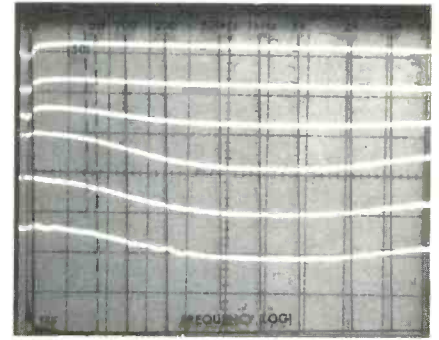

Fig. 10 —
Response of the loudness control
at various levels.

Thumbing through a recent listing of popular home loudspeaker systems, I found relatively few that could handle this power level without being damaged. This suggests that speaker fusing would be important if you plan to use this receiver with anything but those few speakers that can take in excess of 300 watts of raw power without going up in smoke. Don't depend upon the built-in power meters to warn you of excessive power levels to the speakers, since they are strictly average-reading devices calibrated in terms of 8-ohm resistive loads. Even "8-ohm" speakers can exhibit impedances well below their nominal values at several frequencies at which time the "voltage" read by the meters would produce far more power than is indicated. Though the new "Dynamic Head-

room" measurement is specified in dB, it should be mentioned that based upon the short-term signal used to measure the 2.3 dB headroom of this amplifier, it was producing nearly 460 watts of short-term power under these test conditions!

In summary, the chief appeal of the SX-1980, to me, is not its enormous power capability, but rather its excellent tuner circuitry (at least in the FM section), its enormous control flexibility, and the overall sound quality which it delivered during more than a week of solid listening tests. If Pioneer wants to engage in the power race, I am at least pleased to see that in doing so they have not sacrificed the more important characteristics of receiver design.

Leonard Feldman

Enter No. 90 on Reader Service Card

It's what's up front that counts

Every cartridge sounds best with the right load. But who worries about that little detail? We do. That's why the AGI 511A has convenient sockets for cartridge loading capacitors. The sonic improvement with the right ones may shock you.

Eliminating RFI problems can make a big improvement, too. It's the fast RF you don't hear that can cause slewing induced distortion you will hear—the result of an amplifier responding slower than its input signal. Only the 511A has an ultra-high speed preamp—250 V/ μ s—that solves this problem. RFI is then passively

filtered at the output, where it can't affect the cartridge, to avoid problems in later stages. Other designs have to reduce RFI with an input filter, but this compromises cartridge loading.

AGI's unique bi-amp design optimizes two amplifiers in different performance areas, combining the advantages of both. Result: the noise and distortion of the best conventional designs, plus an order of magnitude faster slew rate.

Remember, it's what's up front that counts, for the benefit of what goes out the back, jack.

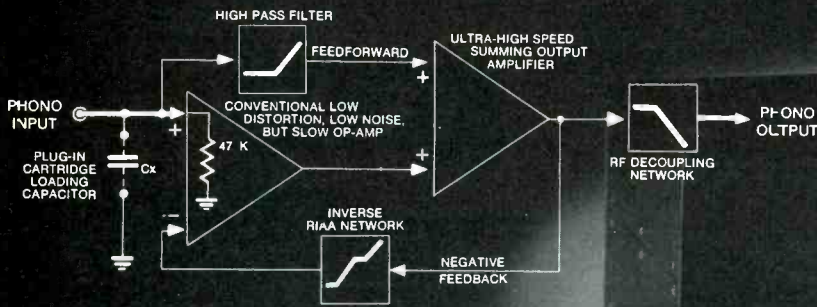

AGI BI-AMPLIFIED PHONO STAGE



Write for the full story—there's lots more
AUDIO GENERAL
Dept. A-9, 1631 Easton Road, Willow Grove, Pa. 19090

Enter No. 57 on Reader Service Card



The most powerful argument for our new receiver is not just power.



True, it's tempting to be swept up by our power.

150 watts per channel minimum RMS at 8 ohms, from 20Hz to 20kHz, with no more than 0.07% Total Harmonic Distortion, is nothing to sneeze at.

But raw power means nothing. What's important is how that power is delivered. In the case of the STR-V7, it's brought to you by Sony in a very classy package.

You get a combination of features and controls that are impressive on their own—but almost unheard of in a single machine.

To start with, we've built in a Dolby system, for decoding Dolbyized FM broadcasts.

The advantages of our tuner,

though, need no decoding. They include a normal and narrow FM IF bandwidth selector. It makes life simple for people in areas where their signals are crowded together elbow to elbow.

In our preamp section, the V7 comes equipped with a special phono EQ circuitry. Thanks to Sony's high IQ, it allows for direct connection of a low-output, moving-coil cartridge phono source. Without calling for an external step-up transformer or pre-preamp.

When you're gifted with as much power as the V7, you need a way to keep track of it. This receiver keeps tabs with two power-output meters, monitoring the power being fed to the speakers. So overload can't result from oversight.

And all that power comes from our direct coupled DC power amp. And our power is stable, thanks to a high-efficiency, high regulation toroidal-coil transformer.

There's a lot more to the STR-V7 than power. This receiver takes the best that contemporary technology has to offer, and offers it in a single machine.

Other manufacturers may have the power to bring you power. But only Sony has the power to bring you more than just power.

SONY[®] AUDIO

© 1978 Sony Industries, a division of Sony Corp. of America, 9 West 57, N.Y., N.Y. 10019. Sony is a trademark of Sony Corp.

Enter No. 29 on Reader Service Card

McIntosh Model C-27 Stereo Preamp



MANUFACTURER'S SPECIFICATIONS

78

Rated Outputs: Main, 2.5 V (maximum greater than 10 V) into 22-kilohm or greater load; Tape, 0.25 V (maximum greater than 10 V) into 22-kilohm or greater load, and Center Channel (L + R) 2.5 V into 22-kilohm or greater load.

Input Sensitivities: High Level, 250mV @ 100 kilohms, and Low Level (Phono 1 & 2), 2 mV @ 47 kilohms and 100 pF.

Frequency Response (any input): 20 Hz to 20 kHz, +0, -0.5 dB.

Hum and Noise: Phono, 80 dB below 10 mV input unweighted, 85 dB IHF "A" weighted; High Level, 85 dB unweighted, 90 dB IHF "A" weighted.

Dimensions: Front panel, 16 in. (40.6 cm) W x 5 7/16 in. (13.8 cm) H. Chassis, 15 in. (38.1 cm) W x 5 in. (12.7 cm) H x

13 in. (33 cm) D, including PANLOC shelf and back-panel connectors. Required knob clearance in front of mounting panel is 1 1/2 in. (3.8 cm).

Weight: 20 lbs. (9.1 kg).

Power Requirements: 120 V, 50/60 Hz.

Price: \$749.00.

The venerable firm of McIntosh Laboratory, Inc., seems intent upon changing at least part of its corporate image. Whereas "Mac" has, in the past, been extremely slow to introduce new products, they presently seem to be engaged in a major engineering effort aimed at bringing forth several new audio component products annually. It is barely a year since we tested and reported on their *ne plus ultra* C-32 preamp and yet, here we have another new preamplifier, the Model C-27, which seems destined to replace the long-lived C-28 preamp that has been around for several years. While the C-27 retains the familiar

front-panel look which instantly identifies the unit as a McIntosh product, internal circuitry is brand new — from the preamp equalizer section to the audio output stages.

The C-27 falls somewhere between the two extremes of control-chassis design philosophy. It is neither a "straight wire with gain" design (which generally eliminates just about every control but volume and program selection) nor is it a "no holds barred" design replete with every tone-tailoring and signal-processing circuit imaginable. Rather, the C-27 takes a mid-course approach, providing those controls and switching functions



"I'm very impressed with the way Radio Shack has translated latest technology into good looks and precision record playing in the 400."

Peter Nero
Composer/
Pianist

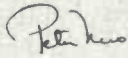
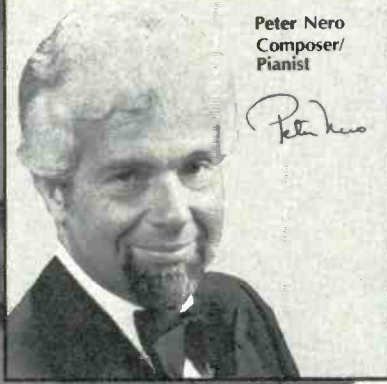
"Direct" to you from Radio Shack

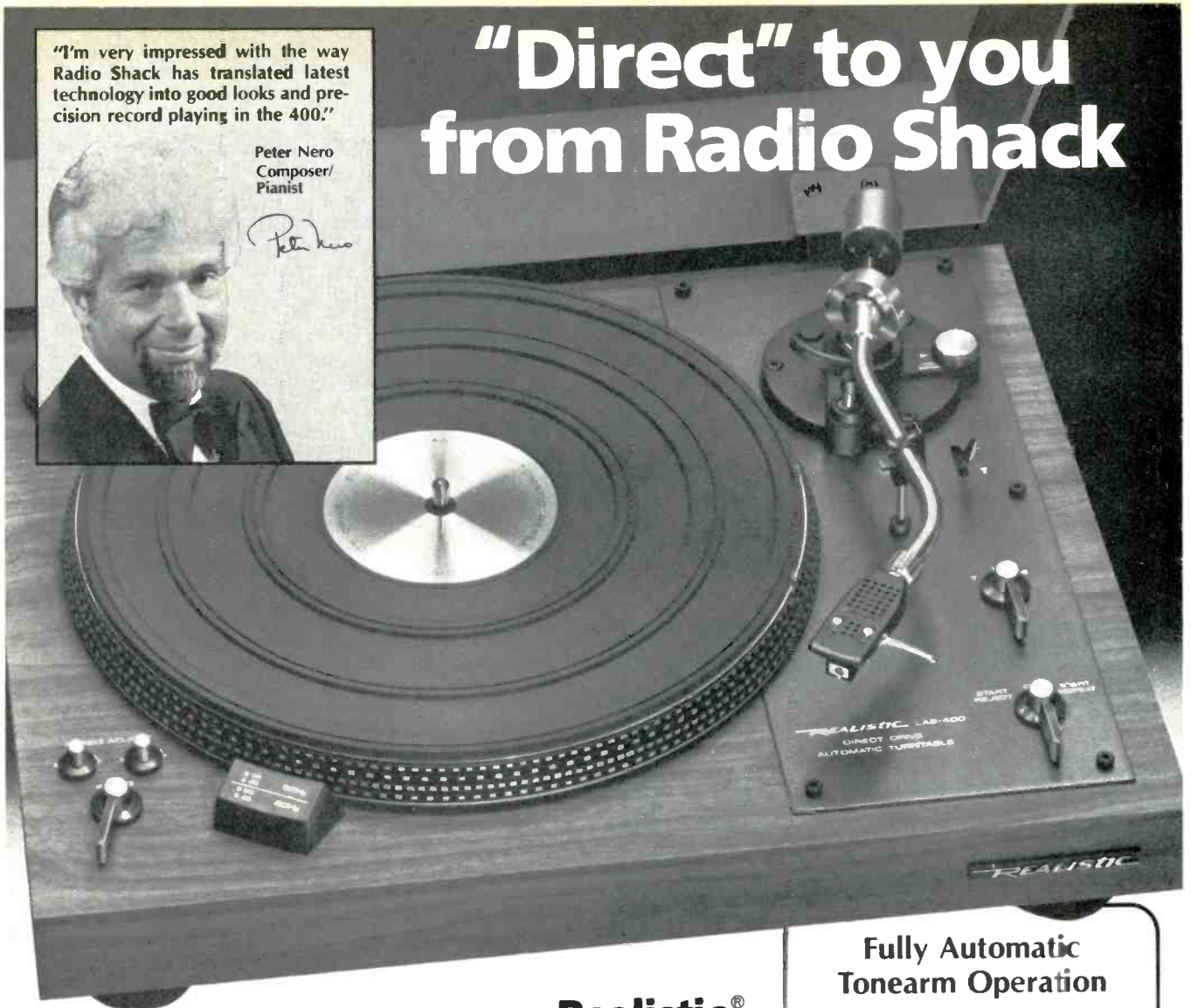

Realistic® Direct-Drive Automatic . . . Finest Turntable We've Ever Offered

Two motors, damped cue/pause, S-shape tonearm, speed controls, \$39.95-value Realistic/Shure cartridge

The LAB-400 makes studio performance both affordable and convenient. Its massive die-cast platter rests directly atop a 16-pole brushless DC servomotor. The platter and motor rotate at the same speed, either 33 $\frac{1}{3}$ or 45 RPM — no idler wheels, reduction gears or belts to alter the music that's stored in your record's grooves. The result: wow and flutter is less than 0.03% WRMS and rumble is better than -63 dB (DIN B). The fully automatic tonearm has an effective length of 8 $\frac{1}{16}$ ", for flawless tracking down to $\frac{1}{2}$ gram. Handsome walnut vinyl veneer base with ultra-modern, slim design. Elliptical-stylus magnetic cartridge and detachable hinged dust cover — significant "extras" that aren't extra. All for \$199.95.*



FREE! New '79 Catalog

Come in for your copy and see what's really new in electronics. Bigger than ever! 176 pages, over 100 in full color. 2000 exclusive items.

* Price may vary at individual stores and dealers.

Fully Automatic Tonearm Operation

You need never touch the tonearm — just select record size and push start switch. An independent motor does the rest, cueing the arm, gently lowering it onto the record, and removing it at disc's end. With repeat mode, cue/pause, anti-skate and tracking force controls.



Two speeds with controls for $\pm 4\%$ pitch adjustment.



Neon light with strobe disc for checking speed.



Low-profile styling with precision shock-mounts to stop acoustic feedback.

Radio Shack®

A DIVISION OF TANDY CORPORATION • FORT WORTH, TEXAS 76102
OVER 7000 LOCATIONS IN NINE COUNTRIES

which are deemed most important by those audiophiles who are honest enough to admit that perhaps their listening environment is not acoustically perfect and that, perhaps, even their speaker systems are not flat from d.c. to Channel 5. Rather than forego tone controls and cut-off filters, such audio buffs prefer to have these facilities in a control unit providing their presence in the signal path does not introduce any new form of distortion.

While the C-27 pictured here is shown mounted in an optionally available wood cabinet, McIntosh's familiar *Panloc* mounting arrangement makes for easy mounting of the unit into a wood-panel furniture cabinet or shelf, with the usual metal brackets and needed hardware supplied as part of the package. The front panel exceeds chassis size in both of its dimensions, which makes for a non-critical panel cutout for custom installations. The front panel of the C-27 is anodized gold and black with McIntosh's familiar gold-teal blue panel nomenclature illumination which magically appears when power is applied. Rotary controls along the top of the panel include a five-position program input selector (*AUX 1, AUX 2, Tuner, Phono 1, and Phono 2*), a mode selector (left or right to both outputs, stereo reverse,

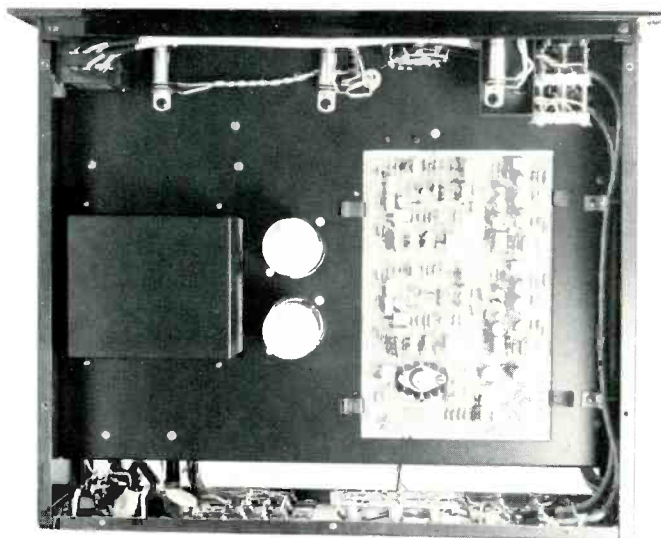

Completing the panel layout is a group of pushbuttons and a headphone jack at the lower left. The buttons, five in all, take care of the two tape-monitor circuits and provide tape dubbing from either of two connected tape decks to the other. The final button turns on power to the unit and has an illuminated rectangle just above it to indicate that power is on.

Adjacent to the four switched and one unswitched convenience a.c. receptacles on the rear panel are three sets of spring-loaded terminals which require only that the stripped ends of power amplifier and speaker connecting cables be inserted into the small holes exposed when the terminal keys are depressed. It is this arrangement which brings speaker switching capability to the front panel of the C-27, and a handy feature it is too since most high-quality basic power amplifiers are normally equipped with only one set of speaker terminals. The right portion of the rear panel is equipped with the necessary phono-tip jacks for signal inputs, tape-in and tape-out circuits, two pairs of main output jacks (in case you want to feed two separate power amplifiers) and a "center channel" output for feeding the sum (L + R) of both channels to a separate monophonic power amplifier for background music in an alternate location or for powering a center-channel speaker system in the main listening area. A 0.5 ampere line fuse holder completes the rear panel layout.

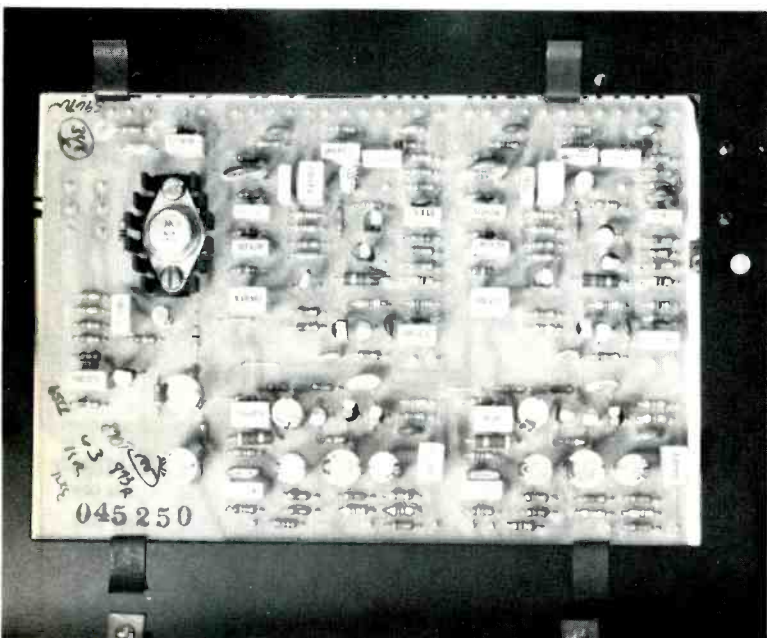

Fig. 1 — Close-up view of the major P.C. board of the McIntosh C-27 preamplifier.

stereo, L + R mono, left plus right to left or right outputs) and, at the extreme right, the master volume control. The four rotary control sets at the lower right of the panel are dual concentric types. The first of these introduces, singly or in combination, the high- and low-cut filters and selects either or both sets of loudspeakers which can be switched via the front panel providing the power amplifier's outputs are connected to the rear of the C-27 instead of directly to the speakers. Bass and treble tone controls permit tonal tailoring of each channel separately, while the right-most control in this group is a combination balance and loudness control. The loudness control of the C-27 works a bit differently from that in the C-32. The user is instructed to set the volume control for maximum lifelike listening levels while the loudness knob is set to its "flat" (counterclockwise) position. Then, for lower listening levels, the *loudness* control is rotated (rather than the volume control) and proper Fletcher-Munson compensation is introduced as listening levels are lowered to the desired level.

Circuit Highlights

A second internal view of the C-27 chassis is pictured in Fig. 1, a detailed view of the major circuit board which contains all of the active audio signal handling circuitry, including the preamplifier-equalizer low level stages. Smaller PC modules include the pushbutton switch circuits, input terminal boards, a switch indicator circuit board (for illuminating the front panel LEDs which light up when tape monitoring or tape copying is employed), and a power supply module. Signal paths can be traced by consulting the block diagram of Fig. 2. The input selector routes the different input signals within the C-27. Isolating networks are present at each high-level input and shorting-switch contacts ground unused inputs. The isolating networks also block any d.c. voltages that might be present, preventing pops or clicks when changing inputs. The phono preamp section uses three selected transistors per channel. Low impedance components are used in the RIAA equalization network, drive for which is provided by the final stage which operates at an adequate current level to drive the low impedance without slew rate limiting. Isolating networks are included at each tape output and input. The volume control is a step-attenuator type having 32 steps

"Get everything that's coming to you!"

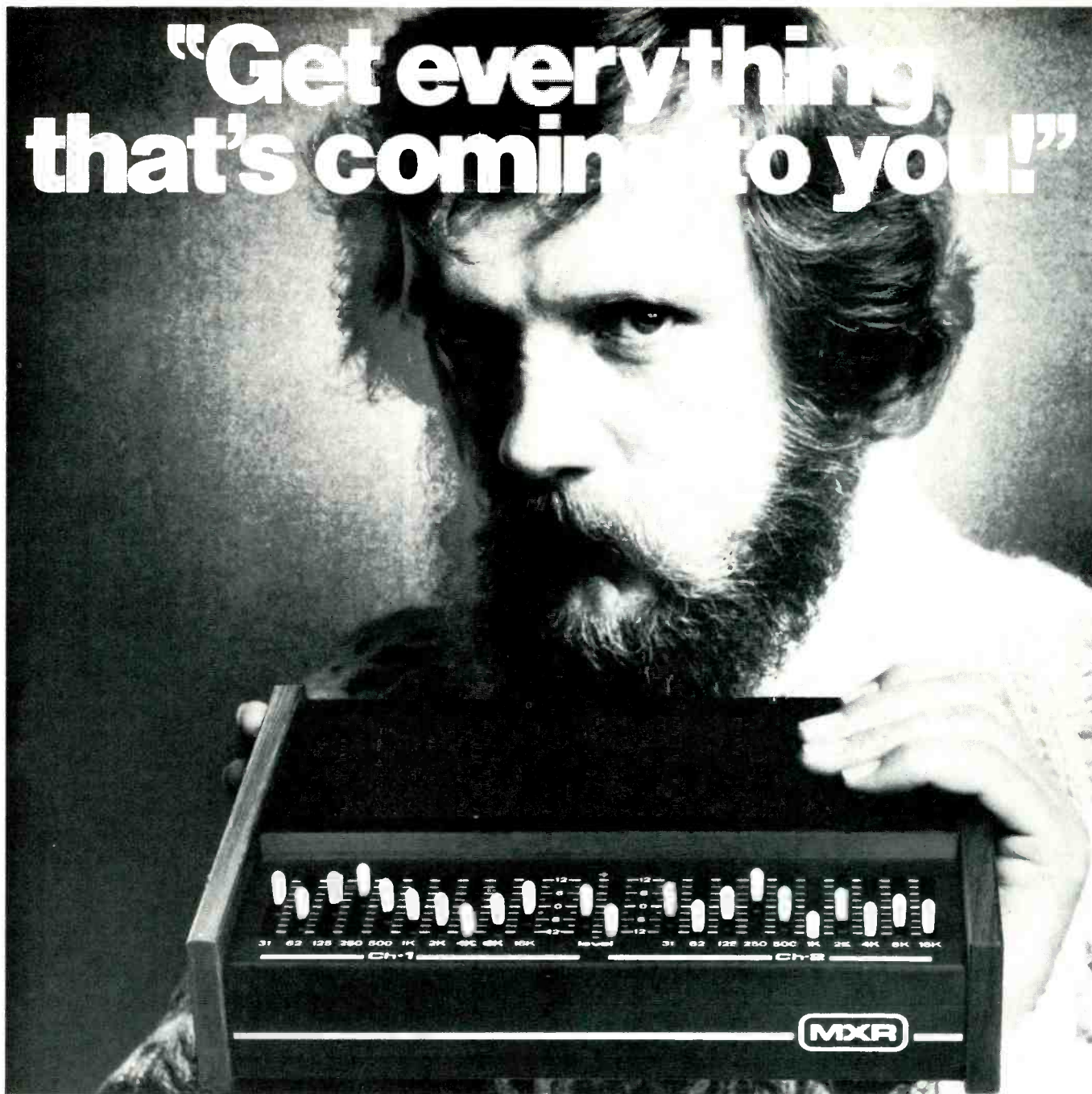

81

Everything but the effects of poor room acoustics, poor speakers or poor program quality with the MXR Stereo Graphic Equalizer.

You've got a room that's a lot like a sponge... rugs, drapes, overstuffed chairs. And every time you turn on your system, most of the aural glory gets soaked up. Or, you've bought a sound system that has an impressive price but alas, a depressing sound. Your records, tapes and radio sources may sound good to some, but to you, the high fidelity just isn't high enough. And you'd lose if you made a trade.

Get into control with the MXR Stereo Graphic Equalizer. It lets you tailor frequency responses and adjust acoustics to your desires. Control 10 frequencies plus level on each of two channels. Play with the lows, boost the mid-ranges, and soar with the highs. Bring each speaker closer, or move it

farther away at the touch of a slide control. The MXR Equalizer's frequency controls not only adjust for the interior of your room, but also for the interior of your system, making a small system sound big... a big system sound mammoth.

Built with the same ingenuity are our Compaander which enhances sound for home recording, and our new Dynamic Processor, which brings recorded dynamics to life and removes impulse noise. Hear the entire MXR line at fine audio dealers. Or write MXR Innovations, Inc., 247 N. Goodman St., Rochester, N.Y. 14607. Or call 716-442-5320.

Also distributed in Canada by White Electronic Development Corporation, 6300 Northam Drive, Mississauga, Ontario.

MXR Consumer Products Group

Enter No. 62 on Reader Service Card

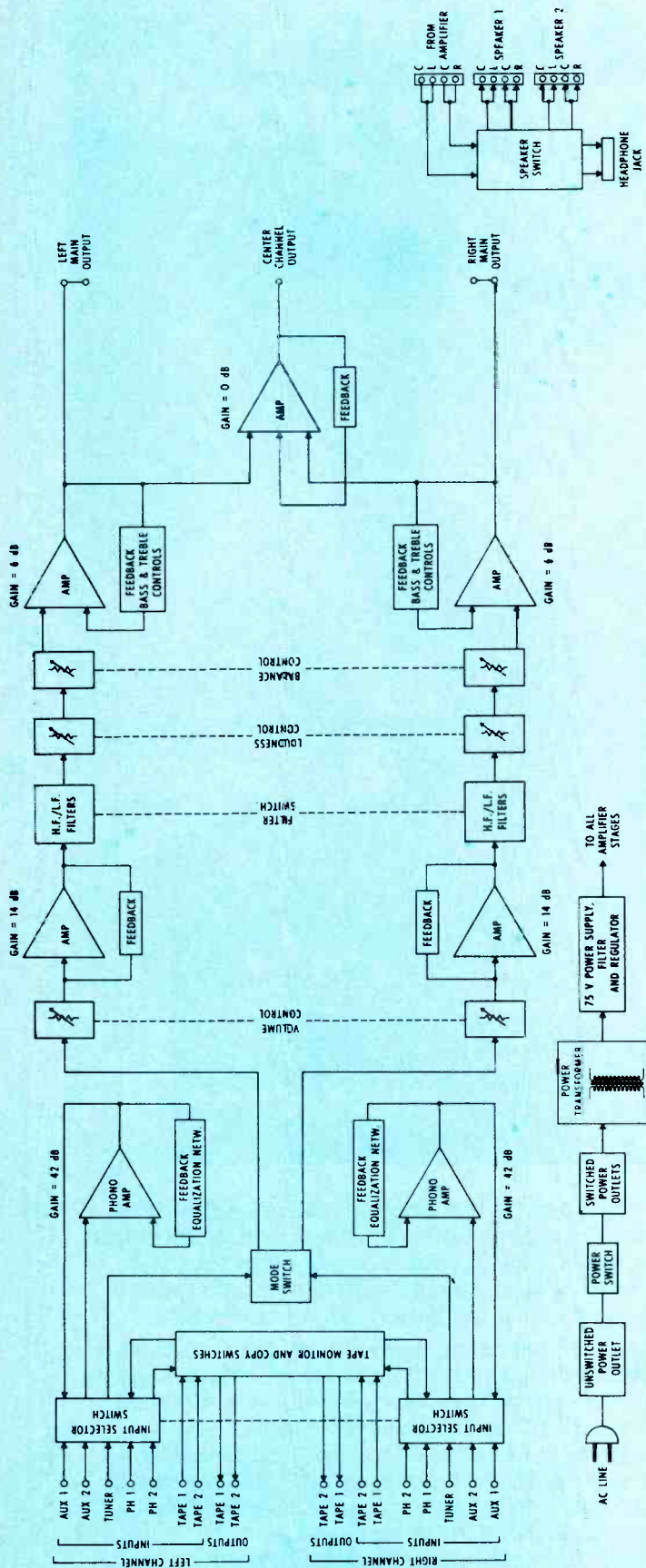

Fig. 2 — Block diagram of the C-27 circuits.

and 70 dB of range, plus a total attenuation position. A voltage gain stage follows the volume control and provides 14 dB of gain. High- and low-cut filters follow, with the signals then passed along to the loudness and balance control, and then to another gain stage for an additional 6 dB of amplification. This last gain section is used for the bass- and treble-control circuits and consists of a three-stage linear amplifier with tone controls included in a negative feedback circuit using precision capacitors and resistors for shaping the desired frequency response characteristics depending upon the setting of the tone controls. The output of this amplifier is fed to the two pairs of main output jacks.

The C-27 power transformer uses a grain-oriented, silicon-steel core, plus copper and magnetic steel shields to eliminate radiated magnetic hum fields. The power supply uses zener-diode reference voltage regulation and electronic filtering. Turn-on and turn-off time characteristics of the power supply are controlled to prevent switching transients. The total semiconductor complement of the C-27 includes 18 silicon-planar transistors, four silicon diodes, and five light-emitting diodes.

Laboratory Test Measurements

All of our measurements were made with respect to rated output (2.0 volts from the main output terminals) unless otherwise stated. We first studied the performance of the phono-equalizer section. Input sensitivity for rated output measured 2.3 millivolts for both phono inputs. Though McIntosh does not provide a "limit spec" for phono overload, we consider this to be an important specification. The phono inputs were able to handle signal levels of 135 millivolts at 1 kHz before noticeable first-stage distortion occurred — considerably more than is likely to be delivered even by a high-output cartridge tracing the most heavily-modulated record grooves. Signal to noise in phono, referred to a 10 mV input, measured 82 dB unweighted, increasing to 89 dB when an "A" weighting network was inserted in the path between the output and the measuring instruments.

A word is called for regarding the playback curve measured via the phono inputs as shown and photographed from the face of our spectrum analyzer's CRT tube. McIntosh has elected to adopt the new IEC standards for playback which call for an additional roll-off time constant of 7960 microseconds in addition to the three time constants normally prescribed for RIAA equalization. This final low-end roll-off makes sense, since it reduces needless amplification of turntable rumble components which serve no purpose other than to overload the bass power output capabilities of modern power amplifiers (especially those that have response down to "d.c.") and to cause speaker cones to fluctuate wildly, sending the voice coils into non-linear regions of operation. The final low-end roll-off or turnaround of the new curve is clearly visible in our scope photo of Fig. 3, and, although our frequency sweep extends only down to 20 Hz, the response continues to roll off below that frequency at a 6-dB-per-octave rate, exactly as prescribed by the new IEC standards. If you try to measure the phono response against the "old" RIAA curve, however, you will find that at 30 Hz it differs from the old prescribed point-by-point plot by approximately 1.3 dB. In terms of the IEC playback curve, the equalization of the C-27 was so accurate that it varied by no more than 0.1 dB at any of the remaining test points measured.

Figure 4 is a plot of distortion versus frequency (at rated output) via the high-level inputs, as observed at the main output terminals. Over the entire spectrum from 20 Hz to 20 kHz, harmonic distortion never exceeded 0.025 per cent and at mid frequencies it measured an extremely low 0.009 per cent. Since the distortion measured from the phono inputs to the tape outputs was even lower, we did not bother to plot these results since the high-level section would govern actual distortion of the output signals under actual use conditions. Though McIntosh does not quote IM distortion figures for the C-27, we neverthe-

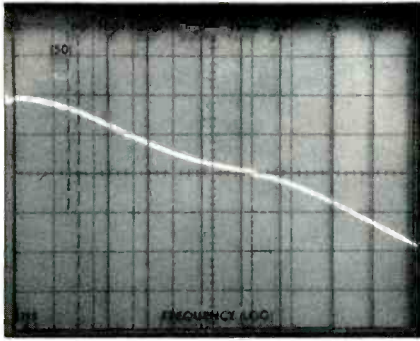

**Fig. 3 —
The RIAA
playback response.**

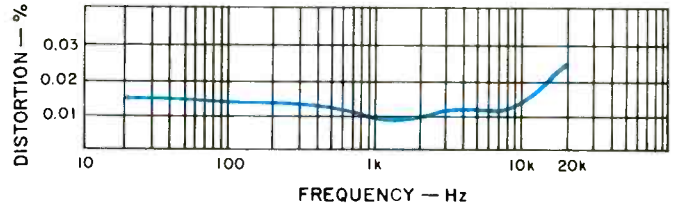

Fig. 4 — Distortion vs. frequency for the rated output of 2.0 volts (AUX input to Main outputs).

less measured this important parameter as well and, for rated equivalent output from the main output terminals, obtained a reading of just under 0.04 per cent. Maximum output obtained from the main output terminals was 10.0 volts for a rated figure of 0.05 per cent harmonic distortion.

Tone-control action of both the bass and treble controls is so precise and well calibrated that we decided to trace overall response for each of the 10 possible settings for each of those controls. The results are displayed in the 'scope photo of Fig. 5. Flat response is represented by the center curve of this series and was measured as flat within 0.5 dB from 10 Hz to 23 kHz. The ± 3 dB points in response occurred at 4 Hz and 60 kHz. Signal-to-noise ratio in the high level settings measured 86 dB below rated output, unweighted, and 92 dB with an "A" weighting network inserted, both figures exceeding specs published by McIntosh. Volume control tracking was found to be accurate from left to right channels within 0.2 dB from maximum settings down to a ± 70 dB level.

The action of the high- and low-cut filters is illustrated in the 'scope photos of Fig. 6. While the slope rates are clearly only 6 dB per octave (we prefer steeper slopes ourselves), McIntosh wisely set the cut-off points at sufficiently high and low frequencies (50 Hz for the low-cut and 5 kHz for the high-cut) so that their introduction into the signal path would not take too big a "bite" out of musical content or program sources that require "cleaning up" because of background hiss or low-frequency noise and rumble.

The action of the previously described loudness control is clearly illustrated in the three response plots shown in Fig. 7. Note that these curves were achieved with a constant setting of the master volume control and only the loudness control setting itself was varied, from one extreme to the other. Total level variation afforded by this control amounted to approximately 22 dB (each vertical division in Fig. 7, as well as in Figs. 3, 5, and 6 represents an amplitude difference of 10 dB).

Use and Listening Tests

All in all, McIntosh seems to have come up with a brand-new, carefully designed and constructed preamplifier/control unit that should mate nicely with better power amplifiers, speaker systems, and program-source components.

We played a variety of direct-to-disc records through the C-27 which was used to drive a high-quality 110-watt-per-channel stereo power amplifier which, in turn fed our reference loudspeakers. Response was balanced and uncolored and, using a reference tuner and our newly acquired Sound Technology 1100 signal processor, we were able to compare self-produced high-quality programming recovered from our reference tuner by feeding it first directly through the power amp and then through the combination of the C-27 and the power amp, with all gains equalized for identical sound levels. We were unable to detect any difference between the two modes of reproduction, affirming the fact that the "straight wire with gain" sound can be achieved even when tone controls are incorporated in a preamplifier.

The phone jack derives its power from the speaker outputs, which, as mentioned, can be connected at the rear of the C-27 (along with the power amplifier outputs) so that front panel speaker/headphone switching becomes possible. Users of the C-27 who own headphones will want to avail themselves of this feature even though a self-contained phone amplifier (provided in the more expensive C-32) is not incorporated in the C-27 and an "off" position on the C-27's speaker switch makes this form of listening possible and convenient.

By eliminating some (but not all) of the features of the higher-priced C-32, McIntosh has come up with what will undoubtedly be another long-lived preamplifier that will be affordable to a greater number of potential purchasers. In our opinion, its suggested price is not at all inconsistent with the level of performance it achieves or with its excellent and rugged design and construction features.

Leonard Feldman

Enter No. 92 on Reader Service Card

**Fig. 5 —
Tone control range
of the C-27.**

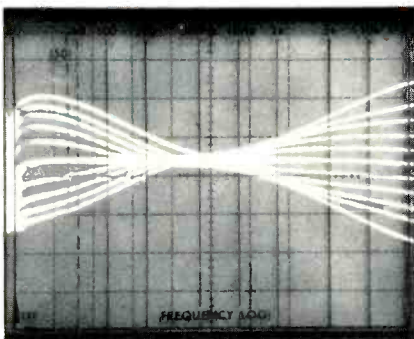

**Fig. 6 —
Low- and high-cut
filter response.**

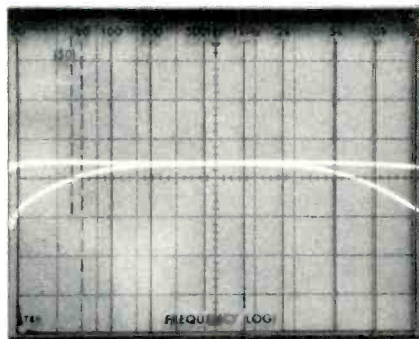

**Fig. 7 —
Action of the separate
loudness control.**

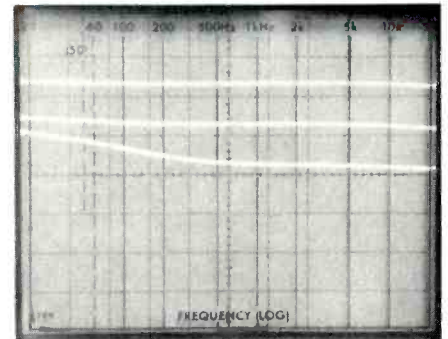



Studer ReVox Model B77 Open-Reel Tape Recorder

MANUFACTURER'S SPECIFICATIONS

Frequency Response: 30 Hz to 16 kHz @ 3 3/4 ips, 30 Hz to 20 kHz @ 7 1/2 ips.

Harmonic Distortion: 1 per cent @ 3 3/4 ips, and 0.6 per cent @ 7 1/2 ips.

S/N Ratio: 59 dBA @ 3 3/4 ips, 62 dBA @ 7 1/2 ips.

Crosstalk: -45 dB.

Erase: 75 dB

Input Sensitivity: Mike, Lo Z, 0.15 mV, Hi Z, 2.8 mV, Line 40 mV.

Overload Margin: 40 dB.

Output Level: Line, 1.55 V; Head-
phone, 5.6 V (open circuit) for 200- to
600-ohm phones.

Flutter: 0.1 per cent wtd. peak @ 3 3/4
ips, 0.08 per cent wtd. peak @ 7 1/2 ips.

Speed Tolerance: 0.2 per cent.

Wind Times: 135 seconds for 3600
feet.

Dimensions: 17.8 in. (45.2 cm) W x
16.3 in. (41.4 cm) H x 8.14 in. (20.7
cm) D.

Weight: 37.4 lbs. (17 kg).

Price: \$1295.00.

The Studer ReVox B77 open-reel recorder retains the advantages of the A77, eliminates limitations of the earlier models, and adds features of its own. (The A77 remains in the product line, at least for the time being.) The front-panel styling of this high-class audiophile recorder is similar to that of the professional A700 model. Interlocked push-button switches select speed, 3 3/4 or 7 1/2 ips. Below are the large-handle toggle switches for power and monitor selection and paralleled jacks for headphones. This can be a handy feature at times, providing a front-panel output in addition to one for a set of phones. The level at these jacks is controlled by a dual-section, slip-clutch pot, which does not affect the regular line outputs on the back panel. The

output selector switch, however, does affect all outputs including metering, and can be set for stereo, reverse stereo, left channel to both outputs, right channel to both outputs, and mono which combines the two channels and feeds the mix to all jacks. The choices provided with this switch facilitate a number of tasks without the need to change connections and use adapters. The smooth-acting input level pots have knobs of a good size, an improvement over those on the A77. Alongside are the record presets with a large status light above each switch, illuminated when the recording process starts. The large toggle handles are convenient, but were judged to be subject to inadvertent switching. The input selector switches have posi-



tions for both low- and high-impedance single-ended microphones, *Radio* (DIN), AUX, and for feeding in the output of the other channel for sound-on-sound recording. Mike inputs are standard phone jacks, and it might be noted that mike/line or other mixing is possible, if recording is done on just one channel.

The two level meters have even illumination and excellent legibility. The peak indicators are located in the meter faces which gives a continuous, no-effort display without diverting attention from the VU meters. The light-touch tape motion switches are logic controlled, and any order of commands will be followed, including *Pause* in a wind mode. Unfortunately, it does not latch in, and the button must be held for the duration of the pause. The logic also permits going into record from fast wind, as long as the record presets are in and *Play* is held until recording starts.

Behind a flip-down cover are the reel-size switch and the *Cue/Edit* slide switch, which puts the tape in contact with the heads from *Stop*. It is released by moving the pinch-roller arm or by going into play. When in *Cue/Edit*, fast-wind modes become momentary-contact controlled for any needed tape shuttling. Tape threading is quite straight-line, and there is notably more clearance than on the A77. There is easy access for cleaning and demagnetization and, with removal of the snap-on head assembly cover, alignment adjustments become immediately available. To the right is another aid to editing, a small splicing block with a built-in, shear-type cutter. The counter and its reset

have a slide-sync function. The carrying handle on the top of the high-impact polypropylene cabinet allows one-hand transporting for that live recording, very possible with the admirably low weight of 37.4 lbs. After removal of the four retaining screws, the recorder assembly on its rigid, box-girder frame was pulled out for inspection.

There are 10 PCBs with high-quality components, and all had excellent soldering. The overlay on the cover for the plug-ins was marked to show the location of adjustments behind the panel, but the parts on the cards themselves were not identified. Plug-type connections were used for most purposes, with a minimum of interconnection soldering. Many items conveyed the impression of ruggedness for long-term reliability, but the turntable and capstan motors along with the brake and play solenoids were most notable. The capstan frequency pick-off was rigidly mounted adjacent to the slots in the rotor shell, fundamental elements in the ReVox drive system which are basically immune to variations in line voltage or frequency.

Performance

The playback response of the B77 was within 2 dB at both speeds with the exception of 50 Hz at 7½ ips. The pink-noise/RTA checks showed that the record/playback responses were very good for Ampex 456, Maxell UD, Memorex Quantum, and TKD Audua, as well as with Scotch 206/207 for which the unit had been adjusted. Meter indications for the reference levels on the test tapes were very close, with the zero indication within 0.5

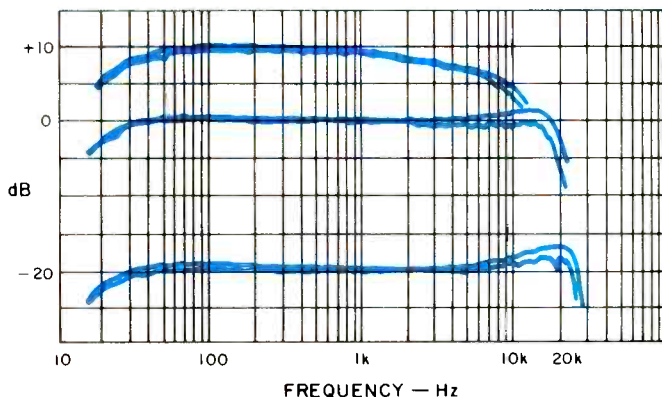

Fig. 1 — Record-playback response using Scotch 206 at 7½ ips. (Record 0 reference level is that for 200 nWb/m fluxivity at 1 kHz.)

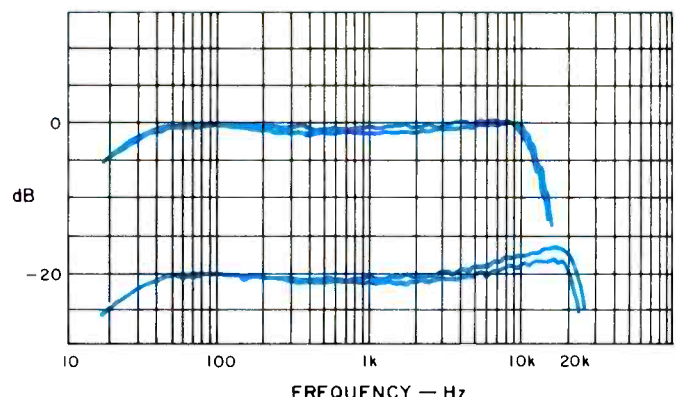

Fig. 2 — Record-playback response using Memorex Quantum at 3¾ ips. (Record 0 reference as above.)

are above the head assembly. The reel turntable shafts have spring-loaded retainers which work directly on small reels and will hold on the adapters required for large-hub 10½-inch reels.

The line-in/line-out phono jacks and their level-set pots on the back are clustered together with sockets for DIN-type systems and for optional remote controls for tape motion and capstan speed. The tape-motion control includes record and timer-start functions. The speed control, in conjunction with tape-speed selection, can provide speeds all the way from 2.5 to 11 ips. Just above are the voltage selector, a fuseholder, and the socket for the detachable power cord. With the addition of another plug-in module (not in the unit evaluated), the B77 can

dB of the 257 nWb/m ReVox specification. The reference record level used was that for 200 nWb/m fluxivity at 1000 Hz, which was about -1.5 dB on the meters. (Note that flux levels at other frequencies are different even when the record/playback response is perfectly flat.) The response with Scotch 206 at reference level and 7½ ips (Fig. 1) was within 3 dB from 17 Hz to 18 kHz for the left channel, to 20 kHz for the right. The responses 20 dB lower were from 16 Hz to 23.5 kHz (left) and 25.5 kHz (right). With the record level +10 dB, the -3 dB points were at 21 Hz and about 7 kHz. These results for Scotch 206 are not all that unusual at the high frequency end, but the smoothness over the entire frequency range is excellent indeed.

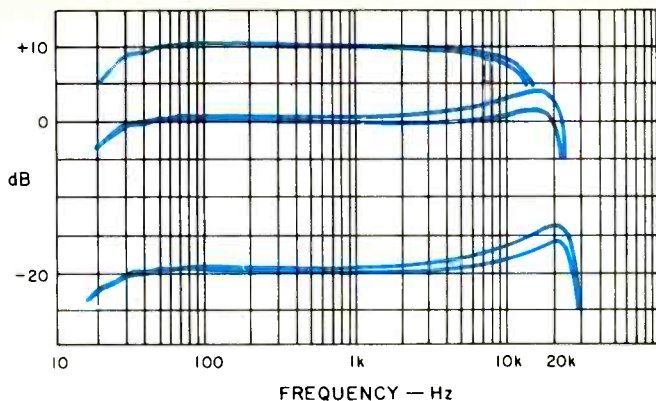

Fig. 3 — Record-playback response using Maxell UD at 7½ ips. (Record 0 reference as above.)

86 Studer ReVox claims for superior head design are graphically illustrated with the extended low-frequency response with just the slightest indication of head contour effects, superb performance. Similar plots were made using Memorex Quantum at 3¾ ips (Fig. 2). At reference level, response was from 20 Hz to 13 kHz. At the -20-dB record level, the upper limit moved out to 23.5 kHz (average), but there was a peak in the response around 17 kHz. With Maxell UD at 7½ ips, the responses extended further than with Scotch 206, but at the expense of excessive peaking at the highest frequencies (Fig. 3). This deviation could be reduced greatly with a slight increase in bias. The small discrepancies between the two channels could be eliminated in similar fashion. Studer ReVox, however, takes the position that bias switches or pots should not be readily accessible because of possible abuse by unqualified users. That is a valid point, but I suspect that the more technically oriented owners will drill access holes in the bottom of the cabinet, just as many have done with the A77s.

The playback of a recorded 10-kHz tone had a 30-degree phase discrepancy between channels, evidence of very good alignment between the heads. Phase jitter at 7½ ips was 15 degrees, also very good. The bias residual in the output was

down into tape noise, excellent design and adjustment. The playback of a recorded 1-kHz square wave had relatively small tilt (Fig. 4), another demonstration of the superb low-frequency response, and some short-duration ringing at the EQ peaking frequency. Some momentary, partial dropouts appeared in the stored waveform.

Plots were made of HDL₃ vs. record level for Scotch 206 at both speeds and Maxell UD at just 7½ ips (Fig. 5). On a dB-dB basis, the functions were the most linear ever measured, with just a slight upturn near the 3 per cent points. At the low end, HDL₃ continued to reduce to the noise limits of the test equipment, with little evidence of distortion in the electronics. From 30 Hz to 7 kHz, HDL₃ was very low, particularly at 10 dB below reference level. Throughout this entire range, other harmonics were consistently very low, excellent magnetic design. Signal-to-noise ratios with IEC "A" weighting at 7½ ips were 58.7 dBA for Scotch 206 and 59.3 dBA for Memorex Quantum at reference level, and 67.0 and 70.0 dBA for the same tapes for HDL₃ = 3 per cent. At 3¾ ips using the Memorex tape, the figures were 57.1 dBA at reference level and 65.2 dBA at the 3 per cent point. These are all excellent figures, and don't forget — without Dolby NR. With CCIR weighting, the relative results were the

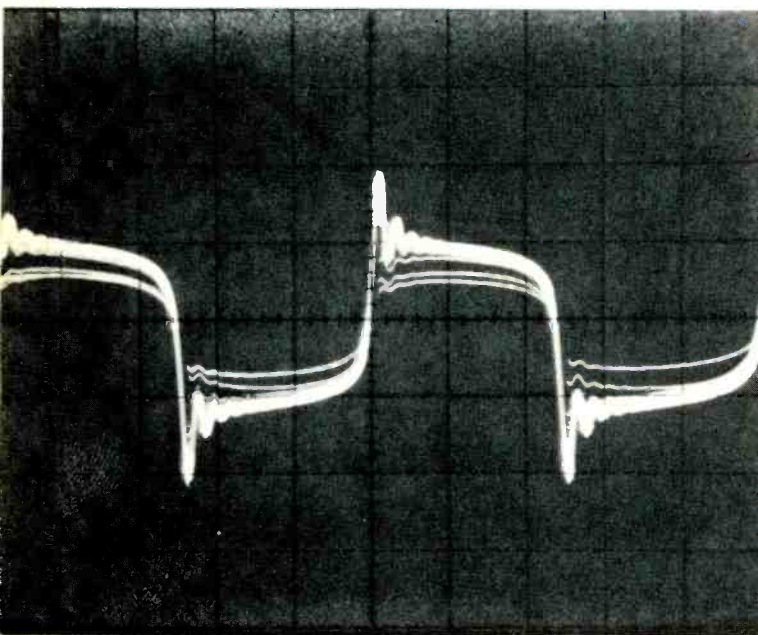
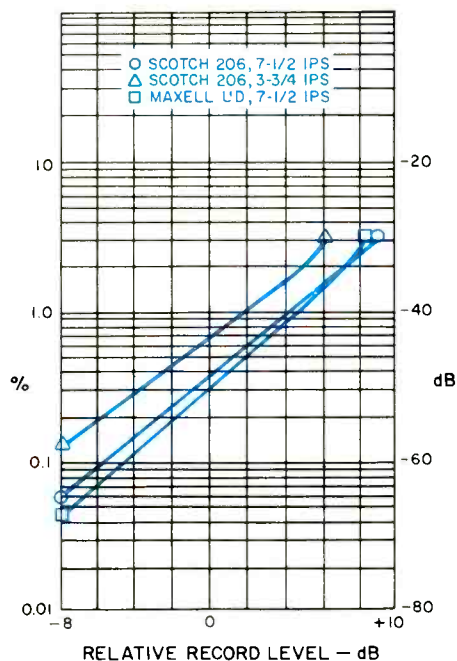
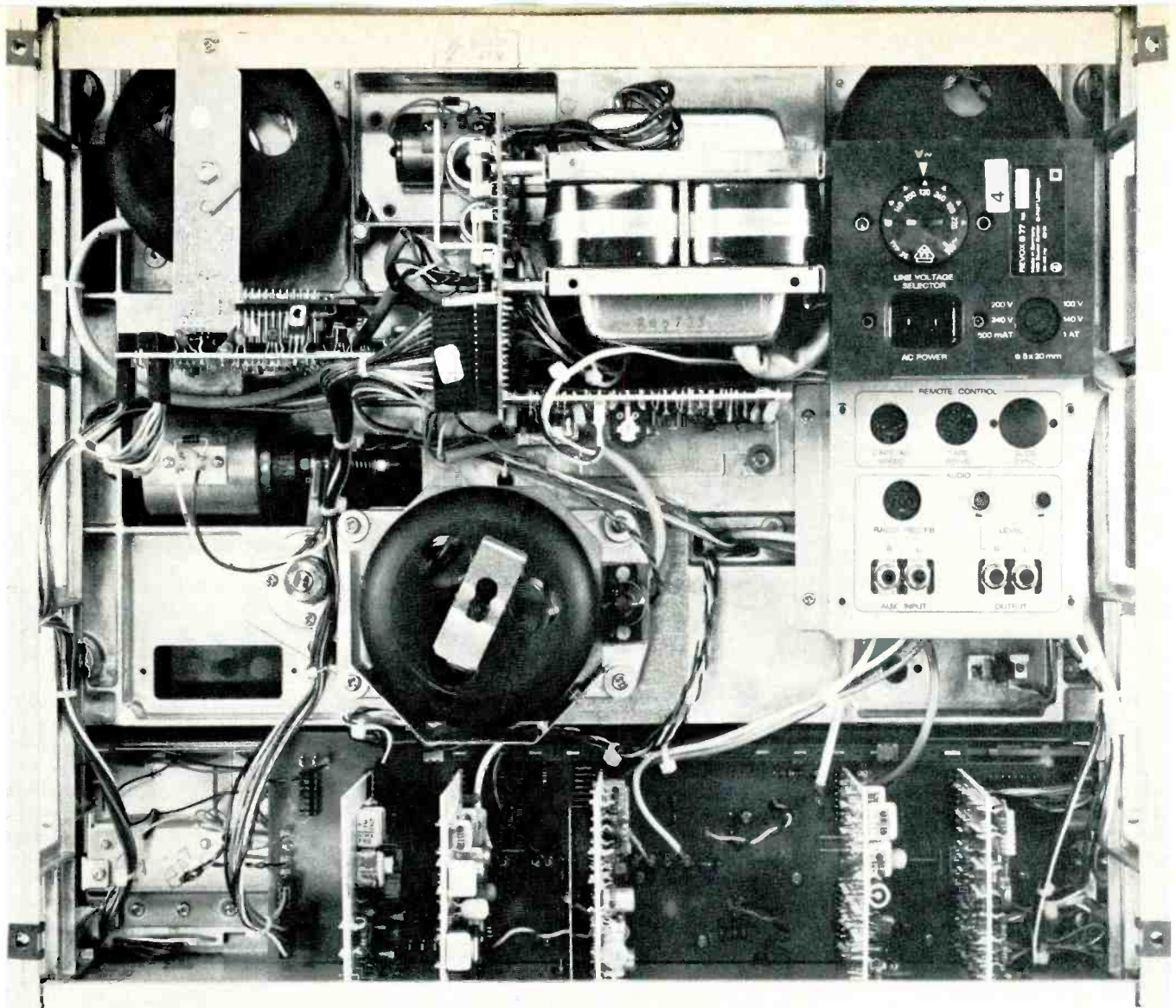

Fig. 4 — Playback of recorded 1-kHz square wave. (Scale is 0.2 mS/div.)

Fig. 5 — Third harmonic distortion vs. record level at 1 kHz. (Record 0 reference level as in Figs. 1-3.)





same, but all of the figures were 8 to 9½ dB less (smaller number). Separation from one channel to the other was a good 51 dB, and crosstalk to the adjacent track of opposite play direction was a good 69 dB. The erasure of a 1 kHz was excellent by any standard, down at least 90 dB.

The input sensitivity for low-impedance mike was all the way down to 0.046 mV, and even with the high-impedance setting only 1.4 mV was required. The line sensitivity was much higher than that normally encountered, just 17 mV for a zero indication. All of the measured sensitivities were six dB or more better than the specifications. Input overload was 48 dB or more above the sensitivity figures listed. Output clipping at the line-out jacks was reached at a level equivalent to a +17 meter indication. The input level pots tracked within a dB for the same pot positions. In accordance with ReVox specifications, the output levels were measured with the meters at +6. The line outputs averaged 1.48 V, just a little less than the spec. The headphone output was 5.5 V open circuit, 2.75 V with a matching 220-ohm load. Although the manufacturer recommends headphones with impedances from 200 to 600 ohms, the circuit will deliver a very adequate 190 mV to 8-ohm loads. (Many so-called 8-ohm headphones are actually 100 ohms or so.) The line-output level-set pots were left at maximum for all tests, although they provide up to 26-dB attenuation for system matching. The sections of the monitor pot tracked within ½ dB over most of its rotation. The total spread in output levels for all positions of the output selector switch was ½ dB, indicative of carefully set internal adjustment pots. The dynamic response of the two meters was in accordance with VU standards, but the extended frequency re-

sponse to over 200 kHz is subject to question. The peak indicator threshold was very close to +6 VU with a CW input, and was still firing with a toneburst with duration reduced to 15 mS. The meter scaling was very close with maximum errors of 0.2 dB.

All indications from test tapes and a strobe were that the recorder tape speeds were close to exact. There were no indications whatsoever of speed changes from 100 to 130 line voltage. At 3¾ ips, the typical weighted peak flutter was 0.06 per cent. At 7½ ips, the flutter was 0.028 per cent on the average, with a maximum value of 0.04 per cent (Fig. 6). These results are well within the specifications and are direct evidence of superb tape motion. There were substantially no shifts in record-to-playback speed, and a slight shift plotted in one case was from drift in the metering. The wind times for a 3600-foot 10½-inch reel was 132 seconds. The time required to go from fast wind to play was less than two seconds at all times, smooth and fast.

Listening & Use Tests

Tape loading was easy and direct with little to snag the tape on, and there was good access for regular cleaning and demagnetization. Snapping off the head assembly cover did improve access to the capstan and scrape flutter filter. There was a good feel to all of the pots and switches during all phases of the testing. The logic-controlled, tape-motion switching performed without error, including the usual "torture" test. As stated before, a latch-in pause control did seem a definite lack at times. There was good meter action, and the placement of the overload LEDs seemed ideal in actual use.

There were some troubles with tape motion, but the major

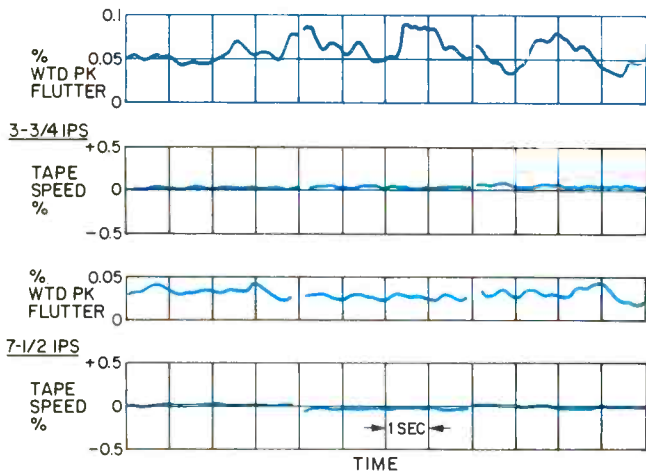

Fig. 6 — Peak-weighted flutter and tape speed variations at 3¾ and 7½ ips.

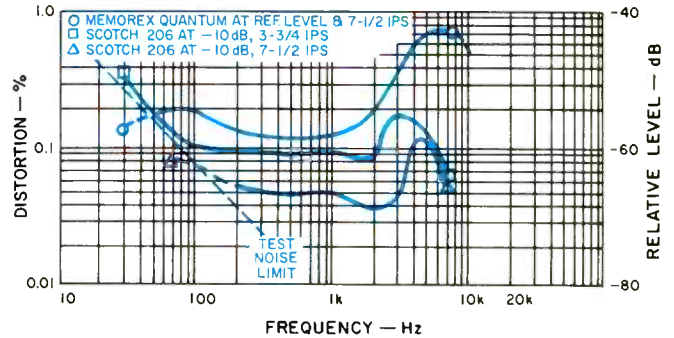

Fig. 7 — Third harmonic distortion vs. frequency.

difficulties disappeared with use. When first started in play, there was a scraping noise from the right reel turntable. Removing the front panel aided in making the tentative conclusion that some brake lining glue was rubbing against the brake band. In any event, the sound was gone by the time the testing was complete. A minor ailment, but annoying, was slippage in the counter. The errors were not great, but they kept creating confusion on where the exact start/stop points were.

The 44-page trilingual instruction book is logical and thorough with good descriptions complemented by clear illustrations. No schematic is included, but there is an excellent signal-flow block, and circuits are given of the remote control units, so you could even make your own. Clicks from pause and stop

were 5 dB out of tape noise; the record click itself was covered by tape noise. Different sources were recorded, and there was nothing to fault in the playback. The B77 really shone when it was used to record the revised *Mass* by Leonard Kastle. (The earlier version had been performed on national PBS TV on Christmas 1977). The whole combination of this easy-to-carry high-performance unit with its excellent metering and of the inherent qualities in the music and its performance generated a tape which caused many a comment on its excellence. The \$1,295.00 price tag will be more than tough for some, but in a number of the important areas of recorder performance, the B77 is superior to units costing a fair amount more. Studer ReVox may very well have another winner.

Howard A. Roberson

Enter No. 93 on Reader Service Card

Pair up for perfect reproduction

With Osawa's Dynamic Duos

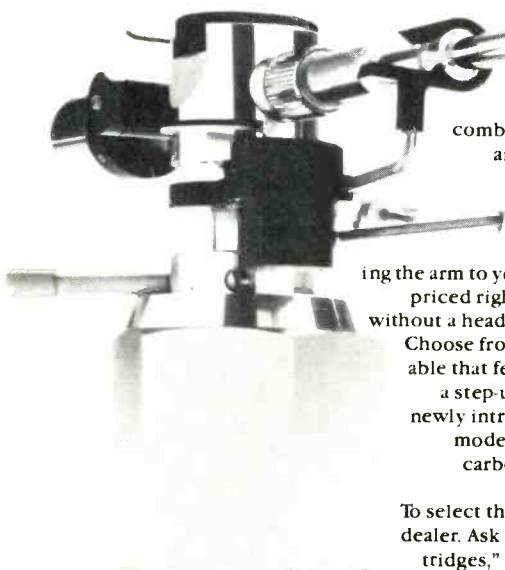
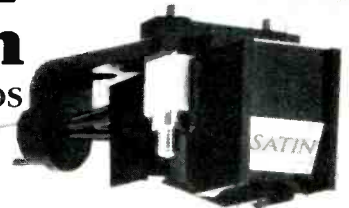

Advanced electronics are just not enough. For the most realistic music reproduction you need a high performance tonearm/cartridge combination to ensure smooth, wide frequency response and highly accurate tracking. The kind of top-quality performance that the **Osawa duos** deliver.

Start with the **Ultracraft AC-300 MK-II** tonearm that features adjustable oil damping. This eliminates resonances by fine tuning the arm to your cartridge. Then select the **Osawa** cartridge that's priced right for you. You can mount it directly on the tonearm without a headshell, thus reducing effective mass to the minimum. Choose from 4 **Satin Moving Coil** models, the only MCs available that feature user-replaceable stylus and that don't require a step-up transformer or pre-preamp. Or choose one of the newly introduced high-compliance **Moving Permalloy (MP)** models by **Osawa**. Top-of-the-line 300 MP offers a unique carbon-fiber cantilever that is extremely lightweight yet extraordinarily strong.

To select the combination that's ideal for you, visit your **Osawa** dealer. Ask him for the **Osawa** "Consumer Guide to Phono Cartridges," and then get a complete demonstration. Whichever combination you select, the name **Osawa** assures you the ultimate in clean and faithful music reproduction.

OSAWA & CO. (USA) Inc./521 Fifth Avenue, New York, N.Y. 10017/Tel. (212) 687-5535-9/TELEX: 23-6593



Enter No. 75 on Reader Service Card



Power...
Precision...
Presence...

The **CROWN** Distinction Series

These new components, designed and built solely for sonic excellence, are intended for the discriminating listener who needs equipment meeting the highest standards of audio technology. They express everything Crown has learned in twenty-five years of building state-of-the-art audio components.

SA-2 Power Amplifier 221 watts per channel into 8 ohms, .01% THD, 3 Hz — 20 KHz. New patent-pending protection circuitry. Drives any load. Internal cooling.

DL-2 Controller New precision in preamplification. Separate phono pre-amp and power supply for low RFI and line noise. S/N down 97dB unweighted. Frequency response ± 0.2 dB, 3 Hz to 100 KHz. Digital balance/level control.

EQ-2 Equalizer for concert-hall presence in your listening room. Eleven bands per channel (± 15 dB per band) with center frequency control for each band.



 **CROWN**

1718 W. Mishawaka Road, Elkhart, Indiana 46514

American innovation and technology...since 1951.

Listen to the complete line at your authorized Crown dealer now, or write for information,

Nakamichi Model CM-700 Electret Condenser Microphone Systems

MANUFACTURER'S SPECIFICATIONS

Generating Element Type: Electret condenser

Directivity: Cardioid or omnidirectional.

Frequency Response: 20-20,000 Hz ± 3 dB

Output Impedance: 600 ohms, ± 15 per cent, balanced.

Sensitivity, Cardioid: -65 dB (1 kHz, 0 dB = 1 V / μ bar).

Sensitivity, Omnidirectional: -63 dB (1 kHz, 0 dB = 1 V / μ bar).

Maximum Input SPL: Cardioid, 130 dB (145 dB with 15-dB attenuator); Omnidirectional, 128 dB (143 dB with 15-dB attenuator), both re: 20 microPascals for 3 per cent distortion.

D.C. Power Requirement: 6 V, 1 mA using silver-oxide battery — Eveready type no. 544.

Battery Life: 200 hours, continuous use.

Accessories Supplied: Battery, windscreen, two-conductor cable with XLR and phone plugs, foam-lined vinyl case, stand adaptor, 15-dB attenuator section, and CP-702 omnidirectional capsule.

Accessory Available: CP-703 shotgun ultradirectional capsule with foam windscreen.

Price: CM-700, \$185.00 and CP-703, \$85.00.

Note: The CM-700 microphone includes CP-701 cardioid capsule, standard center section (FET preamp), plus the microphone body which includes the *Off-Flat-Lo Cut* switch and 3-pin output connector. It also includes the accessories listed above, but not the shotgun capsule.

This is a high-quality electret system, having a very small diaphragm (16 mm), and is suited to audiophile music recording applications as well as in sound reinforcement for the performing arts. The cardioid and omnidirectional capsules are most useful for the former application and the shotgun capsule for the latter. The system is suited to professional use from the viewpoint of audio quality, but applications in studios and permanent sound systems may be limited because the CM-700 cannot be remote powered (Remote-powered mikes usually cost more than the CM-700.) The shotgun attachment is good for special purposes involving long distance sound pickup such as wildlife sound recording and surveillance applications.

The CM-700 microphone system is perhaps unique among electret or air-condenser microphone systems because the FET preamps, as well as the condenser transducer capsules, can be interchanged. All of these pieces are included in the CM-700 system, and there is nothing extra to buy except perhaps the

CP-703 shotgun capsule. This is logical because not all users will need this accessory. Our first impression was that you get quite a lot of parts for the money, and if worked only half as well as advertised, it would still be a bargain. The CM-700 system plus the CP-703 shotgun posed a formidable challenge for our laboratory because if we tested all possible combinations of pieces in all possible ways, it would require ten-to-the-nth hours!

The principal parts of the CM-700, starting at the connector end, are the main body with the *Off-Flat-Lo cut* switch, the battery, the center piece containing the FET preamp, and the condenser-transducer capsule. The battery fits into the barrel of the main body and the center piece screws on and holds the battery in place. You have a choice of two preamps plus two capsules (three including the shotgun). One preamp (unmarked) yields flat response and normal sensitivity. The preamp marked '-15 dB' yields flat response, 15 dB lower sensitivity, and correspondingly higher sound pressure capability. The cardioid or omni cap-

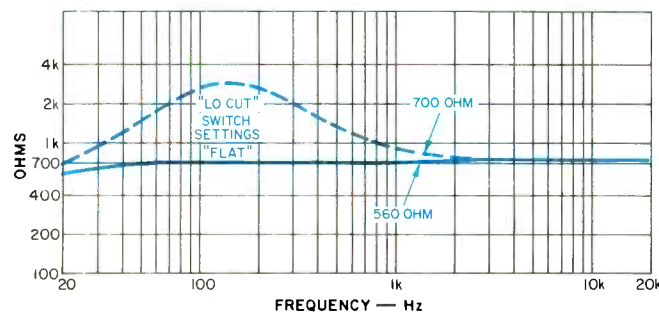

Fig. 1 — Impedance of the Nakamichi CM-700 microphone system with the CP-701, 702, 703 capsules, and 0 or -15 dB preamps (center section).

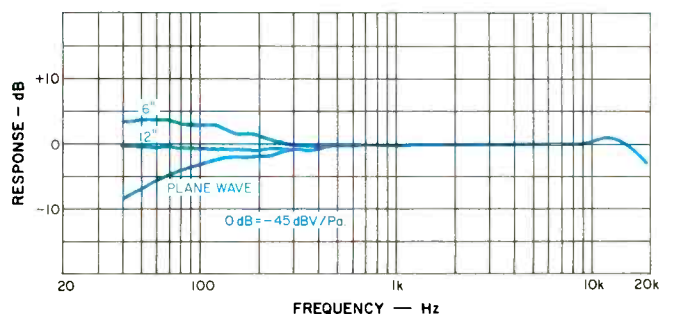
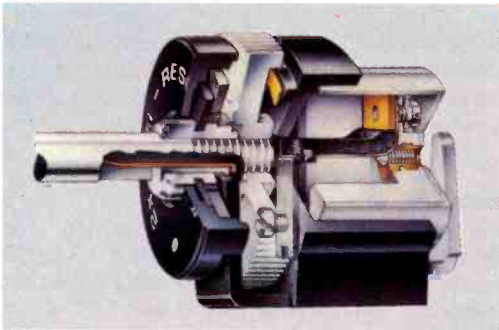

FIG. 2 — Frequency response vs. distance with the CP-701 cardioid capsule.

If the bass isn't as clean as you'd like...

The problem may be your tonearm. Not your amplifier or speakers.



Cutaway view of anti-resonance counterbalance. (A feature of Dual models 604, 621, 721 and 1246)

Solid lines show effectiveness of anti-resonance filters in damping resonant amplitudes of three different cartridges (compliance 15, 25 and 43 x 10⁻⁶ cm/dyne). Broken lines show higher resonant amplitudes with conventional counterbalance.

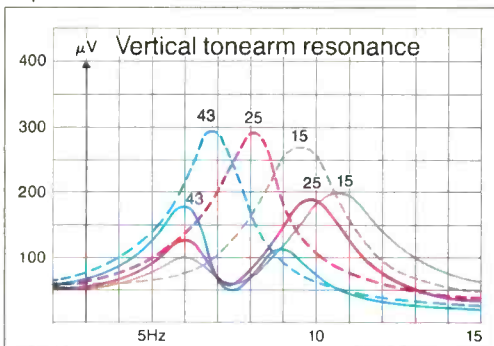

These are specially tuned to damp resonant energy in the tonearm/cartridge system and chassis.

The startling effectiveness of these filters in lowering the resonant amplitude of three cartridges having different compliances can be seen in the graph. Whether the improvement in the bass is subtle or obvious to you depends on the other components and your listening environment.

We've prepared a technical paper on this subject which we'll send to you if you write us directly. You may discover that you don't have to replace your amplifier or speakers after all.

If you've been wondering why your high-powered amplifier and great speaker system don't deliver deep bass as cleanly as you'd like—especially at high listening levels—the problem may well be the effects of resonance on the stylus.

Ideally, the stylus should move only in response to the contours of the record groove. But in reality, the stylus tip also responds to various resonances: its own (with the stylus shank) and the combined resonance of the tonearm/cartridge system.

These subsonic frequencies, though inaudible in themselves, can have very audible effects. Especially with warped records. They can drain amplifier power and cause excessive movements of the low frequency driver. They can cause the tonearm to vibrate and even to momentarily leave the groove. All of which results in audible distortion.

Competent tonearm designers know all this and do their best with materials, masses and compliances to establish the inevitable resonances at the least harmful frequencies (usually between 8 and 10 Hz) and with the lowest possible amplitudes.

Dual's tonearm designers have taken a significant step beyond this.

The unique counterbalances of our direct-drive models (604, 621 and 721) and our top belt-drive multiple-play model (1246) contain two mechanical anti-resonance filters.



For the life of your records

United Audio, 120 So. Columbus Ave., Mt. Vernon, NY 10553

Enter No. 9 on Reader Service Card

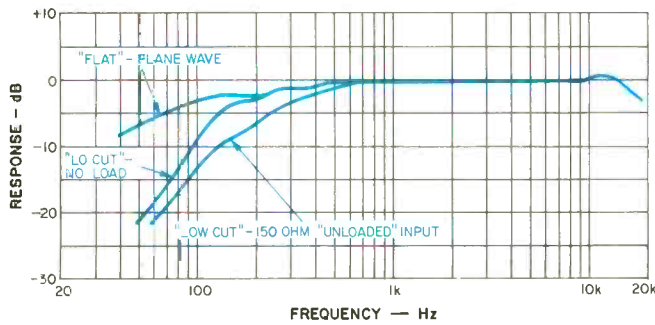

Fig. 3 — Effects of loading on "Lo-Cut" frequency response with CP-701 cardioid capsule.

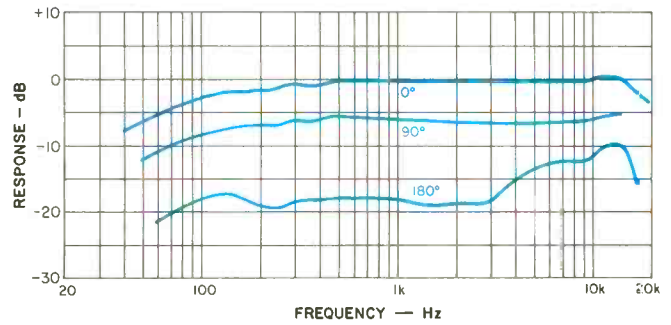

Fig. 4 — Frequency response vs. angle with the CP-701 cardioid capsule.

sule may be used with either preamp. The rigid plastic windscreen can be slipped over the capsule to a positive stop at the base of the preamp, and this screen is more durable than a foam sock which eventually deteriorates.

The CP-703 shotgun capsule is not simply a capsule . . . it consists of a condenser capsule attached to a 16-in. long tube, of 1/2-inch diameter, with a series of small holes along the length of the tube. This assembly is screwed onto a FET preamp, which is unmarked, but appears identical to the preamp/center section that is used with the other capsules. We mixed up these two preamps and had to make an acoustic response test to sort them out. They are electrically different — the shotgun preamp frequency response is specially tailored for maximum speech intelligibility. A foam windscreen covers the entire length of the shotgun pipe, capsule, and preamp.

Our entire kit included three capsules, three preamps, two windscreens, a mounting swivel, and a cable assembly. The cable is terminated in a 1/4-inch phone plug for use with unbalanced inputs such as on Nakamichi equipment, but the mike

may be used with balanced inputs, center-tap grounded or floating, by using a standard mike cable with an A3F connector on the mike end. The system is available in any color as long as you choose black, in keeping with Nakamichi's "black look."

Laboratory Tests

Figure 1 shows the impedance curves. The impedance on "flat" setting conforms to the 600-ohm nominal spec value. EIA Standard SE-105 states that a *low impedance* microphone shall be 600 ohms or less, but states a maximum value of 180 ohms as standard. This is being ignored by many makers, and the *Audio* October, 1977, Directory issue shows that today's hi-fi microphones range from 150 to 600 ohms. We experienced no loading effects when testing the mike into the 150-ohm "unloaded" input of our broadcast mike preamp with the mike switch on "Flat" response, but on "Lo Cut" experienced loading effects because the mike impedance exceeds 2000 ohms at 150 Hz. More about this later, but we recommend that the user

92



The truth is clearly seen in every Scotch[®] Master[™] Cassette. thanks to our see-through cassette shell. You can see the unique roller guides that reduce friction by moving the tape evenly across the head. And the two radially creased

shims that insure a smoother wind, improved mechanical reliability and reduced wow and flutter. Even the recorder head penetration.

The sexy, see-through Master Cassette shell. It's kind of like getting the naked truth.



make certain that his equipment input is "unloaded" before connecting the mike to a 150-250 ohm input. Most inputs are "unloaded," that is, the actual impedance is 5 or 10 times nominal value.

Figure 2 shows the on-axis frequency response of the CM-700 with cardioid capsule and normal gain FET preamp. At 12 inches, the response is ruler-flat and equal or better than any air- or electret-condenser mike we've tested. The rolloff above 16 kHz may be ignored. If we interpolate to a distance of 50 cm (20 inches), our curve matches the factory curve supplied (this may not be supplied with your mike), within about ± 1 dB. Results on sensitivity agree precisely with the factory value. The factory curve was not corrected to plane-wave conditions so the low-end rolloff appeared slight. Our "Testing Update" article discusses the plane-wave testing problem. For distant miking, the cardioid capsule response is lacking in bass. Some cardioid condenser mikes have a bass rolloff which is good for many field uses, where very low frequency ambient noise is present and for pop music which has lots of bass. For classical music, bass boost may be desired, and we will describe an inexpensive way to equalize the mike.

Figure 3 shows the impedance loading effects. For "Flat" setting, response was the same into our preamp or into an open circuit. With "Lo Cut" setting, the preamp produced more bass rolloff than an open circuit. In the voice frequency range above 200 Hz, the preamp loading helps to compensate for proximity effect, but your preamp may not exhibit the same loading as ours.

The frequency response at various angles (Fig. 4) gives a hint of the superlative quality of the CM-700/CP-701. The 90-degree curve is nearly identical to the 0-degree curve. Presumably, the frequency response is unchanged throughout the entire front hemisphere. The small diaphragm size is responsible for this uniformity. All $\frac{1}{2}$ - or $\frac{3}{8}$ -inch diameter laboratory microphones generally have rather uniform directivity to 15,000 Hz, but $\frac{3}{8}$ - or

1-inch diameter microphones do not. Precision sound level meters are now equipped with $\frac{1}{2}$ -inch diameter microphones to permit accurate measurements at high frequencies in reverberant rooms where sound wave direction is random.

The CP-702 omnidirectional capsule (Fig. 5) has ruler-flat bass response and a nice compromise adjustment of the high frequency response. There is a slight excess of highs in the 0-degree curve for close miking and a slight deficiency in the 90 degree or random incidence responses for distant miking, such as when the mike is suspended over an orchestra. The small variation in response from 0 to 90 degrees is scarcely audible and, again, is a result of the small diaphragm.

The plastic windscreen produced little change in response (Fig. 5), less than most foam screens. The screen was found to be effective outdoors in winds up to 10-15 knots. There is a problem with screen I.D. tolerances, because one screen fit too tightly and marred the mike finish, while another fit too loosely.

The CP-703 shotgun capsule was tested at six feet outdoors due to its great length. (See the "Testing Update" article.) Figure 6 shows the frequency response, and it may be assumed that a plane wave exists at this distance. Our data does not correlate with the factory curve, undoubtedly because of the big difference in distances to the source — 50 cm vs. 6 feet. We presume our test is more accurate. The "Flat" response is generally undesirable for shotgun applications. The rising response on "Lo-Cut" appears ideal for long distance outdoor speech pickup, as it will reduce low-frequency noise and emphasize the higher frequencies so critical to intelligibility. Figure 7 shows a non-standard condition where we used the preamp section from the cardioid/omni capsules. The response is considerably flatter, and we thought might be more ideal for quiet locations, as in a studio or auditorium. Note the increased sensitivity. The foam screen for the shotgun was not terribly effective on a breezy day, and tests had to be postponed until the wind was less than five mph.

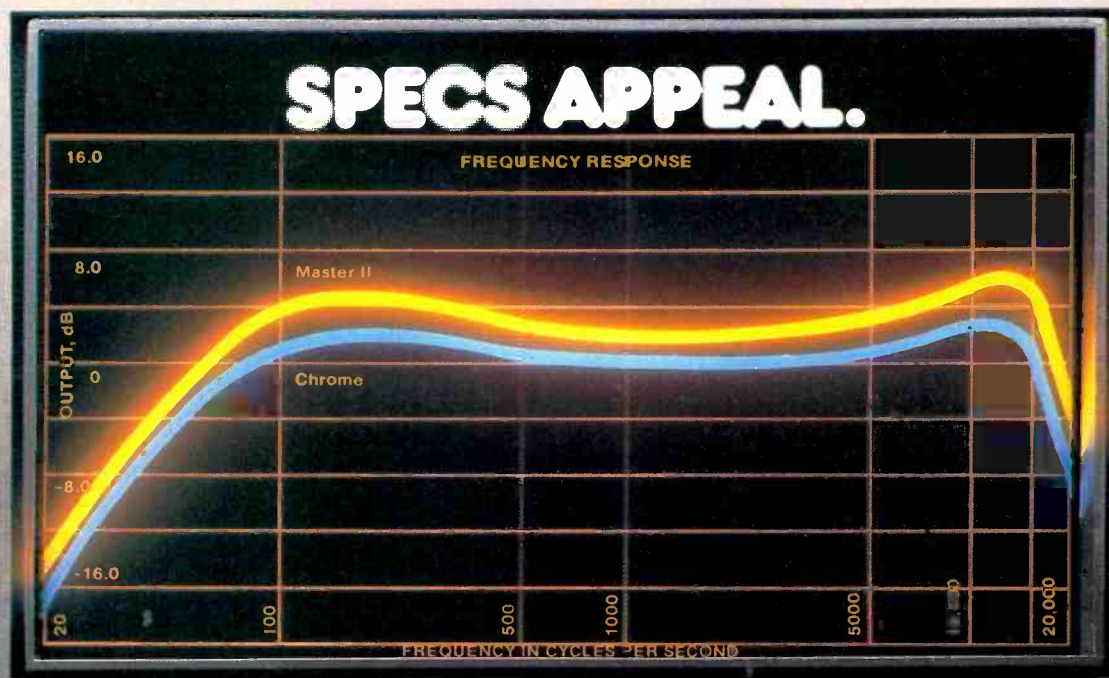

Master I Cassette is for normal bias recording. It features an excellent dynamic range, low distortion, uniform high frequency sensitivity and output that's 10 dB higher than standard tapes.

Master II Cassette is for chrome bias recording (70 microsecond equalization). It features a special coating that gives it a 3 dB better signal-to-noise ratio at low and high frequencies



than chrome cassettes.

Master III Cassette is for ferri-chrome bias recording. It offers a 3 dB output improvement at low frequencies and 2 dB output

improvement at high frequencies over chromium dioxide.

SCOTCH® RECORDING TAPE. THE TRUTH COMES OUT.

Enter No. 33 on Reader Service Card

Figure 8 reveals the excellent directional characteristics of the CP-703. Essentially null response is obtained at 90 and 180 degrees. A microphone of this type should degrade to a cardioid pattern below about 500 Hz, but Nakamichi has apparently defied the laws of physics, maintaining uniform directivity at low as well as mid and high frequencies. (Some years ago we stated in a Patent Application that a shotgun mike must be 22-feet long to obtain this performance!)

So far, all of these data show that the CM-700 is equal (and dare we say superior?) to any air or electret condenser we have tested. The small diaphragm size is responsible. But it is well known that 1/2- or 3/8-inch laboratory condenser mikes have poor signal-to-noise ratio; that is the noise level expressed in equivalent SPL is high, reducing usable dynamic range. The noise test (see "Testing Update" article) is critical to proving or disproving the superiority of this microphone.

Our test results shown in Fig. 9 reveal a fairly uniform noise spectrum, and the unweighted and "A" weighted levels are 29 and 22 dB, respectively. The one-third octave levels are a few dB higher than a good air condenser at mid frequencies (see our January, 1978, review), but the low frequency noise levels are significantly lower. The 22 dB "A" weighted scale level means that microphone noise will be less than ambient noise in a very quiet studio, church, or auditorium. Our BK-5B reference mike measured only 3 dB "A" weighted scale less noise, and it has no internal amplifier to make noise! Again, Nakamichi appears to have repealed the laws of physics. We see little reason to purchase a larger, more costly air-condenser microphone, unless you need special features such as remote powering.

The dynamic range, frequency response, and directional properties of the CM-700 with the omni capsule are ideal for sound measurement as well as for speech and music pickup. Specifically, *the omni capsule is suitable for Type 1 precision sound level meters meeting ANSI Standard S1.4-1971.* The cardioid is particularly suited to loudspeaker tests in rooms because of its uniform frequency response and ability to reject reflected sound. A cardioid mike may be ideal to use for system/room equalization because, not unlike your ears, it discriminates against reverberant sound. [The editor reminds us that TDS equipment, *a la* Dick Heyser, discriminates against reflections, permitting an omni mike to be used for speaker testing in rooms.]

The phasing test showed pin-2 positive in accordance with the prepared revision to the EIA standard. The clipping level with cardioid capsule and closeup speech was 129 dB re: 20 microPascals. The measured output of the "-15 dB" preamp was approximately 15 dB less than the standard preamp, and we can only assume that the clipping level increased to at least 129 + 15.0 = 144 dB re: 20 microPascals.

Listening and Use Tests

The Nakamichi CM-700 sounds identical to our BK-5B reference microphone except for a slight decrease of "presence"

when reproducing speech at 6- to 12-inches distance. The BK-5B has a smoothly rising response from 50 to 6000 Hz and a ruler-flat mike sounds a bit dull by comparison. Similar results were obtained with CP-701 capsule and "Lo-Cut," and CP-702 capsule and "Flat" response.

Then we tried the shake test and heard a loud rattle in the earphones. It required considerable patience and skill to find that there were two similar rattles caused by loose-threaded rings in the bottom of the cardioid capsule and in its preamp. We removed the ring from the capsule because of curiosity, and the entire back plate and insulator assembly fell out! Looking inside the capsule housing, we saw the foil electret which was translucent to light. This was the first electret mike we've taken apart where the foil electret wasn't cemented to the rim of the back-plate. We held out little hope of making the capsule work again. We recalled that electret foils more or less sit on the back plate and, hoping that no critical airspace was involved, we reassembled the capsule.

Well, the cardioid capsule talked again, so we repeated the frequency response test. Lo and behold the response and sensitivity were within about $\pm 1/4$ dB of that shown in Fig. 2! Has Nakamichi repealed the laws of physics again? [Editor's note: Nakamichi promises they'll either tighten the rings or supply a spanner wrench with every mike!]

With a sigh of relief, we resumed our listening tests. Now, nothing rattled. Vibration sensitivity with the cardioid capsule was higher than the BK-5B, and rubbing the mike generated a substantial amount of high frequency sound. This is no worse than a good air condenser, and, similarly, the CM-700 should be resiliently mounted where vibration is a problem. The CM-700 with omni capsule has equal vibration sensitivity, and is not highly recommended as a hand-held vocalist's mike. Another reason not to let a vocalist hold it (besides not wanting it dropped) is that the switch may be accidentally actuated.

The windscreen affords excellent "pop" protection for either capsule, as well as the previously mentioned wind-noise reduction. "Pop" sensitivity was only a little higher than the BK-5B with its large 4-inch diameter accessory screen. We recommend using the screen in all but the most pristine environments and on all occasions when picking up speech or close-miking instruments. Without the screen, the CM-700 has very high wind and pop sensitivity.

The CM-700 has less hum pickup than the BK-5B, which puts it in the "excellent" category. This, no doubt, contributes to the low noise output and lack of 60 Hz and harmonics in the spectrum.

Continuing our talk test versus the BK-5B, we compared sound at 90° off-axis and discovered that the CM-700/CP-701 sounds just the same as on-axis, but the BK-5B has a distinct nasal quality off axis. This aroused our interest, and we fired-up our RCA MI-10006A condenser mike (See *Audio Cyclopeda* and "Update" article) for comparison. We were amazed by the result: On-axis, the two sounded identical, but off-axis the MI-

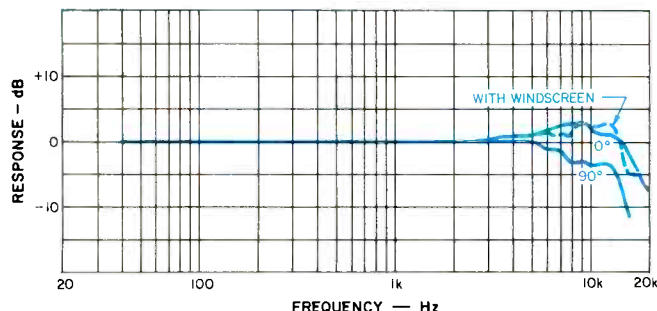

Fig. 5 — Frequency response with the CP-702 omnidirectional capsule.

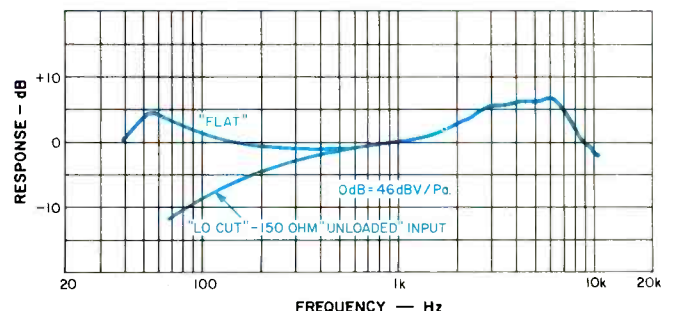

Fig. 6 — Frequency response with the CP-703 shotgun capsule.

WHY YOU OUGHT TO INVEST IN A FISHER SPEAKER SYSTEM RATHER THAN SOMEBODY ELSE'S.

Building a great speaker is something like building a great violin. Although there are many violin manufacturers, the design artistry and painstaking craftsmanship of the Stradivarius won it the reputation as the world's finest.

Making speakers, like making fine musical instruments, is something of an inexact science... even with today's computers. It still takes artistry, craftsmanship, and most of all, experience to produce a great sounding speaker.

Our new Studio Standard ST400 series speakers, manufactured at our modern speaker plant in Milroy, Pa., are the culmination of everything we've learned in producing hundreds of thousands of speakers. At the top of this new line is the ST461 — a speaker that critical listeners consistently rank among the two or three best they've ever heard.

The ST461 combines the staggering bass capability of the 15" Fisher model 15130 woofer, the flawless midrange of two 5" model 500 midrange drivers, and the ultra-high definition of the 3" model 350 horn tweeter. Plus a precision crossover network with adjustable midrange presence and treble brilliance,

and a resettable circuit breaker overload protector. All in a beautifully finished genuine walnut cabinet, at the reasonable price of \$350*. Other ST400 series speakers start at \$120*.

So, if you'd like to own the "state-of-the-art" in speakers, listen to Fisher's new ST400 series.

Fisher components are available at selected audio dealers or the audio department of your

favorite department store. For the name of your nearest dealer, call toll-free 1-800-528-6050, ext. 871 from anywhere in the U.S. (In Arizona, call toll-free 1-955-9710, ext. 871).

*Manufacturer's suggested retail value. Actual selling price is determined solely by the individual Fisher dealer.



FISHER

The first name in high fidelity.



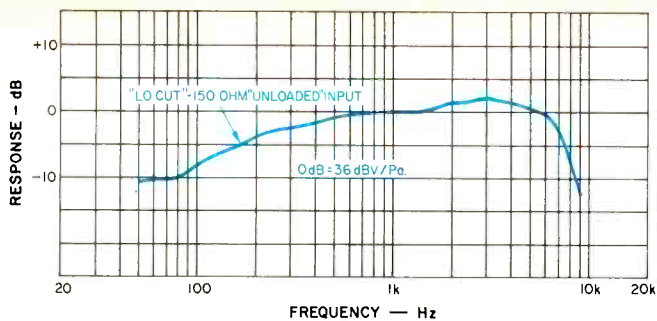

Fig. 7 — Frequency response with the CP-703 shotgun capsule using preamp (center section) for cardioid and omni capsules.

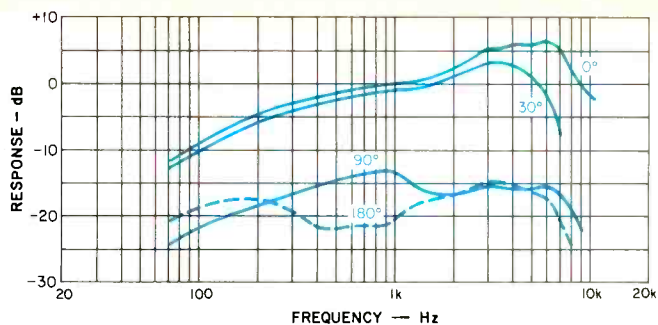

Fig. 8 — Frequency response vs. angle with the CP-703 shotgun capsule on "Lo-Cut," 150 ohms impedance, and "Unloaded" input.

10006A sounded completely muffled compared to the natural sound of the CM-700.

Then we compared the CM-700/CP-701/CP-702 in the studio with recorded music and were astonished to hear an entire top-octave not present in the BK-5B! (The BK-5B has fairly uniform axial response to 15,000 Hz, but at 90° it is not uniform.) Our recorded sources did not have much music in the top octave because the tapes were recorded with BK-5s or 77-DXs, so we tried an acoustic guitar. A lot of very high pitched harmonics were heard with both CP-701 and CP-702 capsules that were inaudible with the BK-5B. The Nakamichi microphone plus earphones enabled us to perceive these sounds more clearly than by ear alone.

The strikingly beautiful sound of the CM-700 on strings inspired us to borrow a second system and substitute CM-700/CP-701 for BK-5Bs to make a recording of the Bach *B Minor Mass* with chorus, soloists, and orchestra, including pipe organ and harpsichord. The location was a high-ceilinged church, seating about 600, and with a reverberation time of approximately three seconds. We used a ReVox A77 reel-to-reel tape deck that we tuned up with Maxell UD tape for ± 1 dB, 30-20,000 Hz frequency response and 10-dB headroom above 0VU. Fortunately, we were able to compare our tape to a previous *B Minor Mass* recorded in the same place with the same machine, but using 77-DX microphones.

Playback in our studio revealed that although the 77s sounded a bit better on the chorus, the top-octave-plus was missing. Of course, the (on-axis) string section sounded better with the CM-700/CP-701, but the sound of off-axis instruments was most startling. The harpsichord on the right could be heard at all times, but at my location in the church I could not always hear it. The brass on the far left were almost too loud, and rich with harmonics. By comparison, the 77-DX sounded as if it were "focused" on the centrally located sources which were chorus, strings, flute, and woodwinds, but off-axis instruments were muffled. In this church, the orchestra stretches from left to right and

subtends a wide angle from the microphones which are positioned in the third row. Bass viol was slightly stronger with the 77-DX, which exhibits uniform response to 40 Hz for plane waves.

The CM-700/CP-703 shotgun was subjected to an entirely different set of listening tests. First we positioned a portable radio, set on a news station, outdoors about 100 feet from the building. It was adjusted for normal speech, 65 dB re: 20 micro-Pascals at one meter. We set up our listening equipment on the roof and compared the Nakamichi to the MI-10006A condenser with its set of pipes, which are the same length as the Nakamichi. We would expect these mikes to be similar. With our unaided ears, we could understand a very few words above the (low frequency) ambient noise, primarily auto and truck traffic. Aided by the Nakamichi, we understood about 80 to 90 per cent of the words. It had to be precisely aimed at the source, but actually performed a little better when aimed at a sloping section of roof which apparently acted as a reflector. The RCA mike picked up only low-frequency noise — no speech was heard at all!

The preamp that is attached to the CP-703 worked best — the other flat response preamp yielded a poorer signal-to-noise ratio. "Lo Cut" had to be used at all times to reject noise.

Then, our son tried the CM-700/CP-703 for stage reinforcement of vocalists in a high school musical show. The outstanding discrimination enabled weak vocalists to be heard above the orchestra and with realistic audio quality, although the rising-response preamp was used, plus "Lo Cut." The director, who has a lot of professional experience, indicated the CP-703 was the best stage mike he'd heard. To achieve these results, a full-time operator was needed in the orchestra pit to aim the mike accurately. In our large auditorium, we need three mikes and three operators to cover the entire stage. The operators should have had monitor phones to assist aiming and handling of the mike.

The mechanical quality of the CM-700 system is excellent, save for the easily-fixed problem of loose rings. The system components have fine threads which may be damaged by careless cross-threading. On our mike, the external threads were not masked during finishing, and we experienced some binding during the first few engagements. The swivel mount incorporates what appears to be a tapered 1/2-inch pipe thread. It fits an iron pipe having a tapered thread, but not the Atlas AD-1 RCA Adaptor which has a straight pipe thread. Microphones should have a straight thread, specified as "1/2-inch NPSM." An adaptor to fit 5/8-27 mike stands is included but it doesn't have a knurled shoulder as the AD-1 does, and pliers were needed to remove it from the stand each time we used the microphones.

The acoustical performance of the Nakamichi CM-700 system is superior to comparable microphones tested to date. The CP-701 cardioid capsule is perfect, save for the bass rolloff on distant sources. It occurred to us that a simple passive equalizer could provide linear bass response.

Figure 10 shows a suitable equalizer that may be inserted into the mike line. Figure 11 shows the measured frequency

Fig. 9 — One-third octave band noise spectrum with the CP-701 capsule on the "Flat" response setting.

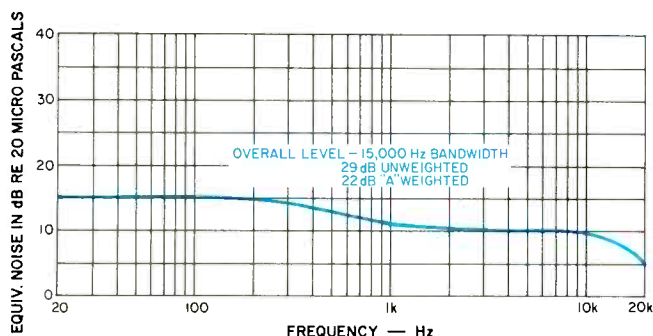



ALL THREE-HEAD CASSETTE DECKS LET YOU HEAR AS YOU RECORD. OURS LETS YOU RECORD PRECISELY WHAT YOU HEAR.

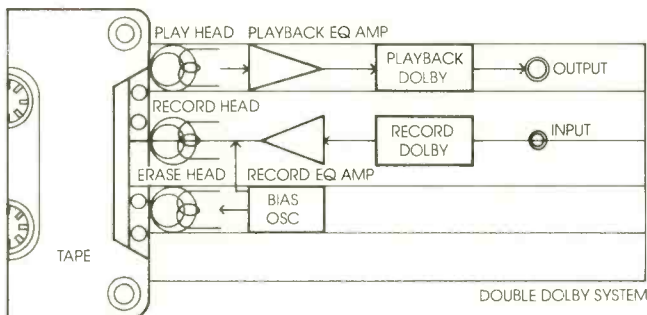

Three-Head Design with Double Dolby.*

Not all three-head cassette decks are created equal. Some manufacturers have designed their decks with separate erase, record and playback heads primarily for convenience. So you can tape monitor as you record.

But our new KX-1030 uses separate heads primarily for performance. Each designed with the optimum gap to record or play back sound more accurately.

As a result, the KX-1030 has a frequency response of 35-18,000 Hz (± 3 dB using CrO₂ tape.)

And to let you take full advantage of the separate record and playback heads, the KX-1030 has a Double Dolby* system with separate circuits for the record amplifier and the playback preamplifier. That way, as you record

with Dolby, you can also tape monitor with Dolby, so you hear the sound precisely as it's being recorded.

The KX-1030 also has a Variable Bias Adjustment Control and a built-in oscillator, so you can adjust the exact bias for the type or brand of tape you use.

We also built in a number of other features like MIC/LINE mixing, memory rewind and a peak indicator.

But as good as all this sounds, wait until you hear the price. Because at \$425.00,** no other comparably priced cassette deck can match

the performance and features of our new KX-1030.

Of course the only way you're really going to appreciate the KX-1030 is to visit your Kenwood dealer. Once you do, you'll be convinced: Performance, convenience, and value set the KX-1030 apart from all the rest.

*Dolby is the trademark of Dolby Laboratories, Inc.

**Nationally advertised value. Actual prices are established by Kenwood dealers.

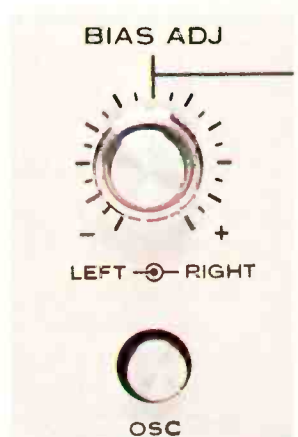

Variable Bias Adjust compensates for tape differences.



KENWOOD®

For the Kenwood dealer nearest you, see your yellow pages, or write, KENWOOD, P.O. Box 6213, Carson, CA 90749

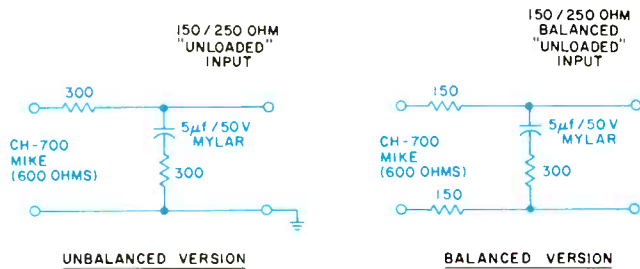

Fig. 10 — Diagram of a corrective equalizer and 12-dB pad for the CM-700 microphone and CP-701 cardioid capsule.

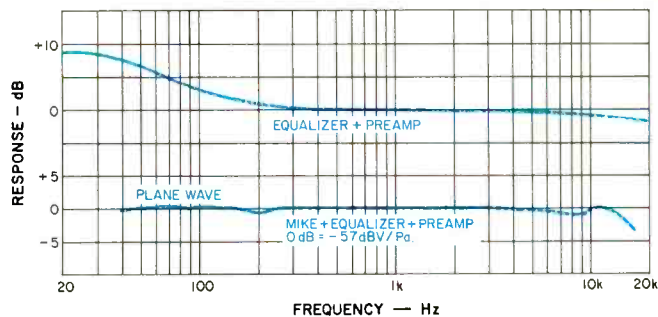

Fig. 11 — Measured response of equalizer for the CM-700 microphone and the CP-701 cardioid capsule, and the computed response of the system.

response of the equalizer, plus our BA-31 preamp, and the resulting ruler-flat acoustical response for plane waves. Of course, electrolytic capacitors are a "no-no" for this application; we use small 50-v mylar capacitors.

This equalizer does two additional useful things: 1) The 12-dB loss reduces the acoustic sensitivity to equal ribbons or dynamics and restores a "normal" gain setting on our ReVox, which in close miking, could prevent recorder overload and would eliminate the need for the -15 dB preamp in cases where SPL is less than 130 dB; and 2) the output impedance (at mid and high frequencies) is reduced to 225 ohms which presents a more suitable source impedance to 150/250-ohm inputs, which are still required to be "unloaded."

In the future we will try this equalizer at a live recording session. We hope it will provide the desired bass without picking up too much VLF ambient noise, and we will also be checking for noise from the recorder preamp. This equalizer is not needed when the source is closer than three feet from the microphone,

so it's mostly for classical recording applications. Others, who want an extra heavy bass sound, may find it useful.

The CM-700/CP-703 omni capsule is an excellent system, requiring no bass equalization, but we can't use them as permanently suspended recording mikes until we figure out how to power them from a remote source. We would appreciate learning of schemes for remote powering, experiences with equalization, and other comments from users. We tried the omni capsule for recording a concert where the mikes were aimed straight up and the instruments and vocalists surrounded the mikes. Sound quality was as good as with the cardioid capsules, and we were spared the complexities of setting up many cardioid mikes.

We highly recommend the Nakamichi CM-700 system for the most exacting applications in music recording and sound reinforcement for the performing arts. To those who doubt that a moderate cost mike system can do justice to a multi-thousand dollar recording or reinforcement system, we say "Try it — we think you'll like it."

Jon Sank

Enter No. 93 on Reader Service Card

Don't fret over technical or systems questions...

Get Your Own AUDIO 1977 Annual Bound Volume!

This handsome, hardcover, library-quality, buckram-bound volume gives you a permanent record of the audio industry's achievements throughout the year—increasing in value and service to you in years to come.

AUDIO's Bound Volume Gives You the Most Comprehensive Coverage Available from One Source.

Here, you will find discussions, analyses and tests of developments and problems associated with professional and home-use audio components—all from the perspective of the entire year. So you can study, compare and evaluate trends at your leisure—without wondering what happened during those months for which you may not have an issue of AUDIO.

Month after month, no other magazine devotes as many editorial pages to component equipment as AUDIO. Thus, here is the most complete record of the audio industry's successes—and failures—that you can find anywhere.

AUDIO's Bound Volume is the handiest, practical reference you can own. It makes a distinctive addition to your personal library... an ideal gift for the discerning audiophile.

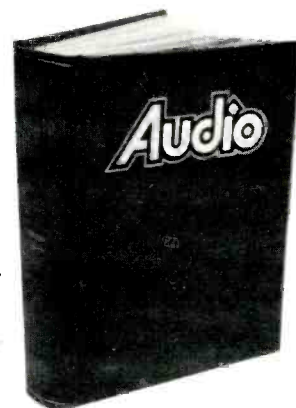

Order Your
AUDIO Bound Volume
Today...

ORDER FORM

AUDIO 1977 Annual Bound Volume Price \$23.00

AUDIO
North American Building
401 North Broad Street
Philadelphia, PA 19108

Yes, please send me _____ copy(s) of the AUDIO 1977 Annual Bound Volume. The \$23 price includes shipping and handling, USA only. For all other countries, the price is \$25. My check or money order is enclosed. (Payment must accompany order.)

Name _____

Address _____

City/State/Zip _____

Start playing with a full deck.

The AIWA AD-6800. It has everything you should expect in a top-flight cassette deck. And that includes our Flat Response Tuning System (FRTS) that adjusts to the optimum bias level for any tape on the market, precisely and effortlessly.

The AIWA AD-6800 uses its own circuitry to measure the precise bias figure of not just one or two, but every brand of cassette tape, whether it's LH, FeCr or CrO₂. The result; a flatter-than-ever frequency response with any tape on the market.

And the new AIWA 3-head Flat Response Tuning System is a snap to use.

First, slip in a cassette and the AD-6800 will load it automatically.

Next, set the Input Selector to "test" and push the "record" key to automatically activate the 400Hz and 8kHz built-in oscillators. You're all set for test recording.



Bias Fine Adjustment allows precise fine tuning for optimum response.

Slide the Azimuth Adjust control for optimum head alignment

and adjust the Bias Fine Adjust knob that corresponds to the type of tape you're using. The AD-6800 will let you know the exact bias necessary for the flattest possible response when the right (8kHz) and left (400Hz) VU meters are in corresponding positions. Now you're ready to record. It's that simple.

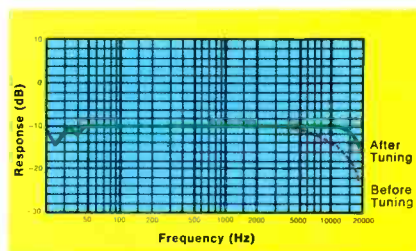

The AIWA Flat Response Tuning System achieves flattest response possible for maximum recording results.

AIWA's new 3-head Flat Response Tuning System (FRTS)

lets you monitor a tape simply by observing characteristics of the frequency response. You can actually "see" the sound so you can record at optimum levels.



AIWA's exclusive Double Needle Meters let you check both VU and Peak levels at a glance because they're combined on the same meter.

And with the AD-6800 you get an incredibly low wow and flutter of 0.05% (WRMS), and with Dolby* on and FeCr tape, an S/N ratio of 65dB, and a frequency response of 20 to 19,000 Hz.

The AD-6800 provides another exclusive feature—Double Needle Meters. AIWA has combined VU and Peak readout on each meter so you can monitor both functions at a glance. A convenience feature you won't find on any other cassette deck. The AD-6800 includes a Peak Hold function, too.

With all this in one great cassette deck and AIWA's exclusive new Synchronized Recording Operation (when used with the AIWA AP-2200 Turntable) you'll begin to understand what precision recording is all about.

The AIWA AD-6800. See it at your AIWA dealer now and start playing with a full deck.



Distributed in the U.S. by: **AIWA AMERICA INC.**, 35 Oxford Drive, Moonachie, New Jersey 07074
Distributed in Canada by: **SHRIRO (CANADA) LTD.**

*Dolby is a trademark of Dolby Laboratories, Inc.

Enter No. 55 on Reader Service Card

continued from page 53

tions in sensitivity. One medium and four minor drop-outs.

Sony UHF: Overall, close to average in performance for the normal-bias ferrics. Very good consistency of sensitivity, skew, and bias requirements for all samples. Occasional shifts in sensitivity of 0.8 dB. Ten minor drop-outs.

Superscope HF: Frequency responses were smooth at -20 dB, a bit limited at the high end, more so at 0 dB. Other results were also about average for the group. Skew and bias requirements were consistent for most samples. C-60s were 1.4 dB more sensitive than C-90s. Sensitivity varied 0.3 dB quite continually. One medium and 10 minor drop-outs. One C-90 jammed. Sonic-welded.

Superscope SHF: Frequency responses were quite similar to HF, but this tape does provide the benefits of higher MRLs and lower noise. About average in performance, overall. Very good consistency in all respects, with the exception of one C-90 which had a somewhat different skew. Random shifts in sensitivity of 0.5 dB. One medium and 11 minor drop-outs.

TDK Maverick: Average frequency responses, but poorer than average in the other areas, except for modulation noise which was lower than most. Excellent consistency of sensitivity, skew, and bias needs for all samples. Zero drop-outs. Cardboard box.

TDK D: The comments on TDK Maverick apply, in general, although modulation noise was average. The C-120 length required 0.9 dB less bias (-1.9 dB) and was 1.7 dB less sensitive. C-180 samples could not be matched for performance and were dropped from the testing. Sensitivity shifts of 0.5 dB appeared ran-

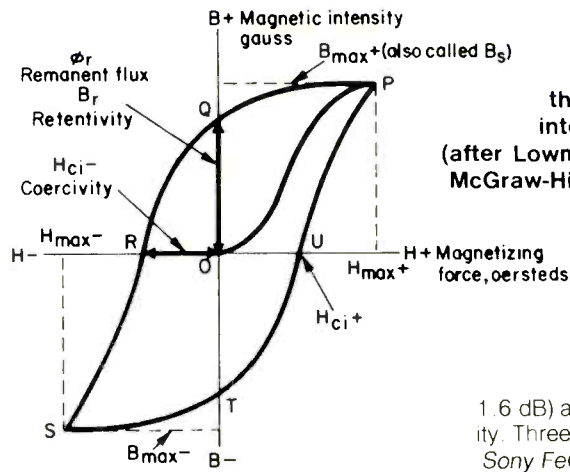

The hysteresis loop shows the relation between magnetic intensity and magnetizing force (after Lowman's "Magnetic Recording," McGraw-Hill, 1972). See Vogelgesang's article in this issue for a discussion of how to analyze the hysteresis loop.

domly. One medium and eight minor drop-outs.

TDK AD: Wide, smooth frequency responses, high MRLs and low noise make this one of the best ferrics. Consistency was outstanding with substantially no variation in sensitivity, skew, or bias requirements among all samples. Zero drop-outs.

Ferrichrome Tapes

BASF Professional III: Wide frequency response at -20 dB, characteristic of the FeCr tapes. High MRLs, in general, and highest S/N ratio of all tapes tested, but also highest modulation noise in category. Excellent consistency among the three C-90 samples. Two minor drop-outs.

Scotch Master III: Wide frequency response at -20 dB, best response of group at 0 dB. Other excellent results including high MRLs and best modulation noise in group. Sensitivity variations and high-frequency amplitude "breathing" with some samples prevented a complete assessment of consistency. C-60s appeared to need 1.1 dB less bias (-

1.6 dB) and to have 0.7 dB less sensitivity. Three minor drop-outs.

Sony FeCr: This tape had the widest frequency response of all tapes at -20 dB, but only a little greater than the other FeCr tapes. Sensitivity was quite consistent for all samples. C-60s required 0.8 dB less bias (-0.2 dB), and there were variations in skew. Two medium and two minor drop-outs.

CrO2 Tapes

BASF: Fairly wide response at -20 dB, but poorest of the group at this level and at 0 dB. Overall, the poorest of the CrO2 formulations. Most samples consistent in skew and bias needs. Some samples required change in bias of 0.5 dB. C-60 sensitivity 0.9 dB lower. Two medium drop-outs.

BASF Professional II: One of the best of the CrO2 tapes in response, with high MRLs and S/N ratio, along with low modulation noise. Consistency very good in all respects, except that one sample required more bias. Minor continual amplitude variations. One medium and three minor drop-outs.

Capitol Music: Frequency responses below average for group. Other characteristics were generally about average. Considerable variations were evident in skew and sensitivity. C-60s required 1.1

100

High-Bias Non-Cro2 Tapes

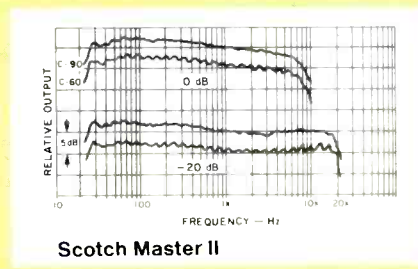
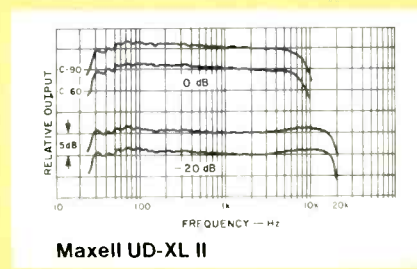
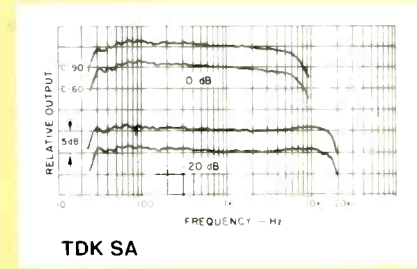
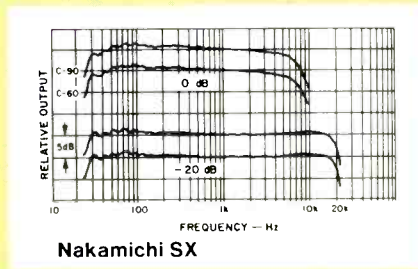
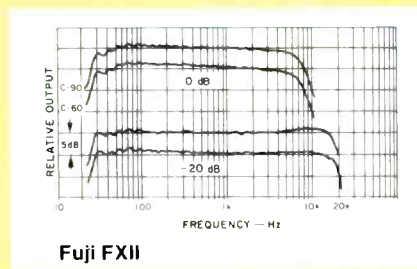



The perfect pair.

The new Koss CM/530 bookshelf speakers with the perfect mirror-image sound.

Here is truly a remarkable achievement in loudspeaker design and performance. The Koss CM/530 bookshelf loudspeaker sets an entirely new standard in extended bandwidth response, high efficiency, low distortion and perfect mirror-image for speakers in its size and price range and within

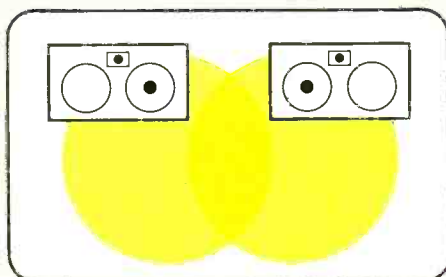

an exceptionally flat energy output and unusually low distortion that provides for a transparency and liveliness not found in other competitive speakers.

Ask your Audio Dealer to give you a live demonstration of a matched pair of bookshelf speakers. You'll be amazed at their perfect mirror-image sound. And while you're at it, try the perfect answer to private listening: Koss stereophones. But by all means, write, c/o Virginia Lamm, for our full color speaker and stereophone catalogs. The Sound of Koss will do great things for your records or tapes . . . and your image.

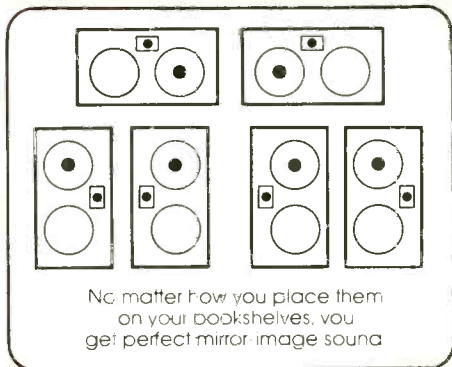

have created a perfectly matched set of bookshelf speakers that can be placed horizontally or vertically without losing the perfect right to left imaging, an incredible degree of dispersion and the beautiful Sound of Koss.

To create the breathtaking depth and clarity in the CM/530, Koss engineers used an 8-inch passive radiator to radiate the sound energy over the lower two octaves. This allowed them to use an 8-inch woofer to reproduce the critical sounds in the midrange up to 3,000 Hz. In addition, the CM/530's 1-inch dome tweeter reproduces

today's technological capabilities.

By designing a left and a right channel configuration for the passive radiator, the woofer and the tweeter, Koss engineers

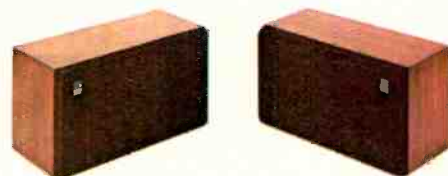

© 1978 Koss Corp.

KOSS® CM/530 BOOKSHELF SPEAKERS
hearing is believing™

KOSS CORPORATION, 4129 N. Port Washington Ave., Milwaukee, WI 53212. International Headquarters: Milwaukee/facilities: Canada · France · Germany · Ireland · Japan

Enter No. 14 on Reader Service Card



At ESS, technology means more than trying to repackage a 50-year-old conventional loudspeaker design under a glamorous new name. Even the best conventional driver *pushes* air on a one-to-one ratio; it moves only as fast as the cone's movements. Only ESS's Heil air-motion transformer *squeezes* air, accelerating it to five times the speed of its own motions.

Free of the distortion and sonic limitations of sluggish conventional designs, Heil-generated sound is unparalleled in dispersion, transient response, dynamic range and musical detail. ESS makes 11 superb Heil-equipped loudspeaker systems, all characterized by a decided feel of excellence. Audition a pair today. See if you're not convinced.

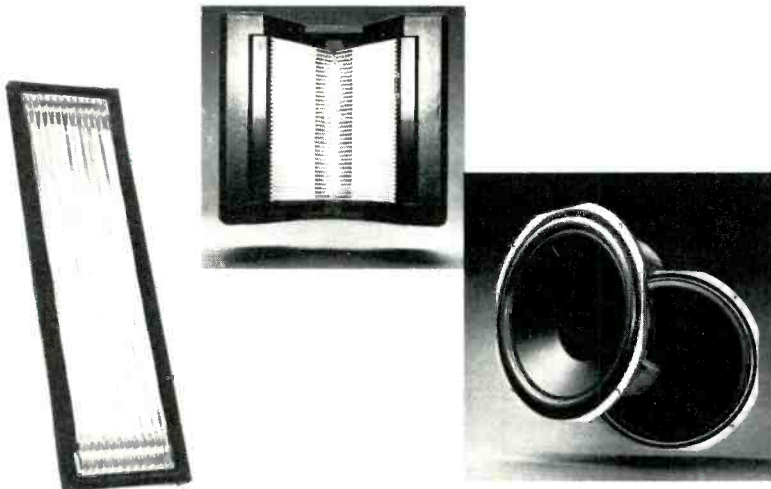

sound as clear as light

9613 Oates Drive, Sacramento, CA 95827



dB less bias (-1.1 dB) and were about 1 dB more sensitive. There were random shifts in sensitivity up to 1 dB. Two major and 10 minor drop-outs. No auto-switch sensing holds.

Memorex: Frequency responses and modulation noise were better than average, while other characteristics were average for this category. Skew and bias requirements were very consistent for all samples. Sensitivity of the C-90s had a spread of 1.0 dB, but the average was close to that for the more consistent C-60s. Sensitivity shifts of about 1 dB appeared every several seconds. Three minor drop-outs. Sonic-welded. Memorex box.

Realistic: This was one of the better tapes in the group, with the best frequency response at -20 dB and better than average MRLs and S/N ratio. Modulation noise, however, was the poorest. The majority of the samples were consistent, but some had different skew. C-60 bias was 0.6 dB higher (-0.1 dB) than the C-90s which had a large spread in sensitivity. Sensitivity varied 0.7 dB with some regularity. Four minor drop-outs. Sonic-welded.

Royal: This formulation produced above-average results in most areas listed in the table. Consistency was poor, however, not aided by the fact that mislabelled C-60 samples were really Royal APC/LN. Two C-90s tripped the end-of-tape sensor because of excessive drag, and two C-60s jammed. The samples that continued to work had minor sensitivity variations. Two minor drop-outs. No auto-switch sensing holes.

Sony: The -20-dB response and most other results were average for CrO₂ tapes. The 0-dB response and the modulation noise were the best in this group. Excellent consistency in skew and bias requirements and in C-90 sensitivity. C-60 sensitivity had a 1.5 dB spread and was 0.8 dB lower, on the average. Two minor drop-outs.

Superscope: The -20-dB response was quite smooth and above average in extent, while the sensitivity, skew, and bias needs were all very consistent for the C-90s tested. Minor sensitivity variations with time. Three minor drop-outs. No sensing holes.

High-Bias non-CrO₂ Tapes

Fuji FX-II: The frequency responses were the poorest in this category, but not at all far below others, and better than the average for the CrO₂ tapes. Other results were slightly below average in most cases. Just two samples each of C-90 and C-60 had been obtained, but since the consistency of skew, sensitivity, and bias was so outstanding among those four, other samples should be expected to show similar excellence. The sensitivity

ty was very stable with time, with 0.2 dB wiggles at the most. Zero drop-outs.

Maxell UDXLII: One of the best tapes in this group and in all categories with extended frequency response, especially at 0 dB, high MRLs and low noise. Consistency was excellent with insignificant variations in sensitivity, skew, or bias among all of the samples. One medium and six minor drop-outs.

Nakamichi SX: Perhaps the poorest tape in this group overall, but superior to the average CrO₂ tape. Not quite equal to the same-source TDK SA reported below. (Being earlier samples might be a cause.) Outstanding consistency with constant sensitivity, skew, and bias for all samples. Three minor drop-outs.

Scotch Master II: This formulation was one of the best performers in most areas of interest, with wide frequency response, high MRLs and the best S/N ratio in the group. On the other hand, sensitivity and skew variations with half the samples caused amplitude changes up to five dB in both cyclic and random fashion. Four major and 12 medium drop-outs.

TDK SA: Average performance for this category, but superior to most CrO₂ tapes. Excellent consistency of sensitivity and skew. C-60s required 0.5 dB less bias (-0.4 dB). Sensitivity variation of 0.3 dB every 2.5 seconds. One major and eight minor drop-outs.

In Summary

Is there one best tape to buy? No. There are really a fair number of well-performing tapes to choose from, with various trade-offs to be weighed according to your own particular needs. We can say that the low-bias ferrics are unacceptable, but in the normal bias range there are a number to choose from. Most of the really good ones have bias quite close to zero, so that will not be a major factor in switching from one to another. Do keep in mind, however, what the effects of bias differences are. The FeCr tapes provide better performance for more money. Are they worth it to you? The non-CrO₂ high-bias tapes gave superior results to the averages for the CrO₂ tapes, but not necessarily when compared to the better ones in that category. The non-CrO₂ tapes had slightly higher flutter, but these differences were very small. The flutter readings varied more from time to time with the same cassette than they did from one type to the other. Your final choice could very well depend upon local availability, best price/performance ratio, or even the ease of writing on the labels.

The general recommendation is to use a tape that offers the combination of performance at least as good as you need, consistency in all respects, and acceptable cost. A

AUDIO • September 1978

Introducing THE BOOM BOX.

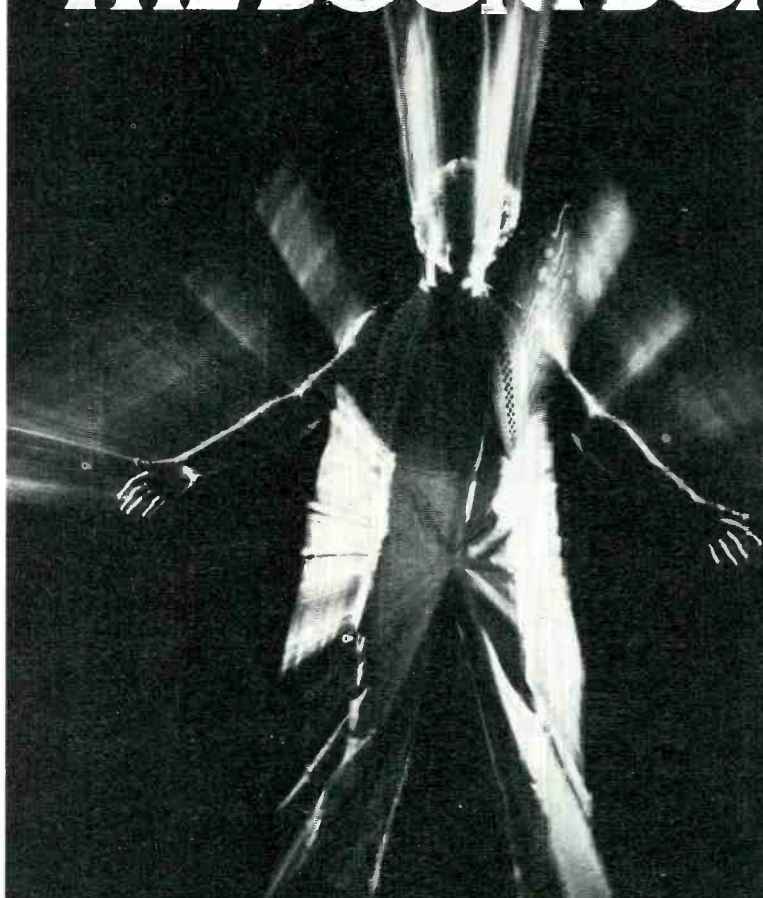

103

It's like listening with your whole body.

You know how good a live bass feels. It talks to you through your chest.

So you know how tough it is to get that sound — and that feeling — when you're listening to records.

But now, you can get last, fast relief from pale bass. Just hook up one dbx Boom Box. And stand back.

In just milli-seconds the Boom Box goes to work so you can feel all the vibrant, low frequency energy of live bass. Because the Boom Box recreates the low frequency sound that's often delibe-

left out in the recording studio.

You actually feel the blast of air a real bass note produces.

The Boom Box does this by seizing the lowest notes, instantly creating new notes an octave lower, and then realistically putting them back into your music. Low frequency notes surge through your hi fi system.

The Boom Box works on any music system that has a tape monitor switch. And that not only makes modest systems sound expensive, it makes expensive systems sound unbelievably real.

Hear the Boom Box. Feel the Boom Box. At your dbx dealer. You'll experience an all-time "low" in musical enjoyment.



dbx

dbx, Incorporated
71 Chapel Street
Newton, MA 02459
517/964-3210

Enter No. 7 on Reader Service Card

The column



Some Girls: Rolling Stones
Rolling Stones Records
COC 39108, stereo, \$7.98.

Some Girls is many things, offensive, occasionally smutty, spirited, and exhilarating. As far as I'm concerned, it's the best Rolling Stones album since **Let It Bleed** nine years ago.

Their previous studio album was **Black and Blue**. I hated it. At the time it sounded tired, bored, and forced. The single *Hot Stuff* sounded like ersatz disco, uncomfortable and affected. The recent live album **Love You Live** was a bitterly disappointing obvious turkey that only reinforced many doubts. This time out the boys sound far more interested. The playing is fiery with a nearly-out-of-control feel missing from the Stones' music machine for far too long. Perhaps a good part of the tentative feel of **Black and Blue** was due to the revolving door lead guitar situation the Stones faced with Mick Taylor's defection. This, the first album with Ron Wood fully integrated into the band, has no such problem. Woody and Keith Richards (he's using the "s" at the end of Richards again) play spittfire lead guitars hand in glove

which produces the most satisfying soloing the Stones have had in a while.

As a group, the songs show a return to edge city. Those reliable old Chuck Berry licks drive *Respectable*, which along with *Lies* is an instant vintage Rolling Stones rocker. *Beast of Burden* sounds oddly like a Smokey Robinson melody with its faint echoes of *Tracks of My Tears*. It is a pretty, almost wistful song. *Before They Make Me Run*, the song Keith sings on **Some Girls**, seems a somewhat obvious comment on the shaky nature of his legal future.

Shattered and *When the Whip Comes Down* both evoke the Velvet Underground. Mick Jagger takes on an early Lou Reed-styled delivery on these. The melody and arrangement of *When the Whip* sound not far from the Velvet's classic *Waiting for My Man*.

The title song has attracted the quickest controversy. Its lyric is a simple-

minded catalogue of the sexual tastes and peculiarities of all the girls who come to mind. The song sounds as if much of it was improvised on the spot. Legend has it that there exists a 10-plus minute version that is so filthy it makes this sometimes racist, sometimes smutty, sometimes tasteless, sometimes scabrous song sound tame. Taken seriously it insults every woman everywhere, but I'm not sure that's how to take it. It is so simple minded that it sounds like a children's playground song more than anything else. Taken satirically it's uproarious, outrageously funny and one of **Some Girls'** most exciting tracks what with some blistering guitar leads.

Far Away Eyes is another satire. This one, with a nod to Gram Parsons and the decadent feel of the first Flying Burrito Brothers album, takes on honky-tonk Country & Western and radio religion, the "put your hands on the radio" stuff. Strange, haunting material.

Miss You, the first single out of the album, is terrific. Charlie Watts' disco-influenced, metronomic drum part is the ramrod of a superb Rolling Stones performance, nothing like the forced fake of

Hot Stuff. A fascinating development with the single's release is the appearance of no fewer than four different mixes of the song. The album version times out at 4:50; the promotional single has mono and stereo versions at 3:47. That stereo single version is the one on the commercially available 45. This much is not uncommon in the record biz. What is uncommon is the release (to radio only as I write this, but with commercial release likely) of a 12-in. single with an 8:36 extended length. Differences are obvious. The stereo single and disco mix have the most life — a positively vibrant sound. The mono mix homogenizes the sound, bringing the vocals, particularly the backing vocals, much farther up front with a creamier texture. Oddly the album's mix suffers by comparison. It clearly lacks the extra edge in the drums and some cutting edge in Jagger's voice.

Other parts of the album, noticeably the uptempo rockers, have some of the edge missing on *Miss You*. Generally Mick's voice is clearer than usual. You can usually even understand the words. It plays best at higher volumes so you can feel the rough edges. Played softly it moves me to turn it up. In contrast **It's Only Rock and Roll**, perhaps the most melodious of Stones albums, plays very well softly and not so well loud. The rougher the album, the better the Stones sound loud. Consider *19th Nervous Breakdown* and *Get Off My Cloud*. In the end you makes your decision and you takes your choice. Therefore, the sound rating below reflects more on the power achieved, rather than on technique.

On **Some Girls** the Rolling Stones sound dangerous, and I haven't been able to say that in years. Whether these rich jet-setters are as dangerous as they sound may be another question, but the music has a natural flow and strength, a "Stones-ness" that makes it work. Whatever the future of the band, **Some Girls** does prove one thing conclusively: There is rock past 35. M.T.

Sound: B

Performance: A

Some Girls: The Rolling Stones
Rolling Stones Records COC 39108,
 stereo, \$7.98.

Finally these boys have regained the right to lay claim to the title of their choice, be it the "Crown Princes of Rock" or whatever the pundits are shouting this week, for **Some Girls** is veritably *Some Album*. Aside from the fact that they've steered totally away from acoustic numbers and Jagger's piano ballads (*Have Mercy!*), and that the one disco tune on the album (*Miss You*)

AUDIO • September 1978

"The Proof is in the Listening..."

Most speaker companies romance you with stories about how their speakers are made and why they sound the way they do.

If you're into the "quality story," we can tell that story very well. If it's craftsmanship that turns you on, our speakers are almost entirely built by hand and tested by ear.

But when you come right down to it... the proof is in the listening. That's why we, at Monitor, want you to listen to our speakers.

Monitor Audio... Quality audio components... from Britain with care.

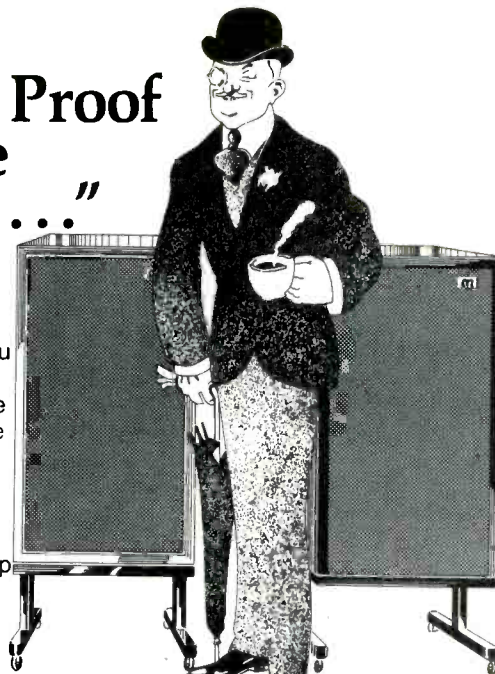

Monitor Audio Ltd.

Canadian Distributor:
 Edon Acoustics Limited, Ottawa, Ontario.

Enter No. 3 on Reader Service Card

Distributed by
AudioSource
 1185 Chess Drive, Foster City,
 Calif. 94404

105

TOLL FREE 800-356-9514

PIONEER



Under Dash
 Cassette Deck
KP-66G

PIONEER

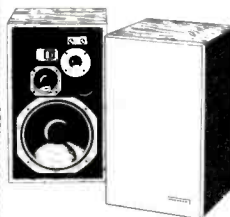

12" 4-Way
 SPEAKER
 SYSTEM
HPM 100

SHARP



Computer
 Cassette Deck
RT-3388

- Home and Car Stereo
- Over 60 Brands Stocked and Discounted
- Write or Phone for Free Price Sheet
- All Equipment in Factory Sealed Cartons
- MASTER CHARGE and VISA Accepted by Phone

WDS
 WISCONSIN DISCOUNT
STEREO

For The Lowest Prices
 Call Toll Free

800-356-9514
 608-271-6889

2517 whalen lane madison, wisconsin 53713

Enter No. 35 on Reader Service Card

Design Council
Award 1978

SME 3009 Series III

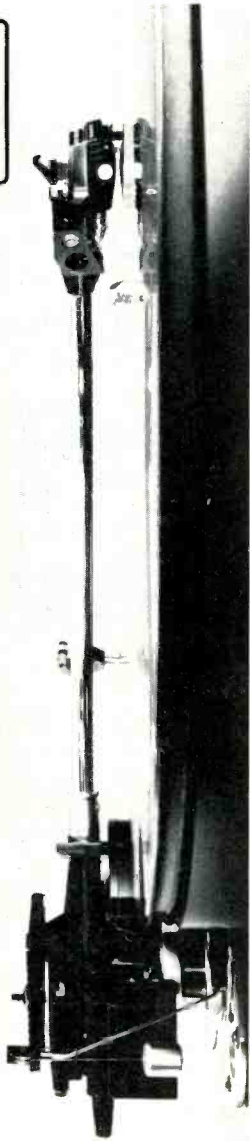

Write to Dept 1448, SME Limited, Steyning, Sussex, BN4 3GY, England
Exclusive distributors for the U.S.: Shure Brothers Incorporated, 222 Hartrey Avenue, Evanston, Illinois 60204
and in Canada: A. C. Simmonds and Sons Ltd, 975 Dillingham Road, Pickering, Ontario, L1W 3B2

"Our technical test of the Series III tone-arm shows without any doubt that SME has succeeded in developing and producing a pick-up arm which enables high as well as low compliance cartridges to do their best."

cannot produce resonances that can be heard or measured."

"The SME Series III is the first tone-arm in our experience where the choice of pick-up is not limited by excessive tone-arm mass or insufficient damping of resonances."

"The effective mass of the arm is so low that the resonance frequency with a soft (high compliance) pick-up can be placed above the critical area below 5Hz, and the damping of resonance is so good that a stiff (low compliance) cartridge

The above comments were made by Knud Sondergaard concluding a detailed technical review of the Series III precision pick-up arm in the December 'ny elektronik' (Denmark).

is infused with so much personality and humor that it transcends the form, this sounds like an impassioned band rather than a bored bunch of drug abusers. Whatever can be said about their ineptnesses on a technical level is washed away by the fact that they haven't assembled an album of tracks this strong in — dare I say it — a decade.

It seems that the Stones are able to produce whenever there's an incentive to improve, the bait this time being a new record deal which allows them free studio time in addition to close to a million dollars per album. When you put that kind of temptation in front of Mick Jagger (with a divorce pending and carrying a price tag approximating said figure), he has risen grandly to the bait; our boy Michael has even taken the occasion to pick up the electric guitar and make The Rolling Stones the first band with three rhythm axemen at the helm and no striking lead player. But I'll hold my cheap shots, for although the guitar breaks are disjointed, no one ever claimed The Rolling Stones' forte to be improvisation, and there's little quarrel to be had with the guitar fills/frills, save for the obvious lack of distinction between Keith Richards' and Ronnie Wood's riff-work.

One is strongly led to suspect that Mick dominates the album composition-wise, although all songwriting credits are Jagger-Richards. The best tracks on **Some Girls** are the title track (a Dylanesque poke at international womanhood), the fast-moving & hysterical *Shattered*, an unusually pretty song called *Beast of Burden*, Keith's anthem *Before They Make Me Run* (though Keith's lead vocal leaves something to be desired), and a Country & Western "tour de farce" called *Far Away Eyes*. The other five tracks are all quite listenable as well, the only complaint being that some take too long to end. Mick's greatest contribution to **Some Girls**, above all else, is his ability to sing with more character and excitement than I believed him capable of. His voice has hardly been in the best of form on recent albums, particularly his croaking on **Love You Live**, but it appears that his pipes and brain are razor sharp and honed to kill these days.

The group sound is more consistent, recognizably Stones rather than their limp delivery of albums past. Seven out of the 10 tunes feature the 44-year-old Bill Wyman on bass, a remarkable showing for the guy who's been edged out of said position many times in the past by Mr. Richards and now must contend with ex-Jeff Beck bassist Mr. Wood as well. Charlie sounds good — even when he plays badly (e.g. the guitar break in

Shattered) his snare cuts through in his inimitably sloppy style. The guitar playing is hardly the most biting ever for these fops, but the combination of the heavily-treated rhythm guitars and Ian McLagan's keyboards make for a lush rhythmic texture, the solidest body of music Jagger's had to sing against in a long, long while.

Now that we know these old men can do this well, there's no reason to make excuses for them in the future. **Some Girls** will be a reference point against which forthcoming Rolling Stones albums will be measured, and, like it or not, it won't be easy to beat. Jagger's talked of doing a highly experimental record a la **Satanic Majesty's Request** for some time, and that may be the only direction for them to attempt. When it comes to flat-out, straight-ahead rock 'n' roll, **Some Girls** is one of the finest examples of the form to be had in 1978 — and what do you have to say for yourselves Mr. Johnny Rotten, Mr. Rod Stewart, and Mr. Bruce Springsteen? J.T.

Sound: A

Performance: A+

Return To Magenta: Mink DeVille Capitol SW-11780, stereo, \$7.98.

Though the group Mink DeVille has risen from the tired corpse of the New Wave/New York Scene, there are several noticeable differences between them and the rest. First off, whereas Television purports to be Tom Verlaine & Co., The Ramones are a "group," and Talking Heads seem to maintain a semblance of synergistic direction, there is no doubt in anybody's mind that Mink DeVille is Willy DeVille. The group is OK, and still going through personnel changes (thank you-know-who they sacked the drummer!) but really nothing special; Mr. DeVille, on the other hand, is a major songwriter and strong singer with a style and identity all his own. The other big difference is that he's had the sense to submit himself to a knowledgeable producer (Jack Nitzsche) who's been able to bring out the artist in Willy.

The first album was just a warmup for this one, where Mr. Nitzsche displayed that he did learn something working as Phil Spector's right hand man all those years, and in fact he seems to be the only person right now carrying on the legacy of "that sound" and achieving any kind of commercial success. **Return to Magenta** is the Righteous Brothers album that never was — *Guardian Angel* and *Just Your Friends* are the spacey-but-lush anthems that the Seventies needs, with string arrangements stolen right from Gene Pitney/Phil Spector's *Every Little Breath I Take*. *A Train Lady*

has Willy singing both Bill Medley and Bobby Hatfield's parts, theoretically speaking, and *I Broke That Promise* is the Drifters song that they never recorded. It doesn't matter that *Soul Twist* is a verbatim rewrite of *One-Way Street* from the last Mink album, and that there are a couple of filler tracks on the album... the fillers make the really special tracks sound even better. This may be the best r&b album ever recorded by a fair-skinned individual, and I dare say that he's still growing as an artist and has a long way to go before he starts falling off. **Return To Magenta** is one of the most striking, soulful, and creative albums ever recorded, and it puts most contemporary balladeers, rockers, and rhythm & blues outfits to absolute shame. J.T.

Performance: A Sound A

Jazz: Ry Cooder

WB BSK 3197, stereo, \$7.98.

Jazz could be the least commercial album Ry Cooder has made. It has a totally different direction than the Tex-Mex and Hawaiian oriented sounds of his last several albums. Here Cooder creates a new seminal jazz music from the late 19th and early 20th centuries. There is *The Dream*, a whorehouse song from around 1880 played with the great Earl Hines. There's a Jelly Roll Morton piece recorded by Cooder alone as an overdub ensemble. And there are three of Bix Beiderbeck's songs of which the solo performance of *Flashes* and the small group setting of *Davenport Blues* stand out. Then there is the complementary material. Three vaudeville songs are present, a lively *Big Bad Bill is Sweet William Now*, *Shine* complete with introduction, and Bert Williams classic *Nobody* for which Ry chooses to affect a Negro accent vocally, a device that is distracting at best. Finally the album is framed by three hymns rearranged into a "string /brass band" setting that is most faithful to the peculiar guitar playing of the remarkable Bahamian Joseph Spence.

The musicianship of **Jazz** is on an extraordinarily high plane. With all acoustic instrumentation, the recording has been able to achieve a natural and warm sound that lets the delicate interplay shine. Additionally, Cooder's liner notes on the inner sleeve shed a lot of light on the genesis of the project.

A brave, thoughtful and exquisitely crafted album, **Jazz** by Ry Cooder deserves much more attention than it is likely to receive from the big mass audience. M.T.

Sound: A Performance: A

AUDIO • September 1978

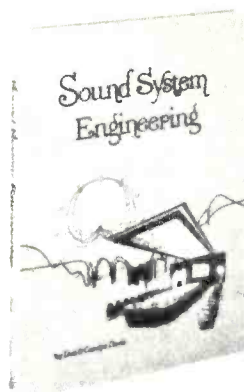

Sound System Engineering

by Don and Carolyn Davis

A new, completely up-to-date book discussing audio systems as a whole. The decibel notation system, loudspeaker directivity and coverage, the acoustic environment, designing for acoustic gain, and interfacing the electrical and acoustical systems are reviewed. Circuit levels, grounding and shielding, servicing cable, useful wiring concepts, impedance matching, fundamentals of time delay, and proofing the installed system are explained in depth. The authors discuss equalizing the sound system, instrumentation, sample design application, and specifications. The many appendices give symbols and abbreviations, recommended installation practices, priority systems, definitions of terms, test questions and answers, and other valuable reference information.

AUDIO Book & Learning Systems Div.
401 N. Broad St.
Philadelphia, Pa. 19108

AU9

Enclosed is check for \$19.95. Send me, postage prepaid, Sound System Engineering.

NAME _____

ADDRESS _____

CITY/STATE/ZIP _____

107

FREE

McIntosh CATALOG and FM DIRECTORY

Get all the newest and latest information on the new McIntosh Solid State equipment in the McIntosh catalog. In addition you will receive an FM station directory that covers all of North America.



MX 113

FM/FM STEREO - AM TUNER AND PREAMPLIFIER

SEND TODAY!

McIntosh Laboratory, Inc.
East Side Station P.O. Box 96
Binghamton, N.Y. 13904
Dept. 1

NAME _____

ADDRESS _____

CITY _____ STATE _____ ZIP _____

If you are in a hurry for your catalog please send the coupon to McIntosh. For non rush service send the *Reader Service Card* to the magazine.

Enter No. 17 on Reader Service Card

SONUS
SERIES II.

THE BEST
KEEPS GETTING
BETTER.



The original Sonus cartridge established a new standard in high definition phonograph reproduction. Yet we believe there is even further room for improvement in this often-overlooked area of high fidelity. So we have taken the original Sonus cartridges and refined their designs, taking full advantage of the latest in materials and techniques. Sonus Series II cartridges are the result of these new design developments.

The new Sonus Gold consists of three models with identical bodies and stylus assemblies, differing only in the form of their diamond tips. The new Sonus Silver comes in two stylus types, and shares all the qualities of their more costly counterparts, yet still can offer a dramatic improvement in sound reproduction overall. Both series employ a transducer system characterized by reproduction of exceptional accuracy, clarity and definition. For full details and a recommendation of which model is correct for your particular system, we suggest a visit to the Sonus dealer nearest you.

SONIC RESEARCH, INC., Sugar Hollow Rd.
Danbury, Conn. 06810

SONUS

High Definition Phono Cartridges

Enter No. 28 on Reader Service Card

Theater music

Donald M. Spoto



A Little Night Music: Original Soundtrack Recording

Columbia KS 35333, stereo, \$6.98

Something is drastically wrong with **A Little Night Music** since it has become a soundtrack recording. Hollywood has vulgarized again, and what was originally a delicate, sophisticated musical has been reduced to an embarrassingly amateurish fiasco.

Although many of the first **Night Music** people are still involved here (music supervisor Jonathan Tunick, director Harold Prince), the music itself has somehow become flatly mechanical, arthritically timed, crassly orchestrated (the *Night Waltz* sounds like a silly carnival tune)—and disastrously engineered: In the middle of one band, *A Weekend in the Country*, there is a very noticeable silent gap between the song's final solo and the choral conclusion. Perhaps engineer Warren Vincent dozed off for a second.

The record boasts an impressive cast: Elizabeth Taylor (Did she really sing all the songs written for Desiree? It doesn't always sound like her!), Diana Rigg, Len Cariou, Hermione Gingold. They all manage to perform most ineptly, even when speaking the bits of mawkish dialogue which are annoyingly dispersed throughout the album. Only Diana Rigg, who doesn't pretend to know how to sing, succeeds, with her tongue-in-cheek bitchiness. Her rendition of *Every Day a Little Death*, although musically dead, is rather intelligent and human.

Columbia has not recorded the soundtrack well: Often many voices sound muddy — as if everyone's got a lisp

An Unmarried Woman: Original Soundtrack Music by Bill Conti
Twentieth Century Fox Records
T557, stereo, \$6.98.

The soundtrack of **An Unmarried Woman** is as upbeat and cosmopolitan as the film itself, upbeat without being banal, and sophisticated without being dull. It's just the right mixture of Hollywood and reality.

Produced by Jerry Peters and composer Bill Conti, the music has appealing jazz overtones and a moving love theme. Only one band should be eliminated, a lyricized version of the title theme music itself. It is tiredly performed by Michelle Wiley, who also wrote trivial, uninspired lyrics for it. (Fortunately, this song is not in the film. And is this the reversion to an old tradition? Remember the sung title theme from Hitchcock's *Torn Curtain* over a decade ago? Universal wanted to make it big on the pop charts too, and the song, as here, never appeared in the film!)

Everything else is fine, the major piece is lively *Chase Me*, an endearing and brief pacer, and *Loft Party* is bubbly and exuberant. The final band, *Erica Leaves Saul*, is the most exhilarating on the disc. Expertly executed, it's guaranteed to lift your spirit.

An Unmarried Woman is finely recorded on Twentieth Century Fox Records. The film is, as they say, cleaning up. The record deserves a hearing too.

HOLOCAUST: Music From the NBC-TV film, written and conducted by Morton Gould

RCA Red Seal ARL 1-2785, stereo, \$7.98.

Holocaust caused something of a small sensation when it turned up as a 9½ hour television movie in the spring of 1978. Newspapers and magazines devoted a good deal of space to the pros and cons of this treatment of the Nazi era. Eager to capitalize on the debate, RCA (the same family as NBC, after all . . .) has just released Morton Gould's extended suite. Long associated with popular music, Gould has also written three symphonies, ballet music and numerous short pieces. The music for *Holocaust* is essentially Hollywood spectacle fare, but there are some extraordinarily lovely touches: The *Berta/Josef Theme*, a kind of *lied* for piano and strings which expresses what the composer has called the "Old World love the couple has for each other;" the *Lullaby*, a sad and gentle slumber song for a young mother and her dead baby; the music for an ugly rape scene, which has some surprisingly Coplanesque dissonances (which means it's really quite traditional!); and the *Rudi/Helena* theme — a quietly moving serenade, glistening in its pale sonorities, pure, free of cliché.

But alas, the clichés are there. The theme for the whole thing, in fact, and the *Fanfares and Transport* for the sequences to the concentration camp, as simple movie spectacle set pieces, and the score gets runny and annoyingly unimaginative. For the recording, Gould has composed an *Elegy* to conclude — "a personal musical comment," he says, but it reminds me of the famous Gershwin *Lullaby*. Rich in orchestration, nicely conceived, this — like the score's best moments — sticks in the feelings perhaps more than the film itself. The recording, done in England with the National Philharmonic, is first-rate; every range is crystal clear, and the bass is never muddy.

Two's Company: Bette Davis and Original Broadway Cast

RCA Legendary Broadway Shows Series, CBMI 2757, mono, \$7.98.

Apparently not content with its reissuance several years ago of vintage movie soundtracks, RCA is beefing up its nostalgia-mania with a series of "legendary cast albums." **Two's Company** is certainly legendary — but not in the way RCA meant. It opened on Broadway in December, 1952, and ran a whopping 90 performances, closing, it is said, because of Bette Davis' jaw infection.

That was, the jacket tells us, the last in a series of misfortunes that plagued the Vernon Duke-Ogden Nash musical

revue. During Broadway tryouts, various show "doctors" were called in (Josh Logan and Arthur Laurents among them) to salvage it. If we're to believe this album, however, nothing worked. It's a monument to banality, both in melody and prosody, and none of it is redeemed by Bette Davis, who belts, lunges, coughs, and tears her way through *Turn Me Loose on Broadway* and *Roll Along, Sadie* (which fails at being a send-up of Maugham's moist tale of the tropical prostitute), and *Just Like a Man*. We don't for one minute believe a word of the lyrics ("high" rhymes with "sky" —

you know, that sort of thing), and the music has all the freshness and spontaneity of a Midas Muffler commercial. Ellen Hanley, who sounds like the producers were priming her to be what Barbara Cook in fact became, sings the love songs with somnambulistic indifference, and the orchestra, under Milton Rosenstock's direction, thumps along gamely, pounding and murmuring as if little mattered. And it doesn't. Why this revue has been resurrected is a mystery. Once was certainly more than enough; twice is a moral issue. The final blow is that it's a flat, poorly mixed monophonic release!

"AWESOME"

and other comments from audio critics
about Ohm F loudspeakers:



Comments from The Complete Buyer's Guide to Stereo/Hifi Equipment:

"The Ohm F is an extraordinary loudspeaker. It has only one driver, which acts as a pulsating cylinder... What this means in terms of sound quality is remarkable. It may well be the finest speaker on the market and is certainly without a doubt among the top few."

Comments from Stereo Review:

"The tests we have made all tended to confirm the claims made for the Ohm F.... In our sim-

ulated live vs. recorded test it rated A to A+... with one of the larger power amplifiers... the sound began to warrant the use of such words as 'awesome'... it is easily one of the best."
(©Ziff-Davis Publishing Co., 11/73, all rights reserved. Reprinted by permission.)

For a free reprint of thirteen complete reviews of Ohm speakers priced from \$100 to \$700, please write us at:

241 Taaffe Pl.,
Brooklyn, N.Y.
11205



We make loudspeakers correctly.

European records

John Wright

It is peculiar how when one new recording of a work appears, competitive versions are issued in rapid succession from other major record companies. At the moment this seems to be centered around Liszt's *Sonata in B minor*. Only a short while ago I had reason to enthuse about the outstanding performance by Berman on the Melodiya label (ASD 3228), which is comparatively unemotional but freely exploits the artist's dex-

recording on Decca (SXL 6756) provides a more romantic and whimsical interpretation of this rather formless sonata. It is played with a technical expertise, that in contrast to these other performances, makes it sound so easy. The piano tone is convincing, portrayed with an adequate sense of spaciousness, and the nearest comparison from my collection for such positive sentimentality and complimentary acoustics is the 1971 recording by Agustin Anievas (EMI HQS 1246) which still weathers well. However, with due consideration between these renditions, my first choice would now lie with this new Decca as the most tasteful musical/engineering balance. Albeit, perhaps, less spectacular, the record reincarnates my initial adolescent attraction to the work . . . even after repeated playings.

In my last record column I had cause to enthuse over Alfred Brendel's interpretation and Philips' recording of Schubert *Impromptus*. This month I give equally unreserved praise for Brendel's contribution to the Liszt catalogue — this time with a selection of items including the well-known prelude and fugue on the name *B-A-C-H*. It is surely the sign of a great performer, be he actor or musician, if he can lend himself equally to a multitude of roles. The "organ-like" playing which Brendel brings to this work is in complete contrast to any other works that I have heard him play. From a technical viewpoint this release (9500 826) retains that uncanny naturalness that epitomizes the best of Philips and as such is the best recording of the Liszt discs mentioned in this issue.

Also in the last column I recommended two Haydn Symphonies, *The Philosopher* and *The Schoolmaster*, played by Neville Marriner and The Academy of St. Martin-in-the-Fields (9500 198). Continuing the series, we have two more releases which are recorded in an equally luscious way, yet being clean and crisp. Haydn *Symphonies 94 & 96*, *The Sunrise* and *The Miracle*, are properly and frivolously performed on 9500 348 while *Symphonies 44 & 49*, *The Mourning* and *La Passione*, on 9500 199 are less immediately attractive but perhaps for this are longer lasting in their appeal.

A quick mention of a great event is that in celebration of Vivaldi's birth 300 years ago, I Musici, celebrating their 25th Anniversary, are engaged in the recording of 10 volumes totalling nearly 50 LPs of his chamber works! Obviously at the expense involved nobody is going to purchase all or even part of this marathon on the basis of cursory remarks from me, but judging by a sampler (available at a reasonable price) I can concur that Philips have maintained their high standards of chamber music recording for which they are justifiably renowned. On 6833 247, this sampler at least is really too good to miss.

Moving forward in time, musically speaking, works for two flutes by J.S., W.F., and C.P.E. Bach are played by Stephen Preston and Nicholas McGegan on DSLO 518. It is an "in-the-room" presentation being slightly dry and in need of a large listening area, allowing a good seating distance from the loudspeakers. The high cutting level results in low background noise, revealing breathy action sound of the instruments. The performance as such I would describe as "straight-laced."

News from Enigma, which was started in June, 1976, by John Boyden and Peter Whiteside (being joined in December of that year by Tony Faulkner as recording manager), is of a recent takeover by WEA Records, a subsidiary of Warner Communications Inc. In less than two years Enigma has issued 45 records in addition to some 25 others already taped but not yet released. Initially it was the company's policy to concentrate on the British market but the future will involve more and more international artists. It is interesting that one of the most dynamic and modern pop record companies should have bought Enigma who are almost alone in making a classical product based upon simple microphone techniques, rejecting with scorn the widespread anti-musical multi-microphone, multi-track techniques of the pop studio.

Something magical generally happens when Sir Adrian Boult conducts while Parker & Bishop record for EMI. Their latest recording of Beethoven's *Symphony No. 6 Pastoral* with the Lon-



Alicia De Larrocha

terity. This has been swiftly followed by a performance of Vladimir Horowitz in his **Golden Jubilee Recital** disc on the RCA label (RL 12548). Considering his age, this is equally flamboyant but with many inexactitudes accompanied by an over-emphasis of contrasts. And now the latest release by Alicia De Larrocha

don Philharmonic on ASD 456 is no exception. It is unashamedly warm and lyrical and is accompanied by subjectively unrestricted low frequencies, resulting in a sonic experience that can only rate as "superb." It is therefore slightly a pity that in the same period the same engineers should record the LSO conducted by Eugene Jochum performing Beethoven's *Symphony No. 5* (ASD 3484) for which if there had been no direct comparison would have deserved a similar rating sound-wise. However, this just misses that higher echelon, being slightly brasher — but perhaps correctly so?

In complete contrast by way of balance, Brian Couzens provides a BBC type "seat-in-the-audience" perspective of the complete Sibelius *Tone Poems* played by the Scottish National Orchestra conducted by Sir Alexander Gibson (RCA RL 25136: 2 records). Apart from some minor pressing flaws, which are becoming more prevalent on this label of late, this whole rendition is likely to appeal mostly to the purists among us and reproduces well at low levels when listening in a quiet environment.

Containing equally good distance effects, HMV's new recording of Bizet's *The Pearl Fishers* creates a highlight on the operatic scene (SLS 5113, 2 discs). It is rare for me to recommend opera records, and this is, regrettably, because they are usually too contrived for my tastes. While I acknowledge the dilemma presented to the engineers by this art form, I do object to "full frontal" soloists thrown before a receding orchestra. Not so in this box set, where the front-to-back perspective is fine in every respect, with the orchestra (enjoyable to listen to on its own) is extended in both range and dynamics, yet with the soloists well positioned, even if synthetically, only just in front. Conceding the insuperable difficulties of opera recordings as a home entertainment medium, this version is difficult to fault and the Chorus and Orchestra of the Paris Opera, conducted by Georges Prêtre, provides an authenticity coupled to some of the loveliest music which has rightfully become very popular.

Returning to music more suited to the home, Elly Ameling, accompanied by Dalton Baldwin (piano), sings *Songs for Gretchen, Ellen and Suleika* by Schubert on Philips 9500 169. Including the famous *Ave Maria*, this has similar qualities to their earlier discs of 16 *Leider* (6500 774), possessing a "single-microphone" feeling about the balance. Equally it is emotional but unsentimental, conveying a depth of feeling yet without embarrassment. The ambience suggests a deceptive cutting level. In fact the record is not too easy to track, and I

found it necessary to keep the stylus impeccably clean, but this is a small sacrifice for the satisfaction provided.

It is coincidental that within the same quarter RCA should choose to issue a two-record set of Schumann *Romantic Lieder* sung by Peter Schreier, accompanied by Norman Shetler on RC 25126, which in its way is outstanding. It is a forward and onward going interpretation, if perhaps a little over-dedicated, but has similarities to the Schubert in the plushness of balance although comparatively sibilant in places.

The market seems insatiable for records of Stravinsky's *The Rite of Spring*. Why this should be defeats me, since for my money if one had to extract the single Stravinsky ballet that stands repeated listening without the visual element, it would be *Petrushka*. However, I must be in the minority since the number of records in my collection alone disproves this. Maybe it is that, in short doses, parts of *The Rite of Spring* make ideal demonstration material for hi-fi enthusiasts. Following this line of thinking, and looking back through the most popular releases, there has been a distinctly "contrived" versus "purist" battle between engineers. Each strategy has succeeded within its own right, but only to a certain extent. One of the most successfully "contrived" discs with particularly impressive brass is that conducted by Sir Georges Solti on Decca SXL 6691, while a comparatively "purist" approach was taken by Philips and Haitink on 6500 482. Bridging the two approaches then came Lorin Maazel on Decca SXL 6735. And now we have yet another new disc which really does not fit into any of these categories.

Conducting the Concertgebouw Orchestra, this time Colin Davis records for Philips (9500 323). It has that distinctive "laid-back" sound but with special crispness, detail, glistening transients, and differentiated timpani. So often where there is an extended bass drum, it results in a homogenous wedge. Not so here where every skin struck can be heard as a separate entity. I hesitate to call it natural but certainly it does possess that quality demanded by the pseudo-purist (despite Enigma's recent release). Containing impact, this is the very best "compromise" recording so far. Very little need be said about the playing except that it embodies a deliberately punctuated interpretation. Surprisingly for the extraordinary results achieved, there is no need to play this record loudly to maintain excitement and neither, despite the nature of the work, is it particularly tiring. To sum up I don't know how this record was made, but the results are so fine I don't even care. Δ

The Audio Critic stands alone.

Of all the publications that review audio equipment by brand name, only The Audio Critic can make every one of the following statements:

- We're totally uninfluenced by advertisers, since we accept neither manufacturers' nor dealers' advertising.
- We not only agonize over subjective listening comparisons but also try to correlate what we hear with fine-tuned objective tests in a truly well-equipped *in-house* laboratory.
- Our test reports are relatively nontechnical but informed by a belief in physics and mathematics, not by pop-tech cults or the untutored folklore of audio-store cowboys. (As a result, serious technologists speak of us with respect rather than the sad smile they reserve for the "undergrounds.")
- We published our first five issues within a span of just over 14½ months.

- Each of these issues reviewed in depth an average of 35 specific items and also included several articles of general interest (such as the now internationally famous cartridge/arm alignment instructions).

The subscription cost of six consecutive issues (indexed as one volume) is \$28, by first-class mail only. (No Canadian dollars, please!) For overseas airmail, add \$5. No single copies are sold for any reason whatsoever, but the unused portion of canceled subscriptions is refundable on request.

A good "starter" issue is Number 6, which is now scheduled to be mailed in August. This is a special midyear reference issue that updates all our previous findings and also brings you many first-time reviews. Or you may want to shoot the works and start with Volume 1, Number 1, so that you'll own a complete set. Of course, we're willing to start you with any issue you specify.

Send for your first six issues today!
Use this convenient coupon or, if you prefer, copy the part that applies to you on any sheet of paper.

- The Audio Critic
Box 392, Bronxville, New York 10708
Enclosed please find
- \$28 for 6 issues starting with the midyear reference issue described above.
 - \$56 for the first 12 issues starting with Volume 1, Number 1.
 - \$28 for 6 consecutive issues starting with Volume 1, Number 1.
 - \$5 supplement per 6 issues for overseas airmail.
 - \$10 supplement per 12 issues for overseas airmail.

NAME _____
ADDRESS _____
CITY _____
STATE _____ ZIP _____

Classical reviews

Edward Tatnall Canby



112

Beethoven: Triple Concerto, Op. 56. Beaux Arts Trit London Philharmonic, Haitink. **Philips 9500 382**, stereo, \$7.95.

Here's one of Beethoven's biggest and least known works, out of the fruitful early-middle period, the time of the "Eroica" *Symphony*, No. 3. It presents problems — it always has. And Philips, in this latter day, has not entirely solved them, as many hopefuls in the distant past have equally foundered.

The problem is — a concerto with three diverse soloists; piano, cello, and violin. It's a late version of the earlier "concertante" (Mozart, Haydn) — but if the earliest works were necessarily long, this one, in a time of much expanded length, has super-difficulties in that respect. Like a hostess with three literary lions at her party — she gets all flustered trying to introduce each of them in proper order — it is the same with Beethoven. By the time things get properly under way, the first side is over.

Philips' problem is a heartening one, the all-American Beaux Arts Trio, which they should know by this time, having recorded them often; a bunch of powerhouses and especially Manahem Pressler at the piano, that irrepressible artist whose mere presence in a record-

ing session radiates enough energy to knock you down. Pit Pressler and his excellent colleagues, Cohen and Greenhouse, on violin and cello, against the mere London Philharmonic under that important but somewhat lethargic Dutchman, Haitink, and you have an imbalance supreme. It is, unwittingly, made more by the Philips engineers, who unwisely have blown up the Beaux Arts Trio to, in VU measurements, slightly larger than the entire London Phil. (see cover). The result is inevitable. A lustre orchestral opening (starting *pp*) and then WHAM, the three soloists practically overwhelm the orchestra, one by one! Interesting, and typical Beau Arts, but not really good Beethoven. I enjoyed it but for the wrong reasons: The B. A. Trio is my favorite.

Sound: B+ Recording: C+
Surfaces: B-

Mozart: The Two Flute Concertos, K. 313, 314; Andante in C, K. 315. Eugenia Zukerman; English Chamber Orch., Pinchas Zukerman. **Columbia M 34520**, stereo, \$7.98.

With the excellently stylish Leppard-trained English Chamber Orchestra, the two Zukermans do a pleasant recording

here of Mozart for flute and orchestra — though you may want to allow contrasting music to intervene after a while side. The extra movement is probably an alternative slow movement for the first Concerto. The orchestra here sounds very much as it does on Philips, bathed in a big, warm liveness; but in this case the soloist is placed fairly close and loud, though still very much surrounded by orchestral sound.

Note: In some of my reviews there will be new letter ratings for the recording itself. Three separate factors will be rated: a) the sound in terms of fidelity; b) the recording technique . . . acoustics, mike placement, balance, etc., and c) the disc surfaces on my copy.

I rate **B** as honorably average or up to the current standards, **C** is deficient, and **A** is marvelous.

Disc surfaces, being irregular, are averaged out. Many recordings have ticks at the beginning but smooth out later on, and this is taken into account.

E. T. C.

Columbia has served up some fairly dreadful surfaces in recent times, full of pops and crackles — but not here. These are smooth and very nearly pop free, and not much to choose between Columbia and Philips, as far as this orchestra is concerned. But who knows — maybe your copy, from a different pressing run, may be poor. Suffice it to know that Columbia is doing at least some fine pressing!

Sound: B Recording: B+
Surfaces: B+

Heinz Holliger and Aurele Nicolet Play Oboe and Flute (Bellini, Molique, Moscheles, Rietz). Frankfurt Radio Symphony, Inbal. **Philips 9500 070**, stereo, \$7.95.

Handel: 3 Oboe Concertos; Concerto Gross No 3 in G Minor; Sonata A 5 in B Flat. Heinz Holliger, oboe, Engl. Chamber Orch., Leppard. **Philips 6500 240**, stereo, \$7.95.

Heinz Holliger is a modest but really excellent oboist, who adapts equally easily to the Baroque demands of Handel and the very Romantic minor music of the mid-Nineteenth century featured on the first of these two discs. Together with the knowledgeable Leppard, the assorted Handel Holliger plays here is sprightly, full of life, and up to the latest (and easiest-to-listen) standards for Baroque playing, short of the use of old-type instruments; these are normal modern. (*Sonata A 5* means a five-part work for solo instruments — this one is adapted for strings and violin solo, played by Kenneth Sillito.)

There are four oboe works on the "Romantic" record, one with flute as well, each of them a characteristic semi-concerto, brief enough by the standards of the time though very much longer than anything by Handel. Neither of the two works by the fairly well-known names, the opera composer Bellini and the pianist Moscheles, are more than standard fare, expert enough but padded out with conventionalities. The best work by far is by the virtually unknown Molique, a quite lovely oboe rhapsody with Schumann-like harmonies. I'd buy the record just for that.

Sound: B+ Recording: B+
Surfaces: A- & B+

Music of C.P.E. Bach. Joan Benson, early piano and clavichord. **Orion ORS 76223**, stereo, \$7.98.

Haydn: Trios, E Flat, G Minor, C Major, H. XV: 29, 19, 27. Amade Trio (Malcolm Bilson, fortepiano, Sonya Monosoff, vl., John Hsu, cello). **Titanic TI-12**, stereo, \$8.00.

For those who find that older music is a revelation when played well on the instruments for which it was designed,

AUDIO • September 1978

INTRODUCING THE ADC LMF CARBON FIBRE TONEARMS.

We chose carbon fibre because of its low mass to high tensile strength ratio. We further lowered the mass by abandoning the traditional tubular shape and engineering the fully tapered profile.

The combination of an LMF tonearm and a fine cartridge will not interact with typical building resonant frequencies or with typical record warp frequencies.

Cueing is viscous damped in both directions and tracking forces are calibrated in 1/10th gram increments. Anti-skate adjustments are variable to 2 grams.

The LMF tonearms each come with three counterweights to enable you to achieve zero balance with minimum tonearm mass, regardless of the weight of your favorite cartridge. Even up to 11 grams. LMF tonearms utilize instrument type stainless steel ball bearings, factory adjusted for maximum stability and low friction angular contact.

The LMF-1 has an integrated head for lowest mass. The LMF-2 has a removable head. This allows changing of pre-mounted cartridges in seconds. Both tonearms permit the use of the highest compliance cartridges with lowest tracking forces.

Only better audio dealers can show you the ADC LMF tonearms. Visit them or write to us for more information.

ADC TONEARMS

A BSR Company
Audio Dynamics Corp., Pickett District Rd.,
New Milford, CT 06776



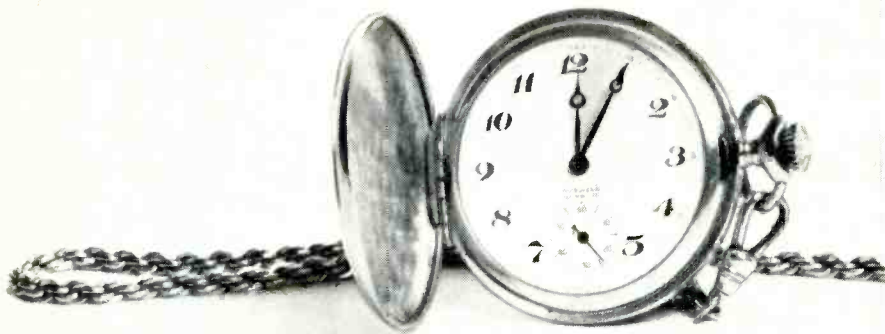

the first 5 minutes don't count

Or even ten!

Sometimes it may take a little while before you know just how good a headphone really is.

Comfort, weight, cord convenience all are vital factors in headphone wearability.

With every minute of use, any manufacturing deficiencies in these areas grow into discomfort and inconvenience.

At Beyer we know these problems and all our headphones are designed to achieve the highest possible wearability factor (Hi-Fi News, September '76, page 143, Beyer DT440 ranked 1st out of six comparative tests for comfort).



Beyer Dynamic

Coupled with physical comfort comes the lack of aural fatigue. That bright overdone sound associated with the 'loudspeaker-on-the-ear' concept oversold by our competitors will often give you a bad headache in minutes. It takes time to appreciate good clean sound. And with time, good sound doesn't tire (Hi-Fi News, September '76, Subjective Headphone listening test, Beyer DT440 ranked 1st).

So visit your Beyer headphone dealer now and give yourself time to compare Beyer headphones against the competition.

**But remember—
the first
5 minutes
don't count!**

Beyer Dynamic. Distributed by Hammond Industries Inc.
155 Michael Drive, Syosset, New York 11791. Telephone (516) 364-1900
West Coast telephone (213) 846-0500, Canada telephone (416) 677-0545

these two discs should be an immense pleasure. All the instruments, though some are newly made, are approximately those the composers might have used.

Carl Philipp Emanuel Bach, the middle Bach son, was the deep thinker among the three, a highly personal Romantic before introspection became common as, say, with the popularity of Chopin. Bach's special instrument was the clavichord, a one-man instrument, inaudible across a room but capable of expressive melodic lines and even a vibrato. In his later years he wrote also for the early piano — which was far closer to the clavichord than to the more formal harpsichord — and never was this relationship better illustrated than on this record, with one side for each instrument. (Turn the clavichord volume *down!*) Joan Benson is a thoughtful and discriminating player of both instruments.

All three instruments in the Amadeo Trio are "original," the violin and cello both old and in the original condition, not "modernized," the fortepiano a 1969 copy of a Viennese instrument of Haydn's time. The effect is indeed a revelation — since these players are all three superb musicians, absolutely top-rank for the music. Such robustness, such strength! The modern piano and violin and cello are louder, but not, decidedly not, stronger in this music. Especially the whirlwind piano with its wide range of tone color, from wiry metallic clangs to gentle and sweet *pianissimi*. THIS is what Haydn wanted!

Sound: B+ & B Recording: B- & B+
Surfaces: B & B

Beethoven: "Appassionata" Sonata, No. 23 in F minor, Op. 57. Ikuyo Kamiya, piano. **RCA Mastering Lab RDC-4**, stereo, (45 rpm), (Direct to disc).

RCA returns to the classical 45 (remember 1949?) in a curious way via this all-Japanese Mastering Lab Series, direct cut in Japan. The label is the old familiar one but some of the extensive booklets are entirely in Japanese characters—not this one, however, which gives us a detailed account of the whole process of direct-to-disc recording of the giant Bosendorfer Imperial piano, the incredible monster that you may have seen in the ads, sitting incongruously in an outdoor park. It took them two days just to get the recording equipment to the Bosendorfer — might have been just as tough vice versa.

It is an interesting recording musically. With all their incredible and growing knowledge of Western music, the Japanese still tend, not unnaturally, to miss a few stylistic and harmonic subtleties here and there as compared with "core" per-

formances out of Europe and the central tradition. This little lady is a powerhouse, with all the drive and the technique you could ever want and more. The piano itself, being German, has a good sound for Beethoven, somewhat unlike our familiar Steinway et al. But there are those curious lapses, not the notes but simply the appreciation of certain pivotal moments and their dramatizing in the playing. Not a thing most listeners will find bothersome.

Don't expect any enormous bass from your hi fi. Beethoven's own piano, for which this music was written (probably an English Broadwood) had a sonorously twangy bass, full of overtones, almost like a harpsichord. And the German monster is a refined product, its long strings never sounding thumpy or boomy—it is a musical instrument, not a hi-fi maker. But for clean percussives, within the musical framework, this disc will do very nicely.

Janet Baker sings Beethoven and Schubert. English Chamber Orch., Leopold. **Philips 9500 307**, stereo, \$7.95.

If you think all the great voices are in grand opera, try Baker. She is rapidly becoming the finest all-around soprano of our time, in the Flagstad league—not only a tremendous big voice but a consummate musician, who throws herself into every work she sings with an intensity that has to be seen to be believed—I saw her live on British telly last summer, doing Benjamin Britten's last big work, a cantata with solo soprano.

Here, she is at her best—and for once, Philips has the sense to get back a bit and allow her huge voice to blend in with the orchestra. (They ruined her recording of Berlioz' *L'Enfance du Christ* by too-close miking.) Moreover, it is an orchestra that, like the singer herself, is perfectly attuned to Beethoven and Schubert—note the superb Beethoven *4th Symphony* with this group, recently reviewed here.

Side 1 is Beethoven, some minor music from *Egmont* as a warmer-up, then a most interesting "Woo" piece (early music without opus number), a grand Italian classic aria; and then the grandest of them all, the same thing later on—Ah, perfido!, and such an electrically marvelous performance I have never before heard. It ought to make your hair stand on end even if you are mostly bald. Then side 2, comes Schubert opera arias chosen from that tragic wealth of great music the composer wrote for operas that never got anywhere, and still mostly haven't. But what incredibly top-rank stuff! The big treat here is *Lazarus*, a huge piece out of an abortive *Easter Cantata* that is surely the greatest Schubert ever written, yet to this moment I had never heard a note of it. Baker

AUDIO • September 1978

elevates this one as she does the big Beethoven, and it is very much the same type of music, though in German.

Arthur Loesser—Bach: The Well-Tempered Clavier, Books 1 & 2. Telarc 5029 (5 discs), stereo, \$39.90.

Love conquers all! Love of music plus a dedicated ear. The late Arthur Loesser of Cleveland made these recordings in 1964, here updated in, no doubt, improved sound. I found them wholly acceptable from a technical viewpoint.

My first reaction, musically, was — NO! Impossible. In this age when Bach is

normally played on the instruments of his own time as intended by him, "piano Bach" is always moot, as far as public performance and recording is concerned. (Home playing is another story.) In 50 years, only a handful of pianists have made great reputations via Bach on the piano. Some did it by gentleness, some via a moderate simulation of the older instruments, most however have simply treated the piano as a piano and Bach as the "universal" composer he has often been called, good for any age, any style.

Within minutes I had come around to

Proprius: A record achievement!



7778/9 JAZZ AT THE PAWNSHOP 2 Record Set



7785 POULENC-ALAIN; Kjell Johnsen, Organist



7784 LANGLAIS-HONEGGER; Kjell Johnsen, Organist



7758 MARIA MUSIK Choral Group; Congas Percussion, Flute



7793 KABRI LARETEI Piano Soloist, Chopin, Grieg, Beethoven



7762 CANTANTE DOMINO Oscar Metetkor

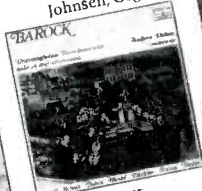

7761 BAROQUE; DROTTNINGSHOLM Baroque Ensemble



7759 INTERNATIONAL FOLK MUSIC Lidingo Chamber Choir

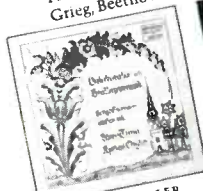

7763 DALAKORALER OCH BROLLOPSMUSIK Bengt Granstam, Organist



7770 KOR; Michaeli Choral Group



7742 EAGLARNA OCH KALLORNA Bengt Berg, Organist



7782 "REJOICE IN THE LAMB" Benjamin Britten, the Stockholm Cathedral Choir

From the recording of the performance to the pressing of the disc itself, Proprius records are produced with unwavering attention to artistry in sound. To capture and preserve the "feel" and warmth of the original performance, Swedish acoustic engineer and musician Bertil Alving carefully positions a matched pair of calibrated omnidirectional microphones in a well-designed hall. The mics "hear" the music as the human ear does. The elimination of expanders, compressors, and other electronic devices, permits the wide dynamic range of the live performance to be fully retained.

The recording engineer, himself, hand operates the cutting lathe to craft a lacquer master of outstanding fidelity, or orchestrating the event as skillfully as a master conductor. The result is breathtaking. These record achievements are now available for your listening pleasure through finer audio and record stores, or use the attached coupon to place your order.

Distributed by **AudioSource**

Please send the following records from the Proprius catalog. (Indicate quantity in the space next to each number.)

7778/9 (2-record set)	_____	7758	_____
7785	_____	7761	_____
7793	_____	7770	_____
7759	_____		
7742	_____		

Enclose \$15 for each record (\$30 for each record set. California residents: add 6% sales tax.)

I enclose check _____ or money order _____
the amount of \$ _____ Charge my BankAmericard/

Master Charge _____ Expires _____

Account No. _____
Signed _____
Name _____
Address _____
City _____ Zip _____

State: _____

Place this coupon in an envelope along with your remittance and mail to AudioSource, 1185 Chess Dr., Foster City, CA 94404. Orders will be processed immediately; however, allow three to four weeks for delivery.

Enter No. 1 on Reader Service Card

Q • How close can hi-fi get to an authentic musical experience?

A • Slip on new Audio-Technica Stereophones and hear for yourself.

If you want to find out how good the new Audio-Technica Stereophones really are, don't just compare them with other headphones. Put them up against the very finest *speaker* systems. But don't just listen to the equipment. Listen to the *music*. And be ready for a surprise!

Judged on the basis of flatness of response, freedom from distortion, transient response, sensitivity, and independence from room acoustics, these new dynamic and electret condenser models are perceptibly better sounding than speaker systems costing hundreds of dollars more.

And if you think that great performance can only come from heavy, bulky stereophones, get ready for another surprise. Our heaviest model is less than 7½ ozs. and our lightest is an incredible 4¾ ounces light. Comfort that lasts an entire opera if you wish.

For all the facts, send for our catalog. But for the revealing truth about stereophone performance, listen and compare at your nearby Audio-Technica showroom. It will be a great *musical* experience.



Model ATH-7
Our finest Electret Condenser with LED peak level indicators
\$149.95



Model ATH-1
The moving coil dynamic stereo-telephone that weighs just 4¾ oz.
\$29.95

 **audio-technica**
INNOVATION □ PRECISION □ INTEGRITY

AUDIO-TECHNICA U.S., INC., Dept. 98A, 33 Shiawassee Avenue, Fairlawn, Ohio 44313
Available in Canada from Superior Electronics, Inc.

Enter No. 53 on Reader Service Card

Loesser—even though his is a startlingly individual, highly Romantic piano approach. He uses astonishing *rubato*, the expressive unevenness of tempo made familiar by the great pianists of the early part of the century but now generally unthinkable in Bach. No neo-classic beat for this man! And he colors up Bach until at times it is like Schumann. At first, all this nearly slayed me. But not for long. The man is just too musical. He has worked and thought for so many years upon these short pieces that the sense of them, even in his unique versions, comes through resplendently. The further along you go, the more convincing they sound.

P.S. One often sore point with piano Bach, Loesser's ornaments are always absolutely *right!* Also the dotted rhythms. Take that, you purists and harpsichordists.

Wagner: Ride of the Valkyries; Tristan Prelude Act I; Siegfried's Funeral March; Forest Murmurs. Los Angeles Philharmonic, Leinsdorf. **Sheffield Lab 7** (direct-to-disc), stereo, \$14.00.

Prokofiev: Romeo and Juliet, excerpts. Los Angeles Philharmonic, Leinsdorf.

Sheffield Lab 8 (direct-to-disc), stereo, \$14.00.

Interesting contrast. These two, out of the same D/D recording session, are musically very different and the difference seems to be a result of the music itself. I found the Wagner excerpts, fi or no, to be remarkably routine and uninspired, except the *Tristan*, which takes on some musical life. On the other hand, the Prokofiev is excellent—you can hear it in seconds. This music the musicians feel is real for them, and they make it sound that way. I cannot believe that the difference is in the conductor, who is an old-line European-trained pro, ex-Boston Symphony, and surely very knowledgeable as to Wagnerian tradition. But it is possible that Leinsdorf, too, finds the Prokofiev more enjoyable to produce, in this late time. How low has the great opera composer sunk, from his palmy days!

The recordings were done in typical West Coast fashion, in a huge Hollywood "scoring stage," built in 1927 for the earliest sound films with music; 16-inch film discs of a filmed "Romeo and Juliet" (not Prokofiev's ballet, which came later) were still on the premises. The sound, according to Sheffield's account, is "quite live, similar to a concert hall" — well, maybe. In the recording, as compared with the norm today, it rates as moderately dead though not unpleasantly so. There was plenty of room for good balance and the L.A. orchestra is well recorded. This slightly dry sound is best for the Prokofiev, which fits neatly

into the period — it was composed in 1935. On records, Wagner needs a bit more mystery and atmosphere (i.e. reverb) to sound right.

For your money you get a big book, names of every member of the orch. and the enormous technical crew—which includes one gent whose title is "Master of the Groove"—and pictures of practically everybody, in addition to program notes.

The pressing, I should add, is near perfect. Alas, it is not West Coast—Teldec GMBH in Germany. Not only ultra-clean but minus the slightest trace of low-frequency rumble and bumble. Can't we do this too?

Sound: A Recording: B-
Surfaces: A

Music of Hugh Aitken, Cantatas 1, 3, 4; Piano Fantasy. Gary Kirkpatrick, pf., Charles Bressler, tenor, Jean Hakes sopr., instr. soloists. **CRI SD 365**, stereo, \$6.95.

Contemporary music on records is usually difficult, but sometimes rewarding. CRI, at least, makes sure that the audio aspect of each of their many recordings is up to high standards, which helps us in the audio fraternity to make some sort of connection. Even the pressing of this item is—for the U.S. of A.—not bad at all.

Before this one, I had indignantly turned off another "contemporary" recording after maybe two minutes; militant, self-satisfied conventionality, I said to myself in disgust. Lotta noise; they sure think they're pretty good. So it wasn't a good mood that I brought to the most difficult, and first, of these Aitken pieces. More contemporary bombast?

Being New York performances, from New York musicians, these are hard and brassy, not very listenable in the outward sound. Inevitable in our greatest city, where life is necessarily brash, or else! But if you will turn the volume down a bit and follow the printed texts, you will hear the wealth of humanity and of musical feeling underlying the New York exterior. Believe you me, it is there, but definitely. I like this music. And I like the performances.

CRI has even managed to acquire some reasonably quiet pressings. Not up to non-American standards, but at least the best we can do, or so it seems. (Now don't go and tell me they sent these to Germany for pressing!)

Jan Ladislav Dussek: Complete Piano Sonatas, vols. 1, 2. Frederick Marvin, piano **Genesis GS 1068/9** stereo, \$6.98 ea.

Those who are into the piano music of Beethoven and Schubert will perhaps be astonished at the work of this Czech-born composer, 10 years older than Beethoven, who died in 1812 and was one of the outstanding composers of his time — Beethoven or no. In a way he was more advanced than Beethoven himself, closer to the Romantic school, as is abundantly clear in these Sonatas. True, he did not have the Beethoven punch, the all-out drama and telling conciseness. But even that, oddly, was forward looking, towards the days of Wagner and Berlioz and Liszt when music sprawled out at enormous lengths.

Dussek was a somewhat pathetic genius, a great keyboard man and thinking composer but, like Rossini, prone to overweight; in the end, he was so huge he could not get out of bed. But there is nothing fatuous about his music, both early and late, as played in a Romantic vein here by Frederick Marvin. It probably sounded just this way, given an earlier-type piano, in Dussek's own day.

Volume 2 is much the best. The *Opus 34 Number 3* is turn of the century in style, florid in the manner of Weber and Rossini of later years—who were very probably influenced by Dussek. The late *Op. 61*, a funeral sonata in honor of Dussek's patron, the Prussian Prince Louis Ferdinand, a splendid musician, killed in battle in 1806, is a startlingly vigorous and modern piece, first rank. The last Sonata, *Op. 71* on Volume 1, is less vigorous, though still forward looking.

The Genesis surfaces, my copies, sound like a lively brush fire. Millions of ticks and bumps. Volume 1, maybe because of *Op. 71*'s length, is cut at a lowish level and seems somehow unfocused. Volume 2 is louder and the sound more incisive.

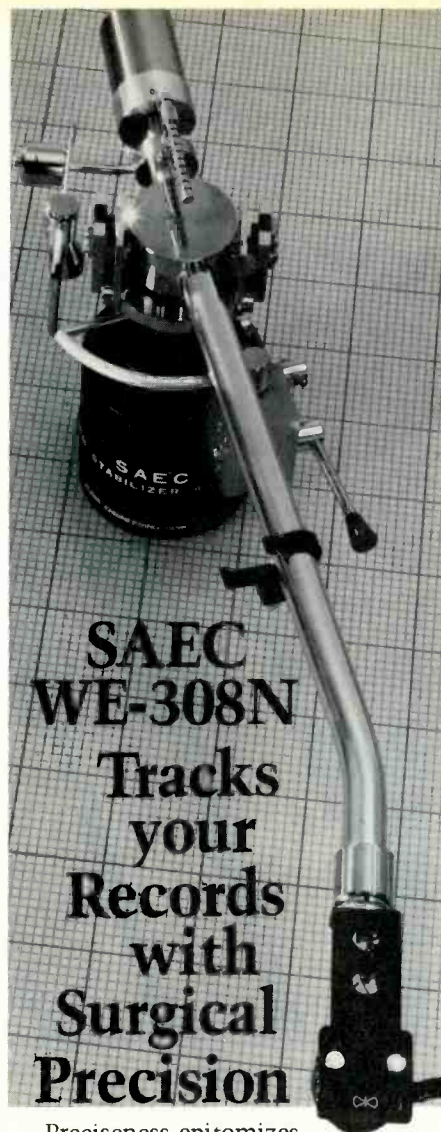

**SAEC
WE-308N
Tracks
your
Records
with
Surgical
Precision**

Preciseness epitomizes SAEC's WE-308N tonearm. It utilizes an advanced design, double knife edge bearing system, automatic tracking pressure compensation, inside force canceller, even an ultra-low resonance "ultimate" headshell.

What does all this do to your records? Virtually nothing. Nothing, that is, when it comes to record wear. But everything when it comes to allowing your cartridge to translate with unwavering accuracy the musical information locked between the grooves of your records.

Write for literature that reveals in detail all the exquisite features of SAEC's WE-308N tonearm, and SAEC's other fine audiophile products.

Distributed by:

AudioSource

1185 Chess Drive, Foster City, CA 94404
Phone: (415) 574-7585

Enter No. 2 on Reader Service Card

Jazz & blues

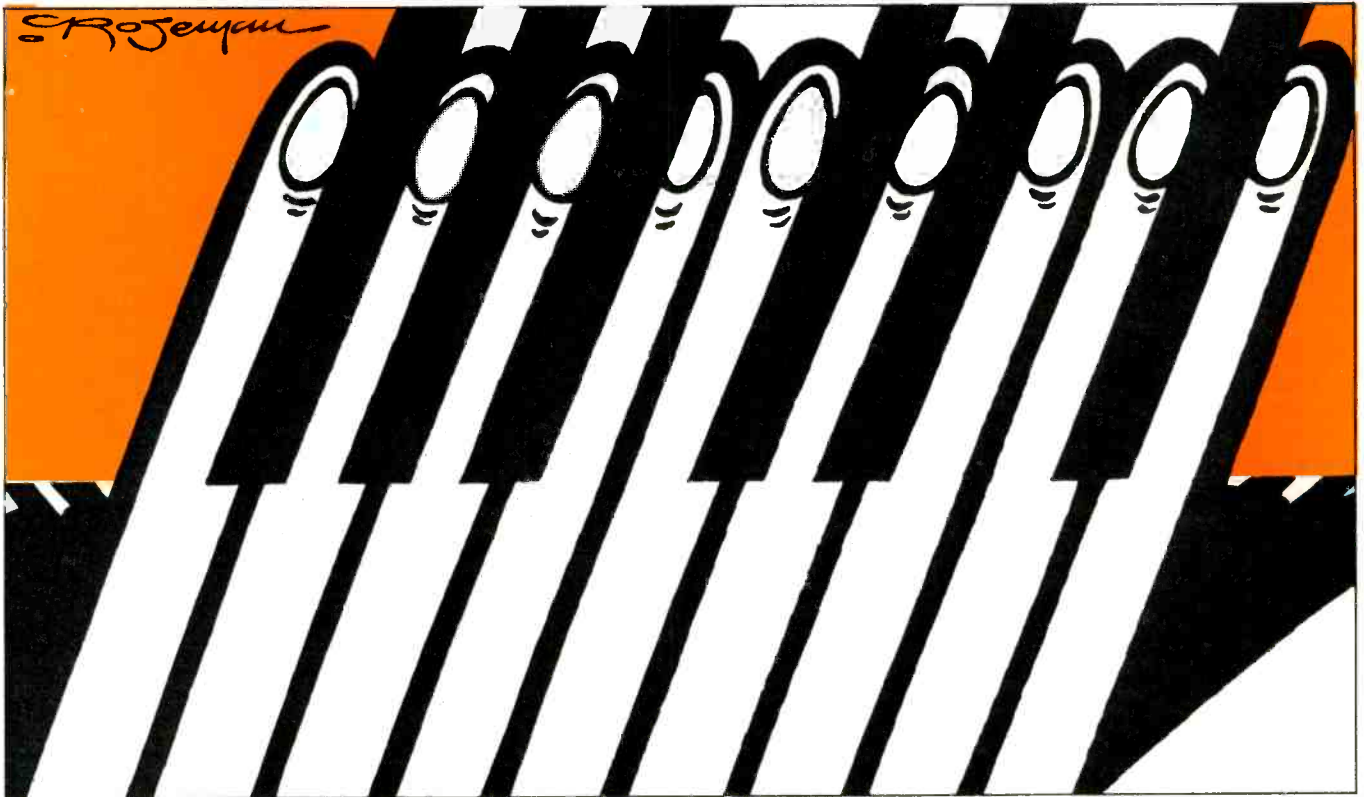

118

Unfinished Boogie: Western Blues Piano, 1946-1952.

Muskadine 104, mono, \$6.98.

Unfinished Boogie is a long-overdue anthology of blues, boogies, and stomps by West Coast pianists from the immediate post-WW II era. Whereas the sophisticated, jazz-inflected balladry of Charles Brown and Cecil Gant dominated California blues in this period, the emphasis on this album is on the rawer, more rural sounds associated with farm and factory workers newly transplanted to the Coast from Texas, Oklahoma and Louisiana.

The "star" of the album is an underappreciated Houstonite named Wilson "Thunder" Smith. *Thunder's Unfinished Boogie* is, fittingly enough, a thunderous boogie with a romping right hand and a powerfully rolling bass line. *Little Mama Boogie* (with Smith's old partner, Lightning' Hopkins — Thunder and Lightning'!—on acoustic guitar) is a killer stomp with a left-hand riff guaranteed to knock you over. *Low Down Dirty Ways* sounds like a Texas counterpart of Professor Longhair's New Orleans gumbo-shuffle; note Luther Stoneham's curious one-chord guitar riff. *New Worried Life Blues* is obviously from the same family as Big Maceo's *Worried Life*, though it's

a considerably different song. Smith also backs Stoneham on the latter's *Mable Blues*; the singer-guitarist is most notable for the novel way in which he varies the ends of lines.

The best-known artist here is Jimmy McCracklin, whose three tracks are early (1946) samples of his lackadaisical vocal approach. At this time he had not developed his piano technique, so he's backed here by J.D. Nicholson, who complements McCracklin's vocal lines with colorful downward splashes. *Baby, Don't You Want To Go* is, as you might suspect, a *Sweet Home Chicago* variant, with the locale shifted to the Mexican border.

Mercy Dee Walton had an r&b smash (circa 1951) called *One-Room Country Shack*, and much of his subsequent material was, more or less, patterned after that hit. Nonetheless, his highly original lyrics, lethargically beefy vocals, and inventive piano commentaries made Mercy Dee a consistently interesting artist. *Straight and Narrow* and *The Pay Off* are fine examples of his *Country Shack* formula, while 1949s *Baba-Du-Lay Fever* (his first recording) is an uncharacteristically jiving scat blues number.

Little Son Willis is an undeservedly

obscure singer-pianist with a very interesting right-hand technique, featuring bright-colored, imaginatively diversified chords. Little Willie Littlefield is best known as a singer (he did the original version of *Kansas City*, while his Charles Brown-flavored *Ruby, Ruby* is still heard on "oldies" radio shows); *Little Willie's Boogie*, recorded in 1948 at age 17, finds him in the unaccustomed role of Albert Ammons emulator.

Most of the original 78s were far from sonic masterpieces, and many were well-worn by the time they were gathered for this collection. Under the circumstances, *Muskadine* should be congratulated for making them sound as presentable as they do. Available from Advent Productions, P.O. Box 635, La Habra, CA 90631. *Tom Bingham*

Performance: B+ to A

I'm Ready: **Muddy Waters**
Blue Sky JZ 34928, **stereo, \$7.98.**

If Muddy Waters has ever before recorded two consecutive albums as strong as **Hard Again** and **I'm Ready**, it has been longer than I care to remember. Arguably, **I'm Ready** is as good as

any other collection he has ever done. Like **Hard Again**, Johnny Winter is a featured guest in a band that includes Jerry Portnoy, "Pine Top" Perkins, Bob Margolin, and Willie "Big Eyes" Smith from his regular touring outfit with the further addition of blues greats Big Walter Horton on harp and Jimmy Rogers on guitar. This group is as solid as a blues band is ever going to be. With superior modern recording unavailable for the great primitive originals of up to 35 years ago, the album bloody well ought to be a killer. And it is.

Muddy has rarely sounded more on top of his music, whether it's a standard like *I'm Ready*, *Hoochie Coochie Man*, *Rock Me Baby*, or *Good Morning Little Schoolgirl* or some of his recent songs. Indeed the remakes may well have outdone the originals. And Muddy's slide guitar on *Screamin' and Cryin'* is a bone-chiller.

Hey there, blues people, it is *all* here on **I'm Ready**. This one is brand-new Muddy Waters that is sure to be recognized as both classic and vintage.

Michael Tearson

Sound: A Performance: A+

Chameleon: Maynard Ferguson
Columbia PC 33007, stereo, \$6.98.

Conquistador: Maynard Ferguson
Columbia PC 34457, stereo, \$6.98.

It's impossible for big band lovers and jazz buffs to ignore Maynard Ferguson although many would like to. But like him or not, Maynard may have the best big band in what's left of the band business. MF's current crew, is without question a blazing powerhouse that offers a strident, efficient brashness; it is, quite honestly, unbeatable at the kind of music it produces. What's more, it is the only big band, aside from Buddy Rich's, with a youthful mass following. (The Stan Kenton and Woody Herman bands have an appeal to some young people, however it is an elitist appeal to sophisticated young musicians, usually members of high school and college lab and stage bands.) Ferguson, on the other hand, is currently embracing the masses, including hundreds of thousands of tone-deaf dummies who dance at the discos and wouldn't know an eighth note from a flatted fifth.

There is tremendous vitality and excellent musicianship in the Ferguson band as demonstrated on these two recent Columbia releases. Ferguson's band as demonstrated on these two recent Columbia releases. Ferguson's shock troops, with fortissimos upfront, put on the kind of brassily vehement exhibition that turns on the rock generation. It is virtuoso stuff, but it is also an appeal that is often more visceral than musical. **Chameleon**, for example, of-

fers rock/pop/soul fans the sonic kick and hyper energy they require. On numbers like the title tune, and on Chick Corea's *Fiesta* and Paul McCartney's *Jet*, Ferguson is able to harness the power and wattage of rock/soul with the boisterous brass voicings that were always his forte.

Like Dizzy Gillespie and Harry James in his younger days, Ferguson paces his brass section impressively. At 49, he is an immensely powerful and accurate trumpet player when leading the section; his ensemble work shines on both **Chameleon** and **Conquistador**. As a soloist Ferguson remains a player with astonishing technical prowess; in terms of technique and range, he is the only trumpeter man in jazz able to work comfortably in the high register. Unfortunately, his solos often have a way of degenerating into tasteless shrieking; it is the kind of bombast that ruins an otherwise fine version of Chick Corea's *La Fiesta* on the **Chameleon** album; *La Fiesta* also boasts a flashing chorus by Alan Zacod's electric piano. *I Can't Get Started* on the same album, is a surprise; except for an ear-splitting opening statement, Ferguson plays this classic fairly straight with a full, round, warm tone almost in the Bunny Berigan tradition; he also takes the vocal and updates the lyrics with references to his ex-boss Stan Kenton and porn star Linda Lovelace.

With **Conquistador**, Ferguson enters the disco sweepstakes. Accepted on its own terms, the best-selling album is impressive. The precision-drilled brass performs immaculately on things like the theme from *Star Trek*, and bouncy, catchy disco tunes like Bob James, *Soar Like an Eagle* and the Theme From *Rocky*. The latter comes complete with lush strings, wah wah guitar figures, and a back-up femme soul group; it's a performance that I confess a certain weakness for, and as a single, I understand it is holding its own with Donna Summer, Thelma Houston, and the Sal-Soul Orchestra. George Benson is on hand to take a few nice licks on the mellow *Mr. Mellow* track, and Ferguson has a tasty, relaxed solo here, staying mostly in the middle register. I have played MF's **Conquistador** for a few young-ish distaff friends of mine who cannot seem to get into Goodman, Basie, or Ellington.

The **Chameleon** album was engineered in NYC and attains Columbia's high sonic standards. The tracks on **Conquistador** were recorded at Media Sound in New York, CBS Studios in San Francisco, and the Wally Heider Studios in San Francisco. The stereo sound is absolutely stunning, combining a powerful big band's macho dynamics with sharply etched detail.

John Lissner

Sound A+ Performance: A



Two of a Kind

The Ampzilla IIa power amplifier and Thaedra II preamplifier were literally made for each other. In design, performance, and appearance they are complementary; fully-complementary, in fact.

Ampzilla IIa's features (such as its fully-complementary servo-controlled circuitry) and specs (200 Watts RMS per channel into 8 Ohms from 20 Hz to 20 kHz at less than 0.05% THD and IM) are perfectly suited to Thaedra II's moving coil phono preamplifier (RIAA equalized) and servo-loop circuitry.

Of course, Ampzilla IIa and Thaedra II can function in separate environments. They just won't be able to provide all the sonic excitement that they can as a team.

Write GAS Company for literature containing complete features and specifications of all its products.

GAS
THE GREAT AMERICAN SOUND CO., INC.
20940 LASSEN ST. • CHATSWORTH, CALIF 91311 U.S.A. • (213) 998-8100
Enter No. 77 on Reader Service Card

You can hear it working. QUIETONE

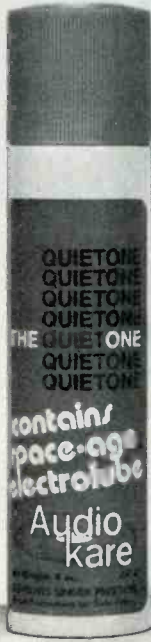

Now, a record treatment that's effective for weeks! No need to treat or brush records each time they are played. A quick spray of QUIETONE, the environmentally safe aerosol that neutralizes static charges, provides carefully measured stylus lubrication and removes surface deposits with a specially developed solvent totally safe for records.

Most clicks and pops disappear. Annoying record hiss is reduced. Styli and record surface alike are protected by the lubrication property of QUIETONE.

And QUIETONE is extremely economical. Selling for less than \$8.00, a single aerosol will treat up to 100 sides. QUIETONE is dry to the touch, yet protection remains and static charges stay neutralized.

QUIETONE — the second generation in record care. Sold with a money back guarantee, available at leading stereo and record shops.



a division of
HAMMOND INDUSTRIES INC.
155 Michael Drive, Syosset, NY 11791 (516) 364-1900

120

Enter No. 40 on Reader Service Card

Body Love: Additions to the Original Soundtrack: Klaus Schulze
Island ILPS 9510, stereo, \$7.98

Contemporary, non-academic electronic music generally falls into three categories. The most popular is the imitative synthesis of Isao Tomita and Walter Carlos. These musicians take the synthesizer and mimic conventional instruments and sounds. It's ultimately a dead end since it rarely explores the new sound potential of the synthesizer and is limited to conventional harmonics. Groups like Cluster and Kraftwerk make up the nucleus of the second category which consists of a metronomic minimalism. Short melodies and cyclic rhythms dominate this music in which the synthesizer is employed as a precision instrument.

But the third category is not just a synthesis of electronic sounds but also a synthesis of musical philosophies. It maintains a traditional sense of classicism without being imitative. The synthesizer is combined with other keyboard instruments for shifting textured layers of sound. With this group Klaus Schulze has a few competitors, such as Tangerine Dream and Ash Ra Tempel, but no peers.

Body Love: Additions . . . is the ninth solo Schulze album but only the first to be released in the U.S. He was an original member of Tangerine Dream, appearing as a drummer on the first album **Electronic Meditations**. But he soon left the group to go solo as an electronic musician. The main body of his work concerns itself with dark liquid surfaces and a drawn-out melodicism that's derived from eastern religious music, as much as western classicism. Rhythms are felt as soft pulsations rather than metered beats.

But his early experiences as a drummer and his urge for spontaneous improvisation have surfaced in some more energized Schulze recordings such as *Picture Music*, *Moondawn*, and the two *Body Love* soundtracks. Here Schulze uses the drums to create a definable percussion rhythm on top of which he layers stretches of synthesized drone, melotron choirs, and sustained organ chords. Finally there is a solo line which strings itself out through the entire piece.

In **Body Love: Additions** . . . the soundtrack to a German hard-core pornographic film by Lasse Braun, Schulze touches both aspects of his work for another in a string of compelling works. For pure visceral energy, *Stardancer 2* is an ecstatic screamer. A sparse opening of electronic drones and random, rumbling percussion shifts into a roar of sound. Schulze emerges with a vivid syn-

AUDIO • September 1978



To Order Free Catalog, Please Write: DIXIE HI FI Dept. (AM) P.O. Box 6496 Richmond, Virginia 23230



To Order. . . Call Toll Free
800-446-7925
(Within Va. . . Dial 804-257-4241)

GUARANTEES THE LOWEST PRICE

- Receivers
- Amps
- Tuners
- TV sets
- Car Stereo
- Portable Radios
- Accessories
- Tape Decks
- Turntables
- Speakers
- and MORE
- PIONEER
- TECHNICS
- ALTEC
- KENWOOD
- BIC
- DUAL
- MARANTZ
- SANSUI
- TEAC
- EMPIRE
- MAXELL

Enter No. 8 on Reader Service Card

J&R BLANK TAPES & ACCESSORIES AT WHOLESALE PRICES!

BLANK TAPES CASSETTE TAPES

BASF Studio C-90	2.39
BASF Professional II or III C-90	3.19
Fuji FX C-90	2.80
Maxell UDXL I or II C-60	2.47
Maxell UDXL I or II C-90	3.47
Memorex C-90 3 pk.	4.99 for 3
Scotch C-90 3 pk.	4.99 for 3
Scotch Master II or III C-90	2.99
Sony Ferricrome C-90	1.14
TDK D C-60	1.14

TDK D C-90	1.56
TDK D C-120	1.98
TDK D C-180 (180 minutes)	2.88
TDK AD C-60	1.62
TDK AD C-90	2.40
TDK AD C-120	3.30
TDK SA C-60	1.98
TDK SA C-90	2.88

REEL-TO-REEL

Scotch 207 1800 ft.	4.99
Scotch 212 1800 ft.	3.79
TDK L 1800 1800 ft.	4.64

Write for our SUPER low prices on other Maxell Tapes not listed. Minimum Order 12 Tapes — 100% Guaranteed.

CARTRIDGES audio-technica.

AT-20 SLA	120.00
AT-15 SA	78.00
AT-14 SA	45.00
AT-12 SA	28.00
AT-10	12.00

STANTON

8815	72.50
681EE S	55.00
681EE	42.50
680EE	20.80
500EE	14.40

EMPIRE

2000Z	60.00
2000T	30.00
2000EII	15.25
2000EII	15.00

HEADPHONES audio-technica.

AT 701	25.40
AT 702	38.40
AT 703	51.20
AT 705	63.20
AT 706	95.88

SENNHEISER

HD 400	24.99
HD 414X	39.97
HD 424K	59.95



V15 Type IV	90.00
V15 III	63.00
M5E D	26.50
M51E D	21.00

PICKERING

XSV-3000	42.95
XV-15 1200E	34.40
XV-15 625E	19.18
XV-15 400E	16.35

KOSS

Pro 4AA (new)	37.00
HVI	45.00
HVI	28.97
HVIC	42.97
HVIC	36.97
KSLC	20.97
TECH VFR	48.00
Phase 2	51.00

HOW TO ORDER: For shipment within 48 hours, send money order or certified check. Two weeks delay on personal checks. Please add \$2.50 per order for shipping & handling. \$5.50 for orders outside U.S.). N.Y.S. residents add tax. No C.O.D.'s. All merchandise 100% guaranteed, brand new & factory fresh.



33 Park Row, Dept. A, N.Y.C. 10038, (212) 732-8600

WRITE FOR FREE CATALOG

Enter No. 61 on Reader Service Card

thesized etching across driving rhythms. *Moogetique* is a sensual dark passage of phased electronic sheets and echo drenched piano. The nearly 30 minutes of *Nowhere-Now Here* divides itself between a contemplative opening and a tension-building development of contrapuntal swirls.

Body Love, like most Schulze recordings, must be heard on good sound systems to be fully appreciated. He can pour out of the speakers like lava or shoot like a laser beam. He surrounds you on all levels of the aural spectrum.

John Diliberto

Sound: A

Performance: A

Beggars and Stealers: Robin Kenyatta **Muse MR 5095**, stereo, \$6.98.

Robin Kenyatta is one of those tertiary figures who is always on the scene but pops out only occasionally to make a statement of his own. Such times were his Vortex recording from '68, **Until**, and **The Girl From Martinique** on ECM in the early 70s. Both were strong, individual statements which showed him to be a fine reed player and a spirited improviser. But they did not garner him sufficient of notoriety and the mid part of the 70s sees him floundering artistically and financially in the land of Funk.

Beggars and Stealers, mostly taken from an early '69 concert, shows us what we've lost. That's not to say this is an exceptional performance. It equals neither of the two performances mentioned. Kenyatta plays tenor here rather than his more familiar alto and soprano. His playing is thin and often unfocused as on *Nairobi Hot 5*. His back-up band, with the exception of Alphonse Mouzon is adequate but nothing more. But the inspiration which lights these performances has the potential to explode at any moment. Such a time is the title track. Kenyatta plays like bubbling fudge, gurgling and slurring in one place and spurting in others. Mouzon's undermiked drums provide a fleet rhythm pattern while Larry Willis (piano) and Walter Booker (bass) hang out ledges for Kenyatta to jump from.

The album concludes with a piece recorded in 1975, a duet with Muhal Richard Abrams. *Ruby My Dear* is a sweet ballad with Kenyatta on smokey alto and Abrams playing piano a bit more florid than usual.

The live portions are poorly recorded and mixed, and add to the thinness of Kenyatta's tenor sound. **Beggars and Stealers** stands as a signpost that Kenyatta (and Mouzon for that matter) have passed by.

John Diliberto

Sound: C

Performance: B-

AUDIO • September 1978

OUR WATTS ARE BIGGER!

\$379⁹⁵



There's no other way to explain it, as the modest power rating (80w/8ohm) doesn't really reflect it's performance. The distortion is not fanatically low, either (@.1% T.H.D., I.M.D.), yet this amp will play louder and cleaner into your speakers than others boasting up to three times the power.

PS AUDIO

1529-C Stowell Center Plaza, Santa Maria, CA 93454

Enter No. 63 on Reader Service Card

DIMENSION

MINI LAB SERIES **MKI • MKXII**
NEW SUB-WOOFER

We think Americans can still build them better for less. Dimension is proud to introduce their new sub-woofer which can be adapted to any of our mini speakers, or to accommodate any speaker you already have. The principle of the sub-woofer is to combine the output of your left and right channel into one common source and transfer it into a 12" enclosure that can deliver the ultimate bass frequencies that most smaller speakers are not able to reproduce at an audible level. The sub-woofer may be placed anywhere in the room you would like for its 20 Hz to 100 Hz response is completely non-directional and practically impossible to detect its location. The electronic components that make up our network are very complex, yet very durable to provide many years of dependable enjoyment for your entire family.

Custom Craft
819 S. Kraemer Blvd. / Placentia, CA 92670 / (714) 630-5440
REP. AND DEALER INQUIRIES WELCOME

Enter No. 60 on Reader Service Card

TOP Discount AUDIO

Your **NATIONAL HEADQUARTERS**

For Famous Brand Electronics By Mail

1150 N. Powis Rd., West Chicago, Ill. 60185 • (312) 293-1825

All Orders Shipped In Factory-Sealed Cartons

Write Or Call For The Lowest Prices Anywhere!

MILLION \$\$\$ INVENTORY

LOWEST PRICES ON

RECEIVERS	TURNTABLES	TUNERS
SPEAKERS	CHANGERS	CARTRIDGES
TAPE DECKS	AMPLIFIERS	HEADPHONES
CALCULATORS	COMPACTS	CAR AUDIO

Top Discount Audio 1150 N. Powis Rd., West Chicago, Ill. 60185 (312) 293-1825

AUG We honor Master Charge and Bank Americard. Date _____

Please send me a quote on _____

MR MS

(First) (Initial) (Last)

(Number And Street)

(City) (State) (Zip Code)

Enter No. 23 on Reader Service Card

STEREO TV

WITH **TELEDAPTER**

TE-200

The TE-200 TELEDAPTER EASILY CONNECTS TO ANY TV & STEREO SYSTEM. Using our coupling and matrix circuit, teledapter takes a low impedance output from the television and delivers two HIGH IMPEDANCE CHANNELS OF SIMULATED STEREO, to drive any amplifier. Frequency response is maintained so you can hear the tinkle of bells or booming bass sounds as it happens on TV. With service warranty and hookup instructions \$21.95 ppd. Guaranteed to make your TV 100% more enjoyable.

TV AUDIO TUNER

TE-300

TE-300 UHF-VHF TV Hi Fi Audio Tuner for the best TV sound - Solid state - mono and simulated stereo outputs - use with any amplifier. Anodized front panel - simulated walnut case. Dare to be 100% entertained - \$199.95 ppd.

SEND CHECK, M.O., MASTERCHARGE, or BANKAMERICARD NO. and Expiration date to: RHOADES NATIONAL CORP. - DEPT. B - BOX 817, HENDERSONVILLE, TENNESSEE 37075. (615) 824-1735.

NAME _____

ADDRESS _____

CITY _____

STATE _____ ZIP _____

SEND COMPLETE CATALOG.

Enter No. 24 on Reader Service Card

good recordings are no accident.

Students at Institute of Audio Research learn the latest technology of music recording.

Workshops permit application of lecture and lab studies to the recording of contemporary music in professional studios.

Earn an IAR Certificate of Completion or earn a BS Degree in Music Technology from NYU via the joint IAR—NYU degree program.

Fall Quarter—
September 6, 1978

Winter Quarter—
January 3, 1979

For information call or write:

institute of audio research

64 University Place,
New York, N.Y. 10003
(212) 677-7580

Licensed by N.Y. State,
Dept. of Education.



Enter No. 11 on Reader Service Card

Folk bag

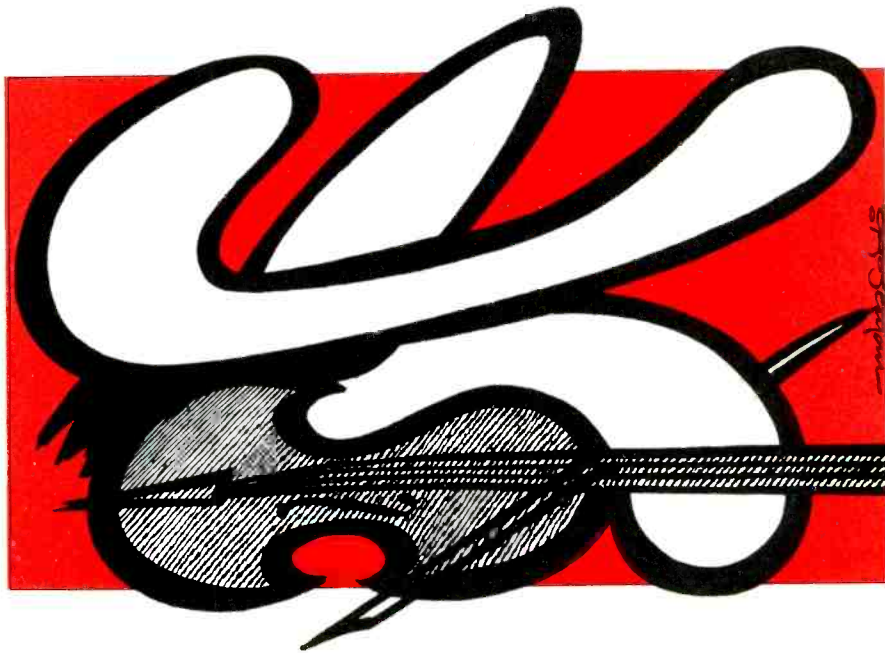

Ramon Ayala y Los Bravos del Norte Tex-Mex TMLP 7022, stereo, \$4.98.

Ramon Ayala rose to prominence as half of Los Relampagos del Norte, an enormously popular Norteno conjunto of the 50s and 60s. This self-titled follow-up to Ayala's somewhat lackluster **Corridos Famosos** (TMLP 7021) indicates that he's no longer content merely to rest on past laurels, but ready to carve his niche as a solo performer.

Truth be told, he doesn't have the most attractive voice in the Rio Grande Valley — somewhat dry and inflexible, with a limited range — but he has a likeable "everyman" personality with which audiences easily identify.

His primary talent is in his imaginative accordion work. Note the way he injects flashy double-time figures into his inventive melody lines, which seem to be a natural extension of the songs (particularly on *Te Equivocaste* and *Por Un Disgusto*). His extemporizations are seldom less than resourceful, his finest moments coming on the extended solo on the *cumbia*, *Adios Reynosa*, and his beautifully paced obbligato to the bolero, *Llorando en Silencio*. Not only are his conceptions appealingly tuneful, he pops the buttons with such an energetic bounce (hear the sprightly *La Mas Bonita*

and the irresistible instrumental polka, *El Oso Negro*) that the music easily transcends language barriers. The one exception is *El Gallo Copeton*, a novelty song oscillating between a *cumbia* and a sort of Mexican twist, which will no doubt leave most gringo listeners (myself included) scratching their heads.

Ayala's unidentified backup trio, Los Bravos del Norte, adds an easy lilt to the polka-tempoed rancheras which dominate the album. The bajo sexto and bass are fashionably restrained. The spirited drumming, on the other hand, not only perfectly complements Ayala's brisk accordion, it's virtually a textbook in Norteno percussion style. The drummer quietly keeps time with hi-hat cymbals for the most part, but spices the beat with simple, yet varied combinations of rolls and crashes at interfaces, during intros and bridges, etc. (hear *Cruz de Palo* and *Por Que Te Fuiste* for examples). The drummer does a particularly fine job of coordinating tom-toms, cymbals, and cowbell on *Adios Reynosa*.

The recording has considerably more clarity and definition than most regional-label ethnic albums. The accordion could have used more bite, though. The surface is a bit scratchy, but again better than most Norteno pressings. The 27-

minute playing time is about average by border-area standards. Distributed by Marsal Productions, Inc., 2015 Castroville Rd., San Antonio, Texas 78237.

Tom Bingham

Sound: B- Performance: B+

Irish Music: The Living Tradition: The Martin Mulvihill School

Inisfree-Green Linnet SIF 1009, stereo, \$6.98.

This is the first in a probable flood of recordings of Irish music in America from one of a number of small companies which have had people out in the field over the past few years. In this case, the company has the double advantage of a producer who is himself a native-born Irishman now working and performing in this country, as well as the cooperation of the head of perhaps the most flourishing school of traditional Irish music in the United States.

Mick Moloney, the producer of this album, was born in Limerick, grew up with native Irish music, and had a successful career as a member of a folk-singing group, The Johnstons, before emigrating to this country to study folklore at the University of Pennsylvania. As an emigrant himself, he shares with Martin Mulvihill a common concern for the fate of their native traditions in this country. The empathy between Maloney and Mulvihill, the shared respect and mutual affection for the talented young Irish-Americans from the Bronx who star on this album, shines through every line of Moloney's notes to the album (an inner sleeve contains biographies of the young musicians, as well as identifications of the tunes and their backgrounds).

This album was made, in part, for the purpose of recording the new and vital tradition of young American-born children of Irish-born parents learning the traditional music of Ireland in this country (and then going back home and beating the bejaysus out of the young kids there in the annual All-Ireland Championships each year too). Mulvihill chose three separate "ceilidh" bands from among the ranks of his school up in the Bronx, together with a selection of the solo stars from each group, and a trio which has won its own separate titles. If the impression this gives you is of a star-studded school of young prodigies, the fact is that Martin Mulvihill's patient teaching and careful supervision has as much to do with their success as native talent; at the same time, there can be no denying the role of such talent. Take, for example, the case of young Eileen Ivers, who has already won three All-Ireland Championships on the fiddle, since she began with the instrument a scant four years ago — when she was eight.

The Eire Og Ceili Band is the youngest, from ages 9 to 13, featuring the heavy use of the tinwhistle, the traditional introductory instrument for young Irish musicians, here and at home. (Eileen Ivers plays with them.) The Glinside Ceili Band ranges in age from 14 to 16, and includes Bernadette Lucey, who, along with Michael Joe Carolan (now, is that a name!) and the aforesaid Eileen Ivers, won an All-Ireland Championship as a trio in 1976. And the Glincastle Ceili Band, ages 16 to 19, includes the driving tenor banjo of Gail Mulvihill, one of Martin's talented daughters, who won an All-Ireland in that division in 1976, too.

The tunes are all jigs, reels, hornpipes, and marches, the same kinds of music on which the young musicians are normally judged back home in the competitions. The sound of a dozen young virtuosos all playing in unison, however, may at first be hard on the ears of those listeners who have come to expect various kinds of counterpoint and ensemble playing from the examples of The Chieftains and The Boys of the Lough. But unison playing is in fact much closer to the normal Irish tradition than the orchestrated compilations of The Chieftains or the close-order trade-offs of The Boys of the Lough; and of course the slow airs employed by these adult musicians (ah, Cathal!) give a variety to the repertoire that is necessarily absent from this album of competition music by younger players.

Another point that might be noted is the absence of the bodhran, the hand-held drum played with a double-ended stick, which many people have also come to associate with Irish music in its better-known form. But again, the snare drums featured on this album agree more closely with the actual instrumentation and practice of street parade bands back home than the relatively-novel concert hall use of the bodhran. Once more, what may be at first startling to American ears coming to this music from The Boys of the Lough or The Chieftains should be recognized, rather, for the normal and traditional practice that it actually is, rather than regarded as deviating from that norm.

Once these barriers to appreciation are overcome — along with the concomitant response to the tender ages of some of the musicians — then it should be possible for the unbiased listener to hear more clearly the remarkable achievement of Martin Mulvihill and his pupils from the Bronx. Children of emigrants who had once feared that their traditions would die out with them, the various bands and soloists featured on this album are both carrying on the old tradition in this country and also, in the process, creating their own for the



Needle in the hi-fi haystack

Even we were astounded at how difficult it is to find an adequate other-brand replacement stylus for a Shure cartridge. We recently purchased 241 random styli that were not manufactured by Shure, but were being sold as replacements for our cartridges. Only ONE of these 241 styli could pass the same basic production line performance tests that ALL genuine Shure styli must pass. But don't simply accept what we say here. Send for the documented test results we've compiled for you in data booklet # AL548. Insist on a genuine Shure stylus so that your cartridge will retain its original performance capability—and at the same time protect your records.

Shure Brothers Inc.
222 Hartrey Ave., Evanston, IL 60204
In Canada: A. C. Simmonds & Sons Limited

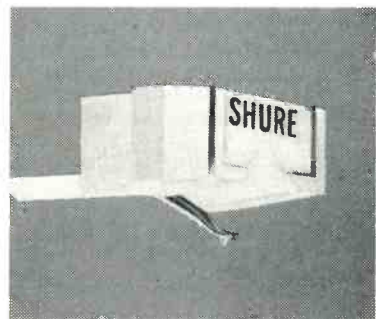

Manufacturers of high fidelity components, microphones, sound systems and related circuitry.

Enter No. 76 on Reader Service Card

AM Comes Alive



The McKay Dymek DA 5 shielded ferrite loop AM antenna has a solid state preamp with tuning and sensitivity controls.

Overcomes the two most common AM reception problems: strong local stations "hiding" weaker distant stations close on the dial, and interference from TV and electrical sources.

Improves inherent long range capabilities of AM — programs listenable from over a thousand miles.

Increases signal strength 4 to 8 times — really sharpens up AM performance in typical hi-fi receivers and tuners.

Factory direct, 20-day money back guarantee. Exclusive rent/own plan available. For more information call toll free:

Nationwide 800/854-7769

California 800/472-1783



McKay Dymek Co.
111 South College Ave.
P.O. Box 5000
Claremont, CA 91711

Enter No. 42 on Reader Service Card

CRAIG ANDERTON MEETS

COMBO ORGAN,



THE RESULT:

ORGANTUA

from **RAIA**

FORGET ABOUT THIN-SOUNDING COMBO ORGANS; ORGANTUA HAS: THREE INDIVIDUAL RANKS (EACH WITH 5 POSITION OCTAVE SELECT SWITCHES) FOR A RICH, THICK SOUND.

ORGANTUA REPRESENTS THE FIRST MAJOR ADVANCE IN COMBO ORGANS IN 10 YEARS. SEND FOR OUR INSTRUCTION MANUAL IT TELLS THE FULL STORY.

no. 6780 - ORGANTUA KIT - \$279.95

(shipped freight collect)

ALSO AVAILABLE CUSTOM ASSEMBLED

() I'm convinced - Send Organantua Kit (\$279.95 enclosed)

() Send Organantua Instruction Manual (\$5 refundable with kit purchase)

() Send FREE Catalog

name: _____

Address: _____

City: _____

State: _____

Zip: _____



DEPT. 9 A, 1020W. WILSHIRE,
OKLAHOMA CITY, OK 73116

Enter No. 21 on Reader Service Card

future. Perhaps the best compliment that can be paid them comes from the perceptive Moloney, in his liner notes: "Such is the drive of their playing that it is very hard, when listening to their music, to imagine them as anything other than top adult bands." How accurate you will find this comment will, of course, depend upon your own prior exposure to Irish music, and your ability to separate the romance of youth from the technical competence and artistry displayed on **Irish Music: The Living Tradition**. But I'll go with Mick Moloney any time.

Order from Inisfree Records, 70 Turner Hill Rd., New Canaan, Conn. 06840.

John McLaughlin

Sound: A

Performance: B

Love Can Take You Home Again:

Carol McComb & Friends

Bay 302, stereo, \$6.98.

Way back in the 1960s a pristine folk album by Kathy & Carol appeared, and next to nothing has been heard from either lady until this 1975 release. Carol McComb still sings occasionally with Kathleen Larisch. In fact an album highlight is their a capella duet of Richard Farina's *Quiet Joys of Brotherhood*.

In The Bay Records tradition, **Love Can Take** is a home-made album played by friends with understanding and warmth and minimal overdubbing. Carol's songs are honest and heart-felt. The performances avoid gratuitous virtuosity, and the whole flowers as a result. Songs like *Thistle and Thorn*, *Renaissance*, and *Dreams Are So Hard to Break* are as butterflies next to most manufactured pop. Real yet lovely, and romantic in the poetic sense of the word.

Michael Tearson

Sound: C+

Performance: B+

Too Late to Turn Back Now: New Grass Revival

Flying Fish FF-050, stereo, \$6.98.

If there is such a thing as progressive bluegrass, then New Grass Revival is the leading exponent. Both the "New" and the "Revival" in the name are completely accurate, and the "Grass" is the pivot.

Too Late to Turn Back Now is a live album recorded at the "1977 Telluride Bluegrass and Country Festival" in Colorado. The revival's material is modern country, things like *Lonesome and a Long Way From Home* and other songs by Peter Rowan, Willis Alan Ramsay, and Gene Clark with Bernie Leadon, the ex-Eagle (*With Care from Someone*). The other three cuts are group originals.

The underpinning of New Grass's sound is the electric bass playing of John Cowan. He's usually playing rock-

style lines while the others are picking country or pure bluegrass. The rock input gives them a jolting kick for a 'grass band. In addition they take liberal stretches to improvise showing both ambition and reach, even if their meandering occasionally gets a bit obtuse.

The recording quality is always at least adequate or better. The live mix is sometimes muddy with one or two players all but inaudible in spots, but enjoyable as a whole.

What I like best about New Grass Revival is that their music defies quick categorization and disposal. They take chances, and that's exciting.

Michael Tearson

Sound: B-

Performance: B

Banish Misfortune: Malcolm Dalglish and Grey Larsen

June Appal JA 016, stereo, \$5.50.

Those of you familiar with the Chieftains' first four albums will recognize the majority of the tunes on **Banish Misfortune (Chieftains 3)**, Island ILPS 9379, being a particularly fecund source).

Certainly, tunes like *The Road to Lisdoonvarna*, *The Nine Points of Roguery*, and the fascinating Irish marches, *March of the King Laois* and *Brian Boru's March* can only benefit from increased exposure. But even more importantly, few if any of them have ever been arranged for hammered dulcimer before, especially by a virtuoso of Malcolm Dalglish's caliber.

Dalglish has a light, buoyant touch which is enhanced by skillful precision (note the triplets and clusters which ornament the title track and *Brian Boru's March*), dazzling agility even on fast-tempo reels (the *Pigeon on the Gate* medley and the *Growling Old Man and Cackling Old Woman* set), and admirably tasteful imagination (such as his sensitive interweavings on the North Hebridian *Christ Child's Lullaby*). His self-built instrument has a soft, lovely chime with a haunting accumulation of overtones, and hardly a trace of metallic brittleness.

Grey Larsen accompanies Dalglish on several instruments, including concertina, whistle, and guitar (in some cases employing overdubbing). While he's not the master musician that Dalglish is, Larsen never detracts from the dulcimerist's artistry. Indeed, his use of different instruments adds variety to the album, the combination of such disparate elements as concertina and dulcimer, or alto recorder and dulcimer, furnishing some intriguing tone colors. While Larsen occasionally stumbles during his solo spots (most obviously on his concertina feature, *O'Connell's Lamentation*), he generally picks himself right back up.

Considering that neither of the Cincinnati-based duo was exposed to Irish mu-

sic until their college days, they've assimilated its winsome melodic qualities and sprightly rhythms to contribute some excellent original compositions. Dalglish's *Midnight Mountain Road* has a strikingly unusual melody, while his *Dog in the Mustard* (great title!) provides an expedient bridge between Larsen's flute air *Tar Hollow* and that familiar standby, *Kid on the Mountain*. Best of all is Larsen's *Drunkard's Path*, which sounds so much like an old favorite that it's not the least bit out of place sandwiched in between *The First of May* and *Ah Comhra Donn*. Also worthy of mention is sides two's schottische medley, learned from melodeon player Michael Kennedy.

The recording is less clangorous, more intimate than many hammered dulcimer albums, befitting Dalglish's gentle instrument. Dulcimer addicts might consider Larsen to be over-balanced slightly, but only on *Foxhunter's Jig* does his dense rhythm guitar drown out the dulcimer. The surface is audible during the quietest moments. Available from June Appal Recordings, Box 743, Whitesburg, KY 41858. *Tom Bingham*

Sound: B- Performance: B+

Kora Manding: Mandinka Music of Gambia

Ethnodisc ER 12102, mono, \$7.95.

The Republic of Gambia is not only famed as the birthplace of Kunta Kinte, it's the home of a magnificent 21-stringed instrument called the *kora*.

The *kora*, which is most often used to accompany singing, is classified as a "harp-lute." Its playing technique and sound resemble a high-pitched somewhat metallic harp, while its construction in many ways parallels the lute and its descendants. The *kora* plays short, constantly reiterated background figures—called *kumbengo*—which are melodically appealing, gently rhythmic, and hypnotic in their tranquil insistence. To keep this *ostinato* from becoming monotonous, it is frequently punctuated by tuneful descending phrases called *birimintingo*.

Tutu Jara, an instrumental *kora* duet, is an excellent illustration of the interplay of these two elements, with Suntu Suso playing intricate *birimintingo* counterpoint to Amadu Kanuteh's wistful *kumbengo*. Amadu Bansang Jebateh's *Bamba* is a virtuoso *kora* showpiece, with a bare-bones *kumbengo* serving as a framework for a dazzling display of the *kora*'s many functions—supplying melody, harmony, rhythm, and percussion (courtesy of the *nyenyemo*, a resonator rattle attached to the *kora*'s bridge).

The vocal selections illustrate another aspect of Gambian music, the contrast between a song's melodic phrases

(*donkilo*) and its semi-spoken narrative sections (*sataro*). On *Lambango*, Fatumata Jebateh sings in a sure, sharp-toned voice, with a hoarse, impassioned shout at the beginning of her melodious *donkilo*. Amadu Kanuteh's *Maki*, on the other hand, is constructed almost entirely of *sataro*, spiked with well-thought-out *birimintingo*; at eight minutes, though, most listeners will undoubtedly find it overlong. There is also a brief, but very emotional unaccompanied vocal, *Suolu kile*, sung by Nyulo Jebateh with fierce intensity.

Ala l'a ke provides an opportunity to compare differing approaches to the same tune, as the song also appears on Aliaji Bai Konte's superb *kora* album for Rounder (5001). Whereas Konte uses the song as a springboard for rapidly ornamented, flamenco-like *birimintingo*, Kunye Saho takes off on an astonishingly jazz-like improvisation with a Latin-funk sway to the rhythm. Nyama Suso's *Sunkariba* incorporates *Ba Toto* (a more complete version of which appears on Bai Konte's album), a descriptive piece supposedly imitating Gambian river frogs, though the charmingly dissonant, high-pitched strumming heard here sounds nothing like "ribb-it."

Sound quality varies considerably from track to track. Though the clarity and presence of the Rounder album is lacking, the album is generally quite acceptable sonically. Indeed, the outdoor recordings, with their birds and village sounds, are very atmospheric. Order from Pachart Publishing House, P.O. Box 6721, Tucson, AZ 85716.

Tom Bingham

Sound: C- Performance: A

Byron Berline & Sundance Live at McCabes

Takoma D-1061, stereo, \$7.98.

This happy reunion of hot blues grassers led by several times national fiddle champ Byron Berline is a good, if not stand-out album. It is a standard mixed bag of bluegrass and country tunes with plenty of fast picking. Average level recording is clear but *notringing* clear. Byron's fans will be especially pleased.

Michael Tearson

Sound: C- Performance: C+

El Principe del Acordeon: Flaco Jimenez

DLB 1037, mono \$4.98.

Thanks to appearances on PBS' "Austin City Limits," the "Chulas Fronteras" film, and records by Doug Sahn and Ry Cooder, Flaco Jimenez — the most fabled of all modern Norteno accordionists — is finally attracting attention beyond the Rio Grande Valley. His records, however, have yet to receive

These Audio Dealers care as much about your records as you do!

That's right, these very select audio dealers have bought the only professionally recognized, permanently installed, wet or dry record cleaning machines in the world. Our machines have been used by broadcast professionals world-wide since 1968. Now, our dealers have installed these machines as a service to their valued customers.

Of course, the technology is secret. Grease, hardened sludge and embedded grit, loosened by a special solution and the cleaning brush, are removed by the suction arm. The record is left dry, clean and free of all chemicals.

So, don't just complain about those ticks and pops caused by dirty records. See if one of the dealers listed below can't get rid of them for you. It only takes about 1½ minutes each side and costs a dollar or less per record (includes special static-free jacket).

Most dealers will also be able to show you two other Keith Monks record care products you can install yourself. Ask him about our Record Sweeper... the one that has a special non-ferrous static conductor built in. Or, our Leveling Kit... the turntable pads that both level and damp the turntable against loudspeaker feedback.



125

Allen's Cameras & Sound Provo, Utah	Grice Electronics Pensacola, Fla.	Woodland Stereo Woodland Hills, Ca
Audio By Zimet Roslyn, N.Y.	Hawthorne Stereo Portland, Oregon	Sound Components Coral Gables, Fla
Audio One Birmingham, Mich.	HI FI Hutch Tampa, Fla.	Sound Ideas Visalia, Ca
Audiophile Sound Studio Cincinnati, Ohio	J.C. Gordon St. Louis, Mo	Sound Mill Mt. Kisco, N.Y.
Audio Reproduction Blacksburg, Va	Jensen's Stereo Shop Burnsville, Minn.	Sound Odyssey Wappingers Falls, N.Y.
Audio Vision Santa Barbara, Ca	Jonas Miller Sound Beverly Hills, Ca	Specialized Sound Audio Consultants Louisville, Ky
Definitive Systems of Newport Newport, R.I.	Lyric HI FI White Plains, N.Y.	Stereo Components Munster, Ind.
Eardrum of New England Burlington, Mass.	Lawrence Stereo Birmingham, Ala.	Stereo Store San Francisco, Ca
Electronic Workshop New York, N.Y.	Manchester Music Manchester, N.H.	Stereo Unlimited La Mesa, Ca
Gordons Electronics Syracuse, N.Y.	Mission Bay Audio San Diego, Ca	Take 5 Audio New Haven, Conn.
Gordon Miller Music Towson, Md.	New England Music Co. Portland, Maine	Tin Ear Stereo Ctr. Richland, Wash.
	Pro Musica Urbana, Ill.	Victor's Stereo Morton Grove, Ill.
	Sight & Sound Morristown, N.J.	

KEITH MONKS (AUDIO) LTD

42 Tiffany Place, Brooklyn, New York, 11231
(212) 596-3460

Enter No. 46 on Reader Service Card

Gain From A Piece Of Wire

Expect greatly improved mid and high frequency response, minimal signal loss, lowered distortion and up to a 2dB gain in volume when you connect AudioSource Ultra-High Definition speaker cables to your system.

That's because UHD cable is more than just a piece of wire. It's actually 120 pieces of wire per cable (60 per lead). Each composed of high purity copper, individually enameled, heat-set and braided into two flat strands aligned at 90° angles to one another. All wrapped in vinyl and as easy to connect to your system as it is to install under carpeting or along walls.

AudioSource UHD speaker cable. Gain from it!



AudioSource
1185 Chess Drive, Foster City, CA 94404
Phone: (415) 574-7585

Please send _____ pairs of UHD-5 (16.4') Speaker Cables at \$32.50 per pair Total _____
 Please send _____ pairs of UHD-10 (32.8') Speaker Cables at \$65.00 per pair. _____
 Add postage and handling of \$1.50 (each). \$1.50
 (California Residents add 6% sales tax.)
 TOTAL _____

I enclose check _____ or money order _____
 Charge my BankAmericard/Visa _____ Master Charge _____
 Account No. _____ Expires _____
 Signed _____
 Mail Speaker Cables to:
 Name _____
 Address _____
 City _____ State _____ Zip _____

Place this coupon in an envelope along with your remittance and mail to AudioSource, 1185 Chess Drive, Foster City, Calif. 94404. Orders received will be processed immediately, however, please allow three to four weeks for delivery.

Enter No. 4 on Reader Service Card

much exposure outside the Chicano market.

Actually, there are two substantially different types of Flaco Jimenez recordings — those that present Flaco, the *conjunto* — leader, and those spot-lighting his abilities as a polka accordionist. In the *conjunto* context, where he accompanies *ranchera* duets, he spins out quick-thinking, intricate improvisations between the vocal lines, often reaching dazzling heights of imaginative fancy.

On instrumental albums like the newly released **El Principe del Acordeon**, in which the accordion is the sole lead instrument (the bajo sexto, bass, and drums playing strictly subservient — albeit crucial — rhythmic roles), the full burden of the melody rests on his shoulders. Because a straightforward, hummable tune is as essential to a polka as a danceable beat, Flaco's improvisations must of necessity be limited to embellishments on the melody. Nevertheless, he ornaments his tunes with well-chosen grace notes and triplets, delightfully pliant rhythmic twists (note *Una Tarde en el Alamo*, *Los Naranjales*, and *Mi Caballo Bayo*, among others), and skillful alterations in tone color that keep the songs from ever becoming repetitious. You won't hear the imaginative off-the-wall extemporizations of Flaco's *ranchera* albums here, but that hardly means his accordion playing is any less inimitable.

The repertoire on this album is refreshingly varied. *Luna de Plata* ("Silver Moon") turns out to be the pop standard, *Sail Along Silvery Moon*, played with a jaunty pop-country bounce. *Juarez* is a smoldering Latin-lover tango, while *Los Tres Sabinos* is an old-fashioned, nostalgic waltz. Eight of the 12 tracks are polkas, including such typical Norteno melodies as *La Puntada*, *Evangalina*, and a medley of Tex-Mex favorites called *Acuarela Nortena*. *Emilia* sounds like a French sidewalk-cafe tune set to a polka beat; who else could get away with making a polka out of *La Paloma*?

The recording is generally respectable, though some distance removed from "alta fidelidad." *Sobre Las Nubes* is quite muffled, while *La Paloma* and a couple others are on the shrill side. The surface is pocked with numerous ticks, pops, and whatnot.

By the time you read this, his first national release (**Flaco Jimenez and his Conjunto**, Arhoolie 3007) should be out. In the meantime, DLB has nine Flaco Jimenez albums, including three from his earlier career as half of Los Caporales. Write to DLB at P.O. Box 37250, San Antonio, Texas 78237

Tom Bingham

Sound: C — Performance: A —

AUDIO • September 1978

126

SPEAKER KITS

SENSIBLE SPEAKER KIT

A well-matched set of components with a sensibly sized cabinet . . . with a sensibly price! This kit exceeds spec's for systems costing 3 and 4 times as much! Cabinet size 21x12x10. . . 10" woofers, 4" dome tweeters, 5" midders, crossovers, damping, hardware; instruction PLUS Sculptured Foam Grill! Qty. Ltd, Order NOW! Better quality, 1/2 cost, plus the satisfaction of having built it yourself. 50 Lbs./pair #8230338 only \$99.88/Pair



BFE II SPEAKER KIT

Full size super-system, includes a 10" woofer with free air resonance of 30 Hz.; a tweeter which utilizes a fluid-cooled mag. coil; plus a 5" midler isolated by a special chamber in the cabinet. The cabinet is a walnut vinyl-clad enclosure with pre-cut holes. Complete with R-C-L network and instructions. Special Bonus: sculptured foam grill! Qty. Ltd. Sh. Wt. 80 Lbs./pair. #8H30239 \$150.00/pair



AM/FM STEREO RECEIVER CHASSIS

Intended for use in a "big name" stereo console . . . until he changed his design. AM, FM, FM multiplex, plus phono and aux. inputs. Up-to-date circuitry includes two IC audio amps. Just add a case and speakers — great for custom "building-in". Chassis measures 12" long x 6" deep x 2 1/2" high. W/instructions, 115VAC. Qty. Ltd. Sh. Wt. 3 Lbs. #8S20307 \$24.88 each -or- \$68.88/3

MOTOROLA® PIEZO-ELECTRIC TWEETERS

Horns, Super-Horns & Direct Radiators. No crossovers required / High Impedance / High Output / Excellent Transient Response / Low Harmonic Distortion. Tomorrow's tweeters today from B&F! MORE COMPONENTS & KITS: AVAILABLE THROUGH OUR FREE CATALOG! SEND FOR FREE CATALOG TODAY!

Please add POSTAGE / SEND ORDERS TO:
 No C.O.D.'s

B&F ENTERPRISES

Dept. A-9
 119 Foster Street
 Peabody, MA. 01960
 (617) 531-5774

SEND FOR OUR FREE CATALOG Over 3,000 surplus BARGAINS!

PHONE ORDERS WELCOME BA - MC - AE

Enter No. 58 on Reader Service Card

HELP!

Anytime you have a question about your Audio subscription, please include a mailing label to insure prompt service on your inquiry.

AFFIX LABEL HERE

CHANGE OF ADDRESS

If you're about to move, please let us know approximately four weeks before the move comes about. Or, if there is anything wrong with your current mailing label, please let us know on this form also. Simply affix your present label here, and carefully print the updated information below.

PLEASE HELP US TO SERVE YOU BETTER

AUDIO MAGAZINE

401 N. Broad Street • Phila., Pa. 19108

Name _____ (Please Print)
 Company _____
 Address _____
 City _____ State _____ Zip _____

Classified

FOR SALE

FOR SALE

FOR SALE

THE \$ENSIBLE SOUND

IN OUR NEW ISSUE—#5, WE REVIEW

Haffer DH101, GAS Thalia, DB-1A, Kenwood L-07C, Ace 3000, PS Audio II, Audionics BT-2, Chartwell LS3/5A, Fried B/2, JR-149, Shure V15-IV, Signet TK7E, Sonus Blue (new), Grado F1+, ADC ZLM, Micro Acoustics MS-1, Audioplate, Speakerlab 3, Crown IC-150A, PSE Studio One, A.I. CM300, Speakerkit 4&5, Advance A, Cizek II, Technics SB5000A, Avid 101, Catalyst 7, AR 15 & 17, Visonic 502, Braun Output C, White Hall Shot, VMPS 404b, Polk Cable, Warp Knot, Garrard Recovery Module, Bose 801 II & 801, Monitor Audio MA3 II. Plus some zero cost tips, inside industry info, and dozens of "Audiophile" record reviews. **SUBSCRIBE TODAY. \$12 (4 issues), \$13 Canada, \$14 First Class Mail, \$17 foreign.**

403 DARWIN DRIVE, SNYDER, NY 14226

COLORADO JOB INFORMATION. Send \$3.00 to Votek, P.O. Box 1718B, Colo. Spgs., CO 80901. 9-8

"ATTENTION SUPER AUDIOPHILES"

SUMO ELECTRIC CO. LTD. AND A-TRAIN LTD. PROUDLY ANNOUNCE THE AVAILABILITY OF THE SUMO CARTRIDGE. AFTER YEARS OF RESEARCH A NEW MAGNETIC CARTRIDGE HAS ARRIVED TO CHALLENGE THE MOVING COILS. WITH ALL OF THE GREAT FEATURES OF THE BEST MOVING COILS SUCH AS LOW MASS, LOW COMPLIANCE, AND EXTREMELY LOW TIP MASS. THE SUMO CARTRIDGE IS FINALLY HERE AT A PRICE THAT CAN BE AFFORDED—\$150—AT YOUR DEALER NOW.

THIS IS ANOTHER FINE PRODUCT THAT A-TRAIN LTD. IS PROUD TO OFFER ALONG WITH THE MORE THAN SUPER AUDIOPHILE DISCS BY AUDIO LAB AND THREE BLIND MICE. SEND FOR OUR BROCHURES RIGHT AWAY.

A-TRAIN LTD., 1230 N. HORN AVE., W. HOLLYWOOD, CA. 90069. (213) 659-4370

TONEARMS—CARTRIDGES—TURNTABLES at lowest prices. Most brands available, including MC cartridges. Other quality brands available. Send #10 SASE for quotes. Audio Unlimited, 401 Reynolds Circle # 2-C, San Jose, CA 95112 (408) 251-8776.

WORLD AUDIO WESTCHESTER, INC.

Westchester's finest audio sales and service dealer is proud to announce the addition of:

Celestion Speaker Systems

to the already fine lines of Lux, Soundcraftsmen, Thorens, Audio-technica, ADC-BSR, AR, AKG, CM LABS, DBX, DECCA, JVC, Jensen, M.A., Optonica, Phillips, Pickering, Pioneer, Stanton, Supex, Sonab, Tandberg. Direct to disc records. Shipping is free in continental U.S.

WORLD AUDIO WESTCHESTER, INC.

211 North Avenue
New Rochelle, NY 10801
914-576-3230

1-9

CONNECTICUT: ADC-Accutrac, Advent, Audio Pulse, B&O, B.I.C., Citation, Dahlquist, Epicure, Harman/Kardon, J.B.L., McIntosh Nakamichi, Ortofon, Phase Linear, Sony, Stax, Tandberg, Yamaha, Cizek, Sonus. Will ship prepaid. Sounds Incredible, 226 White St., Danbury, Conn., 06810. (203) 748-3889—phone quotes only. TF

SAVE ON PRO EQUIPMENT

BGW, CROWN, SHURE, JBL-PRO, TASCAM TEAC VEGA, EV, SENNHEISER, TECHNICS, ESS, HME, STL, WHITE, TADSO AND MUCH MORE. CALL OR WRITE FOR YOUR QUOTE. ANTECH LABS, INC. 8144 BIG BEND, ST. LOUIS, MO. (314) 962-5656

LOW TIM-II AMPLIFIER. Revised circuit. Plans and 2 solder reflow ground plan boards for \$24. Assembled and tested boards 2 for \$143 with plans. Custom Components, Box 33193, Decatur, GA 30033. 10-8

FULTON DEALER OPENS NEAR CHICAGO

Illinois Audiophiles can now see/hear/obtain state of the art Fulton Products. Newest PAH J's, E's, Nuance 1's, 100's, 80's, etc. New high-def. phono and speaker cables, headshell leads and damper mat offer low-cost ways to dramatically improve the sound of your gear for \$7 to \$235. Ten Fulton records. Fulton moving-coil cartridge available soon. Audition by appointment.

THE MUSIC ROOM

Lombard, Illinois (312) 620-7341

STEREO REPRESENTATIVES NEEDED!!!

Sell 100 brands!! Lowest Possible Prices!! Krasco—REP DEPT. —998 Orange Ave. West Haven, Conn. 06516 TF

AUDIONICS P23 Amp. 0.03/0 THD 100w/ch. Mint \$295 E.S.T. (603) 434-6386.

QUAD ESL w/servo-statik bass design w/cover \$1050, SAE 31B \$175, Marantz 7T \$250. Accuphas C200 \$425 (319) 323-6567. 10-8

FULTON J-MODULARS, \$1700 SAE 2200, \$1275. (219) 432-2124 evenings 10-8

VAN ALSTINE DYNA MODS FOR ST-400, ST-416, ST-410, ST-150, PAT-5, PAT-5 BIFET FM-5 are still the best. New \$10.00 improvement kit for Dyna PAT-5 BIFET. Double 400 conversions for both ST-400 and ST-416. Free mod instructions for ST-70, MK-111 and PAS-3X. \$100 audio circuit mods for ARC SP3-A1 All new DC coupled VAN ALSTINE MODEL 1 preamp and MODEL 2 power amp. Crown tape electronic mods coming soon. Jensens Stereo Shop, 2202 River Hills Dr., Burnsville, Minnesota 55337 612-890-3517 12-8

RENOUCE ROTTEN RECORDINGS! Read selected British reviews in the bi-monthly EURO-DISC GAZETTE, then order these European discs judged the finest in technical and musical excellence. Selections mainly classical. Send for free sample issue. No obligation. EURO-DISC GAZETTE, PO Box 337-A, Peterborough, NH 03458. TF

HAFLER DH-101 PREAMP

We expect to be in stock on this exciting new preamp by Dec. 12th. Kit price is \$199.95. Custom wired and tested, \$299.95. Immediate prepaid shipment via UPS. THE AUDIBLE DIFFERENCE, 435 Tasso, Palo Alto, California 94301. (415) 328-1081.

SEMI-PRO AND CONSUMER TAPE EQUIPMENT, HEAD-PHONES. TEAC/Tascam, Technics, Dbx, MAXELL. Best Prices! Prompt Delivery! WDI, P.O. Box 340, Cary NC 27511. 919-467-8122 10-8

CLASSIFIED ADVERTISING RATES

BUSINESS ADS- For Sale. Help Wanted. Services. Business Opportunities. Tape Recordings, etc. etc. \$4.80 per line. First line set in bold face type at no extra charge. Extra lines \$9.60 per line. One point ruled box, extra charge \$8.00. Full payment must accompany order.

NON BUSINESS ADS-Situations Wanted, used equipment for sale by private individuals \$2.80 per line. First line set in bold face type at no extra charge. Extra lines set in bold face type \$5.60 per line. Full payment must accompany order.

FREQUENCY DISCOUNT- 3 times, less 10%. 6 times, less 15%. 12 times, less 20%.

DEADLINE- 1st of two preceding months. (Dec. 1 for Feb. issue).

BLIND ADS- Box numbers may be used at \$5.00 extra for handling and postage.

MAIL ORDER AND DISPLAY CLASSIFIED RATE

1 col x 1"	\$85
1 col x 2"	\$125
1 col x 3"	\$175
2 col x 1"	\$125
2 col x 2"	\$225

Advertiser must supply complete film negative ready for printing for display ads.

AUDIO Magazine
401 North Broad Street
Philadelphia, Penna 19108

HOW TO ANSWER BOX NUMBER ADS

When replying to an Audio Box Number Ad, please use this address Box No. — c/o Audio, 401 No. Broad Street, Philadelphia, Pa. 19108

RHODE ISLAND MUSIC PHILES

If faithful musical reproduction is what you're after; and not the seductive deceptions of musical phantoms, then take a trip to Newport.

KIRKSAETER	GRACE
LUXMAN	KEF
I.M. FRIED	CONNOISSEUR
DB SYSTEMS	RTR
ARISTAN	KEITH MONKS
DAHLQUIST	SUPEX
DECCA	JVC
HARMAN KARDON	GRADO
ORTOFON	AVID
SOUND CONCEPTS	STAX
AKG	BRUEYER DYNAMIC
SATIN	FUJI

Definitive Systems

FINE STEREO & AUDIO COMPONENTS

26 Memorial Blvd West, Newport, RI 02840
847-5740 847-5741

MUSIC BY THE SEA

tube
or not
tube

AUDIO MODIFICATION MANUAL

More than 220 pages of priceless information, including general audio philosophy, specific design criteria, general mod instructions for all classes of tubed equipment and loudspeakers, plus explicit step-by-step procedures for many common components. Latest printing includes much new information, including a construction project for a QUIET Nuvistor (tube) subpreamp, and much more. U.S.A. \$25.00... other countries U.S. \$27.00. California residents add \$1.50 tax. Telephone orders accepted (M/C, VISA). (714) 278-3310. AUDIO DIMENSIONS, 8898 Clairemont Mesa Blvd., San Diego, California 92123.

FOR SALE

the audio advocate

SME
AVID
POLK
ONKYO
SHURE
DECCA
DENON
ROGERS
RH LABS
ARISTON
PARAGON
ACOUSTAT
FORMULA 4
DAHLQUIST
NAKAMICHI
PHASE LINEAR
AUDIO RESEARCH

505 Millburn Avenue Millburn, NJ
(201) 467-8988

CANADIANS: Best Hi-Fi discounts on over 96 leading Hi-Fi brands. Many exclusive factory closeout and special deals. Quotations via return mail. Nationwide mail order service. Free catalogs jam packed with bargains in Hi-Fi equipment, tape and recording accessories, calculators, telephones and accessories, kits, parts etc. Hundreds of factory and government surplus specials too! American inquiries welcome. Rush free catalog request to ETCO, Dept AUA, Box 741, Montreal 183G Hymus, Pointe Claire, Quebec H9R 1E9 TF

Audio and TV tubes factory boxed, speakers, semiconductors—low prices, free price list. Transislectronic Inc., 1365-39th St. Brooklyn, N.Y. 11218 212-633-2800 TF

DIAMOND NEEDLES and Stereo Cartridges at Discount prices for Shure, Pickering, Stanton, Empire, Grado and ADC. Send for free catalog. LYLE CARTRIDGES, Dept. A, Box 69, Kensington Station, Brooklyn New York 11218. For fast service call toll free 800-221-0906.

MARK LEVINSON LNP-2 PREAMPLIFIER OWNERS
If your LNP-2 Preamplifier is more than 2 years old, we would be very interested to give it a thorough check out to insure its optimum performance and continued reliability. Return authorization must be obtained by calling or writing the factory prior to shipping the unit. All required repair work if any will be accomplished at the same time at no charge under warranty.

If you own any MLAS product and are not completely satisfied with its performance, please contact: Mark Levinson Audio Systems, Ltd., c/o Customer Service Department, 390 East Street, New Haven, CT, U.S.A. 06511 or call (203) 624-6625.

ROTEL QUALITY AUDIO COMPONENTS: Immediate delivery all Rotel products including RB-5000 RX-1603 RX-1203 RA-1412 RA-1312 RT-1024. National Sound Quality, Ft. Lauderdale Florida (302) 462-6662

METRO—NEW YORK CITY

G.A.S., FR, Dahlquist, Bang & Olutson, Lux, Linn Sondel, AVID, Janis, Bauree & Wilkens, Grace, many others. Also issues of Absolute Sound.

UNIVERSITY STEREO—Ridgewood, N.J.
57 E. Ridgewood Ave—(201) 447-5700
20 minutes from G. W. Bridge

7-9

PHASE LINEAR 700B 2/cab MINT \$450 or best offer (302) 762-0347.

CABINETS FOR DYNACO PREAMPS, tuners, quadaptor, stereo 120. Literature. GEOMETRIX CABINETS, Box 612, Mexico, MO 65265. 7-9

KOSS Model 1A, mint, \$1600/pair FOB. Van Alstine modified SP-3a-1; \$600, Ampzilla 1: \$650, Nakamichi 600 (preamp): \$450. 904-651-4430 eve. 9-8

FOR SALE

MILWAUKEE & WISCONSIN'S ONLY TRUE AUDIOPHILE DEALER

Specialists in components by Audio Research, Dahlquist, Transcriptors, SAE, Nakamichi, Bozak, MSE, DBX, Revox, Infinity, RTR, Phase-Linear, Tandberg, G.A.S., London-Decca, Stax, Sonus and over 50 others. Wisconsin's ONLY Audio Research dealer with their new product line on demonstration. Plus one of the truly largest displays of tape decks & accessories in the entire country. Over 130 machines on display. WACK ELECTRONICS, INC. 5722 W. NORTH AVE. MILWAUKEE, WI 53208 TF

MIXER made especially for tape duplication. Will produce enhanced high quality second generation tapes. KUHN ELECTRONICS, 1801 Mills Ave., Norwood, OH 45212. TF

JUSTI-METER III

Audio Graphic Recorder, now available direct from manufacturer. \$495.00 complete. Use VISA or Master Charge, giving full information. Shipment immediate. Justi-Meter Corporation, P.O. Box 134, Lehigh Acres, Florida 33936 9-8

PERFECTIONISTS PREFER DYNAKITS

Before Purchase You Owe Yourself Our Quote Mainline 114 971 Fronheiser, Johnstown, PA 15902

ELECTRONIC BARGAINS, CLOSEOUT, SURPLUS! Parts, equipment, stereo, industrial, educational. Amazing values! Fascinating items unavailable in stores or catalogs anywhere! Unusual FREE catalog. ETCO-008, Box 762, Plattsburgh, NY 12901

Professional Hi-Fi Home Study Course—Instructors include Len Feldman, Julian Hirsch, Larry Klein, and Larry Zide. Send \$2.00 for full color AUDIO PRIMER and information on joining (SAC) Society Audio Consultants, Dept. A. 49 East 34th St., New York, N.Y. 10016. TF

AUDIO BARGAINS-FREE LIST. Stamp please. Stereo Cost Cutters Box 8014 (AM878) Canton, OH 44711

HAFLER PREAMP CABINETS. Literature. GEOMETRIX, Box 612, Mexico, MO 65265 7-9

STAX PREAMP, used, mint, \$260. J. Lynch, 1641 N. Commerce, Stockton, CA 95204 (209) 466-6594

1978 AUDIO EQUIPMENT PROFILES has just been published by AUDIO magazine. Order a copy by sending \$3.95 to: AUDIO EQUIPMENT PROFILES, 401 N. Broad St., Philadelphia, PA 19108. Over 50 pages of equipment specifications and nearly 100 pages of test reports. Supply is limited, so order now.

ATTENTION FLORIDA AUDIOPHILES

Components of the highest caliber from manufacturers such as: Acoustat, ADC, Ariston, Armstrong, Audionics, Audio Pulse, Audire, Bryston, Celestion, Denon, Fons, Goldring, Grace, KEF, Linn-Sondek, Luxman, MK, Mayware, Paragon, Revox, RH Labs, Sonus, Threshold, Transcriptors and more.

AUDIO EXCELLENCE
Longwood Village
1-4 and State Road 434
Longwood, FL 32750
(305) 834-9344

9-8

METAL FILM RESISTORS, 1%, .35 watt, 48 values from 27.4 ohms to meg., 12" ea. Send SASE for complete list of values. Gold plated panel mount phono jacks, 90" ea., nylon panel insulators for jacks, 10 for \$1.00. Gold plated shielded metal phono plugs, \$1.00 ea. Low mass nylon cartridge mounting hardware, 18 pc. set, \$2.50. All ppd. COMPONENT SYSTEMS, 5556 Personality Ct., Indianapolis, IN 46227. 9-8

Glue, Screw & Goo Your Way To The World's Finest Speakers For A Lot Less **YES, KITS!**

You can afford and easily build any of the speaker systems in our wide selection of superbly accurate, efficient, high technology, low coloration systems from the finest European and U.S. manufacturers. For example—



I.M. FRIED B/2 MINI-MONITOR

\$300 a pair
SEMI-KIT
(If Factory Assembled, \$500)

These long-awaited mini monitors are being acclaimed as the new reference standard throughout the world and you can build them! The B/2's are phase aligned and psycho-acoustically engineered for astonishing bass response—as you would expect from the former chief of IMF. But that is only where *I.M. Fried* starts: the real centerpiece is the new *Fried* slow slope, soft dome tweeter. This dome tweeter will handle vast amounts of power and will not compress the input signal, no matter how high the level. It overlaps the Bextrene midrange broadly (down as far as 1kHz), improving the upper-mid dispersion and completely eliminating "woofer-tweeter" sound. The coherence of the B/2 must be heard to be believed—the sound is never fragmented. We feel the B/2 offers performance that will satisfy the most demanding listener. Power handling: 25-100W.



JANSEN Z-40 BI-POLAR ELECTROSTATIC

\$628 a pair
SEMI-KIT
(If Factory Assembled, \$940)

The legendary performance of electrostats is now affordable in this easy-to-assemble kit. The top of *Janszen's* new line is a 3-way hybrid system using separate, dual-electrostatic elements for the midrange and tweeter. These fourth generation, high power, ultra-low distortion, bi-polar units are loaded into carbon fiber based lenses to provide virtually omni-directional dispersion for pinpoint imaging. A low crossover point is used to insure exceptionally clean, taut bass. Power handling: 20-100W.

Others from \$150 a Pair!

Write Today For Your

FREE CATALOG
"The Speaker Specialists"
SONIKIT
A4 1173-65th St. Oakland, CA. 94608

the weakest link . . . in your sound system is probably the record itself. HIGH DEFINITION RECORDINGS offers the most complete mail order service of direct-to-disk recordings. We carry Sheffield, Crystal Clear, Umbrella, East Wind, G.A.G., Nautilus, and others. We also stock French EMI, Fresh Aire, Gale, Denon PCM, Crescent, Audio Labs, Three Blind Mice, assorted European pressings and more! Send for our free catalogue.

high definition recordings

P.O. Box 82566
San Diego, CA 92138

FOR SALE

CASSETTE SAVING BREAKTHROUGH!!! Proven best or your-money-back. No minimum. Free same-day shipping. Sample \$1.00 - Facts free. LARKSONG, Box 468F9, Point Arena, CA 95468. 9-8

GET INTO BROADCASTING! Learn how to receive free records, tapes, get an FCC broadcast license, start your own station. Free details. "Broadcasting", Box 5516-N9, Walnut Creek, CA 94596 TF

the audio JOURNAL

830 Mulberry St. Macon, Ga. 31201

At last! The promising new publication about music and high-end audio is here. The staff of The Audio Journal, convinced that a good audio review should contain more than just audio gossip or self-righteous hyperbole, has set out to publish the first audio magazine based on rationale and conservatism. Like most other audio perfectionists, we have been irritated and somewhat amused at the antics of the so-called "undergrounders." We think you'll find our approach a refreshing and informative alternative to all existing audio publications.

The Audio Journal will publish regular sections on equipment and recordings. Our equipment section will contain reports on only the best audio components. Our recordings section will contain domestic and imported discs of both classical and popular music. In addition to our regular sections, we will have numerous specialty articles by the staff of The Audio Journal and by noted experts in the audio industry.

Our first issue, which is due in October, will include:

.....The start of our investigation into the best sounding recordings from around the world.

..... In depth reports on the following components:

the Acoustat-X
the Acoustat Monitor
the Magneplanar Tympani 1-D
the Threshold 400A amplifier
the Hafler DH-101 preamp
the Precision Fidelity strain gauge cartridge
and many others as well!!

..... A guest article by Jim Strickland and Peter Dohm of Acoustat Corp. about electrostatic loudspeakers.

..... And some unexpected extras!

The Audio Journal is published four times per year. Subscription rates for four issues are as follows: U.S.A.-\$18 (first class), Canada-\$19 (first class), Outside North America-\$20 (air mail). Send your check or money order today to: The Audio Journal, 830 Mulberry St., Macon, GA 31201. Our free prospectus is available upon request.

FOR SALE

LEGENDARY.

Mark Levinson. Threshold. Grado Signature. Janis. Pyramid. Grace. Sendor. Rogers. DCM. Paragon. DB. Bryston. Paoli. Linn-Sondek. Bowers & Wilkins. Denon. Verion. Dunalap-Clarke. All these legends at Chestnut Hill Audio, 2302 Lombard Street, Philadelphia, Pa. 19146. (215) KI 6-6178.

CHESTNUT HILL AUDIO.

COLORADO'S AUDIO ALTERNATIVE Boulder Sound Gallery, Ltd.—Purveyors of unusually fine audio systems and service to meet the needs of all serious music lovers. Our product selection includes the Acoustat X ESL, Allison, B & O, B & W, Dahquist, dbx, Dynavector, Fidelity Research, Fons, Luxman, Magneplanar, Mark Levinson, M & K Sound, Quad Acoustical, Quatre, RAM Sound Concepts, Stax, Supex/Sumiko, Yamaha, and Ultraphase. Demo Lux M-6000 amp with new warranty available.

1200 Pearl, Boulder, Colorado 80302, 1-303-444-2626 TF

BRITISH AND EUROPEAN EQUIPMENT DIRECT TO YOU.

Most quality makes of equipment available at advantageous prices. Price list and price quotes send International reply coupon. For specific brochures send \$2.00 bills. Audio T, Dept. B, 190 West End Lane, London, NW6, phone 01-794-7848, Visitors welcome.

McINTOSH, Late 2300 amplifier. Pasiecznik 52 Crest Murray Hill, NJ 07974. 9-8

TOURING SOUND SYSTEMS, 2, 4 and 8 Track Studios. Disco Sound, Cerwin Vega BGW, Altec, Shure, AKG, Tapco, Dyna, Revox, EV, Beyer, Cetec, etc. K & L Sound Service, 75 North Beacon At., Watertown, Mass. 02172. (617) 787-4072. Att: Ken Berger. TF

DYNA MARK III MOD KIT— increased power-less distortion across frequency spectrum. Power supply and amplifier board parts kit with instruction manual \$18.00 Two kits \$32.00 including postage AUDIO DESIGNERS, P.O. Box 122, Ledyard, CN 06339. 7-9

KLIPSCHORN CORNER BASS \$450. (802) 295-9030. 9-8

FOR SALE

LOWEST PRICES ON STEREO-ESOTERIC COMPONENTS & TAPES!!! Over 150 brands. Send SASE for quotes. Audio Unlimited, 401 Reynolds Circle # 2-C, San Jose, CA 95112 (408) 251-8776.

TYPE YOUR SLIDES! Sizes 3½ x 4 \$2.35 per 50 and 2 x 2 \$2.85 per 100 plus postage. Radio Mat Slide Co., 444 N. Peninsula Drive, Daytona Beach, Fla. 32018

ELECTRONIC CROSSOVERS—ALL TYPES. Updated definitive booklet describes applications, how to improve speaker systems, \$5.00 postpaid, credited to first purchase. Huntington Electronics, Box 2009A, Huntington, Conn. 06484 TF

FACTORY SEALED ALLISON 1 SPKRS, Uher Cassetts & Reel to Reel Machines. Brand new items won in a contest. Uher SG-560 reel to reel \$700.00 or B/O; Uher CG-360 cassette, \$775.00 or B/O, Allison 1 prisms, \$600.00 pr. Ask for Michael only. Call 11 AM—3PM (203) 776-3343.

MARANTZ 7C, 7R, 9S: Marantz 7 Professional Rack Mounting Panel. McIntosh G-22 MC-275, Kazuo Takishima, 33-7-1421, Takashimadaira, 2 Chrome, Itabashi-ku, Tokyo, 175 JAPAN 9-8

LOWEST PRICES: BOSE, SAE, NAKAMICHI, dbx AND MANY MORE, QUOTE FROM DYNAMIC SOUND, BOX 168, STARKVILLE MS 39759. 9-8

GOT A HUGE AMP? I'VE GOT THE SPEAKERS FOR YOU! 2 used ESS amt 6 pros, mint, 1000 watt cap., life warranty, \$895 for both? M. Marty, 239 Scottswood, Riverside, IL 312-442-9453

129

WHAT'S NEW?

from the

MOBILE FIDELITY SOUND LAB

ORIGINAL MASTER RECORDINGS™

SUPERTRAMP! "Crime of the Century"

JOHN KLEMMER! "Touch"

STEELY DAN! "Katy Lied"

ZUBIN MEHTA/L.A. PHILHARMONIC, Suites from "Star Wars" and "Close Encounters"

... AND YOU AIN'T HEARD NOTHING YET !!!

AS ALWAYS - HALF-SPEED LACQUER MASTERS

PLATING TO DEMANDING SPECS

SUPER HIGH DEFINITION IMPORTED PRESSINGS

Available at select audio retailers everywhere: \$14.95 each, or from the MOBILE FIDELITY SOUND LAB, P.O. Box MF, VERADALE, WA, 99037 - (509) 928-3301

QUANTITIES ARE DEFINITELY LIMITED! RESERVE YOURS TODAY!

FOR SALE

BUILD YOUR OWN SPEAKERS
SAVE 50 TO 75%



Send for FREE 40 page Catalog/Manual
 Speaker Kits - Components - Crossovers
ACUSTA CRAFT
 Dept. AU P.O. Box 12030
 Shawnee Mission, Ks. 66212

POLK AUDIO MONITOR SERIES

AUDIO BREAKTHROUGHS now has on demonstration the remarkable new Polk loudspeakers. Compare them to the finest loudspeakers in the world. Both the Seven (\$139.99 ea.) and the ten (\$199.95 ea.) utilize high definition polymer laminate base midrange drivers, wide dispersion soft dome tweeters and fluid coupled sub-base radiators. They are capable of reproducing a highly defined phase accurate three dimensional sonic image which rivals the thousand dollar super speakers. They sound great with a small receiver, yet reveal the fine subtleties of state of the art electronics like Levinson, Nakamichi, Essence and G.A.S. Shipped free in U.S. Send for free brochures on Polk or our other fine lines. **AUDIO BREAKTHROUGH**, 1534 Northern Blvd. Manhasset, N.Y. 11030; 516-627-7333.

HI-FI ENTHUSIASTS WANTED!!! Earn more than just spare money in your spare time. We need campus representatives to sell name brand stereo components at discount prices in your area. No investment required. Serious inquiries only please. Contact: Mail Order Dept., K&L Sound Services Co., 75 N. Beacon St., Watertown, Mass. 02172 TF

LOWEST DISCOUNT PRICES ANYWHERE on audio equipment. All major brands discounted. Write for quotes, K&L Sound Services, 75 N. Beacon St., Watertown, Mass. 02172. TF

DO YOU WANT TO BE AN AUDIO INSIDER? You can be if you read the **AUDIO FORUM**. The only audio information publication devoted to the interests of both the audiophile-music lover and the audio professional. Every one can use the AF. Dealers, Importers and Reps find out about the new products and companies—well before their competitors. Manufacturers and designers use AF to bring their design philosophies and products to the attention of the interested public in an ongoing dialogue. Plus audiophile commentaries, free personal ads and much more. Whether you make a living in audio or just want to be in on the action, subscribe today by sending \$15 (\$18 first class, \$22 overseas air) for six bimonthly issues to: AF, Box 578-A, Fairfax, CA 94930. TF

At SOUND COMPONENTS, Inc.
WE'VE GOT IT ALL

- Audionics Bang & Olufsen Beveridge Cylindrical Bryston
- DCM . . . Denon . . . Dynavector . . . Fidelity Research . . . Fulton . . .
- Grace . . . Great American Sound . . . Hafler . . . H.Q.D. Reference System
- . . . Janis . . . KEF . . . Kenwood Purist . . . Linn Sondek . . . Magnepan . . .
- Mark Levinson . . . Paragon . . . Pyramid Metronome . . . Quad . . . Rega
- . . . Rogers . . . Sonex . . . Spondor . . . Stax . . . Verion . . . Yamaha . . .

Master Charge & Visa accepted We ship prepaid within U.S.

SOUND COMPONENTS, INC.
 2710 Ponce de Leon Blvd., Coral Gables, Fla. 33134
 (305) 446-1659

FOR SALE

JERRY'S AUDIO EXCHANGE
 PHOENIX-334 E. Camelback Rd. (602) 263-9410
 TEMPE-130 E. University Dr. (602) 968-3491
 TUCSON-5750 E. Broadway, (602) 622-7407
 MAIL ORDER HOT LINE-MR. WOZ (602) 265-7841 TF

SONY ST 5000 FW \$180. 21 Holly Hill Dr., Mercer 1st., WA 98040.

LOW TIM PREAMP AND POWERAMP KITS OR ASSEMBLED. Free 30-page manual. Write Moonlighter Electronics, 117 Inverness, San Francisco, CA 94132 (415) 664-6703.

CROWN SX-744 deck. best offer (617) 388-4207. 9-8

DISTRIBUTORS BLOW OUT! New factory sealed Fons International Mark I Turntables. Belt-drive, 3-speed, 10-100 rpm, 3-point suspension, Rosewood base, dustcover. Current retail \$314.95. Send check for \$234.95 plus \$15.00 shipping and handling to The Sindell Organization, 11046 Santa Monica Blvd., L.A., CA 90025. (213) 478-3515 9-8

\$1 PER 50 WORDS? YES IN AUDIOMANIA, a publication devoted expressly as an aid for the purchasing, trading and selling of audiophile quality sound reproducing equipment. 12 issues \$6 First ad free with subscription (limit 75 words). Regularly \$1 per 50 words, businesses and non-subscribers \$2 per 50 words. **AUDIOMANIA**, Box 1253, Athens, OH 45701 9-8

NORTHERN CALIFORNIANS

It is our goal to make the joy of music possible for everyone. At any price we offer solid value, superior performance, and traditional service.

We operate on the theory that you as our customer will achieve the greatest long term satisfaction only through a careful analysis of your audio requirements. We strive to offer sober highly cost effective solutions to meet your specific needs.

OUR SELECTION INCLUDES:

- | | | |
|-----------|---------|-----------|
| Tandberg | Denon | B&W |
| Onkyo | Micro | Chartwell |
| JVC | Sonus | Avid |
| PSE | Grace | Cizek |
| Audire | Shure | Aiwa |
| Audionics | Stanton | M&K |
| Hafler | Grado | Ram |

HIGH FIDELITY SHOPPE

1511 North Main
 Walnut Creek, CA 94596
 (415) 932-2242

"WE TAKE PRIDE IN WHAT WE DO"

9-8

QUAD LP's! CD-4 & SQ. Want lists welcome. Write for stock list. Quad First, 719 Warren St., Reading, PA 19601 9-8

STATE OF THE ART TANGENT LOUDSPEAKER LINE now in stock including critically acclaimed RS2 at \$519/pair and RS4 \$739/pair ppd. Woodburn Sound Studio 400 Highland Ct. Iowa City, Iowa 52240 11-8

FOR SALE

AUDIO RESEARCH • JANIS • GALE • BREUER
Audio Reference Systems
TECHNICS • MAGNEPAN •
 808 • 732-3303 • Kahala Office Center
 Suite 201 • Honolulu, Hawaii 96816
ROGERS • GREAT AMERICAN SOUND • SONEX

FLASH!! ARC HAS RETURNED TO TUBES with SP-6 preamp and **MR AUDIO'S BI-MONTHLY** is back to report on it. We are back, rested, and ready to tell you why tubes are better. We are also reviewing the Paragon 12 preamp, Audio Dimensions PAS mod, Paragon's new bass amp and Trevor Lees tube pre-preamp for moving coils. Plus modifications, audio articles and home projects to make your system sound better. You have heard the Mogami and Fulton Gold wire but have you heard the P17 Hon wire? Not to mention Mark Deneen, Ike Eisonson and Trevor Lees all appearing in the same issue. What more could we have done???? Free classified with chartered subscription. Six issues \$15.00 — Overseas \$18.00 **MR AUDIO'S BI-MONTHLY** ... P.O. Box 3022 ... Monterey, Ca. 93940 ... And yes, we are new editors. 9-8

PHASE LINEAR 400 amp \$345, 4000 preamp \$380, 5000 tuner \$325, SAE 500 INRS \$145. All MINT less than 1 yr. (218) 326-1992. 9-8

DISCOUNTED: AKG, SAE, CM LABS, BOSE, QUATRE, RABCO, MARANTZ PRO, JVC, B&W, B&O, LUX, DCM TIME windows \$650, NAKAMICHI, SHERWOOD CPU 100 Tuner \$1900, KENWOOD, INFINITY, many others. Write: **HIGH FIDELITY DISTRIBUTORS**, 4642 Gawan Dr., New Orleans, LA 70127. 9-8

BACK ISSUE MAGAZINES. Over 200 titles. 1890 to 1978. Send stamped Envelope. Free List. Everybody's Bookshop, Dept. AU, 317 West 6th, Los Angeles, Calif. 90014. TF

AUDIO RESEARCH D-150 amp \$1995.00. Fulton Model "J" speakers with cover cubes \$1550.00. Jim (215) 322-6358.

NEW QLS-1 DISCOUNT 20-25% (803) 781-4638 6-8 pm EST.

ATTN: LEACH AMP BUILDERS: news letter & hard to find parts sources. Prebuilt details. TA, BOX 90 RRI, Surry, ME 04684.

POLYDAX (AUDAX) Bextrenes, soft domes, woofers, super-tweeters, Decca Ribbon Tweeters, crossover parts. TA Box 90, RRI, Surry, ME 04684 6-9

DENON TURNTABLES Now available in Wisconsin at THE SOUND SELLER, 1706 Main St., Marinette, 54143. (715) 735-9002. Call or write for literature. Denon is shipped free in the continental U.S. 9-8

PROTECT YOUR LPs. POLY SLEEVES FOR JACKET 9"; ROUND BOTTOM INNER SLEEVES 8"; SQUARE BOTTOMS 6"; POLY LINED PAPER SLEEVES 15"; white jackets 35". POSTAGE \$1.50. HOUSE OF RECORDS, HILLBURN, NEW YORK, 10931. TF

MEASURE FREQUENCY RESPONSE OF ROOMS, SPEAKERS, electronic components, live instruments, etc. Hand-held Real Time Analyzer and Sound Level Meter with built-in professional quality condenser microphone can be used for recording. Reads to ± 0.5 dB. Ivie Octave Analyzer IE-10A, \$595.00. 1/3 Octave Analyzer IE-30A—with lots of extra goodies—\$2,800.00 Pink Noise Generator, \$175.00. Prices postpaid with money-back guarantee. JML Company, 39,000 Highway 128, Cloverdale, CA 95425 6-9

ARIZONA AUDIOPHILES

Dahquist, S.A.E. Revox, Rabco, Nakamichi, Yamaha, Crown, Grace, Stax, Tandberg, Sonab, Supex, Gale, Kipsch, Phase Linear, Uher, Burwen, J.B.L., Harmon-Kardon Citation, A.D.S. Spectro Acoustics, Beveridge, Sennheiser, Teac, Thorens, Stanton, Alwa, Stax, Micro-Seiki, Fidelity Research, Genesis, Optonica, R.T.R., B&W, Toshiba, DBX, Signet, Mitsubishi and Mitsubishi V.S.S.

FOR SALE

PHONO INPUT FILTER

Don't let interference from CB, ham radio, broadcast stations, TV games, hobby computers bug your Hi-Fi system. Just plug PHONO INPUT FILTERS directly into phono input jacks for interference-free enjoyment. Send SASE for free interference cures. At your dealer or order direct...



ELECTRONIC SPECIALISTS, INC., Dept. A
171 South Main St., Natick, Mass 01760

POLK AUDIO MONITOR SERIES

AUDIO BREAKTHROUGHS now has on demonstration the remarkable new Polk loudspeakers. Compare them to the finest loudspeakers in the world. The Mini Monitor (99.95 ea.), Model 5 (109.95 ea.), model 7 (149.95 ea.), and Model 10 (209.95 ea.) all utilize high definition polymer laminate bass-midrange drivers, wide dispersion soft dome tweeters and fluid coupled sub-bass radiators. They are capable of reproducing a highly defined phase accurate three dimensional sonic image which rivals the thousand dollar super speakers. They sound great with a small receiver, yet reveal the fine subtleties of state of the art electronics like Levinson, Wakamichi, Essence, and G.A.S. Shipped free in U.S. Send for free brochures on Polk or our other fine lines. **AUDIO BREAKTHROUGHS**, 1534 Northern Blvd., Manhasset, LI, NY 11030 (516) 627-7333. TF

THE LISTENING ROOM INC.

590 Central Park Avenue
Scarsdale, N.Y. 10583
(914) 472-4558

Cordially invites you to audition our fine line of equipment. **THRESHOLD • BRYSTON • GREAT AMERICAN SOUND • PYRAMID METRONOME 2 + 2 • DAYTON WRIGHT ESL • QUAD ESL • SNELL ACOUSTICS • DAHLQUIST • DYNAVECTOR • DENON • YAMAHA • TANDBERG • POLK AUDIO • LUX REF. • KEF • GRACE • NAKAMICHI • STAX • R.H. LAB • LS3/5A BBC MINI MONITOR BY CHARTWELL • SEQUERRA • PHASE MATRIX • HAFNER • JANIS • FONTEK HEADPHONE • AUDIO PULSE • SPATIAL • OASIS • EMT • VERION • DIRECT TO DISK RECORDS •** Visit our private studios. We ship free anywhere in the U.S. We invite inquiries.

McINTOSH COLLECTORS ITEMS MR-71 tuner & C21 pre-amp Fisher R-200B Multi-Band tuner. Make offer (904) 434-2481

45 RPM ON LINN SOUNDEK? Yes! We've finally done it. Write or call for details on our conversion kit. **AUDIOPHILE SYSTEMS**, 5750 Rymark Ct., Indianapolis, IN 46250 (317) 849-7103

LEACH LOW TIM AMPLIFIER NOW AVAILABLE IN WEST. For info write G. Max Carter, Box 26A, Goldcamp Rd., Colo. Spgs., CO 80906. 6-9

FOR SALE

THE AUDIOGRAM™, a pithy independent newsletter now in its third year, provides timely, money saving reports on the latest products and techniques. Our critical integrity and realistic sense of proportion fill the gap between the commercial magazines and the neurotic underground press. Our June issue contains capsule reviews of:

- Denon 103D, Signet Tk7E, Onlife 20B, Supex 900E Super Cartridges
- The two best headphones
- The three best tonearms
- The best tube preamp
- As well as substantial reports on the Polk Sounding Cable and Verion pick-up transformer.

\$15/16 issues. Free information. **AUDIOGRAM**, Box 27406, St. Louis, MO 63141. TF

AT THE PARAGON OF SOUND

PREAMPS: The Highly Rated CONRAD-JOHNSON; The Superb Paragon 12A & E1.
SPEAKERS: MZ MOD-3 the Snell Acoustic; the Rogers LS 3/5A; the Fundamental Research and new M&K cube Subwoofers.
AMPLIFIERS: Paragon E4 tube amp; **CARTRIDGES:** Supex; GRACE; Dynavector, **TURNTABLES:** Ariston and Denon.
TO NEARMS: Grace and Denon. **TUNERS:** ARMSTRONG 624 FM
ALSO: Paragon E4 Active tube crossover and E6 AC line monitor.
Call (301) 229-2676 (Bethesda, MD) or write P.O. Box 189, Cabin John, MD 20731.

FLINT MICHIGAN

The best Value in Audio
Rogers BBC, the New Rogers Reference Monitor System XA75/L35B. \$1999. db systems, Conrad-Johnson, Leach, Bryston, Visonik, Grace, Watson Labs, M&K cubes, Spectro-Acoustics, Supex, Mordaunt-Short, Connoisseur, Sound Concepts. "Audio House feels the quality of sound you receive for your money is more important than how much you spend."
AUDIO HOUSE 5232 Sagamore Dr., Swartz Creek Michigan 48473 (313) 732-4670 7-8

LOWEST PRICES ON STEREO-ESOTERIC COMPONENTS & Tapes!! Over 150 brands. Send #10 SASE for quotes. Audio Unlimited, 401 Reynolds Circle #12-C, San Jose, CA 95112 (408) 289-8875 1-6 Monday-Friday. 5-9

THE FM STATION REFERENCE WITH EVERYTHING: Maps, detailed program format listings, tips on buying equipment, SCA information, station coverage radii, etc. \$3.95, FM Atlas, 55701. 9-8

CX-844- ALL OPTIONS 4 yrs. old. SX724-P4C MC-30. Best offer. (315) 455-2259. 9-8

SAVE 50% build your own system. Write McGee Radio Electronics, 1901 McGee Street, Kansas City, Missouri 64108.

FOR SALE

STEREO COMPONENT Video Tape Equipment

AKAI • B•I•C • Harman Kardon Phase Linear • ALTEC • Kenwood • TEAC • Marantz • Sony • Technics • Sanyo • JVC • JBL • Pioneer • Dual • RCA Photographic Equipment Too!
TO ORDER CALL TOLL FREE
(800) 421-8537



CAMERA HI-FI VIDEO
516 W. 8th St. Downtown L.A., Ca. 90014 Tel. 488-0341

CAMPUS AUDIO. Lowest prices. All brands, for rates and catalogue P.O. Box 2232 Boulder, CO 80306. 9-8

GRACE 707 MODIFICATIONS Update your 707. Counterweight decoupled, bearings adjusted, Linn ring weight installed. \$50.00 (Mk II owners, partial mod \$30). Write for details. **AUDIOPHILE SYSTEMS**, 5750 Rymark Ct. Indianapolis, IN 46250 10-8

THE ACCURATE ALTERNATIVE IS HERE! Professional System Engineering's DC Amp & Class A Preamp

THE FASTEST PAIR AROUND
ALSO: Acousti Phase, Braun, Clark, Decca, Denon, Essence, Grace, HK, KLH, Parenthian, Sansui DC amps, Sennheiser Pro, and our own Subwoofer System.

PERSONALIZED AUDIO
723 Bound Brook Rd., Dunellen, NJ 08812 (201) 752-3883

THORENS TD-224 rare tt. wal. base w/stereo & mono cartridges \$250. **MARANTZ 7-T** preamp w/matched KOSS Pro 600A headphones & University C/D mic. \$250. **MATTES SSP/200** power amp (110W/ch) sprk. balancer in wal. cab. \$185. **KARG Labs. CT-2** FM stereo tuner (elec. eye tuning) in wal. cab. \$80. All excellent. L. Barry Tinkoff, P.O. Box 590, Fall River, MA 02722. Call eves. (617) 673-6622.

AUDIO PROFESSIONALS: Find out why the **AUDIO FORUM** is the only audiophile-oriented publication that has earned the respect of the entire industry. Eur unique format offers you direct access to the people you want to reach! Write today for details. Don't wait! Box 578-A, Fairfax, CA 94930.

REPLACEMENT STYLI. Diafix. Box 762, Hightstown, NJ 08520 6-9

VACUUM TUBES
and tube-peculiar parts. We offer a complete inventory of high voltage capacitors, precision resistors and tubes. Kits or separate parts available for building circuitries described in our 220 + page Audio Modification Manual. Write for parts list and literature, **AUDIO DIMENSIONS**, 8898 Clairemont Mesa Blvd., San Diego, Calif. 92123. 12-9

STEREOPUS, the quarterly equipment review journal, in its current issue reviews the Snell Type A, Tympani ID, Grado Signature 1B, Van Alstine Model One, Hafner DH-101, Audionics BT-2, Grandson of Ampzilla, Pioneer M-22 (Class A power amp), Sony EL-7, Teac-Tascam 25-2, and much, much more. \$12.50/year (four issues) first class. \$16.00/year overseas. P.O. Box 509, Shalimar, Florida 32579. 9-8

GOLDEN gramophone®		2858 W. Market Street Akron, Ohio 44313 Phone (216) 864-4411
Audio Research	Direct Discs	Hafner
Advent	Discwasher	Grace
ADS	DynaVector	Kenwood
Armstrong	Electro Research	LinnSondek
Bravura	E.M.T.	Magneplanar
Connoisseur	FMI (Fulton J)	Nakamichi
Denon	Grado Signature	Rappaport
	GAS Ampzilla II	Revox
		Rogers
		Setton
		Shure III
		Sonus
		Stax
		Technics
		Threshold

SPEAKING OF MOVING COILS...

CONSIDER THIS:

We believe the Marcof PPA-1 pre-preamp to be the sonic equal of any step-up device available **AT ANY PRICE.** The difference? It's \$89.95.



\$89.95 ppd.



ORDER FROM:

Marcof Electronics • Div of Speaker Craft, Inc. 7505 Big Bend, Webster Groves, Missouri 63119 (314) 968-2170

CHECK THESE FEATURES:

- Designed for high and low output MC cartridges
- No TIM ● Zero feedback ● Class A Circuit
- 1% Metal film resistors ● Matched transistors
- Totally isolated dual mono channels
- THD < .005% (Typically < .001%) ● Noise < -80 db IHF
- Battery operated: (batteries included)
 - no external ground loops ● no line noise
 - no induced hum ● hassle-free installation
- 30 day money-back guarantee
- 2 year limited warranty
- Size: 2" H, 5" W, 5 1/2" D

FOR SALE

SAVE! Demos & Trades
(& some new mdse)

- Audio Research D150 Pwr Amp \$2,400
- Sony MX 16 Mixer \$325
- Fried Model RII Spkrs (pr) \$495
- Kenwood Model 7 Spkrs (pr) \$1,250
- Fulton Model J Spkrs (pr) \$1,400
- Lux C-1000 Preamp \$595
- GAS Thaedra Preamp \$595

Items subject to prior sale.
Phone or write for individual details.

CUSTOM STEREO
1391 S. Hamilton Rd. Columbus OH 43227
614/235-7575

B & O 4002 USES "ANY" CARTRIDGE with standard mounting centers after our modification. Effective mass 2.5 grams. Adjustable silicone damping. \$199.00 with money-back guarantee. JML Company, 39,000 Highway 128, Cloverdale, CA 95425 8-9

CROWN CX 824 TC DECK, brand new in carton \$1800.00 or best offer. Call (201) 782-7186 after 5:30 PM.

USED & DEMO SPECIALS: DB Systems preamp \$375, Lux L100 \$750, Tandbert TR2055 \$550. Tandberg 3500X \$450 SAE MK 30 \$144, SAE MK 24 \$540, Citation 11 w/cabinet \$265, Harman Kardon A402 \$260. All in excellent condition. Contact AUDIO REPRODUCTION, 217 College Ave., Blacksburg, VA 24060 (703) 552-6850.

THE POWER OF MUSICAL SOUND has fascinated great minds through the centuries, as it fascinates yours. But today music is still frozen in tradition; even synthesizers are controlled by conventional keyboards. In the future music will be radically different; scientific studies of brainwave resonance will determine its tones, rhythms, and colors to produce dreamlike, stimulating, even psychedelic states clearly and clearly. "Pythagoron" is the first breakthrough of this musical revolution. Unlike any other sound in its production and effect, "Pythagoron" brings you to a place music has never been. . . . has to be experienced to be really understood . . . more intergalactic than what one expects . . . " GQ 3/78. . . . riveted and totally absorbed by the sound . . . " Village Voice 11/28/77. Available on an L.P. record. "Pythagoron" is \$9.95 from Pythagoron Inc., P.O. Box 2123, Grand Central Station, New York NY 10017. We pay shipping and applicable NY tax. 9-8

MARANTZ 500 (mint) (919) 489-1101 6-11p.m. E.D.T. 10-8

COLLECTORS' ITEMS
STEREO EQUIPMENT
FOR SALE

- 2—Electrovoice Patriclan Loudspeaker Systems (Walnut-Clips horn)
- 1—Ampex F-44 Stereo Tape Deck
- 1—Crown Model 300 Four Channel Recorder
- 1—Seeburg Model 100 L.P. Programmable Player (w/ remotes)
- 1—Dual Model 1019 Automatic Record Changer (w/ cartridge)
- 1—Sony STR 6120 Receiver
- 1—Sony TC-560-D Tape Deck
- 1—L W E 1 Loudspeaker
- 2—L W E VI Loudspeakers
- 2—Quad Electrostatic Screen Loudspeakers
- 2—Marantz Model 7-T Pre-Amplifiers
- 1—Sony 5000F F.M. Stereo Tuner
- 1—Marantz Model 15 Power Amplifier
- 1—K.L.H. Model 18 F.M. Receiver
- 1—Fisher Pre-Amplifier Equalizer (Non-Control Type)
- 2—48" Walnut Equipment Commode Tables (Std. Rack Mount)
- 1—Marantz Stereo Power Amplifier (Tube Type)

Send name, address and phone number to:
P.O. Box 66681, Houston, TX 77006
We will contact you.

Advertising Index

Advertiser	Page	Advertiser	Page
ADC	16, 113	Continental Sound	139
Hi-Fi Components		Hi-Fi Components	
Enter No. 45 on Reader Service		Write Direct to Advertiser	
Hi-Fi Components		Crown	89
Enter No. 71 on Reader Service Card		Hi-Fi Components	
Acusta Craft	130	Write Direct to Advertiser	
Hi-Fi Components		Custom Craft	121
Write Direct to Advertiser		Speakers	
AIWA	99	Enter No. 60 on Reader Service Card	
Hi-Fi Products		Custom Stereo	132
Enter No. 55 on Reader Service Card		Hi-Fi Components	
Akal	75	Write Direct to Advertiser	
Hi-Fi Components		DB Systems	142
Write Direct to Advertiser		Hi-Fi Components	
Apt/Holman	140	Write Direct to Advertiser	
Hi-Fi Components		dbx	103
Write Direct to Advertiser		Boom Box	
Allison Acoustics	32	Enter No. 7 on Reader Service Card	
Loudspeakers		Definitive Systems	127
Enter No. 56 on Reader Service Service Card		Hi-Fi Components	
Audio Advocate	128	Write Direct to Advertiser	
Hi-Fi Components		Diafix Ind.	142
Write Direct to Advertiser		Hi-Fi Components	
Audio Critic	111	Write Direct to Advertiser	
Publication		Discount Music	139
Write Direct to Advertiser		Record Club	
Audio Dimensions	127	Write Direct to Advertiser	
Hi-Fi Components		Discwasher	2, Cover IV
Write Direct to Advertiser		Hi-Fi Components	
Audio Excellence	141	Write Direct to Advertiser	
Hi-Fi Components		Dixie Hi-Fi	120
Write Direct to Advertiser		Audio Store	
Audio General	76	Enter No. 8 on Reader Service Card	
Preamplifier		Dolby Laboratories	63
Enter No. 57 on Reader Service Card		Noise Reduction System	
Audio Journal	129	Write Direct to Advertiser	
Publication		Dual (United Audio)	91
Write Direct to Advertiser		Hi-Fi Components	
Audio Reference Systems	130	Enter No. 9 on Reader Service Card	
Hi-Fi Components		Electro-Voice	18
Write Direct to Advertiser		Loudspeaker Systems	
Audio Source	105, 115, 117, 126	Enter No. 10 on Reader Service Card	
Hi-Fi Components		Electronic Specialists	131, 137
Enter No. 1 on Reader Service Card		Hi-Fi Components	
Hi-Fi Components		Write Direct to Advertiser	
Enter No. 2 on Reader Service Card		Ems, Inc.	138
Hi-Fi Components		Hi-Fi Components	
Enter No. 3 on Reader Service Card		Write Direct to Advertiser	
Hi-Fi Components		ESS, Inc.	102
Enter No. 4 on Reader Service Card		Hi-Fi Products	
Audio Systems	137	Write Direct to Advertiser	
Hi-Fi Components		Fisher	95
Write Direct to Advertiser		Loudspeaker Systems	
Audio-technica	20, 116	Write Direct to Advertiser	
Phono Cartridge		Garland	139
Enter No. 53 on Reader Service Card		Audio Store	
Hi-Fi Components		Write Direct to Advertiser	
Write Direct to Advertiser		Golden Gramophone	131
Audiophile's Sound Studio	140	Hi-Fi Components	
Recording Studio		Write Direct to Advertiser	
Write Direct to Advertiser		H&H Int.	138
B & F	126	Loudspeaker Systems	
Speaker Kits		Write Direct to Advertiser	
Enter No. 58 on Reader Service Card		Hammond	114, 120
B&K	40	Hi-Fi Components	
Test Instruments		Enter No. 40 on Reader Service Card	
Enter No. 5 on Reader Service Card		Beyer Microphones	
Ball	21, 65	Enter No. 69 on Reader Service Card	
Record Preservation Kit		Henry's	131
Write Direct to Advertiser		Audio Store	
Bose	5	Write Direct to Advertiser	
Loudspeaker Systems		High Definition Recordings	128
Write Direct to Advertiser		Direct-to-Disk Records	
Celestion Industries	22	Write Direct to Advertiser	
Speakers		Institute of Audio Research	122
Enter No. 59 on Reader Service Card		Audio School	
Chestnut Hill Audio	129	Enter No. 11 on Reader Service Card	
Audio Store		J&R	120
Write Direct to Advertiser		Mail-Order Discount	
		Enter No. 61 on Reader Service Card	
		JVC	50, 51
		Hi-Fi Components	
		Enter No. 12 on Reader Service Card	
		KEF	86
		Loudspeaker Systems	
		Enter No. 13 on Reader Service Card	

Advertising Index

Advertiser	Page	Advertiser	Page
Keith Monks Hi-Fi Components Enter No. 46 on Reader Service Card	125	H. Sams Audio Cyclopeda Write Direct to Advertiser	29
Kenwood Hi-Fi Components Write Direct to Advertiser	97	Sansui Hi-Fi Components Enter No. 26 on Reader Service Card	15
Koss Hi-Fi Components Enter No. 14 on Reader Service Card	101	Saxitone Magnetic Tape Write Direct to Advertiser	138
L. T. Sound Hi-Fi Components Write Direct to Advertiser	141	Sensible Sound Hi-Fi Components Write Direct to Advertiser	127
Lux Hi-Fi Components Write Direct to Advertiser	37	Shure Hi-Fi Components Enter No. 27 on Reader Service Card Hi-Fi Components Enter No. 76 on Reader Service Card	72, 73, 123
Marantz Hi-Fi Components Write Direct to Advertiser	144, Cov. III	Sonic Research Hi-Fi Components Enter No. 28 on Reader Service Card	108
Mastercraft Antennas Write Direct to Advertiser	140	Sonikit Hi-Fi Components Write Direct to Advertiser	128
Maxell Magnetic Tape Enter No. 16 on Reader Service Card Magnetic Tape Enter No. 66 on Reader Service Card	17, 26	Sony Corp. Hi-Fi Components Enter No. 29 on Reader Service Card	61 77
McIntosh Catalog Enter No. 17 on Reader Service Card	107	Sound Components Hi-Fi Components Write Direct to Advertiser	130
McKay Dymek Hi-Fi Components Enter No. 42 on Reader Service Card	124	Soundcraftsmen Hi-Fi Components Enter No. 30 on Reader Service Card	13
Memorex Magnetic Tape Enter No. 18 on Reader Service Card	4	Speakercraft Speaker Kits Write Direct to Advertiser	131
Micro Acoustics Hi-Fi Components Write Direct to Advertiser	6, 7	Speakerkit Speaker Kits Write Direct to Advertiser	137
Mitsubishi Hi-Fi Components Enter No. 19 on Reader Service Card	30, 31	Speakerlab Speaker Kits Write Direct to Advertiser	138
MXR Hi-Fi Components Enter No. 62 on Reader Service Card	81	Spectro Acoustics Hi-Fi Components Write Direct to Advertiser	14
Nikko Hi-Fi Components Enter No. 41 on Reader Service Card	41	Stanton Hi-Fi Components Enter No. 32 on Reader Service Card	3
Ohm Loudspeaker Systems Enter No. 50 on Reader Service Card	109	TDK Magnetic Tape Enter No. 36 on Reader Service Card Magnetic Tape Enter No. 70 on Reader Service Card	11, 47
Onkyo Hi-Fi Components Enter No. 20 on Reader Service Card	69	3M Cassette Deck Enter No. 33 on Reader Service Card	92, 93
OSAWA Hi-Fi Components Enter No. 75 on Reader Service Card	88	Take 5 Audio Store Write Direct to Advertiser	141
PAIA Hi-Fi Components Enter No. 21 on Reader Service Card	124	Tandberg Tape Recorders Enter No. 65 on Reader Service Card	25
Phase Linear Hi-Fi Components Write Direct to Advertiser	12, 19	Tape World Tapes Write Direct to Advertiser	143
Pioneer Cassette Deck Enter No. 22 on Reader Service Card	Cov. II, Pg. 1	Technics Hi-Fi Components Enter No. 34 on Reader Service Card	23
Playback Mail Order Enter No. 23 on Reader Service Card	121	Trusonic Loudspeakers Enter No. 67 on Reader Service Card	57
PS Audio Preamplifier Enter No. 63 on Reader Service Card	121	Tull, Mary V. Hi-Fi Components Write Direct to Advertiser	132
Radio Shack Turntable Write Direct to Advertiser	79	Visionik Loudspeakers Enter No. 68 on Reader Service Card	67
Rhoades Teledapter TV Sound Tuner Enter No. 24 on Reader Service Card	121	Wisconsin Discout Mail Order Enter No. 35 on Reader Service Card	105
SME Tonearm Enter No. 25 on Reader Service Card	106	Yamaha Hi-Fi Components Write Direct to Advertiser	34

FOR SALE

Unexplained buzz, pops, hash?

Power line surges and hash could be the culprit! Line Cord Surge Suppressor/Hash Filter curbs damaging surges & disruptive hash. Protects valuable equipment. Strips away annoying hash from tools, appliances. Send SASE for free interference cures. At your dealer or order direct.



ELECTRONIC SPECIALISTS, INC., DEPT. A2
171 SOUTH MAIN ST. • NATICK, MASS. 01760

S/F-KW-3
\$22.50

ELECTRO OF NORWAY

We are pleased to be the first dealer in this country selected by Eargasm, Inc. to offer this incredible amplifier and preamplifier. This superior preamplifier is capable of driving the amplifier to its full slewing rate of 126 microvolts per second, as well as directly powering higher output moving coil cartridges. The high bias AB amplifier is fully class A at 16 ohms. Unbelievable on QUADs and LS3/5A. We stock these units for our most discriminating clients. Call for an appointment for a demonstration.

PERFECTIONIST AUDIO LTD.

P.O. Box 174
Pleasant Gap, Pennsylvania 16823
(814)-359-3007 or (814)-238-4071

108

MLAS ANNOUNCES — FREE UPDATED POWER SUPPLY FILTER FOR ANY JC-2 PREAMPLIFIER

If you have a JC-2 Preamplifier, we have a plug-in module which will improve the sonic quality of your unit.

The DRF-2 Active Power Supply Filter module will greatly improve the power supply characteristics of your JC-2 by isolating both channels of phono and thereby preventing any cross modulation which might occur.

If you were one of the few who purchased the DRF-2 as part of our previous update policy, we would like to offer you a \$65.00 credit towards any currently available JC-2 update modification.

For further information regarding update modifications for the JC-2 and/or to order your free DRF-2, please address your correspondence to Mark Levinson Audio Systems Ltd., c/o Customer Service Department, 390 East Street, New Haven, CT, U.S.A. 06511.

Please be sure to state your JC-2 serial number, original DRF-1 serial number and/or DRF-2 serial number if you are requesting credit.

137

AMPEX TAPE—NEW 1800 on 7" reel 12 for \$18 POST-PAID, 1200' 12 for \$13 POSTPAID—free list—WIDE RESPONSE, 6114A, SANTA MONICA BLVD., HOLLYWOOD, CA 90038 TF

LINN SONDEX OWNERS play 45 rpm records. 45rpm adapter finally available. Send \$50 to MH Audio Group Box 828 Orange, CA 92666. CA resid. add \$3 tax. Money back if not satisfied.

QUICKEST AIRMAIL SERVICE DIRECT FROM TOKYO
CARTRIDGES: Coral 777EX \$103.00, Denon DL-103S \$128.00, DL-103D \$170.00, Entree EC-1 \$140.00, Grace F-9L \$93.00, F-10L \$210.00, FR FR-1/III \$172.00, Dynavector 15BQ (same as 20B) \$132.00, 20C \$187.00, Satin M-18BX \$200.00, JVC MC-1 \$240.00. TONE ARMS: Audiocraft AC-300/II \$220.00, Denon DA-307 \$187.00, FR FR-64S \$300.00, FR-66S \$610.00, Grace G-704 \$190.00, G-714 \$195.00, G-945 (Silver) \$230.00, Dynavector DV-505 \$286.00, Stax UA-7CF \$220.00. All brand new w/full warranty. Ready for prompt shipment. Packing & Air Postage all included. Send order with Cashiers Check. Many other items available — Ask for Quotations with \$1.00 for postage. JAPAN AUDIO TRADING CO., LTD., Saikaen Bldg., 4-33-21, Kamimeguro, Meguro-Ku, Tokyo 153 10-8

Lambda Series II by SpeakerKit, Ltd.

Woofers with butyl surrounds. Transmission lines. Open dome midrange and tweeters. Infra-woofers and ultra-tweeters. Accurate sound at a reasonable price. Send 25¢ for Series II catalog and manual.

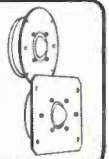

SpeakerKit Box 12A, Route 2, Menomonie, WI 54751

FOR SALE

SAVE up to 60% BY MAIL on: SCOTCH, TDK, BASF, MAXELL, MEMOREX, CAPITOL MUSIC TAPE, CERTRON (over 180 different reel & cassette tapes to choose from); top brand recorders; America's largest collection of taping accessories, too. Same day service. **FREE catalog.**

America's Recording Tape Specialists

SAXITONE TAPE SALES

1776 a Columbia Rd., Washington, D.C. 20009
(202) 462-0800

HAFLER IS HERE!

We have in stock the DH-101 kit, \$199 and the DH-101 factory or custom assembled, \$299. We anticipate having the DH-102 head amp (installs in the DH-101) in stock by October 15, 1978. Projected prices: DH-102, \$74.95; DH-101 assembled with DH-102 installed by OAC, \$375. Free shipping. Visa and Master Charge honored. Demonstration by appointment. OXFORD AUDIO CONSULTANTS, P.O. Box 145, Oxford, OH 45056, 513-523-3895. Also open evenings & weekends. 11-8

DYNA STERO 70 MOD KIT. Tighter bass, improved transient response, higher definition. Complete instructions, schematics, parts list, \$5.00. With parts kit, including all new tubes, \$75 all postpaid. Audio Designers, Box 122, Ledyard, Conn. 06339. 7-9

DAVID HAFLER IS BACK!

The man behind the original Dynakits is back with his own company and a new state-of-the-art preamplifier at a bargain price! Available as a KIT or CUSTOM ASSEMBLED by expertly trained wirers—each performance certified. For further details write or call AUDIOKIT—260 Old Country Road Hicksville, N.Y. 11801 (516) 822-5749

GO TO BED WITH MUSIC CONTROL-1 automatically switches your system off. Works with tapes or records. \$60.00. Electromedia, P.O. Box 26S., Livingston, N.J. 07039. 12-8

FOR SALE

KEITH MONKS Record Cleaning Machine, \$595. KMAL M9BA MkIII tonearm, new in box, \$85. (317) 787-8525. 9-8

STATE OF THE ART IN N. CALIFORNIA

is now on demonstration at The Audible Difference. Hear the superb Threshold NS-10 preamp/400A power amp through Dick Sequerra's stunning Metronome loudspeakers. Audition Peter Snell's superb Snell Acoustics Type A loudspeaker system with Threshold's new medium power CAS-1 amplifier. For the ultimate in high-power amplification, audition the Threshold 8000A mono amplifiers. Hear how good a bi-amp system can be with John Curl's new transient perfect crossover from Symmetry, the ACS-1, plus Paragon's 125 watt solid state bass amp. Experience the beautiful new Paragon 12A preamp, plus Thaedra II from G.A.S.

Hear the ultimate direct drive turntable, the Denon DP-6000, plus the audiophile reference Linn Sondek with Linn-modified Grace 707 tonearm. Examine the precisely machined bearing of the new glass platter, belt drive Planar tables from Rega Research. Hear the ultra-musical Paragon System E preamp, plus the new high performance, moderate cost Thalia/grandson combination from G.A.S. Audition a new generation of compact high performance loudspeakers from Polk and Cizek, plus BBC minimonitors from Spendor and Rogers. For the music listener who demands the best, we offer the Breuer Dynamic Tonearm, plus the EMT cartridge with Verion transformer.

For that extra measure of sonic purity so important to the critical audiophile, we recommend and stock Polk Sound Cables; Mogami wire; the anti-resonant Platter Pad, \$24.95; Audio Perfection audio interconnect low capacitance cables, \$15/pr; plus the Stylift at \$19.95 and a wide selection of audiophile quality recordings including Gale Maximum, Fidelity and Denon PCM.

We ship all products prepaid throughout the United States.

THE AUDIBLE DIFFERENCE

435 Tasso, Palo Alto, CA 94301
(415) 328-1081

TF

FOR SALE

WOOFERS • MIDRANGES • TWEETER ZERO PHASE ERROR CROSSOVERS

High power handling 4 1/4" & 5 1/4" midrange units with 2.7 lb. magnet structures • One hundred watt 6", 8", 10" & 12" woofers with 4.7 lb. or 7.6 lb. magnet structures • High quality 1" cloth dome tweeter with 3lb. magnet structure • Wide dispersion, low distortion piezoelectric tweeter handling 150 watts r.m.s. • Revolutionary new ZERO PHASE ERROR CROSSOVER built on glass epoxy printed circuit boards for 2, 3 & 4-way systems • Crossovers are matched to system utilizing our drivers or systems utilizing the high quality POLYDAX units mfg. by AUDAX in France • Large inventory of nonpolar capacitors, non-inductive wire wound resistors & air-core coils.

SEND \$3.00 for prices & CATALOG of complete engineering data, application notes and simplified procedures for measuring Theile and Small's parameters — refundable with first order.

EMS, Inc. • P. O. Box 5301 • Knoxville, TN 37918

MAGNAPLANAR OWNERS

You'll love your Magnaplanars even more when you hear them powered by the ML-2 Class A Power Amplifier. Serious music lovers have written us about the incredible improvements made by using ML-2's full range and with bi and tri-amped Magnaplanar arrays.

For full range operation a pair of ML-2's is sufficient, but a pair of bridged ML-2's per side will give you one of the most memorable listening experiences of your life.

Contact the Mark Levinson dealer nearest you or write Mark Levinson Audio Systems Ltd., 55 Circular Avenue, Hamden, CT 06514, (203) 281-6333 for a referral.

CUSTOMIZED TAPES, Jazz, Big-Band. Over 500 standard tracks. 80 minute cassettes or 8-tracks, \$8.00. Open reel, \$10.00, catalog \$1.00 (refundable). Tapes Unlimited Box 163 Portsmouth RI 02871

FORMULA 4 Universal Alignment Protractor, enables correct setting up of all tone arm assemblies and measuring tracking accuracy over entire disc surface. Original Hi Fi News review \$1. Protractor \$5 Bills only. Mayware Ltd. 15 Heather Walk, Edgware, Middlesex England. 12-8

NAIM NAC12 preamp MC board & power supply \$550. Naim NAP250 \$1750. Supex 901E super \$75. ADC LMF carbon fiber arm \$125. Linn Sondek LP 12 \$285. Linn Isobariks & stands, teak \$1600. Radford SC24 preamp \$150. (317) 923-7642. 9-8

Northern N.J.'s finest store—Lux, Mod DQ-10, IMF, Grace, B&W, G.A.S. Sleeping Beauty, FR, B&O, Linn Sondek, Janis and more. University Stereo, 57 E. Ridgewood Ave., Ridgewood, N.J. 07450. 20 minutes from the G.W. bridge. 201-447-5700. TF

SAVE UP TO 69% ON OVER 100 TOP BRAND AUDIO COMPONENTS FROM CARSTON STUDIOS. NEW ENGLAND'S AUDIO SUPERMARKET ONE OF THE OLDEST MAIL ORDER FIRMS (EST 1952) AND CERTAINLY ONE OF THE MOST RELIABLE. ALL ORDERS SHIPPED FROM STOCKED WAREHOUSE. SEND FOR PRICE QUOTE AND PRICE LIST. CARSTON STUDIOS, OLD BROOKFIELD ROAD, DANBURY, CONN. 06810. TF

SPEAKER INFORMATION KIT.

Get 70 pages of speaker facts, specs, construction tips plus info on our raw speakers, crossovers and a line of nine quality hi-fi speaker system kits. We'll send you our full-color catalog, plus

How To Hook Up Your System, an exhaustive step-by-step treatise on hi-fi system installation, and our Speaker Owner's Manual, chock-full of facts on how to get the most from any speaker system, for only \$1.00. Send to:

Speakerlab, Dept. AD-P
735 N. Northlake Way, Seattle, WA 98103



goodbye box!

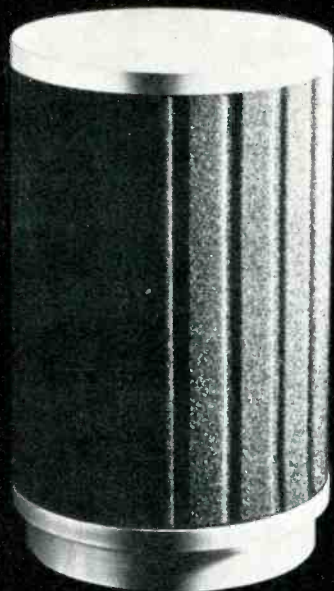

Say 'sayonara' to the resonances, edge reflections and colorations of conventional box speakers. Top-rated, cylindrically-shaped JR 149 features ultra-wide dispersion and unparalleled transparency. From England's highly-regarded Jim Rogers.



H & H International, 354 State St., Rochester, N.Y. 14608 • 716/325-5275

FOR SALE

FREE details **A DIFFERENT KIND OF RECORD CLUB**

Discounts up to 73%, no "agree-to-purchase" obligations. All labels, Schwann catalog of thousands of titles: classical, pop, jazz, country, etc. Discount dividend certificates. Newsletter; accessories; quick service. 100% iron-clad guarantees. Write for free details.

DISCOUNT MUSIC CLUB, INC. DEPT. 14-0978
650 Main Street, New Rochelle, N.Y. 10801

The K-A IMPULSE RIVALS THE SMALL ENGLISH AND EUROPEAN SPEAKER in that the IMPULSE has: a wider life-like dynamic range with bass roll-off into the 30 Hz, spacious extended high end and more sibilant midrange; more handsome and finer cabinetry. Discover another American alternative by K.A. See and hear the IMPULSES only \$199 each! For information and dealer list write or call KUSTOM ACOUSTICS, INC., 6624 W. Irving Park Road, Chicago, IL 60634 (312) 685-6609. 11-8

SURPLUS SPEAKER CROSSOVER CAPACITORS: hundreds of special high voltage-rated non-polarized caps in stock in most popular sizes. Wholesale prices from 1 to 1000 pcs. Write today for quotation on the caps and other x-over parts you need. Haynes Microelectronics, 738 Rhode Island St., Lawrence, KS 66044. 3-9

FM—SCA (67 kHz) ADAPTER

Modifies your FM radio or tuner to double as receiver of hidden talk and music programs carried over many stations. Instructions, including article "SCA: Radio the FCC Doesn't Want You to Own." \$13 kit; \$18 wired unit from FM-SCA, Adolf, Minnesota 55701.

THOUSANDS OF LIKE NEW LP's and prerecorded tapes. Catalogue—\$1.50. House of Records, Hillburn, New York 10931.

KLH MODEL 9 - 2 Pairs - Hartley 24 inch Super-Woofer in cabinet. Crown VFX Crossover. Mint condition. \$2100.00 firm. You pick up. 215-865-1355 9-8

CROWN SX 724 deck, mint, \$750 Jacoby 406-442-5934. 9-8

ULTIMATE REFERENCE COMPONENTS: UPDATE

At Audio one, we are proud to present a new standard in electronics:

THE SPATIAL COHERENCE PREAMPLIFIER

Designer Richard Knapp, has developed a new amplification process utilizing the TFET-Valve (also developed by Mr. Knapp). The sonic result of which, reaches a new frontier of reproduction quality. In particular, the spatial relationships (e.g. depth, localization, etc.) and musical timbres are reproduced with a degree of realism that is absolutely astonishing! The Spatial Coherence preamplifier will make a MAJOR sonic improvement in ANY system regardless of the preamplifier currently used. One audition will spoil you for anything else. The way the information from disc is suspended in space, the retrieval of ambience, the dynamic range, the correctness of timbre and the incredible definition are all parameters that you will hear for the first time on the Spatial. Literature and technical details of this new technology are available and a backlog of orders has already begun. We suggest you contact us immediately for further information.

We have a rash of new and exciting products for the audiophile: From Britain, the Tangent loudspeakers ranging from \$99.95 to \$499.95, featuring bextrene cones and time corrected crossovers. The superb Armstrong 602 speaker in mirror-imaged rosewood pairs. The first table to sonically surpass the Linn, the STD 305D. From America, the time and pulse aligned MZ Mod 3 speakers. Audionics new belt drive turntable (we have excellent delivery on Audionics CC-2 amplifiers). The Promethean Phase II A cartridge. Additionally, we have a new reference speaker cable. The Lenco-clean "wet" record playing system that doubles both record and stylus life, for \$24.95! The Stylift. The Grace 707 mkII tonearm. Our incredible selection of direct and reference discs (well over 50 titles) and much more. When it comes to musical accuracy, Audio one is not just another alternative. Audio one... is the answer!

AUDIO ONE

167 N. Woodward Birmingham, MI 48011 (313) 646-6666

FOR SALE

"McINTOSH MC-60's (2) factory refurbished, new tubes. Best offer. Want to purchase Gale speakers. (312) 752-6231. 9-8

PHASE LINEAR 1000 Autocorrelator, MMT \$235/BO Robert Guerin, 7125 Gailway, Fair Oaks, CA 95628. 9-8

AUDIO RESEARCH/ Van Alstine SP-2C, best offer, (312) 374-5376. 9-8

MARANTZ 7T pre-amp w/case; \$190. L. Keene, 120 Gary Lane, Cocoa, FL 32922. 9-8

ALTEC LANSING EQUALIZER 729A 1/2 octave, \$1200 value only \$575. Pair of McIntosh C-8 preamps \$75. 305-987-7819. 9-8

THE BASS MINT MODEL 10/24: a high definition sub-woofer with genuinely deep response. For information send S.A.S.E. to THE BASS MINT, Box 153, Powell, OH, 43065. 11-8

CASSETTE SAVING BREAKTHROUGH!!! Proven best or your-money-back. No minimum. Free same-day shipping. Sample \$1.00 — Facts free. LARKSONG, Box 468F9, Point Arena, CA 95468. 9-8

PEAK POWER INDICATOR- Accuracy ± .25dB, 18 power/impedance ranges plus AUX (uses programmable reference). \$120. (312)477-6959 or reply Box A864 c/o AUDIO. 9-8

INFINITY SERVO-STATIC I speaker system, \$950. Sony 3200F basic amp; \$300. Call Portland, OR (503) 228-0227. 9-8

ADVENT 300 \$180. Lecson AP3 \$410. Pioneer SA-9900 \$280. Allmint. (608) 257-9882 evenings. 9-8

TANDBERG TR 2075 \$800 (803) 494-2021. 9-8

PIONEER TX9100 stereo tuner, cabinet, mint, original carton — best offer. Pre-recorded stereo tapes — reasonable — list available. (212) 376-4842. 9-8

THRESHOLD 800A pwr amp \$1500 or best offer. New Denon 1035, AU320 & Stax UA-7 arm. for best offer over \$350. Trades considered (301) 587-8143. 9-8

POLICE/ Fire scanners, Crystals, Antennas, CB Radio, Radar detectors, HPR Box 19224, Denver, CO 80219. 11-8

MAKE OFFERS: Sony 2000 preamp-tape head in, center channel out \$175. Phase Linear 4000 preamp \$250. Accusound 500 spkrs, by Technisound maker of drivers for AR, KLH, etc. 22W25HI5D \$250 pr. Philips 212 TT needs fites \$50. PS-Audio phono preamp \$75. Frazier grey utility 2 way horn loaded spkr 23W27HI5D \$150. would be good paired with Electro-Voice Patrician-black-18" woofer 58H35W28D \$150. YOU HAUL SPKRS. Three (3) Uher 4400 5" open reel portable recorders, AC/charger, cases & mikes. \$200. each: Harger-201-735-5817. 9-8

FOR SALE

continental sound

SPECIALISTS IN FINE AUDIO EQUIPMENT
Franchised dealer for:

Allison	AKG	Setton
Klipsch	ADC Tone Arm	CM Labs
Avid	Grace	dbx
Advent	S.M.E.	MXR
Bose	Nakamichi	Audio Pulse
AR	Technics Pro	Ortofon
Thorens	Harman/Kardon	Citation

98-77 QUEENS BLVD.
REGO PARK, N.Y. 11374
(212) 459-7507

MARK LEVINSON ML-1, A3, D5 cables. (919) 933-5630 after 6:00 est. 11-8

ACUSTAT-X SPEAKER system, LUX 3045, LUX CL-32 Fried model M speakers. (919) 933-5630 after 6:00 est. 11-8

AUDIO RESEARCH D-76 SP3A-1, TYMP. III A B&O 4002. Best Offer. (313) 354-9047. 9-8

INFINITY FET PREAMP, EC. \$550, ES-1 headphones \$150, JBL-SA660 amp. \$250. Matthews (614) 464-0810. 9-8

"BONGIORNO IS BACK"

After more than 1 1/2 yrs of absence we are proud to announce the new Sumo Amplifier. It is different in every way and consistent with the advancements of designs by James Bongiorno.

In the past, Mr. Bongiorno has designed the Dynaco 400, the entire line of S.A.E. amps, and more recently the products from G.A.S. These were and still are great products. But time moves on and new progress and new ideas must be born.

The new Sumo amplifier will be at your dealer soon along with the Sumo preamp. They will also have features that are new and original, but at prices that can be afforded, in the Bongiorno tradition.

- The Sumo Cartridge
- The Sumo Bridge
- The Very Clever Little Crossover
- The Sumo Preamp
- The Sumo Amplifier

—See Them Soon—

SUMO ELECTRIC CO. LTD.
1230 N. Horn Ave.
W. Hollywood, CA 90069
(213) 659-4370

9-8

ATTN. Constructors of LEACH Amplifiers; parts sources info, factory built. Catalog: TA Box 97A, W. Cornwall, CT. 06796 Postage now up to 40¢, please help with stamps. 9-8

GA GARLAND AUDIO, INC.

WHERE ONLY THE FINEST IS GOOD ENOUGH

AUDIO RESEARCH	GRACE	MARK LEVINSON
MAGNEPAN	NAKAMICHI	SEQUERRA
LUX	MICRO SEIKI	GALE

—two northern california locations—

SAN JOSE
2960 Stevens Creek Blvd.
(408) 244-6724

BERKELEY
3101 Telegraph Ave.
(415) 841-1591

Tues/Thurs, 11-8 — Wed/Fri, 11-6 — Sat, 10-5 —and by appointment—

FOR SALE

FOR SALE

FOR SALE

The Apt/Holman Preamplifier

For literature, the name of your local dealer, and ordering information, please check the box.



For a collection of five technical papers by Tom Holman, please check the box and send \$2.00.

\$447.00

Name _____
Address _____

Apt Corporation Box 512 Cambridge, Massachusetts 02139

IN ILLINOIS — AUDIONICS, CONRAD-JOHNSON, ROGERS JR 149 and sub woofer, Polk Speakers and Soundcable, M&K, Formula 4, Leach, Connoisseur, Dynaco, Promethean. SYSTHEMATIC SOUND, 512 Bridge St, Rockton, Illinois 61072. (815) 624-4902 11-8

INFRASONIC COMPENSATOR — MODEL A —

Reduce Power Wasting Distortion — Increase Clarity and Solidify Bass. Steep Cut-Off, Self-Contained, A/C Powered Active Filter Removes Harmful Sub-Sonic Energy from your Component Stereo System. — 55DB (Minimum) at 4 CPS. Only \$54.95 Postpaid. AUDIO-SPECTRICS, P.O. Box 4223, Yuma, AZ 85364. 11-8

ATTENTION LOUISIANA AUDIOPHILES! Acoustat, Audionics, Apt-Holman, DCM Time Window, Yamaha, Lux, Stax, Gale, Denon, Grace, Sonus, Signet, Mitsubishi, B&O, Advent. Available at **AUDIO SYSTEMS, INC.** SUITE L 3302 Johnston St. Lafayette, Louisiana 70503 (318) 984-7007. 9-8

ANOTHER FIRST FROM PARAGON

If you own a sub-woofer you need the System-E5 sub-woofer amp from PARAGON. Your bass can be articulate, clear and have more impact, with an amplifier specifically designed for bass. The E5 is your key to cost effective biamping because it comes in single channel modules. You buy only what you need when you need it. Single modules come in a stereo chassis for later addition of another module for use with stereo sub-woofers. Naturally, each module has its own mammoth 52 joules power supply capable of driving 2 ohm loads at full output, and naturally, it's from PARAGON. The people who lead with innovation, rather than follow with imitation. Write to me, Diana Graeber, for complete information on this exciting and innovative new amplifier. System-E5 single \$249.00, System-E5 dual \$449.00 Paragon, 997 east San Carlos Ave., San Carlos, Ca 94070 8-9

AUDIOWORKS

We are accepting orders for the new Rappaport power amplifier. This amplifier is an innovative design employing extremely fast class A circuitry with zero feedback and high power output. It can be heard with other fine equipment at our studio, free of store traffic and sales hassles.

Audio works features speaker systems by SNELL, Acouatics, Symdex Sigma, Spendor, Thiel, Gale, Point 3 Systems, Clark Systems. Electronics by Rappaport, Audionics, Bryston, Conrad-Johnson, Denon, Verion, Wintec. Gramophone equipment by Denon, Grace, Audionics, Promethean, Fidelity Research, SAEC, Audiocraft, Decca, Platter Pad.

Audiophile recordings, accessories, consulting, and ideas. Prepaid, insured shipping to lower 48 on most items.

AUDIO WORKS
P.O. Box 4314
Harrisburg, PA 17111
(717) 652-6996

9-8

WHAT COSTS LESS than a direct-to-disc recording, is more fun, plays longer, and never wears out? The Hi-Fi Game! Immediate delivery. \$11.95 to Penijon Games, Box 2129, Martinez, CA 94553. 8-9

VAN ALSTINE Double Dyna 400 \$800. Fulton J. Modular Subwoofers with adjustable crossover to blend in the FMI 80's or other speakers, \$450. (617) 648-4191 before 8 PM EDT. 9-8

MAGNECORD 1028 w/casemint \$500. (212) 249-4611. 9-8

HEWLETT-PACKARD 8058A SPL meter & 15119A mic., orig. \$850, \$200. Erdly, 22 S. 4th St., Clearfield, PA 16830. 9-8

POLYDAX (AUDAX) Bextrenes, soft domes etc., Decca Ribbon tweeters Leach Amplifiers. Catalog: TA Box 97A, W. Cornwall CT. 06796. Postage now 40¢, please help with stamps. 9-8

PHILA. AREA Denon 'S' cart. 4 mons. old, \$120. Linn Sondek LT-12 6 mons. old, \$420. Ask for Bob (215) 836-4858 or 836-5975. 9-8

TONEARMS—CARTRIDGES—TURNTABLES at lowest prices. Most brands available, including MC cartridges. Other quality brands available. Send #10 SASE for quotes. Audio Unlimited, 401 Reynolds Circle # 2-C, San Jose, CA 95112 (408) 251-8776.

THRESHOLD 800A exc. cond. \$1650 or best offer. Meyer, Box 101, St. Charles, MO 63301 11-8

AUDIO HORIZONS™ is a new and different publication with news and component reviews for the mature, serious audiophile. The first issue, which is now available, contains reviews of several unique products never before reviewed by any other American audio publication. Subscriptions are \$18 for 6 issues, \$24 for foreign subscriptions. All issues are sent by first class mail only. AUDIO HORIZONS, P.O. Box 10973, Ferguson, Missouri 63135. 9-8

INFINITY ES-1 Never opened. (614) 397-0527. 9-8

HI-LEVEL SOUND SYSTEM GEAR!! Used components by BGW, Vega, Community, Uni-Sync and others. Call for info, or send SASE (30 cents postage). Steve Hirsch, 10 Decatur St., Burlington, Vt. 05401 (802) 862-1905 day, 658-1636 after 8. 9-8

\$1 PER 50 WORDS? YES IN AUDIOMANIA, a publication devoted expressly as an aid for the purchasing, trading and selling of audiophile quality sound reproducing equipment. 12 issues \$6 First ad free with subscription (limit 75 words). Regularly \$1 per 50 words, businesses and non-subscribers \$2 per 50 words. AUDIOMANIA, Box 1253, Athens, OH 45701 9-8

KLIPPSCHORN OWNERS TAKE NOTICE

There are good reasons why you love your K-horns. But did you know that there is only one amplifier which can bring out their true potential for clarity, depth and overall quality of sound?

The **ML-2 Class A Power Amplifier** has the smoothness of the best vacuum tube designs without the veiled, closed quality inherent in even the best triode designs.

Find out what your K-horns can really do. Call or write Mark Levinson Audio Systems Ltd., 55 Circular Avenue, Hamden, CT 06514, (203) 281-6333, for a listing of the Mark Levinson dealer nearest you.

SON OF AMPZILLA rack mount, mint. \$330. (414) 682-1882. 9-8

AUDIOPHILES —Check your system using our unique cassette tape. \$12.95 PPD BRD Co. 40 Deerfield Dr., Easton, CT 06612. 10-8

LEVINSON HQD SPEAKER SYSTEM. Includes Quads, Tweeters, Xovers, and Janis W-1 subwoofers. \$6,500. Also 1NP-2 preamp, \$1,750. (415) 433-1335. 8-10

JUST WHAT YOU NEEDED— ANOTHER UNDERGROUND HI-FI MAGAZINE

But, read on, we're different. We know we'll never publish on schedule, we're totally biased, and we can be bribed. Our magazine does have one redeeming social value, it's FREE. BIASED is the newsletter of Audiophile Systems. In it you will find several no cost ideas that will improve the performance of your system, information on our products (Linn and Naim), reviews of other products, and regular features including the Fubar award for overly creative advertising, and Reviews of the Reviewers. Send self addressed stamped envelope to BIASED, 5750 Rymark Ct., Indianapolis, IN 46250

TONEARMS-CARTRIDGES-TURNTABLES at lowest prices. Most brands available, including MC cartridges. Other quality brands available. Send #10 SASE for quotes. Audio Unlimited, 401 Reynolds Circle # 12-D, San Jose, CA 95112 (408) 289-8875 1-6 M-F. 5-9

LEVINSON JC-1AC head amp. — perfect cond. — \$200. Call (901) 683-5355 evenings. 9-8

140

Are your speakers sitting on the floor? If so, you are probably missing out on the best sound quality your speakers are capable of producing, and turning your listening room into a gigantic woofer. Introduce your speaker to "The Stand" by Mastercraft Audio. "The Stand" will • Place your speaker at the perfect height for best sound projection



Model 203



Model 208



Model 111

the stand.

• Isolate lower frequencies from the floor • Accommodate most speakers from the mini to the esoteric. Features include oil finished wood posts with tops and bases in black matte (stained wood veneers for deluxe models), non-slip speaker mounts, concealed speaker wire provision, and feet to minimize resonance. "The Stand" at your nearest audio dealer or write —

Mastercraft Audio
P.O. Box 2661
Huntington Station, N.Y. 11746
Dealer inquiries invited.

Audiophile's Sound Studio

7521 KENWOOD AVE.
CINCINNATI, OH. 45236
PHONE 513-984-0355

Handling only the finest in domestic and imported components, from B&O to the incomparable MARK LEVINSON HQD SYSTEM

7459 ELMWOOD AVE.
MIDDLETON, WI. 53562
PHONE 608-831-5955

A complete selection of "limited edition" records is available. Each store has private listening rooms, also professional sales and service staff. Delivery and set-up can be easily arranged. Send for a FREE copy of our BROCHURE and NEWSLETTER.

FOR SALE

Exclusive Conn. dealers
for Dick Sequeira's
Metronome 2 + 2W
Loudspeaker.

PYRAMID
RAPPAPORT
BRYSTON
WATSON LAB
PROMETHEAN
KEITH MONKS
SOUND CABLE

M & K
DENON
HAFLER
SYMDEX
JR 149
ADC
CYBELE

Take



TAKE 5 AUDIO

32 ELM ST.
NEW HAVEN, CT. 06510
(203) 777-1750

- One of the EAST COAST'S largest Direct Disc dealers
- KEITH MONKS record cleaning center
- Large consignment listings
- Appointments available any evening

G-B ELECTRONICS

Serving audiophiles who know live music. We offer a carefully selected group of audio components and outstanding laboratory service since 1945. **SPEAKERS:** SNELL ACOUSTICS Type A, SPENDOR BC-1 & SA-1, JR 149 & JR SUPERWOOFER, SYMDEX. **PREAMPS:** THRESHOLD NS-10 & TRESHOLD pre-preamp. CONRAD-JOHNSON (TUBE DESIGN), RAPPAPORT, AGI POWER AMPS: THRESHOLD 4000 200 watt Class A Cascode design, THRESHOLD 400A 100 watt Class A, CAS 1 75 watt Cascode amp. **TURNTABLES:** ARISTON, DENON, CONNOISSEUR **TONEARMS:** GRACE & HADCOCK **CARTRIDGES:** PROMETHEAN II (absolutely outstanding) **CABLE:** COLUMBIA & AUDIO SOURCE **MISC.:** SHEFFIELD & CRYSTAL CLEAR Discs, DECCA Brushes, K. Monks Feet etc. **G-B ELECTRONICS** 18 P.O. BOX 385, HAWTHORNE, N.J. 07507 (201) 427-8885 for information & individual appointment. Perfectionist Sales & Service Since 1945 11-8

QUALITY VACUUM TUBE PREAMPLIFIER The conrad-johnson stereo preamplifier offers breathtaking impact, clarity, and definition. Low noise, precision audio circuitry combined with highest quality switches and controls and elegant, durable gold anodized aluminum faceplates and knobs provide lasting beauty and performance. Available from selected dealers or direct for \$499. Write for information: conrad-johnson design, inc., 1474 Pathfinder Lane, McLean, Va. 22101. 3-9

RCA DIRECT TO DISC RECORDS. The incredible recordings of Beethoven's "Appassionata" piano sonata and Lew Tabackin's jazz quartet session "Trackin'" are available by mail order. These two fine records have been reviewed by "Absolute Sound" and "Stereophile" magazine. Each record is \$14.00 postpaid. Visa and MC honored. Send for records or reprints of record reviews to SPECS Corp., 130 Fallen Leaf Drive, Hillsborough, CA 94010 9-8

DBX 128 \$450 new—sell \$215—mint. Call Tom (414-682-1882) 9-8

FOR SALE

RARE INT: FISHER FM-1000, R200B (SW); McIntosh mc. 60. (3) mc-30's; jblLE14C (coax); Elec-voice (4) SP8B's. Bond, 821 Av Salvador, San Clemente, CA 92672. 9-8

MARANTZ CLASSICS: 8B, 7C, (\$300 ea.) 10B (\$550) Paul (512) 255-6463. 11-8

SUPEX—ORTOFON—DENON—OTHER MOVING COIL CARTRIDGE OWNERS: Send for free literature on our Micro Preamp Superb performance at \$129.95 Huntington Electronics, Box 2009A, Huntington, Conn. 06484 TF

TUBES- GENALEX, TELEFUNKEN, VALVO - for audiophiles who demand premium quality European replacements for ARC, Dyna, Marantz, McIntosh and other preamps, amps, & tuners.

Just a few popular types include:

	Matched Pns.	Each
GENALEX: KT88/6550	\$49.55	\$23.95
	KT66	22.45
TELEFUNKEN: ECC83/12AX7	\$4.95	
	ECC82/12AU7	4.95
	EL34/6CA7	\$23.95
VALVO: ECC83/12AX7	\$4.95	
	GZ34/5AR4	7.95

Tube price lists are not available due to frequent stock/price changes. Quotes provided on request for other than advertised tubes. Save 10% and get a complete Retube Kit for any specific unit.

Send orders and inquiries to: SOUND SERVICES, Lake Walton Road, Wappingers Falls, NY, 12590. Telephone: 914-226-5414.

NOTES ON THE K-A LABYRINTH: Audiophiles, become enlightened! Why clutter up your listening room with bulky sub-woofers, mid and tweeter arrays, and a pile of electronic components? . . . when one pair of K-A LABYRINTHS will do the job. Less than \$1500 pair. For information and dealer list write or call: KUSTOM ACOUSTICS, INC., 6624 W. Irving Park Road, Chicago, IL 60634 (312) 685-6609. 11-8

ACCUPHASE P-300 \$450, Soundcraftsmen PE 2217 \$275, Trevor Lees preamp, latest mods \$175, Trevor Lees high level gain stage \$95. all excellent condition. (707) 938-1131.

AT LAST! THE ULTIMATE CABINET DESIGN FOR HOUSING STEREO COMPONENTS - THE CUSTOM SOUND MODULAR EQUIPMENT CABINET. EARLY TWO YEARS IN DEVELOPMENT FEATURING:

- Flexible modular design expandable to suit any size installation.
- Accomodate any size components including the largest.
- Totally enclosed design with locks prevents dust buildup, tampering, or theft of valuable equipment.
- Bottom casters for mobility and rear door for easy rear access.
- High grade furniture design and construction.
- Very attractively priced.

Before you invest in a rack, call or write for our free illustrated information. Custom Sound Service, 8460 Marsh Road, Algonac, Michigan 48001. (313) 794-5400. 11-8

FOR SALE

L.A.—SOUTHERN CALIFORNIA
DENON
ROGERS
AUDIONICS
KOSS ELECTROSTATIC
NIELSEN-VAN ALSTINE CARTRIDGES
PROFESSIONAL SYSTEMS ENGINEERING

With just these six lines we can take you from an enjoyable accurate \$1410 system—better than you thought possible—to a no nonsense, blow-your-socks-off super system that doesn't need pampering.

For more information about how one of these lines might help you improve your system please call or write. We also recommend: Linn Sondeck, Cizek, Lentek, Stax, RH Labs, RAM, Goldring, Audiocraft, Decca, Connoisseur, Armstrong and Stylft.

EXECUTIVE AUDIO

by appointment only (213) 394-6463
2210 Wilshire Blvd. suite 207 Santa Monica, Ca. 90403
Shipping prepaid, insured in U.S. 6-9

PROPER TONEARM GEOMETRY!! Optimum offset angle, overhang, vertical pivot height and angle. Resonance damping construction. Jewelled pivots. Height adjustable while playing records. Effective mass 2.5 grams. Damped cueing. Anti-skate bias. TA-3A with silicone damping, \$249.00, TA-4A without damping (otherwise identical), \$199.00. "Universal" nylon hardware, \$1.00; alignment protractor, \$3.00. Prices include postage and money-back guarantee. JML Company, 39,000 Highway 128, Cloverdale, CA 95425 7-8

HIGH FIDELITY

UNZOO OBFUSCATION OF SALON AUDIO STATE-OF-ART: ADS, BOSE, YAMAHA, B&O, MCINTOSH, KLIPSCH, AUDIO PULSE, SAE, THRESHOLD, JANSZEN, KEF, DAHLQUIST, ANALOG, BRYSTON, OTHERS AT BEST DISCOUNTS. Professional Audio Engineers available for FREE, no b.s. Advice information. (Send \$1.00 for priority mail, postage, literature.) Trade-Ins. GOLDEN EAR AUDIO-ELECTRONICS. Specific quotes: G.E.A.—E., P.O.B. 296, Idaho Springs, Colorado, 80452 (303) 582-5200, 9:00 A.M.—9:00 P.M. (M.S.T.)

LESLIE SPEAKER SYSTEMS. Confidential catalog free. KNAPCO, 4750 96th St. N, St. Petersburg, FL 33708. 9-8

PROTECT VALUABLE AUDIO EQUIPMENT Against Damaging A.C. power line surges. Stop annoying "Pops," "Clicks," "Buzz" and "Hash" caused by motors, appliances, tools. Line cord hash filter/surge suppressor (1000 watt—Model KW-3) \$20.95 ppd. Send stamped, addressed envelope for free interference flyer. ELECTRONIC SPECIALISTS, INC., Box 122-A, Natick, Mass. 01760.

PARANOID ABOUT SPECS? Prove or disprove playback performance cassette and record player with surprising new technique developed by Emory Cook. Test cassette or record, instructions \$3.95 (CT res. add tax). COOK LABS, Inc. 375 Ely Ave., Norwalk, CT 06854.

A SINGER'S DREAM!



REMOVES VOCAL FROM MOST STEREO DISCS
The Thompson Vocal Eliminator can actually remove most or all of a solo vocalist from a standard stereo record and yet leaving the background music virtually untouched! Not an equalizer! We can prove it works over the phone. Write for a brochure and demo record below. COST: \$195.00

ECHO Ambiance

We do it BETTER for LESS
Whether your interest is in using ambiance for a concert hall effect or as an echo chamber for studio recording use, we manufacture a broad line of sophisticated analog delay Echo and Reverberation devices at prices which only direct sales make possible. Prices range from \$159 to \$495.
Write for a brochure and demo record. Include \$1 to cover costs (refundable with order).
Write to: **LT Sound**, Dept AU, P.O. Box 1061, Decatur, GA 30031 (404) 284-5155

Audio Excellence

A UNIQUE STEREO SHOWROOM DEDICATED TO THE PERFECTIONIST

Presenting Components from the Prestigious Companies of

THRESHOLD GAS SNELL ACOUST CIZEK
BEVERIDGE LUX VAN ALSTINE ROGERS
PARAGON DCM FULTON CART. EPA 100
BRYSTON GALE GRADO SIG. HARBETH

AT LAST, AN AUDIO SALON IN NORTHERN CALIF. ADVANCING
THE ART IN THE ATMOSPHERE OF OUR ELEGANT SOUNDROOMS!

584 Washington Street, San Francisco 94111 415-433-1335

RECORDS

IF YOU CAN'T HEAR the strong 16 Hz to 32 Hz pedal fundamentals on our Hammond Castle Pipe Organ record, take the grille off your speaker and watch the vibrations! A beautiful performance by Douglas Marshall. Includes Franck-Final, Pastorale in E Major, Bach — Little Fugue, Sinfonia, Vienne — Carillon, and Campra — Rigaudon. Decibel Records dB 1000 Indirect Disc. Price \$15 each postpaid. Send check or money order. Massachusetts residents only add \$.75 sales tax. Decibel Records, Dept. 17, P.O. Box 631, Lexington, Massachusetts 02173. 9-8

SHOW ALBUMS—Rare Out of Print LP's. 64 page list \$1.00 Bakers Wife cast LP \$9.95. Broadway/Hollywood Recordings, Records, Georgetown, Conn. 06829 TF

HAVING TROUBLE FINDING DIRECT-TO-DISC AND SOTA RECORDINGS? WE HAVE THEM ALL. SEND FOR FREE CATALOGUE. KNOT SO CHEAP RECORDS, 7505 BIG BEND, DEPT. AM12, WEBSTER GROVES, MO. 63119. 1-8

FOR DISC JOCKEYS ONLY. European & Canadian imported records. Retail & wholesale. (Disco only.) Call Mike Pabone, PRO SOUND ASSOCIATES, Toll free (800) 221-3235 or (212) 747-0600. 44 Trinity Place, New York, NY 10006. 10-8

JAZZ DELETIONS — Large Selection. Free Catalogs (Set Price/auktion). JAZZ HOUSE, Box 455 (AUD), Adelaide P.O., Toronto, Canada M5C 2J5. 9-8

JAZZ, ROCK, CLASSICAL Big Band LP's, Tapes, Current Imports, Cutouts, Catalogs, \$1. NERT, Box 268-A, Lawrence, MA 01842. 9-8

DIRECT TO DISC RECORDINGS: All labels including Sheffield, Crystal Clear, M&K, Umbrella. Send \$1.00 for catalog. Disconnection, 4201 Jetton Ave., Tampa, FL 33609. TF

RECORDS, RECORDS, RECORDS

Old, New & Direct Disc too! Send \$1. for Complete Info. S.E.O.J., 519 Wheat, Johnstown, PA 15902. 4-9

DIRECT MASTERED RECORDS—Free 20 page catalog. Low prices, large selection. Phone orders accepted. The Essentials, 761 Shell Beach Road, Shell Beach, CA 93449. 9-8

WHILE YOU WERE LOOKING for out-of-print records, you should've been looking for us. DISContinued. 444 S. Victory Blvd., Burbank, Ca. 91502 TF

FREE SOUNDTRACKS & CASTS CATALOG! Personalities! ST/OC Valuebook: \$4. RTSA 711 W. 17th G-1 Costa Mesa, CA 92627. TF

"RECORD JACKETS. Replace old, torn, LP jackets with clean, glossy, pure white or black jackets. Plastic lined inner sleeves, 78 sleeves, opera boxes. Free catalog. CABCO A6, Box 8212, Columbus, Ohio 43201." TF

SOUNDTRACKS — JAZZ — POP. Vincent, Box 5202, Long Island City, NY 11105. A

PLANS & KITS

TAPE-SLIDE SYNCHRONIZER, multiprojector lap-dissolve plans, \$5.50. With mixer, compressor, preamp schematics, \$8.50. The Millers, 1896 Maywood, S. Euclid, OH 44121.

WANTED TO BUY OR TRADE

W.E. 594A DRIVER. 21 Holly Hill Dr., Mercer Island. WA 98040. 9-8

WANTED: PAIR ALTEC 100A Bass energizers. Write: R. V. Marchbank, 1626 East 54th St., Tulsa, OK 74105.

WANTED: (AB) USED QUAD ESL'S, Marantz and McIntosh tube equipment. State price and condition. SOUND ADVICE, 1906 Beacon Street, Brookline, MA 02146 (617) 734-2727.

ONLY THREE THINGS REALLY MATTER IN A PREAMP'S PERFORMANCE

1. Accuracy of frequency response
2. Low noise
3. Low distortion

The DB Systems DB-1A has...

1. The most accurate phono equalization available (± 0.07 dB 10Hz - 40kHz).
2. Noise as low as any on the market with actual cartridge attached (moving magnet type).
3. The lowest distortion of any preamp available (less than 0.0008%, 20Hz - 20kHz).



DB SYSTEMS • P.O. Box 187 • Jaffrey Center, NH 03454

WANTED TO BUY OR TRADE

OPEN REEL pre-recorded tapes rock, folk, Quad, stereo, especially by Ampex, at 7 1/2. Lovin Spoonful "Best of" Volumes I and II, any Beatles. By Columbia, Blood, Sweat, and Tears, "Child-Father-Man" and Joplin-Big Brother, "Cheap Thrills." Ray 2282 Woodward Ave, Lakewood, OH 44107 10-8

WANTED—AUDIO BACK ISSUES

Are you willing to part with a May '47 and/or an Aug. '66 issue of Audio? We're willing to swap a one year (new or renewal) subscription for it!!! Please do not send the magazines! Drop us a line first and we'll tell you where to send them. Write to Mrs. Jean Davis, Audio Magazine, 401 N. Broad St., Phila., Pa. 19108. 10-8

INFINITY 2000A LOUD SPEAKERS WANTED. GOOD PRICE. WRITE TO: PER MORTEN JOSEFSON, OSTSKOGEN TERR. 11, 3470 SLEMMESTAD, NORWAY.

MARANTZ 7C, 9. State price, condition, phone J. Fong, 1238 Green St., San Francisco, CA 94010.

WANTED: MARANTZ 9, 8B, 1, 2, 3, 5, 6. McIntosh C22, MC240, etc. State price, cond., phone. P.O. Box 962, Hollywood, CA 90028. Call (213) 851-1107. 11-8

OPEN REEL, pre-recorded tapes. Rock, folk, jazz, classical, stereo, quad. Ray. 2282 Woodward, Lakewood, Ohio 44107. 10-8

CASH FOR your unwanted LP's & reel to reel tapes. Records, Box 323, Hillburn, New York 10931. TF

WANTED: Used Sony TC-142 or TC-126CS. Doesn't have to work. Michael Barnett 238 Garland Ave., Decatur, GA 30030. 9-8

MARANTZ 9, 8B, 1, 2, 3, 5, 6. McIntosh C22, MC275, 240, etc. State price, cond., phone. P.O. Box 962, Hollywood, CA 90028. Call (213) 851-1107. 11-8

CANADIAN DEALER looking for American trade connections willing to work on cost plus basis (for cash quantity purchases) on closeouts, deals and regular stock. Interested JBL, Shure, Audio Technica, BASF, TDK, Scotch, Watts, Marantz, Harmon Kardon, etc., Replies held confidential. Write. ELECTRONICS, Box 762, Plattsburgh, N.Y. 12901 10-8

INSTRUCTION & EDUCATION

CLASSES IN MUSIC RECORDING. Record Production, publishing, disc mastering, film recording. Taught by famous engineers and producers. Held in 16/24 track recording studios. Contact: University of Sound Arts, 1508 Crossroads of the World, Hollywood, CA 90028. (213) 467-5256. 3-9

TAPCO and ELECTRO-VOICE, mixers, equalizers, amps, mics, and raw loudspeakers. Write for low mail order prices, Sonix Co., P.O. Box 58, Indian Head, MD 20640 8-9

SPEAKERS

SURPLUS SPEAKER CABINETS

FINISHED & READY FOR YOUR DRIVERS
Send for your FREE pictured literature to America's largest surplus cabinet dealer:

OHIO MERCHANDISE
2825 S. MAIN ST., AKRON, OHIO — 44319

HIGH FIDELITY SPEAKERS REPAIRED
AMPRITE SPEAKERS SERVICE
655 Sixth Avenue, New York, N.Y. 10010
212-CH3-4812

MUSICAL INSTRUMENTS

UP TO 60% DISCOUNT. Name brand instruments. Catalog Freeport Music, 114R Mahan St., W. Babylon, N.Y. 11704.

BUSINESS OPPORTUNITIES

EARN \$500.00 WEEKLY! per 1,000 envelopes you stuff at home, choose your hours. Free supplies, information: MAIL-CO Box-771, N.Y.C. 10011. 9-8

CAMPUS REPRESENTATIVES — Earn big money as a QSI Campus Rep! For Info. contact QUADRAPHONIC STUDIOS INTERNATIONAL, 4151 Emerson St., Skokie, IL 60076. TF

CABLE FM BROADCAST STATION. Unique no investment/experience business makes money! Others work for you! Free details. "CAFM", Box 5516-N9, Walnut Creek, CA 94596 TF

PRESENT YOUR IDEAS TO INDUSTRY. Free Kit containing successful invention background and disclosure information. Send for Kit-AUD, IMI, 401 Wood, Pittsburgh, PA 15222 11-8

SERVICES

STYLUS RE-TIPPING

FIRST IN COUNTRY

SHIBATA tip in place of spherical or elliptical improves the stylus response

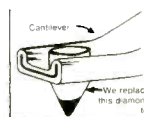

worn records sound better, too!

PRICES
Moving coils and all Deco models. All other regular stylus. All work 100% guaranteed
Sph & Ell. \$30.00 Spherical \$ 7.99 Styl returned within 24 hours
SHIBATA \$35.00 Elliptical \$ 9.99 Send to
Broken cantilever add \$15.00 SHIBATA \$15.99 DRAFIX Box - 762
Hightstown N.J. 08520

SERVICES

TAPE HEAD REFINISHING — Precision method restores full frequency response, \$15.00 ea. One day service. E. Maher, 5 Evans Place, Orinda, CA 94563. TF

TAPE HEADS, re-surfaced and lapped. Returned by insured mail. One day service. \$17.50 ea. Allied, 861 S. Vermont St., Palatine, IL 60067.

PRO-SOUND ASSOCIATES Professional Sound reinforcement, top of line equipment only. Use for our installations. (Professional only) Call Pro Sound Associates, 44 Trinity Place, New York, NY 10006 Toll free (800) 221-3235, (212) 747-0600. 12-8

NASHVILLE RECORD PRODUCTIONS WILL PRESS HIGH QUALITY PURE VINYL RECORDS FROM YOUR TAPES. SEND FOR SAMPLE RECORD AND PRICE LIST. ALSO FINEST DISC MASTERING. 469 Chestnut St., NASHVILLE TENNESSEE 37203 TF

ALL SPEAKERS REPAIRED

FAST SPEAKER RECONING SERVICE ON ALL TYPES OF TRANSDUCERS. FACTORY AUTHORIZED SERVICE FOR JBL, ALTEC, CETEC AND ELECTROVOICE. DEALER DISCOUNTS AVAILABLE. ANTECH LABS, INC. 8144 BIG BEND, ST. LOUIS, MISSOURI 63119 (314) 962-5656

CUSTOM RECORDING SERVICE, Tapes, discs, and cassettes. Stereo and mono. Live and copies. Editing. Masters and pressings. High quality at reasonable rates. Joseph Giovanelli, Audio-Tech Laboratories, 2819 Newkirk Ave., Brooklyn, N.Y. IN9-7134 TF

RADIO PROGRAMS

NATIONAL RADIO TRADER quarterly publication for old radio hobbyists. Sample issue \$2.00. Box 1147A Mount vernon, Washington 98273. 9-8

RENT RADIO SHOWS: Make your own copies or just listen. Great way to build your collection reasonably. Catalog \$1 refundable. OTR Rental, Box 1146, Livermore, Ca. 94550 TF

YESTERDAYS RADIO ON TAPE. Reels Cassettes. Quality Sound. Reliable Service. Catalog \$1.00 refundable with first order. ADVENTURES, Box 4822-A, Inglewood, California 90302. TF

1930-1962 RADIO PROGRAMS. Beats television!! Tapes. \$1.00 hour! Established esteemed dealer, informative 200 page catalog \$1.25. Cassette samples \$2.00. AM Treasures, Box 192AU, Babylon, N.Y. 11702 TF

VINTAGE RADIO: Lowest rates, post free. Traders welcome. Also trading for comics, films, pulps, etc., video tapes, too. SIGNALS, Box 5063, Sta. E. Edmonton, Alta., CANADA. 3-9

CATALOGS. Broadcasts, soundtracks. Personalities of Thirties, Forties. Box 225, New York, N.Y. 10028.

GOLDEN AGE RADIO. Your best source for radio, tapes—reels or cassettes. Box 25215-DA, Portland, OR 97225. 10-8

NATIONAL RADIO TRADER quarterly publication for old radio hobbyists. Sample issue \$2.00. Box 1147A Mount vernon, Washington 98273. 9-8

RECORDING

RECORDING STUDIO ENGINEER CAREER? Or movie scoring. Degree Unnecessary. Send two 15¢ stamps to Attainment Research, Box 45333-AU, Dallas, Tx. 75245

BARGAINS! RECORDS. TAPES: blank, prerecorded. Close-out prices! Catalog \$1.00 (refundable). Tower, Box 12, Lewes, Del. 19958.

TAPE & TAPE RECORDERS

BLANK TAPE SALE

MAXELL RECORDING PRODUCTS: We carry the complete line of Maxell's quality products. Write or call for prices.

TDK: SA-C60	1.97	Ampex: Grandmaster C-60	\$2.19
TDK: SA-C90	2.87	Ampex: Grandmaster C-90	2.89
TDK: ADC-90	2.39	BASF: Studio or CRO ²	
Scotch: Master I C-90	2.79	C-90	2.49
Scotch: Master II or III		BASF: Prof. I C-90	2.69
C-90	3.24	BASF: Prof. II or III C-90	2.79

Minimum order 12 pieces. All tapes can be assorted. PA add sales tax. Shipping \$2.50 per order. Or write for complete catalog

TAPE WORLD, 220 Spring St., Butler, PA 16001 412-283-8621

CASSETTE SAMPLER SPECIALS (Dolby). Piano Concerti: Mozart No. 21, Beethoven No. 2, \$2.49 ea., Both \$3.98. Free Catalog of classical and jazz records, tapes and instruction books. MUSICAL CONCEPTS, Box 53A, Cedarhurst, NY 11516. 9-8

SAVE \$\$\$ ON BLANK CASSETTES— First line state-of-the-art guaranteed performance. Simple ordering. No minimum. Fast free shipping. Sample C-46, \$1.00. Larksong, Box 641, Point Arena, CA 94568.

TDK, MAXELL, MEMOREX, BASF, cassettes, reels 8-tracks. Lowest prices. New, Guaranteed. FREE CATALOG S&S Audio, P.O. Box 56039, Harwood Hts., IL 60656

OLDIES TAPES ON OPEN REEL TAPE. Rock n' Roll songs by their year of release. Over 100 songs per year. Free brochure. Rock N' Reel Rental, Dept. C, 4 Prescott Ave., Dix Hills, NY 11746.

STEREO & QUADRAPHONIC OPEN REEL TAPES. Popular, Classical, Jazz. Lowest prices. Catalog \$1.00 (refundable). Real Sound, P.O. Box 71A, Shillington, PA 19607.

SCOTCH RECORDING TAPE, lowest prices TAPE CENTER Box 4305B Washington, D.C. 20012. USA, APO, FPO

EVERYTHING ON OPEN REEL! Classical. Popular. Dolby. Quadraphonic. Latest releases. For Catalog, send \$1.00. Barclay-Crocker, Room 1470A, 11 Broadway, New York, New York 10004.

NAME-BRAND RECORDING TAPE, custom loaded. Available in cassettes, reels, cartridges. Huge savings direct from manufacturer. Also low everyday prices on Maxell, TDK, Ampex, Scotch, BASF, etc. New catalogue now available. MJS, 2514 Seaboard Ave., San Jose, CA 95131. (408) 262-8793.

MXR's 10 Band equalizer, Dynamic processor, Componder. Disc-washer products. Maxell tape discounted. N.A.B. AUDIO, Box 7, Ottawa, IL 61350.

TAPE HEAD REFINISHING— Precision method restores full frequency response, \$15.00 ea. One day service. E. Maher, 5 Evans Place, Orinda, CA 94563.

CLASSICAL CASSETTES. FREE Catalog . . . Stereo-Dolby . . . Quality Guaranteed . . . Credit Cards Accepted. EKR Classics, GPO Box 1977AH, New York, New York 10001. 9-8

IF LATIN MUSIC TURNS YOU ON, let us send you our free brochure. We specialize in 8-track, cassettes and reels of Salsa and Tipica. SOULSOUNDS, P.O. Box 12, New York, NY 10471. 10-8

LOWEST PRICES ON MAXELL, BASF, TDK, FUJI TAPES!!! Send # 10 SASE for free catalog. All new, guaranteed!! Audio Unlimited, 401 Reynolds Circle # 12-E, San Jose, CA 95112 5-9

AKAI 400 DSS quadra-sync tape deck. 10 reels BASF studio series NAB tape. Only \$1200. Mr. P, Box 5513, Statesville, NC 28677. 9-8

UNIQUE, COLLECTOR'S TAPE RECORDINGS — NEW and old radio programs. Exclusive shows, features, oddities, music! \$3.00 brings 32 minute demo (reel/cassette), literature included. MCP Studios, Box 521, Newberry, S.C. 29108. 9-8

TAPE RECORDINGS

OPEN REEL TAPES, Hundreds of rock/soul/classical/shows, a few jazz/folk/pop, \$1 plus SASE. Sell or trade. Ray 2282 Woodward Ave., Lakewood, OH 44107.

HELP WANTED

AUSTRALIA - NEW ZEALAND WANT YOU!! 50,000 Jobs! Big pay! Reports \$2.00. AUSTCO, Box 8489-K, Long Beach, CA 90808 8-9

OVERSEAS JOBS — Now hiring all Occupations. High pay. Transportation. Computerized Reports, \$2.00 TRANSWORLD, International Airport, Box 90802-K, Los Angeles 90009

RADIO-TV JOBS . . . Stations hiring nationwide! Free details: "Job Leads," 1680-HK Vine, Hollywood CA 90028 9-8

MISCELLANEOUS

JEeps — \$59.30! — CARS — \$33.50! 200,000 ITEMS! — GOVERNMENT SURPLUS — Most COMPREHENSIVE DIRECTORY AVAILABLE tells how, where to buy — YOUR AREA — \$2.00 — MONEYBACK GUARANTEE — Government Information Services, Department SA-9, Box 99249, San Francisco, California 94109 (433 California) 11-8

ELECTRONIC BARGAINS, CLOSEOUT, SURPLUS! Parts, equipment, stereo, industrial, educational. Amazing values! Fascinating items unavailable in stores or catalogs anywhere! Unusual FREE catalog. ETCO-008, Box 762, Plattsburgh, N.Y. 12901

16MM SOUND FEATURES, shorts, new, used, for sale. Free catalog National Cinema, 333 W. 57th St., N.Y.C. NY 10019

YELLOW PAGES OF AUDIO—\$3.95

Sourcebook to 1,100 periodicals. 250 books, 7,500 products! Future Publications, 137 Valley Park S. Bethlehem, PA 18018 1-9

REFERENCE RECORDINGS, including German and English EMI, Direct to Disc etc. Also onion skin lined sleeves. SASE for free list. Renaissance Records, 1133 S.W. Morrison Portland, OR 97205.

JAZZ WORLDWIDE Sample \$1. International Jazz Federation 1697 Broadway, No. 1203A, New York, NY 10019.

Is your name and address correct?

Please check the address label on this issue of Audio. If not accurate, please send corrected label, with this notice, to:

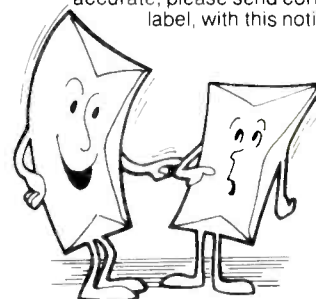

**Circulation Department
Audio**

North American Building
401 N. Broad St., Philadelphia, PA 19108

17 MARANTZ COMPONENTS WHATEVER THE MIX IT'S ALWA

Now there's a Marantz component system for everyone! From our most affordable to our finest—with 223 systems priced in between—Marantz delivers the same top Marantz quality and the same stunning Marantz look. There's never a compromise! And with so many systems to choose from, you'll be able to find the exact match for your listening requirements and budget.

A MARANTZ EXCLUSIVE: MIXED SYSTEMS THAT REALLY MATCH.

From the least expensive to the most expensive, all Marantz Pre-Amps, Power Amps, Console Amps, Tuners and Front-Load Cassette Decks feature the same front panel size, the same striking cosmetics, the same top quality design philosophy. So whatever component combination you choose, you'll have a perfect match. Only with Marantz.

BRINGING IT ALL TOGETHER.

Once you have selected a system, only one question



The RM-3700 STACK RACK contains three Marantz components on fixed-positioned shelves, an accessory shelf and divided record compartment behind its full-length smoked-glass door. The Marantz system shown includes the 6170Q Turntable, 2110 Tuner, 1180DC Integrated Amplifier, 5010B Cassette Deck and Design Series 930 Speakers.

remains: Where do you put it? With a Marantz STACK RACK you can bring it all together—with style. The RM-3100 "Professional" STACK RACK (at right) will accommodate up to four Marantz components equipped with optional rack handle adaptors. Or you may prefer the RM-3700 "Decorator" STACK RACK (above) which encloses three Marantz components behind its full-length smoked glass door. A perfect fit in either rack, your entire system will be at your fingertips.

BUILD NOW. ADD LATER.

Once you see and hear what Marantz components have to offer by way of more performance per dollar, striking appearance and unheard of flexibility, you'll be sold. You'll have a perfectly matched system tailored to your specific needs from as little as \$650* to \$2100.* And don't hesitate when you want to upgrade any part of your system. Any Marantz component you upgrade to will match what you already have.

MIX AND MATCH BY MARANTZ—IT'S ALL FOR YOU.

17 separate components from Marantz. Designed to mix and match into 225 different systems to give you unprecedented flexibility. Whoever you are, Marantz has the perfect system for you.

The three unit Marantz system shown at right includes the 2100 Tuner, 1090 Integrated Amplifier and the 5000 Cassette Deck with 6270Q Turntable. The four unit Marantz system shown at the far right includes the 2130 Tuner, 3650 Pre-amplifier, 5030B Cassette Deck and the 300DC Amplifier with a 6370Q Turntable.

25th Anniversary **marantz®**

*These prices are for informational value only (actual prices are set by Marantz retail dealers) and do not include turntables, racks, optional rack handles or speakers. ©1978 Copyright Marantz Co., Inc., a subsidiary of Superscope, Inc., 20525 Nordhoff St., Chatsworth, CA 91311. All Rights Reserved.

**5. 225 MARANTZ SYSTEMS.
AS A MATCH - FROM \$650* TO \$2100.***





Record Ecology in DiscKit Form —you'll save more than money

DiscKit is a milled walnut tray and dust cover that saves you 15% with the Discwasher products in the kit. (\$46 versus \$54 separately)

DiscKit includes: 1) The Discwasher System Record Cleaner with D3 Fluid, 2) the Zerostat anti-static pistol and test light, and 3) the SC-1 Stylus Cleaner.

But you'll save more than money. You'll save your rec-

ords from imbedded micro-dust, your cartridge stylus from abrasion and your ears from a lot of static.

Record Ecology from Discwasher—a substantial bargain.

(Walnut tray and dust cover are available separately as

the Discorganizer, \$12.50.)

All from Discwasher, Inc., 1407 N. Providence Rd., Columbia, Missouri 65201.

