

Audio

Lirpa VDRS

THE AUTHORITATIVE MAGAZINE ABOUT HIGH FIDELITY • APRIL 1978 \$1.25

47425 

Tape Edge Quality

Antennas-
System
Guide

Judging
FM Specs



04

EUGENE

2608 CENTRAL BLVD

DR. L. HUNTER

003375 280 100201510111811

DECKS, OLD IDEAS.

controls plus two large VU meters. All of which helps reduce the dimensions considerably.

Of course, as you can see from the picture, the entire unit is rack mountable. But what you may not have noticed is that the RT-707, unlike any other tape deck, is stackable. It's made to fit right in with the rest of your components.

AUTO-REVERSE AND OTHER EXTRAS.

While many tape decks have auto-reverse, chances are you won't find it on other comparably priced 7-inch tape decks. You also won't find a repeat button that lets you listen to your tapes endlessly, or circuitry that allows you to hook the RT-707 up to a timer, so you can make recordings even when you can't be there to supervise them.

Obviously, these are only a few of the virtues of our new RT-707. But there are also things like a highly accessible tape head alignment that lets you adjust and clean the tape heads without removing the cover. Solenoid push-button controls that give you direct function switching, so you can go from one mode to another without damaging the tape. And a floating guide roller that helps decrease intermodulation.

The point is, you'll see a lot of things on the RT-707, that you won't see on any other 7-inch tape deck.

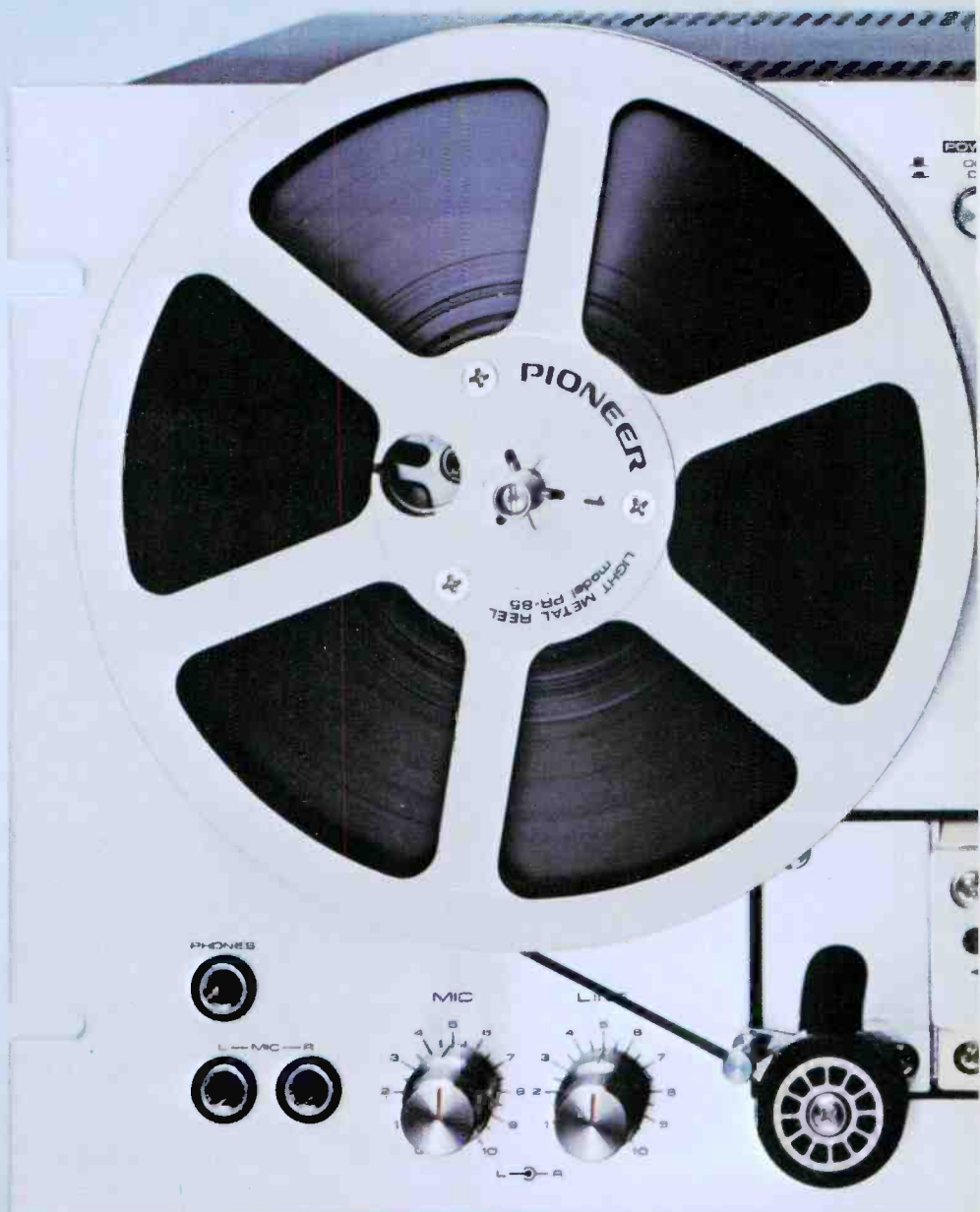

But all this revolutionary thinking wouldn't mean much if the RT-707 weren't built to fit comfortably into your budget. It is. In fact, its price is comparable to any "good" tape deck.

See your Pioneer dealer and get a closer look at the most extraordinary 7-inch tape deck ever built.

We think you'll find the only things that the RT-707 has in common with other 7-inch tape decks is the size of the reels. And the size of the price.

High Fidelity Components
PIONEER
WE BRING IT BACK ALIVE.

©1977 U.S. Pioneer Electronics, 85 Oxford Drive, Moonachie, New Jersey 07074

FREQUENCY RESPONSE: @ 7 1/2 ips 20-28,000 Hz ± 1 (30-24,000 Hz ± 2 dB)
SPEEDS: 7 1/2 ips (19 cm/sec.) 3 1/4 ips (9.5 cm/sec.) ± 0.05%
MOTORS: FG AC Servo direct drive motor + 1 capstan driver, 6-pole inner rotor special induction motor x 2 reel driver
VOW AND FLUTTER: @ 7 1/2 ips 0.05 (W/RMS)
SIGNAL TO NOISE RATIO: More than 58 dB
HARMONIC DISTORTION: No more than 0.3%
REFERENCE TAPE: Scotch #206

Enter No. 30 on Reader Service Card

THE RT-707.

UNLIKE OTHER 7-INCH TAPE DECKS THIS ONE ISN'T FILLED WITH 15 YEAR

Now there's one 7-inch open reel tape deck with the kind of technology and features found in some of today's most sophisticated 10-inch tape decks. Pioneer's new RT-707.

In fact, the 707, when compared to other 7-inch tape decks, makes them look and sound 15 years old.

THE MOST ACCURATE DRIVE SYSTEM: DIRECT-DRIVE.

The average 7-inch tape deck is equipped with an old fashioned, high speed drive system that works on belts or pulleys.

A system that generates excessive heat, wow and flutter and comes with its own nifty little "noisemaker": a fan. Not the RT-707. It's driven by a far more accurate and efficient AC Servo direct-drive motor. A motor that generates its own frequency to monitor and help correct variations in tape speed. Which results in incredibly little wow and flutter—0.05% (WRMS). In addition, the drive system of the RT-707 is unaffected by fluctuations in line voltage and won't deteriorate with age like belt-drive. And because it doesn't generate heat it doesn't need a fan. So what you'll hear is music with a clarity and crispness not possible on any 7-inch, or many 10-inch tape decks.

A FIRST FOR 7-INCH TAPE DECKS. PITCH CONTROL.

Thanks to this extraordinary direct-drive system, it's also made pitch control possible for the first time on any 7-inch tape deck. Which means that you can regulate the speed of the tape, so your recordings will

have perfect pitch even if they weren't originally recorded that way.

BEYOND THE RANGE OF MOST 7-INCH TAPE DECKS.

In the past, the most you'd expect from any 7-inch tape deck in terms of frequency response was respectability.

But Pioneer's engineers have gone far beyond that. Our super-sensitive tape heads, for instance, will pick up and deliver frequencies from 20 to 28,000

Hertz. The preamplifier, which is built around Pioneer designed integrated circuits, will handle up to 30 decibels more input than any other 7-inch tape deck without distorting. So you can capture all the depth and presence of each and every instrument without losing any part of the music.

A WHOLE NEW WAY OF LOOKING AT TAPE DECKS.

Where most 7-inch tape decks are big and clumsy, new technology has helped us make the RT-707 smaller and more compact.

For example, between the take-up reels on the "dinosaurs" of the past, you'll find nothing but wasted space. On the RT-707, however, you'll find this space occupied by a series of highly sensitive



The extraordinary direct-drive system.

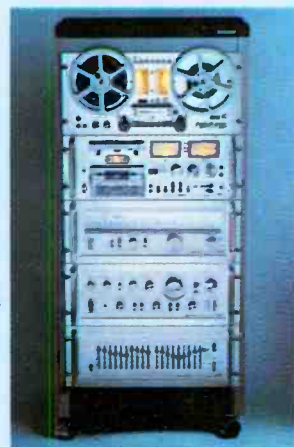

Unlike others, the RT-707 can be stacked or rack-mounted.

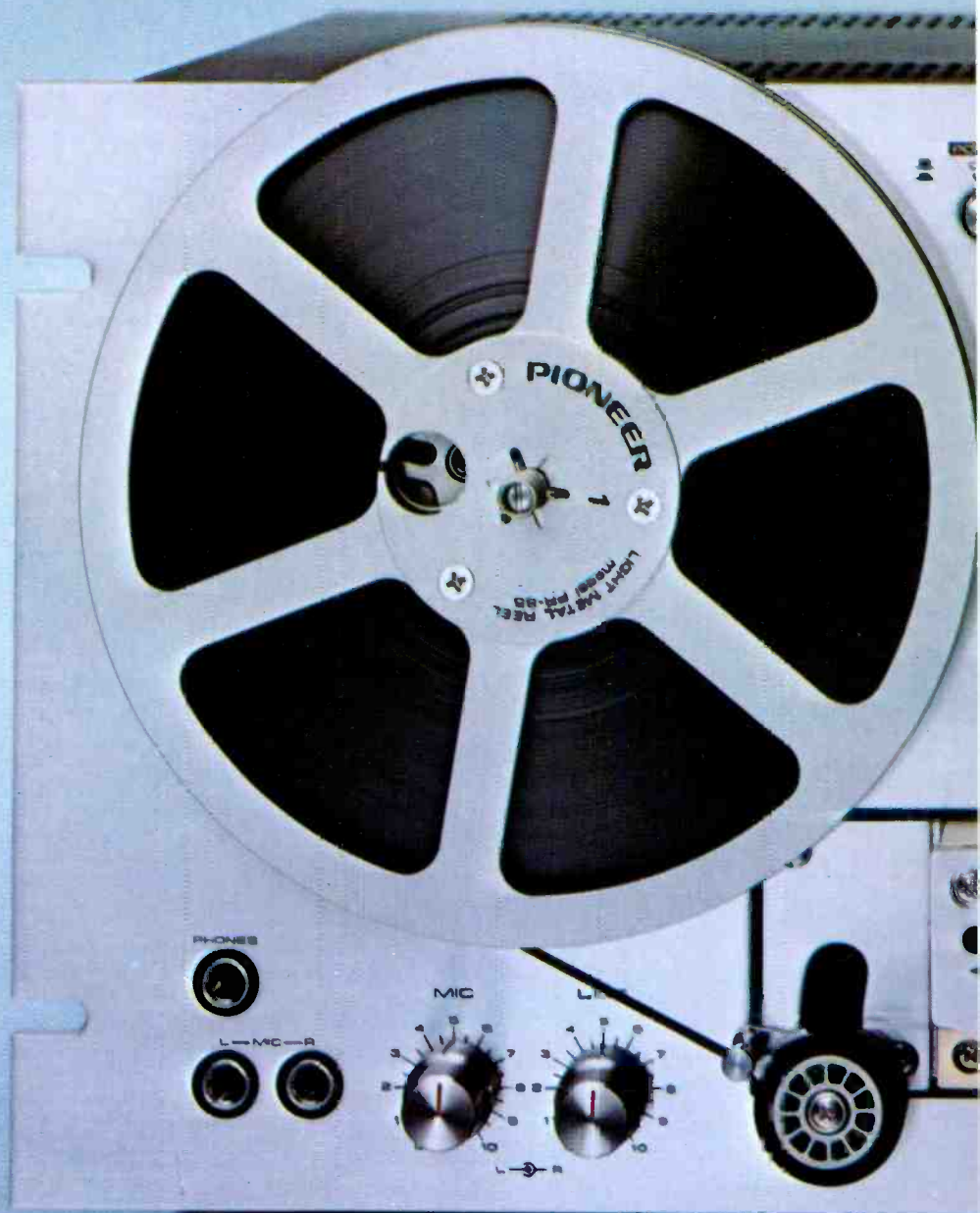

**THE ONLY THING IT HAS
IN COMMON WITH
OTHER 7-INCH
TAPE DECKS IS THE
SIZE OF ITS REELS.**

SPEED MONITOR BIAS EQ REC MODE
19 8 5 TAPE SOURCE STD LH STD LH OFF ON OFF ON

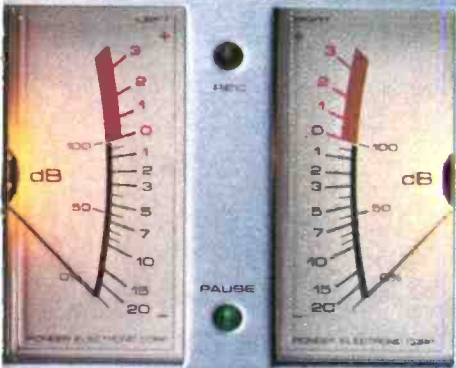

RESET REPEAT PITCH CONTROL
PUSH ON

PIONEER AUTO REVERSE DIRECT DRIVE AT-707

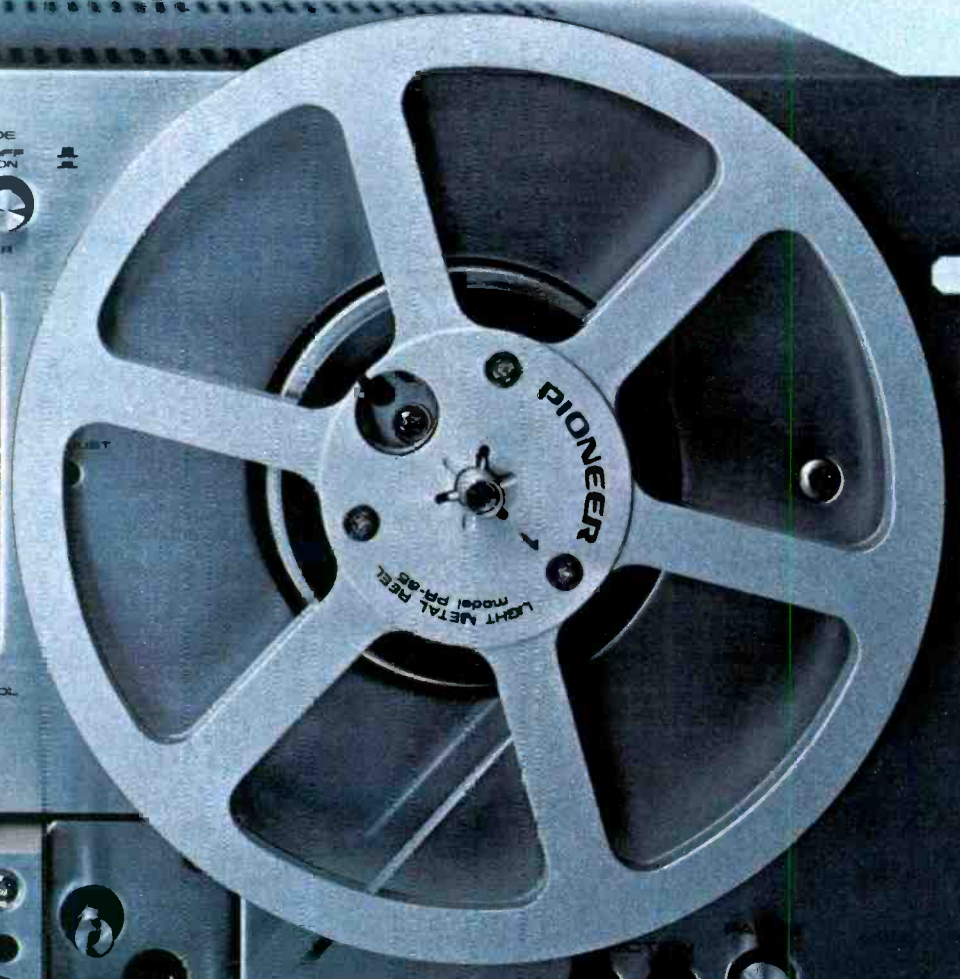

REC PAUSE
PLAY F.F. R.W. EJECT

DENON

MOVING COILS

Suddenly you can hear

"MC" cartridge systems are inherently linear, inherently musical, inherently Denon.

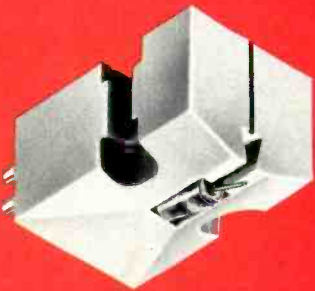

103S—Modified elliptical reference for two and four channel material. Suddenly you can hear.



103D—The newest, most perfect Denon cartridge. Special cantilever and elliptical stylus plus lower mass allow the 103D to reproduce music otherwise heard only at recording sessions.



103T—A combination offer of matched Denon transformer and the famous 103C cartridge. The most economical way to hear with moving coils.

If you would like to hear more, go to your franchised American Audioport dealer. Listening is convincing.

American Audioport, Inc.
1407 N. Providence Rd.
Columbia, MO 65201

Audio

April 1978

"Successor to ~~RADIO~~ Est. 1917"

Vol. 62, No. 4

Feature Articles

Tape Slitting & Edge Quality	28	Wayne Saylor
Antennas, Part IV —		
Complete Antenna Systems	42	M.J. Salvati
Open-Reel Renaissance	52	Gary R. Gruber
FM Specifications Revisited	58	Leonard Feldman

Equipment Profiles

Lirpa "VDRS" Vehicular Disc Reproduction System	71	Prof. I. Lirpa
Project/One Mark IVB Stereo Receiver	81	Leonard Feldman
Ace Audio 3100 Preamplifier	87	Leonard Feldman
Garrard GT-35 Turntable	90	George W. Tillett
Dual 939 Auto-Reverse Cassette Deck	92	George W. Tillett

Record Reviews

The Column	95	Michael Tearson/Jon Tiven
Jazz & Blues	102	
Tape & Turntable	110	
Classical	112	Edward Tatnall Canby
The Folk Bag	114	Tom Bingham/John McLaughlin

Audio in General

Audioclinic	6	Joseph Giovanelli
Audio ETC	8	Edward Tatnall Canby
Tape Guide	14	Herman Burstein
Behind The Scenes	16	Bert Whyte
What's New in Audio	22	
Obituary	26	
Classified Advertising	120	
Advertising Index	126	

About The Cover: Audiophiles still find that maximum fidelity from tape is obtained with an open-reel deck.
Photo by Chas. Mills & Son, Philadelphia

AUDIO Publishing, Editorial, Subscription and Advertising Production offices, North American Building
401 No. Broad St., Philadelphia, PA 19108 Telephone (215) 574-9600. Postmaster Send Form 3579 to above address.



at last! a real international agreement!



We knew we had something special in Pickering's XSV/3000. All of our technical tests and subjective listening studies gave strong indication of its excellence . . . but we were simply amazed at the unanimous praise heaped on this new product by the critics and reviewers world-wide.

We have never seen such an accolade for a new product and we attribute it to the engineering innovations that made this cartridge what it is.

So, we put together a booklet which gathers all eight reviews from all over the world.

Go to your nearest store or ask us to send you one. Read the reviews for information . . . then listen to Pickering's XSV/3000 and be convinced.

For your copy, write to Pickering & Co., Inc., 101 Sunnyside Blvd., Plainview, N.Y. 11803. Dept. A

© Pickering & Co., Inc. 1978



"for those who can hear the difference"

Enter No. 29 on Reader Service Card



Model AT16Sa/H Dual Magnet Stereo Cartridge pre-mounted in Universal tone arm head shell.

To find out how much better our cartridge sounds, play their demonstration record!

There are some very good test and demonstration records available. Some are designed to show off the capabilities of better-than-average cartridges... and reveal the weaknesses of inferior models. We love them all.

Because the tougher the record, the better our Dual Magnet™ cartridges perform. Bring on the most stringent test record you can find. Or a demanding direct-to-disc recording if you will. Choose the

Audio-Technica cartridge that meets your cost and performance objectives. Then listen.

Find out for yourself that when it comes to a duel between our cartridge and theirs... we're ready. Even when *they* choose the weapons!

What you'll hear is the best kind of proof that our Dual Magnet design and uncompromising craftsmanship is one of the most attractive values in high fidelity. For their records... and *yours!*



audio-technica
INNOVATION □ PRECISION □ INTEGRITY

AUDIO-TECHNICA U.S., INC.
Dept. 48A, 33 Shiawassee Avenue, Fairlawn, Ohio 44313
In Canada: Superior Electronics, Inc.
Enter No. 55 on Reader Service Card

Audio

Editor

Eugene Pitts III

Associate Editors:

Edward Tatnall Canby, Bert Whyte

Assistant Editor

Eugene J. Garvin Jr.

Marketing Director

Sanford L. Cahn

Design

Frank Moore

Design Assistant

Debbie DePietro

Circulation Manager

Jean Davis

Advertising Production & Editorial Assistant

Gloria Klaiman

Senior Editors:

Richard C. Heyser, B. V. Pisha

Contributing Editors:

Tom Bingham, Herman Burstein,
Geoffrey T. Cook, John Diliberto,
Leonard Feldman, Joseph Giovanelli,
Bascom H. King,
C.G. McProud, Dan Morgenstern,
George Pontis, Howard A. Roberson,
Jon Sank, Donald M. Spoto,
Michael Tearson, George W. Tillett,
Jon Tiven.

Publisher

Jay L. Butler

AUDIO (title registered U.S. Pat. Off.) is published monthly by North American Publishing Co., Irvin J. Borowsky, President, Frank Nemeyer and Jay L. Butler, Vice Presidents, Harry Feld, Treasurer, Joseph Florentine, Chief Financial Officer, Mary Claffey, Vice President/Circulation; R. Kenneth Baxter, Vice President/Manufacturing; Sandford L. Cahn, Marketing Director, Mary Anderson, Secretary/Production Director; John Nolan, Corporate Art Director, Vic Brody, Promotion Director, S.O. (Shap) Shapiro, Circulation Consultant.

Subscription Rates: United States only, 1 year for \$9.00; 2 years for \$16.00; 3 years for \$22.00; outside the U.S., 1 year for \$11.00; 2 years for \$20.00; 3 years for \$28.00. Printed in U.S.A. at Concord, New Hampshire. All rights reserved. Entire contents copyrighted 1978 by North American Publishing Co. second class postage paid at Philadelphia, PA and additional mailing office. Back issues, \$2.00 each.

World Library Congress Number: ISSN 0004-752X

Microfilm Copies: University Microfilms International, 300 North Zeeb Rd., Ann Arbor, MI 48106

Dewey Decimal Number: 621.381 or 778.5

National Sales Office: Jay L. Butler, Publisher, 545 Madison Ave., New York, NY 10022 Telephone (212) 371-4100

West Coast Sales Office: Jay Martin, 17000 Ventura Blvd., Encino, CA 91316 Telephone (213) 788-9900

Continental European Representative: V. B. Sanders, International Publishers Advertising Service, Raadhuisstraat 24, P.O. Box 25, Graft-De Ryp, Holland Telephone, 02997-1303; telegrams, Euradteam—Amsterdam.

England: The Paul Singer-Lawrence Media Group, 54 Burton Court, London SW3, SY4, England Phone, 01-730 3592

EDITORIAL CONTRIBUTIONS are welcomed but should be accompanied by return postage. Submissions will be handled with reasonable care, but the publisher assumes no responsibility for return or safety of manuscripts, photographs, or artwork.

AUDIO Publishing, Editorial, Subscription and Advertising Production offices, North American Building, 401 No. Broad St., Philadelphia, PA 19108 Telephone: (215) 574-9600. Postmaster: Send Form 3579 to above address



Leader in editorial excellence

Soundcraftsmen equalizers

The new high-performance "State-of-the-Art" Equalizers that set un-equalled Industry Standards!

SOUNDCRAFTSMEN FIRSTS:

- 1ST** to invent low-noise home equalizers
 to invent the 10-octave pre-amp/equalizer
 to invent the CLASS H amplifier
 to invent the high performance 114 dB S/N, 44 dB range, home equalizer

EQUALIZERS are used everywhere in the music-making chain: by live performers, recording studios, mixing consoles, AM and FM stations, and so on. In every step, each of the engineers use EQUALIZERS to make the music sound the way they think it should sound. So after everyone else makes the music sound the way they like it, it's up to you to use that same instrument — THE EQUALIZER — to make the final adjustment, and make the music sound the way you like it to sound in your own home.

THE EQUALIZER YOU BUY IN 1978 SHOULD HAVE THESE FEATURES:

- We include all the accessories and features that are a must to make EQUALIZING easy, as well as an amazingly rewarding new experience . . . An ENVIRONMENTAL DO-IT-YOURSELF TEST RECORD edited and announced by Soundcraftsmen especially for use with the Soundcraftsmen equalizer . . . COMPUTONE CHARTS for making a record of, and resetting in seconds, any desired EQ curve . . . a Full-Channel FREQUENCY SPECTRUM LEVEL CONTROL on each channel for instant "no distortion" in/out balancing . . . LIGHT-EMITTING DIODES for precise visual signal level balancing . . . A GRAPHIC DISPLAY of each EQ curve . . .

FREE BROCHURE

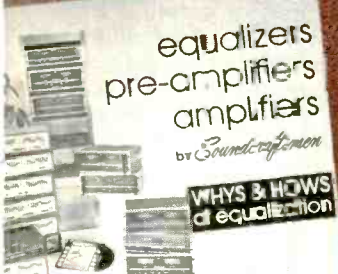

Includes TEST REPORTS, complete specifications, Class "H" amplifier ENGINEERING REPORT, EQ COMPARISON CHART, and the "WHYS & HOWS" of equalization — an easy-to-understand explanation of the relationship of acoustics to your environment. Also contains many unique IDEAS on "How the Soundcraftsmen Equalizer can measurably enhance your listening pleasures." How typical room problems can be eliminated by Equalization, and a 10-POINT "DO-IT-YOURSELF" EQ evaluation checklist so you can FIND OUT FOR YOURSELF WHAT EQ CAN DO FOR YOU!

GUARANTEED TO IMPROVE YOUR SYSTEM MORE THAN ANY OTHER ADD-ON COMPONENT

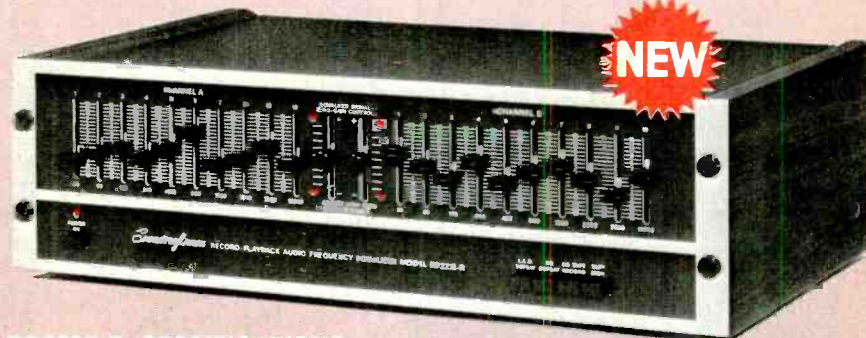

RP2215-R SPECIFICATIONS

- IN-OUT MONITORING: Continuous Vis. of L.E.D. input-to-output level.
- HARMONIC DISTORTION: Less than .01% at 2 V.
- IM DISTORTION: Less than .01% at 2 V.
- SIGNAL-TO-NOISE: a. 114 dB at 10 V-output. b. 100 dB at 2 V output.
- INDIVIDUAL OCTAVE CONTROLS: (32 dB total adjustment range)
 - a. ± 22 dB—each octave (all other octaves set at max.)
 - b. ± 15 dB—each octave (all other octaves set at zero)
- EQUALIZER GAIN/CUT CAPABILITY: +32 dB - 38 dB (all controls max.)
- "FREQUENCY SPECTRUM LEVEL" zero-gain controls for each channel.
- FILTER TYPE: Precision-tuned passive wire-wound Inductors
- PRICE: \$370.00 (including cabinet)

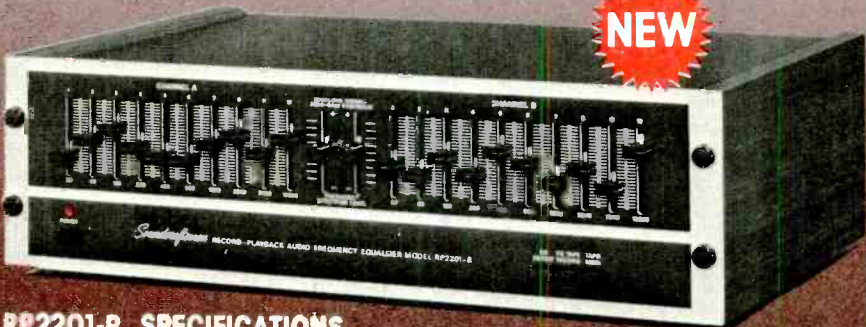

RP2201-R SPECIFICATIONS

- SIGNAL-TO-NOISE: 105 dB below full output
- INDIVIDUAL OCTAVE CONTROLS: (32 dB total adjustment range)
 - a. ± 16 dB—each octave (all other octaves set at max.)
 - b. ± 12 dB—each octave (all other octaves set at zero)
- EQUALIZER GAIN/CUT CAPABILITY: +22 dB - 28 dB (all controls max.)
- FILTER TYPE: Op-Amp-Synthesized Inductors
- PRICE: \$299.00 (including cabinet).

other Soundcraftsmen High-Performance Products

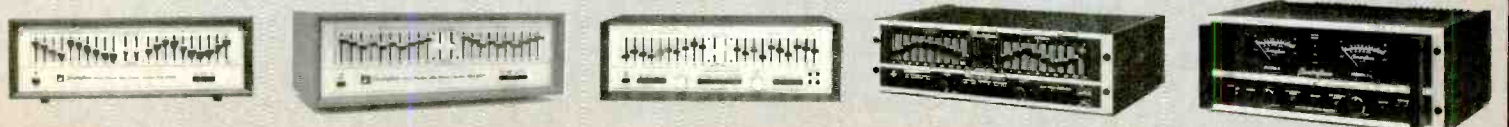

RP2204—\$329.50 RP2212—\$369.50 PE2217—\$529.50 PE2217-R—\$549.00 MA5002—\$699.00

Manufactured in California, U.S.A. by Soundcraftsmen, 1721 Newport Circle, Santa Ana, CA 92705 . . . For name of your nearest dealer, phone us at (714) 556-6191

Enter No. 42 on Reader Service Card

Because
music is
mostly
transients.



Our 282-e cartridge.

From the attack of an organ note to the bite of a plucked string, music is mostly transients: sudden bursts of sound at all frequencies. On a stereo record, transient signals define the characteristic attack and decay of musical sounds, differentiating one instrument from another.

Until Micro-Acoustics' direct-coupled design (U.S. Pat. No. 3952171), all high-fidelity cartridges concentrated on *tracking ability*: maintaining contact between stylus and groove at low forces, for minimum record/stylus wear. This reduces *transient ability*, because under-damped moving assemblies tend to remain in motion, impairing clarity and definition. On the other hand, earlier cartridges with stiffer stylus assemblies had better transient ability, but greater wear.

Unlike these single-pivot cartridges, which maximize one ability, Micro-Acoustics' 282-e has twin pivots optimized for *both* abilities. Resulting in superior transient and tracking performance from one cartridge on *all* records, including warped discs. Performance totally independent of tonearm cable capacity or preamp input impedance.

Visit your MA dealer and let your ears convince you. Or use our unique test record for evaluating and comparing cartridge tracking and transient ability. Just send \$5.00 for a postpaid copy, or write for free information. Micro-Acoustics Corporation, 8 Westchester Plaza, Elmsford, N.Y. 10523. In Canada, H. Roy Gray Ltd., Markham, Ont.

ma

Micro-Acoustics

"Because good tracking isn't enough."

© 1977, Micro-Acoustics Corporation.

Audioclinic

Joseph Giovanelli

Turntable Hum

Q. I have a direct-drive turntable which produces a high-pitched hum after I use it about 20 minutes or so, even though the hum is not audible through my speakers. What is my problem?—Willie Stanley, English-town, N.J.

A. The hum produced by your turntable may be the result of loose laminations in either the motor or the power transformer or it may also be defective shock mounts. Because some time is needed before the "hum" is heard, heat is probably a factor in producing this sound. If the sound is not too annoying, I doubt that it is significant.

Rust Removal

Q. I have some small electronics tools that have become rusted. What is the best way to remove this rust?—Robert Watson, Dover, Del.

A. Tools with rust deposits can be readily cleaned by lightly spraying them with WD-40 and then lightly polishing them with very fine steel wool. If the rust is heavy, it will be necessary to reapply the WD-40 more than once and to use either sandpaper or emery cloth. For really heavy rust, use Naval Jelly but keep it out of any of the electronics.

Squarewaves

Q. What is the advantage or significance of a speaker that can reproduce square waves?—Eli Sammett, Flushing, N.Y.

A. There are a number of musical instruments which produce sudden "starts" or "stops" of sound. A square wave is an artificial means of doing the same thing. If such a wave shape is presented to a component such as a speaker, amplifier, tape recorder, etc.,

it would be nice if the output of the device would reproduce the shape exactly as it appears when it enters the input. Depending upon the nature of the difference between the output and input waveforms, one can tell if a speaker is having difficulties with sudden starts, sudden stops, or a combination of both.

If a waveform contains many harmonics, then it would tend to have the appearance of a square wave. If this waveform is presented to the input of a component and if the output waveform ends tend to be rounded off, this means that some of the higher frequency harmonics have been removed because of a frequency response that doesn't go high enough to encompass the energy contained in the waveform.

Impedance Matching

Q. Is impedance matching necessary only for optimizing the reproduced sound?—Michael D. Muller, APO, New York

A. Generally speaking, when we drive a transducer we wish to supply a maximum of power. When we drive an electronic circuit, we want to transfer a maximum of voltage. For example, the impedance of a power amplifier is generally much higher than the output impedance of the preamplifier so that a maximum of voltage is transferred between the two devices. However, if we are concerned with a maximum transfer of power between these, or any two circuits, we would match impedances and it is only by doing so that a maximum of power is transferred from one component to another.

If you have a problem or question on audio, write to Mr. Joseph Giovanelli, at AUDIO, 401 North Broad Street, Philadelphia, Pa. 19108. All letters are answered. Please enclose a stamped, self-addressed envelope.

AUDIO • April 1978

THE MOST IMPORTANT FEATURE IN THESE DECKS IS BASED ON A TIMELESS IDEA.



The features and specifications of TEAC decks have changed, but the timeless constant has been TEAC reliability. Every improvement we've made has added to this reliability. It's our most important feature.

Every TEAC cassette deck from the least expensive to the most expensive is built to last a long, long time. That's been true since the first TEAC was built more than 25 years ago.

A-103 Specifications:

Wow & Flutter:
0.10% (NAB weighted)
Signal-to-noise ratio:
50dB (without Dolby)
55dB (with Dolby at 1kHz)
60dB (with Dolby over 5kHz)
Frequency Response:
30-14,000Hz (CrO₂/FeCr)
30-11,000Hz (Normal)

Take the new A-103, one of the least expensive TEAC's you can buy.

Despite its low price, the A-103 is manufactured to the same tolerances as decks costing three times as much. And, where most decks have a maze of hand-wired switches, harnesses and boards inside, the A-103 boasts an innovative design which replaces all that with a single circuit board directly coupled to the front control panel.

A-640 Specifications:

Wow & Flutter:
0.06% (NAB weighted)
Signal-to-noise ratio:
57dB (without Dolby)
62dB (with Dolby at 1kHz)
67dB (with Dolby over 5kHz)
Frequency Response:
30-16,000Hz (CrO₂)
30-14,000Hz (Normal)

TEAC's more expensive A-640 brings engineering sophistication to a new high with plug-in circuit boards, two motors and electronically operated push buttons for feather-touch, maintenance-free reliability.

People who work with tape recorders know

TEAC tape recorders work and keep on working. That's the reason people whose living depends on sound judgement, depend on TEAC. You can, too.

TEAC®

First. Because they last.



©TEAC 1977



*Dolby is a trademark of Dolby Laboratories, Inc.

TEAC Corporation of America • 7733 Telegraph Road, Montebello, California 90640 • In Canada TEAC is distributed by White Electronic Development Corporation (1966) Ltd.

Audio etc.

Edward Tatnall Canby

I have been accumulating a good backlog of practicality in the living room, lately, via equipment which is either brand new or—just as good—older but directly related to the latest. Good features, after all, do tend to stay around from model to model. More items to mention, then, and some simple thoughts on living room terminology, a small but important aspect of the hi-fi biz. Things are very good in the living room right now. Take that from a music man who has seen much of what has passed for fi since our distant beginnings. Music listening is easy, as well as sonically gratifying. Even if the prices are up 3 dB again.

We have seen some good changes in terminology, not the engineering sort but those which the hi-fi beginner must face up to. *Rig* and *system* rightly suggest collections of separate components that are not really separate, nor “units” either, since most of them combine various functions. No longer do we advise our Aunt Minnie to buy separate units. If she wants the easiest, she’ll just get herself

a stereo. A *system* is even better, and on up to the very best, and we won’t argue as to which is hi fi. Gone, too, is that ugly word *chassis*, replaced by more gracious terminology, like *receiver*. I don’t even remember what a hi-fi chassis was, to tell the truth, and what could a tyro understand by such a term? When I was a child, though innocent, I knew very well what that word meant. It was the female anatomy, underneath the outerwear. Also, illogically, the underparts of a motor vehicle, *minus* body, a much less interesting meaning. What was a chassis? Well, anyhow, it was definitely stripped down.

A word I particularly like is *deck*,

because it is (a) sensible, (b) short and sweet, and (c) obscure in its hi-fi origin, though I can make easy guesses. In Europe last year I ran into wider uses of *deck*, including the phono or record deck. Why not? If you have a tape deck, then a phono deck is logical, a parallel source of signal; from there you can go to a radiodeck, or, if you will, an FM deck, or AM/FM—cassette.

The idea behind a deck presumably refers to signal level; on ship a deck is equivalent to a story or floor on land,

Turntable Turnaround

Add one to the phono decks I mentioned last month. The new manual-play AR 77XB has come in to replace my ancient one, and yes, it is the same old reliable, with minor but good refinements and an enhanced price, still rating as a “good buy what with inflation” and all that. Newly svelte and compact, newly styled, and it is definitely not bothered by my loose floorboard. Of course, suddenly I miss the auto shut off of the interim replacement; I am recently spoiled.

But in a few days I will forget that easily. I like the slow-damped lift/descend lever, so you do not need to touch the cartridge (though if you don’t pull the lever all the way forward your stylus will catch the table edge). In this deck the arm and turntable are a single unit, isolated on floppy springs from the base itself, and locked together so that the combined unit can move to avoid all kinds of heavy rumble and shock without the stylus jumping free. Clever idea and it still works. But one operational clumsiness must be noted, inherent in this design. You will find that it is sometimes difficult to remove records from the spindle. The close-fitting center holes stick to the shaft and, as you try, the whole arm/chassis unit wobbles around and the record just won’t let go. If you heave too hard, the arm flies up in the air. Careful warping and wedging does the job if you have a bit of patience, and I find this not too high a price to pay in convenience. As for the speed changing, involving taking off the outer half of the table and moving the drive belt from pulley to pulley, it isn’t a problem unless you play alternate 33 and 45 recordings. All in all, this phono



one level among many. In rack-mounted home equipment, a series of “decks” may be mounted one above another, too, for a spatial level. All very harmonious, and we should expand our present usage to any component that is a source of line-level signal from one or another of the basic signal sources, minus “body”, i.e. power amplifiers and speakers. An FM deck, I suggest, is more logical than an FM tuner, since receivers are also tuners. And a phono deck (disc deck, record deck) bypasses “table,” not a very good word for a turning platter. We have too many tables around as it is, from coffee tables to log, tide, IRS, and ours is the only one that spins.

ness must be noted, inherent in this design. You will find that it is sometimes difficult to remove records from the spindle. The close-fitting center holes stick to the shaft and, as you try, the whole arm/chassis unit wobbles around and the record just won’t let go. If you heave too hard, the arm flies up in the air. Careful warping and wedging does the job if you have a bit of patience, and I find this not too high a price to pay in convenience. As for the speed changing, involving taking off the outer half of the table and moving the drive belt from pulley to pulley, it isn’t a problem unless you play alternate 33 and 45 recordings. All in all, this phono

YOU'LL PROBABLY ENJOY YOUR HIGH FIDELITY SYSTEM WITHOUT THE PHASE LINEAR 6000. THE QUESTION IS, HOW WELL?

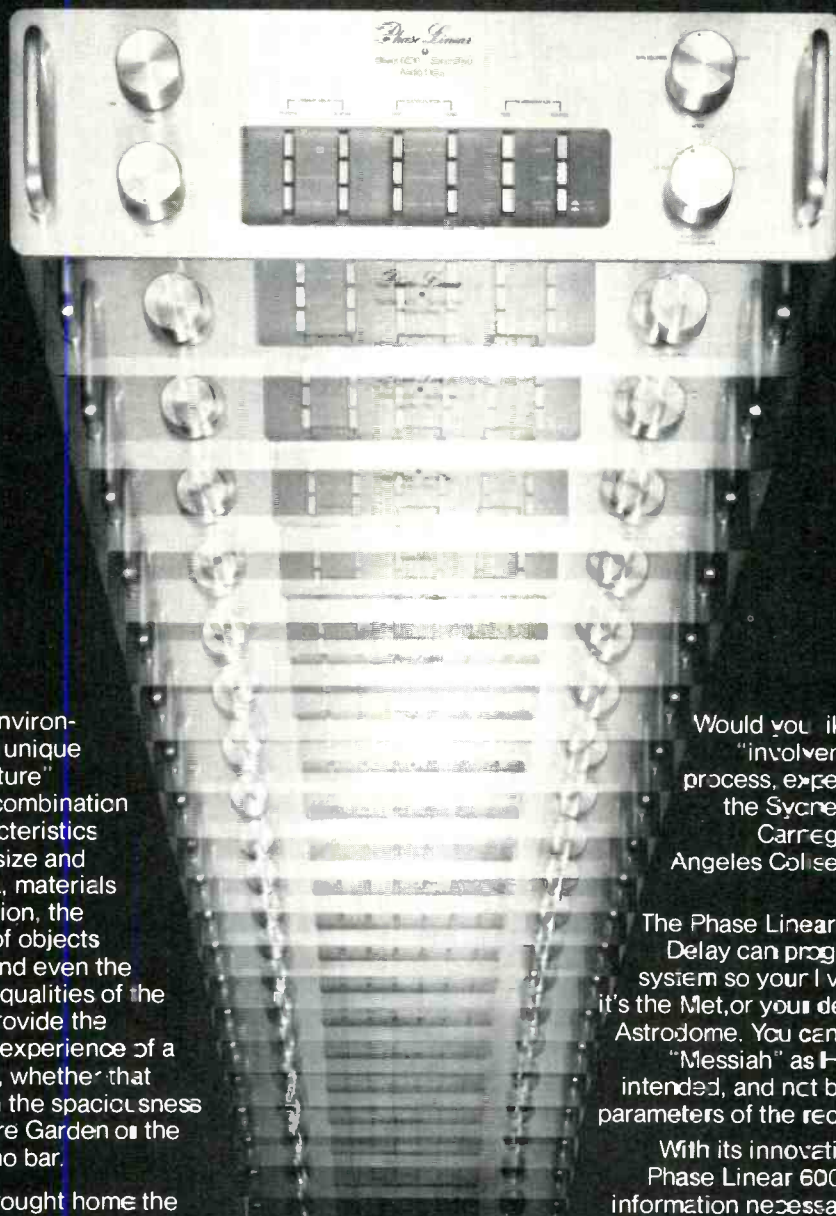

Every listening environment has its own unique "acoustical signature" resulting from a combination of physical characteristics and factors. The size and shape of the area, materials used in construction, the "baffling effect" of objects within the area, and even the sound absorbing qualities of the audience, help provide the spatial and sonic experience of a live performance, whether that performance is in the spaciousness of Madison Square Garden or the intimacy of a piano bar.

Have you ever brought home the recording of a performance you particularly enjoyed, only to feel on playback, that it just was not the same as it was in the flesh? You didn't feel as "involved" as you did when you were there?

You were right. It's not the same.

In fact, much of the sonic and spatial "experience" that made you a part of that live performance was lost in the recording process.

So where does this leave you?

Would you like to regain that "involvement," and in the process, experience La Scala, the Sydney Opera House, Carregie Hall, the Los Angeles Coliseum, or just your favorite disco?

The Phase Linear 6000 Analogue Delay can program your stereo system so your living room thinks it's the Met, or your den thinks it's the Astrodome. You can enjoy Handel's "Messiah" as Handel originally intended, and not be limited by the parameters of the recording process.

With its innovative circuitry, the Phase Linear 6000 recreates the information necessary to reproduce various acoustical environments. Experience in your own home this world of depth and spaciousness that was once unique only to an actual live performance.

In a single page, we cannot begin to describe the Phase Linear 6000 Audio Delay and the technology behind it. For detailed explanation of its operation plus a 20-page Owner's Manual, please send \$2.00 to PHASE LINEAR, Dept. (A-6), 20121 - 48th Ave. W., Lynnwood, WA 98036, USA.

Phase Linear
THE POWERFUL DIFFERENCE

DISTRIBUTED IN CANADA BY H. ROY GRAY LTD. AND IN AUSTRALIA BY MEGASOUND PTY LTD.

deck can hold its place as the ultimate in top performance with starkly basic simplicity, which is a thing many of us still can use. But I did enjoy the good automatic shut off of that temporary unit, a Technics SL-1350.

Cassette Componentry

I mentioned a useful recent type of cassette deck in connection with my work on binaural directionality; it has since proved even more useful to me in many ways and I recommend the type, which now appears—at last—in a number of lines: The battery/a.c. two-channel portable cassette deck. Mine, again, was the JVC KD-2, one of

several in that company's roster of models, and if it is typical of others, then we have an important new operational area here, extending the hi-fi "system" into new uses, joining the basic indoor home facilities to a wide range of peripatetic ("walking around") activities away from the power line.

These decks are generally smaller and lighter than the indoor a.c. cassette decks—which seem to get grossly bigger and bigger every year—and they are set up a bit like a flounder or flat fish, with controls arranged so the unit can be carried on the hip with meters visible, and alternatively set

down flat or at an angle. Mine has a shoulder belt built in, and all basic controls are immediately accessible to either hand in the carrying, which is remarkably easy for such a complete unit. Mikes and/or phones plug into the forward side as needed and an instant battery check on one meter keeps things safely under control in the field. Even with two channels and a larger than hand-held size, the unit will run plenty long thanks to the minimal drain on the batteries required to keep the cassettes turning and the juice flowing.

I should add that, unlike many smaller single-channel portable cassette decks, this type is fully "stereo" in all respects and compatible with any indoor equipment in your system. The "ins and outs" are 100 per cent standard, the two meters are VU, and the levels come out right. Thus, a deck of this portable sort serves very well, too, as an indoor unit, via a.c.—or battery if you are too lazy to hook up the cord—and I have been using mine in that fashion, to take down radio programs, copy off tapes as well as discs, even as an intermediate stage in transferring material from, say, a 15 ips reel-to-reel tape to 7½ ips on the same machine. Quality stands up well in these transfers, all things considered including Dolby/ANRS. You will also find in these decks the same variety of equalization and bias positions that occur on the indoor type of deck, as well as all the usual controls, including a master volume and separate volume controls for each input. There is even a level control for the stereo phone output, to cope with widely different phone characteristics as well as different ears.

Battery Backup

I think what I like best in my cassette portable is a feature now taken for granted in all battery equipment but still new and intriguing to me. Pull out the a.c. cord and the machine just goes right on through use of an automatic battery connection. And the same the other way... if by chance the power fails when you are recording via a.c., you're safe.

Yes (you boat and car people), there is even a low-voltage d.c. power input socket, if you want to save your internal batteries while on board. In my particular deck, though, it is six volt, not 12, for a sensible reason. This allows you to operate with only four D cells, saving both weight and space. I expect that other portable decks, a bit larger and heavier, may offer the 12-volt option out of eight D cells or equivalent. Check for yourself the model of your choice.

"The most musical loudspeaker in my experience"

"Exciting to hear... outperformed its specifications... not a hint of shudder or overload... the most musical loudspeaker in my experience. I have no higher praise for any speaker than that. It out-performs anything of its size at any price in my experience."

PULSE England

"Precise"

"Martin engineers have made a success of an attractive, brilliant and precise loudspeaker, without any fatiguing, colorations or distortions."

HiFi France

Superb speakers
from \$80 to \$600



Gamma 310

U.S.A.
Martin

The sound of perfection

Martin Speaker Div., Eastman Sound Mfg. Co., Inc., Mickleton, NJ 08056 • 609/423-0100

Enter No. 12 on Reader Service Card

AUDIO • April 1978

"Direct" to you from Radio Shack

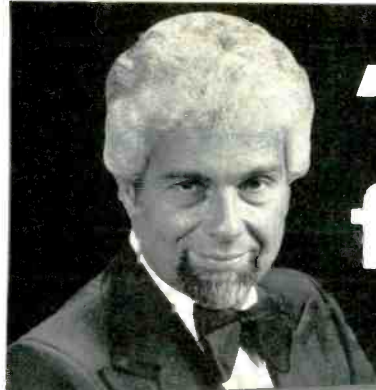

"I'm very impressed with the way Radio Shack has translated latest technology into good looks and precision record playing in the 400."

Peter Nero
Conductor/Pianist

Peter Nero



Realistic® Direct-Drive Automatic... Finest Turntable We've Ever Offered

Features two motors, damped cue/pause, S-shape tonearm, speed controls, \$39.95-value Realistic/Shure cartridge

The LAB-400 makes studio performance both affordable and convenient. The massive die-cast platter rests directly atop a 16-pole brushless DC servomotor. Platter and motor rotate at the same speed, either 33 $\frac{1}{3}$ or 45 RPM. No idler wheels, reduction gears or belts to alter the music that's stored in your record's grooves. The result: wow and flutter is less than 0.03% WRMS and rumble is better than -63 dB (DIN B). The fully automatic tonearm has an effective length of 8 $\frac{1}{16}$ " for flawless tracking down to $\frac{1}{2}$ gram. Handsome walnut veneer base with ultra-modern, slim design. Elliptical-stylus magnetic cartridge and detachable steel-hinged dust cover — significant "extras" that aren't extra. All for \$199.95.*

Fully Automatic Tonearm Operation

You need never touch the tonearm — just select record size and push start switch. An independent motor does the rest, cueing the arm, gently lowering it onto the record, and removing it at disc's end. With repeat mode, cue/pause, anti-skate and tracking force controls.



Two speeds with controls for $\pm 4\%$ pitch adjustment.



Neon light with strobe disc for checking speed.



Low-profile styling with precision shock-mounts to stop acoustic feedback.



These two credit cards honored at most Radio Shack stores.
*Price may vary at individual stores and dealers.

SOLD ONLY WHERE YOU SEE THIS SIGN:

Radio Shack®

A DIVISION OF TANDY CORPORATION • FORT WORTH, TX 76102
OVER 6000 LOCATIONS IN NINE COUNTRIES

FOR
EVERY
SYSTEM
WORTH
MORE THAN
\$500



If you've invested \$500 or even \$5000 in your high fidelity system, read on. Because what we have to say can have a lot to do with the quality of sound you're hearing.

Unfortunately, one of the most overlooked components in a fine sound system is the cartridge. And all too often, it can be the one place where you skimped on quality. (Out of sight, out of mind, as they say).

We sincerely believe that an investment in a Sonus cartridge will truly surprise you with the way it improves the quality of your record reproduction. The analytical quality of the Sonus brings out the inner voices of complex musical passages clearly and cleanly. Listening fatigue disappears. And a Sonus introduces no extraneous coloration of its own.

But what we're talking about is said even better by Sonus owners. "Excellent clarity," "more fulfilling sound," "open, airy 3-D sound," "superb depth and definition," "clean, accurate and transparent sound," are typical of thousands of enthusiastic comments we have received from owners of Sonus cartridges.

Make sure your cartridge matches up to the rest of your system. Write us for further information and the name of the Sonus dealer nearest you.

Manufactured in the U.S.A. by:

SONIC RESEARCH, INC.,

27 Sugar Hollow Rd., Danbury, Conn. 06810

SONUS

High Definition Phono Cartridges

Enter No. 40 on Reader Service Card

Herman Burstein

Tape guide

Optimizing Response

Q. What are your recommendations for optimizing a Tandberg tape deck for use with Scotch tape at 3¾ ips? — Russ Curtiss, E. Hartford, Conn.

A. In the case of any tape deck, I would be inclined to do nothing about a change in bias if the frequency response at 3¾ ips checks out flat within a 2 dB range up to about 13 or 14 kHz. If the treble response does deviate more than this, either upward or downward, adjust the bias until you get a reasonably flat response in record and playback.

Cassette Deck Adaption

Q. I would like to replace the record changer of an old stereo console with a cassette deck even though it doesn't have an auxiliary input for a tape recorder. Could a deck output be adapted to make it suitable for the phono input? — A. Mello, Rutherford, N.J.

A. Chances are that no modification of any kind is necessary as most moderate priced stereo consoles employ a piezoelectric (crystal or ceramic) cartridge and therefore the phono inputs of such units are intended for pickup producing a signal of relatively high voltage and constant amplitude . . . the same kind of signal available at the output of a cassette machine.

If, by any chance, the console has a phono input intended for a magnetic cartridge, then you have to connect the output of the cassette to a point past the stage of preamplification and equalization intended for a magnetic pickup. The appropriate point would likely be at the switch used to select radio, phono, etc.

Erratic Response

Q. I have a KLH Model 41 open-reel, stereo tape deck with a strange problem, in playback the high frequency

response is rather erratic. This problem is not as severe on my own tapes as on prerecorded ones. Some tapes are affected primarily on the right channel, others on the left. When the high frequencies drop out, they can usually be restored for a few seconds by increasing the tension on the pressure pad. Strangely enough, prerecorded tapes sound fine on their first playing. I have tried cleaning and demagnetizing the heads, guides, pressure roller, and capstan. I have replaced the pressure pads, replaced and aligned the playback head, made sure the pressure pads are contacting the heads fully, and checked for tape guide wear. — Edgar F. Scales, Pratt, W. Va.

A. There is a small chance that the span or positioning of your tape guides permits the tape to skew a bit so that the azimuth changes and causes treble loss. Possibly the tape picks up dust and dirt so that it fails to make good contact with the playback head, while a new tape would be clean and make good contact. Also, there might be some metal part in the tape path which you have failed to demagnetize or clean properly.

Tape Storage

Q. How far can I safely store my prerecorded tapes from my tape deck and loudspeakers? — D. Pearson, Salt Lake City, Ut.

A. Ordinarily a distance of as little as three inches will safeguard your tapes from fairly powerful magnetic fields. A separation of six inches or more should give an adequate margin of safety.

If you have a problem or question on tape recording, write to Mr. Herman Burstein at AUDIO, 401 North Broad Street, Philadelphia, Pa. 19108. All letters are answered. Please enclose a stamped, self-addressed envelope.

AUDIO • April 1978

ARE YOU BLAMING YOUR TAPE RECORDER FOR PROBLEMS CAUSED BY YOUR TAPES?

Every day people all over the country go into hi fi dealers with complaints about their tape recorders.

When in reality what they should be complaining about is their tapes.

Because the fact is, a lot of the problems that plague tape recorders can be attributed to bad tape.

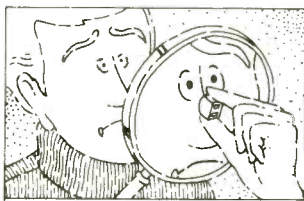

HEAD WEAR IS CAUSED BY YOUR RECORDER. OR IS IT?

If you have to clean your tape heads more than usual, for example, it could be your tape doesn't have a special nonabrasive head cleaner.

Maxell has one.

If your recorder jams, it can be any number of things. Maxell does something to prevent all of them.

We make our cassette shells of high impact polystyrene. And then so they won't crack

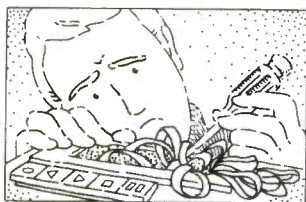

JAMMING IS CAUSED BY YOUR RECORDER. OR IS IT?

even after years of use, we finish them to tolerances as much as 60% higher than industry standards.

Inside, we use free rolling Delrin rollers so the tape doesn't stick.

And finally, we screw instead of weld everything together because screws make

for stronger cassettes.

If your recorder frequently suffers lapses in sound, it could be the tape is of inferior quality. And nobody's bothered testing the tape for dropouts before it leaves the factory.



DROPOUTS ARE CAUSED BY YOUR RECORDER. OR ARE THEY?

Maxell tape is made of only the finest polyesters. And then every



POOR TRACKING IS CAUSED BY YOUR RECORDER. OR IS IT?

step of the way it's checked for even the slightest inconsistencies.

So if you're having problems with your recorder, try a Maxell cassette, 8-track or reel-to-reel tape.

You might find there's really nothing wrong with your tape recorder, just with your tape.

15



MAXELL THE TAPE THAT'S TOO GOOD FOR MOST EQUIPMENT.

Maxell Corporation of America, 130 West Commercial Ave., Moonachie, New Jersey 07074.

Enter No. 23 on Reader Service Card

Behind the scenes

During the 1977 Winter Consumer Electronics Show in Chicago, on one balmy evening when the wind chill factor was a mere 80 degrees below zero, thousands of benumbed, blue-faced conventioners fervently swore ... "never again!" Thus was born the noble experiment of relocating the 1978 Winter Consumer Electronics Show (hereinafter known as the WCES) from the arctic wastes of Chicago to the more salubrious climes of Las Vegas. ...

There were many people opposed to such a move, feeling that the tinsel and glitter, the flesh pots, and gambling hells of Las Vegas would subvert the conventioners, appealing to their baser instincts, and there would be more dollars for dollies than dollars for decibels! Well, the 1978 WCES has come and gone, and from all reports it was a highly successful show, with the attendees surviving Las Vegas with a minimum of financial trauma. Oh, there doubtless are some high rollers

within the industry who tried to "beat the house," and they will be eating beans the rest of the year. The 42,676 people who attended the show represent a new record for this event, and the most general comment was that this was an "order-writing" show, a very nice state of affairs, even if the orders were basically generated by the decline of the dollar abroad. I was laid low by the flu and could not attend the WCES personally, so this report on audio developments at the WCES is through the courtesy of surrogate eyes and ears of friends who were there, and whose observations and comments are completely reliable.

If the last several shows seemed to indicate increased emphasis on separates ... preamps and amplifiers ... then at this WCES the pendulum has started to swing back to receivers. There were new models galore, and the horsepower race continued. Pioneer became the new wattage champion for the moment with their 270-watt-per-

channel SX-1980 receiver supplanting the 250-watt-per-channel Marantz 2500. Pioneer introduced a total of four new receivers and make much of the fact that all of them have direct-coupled amplifiers with low values of TIM. Needless to say, the "brute force" SX-1980 is replete with all manner of "whistle and bell" features in its FM and phono preamp sections, and we will survey them in due time in an *Audio* profile. The Marantz 2500 continues as top dog in that firm's line, which now includes several new lower powered units. Sansui has entered the lists with a 220-watt-per-channel receiver, the G22,000 which has a clever and unique feature in that the amplifier section is a separate module which can be physically removed from the main chassis. Aside from offering flexibility in installation, it is easy to envision Sansui making higher-powered modules available for the customer who wants to upgrade his unit. The Nikko people introduced a 175-watt-per-channel receiver, while Kenwood eschewed the power race and concentrated on refinements in several new receivers. Hitachi introduced a \$400.00 Class-G receiver, the SR-804, a 50-watt-per-channel unit, which brings the firm's line-up of receivers in this class to three. Most of the other receiver manufacturers introduced units at various fairly hefty power ratings. One is bound to say that with the current profusion of high wattage receivers their prospective owners had better be careful in choosing the power-handling capacity of their speaker systems and pay strict attention to the fuse protection available for their speakers. It is odd too that higher and higher powered receivers continue to proliferate at a time when there is a trend toward higher efficiency vented speaker systems! Finally in respect to these super-power receivers, there is going to have to be a re-evaluation of their "bookshelf" mounting. It is a rare bookshelf that can handle a unit 20 inches deep and nearly 80 pounds in weight!

Preamps and Amps

Whatever the situation with receivers, new preamps and amplifiers continue to appear, and the WCES had

Audiophile Group Formed

With the move to Vegas from Chicago, we wondered how many of the little companies that had previously taken rooms in the Bismark would make the trek west. Well, we found them, finally, on the afternoon of the next to the last day of the show in the Westward Ho Motel. And, interestingly, they are in the process of organizing themselves, but let Bert Cohen of Great White Whale tell their objectives:

"The Audiophile Group was formed to present a convenient means for high-end audio dealers and the interested public to see and hear the less well publicized and advertised products that our companies represent."

The coordinators of this enterprise are Bert Cohen, Great White Whale, 348 E. 84th St., New York City 10028, 212/628-1470; Bob Waterstripe, DCM Corp., 2275 So. State Rd., Ann Arbor, Mich. 48104, 313/994-8481, and Bob Coyle, Hervic Electronics, 14225 Ven-

tura Blvd., Sherman Oaks, Calif. 91423, 213/990-2777. Discussions with Cohen and Coyle indicate that these firms do not have the financial wherewithal or personnel to attend and staff booths or rooms at very many consumer or trade shows. By banding together, they hope to get past some of these hurdles. While there are still firms joining the group, the following had shown their interest by press time:

American Audioport, Anglo-American Audio, Audio Analyst, Audio General, Audire, Burhoe, Cizek, Crosspoint, DB Systems, Delphi, Electro-Research, Fidelity Research, Fulton, Great American Sound, Harold Beveridge, H&H, Innotech, Janis, Magnepan, Mobile Fidelity Sound, Oasis, Petroff Labs, Polk, Professional Systems Eng., PS Audio, Qysonic, Ram Audio, Rappaport, RH Labs, Sindell, Snell, Sumiko, Threshold, Van Alstine, Verion, and Win Labs.

—E.P.

To get a superb performance, you need a precision machine.

To command a great performance, a cassette shell and cassette tape must be engineered to the most rigorous standards. Which explains why we get so finicky about details. Consider:

Precision Molded Cassette Shells—are made by continuously monitored injection molding that virtually assures a mirror-image parallel match. That's insurance against signal overlap or channel loss in record or playback from A to B sides. Further insurance: high impact styrene that resists temperature extremes and sudden stress.



Five-Screw Assembly—for practically guaranteed warp-free mating of the cassette halves. Then nothing—no dust or tape snags—can come between the tape and a perfect performance.

An Ingenious Bubble Surface Liner Sheet—commands the tape to follow a consistent running angle with gentle, fingertip-embossed cushions. Costly lubricants forestall drag, shedding, friction, edgewear, and annoying squeal. Checks channel loss and dropouts.

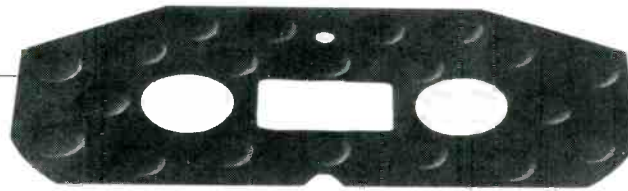

Perfectly Circular Hubs and Double Clamp System—insures there is no deviation from circularity that could result in tape tension variation producing wow and flutter and dropouts. The clamp wedges the tape to the hub with a curvature impeccably matched to the hub's perimeter.



Head Cleaning Leader Tape—knocks off foreign matter that might interfere with superior tape performance, and prepares the heads for...

Tapered, Flanged Rollers—direct the tape from the hubs and program it against any up and down movement on its path towards the heads. Stainless steel pins minimize friction and avert wow and flutter; channel loss.

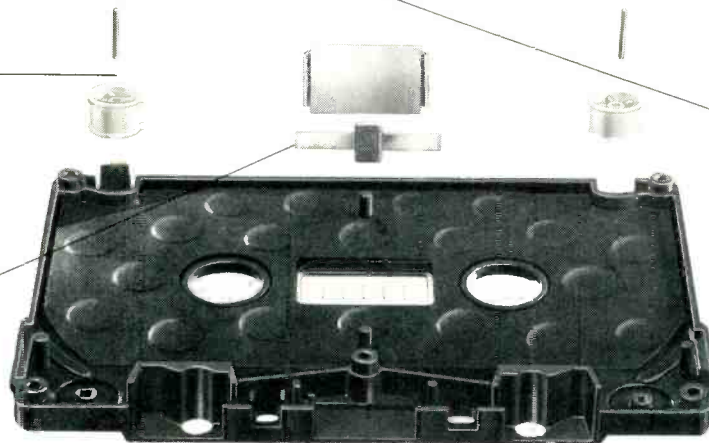

Our famous SA and AD Tape Performance—two of the finest tapes money can procure are securely housed inside our cassette shells. SA (Super Avilyn) is the tape most deck manufacturers use as their reference for the high (CrO₂) bias position. And the new normal bias AD, the tape with a hot high end, is perfect for any type of music, in any deck. And that extra lift is perfect for Dolby tracking.

Resilient Pressure Pad and Holding System—spring-mounted felt helps maintain tape contact at dead center on the head gap. Elegant interlocking pins moor the spring to the shell, and resist lateral slipping.

TDK Cassettes—despite all we put into them, we don't ask you to put out a lot for them. Visit your TDK dealer and discover how inexpensive it is to fight dropouts, level variation, channel loss, jamming, and other problems that interfere with musical enjoyment. Our full lifetime warranty* is your assurance that our machine is the

machine for your machine. TDK Electronics Corp., Garden City, N. Y. 11530. Canada: Superior Electronics Ind., Ltd.

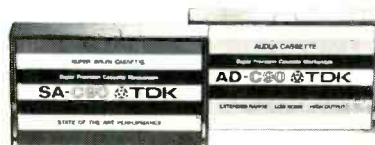

TDK
The machine for your machine.

*In the unlikely event that any TDK cassette tape ever fails to perform due to a defect in materials or workmanship, simply return it to your local dealer or to TDK for a free replacement.

Enter No. 45 on Reader Service Card

ALLISON: FOUR

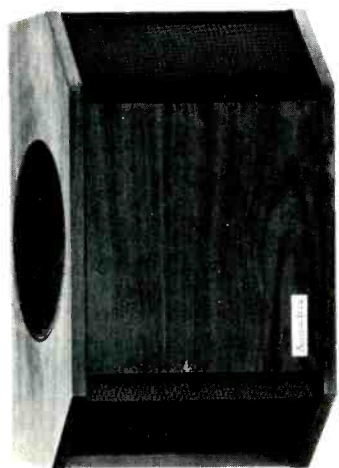

Enter No. 3 on Reader Service Card

Allison dealers are now demonstrating the ALLISON:FOUR, the first "bookshelf" loudspeaker system with Stabilized Radiation Loading. This unique design minimizes the large variations in middle-bass power output produced in conventional systems by reflected impedance from room boundaries. In uniformity of bass power delivered to a real listening room, the new model FOUR's only peers are the larger and more expensive Allison three-way systems.

The FOUR is a two-way system with a crossover frequency of 2,000 Hz. But its extreme low-frequency response is the same as that of the ALLISON:TWO, and it is

*Patents pending

**Higher in the South and West because of freight cost.

fully equivalent to other Allison systems in high-frequency range, smoothness, and omni-directional dispersion in the forward hemisphere.

These factors give the ALLISON:FOUR great flexibility in room placement without performance compromise. It can be placed on a table or shelf, or hung on a wall using the wall-mounting hardware supplied with it. A stereo pair can be located on the same wall, on adjacent walls, or even on opposite walls away from the main listening area; there is no requirement that the systems face toward the area.

The ALLISON:FOUR's price is \$185.00**. Descriptive literature, complete specifications, a statement of Full Warranty, and a list of dealers are available on request.

ALLISON ACOUSTICS 7 Tech Circle, Natick, Massachusetts 01760

a gaggle of new units. Cerwin-Vega were showing their new A-4000 power amplifier, rated at 350 watts per channel with less than 0.02 per cent THD. Price is expected to be \$1200.00, with delivery anticipated in late January. Phase Linear was on hand with technically updated and cosmetically restyled versions of their current line plus the Model 3000, a new preamp and control center, and a blockbuster amplifier, the Dual 500 which puts out 505 watts per channel at 8 ohms! The unit has an LED output metering system and an automatic high/low impedance operating mode, which is said to easily handle loads down to 2 ohms. In spite of the massive output, THD is claimed to be only 0.09 per cent. Price is slated at \$1395.00. Phase Linear was also showing the Model 6000, their entry into the delay line races, which offers initial delays of 15 and 60 mS adjustable to 20 and 90 mS via clock controls, five discrete delay paths, and reverberation delay adjustable from 200 mS to 4 seconds. Price is \$599.95. Nikko finally was showing its intriguing Alpha 5 Class-A power amplifier. Rated at 100 watts per channel, like most of its Class-A brethren it is expensive, at an anticipated \$3000.00 per copy. Hitachi was understandably making much of two new amplifiers which employ metal oxide silicon field effect transistors (MOS FETs) in place of conventional bipolar transistors. The first of their kind in the U.S., the units feature ultra-low distortion. The HMA7500 puts out 75 watts per channel, while the HMA9500 is a 100-watt-per-channel unit with THD of 0.005 per cent. Price on this unit is tagged at \$1350.00. Mitsubishi was showing what they term a "dual monaural" power amplifier, the DA-A15DC, of 150 watts per channel, with THD of 0.01 per cent at rated power. An uncommonly handsome and beautifully finished unit, it has the unique facility of "docking" or mating with companion preamp, preamp/tuner, or power level meter. Controls on these units then regulate the combined devices. Price of the amplifier is \$630.00. A newcomer to the audio scene was Professional Systems Engineering, Inc. of St. Paul, Minnesota. They were showing their Studio One preamp, which uses all discrete Class-A circuitry and claims a phono S/N ratio of 90 dB below 10 mV, and the companion Studio Two power amp, an 80-watt-per-channel unit, all discrete direct-coupled, which features a slew rate of 100 volts per microsecond, making it one of the fastest amplifiers on the market. They claim

TIM is virtually non-existent with a slew rate this fast. The BGW company is well known for its amplifiers, and their new Model 410 is particularly designed for the audiophile, rather than the professional market the firm has usually catered to up to now. The unit has an output of 200 watts per channel, with a claimed rise time of less than 3 microseconds and a slew rate of 40 volts per microsecond. As a consequence, TIM is said to be less than 0.02 per cent from 250 milliwatts to 200 watts. Output monitoring is provided via LED readouts. Winding up news of amplifiers is the most unusual Soundcraftsmen Amp-Qualizer Model EA5003. This is a combination of the Class-H, 250-watt-per-channel "variable" amplifier introduced last year and a 20-band octave equalizer. When one desires to use the unit as a straight amplifier, there is an equalizer defeat switch. Price is \$849.00.

Tape Decks

In the area of tape machines, we have recently had new open-reel units from Revox and Pioneer, and now they are joined by the new Teac A6600, a ¼-track, 2-channel, four-head machine featuring automatic reverse play and automatic repeat play. The A6600 has a two-capstan, servo-motor system, 3¼- and 7½-ips speeds, front panel bias and EQ adjust, and mike/line mixing. Price is \$1300.00. As I'm sure you know, for many years now Superscope has been handling Sony tape machines. As a result of a new arrangement, Sony is marketing the cassette machines, and to celebrate the event they have introduced three new front-loading cassette machines, the top of the line TC-K72 at \$500.00, the TC-K4 at \$280.00, and the TC-K3 at \$220.00. All feature Dolby noise reduction, and the deluxe TC-K72 has such niceties as a direct-coupled amplifier and full-logic solenoid controls. While nothing much seems to be happening with the Elcaset format, Sony also introduced their new EL-4 and EL-7 Elcaset machines, both sporting three motors and three heads. Now that Sony is going to produce Elcaset tape blanks in their Alabama plant, we may see some action with the Elcaset format. The Sony PCM attachment for their Betamax was demonstrated again, but still no hard information as to availability. Hitachi introduced its latest three-head, front-loading stereo cassette machine, the D900. Using a phase-controlled servo motor, the wow and flutter is rated at 0.05 W rms, the unit features full-logic solenoid con-

A system as elaborate or as simple as you want it... but *unique*, no matter how you slice it.

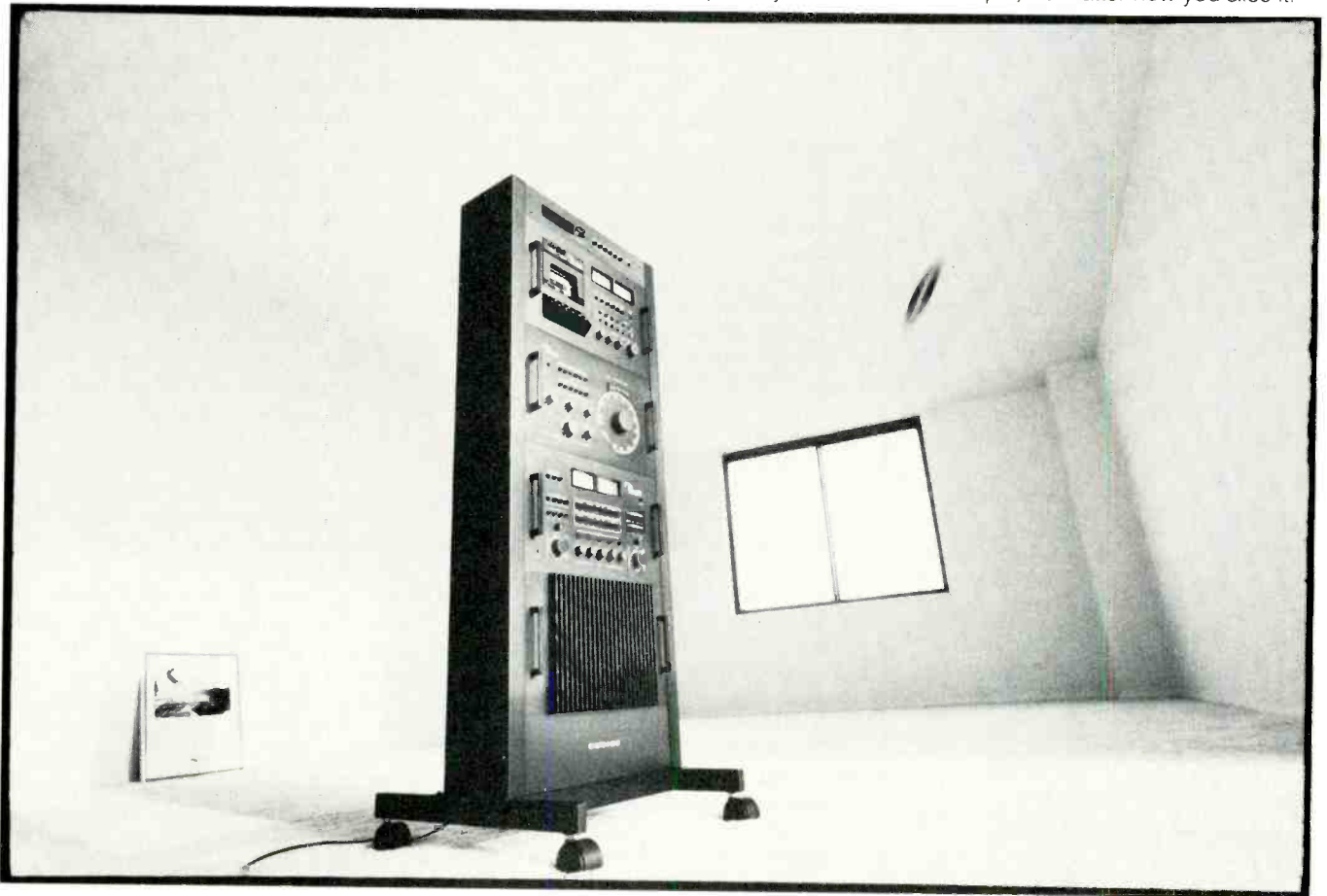

19

System One is not Science Fiction.
It is a distinctly sensible way of putting together
an incomparable high-fidelity system.

The monolithic System One rack features
an integral digital program timer.
Into the rack go varying combinations of
the highly acclaimed Nakamichi 600 Series Components:
the 600 Cassette Console, 630 FM Tuner Preamplifier,
610 Control Preamplifier, and 620 Power Amplifier.

You choose the combination that's best for you.

Strikingly handsome and surprisingly compact—
a source of great pleasure as well as the object
of many unsolicited compliments, we assure you.

Write for more information:
220 Westbury Avenue, Carle Place, New York 11514.



Products of unusual creativity and competence...

Enter No. 25 on Reader Service Card

Once, our G-707 was only the newest tonearm around. Then rave reviews came and music fans went crazy. Never'd heard so much before; couldn't get enough of 'em! So our dealers went crazy, with back orders. Well, we're not the newest anymore; just the most widely imitated! It's flattering, but don't be confused. We make the one with the tube that won't flex, the bearings that don't chatter, and the headshell that damps-out resonance. It also, we are told, brings a fine cartridge "to life" like no other.

It's the same Grace Tracmaster G-707. It's a \$150 bargain. And more people are buying one than ever before? There must be a reason! Isn't it time you should see your Grace Audio Specialist.

"America's only Complete Family
of Component Tonearms and Cartridges"

Winning the Arms Race

Grace TRACMASTER G-707
The Best On Record!
Still.

BROUGHT TO YOU BY **Sumiko**
P.O. Box 5046 / Berkeley, Ca / 94705 (415) 843-4500
Enter No. 44 on Reader Service Card

controls and double Dolby noise reduction to use with the three-head monitoring. Really interesting news is that the Mitsubishi PCM cassette deck would be available in late 1978 at a price tag of less than \$2000.00. The Sharp RT3388 cassette deck with its versatile microprocessor can automatically locate up to 19 selections, has a direct memory function and electronic tape counting, and for all I know it will even clean your windshield! With all this one would expect it to cost more than \$349.95. Lastly in the tape department, I have few details at press time but Discwasher was showing the Denon DR750 cassette deck among many new turntables, tonearms, amps, tuners' and moving-coil cartridges, transformers, and pre-preamps from that estimable Japanese firm. While this front-load, vertically oriented deck uses only two heads, the record/play head has a Sendust tip on a ferrite core. Frequency response for the DR750 using chrome tape is specified as 35 Hz to 18 kHz ± 3 dB, while the preliminary price of \$1565.00 makes it one of the most expensive decks presently on the market.

Speakers

As usual at any audio show, WCES included, there is no dearth of new loudspeakers. Thankfully, among all the numbing conformity of endless arrays of walnut boxes, there is usually something to titillate the jaded ear. From all the reports I've had, Infinity Systems' new Quantum Reference Standard speaker system was far and away the best sound at the WCES. At \$6500.00 per pair (gasp), they should be! For that kind of money, they should be physically imposing, and at 6 feet, 8 inches high by 4 feet wide and 2 feet deep, they are. Each speaker has three electromagnetic induction ribbon midrange units, which cover the range from 100 Hz to 4 kHz. These are aluminum ribbons bonded to ultralightweight plastic membranes, suspended in an intense planar magnetic field. From 4 kHz up, electromagnetic induction tweeters, of similar design to the midrange units, but with samarium cobalt magnets are used. Some 13 of the tweeters are used facing forward in a vertical array, and seven of the tweeters face rearwards to balance the dipole radiation of the midrange drivers. Bass below 100 Hz is handled by a 15-inch, Watkins dual-voice-coil woofer, which must be driven by a separate 150-watt-minimum amplifier. To tie all these elements together is an

electronic crossover and equalization unit. To drive the system above 100 Hz, another 100-watt-minimum amplifier is required. In Las Vegas, a new Infinity amplifier, a tube/solid state hybrid, was used to drive all elements. The frequency response claimed for the speaker system is plus or minus 2 dB from 18 Hz to 32 kHz. That should cover the frequency spectrum of any known program source and then some! I look forward to auditioning these unique speakers.

Another pleasing speaker was the new AR9 from Acoustic Research. This is a four-way system, using five drivers, and is designed to be floor standing, and its there where many speaker builders are placing tweeters on the rear and sides of their enclosures to increase high-frequency ambience, the AR folks have put their two woofers on the sides, which they say, reduces Doppler distortion. The other drivers are placed normally on the front of the enclosure, but are in a vertical line, and this helps give a more accurate stereo imaging. It's a pretty big speaker, better than 52 inches tall, but it's their new top of the line. The price is about \$650.00.

A really far-out speaker was shown by Plasmatronics, Inc. of Albuquerque, New Mexico. You may remember the Ionovac "ozone" tweeter, and this system appears to work on a variant of that principle. Helium gas is used here and ionized with a built-in Class-A tube amplifier. The significant difference with this "plasma" driver is that it operates from as low as 500 Hz; a conventional bass driver is used for frequencies below 500 Hz. This surely is an exotic bird, and I'd like to hear it some day. ESS finally has their full-range Heil "Transar" speaker in production at a reported price of \$3250.00 per pair. What I've heard of the units thus far have not been under ideal conditions, and I'd have to live with them a while before I venture an honest opinion. Interesting they most certainly are! Reports are that this system sounded pretty good, though again this is a large economy size unit.

Space precludes mention of many other items, but I am intrigued with Analog and Digital Systems ADS 10 Acoustic Dimension Synthesizer. This combines a digital time delay unit, with built-in 100-watt-per-channel amplifier and two specially configured speakers for ambience or full amplitude rear channel generation. Price is said to be less than \$1000.00. Δ

Why you should consider the new Garrard GT35 if you're thinking Dual or B.I.C.

We'll say it straight out. The new Garrard GT35 is the best all-around turntable anywhere near its price. Let's do some direct comparing.

Start with the motor. The Dual 1245 features a fine 8 pole, synchronous motor and the B.I.C. 981, a 24 pole, synchronous unit.

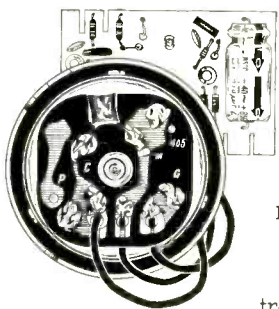

The new Garrard GT35 incorporates a servo-controlled, DC motor.

Servo control provides absolutely steady speed. The motor, (and thus the rotation of the platter), is immune to fluctuations in household voltage or frequency. Len Feldman, writing in *Radio Electronics*, reviewed it as a "significant breakthrough" superior to the "synchronous motor however many poles it might have." The GT35 is the only, belt-driven, single/multiple play turntable in the world with a servo-controlled, DC motor.

Chalk one up for the new Garrard GT35.

Now for the tonearm. Remember that the delicate stylus, as it traces the groove, bears the full weight of the tonearm. The heavier the tonearm, the greater the wear on the record and stylus. Light is right. The effective mass of the GT35

tonearm (measured with a Shure M95ED cartridge, tracking at 1¼ grams) is a mere 20.4 grams. That's lighter than the tonearm of the Dual 1245 at 27.5 grams or the B.I.C. 981 at 25.6 grams. In fact, the new Garrard GT35 has the lightest tonearm of any single/multiple play turntable.

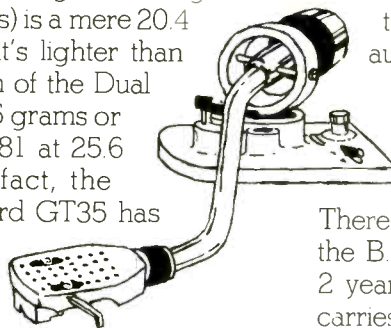

Chalk up one more for the new Garrard GT35.

The Dual, B.I.C. and Garrard all protect your records as only fully automatic turntables can. And all provide the convenience of multiple play. But only the new GT35 boasts the patented Delglide® system. Unlike the Dual and B.I.C. automatic mechanisms, Delglide is driven by its own belt and is located directly under the tonearm.



Tonearm control is by simple rotary action. It's no wonder that *Radio Electronics* said, "...the pick-up arm is handled more gently than could

be done by the steadiest of hands." We make this claim: Delglide is the smoothest and quietest automatic system ever incorporated in a turntable—of any kind.

That's still another one for the new GT35.

There's more. The Dual 1245 and the B.I.C. 981 are warranted for 2 years. The new Garrard GT35 carries an unprecedented 3 year warranty. That's our way of underscoring its exceptional reliability.

Finally. The price advertised by the manufacturer. Including the base and dust cover, the Dual 1245 is \$240 and the B.I.C. 981, \$237. The price of the new Garrard GT35: just \$219.95.

The GT35: a "breakthrough" motor, the lightest tonearm, the smoothest and quietest automatic system and a 3 year warranty.

Consider the GT35. If you're thinking Dual, or B.I.C. Or Technics. Or Pioneer. Or Sony. Or ...



Garrard
The turntable specialist.

For a free brochure, write:
Garrard, Division of Plessey Consumer Products, Dept. C
100 Commercial Street, Plainview, N.Y. 11803.

Enter No. 15 on Reader Service Card

What's new

Martin Research Test Comparitor

The Model 101 A/B Test Comparitor provides convenient A/B listening test between two stereo pairs of speakers

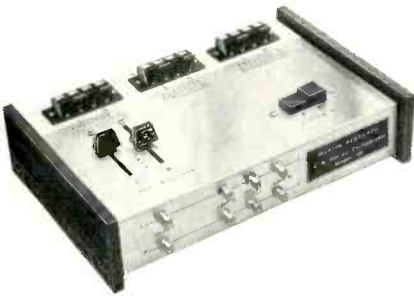

22

or between two stereo amplifiers or receivers for equipment reviewers, professional engineers, audio dealers, manufacturers, and serious hobbyists with a simple means of performing subjective evaluations, needed to compliment other measurements. For A/B testing of speakers the unit accepts any common line-level signal such as tuner or tape deck, while source and amplification unit are connected to phono jacks on the comparitor by ordinary patch cords. Speakers are connected to the test unit by ordinary speaker wire at convenient terminals on top. Since speakers usually have differing efficiencies, especially when made by differing manufacturers, a pair of slide pots permit adjustment of level coming into the amplifier so that the speaker pair can be judged at exactly the same loudness level. A calibrated scale indicates difference of relative efficiency in dB between the two pairs. Unlike a control in a speaker line, which could provide the necessary equalization, the pair of slide pots will not affect either speaker's damping factor, eliminating the danger of an impedance mismatch. For A/B testing of amplifiers, the comparitor's A/B system selector switch automatically disconnects the input signal of the amp not being fed to avoid possible damage to that unit. Price: \$49.50.

Enter No. 100 on Reader Service Card

Pyramid Loudspeaker

The Metronome 2+2W Loudspeaker system features linear periodic diffraction for accurate imaging in a multi-driver configuration. It has acoustic phase coherence, very low impulse response recovery time (time energy smearing), dynamic range capability, with minimum distortion, equal to the best dynamic range available on recorded source material 70 dB. A stereo pair of these speakers will produce an instantaneous sound pressure level of 115 dB at four meters in a living room measuring 16 x 22 x 9 ft. with a 500-watts-per-channel amplifier. There is an 8-in. acoustic suspension woofer with a 6-in. piston, a 4½-in. loaded cavity midrange with a 3-in. piston, and a 2-in. loaded cavity

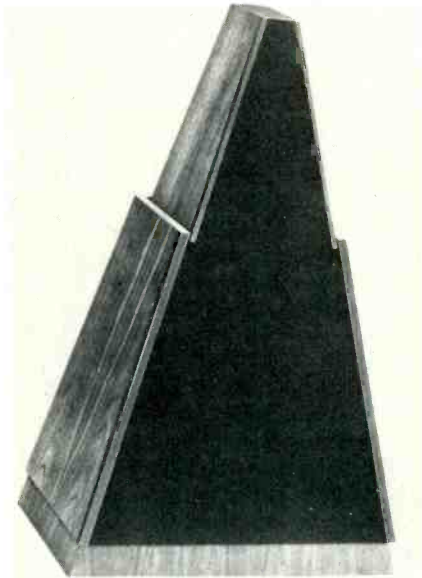

tweeter with a 1½-in. piston. The crossover frequencies are 70 Hz for the woofer, 250 Hz for the midrange, and 5 kHz for the tweeter. The crossover consists of air core inductors-mylar capacitors; slope is the first order network (6 dB per octave), and constant resistance is "Q" controlled. The specified frequency response is from 28 Hz to 18 kHz, ±3 dB; THD and IM distortion is 1.0 per cent from 1.8 kHz through 4.5 kHz; recommended amp power rms is 150 watts minimum and

500 watts per channel maximum, and sensitivity is 1 watt/1 meter/88 dB SPL pink noise. Price: \$2300.00.

Enter No. 101 on Reader Service Card

Mura Microphone

The Model DX-20V slim-line microphone with cardioid response has high- or low-impedance sensitivities of -56 dB or -74 dB, and a frequency response of 60 to 15,000 Hz. Its uni-directional cardioid pattern minimizes noise and acoustic feedback, and having dual impedance capabilities, can be used as either a 600-ohm or 50,000-ohm transducer. Also featured is a 20-ft. shielded foot cable, a standard ¼-in. phone plug, and an on-off mike switch. Price: \$49.95

Enter No. 103 on Reader Service Card

Phase Linear Power Amplifier

The Dual 500-Series Two power amplifier is rated at 505 ave. watts per channel minimum into 8 ohms, 20 Hz - 20 kHz, with a THD of 0.09 per cent. The power semiconductor complement is rated at 8000 watts. Also



featured are an LED metering output system, individual channel controls, high/low impedance operating modes automatically or manually activated to handle loads down to two ohms, and high frequency limiters. Price: \$1,349.95.

Enter No. 104 on Reader Service Card

ADI Equaliser

The Type 1500 dual-channel, automatic graphic equaliser provides for control of acoustics, elimination of feedback, and adjustment for perfect response. Featured are a precision pink-noise alignment source; red and



THE UNBIASED TRUTH FOR EVERY BIAS POSITION.

The truth is clearly seen in every Scotch® Master™ Cassette, thanks to our see-through cassette shell. It lets you watch the inner workings of the cassette. And it shows you the mechanical improvements that make for true, pure sound, no matter what switch position you prefer.

Normal Bias Recording. Our Master I Cassette features an excellent dynamic range, low distortion, uniform high frequency sensitivity and output that's 10 dB higher than standard tapes.

Chrome Bias Recording (70 microsecond equalization). Our Master II Cassette features some spectacular performance characteristics, including a special coating that gives it a 3 dB better signal-to-noise ratio at low and high frequencies than chrome cassettes.

Ferri-Chrome Bias Recording. Our Master III Cassette is formulated with the most advanced technology available, giving a 3 dB output improvement at low frequencies and

2 dB at high frequencies. The unique dual layer construction increases both low and high frequency sensitivity over chromium dioxide and ferric oxides.



**SCOTCH® RECORDING TAPE.
THE TRUTH COMES OUT.**

Enter No. 49 on Reader Service Card

green LEDs; low-noise and low-distortion, doublepole, Butterworth, active octave bandpass filters to ANSI standards, and digital comparator circuits. Range is ± 12 dB. Frequency response for equaliser out is ± 0 dB d.c. to 250 kHz; equaliser in is ± 0.5 dB 25 Hz to 22 kHz, ± 1.5 dB 20 Hz to 26 kHz. Noise is -104 dB ref. to max. output, -82 dB ref. to 0 dBm; THD less than 0.05 per cent @0 dBm, 20 Hz to 20 kHz; maximum input +30 dBm, maximum output +22 dBm at clipping; input gain -50 dB to +12 dB; input impedance 10 kilohms, output impedance 250 ohms. Price: \$795.00.

Enter No. 105 on Reader Service Card

Miller and Kreisel Passive Crossover Network

The LP-1 is a totally passive crossover network designed to follow a high-quality preamplifier to provide separate drive for both a sub-woofer driven by one power amplifier and mid range/high frequency speakers driven



by another power amplifier. It has no transmission loss in its pass band, and provides 12-dB-per-octave cutoff rate in going from low pass to high cutoff; and 18 dB per octave from high pass to low cut-off. The unit avoids the necessity of adding further stages to an excellent amplifier-preamplifier chain while still providing the dynamic range advantages of bi-amping. Price: \$120.00.

Enter No. 106 on Reader Service Card

Rack-It Racks and Consoles

These equipment racks are 45 in. high x 17 in. deep. One rack, with three adjustable shelves, will accept equipment up to 24 in. wide, while the 19-in.

rack will accommodate 38½ in. (22 rack spaces) of standard rack size equipment. The tape console will accept any tape machine up to 19 in. wide x 21 in. long, and has a shelf for tape and accessory storage. Finished in dark walnut formica, they all have 2½ in. ball type casters. Price: \$180.00 each.

Enter No. 107 on Reader Service Card

Technics Cassette Deck

The Model RS-631US cassette deck features a memory autoplay incorporating rewind autoplay, memory rewind, and an automatic stop; a pair of VU or peak-check meters; a Dolby



system; MPX filter; an HPF head; fully automatic stop, and a timer stand by system. Also featured is an FG servo motor, muting circuitry, cue/review, separate outputs, and mixing of microphone and line inputs. The frequency response is 30-17,000 Hz with CrO₂ and FeCr tapes and 30-14,000 Hz with normal tapes. Wow and flutter is 0.06 per cent W rms, and the S/N ratio is 67 dB with Dolby in and 57 dB with the Dolby out. Price: \$299.95.

Enter No. 108 on Reader Service Card

Brady Catalog

The free, 12 page, illustrated catalog is designed to aid in the selection of splicing and sensing tapes. It includes information and specifications on Brady splicing, cueing, and sensing tapes for audio and video cassettes, 8-track cartridges, and duplicating masters.

Enter No. 109 on Reader Service Card

Analog Engineering Amplifier

The Model A-620 power amplifier is rated at 325 watts at any frequency from 5 to 40,000 Hz with no greater than 0.05 per cent IM distortion at any power from ¼ watt to rated power. The unit has a slew rate of 65 V μ S which will drive loads as low as 1 ohm without the need for forced air fan cooling, and has a damping factor of 500 at 1 kHz. It features peak-following power output meters, calibrated in watts into 8 ohms, converted into linear dB in two scales that are switchable from ½ watt to 50 watts and 0 dB as 5 watts extending to 500 watts at

+20 dB; two large light emitting diodes mounted on the meter face to indicate short term transients or high power conditions; a power On/Off switch, and a reset switch for the electronic amplifier/speaker protector circuit. Price: \$1220.00.

Enter No. 110 on Reader Service Card

Qysonic Loudspeaker

The Array loudspeaker has two 8-in. low-frequency drivers, one 4½-in. mid-frequency driver, one 2-in. high frequency cone, and one 1-in. high frequency dome. The specified frequency response is 30 Hz - 23,000 Hz ± 2 dB, impedance is 6 ohm nominal, power requirements are a minimum of 20 watts ave./channel, and power handling is 85 watts continuous input. Price: \$425.00.

Enter No. 111 on Reader Service Card

CSC Catalog

A new, free, 12-page catalog describes CSC electronic prototyping, development, and testing hardware, including hand-held logic probes and matching digital pulser; MAX-100 frequency counter and accessories; Quick Test, Experimentor, Proto-Board solderless breadboards; Design Mate test instruments and matching blank cases; Proto-Clip IC test clips, and clip-on IC logic monitors.

Enter No. 112 on Reader Service Card

Teac Open-Reel Deck

The A-6600 open-reel tape deck is a ¼-track, two-channel, four-head machine with full IC logic control, automatic reverse using sensing foil, and automatic repeat play. Features include a two-capstan servo tension system, 20-dB microphone attenuator,



cue control, automatic space and individual microphone and line controls for each channel, two-position bias and equalization selectors, VU meters, independent input-level controls, an output level control, and left- and right-channel record mode selectors. Price: \$1,300.00.

Enter No. 113 on Reader Service Card

For about \$15 you can buy the only total record care system or something less.

You have a choice. You can buy a fancy handled record cleaner. Or, for about the same money, you can have the only total record care system there is.

That is, our new Sound Guard™ record cleaner and our famous Sound Guard® record preservative. Both in one package.

The Sound Guard™ Total Record Care System.

With it, you do more than clean everything off your favorite records from dust particles to oily fingerprints.

You actually protect your record's life with a microscopically thin, dust-resistant patented lubricant.

If you want the most for your \$15* (and

the best for your records), you have to have the only total record care system there is.

Like all Sound Guard products, the Sound Guard Total Record Care System is sold in audio and record outlets.



*Suggested retail price.



Sound Guard® keeps your good sounds sounding good.



Sound Guard preservative—Sound Guard cleaner—Sound Guard Total Record Care System
Sound Guard is Ball Corporation's registered trademark. Copyright © Ball Corporation, 1978. Muncie, IN 47302

THE STRANGE SHAPES OF KEF



The famous B139 Bass Driver.

Flat-fronted and elliptical.

Do you know why? The new Model 105.

Each drive unit has its own, curiously shaped compartment.

Do you know why? The Cantata.

It's tall, narrow, and we've positioned the mid-range unit *above* the tweeter.

Do you know why?

Here are some of our expert KEF dealers who can help you with the answers.

Call in and get your entry form right away.

Arizona Audio Ltd., Phoenix, AZ.
Stereo Showcase, Sacramento, CA.
Paris Electronics, Los Angeles, CA.
Sound Systems, San Francisco, CA.
Sound Track, Arvada, CO.
Greenwich Stereo, Riverside, CT.
Harbor Sound, New London, CT.
New England Audio, New Haven CT.
Audio Excellence, Longwood, FL.
House of Stereo, Jacksonville, FL.
Sound Components, Coral Gables, FL.
Victor Stereo, Chicago, IL.
Wilson's Audio, New Orleans, LA.
Natural Sound, Framingham, MA.
K & L Sales Corp., Watertown, MA.
Audio Dimensions, Birmingham, MI.
Sight & Sound, Morristown, NJ.
Eastern Audio, Morristown, NJ.
Hi-Fi House, Albuquerque, NM.
Ear Drum of New Jersey, Nanuet, NY.
Electronic Workshop Sales, New York, NY.
Gordon Electronics, Syracuse, NY.
Lyric Hi-Fi, White Plains, NY.
The Listening Room, Scarsdale, NY.
The Speaker Shop, Buffalo, NY.
Barclay Rec. & Elec., Narberth, PA.
Definitive Systems of Newport, Newport, RI.
Hillcrest High Fidelity, Dallas, TX.
Audio Associates, Falls Church, VA.
Stereoland, Federal Way, WA.
Audiophile Sound Studio, Middleton, WI.



Enter No. 19 on Reader Service Card

Speaker Authority Dies

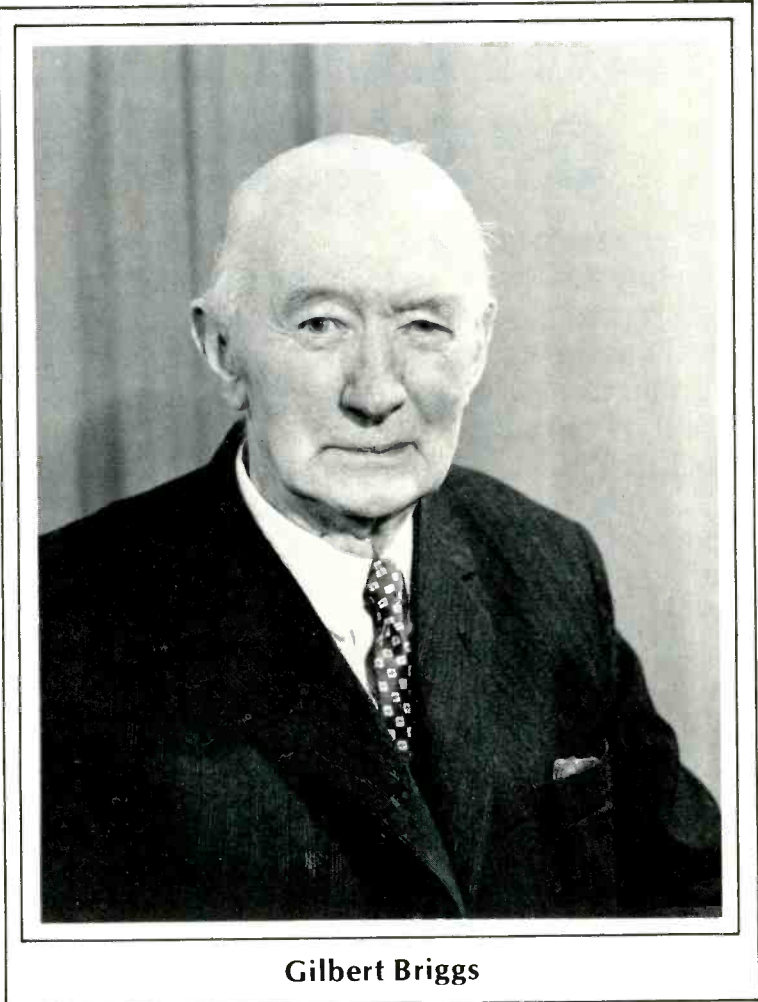

Gilbert Briggs

Audio pioneer Gilbert Briggs died at his home in Ilkey, Yorkshire, England, on January 9th at age 87. His books on sound reproduction contributed, in no small way, to the growth of the audio industry. His best known book was "Loudspeakers, The Why and How of Good Reproduction." Other works included "Audiobiographies," "Sound Reproduction," and "Pianos, Pianists and Sonics." These books were eventually translated into many languages, including Japanese. A kind and gentle person with an endearing sense of humor, his books were a pleasure to read.

The founder of the Wharfedale Loudspeaker Company in 1932, he was a generous person to work for. I will remember when I was the technical

director at Wharfedale, some 15 years ago, one of my engineers asked the company accountant for an advance on his salary so that he could make a deposit on a car. The matter was referred to Mr. Briggs who then asked me whether the man was a good engineer. I replied that he was and Mr. Briggs replied, "I'll give him the money to buy a car," which he did. At the time of this incident there were fewer than 200 employees at Wharfedale, and Mr. Briggs knew every one of them by name. I would often find him on the assembly line asking the men about their families, and he made sure that everyone received a gift at Christmas.

He will be greatly missed by his many friends all over the world.

George W. Tillett

AUDIO • April 1978

THE STRANGE SHAPES OF KEF.

An exciting, entertaining and educational competition. You could win a pair of speakers worth \$1000!

You probably know of KEF as one of the world's leading authorities on loudspeaker design.

But do you know why KEF pioneered the use of Digital Analysis in measuring loudspeaker performance, starting in 1971?

Do you know why KEF also pioneered the use of many new materials, for example, Bextrene, used by KEF for loudspeaker cones, instead of the conventional paper material, ever since the early sixties?

Do you know why the celebrated KEF B139 flat-fronted elliptical bass driver is the shape it is?

Or why the new Model 105 has those individual compartments for each drive unit?

And why we positioned the mid-range unit above the tweeter (instead of the other way round as in conventional speakers) in our highly successful Calinda and Cantata systems?

Here's how to find out how your ideas on speaker design match up with those of our experts.

Stop by at your nearest KEF dealer, and ask for an entry form for our new competition. It contains a lot of very interesting questions, and the answers are quite

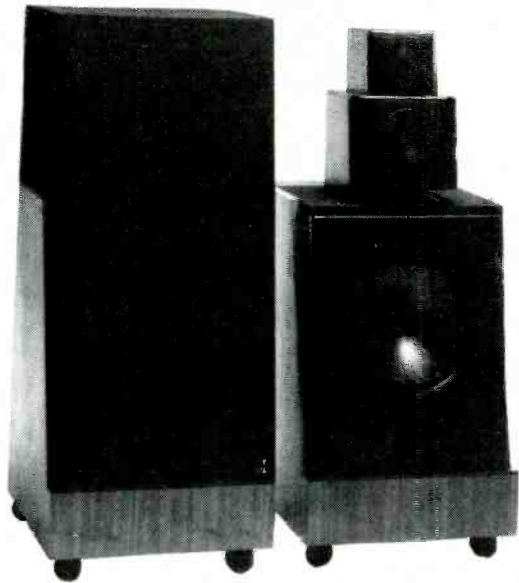

THE NEW MODEL 105.

straight-forward when you know the facts.

Your dealer can give you leaflets and other information to help you.

Then send in the completed form to reach us by no later than 30 May 1978.

The best all-round entry, judged by an expert panel, will receive a prize of a pair of Cantata loudspeakers, worth \$1000. And the five best runners-up will each receive a \$100 gift voucher to spend on their next purchase of KEF equipment from their helpful dealer.

Are you the one who knows all the answers? Hurry to your KEF stockist and we're pretty certain you'll learn something new about loudspeaker design.



THE CANTATA.

KEF ELECTRONICS LTD.,
US DISTRIBUTORS INTRATEC, PO BOX 17414, DULLES INTERNATIONAL AIRPORT,
WASHINGTON DC 20041.



THE QUEEN'S AWARD
TO INDUSTRY



Enter No. 19 on Reader Service Card

AmericanRadioHistory.Com



Tape Slitting & Edge Quality

Wayne Saylor*

* Audio Engineer,
Memorex Corporation,
Santa Clara, Calif.

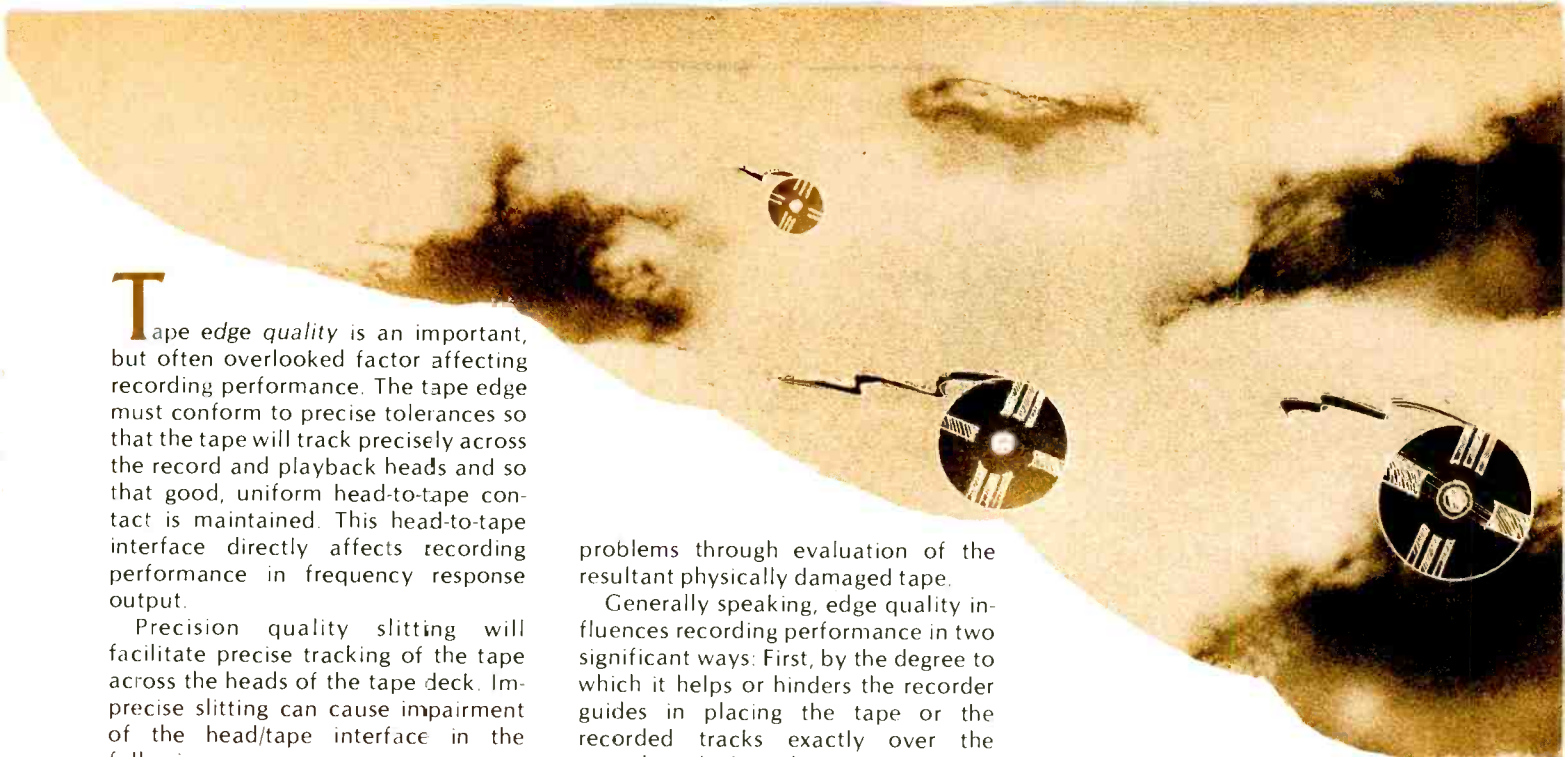

Tape edge quality is an important, but often overlooked factor affecting recording performance. The tape edge must conform to precise tolerances so that the tape will track precisely across the record and playback heads and so that good, uniform head-to-tape contact is maintained. This head-to-tape interface directly affects recording performance in frequency response output.

Precision quality slitting will facilitate precise tracking of the tape across the heads of the tape deck. Imprecise slitting can cause impairment of the head/tape interface in the following ways:

1. Loss of head-to-tape contact caused by debris from poor slitting results in loss of output, which is greater at higher frequencies.

2. Loss of head-to-tape contact caused by curvature, resulting in poor contact or head-to-tape separation on one edge of the tape relative to the other edge. This results in a different frequency response and output between the two stereo channels. The edge track (left channel) will usually have more output fluctuation.

3. Tape travel relative to the head in other than a purely longitudinal direction. This causes the recorded tracks to not entirely traverse the full width of the playback head gaps.

4. Azimuth errors due to curvature resulting in loss of output proportional to frequency (the higher the frequency, the greater the loss).

Effects of Slitting Deficiencies

Before discussing the specific ways in which edge quality affects recording performance, it must be noted that the symptoms (especially the physical symptoms) of poor edge quality are similar, if not identical, to many of the symptoms of consumer tape deck guiding, transport, and tape handling problems. The following discussion is made assuming the tape is being played on a machine with ideal tape handling (i.e., heads are properly aligned, guides are not worn, and tensions and brakes are in good condition).

For an in-depth discussion of tape deck transport problems, refer to "Cassette Transport Problems" in the September, 1974, issue of *Audio* magazine. The article, written by the Memorex Audio Tape Plant Manager, describes how to recognize transport

problems through evaluation of the resultant physically damaged tape.

Generally speaking, edge quality influences recording performance in two significant ways: First, by the degree to which it helps or hinders the recorder guides in placing the tape or the recorded tracks exactly over the record or playback heads for accurate signal performance, and, secondly, by the amount of debris produced. Poorly slit tape contains oxide residue from the slit edge when the tape is new and will generate more debris as the fractured, rather than sheared, edge deteriorates (see Fig. 1). During playback, this debris will speed up residue accumulations on the head and transport mechanisms, causing signal loss due to separation of tape-to-head contact.

Reason Tape Must Be Slit

Magnetic recording tape is coated much wider than the ¼-inch width (0.150 inch for cassette) used on consumer tape decks and therefore has to be slit to the appropriate width, depending on the application. Slitting is the tape manufacturing step that determines edge quality.

Magnetic tape consists of a layer of highly specialized oxide coated onto a clear polyester base film. The base film used in the coating process is usually either 12- or 24-inches wide, depending on the width of the coating machine being used. The length of the base film is at least 7,500 feet; sometimes multiples of 7,500-foot lengths are used. A roll of base film 7,500 feet in length by 12 or 24 inches in width coated with magnetic oxide is called a *web*.

The oxide coating consists of the oxide powder together with the polymeric system which binds the oxide particles together and to the base film. During the coating process, the oxide mixture is liquified with solvent along with such additives as lubricants, plasticizers, and dispersants or wetting agents.

Immediately following the coating process and oven drying, the coated

web is "calendered." Calendering is a surface treatment and oxide compaction process used mainly to obtain a smooth, highly polished tape surface which is necessary for good output, especially at the higher frequencies. Following calendering, the web must be slit into individual tape widths so that the tape can be loaded either into cassettes or onto reels.

The Slitting Process

Strictly speaking, "slitting" refers to the single manufacturing step of shearing the coated web into exact 0.248- or 0.150-inch widths. The slitting process should, however, be considered as three inter-related steps forming a continuous process (see Fig. 2):

1. The *unwinding* of coated web and in-feed to the slitter blades.

2. The *slitting* of the tape with the slitter blades.

3. The *winding* of slit tape onto take-up hubs.

Imprecise performance in the first or third step can also have negative effects on slitting quality. Quality tape manufacturers constantly monitor the slitting process and inspect the tape slit to insure that all three slitting steps are being performed correctly within close tolerances (see Fig. 3). Typical width tolerances for cassette and open reel tape are +0.000 inch and -0.002 inch. Within the slitting process, there are three critical factors that determine tape edge quality. They are the *tracking* of the tape in and out of the blades, *blade geometry*, and *control of tensions* and speed.

Tape Tracking

The entire slitting process, from the unwinding of the web through the

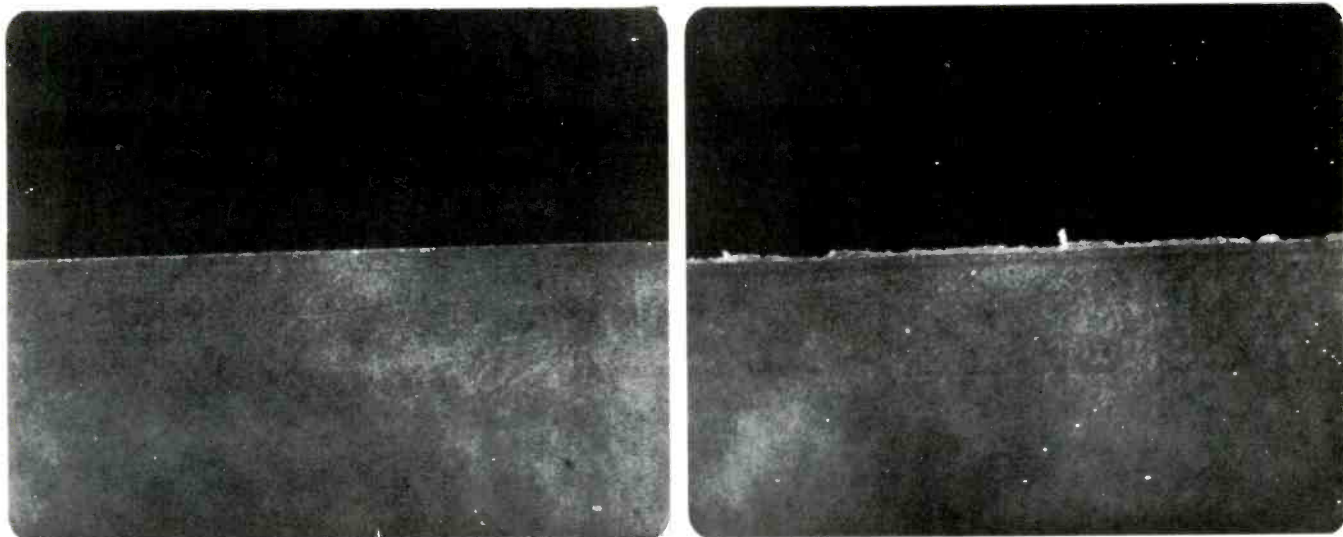

Fig. 1—Tape edges compared. Precisely slit edge (left) contrasts with poorly slit edge (right) when each edge is magnified 200×.

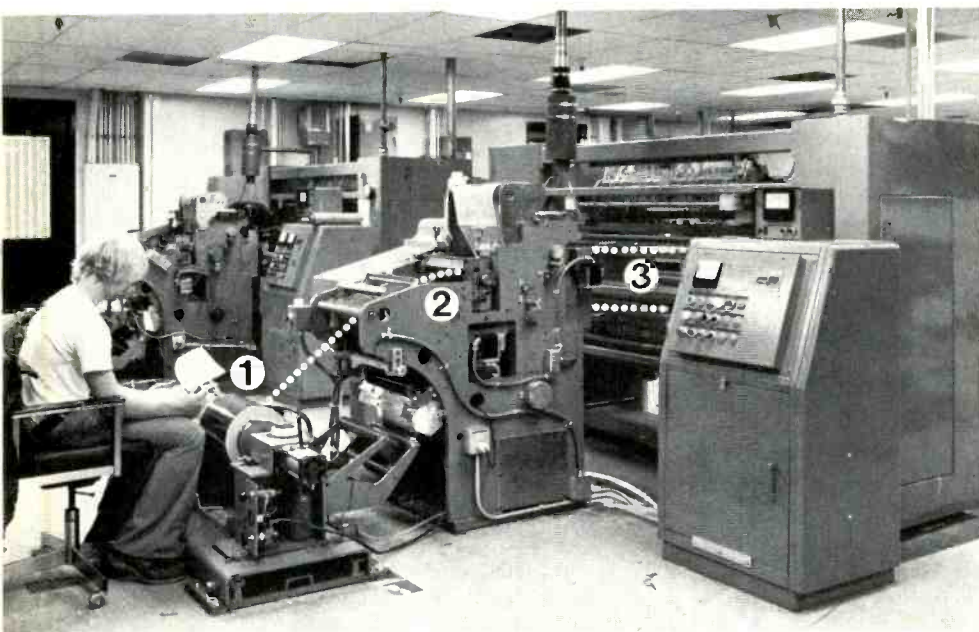

Fig. 2—In slitter operation, tape is unwound from the web (1), transported through blades (2), with slit tape drawn past guides (3), and wound onto pancakes on the far side of the machine. An operator monitors the web during this operation.

Fig. 3—Memorex maintains a quality control station next to the slitters where operators regularly check edge quality with a microscope. The photographs posted over the microscope illustrate acceptable and unacceptable degrees of edge quality to aid operator in determining quality.



take-up of slit tape onto hubs must be performed as a single, straight, smooth, and even-tensioned motion. Fluctuations in tape movement result in tape which is not cut straight or which is torn or stretched, each of which will significantly affect the record and playback performance.

Blade Geometry

The slitter is a shearing mechanism utilizing pairs of circular knives for continuous, rotary-shear cutting. To slit a 12-inch web into 80 widths of cassette tape or 48 widths of open-reel or 8-track tape, 81 or 49 pairs of blades are used respectively (see Fig. 4). The blade pairs cut the tape in a manner similar to the way scissors cut. The fact that they are circular and rotate merely allows the two blades of each pair to maintain positive edge contact near the periphery continuously, while slitting the entire length of the web at high speed. The shearing or cutting is done where the two blades of each pair intersect on the periphery of the blades (see Fig. 5). The sides of the two blades of each pair not only actually touch during slitting, but additionally, a pressure is applied in the direction of the axis of rotation to insure that the two blades of each of the 81 or 49 pairs actually make positive contact at all times. This is referred to as *blade side loading*. Because of critical cumulative and mechanical dimension tolerances in the assembly (consisting of the pairs of blades), tape is slit from 12-inch, rather than 24-inch width, webs. The blades, made of hardened tool steel, must be ground to exact dimensions and must be precisely assembled on the shafts of the blade set so that contact between all pairs is uniform. Cleaner shear is obtained with lower

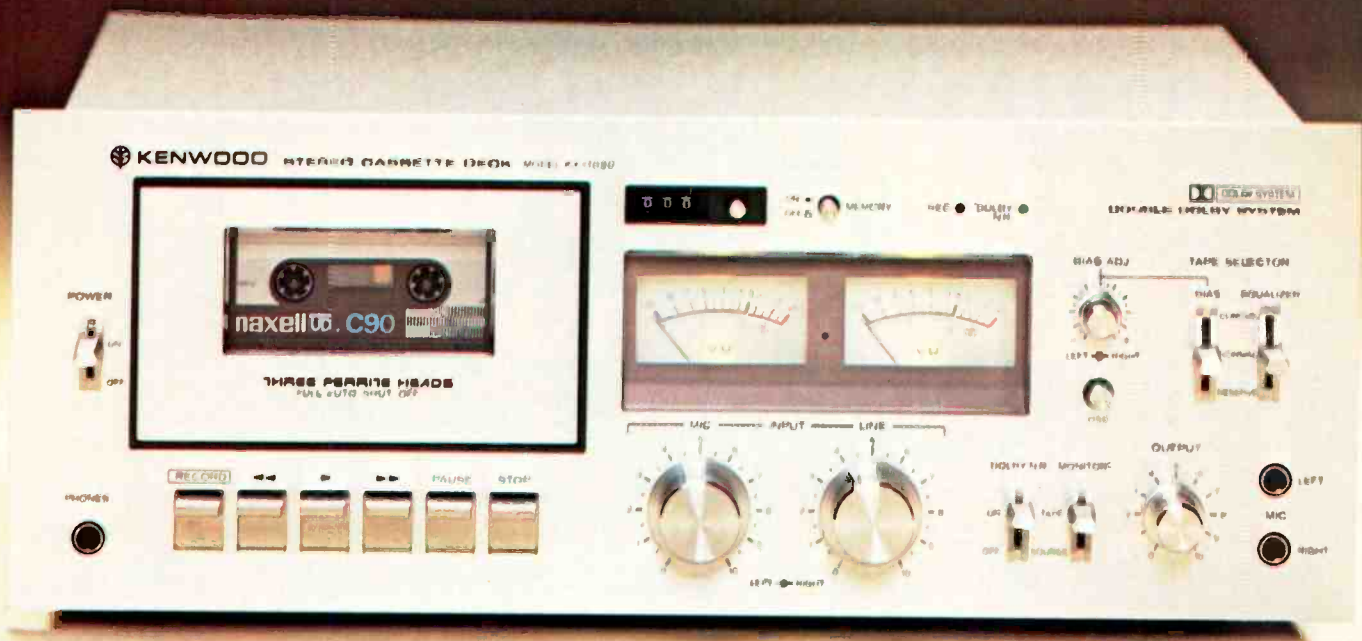

ALL THREE-HEAD CASSETTE DECKS LET YOU HEAR AS YOU RECORD. OURS LETS YOU RECORD PRECISELY WHAT YOU HEAR.

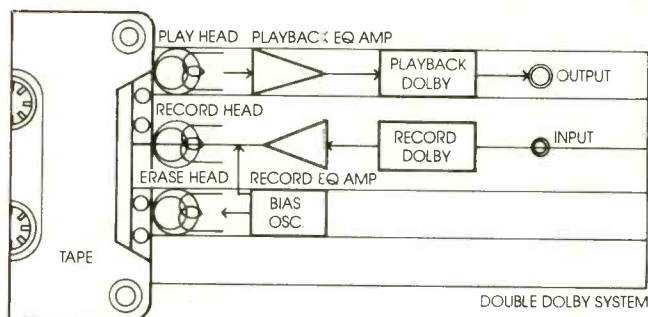

Three-Head Design with Double Dolby.*

Not all three-head cassette decks are created equal. Some manufacturers have designed their decks with separate erase, record and playback heads primarily for convenience. So you can tape monitor as you record.

But our new KX-1030 uses separate heads primarily for performance. Each designed with the optimum gap to record or play back sound more accurately.

As a result, the KX-1030 has a frequency response of 35-18,000 Hz (± 3 dB using CrO₂ tape.)

And to let you take full advantage of the separate record and playback heads, the KX-1030 has a Double Dolby* system with separate circuits for the record amplifier and the playback preamplifier. That way, as you record

with Dolby, you can also tape monitor with Dolby, so you hear the sound precisely as it's being recorded.

The KX-1030 also has a Variable Bias Adjustment Control and a built-in oscillator, so you can adjust the exact bias for the type or brand of tape you use.

We also built in a number of other features like MIC/LINE mixing, memory rewind and a peak indicator.

But as good as all this sounds, wait until you hear the price. Because at \$400.00,** no other comparably priced cassette deck can match the performance and features of our new KX-1030.

Of course the only way you're really going to appreciate the KX-1030 is to visit your Kenwood dealer. Once you do, you'll be convinced: Performance, convenience, and value set the KX-1030 apart from all the rest.

*Dolby is the trademark of Dolby Laboratories, Inc.
**Nationally advertised value. Actual prices are established by Kenwood dealers.



Variable Bias Adjust compensates for tape differences.



KENWOOD®

For the Kenwood dealer nearest you, see your yellow pages, or write, KENWOOD, P.O. Box 6213, Carson, CA 90749

**When it comes to
speaker design, JVC goes
2969 times further.**



Traditionally, speakers are designed and tested by placing a special microphone in front of the speaker, and examining the sound it picks up on an oscilloscope. The oscilloscope pattern is then drawn or photographed for comparison purposes. And, by a tedious trial-and-error process, speaker design engineers try different speaker, crossover and enclosure combinations to express their sound philosophy.

But JVC has put an end to these archaic and time-consuming procedures.

By using a specially-constructed electro-mechanical transport device that creates a field of 2969 microphone positions; then feeding these sound impulses into a computer, then onto a laboratory video screen and onto motion picture film, JVC engineers can actually see what a speaker will sound like... before they get too far down the line in the design process.

This exclusive JVC development is called Phase Moire ("Mor-ay") Propagation Pattern Technology.

How the Phase Moire technology works

The motion picture film produced by the combination of nearly 3000 pickup points, the computer, and high-speed filming of the resulting patterns from the face of the video screen, actually shows how a speaker, crossover network or entire speaker system performs, rather like "sound in action."

It all looks good, but it sounds even better

The SK-1000 is the careful result of Phase Moire Technology and human engineering. Capable of handling up to 170-watt peaks (85 watts RMS), this extraordinary-sounding,

unusually efficient speaker system delivers truly magnificent, rock-solid bass from its 12-inch free-edge woofer and heavy magnet structure. Vocals and midrange are unusually smooth, with a pleasing sense of presence, thanks to our specially-designed 5-inch midrange driver. Clear, crisp brilliant highs are produced with a 1-inch dome tweeter that disperses them evenly within the listening area.

A final note on technology

Once we discovered the technology needed to produce better-performing speaker

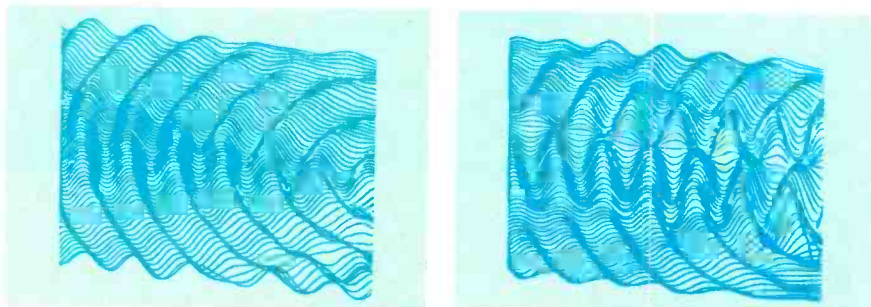

These two Phase Moire patterns represent the crossover frequency response of two similar multi-speaker systems. The left-hand pattern was produced by a JVC SK-1000. Its evenly-undulating shapes indicate a smooth transition from one speaker element to another. The turbulent, uneven pattern on the right is typical of a poorly-designed speaker/crossover combination.

components and systems, we put it to work to help us build a modestly-proportioned (and priced) speaker system that would come as close as possible to the highest levels of integrity in musical reproduction. We feel we've succeeded. But all the technology in the world can't fool two of the most sophisticated testing devices known: your ears. And all the words in the world can't really tell you what the SK-1000 really sounds like. So we suggest that you hear what we've been talking about at a JVC dealer.

JVC

We build in what the others leave out.



JVC America Company, Division of US JVC Corp., 58-75 Queens Midtown Expressway, Maspeth, N.Y. 11378 (212) 476-8300
Canada: JVC Electronics of Canada, Ltd., Scarborough, Ont.

Enter No. 50 on Reader Service Card

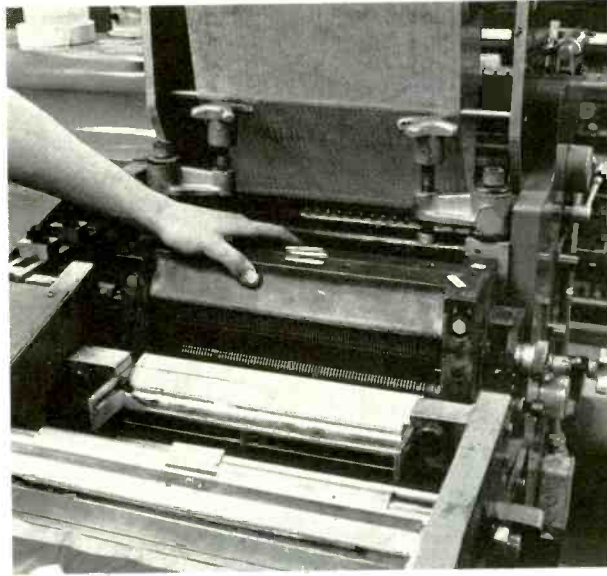

Fig. 4—The 81 pairs of slitter blades used for cassette slitting are precisely mounted on two parallel shafts.

side loading and engagement. The more exact the blade dimensions, the lower the engagement and side loading that can be afforded.

Control of Tensions and Speed

The rotating blades move approximately 3 per cent faster than the web speed. The coated web is unwound and transported through the slitter blades at speeds ranging from 200 to 2,000 feet per minute. Speed differences reflect such factors as oxide thickness, coating formula types, and slitting machine precision and general sophistication. Varying tensions have the effect of varying the relative blade/tape speed. This can cause uneven shear quality and result in poor slitting. The slitting machine must be capable of stopping, starting, accelerating, and decelerating in exactly co-ordinated procedures. This is especially true in slitting open-reel tape since the leader at the beginning and end of each reel length must be spliced into the web and slit with the tape.

The tape which has been slit and wound onto a hub is called a "pancake" (see Fig. 6). The pancake is the configuration of slit tape prior to other steps within the manufacturing process such as cassette and cartridge loading and winding onto reels.

The tape in many layers wound onto the hub or on a reel is referred to as the "pack." A reel or pancake is said to have a good pack if it is not wound either too loosely or too tightly and if all wraps of the tape are exactly on top of the previous layer laterally so that the slit edges of the tape on the pack are parallel with the side of the hub. For each slit edge, all wraps should be in the same plane, which itself should be perpendicular to the axis of the hub.

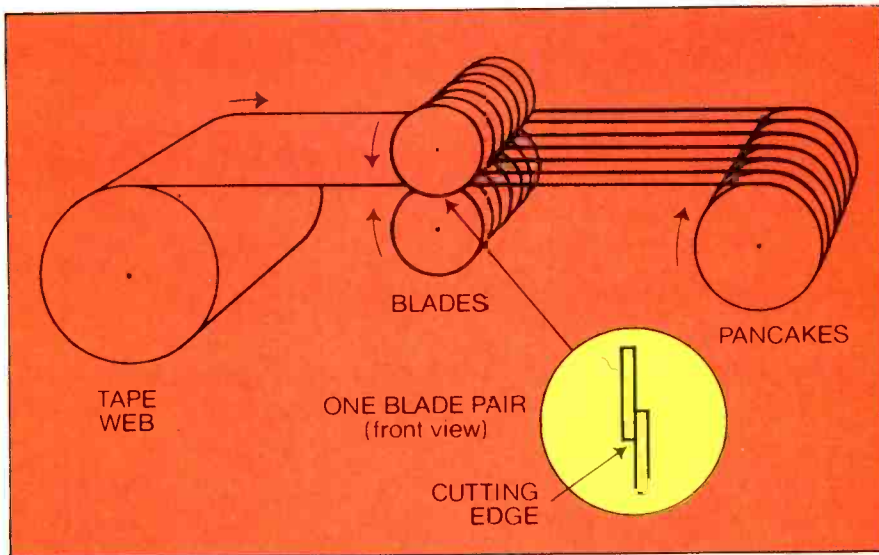
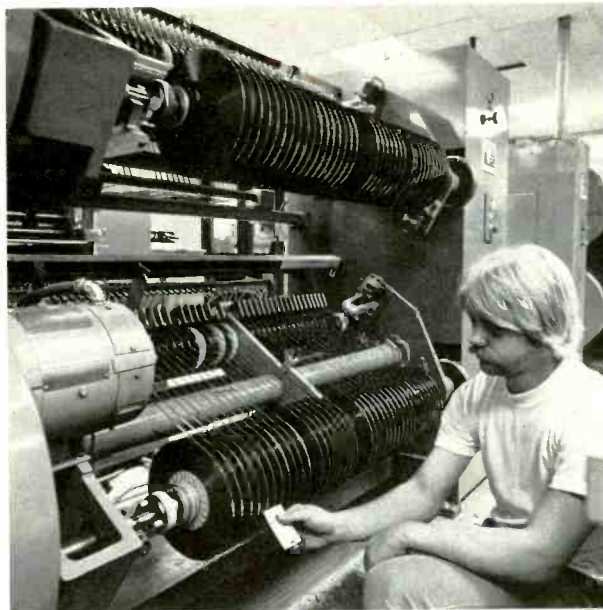

Fig. 5—Diagram of the slitting machinery.

Fig. 6—Pancakes of cassette tape are shown at the take-up end of the slitting operation. Each pancake contains 7500 feet of tape.



Slitting Technology

A contributor to the vast improvements made in open-reel quality during the last decade has been the technology developed to permit precision high-speed slitting of the more delicate cassette tape. Yet another contributor is the even more stringent requirements of some video helical scan formats.

Cassette tape is more difficult to slit than open-reel tape for several reasons. Cassette tape is narrower (0.150 inch versus 0.248 inch). It is not as thick; a typical cassette tape is about half the thickness of open-reel tape. The thinnest base film used in open-reel is the same as the thickest base



**The world's finest audiophile recorder
has become even finer**

With its large professional VU meters using LED peak overload indicators, its full electronic logic control of tape motion and its precision tape cutter and splicer, the new B77 stereo tape recorder sets new standards of convenience for the discriminating recordist.

Add to this the legendary ReVox superiority in audible sound quality and you have the finest audiophile recorder in the world at a price that will pleasantly surprise you.

Willi Studer wouldn't have it any other way.

To learn more about the even finer ReVox B77, write to us for complete information and the address of your nearest demonstrating ReVox dealer.

STUDER REVOX

Studer Revox America, Inc., 1819 Broadway, Nashville, Tennessee 37203 / (615) 329-9576 • In Canada: Studer Revox Canada, Ltd. / (416) 423-2831

Enter No. 43 on Reader Service Card



DISHING

Fig. 7

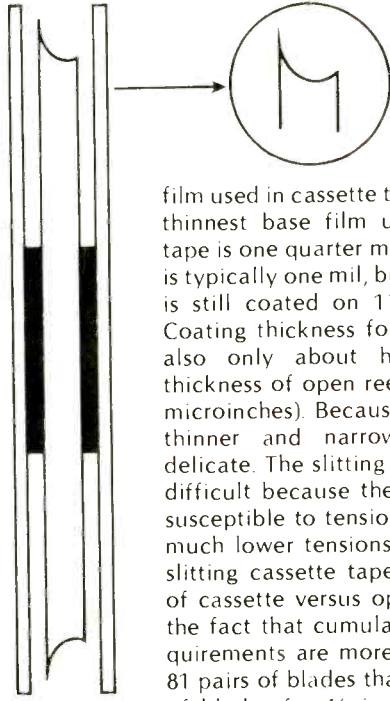

RIDGING

Fig. 8

film used in cassette tape (half mil); the thinnest base film used for cassette tape is one quarter mil. Open-reel tape is typically one mil, but some open reel is still coated on 1½-mil base film. Coating thickness for cassette tape is also only about half the coating thickness of open reel (200 versus 400 microinches). Because cassette tape is thinner and narrower, it is more delicate. The slitting is therefore more difficult because the process is more susceptible to tension differences and much lower tensions must be used in slitting cassette tape. Another aspect of cassette versus open-reel slitting is the fact that cumulative tolerance requirements are more stringent for the 81 pairs of blades for ¼ inch open reel. The track width for cassette is only half the typical width for open reel, making more demands on straightness, and the recorded wavelength in the cassette is half that of open reel, thus making any

head/tape separation problems, due to debris, curvature, etc., twice as severe with the cassette format. Video recording utilizes even narrower tracks than cassette and the symptoms of poor slitting are not only audible but visible, yielding a greater subjective impairment overall.

Recognizing Slitting Problems

Evidence of poor edge quality (poor slitting) can be detected by visual inspection. Since, as noted, the symptoms of poor edge quality can also be the result of machine transport problems, the audiophile should make it a practice to visually inspect each new reel of tape while it is new before ever playing it. Inspect for the following:

Dishing is caused by misalignment in the take-up or winding of slit tape, by a stretched edge, or slit curvature. Dishing occurs when successive layers of tape on the pack are gradually packed toward one side of the hub. Thus, the side of the pack will not be perfectly flat but will be concave shaped—somewhat resembling a dish. Tape which has been slit with curvature tends to “curve” toward one edge as it is being wound onto the hub (see Fig. 7). A stretched edge results in much the same pack characteristics and can also be caused by the user’s tape deck. It is important to inspect the pack of new tape as it comes from the manufacturer in order to pinpoint whether a bad pack is due to the tape or the tape deck.

Ridging describes the condition in which one edge of the tape pack is higher than the other when the tape is viewed looking at the periphery of the pancake (or reel) with a line-of-sight parallel to the pack edge (see Fig. 8).

Ridging indicates that one side of the tape has been stretched or fractured but that guiding while winding up the slit tape has forced the tape to wind onto the pancake flat rather than dished. Ridging can be caused by poorly sheared slitting often due to incorrect blade geometry where the edge of the tape is microscopically deformed. This results in a greater thickness at the edge, thus causing the “ridge.”

Blowouts are individual layers or a group of several layers of tape protruding outside the tape pack (see Fig. 9). When the blowout occurs, these layers are wrapped onto the pancake offset to one side. Subsequent layers may be wound onto the pancake in the correct lateral location relative to the hub. Blowouts are caused by improper winding tension or lack of precision guiding. Blowouts tend to be aggravated by curvature. Reel flanges often crush the protruding blowout,

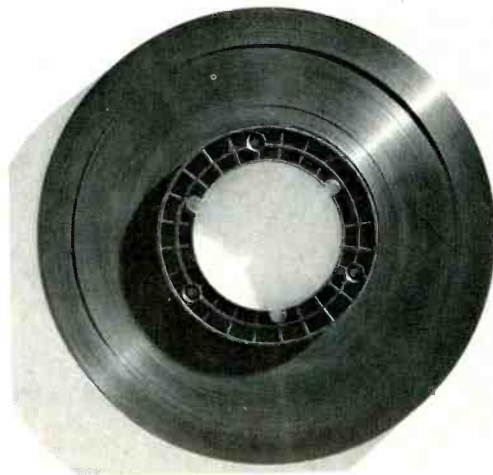
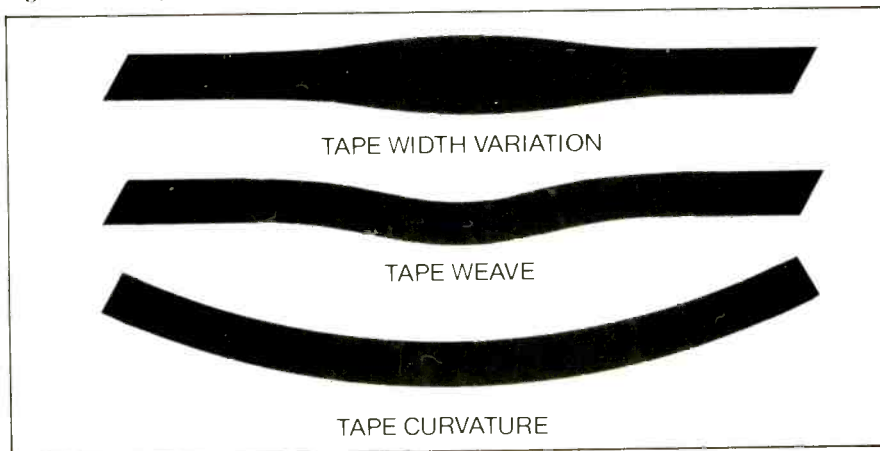

Fig. 9—An example of a blowout, layers of tape protruding outside the tape pack.

Fig. 10—Examples of width variation, weave, and curvature.



You're looking at the world's best-designed tonearm.

This is a Dual tonearm. It can make a big difference in the way your records sound. And how long they last.

The four-point gyroscopic gimbal is widely acknowledged to be the finest suspension system for a tonearm. It pivots the tonearm precisely where the vertical and horizontal axes intersect. The arm remains perfectly balanced in all planes of movement.

Further, the straight-line tubular design achieves the shortest distance between pivot and stylus. That's basic geometry. Curving the tonearm adds mass, decreases rigidity and makes the arm prone to lateral imbalance.

The vernier counterbalance permits you to balance the tonearm with micrometer-like precision. Tracking force is applied so that the stylus remains perpendicular to the record, even if the chassis is not level.

All this serves to establish and maintain the correct cartridge-to-groove relationship. So the stylus can trace the rapidly changing undulations of the groove walls freely, precisely and with the lowest practical force. In short, flawless tracking.

Despite the advantages of the gimbal-mounted tonearm, you won't find many around. But now, you will find one on every Dual turntable. Even our lowest-priced model, the new, fully automatic 1237.*

It's one more example of Dual's total commitment to engineering excellence.



Enter No. 11 on Reader Service Card
For the life of your records

Dual

United Audio, 120 So. Columbus Ave., Mt. Vernon, NY 10553

*Less than \$135. Other Duals to \$400. Actual resale prices are determined individually by and at the sole discretion of authorized Dual dealers

causing severe damage to the tape edge.

Cinching is apparent in either of two ways, as an accordion-like layering in the tape pack and as a loop of tape in the pack wound back on itself. The cause is usually loose winding followed by higher tension, rapid rotation, or stopping suddenly. It will affect recording performance by presenting a folded or distorted surface to the head causing signal loss. Cinching can occur easily on many tape decks if winding tensions are too low, especially in "fast" modes. A low-tension wind followed by abrupt stops and starts causes cinching. It is easy to cause

cinching while threading if the tape needed for threading is pulled from the pack with brakes on. Tape needed for threading should instead be unwrapped from the pack.

Debris will occur even in the highest quality tape, which will have some residue from the slitting process, but quality manufacturers use fastidiously maintained slitting equipment and stringent process quality control monitoring to insure that slitting debris are virtually nil. One way to check for debris on a new reel of tape which has never been played is to examine the sides of the pack for evidence of oxide dust. Debris due to poor slitting will

usually cause one side of the pack to be a slightly different color than the other side. The most common symptom of slitting debris with new tape is the accumulation of oxide on and around tape deck heads, guides, tape lifters, etc. Debris can clog heads when they cause a separation of the tape from the heads. Of course, such tape deck problems as worn tape-edge guides or burrs in the tape path on any tape-contacting mechanism can generate debris on any tape.

Three other, more subtle, tape edge-related problems are *width*, *weave*, and *curvature* (see Fig. 10). Tape which has width variations usually has some weave and vice versa. In the purest sense of the word, tape could have weave and the measured distance between the edges would always be the same (parallel edges), but the tape, if laid out on a flat surface, would exhibit a cyclic serpentine "weave" along its length. Blade wobble causes width variations and weave.

Tape exhibiting width variations sometimes alternates from overwidth to underwidth, but not necessarily symmetrically. Width variations are more specifically related to wobble of the blades, while weave can also be due to lateral instability and side-to-side differences in web tension as the web enters the slitter blades.

Tape is slit with curvature when the web tension at the slitter in-feed is greater on one side than on the other side of the web. Slitter alignment and web tensions are crucial to slitting without curvature. Curvature is measured by laying a length of slit tape on a flat, smooth surface such as plate glass. When the tape is completely flat on the surface, the curvature measure is the distance of the middle of the length of tape from a line between the two ends of the length of tape.

Summary

In summary, there are many ways in which tape edge quality affects recording performance mostly through factors relating to head-to-tape interface. Slitting deficiencies are indicated when dishing, blowouts, ridging, cinching, or debris is visible in the tape pack. Tape edge damage caused by the tape deck can also be identified if these edge-related parameters are, after several passes, compared with the condition of the tape edge when it was new. By careful visual inspection of each new reel, the discerning audiophile can assess the slitting quality of the tape he buys to be sure that maximum recording performance is achieved. A

DIRECT-TO-DISC RECORDING: A progressive step backward.



Recording has come a long way since Edison and Berliner. But not all of the changes have meant progress. A case in point is the introduction of tape recording... a not unmixed blessing.

Granted that tape has advantages of portability, cost savings, ease of editing, and versatility. Its freedom has permitted recordings to be made that would otherwise have been impossible.

But freedom has its price. And the tape medium has serious limits of dynamic range, frequency response, noise and distortion that restrict the potential of the modern stereo phonograph record.

Proof of this audible difference is immediately evident when one listens critically to a well-made direct-to-disc

recording where the performance is captured directly on the master disc...uninterrupted, unimpeded. Without the intervention of tape, a remarkable clarity of sound issues forth.

But you'll also hear something more than just superb sound...the evident dedication of all concerned for quality at every stage of the record's production, from performance to pressing. Everyone is "up". An attitude too easily lost in taped performances that "can be fixed in the remix."

Direct-to-disc is demanding of everyone. Unforgiving because it is so revealing. And to the listener it can be an experience fully satisfying in its own way as the concert hall.

Don't deny yourself the pleasure.

Audio-Technica U.S., Inc. distributes direct-to-disc recordings from *Umbrella Records*, Toronto, Canada and *Sonic Arts "Direkt-to-Disk"* of San Francisco. These and other direct-to-disc records are available at most Audio-Technica phono cartridge dealers, or write to us for list of current titles and ordering information.



AUDIO-TECHNICA U.S., INC., Dept. 48A, 33 Shiwasssee Avenue, Fairlawn, Ohio 44313

The following direct-to-disc records are available from Audio-Technica:

- Rough Trade Live! UMB-DD1 \$14.95
- Nexus Ragtime Concert UMB-DD2 \$14.95
- Zimbalist Violin Sonatas UMB-DD3 \$14.95
 - Phillip Frank, violin, Bernard Frank, piano
- Big Band Jazz (double album) UMB-DD4 \$21.95
 - Rob McConnell and the Boss Brass
- Piano Fireworks, Sonic Arts Laboratory Series #1 (double album) \$21.95
 - Russell Stepan, piano, Chopin Impromptu in C# Minor, Polonaise in A Flat Major (3 different recording ambiances, plus test record)
- The Piano, David Montgomery, Sonic Arts Laboratory Series #2 \$14.95
 - Beethoven, Four Country Dances; Brahms, Five Waltzes from Opus 39; Godowsky, Alt Wein; Schubert, Twelve Landler, Opus 171; von Weber, Waltz in E Flat ("Frau Lieserl juhe!")

The one alternative to separates: The Yamaha CA-2010 Integrated Amplifier.

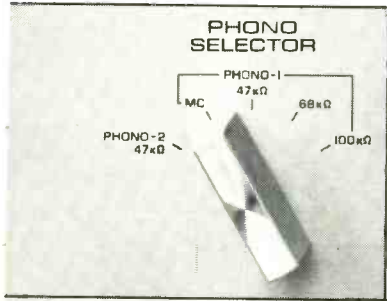

The Head Amplifier. Discerning music lovers all over the world are discovering the transparent highs and extended frequency response of the moving coil phono cartridge. While other manufacturers require the addition of an expensive preamp or step-up transformer to boost the low output signal, Yamaha included a special head amplifier in the CA-2010. It's available with the flip of a switch on the front panel. And to help you get the most out of moving magnet cartridges, there's a 3-position phono impedance selector.

The Preamplifier. To assure exact, repeatable bass and treble settings, the controls are precision calibrated in 1/2dB steps. Dual turnover frequencies for both ranges double the versatility of these accurate tone controls. Completely independent Input and Output Selectors let you record one source while listening to another. And the power meters are easily switched to REC OUT readings in millivolts, so you can monitor the actual output level to your tape deck for cleaner, distortion-free recordings.

The Power Amplifier. 120 watts RMS, with no more than 0.03% THD 20Hz to 20,000Hz into eight ohms.

For tighter, cleaner bass response, the amplifier can be switched to DC operation.

Class A operation is switchable on the front panel, delivering 30 watts RMS, with no more than 0.005% THD 20Hz to 20,000Hz into eight ohms.

The twin power meters are fast-rise, peak delay—they can track even the briefest of transient bursts. Plus they can respond to levels from 1mW to 316W (into eight ohms).

Real Life Rated.™ The specifications of the individual components of the CA-2010 are superior to many separates. Individual specifications alone, however, can't possibly reflect actual in-system performance. That's why Yamaha measures overall performance from phono in to speaker out, rather than at designated points along the signal path. Furthermore, we measure noise and distortion together over a broad output range rather than individually at the optimum output.

Our Real Life Rated measurement is called Noise-Distortion Clearance Range (NDCR). On the CA-2010, NDCR assures no more than 0.1% combined noise and distortion from 20Hz to 20kHz at any power output from 1/10th watt to full-rated power.

Superb tonality from a musical tradition of technical excellence. The tonal accuracy of our audio components is referenced to the same standards used to evaluate the tonal accuracy of our world-renowned musical instruments. The result is a rich, clear tonality that is unknown elsewhere. You really must hear it.

You really must hear the same resolutely accurate music reproduction available from all four Yamaha Integrated Amplifiers and four superb tuners. All are made to a single standard of excellence—a standard rooted in a 90-year tradition of musical perfection.

For a personal audition of the new Yamaha CA-2010, as well as the rest of our complete line of components, just visit your nearest Yamaha Audio Specialty Dealer. If he's not listed in your Yellow Pages, drop us a line.



YAMAHA

Audio Division, P.O. Box 6600, Buena Park, CA 90622

0.03%
-96 dB S/N

**Real Life
Rated**™

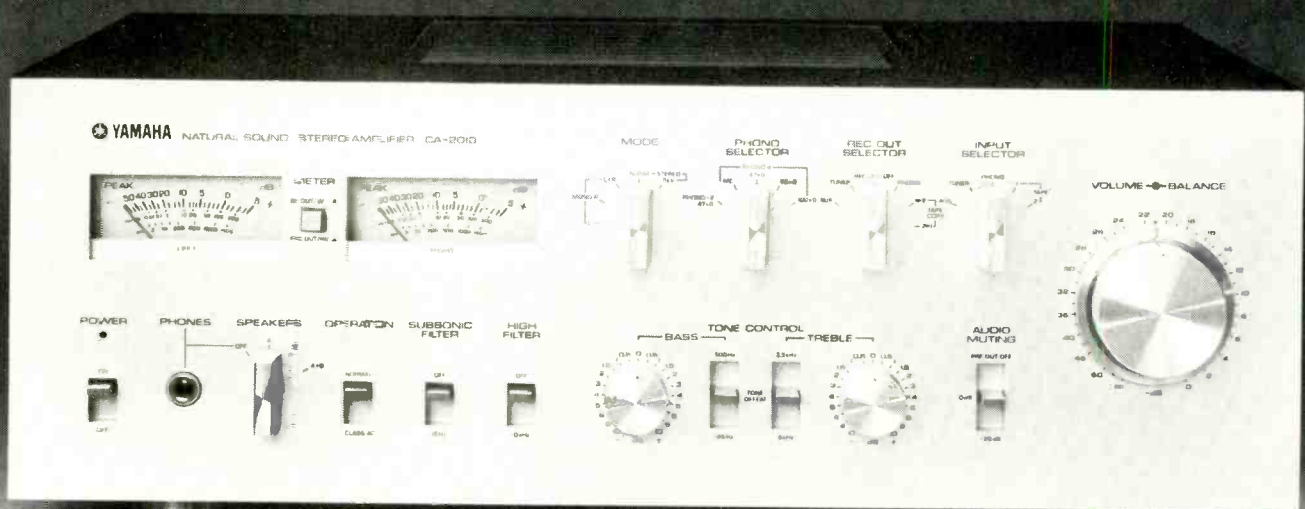

Mitsubishi Pre-empts the Receiver.

Introducing the docking tuner/preamplifier and amplifier. Exclusively Mitsubishi.

It is not a receiver. It is what receivers try to be.

It is two components. Tuner and preamplifier on one chassis. That docks with our dual monaural power amplifier.

It has The DM Factor. Dual Monaural construction. Exclusively Mitsubishi.

It means more than mere stereo. It means inside our stereo tuner/preamplifier are two perfectly matched mono preamplifiers. Just like our component preamplifiers. But not like any receiver.

Because it is not a receiver.

It is a tuner with THD in stereo at 0.08%. With signal to noise in stereo at 75dB. With switchable selectivity for uncompromising reception.

With incredible clarity and

definition. Ten violins sound like ten violins, not one big mushy solo.

It is a dual monaural pre-

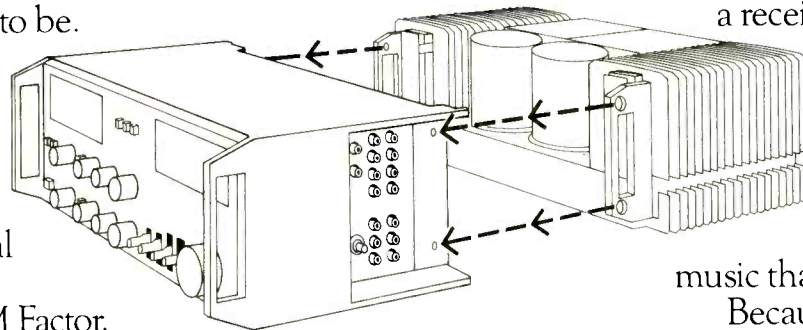

amplifier with interchannel separation at better than 80 dB at 20kHz. Far better than any receiver. With THD at less than 0.002%. For effective elimination of leaks, crosstalk, or any influence able to distort the stereo image.

With the ability to handle the moving coil cartridge. For signal to noise at -77dB (0.1mV input). Previously unheard of in any preamplifier.

It is a tuner/preamplifier that docks with a dual monaural power amplifier. 100 watts or 150 watts. With max RMS output power into 8 ohms from 15Hz to 30kHz.

With THD at no more than 0.05% at rated output.

It is a single, uncluttered unit with the convenience of a receiver. But the integrity

of the exclusive DM Factor. The prime factor in making sure our equipment doesn't fictionalize any

music that it plays.

Because the equipment is Mitsubishi. And Mitsubishi has a standard: what comes out must be as real as everything that went in.

Listen to the most expensive receiver you can. Then hear our DA-C20 dual monaural tuner/preamplifier and self-docking amplifier.

Hear what our standard really sounds like.

And, believe us, it doesn't sound like any receiver in the world.

 **MITSUBISHI**
AUDIO SYSTEMS

For more information write Melco Sales, Inc., Dept. A, 3030 East Victoria Street, Compton, California 90221.

Enter No. 24 on Reader Service Card



ANTENNAS PART IV

COMPLETE ANTENNA SYSTEMS

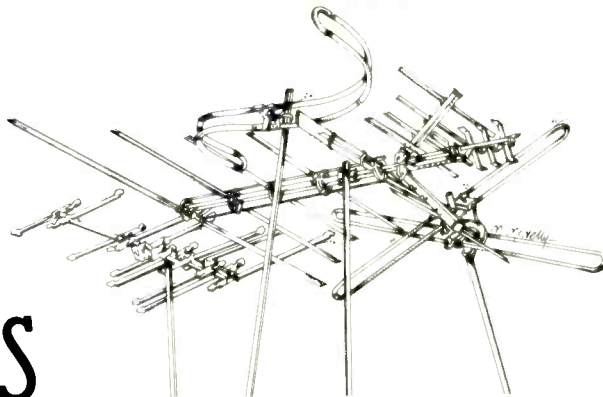

M. J. Salvati

This concluding article of the **FM Antenna Systems** series summarizes much of the earlier information by showing how the various recommended system components can be combined to produce high-quality antenna systems tailored to specific situations. This is done with the three-column chart appearing on the following pages. To use this chart, scan the **Reception Situation** column until you find the one that most closely matches your own. Then, look at the corresponding **Antenna System** column to see which components you will need. The number in the corresponding **Layout** column indicates which of the **System Layout** diagrams to follow in connecting the various components together.

The various factors considered in outlining the reception situations include whether the system is for FM only or TV/FM reception, the number of tuners and/or TV sets served, the local signal strength, the presence or absence of r.f. and/or multipath interference, and whether reception will be from one direction or several. Single-direction, weak-signal reception situations are further broken down by climate to permit choosing the lowest loss twinlead usable under the circumstances. If a reception factor is *not* mentioned in a particular reception situation, it means that the recommended antenna system is the same either way.

For simplicity, only one each of the recommended components (antenna, transmission line, etc.) are listed in the Antenna Systems. For convenience in purchasing, the components selected for a particular Antenna System are from the same manufacturer whenever possible. However, any of the other models recommended in the previous articles can be substituted; let price and availability be your guide. For instance, the Jerrold QFM-9 antenna with STO-82 balun can be substituted in any system specifying the Winegard CH-6060. In fact, the Jerrold combina-

tion has the edge in interference situations because of its slightly narrower beamwidth. Similarly, any of the previously recommended spooled RG59 (or RG6) sized foil cables can be substituted for the more convenient (but more expensive) Winegard CX-series prefabricated cables.

Certain subjective decisions were made in regard to technical approach. For instance, switches were selected for "single FM tuner/single TV set" antenna systems in weak-signal areas instead of band separators (and their performance problems). Spooled coaxial cable is specified for the antenna cable in multiple-set systems instead of prefabricated cable because many pieces of different lengths are also required for the distribution system. Be sure to purchase a dozen or so F-connectors when using spooled cable.

Reliable antenna rotators are available from Alliance, Cornell-Dubilier, Channel Master, Radio Shack, Antenna Corp. of America, and others. Most of these manufacturers offer a choice of either automatic or semiautomatic control units. Automatic rotators are most convenient when you know the bearing of the desired FM station; simply turn the knob to the desired bearing and the antenna will rotate to point itself in that direction. If you like to "hunt" new stations, the semiautomatic is preferable. With this type the antenna rotates as long as you hold down a rotation button, and a pointer indicates the immediate direction.

You will notice that all of the Antenna Systems are designed for FM-only, VHF-TV/FM, or UHF/VHF/FM reception. Although the UHF/VHF/FM systems can be used in areas where only FM and UHF TV are receivable, it is quite silly to do so since most of the size, cost, and performance of an all-band antenna is attributable to the VHF section. Far superior performance at less cost is obtainable by installing separate FM and UHF antenna systems. The separate antennas can be installed on the same mast and rotated together, or the upper one can be rotated and the lower one fixed.

Multiple Set Considerations.

I strongly recommend that all multiple tuner installations use directional couplers regardless of signal level to ensure no multipath-like problems from mis-termination. In strong signal areas (5-50 millivolts output from a medium-sized log periodic), directional couplers with 12- to 20-dB tap attenuation should be used. In medium-signal areas (2-5 millivolts), 6 to 9-dB directional couplers (RMS Electronics CA-1090 and CA-2012S series) are indicated. The style (1-tap, 2-tap, or 4-tap) of directional coupler(s) used in a multiple-set installation cannot be specified because it depends not only on the number of sets served, but also on the layout of the building in which the system is installed. The factors discussed in Part II must be considered in designing your system.

For simplicity in the multiple-set System Layout diagrams, only two sets are shown being served by the trunk line. In practice, additional directional couplers can be connected into the line to serve more sets (FM tuners and/or TV receivers), or multiple-tap directional couplers can be substituted for the single-tap couplers shown.

The only way to achieve multiple set operation in a weak-signal area is to use a low-noise distribution amplifier (good) or a mast-mounted preamp (best) to minimize the degradation in perceived S/N ratio that results from dividing a weak signal among many sets. However, this can only be done if *all* the signals in the passband of the amplifier (including local interference) are weak. Unlike FM tuners and TV sets, broadband amplifiers have no selectivity before their active devices, so even the finest are more susceptible to crossmodulation.

When selecting an amplifier for TV/FM systems, be sure it has either no FM trap at all, or one that can be switched out of the circuit. Also, select a unit with a very low noise figure (3-4 dB) to minimize the degradation in S/N ratio. All of the Winegard mast-mounted preamps shown in the sample layouts provide at least 14 dB gain,

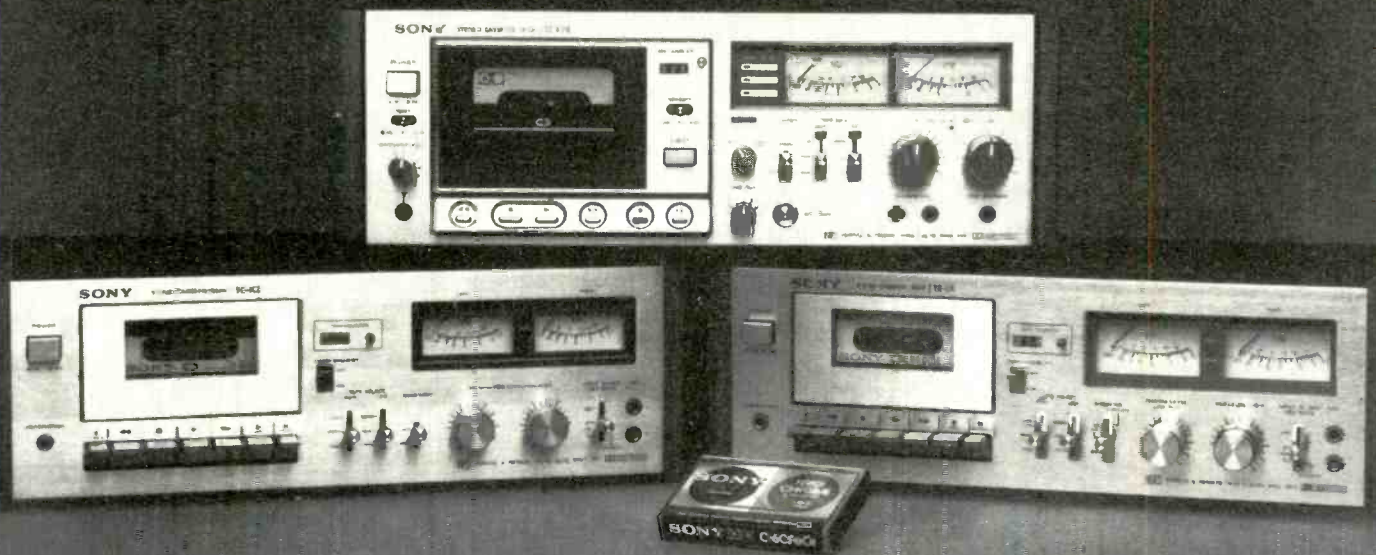

We confess. We couldn't have done this without a 30 year head start.

Thirty years ago, other manufacturers didn't know where to begin making a tape recorder.

Sony not only knew where to begin, but was putting the finishing touches on its first tape recorder.

That's quite a jump to have on a very startled competition.

Today, we're still keeping them jumping. Proof positive: our 3 new front-loading cassette decks. The TC-K7II, K4 and K3.

Three decades of sound engineering, in producing both tape and tape decks, have gone into these machines. Which is clearly evident from the sound that comes out of them.

Our transport mechanism. Designed so the music can transport you.

The tape transport mechanism is perhaps the most important engineering challenge of a tape deck. Sony deals with it through a DC servo-con-

trolled motor. A frequency generator (found on the K7 and K4) emits a signal which is relayed to electronic circuitry, thereby controlling motor speed.

This insures accurate, stable tape movement.

Sony's intelligent design encompasses something as obvious as a servo-motor. And something as seemingly trivial as the best rubber compound for the pinch roller, or the best oil for the flywheel bearing.

Nothing escapes Sony's attention: we're a prisoner of our perfectionism.

Our head keeps us ahead.

Our heads are our own ferrite-and-ferrite formula. Not bought from a different supplier, they're made by Sony. The hard, high polish surface assures you of optimum contact, minimum wear and maximum life. (The life expectancy of a ferrite head is 200 times longer than that of a conventional permalloy head. See what a head start

can do when it comes to making heads?)

Other features of these cassette decks include a Dolby Noise Reduction System. Three-position bias and equalization switches for standard, ferrichrome and chromium dioxide tapes. Rec-mute for instant muting while recording.

As complex as these electronics are, that's how simple we've designed the controls to be. They're refreshingly logical. With a solid, responsive feel.

Thirty years ago, Sony was out in front.

Today, catch one of these cassette decks at your Sony dealer, and you'll see that no one has caught up with us.

SONY[®] AUDIO

© 1978 Sony Corporation of America, 9 West 57th Street, New York, N.Y. 10019

Enter No. 41 on Reader Service Card

have VHF/FM noise figures of about 3 dB (the lowest currently available in a broadband amplifier), and FM traps that can be switched out. The Winegard AC-9130 has very-high gain (24 dB) for extremely-weak signal VHF/FM reception. An AH-0100 housing is needed to use any of these Winegard AC-series preamps with Jerrold antennas (or any other antenna, for that matter, other than Winegard Chromstars).

The low-cost, low noise (3.5 dB) Winegard GA-6700 can be used in a similar manner to use any of these FM tuner systems in a weak-signal area.

The author reports finding ad-

ditional substitutes in case you have difficulty in obtaining some components; the RCA 10G221 and Arista 900 band separators are high-performance substitutes for the Jerrold FSX1314. Similarly, Antenna Corp. of America's HDW-series of prefabricated cables is an exact substitute for the Winegard CX-series.

Installation Details.

Lightning protection must be provided for every antenna system. A four-foot rod driven into the earth should be connected to the antenna mast by No. 8 aluminum wire. Additionally, a

lightning arrester (also connected to the earth) is required for systems using unshielded twinlead. Shielded twinlead and coaxial-cable must have their shields connected to earth ground.

Use high-quality 10-foot mast sections. Channel Master Duratube mast sections are the author's choice because of their high strength and exceptionally good rust-proofing. The Model 2012 is suitable for omnis, the 1812 for FM log-periodics, and the 1612 for large TV/FM antennas. Finally, make sure the mast is securely mounted. Follow the directions accompanying the mounts you select, and don't make any compromises in their attachment.

Reception Situation

Antenna System

Layout

A) Single FM tuner Very strong signal area Many-direction reception No interference or multipath Low cost and simple operation	Channel Master 4403 antenna Belden 9090 twinlead	1
B) Single FM tuner Strong-signal area Many-direction reception	Winegard CH-6060 antenna Winegard CX coax Antenna rotator	2
C) Single FM tuner Strong-signal area Single-direction reception	Winegard CH-6060 antenna Belden 9090 twinlead	3
D) Single FM tuner Weak-signal area Many-direction reception	Winegard CH-6065 antenna Winegard CX coax Antenna rotator	2
E) Single FM tuner Weak-signal area Single-direction reception No interference or multipath Dry Climate	Winegard CH-6065 antenna Belden 8275 twinlead	3(Note 4)
F) Single FM tuner Weak-signal area Single-direction reception No interference or multipath Wet climate	Winegard CH-6065 antenna Belden 8290 twinlead	3
G) Single FM tuner Weak-signal area Single-direction reception Interference and/or multipath	Winegard CH-6065 antenna Belden 8290 twinlead	3
H) Single FM tuner/single U/V TV set Strong-signal area Many-direction reception	Jerrold VU-932S antenna Jerrold STO-82 balun Jerrold CAC-59 coax Antenna rotator Jerrold DC-12 dir. couplers Jerrold FSX-1314 band sep. Jerrold TR-75F terminator	4(Note 1)
I) Single FM tuner/single U/V TV set Strong-signal area Single-direction reception	Jerrold VU-932S antenna Belden 9090 twinlead Jerrold FS-1314-FM band sep.	5

Reintroducing A World Standard...

CBS Laboratories' STR Professional Test Records



For over ten years, the original series of these high-precision test records set a standard for the audio industry. Now the new series sets an even higher standard. It's been revised, recut and expanded.

The new series consists of eight records for professionals and one for non-professional audiophiles.

Each record contains a complete series of easy-to-use tests to help you rapidly and accurately evaluate components and systems. Even one of these records can eliminate the need for costly, additional equipment. Each will find productive use and save you hours in the laboratory, on the production line and in field testing.

Take a look at what this essential testing series contains:

SEVEN STEPS TO BETTER LISTENING—For only \$6.98, you can improve your system with CBS Laboratories' "Seven Steps to Better Listening." This high-precision test record enables you to make sure that your equipment functions properly . . . to tune your system to your ears and your room acoustics. Included is a detailed 16-page booklet by Audio's Edward Tatnall Canby explaining how to use the record to improve the performance of your system. With the record you can perform the following "ears alone" tests: left-right identification, phasing, loudspeaker balance, tone control setting, alternate phasing, buzz and rattle elimination, lateral tracking, and vertical tracking.

★ **STEREOPHONIC FREQUENCY TEST RECORD STR 100** Designed for the evaluation of pickups and systems. Provides a constant amplitude characteristic below 500 Hz and a constant velocity characteristic above 500 Hz. Tests include: Sweep Frequency—with the sweep rate synchronized for use with a graphic level recorder; Spot Frequency—with voice announcements; Channel Separation; Wavelength Loss and Stylus Wear—to pinpoint oversize or worn-out styli, and excessive pickup tracking force; Compliance; Phasing; Vertical and Lateral Tracking; Tone Arm Resonance—to check system performance at low and subaudible frequencies and thus reveal undamped resonance which may cause equipment overloading.

★ **318 MICROSECOND FREQUENCY RESPONSE TEST RECORD STR 170** Provides pickup designers and recording studios with a high-level, easily-equalized signal for frequency response and channel separation measurements. The STR 170 employs a 318 microsecond characteristic corresponding to the "test" or "flat" mode common to most disc recording equipment. Constant amplitude recording is employed in the region below 500 Hz with constant velocity recording in the region above. The transition is smooth, in contrast with the STR 100 which employs a sharp breakpoint at 500 Hz. The record is suitable for use with a graphic level recorder to provide permanent, visible records for precise evaluation.

★ **SQUARE WAVE, TRACKING AND INTERMODULATION TEST RECORD STR 112** Enables detailed study of tracking capabilities of stereophonic phonograph pickups. The square wave modulation allows a rapid appraisal of stylus-lip mass, damping, and tracking. Low frequency compliance and tracking are determined by means of 300-Hz bands of progressively increasing amplitude. Intermodulation distortion measurements are made possible by graduated 200-Hz intermodulation test bands. The Str 112 has been cut with vertical angle approximating 15°, which is representative of current recording practice.

★ **WIDE RANGE PICKUP RESPONSE TEST RECORD STR 120** Makes possible the measurement of pickup response at frequencies far beyond the audible range, where elusive distortion elements can cause audible distortion. The low-frequency range includes glide-tones at twice normal level for the detection and elimination of arm resonance, loudspeaker cone and cabinet rattles. Other tests include: silent grooves for measuring rumble and surface noise characteristics; and standard level bands at 0 dB for overall system S/N measurements. This record is suitable for use with a graphic level recorder to provide permanent, visible records for precise evaluation.

★ **BROADCAST TEST RECORD STR 151** Developed especially to meet the needs of broadcast engineers, audiophiles, and other professionals seeking a convenient signal source for the testing and adjustment of all audio equipment. Tests include: phonograph pickup response and separation, speed accuracy at 33 1/3 and 45 rpm, wow and flutter, rumble and hum detection, ballistic test of V.U. meters and many others.

★ **QUADRAPHONIC TEST RECORD SQT 1100** Designed for calibration, verification, and adjustment of SQ™ decoding equipment. The record provides test bands for pickup measurements, for adjustment of decoder electronics and for channel identification and balance. Each band is described in terms of recorded characteristics and its intended use.

★ **RIAA FREQUENCY RESPONSE TEST RECORD STR 130** Provides RIAA frequency characteristics for the calibration of professional recording equipment and for testing the response of professional and consumer record reproduction equipment. This record is suitable for use with a graphic level recorder to provide permanent, visible records for precise evaluation. Spot frequency bands for use without automatic equipment are included.

★ **RIAA PINK NOISE ACOUSTICAL TEST RECORD STR 140** Designed for acoustical testing of systems and loudspeakers and for psychoacoustic tests on reproduction equipment. With the STR 140 it becomes possible to test loudspeakers in the room in which they will be used. Spot frequency tones with voice announcements facilitate the testing procedure. Continuous glide-tones in 1/3-octave bands cover the frequency range from 30 to 15,000 Hz and are synchronized with a graphic level recorder.

The original series has been unavailable for many years. Quantities of the new and improved series are also limited. So make sure you have perfect copies on hand for years to come by ordering duplicates. Fill out and mail the coupon now for immediate action.

SQ is a Trademark of CBS Inc.

Only a limited quantity are available. Be sure to order enough for many years of use.

SEND TO:
AUDIO TEST RECORDS
401 N. Broad Street
Philadelphia, Pa. 19108

AU/4/78

Send me the following test records:

- Seven Steps to Better Listening (STR 101) \$6.98 each. Quantity _____
- Stereophonic Frequency (STR 100) \$10.00 each. Quantity _____
- Square Wave, Tracking and Intermodulation (STR 112) \$15.00 each. Quantity _____
- Wide Range Pickup Response (STR 120) \$15.00 each. Quantity _____
- RIAA Frequency Response (STR 130) \$15.00 each. Quantity _____
- RIAA Pink Noise Acoustical (STR 140) \$15.00 each. Quantity _____
- Broadcast test (STR 151) \$15.00 each. Quantity _____
- 318 Microsecond Frequency Response (STR 170) \$15.00 each. Quantity _____
- Quadraphonic Test (SQT 1100) \$15.00 each. Quantity _____

Amount Enclosed \$ _____
(Payment must accompany order)

Name _____

Address _____

City _____

State _____ Zip _____

Enter No. 39 on Reader Service Card

J) Single FM tuner/single U/V TV set Weak-signal area Many-direction reception	Jerrold VU-934S antenna Jerrold STO-82 balun Jerrold CAC-6 coax Jerrold DCS switch Antenna rotator Jerrold FSX-1314 band sep.	6(Note 1)
K) Single FM tuner/single U/V TV set Weak-signal area Single-direction reception No interference or multipath Dry climate	Jerrold VU-934S antenna Belden 8275 twinlead Jerrold-Taco 873 switch Channel Master 0012 band sep.	7(Notes 2,4)
L) Single FM tuner/single U/V TV set Weak-signal area Single-direction reception No interference of multipath Wet climate	Jerrold VU-934S antenna Belden 8290 twinlead Jerrold-Taco 873 switch Channel Master 0012 band sep.	7(Note 2)
M) Single FM tuner/single U/V TV set Weak-signal area Single-direction reception Interference or multipath present	Jerrold VU-934S antenna Belden 8290 twinlead Jerrold-Taco 873 switch Channel Master 0012 band sep.	7(Note 2)
N) Multiple FM tuners Strong-signal area Many-direction reception	Winegard CH-6060 antenna Winegard CL-2700 coax Antenna rotator RMS directional couplers RMS CA-1230 termination	8
O) Multiple FM tuners Strong-signal area Single-direction reception	Winegard CH-6060 antenna Winegard CL-2700 coax RMS directional couplers RMS CA-1230 termination	8(Note 3)
P) Multiple FM tuners Weak-signal area Many-direction reception	Winegard CH-6065 antenna Winegard CL-2700 coax Antenna rotator Winegard GA-6700 preamp RMS directional couplers RMS CA-1230 termination	9
Q) Multiple FM tuners Weak-signal area Single-direction reception No interference or multipath	Winegard CH-6065 antenna Belden 8275 twinlead Winegard FM-340 preamp RMS CA-2500 balun Winegard CL-2700 coax RMS directional couplers RMS CA-1230 termination	9(Note 3)
R) Multiple FM tuners Weak-signal area Single-direction reception Multipath and/or interference	Winegard CH-6065 antenna Winegard GA-6700 preamp Winegard CL-2700 coax RMS directional couplers RMS CA-1230 termination	9(Note 3)
S) Multiple FM tuners and U/V TV sets Strong-signal area Many-direction reception	Jerrold VU-932S antenna Jerrold STO-82 balun Jerrold CAC-59 coax Antenna rotator Jerrold directional couplers Jerrold FSX-1314 band seps. Jerrold TR-75F termination	4(Note 1)

Audio-Technica announces a creative new start toward better sound.



AT813
Electret
Condenser
Cardioid

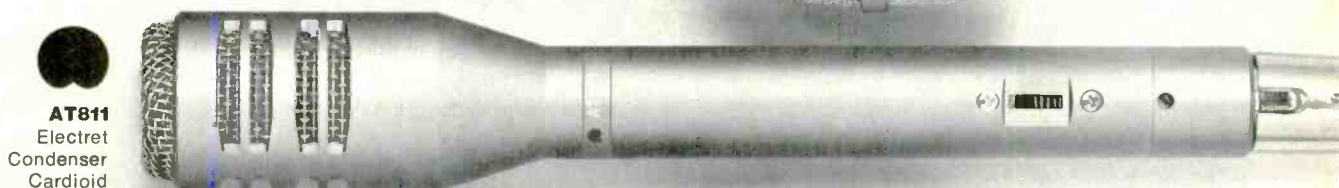

AT811
Electret
Condenser
Cardioid



AT801
Electret
Condenser
Omnidirectional

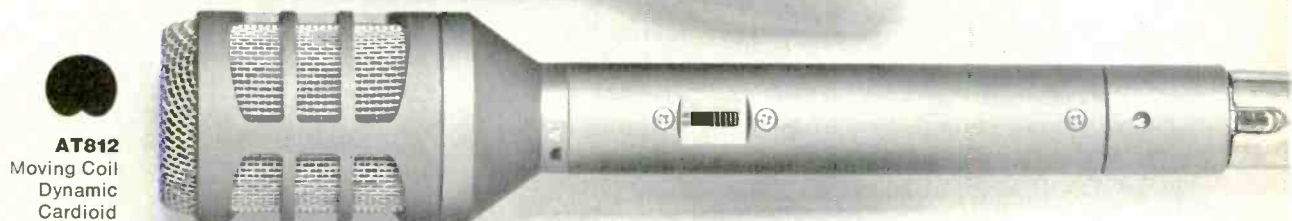

AT812
Moving Coil
Dynamic
Cardioid

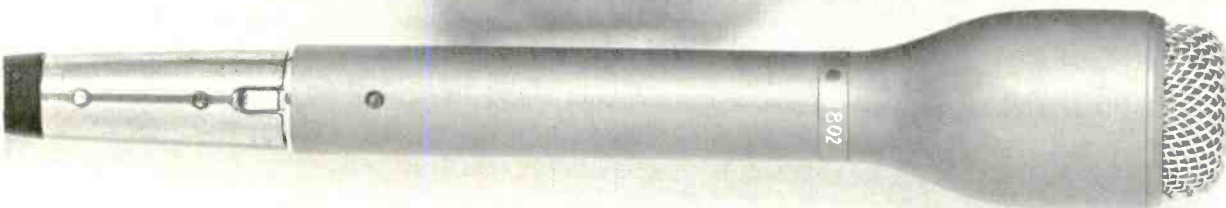

AT802
Moving Coil
Dynamic
Omnidirectional

Every "live" recording has an excitement all its own. You must capture sound that will never be heard exactly the same again. And in some cases the recording is literally a once-in-a-lifetime chance. With no opportunity to remake the tape or disc.

Your creativity, your knowledge and experience are on the line. Now is when you appreciate the precision of Audio-Technica microphones. Performance is consistent. With results that help you extend your personal standards.

Audio-Technica gives you a choice of superb new electret condenser or moving coil dynamic microphones. A choice of omnidirectional or cardioid (unidirectional) pickup patterns. With smooth, extended response that complements the finest recorders. Audio-Technica microphones look, sound, and act very, very professional.

Add more than a little creative excitement in your life, with Audio-Technica microphones, today.

 **audio-technica**. *Great sound, right from the start!*

AUDIO-TECHNICA U.S., INC., Dept. 48A, 33 Shiawassee Avenue, Fairlawn, Ohio 44313 • In Canada: Superior Electronics, Inc.

T) Multiple FM tuners and U/V TV sets Strong-signal area Single-direction reception	Jerrold VU-932S antenna Jerrold STO-82 balun Jerrold CAC-59 coax Jerrold directional couplers Jerrold FSX-1314 band seps. Jerrold TR-75F termination	4(Note 1)
U) Multiple FM tuners and U/V TV sets Medium-signal area Many-direction reception	Jerrold VU-934S antenna Jerrold STO-82 balun Jerrold CAC-6 coax Antenna rotator Jerrold directional couplers Jerrold FSX-1314 band seps. Jerrold TR-75F termination	4(Note 1)
V) Multiple FM tuners and U/V TV sets Medium-signal area Single-direction reception	Jerrold VU-934S antenna Jerrold STO-82 balun Jerrold CAC-6 coax Jerrold directional couplers Jerrold FSX-1314 band seps. Jerrold TR-75F termination	4(Note 1)
W) Multiple FM tuners and TV sets UHF/VHF/FM Weak-signal area Many-direction reception	Jerrold VU-934S antenna Winegard AC-9880 preamp Winegard AH-0100 housing Winegard CL-2800 coax Antenna rotator Jerrold direction couplers Jerrold FSX-1314 band seps.	10
X) Multiple FM tuners and TV sets UHF/VHF/FM Weak-signal area Single-direction reception	Jerrold VU-934S antenna Winegard AC-9880 preamp Winegard AH-0100 housing Winegard CL-2800 coax Jerrold directional couplers Jerrold FSX-1314 band seps.	10(Note 3)
Y) Multiple FM tuners and TV sets VHF/FM Weak-signal area Many-direction reception	Jerrold VU-934S antenna Winegard AC-2950 preamp Winegard AH-0100 housing Winegard CL-2700 coax Antenna rotator RMS directional couplers RMS CA-2500 balun	11
Z) Multiple FM tuners and TV sets VHF/FM Weak-signal area Single-direction reception	Jerrold VU-934S antenna Winegard AC-2950 preamp Winegard AH-0100 housing Winegard CL-2700 coax RMS directional couplers RMS CA-2500 balun	11(Note 3)

Manufacturer's Directory

If you cannot locate the desired device at your local electronics store, write to the manufacturer at the address listed below for ordering information.

Alliance Mfg. Co.
Alliance, Ohio 44601

Channel Master
Ellenville, NY 12428

RMS Electronics
50 Antin Place
Bronx, NY 10462

Antenna Corp. of America
Box 865
Burlington, Iowa 52601

Cornell-Dubilier
150 Avenue L
Newark, NJ 07105

Radio Shack
One Tandy Center
Ft. Worth, TX 76102

Belden Corp.
Box 1331
Richmond, IN 47374

Jerrold Electronics
Box 487
Hatboro, PA 19040

Winegard Co.
3000 Kirkwood St.
Burlington, Iowa 52601

Layout Notes

1) For VHF/FM only, use Jerrold T-4000 baluns instead of FSX-1314 band separators.

2) For VHF/FM only, omit Channel Master 0012 band separator.

3) Omit antenna rotator

4) Ignore twinlead shield connection.

IF YOU'RE NOT DESIGNING WITH A CSC PROTO-BOARD, LOOK AT ALL YOU'RE MISSING.

Utility—Models are available with or without built-in regulated power supplies (fixed or adjustable).

Economy—Eliminate heat and mechanical damage to expensive parts. Save money by re-using components.

Versatility—Use with virtually all types of parts, including resistors, capacitors, transistors, DIP's, TO-5's, LED's, transformers, relays, pots, etc. Most plug in directly, in seconds.

Durability—All Proto-Board models are carefully constructed of premium materials, designed and tested for long, trouble-free service.

Expandability—Proto-Board units can be instantly inter-connected for greater capacity.

Visibility—All parts are instantly and easily visible, for quick circuit analysis and diagramming.

Speed—Assemble, test and modify circuits as fast as you can push in or pull out a lead. Save hours on every project.

Adaptability—Use in design, packaging, inspection, QC, etc. Works with most types of circuits in many, many applications.

Flexibility—Use independently, or in conjunction with other accessories, such as scopes, counters, CSC Proto-Clip™ connectors, Design Mate™ test equipment, etc. One Proto-Board unit can serve a thousand applications.

Accessibility—All parts are instantly and easily accessible, for quick signal tracing, circuit modifications, etc.

Variety—A wide variety of models are available with capacities ranging from 630 to 3060 solderless tie-points (6 to 32 14-pin DIP's), to fit every technical and budget requirement.

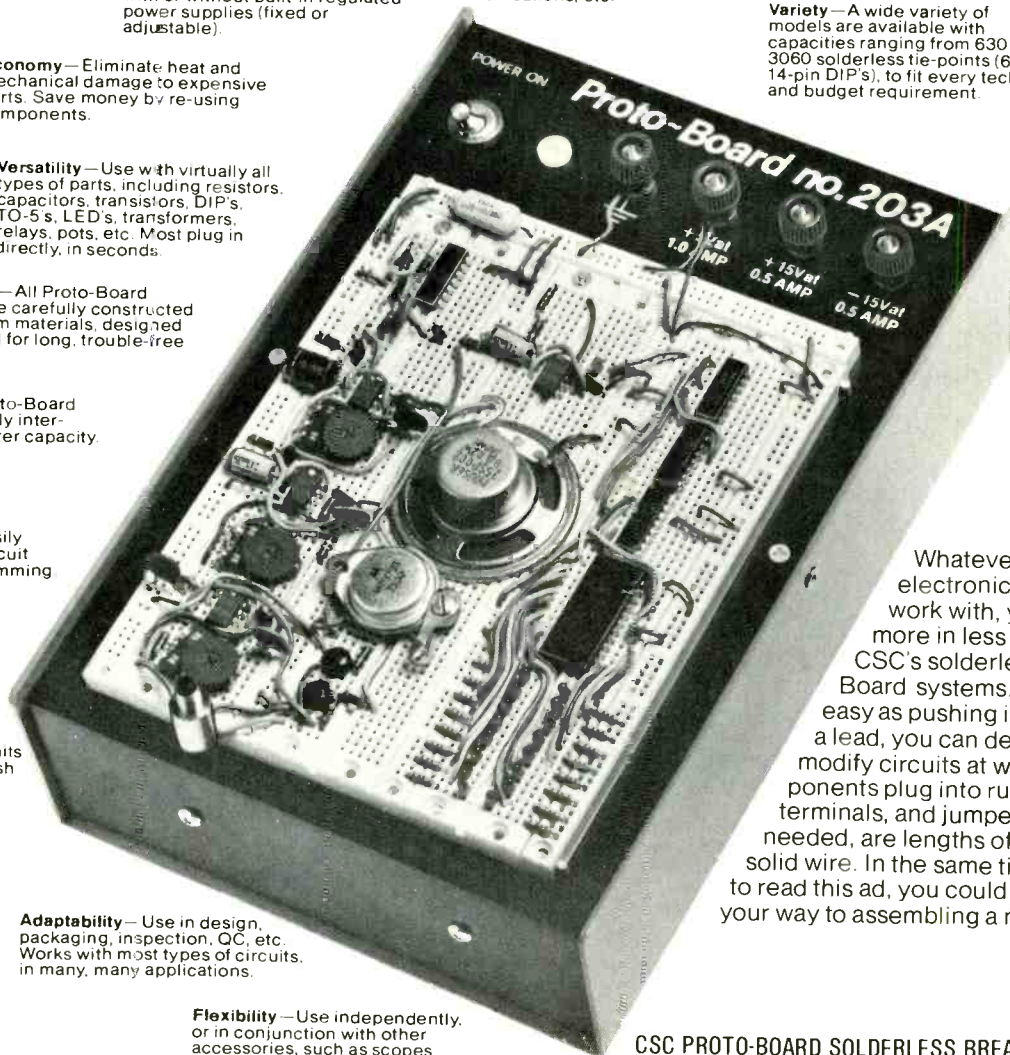

Whatever type of electronic circuits you work with, you can do more in less time with CSC's solderless Proto-Board systems. As fast and easy as pushing in or pulling out a lead, you can design, test and modify circuits at will. Components plug into rugged 5-point terminals, and jumpers, where needed, are lengths of #22 AWG solid wire. In the same time you took to read this ad, you could be well on your way to assembling a new circuit.

Order today. Call 203-624-3103 (East Coast) or 415-421-8872 (West Coast): 9 a.m.-5 p.m. local time. Major credit cards accepted. Or see your CSC dealer. Prices slightly higher outside USA.

CONTINENTAL SPECIALTIES CORPORATION

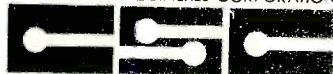

70 Fulton Terrace, Box 1942, New Haven, CT 06509
203-624-3103 TWX 710-465-1227

WEST COAST: 351 California St., San Francisco, CA 94104,
415-421-8872 TWX 910-372-7992

GREAT BRITAIN: CSC UK LTD., Spur Road, North Feltham Trading Estate,
Feltham, Middlesex, England. 01-890-8782 Int'l Telex: 851-881-3669

CANADA: Len Finkler Ltd., Ontario

CSC PROTO-BOARD SOLDERLESS BREADBOARDS

MODEL NUMBER	NO OF SOLDERLESS TIE-POINTS	IC CAPACITY (14-PIN DIP'S)	MANUFACTURER'S SUGG. LIST	OTHER FEATURES
PB-6	630	6	\$15.95	Kit - 10-minute assembly
PB-10C	760	10	19.95	Kit - with larger capacity
PB-101	940	10	29.95	8 distribution buses, higher capacity
PB-102	1240	12	39.95	Large capacity, moderate price
PB-103	2250	24	59.95	Even larger capacity only 2 7/8¢ per tie-point
PB-104	3060	32	79.95	Largest capacity, lowest price per tie-point
PB-203	2250	24	80.00	Built-in 1%-regulated 5V, 1A low ripple power supply
PB-203A	2250	24	129.95	As above plus separate 1.5-amp +15V and -15V internally adjustable regulated power supplies



















© 1978 Continental Specialties Corp.
Prices and specifications subject to change without notice.

Enter No. 8 on Reader Service Card

ANTENNA SYSTEMS

50

LEGEND

-  BALUN
-  TERMINATOR
-  ROTATOR
-  POWER SUPPLY
-  TV BAND SEPARATOR
-  TV/FM BAND SEPARATOR
-  DIRECTIONAL COUPLER
-  MAST-MOUNTED AMPLIFIER
-  ALL-CHANNEL TV SET
-  FM TUNER
-  75Ω INPUT
-  300Ω INPUT
-  GROUND
-  RF SWITCH
-  FM ANTENNA
-  ALL CHANNEL TV/FM ANTENNA
-  COAXIAL CABLE
-  SHIELDED TWIN LEAD

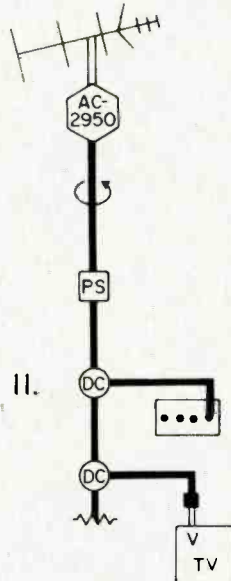
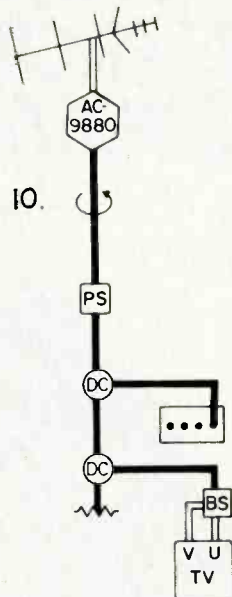
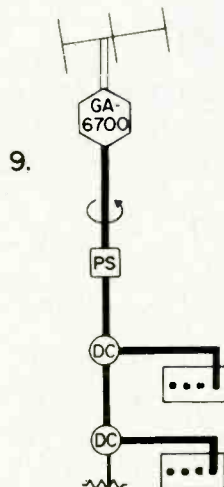
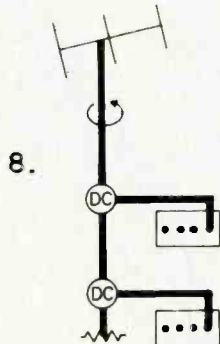
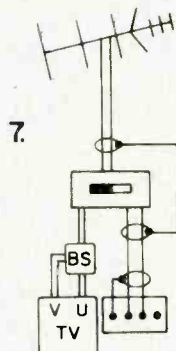
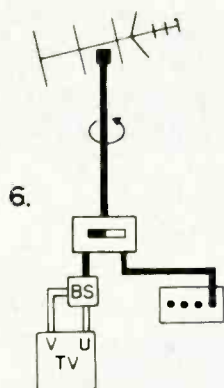
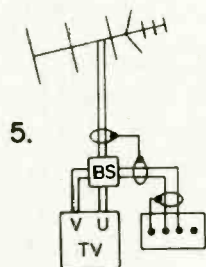
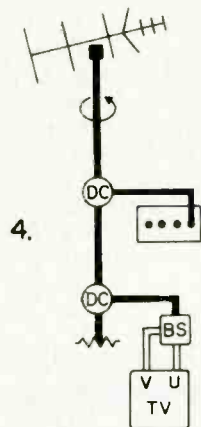
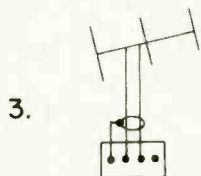
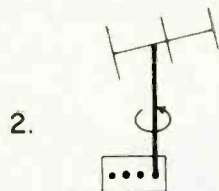
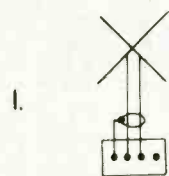

HITACHI

The New Leader In Audio Technology



...introduces the world's most powerful 50 watt receiver.

The new Hitachi SR 804 stereo receiver has the revolutionary Class G amp that instantly doubles its rated power from 50 to 100 watts to prevent clipping distortion during those demanding musical peaks (note the clipped and unclipped waves in the symbolic graph above). The SR 804 is conservatively rated at 50 watts RMS, 20-20,000 Hz into 8 ohms with only 0.1% THD.

Class G is just one example of Hitachi's leadership in audio technology. Power MOS/FET amplifiers, R&P 3-head system cassette decks, Uni-torque turntable motors, and gathered-edge metal cone speakers are just some of the others. There's a lot more. Ask your Hitachi dealer.



HITACHI

When a company cares,
it shows.



52

Anthony Weitz

Open-Reel Renaissance

Gary R. Gruber, Ph. D.*

Two years ago, after more than a decade of production of pre-recorded, 7½ ips, open-reel tapes, the Ampex Corp. bowed out of the business. Ironically, however, the last set of pre-recorded reels Ampex produced, Solti's *Beethoven Nine Symphonies*, were sonically and interpretively the best they had ever produced.

* Editor, Stereotape Review
191 Throckmorton Ave.
Mill Valley, Calif. 94941

AUDIO • April 1978

Para - Power

(Parametric Equalizers by SAE)

SAE has long been involved in the field of tone equalization. From our pioneering efforts in variable turn over tone controls to our more recent advancements in graphic equalizers, we have continually searched for and developed more flexible and responsive tone networks. From these efforts comes a new powerful tool in tone equalization — the Parametric Equalizer. Now you have the power of precise control.

Our 2800 Dual Four-Band and 1800 Dual Two-Band Parametrics offer you controls that not only cut and boost, but also vary the bandwidth and tune the center frequency of any segment of the audio range.

With this unique flexibility, any problem can be overcome precisely, and any effect created precisely.

With either of these equalizers, you have the power to correct any listening environment or overcome any listening problems that you are faced with. Whether you need a third octave notch filter, tailored bandwidth to resurrect a vocalist, or a tailored cut to bury an overbearing bass, the control flexibility of Parametric Equalizers can fill these needs and many more. And of course, as with all SAE products, they offer the highest in sonic performance and quality of construction.

53

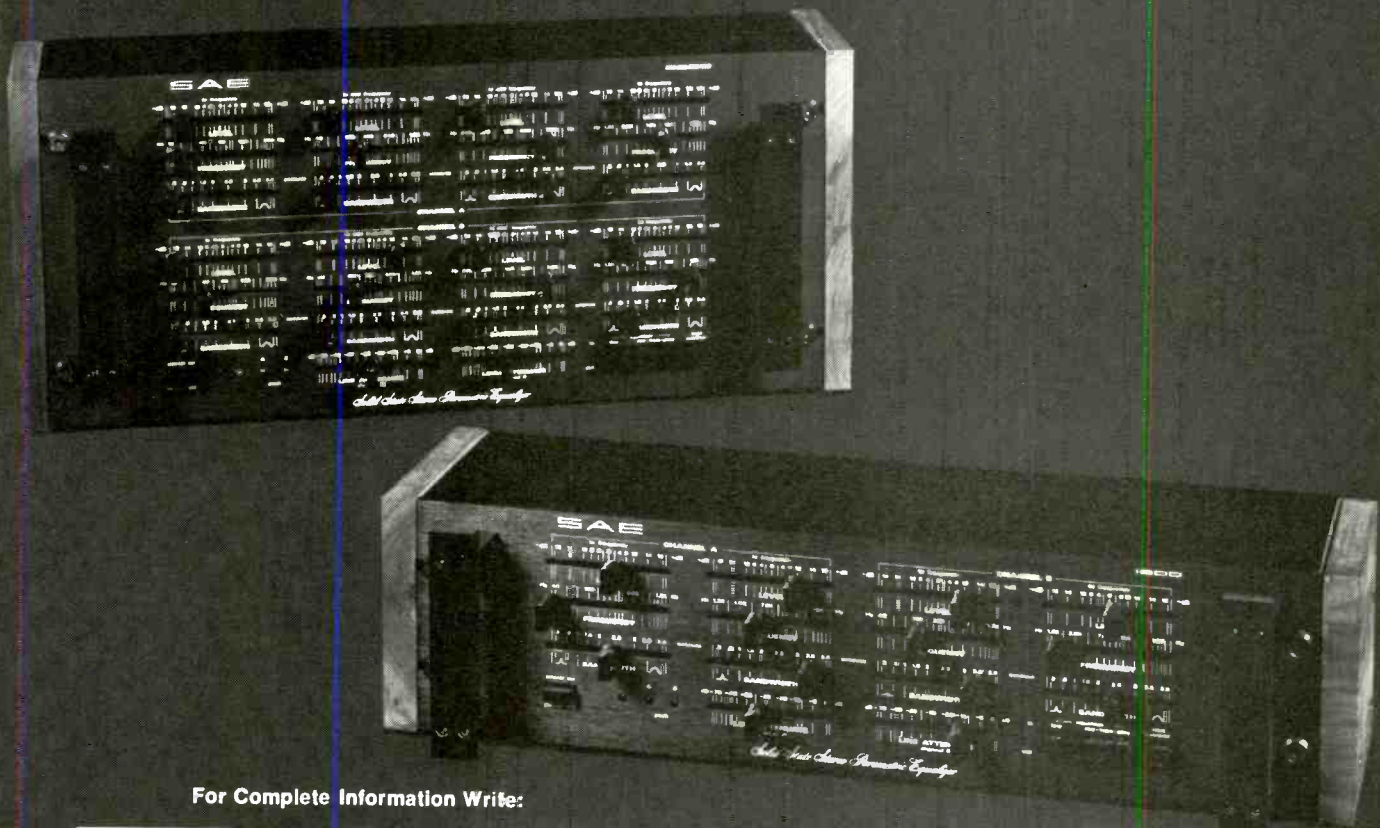

For Complete Information Write:

SAE
Scientific Audio Electronics, Inc.
P.O. Box 60271 Terminal Annex, Los Angeles, CA 90060

Enter No. 36 on Reader Service Card

During the last years of production Ampex even developed a national tape club but, in spite of the efforts of Ampex's Russ Fields and Mike Ayers, the operation was closed down. That was over two years ago, and with Angel, Columbia, and DGG out of the open-reel tape business, the only company left in the production of pre-recorded open-reel tapes was Stereotape, which at the time wasn't producing any Dolby B tapes and was gradually offering fewer selections on the open market. For a time it appeared as though the medium of pre-

recorded open-reel tapes was coming to a dismal end.

Reel Renaissance

At the same time, Barclay-Crocker on the East Coast was contemplating entry into the open-reel market. Sonar, also on the East Coast, was still producing some open-reel tapes, and Stereotape, on the West Coast, was planning a revival of open-reel production.

About a year ago, Barclay-Crocker produced their first open-reel tapes and, at the same time, Stereotape also

resumed production. Barclay-Crocker, with the Musical Heritage Society, Vanguard, Unicorn, Desmar, and Halcyon labels, is geared towards the more esoteric tastes, while Stereotape with London, DGG, RCA, etc. attracted the standard classical and popular tastes. Both companies Dolbyize their tapes so the noise level is quite low.

Some tape enthusiasts used to complain that they had trouble guessing where the program on the first side of some reels began and, occasionally, they had to *Fast Forward* the tape on the first side in order to reach the first

“WOW”

and other comments from audio critics about Ohm C₂ loudspeakers:



Comments from High Fidelity:

“The speakers produce a sound that is clear and well detailed and - if you want it that way - loud. Transient response is crisp.”

“Surely, all things considered, the design of the Ohm C₂ represents a fine achievement. With classical music its performance is adequate with something to spare. And with popular music - wow!”

Comments from The Complete Guide to Stereo/Hifi Equipment:

“The C₂ is a high-efficiency speaker with ruler-flat re-

sponse to 37 Hz., high-power handling capability, very smooth treble response, and excellent dispersion. Considering the size of the box, performance and price, the Ohm C₂ must be reckoned with as one of the better speaker values available... Ohm speakers are very well made, and we recommend this model highly.”

For a free reprint of thirteen complete reviews of Ohm speakers priced from \$100 to \$700, write us.

241 Taaffe Pl.,
Brooklyn, N.Y.
11205



We make loudspeakers correctly.



selection. That was because the second side of the tape contained a longer program. Barclay-Crocker has virtually eliminated this problem with what they call the “sonic sentry.” The way this works is, when the second side of the tape has a longer program than the first side, you are instructed to put your tape deck in the *Fast Forward* mode and listen for a high frequency oscillating tone. When you hear the tone, stop the tape and start your machine in the normal playback mode.

As far as the samples I've reviewed, Stereotape always seems to start their programs at the beginning of the tape, making it unnecessary to employ a process similar to Barclay-Crocker's “sonic sentry.” Both companies let their program on the first side end where the program on the second side begins. If you do not have a reversing mechanism on your tape deck, all you need to do is flip the reels over to continue with the second side.

All Barclay-Crocker and Stereotape reels are Dolby B encoded and if your deck is equipped with Dolby, just put the switch on. However, if it is not, you may reduce the treble controls on your amplifier slightly.

Open Reel vs. Cassette

Many readers may ask the following pertinent question: With the technical advances recently taken with the pre-

Here's How Dolby FM Gives You: **More Signal** ↑ **Less Noise** ↓

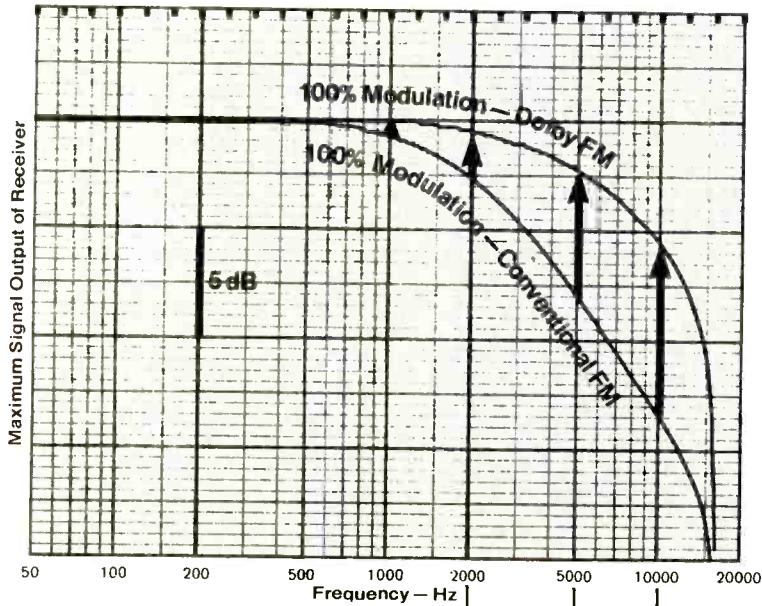

Increased Dynamic Range Capability
+5 dB +8 dB +10 dB +10 dB

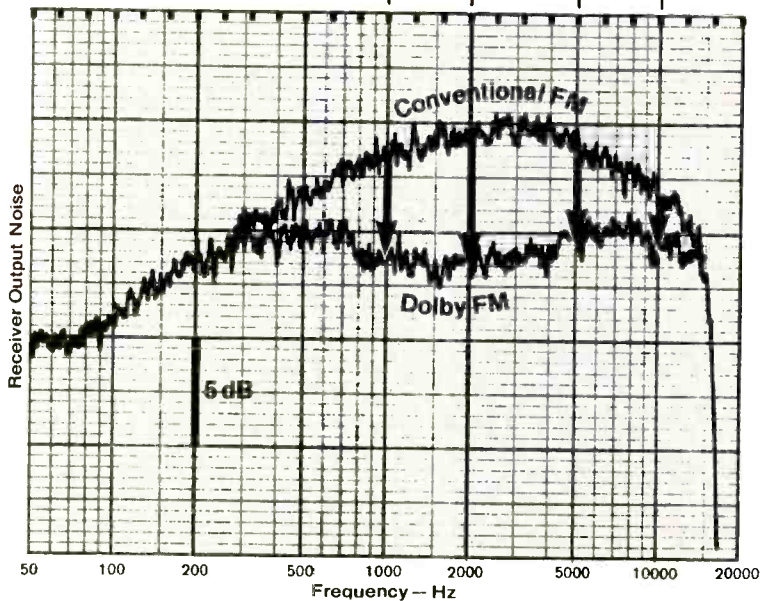

These curves show the improvement in maximum high-frequency output level with Dolby FM. Contemporary wide-range program material will not "fit" under the 100% modulation limit of the 75 microsecond conventional FM curve; the signal must be high-frequency limited (or reduced in overall level) enough to do so. Such program material will, however, fit under the 25 microsecond Dolby FM curve. (Note that these curves are maximum output curves; they are not frequency response curves in the normal sense. At low modulation levels both curves would be flat to 15 kHz.)

All curves were made on a typical new stereo receiver with full Dolby FM decoding capability. The receiver was driven from the rf output of a Sound Technology 1000A FM signal generator, operating at a frequency of 97 MHz. The rf level was set at 100 μ V at the 300 ohm antenna input terminals of the receiver.

For the maximum high-frequency output curves, the output of a B&K 1024 audio sweep oscillator was fed into the FM generator at a level giving 100% FM modulation at all frequencies (± 75 kHz deviation, including 19 kHz multiplex pilot). One stereo channel of the receiver (tape output) was fed directly into a B&K 2305 chart recorder. The Dolby FM/conventional FM switch on the receiver was then operated to give the two recordings shown.

For the noise level curves, the audio input to the FM generator was switched off. The receiver output was fed to a Radiometer FRA 3 wave analyzer which was coupled to the chart recorder and calibrated to give a flat chart recording with pink noise input. The Dolby FM/conventional FM switch on the receiver was then operated to produce the two noise spectrum recordings shown.

In all of the chart recordings note that there is a sharp drop in response above 15 kHz. This is normal for all FM receivers and is caused by the filters necessary for rejection of the 19 kHz and 38 kHz multiplex components.

These chart recordings show the noise reduction effect of Dolby FM. The top curve is the noise spectrum of conventional 75 microsecond FM. The bottom curve shows the reduced noise level of Dolby FM.

These chart recordings show how the Dolby FM technique increases the available high frequency dynamic range of FM broadcasting.

The Dolby FM process works on both extremes of the dynamic range. The maximum permissible level of high frequency signals is increased, while low

level noise is reduced. The 10 dB action of the Dolby B system is split in an optimum way between these two equally important areas of operation. The net result is an FM system which can pass signals from transmitter input to receiver output with high integrity.

To find out more about this new development, please write to us for further

details. The following information is available:

1. Explanations and technical details on Dolby FM.
2. A list of stations with Dolby FM encoder units.
3. A list of receivers with built-in Dolby FM circuits.



Dolby Laboratories

'Dolby' and the double-D symbol are trade marks of Dolby Laboratories

731 Sansome Street
San Francisco, CA 94111
Telephone (415) 392-0300
Telex 34409
Cable Dolbylabs

346 Clapham Road
London SW9
Telephone 01-720 1111
Telex 919109
Cable Dolbylabs London

Table 1

Here are some outstanding new reels produced by Barclay-Crocker (B) and by Stereotape (S). I have rated each of these tapes by E* for super-excellent, E for excellent, G for good, and F for fair, concerning interpretative performance (P), sound quality (Q), and signal-to-noise ratio (N).

	P	Q	N
Saint-Saens: <i>Caprice and Woodwind Sonatas</i> , Minneapolis Chamber Ensemble-MHS-3224 (B)	F	G	G
Kodaly: <i>Duo; Sonata</i> ; Olefsky (cello), Posner (violin) MHS-3047 (B)	G	E	G
Mahler: <i>Symphony # 4</i> ; Abravanel/Davrath/Utah SO Van-10042 (B)	E*	E	E
Haydn: <i>Symphonies Nos. 90 & 91</i> ; Blum/Estherhazy Orch., Van-10044 (B)	E*	E	E
Leroy Anderson: <i>Fiddle Faddle and 14 other Anderson Favorites</i> , Van 10016 (B)	E	E	E
18th Century <i>Concerti for Harps and Strings</i> MHS 3320 (B)	E	E	E
James Taylor's <i>Greatest Hits</i> —WST 2979 (S)	E*	E	E
Copland: <i>Clarinet Concerto</i> ; Crusell: <i>Grand Concerto Unc 0314</i> (B)	E	E	E
J.S. Bach: <i>Cantatas Nos. 11 & 80</i> , Van 71193 (B)	E	E	E
Goldmark: <i>Rustic Wedding Symphony</i> , Unc 2142 (B)	G	E	E
Verdi: <i>Il Vespi Sicilliani</i> : RCA EOP4 0370 (S)	E	E	E
Beethoven- <i>Nine Symphonies</i> : Solti/CSO, Lon CSA09 (S)	E*	G	G
Dvořák: <i>Dumky Trio</i> ; Smetana: <i>Piano Trio</i> , DG 2530594 (S)	E	E	G
Gould: <i>Latin American Symphonette</i> ; Gottschalk: <i>Night in the Tropics</i> , Van 721218 (B)	E	E*	E
Rachmaninoff: <i>Third Symphony</i> , Stokowski, Des 1007 (B)	E	E*	E*
Mahler- <i>Symphony No. 3</i> , Levine, RCA 1757 (S)	E	E	E
Neilson: <i>Symphonies Nos. 6 and 3</i> , Unc 0326 (B)	G	E	E
Prokofieff- <i>Five Piano Concerti</i> -Ashkenazy, Lon 2314 (S)	E	E	G
Brahms: <i>Violin Concerto</i> , Milstein, DG-2530592 (S)	E	E	G
Tchaikovsky: <i>First Piano Concerto</i> , Berman, DG 2530677 (S)	E	E*	E
Monteverdi: <i>Vesperae Della Beate Vergine</i> -Ar-2710017 (S)	E	G	G
<i>Music of the Gothic Era</i> , Munrow, AR 2710019 (S)	E	E	G
Gershwin: <i>Porgy and Bess</i> , Lon OSAO 13116 (S)	E	E	E
Saint-Saens: <i>Third Symphony</i> , DG 250619 (S)	E	E	G

The above recordings are well worth the investment. Some record outlets carry the Stereotape reels. However, it would be best to write to these addresses for ordering information and catalogs:

For Stereotape Releases: The Reel Society, 8125 Lankershim Blvd., North Hollywood, Cal. 91605

For Barclay-Crocker Releases: Barclay-Crocker, 11 Broadway, Room 857, New York, N.Y. 10004

Table 2

"The Reel Revolution," as Russ Fields of the Reel Society put it, "rolls on." Here are some interesting tapes that will be available in the next few months. Again, (B) denotes Barclay-Crocker, and (S) denotes Stereotape. (Although Barclay-Crocker is producing new tape releases steadily, I did not get an advance release sheet at the time of writing this article, thus accounting for many more Stereotape selections here).

- Vaughan Williams: *Fantasy on a Theme of Tallis*; Dvořák. *Serenade*,
Stokowski, Desmar 1011 (B)
- The Best of the Grateful Dead*, WST-2764 (S)
- This is Duke Ellington*, EPP2-6042 (S)
- Dvořák: *Slavonic Dances* (Complete), ST 801 (S)
- Chopin: *24 Preludes, Polonaises* (Pollini), ST-803 (S)
- Bernard Herrman conducts great *British Film Scores*, *Psycho* and other
film scores, ST 902 (S)
- Mahler: *Symphony # 2*, Mehta/VPO, CSAO 2242 (S)
- Tchaikovsky: *Symphony # 5*, Solti/CSO, CSO 6983 (S)
- Rimsky-Korsakov: *May Night* (Complete), DG 3652104 (S)
- Wagner: *Die Meistersinger*, Lon OSAO 1512 (S)

recorded cassette tapes, is the sound really that much better on the new open reels? To answer this question honestly, I must say that some cassettes, particularly Polydor's DGC, London, Advent, and Angel, elicit some startling sonics. But the new open reels produced by Stereotape and Barclay-Crocker do show the differences between the new open reel and the current cassette. The sound on the open reel is fuller with a greater dynamic range and the distortion at high volume levels is noticeably less. As an example, the Advent cassette recording of the Rachmaninoff *Third Symphony* with Leopold Stokowski (E-1046) is technically superb, while the Barclay-Crocker open-reel tape version (D-1007) of the same Desmar recording is technically ultra-superb! The Tchaikovsky *First Piano Concerto* with Berman and von Karajan on the DGC Polydor cassette (3300-677) is big sounding and quite breathtaking, however, the Stereotape open-reel version of the same DGC recording (DG-2530-677) is even more so. Physically, we should expect this difference since the 7½ ips open-reel tape travels past the playback head four times as fast as its cassette counterpart. Also, the width of the open reel is greater than the width of the cassette tape, providing for retention of better and more signal. The structure of the cassette invites more wow and flutter—many times you will need a cassette deck that will adjust for azimuth angle of the tape head for each tape played on the machine. Finally, the tolerances on an open-reel deck are less critical than those on a cassette deck. This is the reason why some cassettes jam, squeal, or have much more drop-out of signal than an open-reel tape does. Of course, if you want convenience, you can't beat the cassette; in this regard, the cassette is better than either the record or the open reel. But, if you want to come closest to realistic sound, then the open-reel format is best, especially when you are listening to large orchestral pieces or operatic works.

Epilogue

It is now apparent that the open reel pre-recorded tape format is here to stay. Hopefully, in the near future, Stereotape and Barclay-Crocker will produce tapes by the companies of Angel, Philips, Argo, Das Alte Werk, Telefunken, Orion, and Columbia. In any event, what is now being produced is quite satisfactory and should indeed quench the ever increasing thirst of the demanding audiophile and music lover. A

As you would expect from LUX, our new R-1050 tuner/amplifier “is no mere run-of-the-mill receiver.”

When LUX Audio entered the U.S. audio scene in 1975, we brought with us a worldwide reputation for excellence. But since we also brought only our separate amplifiers and tuners, relatively few audiophiles could enjoy the special qualities of LUX performance.

Now, everyone who would like a LUX tuner, preamplifier and power amplifier—on a single chassis—can have them just that way. We choose to call these new models “tuner/amplifiers,” although you probably think of them as “receivers.” What’s more important is how Hirsch-Houck Labs described the R-1050 in *Stereo Review*:

“Given its features, appearance and performance, this is no mere run-of-the-mill receiver. . . . The excellent audio-distortion ratings . . . obviously place it among the clearest of the currently available receivers. . . . every aspect of the receiver’s operation and handling was as smooth and bug-free as its fine appearance would suggest.”

Typical of the circuitry and features that result in such fine performance are these: a dual-gate MOSFET front end for high sensitivity, and a special linear-phase filter array for high selectivity, low distortion and wide stereo separation. The preamplifier section has a two-stage direct-coupled amp for accurate

RIAA equalization and a good phono overload capability. And the power amplifier is direct-coupled DC, in a true complementary symmetry configuration, for excellent transient and phase response.

Operating features include a six-LED peak level indicator for each channel; tape-to-tape dubbing with simultaneous listening to other program sources; turn-on time delay speaker protection plus automatic overload shutdown.

The sound of the R-1050 has been appreciated as much in England as here. For example, the British magazine *HiFi at Home* said: “. . . treble quality was light and delicate, something LUX engineers always seem to achieve. . . . bass output seemed plentiful and strong, as is often the case with enormous, low impedance power supplies.”

If we’ve encouraged you to experience the sound of a LUX tuner/amplifier, your next step is to visit one of our carefully selected dealers. We’ll be pleased to send you the names of those in your area.

Luxman R-1050: 55 watts per channel, THD 0.05%. Suggested price \$595. Other Luxman tuner/amplifiers: R-1040, 40 watts per channel, THD 0.05%. Suggested price, \$445. R-1120, 120 watts per channel, THD 0.03%. Suggested price, \$895. (Power ratings are minimum continuous output per channel, with both channels driven simultaneously into 8 ohm loads, from 20 to 20,000 Hz, and no more than quoted total harmonic distortion.)

LUX Audio of America, Ltd.

160 Dupont Street, Plainville, New York 11803 • In Canada: White Electronics Development Corp., Ontario



It is now just about three years since the IHF, the IEEE, and the EIA adopted new standards for the uniform measurement of FM tuner performance. The new standard (given IHF number IHF-T-200, 1975 and IEEE Standard Number 185-1975), issued on May 19, 1975, represented a much-needed updating of FM measurement techniques. (IHF-T-200, 1975 may be obtained from the Institute of High Fidelity, 489 Fifth Avenue, New York, N.Y. 10017 at a cost of \$5.00.) The previous standard available from the IHF had been promulgated way back in 1958 (before the days of stereo FM), while the old IEEE standard was even older, having been last issued in 1947 when FM was still in its infancy as far as public acceptance was concerned.

Most manufacturers of FM tuners and receivers have adopted some of the measurement and reporting techniques spelled out in the new standard. Very few manufacturers have actually published every specification called for in the new standard. A few manufacturers continue to ignore the new standard entirely, and what few specifications they do publish are still based upon earlier standards. Table 3 of the new standard is reproduced here as a partial explanation of why many manufacturers don't bother to detail *all* of the specifications of an FM tuner in their advertising and promotional brochures. No less than 22 separate published specifications are called for in the case of monophonic performance, while an additional 11 specifications are called for in the case of stereophonic performance. Several of these specifications require multiple listings (e.g., distortion at 65 dBf actually calls for readings at three modulating frequencies in mono and the same three frequencies must be used and listed for stereo distortion figures), making the list of required

FM Specifications Revisited

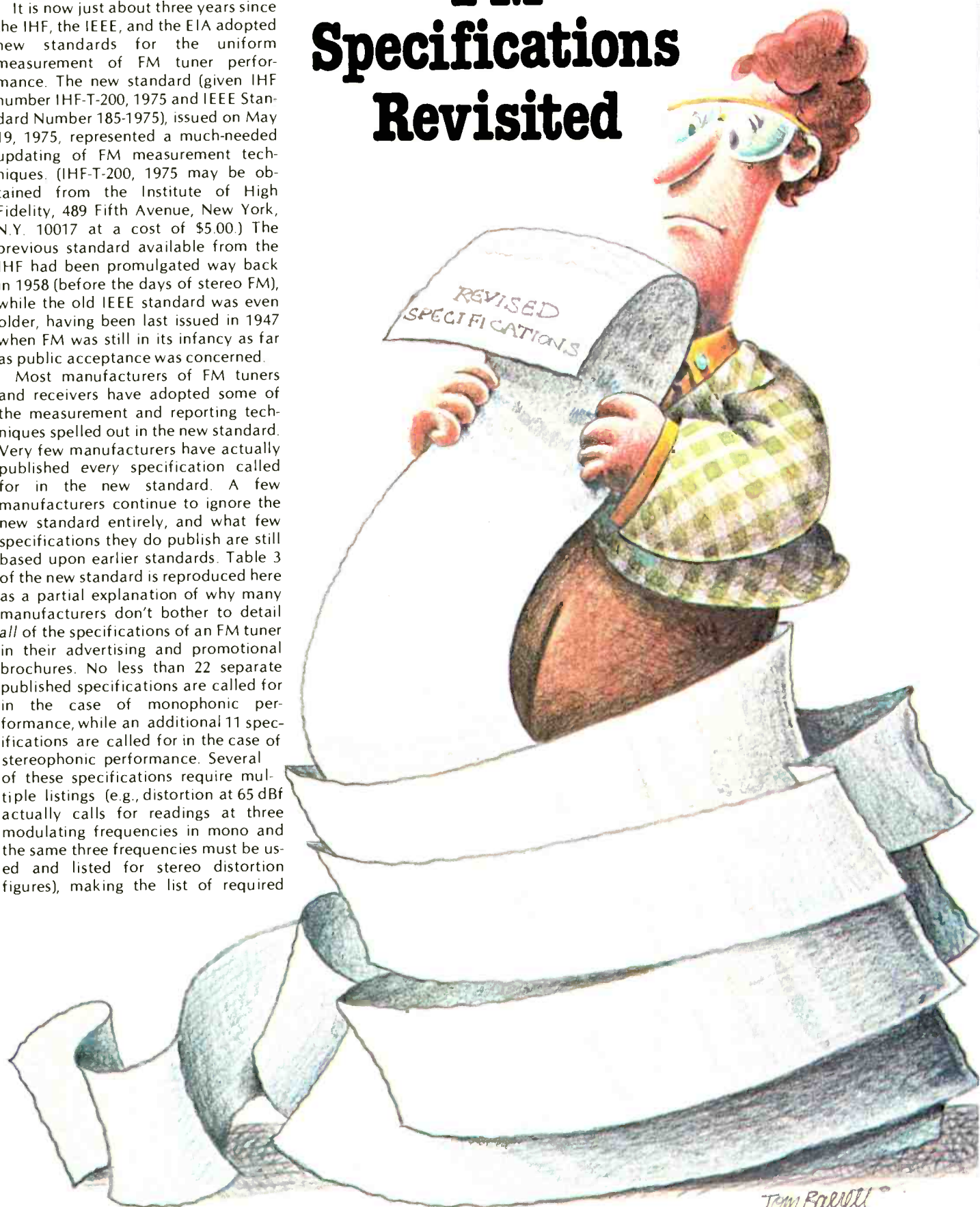

Tom Barrell

AUDIO • April 1978

specifications even longer. In the case of the IHF (which is concerned primarily with manufacturers whose tuner products might properly be called "high fidelity" equipment), that trade association does not have any legal means to force even its members to embrace the new standard. The IHF can only suggest to and encourage its members to abide by the new standards. The choice of specifications which members of the IHF (and others) have made tells us much about the nature and usefulness of many of the new specifications and measurements.

Usable Sensitivity

Although much has been written about the relative unimportance of this specification, most manufacturers continue to "feature" it as the specification of primary importance—at least as far as monophonic performance of the FM tuner is concerned. What's more, public awareness of "microvolt" notations of signal strength prompts many to continue to list usable sensitivity in that form, rather than to use the new and more meaningful "dBf" power notation for signal strength. Many continue to quote sensitivity in both forms. A simple formula for conversion from microvolts to dBf (assuming a 300-ohm antenna input impedance) is:

$$\text{dBf} = 20 \log_{10} \mu\text{V}/0.55$$

Not surprisingly, very few manufacturers tell us the value of "usable sensitivity" for stereo operation of their products (though these days, most FM listening is in the stereo mode). There are at least two reasons for this deliberate omission. Most FM tuners have automatic switching from mono to stereo. The switchover point is usually set by the manufacturer so that when a signal is strong enough to cause the transition from mono to stereo operation, the noise and distortion will be well under 3 per cent (or more than 30 dB below the desired output signal level). If a manufacturer sets the switching threshold to, say, 5 μV (19.2 dBf), that becomes, per force, the "stereo usable sensitivity." On the printed spec sheet, such a number is not terribly impressive when compared with the 1.8, 1.7, or 1.6 microvolts figures (10.3, 9.8, or 9.3 dBf) normally associated with mono usable sensitivity of modern tuners.

Even where auto switching from mono to stereo is not featured, one can expect the stereo usable-sensitivity figure to be poorer than that of the mono usable sensitivity, and manufacturers are understandably reluctant to disclose this seeming disparity.

50-dB Quieting

The most important specification appearing in the new standard calls for a statement of signal strength required in mono and stereo for the noise to be suppressed 50 dB compared with the 100 per cent modulated output signal at 1 kHz. Manufacturers have seemed more willing to publish these figures. Readers of specification sheets should not be disappointed to find that at least 20 dB more of input signal is required to reach this "listenable" noise level in stereo than is required in mono. Thus, a tuner claiming a 50-dB quieting requirement of 12.0 dBf in mono (2.2 μV), will, at its best, require 32.0 dBf (22.0 μV) of input signal to achieve the same degree of quieting in stereo. Design limitations usually result in even greater discrepancies between these two published figures.

Signal-to-Noise Ratio

In the case of this specification too, manufacturers have generally complied with the new standard and offered S/N values (in dB) for both mono and stereo performance. By the time a strong signal (65 dBf) is applied to the antenna terminals of most tuners, the difference in quieting between mono and stereo operation has usually reached a much lower figure. Typically, a tuner having a 70-dB S/N ratio in mono may exhibit quieting of 65 dB or even more in the stereo mode. Figure 1 shows the manner in which the stereo and mono quieting curves tend to converge as signal strength increases.

Distortion at 50-dB Quieting

One seldom sees this value published at all and, in my opinion at least, this is one specification which the stan-

Table 3—Receiver Performance Evaluation

Specification Ratings		Monophonic	Stereophonic
Usable sensitivity	dBf	(Section 6.3)	(Section 7.1)
50-dB quieting sensitivity	dBf	(Section 6.4)	(Section 7.2)
Signal-to-noise ratio at 65 dBf	dB	(Section 6.5)	(Section 7.3)
Hum and noise at 65 dBf	dB	(Section 6.6)	—
Minimum volume hum and noise	dB	(Section 6.7)	—
Muting threshold	dBf	(Section 6.8)	(Section 7.4)
Frequency response 30 Hz to 15 kHz	\pm dB	(Section 6.9)	(Section 7.5)
Distortion at 50-dB quieting	per cent	(Section 6.10.1)	(Section 7.6.1)
Distortion at 65 dBf	per cent	(Section 6.10.2)	(Section 7.6.2)
Intermodulation distortion	per cent	(Section 6.12)	(Section 7.6.3)
Capture ratio	dB	(Section 6.13)	—
Adjacent channel selectivity	dB	(Section 6.14)	—
Alternate channel selectivity	dB	(Section 6.14)	—
Spurious response ratio	dB	(Section 6.15.1)	—
Image response ratio	dB	(Section 6.15.2)	—
I f. response ratio (balanced)	dB	(Section 6.15.3)	—
I f. response ratio (unbalanced)	dB	(Section 6.15.3)	—
R.f. intermodulation	dB	(Section 6.16)	—
AM suppression ratio	dB	(Section 6.17.3)	—
Frequency drift	kHz	(Section 6.18)	—
AFC correction factor	—	(Section 6.19.2)	—
AFC offset error	\pm kHz	(Section 6.19.3)	—
Stereo separation	dB	—	(Section 7.7)
Subcarrier product ratio	dB	—	(Section 7.9)
SCA rejection ratio	dB	—	(Section 7.10)

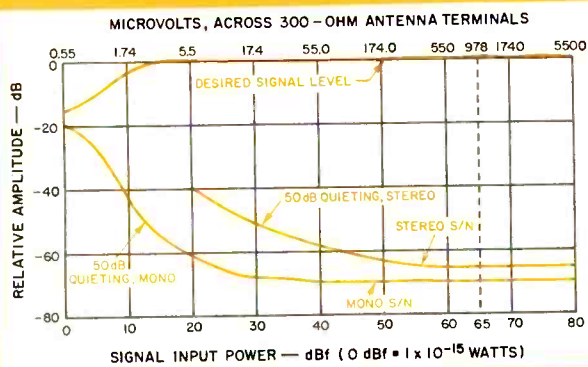

Fig. 1—Mono and stereo quieting in the FM section.

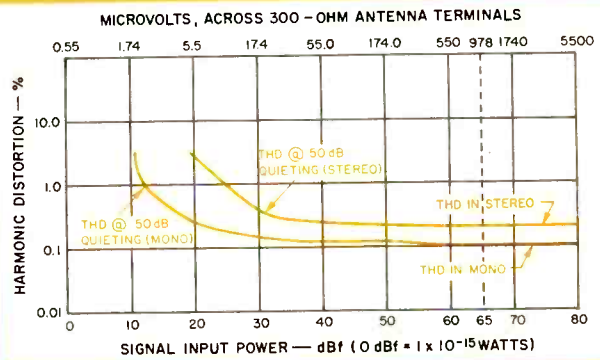

Fig. 2—Mono and stereo distortion characteristics in the FM section.

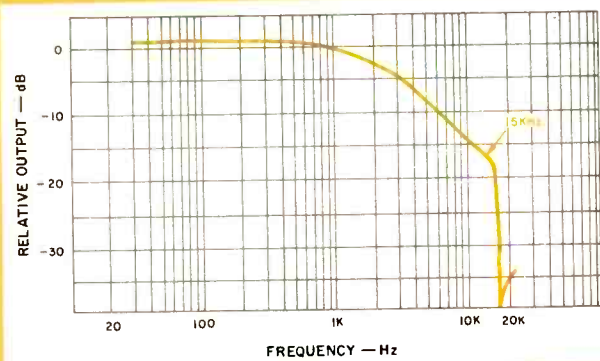

Fig. 3—Ideal frequency response of an FM tuner follows the 75- μ S de-emphasis to beyond 15 kHz with a sharp notch in response at 19 kHz.

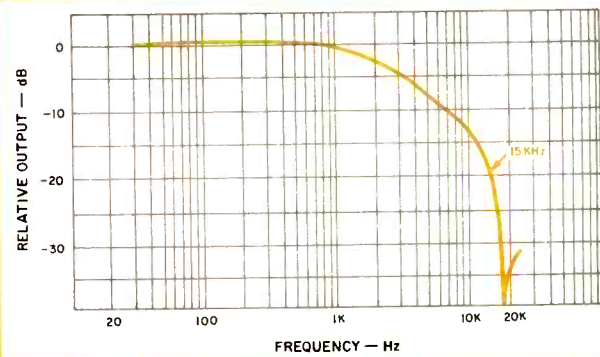

Fig. 4—In a less-than-ideal response curve the 19-kHz filter action interacts with the 75- μ S de-emphasis curve above 10 kHz.

dards committees responsible for the new standard might have been better off omitting and Fig. 2 shows why. Note that in Fig. 1, 50 dB of quieting in mono was reached with an input signal level of 12.0 dBf (2.2 μ V). As we can see in Fig. 2, at that signal level, distortion is still quite high (1.0 per cent in our example). The combination of incomplete limiting and minimal AGC levels restricts i.f. bandwidth and detector linearity so that 100 per cent modulation at such low signal levels is "pushed" beyond the linear operating range of the i.f. detector circuitry of the tuner. Thus, the better the 50-dB quieting of the tuner in mono, the "poorer" the 50-dB quieting distortion is likely to be. Adding further to this contradiction is the fact that since a greater signal input is required to attain 50-dB quieting in stereo, the 50-dB quieting distortion in the stereo mode nearly always turns out to be lower than in the mono mode—a contradiction not easily understood by the average consumer.

Frequency Response

One would think that designers would have no difficulty in maintain-

ing near-perfect frequency response in an FM tuner from 30 to 15,000 Hz (the legal limits of audio modulation in FM). Yet, as is easily seen from the many published tuner spec sheets, it is not unusual to find claimed response varying by ± 1.0 dB, ± 1.5 dB, or even worse. Again, two conflicting factors are at work here. Ideally, the response of the tuner to 19 kHz should be minimal in order to suppress any 19-kHz, stereo-pilot signal output from the tuner. Substantial output at this frequency can have an undesired effect when FM programs are recorded onto tape decks equipped with Dolby circuitry (the Dolby decoder senses this signal as a high frequency audio "program" signal causing false Dolby encoding) and can, in some cases, actually be injurious to tweeters. In still other instances, 19 kHz (and harmonic products of that pilot frequency) can cause audible "beats" when recorded on tape.

But rejection of this unwanted output requires a carefully designed 19-kHz, notch-filter circuit in series with the output signals. Unless that filter is of a multi-pole (and thus expensive) design, it is likely to start "rolling off"

desired response in the range from 10 kHz and upwards. Figures 3 and 4 illustrate this problem. Response of an "ideal" filter is illustrated in Fig. 3, while the less-than-ideal situation (typically found in many tuners and receivers) is shown in Fig. 4.

Intermodulation Distortion

Most experts agree that the intermodulation distortion tests specified in the new standards tell more about the audible performance of a tuner than the harmonic distortion tests. Yet, virtually no tuner or receiver manufacturer bothers to specify this important number. Here, I think, the reasons arise more from practical considerations than from any attempt to withhold information. The IM tests require the use of two signals of equal amplitude (14 kHz and 15 kHz) with an instantaneous peak deviation of ± 75 kHz. The resulting 1000-Hz IM product at the output must be measured using a 200-Hz-to-1500-Hz bandpass filter and expressed as a percentage of the output that would be obtained when 1000-Hz modulation at ± 75 kHz is used. The test set-up is illustrated in Fig. 5. Unfortunately, none of the popular FM

Empire's Blueprint for Better Listening...

No matter what system you own, a new Empire phono cartridge is certain to improve its performance. The advantages of Empire are threefold. One, your records will last longer. Unlike other magnetic cartridges, Empire's moving iron design allows our diamond stylus to float free of its magnets and coils. This imposes much less weight on the record surface and insures longer record life.

Two, you get better separation. The small, hollow iron armature we use allows for a tighter fit in its positioning among the poles. So, even the most minute movement is accurately reproduced to give you the space and depth of the original recording.

Three, Empire uses 4 poles, 4 coils, and 3 magnets (more than any other cartridge) for better balance and hum rejection. The end result is great listening. Audition one for yourself or write for our free brochure, "How To Get The Most Out Of Your Records." After you compare our performance specifications we think you'll agree that, for the money, you can't do better than Empire. Empire Scientific Corp., Garden City, New York 11530

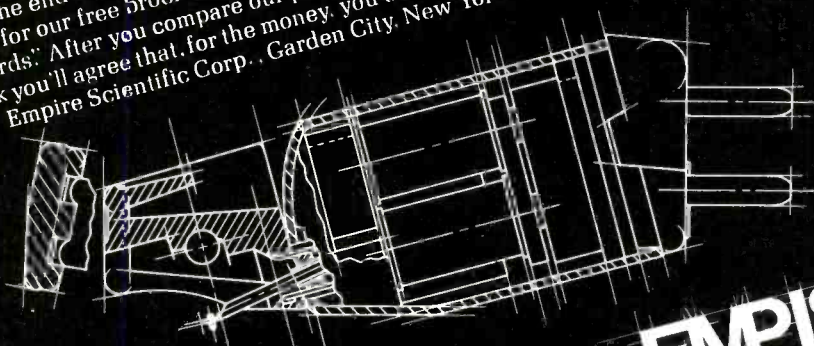

EMPIRE

MODEL	4000 D/III	4000 D/I	2000Z	2000Z	2000 E/III	2000 E/II	2000 E/I	2000 E	2000
FREQUENCY RESPONSE	10Hz-50kHz ± 3 dB	15Hz-45kHz ± 3 dB	20Hz-20kHz ± 2 dB	20Hz-20kHz ± 1½ dB	20Hz-20kHz ± 2 dB	20Hz-20kHz ± 2 dB	20Hz-20kHz ± 3 dB	30Hz-20kHz ± 3 dB	20Hz-20kHz ± 3 dB
TRACKING FORCE RANGE	¾-1¼ gm	1-1¼ gm	¾-1¼ gm	¾-1¼ gm	¾-1½ gm	¾-1½ gm	1-2 gm	1¼-2½ gm	1½-3 gm
SEPARATION	15Hz to 1kHz 23 dB 1kHz to 20kHz 20dB 20Hz to 500Hz 15dB 500Hz to 15kHz 15dB	24 dB 20 dB 15 dB	20 dB 30 dB 25 dB	18 dB 27 dB 22 dB	20 dB 28 dB 20 dB	20 dB 25 dB 18 dB	18 dB 23 dB 15 dB	18 dB 23 dB 15 dB	16 dB 21 dB 13 dB
I.M. DISTORTION @ 3.54 cm/sec	.2% 2kHz-20kHz	.2% 2kHz-20kHz	.08% 2kHz-20kHz	.08% 2kHz-20kHz	.1% 2kHz-20kHz	.15% 2kHz-20kHz	.2% 2kHz-20kHz	.2% 2kHz-20kHz	.2% 2kHz-20kHz
STYLUS	.2 mil bi-radial	.2 mil bi-radial	.2 x .7 mil elliptical	.2 x .7 mil elliptical	.2 x .7 mil elliptical	.2 x .7 mil elliptical	.2 x .7 mil elliptical	.3 x .7 mil elliptical	.7 mil spherical
EFFECTIVE TIP MASS	4 milligram	4 milligram	2 milligram	2 milligram	6 milligram	6 milligram	6 milligram	9 milligram	1 milligram
COMPLIANCE	30x10 ⁻⁶ cm/dyne	30x10 ⁻⁶ cm/dyne	30x10 ⁻⁶ cm/dyne	30x10 ⁻⁶ cm/dyne	20x10 ⁻⁶ cm/dyne	18x10 ⁻⁶ cm/dyne	17x10 ⁻⁶ cm/dyne	16x10 ⁻⁶ cm/dyne	14x10 ⁻⁶ cm/dyne
TRACKING ABILITY	30 cm/sec @ 1kHz @ 1 gm	30 cm/sec @ 1kHz @ 1½ gm	38 cm/sec @ 1kHz @ .9 gm	38 cm/sec @ 1kHz @ 1 gm	32 cm/sec @ 1kHz @ 1 gm	28 cm/sec @ 1kHz @ 1¼ gm	28 cm/sec @ 1kHz @ 1½ gm	28 cm/sec @ 1kHz @ 1¼ gm	32 cm/sec @ 1kHz @ 2 gm
CHANNEL BALANCE	within 1 dB @ 1kHz	within 1½ dB @ 1kHz	within ¾ dB @ 1kHz	within 1 dB @ 1kHz	within 1 dB @ 1kHz	within 1¼ dB @ 1kHz	within 1½ dB @ 1kHz	within 1½ dB @ 1kHz	within 1½ dB @ 1kHz
INPUT LOAD	100k Ohms/channel	100k Ohms/channel	47k Ohms/channel	47k Ohms/channel	47k Ohms/channel	47k Ohms/channel	47k Ohms/channel	47k Ohms/channel	47k Ohms/channel
TOTAL CAPACITANCE	under 100 pF/channel	under 100 pF/channel	300 pF/channel	300 pF/channel	400-500 pF/channel	400-500 pF/channel	400-500 pF/channel	400-500 pF/channel	400-500 pF/channel
OUTPUT @ 3.54 cm/sec	3 mV/channel	3 mV/channel	3 mV/channel	3 mV/channel	4.5 mV/channel	4.5 mV/channel	7 mV/channel	7 mV/channel	7 mV/channel

Enter No. 13 on Reader Service Card

signal generators currently used by most manufacturers have this built-in test signal available, and the required bandpass filter is not standard either. Thus, it would seem that manufacturers have simply been too lazy to build their own test fixtures for this important test. (That applies to this equipment reviewer as well, though I have, many times, vowed to correct that omission!)

Table I—FM Tuner Specification Priorities.

Order Of Priority From 0 to 15

15 Major Specifications In Order Listed In IHF-T-200, '75	In-City Dwellers With Strong Signals Closely Spaced On Dial	Fringe-Area Dwellers With Only A Few Weak Signals Received
Usable Sensitivity*	5	2
50-dB Quieting Sensitivity*	1	1
S/N at 65 dBf*	8	6
Muting Threshold	—	7
Frequency Response*	3	3
THD at 50-dB Quieting**	—	5
THD at 65 dBf*	7	11
IM Distortion*	4	9
Capture Ratio	4½	4
Adjacent Channel Selectivity	15	—
Alternate Channel Selectivity	2	12
Spurious Response Rejection	10	—
Image Response Rejection	9	10
I.f. Rejection	11	13
AM Suppression Ratio	6	8
Stereo Separation	13	14
Subcarrier Rejection***	14	15
SCA Rejection****	12	—

Notes: These are the priorities author Len Feldman feels should be assigned to FM tuner specifications. Note that in many instances, a specification that is important for close-in dwellers is of lesser importance to fringe-area inhabitants.

*Figures must be provided for both mono and stereo reception.

**Of lesser importance in stereo, since tuner is well beyond full limiting and wide bandwidth reception at 50-dB quieting.

***Only of concern if you plan to record onto tape from FM.

****Only of concern if stations in your area transmit SCA signals.

Unchanged Specifications

The following specifications and their methods of measurement remain substantially the same as they were in earlier tuner measurement standards. Alternate channel selectivity, spurious response ratio, capture ratio, i.f. response ratio, image response ratio, and AM suppression ratio. Not surprisingly, most manufacturers find no difficulty in fully disclosing these specs. On the other hand, *adjacent* channel selectivity, though clearly called for in the new standards, is almost never published by tuner or receiver manufacturers. Again, the manufacturer is

faced with conflicting requirements here. If the tuner is designed with an extremely wide i.f. bandwidth in order to provide ultra-low distortion performance, the adjacent channel selectivity (and sometimes even the alternate channel selectivity) is going to be a relatively low number. After all, the tests for adjacent channel selectivity involve measuring the response of the tuner to a signal that is only 200 kHz removed from a desired signal. In an ultra-low distortion tuner, the adjacent channel selectivity figure may be as low as from 5 dB to 20 dB or so! Most manufacturers probably conclude that the audio consumer, having been conditioned to expect high "selectivity" figures, will be discouraged by such "low" selectivity values and will fail to understand the difference between *adjacent* and *alternate* channel selectivity. This is especially so since, for years, manufacturers have listed this specification as, simply, "selectivity"—without specifying the fact that it was measured for a signal that is 400 kHz (two channels away) from the desired signal.

As many readers are probably aware, a trend that has developed recently is to offer tuners with variable (or two degrees) of selectivity. "Narrow" settings are used when stations are close together on the dial (at the expense of ultra-low distortion), while "wide" settings are used when signal frequencies are far enough apart on the dial so that the lower selectivity afforded by such i.f. circuit configurations does not cause interference problems and yields the lowest distortion figures possible.

Subcarrier Product Ratio And SCA Rejection Ratio

These specifications and the methods used to measure them are two which relate to the stereo performance of tuners and receivers. We have already discussed subcarrier product rejection and how it is interrelated with a tuner's frequency response. Quite a few manufacturers are quoting this figure correctly and accurately.

As for SCA rejection ratio, I am certain that just about every dedicated FM listener has, at some time or other, been subjected to mysterious swishing and gurgling noises when listening to certain FM stations. As most readers know, many FM stations earn additional revenues by leasing their subcarrier facilities to such private communications firms as background music operators, private news services, and special services such as talking-

Nikko Sounds as Professional as it Looks

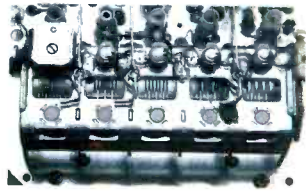

5-gang capacitor

Alpha II amplifier.

One look at the front panel controls and it is obvious these units possess an unusual combination of creative features. Nikko engineers also developed the advanced technology you can't see.



Toroidal power transformer

only the signal you want to hear.

The thinline Beta I preamp employs high voltage FET's for exceptionally fast signal reaction and extremely high efficiency and linearity in the high frequency range. A toroidally wound power transformer reduces hum radiation while the phono overload rejection capability is one of the highest ever measured.

If you thought Nikko only makes rock-solid, quality-built receivers, we have some pleasant surprises.

For the discerning listener, we present a selection of rack-mountable stereo components from Nikko Audio's Professional Series. The Gamma I FM tuner, The Beta I preamp and the

Technology which makes these components truly professional in sound as well as appearance.

The advanced design 5-gang capacitor (highest rated capacitor available) gives the Gamma I tuner superior FM sensitivity (1.8 μ V) and selectivity (35dB wide, 85dB narrow). You get the signal you want, and

On the Alpha II amplifier, totally independent, dual power supplies offer far greater dynamic range and lessened crosstalk than the usual split single power supply and significant headroom. (120 watts per channel, both channels driven into 8 ohms, from 15 Hz to 20 kHz with THD and IM distortion a phenomenally low 0.03%.)



Dual power supplies

always affordable.

Take another look at the features and controls. Then visit your Nikko dealer and experience true professional sound.

Available with black or brushed aluminum front panel

Nikko Audio

For those who take their stereo seriously

Nikko Electric Corp. of America

16270 Raymer St., Van Nuys, Calif. 91406 (213) 988-0105

In Canada: Superior Electronics, Inc. © Nikko Audio 1978

Enter No. 26 on Reader Service Card

The super fidelity receiver

The Sansui G-9000

A lot of money? You bet it is. But that's what it cost Sansui to develop the world's most advanced receiver. The Sansui G-9000 super fidelity DC receiver. Never before has music reproduction been so clean, brilliant, and true. When you listen to a G-9000 you'll actually hear a difference. When you look at the specifications, you will understand why.

The amplifier section is DC and direct coupled to achieve the widest frequency response of zero Hz to 200kHz (from main-in, -3dB). A slew rate of $80V/\mu\text{sec.}$ achieved through unique Sansui amplifier circuitry (patent pending), ensures fastest response to all musical signals. And we have virtually

eliminated distortion. THD is all the way down to 0.02% at full rated power of 160 watts per channel, min. RMS, both channels driven into 8 ohms from 20-20,000Hz.

The FM section offers selectable IF bandwidth, for greatest selectivity in crowded signal areas and lowest distortion (0.08% stereo) under normal listening conditions. Sensitivity is $1.5\mu\text{V}$ (8.7dBf), and capture ratio is a very low 0.9dB.

Sansui engineers have used independent power supplies with a dual-wound toroidal transformer to ensure minimal hum and channel crosstalk. Large oval capacitors provide a more-than-ample power reservoir. And the phono equalizer is de-



someone paid a million for. pure power DC receiver.

signed for extraordinary accuracy (± 0.2 dB, 20 Hz-20 kHz) and high overload margin (330 mV RMS).

The Sansui G-9000 is, all in all, more advanced than nearly every separate amplifier and tuner available today at any price. And certainly more convenient. Especially when you look at and handle the full complement of "human engineered" controls. They are beautifully positioned, superbly smooth and outstandingly accurate. We have even placed all the input, output and speaker terminals at the sides, with rails for hiding the cables.

Interested? Then visit your nearest Sansui dealer today. You'll be surprised to learn that our

suggested retail price is only \$1,050 and that we also offer the G-8000 pure power DC receiver, with nearly all the advantages of the G-9000, but with slightly less power, at the suggested retail price of only \$900. Which isn't a lot when you consider that these super fidelity components are easily worth a million.

SANSUI ELECTRONICS CORP.

Woodside, New York 11377 • Gardena, California 90247

SANSUI ELECTRIC CO., LTD., Tokyo, Japan

SANSUI AUDIO EUROPE S.A., Antwerp, Belgium

In Canada: Electronic Distributors

Simulated walnut grain cabinet.



Enter No. 37 on Reader Service Card

Sansui

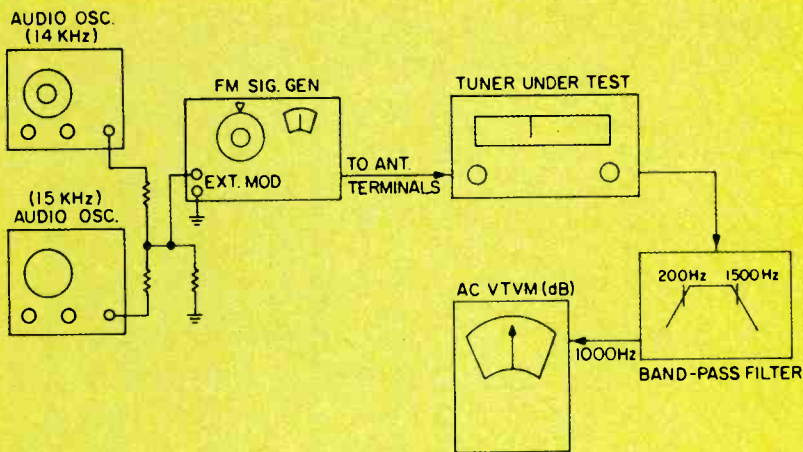

Fig. 5— Setup required for measuring the IM distortion of an FM tuner.

books for the blind. In the case of stereo FM stations, this service is transmitted via a 67-kHz subcarrier which is frequency modulated by the subscriber audio information. In theory, at least, regular listeners to FM should not hear any of this audio material, and special sets are leased to subscribers who are entitled to this SCA service. The gurgling and swishing sounds referred to are the result of cross modulation and intermodulation effects taking place either at the transmitter or (more likely) at the tuner.

I have often found, when listening to and bench testing certain FM tuners and receivers, that the published specification regarding SCA rejection does not provide reliable correlation with what I hear when tuning to a station which is known to be transmitting an SCA signal. I suspect that the reason why the audible effects of SCA interference are greater than might be expected from the published specs is very likely that manufacturers, in

testing for SCA rejection, are merely applying a fixed 67-kHz modulating signal to their FM generators at an appropriate modulation level of 10 percent and measuring the resultant output at the audio output terminals of the tuner or receiver. That sort of static test will yield impressively high rejection figures for almost any decent tuner.

Unfortunately, that type of test does not correspond with what actually takes place when a transmitter sends out an SCA sub-carrier signal. A careful reading of the new standard discloses that the 67-kHz sub-carrier signal used must in turn be *frequency modulated* by a 2.5-kHz sine wave to an extent of ± 6 kHz. In other words, the 67-kHz carrier is made to vary from 61 kHz to 73 kHz at a 2.5-kHz rate. It is this *modulation* of the 67-kHz sub-carrier which causes the audible interference to a stereo listener, rather than the presence of the 67-kHz carrier itself as part of the recovered signal complex. While several FM signal gen-

erators (including the popular Sound Technology Model 1000A) do have a built-in 67-kHz signal capable of modulating the main carrier, these generators have no direct provision for frequency modulating that carrier, and so many manufacturers do not bother to construct or purchase the necessary equipment to make the test properly. In my own lab, I have worked out a simple way in which to create this FM modulated 67-kHz sub-carrier. Since I own two FM signal generators anyway (two are required for such measurements as selectivity and capture ratio) as well as a "univerter" (which is normally used to create an i.f. signal at 10.7 MHz for measuring i.f. rejection), I found that I could create a "beat frequency" of 67 kHz between one of my signal generators and the univertor (in much the same way that a beat of 10.7 MHz is created using these two pieces of equipment). By then modulating the generator of this combination with a 2.5-kHz signal and with a deviation of ± 6 kHz, out comes a modulated 67-kHz carrier which can then be used to modulate the main carrier of my second generator. The test setup is shown in the diagram of Fig. 6. Both the univertor and the generator associated with it must be fully stabilized and free of drift in order to maintain a constant 67-kHz beat frequency sub-carrier using this method, and I use a frequency counter to insure against possible drift of the critical 67-kHz frequency while making the SCA rejection measurement.

Summary

Much has been written lately about the lack of correlation between bench measurements made on modern amplifiers and their ultimate listenability. Indeed, I agree that there are probably many static measurements which we have not learned to make on an amplifier which would enable us to obtain a more meaningful set of test data if we but knew what those measurements might be.

In the case of FM tuner performance, however, I believe that the new standards *do* offer a comprehensive picture of the merits (or demerits) of a tuner or receiver insofar as its FM performance capability is concerned. A statement of all (or at least nearly all) of the specifications which the standard recommends be published can help the consumer who wants to purchase a superior FM tuner or receiver to make a proper judgment. Now it's up to more manufacturers to take the trouble to use the new standard for all it's worth.

Fig. 6— Suggested method of creating modulated 67 kHz sub-carrier for proper measurement of SCA rejection.

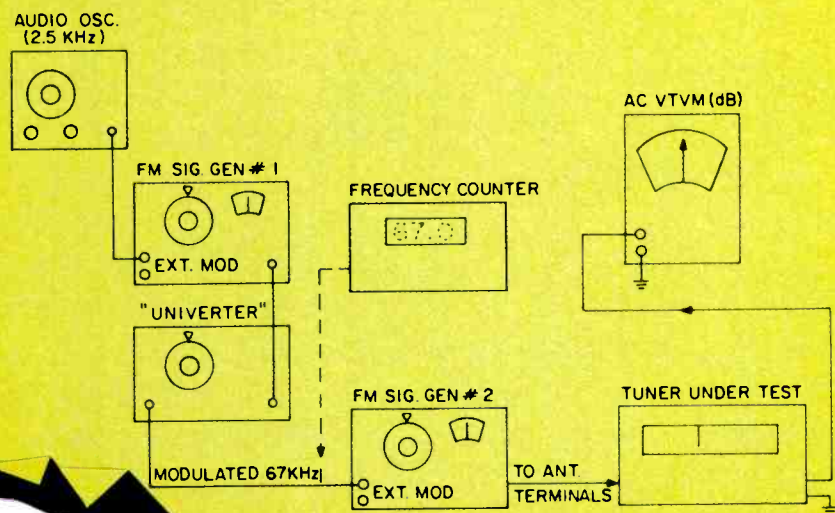

UNLOCK YOUR EARS.

Suppose you're in an art museum and find half of every picture covered with masking tape.

Outrageous?

Sure. But you listen to music the same way. Crescendos and pianissimos are sandwiched and crowded towards the middle.

The villains are the recording and broadcast processes – tapes, records, AM/FM. They have limitations that sacrifice almost half the dynamic range – the range between quiet and loud – of all the music you hear.

But now there is a way to unlock these processes ... so your system can let you hear what you would actually hear at a live performance.

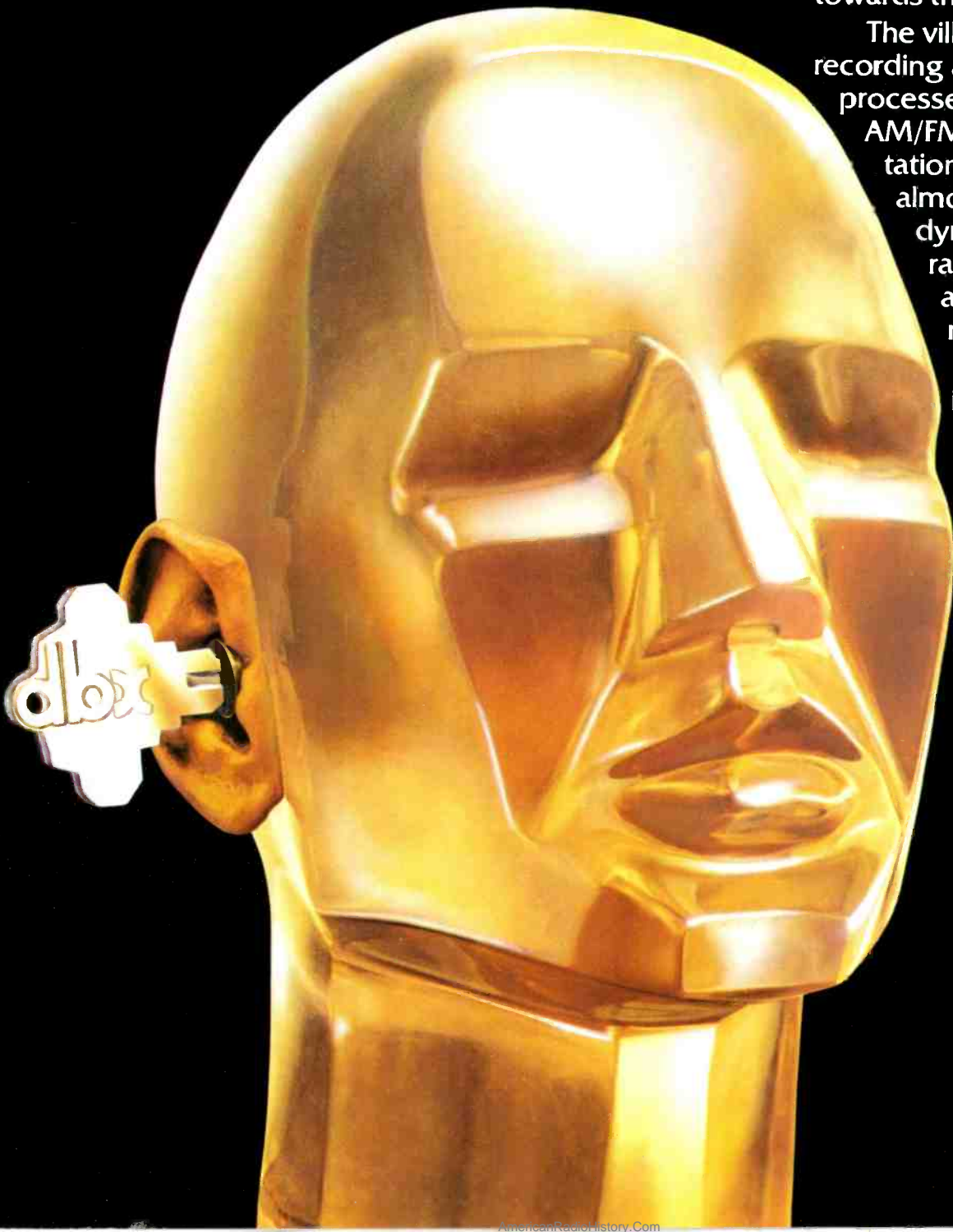



Who cares?

Your ears. They know what a live performance is like. So they can tell when compression blurs the sharp edge of percussive attacks, muddles the contrasts between quiet and loud instruments, and sacrifices definition. And the more compression, the more the music sounds flat and pinched, almost two-dimensional.

The solution – decompressed sound

Reverse the process. Simply by making quiet sounds more quiet and loud sounds louder, the way they are in a live performance, your system can pack your music with vitality and excitement. Realism, if you prefer. This is called expansion. The contrast between quiet and loud becomes startling, and musical performances approach the electrifying intensity of a live concert hall. The device that achieves this is called a dynamic range expander.

A few words about another amazing instrument

The dbx 3BX dynamic range expander. It's more than a state-of-the-art expander. It is the state of the art. Other companies' expanders operate only on a portion of the dynamic range and damage true musical perspective. The 3BX, however, is a true linear expander. It uniformly expands the dynamic range of all levels and all frequencies. Key elements are a patented rms detector which accurately senses the dynamic content of your music, and a voltage controlled

A few words about an amazing instrument

The human ear. It outperforms the best studio tape recorder by about 50%. The least sound it can hear is about 0dB of sound pressure level (or decibels, which is a scale for measuring the loudness, or quietness, of sound). The loudest sound it wants to hear is around 130dB. This gives it a dynamic range – the sound space if you will, between quiet and loud – of about 130 dB. The professional studio tape recorder has a dynamic range of only about 58 dB. And there lies the problem. A professional tape recorder "hears" a lot less than you do.

The problem – compressed sound

How does a recording engineer squeeze a musical performance with a range of 100 dB into a recording range of 58 dB? He can restrict the loud and quiet passages. Or he can squeeze. Push the quiet parts up, making them louder. Then push the lounds down, making them more quiet. Until everything is compressed into a 58 dB range.



amplifier which it instructs to increase or decrease level. Moreover, the 3BX separates the frequency spectrum into three bands and expands each individually. By knowing at any given instant which bands require expansion, the 3BX achieves stunning clarity and musical depth.

It's almost like having a Hi-Fi system for each instrument

Listen to music through a 3BX. What you're hearing is actually better than the broadcast source – better than the tape, better than the record, better than the FM signal. Definition is breathtaking. You'll hear the sharp attack of a brass section. The soft brushwork of a drummer. Every nuance and texture of a symphony string section will have incredible presence. And crescendos will build with conviction and amazing depth.

You not only hear what you're getting, you see what you're getting

The more you listen to the 3BX, the more you'll appreciate it. You can set the linear expansion for anything up to 50% more dynamic range. There is a pre/post switch for taping and/or listening. But the most visually intriguing part of the 3BX is the LED indicator bank for each of three frequency bands which shows you just where and how much expansion you're enjoying. You'll see the board light up when a double forte note jumps out of the speaker. Or with the sudden shout of a rock singer. Or when you hear a string section

and it feels almost thick with depth and you not only become more aware of the harmonics, but are able to pick out individual instruments. And the transition level control lets you center the program on the display, so you can see exactly what is going on.



The only component you won't have to upgrade

It will make no difference how modest, or expensive, your system is. The 3BX produces dramatic results with any system because it attacks the bane of all systems — the program source. So while you upgrade your system, the 3BX upgrades what goes into your system.

Be prepared for a rather pleasing side effect

The loss of about 20 dB of noise inherent in most records, tapes and FM broadcasts. As a matter of fact, noise approaches inaudibility.

There's more to hear

After you've heard the 3BX, listen to the dbx 118 linear dynamic range enhancer. It not only expands the dynamic range of sound, like the 3BX, for better listening, it can also compress the dynamic range of sound for background music for the home and special recordings. And if you're into copying your tapes and records onto cassette or open reel, you'll want the dbx 128. It makes tape copies that sound better than the records. It has two separate signal processing

units in one. The first is a dynamic range enhancer for expansion or compression of sound sources. The second is a dbx II tape noise reduction system which allows wide dynamic range material to be recorded on tape with no audible noise added by the tape recording process.

A challenge

What we say here is nothing compared to what your ears will tell you. As a matter of fact, we'd like to offer you a friendly challenge. If you think your system is so good it can't be improved upon, drop in on your dbx dealer and listen to a similar system with a dbx expander. The difference will startle you. And that's a promise.

To receive additional information, plus your nearest dbx dealer's location, write to us at the address below, or circle reader service number 10.

dbx

dbx, Incorporated
71 Chapel Street, Dept. I
Newton, MA 02195
617/964-3210



Circle number 10 on the reader response card.

Equipment profiles



71

Lirpa "VDRS" Vehicular Disc Reproduction System

MANUFACTURER'S SPECIFICATIONS

Wow & Flutter: 0.
Rumble: 0.
Noise: 0.
Grunge: 0.01.
Separation: 8.

Output: 9.5 watts.
Tracking Force: 0.003 grams.
Crosstalk: 0.
Back Talk: —
Frequency Response: 3-30, ± 0.5 .
Distortion: Below Annoyance.
Tire Treads: Yes.

Transient Distortion: Reduced to 0 after one playing.
Denominational Differences: 0.
Pinwheel Effect: Near threshold of pain for dogs.
Price: Very high.

(Editor's Note: Until last year, it was our policy not to let manufacturers take an active part in the testing of equipment. But, again, with the introduction of the Lirpa VDRS, it seemed best to let the maker explain and measure this extraordinary new piece of equipment inasmuch as we were unable to find anyone else who was able to understand its operating principles, much less measure its performance.—E.P.)

This somewhat unorthodox method introducing a new audio component has been brought about by misleading rumors and a vicious whispering campaign both within the audio industry and by those consumers who have never been able to see (or hear) the value of equipment bearing the proud Lirpa name. An insidious plot, orchestrated by jealous competitors, has duped the unwary buyer into believing that our new VDRS system for playing records is some kind of tinker

Like.

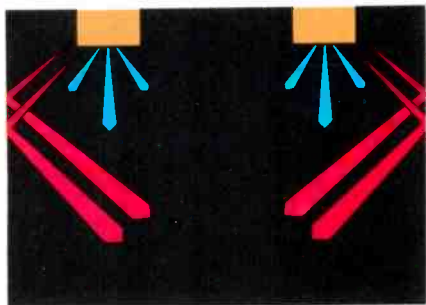

The Bose Model 301 is the least expensive Direct/Reflecting® speaker.

It is a true bookshelf speaker that can fill an entire library with music. Its size is small. Its sound is big.

Like other Bose Direct/Reflecting® speakers, the Model 301 speakers reflect off the side walls of your room for an open, spacious sound. And, you can use the Direct Energy Control to adjust the sound pattern to suit your taste and your listening room. Either way, you get a feeling of spaciousness and life-like sound you just don't expect from a speaker of its size and price.

More Like.

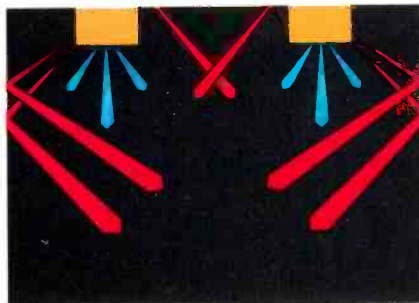

If you want sound that is even more like live, there is the new Bose Model 501.

The Model 501 is a floor-standing speaker that delivers wall-shaking bass through a 10-inch, high-performance woofer. Each speaker is "asymmetrical." One tweeter fires inward, one outward. And the left speaker works with the right to create full, rich, balanced stereo. In every corner of your room.

If your listening room isn't exactly ordinary, you can use the Direct Energy Control to adjust the high-frequency radiation of the outside tweeters. In other words, you shape the sound to fit your room.

Plus, the new Bose 501 looks as good as it sounds.

Most Like.

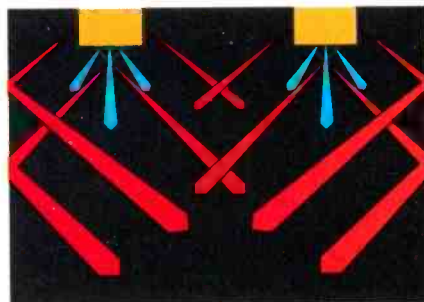

Still closer to the sound of "live" is the Bose Model 601. A high-performance speaker that behaves like one, in just about any listening environment.

Six drivers—two woofers and four tweeters—are precisely positioned so that sound comes from many directions to fill the room with sound. This configuration is essential to the exceptional spatial realism of the Model 601.

Half the drivers in the Model 601 radiate upward—above the level of sound-absorbing furniture.

In addition, there is a Symmetry Control so you can adjust the speaker's spatial characteristics to fit your living room.

The Bose Model 601 delivers life-like music better than any other speaker. Except one.

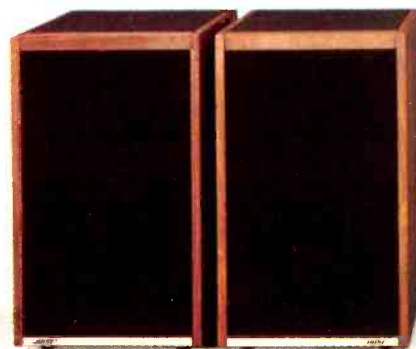

Live.



The ultimate. The Bose 901 Series III. Designed to re-create every dimension of live-performance sound for the greatest listening pleasure imaginable.

Nine matched, full-range drivers in each enclosure deliver the clearest highs, and the most powerful lows. Sound reflected in precisely determined patterns creates a feeling of spaciousness unsurpassed by any other speaker.

The patented Acoustic Matrix™ enclosure allows the Bose 901 Series III to deliver bass that cannot be duplicated in a con-

ventional wood enclosure. And a new, exclusive high-efficiency driver lets the Series III put out tremendous sound without a lot of expensive power.

Listen to the Bose 901. There are no speakers. Just music. Music as if you were hearing it for the first time. Live.

Of course, none of this just happens. For an explanation of the advanced technology behind Bose Direct/Reflecting® speakers, send \$1.00 to Bose, Dept. L, The Mountain, Framingham, MA 01701. We'll send you a comprehensive literature package.



BOSE®

The closest you can get to live music without being there.

toy that will never perform optimally. To this, we at LirpaLabs answer by unveiling the engineering prototype of our Vehicular Disc Reproduction System (VDRS). To dispell industry rumors, readers will immediately see that it is NOT an automotive record player meant to compete with mobile tape formats. (So there!)

There is no denying the fact that the advances in audio are coming fast and furious. The simple truth of the matter is that technological "breakthroughs" occur so frequently that today's state-of-the-art component will probably be obsolete just in time for next year's model. This line of reasoning went into our development of VDRS. To market just another turntable based on out-moded ideas—even a good turntable—is simply not the Lirpa way. The science and technology behind VDRS leap-frogs ahead of all other record playing systems, and VDRS is sure to be the ultimate record playing system for years to come.

The engineers at LirpaLabs have long understood the need for a top-quality record playing system—even though today's records with their 33 1/3 playing speed are terribly inadequate (Lirpa engineers have always felt that 39 rpm is far more practical, especially for audiophiles who have trouble with fractions and decimals). Nonetheless, until the industry makes the move to 39, we will bow to the realities of the marketplace. Therefore, the VDRS will play both today's 33 and tomorrow's 39.

We appreciate the wise move on the part of the editors of *Audio* in allowing us to make our presentation and review of VDRS. The development of VDRS is a prime example of the necessity of this type testing and evaluation—we aligned VDRS to perform optimally with our own special test equipment, not someone else's. What measures 100 per cent on our gear may very well register a different "score" on another brand of test equipment. And, as we have often argued, who is better qualified to judge this stuff than the people who invented it in the first place?

The Lirpa Vehicular Disc Reproduction System (notice the avoidance of the word "turntable") is a radical departure from all other designs in record playing equipment. There are numerous reasons for such a dramatic change in technology: It looks nice, it looks expensive, it will be expensive, people buy more on the basis of looks and price than on quality, and finally, with the quality of today's recordings, top-notch hi-fi gear isn't necessary to extract all the sound the disc has to offer. However, it is hoped that someday recordings will be able to match the performance capabilities of VDRS. And,

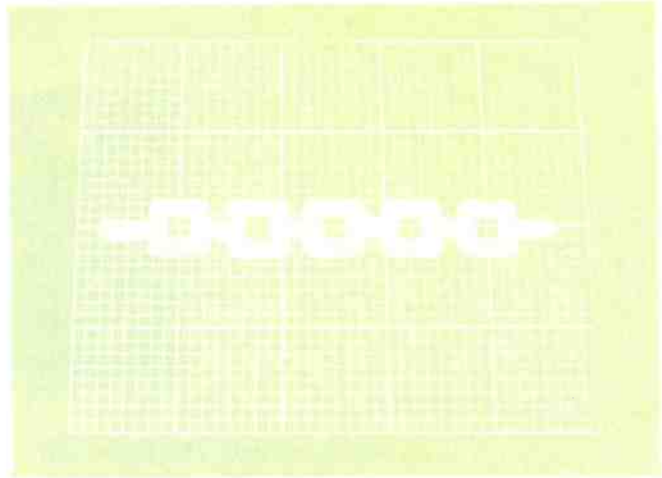
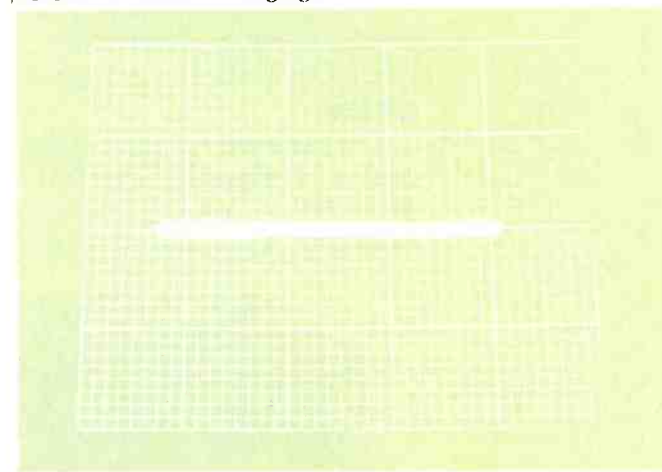

Fig. 1—The LirpaGraph of square-wave response at 20 kHz.

Fig. 2—The LirpaGraph of a 20-Hz burst test . . . note the absence of ringing!



74



the Lirpa marketing staff says he honestly believes that we'll be able to sell a few of these.

The Goal: To overcome ALL of the problems normally encountered in playing records. To that end, VDRS operates with none of the following, tracking force, inaccurate anti-skating devices, tonearm mass, tonearm resonance, speed variations, pinwheel effect, and turntable induced wow, flutter or rumble, as well as audible denominational differences.

The Solution: The vehicular Disc Reproduction System—a whole new concept in direct drive. Our VDRS design incorporates the stationary disc/moving cartridge principle. This concept immediately eliminates 90 per cent of the problems in conventional record players. But, in designing VDRS, scores of new engineering difficulties had to be overcome. Success has been achieved to the point that the entire VDRS package will offer the unprecedented guarantee for the full life of the warranty—30 days or 3,000 miles, whichever comes first. And that includes the stylus.

The Development: Thinking that it might still be possible to design a Lirpa record player using conventional tonearm design, a series of tests were conducted at LirpaLabs using the

IOC*

a new distortion indicator
for the serious listener



*Input-Output Comparator

The Crown IOC is an unusual and more accurate method of amplifier distortion indication. The IOC circuit, now available exclusively on Crown amplifiers, continually compares output and input waveforms. If they don't match, the front panel LED's light up.

The Crown IOC is extremely sensitive and reports distortion that may not be obvious. Such distortion can degrade listening pleasure.

The Crown IOC also reports many different causes of distortion. Your Crown IOC amp will tell you if the input signal is driving the output stages into clipping; if

the input slew rate is too fast for output stages; if you have unusual load problems; if there is a short in output lines; if the protection circuits are activated; if distortion in the output exceeds .05% THD or IMD, and if the amplifier and load are not compatible.

No other distortion indicator provides this much information. The Crown IOC is your guarantee that the amp output is not distorted; that you are sending a clear, uncolored signal to your speakers.

Crown amplifiers with IOC instrumentation are now in your dealer's listening room. They ought to be in yours.



1718 W. Mishawaka Road, Elkhart, Indiana 46514

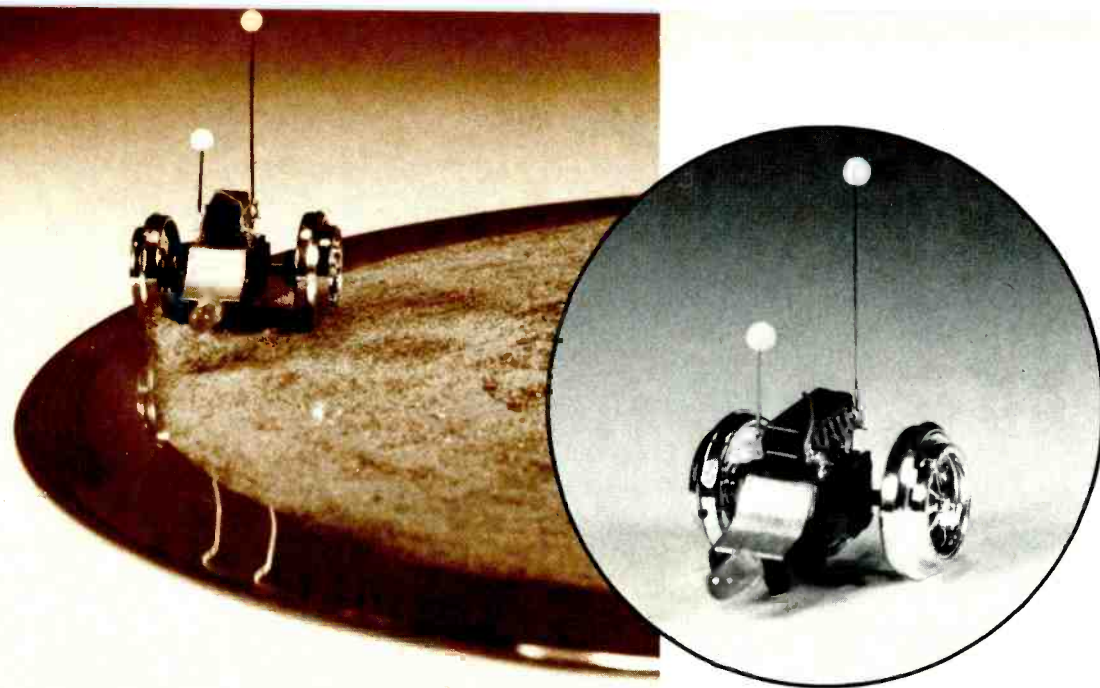

finest commercially available tonearms. None was able to meet our zero-measurement specifications. One of the tests involved different amounts of sound and pressure applied at the cartridge end of the tonearm and measured with sophisticated Lirpascopes for both static and dynamic readout. Results showed that every tonearm can be induced to conduct either sound, heat, and/or electricity to some degree. The newer carbon fiber tonearms (and our own experimental models of glass, tissue paper, balsa wood, and styrofoam) share a definite tendency to shatter during heavy pressure simulation (which involves striking the test models with a small metal mallet). The Lirpa solution—the only solution—is to do away with the tonearm entirely and have the cartridge/stylus assembly become a self-contained and self-powered unit, free from all physical connections and dependency on the disc support structure. And, by having the record remain motionless while the cartridge moves, the problems and compromises of earlier turntable designs are eliminated totally. No more belts, pulleys, idler wheels, or tricky direct drive mechanisms with their stators and rotors.

Tracking force has always been a compromise between what sounds good and what is technically permissible. The Lirpa VDRS cartridge comes equipped with a new and revolutionary stylus configuration—the TGC (Total Groove Contact) which tracks lighter than every other stylus on the market—0.003 grams. Unlike older models which touch only a portion of the groove walls (thereby requiring more downward pressure), the TGC stylus incorporates a new triangular shape which reaches from the top down to the very bottom of the groove—allowing the ultra-light tracking force while preserving and extending the life of the record. An added benefit is the forward thrust shape that, when combined with the triangular angles, resembles an inverted snow plow, which, while playing a record, is actually cleaning the groove, throwing out messy piles of dust, dirt, and vinyl shavings—all of which interfere with clean sound. The final advantage of TGC (as if the preceding weren't enough) is the uncanny ability of TGC to completely transform obsolete CD-4 quadrasonic albums into two-channel stereo discs by totally obliterating the unwanted 30-kHz carrier signal. The VDRS/TGC unit is factory adjusted for optimum tracking weight and is NOT user adjustable, which results in one less instance where the well-intentioned consumer can screw up a perfectly sound idea.

At first glance, the VDRS unit looks a bit like some miniature lunar lander out of NASA's space program. Indeed, many of the VDRS ideas are a direct outgrowth of Lirpa research into the cost-effectiveness of pre-fabricated concrete space capsules. An idea of the VDRS technique can be gleaned from its comparison with a toy tricycle. The two rear wheels provide movement, following the course set by the front "guide," in this case, the stylus. In this manner, all previous attempts at proper groove tracking are surpassed.

Note that the "axle" supporting the inner wheel is slightly longer than the other (outer) one. This allows flawless tracking of the tricky outer grooves. And, because the inner wheel is always travelling in a smaller circle, an internal IC-controlled differential gear (with infra-red LED readout assures constant compatible rotations (± 15 per cent). In normal (read outdated) disc play, the record revolves in a clockwise direction. Weeks of careful, computer-assisted study showed that to compensate for this, it is necessary for the VDRS/TGC module to travel in a counterclockwise motion. (For the technically ignorant, this means it follows the direction of the new Lirpa digital clocks—\$9.95 at fine jewelry stores.)

The internal workings of the VDRS/TGC travelling module are a marvel of electronic miniaturization and design. Aside from the forward and reverse drive mechanisms (which, I suppose we'll have to explain), the most unique feature is the Lirpa magnetic moving-quartz crystal (pat. pend.) which yields the clean sound of a moving-coil design yet, through the principle of standard magnetic design, yields a whopping 9.5 watt output. This ultra-clean signal is transmitted to the control module and signal receiver where it is routed to the user's own amplifier or table radio. The cantilever is a special synthetic plastic compound which is immune to the vibrational difference signals so often encountered in other record players. Also, since the cartridge (and its transmitter) is in constant motion, a special anti-doppler effect integrated circuit is used. This total lack of dopping is one cause for the unwavering transparent sound of VDRS.

Aside from the control and transmitting and receiving electronics, the most difficult obstacle in perfecting VDRS was the drive mechanism. Because the VDRS/TGC module is not connected to a conventional pivoting tonearm and because the record remains motionless during play, the cartridge and stylus must be self-powered. And movement in the aforementioned counterclockwise direction requires much more power

ONKYO'S QUARTZ-LOCKED ...ACCLAIM BY IMITATION

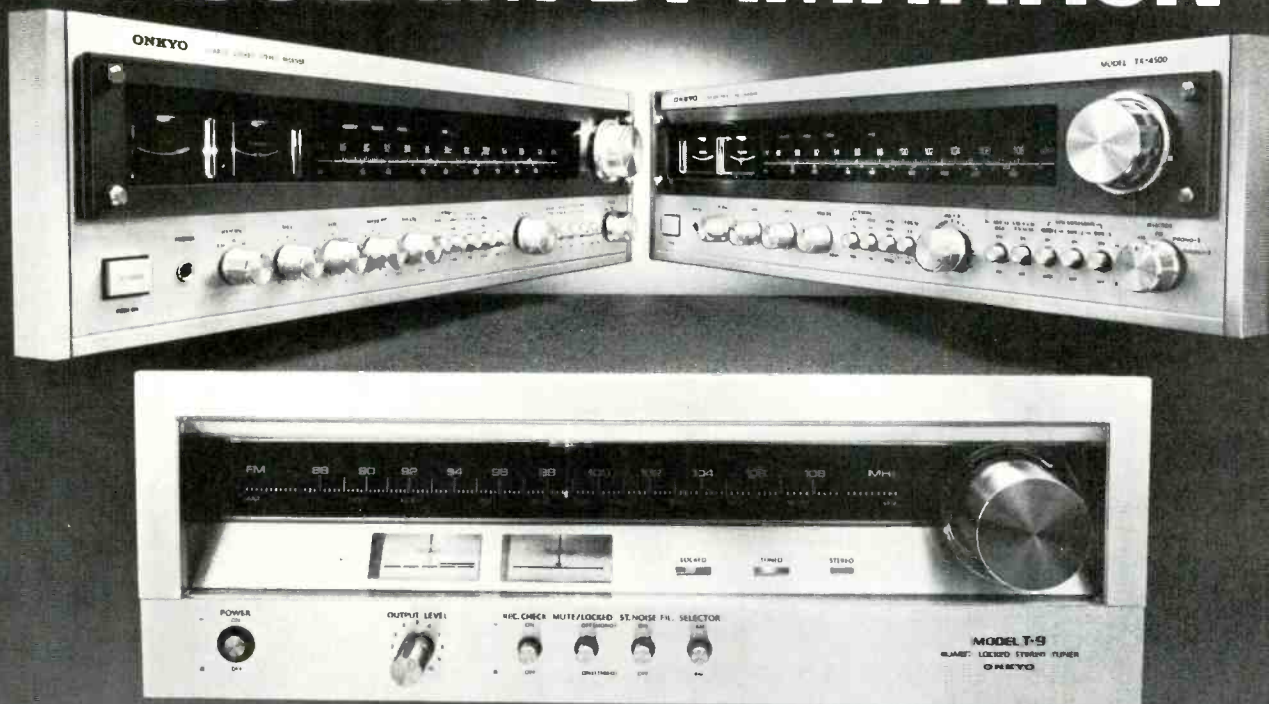

You know how much you count when people start imitating you. That's happening now with Onkyo's unique Quartz-Locked Tuning System. Since Quartz-Locked has proved to be about the best tuning system in the business, some big names are trying to equal our success.

You might, of course, be better off if they did copy the Onkyo Quartz-Locked. Then you'd have the system which Hirsch-Houck Labs said, "... was virtually impossible to mistake..."* A statement other independent labs have agreed with.

Onkyo's Quartz-Locked Tuning System is controlled by a Sentry Circuit which reacts to your touch on the tuning knob, unlocking Quartz-Locked when you touch it for tuning; locking it when you release the knob.

The system works through a quartz crystal controlled reference signal in constant comparison to the IF frequency. Quartz-Locked detects and corrects off-frequency conditions so fast you never even know it's happening. The result...continuous maximum reception that's rigidly stable.

Of course, we've had Quartz-Locked in our labs for years before putting it on the market. And, in the little more than a year it's been out, Quartz-Locked has made a name for itself... and a lot of audio fans

who appreciate the way it does what it's supposed to do.

In addition to Quartz-Locked receivers, Onkyo also has a Quartz-Locked tuner for up-grading your system. And a few more Quartz-Locked components coming off the drawing board now.

The best way to be sure of getting the Quartz-Locked system that set the standard is to be sure it says "Onkyo Quartz-Locked Tuning System."

Perhaps it can be imitated. We doubt it can be equalled.

ONKYO QUARTZ-LOCKED AUDIO EQUIPMENT

TX-4500 Quartz-Locked AM/FM Stereo Receiver

Power output 55 watts per channel, minimum RMS at 8 ohms, both channels driven from 20 Hz to 20 kHz, with no more than 0.1% Total Harmonic Distortion.

TX-8500 Quartz-Locked AM/FM Stereo Receiver

Power output 110 watts per channel, minimum RMS at 8 ohms, both channels driven from 20 Hz to 20 kHz, with no more than 0.1% THD. Dual Power supply.

T-9 Quartz-Locked AM/FM Stereo Tuner

Dual Gate MOS FET 4-Gang Variable capacitor front end with Usable Sensitivity 1.7 μ V; 50 dB Quieting Sensitivity of 3 μ V; Harmonic Distortion: Mono 0.15%, Stereo 0.3%; Stereo Separation 40 dB at 1 kHz.

*POPULAR ELECTRONICS AUGUST, 1976

Artistry in Sound

ONKYO®

Eastern Office: 42-07 20th Avenue, Long Island City, NY 11105 (212) 728-4639

Midwest Office: 935 Sivert Drive, Wood Dale, Ill. 60191 (312) 595-2970

West Coast Distribution Center: Damark Industries, Inc., 20600 Nordhoff Street, Chatsworth, California 91311 (213) 998-6501

Canada: Sole Distributor, Tri-Tel Associates, Ltd., Willowdale, Ontario, Canada M2H 2S5

Enter No. 66 on Reader Service Card

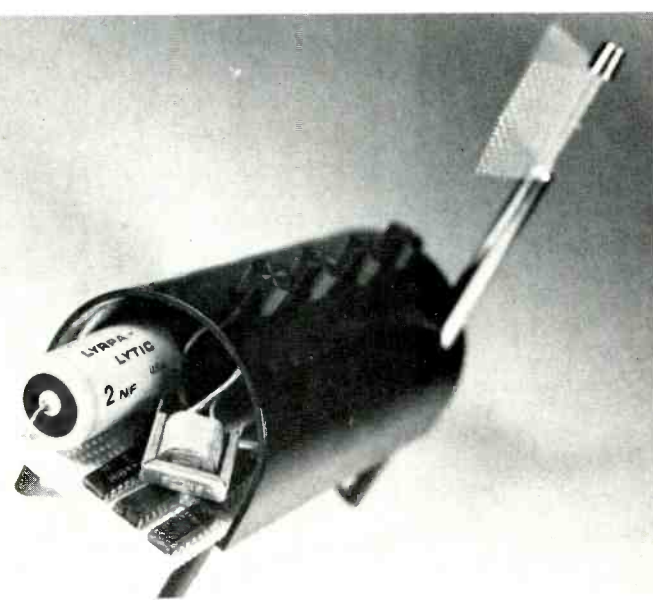
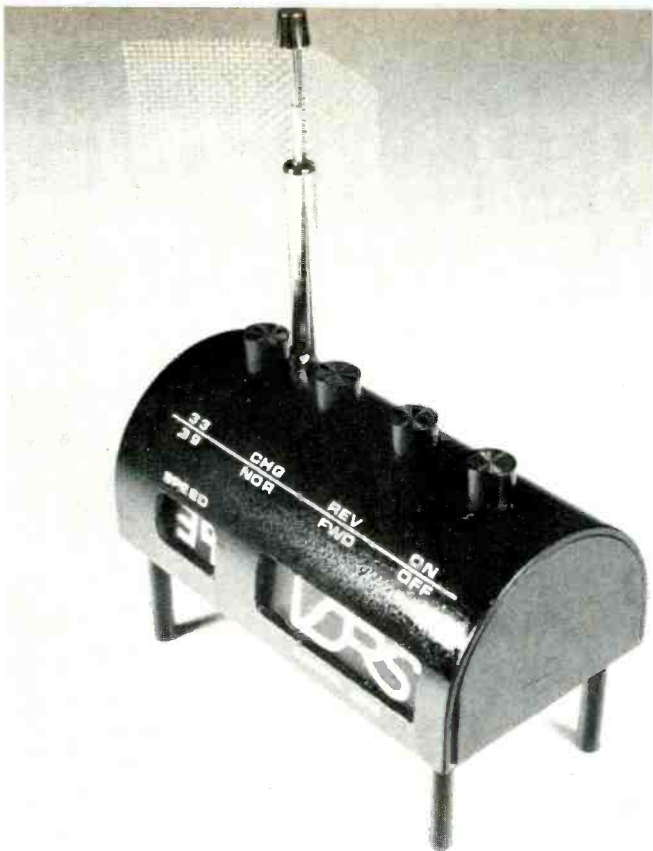

than not moving at all. Various types of power supplies were tried and found to be incapable of meeting Lirpa's high standards. The first was a large magnet, moving helically beneath the disc support to "pull" the TGC module around the record. Unfortunately, the magnetic field thus generated interfered with the cartridge output. It also caused small metal objects to fly through the air and adhere to the base of the VDRS unit. The second was photo-optical transmission of energy which worked well in experimentation except that proper component alignment was far too critical for mass production. However, we are happy to report that soon you will be able to purchase Lirpa wireless Christmas tree lights. Solar power cells, the third, were rejected due to the difficulties in mounting a 2000-watt klieg light six inches above the disc sur-

face. Also, this method resulted in melting both the record and VDRS/TGC module into an unsightly lump of plastic. Finally, it was determined that a rechargeable battery would be ideal. Hidden inside the VDRS/TGC body is a subminiature titanium oxide wet cell (TOWC) sealed in a capsule of hydrogenated copper/stainless steel alloy (HCSSA). The battery is good for 10 to 12 hours of play before a one-hour recharge is required. Because the entire VDRS-TGC-TOWC-HCSSA system is meant only for 33 and 39 rpm play (Lirpa engineers have no faith in the 45) longer battery times are realized than would otherwise be possible. The heavy-duty disco model comes equipped with dual-TOWC (DTOWC) batteries.

Atop the cartridge body is a sandwich of diagonally linear multi-function ICs, which handle motion control, signal transmitter, instruction receiver, and anti-dopple. These advanced micro-processors were specially developed for Lirpalabs by a conglomerate of electronics firms who, for reasons unknown, wish to remain nameless. These firms are currently working on a new Lirpa idea tentatively called the "vacuum valve."

Although the VDRS concept is revolutionary in its complex design, in actual use it is amazingly simple. To play, just place the cartridge body in the lead-in groove (remember counterclockwise) and select the proper speed at the control center. (For some time, we expect that most consumers will be using the 33 mode.) Push the direction button, and away it goes. Sit back and enjoy up to 12 hours of uninterrupted music without tonearm resonances, rumble, wow, or pin-wheel effect. If, during the course of play, the battery runs down to the danger point, there is no distorted sound due to slower motion. Instead, the VDRS/TGC cartridge is designed to simply flip over onto its side where it waits, motionless, for you to recharge it.

Recharging is also a simple, uncomplicated maneuver. Note that at the rear of the cartridge body are two prongs. These resemble the connecting pins found on older cartridges. However, on VDRS, they are battery plugs which are inserted in the proper jacks on the back of the control module. These spring-loaded jacks are sensitive to the slightest pressure and inserting the cartridge prongs immediately activates the recharge circuitry. The entire system shuts off upon completion of the recharge cycle.

Many observers have questioned the need for a reverse speed on the VDRS control panel. This too is part of the Lirpa plan for the ultimate record playing system. Not shown in the photograph, but an integral part of the prototype, is a special compound on which the record is placed for playing. However, this is more than the usual turntable mat. It is a specially grooved high-polymer material which is designed for its static reduction properties as well as stylus cleaning. Because of the unique shape of the TGC stylus, it may be necessary to clean the stylus more often and more vigorously than in outdated stylus designs. To do this, the cartridge is placed on the mat and the direction control switched to reverse. One or two complete revolutions is all that is needed to restore the stylus to pristine condition.

Lirpa's new VDRS equipment will be available (eventually) through selected dealers for the discriminating audiophile. You are invited for a sneak preview of VDRS at the Lirpa hospitality suite in New York's Waldorf Astoria during the June Consumer Electronics Show.

Retail price has not yet been announced, however, one Lirpa official has been heard to say "Not cheap."

Test Information

There may be a curious reader or two interested in the "behind-the-scenes" testing procedure used to validate the

The sound of FXcellence. From Fuji.

Fuji, the world-renowned maker of premium video tape and the superior FX audio cassettes, has developed two new FX formulations.

The new FX-I pure ferrix cassette is the finest normal bias cassette tape available today. It offers extremely wide dynamic range and excellent signal-to-noise ratio. FX-I is completely compatible with all cassette machines including home, portable and car stereo units.

The new FX-II Beridox cassette is the finest high bias cassette available today.

Its unique formulation is derived from Fuji's many years of video tape experience. It has unmatched high frequency response, extremely low noise and distortion. FX-II is completely compatible with all cassette machines which have high bias capability.

Once you try the new Fuji FX-I or FX-II cassette, you'll never buy any other brand of cassette again. The sound is that much superior. Available at fine audio dealers everywhere. Buy Fuji FX cassettes today.

The new FX-I and FX-II

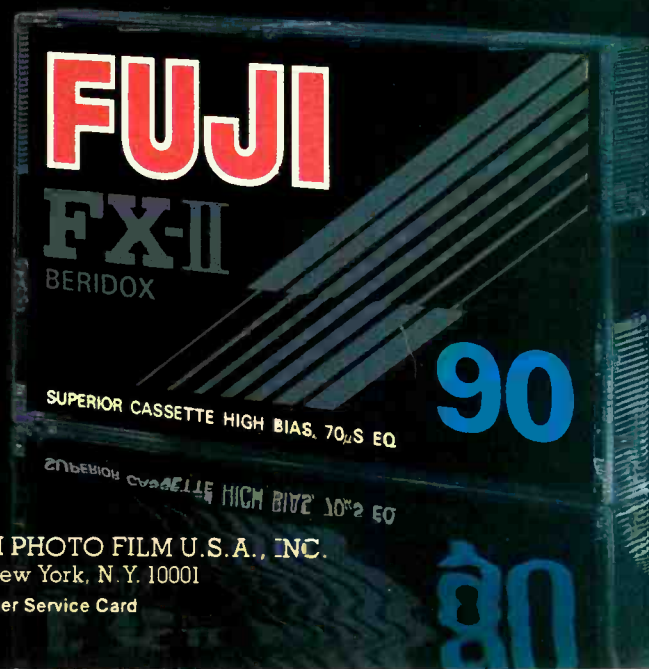

MAGNETIC TAPE DIVISION FUJI PHOTO FILM U.S.A., INC.

Empire State Building/New York, N.Y. 10001

Enter No. 14 on Reader Service Card

technical specifications. LirpaLabs is proud to reveal for the first time some of its most guarded testing secrets. To be sure the main ingredient for success is the careful seasoning of its two employees. Second is the utilization of the latest custom designed and calibrated test equipment. Third, and the most well kept secret in the audio industry, is the exclusive use of Lirpa's D.I.M. standards of measurement. Developed by dedicated Lirpateers, D.I.M. represents a new zenith of excellence heretofore unmeasurable by existing testing methods.

According to instructions listed in the VDRS Driver's Manual, the playing module was plugged into the charging unit, charged to full capacity, then run for 10 continuous hours. The module was then fully recharged and readied for testing. The initial break-in period is recommended to allow the proper seating of the drive mechanism and the burning-in of the program chip in the control unit. From "before" and "after" tread depth measurements, the life expectancy of the tires is 5000 sides of an average LP. (Editor's Note: On the basis of predictions by LirpaLab's engineers that discs with wide lands would provide longer tread life, *Audio's* testing staff made independent tests using blank records usually reserved for rumble testing and found that radial tires lasted an average of 10,000 hours, though this is admittedly "best case" testing. — E.P.)

Actual product evaluation began with tracking ability and distortion testing. For this purpose a special "Obstacle Course" record was manufactured. In addition to the usual tests found on such records there is a built-in, super-exaggerated 7-Hz vinyl ripple. This feature simulates the effect of leaving a record on the rear window ledge of an automobile in the hot sun. In this test and the stylus compliance check VDRS scored a fat 0! It was the distortion test

that proved the true benefit of VDRS. By depressing the *Forward Reverse* switch five times within one second the moving module lifted its stylus from the groove, meandered to the innermost groove, and began playing the sibilant test cut. Lirpa engineers were somewhat disturbed at what they thought was a touch of harshness on the heavily modulated sibilant passages. Repeating the tests, however, produced new and startling results. During the second playing the harshness had almost totally disappeared! A third playing produced even more perfect smoothness. Undeniably, the very same phenomenon that miraculously transforms CD-4 discs to stereo seemed to be present, ever enhancing stereo recordings. Since these tests have taken place Lirpateers have removed all external record processing equipment from LirpaLabs. Thus, click, pop, scratch, hiss, and noise filters are doomed to extinction.

The Lirpagraphs and photos further demonstrate the powerful capabilities VDRS possesses. In each of the tests performed the VDRS equaled or outperformed its published specifications, the least of which is its ability to drive a pair of speakers directly with no power amplifier!

Consumer Safety Notice

In the interest of audiophile protection, Lirpa engineers recommend some form of bodily protection when near an operating VDRS. Since "S" band frequencies are used to supply tracking and audio information, there exists a possibility of radiation damage to human tissue and organs. Although levels of radiation comply with FCC regulations, the engineers suggest a pair of protective goggles and special clothing be worn. (Lirpa Model 44 "S" band goggles @\$10.95 and Lirpa brand "See-thru" lead underwear from \$14.50 available at fine clothing stores everywhere.) Prof. I. Lirpa

80

Introducing the Avid Model 80.

It's easier to tell you what it won't do.

That's because, for about \$80*, our new Model 80 does almost everything our larger, more expensive systems do. The kind of performance that has made Avid the most talked about line of speakers.

Of course, the Model 80 won't go quite as deep (say, below 50 hertz) as our larger speakers. But you will get clean, low distortion bass, a smooth mid-range and a well-dispersed high end that is truly the equal of many larger, more expensive systems.

The Model 80 doesn't have the extra convenience of a wide-range balance control. But you will get a speaker that has been carefully balanced at the factory by our unique testing program called Q-Span™ that guarantees a perfectly matched pair.

Finally, the Model 80 doesn't have a genuine walnut cabinet. The real thing is nice, but it's also an expensive luxury that really does nothing for performance. The new Avid Model 80. Satisfying performance at a reasonable price. Hear it at your Avid dealer's now.

*Actual prices vary from \$75 to \$80, depending on shipping destination.

Avid Corporation/ 10 Tripps Lane, E. Providence, R102914/ Distributed in Canada by: Kairon Electronics, Montreal, Quebec

Enter No. 6 on Reader Service Card



AVID.

Be an Avid listener.

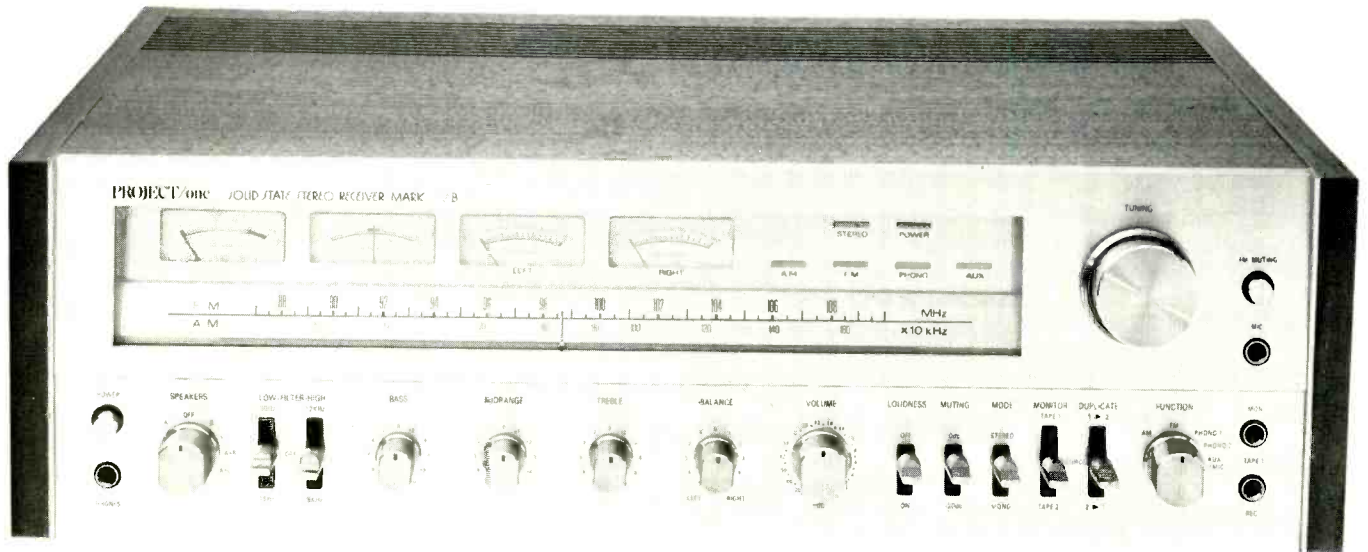

Project/One Mark IVB Stereo Receiver

MANUFACTURER'S SPECIFICATIONS

FM Tuner Section

Usable Sensitivity: 1.7 μ V (10.0 dBf).
Capture Ratio: 1.5 dB.
Selectivity: 70 dB.
S/N Ratio: 72 dB (Mono).
Image Rejection: 90 dB.
I.f. Rejection: 100 dB.
Spurious Rejection: 90 dB.
AM Suppression: 55 dB.
THD: Mono at 1 kHz, 0.2 per cent; Stereo at 1 kHz, 0.5 per cent.
Frequency Response: 20 Hz to 16 kHz, +0.2 dB, -3 dB.
Stereo Separation @ 1 kHz: 45 dB.

AM Tuner Section

Sensitivity: 20 μ V (external antenna).
Selectivity: 30 dB.
S/N: 50 dB.
Image Rejection: 45 dB.
I.f. Rejection: 45 dB.

Amplifier Section

Power Output: 75 watts per channel continuous, 8-ohm loads, 20 Hz to 20 kHz (95 watts with 4-ohm loads).
Rated THD: 0.1 per cent.
Rated IM: 0.1 per cent.
Damping Factor: Greater than 35.
Residual Noise: 1 mV.
Input Sensitivity: Phono 1 & 2, 2.5 mV; AUX & Tape, 120 mV; Mike, 3 mV.
Phono Overload: 130 mV.

Hum and Noise (A Weighted): Phono, 70 dB; Mike, 70 dB; High Level, 90 dB.

Frequency Response: Phono, RIAA \pm 1 dB, High Level, 10 Hz to 35 kHz, \pm 0.5 dB.

Tone Control Range: Bass, \pm 10 dB @ 100 Hz; Midrange, \pm 5 dB @ 1 kHz, Treble, \pm 10 dB @ 10 kHz.

Filter Cut-Off Frequency: High, 8 or 12 kHz (12 dB/octave), Low, 15 or 30 Hz (12 dB/octave).

General Specifications

Power Consumption: 350 watts.
Dimensions: 20 $\frac{7}{8}$ in. (53 cm) W x 6 $\frac{1}{16}$ in. (17 cm) H x 13 $\frac{3}{16}$ in. (35 cm) D.
Price: \$549.95.

In earlier days, I used to regard stereo receivers as being in two distinct classes: Those manufactured by major, well-known companies and those manufactured by lesser known makers under contract to retail chain stores. These days, it is almost impossible to distinguish between these two receiver categories, as some of the retail chains of audio dealerships have grown to the point where they can hire the engineering and production facilities of highly qualified high-fidelity component manufacturers. In fact, it is rumored that many of the "name brand" manufacturers also produce "private label" sets for such retail outlets. The Project/One brand is one that was developed for the Playback, Inc., retail outlets based in and around the Chicago area.

The front panel of the Project/One Mark IVB stereo AM/FM receiver suggests that Playback, Inc., was not quite ready to tread new design grounds but rather "borrowed" the best features and layout from several of the better known receivers around. The face plate is all gold-anodized in color, while the dial area features the gently rear-sloping configuration for easier visibility and a light-colored background upon which are inscribed the frequency calibrations for AM and FM. Calibration markings for the FM are at 0.5 MHz intervals, with AM markings less well defined. Above the dial scales are four separate meters, two for signal-strength and center-of-channel tuning, the other two calibrated in watts for left- and

right-channel power-output indications. To the right of the meters are a series of six illuminated strip-lights which indicate stereo FM reception, power-on, and program source selection. The flywheel-coupled tuning knob is just to the right of the dial opening, as are an FM muting switch (for silent interstation tuning) and a microphone input jack. Controls and switches along the lower section of the panel include a power On/Off button, speaker selector (with provisions for choosing any two out of three sets of connected speakers), two position low- and high-cut filter levers, bass, midrange, and treble tone controls, balance, master volume (step-detented) and program selector switch, and five additional lever switches. These last handle loudness, audio muting, mono/stereo switching, tape monitoring (of up to two connected decks), and tape dubbing. Tape-1 input and output circuits are duplicated in the form of stereo phone jacks on the front panel (in parallel with those at the rear), while a stereo headphone jack is located at the extreme lower left of the panel, just below the power switch.

The rear panel is equipped with three sets of spring-loaded speaker terminals (color coded and requiring only simple insertion of stripped ends of wire), a line fuseholder, and switched and unswitched a.c. receptacles at the right. At the upper left are the usual 300- and 75-ohm antenna terminals, AM antenna terminals, a pivotable ferrite-bar AM antenna,

and a chassis ground terminal. Two sets of phono-input jacks, the aforementioned tape-out and tape-in jack sets (including a DIN connector for the Tape-2 circuits) and preamp- out/main amp-in jacks which are supplied with interconnecting wire jumpers.

Internal Construction

No schematic diagram was supplied with the Project/One Mark IVB receiver, but we did examine its layout and construction, after quick and easy removal of the chassis from its four-sided wood cabinet. In addition to the self-contained front end, which utilizes a four-section tuning capacitor for FM and a two-gang arrangement for AM, there are nine other circuit board modules. Front-panel switches and controls are all directly mounted to a long voltage-amplifier, tone-control circuit board which makes for a minimum amount of inter-module direct wiring. What little interconnection wiring exists is carefully harnessed and neatly dressed in as clean a layout as we have seen for any receiver. Identical power output modules are vertically mounted with output transistors mounted separately nearby on a single heavy heat sink structure. The power transformer seemed a bit on the small side for a receiver in this power category but was later proven to be adequate for its task. Short circuit protection is afforded by a relay-type protection circuit which also delays turn-on of the unit for a few seconds after the power switch is depressed

to prevent pops and thumps from reaching speakers. Six internal fuses (in addition to the externally accessible line fuse) are associated with the d.c. voltage supplies but are not regarded as customer replaceable. All circuit-board copper-foil patterns are reproduced by silk screening on the component side which makes for easy circuit tracing in the event that servicing becomes necessary. All in all, the Project Mark IVB is neatly laid out and appears to be as competently designed as receivers from most any of the "name brand" manufacturers.

FM Tuner Section Measurements

Usable sensitivity measured $1.7 \mu\text{V}$ (10 dBf) in mono, exactly as claimed, but since stereo switching did not take place until an input signal strength of $18 \mu\text{V}$ (30.3 dBf) was applied to the antenna terminals, we would have to call that the "usable sensitivity" in stereo. The 50-dB quieting point was reached with an input signal strength of as little as $2.1 \mu\text{V}$ (11.6 dBf) in mono, but required a rather high input level of $47 \mu\text{V}$ (36.6 dBf) for the same degree of quieting in stereo. Ultimate S/N in mono was an impressive 79 dB; 71 dB in stereo. Figure 1 shows the mono and stereo quieting characteristics of the FM section as well as the harmonic distortion values for a 1-kHz modulating signal with increasing signal strength. For 65-dBf inputs, THD was a low 0.13 per cent in mono; 0.15 per cent in stereo. We did note that THD

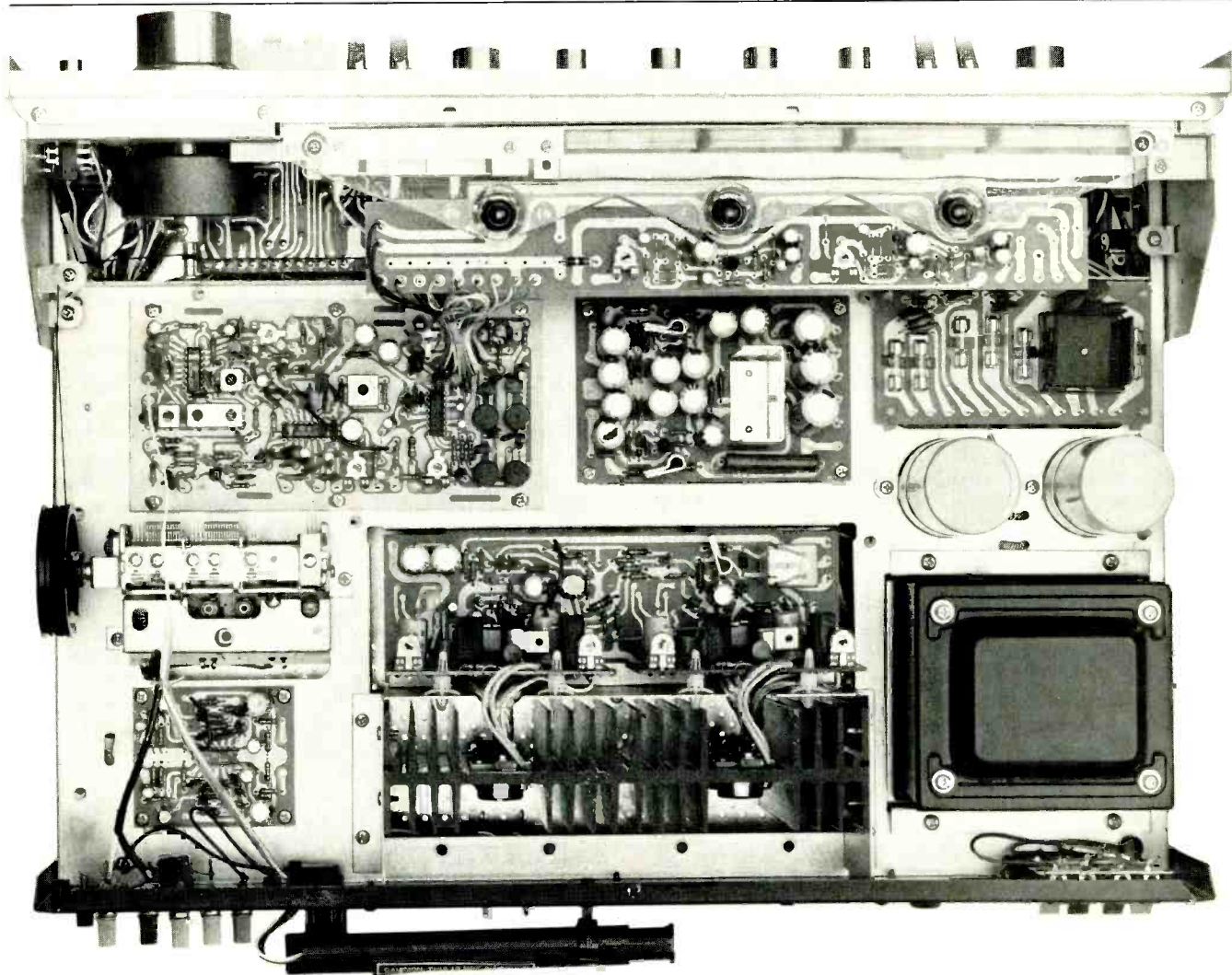

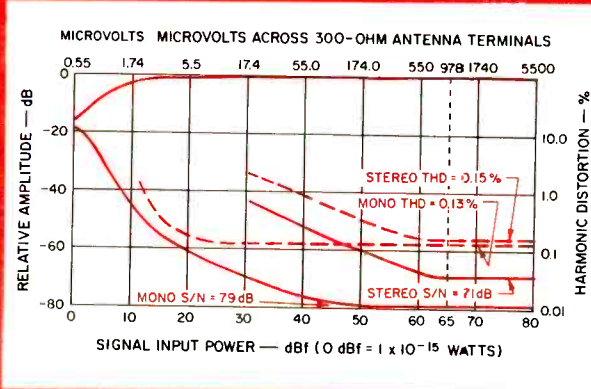

Fig. 1— Mono and stereo quieting and distortion characteristics.

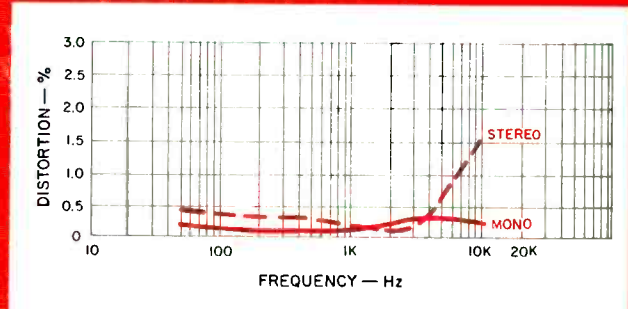

Fig. 2— Distortion vs. frequency in mono and stereo.

increases rather rapidly as one approaches full modulation and, by backing off on the modulation just a few kHz, both mono and stereo THD dipped below 0.1 per cent for mid-frequencies.

A plot of distortion versus frequency of modulation is shown in Fig. 2, and the rising distortion characteristic in stereo for higher frequencies was largely due to the presence of visible and audible "beats" at those high frequencies between the pilot-carrier and the test frequency. Muting level was set by the manufacturer at a low 1.5 μ V (8.7 dBf). For the three required test frequencies used to check separation, we measured 45 dB at 1 kHz, 42 dB at 100 Hz, and 30 dB at 10 kHz. A complete graphic plot of separation versus frequency was made using our spectrum analyzer's own signal (sweeping from 20 Hz to 20 kHz) to modulate the signal generator and is reproduced in the 'scope photo of Fig. 3. This plot (which includes the 75 microsecond roll-off characteristic) also shows that the 19-kHz notch filter, used to suppress sub-carrier products at the output, begins to act too early within the audio band, resulting in a 10-kHz output which is nearly 5 dB more attenuated than it should be. From the appearance of the plot, we suspect that the values chosen for the 75-microsecond network are probably a bit off, since roll-off begins at too low a frequency. Of course, one could easily boost the treble control somewhat in actual listening to compensate for this frequency response discrepancy in FM. Capture ratio measured 1.7 dB, a little bit poorer than the 1.5 dB claimed, but image, i.f., and spurious response rejections

were all exactly as claimed, and AM suppression measured 57 dB as opposed to 55 dB claimed. Sub-carrier rejection measured 64 dB, high enough so as to preclude any problems when recording FM programs onto cassette tape decks not equipped with appropriate MPX filtering circuits.

The AM tuner section was found to be typical of its breed, with sensitivity measured as 25 μ V (external antenna), signal-to-noise ratio readings of 48 dB (for a 1 mV signal input), and image and i.f. rejection both measuring close to the 45 dB claimed. Selectivity measured 28 dB instead of 30 dB.

Amplifier Measurements

Using 8-ohm resistive loads, the amplifier section of the Mark IVB delivered 80.7 watts of continuous power per channel before rated THD of 0.1 per cent was reached. At rated output (75 watts per channel), THD was only 0.025 per cent for a 1-kHz input signal, while IM measured 0.055 at that output level. Since the Project/One receiver does offer a published specification for 4-ohm load operation, we measured performance under that load condition as well. Power output for rated THD (0.1 per cent) measured a gigantic 150 watts, with THD readings for the rated 95 watts per channel level a mere 0.064 per cent. Under these load conditions, however, IM distortion reached its rated value of 0.1 per cent with only 75 watts of output per channel and increased to 0.19 per cent for the rated 95 watts per channel output. Of mild concern to us was the fact that only the left channel met spec at 20 kHz, measuring 0.09 per cent THD versus 1.6 per cent THD for the

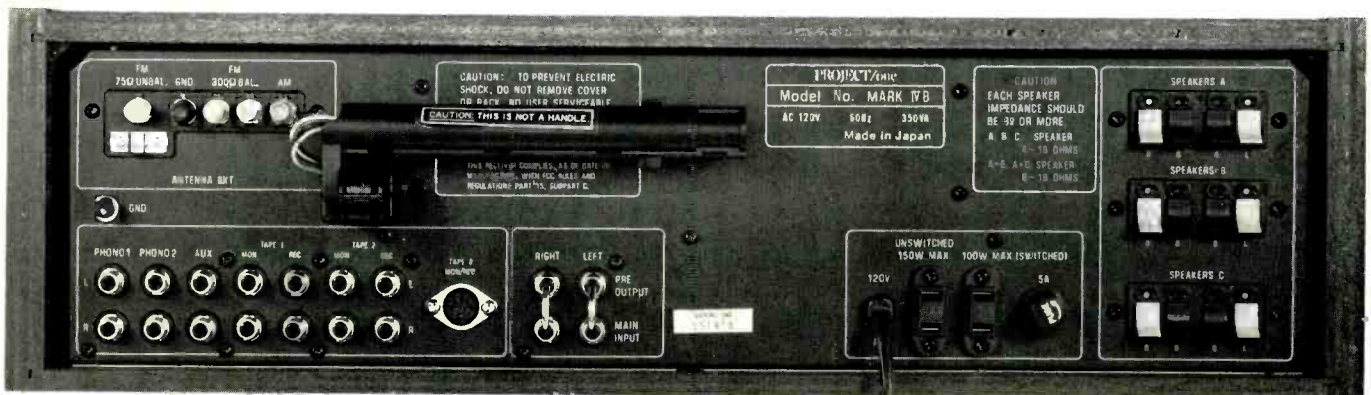

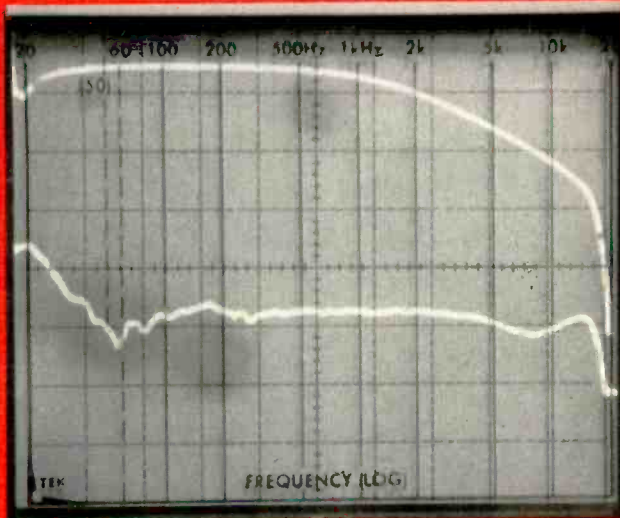

Fig. 3—Stereo FM separation.

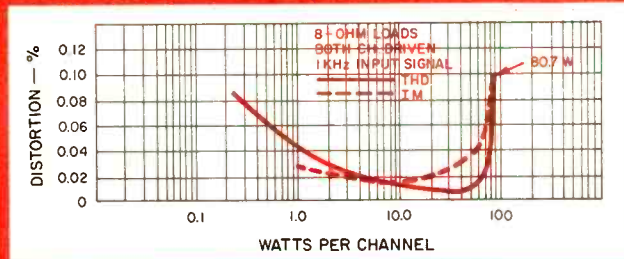

Fig. 4—Harmonic and intermodulation distortion vs. power output with 8 ohm loads.

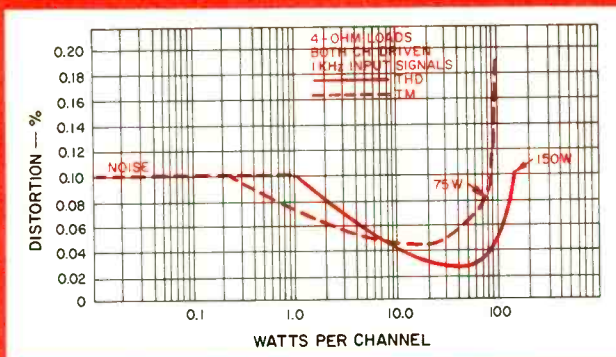

Fig. 5—Harmonic and intermodulation distortion vs. power output with 4 ohm loads.

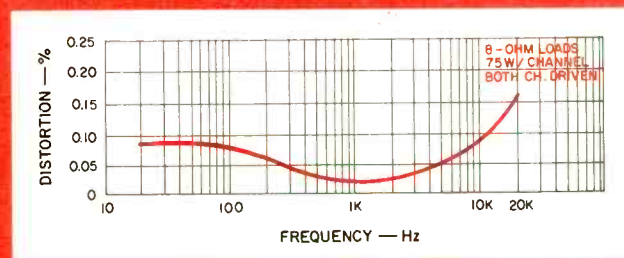

Fig. 6—Distortion vs. frequency under 8 ohm loads, both channels driven.

84

right. Power output for a 1-kHz signal and for an IM test signal versus distortion is shown for the 8-ohm load conditions in Fig. 4, and the same results are plotted for 4-ohm operation in Fig. 5. Damping factor measured 55 at mid frequencies, decreasing to 35 at 20 Hz. A graph of distortion versus frequency for full rated output (75 watts into 8 ohm loads) is plotted in Fig. 6.

As for the phono preamplifier section, we measured an input sensitivity of 2.3 mV via either the *Phono-1* or *Phono-2* inputs and overload capability was 150 mV, better than the 130 mV claimed. RIAA response from 30 Hz to 15 kHz was off by no more than ± 0.5 dB as compared with the 1.0 dB tolerance claimed. Beginning with this test report, we are able to show RIAA response graphically on our spectrum analyzer, thanks to an accurately calibrated inverse RIAA network built into the new Sound Technology stereo test panel Model 1200A which now serves as an interface for our other ST test instruments and our viewing oscilloscope. These results are shown in the 'scope photo of Fig. 7.

A-weighted signal-to-noise ratio in phono measured 70 dB (referenced to actual input sensitivity), while for the high level inputs (AUX or tape), S/N referred to the rated output of 75 watts was -89 dB. Residual noise was 98 dB below rated output (with master volume control at minimum). Range of control of the bass, midrange, and treble tone controls is plot-

ted in the 'scope photo of Fig. 8, where each vertical box represents an amplitude of 10 dB.

The high- and low-cut filters behaved pretty much as claimed, and we do consider the availability of two cut-off points for both of these filters to be a useful feature. In the case of the low-cut circuits, the action of the 15-Hz cut-off setting is barely visible in Fig. 9 since our sweep extends only from 20 Hz upwards to 20 kHz.

We were somewhat puzzled by the response curves obtained using the loudness control feature of the Mark IVB with various settings of the master volume control. As can be seen from the plots of Fig. 10, treble compensation of this loudness circuit actually is greater than the boost afforded in the bass region. This is disturbing since many audio experts maintain that no treble boost at all is required at the treble end—or very little at most. We suspect that the designers of this circuit provided such extreme emphasis so that the listener would definitely "detect a big difference" when the loudness switch is activated.

Listening and Use Tests

The aforementioned Sound Technology stereo test panel has the unusual capability of permitting a tester to switch directly from load resistors to our lab monitoring speakers at

WHICH TAPE DECK SHOULD YOU BUY?

Specifications	Pioneer CT-F9191	TEAC A 650	AKAI GXC-710D	Fisher CR5120
Tape Heads	2	2	2	3
Motors	2 (1DC Servo) 1 (1DC Torque)	2 (1DC Servo) 1 (1DC Reel)	1 (4 Pole Hysteresis Synchronous)	2 (1DC Servo) 1 (1DC Governor)
Drive System	Single Capstan	Single Capstan	Single Capstan	Dual Capstan
Wow & Flutter	0.07% WRMS	0.06% WRMS	0.08% WRMS	0.05% WRMS
Total Harmonic Distortion	1.5%	(Not Available)	1.5%	1.4%
Frequency Response (CrO ₂ /FeCr)	30Hz-15kHz ± 3dB	30Hz-16kHz (Incomplete Spec)	30Hz-16kHz ± 3dB	30Hz-17kHz ± 3dB
Signal/Noise Ratio (with Dolby on @ 1kHz)	63dB over 5kHz	62dB	60dB over 5kHz	62dB
Dolby Noise Reduction	Yes	Yes	Yes	Yes
Dolby FM Circuitry	No	Yes	No	Yes
Pre-amps	2	2	2	4
Approximate Retail	\$450	\$550	\$425	\$400

All product specifications from published company sales literature.
Price information from High Fidelity, August, 1977 issue.

The four tape decks compared above are all fine pieces of equipment.

But look closely at the table above and you'll see why the Fisher CR5120 is the most outstanding value in cassette decks today.

You can actually get a Fisher professional quality 3-head deck for about the price of many 2-head decks.

What you don't see in the table is the superb Fisher engineering that built this high-priced performance into a medium-priced tape deck.

For example, we engineered separate record and playback heads into the CR5120, not only to significantly improve recording quality, but also to permit monitoring directly off the

tape — the only sure way to get professional recordings every time. All three of the CR5120's heads are made of glass-hard sintered ferrite for virtually unlimited life, without deterioration of sound quality.

The CR5120 even includes dual-process Dolby† — separate Dolby circuits, one for recording and one for playback — so you hear fully decoded playbacks when you're monitoring a recording. And a Dolby FM switch with 25µs deemphasis conversion lets any tuner or receiver handle Dolbyized FM broadcasts.

To assure virtually perfect tape motion, the CR5120 uses a DC servo-controlled Hall-effect motor in the dual capstan transport, plus a separate DC motor to drive the reels.

Other CR5120 features are: source/tape monitor switch, VU level meters, LED peak indicators, switchable limiter to prevent overload distortion, memory counter, and lighted mode indicators. All for about \$400*.

Which tape deck should you buy? See a Fisher dealer and try the CR5120 for yourself.

Flip the source/tape switch and compare the source and recording while you're listening — the only way to really evaluate the performance of a tape deck (you can't do this on a two-head deck).

Fisher audio components are available at selected audio dealers or the audio department of your favorite department store. For the name of your nearest dealer, call toll-free: 1-800-528-6050, ext. 871 from anywhere in the U.S. (in Arizona, call toll-free 1-955-9710, ext. 871).

*Manufacturer's suggested retail value. Actual selling price determined solely by the individual Fisher dealer.

 **FISHER**
The first name in high fidelity.



CR5120

†Dolby is a trade name of Dolby Labs, Inc.

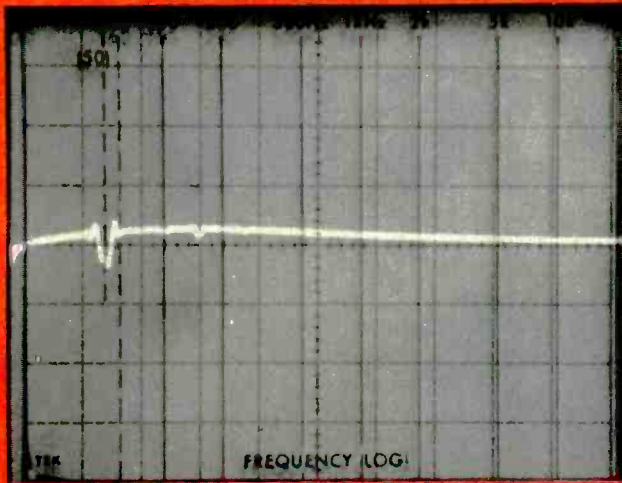

Fig. 7—Overall frequency response.

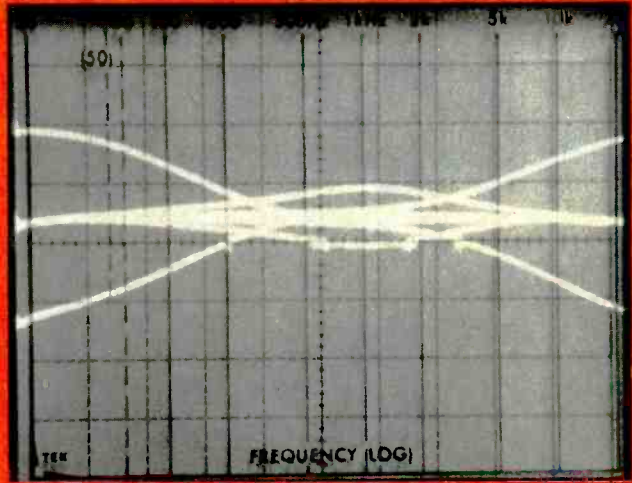

Fig. 8—The bass, midrange, and treble control range with the Project/One Mark IVB receiver.

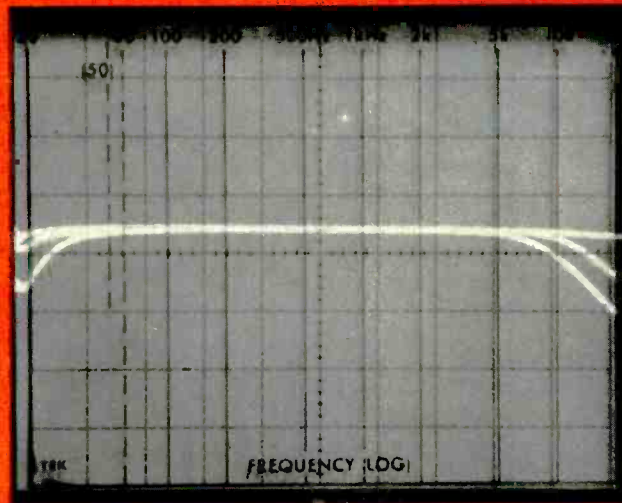

Fig. 9—Low and high-cut filter responses.

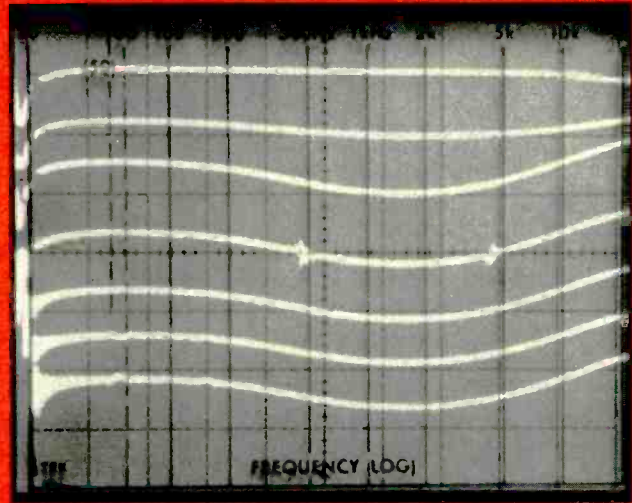

Fig. 10—Loudness control action.

the push of a button. This now gives us the opportunity to audibly evaluate what is going on during static bench testing of audio equipment in addition to listening tests which are conducted at our leisure after bench testing has been completed (often, for several days afterwards). In any event, the FM section exhibited good sensitivity and quieting in both forms of listening tests and pulled in just about all of the stations by which we audibly judge such things as sensitivity and quieting ability. The stereo switching threshold is, in our opinion, set at too high a level which prevented us from receiving some weak-signal stereo transmissions which are normally heard in stereo on other receivers. FM calibration was off by -150 kHz at 98 MHz and by $+100$ kHz at the high end of the dial and, as we might have guessed, FM lacked a certain amount of high-end brilliance which had to be compensated for by means of the treble control to equalize for the premature roll-off discussed earlier. The limitations imposed by the increased distortion with increasing modulation only became apparent for stations which

habitually overmodulate (and served to disclose which stations in our area are at fault in this regard!).

Phono performance was quite good, with no evidence of overload distortion, even on heavily recorded passages, and what seemed to be a good interface between the cartridge and input stages. The amplifier section seems to strain a bit as very loud volume levels are approached, but is quickly tamed by backing off a bit on the master volume control. The use of medium- to high-efficiency speakers should enable the owner of this receiver to attain quite satisfactory listening levels even in large listening rooms, however.

Obviously, one of the chief purposes of a retail chain in creating its own line products is to be able to offer such products at highly competitive prices. (After all, one degree of price mark-up is eliminated in such arrangements between a retailer and a prime manufacturer.) On that basis, the people at Playback have met with success. The Mark IVB compares very favorably with receivers costing more than its suggested retail price.

Leonard Feldman

Enter No. 90 on Reader Service Card

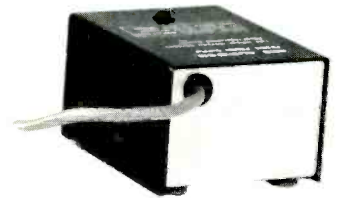
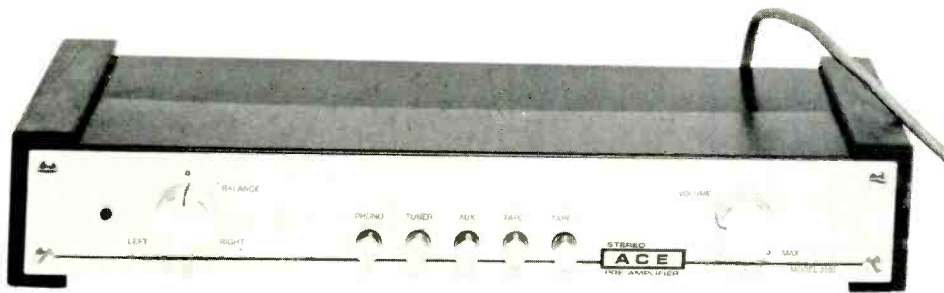

Ace Audio Model 3100 Stereo Preamp

MANUFACTURER'S SPECIFICATIONS

Rated Output: 2.0 V into 10 kilohm load.

Maximum Output: 8 V.

Gain: High Level, 20 dB; Phono, 60 dB.

Phono Overload: 90 mV.

Equalization: RIAA ± 0.5 dB.

Input Impedance: High Level, 33 kilohms; Phono, 47 kilohms.

Output Impedance: 470 ohms.

Frequency Response: 20 Hz to 20 kHz, ± 0.1 dB; 1 Hz to 75 kHz, -1.0 dB.

THD: 0.02 per cent max.

IMD: 0.02 per cent max.

S/N: Phono, 73 dB below 8 mV input; High Level, 90 dB below 0.8 V input.

Power Consumption: 5 watts.

Dimensions: 14½ in. (36.8 cm) W x 2¾ in. (7 cm) H x 7 in. (17.8 cm) D.

Weight: 4.0 lbs. (1.8 kg).

Price: \$325.00; Model 3000 with integral power supply, \$250.00; 3000 as kit, \$156.00.

A while back, Ace Audio Co. of Long Island, New York, startled the audio fraternity by introducing a product called the "zero distortion" preamplifier. Those of us who first read the ads wondered just how long it would be before the Federal Trade Commission would be taking the Ace people to court. How could *any* preamp have zero distortion? Perhaps 0.0001 per cent or even 0.00001 per cent maybe, but *zero*? Well, as our more knowledgeable readers may know, the claim applied *only* to the high-level input section of the preamp control unit and was actually true. The high level section was passive—just a pair of gain controls—so, of course, with no amplifying stages, "zero" distortion was introduced. That unit had about 40 dB of gain in the phono stage, which meant that if your phono cartridge had a nominal output of 2.0 millivolts you'd come out of the preamp at a level of 0.2 volts—not really enough to drive most better power amps with which one might be likely to use such a "pure" signal-handling product. One could, of course, go for higher output

cartridges but then the choice becomes rather limited—especially if a top-performing pickup is what you are after. So, Ace Audio has gone ahead and done the next best thing. They have designed another preamp with around 20 dB of gain in the flat-amp or high-gain section, retaining the 40 dB of gain (at 1 kHz) for the phono-equalizer stages, and that brings us to the Model 3100 under investigation at our labs. The specifications shown at the beginning of this report also apply to the Model 3000. In that unit, the power supply is built right into the low-profile package and there is a power *On/Off* switch. On the unit we tested (Model 3100), a separate power supply is provided, with a fairly long interconnecting cable between it and the main section of the preamp for further improvement in signal-to-hum-and-noise figures. This unit does not have an *On/Off* switch but with its low power consumption you can just as well leave it on all the time or, if you insist, you can pull the power cord every time you are through listening.

87

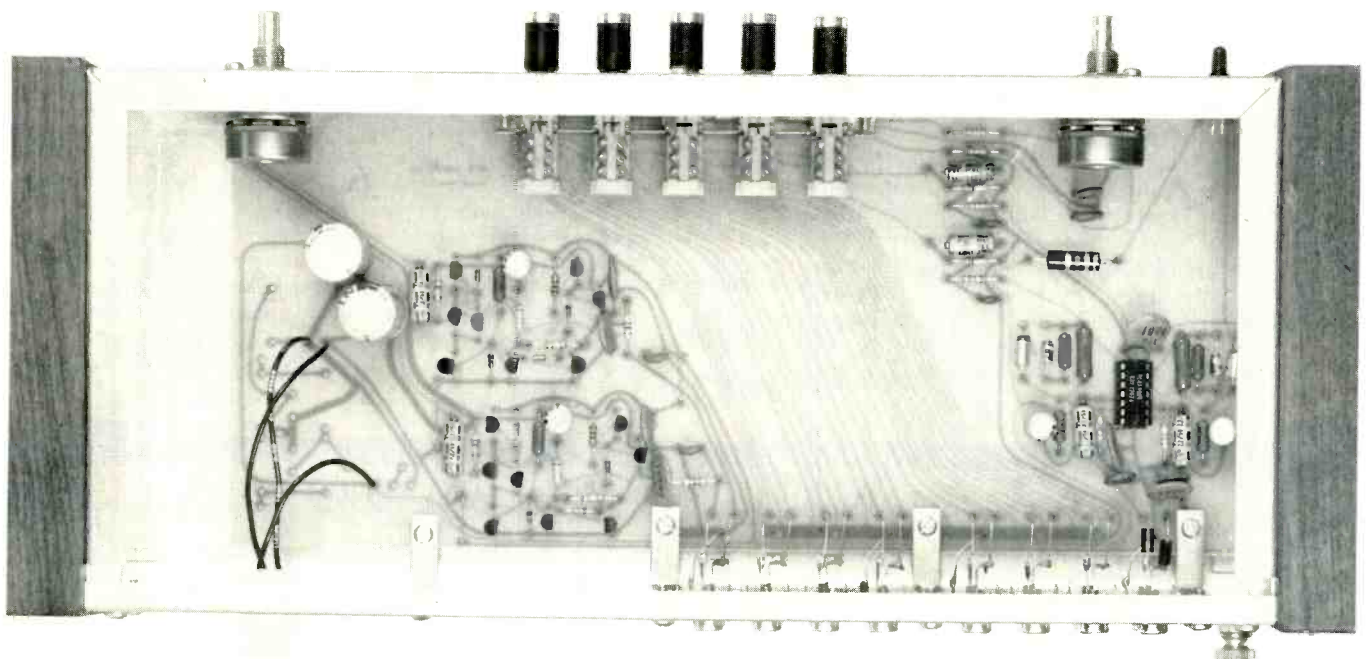

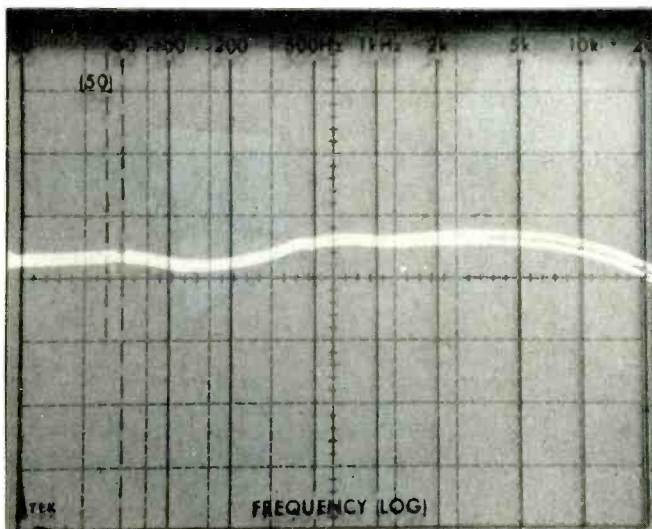

Fig. 2—Phono-stage deviation from RIAA, 20 Hz to 20 kHz. (Vertical scale is 2 dB per division.)

The basic philosophy of Ace Audio has been to provide virtually *no* signal-processing frills. Thus, there are only two rotary controls and five pushbuttons on the front panel of the 3100. The left control is a balance control, and near it is an LED *Power-On* indicator, while the control at right is the master volume control. Pushbuttons select *Phono*, *Tuner*, *AUX*, and two sets of *Tape-In* and *Tape-Out* jacks. Circuitry is arranged in such a way that if you have two decks connected, it is possible to dub or copy from one to the other by depressing one of the tape buttons while making sure that the three primary buttons are released.

The rear panel of the version we tested has only the required input and tape output and main output jacks, plus a four-pin connector to which the aforementioned power supply is connected. We understand that the Model 3000 also has auxiliary a.c. receptacles (one switched, two unswitched) for connection of other components.

Construction and Circuitry

All component parts are mounted on a single large circuit board which takes up most of the "floor space" in the unit. The layout is quite open, making it extremely easy for the novice kit-builder to assemble the unit. Pushbuttons are all on one assembly which mounts right into the board as do the two sets of potentiometers.

A complete schematic of the Model 3000 (including power supply) is shown in Fig. 1. Phono signal preamplification is accomplished by means of a single type 4739 IC, the input to which is terminated with a 50-pF capacitor and the usual 47-kilohm load resistor. Balance and volume controls precede the flat amplifier stages which include a push-pull, NPN-PNP, complementary-symmetry pair as output stages. Since the circuit is powered by dual-polarity supply voltages (± 18 V d.c.), the output is at zero potential and no output coupling

capacitor is required. The power supply is designed for slow turn-on which is built into the regulators (approximately 0.2 seconds). This virtually prevents transients during turn-on as far as the preamp itself is concerned, though associated components (the power amplifier, etc.) may still produce such transient phenomena upon turn-on. As can be seen from the schematic, there is no buffering between the inputs or phono section outputs to the tape recorder outputs, so users must make certain that any tape recorders connected to the Model 3100 have sufficiently high input impedances so as not to "load" the signal appearing at these output jacks.

Laboratory Measurements

Phono input sensitivity for rated output (2.0 volts at 1 kHz) measured 2.4 millivolts. Referred to that input level, signal-to-noise ratio measured an impressively high 71 dB. If we were to translate that reading to Ace Audio's reference of 8 millivolts in (where they came up with that odd figure we'll never know), the number turns out to be far better than their claimed 73 dB, some 81.5 dB. Hum and noise via the high level inputs measured 84 dB, but again, if we translate that to Ace Audio's arbitrary 0.8 volt input reference (as against actual input sensitivity of 250 mV), we come up with a figure of 94.1 dB—considerably better than the 90 dB claimed. At least part of this measurably better result is undoubtedly due to the separate power supply, which keeps all stray hum fields completely out of the chassis of the preamp proper.

Phono overload measured 110 millivolts, well above the 90 mV claimed, and RIAA equalization was accurate to within 0.4 dB of the prescribed RIAA curve from 30 Hz to 15 kHz. (Ace Audio, like so many other manufacturers, has not yet adopted the so-called "new" RIAA curve which still requires official approval, but has been approved by the IEC and is being used by a few preamp manufacturers.) Accuracy of RIAA response is shown in Fig. 2.

Harmonic distortion in phono measured 0.025 per cent at 1 kHz and 30 Hz, increasing to 0.05 per cent at 15 kHz. THD using the high level inputs measured 0.006 per cent at 1 kHz, 0.015 per cent at 20 Hz, and 0.05 per cent at 20 kHz. IM distortion via the high level inputs measured a very low 0.005 per cent at rated equivalent output. Maximum output from the high-level section of the preamp reached 11 volts (as against 8 volts claimed) before noticeable clipping occurred.

Listening and Use Tests

One of the ways in which we like to judge the "purity" of a preamplifier such as this involves a substitution test. Happily, we own some state-of-the-art master tapes, recorded at 15 ips, which, to our ears at least, sound as close to a live performance as anything we have yet heard (at least using analog tapes). Our tape playback mechanism provides enough clean output signal to drive a high-powered basic amplifier, which serves as our standard, and a pair of speakers which we use for all of our reference listening. By interposing the preamp under test between the tape source and the power amp, we can easily compare and analyze any coloration introduced by the preamp. During extremely quiet passages, with volume set very high, we were able to detect a

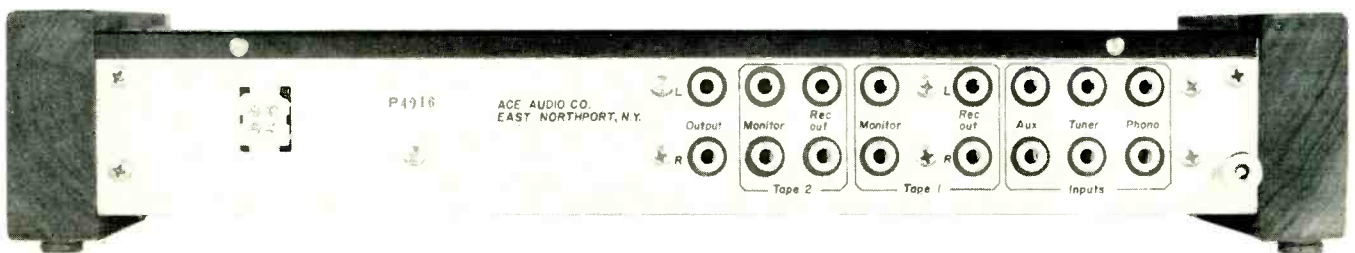
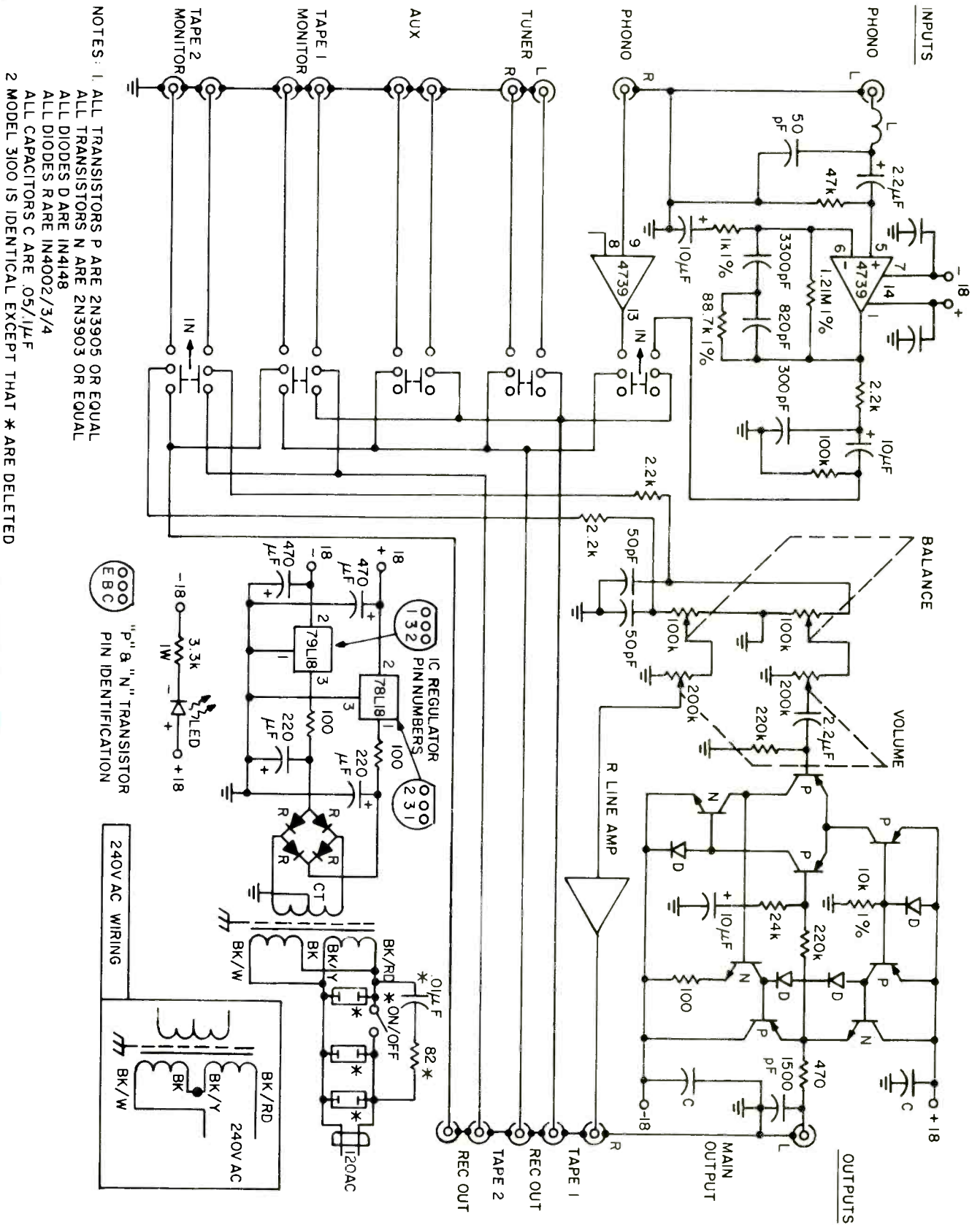

Fig. 1 — Schematic for the Model 3000 preamplifier.



NOTES: 1. ALL TRANSISTORS P ARE 2N3905 OR EQUAL
 ALL TRANSISTORS N ARE 2N3903 OR EQUAL
 ALL DIODES D ARE IN4148
 ALL DIODES RARE IN4002/3/4
 ALL CAPACITORS C ARE .05/1uF

2 MODEL 3100 IS IDENTICAL EXCEPT THAT * ARE DELETED

PRE-AMPLIFIER MODEL 3000 SCHEMATIC.

"P" & "N" TRANSISTOR
 PIN IDENTIFICATION
 (EBC)

240V AC WIRING

very slight increase in hum but we hasten to add that under no circumstances would we (or should you) leave volume settings at that level, for to do so would be to invite ear-shattering sound when musical crescendos occur. Our power amp happens to be a tube type, and usually the addition of a preamp in series tends to color the sound so that it takes on a kind of brightness or brittleness which some describe as "transistor sound." There was virtually no evidence of this in the case of the Ace Audio 3100. In fact, at realistic listening levels, and with levels of each setup adjusted precisely using test signals first, a typical "blindfold" test would make it impossible for us to tell when the preamp was in circuit and when it was not. That's about all one could ask of a "straight line" preamp that simply provides adjustable gain up to about 20 dB.

As for the phono section, comparisons are a bit more difficult to make since so much depends upon the cartridge used, how well it interfaces with the phono inputs, and what

sort of recording is used in the test. Nevertheless, we are prepared to give the Ace Audio Model 3100 equally high marks as far as phono reproduction is concerned. Frankly, when we saw that IC being used in the preamp, we had our doubts, for so many preamp sections using an IC have disappointed us in the past. Aside from the fact that the use of discrete components here might have resulted in slightly lower measured distortion (academic, at best), we must confess that the people at Ace Audio seem to have mastered the techniques needed to build a preamp-equalizer circuit around an IC and then some.

Obviously, if you need tone controls, filters, multiple phono inputs, simultaneous dubbing and listening (to another program) facilities and the like, this preamp is going to seem overpriced or under-featured to you. On the other hand, if you would rather not have these frills and seek only good, accurate preamplification, this unit (especially in kit form) may prove to be quite a bargain at that. *Leonard Feldman*

Enter No. 91 on Reader Service Card

Garrard Model GT-35 Automatic Turntable

MANUFACTURER'S SPECIFICATIONS

Speeds: 33 and 45 rpm.

Motor: D.c. servo controlled.

Number of Records in Auto Mode: 5.

Wow & Flutter: 0.05 per cent.

Rumble: -68 dB (DIN B).

Dimensions: 18 in. (45.7 cm) W

× 14½ in. (36.8 cm) D

× 7½ in. (19 cm) H.

Weight: 15½ lbs. (7 kg).

Price: \$219.95



The Garrard GT-35 is next to the top-of-the-line automatic turntable from this old, established company and, as you might expect, it incorporates many of the innovations used on the GT-55, first of the "Generation Two" series. These features include the Delglide mechanical system with its self-lubricating properties and the new d.c. servo belt-drive motor. The GT-55 has a straight magnesium arm and offset tangential-tracking, articulating headshell, while the newer GT-35 has an aluminum S-shaped arm with a magnesium head shell. The weight of the arm is lower; 12 grams for the GT-35 as compared to 14 grams for the GT-55. Jeweled bearings are used in the vertical pivot and ball bearings in the horizontal pivot.

An uncomplicated platform-type record stacking system is employed, taking a total of five records. There are two alternative center spindles, one for multiple play and one for

single play, supplied with the unit. On the right hand side are three rotary controls: The first one is for either *Start* or *Reject*, while the second control has four positions, *Off*, *Manual*, *Automatic*, and *Repeat*. The third control selects the speeds, either 33 or 45 rpm. At the rear is a *Cue* lever and an *Anti-Skating* dial, both of which are mounted on the tonearm base. On the left-hand side, at the front, are two small speed controls together with an LED strobe light that shines on bars cut into the rim of the platter, which is made of diecast aluminum and tips the scales at 3½ lbs. (1.59 kg). The Delglide system which controls the tonearm movement is driven by a separate belt... a method claimed to give a smoother overall operation than conventional single-belt arrangements.

In appearance, the turntable bears a closer resemblance to the current U.S. and Japanese designs, rather than European

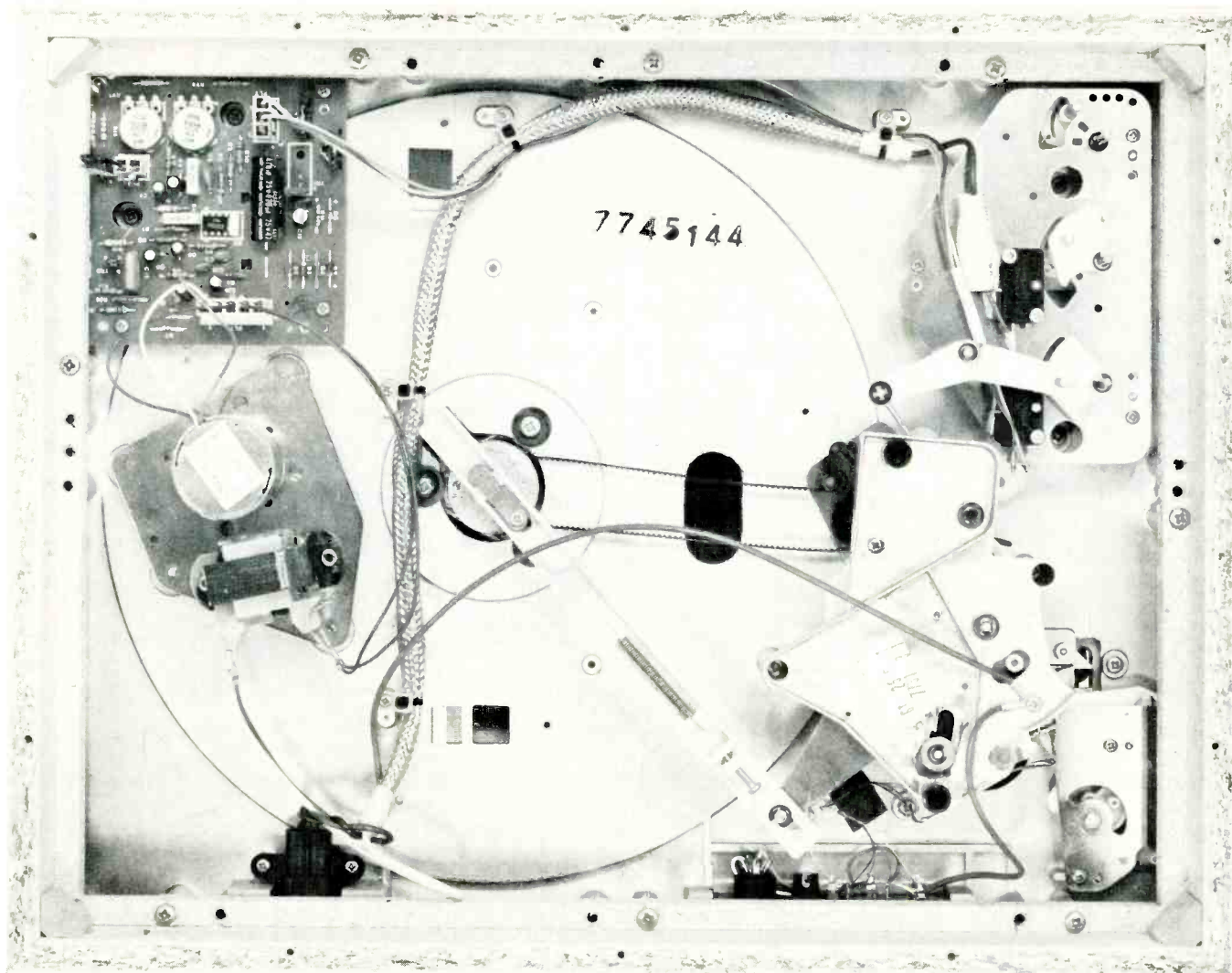

designs, with an attractive black and silver finish making a pleasing contrast to the rosewood veneered base. The unit comes complete with a transparent dustcover and a separate power supply lead which plugs into a socket at the rear. Phono terminations are taken to a pair of RCA-type sockets, also at the rear.

Measurements

For test purposes a Shure V-15 MK III was used, although an Audio Technica AT-13e was also checked later. An alignment gauge is supplied with the turntable, and even the clumsiest should have no difficulty using it in mounting a cartridge. The tonearm was set up by the usual static balance method, while the tracking force and *Anti-Skating* dial were both adjusted for 1.8 grams. The first test was for wow and flutter and the combined figures came out to a hair over 0.04 per cent. Rumble measured -61.5 dB using the ARII weighting method, which roughly corresponds to -71 dB with the DIN B rating method, and this means that the unit was some 3 dB better than the 68 dB DIN specified. The speed control range was -4.5 to $+5$ per cent, and the speed remains constant and is not affected by reasonable power supply variations. The stylus force and anti-skating calibrations were found to be very accurate... certainly within 5 per cent above one gram. I ought to mention that there are two scales on the *Anti-Skating* dial, one for conical styli and the other for elliptical and CD-4 styli. Tonearm resonance measured 9 Hz with the Shure V-15 Mk III cartridge, a safe frequency, and arm friction was too low to measure accurately, although it

was confirmed that the lateral friction was somewhat greater than the vertical. Tracking error was, as might be expected, less than 5 degrees per inch which is typical of this kind of arm configuration.

Turning to the automatic function, the changing cycle was faster than usual, taking only seven seconds to complete the cycle. I was pleased to see that the tonearm was handled very nicely and gently; in fact I doubt that many people could move the tonearm as carefully. The cue lever appeared to be well damped and free from annoying side play.

Listening and Use Tests

Record changers have come a long way since those "built like a battleship" models which were enormously complicated mechanical marvels appearing on the market almost 40 years ago. Modern units, like the GT-35, perform the same functions with a minimum of parts, noise, or fuss, and they do this while offering such advantages as servo-speed control, precisely-made tonearms which can track at less than one gram, and provision for single-play manual operation.

The workmanship on the GT-35 is excellent and the unit comes with a three-year warranty. The simple, straightforward mechanism with Delglide should give years of trouble-free service. Are there any criticisms? Yes, there are two small criticisms; it is difficult to see the indicator markings on the control knobs and, probably more important, I would like to see less sideplay on the tonearm base. George W. Tillett

Enter No. 92 on Reader Service Card



Dual Model C 939 Auto-Reverse Cassette Deck

MANUFACTURER'S SPECIFICATIONS

Speed: 1 7/8 ips, ±1 per cent.
Wow & Flutter: 0.1 per cent in record/replay (DIN).
S/N: 53 to 58 dB without Dolby; 63 to 65 with Dolby.
Erase: 65 to 70 dB.

Frequency Response: 20 Hz to 17 kHz with FeCr, 20 Hz to 14 kHz with FeO₂ tape (DIN).

Distortion @ 1kHz: 1 per cent with FeCr tape, 1.8 per cent with CrO₂, and 1.2 per cent with FeO₂ tape.

Line Input for 0 VU: 70 mV.

Output: 0-700 mV.

Headphone Output: 4 to 2000 mV, adjustable.

Dimensions: 17 1/4 in. (43.8 cm) W x 11 1/4 in. (30 cm) D x 5 3/4 in. (14.6 cm) H.

Weight: 15 1/4 lbs. (6.9 kg).

Price: \$550.00.

92

European audio designs, especially those hailing from the Scandinavian countries and West Germany, tend to be rather different from their American and Japanese counterparts, and this new Dual cassette deck is no exception. First of all, it is not the "usual" front-loading type, and instead of offering variable bias, a monitor head, and provision for a timer like most decks in this price range, it has an auto-reverse tape function, a special "fade edit" circuit, and two groups of LEDs in place of VU meters. Each channel has seven green LEDs calibrated from 0 VU to -20 dB, plus five red ones for +1 up to +5 dB. These LEDs are mounted on a neat hinged bracket at the rear on the right-hand side along with illuminated indicators showing tape direction, record function, and Dolby with a two-position switch for peak/average indication of the LEDs. Two pairs of sliders, each 2 1/2 inches long, are on the main panel in front and control the level of the line and microphone inputs. To the left is a group of six adjustable controls for *Output*, *Dolby Calibration*, and *Headphone Level*, while just in front of these is another pair marked *Fade-Edit*, about which more later. There are eight control keys on the front, two of which are not usually found

on other cassette decks. One of the additional keys is marked *Cont*, and as the name suggests, depressing it enables the machine to play continuously until the key is released. The second added key puts the cassette into the reverse mode for playback. The illuminated tape compartment is just behind it, and next are the large *Eject* button, the digital counter, and the *Memory* switch. On the right of the tape keys are two groups of three pushbuttons: the first three are for tape selection marked *Fe*, *Cr*, and *FeCr*, then there is a pair for the Dolby functions (*Tape* and *FM*), while the last switches in a "limiter" to prevent overloading when recording. On the extreme right there are three standard quarter-inch phone jacks for microphones and headphones. All the other input and output sockets, including a DIN connection, are at the rear.

Now for an explanation of the *Fade-Edit* controls... the left control is a safety interlock, and the control on the right introduces the variable erase oscillator so that you can partially or completely erase a recording. In order to prevent accidental erasure, the oscillator switch is spring loaded so it has to be held down during the editing process. In operation, the deck is put into the playback mode so you can hear the recording to be edited, either via the amplifier or the headphones. The instruction manual suggests that you can use the *Fade-Edit* facility to remove the noise made by record scratches, but you will have to work very quickly to accomplish this, otherwise you will remove a chunk of music as well. The control does have its uses, especially since the actual amount of erasure is controllable.

The drive motor is the synchronous type with separate belts for the take-up torque and capstan, while the fast-wind mode is gear driven, an interesting idea. A photo transistor

Fig. 1—Playback response from a standard test tape.

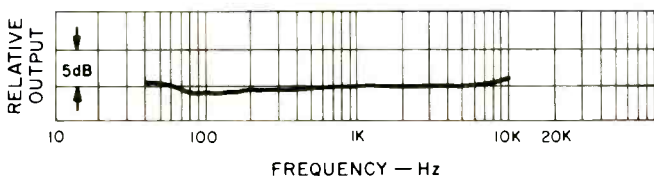

Table 1—Signal-to-noise ratios of the Dual 939 using various types of tape, all referred to 3-per cent distortion.

Brand, type	S/N, dB	S/N, dB, with Dolby
Meriton FeCr	58	66
Maxell UD	60	69
TDK SA	60	67
BASF Super Chrome	59	66

continuously monitors the tape movement and prevents the formation of tape loops, while at the same time providing the signals for auto-stop and reverse control.

The deck is somewhat larger than usual, measuring 17 ¼ inches, by 11 ¾ inches, by 5 ¾ inches high. Feet are provided for either vertical or angled mounting, and a plastic cover is available. Styling is the conventional black and silver combination with a wooden base.

Measurements

Playback response with a standard test tape is shown in Fig. 1. As a Maxell UD cassette came with the deck, this was used to measure the *Record/Replay* response, and the results are shown in Fig. 2. The -3-dB point was at 15.5 kHz with some fringing in evidence at the low end. Next, this cassette was replaced by a TDK SA, and the selector switch was set to Cr. Now the high frequency response extended to 16.5 kHz, which is very good. As a sample of the new BASF Super Chrome tape had just arrived, I was anxious to see how it compared with the other tapes, and Fig. 4 tells the story. At 0 VU the saturation was relatively low, but the -20 dB response had an appreciable rise from around 3 kHz to a maximum of +4 dB at 15 kHz, confirming the manufacturer's claim that this new tape is more efficient with a "hot" high frequency response. The last tape checked was the Meriton

Ferri-Chrome, and here the upper -3-dB point was 16.6 kHz ... approximately the same as the TDK SA. (However, the output was lower, but I'll come to that shortly.)

Next, all four tapes were tested for distortion at 1 kHz (see Fig. 6), and it will be seen that the Ferri-Chrome starts off with the lowest distortion, but above +2 dB, the UD is slightly the better here.

Distortion versus frequency was the next test, and these particular measurements were made at 0 VU to indicate what headroom is available at mid and lower frequencies. This is admittedly a severe test but, obviously, a lot more meaningful than one made at -10 dB or so. The procedure is to begin with a 1-kHz signal which results in a 0-VU indication on the LEDs (in this case), and this input level is kept constant throughout the frequency range. Usually the meters will indicate a constant level, but in some cases the input to them is frequency "tailored" in an effort to prevent overloading. Then again, the meters could be connected to either equalized or unequalized circuits—there's no absolute standard for home recorders. In the case of the Dual C-939, the response of the indicator is "tailored" at both ends of the scale, as shown in Fig. 7. It will be seen that the relationship is linear between 150 Hz and 2 kHz, the LEDs gradually lighting up above and below this midrange band. The UD and FeCr show good headroom (or low distortion) down to 30 Hz, while the SA and Super Chrome tapes cannot accept quite such high signals below 100 Hz. So, the LEDs give a better indicator of overloading in this range, although this overloading is not likely to happen except, possibly, with organ music or electronic compositions. The signal-to-noise figures for a 1-kHz signal, referred to 3-per cent distortion, are shown in Table 1; the actual output varied from 400 to 800 mV, according to the kind of tape.

The *Record-Replay* response of the Dolby circuitry was checked down to -40 dB, and the deviations were found to

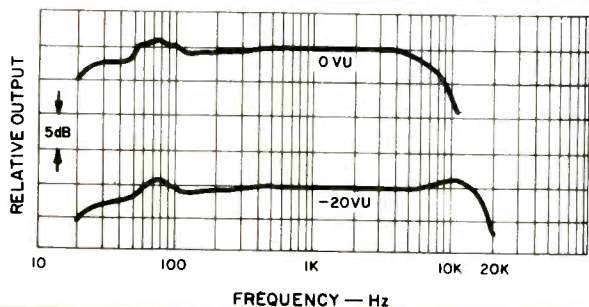

Fig. 2—Record/Replay response with the Maxell UD tape.

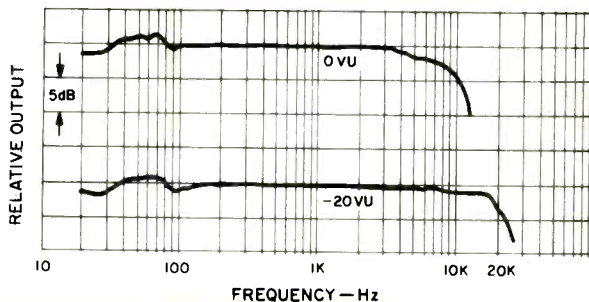

Fig. 3—Record/Replay response with the TDK SA tape.

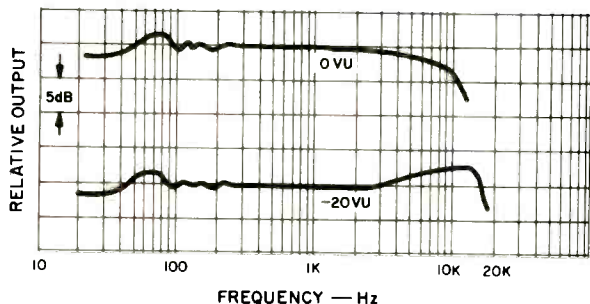

Fig. 4—Record/Replay response with BASF Super Chrome tape.

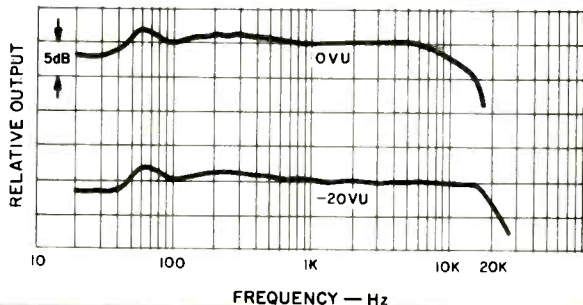

Fig. 5—Record/Replay response with Merriton Ferrichrome.

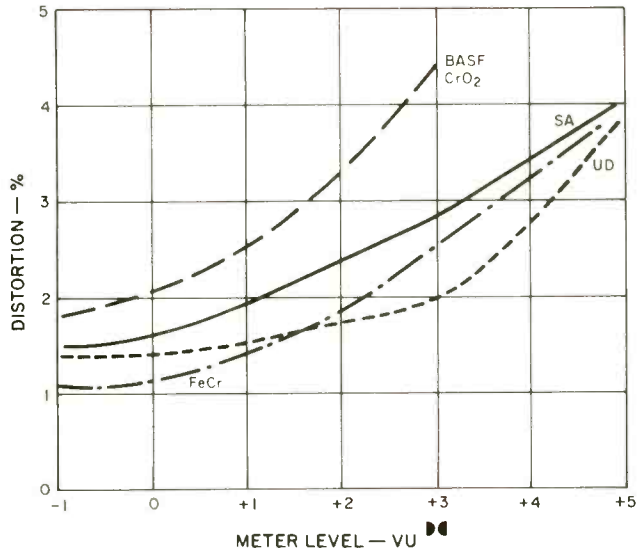

Fig. 6—Distortion at 1 kHz.

be less than 2 dB. Input required for 0 VU was 70 mV line and 0.03 mV at the microphone socket. Switching to microphone decreased the signal-to-noise by 9 dB with the input control at maximum. Erase efficiency was better than 65 dB with CrO₂ tape. The wow and flutter was commendably low at 0.06 per cent, while the speed was almost "on the nose" at 0.03 per cent slow. Rewind time for a C-90 cassette was 65 seconds.

Listening and Use Tests

I used the 939 cassette deck for a period of several weeks, and the unit gave me no trouble whatsoever. I must admit,

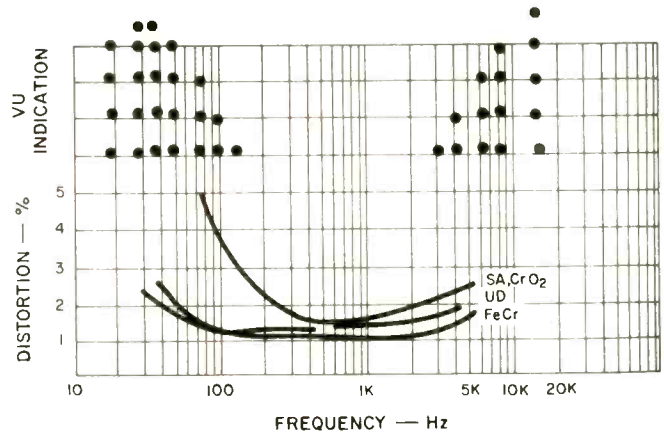

Fig. 7—Distortion vs. frequency for constant input giving 0 VU at 1 kHz.

though, that it did take a little time to get used to the electronics being totally controlled by the tape keys. The LED indicators work very nicely, and in many circumstances might be preferred to VU meters, particularly because of their fast action in the peak-reading mode.

In terms of general performance, Dual's 939 cassette deck is fully up to the extremely high standards we have come to expect from cassette decks in this price range. The auto-reverse facility will, undoubtedly, appeal to those of us who have a large collection of pre-recorded tapes. However, I am sure that many enthusiasts, especially those who've had experience with reel-to-reel tape decks, will say that the most useful feature of the Dual 939 cassette deck is the *Fade/Edit* switch.

George W. Tillett

Enter No. 93 on Reader Service Card

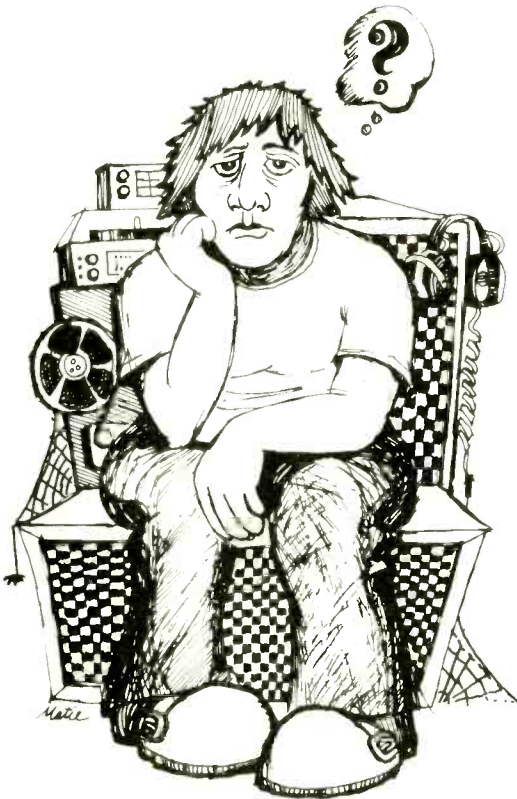

Audio Classified Ads

Want to buy, trade or sell components? Want to offer or buy a service? Want a job in the audio field? Your ad belongs in Audio. Rates are low—results high.

RATES: Commercial, 60¢ per word; situation wanted or non-commercial, 35¢ per word. We reserve the right to determine classification as commercial or non-commercial. **Payment must accompany all orders.**

Place your ad today!

Send copy to:
Audio Magazine
 401 N. Broad Street,
 Philadelphia, PA 19108
 Attn: Classified Dept.

Michael Tearson

Jon Tiven

The column

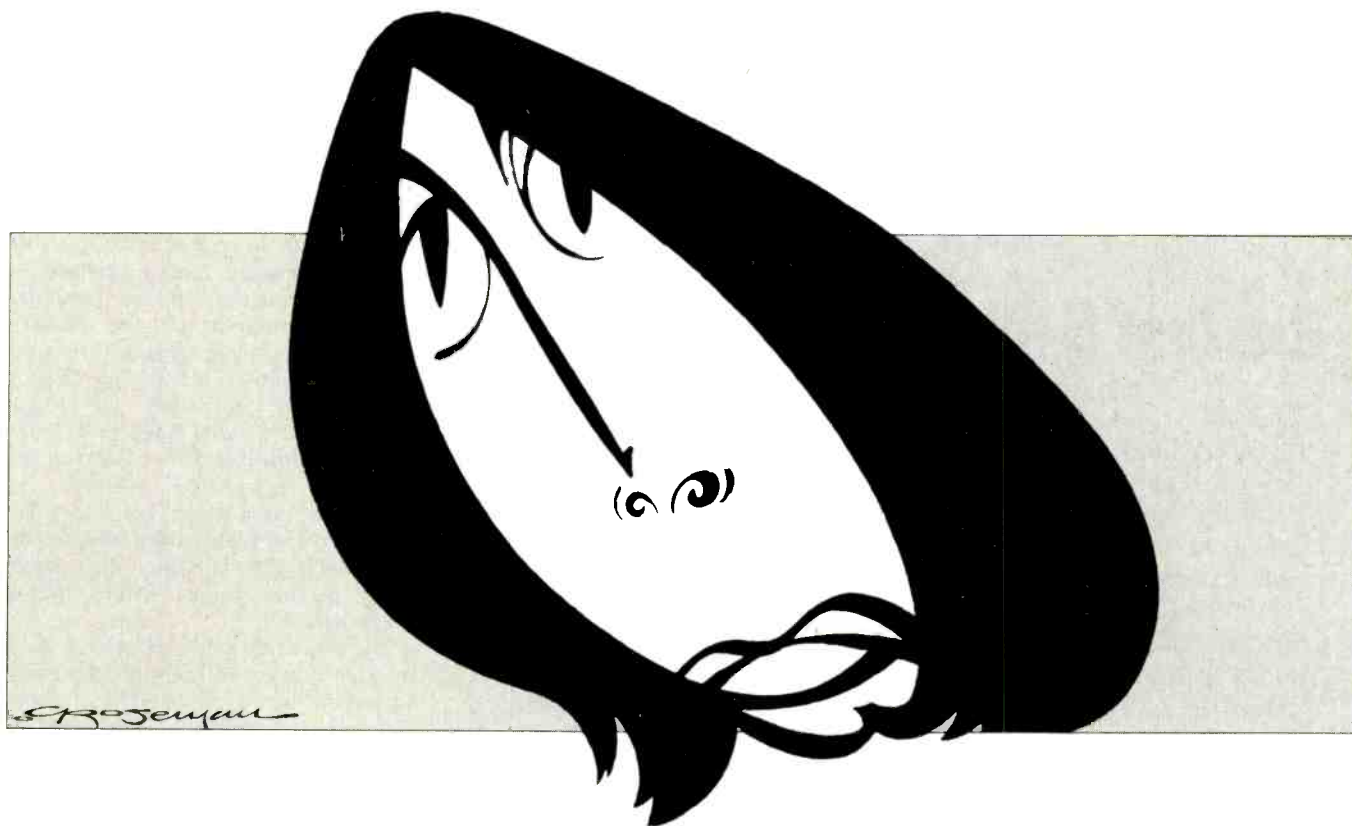

Running on Empty: Jackson Browne
Asylum 6E-113, stereo, \$7.98.

Running on Empty was recorded live and on the run. It includes performances live on stage, in hotel rooms, in a rehearsal hall, even rolling along on the bus. One, Danny O'Keefe's *The Road*, combines hotel, first verse up to the built-in pause in the melody when crickets appear and it segues to the stage at the same point in the song. Only the altered texture of the sounds and ambience signals the switch. The pause in the second verse yields a magical moment when the crowd cheers apparently for the crickets singing along.

In fact, the album is remarkably well recorded for a live in the field recording. It has terrific presence and personality. By itself **Running on Empty** defines audio *verité* as a medium. Special kudos go to engineer Greg Ladanyi.

Musically **Empty** is Jackson Browne's most entertaining album ever. It is thematically bound up in the theme of the road experience; all the

songs describe what happens or how you feel out there. The new ones are distinctively Jackson's. They feel it. But Jackson has been lazy with his melodies. Both of the rockers, the title song and *You've Got the Thunder*, cop the main riff of *Take It Easy*. *The Load Out* is very close to *The Pretender* which itself reminds me of *For Everyman*. *Rosie* brings *Ready or Not* back to mind. As obvious as it is Jackson's self-thievery really doesn't matter within the good feelings of the album. Surely it is both the happiest and most optimistic album Browne has recorded. The emotional turmoil of **The Pretender** and **Late for the Sky** clearly is just not the concern of **Running on Empty**. The unrest has led to a fresh and fertile new period.

Running on Empty is both highly cinematic and thoroughly thought out. That cover is what his stage set looked like on the tour during which the album was recorded. The picture book inside is lavish, provocative, and enlightening as well. Every detail has been covered, all the way down to

superior sequencing of selections. Call this a rave review. M.T.

Sound: A+ Performance: A+

Don Juan's Reckless Daughter: Joni Mitchell

Asylum BB-101, stereo, \$12.98.

Don Juan's Reckless Daughter elaborates stylistically on its two predecessors **Hejira** and **The Hissing of Summer Lawns**. The cover art is even quite reminiscent of **Hissing's**. The snake image which has been central to Ms. Mitchell's writing on these recent collections is consistent on **Daughter** and seems to frame the three albums into a trilogy. Indeed **Daughter** contains some leftover songs that never made it to the earlier ones. The song *Jericho* has appeared before in a somewhat embryonic form on the live **Miles of Aisles** collection. Two others, the title song and *Talk to Me*, have been in her concert performances since at least February 76, before reaching vinyl.

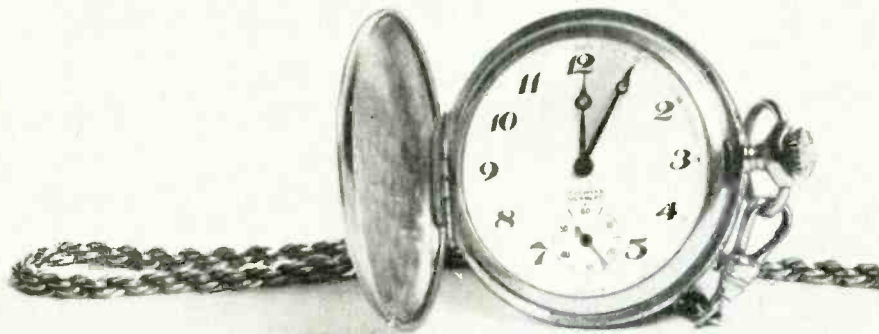

the first 5 minutes don't count

Or even ten!

Sometimes it may take a little while before you know just how good a headphone really is.

Comfort, weight, cord convenience all are vital factors in headphone wearability.

With every minute of use, any manufacturing deficiencies in these areas grow into discomfort and inconvenience.

At Beyer we know these problems and all our headphones are designed to achieve the highest possible wearability factor (Hi-Fi News, September '76, page 143, Beyer DT440 ranked 1st out of six comparative tests for comfort).



BEYER DYNAMIC
Distributed by Hammond Industries Inc.

155 Michael Drive, Syosset, New York 11791 (516) 364-1900

Coupled with physical comfort comes the lack of aural fatigue. That bright overdone sound associated with the 'loudspeaker-on-the-ear' concept oversold by our competitors will often give you a bad headache in minutes. It takes time to appreciate good clean sound. And with time, good sound doesn't tire (Hi-Fi News, September '76, Subjective Headphone listening test, Beyer DT440 ranked 1st).

So visit your Beyer headphone dealer now and give yourself time to compare Beyer headphones against the competition.

**But remember—
the first
5 minutes
don't count!**

Musically **Don Juan's Reckless Daughter** is ambitious even for the restless Ms. Mitchell. The pop threads of **Court and Spark** appear to be entirely forsaken for starker, more suggestive rhythms, a style almost designed to ward off excessive mass acceptance.

Two of the four sides are side-long excursions. *Paprika Plains* rambles meditatively and seemingly autobiographically through an elaborate orchestral setting by the English composer Michael Gibbs. Side three opens on *Otis and Marlena*, contrasting O & M's fun & sun vacation with the Hanafi Moslem terrorism of Washington, D.C., last summer. It segues into *The 10th World*, a lengthy and ultimately indulgent percussion dream sequence set in the minds of the Hanafis perhaps. This in turn segues into a peculiar percussive version of *Dreamland*, earlier recorded by Roger McGuinn on **Cardiff Rose** in a much more straightforward rock and roll setting. The percussion heightens to nightmare irony such lines as "Tar Baby and the great white wonder sitting over a glass of rum." This whole side might have been titled "Wanderlust."

The other two sides include songs in song format, yet still related to the omnipresent theme of wanderlust, both physical and spiritual. The opening gambit *Cotton Avenue* opines "If you got a place to go/You just got to go there/If you got no place special/Then you just go no place special," and sets the tone for all that is to come. It is a prophetic thought. *Talk to Me* and *Jericho* look heads and tails fashion at the difficulties in making personal connection; *Talk to Me* neurotic, nervous chatter, and *Jericho* pensive and a bit bitter.

Opening the final side, the title song is the album's centerpiece relating as well to **Hissing** and **Hejira**. She joins the snake to the eagle, amplifying their personal meanings, "The eagle and the snake are at war in me/The serpent fighting for blind desire/The eagle for clarity." The final statement *The Silky Veils of Ardor* harkens to her folk music roots. The song has only acoustic guitar backing and lyrics borrowed and bent from *Come All Ye Fair and Tender Ladies*, *Poor Wayfaring Stranger*, and *Dink's Song*, traditional songs all woven into a credo on the pain of love and the power of dreams.

The unbilled musical co-star of **Don Juan** is Weather Report's bass player Jaco Pastorius. His eloquent, startling bass lines capture an inordinate amount of the musical attention. His collaborations with Joni, begun on **He-**

jira, seem to inspire her into ever more distant uncharted regions. Other notables include John Guerin on percussion, Larry Carlton on guitar, and Weather Report's Wayne Shorter on sax. The sound has been crafted by Henry Lewy, who has worked on every Joni Mitchell album from *Clouds* (her second) on. As usual, he has done a brilliant job, especially on the special effects and Jaco's bass.

Don Juan's Reckless Daughter has its full share of excess and failed ambition, plus wandering and occasionally vague melodies, but it is an exciting and fascinating document nonetheless. It is a far cry from my favorite Mitchell, but it is insistent and disturbingly attractive.

One other serious flaw is in the total time of the set. The four sides sum to 59:30, safely under an hour. The \$12.98 list price is pretty steep for that little music. Could there not have been one or two more hidden songs that fit, or a dollar or two less at the counter? *M.T.*

Sound: A Performance: B-

Never Mind the Bollocks, Here's The Sex Pistols

Warner Brothers BSK 3147, stereo, \$7.98.

First off, this critic would like to state that I love all the Sex Pistols singles and am not significantly influenced by the fact that they do not play all their own instruments (Chris Spedding, guitar; Paul Thompson, drums; John Wetton, bass). I must say, though, that had I never bought any of their 45 rpm records, this album might well have kicked me in the teeth.

Unfortunately, however, aside from the singles there are only three cuts which move me, the horrific *Bodies* which deals with the subject of abortion in an undelicate manner, their dismissal of their roots with the nasty *New York*, and the famed pointed finger at their former record label(s), *E.M.I.* Of the four singles, three are very good but there is a marked decline in innovation from one single to its successor in chronological order. *Anarchy* is the definitive statement, *God Save the Queen* is a successful followup without the same potency, *Pretty Vacant* is true to the Pistols mold but not exactly captivating to the last, and *Holidays in the Sun* somehow is uninspiring from start to finish, complete with a riff nicked from the Jam's *In the City*.

The rest is pure filler, both lyrically and musically—they would be better off including the flip sides to the singles which were at times as good as the A-sides. Chris Thomas' production

is very good and aids tremendously in making the Pistols musical. However, this should not be overestimated—a recent Kiss cover of *Anyway You Want It* made me pull out my **Dave Clark Five's Greatest Hits** album and the sound on those tracks is far more explosive than the bulk of this record. Thomas is good, but the Pistols don't yet have the depth to hold the listener's attention for more than three minutes with any one song, and the challenge for the rest of the Seventies is to do just that. When they come up

with six minutes of lyrics, dynamics, and melodies which grab me by the seat of my pants and don't let go for a second, then they can be legitimately acknowledged as more than just a political singles band. Lord knows Britain's given America tons of singles bands, some of which take and some of which don't—but why bother putting out an album if the bulk of it is already available on singles, and the rest is forgettable? *J.T.*

Sound: B+ Performance: B

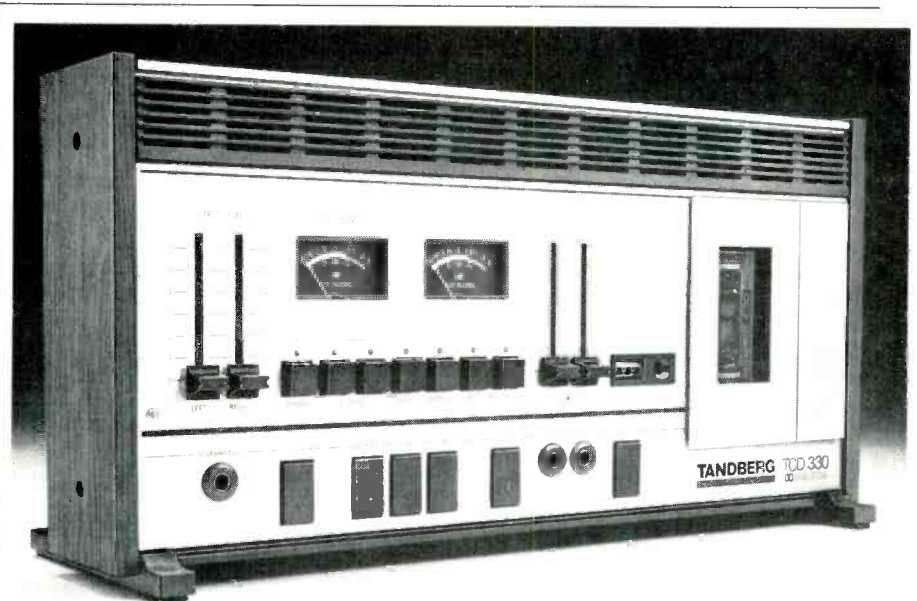

TANDBERG ALONE OFFERS REEL-TO-REEL PERFORMANCE FEATURES IN A CASSETTE DECK

3 Separate Heads/3 Motors/Dual Capstans

These & other features found exclusively on Tandberg's TCD-330 make it not only the finest cassette deck, but also the cassette deck with performance exceeded only by the best reel-to-reel machines. Three separate heads for no-compromise recording & monitoring. A 3-motor, dual capstan closed loop transport, coupled with complete logic-controlled solenoid operation. Adjustable azimuth & built-in 10kHz tone generator, allowing the user to select the perfect alignment for each cassette, as well as spot dropouts and inferior tape. Equalized peak-reading meters. Automatic take-up of tape loops when cassette is inserted. Servo-controlled high speed winding. Vertical or horizontal operation, plus optional remote control & rack mounting.

Only the TCD-330 has what it takes to deliver cassette performance exceeded only by the finest reel-to-reel machines. Ask your Tandberg dealer for a "Hands-on" demonstration. Write or call us toll-free at 800-431-1506 for his name. Tandberg of America, Inc. Labriola Court Armonk, N.Y. 10504

TANDBERG

Enter No. 46 on Reader Service Card

STOP!

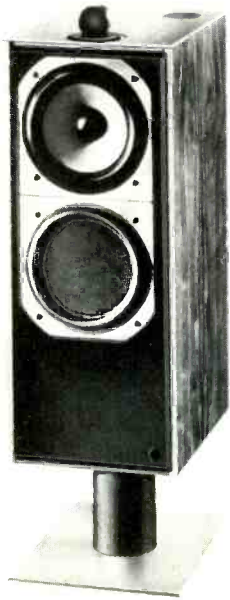

LOOK!

At the all new B&W Loudspeaker with its components designed and built in B&W's factory in England. A B&W developed spheroidal transducer provides better control and dispersion for high frequencies. Mid-range is a special B&W design, flat from 70 Hz to 3KHz. Plus a new ultra-low frequency radiator for complete bass reproduction. Includes a loudness contour control. B&W computer research into phase and transient distortion have provided design data that makes the DM-7 an outstanding value.

WRITE today for a free technical brochure on the DM-7 and the name of your nearest dealer.

LISTEN!

...at your dealer

For linear frequency response, 30Hz - 25KHz ± 2dB • For a large listening window. Vertical ± 1dB within 10°; horizontal ± 1.5dB within 40° • For distortion of less than 1%, 3rd harmonic. • For the sound of engineering excellence.

B&W Loudspeakers

from Anglo-American Audio Co., Inc.
P.O. Box 653
Buffalo, NY 14240 U.S.A.

Enter No. 7 on Reader Service Card



Point of Know Return: Kansas
Kershner JZ 34929, stereo, \$7.98

Okay, so my review of Kansas' last effort *Leftoverture* was more vituperous than that album deserved. That's all past anyway. With **Point of Know Return** the crowd doesn't taste half bad either, and for that matter neither does the album.

It has strong melodies to support their sometimes meandering solos, strong harmonies to prop up the songs' hooks and a strong bottom at the musical core, plus excellent produc-

tion to giftwrap it all. Kansas' music has the openness of Yes combined with a strong grasp of song sense. They are technically proficient in the studio and capable of exciting pyrotechnics live. Their years of steady work have paid off in a solid band, if not a trailblazer, with a full enough legion of fans to make them a hockey rink sized attraction. **Point of Know Return** is a classy, clearly and cleanly recorded offering from them. *M.T.*

Sound: B+ Performance: B+

I'm Sorry, I'll Read That Again: Sound-track
EMI M-11634, mono, \$3.98.

I'm Sorry, I'll Read That Again was a hit BBC radio series around 1967. In the last year, it has appeared on National Public Radio very successfully here in the colonies. It bridges the eras of the Goon Show and of Monty Python's Flying Circus from which John Cleese is an integral part here.

It's funny stuff, often silly in the British Humour tradition. There are short bits and lengthy involved pieces of scope and story that all adds up to a 55+ minute album at a low list price. It is a must to devotees of the genres of Goon and Python for sure. *M.T.*

Sound: C Performance: B+

Foot Loose and Fancy Free: Rod Stewart
WB BSK 3092, stereo, \$7.98.

A far more raucous and rocking effort than the last few of Rod Stewart's albums, this one. The songs expand on the title's concept to create an anything-can-happen atmosphere spawned by the end of his cover of **People** romance. That romance reached its audio peak with the lady Britt's moaning on the hit *Tonight's the Night*.

Never the subtle lad, Rod's new songs share a goodtimey, raw sexuality as in *Hot Legs*, *You're Insane*, *Born Loose*, and the ballad hit *You're in My*

Heart. These songs together make up a strong first side, much more so than side two. That side opens with the album's gross error, a remake on the Vanilla Fudge arrangement of *You Keep Me Hanging On*, most likely the idea of former Fudge drummer Carmine Appice who's pounding 'em for Roddy these days. From there it has to be uphill, but the intensity of side one is long gone.

Tom Dowd's production is its usual slick self, but the band just isn't very strong. Most of all an obvious lack of sympathy is the problem. Although **Foot Loose** tries valiantly to recapture



the freewheeling ambience of such masterworks as **Never a Dull Moment**, **Gasoline Alley**, and **Every Picture Tells a Story**, three of the strongest album runs of any 70s artist.

But there's one thing you can't escape on **Foot Loose** and that is the message ... old Roddy's available again girls and looking for you. *M.T.*

Sound: B Performance: C+

Cabretta: Mink DeVille
Capitol ST-11631, stereo, \$6.98.

Mink DeVille is one of the first of the CBGB'S groups to receive a major company contract, and their debut album amply demonstrates the company's well-founded faith in them. They play classy rock'n'roll in a variety of styles. Their leader Willy DeVille, who also writes the majority of the material, has a marvelous presence and an uncanny ability to assume different characters in voice.

In making that great leap to vinyl, Mink DeVille has had the great luck of having as producer Jack Nitzsche, engineer and arranger of many legendary Phil Spector sessions and later associated with Neil Young and Rolling Stones sessions. Nitzsche is perhaps best known for taking outlandish risks on record and making them pay off, and that is precisely his role with Mink DeVille. He catalyzes their sound into something very non-ordinary. The production is seductive and deceptively graceful with intriguing and consistently surprising.

The invention comes from the DeVilles, the realization from Nitzsche. However it slices, even if my theories about **Cabretta's** genesis are all wet, this is an excellent record that delivers importance when I expected nothing.

M.T.

Sound: B+ Performance: A

Reckless Abandon: The David Bromberg Band

Fantasy F-9540, stereo, \$7.98.

Bromberg's back, eclectic as ever, with another fine, if occasionally flawed album. Side one is possibly the strongest that any Bromberg album side has ever been. He opens with a super new self-penned song *I Wanna Go Home* followed by a superior version of *Stealin'*, an exquisite fiddle tunes medley, Murray McLachlan's *Child's Song* done up with an odd yet affecting group backing vocal and string arrangement, and finally buddy Jim Ringer's reworking of the Stagger Lee legend under the name of *Mrs. DeLion's Lament*.

Side two opens smashingly well with

another fiddle tunes medley hooked around a Civil War theme and Rick Danko's *What a Town*, a song ideally suited to David. Then things get sticky with *Baby Breeze*, a forgettable original with soupy strings. Next on is *Beware, Brother, Beware*, an oratorical warning, delivered over a disco bed, to the men in the audience about the other sex. The track lasts way too long. ... he should have followed the title's advice on this one. The album may be **Reckless Abandon**, so that may be the artist's excuse. But it's still an excuse, at best, for an error. To make

up for the preceding self-indulgence Bromberg astutely and knowingly closes with a stellar version of Blind Willie Johnson's blues *Nobody's Fault But Mine*, a serious, steaming piece of redemption.

Reckless Abandon demonstrates David's ever-growing confidence and improvement as vocalist and band-leader. Despite the two glaring flaws, this is still his best-recorded and best-played studio effort. But the flaws hurt. *M.T.*

Sound: A Performance: B

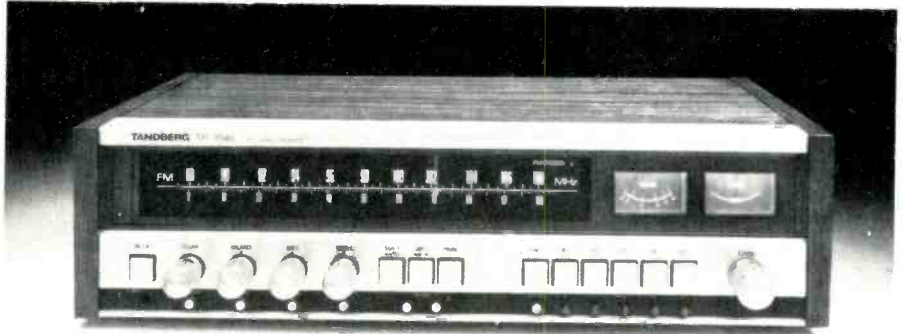

CLEAN & FAST

99

Engineers around the world frequently use the term "Clean & Fast" to describe the performance of Tandberg's Series 2000 stereo receivers. We are very pleased, because this is a rather unusual term to apply to integrated receivers.

Today there are new standards of measuring amplifier performance under actual music listening conditions being applied to the more advanced separates: Rise Time, Slew Rate, DIM (Dynamic Intermodulation) and PhaseLinearity. The four models in Tandberg's Series 2000 are the only receivers to excel in these new measurements normally associated with exotic separates, earning the reputation "Clean & Fast."

An adequate description of these new measurements is not really possible in this limited space, so we invite you to request our very thorough brochure "An Introduction to Tandberg Series 2000 Receivers" from your authorized dealer. We think you will be impressed, particularly when you compare our specs with the most sophisticated separates.

The Series 2000 receivers stand out in many other traditional, but still important areas of specifications as well. Again, they are too numerous to adequately mention here, but we're tempted to list just a couple: An FM tuner on its own chassis that exceeds the performance characteristics of most separate tuners; a pre-amplifier with low noise, dynamic range and distortion characteristics of the very best separates.

For your nearest dealer, write: Tandberg of America, Inc., Labriola Court, Armonk, N.Y. 10514; or call toll-free 800-431-1506.

TANDBERG

Only in The Audio Critic.

Where in the world would you find an equipment review proving with sophisticated laboratory measurements and listening tests that a certain cult-venerated \$3000-a-pair speaker system is a turkey?

Only in The Audio Critic.

Certainly not in the commercial hi-fi slicks; they wouldn't dream of offending the audio industry with such heavy stuff. (Besides, the manufacturer of the speaker is an advertiser.)

Nor in the "underground" audiophile reviews; their innocent enthusiasm created the cult to begin with.

Only The Audio Critic combines the four essential qualifications for valid audio reviewing, of which other publications have but one or two or none: (1) educated ears, (2) a disciplined foundation in electronics and electro-acoustics, (3) a complete, in-house laboratory facility, and (4) no advertising, and therefore no editorial pressure, by either manufacturers or dealers.

As a result, The Audio Critic is refreshingly free of fad-of-the-month recommendations, mealy-mouthed hedging about what's best, and untutored pop-tech expertizing. The five issues published so far contain well over a hundred of the longest, toughest, best-documented test reports in the business, not to mention dozens of other equally informative features.

Nor does The Audio Critic restrict itself to equipment in the four-figure category; it has already unearthed quite a few little-known and reasonably priced components that outperform the high-priced hypes by a wide margin. And its already world-famous articles on tone-arm and cartridge alignment have enabled a large number of audio enthusiasts to achieve a substantial sonic improvement in their systems without spending a nickel.

The Audio Critic is published at intervals averaging two to three months and is available by subscribing to six issues for \$28, first-class mail only. (No Canadian dollars, please!) For overseas airmail, add \$5. No single copies are sold for any reason whatsoever, but the unused portion of canceled subscriptions is refundable on request.

We strongly suggest that you begin your subscription with Volume 1, Number 1, in order to own a complete set and be thoroughly familiar with our approach.

If you wish, however, we'll start you with any issue you specify.

Send \$28 for your first six issues today to The Audio Critic, Box 392, Bronxville, New York 10708.

The Audio Critic

Marin County Line: New Riders of the Purple Sage

MCA 2307, stereo, \$6.98.

The last several New Riders of the Purple Sage albums have been strictly undistinguished. **Marin County Line**, while an improvement, is oddly schizophrenic. Side one contains five songs written and sung by the latest Riders bass player, Stuart Love, while side two is the usual.

Love's songs are alright. *Llewelyn* a historical drama and *Green Eyes a Flashing* are his best, and not coincidentally the two songs of his with strong story lines. The Love side downplays the Riders' honky tonk, and as a result lacks personality.

Flipping it over you find Dave Ellingson's *A Good Woman Likes to Drink with the Boys* revives the classic NRPS sound, and then *Jasper* by John Dawson and David Nelson reintroduces the Riders' vocal personality.

Taken as a whole **Marin** is easily the best NRPS in years. It has a vibrant and crisp sound, much superior to their last few gutless albums. Unfortunately, the pressing was a noisy one with much surface noise between songs.

Closing in on a decade as a band, the New Riders have lacked direction recently and it's good to see them regain it, even if they're not sure which of the two to commit to. M.T.

Sound: B

Performance: B

The Stranger: Billy Joel

Columbia JC 34987, stereo, \$7.98.

Billy Joel's suburban tales of growing up and then older take on a tinge of desperation in **The Stranger**. *Movin' Out*, Anthony's story of fleeing home and its stifling family scene, and *Scenes from an Italian Restaurant* which delineates the rise and fall of Brenda and Eddie's relationship, are both powerful scenarios, very cinematically written. *The Stranger* is a moody one about the hidden face in all of us. The seduction plot of *Only the Good Die Young* is undermined by the confusing title though. The finale *Everybody Has a Dream* is one Billy waited six years to record, but its imagery of quiet desperation perfectly fits the new album. There is one song, however, that appears certain to receive many cover recordings by many people, the ballad *Just the Way You Are*.

Billy Joel's music is what it wants to be, usually catchy or moody, but only rarely joyous probably because most of the stories don't end happily. What emerges as Joel's emotional impact is ambivalence.



For a Phil Ramone production, the album rocks surprisingly hard. In all likelihood Phil, for the most part, just stayed out of Billy's way, although some detailing, like Billy's occasional mood whistling for sheer effect, probably emanated from Ramone, but that's just guessing. Other nice touches are Dominic Cortese's accordion on *Italian Restaurant* and Vienna and Phil Woods' sax part on *Just the Way You Are*.

I'm sure **The Stranger** will do well for the ever more popular Billy Joel, but it leaves me with thoroughly mixed feelings. M.T.

Sound: B

Performance: B+

Out of the Blue: Electric Light Orchestra

Jet/United Artists JTLA 823-L2, stereo, two discs, \$11.98

It's a measure of their self-confidence, especially of leader/singer/producer/composer Jeff Lynne, that ELO's successor to their fabulously successful **New World Record** is a studio two-record set.

Out of the Blue has been lavished with state-of-the-art rock sound throughout. It was recorded in Munich where Lynne achieved a precision and depth to the sound, as well as superior stereo placements even ELO has not had before. It is a big, wide sound.

Lynne's new material is faithful to the ELO tradition. If the new twists in

the music are only production tricks, it is at the same time at least as highly polished and realized as it has ever been. Quintessential pop this. Mixing it must have been a bitch.

The sheer volume of material makes picking favorites difficult. Still if standouts are few, the level is amazingly consistent for four sides. Lynne knows the craft of pop music. He writes, specializes in songs that at first appear lightweight, but with repetition gain strength, especially given the benefit of the superior recording quality on this disc.

Special mention to Shusei Nagaoka for his mind-boggling cover illustrations, state-of-the-art record cover work. *M.T.*

Sound: A Performance: B+

Show Some Emotion: Joan Armatrading

A&M SP-4663, stereo, \$7.98.

Show Some Emotion is a fine album though not as exciting as **Joan Armatrading**, its predecessor. The major difference is in the material itself. Joan's unique, hypnotic vocals backed by Glyn Johns' shimmering production are just as fine, but something of the focus, something more emotional than musical seems to be missing, though this new album still makes very good listening indeed.

Then again, it could come down to the new set of musicians Joan is working with. **Show Some Emotion** is not so disarmingly simple and innocent as **Joan**. That album's near-miss with a mass break-through might have made Joan's management edgy, looking for the added intangible to push her over the top. Thus, the excellent Georgie Fame on Fender Rhodes piano and John "Rabbit" Bundrick on organ. The move is well meant but it sounds a bit confused.

When Joan is on, she is a very special talent sounding like nobody else. When the song is right, as the title song or *Mmam Mercy* or *Get in the Sun* are, almost nobody can touch her for raw emotion and electricity. **Show Some Emotion** is a tentative step forward. Tentative but positive. The only thing holding it back is the inconsistency of this set of songs. *M.T.*

Sound: B Performance: B-

Decade: Neil Young

Reprise 3RS 2257, stereo, \$14.98.

In the year that release of this three-record retrospective was delayed, its list price went up \$3 while two of the seven previously unreleased tracks,

Like a Hurricane and *Star of Bethlehem*, were issued on **American Stars 'n' Bars**. This naturally has diminished the set's value, but it remains a fascinating over-view of one of pop music's greatest enigmas, Neil Young, the superstar with the self-destruct drive that won't quit.

Decade covers the Buffalo Springfield period, the subsequent solo work, and the Crosby, Stills, Nash & Young partnership. Consequently little of great import is excluded. The five newly released tracks date from throughout the period, from Springfield's *Down to the Wire* to his original demo of Linda Ronstadt's hit *Love is a Rose* to *Campaigner* his summer of '76 reflections on R.M. Nixon. The other two, *Winterlong* and *Deep Forgotten Lake* are vintage Young.

Neil's barely legible handwritten notes on the selections enlighten their origins and intents. **Decade's** more or less chronological sequence allows you to witness Neil's passage through his dark and light periods with some understanding, if not sympathy.

As often happens on reissues, the tracks are a bit noisier than on their original release. Additionally, Neil's often crude recording practices often create sound of less than optimal quality.

What gives **Decade** its real meaning is the great big question mark at its core, namely Neil Young himself, a fascinating pathology of a superstar, or, now that I think of it, more of an anti-star. *M.T.*

Sound: C Performance: B+

Glenda Griffith

Ariola SW-60018, stereo, \$7.98.

Glenda Griffith's debut album is pleasant enough. It features an all-star cast spearheaded by its producer, the Eagles' singing drummer Don Henley. The songs, not the singer, are where the album's focus falls. They include a pair of originals, Marty Robbins' country chestnut *Don't Worry About Me*, The Gram Parsons arrangement of Tom T. Hall's *I Can't Dance*, songs by Carole King, Jesse Winchester, and no fewer than four by the underrated Danny O'Keefe, a very satisfying mixture.

The support is impeccable, never getting in the way. The readings show understanding and care, especially on O'Keefe's *Quits* and *All My Friends*. The sound crafted by Greg Ladanyi is warm and the end result is an easy-going set of modern California country. *M.T.*

Sound: B Performance: B-

AKAI INTRODUCES THE PERFECT COUPLE.

Choosing a tuner and integrated amplifier is a lot like choosing a mate. You look for things like compatibility, performance, appearance and fidelity.

Now AKAI makes the matching process foolproof with a couple paired on the grounds of total compatibility. And while they incorporate specs and features not found on all-in-one receivers, they're priced to be affordable.

Hear them today at your AKAI dealer. And live in perfect harmony.

AM-2800 INTEGRATED AMPLIFIER 80 watts per Channel Continuous Output Power, Min. RMS at 8 ohms from 20 to 20,000 Hz with no more than 0.08% Total Harmonic Distortion.

Large Power Output Meters with 100 or 3 watt Scale Selector, Low and High/Low Loudness Control, High and Low Frequency Filters, Audio Mute (-15 dB or -30 dB), Bass, Midrange and Treble Controls. Two Phono Inputs, two Tape Inputs.

Power Bandwidth (IHF): 7 Hz to 40 kHz/8 ohms. **Residual Noise:** less than 0.5 mV at 8 ohms.

AT-2600 STEREO AM/FM TUNER Phase Lock Loop MPX Circuitry, Balanced Flywheel Tuning, High Blend Switch, Signal Strength/Deviation and FM Tuning Meters, Output Level Control and Automatic Frequency Controls, Variable FM Muting.

Sensitivity (IHF): 1.7 μ V; **Capture Ratio:** 1.0 dB; **Stereo Separation:** more than 45 dB (1 kHz).

AKAI

You never heard it so good.

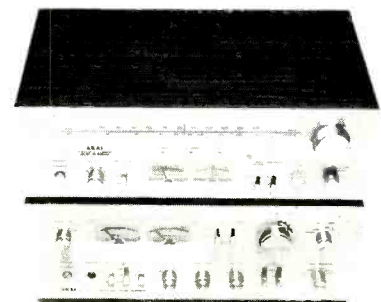

Jazz & blues



First Meditations: John Coltrane
ABC/Impulse AS-9334, stereo, \$6.98.

First Meditations is the earliest known version of Coltrane's extended composition **Meditation** recorded in November of '65. With the continually evolving style of Coltrane, they become different yet related pieces. On the surface, the structure of the piece itself is different. Both contain five parts, but the sequencing is altered; the segment entitled *Joy* in **First Meditations** recorded in Sept., '65, is replaced by the opening *Father, Son and Holy Ghost* on the later **Meditations**.

The structure of the group is also different. **First Meditations** contains one of the last recordings of Coltrane's classic quartet of McCoy Tyner, Elvin Jones, and Jimmy Garrison. They provide the core for the later **Meditations** with the addition of Pharoah Sanders on tenor and Rashied Ali on drums.

First Meditations shares the same spiritual unity and force as **Meditations** but with a less cluttered sound and a more easily defined pulse among the polyrhythms of Elvin. Coltrane's solos are involved scalar runs and

transitions slowly evolving through repetition. Tyner comps brilliantly behind him, hinting at the main theme but never resting on it. After a stuttering exchange with Coltrane and Elvin on *Consequences*, he launches into a pounding display of sweeps and washes.

First Meditations is not a studio outtake or some dredged-up live performance, but an official studio performance by Coltrane which somehow didn't make it onto vinyl until 17 years after its recording. **First Meditations** will make you relisten to **Meditations** (Impulse A-9110), not for comparison, but for more. *John Diliberto*

Sound: B

Performance: A+

The Mikrokosmic Unit: Heath Allen
Mikrokosmic Music MMI-001, stereo, \$7.98.

Heath Allen's Mikrokosmic Unit is a mixture of sounds and forms. They operate on the periphery of the *avant-garde* where concepts melt into each other. The dominant strains are classical and *avant-garde* jazz with

Heath's compositions moving his ensemble adroitly among them, drawing on the common ground they share. Heath's piano style is without frills. It bears a coarseness and density out of Bartok, and this style extends into his compositions.

Fanfare begins with a piano solo which moves from dramatic, pounding chords into classical rivulets. A drum roll from Mike Dougherty leads in the rest of the band for an Ornette-style unison horn line over a revolving rhythm. The horn line reappears between sections of frenetic free improvisation with the twin saxes of George Bishop and Steve Marcucci engaging in a violent duet.

But Heath's music is not without its quiet moments. *I Love You* opens the album with a delicate ostinato piano riff from which Marcucci plays the sweet alto melody. It's followed by the ethereal *Possessed* with the saxes and piano sifting through the spray of bells and percussion.

Heath Allen has made an individualistic debut with this self-produced and distributed disc. His roots are evident but are blended into his

As the number one professional speaker company, we have to satisfy the most discriminating ears. Recording engineers and artists. What they're listening for is faithful sound reproduction of a live performance. And for over forty years, that's exactly what we've been able to deliver.



can get super-high efficiency and a range of highs you've never heard from a compression driver.

At the same time, we've also enhanced low-frequency response.

Our new computer-designed, tuned and vented enclosure gives you the best ratio of lower limit vs. sensitivity.

The same professionalism pays off for you when Altec Lansing leaves the studio and gets down to some serious playing at home.

The patented Altec "Tangerine™" radial phase plug, for example, is one of our most recent breakthroughs, and it's built right into the compression drivers on our Models 15 and 19. Unlike old circumferential phase plugs, our new radial design actually widens your high-frequency bandwidth. So now you

Finally, we improved the dividing network with a new frequency-selective, dual-range equalizer. You'll get smooth transitions without the roughness and distortion associated with ordinary crossover designs.

So listen to our speakers and hear how our work for professionals comes into play. For the name of your local dealer and a full line catalog, just write us: Altec Lansing International, 1515 S. Manchester Ave., Anaheim, CA 92803, (714) 774-2900.



Enter No. 4 on Reader Service Card

THE NO.1 PROFESSIONAL SPEAKER

AT WORK. AND PLAY.



Studio: Mother Music Sound Recorders; Orange, CA

Introducing the Koss Theory of loudspeaker design and the three new Koss CM speaker systems that prove it.

When Koss invented the stereophonic, music lovers and audio experts were amazed at the low distortion, broadband frequency response, and high efficiency achieved by the Koss drivers. Indeed, the resultant Sound of Koss created a revolution in the audio industry.

Today, the exciting new Koss Theory of loudspeaker design has created another revolution. By developing a complex series of audio engineering formulas and by utilizing the precise knowledge of modern computer science, Koss engineers have created a breakthrough in loudspeaker technology of such significance that it heralds the second major revolution in loudspeaker design technology. For the first time, it's now possible to scientifically derive and produce the optimum system parameters for any loudspeaker.

By computerizing the Koss Theory and by first selecting the number of bandpasses desired in the system, the system's desired efficiency, the f_3 , low bass cutoff, and the desired cabinet size; Koss engineers are able to derive specific design parameters for every component in the total system. In fact, the Koss Theory is so sophisticated that even the structural design of the cabinet and the precise positioning of the components in the cabinet for optimum dispersion and phase coherency are specified.

Of course, what's really important is not the Koss Theory itself but the sound of the three new Koss speakers

that prove it. Indeed, with current technology, there are no speakers available at similar prices that can match the Koss CM 1010 two bandpass loudspeaker, the Koss CM 1020 three bandpass loudspeaker or the Koss CM 1030 four bandpass loudspeaker in low distortion, high efficiency, and broadband frequency response.

But then, the incredible sound of these three new speakers isn't surprising when you consider some of the revolutionary new features they offer:

Take for example, the CM 1010's unique mass aligned 10-inch passive radiator that enhances the lower 2 octaves of the bass and allows for the use of a specially designed 8-inch woofer to reproduce the critical midrange up to 2.5 kHz. With the alignment mass in place, the CM 1010 reproduces a maximally flat response from an f_3 of 35 Hz on outward. However, by

removing the alignment mass, those who prefer more acoustic energy in the 50 to 80 Hz range can create an f_3 of 40 Hz and a low bass ripple of $1\frac{1}{4}$ dB centering on 60 Hz.

Or take the CM 1020's dual port design that provides an optimal cross sectional port area for proper cabinet tuning. Or the unique parallel midrange design of the CM 1030. By utilizing two $4\frac{1}{2}$ -inch drivers operating in parallel, Koss engineers were able to decrease the excursion of each driver thus creating a dramatic decrease in potential driver distortion and an equally exciting increase in the overall brilliance and presence of the midrange response. Then again there's the Koss high bandpass 1-inch dome tweeter and unique acoustic transformer that creates an incredible 6 dB increase in headroom.

And, of course, there's also the patented quasi second-order crossover network that provides a smooth, acoustically invisible transition from bandpass to bandpass.

But those are just some of the revolutionary features offered by the new Koss CM loudspeakers. Why not prove the Koss Theory of loudspeaker design to yourself by asking your Audio Dealer to give you a full demonstration of the beautiful Sound of Koss. Or write to Fred Forbes, c/o the Koss Corporation, for our free, full color CM loudspeaker brochure. Once you've heard these revolutionary new loudspeakers, we think you'll agree: hearing is believing.





KOSS[®] CM SPEAKER SYSTEMS

hearing is believing[™]

KOSS CORPORATION, 4129 N. Port Washington Ave., Milwaukee, Wisconsin 53212
Koss International / London, Dublin, Paris, Frankfurt • Amsterdam • Koss Limited / Ontario • Koss K.K. / Tokyo

Enter No. 21 on Reader Service Card

AmericanRadioHistory.com

Now — Reach For NEW DAWN

New Dawn is...fashions — romantic and sultry
 New Dawn is...careers to grow on
 New Dawn is...sports — to stay fit and beautiful
 New Dawn is...music and art — what's hot and lasting
 New Dawn is...love and other relationships

The New Dawn Of the New You

Special introduction subscription price...
 only \$3.75 per
 year...Use
 coupon below or
 Pick up a copy
 at your
 newsstand.

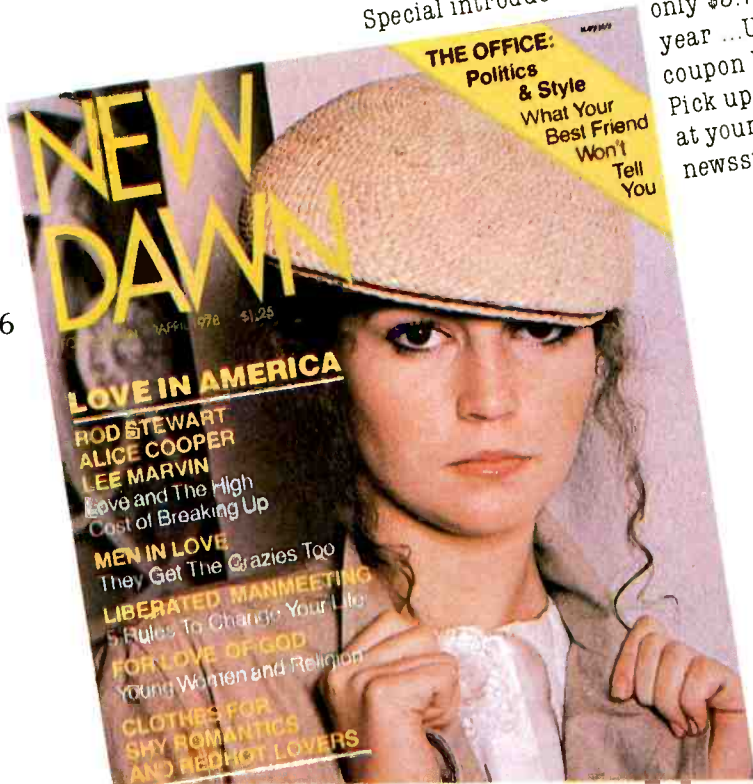

106

NEW DAWN 401 N. Broad St., Phila., PA 19108

Dept. A-4

Please send me NEW DAWN for one year (6 issues) at half price, only \$3.75.
 That is 50% off the regular price of \$7.50 a year.

Bill me Payment enclosed

Name _____

Address _____

City/State/Zip _____

For new subscribers only. Add \$2.00 for postage outside U.S. and
 possessions. Allow 4-6 weeks for delivery of first issue.

own new identity, of which the Mikrokosmic Unit is an ideal expression. And unlike most *avant-garde* self-produced recordings, this one has a clear sound and one of the cleanest pressings I've heard in years.

Available for \$5.00 plus \$.75 postage from Heath Allen, 1335 Ellsworth St., Philadelphia, Pa. 19147. *John Diliberto*

Sound: B Performance: A —

Suicide

Red Star RS 1, stereo, \$6.98.

Suicide is music for urban decay. The vision of Alan Vega and Martin Rev, the pair that makes up Suicide, consists of bleak, barren music and stories that are as hard as concrete and as empty as a sewer hole. Vega is a vocalist who treats his voice with some kind of reverb unit, and his narrative style is influenced by Jim Morrison's stark deliveries. But while Morrison was simply lost in a psychotic quagmire, Vega is ready to jump over the edge and Martin Rev is ready to push him. Rev plays a keyboard plus some primitive electronic instruments like audio generators and oscillators. With them, he sets up the consuming mono-rhythms and coarse electronic textures to underscore Vega's voice.

Suicide is some of the most desperate music I've ever heard. In *Frankie Teardrop* the main character is driven to the brink with unemployment, mouths to feed, and no way out except suicide. But not before he puts the gun to his six-month-old child's head and his wife. His choked electronic screams are terminal. *Girl* is a love song of the most tortured desire.

The **Suicide** debut is recorded with a rough edge that clearly indicates a desire for pinning modulation needles and distortion.

For more information write to Red Star Records, Inc., 200 W. 57th St., New York, NY 10019. *John Diliberto*

Sound: B — Performance: A —

Birthright: Hamiet Bluiett

India Navigation IN 1030, \$6.98.

While Anthony Braxton's **For Alto** was not the first solo saxophone recording (Coleman Hawkins' **Picasso** preceded him), it did send shockwaves through the jazz community. Bop alto-man Phil Woods decried Braxton in a "downbeat" blind-fold test as not only having an incredible ego to think he could pull off such an extended performance without a rhythm section, but also for being simply unmusical. While I think Wood's opinion is probably less rigid now, it might have been completely different if he had heard

Hamiet Bluiett's **Birthright** recording first.

Birthright is sub-titled "a solo blues concert." Bluiett himself claims not to be a bluesman, but the immediacy and punch of the blues is present in his baritone sax. His control over the big instrument is subtle and agile. From the sweet tones of *Doll Baby aka Song Service* to the electronic sounding scrapes on *My Father's House*, Bluiett literally rollicks through this improvisational performance. He'll roam out to the fringes with shrieking sonics then come back in with a foot-stomper.

The recording of this record is also unusual. Many microphones were set up across the stage so that as his sound is picked up, it changes in ambience and its position in the stereo spectrum while he wanders across the stage. There are also some unintentional quirks with the traffic noises outside The Kitchen creating a rumbling resonance to accompany the baritone. **Birthright** is not an innovative or virtuoso performance. It's a swinging, celebratory exposition by a sensitive musician.

John Diliberto

Sound: B- Performance: B+

Sidelines: Steve Lacy/Michael Smith
Improving Artists IAI 37.38.39,
stereo, \$7.98.

Sidelines pairs the classically toned piano of Michael Smith with Steve Lacy's hard, sinewy, and eccentric soprano sax for seven varied duets. Lacy's odd style is hard to overcome and even the tunes have that quirk. Lacy is obviously the front man here with Smith providing the clusters and handholds for Lacy's sax to grab onto. On *Beeline* the theme is stated in time to some sort of chiming clock that ticks and then rings a bell on the fourth beat. *Worms* features Lacy playing two saxes, either overdubbed or simultaneously running through a slightly off-center scale.

Lacy can be graceful, as in *Existence* where Lacy's soaring soprano is wafted by Smith. On *Time 2* it's hard to tell how much was improvised since the relationships are so perfect and delicate.

Sidelines is a cerebral exchange between two musicians who come from different orientations but have found the common ground which can bind *avant-garde* classical and jazz together. They are captured here with clarity, presence and *Improving Artists'* noiseless surface. *John Diliberto*

Sound: A- Performance: A-

AUDIO • April 1978



107

Revolutionary! Sound-shaping taping mike.

Never before — a single microphone that gives you the versatility of 16 microphones! Four tiny frequency filter switches built into the new Shure 516EQ E-Qualidyne Microphone let you tailor sound for studio effects in virtually any recording situation: flick a switch to add sizzle to vocals . . . flick another switch to highlight the sound of a bass drum. You can even compensate for the acoustic response of a room — *right from the microphone!* In all, the 516EQ creates 16 different response variations that can add a new, professional sound to every tape you make. Available singly or in pairs for stereo recording. Ask to hear a recorded demonstration at your participating Shure dealer.

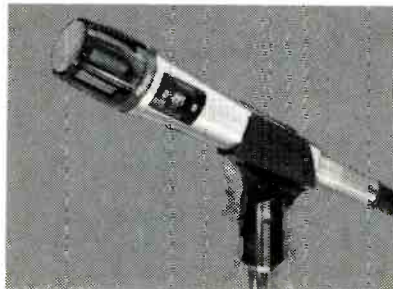

Shure Brothers Inc.
222 Hartrey Ave., Evanston, IL 60204
In Canada: A. C. Simmonds & Sons Limited



Manufacturers of high fidelity components, microphones, sound systems and related circuitry.

Enter No. 38 on Reader Service Card

The Music of Morris Pert

All About Music ABM 21, (import), stereo, \$8.98.

Morris Pert and his music are two things which challenge easy categorization. Pert is a classically trained percussionist and pianist with all the right degrees and academic rewards who has moved steadily away from his training into the mainstream of England's rock *avant-garde*. His first move came when he joined fellow classical percussionist-turned-rocker Stomu Yamashta with his Red Buddha Theatre and Come To The Edge bands. Later Pert formed his own experimental group Suntreader then joined the fusion band Brand X.

The Music of Morris Pert displays two sides of Pert. Side one has two compositions which would fall into the *avant-garde* classical field. *Luminos* for bassett horn and piano and *Four Japanese Verses* for soprano and piano are concerned with sound, coloration, and texture. *Luminos* contrasts and blends the deep misty sound of the bassett horn with the harmonies of the piano keyboard and the sonorities and discords from playing inside the piano. *Four Japanese Verses* feature the same piano techniques to get oriental sounds ranging from temple gongs to gamelans and kotos. These are played off the pure, but unmannered soprano of Veronica Hayward.

Side two features what must have been an early formation of Suntreader in a live performance. Pert is still involved with sound and contrasts but with Suntreader there is more freedom for the performers who improvise within, parameters set by Pert. *Chromosphere*, the side-long composition mixes acoustic and electric elements with magnetic tape. It moves from the probing opening into a storm of cymbal washes, then a violent drum section which transmutes into electrical and acoustic scrapings of electric cello, fuzzed, wah-wahed bass, and electric french horn. The third movement is a contemplative section with stately contrapuntal lines formed with acoustic and electric pianos and solemn bells and percussion.

Chromosphere is relentless in its force, yet restful in its final moments. The quintet, composed of Pert (tuned percussion, drums, and electric piano), Peter Robinson (keyboards), Neville Whitehead (bass), Paul Buckmaster (cello, acoustic piano), and Martyn Ford (French Horn), all play with intuitive insight.

The whole work, including the live Suntreader side, is recorded with clarity and presence, and an enveloping stereo mix. *Luminos* and *Four Japanese*

Verses show Pert to have a clear grasp and approach to *avant-garde* composition and performance. But *Chromosphere* shows an innovative flare which has been submerged in the years since this performance. *John Diliberto*

Sound: A — Performance: A

Rebirth Cycle: Mtume

Third St. Records TSJ 100, stereo, \$7.98.

Mtume has been the percussionist for most of Miles Davis' electric bands over the past years. But while this long experience has had an obvious influence on him, Mtume has followed his own leanings which are deeply rooted in African tradition and spiritualism. His first two albums *Kawaida* and *Alkebu-Lan* were ragged, energetic affairs with a good deal of free-blowing and spiritual "rapping." *Rebirth Cycle* is an evolution from these records. It features a large group of 18 musicians playing in a tightly knit, all-star ensemble which would be impossible to gather together today.

The center-piece, *Sais*, ebbs through its several sections with inevitable beauty. After the spoken introduction by Muktar Mustapha, John Stubblefield sets the tone with a stately bass clarinet line that moves throughout the side, sometimes carried by another instrument. Both Jean Carn and Dee Dee Bridgewater sing with an almost revelatory power as the piece weaves from Reggie Lucas' tortured guitar solo into an eerie string quartet section with the arco basses of Cecil McBee and Buster Williams, Leroy Jenkin's violin and Diedre Johnson's cello. The reed section of Jimmy Heath, John Stubblefield, and Azar Lawrence are never given extended solos in the traditional sense but accelerate *Sais* with colorful runs and fervent bleating.

Flip it over and you think someone pressed a Roy Ayer's disc into the other side. *Yebo* is a funky tune with the Miles Davis group of the time (1975) plus a vocalist. But the spiritual groove returns with the balladic *Cabral* featuring Jean Carn. *Body Sounds* is an electronically altered percussion segment unconsciously in debt to Pink Floyd's *Several Small Species of Animals*. . . . The album closes with *Umoja* sung in both standard western style and the traditional african nasal style which adds a childish innocence to otherwise throbbing, intense prayer.

Rebirth Cycle is another extension of the *avant-garde* into the 70s where composition is equally important to improvisation and musicians interact for the whole rather than their par-

ticular sections. The superior recording which brings each instrument through without blurring enhances the intricate weave which Mtume has orchestrated.

Available from Third St. Records, 10 N. Third St., Phila., PA 19106.

John Diliberto

Sound: A — Performance: A —

Spirits in Fellowship: Vinny Golia Ninewinds 0101, stereo, \$6.98.

Vinny Golia is a multi-reed man whose vast talents range not only from his playing but also to his compositions. His moods travel from fast post-Ornette arrangements to Don Cherry's global music approach. He has gathered a like-minded group for this album, whose title reflects the affinity these musicians have. Roberto Miranda and Alex Cline remind me of another powerful rhythm team, Dave Holland and Barry Altschul. Miranda plays bass in that sure-footed Holland style, while Cline's drumming is more musical and attuned to sounds rather than pulses, as evidenced on this record and his performances with Julius Hemphill. On the cookers like *Anger*, they create a revolving bottom. For the more introspective tunes, such as *The Human Beings* and *Haiku*, they float through the background with deft shadings.

For a counter voice, Vinny uses John Carter, an overlooked reed-man, who plays a spiraling clarinet. His solos on *Anger* and *Sequence* whip around the rhythms of Cline and Miranda. In duet with Golia, they spin in concentric circles. Golia himself is a powerful player who manages to stay on top even when playing a piccolo amidst the churing rhythms of *Sequence*.

But *Spirits in Fellowship* is a record that uses the musicians improvisational sensibilities to create moods which are clearly defined in Golia's compositions. While everyone improvises throughout the disc, they stay attuned to the piece and each other. *Spirits in Fellowship* is one those records that fits together perfectly from the conceptions in Golia's head through the extensions which, in this case, are the musicians.

The album is well-recorded. A haunting use of over-dubbing on *Haiku* creates a shimmering drone out of the layered arco bass, bowed Tibetan Bell, and plastic corrugated tubes.

Available from Vinny Golia, 9232 McLennen, Sepulveda, CA 91343.

John Diliberto

Sound: B+ Performance: A

Lena: A New Album: Lena Horne
RCA BGL 1 1799, stereo, \$6.98.

Lena Horne may not be everyone's idea of a jazz singer, but she is a remarkable, durable artist who has remained in close contact with jazz—its beat and its phrasing, and who, when she swings, can artfully and skillfully ride the jazz pulse. This RCA release has been kicking around for about a year, and is her finest album since her splendid **Lena, Lovely and Alive**, cut in 1964, also for RCA.

On the 1964 album, Lena was accompanied by a big band led by Marty Paich, and showed her jazz influences, syncopating notes that crackled with electricity, uncorking a driving attack on up-tempo numbers like *I Concentrate on You*. On the moodier **Lena: A New Album**, Horne's rich, tawny voice is supported by Robert Farnon's plush orchestrations. Her caressing tones do justice to such fine standards as *Someone To Watch Over Me*, *My Funny Valentine*, *I've Got the World on a String*, *My Ship*, and Billy Strayhorn's difficult *Flower is a Lovesome Thing*. On each reading, she shades and phrases sensitively, making these songs ring true. Lena is no jazz ad-libber like Ella, nor does she have the ability of a Billie Holiday to improvise on a pop tune with fluent and musically meaningful changes of melodic line.

That she is still Lena, the slightly naughty night club performer is revealed on *Deed I Do* and *I Feel So Smoochy*, but even here she has eliminated the cabaret-act excesses that this writer used to find annoying—on every track of this fine collection, she has taken the musical high road. An additional and very classy jazz touch comes from Phil Wood's alto sax accompaniments. **Lena: A New Album** may not be out-and-out jazz, but it is an outstanding LP of good popular songs with a jazz connection. The album was recorded, edited, and mixed at Olympic Studios in London, and the sound is flawless.

John Lissner

Sound: A + Performance: A

Copulatin' Blues, Vol. 1
Stash ST 101, mono, \$5.98.

The Stash catalog of old blues and jazz recordings includes such interesting collections as **Reefer Songs, Tea Pad Songs, Early Viper Jive, AC/DC Blues and Pot, Spoon, Pipe and Jug. Copulatin' Blues**, released about a year ago, consists of 16 tracks celebrating the wonderful subject of sex. Most of these rare recordings date from the 1930s. Outstanding are the two Bessie Smith tracks, *I Need a Little Sugar in My Bowl* and *Do Your Duty*,

from her last session recorded by John Hammond in 1940. The all-star line-up includes Frankie Newton, Chu Berry, Jack Teagarden, and Benny Goodman. A splendid blues singer I never heard of, Lil Johnson, sings *Press My Button*, *You Stole My Cherry*, and *Stavin' Chain* with a robust, gutsy enthusiasm that almost matches the great Bessie.

Jelly Roll Morton's famous *Winin' Boy* Library of Congress recording is also included, but unfortunately, it has been dubbed from a very scratchy 78 rpm. Most of the remaining tracks offer reasonably decent sound. I liked Lucille Brogan on *Barbeque Bess* who says "My barbeque is the only thing I

sell" and Georgia White who says "If I can't sell it, I'll keep sittin' on it."

There's pungent instrumental jazz backing on many of the cuts—for example, Buster Bennett on soprano sax and pianist Blind John Davis play some fine jazz behind Marline Johnson on *Don't You Make Me High*. Another beauty is Sidney Bechet's vital and exciting *Preachin' Blues* recorded in 1940 with his New Orleans Feet Warmers. This worthwhile anthology is available from: Stash Records, 106 Prospect Park West, Brooklyn, N.Y. 11215.

John Lissner

Sound: B — Performance: A

ADS Has The Perfect Speaker For You.

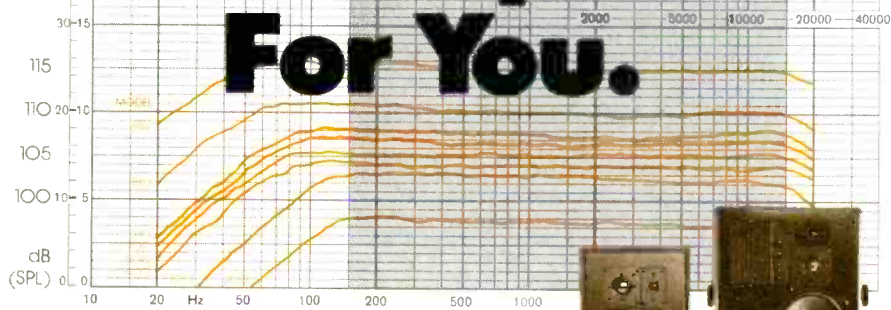

From the world's first miniature loudspeaker – the remarkable ADS 200 – to the sophisticated bi-amplified studio reference monitor – the model 910 – all ADS loudspeakers offer performance to suit the needs and tastes of the most demanding music-lover.

Uncommon qualities are common to all our speakers. They combine the utmost neutrality with accuracy to create what has been aptly described as "Invisible Sound" – reproduction so transparent and precisely imaged that the speakers seem to disappear.

The shaded area in the above graph indicates the frequency band in which 95% of all musical sounds occur. Throughout this range – between 150 Hz and 15,000 Hz – the response curves of all ADS transducers are practically indistinguishable and as smooth as technically achievable.

Naturally, our more expensive speakers will go progressively lower in deep bass and somewhat higher in the uppermost octave. The dynamic range and attainable peak sound pressure level are in direct proportion to your investment.

Because you, the listener, will have your own SUBJECTIVE perceptions about your music, we created the best possible sound transducer for you: an OBJECTIVE speaker.

You take pride in being a discerning listener. We take equal pride in the exceptional performance and value of all ADS products. Shouldn't your next step be to visit one of the select dealers representing ADS? He will competently translate the above graph into sound during a critical A/B comparison in his showroom.

Whether you spend about one hundred dollars for the tiny model 200 or approximately seven hundred dollars for the imposing 910, we are confident that ADS has the perfect speaker for you.

For more information on:

ADS Miniature Speakers ADS Car Systems

ADS Speakers for the Home ADS Studio Monitors

Send this coupon to:
ADS Analog & Digital Systems, Inc.
One Progress Way, Wilmington, MA 01887

NAME _____

STREET _____

CITY _____ STATE _____ ZIP _____

BEAUTY FULL AGI 511A

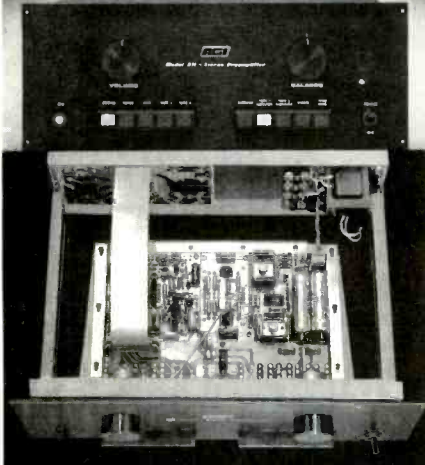

Our competition thinks beauty is only skin deep. We know better. Request the full story about the world's fastest preamplifier and its guaranteed specs — some that others only dream about.

AUDIOD GENERAL, INC.
Dept. A-4, 1631 Easton Rd., Willow Grove, Pa. 19390

Enter No. 5 on Reader Service Card

Tape & turntable

Carmen: The Symphony Jazz Ensemble QCA Records QCA 364, stereo, \$6.98.

The Symphony Jazz Ensemble is a group of musicians who are moonlighting from their regular gigs as members of the Cincinnati Symphony Orchestra and studio and session men. While all the members are gifted technicians, the album reflects someone else's conception of what a contemporary jazz piece should be, rather than a natural outflow of their own musical proclivities. The album lacks any extended improvisation with the few solos that occur sounding as if they were charted.

The side-long *Suite from the Opera Carmen* is the album's centerpiece with crisp and dynamic arrangements that offer a pleasant background, but nothing much to move the mind. There are no rough edges or biting solos but rather slick transistions, some inventive synthesizer that avoids clichés, and tight ensemble work. It's something my high school band leader would've loved.

The second side launches a trio of self-consciously contemporary jazz pieces with electric piano, snappy ar-

rangements, and brief, uninvolved solos. But it's not offensive. It nods in the background and you can pop your fingers and tap your toes. Frank Proto, who produced, arranged, and played bass on the album, has a good ear for the middle of the road. In the end, however, like most ventures that fall halfway between here and somewhere else, music on this polished recording doesn't mean too much.

(The surfaces of this disc are substantially better than run-of-the-mill recordings and do not interfere with the enjoyment of the music. While the dynamic range is middling good, use of an expander does bring more of a "live" feel, particularly with the ensemble work. You're not going to mistake the instruments for real ones right in the room with you, but the essential character of the instruments, especially the brass, is well done.—E.P.)

Available from local dealers or by mail from QCA Records, 2832 Spring Grove Ave., Cincinnati, Ohio 45225.

John Deliberto

Sound: B+ Performance: C

110

SPEAKER KITS

Full Size 3-Way Speaker System

LIMITED EDITION!

Full size 3-way air susp. system for superb sound reproduction. 10" woofer, dome tweeter, 8" midrier, x-over, damping, hardware, grill cloth and cabinet. All that... only \$88.88/pair. Ltd. Qty. Shpg. allow for 2-40 Lb. parcels. FOB Peabody, Ma. 01960. #BZ30094 . . . \$88.88/pair 26 1/2 x 14 1/2 x 11 1/2"



ALSO - Our regular speaker kits:

Speaker Kit No. 2

"Odd ball cabinets, tweeter & port on 45° angle from woofer for directional hi freq. 8" woofers, dome tweeters, x-overs, grill cloth & instructions. 7ZU70242 . . . (35 Lbs) . . . \$44.50/pair \$44.50!



Speaker Kit No. 1

Super Cabinets, (21x12x8") with same parts as No. 2 above, plus damping and hardware. New reduced price! \$59.50! 7ZU70263 . . . (45 Lbs) . . . \$59.50/pair

Stereo Power Amp

16 Watts

COMPLETE KIT

Only \$12.88!

A complete kit of parts for only \$12.88. Takes 1 soldering iron & 10 minutes to build. 16 watts RMS total. You add case, controls, input and speakers. Runs on 115VAC. #BZU80015 . . . 15 Lbs.

OTHER SPEAKERS & COMPONENTS are available through our catalog!

Please add POSTAGE. No C.O.D.'s

SEND FOR OUR FREE CATALOG Over 3,000 surplus BARGAINS!

PHONE ORDERS WELCOME BA - MC - AE

B&F ENTERPRISES
Dept. A-4
119 Foster Street
Peabody, Ma. 01960
(617) 531-5774 **B&F**

Efrem Zimbalist, Father & Son. (Violin Sonata in G minor; Violin Sonata.) Philip Frank, vl., Bernard Frank, pf. **Umbrella DD 3, stereo, \$14.95, (distr. Audio Technica).**

The Canadian Umbrella label now rates as a seasoned direct-to-disc promoter with relatively abundant experience in this specialized medium. This record is a mature and well-produced offering in every way, the various aspects harmoniously, agreeably at one—music, performance, recording and what we might call programming—an interesting idea, two sonatas for violin and piano, one by the father, the other by the son.

Yes, these are both *the* Efrem Zimbalist. For musicians, the old man, a dean of violinists and international performer, whose wife was the opera singer Alma Gluck; for the rest of us the son, widely known in TV and film acting. Both father and son have composed on the side, both drawing on a wide area of musical environment and tradition. Not surprisingly, then, both sonatas are beautifully written and wholly expert, the son's as the father's.

Neither is radical nor very original—that surely was not the intention. Both reflect the high period of very late Romanticism in the early years of this century, with rich, elegant expression and lush harmonies; Zimbalist junior's work deftly incorporates a more modern Hindemith influence and a dash of neo-classicism (though the music was completed in the 1970s, as the father's was as late as 1927). Also, not surprisingly, the two performing brothers, old Zimbalist family associates, are superb in the playing and most sympathetic; it is almost a family affair, and sounds it.

Direct to disc? It's good to say that Umbrella knows its classical sound and has given a fine and natural ambience to these two instruments, violin and piano, if perhaps with the piano a shade too much in the background for such vigorous music. Minor criticism! I enjoyed every bit of both sides, and, needless to point out, the clean sound and quiet surfaces contributed most harmoniously to the over-all impression. That is as it should be.

Others don't stack up against the books from Audio

No. 607, This volume is a handbook on the broad aspects of the practice and principles of multitrack recording.

No. 618, Covers both the advantages and disadvantages of each enclosure type.

No. 617, This is a thorough learning manual about microphones and how they work.

No. 622, Directed toward both the theory and the practical applications of audio circuits.

No. 619, The book attempts to address the considerations in applying the IC op-amp with maximum effectiveness in a wide variety of circuits.

No. 620, This book explains the operation of unique IC op-amp applications.

No. 608, Here is the whole event-filled story of the phonograph's first century.

No. 903, This new modern publication discusses the audio-system as a whole.



No. 609, This book has become a bible for serious scholars of the technical and legal aspects of the development of the audio-visual industry.

No. 623, This text tells and shows practically and authoritatively the uses of the microphone.

No. 621, The book discusses all types of timers, using representative industry standard devices as examples.

No. 612, This extensive survey of sound should be required reading for every recording engineer and audiophile.

No. 616, This book presents important information for those who want to, and should understand the performance characteristics of the room itself.

No. 613, This is the most up-to-date, complete, and accurate single volume on the development of television and radio now available.

Please send me the book(s) I have checked.
Enclosed is my proper remittance for \$ _____
I understand if I am not fully satisfied I may return my selection(s) in undamaged condition within 10 days for a full refund.

- 607, HANDBOOK OF MULTICHANNEL RECORDING, \$10.95
- 608, THE FABULOUS PHONOGRAPH, 1877-1977, (softback) \$6.95
- 609, FROM TIN FOIL TO STEREO, (softback) \$9.95
- 612, SOUND RECORDING, \$16.95
- 613, AMERICAN BROADCASTING, \$26.50
- 616, ACUSTIC TECHNIQUES FOR HOME AND STUDIO, \$8.95
- 617, MICROPHONES—How They Work and How to Use Them, \$8.95
- 618, HOW TO BUILD SPEAKER ENCLOSURES, (softback) \$4.95

- 619, IC op-amp COOKBOOK, (softback) \$12.95
- 620, UNIQUE IC op-amp APPLICATION, (softback) \$4.95
- 621, IC TIMER COOKBOOK, (softback) \$9.95
- 622, AUDIO IC op-amp APPLICATIONS, (softback) \$4.95
- 623, THE USE OF MICROPHONES, (softback) \$6.95
- 903, SOUND SYSTEM ENGINEERING, \$19.95

Name (please print) _____

Address _____

City/State _____ Zip _____

Please allow 4-6 weeks for delivery

Audio

Book and Learning Systems Division

North American Publishing Company, North American Building, 401 N. Broad Street, Philadelphia, PA 19108

Audio Magazine is published by North American Publishing Company, leaders in editorial excellence.

AAM4

Classical reviews

Edward Tatnall Canby

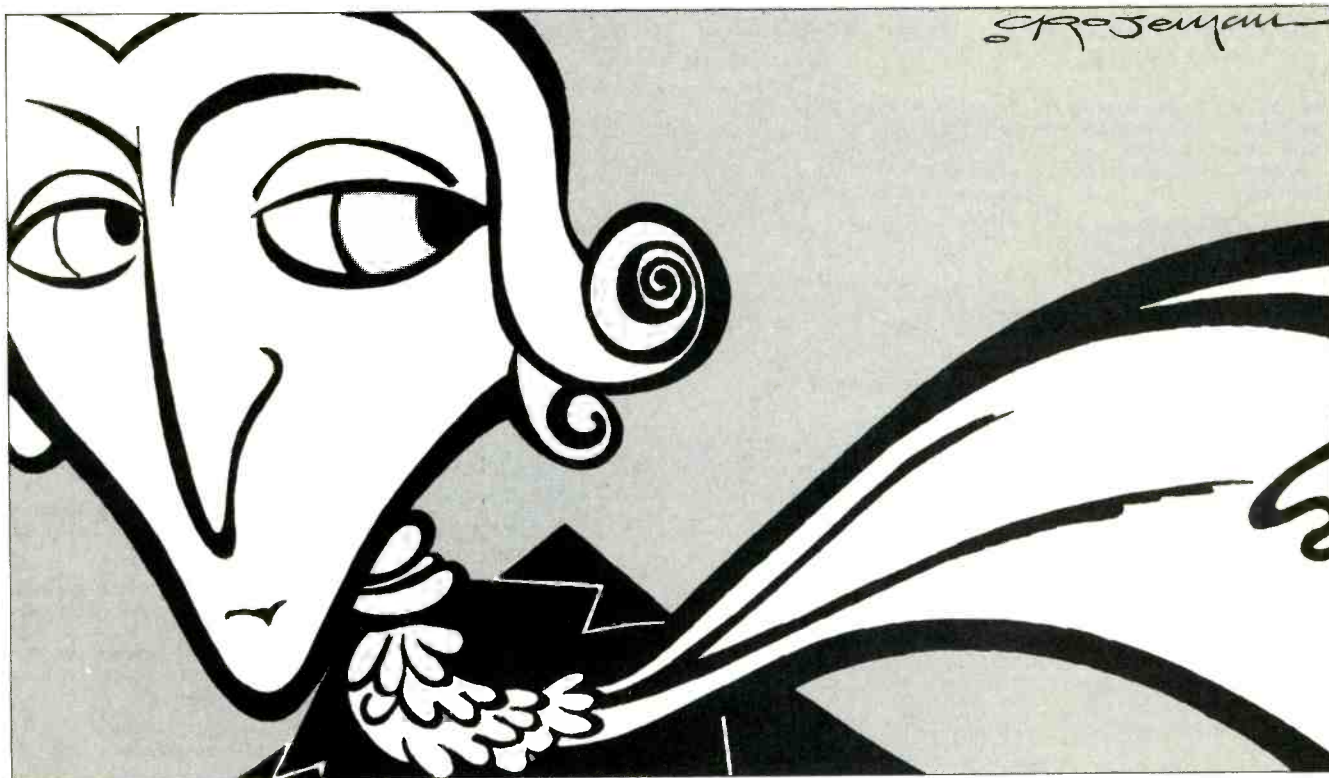

112

Haydn Piano Trios H. XV Nos. 2,6,8. (Volume 8). The Beaux Arts Trio. Philips 9500 325, stereo, \$7.95.

Though imported in the disc, this and its very many fellow recordings derive from one of America's most stylish and energetic groups, impeccable artists for European music though all three are habitual Americans. (Pressler was born in Germany but has been around these parts long years and makes his base in Indiana, Cohen and Greenhouse are New York types.) Philips is systematically recording *all* the Haydn trios, which—if you know Haydn—is not too unlike all the symphonies (104) or all the string quartets. But Haydn is merely the latest in many Beaux Arts series—astonishing and, if I may say so, disturbing, the way the big European record outfits go imperturbably on producing the very finest music in enormous quantities, while our own biggies sit around reissuing legends and borrowing from Moscow or elsewhere as far as Japan.

Nor, I should add, is it any less disturbing that the sonic quality and the pressing, as so many of us have noted, also continue imperturbably excellent, imperturbably better and better, year after year, and no sort of economic inflation or recession or what have you seems to change a thing. 'Nuff said—this is a review! But we should be reviewing these players, not Philips.

The Beaux Arts Haydn is indeed impeccable, well styled and easy in the listening with a splendid balance of interest between piano, violin, and cello and a very good recorded sound, as might be expected. I would say that, however, the somewhat irrepressible piano of Manahem Pressler is relatively subdued here, as it must be, whereas in Brahms and the like he lets go with the most engaging potency. In other words, when the style demands it, he knows how to scale down. But not too much—he still sounds full of liveliness, and his two friends go right along with him.

Enesco: Symphony No. 3 in C, Op. 21. Orchestra simfonică și Corul Filarmonicii din Cluj-Napoca, Baciú. **Electrecord (Romania) ST-ECE 01234** stereo.

Now this is what we might have expected as "standard fare" in the classical department out of Romania. Over here, Enesco is known virtually for one work, the familiar *Romanian Rhapsodies Op. 11*, dating from the very early 1900s, both of which are regularly recorded in the West. This big, sprawling Symphony is much later, composed 1916-18, right in the middle of WW I but sounding very much of the late pre-war period, full of Romantic mysticism, impressionistic, written for a vast orchestra and a chorus (rather lovely wordless melodies). The substance is not very important and the style derivative in the extreme; the lengthiness will wear you down. Awfully, awfully long for such a fulsome expression! Yet Enesco is an expert orchestrator, and his musical language is at least honestly what it is—many people will enjoy it.

AUDIO • April 1978

The recording, like others in this Electrecord series, is excellent and so is the pressing.

For more information write to Electrecord Recording Co., Bucharest VII, Str. Luigi Cazzavillian No. 14-16, Romania.

Shostakovitch String Quartets 14, 15. Taneyev Quartet. Columbia/Melodiya 34527, stereo, \$6.98.

Here are Shostakovitch's two last quartets, not far from his very last works of any sort, and they are extraordinary in the listening. For here is a man, first known to us as a bouncy, acidly humorous, young radical back in the early Thirties with his famed First Symphony (and later the even more popular Fifth), then as the overwhelmingly grandiose symphonist of the great War between Hitler and Stalin—the vast and sprawling "Leningrad" Symphony, No. 7, full of hard, massive military marches—and then, on and on, gradually withdrawing into himself as ill health plagued him, less and less grandiose, more and more spare, dry, thin but intense. . . and here is the final product. The fifteenth Quartet is enough to scare you. "In the valley of the shadow of death," and the place is as sere as a desert, bleak, burning, hard. As you listen you can see that drawn, downward-turning mouth in his later pictures. A tragic face, eloquently tragic music, to match. I found it very impressive. He was not always a good composer and often prolix and obvious. But this was no weakling in music.

Dinu Lipatti: Șătrarii (Symphonic Suite); Symphony Concertante for Two Pianos and String Orchestra. Orch. simfonică a Filarmonicii din Cluj-Napoca, Emil Simon. S. Cosma and C. Gheorghiu, pianists. Electrecord STM-ECE 01120 stereo.

Dinu Lipatti was Roumania's finest export after Enesco, one of the great international pianists, who died tragically young, his star on the rise in the 1940s. Few of us knew he was also a composer; these two works from the 1930s are very much of that time, the dominant influence being Stravinsky, but with a Romantic and even mystical overlay; both are thoroughly professional music and well worth our attention. Once again—ultraquiet surfaces and excellent recorded sound.

For more information write to Electrecord Recording Co., Bucharest VII, Str. Luigi Cazzavillian No. 14-16, Romania.

AUDIO • April 1978

YOU ASKED FOR IT!

Q. "What should I do?" "All this new technology has made my expensive system obsolete!" "I'd like to have better sound, but I can't afford to keep up with state-of-the-art."



A. Yes you can! A PS II phono preamplifier will bring advanced engineering to your system at an affordable price. Our modular preamp replaces the most critical link in your audio chain. We guarantee you'll like the difference or we'll buy it back.

\$119.95

Cal. residents include 6% sales tax. \$5.00 shipping & handling on direct orders. Visa, BankAmericard and Mastercharge welcome.

PS AUDIO

1529-C Stowell Center Plaza, Santa Maria, Calif. 93454

Enter No. 51 on Reader Service Card



*patent pending



Qysonic Array

AN ALTERNATIVE TO SPEAKERS:

If a speaker sounds good in a store, will it sound good when you get it home? Qysonics patented[®] Critical Alignment System not only improves imaging; it also makes the Arrays less room critical. Resonance, "beaming" and standing wave "dead spots" are virtually eliminated. Remember, your speakers must work well in your room; without need for additional electronics such as equalizers and expanders. So, before you blow your money on more electronics, consider replacing your speakers with the alternative, Qysonic Array.

QYSONIC RESEARCH CORP.

920 S. Placentia Ave., Placentia, Cal. 92670
Tel. (714) 630-5321

Enter No. 34 on Reader Service Card

Primo

—Leader in the Microphone Field—

KNOWN FOR EXCELLENCE OF SOUND

PROFESSIONAL USE

CMU-503 is a condenser microphone specifically developed for multipurpose sound collection.

The preamp section employs stringently selected FET and a unique circuit design to achieve an inherent noise of 20dB and maximum input of 140dB so that it can be used confidently from OFF to ON.

UD-303 is the ultimate dynamic microphones and incorporates the advantages of the condenser microphone in music recording and hand-held vocal tonal quality. In order to achieve the ultimate in tonal quality we have conducted numerous listening tests and made numerous recordings of orchestral and vocal performances.

EMU-4520 is a professional use high quality Electret condenser microphone. Since it has same excellent tonal quality as professional condenser microphones used in broadcast stations, it is ideal for loudspeaker use, hi-fi recording and other audiophile sound collection applications.

CMU-503

EMU-4520

UD-303

Power supply for
Model CMU-503



Vocal use dynamic microphone
Live recording use microphone

PRIMO MICROPHONE INC.

2468 DELTA LANE, ELK GROVE VILLAGE,
ILLINOIS 60007, U.S.A.
TEL: 312-595-1022, TELEX: 28-3474 PRIMO MUS ELGR

PRIMO COMPANY LTD.

6-25-1, MURE, MITAKA-SHI, TOKYO, JAPAN
TEL: 0422-43-3121~9 TELEX: 2822-326 PRIMO J

Enter No. 33 on Reader Service Card

Folk bag

Tom Bingham

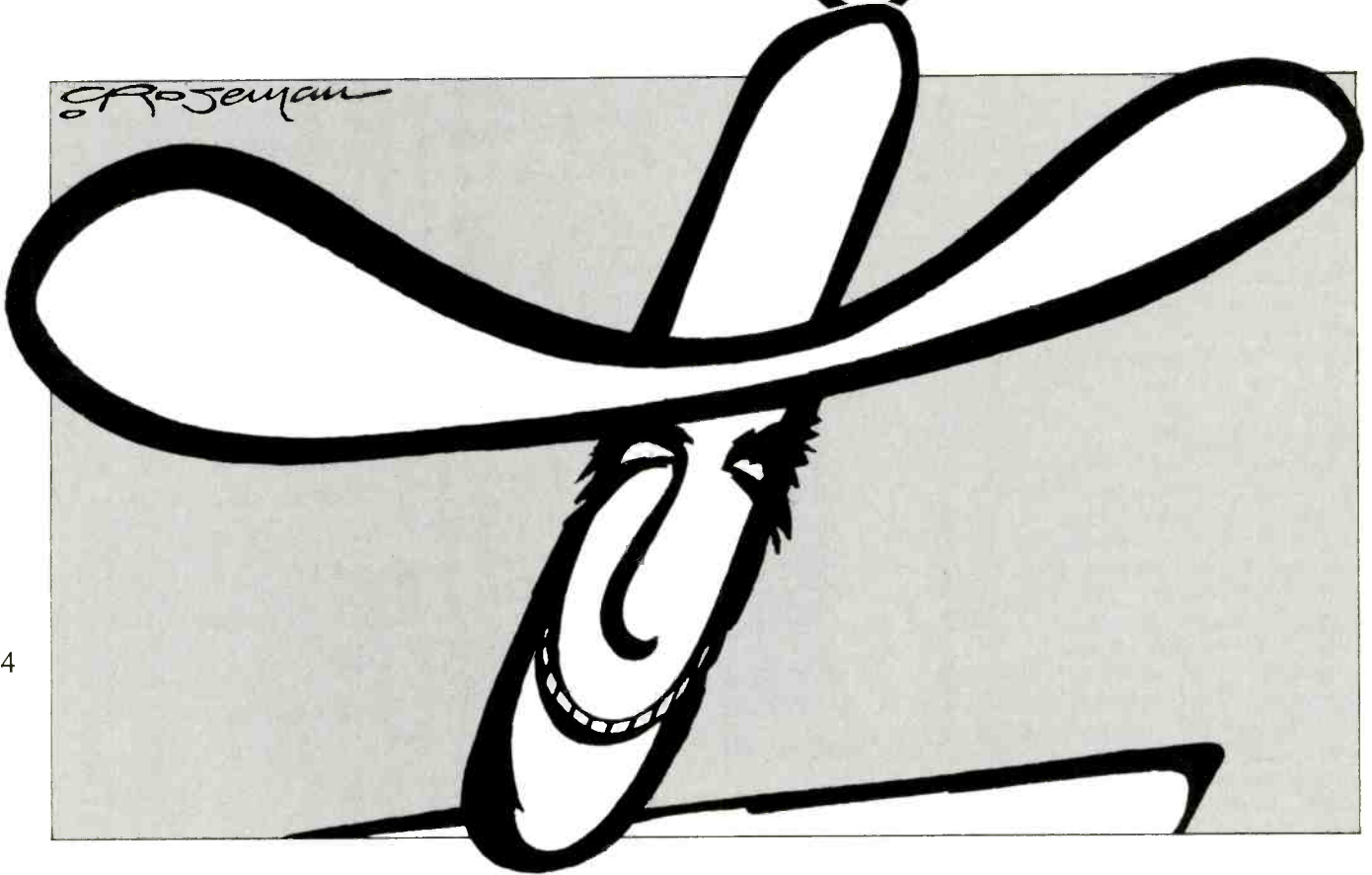

114

Spade Cooley, Vol. 3
Club of Spade #00103, rechanneled stereo, \$4.95.

In the decade following the end of World War II, Bob Wills' only serious rival as bossman of the Western Swing field was an ill-fated fiddler named Donnell "Spade" Cooley. (In fact, Cooley billed himself as "The King of Western Swing," thereby naming the musical idiom which Wills had developed but never bothered to label.) Through that 10-year period, Cooley dominated country music in California, becoming one of the West Coast's first television idols and spawning several other top-name Western artists (including no less than Tex Williams) in the process.

Spade Cooley was one of the most adventurous stylistic innovators American popular music has ever produced, blending country, folk, jazz, big-band pop, and a surprising range of international influences in a completely new way. Much more assertive when

it came to orchestration, he combined fiddles and steel guitar with his full-sized big-band as often as possible, utilizing upwards of 20 musicians at one time if feasible. In his continuous search for a music with the broadest possible appeal, he occasionally went too far in the direction of bland pop. (In later years, as on Vol. 2 of this series, he was not adverse to catering to the Lawrence Welk audience.) However, this album of live radio transcriptions from Spade Cooley's "golden era" contains some of the most shrewdly calculated, yet daring experiments ever essayed by the classically-trained son of a hoedown fiddler.

Cooley demanded and got a high standard of accomplishment from his musicians. His fiddle ensembles, using what sounds like from four to six fiddlers at any given time, were extravagant and very impressive, sweet-toned, and obviously well-drilled, as their execution at breakneck tempos

demonstrated. For an example, listen to *Hoedown*. Two of the most fabled musicians ever to swoop and slur on a steel guitar—Joaquin Murphy and Noel Boggs—performed with the band; though the personnel for these transcriptions is not listed, I'm inclined to think that Boggs plays on *Pan Handle Rag* while Murphy solos with the big-band on *I Can't Give You Anything But Love* and *In the Mood* (both straight jazz performances). The brass and reed sections rivalled any big bands of the post-war era.

It's important to note that where Bob Wills drew his swing influences from the jazz-oriented black bands (Basie, Lunceford, et al.), Cooley was more attuned to the commercial dance bands (Glenn Miller, Kay Kyser, Les Brown, and the Dorseys). The arrangements, many of them by accordionist Larry De Paul, were often quite ingenious, with the Miller-esque reeds handled particularly well. A few of the tracks here though, are strictly dated

AUDIO • April 1978

pop, including the saccharine *Que Sera Sera* and *Sugar Blues*, the latter enlivened by female vocalist K.C. Jones' perky Teresa Brewer mannerisms.

The most intriguing cuts, however, are those in which Cooley and De Paul brought together country and big-band elements to a startling degree. The album opens with the most oddball *Arkansas Traveler* ever recorded (hectic fiddles with novelty big-band breaks). *Dill Pickles Rag* features the fiddles, but the third strain is given to the Welk-ish big band, complete with accordion fills. *Spadella* throws in everything—a melody out of a Hollywood harem movie, semi-classical fiddles, big-band horns, country steel, ragtime piano, and Myron Floren-type accordion—switching from one element to another without sounding chaotic. Most impressive of all is the traditional fiddle tune, *Lost Indian*, which Cooley transforms into a sort of Western Swing equivalent of *Hora Staccato*, featuring sweeping uptempo fiddles, steel glisses, and flag-waving pseudo-Indian horns.

Spade Cooley's implausibly wide-ranging artistic vision and all-encompassing scope, coupled with his audacity in trying to innovate while courting the widest of all possible pop audiences and maintaining his stature in the country market, led him to pursue the ultimate in musical hybrids. Not surprisingly, the results are only intermittently satisfying today. The best of his efforts sound as overwhelming as ever, though the blatantly commercial material has too much of a period flavor to hold up. Still, even if you aren't fully convinced by his gadabout experimentation, it should at least fascinate you. Spade Cooley was without question one of a kind, whose exact like we may never encounter again.

The rechanneling does give the illusion of stereo, though it's the sort in which the vocals and instrumental solos are split between left and right channels without meeting in the middle, thus creating a phantom duet when only a single voice or instrument is featured. The rhythm section, horns, and strings fare much better, and no doubt sound much brighter here than on the original transcriptions. Sound quality varies considerably from cut to cut, but is rarely better than fair. Total playing time is 25 minutes.

A free catalog and Cooley biography are available from Club of Spade, P.O. Box 1771, Studio City, CA 91604.

Tom Bingham

Performance: B- to A

AUDIO • April 1978

Hand Music

The Beomaster 2400 receiver. Music at your fingertips from anywhere in your listening room. Cordless remote control makes music so convenient, so accessible, that it's woven naturally into your life.

Our portfolio of literature explains this sophisticated receiver in detail. Write to us for it.



Bang & Olufsen

Bang & Olufsen of America, Inc. • 515 Russe Rd. • Elk Grove Village, IL 60007 • Dept. 10

Enter No. 56 on Reader Service Card

115

FREE

McIntosh CATALOG and FM DIRECTORY

Get all the newest and latest information on the new McIntosh Solid State equipment in the McIntosh catalog. In addition you will receive an FM station directory that covers all of North America.



MX 113

FM/FM STEREO - AM TUNER AND PREAMPLIFIER

SEND TODAY!

McIntosh Laboratory, Inc.
East Side Station P.O. Box 96
Binghamton, N.Y. 13904
Dept. 1

NAME _____

ADDRESS _____

CITY _____ STATE _____ ZIP _____

If you are in a hurry for your catalog please send the coupon to McIntosh. For non rush service send the *Reader Service Card* to the magazine.

Enter No. 22 on Reader Service Card

All In the Name of Love: John Hartford
Flying Fish 044, stereo, \$6.98

There's an old sailor's aphorism I'm reminded of each time I hear a new John Hartford album. It comes from the navigational facts of life, where the pilot is careful to make it clear that it's up to the skipper to accept or reject his "suggestions" as to which course to steer. So, any time you saw someone going their own way regardless of what anyone else thought, you'd say, "Pilot's advice— Captain's orders, eh?"

And John Hartford switches back and forth from pilot and captain to deckhand to banjo-picker supreme and



all the way around the compass again in another raft-full of riverboat pirates, fiddlers, pickers, and grinners, in yet another immensely entertaining and enormously curious album in a series which began somewhere around **Mark Twang**, went on to **Nobody Knows What You Do**—and now **All In The Name of Love**—and whose future course hasn't been charted yet, let alone steered by anyone on board.

So it's risk-taking music, once more, and the high level of professionalism visible throughout, once more, is what prevents this album from becoming mere eccentric experimentation (with Benny Martin on fiddle?) or plodding variation-for-the-sake-of-variation (Buddy Emmons, Sam Bush, Roy Husky, and Larry Colvard?), which is always the danger risked by such sitting-down session music.

Not that it's uniformly successful, either. How could it be, when you have to switch ears almost on every song, from the title tune to a drum-heavy *Cuckoo's Nest* to a gentle *In Sara's Eyes* to a round-robin *Gentle on My Mind*, to a raspily dirty *Boogie*. . . ? And that's only side one. The second side follows the same pattern, alternation of gentle loveliness with crisp virtuosity, zany experiment (*Dancing in the Bathtub*; with the sound of one hand clapping on a wet chest?) and sweet moments, *macho bravado* undercutting the warmth but that inspired musical intuition rescuing even the closing song (*Also Love You For Your Mind*) from the Paul Anka suspicions that naturally enclose such a title.

If it sounds as if I'm saying I don't know which handle to pick John Hartford up by, that's close enough. If it sounds as if I think he's endlessly fascinating and absolutely worth the attention that will be paid to this album simply because his name is on it, that's even closer. When you figure it out, let me know. By then, I'm sure he'll be off around another bend in his own big river of music—and we'll be floating on down after him, shaking our heads still.

This may be obtained from Flying Fish Records, 1304 W. Schubert St., Chicago, Ill. 60614. *John McLaughlin*

Sound: B Performance: B

In Prison, In Person: Sonny James
Columbia KC 34708, stereo, \$6.98

It's no longer a novelty for a country star to record in a prison, but Sonny James takes it a step further. His backup band on this album is made up entirely of inmates from Tennessee State Prison.

Individually, the prisoner-musicians are hardly of the caliber of Nashville studio veterans, but as a unit they put to shame most big-name country artists' regular touring bands. They're obviously well-rehearsed, with much hard work and involvement going into the rhythm arrangements. The backing vocals are particularly fine, in a country-gospel idiom fashioned after Sonny's regular vocal group. On three cuts, the band is joined by a perky trumpeter who plays in the muted staccato style heard on early honky-tonk records; this sputter approach sounds a mite corny today, though it's appropriate to the non-commercial country context of this record.

Sonny resists the temptation to make this a "greatest hits live" album by sticking mostly to well-known country classics, many of them in a honky-tonk vein (among them Ray Price's

Heartaches By the Number and Al Dexter's *Pistol Packin' Mama*—an material perfectly suited to the occasion). Needless to say, the inmate audience responds rabidly, especially on *Walkin' Tall*, James' original written for this album, concerning a man being released from prison—I'm surprised it didn't start a riot!

Though the concert was held in the prison gym, the sound compares favorably with live recordings done in more conducive surroundings. Excluding introductions and other talk, there's only 22 minutes of music here. That may not be a punishable offense, but it sure is a crime! *Tom Bingham*

Performance: A- Sound: B+

Cajun Swamp Music Live: The Clifton Chenier Band

Tomato TOM-2-7002, Stereo, \$7.98.

A Tribute to Leadbelly: Various Artists

Tomato TOM-2-7003, stereo, \$7.98.

Lightnin': Lightnin' Hopkins

Tomato TOM-2-7004, stereo, \$7.98.

Tomato Records debuts with this initial release of three two-pocket blues sets. All are worthy albums.

Clifton Chenier, the legend from Louisiana, is captured hot and live at the Montreaux Festival, and the band's Cajun sound is beautifully recorded at its best.

The Leadbelly memorial features performances by Pete Seeger and Arlo Guthrie, Sonny Terry and Brownie McGhee, and the Lunenberg Travelers at a Leadbelly tribute concert held in Hunter College.

Lightnin' was previously released on Poppy, an earlier version of Tomato. It

Clifton Chenier



is one of the very best of his many, many albums.

All three benefit from Milton Glaser's attractive packaging, but the Leadbelly album has insufficient credits. Tomato is off to a fine start.

Another release just received is a three-disc **Best of Dick Gregory (TOM-3-9001, \$9.98)**. This is a generous selection from Gregory's many Poppy albums. *Michael Tearson*

Chenier

Sound: B+ Performance: A

Leadbelly

Sound: B- Performance: B+

Hopkins

Sound: A- Performance: A

Tell The Child About God: Consolers Nashboro 7158, stereo, \$5.98.

The Consolers are a husband-and-wife gospel duo from Miami who have recorded no fewer than 17 albums, every one a smash hit in the South though virtually unknown elsewhere. Sullivan and lola Pugh have maintained their enormous regional popularity over a 22-year span, without once swerving from the anachronistic down-home gospel style which has become their exclusive property.

The Pughs split the lead vocals 50-50. Four cuts feature lola's big, round contralto, while on four others, Sullivan sings a scratchy baritone lead. In addition, each has a solo—Sullivan sings *His Eye Is On the Sparrow* out-of-tempo, very slowly and deliberately, to a spare backdrop of reverberating guitar arpeggios, cymbal waves, and bass drum punctuations; lola sings a powerful *People Don't Seem To Care*, seconded by Sullivan's blues-drenched guitar. In all cases, the singing is strong, thoughtful, and unostentatious. It perfectly matches their material (most of it written by Sullivan), which concerns itself with simple truths simply stated and couched in attractive and appropriate melodies.

Sullivan's guitar is occasionally reminiscent of Roebuck Staples, but in a quite original, albeit elementary style. He strums the bass strings to provide both a relaxed rhythm and quiet bass textures, while his treble strings give off a curious whine. Kenny Lupper on keyboards and drummer James Burke provide tasteful support throughout. Available from Nashboro, P.O. Box 60188, Nashville, TN 37206.

Tom Bingham

Sound: C Performance: A

MOST \$600 RECEIVERS SOUND AS GOOD AS THIS ONE. BUT THIS ONE SELLS FOR UNDER \$300.*



The average \$600 receiver sounds as good as the new Pioneer SX-650 until you start listening to prices.

If \$600 is your kind of price, an SX-650 should qualify as your kind of receiver. Not only will it give you the kind of features and sound quality you'd expect for that kind of money; it'll also leave you with roughly half your receiver budget unexpectedly unspent.

But suppose your idea of a receiver price is somewhere under \$300.* The SX-550 will sound better to you than anything you thought you could afford. Because it has more power, a wider frequency range, less distortion, and far greater versatility than most other receivers in that category.

When you listen to an SX-650 you'll find either its price or its performance amazing. Depending on which you hear first.

High Fidelity Components
PIONEER
WE BRING IT BACK ALIVE.

U.S. Pioneer Electronics, 85 Oxford Drive, Moonachie, New Jersey 07074
*The value shown in this ad is for informational purposes only.
Actual resale prices will be set by the individual Pioneer dealer at his option.

Enter No. 31 on Reader Service Card

TDK AMPEX

Minimum Order 12 Tapes

Blank Tapes

at wholesale prices!

CASSETTE TAPES		
AMPEX C-90 3 pk/w stackette		\$4.99 for 3
BASF Studio C-90		2.80
Fuji FX C-90		2.80
Maxell LN C-90		1.99
Maxell UD C-60		1.93
Maxell UD C-90		2.84
Maxell UD C-120		3.84
Maxell UDXL 1 or 2 C-60		2.47
Maxell UDXL 1 or 2 C-90		3.47
Memorex C-90 3 pk		5.99 for 3
Scotch C-90 3 pk		4.99 for 3
Scotch Master 2 or 3 C-90		3.29
Sony C-90		1.79
TDK D C 60		1.14
TDK D C 90		1.56
TDK D C 180 (180 minutes)		2.88
TDK AD C-60		1.62
TDK AD C-90		2.40
TDK AD C-120		3.30
TDK SA C-60		1.98
TDK SA C-90		2.88
REEL-TO-REEL		
Maxell UD 50-60 (1200 ft.)		4.31
Maxell UD 35-90 (1800 ft.)		4.99
Maxell UDXL 35-90B (1800 ft.)		6.07
Maxell UD 35-180 (3600 ft. 10 1/2")		12.99
Scotch 212 (1800 ft.)		3.79
Scotch 207 (1800 ft.)		4.99
TDK L-1800 (1800 ft.)		4.64
8-TRACK		
AMPEX 382 8T 90 min		1.49
Maxell LN 8T 90 min		1.99
Memorex 2 pk 90 min		3.99 for 2
Scotch 2 pk 90 min		3.99 for 2

J & R Music World
33 Park Row, N.Y.C. 10038
(212) 732-8600

MAIL ORDERS: For shipment within 48 hours send money order or certified check. Two weeks delay on personal checks. Please add \$2.50 per order for shipping & handling. N.Y.S. Residents add tax. NO C.O.D.'s. ALL TAPES 100% GUARANTEED. Minimum Order 12 Tapes.

Write for prices on other tapes

Enter No. 18 on Reader Service Card

TOP Discount AUDIO

Your NATIONAL HEADQUARTERS

For Famous Brand Electronics By Mail

1150 N. Powis Rd., West Chicago, Ill. 60185
Ill. 60185 • (312) 293-1825

All Orders Shipped In Factory-Sealed Cartons

Write Or Call For The Lowest Prices Anywhere!

MILLION \$\$\$ INVENTORY

LOWEST PRICES ON

RECEIVERS	TURNTABLES	TUNERS
SPEAKERS	CHANGERS	CARTRIDGES
TAPE DECKS	AMPLIFIERS	HEADPHONES
CALCULATORS	COMPACTS	CAR AUDIO

Top Discount Audio 1150 N. Powis Rd. West Chicago, Ill. 60185 (312) 293-1825

AU4 We honor Master Charge and Bank Americard Date _____

Please send me a quote on: _____

MR MS (First) (Initial) (Last)
 _____ (Number and Street)
 _____ (City) _____ (State) _____ (Zip Code)

Enter No. 32 on Reader Service Card

String Synthesizers Can Be: Just strings...



...OR they can have:

violins/cello/piano, variable chorusing, keyboard split, synthesizer interface, variable sustain controls, jacks for foot controls, dual violin/cello mixers, separate mixable piano output, stereo string & computer interface options.

Stringz 'n' Thingz just \$295

from PAIA You're gonna love it!

TELL ME MORE

- Send Assembly & Using Manual for Stringz 'n' Thingz (\$5 enclosed)
- Send FREE catalog of other PAIA kits.

name: _____

Address: _____

City: _____ State: _____ Zip: _____

PAIA DEPT. 2 - A • 1020 W. Wilshire Blvd.
ELECTRONICS • Oklahoma City, OK 73116 •

Enter No. 28 on Reader Service Card

24 Great Hits by Bob Wills and his Texas Playboys

MGM MG-2-5303, rechanneled stereo, two records, \$8.98.

Bob Wills joined MGM in 1947 after 12 spectacular years with Columbia. Even though many of these tracks were highly successful in their day, very few of them have ever found their way to LP. Unfortunately, though MGM took the trouble to program them chronologically, neither the dates nor personnel are listed.

Side one, from 1947, features one of the hardest swinging bands Wills ever led, thanks in part to drummer Johnny Cuvieello and Bob's bass-playing brother, Billy Jack Wills. Tommy Duncan's laid-back singing is marvelous throughout the side, particularly so on *Bubbles in my Beer* and *Keeper of My Heart*. Tiny Moore set the standard for all electric mandolinists to follow by treating the instrument like a high-pitched jazz guitar (note *Still Water Runs the Deepest* and *Cross My Heart I Love You*). Steel guitarist Herbie Remington, pianist Millard Kelso, and guitarist Eldon Shamblin also shine. All six cuts are classics.

Side two begins in 1949, with Jack Loyd's blatant Tommy Duncan imitation, *I Ain't Got Nobody*. Alex Brashear plays perky dixieland on this cut and on Remington's immortal *Boot Heel Drag*, which also features one of Johnny Gimble's earliest recorded fiddle solos. The rest of the side, from 1950, includes Rusty McDonald's original version of *Faded Love* and Laura Lee McBride's yodelled *I Betcha My Heart I Love You*. Soloists include Mancel Tierney on piano and Billy Bowman on steel, as well as Gimble on electric mandolin.

Side three opens with Gimble's biggest hit, *The End of the Line*, with a hot fiddle solo by the late Keith Coleman. But by 1951, much of the distinctiveness of Wills' music was dissipating; *I'm Tired Of Living This Lie* (vocal by Ramona Reed) and *Send Me A Red Rose* (shakily sung by Joe Ferguson) have a definite commercial-pop blandness to them. On the plus side, we have Wills' personalized vocal on *Sittin' On Top of the World* (Bobby Koeffer on steel), a remake of *Silver Bells* (sweet-toned fiddling by Wills and Joe Holley), and Darrell Glenn's honky-tonkin' *I Won't Be Back Tonight* (1952).

Side four, 1953-54, represents the ultimate deterioration of the classic Texas Playboys sound. Aside from Jesse Ashlock's fiddling on *Bottle Baby Boogie* (vocal by Billy Jack) and Wills' fabled, formless meanderings through *St. Louis Blues*, side four is totally

devoid of Wills' old creative spark. Nonetheless, the first three sides contain some of Bob Wills' finest recordings.

The 1947 tracks are rather dead sonically, but the sound improves through the years, peaking at passable. The holes of both records are far too small.

Tom Bingham

Sound: C Performance: C to A+

Moments of Happiness: Rosalie Sorrels Philo 1033, stereo, \$6.98.

Rosalie Sorrels' new album on Philo is one of those records which grows on you the more you listen to it. Her voice is distinctively mannered in presentation, reminding you more of Billie Holliday—or, on *Falling In Love Again*, of Marlene Deitrich—than of any contemporaries in the folk and blues field with whom she might otherwise be grouped, given her repertoire and associations with such people as Utah Phillips (curiously not represented on the album), Paul Geremia, and Eric Von Schmidt. But the riches in jazz accompaniment here, from Mitch Greenhill's Kessel-style guitar to Jeff Gutcheon's firm piano line and John Payne's mellow woodwinds, provide a perfect setting for her choice of songs and her individual stylings, from the tromping *Ain't Nobody Got the Blues Like Me*, to her own wistful *Green Firefalls* and the fine title tune, which stands in ironic recognition of the transitory nature of emotions (the album's sleeve decoration is a composite photograph of the outstretched wings of a moth and a butterfly, courtesy of Dr. Gordon R. Neilsen, Extension Entomologist, University of Vermont). Even *Up Is a Nice Place To Be*, accompanied as it is by Tony Markellis' subtle work on bass, doesn't escape the moodiness of these blues.

The end result, then, is an album to accompany melancholy, maybe even to stimulate it. It would be going too far to call it "cafe singing," but it's certainly far from a coffeehouse singalong. As such, it's a fascinating piece of listening, another in the recent Philo series showcasing contemporary singer-interpreters (rather than traditionally-defined "folksingers"), to be placed with Mary McCaslin and Jim Ringer's recent outings for Philo rather than with their Margaret MacArthur or Priscilla Herdman releases. If this disc reminds you of Kate Wolf in some places, in other places it will remind you of nobody but Rosalie Sorrels. In the end, I'd rather Rosalie.

John McLaughlin

Sound: A Performance: A

118

STEREO

WITH TELEADAPTER

The TE-200 TELEADAPTER EASILY CONNECTS TO ANY TV & STEREO SYSTEM. Using our coupling and matrix circuit, teledapter takes a low impedance output from the television and delivers two HIGH IMPEDANCE CHANNELS OF SIMULATED STEREO, to drive any amplifier. Frequency response is maintained so you can hear the tinkle of bells or booming bass sounds as it happens on TV. With service warranty and hookup instructions \$21.95 ppd. Guaranteed to make your TV 100% more enjoyable.



TE-200

TV AUDIO TUNER

TE-300 UHF-VHF TV Hi Fi Audio Tuner for the best TV sound - Solid state - mono and simulated stereo outputs - use with any amplifier. Anodized front panel - simulated walnut case. Dare to be 100% entertained - \$199.95 ppd. SEND CHECK, M.O., MASTERCHARGE, or BANKAMERICARD NO. and Expiration date to: RHOADES NATIONAL CORP. - DEPT. B - BOX 817, HENDERSONVILLE, TENNESSEE 37075. (615) 824-1735.

NAME _____

ADDRESS _____

CITY _____

STATE _____ ZIP _____

■ SEND COMPLETE CATALOG

Enter No. 35 on Reader Service Card



TE-300

Fogarty's Cove: Stan Rogers
Barn Swallow Records, 120 Clare St.,
 Winnipeg, Manitoba

This is another privately produced album from the new cottage industry of home recordings. And we are extremely fortunate that the technology to produce this kind of album is now in the hands of artists and music lovers who would take a chance on such a product. Consider what would have happened if this 23-year-old giant from the Canadian Maritimes, with his Amish beard and his roaring baritone, had tried to work his way through "normal" record company channels. "Um, we already have a Canadian Archie Fisher, name of Gordon Bok," they might have said. "Ever consider changing your name to, oh, Alan Lightstep?"

But Mitch Podolak, who runs the Winnipeg Folk Festival, knew a winner when he heard one, and the result is this gem of an album. It is simply full of ancient-sounding ballads, wild sea shanties, and rocking love songs, rollicking singalongs, and quiet hum-alongs.

Perhaps the most fascinating part is that only one song on the entire album, *The Maid on the Shore* (a Canadian version of *The False Knight*), is actually in the public domain. All of the others, from the breezy footstomper which opens the album, *Watching the Apples Grow*, through to the menacing *Giant*, the wistfully lovely, *Rawdon Hills* (compare Debby McClatchy's *Hills of Kentucky*), and the swaying lament for the old days, *Make and Break Harbor* (compare Archie Fisher's *Leave the Land Behind*, as Archie himself has done), were composed by Stan Rogers. This is the best possible tribute to his deeply grounded sense of the Canadian ballad tradition out of which he so strongly surges, like the giant, who'll "rise with the moon."

And we have left aside the absolute sleeper of the album, **Barrett's Privateers**. First heard by many Americans at the Mariposa Folk Festival, this thunderous curse on warfare became the anthem of the 1977 folk festival circuit, swelling with each new performance at each new venue. It took over not only at Mariposa and Winnipeg, but also in Washington and Philadelphia; at the Eisteddfod in Massachusetts in September, the farewell appearance for many of the British Isles contingent this summer, **Barrett's Privateers** became the vaulting, soaring benediction to the season and a unanimous tribute to Stan Rogers. If you have not heard this song, then you have missed a hair-stirring experience.

John McLaughlin

AUDIO • April 1978

DIXIE GUARANTEES THE LOWEST PRICE

PIONEER TECHNICS ALTEC KENWOOD

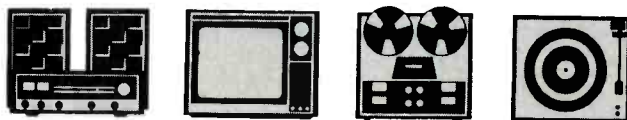

Whatever you need in the way of audio or home entertainment equipment, you'll find it at Dixie. We stock a complete line of receivers, amps, tuners, turntables, tape decks, speakers, TV sets, portable radios, car stereo, accessories, and more at the guaranteed lowest prices in town!

To Order... Call Toll Free
800-446-7925

(Within Virginia... Dial 804-257-4241)



FREE 108 pg. Catalog

The price of a postage stamp will get you our incredible new Buyers Guide. Its 108 pages of informative copy, comparison charts, terms and definitions and of course lots of big-name audio at the lowest prices.

To order catalog, please write:
 DIXIE HI FI Dept. (A)
 P.O. Box 6496
 Richmond, Virginia 23230

BIC DUAL MARANTZ SANSUI TEAC

Enter No. 57 on Reader Service Card

EMPIRE MAXELL SONY KLH PICKERING

HELP!

Anytime you have a question about your Audio subscription, please include a mailing label to insure prompt service on your inquiry.

AFFIX LABEL HERE

CHANGE OF ADDRESS

If you're about to move, please let us know approximately four weeks before the move comes about. Or, if there is anything wrong with your current mailing label, please let us know on this form also. Simply affix your present label here, and carefully print the updated information below.

PLEASE HELP US TO SERVE YOU BETTER

AUDIO MAGAZINE

401 N. Broad Street • Phila., Pa. 19108

Name _____
 (Please Print)
 Company _____
 Address _____
 City _____ State _____ Zip _____

AU/4/78

IN CHICAGO
 ...the **BEST VALUE**
 for
QUIET LUXURY



- Spacious suite with its own all-electric kitchen/bar.
- Complimentary continental breakfast served in your suite.

1300 N. ASTOR ST.
 CHICAGO, ILL. 60610
 William C. Wolf,
 Gen. Mgr.
 (312) 943-1111

30 FLOORS OF DRAMATIC SUITES & MASTER BEDROOMS

where you dine
 in elegance
 at **MAXIM'S**
 de PARIS

ASTOR TOWER HOTEL

Classified

FOR SALE

World's finest speaker kits

I.M. Fried Transmission Lines, Line Tunnels, Bextrene Drivers
JansZen Electrostatic Hybrids
Dalesford Bextrene Drivers
Radford Zero Distortion Electronics, Bextrene Drivers and Transmission Line Monitors
Rectilinear High-Output Rock/Classical Monitors
Audiophile Classics Published Monitor Designs
 Write for Catalog, Test Reports
 Dept. A1 89 Terra Vista San Francisco CA 94115 **Sonikit**

CANADIANS—DYNACO COMPONENTS AT TREMENDOUS DISCOUNTS. Write En Jay Sales Hornepayne Ontario.

PERCUSSION RECORDING of superior quality. Write Percussion, Dept. A, P.O. Box 88, Palisades Park, N.J.

"ATTENTION SUPER AUDIOPHILES"

SUMO ELECTRIC CO. LTD. ANO A—TRAIN LTD. PROUDLY ANNOUNCE THE AVAILABILITY OF THE SUMO CARTRIDGE. AFTER YEARS OF RESEARCH A NEW MAGNETIC CARTRIDGE HAS ARRIVED TO CHALLENGE THE MOVING COILS. WITH ALL OF THE GREAT FEATURES OF THE BEST MOVING COILS SUCH AS LOW MASS, LOW COMPLIANCE, AND EXTREMELY LOW TIP MASS, THE SUMO CARTRIDGE IS FINALLY HERE AT A PRICE THAT CAN BE AFFORDED—\$150—AT YOUR DEALER NOW. THIS IS ANOTHER FINE PRODUCT THAT A-TRAIN LTD. IS PROUD TO OFFER ALONG WITH THE MORE THAN SUPER AUDIOPHILE DISCS BY AUDIO LAB AND THREE BLIND MICE. SEND FOR OUR BROCHURES RIGHT AWAY.

A-TRAIN LTD., 1230 N. HDRN AVE., W. HOLLYWOOD, CA. 90069. (213) 659 4370

CLASSIFIED ADVERTISING RATES

BUSINESS ADS—For Sale, Help Wanted, Services, Business Opportunities, Tape Recordings, etc. etc \$4.80 per line. First line set in bold face type at no extra charge. Extra lines \$9.60 per line. One point ruled box, extra charge \$8.00. **Full payment must accompany order.**

NON BUSINESS ADS—Situations Wanted, used equipment for sale by private individuals \$2.80 per line. First line set in bold face type at no extra charge. Extra lines set in bold face type \$5.60 per line. **Full payment must accompany order.**

FREQUENCY DISCOUNT—3 times, less 10%. 6 times, less 15%. 12 times, less 20%.

DEADLINE—1st of two preceding months. (Dec. 1 for Feb. issue).

BLIND ADS—Box numbers may be used at \$5.00 extra for handling and postage.

MAIL ORDER AND DISPLAY CLASSIFIED RATE

1 col x 1"	\$85
1 col x 2"	\$125
1 col x 3"	\$175
2 col x 1"	\$125
2 col x 2"	\$225

Advertiser must supply complete film negative ready for printing for display ads.

AUDIO Magazine
 401 North Broad Street
 Philadelphia, Penna 19108

HOW TO ANSWER BOX NUMBER ADS

When replying to an Audio Box Number Ad, please use this address Box No. _____ c/o Audio, 401 No. Broad Street, Philadelphia, Pa. 19108.

FOR SALE

Fisher Receiver—old Model R-3. Excellent Condition. Make Offer. Wlter, 1009 Sierra Ln. N.E., Rochester, MN 55901.

HAFLER DH-101 PREAMP

We expect to be in stock on this exciting new preamp by Dec. 12th. Kit price is \$199.95. Custom wired and tested. \$299.95. Immediate prepaid shipment via UPS. THE AUDIBLE DIFFERENCE. 435 Tasso, Palo Alto, California 94301. (415)328-1081.

ANTI-SKATING for AR TURNTABLES!! Proven counter-weight design of nickel steel & aluminum construction. Install yourself in minutes. \$7.00 postpaid. (Dealer inquiries invited.) AUDIO INNOVATIONAL PRODUCTS, P.O. Box 1607, Portsmouth, N.H. 03801.

FULTON J-MODULARS, \$1650. Audio Research D-150, \$2400. (415) 278-4519.

LOWEST AUDIO PRICES POSSIBLE

Write for our Quote: Sound Electronics of Johnstown, 519 Wheat, Johnstown, Pa. 15902.

MAGNEPLANAR? DAYTON WRIGHT? QUAD? ACOUSTAT? BEVRIDGE? QLS? PYRAMID?HQD?

WHAT PRICE REALITY?

THE DCM TIME WINDOW AT AMERICAN AUDIOPHILE.
 5 SUNRISE PLAZA, VALLEY STREAM, NY 11580
 (516) 561-7114

ATTENTION AUDIOPHILES

Finally state of the Art Electronics at affordable prices. The audionics BT2 preamplifier & PZ3 series II Amplifier are now available at American Audiophile. These highly regarded components offer the finest attributes of tubes & solid state electronics. The crystalline transparency & front to back depth must be heard. AMERICAN AUDIOPHILE TRADING CORP., 5 Sunrise Plaza, Valley Stream, NY (516) 561-7114.

FDR SALE—Classic Marantz Model 500 stereo power amplifier. Excellent cond. \$1175. Ira Leonard, 50 Green St., Brookline, MA 02146. (617) 731-5817.

TYPE YOUR SLIDES!! Sizes 3 1/4 x 4 \$2.35 per 50 and 2 x 2 \$2.85 per 100 plus postage. Radio Mat Slide Co., 444 N. Peninsula Drive, Daytona Beach, Fla. 32018

FRIED SPEAKERS AT DESIGNATRON

Designatron is pleased to have the fantastic Fried "Signature Series" speakers. Our customers say "incredible" and compare them with speakers costing hundreds of dollars more! "High Fidelity" said "transparent, sparkling." "Stereopus" said "thoroughly honest sound." The Fried Series begins with the Model Q—at only \$140.00 ea.—truly a bargain. The Model Q is bookshelf size, using plasticized drivers, and has superb impulse response. Also available the newly refined Model R Mark II at \$425.00 ea., the phase coherent Model B at \$235.00 ea., and Model M with transmission-line base at \$800.00 ea. Come audition or write for detailed information on Fried and other edge-of-the-art products from Designatron. Fried Model Q's shipped free in continental U.S. Designatron Stereo Store, 260 Old Country Rd., Hicksville, N.Y. 11801. [516]822-5277.

TREVD R LEES PREAMP, black faceplate, extra set Telefunken tubes, \$250.00; Pat-4, \$75; both mint, (314) 474-7003.

FREE CLASSIFIED ADVERTISING—HI-FI MARKET REPORTS—SUBSCRIBER-ONLY EQUIPMENT BARGAINS. \$15/12 issues. Stamp for sample. SCC Newsletter, Box 8014 (AM578), Canton, OH 44711.

FOR SALE

	GOLDEN gramophone	2858 W. Market Street Akron, Ohio 44313 Phone (216) 864-4411
	Audio Research Advent ADS Armstrong Bravura Connoisseur Denon	Direct Discs Discwasher DynaVector Electro Research E.M.T. FMI (Fulton J) Grado Signature GAS Ampzilla II

FUTTERMAN HANDCRAFTED tube amplifiers. Golden Ear Reference Loudspeaker System. C/M CC-1 super versatile preamp \$360.00; C/M604 Electronic X/over \$195.00; C/M607 Disco Mixer (sensational), \$185.00; C/M-914 amplifiers. Becker, Blaupunkt automobile radios. Audio Research D-150 amplifier, pristine, inquire. Marantz 10B tuner, mint \$800.00. McIntosh MC-2300 amplifier, pristine \$1,135.00. Thaedra # 301 preamp, pristine \$600.00. Levinson JC-2 preamp, A/D cards, pristine \$1,175.00. JBL SE-460 amplifier, mint \$400.00. PML # ST-6 professional stereo microphone w/power supply, cables, value \$1,500.00, only \$900.00. **WANTED:** McIntosh 275's, MC-3500's, Marantz 5's, 7C's, 8B's, 9's; Signal-One CX-11. GOLDEN EAR, Box 2189, Riverview, Michigan 48192. (313) 479-1234.

BAV AREA & CENTRAL VALLEY MUSIC LOVERS

AUDIO ARTS

2117 Second Street (415) 447-7447
 Livermore, Calif. 94550
 Tuesday - Sunday

Van Alstine	QED's	B & W
Time Windows	Audire	Rogers LS3/5A
Armstrong	Frazier	
Dynavector	Fons	M & K
Grace	Connoisseur	Verion
Goldring	Grado	Win Labs

Professional Systems Engineering

Fons Orphan Arm Sheffield Lab
 Custom Modifications Component Service
 We will ship prepaid and insured throughout the U.S.

PHILIPS SPEAKER KITS, Speaker components, in San Francisco. Just Speakers. (415) 647-6538.

AUDIO PROFESSIONALS: Find out why the AUDIO FORUM is the only audiophile-oriented publication that has earned the respect of the entire industry. Our unique format offers you direct access to the people you want to reach! Write today for details. Don't wait! Box 578-A, Fairfax, CA 94930

MUST SACRIFICE

STATE OF THE ART SPEAKER SYSTEM

BRAND NEW ACOUSTAT X

DIRECT DRIVE ELECTROSTATIC SPEAKERS

THESE UNITS ARE ONLY THREE MONTHS OLD AND STILL UNDER WARRANTY INTERNAL AMPLIFIERS AND CUSTOM MADE MATCHING WALNUT PEDESTALS INCLUDED. OWNER NEEDS CASH... \$1400.00 FIRM PLUS SHIPPING COSTS CALL (215) 839-0600... BUSINESS HOURS

CROWN VFX-2 CROSSOVER. Mint condition with very few hours. Best offer. EME Consultants, Box 23047, Lexington, KY 40523 or call (606) 272-4311 Evenings.

COLORADO's AUDIO ALTERNATIVE—Boulder Sound Gallery, Ltd.—Purveyors of unusually fine audio systems and service to meet the needs of all serious music lovers. Our product selection includes the Acoustat X ESL, Allison, B & O, B & W, Dahlquist, dbx, Dynavector, Fidelity Research, Fons, Luxman, Magneplanar, Mark Levinson, M & K Sound, Quad Acoustical, Quatre, RAM Sound Concepts, Stax, Supex/Sumiko, Yamaha, and Ultraphase. Demo Lux M-6000 amp with new warranty available. 1200 Pearl, Boulder, Colorado 80302, 1-303-444-2626

ADVENT

Hi Fi Components

big discounts!

REF. NO.	SALE
Walnut Loudspeakers	300 245
Utility Loudspeakers	260 215
Powered Loudspeakers	900 695
Smaller Loudspeakers	188 149
#2 Loudspeakers	178 139
#3 Loudspeakers	104 89
300 Receiver	270 239
201 A Dolby Cassette	400 339

TO ORDER SEND 50% DEPOSIT. BALANCE C.O.D. MASTER CHARGE, VISA, AMERICAN EXPRESS ACCEPTED

Quantities limited. Allow 6-8 weeks for delivery.

the warehouse
187 N. MAIN ST. HELLGATE, N.J. 08052
908-761-2900

Write for catalog of other amazing money saving values.

AUDIO DEN LTD.

Long Island's finest audio dealer is proud to announce the addition of:

- AUDIO RESEARCH SYSTEM
- THRESHOLD ELECTRONICS
- ACOUSTAT X LOUSPEAKERS
- VERION TABLES
- SAEG & DYNAVECTOR TONEARMS
- EMT CARTRIDGES
- GALE RECORDS

To the already fine lines of Bravura, OB Systems, Rappaport, Rogers, Quatre, Infinity, Yamaha, CM, Nakamichi, Fulton (60, 80, 100 in stock), Dahlquist, RTR, Polk, Avid, Magneplanar, Quad, (ESL and electronics) Lux, Onkyo, B&O, Revox, Crown, Sonus, Grado Signature, Denon, Grade Formula Four and Sheffield Labs. FREE INSTALLATIONS IN N.Y. AREA. NO CHARGE FOR SHIPPING.

AUDIO DEN LTD.

1320-34 Stony Brook Road
Stony Brook, New York 11790
516-751-3350

THRESHOLD 800A \$1650. Tympany 1-C speakers \$850.00, TEAC 3340 \$600. All mint condition. Larry Ravitz, Kalamazoo, Mich. (616) 344-8203.

OTARI MX-5050 QXHD 4-TR REEL TAPE MACHINE. NEW CONDITION. LESS THAN 100 HRS USE. \$1800.00 TAPCO-6100RB, 6100EB 14 INPUT P.A. MIXER, MONITOR MIX, REVERB 3 BAND E.Q. LIKE NEW \$600.00 CALL TOM. 614-653-4722 EVENINGS, WEEKENDS (OHIO)

ARC D-51's D-75A's, D-76's (919) 933-5630

ACTIVE ELECTRONIC CROSSOVERS

Plug-in Butterworth (maximally flat) filters in 6 db., 12 db., or 18 db. per octave attenuation, any specified frequency. Complete crossover in attractive cabinet with all terminations and regulated power supply.

MONAURAL BI-AMP	\$ 92.00
STEREO BI-AMP	\$126.00
STEREO TRI-AMP	\$209.00
STEREO QUAD-AMP	\$279.50

Suggested added features: Summer for "Single Woofer" systems, sub-sonic noise elimination filters; level controls.

FOR OEM'S AND HOME ASSEMBLERS
500 Series dual filters and/or plug-in filters; regulated power supplies.

WRITE FOR FREE BROCHURE AND PRICE SHEET

DeCoursey ENGINEERING LABORATORY

11828 Jefferson Bl. • Cuivier City, CA 90230
Phone: (213) 397-9668

FOR SALE

STATE OF THE ART IN MIAMI, FLORIDA

Quite simply, only the very finest in audio components . . . Mark Levinson Audio Systems

featuring: H.Q.D. System, LNC-2, ML-1, ML-2, LNP-2, JC-1-AC & DC

Great American Sound, Fulton Musical Industries, Quad (of England), Stax, Acoustat-X, Magnepan, Sonex, Gale, KEF, Rogers, AGI, Audio Pulse, Lentek, Yamaha, IMF Electronics, Fidelity Research, Grace, Supex, Promethean, Linn Sondek, M&K, Braun, Janis, Sequerra, Bang & Olufsen, Armstrong, KMAL, Decca, Lecson, Naim, Rabco, Otari, Spondor, Rega, AEI, Bryston, Pyramid, Also, Discwasher record care products and audiophile records such as Mark Levinson Acoustic, Sheffield, Audio Lab, M&K, Reference Recordings, Crystal Clear, Gale.

SOUND COMPONENTS INC. 2710 Ponce de Leon Blvd.

Coral Gables, Florida 33134
305-446-1659

TWX: 810-848-7627

Mastercharge & BankAmericard accepted. We ship mail order prepaid within U.S.

ONLY TEN MINUTES FROM THE MIAMI INTERNATIONAL AIRPORT—WE WELCOME VISITORS FROM ABRDAD!!!

SOUND ADVICE MAGAZINE: Now, in issue 5, an exclusive in depth interview with John Iverson of Electro Research plus a look at his new electro kinetic phono pickup. Also reviews of power amplifiers: Threshold 400A, DB Systems, Stax DA-80, and Yamaha B-2. We compare, sonically, the Linn-Sondek and Technics SP10 MK II turntables, with objective as well as listening tests. We present Part 1 of an extensive survey of tone arms, including the Breuer Dynamic, Oynavector, Black Widow, Mayway. We look at the state-of-the-art in headphones, plus a comparison of some surprising moderately priced loudspeakers also. Insight into the super audiophile discs coming from Japan. Plus a rebirth of reel-to-reel tapes. And much more. Sound Advice: 4 issues \$15 first class and \$18 overseas (sent airmail). Check or Money Order U.S. Funds made payable to "Friday Publishing Inc." To: Sound Advice, 68 Post St., Suite 226, S.F. CA 94104.

BACK ISSUE MAGAZINES. Over 200 titles, 1890 to 1978. Send stamped Envelope. Free List. Everybody's Bookshop, Dept. AU, 317 West 6th, Los Angeles, Calif. 90014.

THE AUDIO ADOVOCATE MILBURN, N.J. 201-467-898B

ARIZONA AUDIOPHILES

Mark Levinson, Dahlquist, S.A.E., Sequerra, Revox, Rabco, Nakamichi, Yamaha, Transcriber, Crown, Grace, Stax, Tandberg, Accuphase, Sonab, Supex, Gale, Klipsch, Phase Linear, Uher, E.S.S., Burwen, Sony V-FET, J.B.L., Harmon-Kardon Citation, A.D.S., Spectro Acoustics, Jennings Research, Beveridge, Senheiser, Teac, Thorens, Stanton, Aiwa, Stax, A.K.G., Ariston, Micro-Seiki, Fidelity Research.

JERRY'S AUDIO EXCHANGE

PHOENIX—334 E. Camelback Rd. (602) 263-9410
TEMPE—130 E. University Dr. (602) 968-3491
TUCSON—5750 E. Broadway. (602) 622-7407
MAIL ORDER HOT LINE—MR. WOZ (602) 265-7841

MARANTZ-8B AMP., Elect. X'over, SLT-12U Turntable, JBL-LE15A, PR15, D131, Cobraflex, Berlant 10 1/2" reel deck & amps, McIntosh 240. All mint. Brenner, 10521 Azalea Park, Pinellas Park, Fla. 33565

STAX 125 Preamp and SRX headphones \$450 Sony, TA-3200F amp \$225 - both excellent 401-861-9227. Sawdy, 250 Highland Ave, Providence R.I. 02906

SERVO-STATIK I rosewood, completely rebuilt, specially designed midrange transformers (919) 933-5630

NEW DISCLOCK



Pendulum Clock
(Pictured) 29.95

Non-Pendulum 19.95

INCLUDES
POSTAGE & HANDLING

Battery not included

Fla. residents add 4% sales tax

MODERN DESIGN

1731 N.E. 51st St. • Pompano Bch, FL 33064

RACK LABS—Variable stereo crossovers turntable from 250 Hz to 7K Hz. Portable disco mixers and 5 band feedback eliminator. 136 Park St., New Haven, CT 06511.

TOURING SOUND SYSTEMS, 2, 4, and 8 Track Studios, Disco Sound, Cerwin Vega BGW, Altec, Shure, AKG, Tapco, Dyna, Revox, EV, Beyer, Cetec, etc. K & L Sound Service, 75 North Beacon At., Watertown, Mass. 02172. (617) 787-4072-Alt. Ken Berger.

Audio Research D150 Amplifier. Serial No. 674250-2. Best offer over \$2,500. 319-354-1196 evenings

Marantz 10B Perfect \$500 Advent cassette \$75 813-774-5671 Evening.

SONY TC 880-2 OPEN REEL RECORDER. RECORDS HALF-TRACK, PLAYS BACK HALF OR QUARTER TRACK. LIKE NEW. USED ONE MONTH. "ABSOLUTE SOUND" RATES IT #1. DAYTIME, CALL ARBOR 212-421-0521 EVENING CALL 212-688-3474

KOSS MODEL I BEST OFFER-NO REAS OFFER REFUSED—KENNETH JOSEPH 6 SHELVIEW DR SHELTON, CT 06484 203-929-0647

Index to all audio equipment test reports in 1977 issues of 9 magazines for \$2.50. J. Hurtgen, 775 Southgate, Holland, MI 49423.

Hartlay 24" WOOFER IN 60 Cu FT INCLOSURE 5'x4'x3' BEST OFFER KEN JOSEPH 6 SHELVIEW DR SHELTON CT-06484-203-929-0647

2 RTR ESR-15's \$500. Advent Dolby 100, \$175. Magnecord 1024-42RX, inquire for details. J. Ebbert, 770 Holly Rd. Wayne, Pa. 19087.

GENESIS MODEL THREE SPEAKERS. EXC. COND., FULL WARR., \$475.00 pair. KEN 1-203-457-1443

GOODWIN'S

recommends Mark Levinson, Verion, Linn Sondek, Fidelity Research, Studer, Stellavox, and THE MARK LEVINSON HQD SYSTEM.

By Appointment

Goodwin's Inc.
617-266-0608

33 Newbury St.
Boston, MA 02116

AR-LST's, absolutely mint, flat 30-20kHz, list new \$1200/pr., 2 years old, \$800/pr., will haggle. (419) 472-9321.

Is your name and address correct?

Please check the address label on this issue of Audio. If not accurate, please send corrected label, with this notice, to:

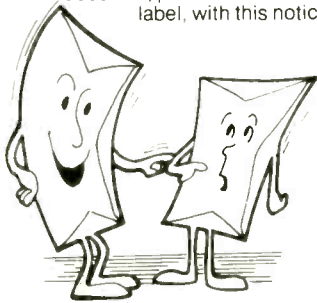

**Circulation Department
Audio**
North American Building
401 N. Broad St., Philadelphia, PA 19108

HI-FI ENTHUSIASTS WANTED!!! Earn more than just spare money in your spare time. We need campus representatives to sell name brand stereo components at discount prices in your area. No investment required. Serious inquiries only please. Contact: Mail Order Dept., K&L Sound Services Co., 75 N. Beacon St., Watertown, Mass. 02172

THE NEW YORK AUDIO SOCIETY, INC. is a non-profit member-supported Hi-Fi Club. Come and hobnob with others like yourself to widen your knowledge of Audio Products and Systems and make new acquaintances. Informative monthly meetings feature new product demonstrations, lectures on latest Hi-Fi developments and exchange of information. All Audiophiles are invited to attend one session as our guest. Details about meetings and membership available. Write Box 125 Whitestone Sta., Flushing, N.Y. 11357 or call (516)593-6538.

AUDIO HOUSE = VALUE

M&K subwoofers offer value. They reveal sound on your records that you are not hearing. Add one subwoofer to a pair of high quality speakers and hear the most cost effective improvements possible. The subwoofer may be placed anywhere to be effective. Goliath I \$375. Goliath II \$175. Shipping prepaid. 5232 Sagamore Dr., Swartz Creek, Mich. 48473. 313-732-4670

ATTENTION: NEW JERSEY AUDIOPHILES

A real no-nonsense audio place exists!!!

CONTEMPORARY SOUND ASSOCIATES handles and evaluates some of the finest names in audio.

- | | | |
|------------------|----------|------------------|
| • FRIED | • RAM | • LINN SONDEK |
| • DB SYSTEMS | • SUPLEX | • VAN ALSTINE |
| • LUXMAN | • 3A | • TRANSCRIPTOR |
| • KEITH MONKS | • STAX | • CREIGHTON LABS |
| • SOUND CONCEPTS | • GRACE | • HEGEMAN SUB |

A TRULY PERSONALIZED SERVICE

35 Little Falls Rd. Fairfield N.J. 07006
(201)575-1135

POLK AUDIO MONITOR SERIES

AUDIO BREAKTHROUGHS now has on demonstration the remarkable new Polk loudspeakers. Compare them to the finest loudspeakers in the world. Both the Seven (\$139.99 ea.) and the Ten (\$199.95 ea.) utilize high definition polymer laminate bass midrange drivers, wide dispersion soft dome tweeters and fluid coupled sub-bass radiators. They are capable of reproducing a highly defined phase accurate three dimensional sonic image which rivals the thousand dollar super speakers. They sound great with a small receiver, yet reveal the fine subtleties of state of the art electronics like Levinson, Nakamichi, Essence and G.A.S. Shipped free in U.S. Send for free brochures on Polk or our other fine lines. **AUDIO BREAKTHROUGHS**, 1534 Northern Blvd., Manhasset, N.Y. 11030; 516-627-7333.

FOR SALE

QUALITY VACUUM TUBE PREAMPLIFIER

The conrad-johnson stereo preamplifier offers breathtaking impact, clarity, and definition. Low noise, precision audio circuitry combined with highest quality switches and controls and elegant, durable gold anodized aluminum faceplate and knobs provide lasting beauty and performance. Available from selected dealers or direct for \$499. Write for information: conrad-johnson design, inc., 1474 Pathfinder Lane, McLean, Va. 22101.

CYENUS TELEPROJECTION SYSTEM is a wide screen television system with a bright, sharp, and lifelike 50 inch diagonal image. This unit has been used for approximately 6 months, but is in very good condition. The retail price is \$1499 but the asking price is \$895. The unit will be shipped prepaid C.O.D. Call 703-552-5568.

SAN DIEGO, CALIFORNIA

FULTON/FMI-BRAVURA-PRO MUSICA, AUDIO RESEARCH, MAGNEPLANAR, KMAL record cleaning, Audio Pulse and other state-of-the-art components. Mission Bay Audio, 4501 E. Mission Bay Dr., San Diego 92109.

AKG, AMPZILLA, ARISTON, BEYER, CIZEK, CROWN, Dahlquist, DB Systems, Denon Electronics, Entre, Fons, Grace, Grado Signature, Infinity, Nakamichi, Ortofon. **PHASE LINEAR, PMI** REVOX SAE, SAEC, Sennheiser, Sequerra, Sony, Stanton, Stax, Supex, TASCAM, Technics, Thorens, Audio Pulse, Acoustat, I.M. Rogers, Ram, etc.

HI-FI HAVEN

28 Easton Ave.
New Brunswick, N.J. 08901
201-249-5130

REVOX A77-1104, \$600; PHASE 4000, \$390; PHASE 400, \$290, BOSE 901 PAIR \$350, KOSS ESP-9 \$50 Ppd. CLYDE MCKENNEY, 7219 WILLIAMS DR. SO., ST. PETERSBURG, FL 33705 813-867-5913 after 7:00P.M. NEED CAR



BUILD STEREO SPEAKERS WITH JUST GLUE AND STAPLES.

Save up to 50% of the cost of ready-built speakers by assembling Speakerlab kits. We've done the design, carpentry and wiring, leaving you only the actual installation of the speaker drivers. Most people take less than two hours to assemble a kit. Illustrated, easy-to-follow instructions check you each step of the way. (And if you still can't finish the kit, we'll do it for you for just the cost of return freight.)

When you're through, you have a high quality, multi-element stereo speaker with a resonance-free enclosure, fiberglass damping, a crossover with level controls, and drivers that are some of the best in the industry.

Send for our free 52-page catalog. It's practically a manual on speaker building.



Dept. AD-D 5500 35th N.E., Seattle, WA 98105

LOWEST DISCOUNT PRICES ANYWHERE on audio equipment. All major brands discounted. Write for quotes, K&L Sound Services, 75 N. Beacon St., Watertown, Mass. 02172.

BRITISH AND EUROPEAN HI-FI, most makes, from England's Hi-Fi mail order specialists. Save on LS3/5A, KEF, Radford, Tandberg, Tannoy, etc. Shipping list free or send \$3 to include literature. Goodwins, 7 The Broadway, Wood Green, London N22. Phone 888-0077. Callers welcome.

DAHLQUIST 00-10, never opened, have receipt. Asking \$650. Chin, 56 Mott St. #2, N.Y.C., N.Y. 10013

JANIS Decoursey X over \$145. (408) 625-2433.

LUX CL 35 III PREAMP \$550. (2) **LUX MB3045 POWERAMPS** \$370 EA., **RABCO ST-7** \$350, **KEF 104** \$200 EA., ALL USED BUT IN MINT CONDITION. WRITE P.O. BOX 688, BLACKSBURG, VA. 24060

ESS Hell Amt-3 Monitors, like new with cartons, \$500 pair. Keep trying (804) 977-4618.

JR system



Just add the new **JR** Super Woofer to the legendary **JR 149's** and a system of unequalled quality and flexibility becomes a reality. In rosewood, walnut, teak and black.

A GROWING FAMILY . . . FROM H & H INTERNATIONAL
354 State St., Rochester, N.Y. 14608 • 716/325-5275

Progressive Audiophile Services.

Specializing in Private Demonstration and Consultation.

Featuring:
RAPPAPORT HAFNER
BRYSTON JR
SYMDEK DENON
CONNOISSEUR
ADC ZLM/LMF ARM
SOUND CABLE
KEITH MONKS
PROMETHEAN

- Large Selection of Special Recordings.
- Keith Monks Record Cleaning Service.

TAKE 5 AUDIO

32 ELM ST.
 NEW HAVEN, CT. 06510
 (203) 777-1750



BUY HI-FI EQUIPMENT "DISTRIBUTOR DIRECT" No middle-men or Salesman's commissions to pay! Quick service, excellent stock, equipment to fit every purse and aesthetic taste. Write for quotes: Hi-Fi Sales, Box 348, Dept Q Bryn Mawr, Pa. 19010 (215) 544-1465.

VAN ALSTINE DYNA MODS FOR ST-400, ST-416, ST-410, ST-150, PAT-5, PAT-5 BIFET, FM-5 are still the best. New \$10.00 improvement kit for Dyna PAT-5 BIFET. Double 400 conversions for both ST-400 and ST-416. Free mod instructions for ST-70, MK-111 and PAS-3X. \$100 audio circuit mods for ARC SP3-A1. All new DC coupled VAN ALSTINE MODEL 1 preamp and MODEL 2 power amp. Crown tape electronic mods coming soon. Jensens Stereo Shop, 2202 River Hills Dr., Burnsville, Minnesota 55337. 612-890-3517

HEAR STAR WARS IN MULTI-CHANNEL!

Remember how exciting it was in the theater! Now you can recreate that big-open-deep sound with an AUDIO-PULSE added to your sound system. The AUDIO-PULSE MODEL ONE is the digital time-delay system that really works, it's great for small recording studios—it gives you up to 8 channels of sound to amplify—it's just plain GREAT!

AUDIO PULSE IS AT DESIGNATRON'S STEREO STORES ON LONG ISLAND

260 Old Country Road—Hicksville, N.Y. 11801
 748 Route 25A—Setuaket, New York, 11733

AVAILABLE FOR SHIPMENT ALL OVER CONTINENTAL U.S.A. CALL (516) 822-5277

RIBBON MICROPHONES—4—RCA 77DX polydirectional ribbon microphones w/cases. New condition \$750 for 4 or \$200 each. Cox, 6900 Kimberland Gdns. Ln., Lithowia, Ga. 30058

CROWN-SX-700 Series Tape Recorder, will sell either ¾ or ½ track 2 Channel \$900. Spare SX Electronics \$400. one 17 & two 24" Portable Crown Cases \$75 & \$125 each. Contact John Reynolds, Jr. 219-432-1294

TANOBERG 3041 X, \$225, Pioneer PLA35 semiautomatic turntable with Shure M91, \$100, KOSS Pro4AA, \$30. Bernie Siebers (609) 452-4399 (days & 8-10 PM)

FOR SALE

NAME BRAND RECORDING TAPE, custom loaded. Available in cassettes, reels, and cartridges. Huge savings direct from manufacturer. New catalogue now available, MJS, 516 Brooks, San Jose, Calif. 95125 (408) 998-2693.

CANADIANS: Best Hi-Fi discounts on over 96 leading Hi-Fi brands. Many exclusive factory closeout and special deals. Quotations via return mail. Nationwide mailorder service. Free catalogs jam packed with bargains in Hi-Fi equipment, tape and recording accessories, calculators, telephones and accessories, kits, parts, etc. Hundreds of factory and government surplus specials too! American inquiries welcome. Rush free catalog request to ETCO, Dept. AUA, Box 741, Montreal 183G Hymus, Pointe Claire, Quebec H9R 1E9

SAVE UP TO 69% ON OVER 100 TOP BRAND AUDIO COMPONENTS FROM CARSTON STUDIOS, NEW ENGLAND'S AUDIO SUPERMARKET ONE OF THE OLDEST MAIL ORDER FIRMS (EST 1952) AND CERTAINLY ONE OF THE MOST RELIABLE. ALL ORDERS SHIPPED FROM STOCKED WAREHOUSE. SEND FOR PRICE QUOTE AND PRICE LIST. CARSTON STUDIOS, OLD BROOKFIELD ROAD, DANBURY, CONN. 06810.

HI-FI REPS NEEDED. Excellent Stock, Lowest Prices, Friendly Service. No investment or obligations! Hi-Fi Sales, Box 348 Dept A, Bryn Mawr, Pa. 19010 (215) 544-1465

VACUUM TUBES

and tube-peculiar parts. AUDIO DIMENSIONS offers a complete inventory of high voltage capacitors, precision resistors and tubes. Kits or separate parts available for building circuitries described in our 230 page Audio Modification Manual. Write for parts list, literature and outline of services. AUDIO DIMENSIONS, 8898 Clairemont Mesa Blvd., San Diego, CA 92123.

DISGUSTED WITH AMERICAN RECORDINGS? Tired of paying import prices? Join us at STEREOPHILE in mounting a campaign to bring US record companies back to the view that high fidelity means musical realism, not tick, boom and screech. For information about this lively, literate publications that is still leading the audio industry since 1962, write STEREOPHILE, Box 49S, Elwyn, Pa. 19063, or send \$12 for 4 issues.

SURPLUS SPEAKER CROSSOVER CAPACITORS: hundreds of special high voltage-rated non-polarized caps in stock in most popular sizes. Wholesale prices from 1 to 1000 pcs. Write today for quotation on the caps, and other x-over parts you need. Haynes Microelectronics, 625 Post St., Suite 413, San Francisco, CA. 94109.

LEACH LOW TIM AMPLIFIER NOW AVAILABLE IN WEST. For info write G. Max Carter, Box 26A Goldcamp Rd., Colo Spgs. CO 80906

FOR SALE

New Lambda Series from SpeakerKit

Featuring the newest Philips and Electro-Voice drivers with computer-assisted crossover design. Outstanding quality at a surprisingly affordable price. Assemble it yourself. Write for details.



SpeakerKit Box 12A, Menomonie, WI 54751

KENWOOD Audio Purist

1. Refine every idea that's come along in audio.
2. Expand on separate power supplies to the ultimate and build a super-amp for each channel and directly drive each speaker
3. Make the signal go through the shortest most direct path in the preamp to keep it pure
4. Make the BEST phono preamp—period!
5. Patent a new connector that eliminates noise and hum between amplifier and preamp
6. Make it all affordable to a large number of audiophiles and music lovers.

HERE'S THE SOLUTION:

The KENWOOD AUDIO PURIST DIRECT DRIVE SYSTEM available at DESIGNATRON'S STEREO STORES—260 Old Country Road, Hicksville, Long Island, N.Y. 11801 and DESIGNATRON—748 Route 25A, Setuaket, Long Island, N.Y. 11733 CALL (516) 822-5277

Apt-Holman PREAMPLIFIER

He did the research and design work that is the HOLMAN Pre-Amp Circuit in the Advent Receiver. Now Tom has started his own company, the APT Corp. He has designed a state-of-the-art preamplifier that has all the switches, controls, quality, and QUIET you crave—and even better, you can afford it! ONLY \$447. . . . Available from DESIGNATRON'S STEREO STORES, 260 OLD COUNTRY ROAD, HICKSVILLE, N.Y. 11801 Mail and phone orders accepted on Mastercharge and Visa. Ask about our satisfaction guarantee on this product (516) 822-5277

THOUSANDS OF LIKE NEW LP's and prerecorded tapes. Catalogue—\$1.50. House of Records, Hillburn, New York 10931.

THE SENSIBLE SOUND—ISSUE #4—FIRST REVIEWS ANYWHERE

Paragon E1—Van Alstine, Model 1—Audionics BT2 and PZ3—PSE, Studio One and Two—Magnepan MG1—New Advent—Grado FTE + 1—Audio International CM914 and CM300—Audioanalyst M6—Technics SB6000A—B.I.C. Formula 6—Stylift—ADC, Sound Meter—Disctracker—McIntosh XJ5—Audio Technica, 706 phones—MicroAcoustics FRM1A—B&W DM7—3A Adagio—JR 149—Fried Model B—Also the Pickering XSV 3000—Empire 2000Z—AOC, XLMII—Shure V15/III—M.A. 2000e—Spendor BC1—Onkyo A7—Advent 300—DBX 117—B+O M70—B&W DM5 and DM2a and OMS—Crown 0150A and IC150A—Spectro Acoustics 202—Yamaha NS1000—ADC 710—Nakamichi 420—Plus dozens of record reviews and our usual features. Subscribe today—\$10 (4 issues), \$11 Canadian, \$12 F.C. mail, \$16 Foreign. 403 Darwin, Snyder, NY 14226

DISC BEAM

Turntable illumination system now available. Compact light inside dustcover turns on when cover is raised. No moving parts—one minute installation. Satisfaction guaranteed—prompt delivery. Send \$24.95 to AB Audio, 1476 California St. Box 333, San Francisco, Calif. 94109.

PROPER TONEARM GEOMETRY!! Optimum offset angle, overhang, vertical pivot height and angle. Resonance damping construction. Jewelled pivots. Height adjustable while playing records. Effective mass 2.5 grams. Damped cueing. Anti-skate bias. TA-3A with silicone damping, \$149.00. TA-4A without damping (otherwise identical), \$124.00. "Universal" nylon hardware, \$1.00. alignment protractor, \$1.00. Prices include postage and money-back guarantee. JML Company, 39,000 Highway 128, Cloverdale, CA 95425



GARLAND AUDIO

"DISTINGUISHED FOR THE VERY FINEST"

THE EXQUISTE AUDIO PRODUCTS OF AUDIO RESEARCH, MARK LEVINSON, SEQUERRA, MAGNEPAN, GALE, GREAT AMERICAN SOUND, LUX, NAKAMICHI, QUAD AND MORE ARE OPTIMIZED AS A SPECIALTY OF OUR ART AS IS OUR HOSPITALITY AND SERVICE.

SAN JOSE

2960 STEVENS CRK. BL.
244-6724

BERKELEY

3101 TELEGRAPH AVE.
415-841-1591

TUE - FRI - 11 - 6, SAT - 10 - 5 AND BY APPT.

FOR SALE

\$595 *** \$595**

Complete recording session. With our recording staff band of five professional musicians, modern studios, backup singers, producer, pressing 1000 records on well-established label. With credit plan available to everyone, only \$595.

THAT RECORDING PLACE
P.O. Box 11032-BH
Memphis, Tenn. 38111

ESOTERIC PRODUCTS—New and used. Audio Research, Nakamichi, Ampzilla, Luxman, B&O, Dahlquist, Quatre. Write for list. STEREO SHOP, 107 Third Ave SE, Cedar Rapids, Iowa 52401

PERFECTIONISTS PREFER DYNAKITS

Before Purchase You Owe Yourself Our Quote Mainline 11a 971 Fronheiser, Johnstown, PA 15902

YOUR MAIL-ORDER TAPE SPECIALIST IN WASH. D.C. SAME DAY SHIPMENT-DISCOUNT PRICES-BASF, SCOTCH, MAXELL, TDK & CAPITOL. FREE PRICE LIST. SAXITONE TAPE SALES, 1776 COLUMBIA RD. N.W., WASH. D.C. 20009

SUPEX—ORTOFON—DENON—OTHER MOVING COIL CARTRIDGE OWNERS: Send for free literature on our Micro Preamp Superb performance at \$99.95. Huntington Electronics, Box 2009A, Huntington, Conn. 06484

RAPPAPORT PRE-1A, PS-1, MC-1 \$600; DBX 3BX \$350; Black Widow \$75; Audio Research D-100 \$650; Denon AU-320 \$75; Heath AJ 1510 \$250. (713) 892-3104.

Marantz 7c with walnut case (S/N 12531) and two Marantz nines (S/N 3006 & 3010). Performance and physical condition absolutely perfect. 314-966-6340

AUDIO RESEARCH D-76, recently retubed, fans included \$675. 1-804-484-7898.

BADAP-1 IS COMING!

THORENS TD-125 II AB Shure V-15 III. \$225.00 (215)535-1123

THE ABSOLUTE SOUND in its new issue, takes an extended look at Richard Sequerra's first loudspeaker, the Metronome 2, a direct-coupled amplifier from Kenwood; and the Infinity QLS-1. There's also a special report on four cartridges: Sleeping Beauty; the Supex SD 900e-Super; the Pickering XSV-3000; The Grado Signature 1-A. There are also major reviews of a Swiss amp, the FM Acoustics 800a; the Rappaport Pre-1 preamp; the Bravura preamp; Son of Ampzilla; the Dynaco Mk VI tube amp; the Dahlquist passive crossover; the Allison One; the Advent 300; the Marantz 510 basic amp; the Satin M-18 moving coil cartridges; the RTR ESR-15 electrostatic tweeter, and more. Including the Denon DP-3000 turntable; the Sony TC 800-2 tape recorder; the Elac SLS-555E cartridge; and the Power Research System 3-c speaker system. And still more. Including an updated look at the Linn-Sondek turntable and a comparison of the J.H. Formula 4 vs. the Mayware "Formula 4." Among other things, there's an interview with Robert Ludwig, often called the U.S.'s best cutter of master discs.

The price? \$16 (four issues, first class), \$17, in Canada. \$18 (Outside North America, air). Check or money order to The Absolute Sound, Dept. A, Box 5, Northport, N.Y., 11768. Coming up: A new issue that includes a comprehensive report on mini-monitors; the Beveridge electrostatic; the Tympani I-D; the Spondor BC-1; the Grado Signature II; a round-up on Direct Discs, the Denon Pulse Code Modulated Discs, the Gale records, the Mark Levinson records. And more.

WHAT IS AUDIOMART? Audiomart is the unique audio newsletter that doesn't charge for classified ads! Buy, swap or sell your used gear and accessories without cost-per-word worry or two month delays! Subscribe today: \$6/12 issues. Audiomart, Box 821, Stratford, Connecticut 06497.

FOR SALE

AMPEX TAPE—NEW 1800' on 7" reel 12 for \$18 POST-PAID, 1200' 12 for \$13 POSTPAID—free list—WIDE RESPONSE, 6114A, SANTA MONICA BLVD., HOLLYWOOD, CA 90038

Northern N.J.'s finest store—Lux, Mod DQ-10, IMF, Grace, B&W, G.A.S. Sleeping Beauty, FR, B&O, Linn Sondek, Janis and more. University Stereo, 57 E. Ridgewood Ave., Ridgewood, N.J. 07450 20 minutes from the G.W. bridge. 201-447-5700.

FOUR ELECTROSTATIC 139 speakers; 1 L E E 1955 Klipsch; 1 large 1955 #7 Klipsch; 1 Marantz 1955 Model 2 tube amplifier and Model MC-30 tube preamp; 1 3D watt tube McIntosh 412-682-7732.

LOWEST PRICES, BEST SELECTION. All esoteric, 225+ Brands. We'll try to beat any legit price. VTR's, TV's, Calculators. Write for Quotes now. Stellar Sound P.O. Box 49285 Austin, TX 78765

WE'RE OVERSTOCKED and must sell at or below cost, all new, any quantity: Pioneer: PL550 \$210, PL570 \$240, SPEC 1 \$540, SPEC 2 \$300, RT 2022 \$795, TX 6500 \$107, CTF 2121 \$126; TEAC: A23405 \$526, Model 2 Mixer \$226, Marantz 2265 \$327, Technics SA5170 \$149, Phase 400 \$375, Phase 4000 \$449. Much, much more. Call or write STEREO CLEARANCE HOUSE, 2761 Bedford St., Johnstown, PA 15904 (814) 536-1611.

LEACH WIDE BANDWIDTH PREAMPLIFIER preassembled and tested circuit boards. RIAA Board \$35, Output Board \$25, Center Channel Board \$15, Regulated Power Supply Board with transformer \$35, plus \$1 shipping. Components, Box 33193, Decatur, Georgia 30033.

WHAT IS BADAP-1?

NEW! Stereo A-B Test Comparator Model 101

LAB-TYPE A-B LISTENING TESTS NOW POSSIBLE ANYWHERE.

After you've seen the specs you must hear the sound. And the most accurate way to judge what you're hearing is through lab-type A-B comparison listening tests.

The new stereo A-B Test Comparator makes such tests possible anywhere, quickly, conveniently, accurately. Compact unit connects into system with ordinary speaker wire and patch cords.

Allows you to test two stereo pairs of speakers and most stereo amplifiers or receivers.

Order your Model 101 Test Comparator today! Send \$49.50 plus \$2.50 for handling and shipping to MARTIN RESEARCH, P.O. Box 2007, Agoura, Ca. 91301. (Calif. residents add 6% sales tax).

Audio Research Laboratories. Courtesy Discounts Available for Quantities.

BUY HI-FI COMPONENTS THE MODERN WAY:

PHONE & MAIL
Call TOLL FREE or write for LOW PRICES

Nationwide **800/854-7769**
California **800/472-1783**

Approved by Phone

MCK SALES
250 N THOMAS, PO BOX 2100
POMONA CA 91766

TUNERS SONY ST5000FW \$180 FISHER 200 R \$60 206-232 2040

NEW JERSEY—NEW YORK AUDIOPHILES: Audition the SNELL ACOUSTICS TYPE A LOUDSPEAKER SYSTEM. Proclaimed the finest system currently available, judge for yourself. Demonstrations in a living room environment by appointment. G-B ELECTRONICS, P.O. Box 385, Hawthorne, N.J. 07507 (201) 427-8885 evenings & weekends. Literature available.

AN AUDIOPHILE PREAMP FOR \$495? Can't be done? You haven't experienced the SYSTEM-E from PARAGON. This basic preamp excels at one very essential function, preserving and reproducing every last nuance and subtlety from your record grooves. Our exclusive Ultra-Linear Cascode front end will preserve and amplify ALL the information without shaving off the important depth, space, and delicate tonal information which is the true essence of live music. You may discover, as we did, that your present records are better than you thought. PARAGON, one word says it all. For more information write: PARAGON 997 E. San Carlos Ave., San Carlos, CA 94070

AUDIO RESEARCH • JANIS • GALE • BREUER
 • TECHNICS • **Audio Hi-Reference Systems** • MAGNEPAN •
 808 • 732-3303 • Kahala Office Center
 Suite 201 • Honolulu, Hawaii 96816
 ROGERS • GREAT AMERICAN SOUND • SONEK

RABCO SLBE OWNERS-Ultimate modification features adjustable 15-gram tone arm gimbed in jewels. Effective mass 2½ grams. Redesigned centering device. \$295.00. Complete modification \$395.00. Wheaton Music, 2503 Ennals Ave. Wheaton Md., 20902. 301-949-1115

COMPONENTS FOR THE CONNOISSEUR

Acoustat X	Great American Soud
Beveridge	Leach
Dahtquist	Paragon
Janis	Quatre
R 149	Rappaport
Koss	Ariston
Magnapan	EMT
M & K	Formula 4
Polk	Goldring
Rogers	Grace
Snell Acoustics	Grado Signature
Spendor	Linn Sondak
Visonik	Sonus

PAUL HEATH AUDIO
 354 STATE STREET
 ROCHESTER, NY 14608
 (716) 232-2828

MARANTZ 7, 8, 10B. CITATION I. CROWN VFX-2 (215) 688-2047 evenings

PROTECT YOUR LPs. Poly sleeves for jackets 9c. round bottom inner sleeves 7c. Poly lined paper sleeves 15c. White jackets 35c. Postage \$1.50. House of Records, Hillburn, New York 10931.

DHM A WALSH TRANSMISSION LINE LOUDSPEAKER. STATE OF ART REPRODUCTION. BEST OFFER (703) 563-1333 ROANOKE, VA.

Accuphase (200 & P300) Perfect condition. \$900 & ship (417) 883-5725. Trade accepted on Tandberg 10 x or Nakamichi 700 II or 1000 II. Ronald G. Benson, 4372 Valley Dr., Springfield, Missouri 65804.

SPEAKERCRAFT

of Oregon

1st CLASS SPEAKER KITS

... NO HORNS ...
 ... NO CHEAP IMITATIONS ...
 ... NATURAL SOUND ...
 ... 7 MODELS ... SUB WOOFER ...
 ... EASY TO BUILD ...
 ... MONEY SAVING ...

SEND FOR FREE CATALOG

P.O. BOX 13460
 PORTLAND, OREGON 97213
 (1-800-547-5534)
 (1-503-232-1956)

Advertising Index

Advertiser	Page	Advertiser	Page
ADS Loudspeaker Systems Enter No. 1 on Reader Service Card	109	Definitive Systems Hi-Fi Systems Write Direct to Advertiser	114
Ace Audio Hi-Fi Components Write Direct to Advertiser	134	Discount Music Record Club Write Direct to Advertiser	111
Akai Hi-Fi Components Write Direct to Advertiser	101	Discwasher Moving Coil Cartridge Write Direct to Advertiser	2
Allison Loudspeaker Systems Enter No. 3 on Reader Service Card	18	Dixie Hi-Fi Audio Mail Order Enter No. 57 on Reader Service Card	119
Altec Loudspeaker Systems Enter No. 4 on Reader Service Card	103	Dolby FM Write Direct to Advertiser	53
Astor Tower Hotel Write Direct to Advertiser	119	Dual (United Audio) Tonearm Enter No. 11 on Reader Service Card	37
Audio Critic Publication Write Direct to Advertiser	100	Eastman Sound Loudspeaker Systems Enter No. 12 on Reader Service Card	12
Audio Excellence Hi-Fi Components Write Direct to Advertiser	135	Empire Phono Cartridge Enter No. 13 on Reader Service Card	61
Audio General Hi-Fi Components Enter No. 5 on Reader Service Card	110	Fantasy Sound Audio Store Write Direct to Advertiser	122
Audio One Hi-Fi Components Write Direct to Advertiser	121	Fisher Tape Deck Write Direct to Advertiser	84
Audio Reference Hi-Fi Components Write Direct to Advertiser	126	Fuji Magnetic Tape Enter No. 14 on Reader Service Card	79
Audio Systems Hi-Fi Components Write Direct to Advertiser		Garland Audio Audio Store Write Direct to Advertiser	124
Audio-technica. Direct to Disc Write Direct to Advertiser	4, 38, 47	Garrard (Div. of Plessey Consumer Products) Turntables Enter No. 15 on Reader Service Card	21
Microphones Write Direct to Advertiser		H&H International Loudspeaker Systems Write Direct to Advertiser	123, 133
Demo Record Enter No. 55 on Reader Service Card		Hammond Headphones Enter No. 16 on Reader Service Card	96
Audioworks Hi-Fi Components Write Direct to Advertiser	133	Henry's Audio Store Write Direct to Advertiser	137
Avid Loudspeaker Systems Enter No. 6 on Reader Service Card	80	High Definition Recordings Recordings Write Direct to Advertiser	121
B&F Speaker Kits Enter No. 60 on Reader Service Card	110	Hitachi Receiver Enter No. 17 on Reader Service Card	51
B&W Loudspeaker Systems Enter No. 7 on Reader Service Card	98	IAR Publication Write Direct to Advertiser	131
Ball Record Preservation Kit Write Direct to Advertiser	25	International Hi-Fi Dist. Hi-Fi Components Write Direct to Advertiser	132
Bang & Olufsen Hi-Fi Components Enter No. 56 on Reader Service Card	115	J&R Music Audio Mail Order Enter No. 18 on Reader Service Card	117
Bose Loudspeaker Systems Write Direct to Advertiser	72, 73	JVC Hi-Fi Components Enter No. 50 on Reader Service Card	32, 33
Chestnut Hill Audio Audio Store Write Direct to Advertiser	134	KEF Hi-Fi Components Enter No. 19 on Reader Service Card	26, 27
Continental Specialties Proto-Board Enter No. 8 on Reader Service Card	49	Kenwood Cassette Decks Write Direct to Advertiser	31
Crown Hi-Fi Components Enter No. 9 on Reader Service Card	75	Koss Loudspeaker Systems Enter No. 21 on Reader Service Card	104, 105
Custom Stereo Audio Store Write Direct to Advertiser	136	L.T. Sound Hi-Fi Components Write Direct to Advertiser	132
dbx Dynamic Range Expander Enter No. 10 on Reader Service Card	67-70	Lawaco Wire Write Direct to Advertiser	121
Decoursey Electronic Crossovers Write Direct to Advertiser	122		

Advertising Index

Advertiser	Page	Advertiser	Page
Lux Hi-Fi Components Write Direct to Advertiser	57	SAE Hi-Fi Components Enter No. 36 on Reader Service Card	55
McIntosh Catalog Enter No. 22 on Reader Service Card	115	Sansui Hi-Fi Components Enter No. 37 on Reader Service Card	64,65
McKay Dymek Hi-Fi Components Write Direct to Advertiser	125	Shure Hi-Fi Components Enter No. 38 on Reader Service Card	107
Marantz Amplifier Write Direct to Advertiser	138, Cov. III	Sonab Hi-Fi Components Enter No. 39 on Reader Service Card	45
Martin Research Record Cleaner Write Direct to Advertiser	125, 137	Sonic Research Hi-Fi Components Enter No. 40 on Reader Service Card	14
Switching System Write Direct to Advertiser		Sonikit Speaker Speaker Kits Write Direct to Advertiser	120
Maxell Magnetic Tape Enter No. 23 on Reader Service Card	15	Sony Corp. Hi-Fi Components Enter No. 41 on Reader Service Card	43
Micro Acoustics Hi-Fi Components Write Direct to Advertiser	6	Sound Components Hi-Fi Components Write Direct to Advertiser	123
Mitsubishi Hi-Fi Components Enter No. 24 on Reader Service Card	40, 41	Soundcraftsmen Hi-Fi Components Enter No. 42 on Reader Service Card	5
Modern Design Disc Lock Write Direct to Advertiser	122	Speakercraft Speaker Kits Write Direct to Advertiser	126
Mobile Fidelity Recordings Write Direct to Advertiser	135	Speakerkit Speaker Kits Write Direct to Advertiser	124
Nakamichi Hi-Fi Components Enter No. 25 on Reader Service Card	19	Speakerlab Speaker Kits Write Direct to Advertiser	123
New Dawn Publication Write Direct to Advertiser	106	Studer/Revox Reel to Reel Tape Recorder Enter No. 43 on Reader Service Card	35
Nikko Hi-Fi Components Enter No. 26 on Reader Service Card	63	Sumiko Hi-Fi Components Enter No. 44 on Reader Service Card	20
Ohm Loudspeaker Systems Enter No. 27 on Reader Service Card	54	TDK Magnetic Tape Enter No. 45 on Reader Service Card	17
Onkyo Enter No. 66 on Reader Service Card	77	Take 5 Audio Store Write Direct to Advertiser	124
Ovation Audio Audio Store Write Direct to Advertiser	136	Tandberg Hi-Fi Components Enter No. 46 on Reader Service Card	97, 99
PS Audio Hi-Fi Components Enter No. 51 on Reader Service Card	113	Hi-Fi Components Enter No. 47 on Reader Service Card	
PAIA Hi-Fi Components Enter No. 28 on Reader Service Card	118	Tape World Tapes Write Direct to Advertiser	136
Phase Linear Analogue Delay Write Direct to Advertiser	11	Teac Cassette Decks Write Direct to Advertiser	7
Pickering Hi-Fi Components Enter No. 29 on Reader Service Card	3	Technics Hi-Fi Components Enter No. 48 on Reader Service Card	Cov. IV
Pioneer Reel to Reel Tape Deck Enter No. 30 on Reader Service Card	Cov. II, Pg. 1, 117	That Recording Place Recording Studio Write Direct to Advertiser	125
Receiver Enter No. 31 on Reader Service Card		3M Magnetic Tape Enter No. 49 on Reader Service Card	23
Playback Mail Order Enter No. 32 on Reader Service Card	117	University of Sound Arts School Write Direct to Advertiser	135
Primo Microphones Enter No. 33 on Reader Service Card	113	West Side Electronics Hi-Fi Components Write Direct to Advertiser	134
Qysonic Loudspeaker Systems Enter No. 34 on Reader Service Card	113	Yamaha Hi-Fi Components Write Direct to Advertiser	39
Radio Shack Hi-Fi Components Write Direct to Advertiser	13		
Rhodes Teledapter T.V. Sound Tuner Enter No. 35 on Reader Service Card	118		

FREE details A DIFFERENT KIND OF RECORD CLUB

Discounts up to 73%, no "agree-to-purchase" obligations. All labels, Schwann catalog of thousands of titles; classical, pop, jazz, country, etc. Discount dividend certificates. Newsletter; accessories; quick service. 100% iron-clad guarantees. Write for free details.

DISCOUNT MUSIC CLUB, INC. DEPT. 14-0478
650 Main Street, New Rochelle, N.Y. 10801

CONNECTICUT: ADC-Accutrac, Advent, Audio Pulse, B&O, B.I.C., Citation, Dahlquist, Epicure, Harman/Kardon, J.B.L., McIntosh, Nakamichi, Ortofon, Phase Linear, Sony, Stax, Tandberg, Yamaha, Cizek, Sonus. Will ship prepaid. Sounds Incredible, 226 White St., Danbury, Conn., 06810. (203) 748-3889—phone quotes only.

3600' NEW L/N SCOTCH or Ampex tape, 10 1/2" metal reels 5 for \$38.00 12 New Ampex 42 min. 8 Tracks \$9.00. 6 New Ampex 370 C-60 cassettes in Stackette \$5.50. C-90 \$6.50. Sound. Peachtree DeKalb Airport, Chamblee, Ga. 30341

Magnepan MG II's \$500. SP-3A-1 \$400. AMPZILLA \$475. (919) 768-5354.

THORENS TD-160C in sealed carton, \$159. Sony TA-3200F mint, \$249. Quintessence preamp, \$235. Willner, 233-B# 4 Thayer, Providence, R1 02806. (401)-521-2072.

Sony 8550 V Fet Power Amp \$650. D B Pre Amp \$350. 1-218-741-0167

SAE MK IM, PERFECT IN MAC CLINIC 1 YEAR OLD CDST \$660. ASKING \$350 OR BEST 209-897-3863.

YAMAHA B-1 V FET AMPLIFIER WITH UC-1 CONTROL UNIT AND RU-1 KIT. MINT \$1200.00 (513)-325-2681 AFTER 6:00 P.M. EST

SONY 8550 V Fet Power Amp \$650. DB PreAmp \$350. 1-218-741-0167

CROWN SX800 2TRACK RECORD 4 TRACK PLAY. UNIVERSITY C15W UNIVERSITY COBRAFLX T30 DRIVER DYNACO FM3-518-643-2416-6-7 P.M.

CROWN RECORDERS FOR SALE 1 800 series 4 channel CX electronics 1 700 series 2 channel- Masteroom Studio B Reverbation unit. AKG Mikes call after 5:00 P.M. 919-274-3851

Son of AMP-\$300, Nak. 410 preamp-\$200-mint 402-435-5253



Are you being hoodwinked by misleading A-B comparisons in underground subjective reviews?

IAR 3 is destined to become a classic. After the shock waves settle, the science of reviewing audio equipment will be forever changed.

Penetrating investigative journalism at its Finest

International Audio Review
2449h Dwight Way Berkeley Ca 94704 USA

Four issue nos. \$25, eight \$45. Surcharges: first class \$10, overseas surface \$10, air \$20. Bank credit cards accepted.

BIG DISCOUNTS

FOR THE BRANDS THE OTHER DEALERS CAN'T GET...

STEREO COMPONENTS
Largest Selection of Top Name Brands

•Phone Orders shipped within 24 hours
(No deposit required)

•Trade-ins Accepted •Lemon proof Guarantees.



IT'S WORTH
A CALL

(301) 488-9600

9 to 9 DAILY 9-4 SATURDAY

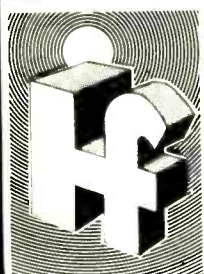

INTERNATIONAL
HI-FI
DISTRIBUTORS
INC.

MORAVIA CENTER
INDUSTRIAL PARK
BALTO., MD. 21206

new
model 35^x 2
stereo music amplifier



10 x 35 Watts=350 Watts. But 10X the power of this amplifier sounds only 2X as loud. So why pay for that expensive big amplifier you may not need? Write for the whole story in our FREE CATALOG of kits and wired units.

ACE Audio Co.

- 35^x 2 power amp
- stereo preamps
- equalizers

#532 5th Street,
East Northport, N.Y. 11731

YAMAHA B-1 amp—\$1200. Marantz 500 amp - \$700. Brad Orison, 130 Second St., Athens, OH 45701. Phone (614) 592-1149 after 6 pm.

FOR SALE

THE HI-FI GAME is a board game that explores the total audio experience. Players buy, sell, and trade, equipment, invest in hi-fi industries, exchange the latest gossip, and follow the newest trends as they compete to build their ultimate super-systems. Playing time: 2-4 hours. \$11.95 to Penjon Games, Box 2129, Martinez, CA 94553 (Californians: add sales tax).

Hartley 24" woofers. Custom walnut by Hartley. Flawless. \$1200 pair plus shipping. 401-724-8486 evenings.

Panasonic, Sony, Sanyko, RCA, and much more at way below retail prices!!!!!! Factory sealed cartons, full warranties, immediate delivery. 162 page, illustrated catalog, \$3.50 (refundable) Tom Kim, 4139 Pascal, Palos Verdes, CA 90274

TAPCO and ELECTRO-VOICE, mixers, equalizers, amps, mics, and loudspeakers. Write for low mail order prices. Sonix Co., P.O. Box 58, Indian Head, MD 20640

ATTN: constructors of LEACH Amps from the AUDIO articles: parts sources, newsletter and details on factory built 100 w/ch LEACH. TA, Box 90 RRI, Surry, ME 04684

IN ILLINOIS—AUDIONICS, RDGERS JR 149, FOLK SPEAKERS and SOUNDABLE, Formula 4, Leach, Dynaco, Connoisseur, Promethean, Goldring, M & K. SYSTEMATIC SOUND, 512 Bridge Street, Rockton, Illinois 61072. (815) 624-4902

Premium blank cassettes, custom loaded, Scotch 8210, Agla 69, MM TM-100. Three C-60 samples, specs, quantity price list \$3.50. MFP Audio, 4700 Overwood Circle, B'ham, AL. 35222.

KEITH MONKS AUDIO ACCESSORIES: Complete leveling kit with adjustable feet and spirit level. . . \$14.00. Record Sweeper for dust removal that also dissipates static charge. . . \$18.00. Professional Record Cleaning Machine with lid. . . \$1,470.00. Plastic lined sleeves also available. No charge for shipping. For additional information, contact Audio Reproduction, 217 College Ave., Blacksburg, Va. 24060 (703) 552-6850.

EXCEPTIONAL OFFERING, like new: (24) Ampex 351 Electronics, both masters and slaves operational, last alignment was for Ampex 406 tape. (12) Scully 280 B's. EMT 930 turntable with extras. Revox A-77 2-track deck. (13) Dynaco Mark III power amps. (4) Dynaco model 70A stereo amps. (2) Dynaco Mark IV amps. Cinema Eng. type 9205-A degausser, ten inch reel size. Sony 1 inch color video recorder model EV-320 plus CLP-1B video color pack. (1) JBL 5305 Pro-mixer. The original NORDEN BOMBSIGHT. (1) Philips Sound Delay Machine model EL 6911/02. (5) Technics turntables SL 110 A. Contact:
CINEMA/SOUND LTD. 212-799-6940.

Audio and TV tubes factory boxed, speakers, semiconductors—low prices, free price list. Translertonic Inc., 1365-39th St. Brooklyn, N.Y. 11218 212-633-2800

USED MINT: GAS Thaedra, Lux PD 121 Turntable, Grace 704 Arm, Yamaha CT 1010, Nakamichi 600. (512) 471-3015

MZ M00 3—a new "State of the Art" speaker from Precedent Audio Products sold as a two or three way system. Superb musical reproduction and an ingenious design. Now at PARAGON OF SOUND. The incomparable BERNING tube-transistor amplifier and the Paragon 12A preamp available too. Call (301) 229-2676 (Bethesda, MD) or write P.O. Box 189, Cabin John, MD 20731.

STAX DA300 class A power amp. B. Duca, P.O. Box 93, Beverly, NJ 08010. (609) 386-7041.

LUX M-4000 AMP, \$995. LUX C-1000 PREAMP, \$595 and NAKAMICHI 1000, \$845. All are in perfect mint condition and less than 1 year old. Call (612-027-6444)

SONY TAE-8450 V-let pre-amp. \$900.00 or negotiate. Reply to Box 842. c/o AUDIO.

A SINGER'S DREAM!



REMOVES VOCAL FROM MOST STEREO DISCS
The Thompson Vocal Eliminator can actually remove most or all of a solo vocalist from a standard stereo record and yet leave the background music virtually untouched! Not an equalizer! We can prove it works on the phone. Write for a brochure and demo record below. **COST: \$195.00**

ECHO

We do it BETTER FOR LESS
You know how fantastic the quad results are. Works with even a mono source! We utilize the LATEST advances in analog delay to produce better bandwidth and longer delays. Only direct sales make price possible. Guaranteed results. Price \$299-\$425 several models. Write for Brochure and demo record. Include \$1.00 to cover costs (refundable with purchase).
Write to: L T Sound, Dept. AU, P.O. Box 1061, Decatur, GA. 30031 (404) 377-9595

CANADA'S lowest prices on name brand components. Free price lists. Audio-Smith, Box 497 Surrey, B.C. Canada

LOWEST PRICES: BOSE, SAE, NAKAMICHI, PHASE LINEAR AND MANY MORE. QUOTE FROM DYNAMIC SOUND, BOX 168, STARKVILLE, MS 39759

MC INTOSH - collector's item. Their 1st amp, 2o w2. 30 yrs. old w/orig. factory rack mt. Mint. Best offer. (516) 593-7153 eves.

HIGHEST QUALITY USED EQUIPMENT
Revox A700 \$1250— Tandberg 2075 rcvr \$850—IMF TLS80 \$640 ea.—IMF TLS50-I \$260 ea.—Yamaha CT7000 \$800—AR3a \$150 ea.—Audio Research EC4 \$150 Luxman C350 \$350—Quad FM3 \$190—Quad 303 \$125—Luxman CL350 \$595—Luxman M2000 \$750—B&O 4002 \$525—B&O M70 \$495/pr. Marantz 18 \$325—JBL Aquarius \$350 ea.—Sony 5000F tuner \$180 Tandberg 6000X \$300—Luxman 3045 tube amps \$350 ea.—AR10PI \$250 ea.—Jeklin Floats \$150—Marantz 4300 rcvr \$350—Marantz 3600 pre-amp \$300.

All used equipment guaranteed 90 days parts & labor. AUDIO CONSULTANTS, INC. 517 Davis St., Evanston, IL 60201 (312) 864-9565.

QUALITY USED EQUIPMENT: ARC SP-4 preamp, \$595; Spendor BCII Speakers, \$395; Lux CL32 preamp, \$439; Technics SP-10 Turntable with Base and Cover, \$295; Decca Arm, \$60; ERA Turntable (New), \$99; Tandberg TR2075 Receiver, \$725; Technics SA5460 (new), \$250; Fidelity Research MKII Cartridge, \$60; Nakamichi MCB1000 Transformer, \$48, and Denon 103C (new) \$89. THE TIN EAR, 704 Symons, Richland, WA 99352. (509) 946-4459.

MILWAUKEE! the Audio Emporium, 6900 W. Brown Deer Rd., where ears and minds are open. Audio Perfection Cables, Audio Research, Bang & Olufsen, Connoisseur, Dahlquist, Decca, Genesis, Grado, Gralyx, GAS, Lux, Magnepan, Polk, Revox, Sonus, Technics. Tues. thru Sat. 10-6 or by appointment, 354-5082

NEW PR. OHMF. Full warranty. \$850 Cash or trade for mint DQ10, DQ1W, DQM1 or equiv. Day (318) 728-4113. B. Calvert, BX 578, Rayville, LA 71269.

NAKAMICHI 500 - \$350. Mint cond. Eric Watkins, 2712 Kelly Ave., Gulfport, Miss. 39501. (601) 863-3728.

JBL PARAGON-WALNUT. Mint; perfect, \$2495.00. Phone (203) 929-5255 or write Box 9, Huntington, Conn. 06484

STEREOPUS Our latest issue is out! Reviews include the B & W DM-6, Infinity QLS, Sonex II, Koss Two and Rogers LS3/5A loudspeakers, Audio Research (solid-state) electronics, Ampzilla II and RAM power amps, the DB Systems and Nakamichi preamps, and much, much more. New full magazine size format. With all the review magazines around, why do you need another? Try us and see! Subscriptions: \$10.00 (12.50 first class), \$12.50 Canada, \$16.00 overseas (air mail). Five issues (two large, three smaller) per. P.O. Box 509, Shalimar, Florida 32579.

SOA CAR RADIOS—Custom modification of AM and FM car radios. Bandwidth, sens., AGC, AFC mod's on most non-cassette units. Pioneer GX-5050, etc. Write: Boxton, Box 43, Del Mar, CA 92014.

New Dayton-Wright SPA preamp, Revox A-700 recorder sacrifice for reasonable offer (201) 746-2794

FOR SALE

DISCOVER DEEP BASS

MILLER AND KREISEL SOUND CORPORATION

SUB WOOFERS CROSSOVERS AUDIOPHILE RECORDS

M&K MAKES 12 MODELS OF SUB-WOOFERS RANGING FROM \$125 TO \$465-ALL UTILIZING M&K'S NEW DOUBLE VOICE COIL

MATRIXING (DVCM)

- Goliath I-Walnut cabinet and audiophile woofer, built in DVCM matrixing and crossover adjustable to 150, 125, 100, 75 and 50Hz on back plate. Designed to be used with Magneplanars, Quads, Dahlquists, B&W's, Acoustats, etc.—\$315.00

- Goliath II-Simulated walnut cabinet. Uses a high power capacity 12" bass driver and the same 5 frequency, adjustable matrixing crossover—\$175.00

- BE-1B-Walnut cabinet audiophile woofer. No crossover network. Includes DVCM. To be used with same speakers as Goliath I. Requires external crossover or biamping. \$230.00

- DBE-1B-6db higher output limit and twice the efficiency of the BE-1B. Contains 2 drivers. \$425.00

- BE-II-Same as Goliath II but without crossover network. Includes DVCM. \$125.00

- Studio Standard-Features 125 SPL @ 40Hz for studio monitors. Contains 4 drivers. \$465.00

- All M&K Sub-woofers are aligned 2nd Order Butterworth (B2) maximally flat ($f_c = f_3$). They are designed particularly for "tight" bass, transient detail, and very low overhang and decay time.

- Today's market offers some superb small super-speakers; small in cabinet size but large in power handling capability and great in transparency and imaging. Together with an M&K Sub-woofer (hidden in a corner), one hears a clean, big sound competitive with the world's finest large speaker systems. M&K particularly recommends that their sub-woofer be used with ADS, Braun, KEF Corelli, Rogers LS 3/5A, Jim Rogers JR 149, Visonik, Sponder and others of the top quality

- M&K, THE SUB-WOOFER SPECIALISTS, INTRODUCE DOUBLE VOICE COIL MATRIXING

Previously, single sub-woofers reproduced bass from both stereo channels by combining the channels at high level using a transformer. Now M&K has eliminated the transformer, thus gaining increased output, punch and linearity. Each channel of a stereo amplifier can feed a separate voice coil though separate input terminals. This dual input design combines the 4 Ohm level power output of both channels of a stereo amplifier into a single woofer. You do not need a bridging adaptor and you avoid wasting half the amplifier power when bi-amping.

- All current stocks of M&K sub-woofers offer this feature. They still have the same superb "tight" low bass detail and absence of coloration of our earlier drivers. With the Bottom End Series, bi-amping is readily carried out without a higher power level matrix or crossover network. The Goliath Series carries an internal crossover network, but can also be bi-amped.

- M&K ALSO INTRODUCE THE LP-1 PASSIVE CROSSOVER NETWORK FOR BI-AMPING STEREO SYSTEMS

Completely passive (no transistors, tubes, op-amps or power supply), yet unlike resistive-reactive passive networks (usually at 6db per octave), the LP-1 has virtually no loss in the pass band and provides 12db per octave from low pass to high cutoff and 18db per octave from high pass to low cutoff (to protect small high-end speakers against excessive bass drive) if you want the exceptional dynamic range advantages of bi-amping, but wish to maintain the superb mid-range and high definition your expensive pre-amp and amplifier produce, you can avoid adding further active stages in the chain by using the unique passive LP-1. It's getting raves from Golden Ear Audiophiles. \$120.00

- The M&K Bass Ramp uses the same elements as the LP-1 crossover in a configuration to drive a single amplifier with adjustable bass & high levels to permit Bottom Ends to be used with high efficiency speakers such as Altec, JBL, KLIPSCH, Tannoy, etc. and allows the full power of your amplifier and its full damping to be available to all speakers. M&K Ramp R-1 \$95.00, M&K Ramp R-2, \$115.00 (Rear Connections.)

- M&K utilizes automatic charted laboratory instrumentation for frequency response, harmonic and intermodulation distortion, phase, tone burst and other transient testing, and calibrated instrument for SPL. Its new recording facility includes a Georg Neumann disc cutting lathe with passive mixing and state-of-the-art electronics. Write for information on new direct-to-disc and other audiophile releases. Currently very popular is the new M&K Bottom End Musical Bass and Transient Test Record, Vol. II. By direct mail, \$7.50 plus \$1.00 postage. See all of the above at your nearby M&K dealer: **MILLER & KREISEL SOUND CORP.**, 8719 Wilshire Blvd., Beverly Hills, Calif., 90211 213-652-8318

- M&K announces the Bass Cube Series, a new line of sub-woofers designed to complement fine furniture and great audio systems. Available in real walnut or rosewood in all standard M&K sub-woofer types. See your nearest M&K dealer.



Professional specialists in high resolution music reproduction.

Bryson
Verion Audio
Sponder
Connoisseur

Grace
Rappaport
Hafler
Symdex

Fons
Snell Acoustics
Denon
Stax

Gale
Russound
Entré I

audioworks

Box 4314
Harrisburg, PA 17111
Phone: 717/652-6996

WESTCHESTER, FAIRFIELD COUNTY THE LISTENING ROOM INC.

590 Central Park Avenue
Scarsdale, N. Y. 10583
(914) 472-4558

Cordially invites you to audition our fine line of equipment. DAHLQUIST • DAYTON WRIGHT ESL • DYNAVECTOR • THRESHOLD • PHASE MATRIX • SNELL ACOUSTIC • YAMAHA • TANDBERG • LUX REFERENCE • QUAD ESL • KEF • GRACE • SAEC • FORMULA 4 • AMPZILLA II • THAEDRA • SON OF AMPZILLA • THOEBE • POLK AUDIO • NAKAMICHI • DENON • STAX • JANIS • PARAGON • BRYSTON • DBX • AUDIO PULSE •

THRESHOLD 400 A CLASS A AMPLIFIER

We ship free anywhere in the U.S. We invite inquiries.

CODE-A-PHONE Answering Machines. Shipped Prepaid and Insured. Immediate Delivery. Call for Low Prices. AN AUTOMATIC ANSWER (408)649-0099, Ca. (800)682-4844.

AUDIOGRAM, THE BI-MONTHLY newsletter that brings you reviews, news, and our views of today's audio world. \$15.00/6 issues. Free information—Write—Audiogram, P.O. Box 27406, St. Louis, Mo. 63141

CAR STEREO—lowest prices anywhere, top name brands. Pioneer, Craig, JIL, Jensen. Write for FREE catalog. MUSIC TREE, 616 Regester Ave., Balto., MD 21212.

E.S. AUDIO MEANS NEVER HAVING TO SAY YOU'RE SORRY. We offer complete pre-delivery check-out of the finest audio components. AR, ADS, Dynaco, Dahlquist, Decca, Grado, J.H. Arms, Grace, Kenwood Pro, M & K, Onkyo, Paragon, Rappaport, Quatre, Sonus, Supex, S.A.E., Trevor Lees, Armstrong plus used equipment. Call or write us.

E.S. AUDIO
8801 Hickman Rd.
Des Moines, IA 50322
(515) 278-8865

STEREO SHOPPER'S "SURVIVAL KIT"—\$5 POSTPAID. Read BEFORE you buy! Satisfaction guaranteed. SCC, Box 8014 (AM478), Canton, OH 44711.

STEREO COMPONENTS AT OR NEAR DEALER COST. Stamp for details. SCC, Box 8014 (AM278), Canton, OH 44711.

AUDIO BARGAINS—FREE LIST. Stamp please. SCC, Box 8014 (AM173), Canton, OH 44711.

NORTH CAROLINA

A complete selection of high quality components for the discriminating music lover. For your pleasure, we offer two locations drawing audiophiles from the Blue Ridge to the Atlantic, knowledgeable staff with decades of combined experience, and these fine products:

DBX	ANALOG ENGINEERING ASSOCIATES
AVID	DCM TIME WINDOWS
STAX	MICRO-ACOUSTICS
DENON	AUDIO ANALYST
REVOX	CONNOISSEUR
SONUS	KEITH MONKS
LUXMAN	YAMAHA
VISONIK	HAFLER
ACOUSTAT	FRIED
RAPPAPORT	CROWN
DYNAVECTOR	ONKYO
LINN SONDEK	GRACE
LINN MODIFIED 707	SUPEX
PHASE LINEAR	REGA

PLEASE VISIT ONE OF OUR SHOWROOMS
STEREO SOUND

175 E. Franklin St.
Chapel Hill, N.C. 27514
(919)942-8546

122 Oakwood Dr.
Winston-Salem, N.C. 27103
(919)722-9201

ULTIMATE QUALITY MATED SYSTEM USED 100 HOURS ONLY. Special finish walnut Klipschorns. Crown 1C150 preamp & Crown 84 watt amp. Revox Dolby A77 tape deck/revox DT480 headphones. Fisher FM 200B stereo tuner (rare collectors item—guaranteed mint condition) RMS antenna. Numerous tapes. Soundcraftsman 20-12 equalizer. Lifetime warranties available. Serious offers only please. (315) 343-4482.

STUDER REVOX A70D 4 track tape deck with remote control, mint, in warranty \$1395. 305-987-7819.

BEDINI/STRELIOFF:

OUTSTANDING ELECTRONICS IN AN ALREADY EXCELLENT FIELD

Why not a catchier (and certainly easier-to-pronounce) name for our line? Simply because—like craftsmen from earlier times—we are proud of our product and are honored to display our names on every hand-crafted unit we make.

We have specifically avoided "geegaws" and eye-catching goodies that contribute nothing to the sonic qualities of our equipment. So you will find no meters or elaborate LED displays on our amplifiers. We have also avoided employing "current clamping" circuitry (frequently characterized by terms such as "output protection devices") and the like because they audibly degrade the sound of an amplifier. (Instead we use fast-acting fuses which work very well). And we have developed the best-sounding circuitry that the "state-of-the-art" permits without espousing recent fads.

Our 100 w.p.c. and 200 w.p.c. amplifiers (extremely conservatively rated) feature a truly modularized design. Basically, each of our stereo amplifiers consists of a single, incredibly-overbuilt chassis, containing two independent monaural amplifiers, each one on a completely separate chassis with handles. These monaural amplifiers "plug-in" to the main cabinet, and are affixed with two allen bolts each. They share an underutilized power supply which employs enormous filter capacitors designed for computer use, and which are the largest of their kind ever seen in a consumer audio product. In fact, the entire amplifier is built like a piece of military gear.

In addition to the two modularized basic amplifiers, we will shortly be introducing our preamplifier with separate power supply, electronic crossover, 75 w.p.c. amplifier, and free-standing speaker system (featuring cabinets built from solid 1½" stock). You will be hearing a lot about us and you will not be likely to forget our name.

Visit us at I.H.F. in Atlanta (May 19-21, 1978) and at C.E.S. in Chicago (June 10-13, 1978). Or write to us c/o H & H International, 354 State St., Rochester, N. Y. 14608.

RHODE ISLAND MUSIC PHILES

If faithful musical reproduction is what you're after, and not the seductive deceptions of musical phantoms, then take a trip to Newport.

KIRKSAETER	GRACE
LUXMAN	KEF
I.M. FRIED	CONNOISSEUR
DB SYSTEMS	RTR
ARISTAN	KEITH MONKS
DAHLQUIST	SUPEX
DECCA	JVC
HARMAN KARDON	GRADO
ORTOFON	AVID
SOUND CONCEPTS	STAX
AKG	BREUER DYNAMIC
SATIN	FUJI

Definitive Systems

FINE STEREO & AUDIO COMPONENTS

26 Memorial Blvd West, Newport, RI 02840
847-5740 847-5741

MUSIC BY THE SEA

AUDIO RESEARCH SP4A, MINT \$695 Call 716 873 8392 AFTER 6 E.S.T.

THRESHOLD 400A now on demonstration! 100 watts/channel of Class A power. Tremendous dynamic capability. Greatly extended bandwidth plus faster slewing. Beautifully styled with LED readout of peak and average power. Listeners expect it to cost twice its price of \$1147. Also new from Threshold, and now on demonstration, is the **NS-10** direct coupled preamplifier.

For the ultimate in tonearms, we stock the **BREUER DYNAMIC!** Also now on display—the superb **OENON** direct drive turntables. Hear the all new moderately priced electronics from G.A.S.—Thalia, Grandson and Charlie the Digital Tuner. We have the Sleeping Beauty in stock!

Hear the **ROGERS LS3/5A** and **SPENDOR SA-1** mini-monitors. We have the **STYLIFT** which lifts your manual tonearm automatically at the end of the record—\$15.95. Ask us about the benefits of using the anti-resonant **PLATTER PAD**. We have the beautiful **GALE** maximum fidelity recordings.

We ship prepaid/insured throughout the U.S. Our other fine suppliers include Ariston, Audionics, Connoisseur, Dahlquist, DB Systems, Formula 4, Grace, Grado, Goldring, Linn Sondek, Infinity Black Widow, M & K, Rappaport, RH Labs, Sonex II, Sonus and Onkyo.

THE AUDIOBLE DIFFERENCE

435 Tasso (415) 328-1081
Palo Alto, Ca. 94301

WORLD AUDIO WESTCHESTER, INC.

Westchester's finest audio sales and service dealer is proud to announce the addition of.

LUX
SOUNDCRAFTSMEN
THORENS

To the already fine lines of Audio-technica, ADC-BSR, AR, AKG, CM LABS, DBX, DECCA, JVC, Jensen, M.A., Optonica, Philips, Pickering, Pioneer, Stanton, Supex, Sonab, Tandberg. Shipping is free in continental U.S.

WORLD AUDIO WESTCHESTER, INC.

211 North Avenue
New Rochelle, N.Y. 10801
914-576-3230

FOR SALE

QUAO 303 PREAMP. \$175. Quad 405 amp, \$300; both under one year old. (316)685-6564.

B & O MMC5000 SHIBATA STYLUS, 4 hrs. use, \$80. (703)280-4467.

TO CENTRAL ILLINOIS

Audio Ltd. is bringing the finest in components including

IMF	Micro-Acoustics	KEF
Quad	Promethean	Sonex
Grace	Thorens	Quatre
Allison	Cizek	Ariston
Rogers BBC	SME	DB Systems

and more. 115 N. Walnut, Champaign 61820. 217-359-3774.

TAPCO-MIXERS AND EQUALIZERS—Lowest prices anywhere. Write to SONIX CO., P.O. Box 58, Indian Head, MD 20640. VISA and MASTERCHARGE accepted.

SYNERGISTICS MOD.71 4 ft. columns \$800.00 JVC JR-S300 \$300.00. MICRO SEIKI Mod. MB15 w/sonus Blue Label cartridge \$250.00. AIWA 1800 \$300.00. Fred Norden, Arcadia, OH 44804 (419) 424-0513.

AUDIO FORUM MAGAZINE is available in WEST L.A. at the AUDIOPHILE! Call (213) 204-1833.

Tannoy 15" Dual Concentric Loudspeaker. Perfect. Purchased new 1953. Make Offer. Vilter, 1009 Sierra Ln. N.E., Rochester, MN 55901.

ATTENTION DYNACO PAT 5 OWNERS! Our PAT 5 phono board update kit will convert your PAT 5 into a stunning state-of-the-art contender. We invite comparison to any preamp. Parts list and instructions—\$5.00, kit—\$55.00 post-paid. Musical Sound Lab, Box 5503, Preston King Station, Arlington, Virginia 22205.

needle in a haystack specializes in stereo styli and cartridges, accessories, special records. All major brands and many hard-to-find replacements available. Free catalog. Dept. A.P.O. Box 17436, Washington, DC 20041.

QUICKEST AIRMAIL SERVICE DIRECT FROM TOKYO All brands of Cartridges & Arms. Great time & money saving! Write us today. JAPAN AUDIO TRADING CO., Saikaen Bldg., 4-33-21, Kamimeguro, Meguro-Ku, Tokyo 153

YOU'VE HEARD ABOUT the legendary Dayton-Wright Electrostatics—now actually hear them at Barclay Recording & Electronics, 233 East Lancaster, Wynnewood, PA 19096 215-667-3048

COMING! THE CROWN Digilogic System—a digitally-controlled preamp with customized phono front-end, SA-2 power amp, and EQ-2 equalizer/tone control system—to Barclay Recording & Electronics, 233 East Lancaster, Wynnewood, PA 19096 215-667-3048

THE AUDIO RESEARCH D-350, with a staggering kilowatt of musical, high-definition sound—now at Barclay Recording & Electronics, 233 East Lancaster, Wynnewood, PA 19096 215-667-3048

FOR SALE

GET YOUR STEREO TUNED-UP with the ★PINK NOISE GENERATOR★

Uses latest MOS IC only \$9.95. See Radio-Electronics January, 1978 or write: West Side Electronics, P.O. Box 636 Chatsworth, CA 91311

KENWOOD K0-500 Turntable, never unpacked \$200; Dynaco AF6 Tuner, excellent \$130. (402) 488-6712.

GAS AMPZILLA II, THOEBE R/m \$1159; w/ sep. GALE audiophile speakers \$325 each. 716-691-3634, 6-12 p.m.

GOLD PLATED shielded metal phono plugs, \$1.00 ea. Gold plated panel mount phono jacks, 90¢ ea. Low mass nylon cartridge mounting hardware, 18 pc. set, \$2.50. All ppd. Component Systems, 5556 Personality Ct., Indpls IN 46227.

THE WAREHOUSE—LOWEST PRICES ON TYPEWRITERS, MANUAL AND ELECTRIC. All brand new, factory sealed, and fully warranted. Free catalog and prices. YOU CAN'T BUY IT ANYWHERE FOR LESS! Fast service. THE WAREHOUSE, Dept. 18, 187 North Main Street, Milltown, New Jersey 08850

REPLACEMENT STYLI. Diatix, Box 762, Hightstown, N.J. 08520

CUING DEVICE FOR AR turntables and others. Precision machined, silicon damped. Easily installed \$16.00 postpaid. LYRELIFT, 582 Franklin Street, Cambridge, Mass. 02139

MILWAUKEE & WISCONSIN'S ONLY TRUE AUDIOPHILE DEALER

Specialists in components by Audio Research, Dahlquist, Transcriptors, SAE, Nakamichi, Bozak, SME, DBX, Revox, Infinity, RTR, Phase-Linear, Tandberg, G.A.S., London-Decca, Stax, Sonus and over 50 others. Wisconsin's ONLY Audio Research dealer with their new product line on demonstration. Plus one of the truly largest displays of tape decks & accessories in the entire country. Over 130 machines on display. WACK ELECTRONICS, INC. 5722 W. NORTH AVE. MILWAUKEE, WI 53208

SANSUI AND KENWOOD! Below mail order prices! Send to: GSH Super Savings, P.O. Box 86, Eden, N.C. 27288.

LOW NOISE RESISTORS—1/4W, 5% from 1 to 4.7 Megohm for 3 1/2¢ each. Fifty per value \$0.85. Postage and handling is \$1.00 per order. FREE catalog and resistor sample. Components Center, P.O. Box 295A, West Islip, N.Y. 11795

DIAMOND NEEDLES and Stereo Cartridges at Discount prices for Shure, Pickering, Stanton, Empire, Grado and ADC. Send for free catalog. LYLE CARTRIDGES, Dept. A, Box 69, Kensington Station, Brooklyn New York 11218. For fast service call toll free 800-221-0906

ROTEL QUALITY AUDIO COMPONENTS: immediate delivery all Rotel products including RB-5000, RX-1603, RX-1203, RA-1412, RA-1312, RI-1024, National Sound Company, Ft. Lauderdale, Florida (305) 462-6862

INNOVATIVE AUDIO

129 Degraw Street, Brooklyn, NY 11231
(212) 596-0888 or 858-3493

Mark Levinson • Sequerra • Bryston • Dunlap-Clarke • DB Systems • AGI • Yamaha • RAM • STAX • SAE • Harman Kardon • BGW • Innotech • Accustat • IMF Electronics • Infinity • Spondor • OHM • Klipsch • ADS • Revox • Radco • Denon • Supex • Grace • Ortofon • Keith Monks

AUDIO • April 1978

LEGENDARY.

Mark Levinson. Threshold. Grado Signature. Janis. Pyramid. Grace. Spondor. Rogers. DCM. Paragon. DB. Bryston. Paoli. Linn-Sondek. Bowers & Wilkins. Denon. Verion. Dunlap-Clarke. All these legends at Chestnut Hill Audio, 2302 Lombard Street, Philadelphia, Pa. 19146. (215) KI 6-6178.

CHESTNUT HILL AUDIO.

FOR SALE

RECORDING STUDIO MAINTAINANCE

Comprehensive hands on training.
Studio equipment trouble shooting
and maintainance.

write or call.

UNIVERSITY OF SOUND ARTS 1500 Crossroads of the World
Hollywood Col 90028 Tel: (213) 467-5256

DYNA STEREO 70 MOD KIT. Tighter bass, improved transient response, higher definition. Complete instructions, schematics, parts list, \$5.00. With parts kit, including all new tubes, \$75 all postpaid. Audio Designers, Box 122, Ledyard, Conn. 06339.

AUDIO MODIFICATION MANUAL

More than 220 pages of priceless information, including general audio philosophy, specific design criteria, general mod instructions for all classes of tubed equipment and loudspeakers, plus explicit step-by-step procedures for many common components. Proprietary modifications presented in detail. Latest printing includes much new information, including a construction project for a QUIET Nuvistor (tube) subpreamplifier, a novel variable VTA headshell and much more. Price includes free consultation service. U.S.A. \$25.00 ... other countries U.S. \$27.00. California residents add \$1.50 tax. Telephone orders accepted (M/C, VISA): (714) 278-3310. AUDIO DIMENSIONS, 8898 Clairemont Mesa Blvd., San Diego, Calif. 92123.

MILWAUKEE!—The Audio Emporium—6900 W. Brown Deer Rd. where ears and minds are open. Audio Research, Bang & Olufsen, Connoisseur, Dahlquist, Decca, GAS, Genesis, Grado, Grafyx, Linn Sondek, Lux, Magnepan, Polk Audio, Shreve-Rabco, Sonus, Technics. Competitive pricing on systems from \$395 to ? Open Tues through Sat. 10-6. Other days and hours by appointment. 354-5082.

AUDIO'S HI-FI HANDBOOK

Complete reference guide to over 1,000 components including prices and specs. All arranged in tabular form for easy comparison. Plus over 30 outstanding articles on audio topics, trends, and advances. State-of-the-art reading for audiophiles. Only a limited quantity available. Over 200 pages. Send \$4.50 (including shipping and handling) to: Jean Davis, Audio Hi-Fi Handbook, 401 N. Broad St., Phila., Pa. 19108.

DO YOU WANT TO BE AN AUDIO INSIDER? You can be if you read the AUDIO FORUM, the only audio information publication devoted to the interests of both the audiophile-music lover and the audio professional. Every one can use the AF. Dealers, Importers and Reps find out about the new products and companies—well before their competitors. Manufacturers and designers use AF to bring their design philosophies and products to the attention of the interested public in an ongoing dialogue. Plus audiophile commentaries, free personal ads and much more. Whether you make a living in audio or just want to be in on the action, subscribe today by sending \$15 (\$18 first class, \$22 overseas air) for six bimonthly issues to: AF, Box 578-A, Fairfax, CA 94930.

LOWEST PRICES ON STEREO-ESOTERIC COMPONENTS!!! Over 150 brands. Write for quotes. Audio Unlimited, 3386 Golf, San Jose, CA 95127. (408) 985-2285.

DISCOUNT MOVIE, Audio Supplies. Write: Coastal, 1428M San Marco, Jacksonville, FL 32207

ROGERS SPEAKERS AND ELECTRONICS: export monitor, compact monitor, and of course, the LS3/5A—the most accurate of all the mini-monitors, also, the Rogers A75 Series 2 integrated amplifier. All at Audio Reproduction, 217 College Ave., Blacksburg, VA. 24060, (703)552-6850

FOR SALE

CYBERACOUSTIC LABORATORY is a research and development center, combined with the most scientifically-advanced audio/acoustics lab. Advanced products for '78 include AKG pickups, Audio/Pulse ambience system, Audio Research D-100A & D350 (very musical), Badap-1 audio computer, Crown Digilogic Control & SA-2 power amp, Dayton-Wright preamps and spkrs., dbx 3BX, Dynavector arm, EMT & Entre moving-coil pickups, FM Acoustics, Formula 4 arm, Fried B, D, H, L, M, Q, R2, S spkrs., Gale Maximum-Fidelity (and most direct-disc) recordings, Grado Signature, IMF International spkrs., KEF (105!), Kenwood Purist, Lux Laboratory Reference, Magnepan/Magneplanar, Mark Levinson Reference Recordings, Otari decks (home and pro!), Polk spkrs. & Cobra Cables, RTR Direct-Drive Electrostatics, Van Alstine amplification, Verion transformers and cables, and MUCH MORE! at 233 East Lancaster, Wynnewood, PA 19096 215-667-3048

SIEMENS, TELEFUNKEN, GENALEX AND AMPEREX and other top quality audio tubes available at very competitive prices. Contact Jim Wallace at 201 McMasters Drive, Monroeville, Penna. 15146 or (412) 373-2602

PIONEER SPEC1 PREAMPLIFIER Spec 2 Power Amp, RG1 Expander \$900.00. Technics SL1500 w/JH Formula 4/Sonus blue \$350.00 2 LKH SCX-A speakers All new condition 703-360-9214.

RENOUCE ROTTEN RECORDINGS! Read selected British reviews in the bi-monthly EURO-DISC GAZETTE, then order these European discs judged the finest in technical and musical excellence. Selections mainly classical. Send for free sample issue. No obligation. EURO-DISC GAZETTE, PO Box 337-A, Peterborough, NH 03458.

CAMPUS REPS! CONSUMERS! DEALERS! Most medium and many high end lines available at lowest wholesale. Make 10%/40% Repping/Demonstrating high quality loudspeaker line. Prices, info. \$1 (refundable w/order) + SASE. (812) 332-4252. AUDIO 1010 S. Dunn, Bloomington, Indiana 47401.

NOW ALMOST 15 YEARS OLD, STEREOPHILE has become the most widely-copied audio publication of them all. It should be: We pioneered subjective testing (by ear), devised a unique vocabulary for describing nuances of reproduced sound, proved that a subscriber-supported magazine could be blunt without being churlish, and led the industry by demanding higher standards of reproduced fidelity than it could provide. STEREOPHILE is not for the neurotic compulsive who must own the Best On the Block, but for the listener who wants the most natural possible reproduction of music. Send \$12 for 4 issues, or write to STEREOPHILE, Box 49S, Elwyn, Pa. 19063 for details.

THE NEXT EVOLUTIONARY STEP IN RECORDS IS HERE!
THE MOBILE FIDELITY SOUND LAB PRESENTS
Original Master Recordings~

THE MOST INCREDIBLY THREE DIMENSIONAL, MUSICALLY ACCURATE AND SONICALLY EXCITING RECORDINGS YOU'VE EVER HEARD! THE MYSTIC MOODS ORCHESTRA PERFORMS ITS MAGIC ON THREE OF THE ALBUMS, AND THE MOST PHENOMENAL RECORDING OF A TUNING FORK AND STEAM LOCOMOTIVE NB 2240 ARE ON THE FOURTH ALBUM!

- #001 "EMOTIONS" THE MYSTIC MOODS ORCHESTRA \$12.95
- #002 "COSMIC FORCE" THE MYSTIC MOODS ORCHESTRA \$12.95
- #003 "STORMY WATERS" THE MYSTIC MOODS ORCHESTRA \$12.95
- #004 "THE POWER AND THE MAJESTY" \$12.95

IF YOU CAN'T FIND OUR RECORDS AT YOUR DEALER, THE MAN YOU'RE TICKED OFF AND SEND US A LITTLER ENCLOSING A CHECK OR MONEY ORDER FOR \$12.95 FOR EACH RECORD YOU WANT. WE'LL PAY THE POSTAGE. WE ARE

THE MOBILE FIDELITY SOUND LAB
PO BOX 96, VFRADALE, WASHINGTON 99037!
AND PREPARE YOURSELF FOR A VISCERAL THRILL!

RECORDING

RECORDING STUDIO ENGINEER CAREER? Or movie scoring. Degree Unnecessary. Send two 13¢ stamps to Attainment Research, Box 45333-AU, Dallas, Tx. 75245

Percussion recording of superior quality. Write Percussion, Dept. A, P.O. Box 88, Palisades Park, N.J. 07650.

SITUATION WANTED

Musician-Engineer seeks position involving work in both fields. B.S.E., M.Mus. degrees. Music, teaching, location recording experience. PO Box 220, St. Clair MI 48079.

AUDIOPHILE SEEKS POSITION IN AUDIO/COMMERCIAL sound field. College grad, 3 yrs. exp. w/disco systems. N.Y.C. or L.I. area. Call (516) 264-3616

PLANS & KITS

LINEAR AMPLIFIER amateur 2-30 MHz, 100 watt solid state. FREQUENCY COUNTER, 300 MHz, portable/mobile, 4"-7" digit display, memory. Splatter free VOX-COMPRESSOR modulation booster. OMNIPOLARIZED BASE ANTENNA. Complete plans \$3.00 each, any 3/\$7.50, all/\$10.00. Free catalog. PANAXIS Productions, Box 5516-N3, Walnut Creek, CA 94596.

DYNA MARK III MOD KIT—increased power—less distortion across frequency spectrum. Power supply and amplifier board parts kit with instruction manual \$18.00 Two kits \$32.00 including postage. AUDIO DESIGNERS, P.O. Box 122, Ledyard, CN 06339

TAPE-SLIDE SYNCHRONIZER, multiprojector lap-dissolve plans, \$5.50. With mixer, compressor, preamp schematics, \$8.50. The Millers, 1896 Maywood, S. Euclid, OH 44121.

Audio Excellence

A UNIQUE STEREO SHOWROOM DEDICATED TO THE PERFECTIONIST

Presenting Components from the Prestigious Companies of
**THRESHOLD BRYSTON PARAGON GAS
APT HOLMAN LUX EPA 100 VERION
SNELL ACOUST. JR 149 ROGERS CIZEK
BEVERIDGE HARBETH GRADO SIG. ENTRE**

AT LAST, AN AUDIO SALON IN NORTHERN CALIF. ADVANCING
THE ART IN THE ATMOSPHERE OF OUR ELEGANT SOUNDROOMS!

584 Washington Street, San Francisco 94111 415-433-1335

SAVE! Demos & Trades

(& some new mdse)

McIntosh 2205 Amp	\$895
JBL L-212 System	\$1150
Acustat X Spkr System	\$1395
Lux 35-III Preamp	\$475
Lux C-1000 Preamp	\$595
Lux 4000 Pwr Amp	\$995
Lux 3045 Pwr Amp	\$325

Items subject to prior sale.
Phone or write for individual details.

CUSTOM STEREO
1391 S. Hamilton Rd., Columbus OH 43227
614/235-7575

PLANS & KITS

TAPE-SLIDE SYNCHRONIZER, lap-dissolve plans, \$5.50. With mixer, compressor, preamp schematics, \$8.50. The Millers, 1896 Maywood, S. Euclid, OH 44121.

DIRECT TO DISC RECORDINGS: All labels including Sheffield, Crystal Clear, M&K, Umbrella. Send \$1.00 for catalog. Disconnection, 4201 Jetton Ave., Tampa, FL 33609.

UHER TAPE RECORDER AND AKE MICROPHONE. Parts, accessories and service. We have moved to larger facilities. Write for a free Catalogue. Martel Electronics Sales, Inc., 970-A E. Orangethorpe Avenue, Anaheim, CA 92801.

RECORD JACKETS. Replace old, torn, LP jackets with clean, glossy, pure white or black jackets. Plastic lined inner sleeves, 78 sleeves, opera boxes. Free catalog. CABCO A6, Box 8212, Columbus, Ohio 43201.

136

Western Pennsylvania's FINEST AUDIO DEALER

Accuphase	Janis Woofers
AEI	LUX
AR	M&K Woofers
Ariston	Magnepan
Armstrong	Mark Levinson
Audire	Optonica
Bryston	Revox
Connoisseur	Rogers LS3/5A
Dahlquist Woofers	SAE
Dayton Wright	Sherwood
dbx	Snell Acoustics
Decca	Sonab
Dennon	Sonus
Fidelity Research	Sound Concepts Delay
Eulton Music	Stax
CAS	Supex
Grace	Teac
Harman-Kardon	Thorens
IMF International	Verion
Infinity	Visonik

"Headquarters for the Verion Cartridge
Alignment System"

PLUS MUCH MORE
Shipping Prepaid & Insured

OVATION

6019 Broad St. Mall
Pittsburgh, Pa.

VISA



412-441-4550

RECORDS

COLLECTORS RECORDS—International Service Since 1971—50,000 LPs Sold @ Auction—Jazz, Soundtracks, Orig. Cast. Personalities, Folk, Comedy, Country Western: R & B, R. & R. Rock, etc. Specify Category or Artist from: Ray Macknic (or) Theo's, P. J. Box 7511 Van Nuys, CA 91406, U.S.A.

FREE SOUNDTRACKS & CASTS CATALOG! Personalities ST/OC Valuebook: \$4. RTSA, 711 W. 17th, G-1, Costa Mesa, CA 92627

RARE JAZZ AND POPULAR Vocal LP's Sold by Auction. Leon Leavitt, 824 1/4 North Las Palmas, Los Angeles, Calif 90038

CATALOGS. Broadcasts, soundtracks, Personalities of Thirties, Forties. Box 225, New York, N.Y. 10028

WHILE YOU WERE LOOKING for out-of-print records, you should've been looking for us. DISContinued, 444 S. Victory Blvd., Burbank Ca. 91502

SHOW ALBUMS—Rare Out of Print LP's. 64 page list \$1.00. Bakers Wife cast LP \$9.95. Broadway/Hollywood Recordings, Georgetown, Conn. 06829

MUSICAL INSTRUMENTS

UP TO 60% DISCOUNT. Name brand instruments. Catalog Freeport Music, 114R Mahan St., W. Babylon, N.Y. 11704.

E-A-S-Y—Tune Your Guitar like a Professional in your own home. Our "VU-PITCH" tuner has six precision reeds which makes accurate tuning simple. Just clamp to your Guitar and adjust strings. Ideal for both beginners and accomplished musicians. Send \$7.98 to: Tre-EI Gifts & Novelties Johnson Street, P.O. Box 7388 Hollywood, Florida 33021

HIGH FIDELITY

UNZOO obtusation of safon audio. STATE-OF-ART: AOS, BOSE, YAMAHA, B&O, McINTOSH, KLIPSCH, AUDIO-PULSE, SAE, THRESHOLD, ROGERS, KEF, OHLQUIST, ANALOG, BRYSTON, OTHERS AT LOWEST DISCOUNTS. Professional Audio Engineers available for FREE, no b.s. Advice Information. (Send \$1.00 for priority mail, postage, literature.) Trade-Ins. GOLOEN EAR AUDIO-ELECTRONICS. Specific quotes: G.E.A.—E., P.O. B. 296, Idaho Springs, Colorado, 80452. (303) 582-5200, 9:00A. M. - 9:00P. M. (M.S.T.).

RADIO PROGRAMS

GOLDEN AGE RADIO. your best source for radio tapes. Box 25215-D, Portland, Oregon 97225.

YESTERDAYS RADIO ON TAPE. Reels-Cassettes. Quality Sound. Reliable Service. Catalog \$1.00 refundable with first order. ADVENTURES, Box 48-2-A, Inglewood, California 90302.

1930-1962 RADIO PROGRAMS. Beats television!! Tapes, \$1.00 hour! Established esteemed dealer, informative 200 page catalog \$1.25. Cassette samples \$2.00. AM Treasures, Box 192AU, Babylon, N.Y. 11702

VINTAGE RADIO: Lowest rates, post free. traders welcome: shows for comics, etc. signals. Box 5063, Station E, Edmonton, Alta. Canada.

RENT RADIO SHOWS: Make your own copies or just listen. Great way to build your collection reasonably. Catalog \$1 refundable. OTR Rental, Box 1146, Livermore, Ca. 94550

SPEAKERS

HIGH FIDELITY SPEAKERS REPAIRED
AMPRITE SPEAKERS SERVICE
655 Sixth Avenue, New York, N.Y. 10010
212-CH3-4812

SURPLUS SPEAKER CABINETS
FINISHED & READY FOR YOUR DRIVERS
Send for your FREE pictured literature to America's largest surplus cabinet dealer:

OHIO MERCHANDISE
2825 S. MAIN ST., AKRON, OHIO—44319

BUSINESS OPPORTUNITIES

Hi Fidelity Service Business For Sale. Well established and well equipped. Warranties for most major lines. Located in Southern Wisconsin. Reply to Box # A841.

CABLE FM BROADCAST STATION. Unique no investment/experience business makes money! Others work for you. Free details. "CAFM", Box 5516-N3, Walnut Creek, CA 94596

\$1000 MONTHLY POSSIBLE! Mailing Commission letters. Information—FREE. Opportunities, Box 721-AU, Lynbrook, N.Y. 11563.

SERVICES

CUSTOM RECORDING SERVICE. Tapes, discs, and cassettes. Stereo and mono. Live and copies. Editing. Masters and pressings. High quality at reasonable rates. Joseph Giovanelli, Audio-Tech Laboratories, 2819 Newkirk Ave., Brooklyn, N.Y. IN9-7134.

TAPE HEAD REFINISHING—precision method restores full frequency response, \$15.00 ea. one day service. E. Maher, 5 Evans Place, Orinda, CA. 94563.

DISCO SOUND SYSTEMS—installations, sales, service & rentals. Mobile OJ available. King Cobra Sound Co., 291 Kings Highway, Brooklyn, N.Y. 11223. Tel: 212-375-4062.

NASHVILLE RECORD PRODUCTIONS WILL PRESS HIGH QUALITY PURE VINYL RECORDS FROM YOUR TAPES. SEND FOR SAMPLE RECORD AND PRICE LIST. ALSO FINEST DISC MASTERING. 469 Chestnut St., NASHVILLE TENNESSEE 37203

MOVING CDIL CARTRIDGES RETIPPED. \$35.00 Elliptical or Shibata. Oiafix, Box 762, Hightstown, N.J. 08520.

YOU WILL NOT BE DISAPPOINTED !!!

We rebuild burned-up stereos & guarantee them for 2 years. Send model & brand for details & prices.

"QUALITY E-S-H SYSTEMS EXPERIENCE"
104 East Court Street, Fairfield, IL 62837

CROWN INTERNATIONAL

Complete repair, overhaul, and rebuilding service for current and early model Crown tape recorders. Reconditioned Crown recorders for sale. Used Crown recorders purchased. TECHNARTS 8555 Fenton Street, Silver Spring, MD 20910 301-585-1118.

TAPE & TAPE RECORDERS

OPEN REEL TAPES. 7 1/2 ips. Dolbyized releases from RCA, London, DG, Warner and others. Airline tapes and quad. Catalog \$1. refunded on first order. THE REEL SOCIETY, 8125-A Lankershim Blvd., N. Hollywood, CA 91605

EVERYTHING ON OPEN REEL! Classical. Popular. Dolby. Quadraphonic. Latest releases. For "Reel News" send \$1.00. Barclay-Cracker, Room 857 A, 11 Broadway, New York 10004.

STATE OF THE ART CASSETTE Recordings. Quarterly cassette magazine. Free brochure. Audio Art, P.O. Box 2961, St. Petersburg, FL 33731.

TAPE & TAPE RECORDERS

BLANK TAPE SALE

MAXELL:		TDK:	
UDXL-C60 (1 or II)	\$2.39	SA-C60	\$1.97
UDXL-C90 (1 or II)	3.35	SA-C90	2.85
UD-C90	2.75	AD-C90	2.39
LN-C90	1.93	D-C90	1.54
UD-35-90	4.83	BASF Studio C-90	2.35
UDXL-35-90B	5.89	BASF Chromium C-90	2.35

Minimum order 12 pieces. All tapes can be assorted.
PA add sales tax. Shipping \$2.50 per order.
Or write for complete catalog.
Tape World, 220 Spring St., Butler, PA 16001

BIG PROFITS: Sell top quality blank recording tape to stores, friends. \$2.00 for details, sample. Refundable. Custom Audio, 4226 Robert, Red Wing, Minn. 55066

TDK, MAXELL, MEMOREX, BASF, cassettes, reels 8-tracks. Lowest prices. New. Guaranteed FREE CATALOG S & S Audio, P.O. Box 56039, Harwood Hts., IL 60656

RECORDING TAPE—OUTSTANDING VALUES
CASSETTES—8-TRACKS—OPEN REEL—ACCESSORIES.
New. Fully Guaranteed. FREE CATALOG. Write
MAGNE HOUSE
2015-17th Street, San Francisco, CA 94103

OLIOES TAPES ON OPEN REEL TAPE. Rock n' Roll songs by their year of release. Over 100 songs per year. Free brochure. Rock N' Reel Rental, Dept. C, 4 Prescott Ave., Dix Hills, NY 11746

STEREO & QUADRAPHONIC OPEN REEL TAPES. Popular, Classical, Jazz. Lowest prices. Catalog \$1.00 (refundable). Real Sound, P.O. Box 71A, Shillington, PA 19607

CASSETTES & REEL TAPES, lowest prices, name brands, also custom loaded w/TDK or SCOTCH Super mastering cassettes in computer shells. FREE literature. STANFORD INTERNATIONAL, Box 609A, San Carlos, CA 94070.

SCOTCH RECORDING TAPE, lowest prices. TAPE CENTER Box 4305B Washington, D.C. 20012 USA, APO, FPO

CUSTOMIZED TAPES, Jazz, Big-Band. Select standard tracks or available artists. Free catalog 80 minute reel cassette or 8 track, \$8.00 Tapes Unlimited, Box 163, Portsmouth, R.I. 02871

REVOX A-77 (1104 or 1304) AT LOW, LOW PRICE \$695. Brand new batch just received in manufacturers sealed cartons, manufacturers warranty. It's a steal. Other models available including a few reworked but top performance A-700's at \$1350. Write for full listing or make checks or money order (\$695 & \$15 freight & handling A-77. NY residents add appropriate sales tax) payable to Entertainment Sound Services, Inc., 78 North Franklin St., Hempstead, NY 11550 (516) 538-2220.

CLASSICAL CASSETTES. Quality guaranteed. Stereo-Dolby. Credit Cards accepted. FREE catalog. EKR Classics, GPO Box 1977 AB, New York, NY 10001.

INSTRUCTION & EDUCATION

EXTERNAL DEGREES. CULA, 1111 Wilshire, L.A. 90017. [213] 481-0950.

BECOME A DJ! Learn how to receive free records, tapes, get an FCC broadcast license, start your own station. Free details. "Broadcasting" Box 5516-N3, Walnut Creek, CA 94596.

CLASSES IN MUSIC RECORDING. Record Production, publishing, disc mastering, film recording. Taught by famous engineers and producers. Held in 16/24 track recording studios. Contact: University of Sound Arts, 1508 Crossroads of the World, Hollywood, CA 90028. (213) 467-5256.

DIRECT TO DISC RECORDINGS: All labels including Sheffield, Crystal Clear, M&K, Umbrella. Send \$1.00 for catalog. Disconnection, 4201 Jetton Ave., Tampa, FL 33609.

MISCELLANEOUS

ORIGINAL OIL PAINTINGS from B&W, color prints/slides. All subjects. Fantastic quality/prices. For information, quotes: American Art Discoveries, 387 South Broadway, Yonkers, N.Y. 10705. (914) 476-7140.

TAPE RECORDINGS

THRILLING LIVE OPERA TAPES. PERFORMANCES SINCE 1930'S. Incredible variety. Reel, cassette. Magnificent Free catalogue. Live Opera, Box 3141 Steinway Station, L.I.C. N.Y. 11103.

SOUNDTRACKS

RECORD GRAB BAG. Thousands of top quality 1977 album releases just waiting to be grabbed. All records guaranteed new and in perfect condition. 5 different records only \$7.00 or 10 different records for an incredibly low \$13.00. Valie Enterprises, Box 21-B, Hollywood, CA. 90028

JAZZ, ROCK, CLASSICAL Big Band LP's Tapes, Current Imports, Cutouts Catalogs \$1. NERT, Box 268-A, Lawrence Mass. 01842

HELP WANTED

OVERSEAS JOBS—Now hiring all Occupations. High pay. Transportation. Computerized Records. \$2.00. TRANSWORLD. International Airport, Box 90802-K, Los Angeles 90009.

AUSTRALIA—NEW ZEALAND WANT YOU!! 50,000 Jobs! Report \$2.00. Ausico, Box 8489-K, Long Beach, CA 90808.

REX HUMBARD MINISTRY has immediate opening for Audio Maintenance Engineer. At least five years experience in recording studio type equipment. Some National and International travel required. Send resume to David Ginaven, 2690 State Rd., Cuyahoga Falls, Ohio 44223

WANTED TO BUY OR TRADE

WANTED—Belle Klipsch Speakers. State price, condition. 138 Brazos, Goodard, KS 67052.

WANTED: Jensen H-222 12" speaker manufactured about 20 years ago. CONTACT: J.G. Duer, Box 606, Exmore, VA 23350.

NEED: Schematic Diagram for a Quad (4 channel) Hooky to put in my stereo set. Pvt. Jake Pinon Jr. 539-68-4658 HOCO HOCOMD. Ft. Dix N.J.

WESTERN ELECTRIC 594A Driver 21 Holly Hill Or. WN 98040

Wanted: Crown TC Tape Counter, RC-40-50 remote control. Jeff 616-963-1321 eves. EST

Marantz 7C, 9S; # 2. TANNOY Autograph (UK).

WANTED: INFINITY 2000A LOUD SPEAKERS. GOOD PRICE. WRITE TO: PER MORTEN JOSEFSON, OSTSKOGEN TERR. 11, 3470 SLEM-MESTAD, NORWAY

McIntosh MC225. State price, condition, phone. CRAIG WILLIAMS, 3068 W. Tower, CINCINNATI, OH 45238

WANTED JBL Paragon used and reasonably priced 615-629-7337 S.L. Soleff, 4715 Murray Hills Drive Chattanooga, TN 37416

Wanted: KLH Model 5 speaker J. Anderson 424 E. Cherry, Flagstaff, Arizona 86001. (602) 774-2647

DYNA MARK III, DYNA STEREO TUBE PREAMP 215-775-3426

Marantz Model 15 or 16 Power Amplifier. Jerry Fortner, 2452 N. Grant, Springfield, Missouri 65803

JBL HARTSFIELD'S, other top of the line speakers J. Wolff 1-228 Mettetal Det. Mich. 48227 1-313-837-3811 eves.

BIG DISCOUNTS ON STEREO COMPONENTS

BOSE — A E Technics INFINITY Dual JBL
harman kardon JVC PIONEER

Phase Linear TANDBERG DOKORDER
KENWOOD B-C TEAC AR SONY

To order call toll free
(800) 421-8537

Henry's

CAMERA HI-FI VIDEO

516 W. 8th St. Downtown L.A., Ca. 90014 Tel. 488-0341

WANTED TO BUY OR TRADE

MARANTZ 7C, 9. State price, condition, phone J. Fong, 1238 Green St., San Francisco, CA 94010.

SANSUI AU777 or AU999 in good condition. D. Gilbert, 106 Union St., Rockville, Ct. 06066. 1-203-872-9769

OPEN REEL, pre-recorded tapes. Rock, folk, jazz, classical, stereo, quad. Ray, 2282 Woodward, Lakewood, Ohio 44107

CASH FOR your unwanted LPs & reel to reel tapes. Records, Box 323, Hillburn, New York 10931.

TO ALL MUSIC mfg companies. Wanted to buy any type of musical instruments, drum, horns, stereos, synthesizers, etc., etc., etc. at manufacturers cost. Send information, Gary Lewis Wholesale Co., 1813 Norwood, Toledo, Ohio 43607

NEW!

From Aerospace and Computer Industries!

PLASTIC GLAZE

DEALER INQUIRIES INVITED

FOR YOUR MUSIC SYSTEM

**Restores • Cleans • Polishes
Removes Scratches**

Plastic Glaze is now available in 4-oz. size for dust covers, tuning scales, cabinets, all plastic surfaces in your music system.

For other home use, cars, airplane or boat, order the economy 8 Oz. size.

Secret formula removes hairline scratches, restores original color, leaves a brilliant scratch-resistant protective coating. Anti-static ingredients repel dust. Contains no harsh abrasives. Meets Mil. Specs, MIL-C-5547 and MIL-C-18767B (ASG).

Protect the beauty & value of your system!

MARTIN RESEARCH

P.O. BOX 2007, AGOURA, CA. 91301

Send \$4.98 TODAY For Each 8 Oz. Bottle or \$2.98 For Each 4 Oz. Bottle

Enclosed is my Check or Money Order For _____ 8 Oz. Bottles
_____ 4 Oz. Bottles

Please Include 50¢ For Postage & Handling.
California Residents add 6% Sales Tax.

Ultimately

Marantz goes beyond THD to lower TIM (transient intermodulation distortion).

Because TIM doesn't show up on conventional amplifier testing equipment, most manufacturers and their engineers aren't even aware that it exists in their amplifiers. Even if they were, they probably wouldn't know what to do about it.

But because Marantz builds for the music and not just the specs we know how destructive TIM can be to pure sound reproduction. And we've developed a revolutionary new circuit design to eliminate it.

The reduction of TIM can be the single most important element in making an amplifier sound better. For instance, two amplifiers with identical total harmonic distortion (THD) specifications should sound the same when compared... but the one with low TIM will sound audibly better! That's because TIM adds an unnatural harshness to the music. It's not only detrimental to pure sound reproduction, but it can have an emotional effect that you experience as "listening fatigue!"

TIM is caused by an improper design of "negative feedback circuitry," by other manufacturers. Every modern amplifier uses it to lower THD. But *excessive* negative feedback coupled with an insufficient slew rate* can lead to gross internal overloads under the constantly

changing transient and sound levels of music. That distortion is TIM.

The gentle slopes of continuous sine wave test signals normally used to test an amplifier simply cannot detect TIM distortion. It requires the type of extremely sophisticated spectrum analysis equipment developed by the space industry to analyze radio frequencies.

Our answer to TIM is a circuit design that ensures the widest bandwidth and the lowest obtainable THD *before* negative feedback is applied. The Marantz 170DC Stereo Power Amplifier (the 1152DC, 1180DC and 1122DC also use this circuitry), for instance, needs only 1/100th (-40 dB) the amount of negative feedback commonly required by other amplifiers to yield the

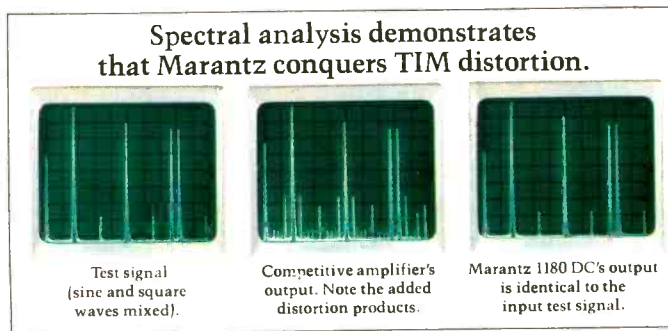

same low total harmonic distortion figures.

same low total harmonic distortion figures.

Incredibly, Marantz amplifiers with low TIM design can deliver flat frequency response from 0 Hz to 20 kHz *without* the use of negative feedback. And this same circuit design provides the optimum slew rate for minimum TIM and maximum reliability.

Result: Marantz reduces TIM to an inaudible level, which means you get clear, clean sound from all your records and tapes. Think of Marantz with low TIM as a window to the original performance.

If you truly want the best reproduction of musical sound available anywhere—and are willing to spend a little more to get it—then go for it. Go for Marantz.



25th Anniversary **Marantz®**

*The maximum change of voltage per unit time. © 1978 Marantz Co., Inc., a subsidiary of Superscope, Inc., 20525 Nordhoff St., Chatsworth, CA 91311. Prices and models subject to change without notice. Your Marantz dealer has the full line of Marantz amplifiers. Look for him in the Yellow Pages.

It's Marantz. Go For It.



Technics introduces three ways to achieve the one ideal: Waveform fidelity.



To achieve waveform fidelity is an achievement in itself. But how Technics audio engineers accomplished it is an even greater achievement.

Like the unprecedented use of two automatically switchable IF bands in the ST-9030 FM tuner. A narrow band for extra-sharp selectivity. And a wide band for extra-high S/N and extra-low distortion. But just as incredible is a pilot-cancel circuit which Technics invented for optimum high-end response. Even the basic tuning function in the ST-9030 is unique. Like an 8-ganged tuning capacitor for outstanding reception.

The engineering in the SU-9070 DC pre-amp is similarly unique. There's a built-in moving coil pre-amp with -157 dBV noise voltage. A moving magnet pre-amp with an extremely high S/N of 100 dB (10 mV input). Direct-coupled circuitry to keep distortion at a minimum of 0.003% (rated THD). What's more, the SU-9070 has inputs for three tape decks.

Finally there's Technics SE-9060 amp. It's DC like our pre-amp. Has a frequency response of 0-100 kHz (+0, -1 dB). And a "strapped" circuit for more than double the power in a multi-amp system.

Compare specifications and prices. And you'll realize there's no comparison for Technics waveform fidelity.

ST-9030. THD (stereo, 1 kHz): Wide—0.08%. Narrow—0.3%. S/N (stereo): 73 dB. FREQUENCY RESPONSE: 20 Hz—18 kHz +0.1, -0.5 dB. SELECTIVITY: Narrow—90 dB. CAPTURE RATIO: Wide—0.8 dB. IF, IMAGE and SPURIOUS RESPONSE REJECTIONS (98 MHz): 135 dB. STEREO SEPARATION (1 kHz): Wide—50 dB.

SU-9070 PHONO MAX. INPUT VOLTAGE (1 kHz RMS): MM—380 mV. MC—9 mV. S/N (IHF A): MM—100 dB (10 mV input), MC—72 dB (60 μ V). FREQUENCY RESPONSE: PHONO 20 Hz—20 kHz (RIAA \pm 0.2 dB).

SE-9060. POWER OUTPUT: 70 watts per channel (stereo), 180 watts (mono) min. RMS into 8 ohms from 20 Hz to 20 kHz with no more than 0.02% total harmonic distortion. S/N: 120 dB (IHF A).

Technics. A rare combination of audio technology. A new standard of audio excellence.

Technics Professional Series
by Panasonic