

Audio

Scenes at CES

THE AUTHORITATIVE MAGAZINE FOR HI-FI FIDELITY • SEPTEMBER 1977 \$1.00

47425 

Thinking
About
Print-Through

John Cage—
Musical
Radical

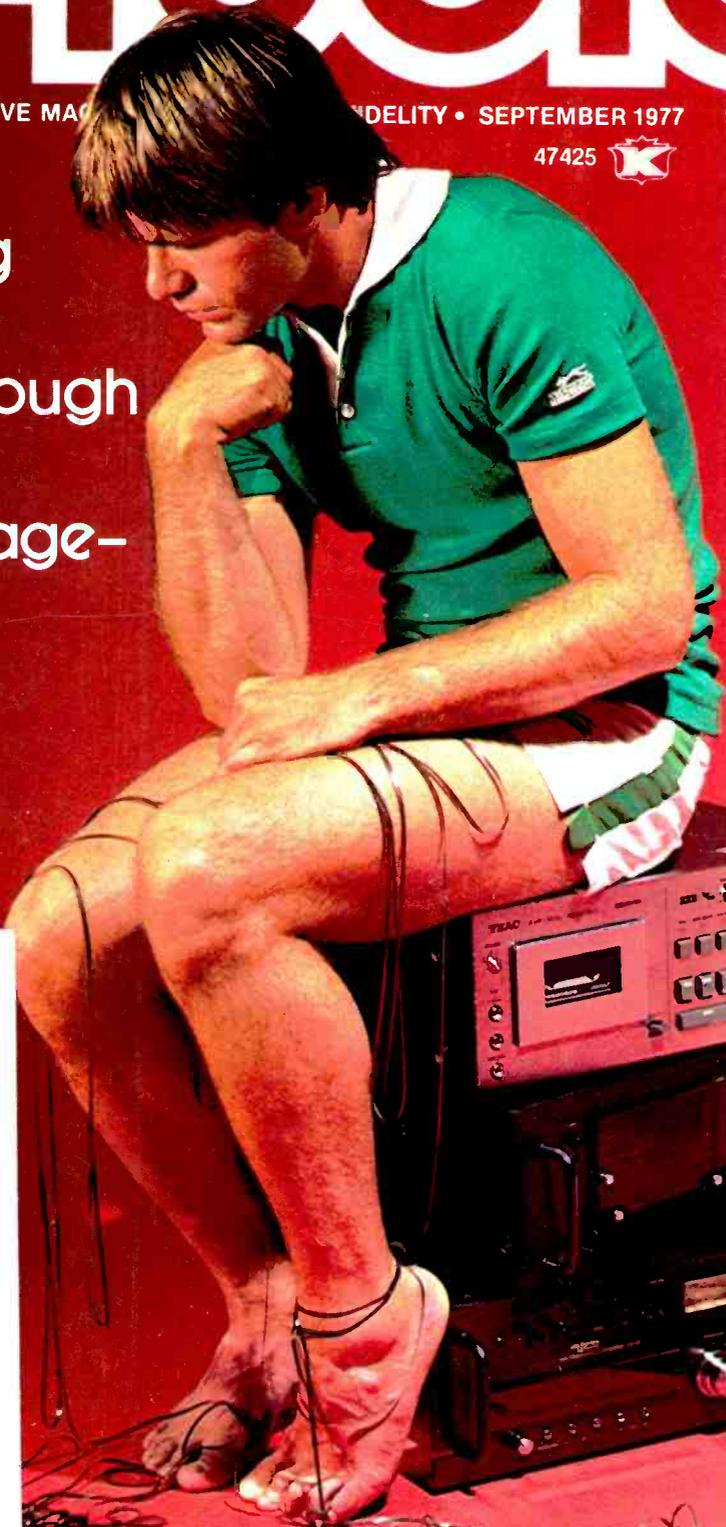

U0803760 0280 70620015P0101312
DOU L HUNTER
2608 CENTRAL BLVD UR 97403
EUGENE

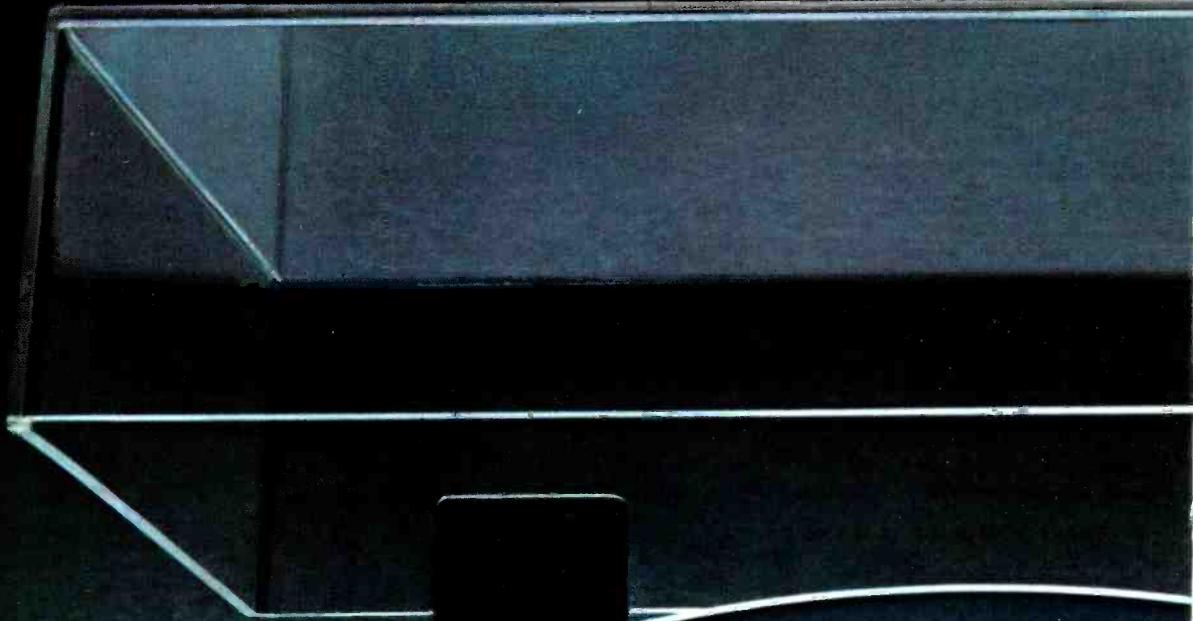

QUARTZ SYNCHRO PULSE

PIONEER

**ONLY PIONEER
COULD INTRODUCE
A QUARTZ
PHASE LOCKED LOOP
TURNTABLE AND
CALL IT A BARGAIN.**



PIONEER

THE PL 570. UNDER \$400.*

The average quartz phase locked loop turntable plays records virtually perfectly, has no audible wow or flutter, is unaffected by voltage changes, and manages to accomplish all this for slightly under \$800.

The new PL 570, on the other hand, has all the same features, but with one distinct advantage: it costs less than \$400.*

Which, you have to admit, is an awfully small price to pay for perfection.

MORE ACCURATE THAN A QUARTZ WATCH.

In brief, the PL 570 works by using a quartz crystal that oscillates 180 million times a minute as a timing mechanism. The speed of our direct-drive platter motor is then "locked" onto that rate of oscillation—and constantly adjusted to account for things like heat, line voltage variations, and even the weight of the record on the platter.

The benefit of all this is simple: the PL 570 can run virtually forever with no variation in speed. In fact, it's so accurate, special measurements are needed to fully describe it. Something called "time drift" is a mere 0.0003%. A figure unsurpassed by the finest quartz watch that gains or loses up to ten seconds a month. And "thermal drift" is 0.00004%. Which means that while we can't guarantee just how well the PL 570 will play in your freezer, normal room and operating temperature variations shouldn't affect it at all.

In more mundane measurements, wow and flutter is 0.025%. Four times under what the human ear can hear. And even with the quartz phase locked loop off, the turntable speed is unaffected with stylus pressure of up to 120 grams. Which, by no small coincidence, is about 119 grams more than you'll ever apply.

FOR THIS KIND OF MONEY YOU SHOULDN'T HAVE TO LIFT THE TONE ARM.

Unlike any other quartz phase locked loop turntable, the PL 570 is automatic. So

you're spared the burden of lifting our tone arm. But this isn't your average tone arm return system. Or your average tone arm, for that matter.

Where most automatic turntables use one motor for both the platter and tone arm, the PL 570 has a separate motor for each. Which means that the action of the tone arm motor never interferes with the accuracy of the platter motor. And where most tone arms sense when to return by using cams and gears that lessen sensitivity and cause vibration, the PL 570 uses a light emitting diode that does neither.

Then there's the tone arm itself. It's fully adjustable. You can even set the vertical tracking angle of your cartridge with a height adjustment lever. And the whole unit is mounted in a ¼ inch aluminum frame that not only looks nice, but helps your records sound nice by removing unwanted resonance.



The heart
of the PL 570:
a quartz crystal.

OTHER FEATURES NOT USUALLY FOUND ON "BARGAIN" TURNTABLES.

When we set out to build the PL 570, we wanted it to be a lower cost quartz phase locked loop turntable. Not lower quality.

So like the quartz turntables that sell for hundreds of dollars more, the PL 570 features an electric strobe circuit that eliminates normal voltage frequency variations so you can adjust the PL 570 perfectly. Plus a "quick down" circuit that lets you go from 45 to 33⅓ almost instantly. And one piece monocoque construction that cuts howling caused by vibration.

At Pioneer, we've become number one today with people who care about music simply because we've always managed to take state of the art technology, and offer it with some consideration of the state of your wallet.

If the PL 570 is any indication, it looks like we're getting better at it all the time.

High Fidelity Components
PIONEER
WE BRING IT BACK ALIVE.

©1977 U.S. Pioneer Electronics, 85 Oxford Drive, Moonachie, New Jersey 07074

*The value shown in this ad is for informational purposes only. Actual resale prices will be set by the individual Pioneer dealer at his option.

Enter No. 22 on Reader Service Card



PIONEER
SLIPMATE PL
DIRECT DRIVE FULL AUTOMATIC
MODEL PL-990

DISCWASHER®
presents
**The Clean Truth
About Your
Naked Stylus**

When your stylus plays over one light fingerprint or one tiny "bead" of vinyl stabilizer, the clean naked diamond becomes a glazed, dust-holding abrasive weapon wearing away at your records and masking their true sound. This unseen build-up may actually hold the tracking tip of the diamond out of the record groove.



Accumulated grit on stylus that looks "clean" to the naked eye.

The SC-1 Stylus Cleaner from Discwasher is designed with a brush that is stiff enough to remove harmful accumulation, but gentle enough to avoid damaging delicate cartridge assemblies. Two drops of Discwasher's D3 Fluid add extra cleaning action to the SC-1 without the side-effects of alcohol, which can harden rubber cantilever mountings.



After cleaning with SC-1 and D3 Fluid by Discwasher.

The retractable, walnut-handled SC-1 includes a magnifying mirror for convenient inspection of stylus/cartridge alignment and wiring.

Get the clean truth from your records; get the SC-1.

**SC-1 STYLUS
CLEANER**



d discwasher inc.

1407 N. Providence Rd.
Columbia, Missouri 65201

Audio

September 1977 "Successor to **RADIO** Est. 1917" Vol. 61, No. 9

Feature Articles 40 John Cage—Musical Radical/David D. Spitzer
54 Thinking About Print-Through/William Manly

Equipment Profiles 66 Pioneer RT-2022 Open-Reel Tape Deck/Howard A. Roberson
70 McIntosh MC-2205 Power Amplifier/Leonard Feldman
77 Nakamichi 630 Tuner-Preamplifier/Leonard Feldman

Record Reviews 46 European Records/John Wright
86 The Column/Michael Tearson & Jon Tiven
92 Jazz & Blues
95 The Folk Bag/Tom Bingham
100 Classical/Edward Tatnall Canby

Audio In General 4 Audioclinic/Joseph Giovanelli
8 Audio ETC/Edward Tatnall Canby
16 Behind The Scenes/Bert Whyte
26 What's New In Audio
32 The Bookshelf/Howard A. Roberson
36 Dear Editor
50 Tape Guide/Herman Burstein
53 Classified Advertising
106 Advertising Index

Editor Eugene Pitts III
Associate Editors: Edward Tatnall Canby, Bert Whyte
Assistant Editor Eugene J. Garvin Jr.
Marketing Director Sanford L. Cahn
Design Frank Moore
Design Assistant Debbie DePietro
Circulation Manager Jean Davis
Advertising Production & Editorial Assistant Gloria Klaiman

Senior Editors: Richard C. Heyser, B.V. Pisha
Contributing Editors: Tom Bingham, Herman Burstein, Leonard Feldman, Joseph Giovanelli, Bascom H. King, C.G. McProud, Dan Morgenstern, George Pontis, Howard A. Roberson, Jon Sank, Donald M. Spoto, Michael Tearson, George W. Tillet, Jon Tiven.

Publisher Jay L. Butler

About The Cover: Print-through doesn't have to be a problem, if one has thought out the basics; William Manly's article on print-through begins on page 54. Photo: Chas. P. Mills & Son, Phila.

EDITORIAL CONTRIBUTIONS are welcomed but should be accompanied by return postage. Submissions will be handled with reasonable care, but the publisher assumes no responsibility for return or safety of manuscripts, photographs, or artwork.

AUDIO (title registered U.S. Pat. Off.) is published monthly by North American Publishing Co., Irvin J. Borowsky, President, Frank Nemeyer and Jay L. Butler, Vice Presidents, Harry Feld, Treasurer, Joseph Florentine, Chief Financial Officer, Mary Claffey, Secretary & Circulation Director, R. Kenneth Baxter, Vice President—Manufacturing, Sanford L. Cahn, Marketing Director, Mary Anderson, Production Director, John Nolan, Corporate Art Director, Vic Brody, Promotion Director

Subscription Rates: United States only, 1 year for \$8.00; 2 years for \$14.00; 3 years for \$20.00; outside the U.S., 1 year for \$10.00; 2 years for \$18.00; 3 years for \$26.00. Printed in U.S.A. at Columbus, Ohio. All rights reserved. Entire contents copyrighted 1977 by North American Publishing Co. Second class postage paid at Philadelphia, PA and additional mailing office. Back issues, \$2.00 each.

World Library Congress Number: ISSN 0004-752X
Dewey Decimal Number: 621.381 or 778.5
National Sales Office: Jay L. Butler, Publisher, 545 Madison Ave., New York, NY 10022. Telephone (212) 371-4100

West Coast Sales Office: Jay Martin, 2525 West 8th St., Los Angeles, CA 90057. Telephone (213) 385-2917

Continental European Representative: V.B. Sanders, International Publishers Advertising Service, Raadhuisstraat 24, P.O. Box 25, Craat-De Ryp, Holland. Telephone: 02997-1303, telegrams, Euradteam—Amsterdam

England: The Paul Singer-Lawrence Media Group, 54 Burton Court, London SW3, SY4, England. Phone, 01-730 3592



AUDIO Publishing, Editorial, Subscription and Advertising Production offices, North American Building, 401 No. Broad St., Philadelphia, PA 19108. Telephone (215) 574-9600. Postmaster: Send Form 3579 to above address.



It was a college broadcast facility; Now it's a public radio station; KUSC, Los Angeles, still has a Stanton in every table

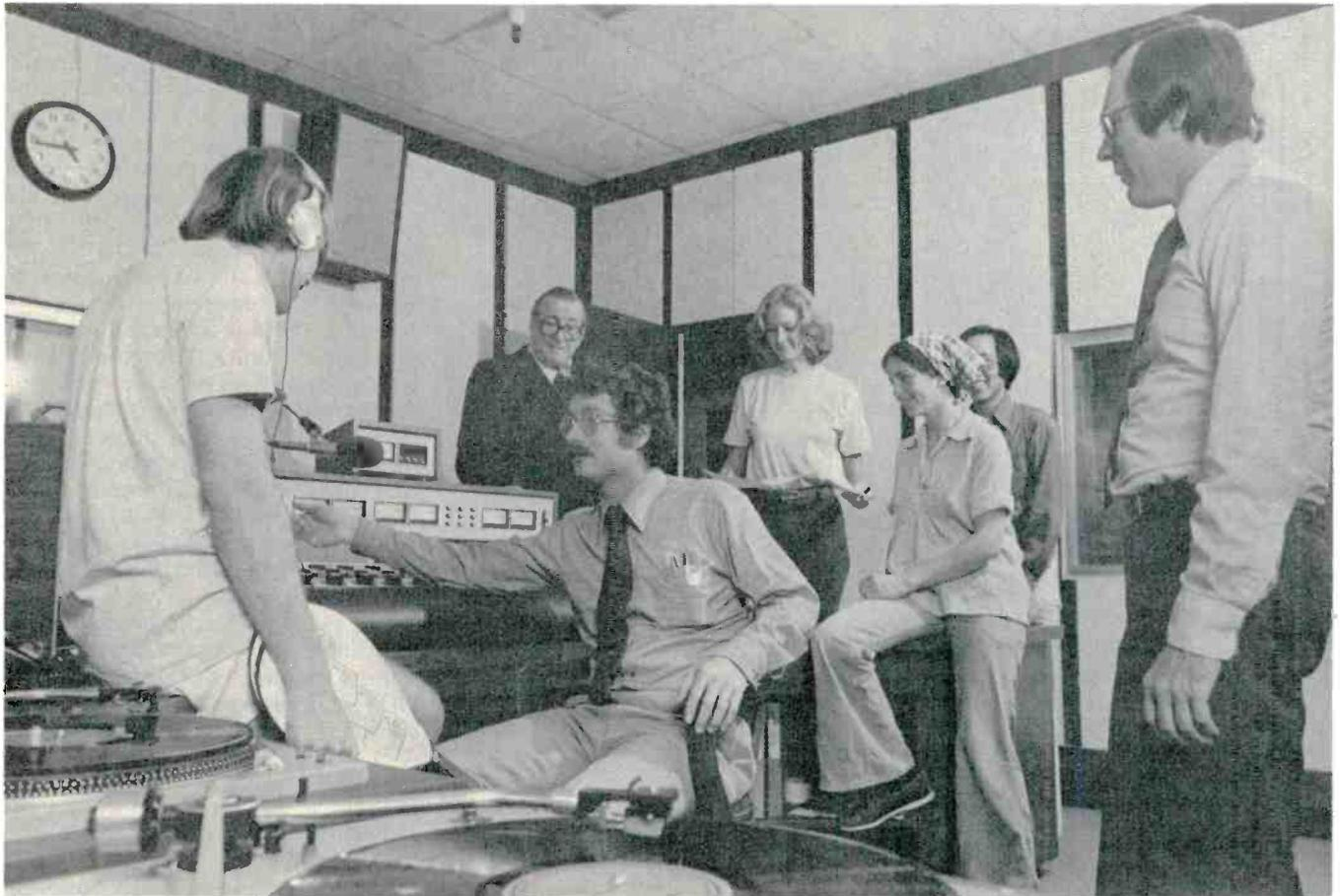

A group of the staff meet in the Broadcast Studio of the Station.

It is interesting that the station which provides top quality classical music service to Los Angeles was an outgrowth of a College Radio Station ... and still bears its original call letters.

It now has been incorporated into the public broadcasting system since it was regarded as "too important a facility to be operated only by students in as large a city as Los Angeles". It serves all of Los Angeles, Ventura and Orange Counties (10 million persons in the market), with a format of 85% classical music and 15% informational programming primarily from the National Public Radio Service. KUSC goes direct from disc to air and uses the Stanton 600E on its turntables.

Since the station has received substantial university support for upgrading their sound, which includes a new transmitting system ... new tower antenna ... new control board ... new turntables ... and new cartridges ... KUSC plans to install Stanton's Calibrated 681SE cartridges in all their turntables.

So, their sure-to-improve sound is certain to have a favorable impact on their growing audience.

Stanton's 681 Calibration Series cartridges offer improved tracking at all frequencies. They achieve perfectly flat frequency response to beyond 20 Kc. And the top-of-the-line superb 681 Triple-E has an ultra miniaturized stylus assembly with substantially less mass than had been thought possible to achieve.

Each 681 Series cartridge is guaranteed to meet its specifications within exacting limits, and each one boasts the most meaningful warranty. An individually calibrated test result is packed with each unit.

Whether your usage involves recording, broadcasting or home entertainment, your choice should be the choice of the professionals ... the STANTON 681.

Write today for further information to: Stanton Magnetics, Inc., Terminal Drive, Plainview, N.Y. 11803.

© Stanton Magnetics Inc., 1977



Ellen Falconer, a broadcast engineer, with two of her associates.



Gilbert Kuang, engineer, at the Master Control Console.



Ellen Falconer, engineer, signaling the start of a scheduled broadcast.



Alan Parker of the Programming Dept. completing a critical listening session in the Record Library.

Enter No. 35 on Reader Service Card

Empire's Blueprint For Better Listening

No matter what system you own, a new Empire phono cartridge is certain to improve its performance.

The advantages of Empire are threefold.

One, your records will last longer. Unlike other magnetic cartridges, Empire's moving iron design allows our diamond stylus to float free of its magnets and coils. This imposes much less weight on the record surface and insures longer record life.

Two, you get better separation. The small, hollow iron armature we use allows for a tighter fit in its positioning among the poles. So, even the most minute movement is accurately reproduced to give you the space and depth of the original recording.

Three, Empire uses 4 poles, 4 coils, and 3 magnets (more than any other cartridge) for better balance and hum rejection.

The end result is great listening. Audition one for yourself or write for our free brochure, "How To Get The Most Out Of Your Records." After you compare our performance specifications we think you'll agree that, for the money, you can't do better than Empire.



EMPIRE

Already your system sounds better.

Empire Scientific Corp.
Garden City, New York 11530

Audioclinic

Joseph Giovanelli

Classes of Amplifiers

Q. What are the various classes of amplifiers? Please give a simple explanation of the differences between them, along with their advantages and disadvantages. — Neall Dralle, Sacramento, Cal.

A. There are a number of classifications into which amplifiers fall. There is class A, B, AB1, AB2, C, and D.

The Class A amplifier is one whose output circuit is biased in the center of its operating curve between saturation at one extreme and cut-off at the other. Thus, the current rises and falls symmetrically as the input swings above and below its idling position. Because of this linear relationship between output and input, this circuit can be run as either a single-ended or a push-pull output.

A Class B amplifier is one which is biased to its cut-off point, and under these conditions only a very small amount of current will flow when no signal is applied to the input, which makes it much more efficient than a Class A stage where a considerable amount of current flows when no signal is applied to the input. Because of the non-linear characteristics of a Class B amplifier, it can be used for audio applications only in a push-pull circuit. While the Class B amplifier is much more efficient than the Class A, it also tends to have more distortion.

Besides Class A and Class B, there are two intermediate classes, known as Class AB1 and AB2. Class AB1 amplifiers are biased more towards cut-off than a true Class A amplifier, but not so close to it as a Class AB2 amplifier. Because these two classes of audio-amplifiers are operated somewhere in their nonlinear region, they must be run in push-pull so that some of the distortion can be cancelled.

The Class C amplifier is biased to a voltage twice that required to cut the stage off. This amplifier can never conduct for anything like a full cycle, even in a push-pull arrangement, therefore these circuits are never used for audio applications.

There is a more modern class of amplifiers known as Class D which operate on a much different principle than merely adjusting the bias point. The Class D amplifier is turned off and on

with a very high frequency signal, thus the output of the amplifier contains this switching signal and special circuits are required at the output of the amplifier to reconstitute the signal from the bits and pieces actually presented. Because it is conducting for very brief intervals, it runs very efficiently, but it is a complex piece of equipment to maintain.

Finally, there is a Class G amplifier from Hitachi which is designed to operate more efficiently over more of the operating range. It boasts an efficiency of 90 per cent or better. Instead of using two transistors, as is the case with Class B and D amplifiers, the Class G uses four. The smaller pair has relatively low power dissipation and output, but whenever a higher amplitude signal comes along, a sensing diode switches on the larger pair of transistors. Consequently, each pair of transistors operates in close to its most efficient operating area, and the overall circuit can be smaller and lighter.

Television Interference with AM Reception

There is an almost perfect remedy for television interference to AM radio reception. It's very simple, but usually only practical for private dwellings.

The cure is an outdoor antenna with shielded lead-in. A simple dipole, constructed from ordinary insulated wire and placed in my attic eliminated all television "whistling."

The antenna requires no insulators. Simply tack as long a wire as possible along the attic beams, break it at the center, and connect an appropriate length of RG 59/U between this dipole and the receiver input terminals. One of the leads from the center of the dipole is connected to the "hot" lead, or center conductor of the cable; the other dipole lead is connected to the shield of the RG 59/U.—Michael Stosich, Bolling Brook, Ill.

If you have a problem or question on audio, write to Mr. Joseph Giovanelli, at AUDIO, 401 North Broad Street, Philadelphia, Pa. 19108. All letters are answered. Please enclose a stamped, self-addressed envelope.

AUDIO • September 1977

A major advance in cassette deck design. The new Sansui SC-5100.

If you're looking for a cassette deck that combines the convenience of the traditional cassette deck with the tonal excellence of open reel, you needn't look any further. Because the Sansui SC-5100 gives you both. And more.

Here's why. Performance meets the standards of today's most advanced component systems. All musical signals are reproduced cleanly and without distortion because of the wide frequency response (20-17,000Hz, chromium), excellent signal-to-noise ratio (67dB, with Dolby*), and unusually low wow and flutter (0.5%, WRMS).

The SC-5100 is ultra-convenient to use. Solenoid operation permits controls that easily respond to your lightest touch. And with the electronically-controlled tape transport you get automatic play and repeat. The illuminated memory counter is also automatic.

For added convenience the SC-5100, when used with a tuner, will record off your tuner or receiver unattended. Or it will wake you gently in the morning with your favorite music.

The SC-5100 offers all the features you'd

expect in a superior cassette deck. Such as large VU meters, a peak level indicator, line input/mic mixing capability, and bias and equalization controls for every tape. We've also added something you didn't expect, Sansui's exclusive Tape Acc-In**. Just touch the control and the tape advances past the leader to the first point suitable for recording. You need never miss or spoil the start of a recording again.

Direct-O-Matic loading is another Sansui exclusive. It makes loading and unloading a snap, gives you access to the tape well for instant insertion and easy cleaning of the heads, and lets you see the direction of the tape and how much is left.

Now you have it, cassette deck convenience with open reel performance. All for less than \$600†. Hear the new SC-5100 at your franchised Sansui dealer. We think you'll agree you've never heard anything like it.

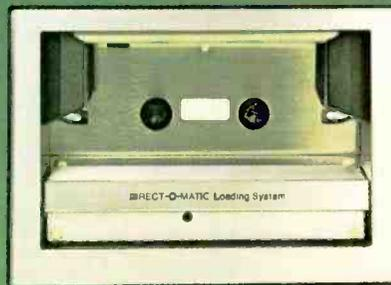

*Trademark of Dolby Laboratories, Inc.
**Patent pending.
†Approximate nationally advertised value.
Actual retail price set at the option of the individual dealers.

A whole new world of musical pleasure.



SANSUI ELECTRONICS CORP.
Woods Hole, New York 11377 • Gardena, California 90247
SANSUI ELECTRIC CO., LTD., Tokyo, Japan
SANSUI AUDIO EUROPE S.A., Antwerp, Belgium — In Canada Electronic Distributors
Enter No. 29 on Reader Service Card



We build the others

TAPE RECORDERS Super ANRS KD-95 STEREO CASSETTE DECK

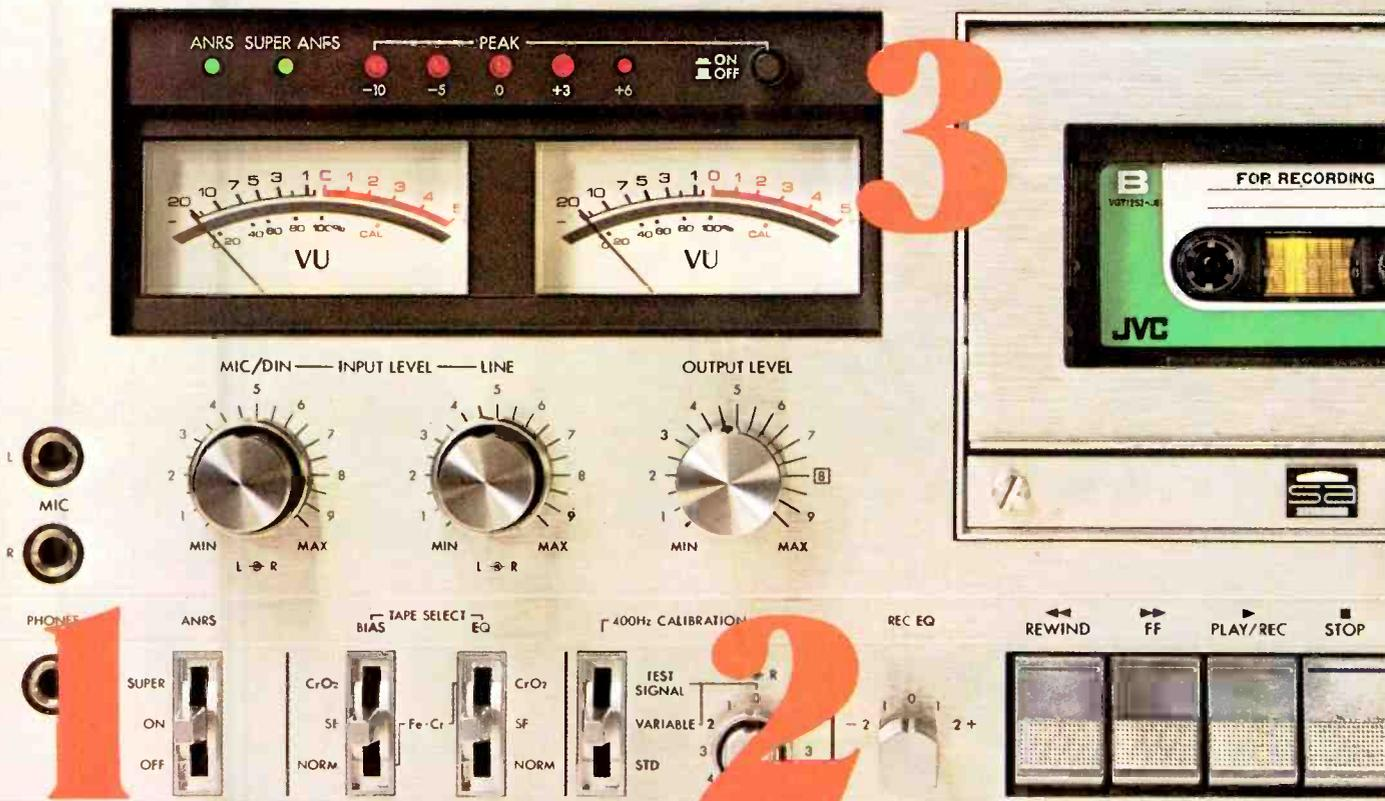

KD 95



CD-S200



KD-75



KD-35

in what leave out.

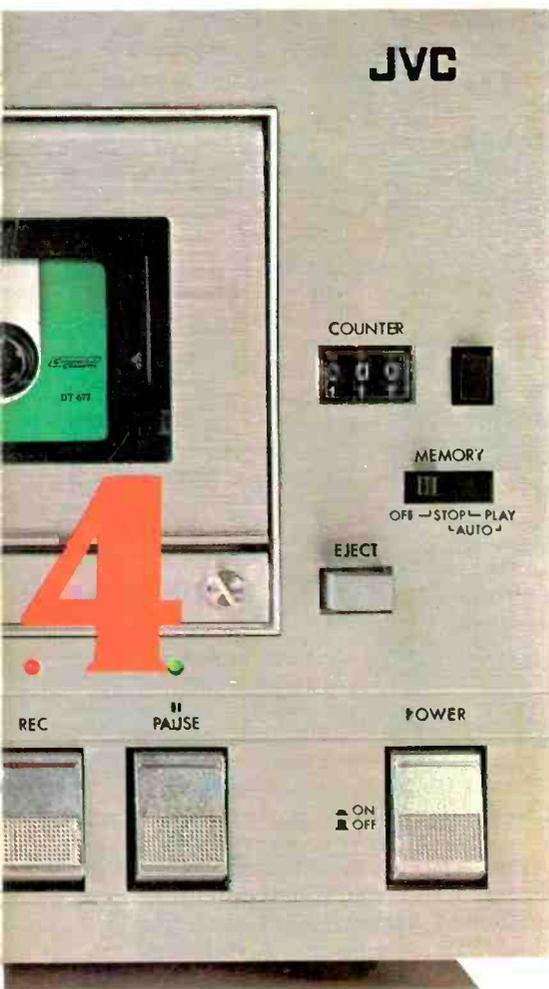

Only JVC gives you improved recording with Super ANRS, Recording/EQ switch, 5 Peak Reading LED's and SA heads.*

The measure of fine cassette deck performance is the sound of the recordings you make. JVC's extensive line of high fidelity decks features these exclusive contributions to cassette deck technology.

1 Our Super ANRS gives you efficient noise reduction, with the added plus of extra-low distortion at high-level high frequencies. And you can switch to our regular ANRS for making recordings to be played using other noise reduction systems. **2** In addition, our extra Recording/EQ switch helps you to precisely adjust the high frequency response of your deck to match any tape you care to use.

3 The entertaining LED's you see on our decks actually help you make better recordings. They're easier to read than VU meters by themselves, so you can record at higher levels without fear of tape saturation.

4 And our SA (Sen-Alloy) heads offer the sensitive performance of permalloy, plus the long life of ferrite in one design. These heads are so excellent in their performance and durability that other manufacturers are buying them from us to use in their decks.

There are a variety of other features to simplify your cassette recording. And our specifications are equal to or better than machines that cost much more.

Once you've seen the things we build in, you'll wonder why the others leave them out.

JVC America Company, Division of US JVC Corp. 58-75 Queens Midtown Expressway, Maspeth, New York 11378 (212) 476-8300. Canada: JVC Electronics of Canada, Ltd., Scarborough, Ont.

For your nearest JVC dealer, call toll-free (outside N.Y.)

800-221-7502.

Enter No. 11 on Reader Service Card

*Not all features in all decks

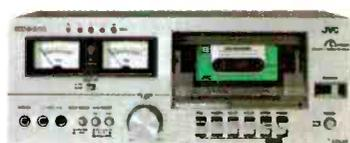

KD-15



CD-1770



CD-1636



KD-2

JVC

Audio etc.

Edward Tatnall Canby

"Ah, sweet mystery of life!" What would this Centennial year of audio be without a few more little mysteries to carry us through to December?

For the responsible engineer, there's always room for improvement in his product and his sweetest mystery is, how? To the scientist, as to the artist and the historian (since time closes in on facts), a residue of mystery is the spice of life—otherwise why bother? To establish exactly how a star is formed out of a million light years of cosmic dust, or how a bit of proto-life somehow developed from a soup of nucleic acids (my only question: would they fizz if you added bicarbonate of soda?)—these are the quests that titillate. Or maybe where G. Washington slept the night of Dec. 6, 1777, our anti-Centennial date. So long as absolutely final answers to these things, and plenty more, continue to elude us we are fascinated. Once they appear, we are bored and move on.

How dull, then, to know every bit of that sequence of events and reasonings that led our good old friend Thomas Alva to indent the foundations of the great industry which supports us all. And how dull to know exactly what the First Phonograph looked like. Of course, practically all of the necessary info, plenty of it in T.A.E.'s own handwriting, is at hand—and so is the First Phonograph. Indeed, since last writing I have laid my own eyes on three of them, all identical. But by great good fortune, we have, collectively speaking, a very long way to go in getting the facts around. Our distribution is plain awful, thank the Lord. Otherwise I really would be bored.

In all truth, there is so much confusion right now that I am positively delighted. As they say, it's a gas. Individually, the readers of this magazine have among themselves absolutely all the info you could ever look for, as I should know from my recent mail; our ardent correspondents, alas, have cleared up most of my pet Edison mysteries for me. Though I did, reluctantly, do a bit of my own research-

were grooves, pre-cut in the brass cylinder, as a million citizens have seen, without noticing, and as numerous readers have attested. Fact. But to my surprise, they were widely spaced out, with relatively enormous areas of flat "land" between. Wasteful? Edison wouldn't seem to have been looking for maximum long play. Or (mystery) did he perhaps space them out in order to give the intervening foil

enough latitude to stretch, so the indentations could fill each groove under the stylus without reaching a rip point? I would think so. Remember, no one had ever seen a phono groove before that one. Canny old Edison. Knew his stresses and strains.

So you see I create a new little speculation to replace each of my lost and answered old ones. But let me get on to the fun.

Talk about second hand info. Needless to say, the great churning vehicles of public audio information, and upon the larger national scene and that small area called the Rest of the

World, have not overlooked the Centennial of recorded sound. It must be celebrated. And so—quick, out to the library! Get the PR going. And send somebody for a photo. That little round circle you see all over now, with 1877/1977 inside it, is merely the beginning, and, of course, on a macro scale it is informationally correct, too, though there remains a cute bit of mystery, the precise mini-moment of the exact day, Dec 6, 1877, when Mary first had her little lamb in the words of Thomas himself. Nobody seems to have worried about that mystery, but I do. Because it's THERE. (Now don't go and tell me, and spoil it all.) Anyhow, there has to be more than a round

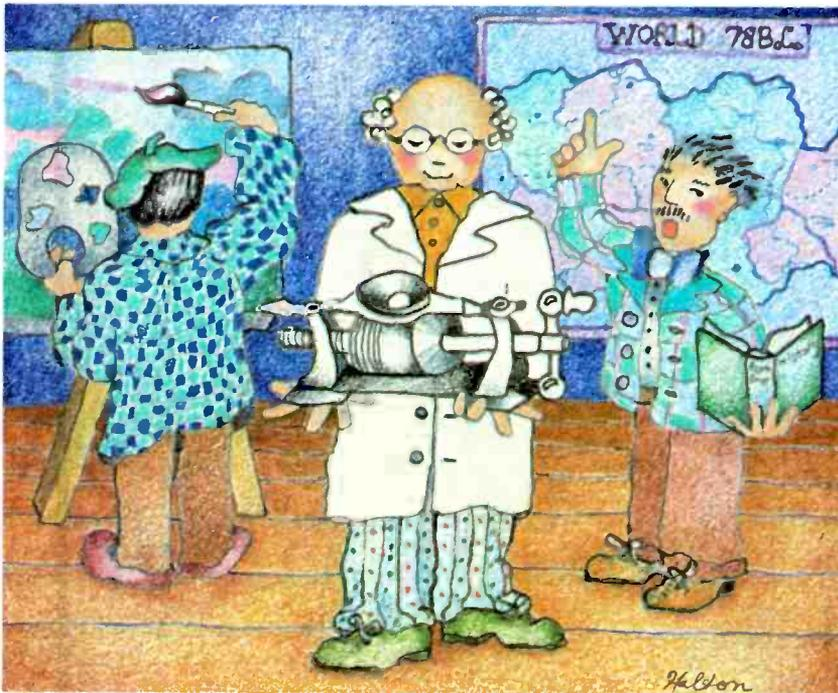

ing, first hand, like getting my own two eyes within a foot or two of the Machine itself, the First Phono. But now I've created a few more puzzles to keep me going, and replace the old ones.

Of the three First Phonos, the first was so dirty in its unwashed case that I could scarcely see the blackened and dusty cylinder. Frankly, I was shocked. The other two, at least, were in good enough condition to be presentable—they were exact replicas, one quite recent. Facts? You can buy a vastly detailed set of drawings, to build your own! I bought but I didn't. Even so, I noted some more mildly questionable items. Yes, there

8 sound reasons to buy our new receiver. Plus its sound.



Sony's new, more powerful STR-6800SD receiver should get a warm reception. Because it not only looks different from other receivers, it *is* different.

It has some features found in more expensive separate components—and other features found nowhere else at all.

1. The most-used controls all in one place. The level control, muting switch, tuning knob and input and tape selectors are all in the upper right-hand corner.

2. A dial pointer that doubles in length when it's close to a station. Together with the signal strength meter and the center channel meter, this Sony exclusive helps you tune more accurately.

3. A stepped level control to keep both channels equal. It guarantees unprecedented accuracy—to within 1/2 db over the whole volume range.

4. MOS FET front end electronics unitized tuning. Because it's unitized, the receiver tunes the same whether it's cold or warmed up.

And MOS FET gives it a very wide dynamic range.

5. Dolby noise reduction system. So you can benefit from Dolby broadcasting. Instead of being an extra, it's built in—operated from the front panel.

6. Phase locked loop. It gives you better stereo separation and less distortion.

7. LEC (low emitter concentration) transistor. This Sony exclusive in the preamp phono stage yields tight RIAA equalization, low noise, low distortion and a wide dynamic range.

8. Sony's most powerful receiver. It delivers 80 watts minimum RMS continuous power per channel at 8 ohms from 20 Hz to 20,000 Hz with no more than 0.15% total harmonic distortion. It has a direct-coupled power amplifier with true complementary symmetry output stages.

And more. To these specifications (remember, we state

them conservatively), add Sony's proven reliability. And you get a receiver that produces a sound that'll make you understand why you have ears.

That's the STR-5800SD at \$600. Or, for less power and a few less features—but no loss of fidelity—the STR-5800SD at \$500 and the STR-4800SD at \$400 (all suggested retail prices).

A sound investment.



SONY

©1976 Sony Corp. of America.
 330 9th Ave., N.Y., N.Y. 10019. SONY
 is a trademark of Sony Corp.

Enter No. 33 on Reader Service Card

seal. We must have press kits. And above all, pictures. Numerous organizations, small and large, and even a few organisations (U.K.), have felt that urgent need. So, ha, ha, HA—what a glorious batch of First Phonos they have dug up for us to look at. You can hear my chuckles a mile away.

First, and biggest, is of course the U.S. govt itself, in the guise of its profit making (?) arm, the P.O. Gotta have a (profit making) commemorative stamp, and so we do. Worthy idea, I hasten to say, and many a collector will be happy to own said stamp, for a

consideration, in future years. As are we to see it now, gummed so colorfully to our fast (?) mail. So, will you kindly take a look at the First Phonograph so immortalized? If you need glasses to see that close, then get out your copy of one of our esteemed brother audio mags, which conveniently arranged to enlarge the stamp to full cover size for one of its Centennial issues.

Governmental Goofs

—So the P.O. thinks THAT is the First Phono? It most certainly is not.



It's the long, thin model with the big flywheel that appears in Matthew Brady's Washington photo of Edison, taken when Thomas A. went down to the Capital to indulge in a bit of well-earned publicity by playing his thing to the President and to Congress. According to an Edison biography, this was in April, 1878. And who, by the way, was the President? Do you think I'd know? But I can tell you. It was Rutherford B. Hayes. This machine, then, came some four months after the First Phonograph, clear out of the Centennial year. For shame, U.S. Govt! But maybe understandable. It was, in fact, the machine that appeared in the Nation's Capital and, after all, we know that burg is a land unto itself. The stamp, of course, shows the first Washington phonograph. What else?

Interesting differences. Evidently Edison had begun to realize the importance of steady pitch. The flywheel he added would have at least eliminated the more erratic ups and downs of the first hand-cranked model. I'll be willing to guess that Mary was marginally unintelligible not so much because of distortion and limited frequency range as simply because of the pitch erratics. That flywheel no doubt improved speech by a great deal and even made music a faint possibility.

So the U.S., wittingly or otherwise, is celebrating the Second Phonograph, officially speaking. Not the first. OK, I'll do you one better. How about that respectable, if somewhat less sizeable local institution of ours known as R.I.A.A., the Record Industry Association of America? Never can quite remember. Yes, it's the outfit that standardized the well known curve for disc recording, ending the war of the equalizations of years ago, and good riddance. It's the organization for all audio manufacturers who are into records in some form or another (and who isn't).

Publicity Foibles

Anyhow, the R.I.A.A. naturally felt that as a leader in the field it should signalize, shall we say, the first signal,

Phase Linear FM Tuner with exclusive Dynamic Range Expander.

With the new Phase Linear 5000 FM Tuner you can actually improve FM broadcasts to rival that of tapes and records. Advanced electronics combine excellent reception capabilities with a unique Dynamic Range Expander that restores compressed FM signals to their original sonic quality. The Phase Linear 5000 has many other un-

usual features not available on most conventional tuners, including an L.E.D. Multipath Distortion Indicator that identifies this type of distortion, thus simplifying its removal; a Variable Muting Control; De-emphasis; and more.

Phase Linear
The Powerful Difference



See your dealer and listen to this remarkable tuner.



Manufactured in the USA. Distributed in Canada by H. Roy Gray, Ltd.

Enter No. 21 on Reader Service Card

You're looking at the world's best-designed tonearm.

This is a Dual tonearm. It can make a big difference in the way your records sound. And how long they last.

The four-point gyroscopic gimbal is widely acknowledged to be the finest suspension system for a tonearm. It pivots the tonearm precisely where the vertical and horizontal axes intersect. The arm remains perfectly balanced in all planes of movement.

Further, the straight-line tubular design achieves the shortest distance between pivot and stylus. That's basic geometry. Curving the tonearm adds mass, decreases rigidity and makes the arm prone to lateral imbalance.

The vernier counterbalance permits you to balance the tonearm with micrometer-like precision. Tracking force is applied so that the stylus remains perpendicular to the record, even if the chassis is not level.

All this serves to establish and maintain the correct cartridge-to-groove relationship. So the stylus can trace the rapidly changing undulations of the groove walls freely, precisely and with the lowest practical force. In short, flawless tracking.

Despite the advantages of the gimbal-mounted tonearm, you won't find many around. But now, you will find one on every Dual turntable. Even our lowest-priced model, the new, fully automatic 1237.*

It's one more example of Dual's total commitment to engineering excellence.



Enter No. 7 on Reader Service Card

For the life of your records



United Audio, 120 So. Columbus Ave., Mt. Vernon, NY 10553

*Less than \$135. Other Duals to \$400. Actual resale prices are determined individually by and at the sole discretion of authorized Dual dealers.

Decca Record Brush:



No Side Effects

Most record cleaners use liquids. They do the job. But not without side effects which reduce the life of your records.

To see why, imagine you are examining a record groove through a microscope while various liquid cleaners are tried. All the cleaners remove a lot of dust, but even the best ones leave some behind. Since liquid was applied, this soft dust dries into hard grit. While the stylus could have pushed a few soft dust particles out of its way, it must now track hard grit particles like they are part of your record. The result: distortion. Not to mention stylus wear caused by the new bumps and grinds it must now traverse.

Decca's research into these liquid side effects, resulted in their pioneering of a new, electrically conductive, carbon micro-fiber - the bristles of the Decca Record Brush. Each Decca Record Brush contains one million of these ultra-thin conductive bristles - 1000 enter each groove removing dust, dirt - and draining off static for lower surface noise and expanded dynamic range.

Decca Record Brush. No fluids, no side effects. Just keeps your records sounding like the first time.

Decca Record Brush available at quality dealers across the U.S. Sugg. list \$14.95

ROGELCO INC.

160 Ronald Dr.,
Montreal, Canada H4X 1M8
Phone (514) 489-6841

Enter No. 27 on Reader Service Card

along with and maybe slightly ahead of the rest of us. But yes! And so—out go the people in charge—hired PR? And pictures, PICTURES! They dug 'em up and they sent 'em out, a folder of gorgeous glossies, printed captions along the margins, along with a complete press-release "History of the Phonograph." Interesting indeed and I read every word. The photo kit was excellent, even including a novel scene of early electrical orchestra recording before a single carbon mike, the one with the box underneath. (What they didn't notice was the studio, small and totally dead, hung all around with big heavy curtains to suppress any lingering room sound. At that time the marvelous usefulness of liveness had yet to be understood. This was an acoustic-type recording made via electronics. They all were for a number of years into the electrical era—just try a few real oldies and see.)

Another picture shows the youthful Peter Goldmark, then top man in CBS Labs, New York City, with the famed stack of 78 albums in a wooden frame around eight or nine feet high and Dr. G. holding the same albums in LP form (10 and 12 inch) in his two hands. Do I remember—I was there at the press conference where this stunt was first pulled off to launch the original LP.

Well, finally, having got the photos in the wrong order, I reached picture No. 1. Guess wot. "Edison's original phonograph, patented in 1877, consisted of a piece of tin foil wrapped around a rotating cylinder. The vibrations of his voice as he spoke into a recording horn (sic) caused a stylus to cut grooves (sic) into the tin foil." That from R.I.A.A., who ought to know. Second-hand info? If there was a "recording horn" on the First Phono, I have yet to see it. Unless you call the receiver on an old telephone a horn. (A tiny horn in front, yes.) And if the stylus cut grooves, then, dear me, what a pile of shredded foil we would have had! But you ain't heard the whole of this R.I.A.A. story.

Picture No. 1, gorgeously detailed and shiny, was a photo of AN Edison-type machine with brass cylinder. And grooves—but only over one half of the surface. Is that a layer of tin foil I can almost discern, half recorded? Do I see a joint, sort of, down near the bottom? (Yes, by the way, a reader tells me that indeed the tin foil phono did play with a repeated fast tick, tick, tick, over the joint, just as I had guessed. Another mystery shattered.) If so, this is the only picture of a brass-cylinder machine I have seen *with the foil in*

place. It definitely was missing on the Three First Phonos I looked at in person.

First Phono Discord

—But hey, what *is* this R.I.A.A. phonograph? IT IS NOT THE FIRST PHONOGRAPH. Nor is it the official Second, the one the P.O. uses. In plain fact, it is a model I have never seen before at all. Mystery, O happy days!

No flywheel, short, and yes, the fatter, shorter brass cylinder of the original model. It must be a very early type. It has a crank like No. 1 too (counterweighted for pitch control). But the solid metal base continues upwards in two curved pedestals, drilled partway up to take the main shaft with the cylinder (the far end threaded, not the near end as in the First Phono)

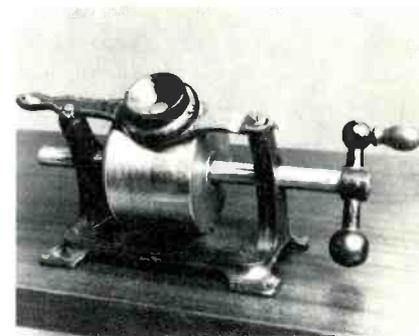

and on the side-slanted top is a cross member holding a telephone-like diaphragm unit; it releases on one side via a handle. Nice scrollwork lines on base and handle. The original model's record and play units were fastened on the base itself, one on each side. This one operates from above—and *there is no second unit.* Was this a record/play head? Looks that way. The Washington model is the same.

So I'm guessing this is No. 1½, early 1878, perhaps before the improved official Washington model of that April. Don't ask R.I.A.A. They still probably think it's the First Phonograph in all its glory. As does the P.O. with its model, on that stamp. How nice to have three versions! That's what you can do with second-hand info, and I'm all for it, if it makes for mystery.

P.S. Believe it or no, the A.E.S., taking over R.I.A.A.'s record history text, has published a booklet that also includes the R.I.A.A. wrong first phonograph, tastefully re-done from the photo into a drawing! As Abe Lincoln said . . .

It's time for everybody else to start playing catch-up. Again.

From the very beginning, experts have acclaimed the performance and feature innovations of Yamaha receivers as nothing less than spectacular.

But now, we've outdone ourselves.

Yamaha is introducing a new line of receivers with such unprecedented performance, it's already changing the course of audio history.

Real Life Rated!™ While traditional laboratory measurements provide a good relative indication of receiver performance, they simply don't tell you how a receiver will sound in your living room in actual operation. So Yamaha developed a new standard for evaluating overall receiver performance under real life conditions. It's called **Noise-Distortion Clearance Range (NDCR)**. No other manufacturer specifies anything like it, because no other manufacturer can measure up to it.

We connect our test equipment to the phono input and speaker output terminals, so we can measure the performance of the entire receiver, not just individual component sections like others do. We set the volume control at -20dB, a level you're more likely to listen to than full volume. We measure noise and distortion together, the way you hear them.

On each of our new receivers, Yamaha's Noise-Distortion Clearance Range assures no more than a mere 0.1% combined noise and distortion from 20Hz to 20kHz at any power output from 1/10th watt to full-rated power.

Four receivers, one standard. On each of our four new receivers, Yamaha reduces both THD and IM distortion to new lows—a mere 0.05% from 20Hz to 20kHz into 8 ohms. This is the kind of performance that's hard to come by in even the finest separate components. But it's a single standard of quality that you'll find in each and every new Yamaha receiver. From our CR-620 and CR-820 up to our CR-1020 and CR-2020.

What's more, we challenge you to compare the performance and features of our least expensive model, the CR-620, with anybody else's most

expensive receiver. You'll discover that nobody but Yamaha gives you our incredibly low 0.05% distortion and -92dB phono S/N ratio (from moving magnet phono input to speaker output).

You'll also discover that nobody else starts out with such a variety of unique features. Independent Input and Output Selectors that let you record one source while listening to another. A Signal Quality Meter that indicates both signal strength and multipath. The extra convenience of Twin Headphone Jacks. Or the accurate tonal balance provided at all listening levels by Yamaha's special Variable Loudness Control.

More flexibility. It's consistent with Yamaha's design philosophy that you'll find the same low distortion throughout our new receiver line. Of course, as you look at Yamaha's more expensive models, it's only logical that you'll find the additional flexibility of more power, more functions, and more exclusive Yamaha features.

For example, there's a sophisticated tuner, with unique negative feedback and pilot signal cancellation circuits (patents pending), that makes FM reception up to 18kHz possible for the first time on a receiver. Plus other refinements like a Built-In Moving Coil Head Amp, Fast-Rise/Slow-Decay Power Meters, and Yamaha's own Optimum Tuning System.

Now's the time to give us a listen. Our new receiver line is another example of the technical innovation and product integrity that is uniquely Yamaha. And your Yamaha Audio Specialty Dealer is an example of uncommon dedication to faithful music reproduction and genuine customer service. It's time you heard them both.

If your Yamaha Audio Specialty Dealer is not listed in the local Yellow Pages, just drop us a line.



YAMAHA

Audio Division, P.O. Box 6600, Buena Park, CA 90622
©1977 YAMAHA INTERNATIONAL CORP.

Real Life Rated

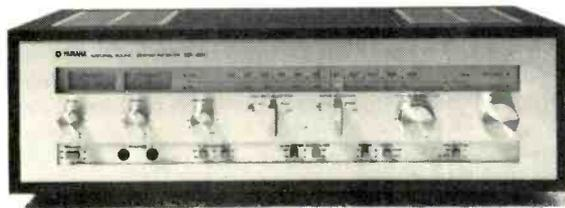

CR-620 0.05% THD 0.05% IM

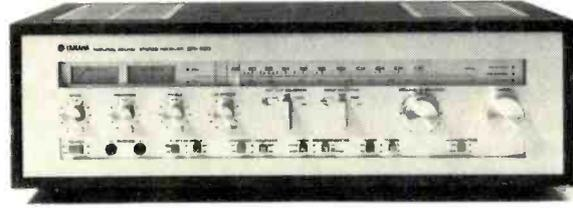

CR-820 0.05% THD 0.05% IM

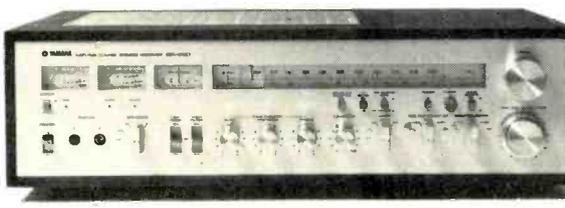

CR-1020 0.05% THD 0.05% IM



CR-2020 0.05% THD 0.05% IM

Behind the scenes

The 1977 Summer Consumer Electronic Show in Chicago marked the eleventh anniversary of this annual event. It also nicely coincided with the Edison Centennial, celebrating 100 years of recorded sound, and the 30th anniversary of commercial television, as well as *Audio's* 30th. Obviously, the CES had a lot going for it this year, and to put icing on the cake, Chicago obliged us with some highly unusual delightfully cool weather, albeit with some rain, and thunderstorms too.

Probably heartened by the surprising success of the winter CES in January and the apparently ongoing improvement in the general business climate, despite inflationary pressures, the mood of the 45,000 plus attending was very upbeat, buoyant, and determinedly optimistic. All first day attendance records were quickly broken as huge crowds surged into the vastness of McCormick Place, and for the first time, in addition to the main floor, both sub-floors were needed to cope with the great number of exhibitors. Across the street, McCormick Inn was reserved for the exclusive use of audio exhibitors. There were mixed reactions to this facility. Most people liked the idea of so many audio exhibits in one location handy to McCormick Place ... but there were many complaints about the small size of the demonstration suites at the Inn, its poor soundproofing and ventilation, and above all, the exasperating slowness of the elevator service, which led to long waiting lines in the lobby and on the exhibit floors. The audio industry has become so large that it still was necessary to visit enclaves of audio manufacturers who were in most of the major Chicago hotels, and the taxicabs were *generously* enriched by our excursions to the various inns.

One thing is certain about the CES. No matter how energetic or conscientious one is, it is just plain impossible to see everything, even when you know where specific demonstration suites are located, to say nothing of interesting exhibits you only learn about when the show is over. Needless to say, there were many interesting new products, with various

trends being reflected in what was offered.

Receivers

It was evident that the receiver power race which has dominated the industry for the past several years is still very much with us. To wit: Marantz became the new champion with its Model 2500, rated at 250 watts per channel into 8 ohms, and for those who own 4 ohm speakers, a rather staggering 330 watts per channel. Features on this receiver include a built-in oscilloscope for tuning in-



dedication, signal strength, multipath rejection, stereo separation and other signal indications, and a claimed signal-to-noise ratio of 50 dB with only 25 microvolts of signal. What Marantz terms a "turbo-flow heat dissipation system" with "pin fin" heat sink design is said to keep this receiver cool, and as a result, the unit is not of the size and weight usually associated with this much power. All this can be yours for a mere \$1495.00. Hitachi has its SR2004 Receiver rated at 200 watts into 8 ohms, but with its Class G amplifier circuitry it is claimed to be capable of 400 watts per channel within rated distortion on transient peaks. The circuit is somewhat analogous to the "current dumping" scheme of Quad amplifiers in that most signal information is handled within the 200 watt power rating of the unit, but when high level transients are encountered, the circuit sort of "shifts" its electronic gears and goes into the higher power mode. The efficiency of the Class G circuit is said to result in less heat for such a high power output, and thus means less heat sinking

and lower weight. The other high-powered receivers at the show have maintained their status quo, with Rotel at 180 watts per channel into 8 ohms, Technics at 165 watts per channel and Kenwood and Pioneer both at 160 watts per channel. With those companies who did not choose to compete in the horsepower race, their receivers reflected technical refinements. Thus the units from Sansui and Sherwood, for example, featured improved sensitivity, better stereo separation, better and more flexible tone controls, phono preamp sections with less noise and distortion, and more accurate RIAA circuits.

When will the horsepower race reach a point of diminishing returns? The end is apparently not yet in sight, with rumors of several 300 watt per channel units in the offing! The size and weight of these brutes can be the limiting factor, but consider the fact that Sony, for example, could conceivably incorporate its Class D switching amplifier into a receiver, which because of its efficiency, put out 350 watts per channel, and still be relatively compact and lightweight. The mind boggles!

As you are no doubt aware, as receivers have become more powerful, more complex, bigger, and heavier, the market for separates has grown apace. Of course, the idea of a separate preamplifier, power amplifier, tuner (and these days, equalizer) is as old as high fidelity itself, and in my book the new emphasis on so-called separates is merely an index to the ever-increasing number of audio consumers who have become audiophiles. I don't think there is any question that separates afford more flexibility, technical sophistication, and exalted levels of quality than is likely to be incorporated into any receiver. For those with the wherewithal to indulge themselves in separate components that are at the fine cutting edge of the art, the sky is the limit. Nuff said?

Tuners

Sherwood's \$2000.00 Micro/CPU 100 FM tuner is finally in production and can probably rank as one of the most sophisticated audio components

How to get a three-motor, direct-drive, isolated-loop deck. And save \$5,500.



"Ingenuity of design can be fascinating for its own sake, but when it results in a product of demonstrable excellence, as with this tape recorder, one can only applaud..."

The review is from *Modern Recording*. The tape deck is Technics RS-1500US. And the ingenuity of design that *Modern Recording* and *Audio* have praised in recent issues is Technics' advanced "Isolated Loop" tape transport with a quartz-locked, phase-control, direct-drive capstan.

By isolating the tape from external influences, Technics has minimized tape tension to an unprecedented 80gms. Eliminating virtually all signal dropout. While reducing modulation and wow and flutter to a point where conventional laboratory measurement is seriously challenged. A considerable achievement when you realize Technics RS-1500US is priced substantially below its professional counterpart. \$5,500 below.

Electronically, too, Technics has provided the ultimate in professional control and performance. A separate microphone amplifier. Record amplifier. Mixing amplifier. And three-way bias/equalization. While IC full logic function controls permit absolute freedom in switching modes.

Compare specifications and prices. Then you'll realize there's no comparison. TRACK SYSTEM: 2-track, 2-channel recording, playback and erase. 4-track, 2-channel playback. **FREQ. RESPONSE:** 30-30,000Hz, ± 3 dB (-10dB rec. level) at 15ips. **WOW & FLUTTER:** 0.013% WRMS at 15ips. **S/N RATIO:** 60dB (NAB weighted) at 15 ps. **SEPARATION:** Greater than 50dB. **RISE TIME:** 0.7 secs. **SPEED DEVIATION:** $\pm 0.1\%$ with 1.0 or 1.5mil tape at 15ips. **SPEED FLUCTUATION:** 0.05% with 1.0 or 1.5mil tape at 15ips. **PITCH CONTROL:** $\pm 6\%$. **SUGGESTED RETAIL PRICE: \$11,500***

Technics RS-1500US. A rare combination of audio technology. A new standard of audio excellence.

*Technics recommended price, but actual retail price will be set by dealers

Technics Professional Series
by Panasonic

Enter No. 37 on Reader Service Card

extant. Using micro-processor technology, it achieves state of the art levels of performance in nearly every FM parameter. For those who like to indulge in "one upmanship," how about a tuner where you can punch a button and come up with not only a LED readout of a station's frequency, but its call letters as well! There is a growing trend to so-called "slim-line" components with low physical profiles. Lux has what they call the LRS series and they have a frequency synthesizing digital tuner (as well as companion preamp, amplifier and graphic equalizer) with very fine specifications. As usual with this company's products, they are cosmetically attractive and beautifully finished. Technics calls their low profile components the "Flat Series," and it comprises an FM/AM tuner, preamp, amplifier, equalizer and metering unit. The tuner features flat group delay filters and is said to be capable of reproducing square waves.

In more conventional format, Sansui was showing their new TU-717 FM/AM tuner which features selectable i.f. bandwidth for lower distortion, 0.09 per cent in stereo is claimed. Still more remarkable is their claim of a S/N ratio of 77 dB in stereo. Yamaha was showing its well regarded CT-7000 FM tuner, which has extremely low stereo distortion. There were many other tuners in various price ranges from the likes of Pioneer, Kenwood, Marantz, Onkyo, in which even the modestly priced units had levels of performance undreamed of just a few years ago. A good many of the tuners (and a lot of receivers) featured Dolby B FM decoding circuits with the 25 microsecond de-emphasis built in, and as Dolby FM broadcasting grows, this will be an ever more appreciated facility.

Amps

Moving on now to preamplifiers, power amplifiers and integrated amplifiers, I must confess to a personal idiosyncrasy, in that I have never had much regard for integrated amps. However, there is no doubt of their growing popularity, especially when coupled with some of the jazzy new tuners now available. These integrated amps are no slouches when it comes to power. Marantz has a new Model 1260DC integrated amp which is rated at 130 watts per channel into 8 ohms, with no more than 0.03 per cent THD. Pioneer's SA9900 integrated amp puts out 110 watts per channel, while Kenwood has their Model 600 with 130 watts per channel.

There are other 100 plus watt units from Lux, Hitachi, Rotel, and Sansui. Irrespective of power output, more attention is being paid to extended frequency bandwidth, minimum phase shift, very low distortion, and RIAA equalization held to a tolerance of ± 0.2 dB, in several of the new integrated amplifiers, notably the Marantz 1260DC listed above, and Sansui's 85 watt per channel AU-717, which boasts of response from d.c. to 200 kHz, $+0.0$ dB, -3.0 dB, with THD rated at 0.025 per cent. Clearly, many integrated amplifiers have achieved levels of performance, that not too long ago were the exclusive province of very fancy and expensive power amplifiers.

Preamps

Preamplifiers. They come in all sizes, shapes, and price ranges, and currently they seem to enjoy the status of a "glamour" component. A great deal of research is being conducted on preamps, and many new designs are on the market. Preamps are the special joy of the most avant-garde audiophiles, and the more exotic the design and specifications, the better. These people feel that various preamps have a profound influence on the quality of sound they get from their stereo systems. Preamps are reviewed and endlessly discussed in the "underground" audiophile magazines, and their sonic qualities described in such terms as "hard and grainy," "gritty," "sweet and open," "transparent," "good depth perspective," "high definition," "ambience suppression," etc. Whatever your reaction to this colorful terminology, and the fact that it does neither quantify nor qualify the particular technical virtue or anomaly which stimulated such responses, there is little doubt that many people do indeed perceive audible differences between various preamps, even when the technical specifications of the preamps are nearly identical. Over the past few years there has been an intensive effort to correlate objective measurement techniques with subjective listening responses to preamps. There have been some moderate degrees of success in this respect . . . in particular, the work of W. Marshall Leach of Georgia Tech, and the joint venture of Ojala and Leoninen of Finland and John Curl in this country on the phenomenon of transient intermodulation distortion has been quite revealing. It is thought by many people that even a very tiny percentage of TIM can make a preamp

have an unpleasant sound. Many designers of preamps now feel that the standard steady-state harmonic and intermodulation distortion measurements which have been used for years have little or no relevance to the dynamic aspects and complex waveforms of music. Unfortunately, there is presently no fully recognized standard of measurement for transient intermodulation distortion. Be that as it may, a number of people claim to have proprietary methods of measuring TIM, and this has influenced the design of their preamps. If one can make a generalization in this matter, those who subscribe to the idea and importance of TIM want a circuit that will give them an "ultra-fast" preamp, where transient signals are not distorted by "time delay" or "time smear" as it is sometimes called. Of course, there is a great deal more to designing a preamp, but this emphasis on TIM would seem to be entirely justified in the light of present experimental evidence. Needless to say, different engineers have different ideas, and the preamps shown at the CES reflected this diversity.

By far the most radical departure from conventional preamp design was Crown International's DL-400 Stereo Control System. This consists of a switching module, power module, and phono stage module. The switching module has eight high level inputs which are digitally selectable via pushbuttons with LED indicators. There is a unique *Volume/Balance* control, which is pushbutton controlled and digitally stepped in 0.5 dB increments (129 positions in all). These controls have a dynamic range of 63.5 dB, and an LED display shows gain in dB above minimum level. Channels can be independently adjusted or ganged over the full range, with a tracking accuracy of 0.2 dB. The tone controls cover bass, midrange and treble, with adjustable turnover frequencies, and are stepped type providing ± 15 dB of boost and cut. A cancel switch is available which will remove the tone controls from the circuit for true flat response. There are rumble and scratch filters, also with cancel switch, a stepped 31 position "Panorama" control for adjustment of stereo image, and inputs and outputs with switching controls for external signal processors such as equalizers and noise reduction units. Well, that is all very nice, but get this people . . . input selection, power Off and On, mute, volume, and balance can all be remotely controlled! The power module of the DL-400 has sev-

Remember the plug-in-shell?

Thorens Isotrack Series Turntables proudly introduce the Plug-In Arm.

Thorens introduces an exciting new tonearm design to complement its highly sophisticated, new manual turntable series. Thorens has eliminated the headshell and its collar connection by incorporating the headshell and tonearm rod in a straight tubular design only 7.5 grams in effective tonearm mass. This reduction in mass (up to 50% that of other tonearms) reduces the inertial forces that affect stylus pressure. Tracking is improved, distortion lowered and stylus and record life are extended. Thorens Isotrack tonearm assures optimum performance with the newest, light weight, high-compliance pick-up cartridges.

The accent is on quality
—The high-speed stability and silent opera-

tion of the belt-driven 16-pole synchronous motor is a tribute to Thorens traditionally advanced engineering. The natural elasticity of the belt filters motor vibrations from reaching the platter, and therefore, the pick-up stylus. In more than twenty years of continuous development, and the manufacture of nearly one-million Thorens turntables, Thorens has brought its belt-drive design to a level of technical perfection not approached by *any other drive system known today.*

Thorens Isotrack turntables featuring the "mini-mass" tonearm—now at your Thorens Isotrack series Dealer, or for further details write:

THORENS
ISOTRACK™

ELPA MARKETING
INDUSTRIES, INC.

East: Thorens Bldg.,
New Hyde Park, N.Y. 11040
West: 7301 East Evans Road,
Scottsdale, Ariz. 85260



Pictured Above: Top Right—TD-126C • Lower Right—TD-145C
Lower Left—TD-156C • Top Left—TD-160C



en switched and one unswitched a.c. outlets, and can handle up to 50 amps. It furnishes d.c. supplies to the switching and phono modules. The DL-400 phono module is designed to be mounted at the turntable to reduce the length of low voltage r.f. sensitive cable. A switch provides RIAA equalization or flat response for use with a microphone. There is a 30 to 50 dB adjustable input gain, and 47 or 100 kilohm input impedances which are switch selectable. Phono input of up to 330 mV is monitored by an LED

overload indicator. A moving coil phono module will be optional. Finally, the DL-400 is designed to accept an upcoming Microprocessor Control for the application of computer control techniques. Clearly, the DL-400 breaks new ground, and I like the concept that allows considerable signal processing, or thorough defeat switches, no processing at all. You may remember that over a year ago I predicted that remote control of preamp facilities would be forthcoming, and now Crown has taken the first

step. The projected price of the DL-400 is \$1495.00.

Another interesting preamp seen at the CES was the Model 520 Stereo Pre-amplifier made by Analog Engineering Associates of Silver Spring, Maryland. Of modular construction, the unit is built to very high standards, using such parts as printed circuit boards of Military or NASA specifications. All interconnecting pins, as well as phono input jacks are 24k gold-plated. Resistors are all 1.0 per cent tolerance, capacitors are solid tantalum, mica, or metallized polycarbonate. Control potentiometers are Allen Bradley Tight-Trac units. Overall construction is anodized aluminum. Phono and high level inputs are pushbutton selectable, as are tape monitor, high and low filters, and mode. Specially configured bass and treble controls, and loudness controls are provided. This is a fairly straightforward design with a minimum of frills. Here is a case where the designers are acutely aware of TIM, and a situation in which they have their proprietary method of measuring TIM. According to the company, they are actually able to use music for their dynamic measurements signal, and after manipulation it is fed into their own computer for analysis. The preamp has impressive specs, not the least of which is in the phono section, where they claim a "total transient error" of 0.004 per cent, 20 Hz to 20 kHz, measured under actual dynamic conditions. Price is less than \$600.00. The company also manufactures two preamps for moving-coil phono cartridges, the deluxe Model 515 featuring variable gain to match MC outputs and variable frequency compensation to compensate for the rising high end of some MC cartridges. The price has not been announced.

The Rappaport PRE-1 stereo preamp was shown at the CES, and is another modular construction unit, that already has earned a following among audiophiles. Here again, the emphasis is on a simple unit with a minimum of signal conditioning to achieve low distortion.

RAM Audio Systems were showing their new RAM200 preamp. The unit features direct input for moving-coil cartridges, wide bandwidth, high slew rate, and all output circuits are Class A complimentary bipolar transistors. Level attenuator is a 36 position gold-plated switch, with metal film resistors. There is a dual LED output level indicator with 46 dB dynamic range. Phono inputs have adjustable resistive and capacitive loading. All inputs

What our subscribers know that others don't.

Did you know that the world's most expensive preamplifier for home use (\$1800!) doesn't sound nearly as good as the sophisticated preamp section of a certain \$260 receiver?

That all tone arms could be designed for lower distortion at no extra cost but, perversely, never are?

That the best-sounding power amplifier ever made is probably a low-powered European unit?

That a certain highly venerated \$650 subwoofer suffers from a fatal design trade-off?

Subscribers to *The Audio Critic*, especially those who started with the first issue (January/February 1977),

know dozens of such unspeakable product truths and are about to learn many more.

Six times a year, *The Audio Critic* points an implacable finger at the best and the worst in high-end audio, mainly in the form of broad, analytical surveys. (For example, the preamp survey in the first two issues covered 32 different models.)

Since it accepts no advertising, not even from retail stores, *The Audio Critic* can be much blunter in its equipment reviews than the commercial hi-fi slicks. And since it backs up its listening tests with the findings of its own superbly equipped laboratory and the counsel of highly qualified consultants, it is unlikely to blunder into the technical illiteracies of the "underground" audiophile reviews.

One year's subscription to *The Audio Critic* (six issues) costs \$28, first-class mail only. (No Canadian dollars, please!) For overseas airmail, add \$5. No single copies are sold for any reason whatsoever, but the unused portion of canceled subscriptions is refundable on request.

We strongly suggest that you begin your subscription with Volume 1, Number 1, in order to own a complete set and be thoroughly familiar with our approach.

Send your \$28 for the first six issues today to *The Audio Critic*, Box 392, Bronxville, New York 10708.

20

Volume 1, Number 2 March/April 1977

The Audio Critic

In this issue:

- We further explain our philosophy.
- We conclude our preamplifier survey (as much as it will ever be concluded), with special attention to the moving-coil scene and to previously untested units. Final recommendations are made.
- We bravely confront the almost invincible ignorance surrounding loudspeaker bass response and review some of the newer subwoofers.
- We begin our comparative survey of power amplifiers.
- Plus our regular features, including some interesting letters to the Editor.



In a Class by Themselves

The Nikko Audio professional group of rack-mount design stereo power amplifiers, pre-amps and a remarkable new FM thin-line tuner are truly in a class by themselves.

The Alpha I basic high-power amplifier and Beta I all-FET preamplifier are classics of power and operational ease. Although they have been available for only a few months, they have already garnered critical acclaim.

Following in this tradition is the new Alpha II power amp, with a continuous power output of 110 watts* per channel, with no more than 0.03% THD.

The "rock-steady" Alpha V "Class A" laboratory standard amplifier with AC/DC

selector is shown in matte black. It delivers 100 watts* per channel, with no more than 0.06% THD. Performance is so pure that the Alpha V is the touchstone by which all other amplifiers will be tested.

The matching Beta V high voltage FE⁻ preamp, atop the Alpha V, is the last word in performance and reliability. It features 3-position mode switching, 5-tape position controls, adjustable impedance/capacitance controls and subsonic filter.

Rounding out the expanded professional line is the thin-line Gamma I FM tuner. Its accuracy (1.8mV usable sensitivity), and features like IF band selectivity, enhance a product virtually unmatched by

any other manufacturer.

The professional group from Nikko Audio—each product crafted to provide the utmost in performance and reliability.

*Minimum RMS, per channel, both channels driven into 8 ohms from 20Hz to 20kHz.

Nikko Audio

For those who take their stereo seriously

Nikko Electric Corp. of America
1627C Raymer St., Van Nuys, Calif. 91406
(213) 988-0105 ©Nikko Audio, 1977

In Canada: Superior Electronics, Montreal, Quebec

feed into FETs for low noise. Price \$1000.

David Hafler made audio history with his original Dynaco preamp kit. Having long since divested himself of his interests in Dynaco, and more recently Ortofon, he has formed his own David Hafler Co. in Philadelphia. Now he is once again offering a preamp kit (it will be available wired as well), the Model DH-101. This is another basically simple unit, with a volume and balance control, bass and

treble controls, and pushbutton selectable phono, tuner, tape, aux, etc. The difference that makes this kit remarkable is that for an anticipated price of \$200, this unit has been designed with close attention to TIM distortion. So much so that they have published scope photos of the square wave and pulse response through the phono section of the preamp (using, of course, an inverse RIAA equalizing network) and the input and output traces are impressively symmetrical. I

should also note that they use the September 1976 revised RIAA equalization specification, and this unit is ± 0.5 dB from 2 Hz to 20 kHz. It will be interesting to hear what this preamp sounds like.

Harman Kardon was showing their new \$550.00 Citation 17 preamp. Now this unit was designed with close adherence to the ideas on TIM distortion expressed in the Ojala/Curl paper. Thus, they have opted for the use of minimum negative feedback, fast square wave rise-time, fast slew rate, and other means to achieve very low TIM. The Ojala/Curl paper is not a blueprint or circuit diagram, but its ideas can be translated into engineering applications, and I certainly want to listen to a preamp designed around these principles.

Power Amps

Power amplifiers are dear to the heart of every rabid audiophile. The remarks I made concerning preamplifiers in respect to transient intermodulation distortion are equally applicable to power amplifiers with, of course, proper modifications in consideration of the vastly greater output of these amplifiers. Amplifiers have their own special problems too. The class they operate in and the output wattage can affect their thermal stability... some need more heat-sinking of the output devices than others... some amps need forced air cooling as well. Protection circuitry against shorts can be a problem, especially since some of them have an audible effect on the signal. Many amplifiers are sensitive to varying types of load, and with some units if the load impedance falls below 4 ohms you see some catastrophic failures. All of this doesn't faze amplifier designers... hope springs eternal with them, and new amplifiers appear almost as often as loudspeakers. At the CES, power amplifiers were all over the place, but here is a selection of those we saw that appeared to have some special qualities.

The Threshold Corp. of Sacramento, Calif. were showing two of the most interesting amplifiers I've seen in a long time. Both operate in class A. Now you have to understand that "class A" has become another of those magic "cult" terms for audiophiles. It is very "in" right now, and I can assure you that the midnight oil is burning in the labs of many manufacturers trying to come up with some class A amplifiers to take advantage of this situation. Briefly, the advantages of class A operation are that the out-

22

Soundcraftsmen

we've got equalization all together —

and all of us are dedicated to helping you improve the sound of your fine stereo system.

Equalizers are used everywhere in the music-making chain: by live performers, recording studios, mixing consoles, AM and FM stations, and so on. In every step, each of the engineers use equalizers to make the music sound the way they think it should sound. So after everyone else makes the music sound the way they like it, it's up to you to use that same instrument—the equalizer—to make the final adjustment, and make the music sound the way you like it to sound in your own home.

We also include all the accessories and features that are a must to make equalizing easy, as well as an amazingly rewarding new experience... An Environmental Do-it-yourself Test Record edited and announced by Soundcraftsmen especially for use with the Soundcraftsmen equalizer... Computone Charts for making a record of, and resetting in seconds, any desired EQ curve... a Full-Channel Frequency Spectrum Level Control on each channel for instant "no distortion" in/out balancing... Light-Emitting-Diodes for precise visual signal level balancing... A Graphic Display of each EQ curve... And a minimum 24dB range of adjustment for each octave... Specifications: S/N: better than 100dB at full output... THD: less than .05% @ 1v... Filter type: Toroidal and Ferrite Core.

FREE 6-PAGE BROCHURE

The WHY's and HOW's of EQUALIZATION
• CHECKLIST for your EQUALIZATION-EVALUATION
• 10-point "TOTAL SYSTEM" EQUALIZATION program

Soundcraftsmen
Instructional Test Record
Room Equalization Instructions

Only Soundcraftsmen offers you a choice of seven models — select the equalizer that best matches your system, and your pocketbook.

Manufactured in California, U.S.A. by Soundcraftsmen, 1721 Newport Circle, Santa Ana, CA 92705... For name of your nearest dealer, phone us at (714) 556-5191... Suggested Prices (top to bottom): PE2217R - \$549.00, PE2217 - \$529.50, SG2205 - \$370.00, RP2212 - \$369.50, RP2204 - \$329.50, 20-12A - \$299.50 (includes cabinets shown), TG2209 - \$550.00 (Case extra).

Enter No. 34 on Reader Service Card

AUDIO • September 1977

B-I-C VENTURI proudly announces two new speakers, and no big changes.

Twice in the past four years, B-I-C innovations have significantly changed loudspeakers.

In 1973, B-I-C applied the venturi principle to speaker design (U.S. Patent #3,892,288) and introduced B-I-C VENTURI™ Speaker Systems.

That ushered in the high-efficiency era, with many long-time leaders quickly attempting to follow our lead.

In 1976, B-I-C perfected a series of monitor and control functions that equipped speakers to make the entire system perform better, and introduced the System Monitor Speaker.

That gave the loudspeaker a new role in the stereo system, and the user the ability to purify his system's output.

Today, the changes we have to announce are significant in a different sense.

The new Formula 6 and Formula 3 models (on optional bases below) represent no major innovations. But they complete a line of speakers that has already established fundamental new principles of speaker design and performance. Principles that will endure for years to come.

The Formula 6 Spec II brings the number of Monitor Series Speakers to three, and fills a size

and system design position between the 5 and 7. And the new Formula 3 fills a similar slot between the 2 and 4.

Thus, whatever stage of upgrading a music system is in, there's a B-I-C VENTURI Formula to fill that need.

And there's a further significance, we think.

The astute audiophile is fully aware that, in the speaker business, technological exercises abound. And that many yield marginal improvements at very high cost.

At B-I-C, our approach is quite the opposite.

Rather than esoteric speaker designs for a few, our commitment is to fundamental speaker advancement for many. And that is why B-I-C VENTURI speakers remain way ahead without being way out.

For literature on all seven B-I-C VENTURI Formulas, write us at the address below.



B-I-C VENTURI SPEAKER SYSTEMS

TOMORROW'S TECHNOLOGY TODAY

B-I-C VENTURI, Westbury, N.Y. 11590. B-I-C, B-I-C VENTURI and BICONEX are trademarks of British Industries Co. Division of Avnet, Inc. In Canada: C.W. Pointon, Toronto.

Enter No. 2 on Reader Service Card

Now... 3009 Series III

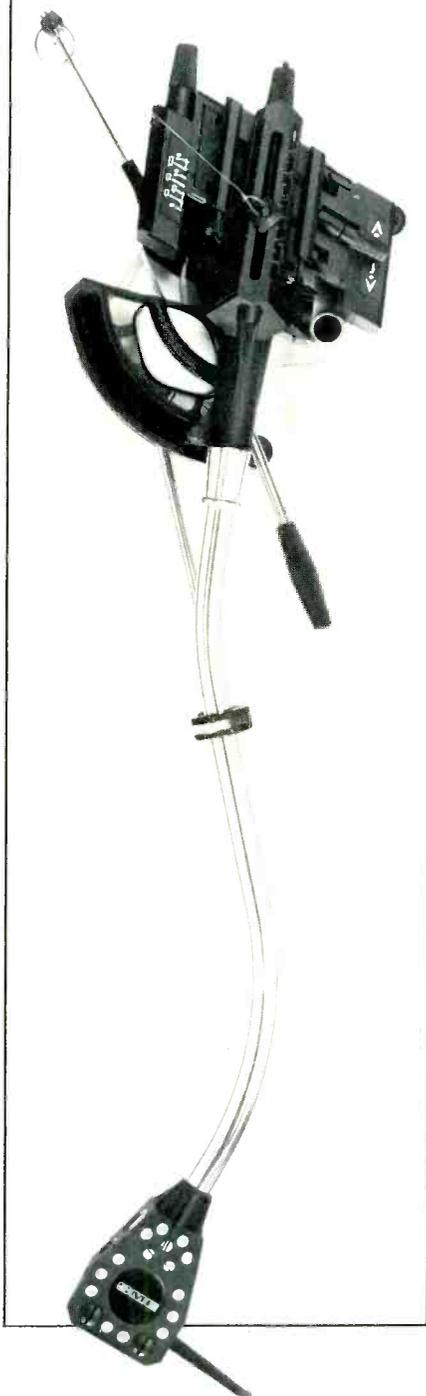

Write to Dept 1446, SME Limited
Steyping, Sussex, BN4 3GY, England

Exclusive distributors for the U.S.:
Shure Brothers Incorporated
222 Hartrey Avenue
Evanston, Illinois 60204

and in Canada:

A. C. Simmonds and Sons Ltd
975 Dillingham Road
Pickering, Ontario, L1W 3B2

SME

put transistors are always "turned on" and can respond instantaneously to an input signal. In class AB and B amplifiers, it takes a finite amount of time for the transistors to "turn-on" and "turn-off" in each cycle, and this causes what is termed crossover distortion, which is characterized by high order harmonics, which are generally offensive to the ear. Thus a class A amplifier does not have any crossover distortion. Class A operation achieves smooth power transfer characteristics, because the transistors are continuously operating in their most linear region. There is a more desirable distribution of distortion harmonics, and these are primarily 2nd and 3rd order harmonics, which can be reduced with minimum negative feedback. The inherent linearity of class A operation means that transient intermodulation distortion is greatly reduced. Class A certainly is desirable, but . . . it is grossly inefficient and high output power is difficult to achieve, and since the amplifier is always "on," and constant bias is required even at idling, so horrendous amounts of heat are produced. Thus, class A amplifiers are usually of limited power output, and require very extensive heat-sinking and cooling facilities. The Threshold engineers have come up with a unique patented circuit to solve these problems. This is a dynamic biasing circuit, and I quote from their literature . . . "the circuit senses the internal bias needs continuously and instantaneously adjusts the idle current to the levels required to maintain constant class A operation of all output transistors . . . This allows the Threshold 400A amplifier to idle at one fourth the power of an equivalently rated conventional class A design." Threshold's first class A amplifier is a 200 watt per channel into 8 ohms unit, with large power output meters, and forced air cooling. Price is \$2175.00. At CES, the Threshold people told me that this amplifier is gradually being phased out of production. I saw a prototype of its replacement. It is a larger unit, with massive heat sinks since it is convection cooled, but it is rated at the same 200 watts per channel. Their newest class A amplifier is the 400A, which has an output of 100 watts per channel into 8 ohms. A rack mount unit, it has LED displays for peak versus average output level readings for each channel. TIM distortion sidebands are rated at 80 dB below a 10 watt output signal consisting of a 1.5 kHz square wave mixed with a -20 dB

80 kHz sine wave. This test presumably is basically the same as the Otala/Curl "square/sine" test given in their AES paper. Rise time is listed as 750 nanoseconds, and slew rate is 50 volts per microsecond. A spectacular amplifier, it is expected to sell for \$1395.00.

Mark Levinson now has his class A mono amplifier in production. The unit is rated at 25 watts at 8 ohms, 50 watts at 4 ohms, and 100 watts at 2 ohms. The amplifier weighs in at 45 lbs. and is also smaller (19 in. wide x 21 in. deep x 8.5 in. high) than the prototype shown last year. The unit has extensive heat sinking. The amplifier is said to use low amounts of feedback and this coupled with a high slew rate of 100 volts per microsecond should result in very low values of TIM. Because of high current output, it is claimed to be more powerful than some 100 watt amplifiers, when driving a speaker under dynamic conditions. Price is estimated at \$1600.00.

Crown International was showing a companion amplifier to the DL-400 preamp previously discussed. Model D-440 has an output of 221 watts per channel into 8 ohms, and 400 watts per channel into 4 ohms. THD is rated at 0.05 per cent, 20 Hz to 50 kHz. Cooling is by a two-speed fan. There is an LED indicator system for various functions, including "overload" to indicate clipping or slew-rate distortion . . . or in Crown's words, "sometimes referred to as TIM." No price information at present.

I have been talking about pre-amplifiers and amplifiers designed around some of the ideas in the Otala/Curl AES paper. Well, how about an amplifier designed by John Curl himself? John has evidently designed an amplifier for a group known as Symmetry Audiophile Systems in San Francisco. These people had a hotel suite and John Curl was there, showing a new electronic crossover he had designed. Unfortunately, the amplifier, designated the JCA-1 was not on hand, but I have spec sheets which are real eye-openers . . . the unit is rated at 150 watts per channel into 8 ohms, has only 26 dB of feedback, a staggering 250 volt per microsecond slew rate, and "unmeasurable" TIM. The JCA-1 uses a V-FET front end and what John calls "four quadrant symmetry bridged outputs." The suggested price is \$1100.00, and I sure would like to get my hands on these amps!

There was so much new equipment at the CES, that I'll have to continue this report next month. A

SAE Power

SAE's goal today, just as it has been for over 12 years, is the design and production of fine audio components which offer the best value in both sonic performance and quality construction. Our line of amplifiers stand as a testament to this goal.

First, their design — all SAE amplifiers have fully complimentary circuitry. In this unique design approach, not only the output (as in conventional amplifiers), but the drive and input stages, are completely complimentary. This ensures low transient and steady-state distortion, plus full stability and fast overload recovery. Combine this with our high slew rate for accurate transient response, feedback gain controls which will not degrade the input signal (2600, 2400L), and monocoque construction with its low weight and high reliability (2200, 2400L).

The result is state-of-the-art performance, but to realize this performance we must have the second part of our goal — production. In order to ensure optimum performance from these unique design concepts, SAE retains total control over the manufacture, selection, and assembly processes. We maintain 40,000 sq. ft. of production area where the latest techniques in metal and circuit board fabrication, component selection and product assembly are employed. The result of these efforts is the line of high quality amplifiers pictured here, each an outstanding value in its power range and each a true SAE component where performance and value come together — that's SAE Power!

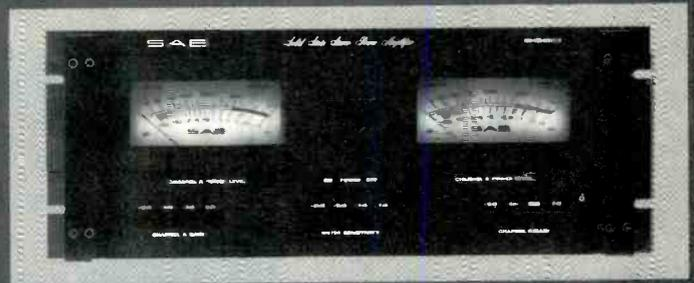

2600 - 400 Watts* — our most powerful amplifier, designed for high power home environments. The 2600 ensures clean, dynamic reproduction at the highest power levels.

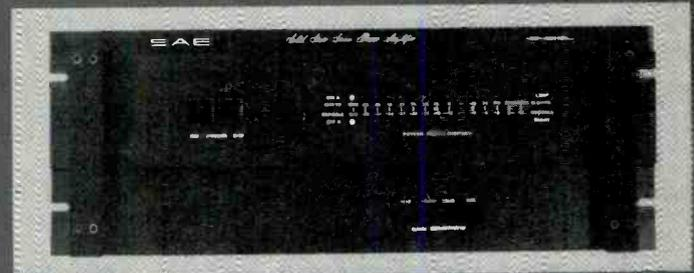

2400L - 200 Watts* — combining performance and reliability in a surprisingly compact package. This amplifier can reproduce the most demanding program material without strain.

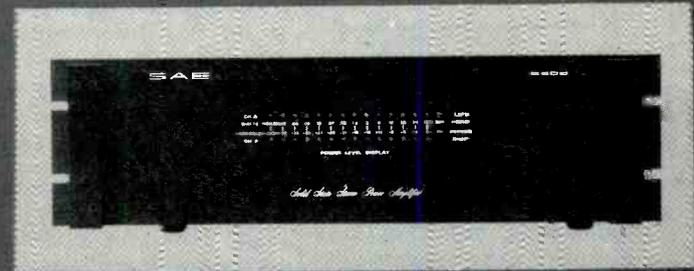

2200 - 100 Watts* — Incorporating our advanced circuitry and technology, the 2200 offers high levels of clarity and definition at a popular power level.

*All power ratings are per FTC requirements and are stated with the following parameters: 20Hz to 20kHz, from 250 mW to rated power with less than 0.1% Total Harmonic or Intermodulation distortion.

SAE
Scientific Audio Electronics, Inc.

P.O. Box 60271 Terminal Annex, Los Angeles, CA 90060

What's new

Ram Power Amplifier

The Model Ram 512 power amplifier features 5-in., 43-dB range power-level meters, LED peak responding indicators, no current limiters, d.c. offset relay speaker protection, open loop gain of only 60 dB (closed 27 dB), and propagation delay less than 0.2 microseconds. The unit offers 180 W rms/ch continuous power into 8 ohms with both channels driven, 20-20,000 Hz \pm 0.1 dB; IM & THD is 0.08 per cent at rated output; hum & noise, -110 dB; input sensitivity, 1.7V for rated output; input imp., 50,000 ohms and damping factor, greater than 1000 20-20,000 Hz. Price: \$1150.00.

Enter No. 70 on Reader Service Card



Heath Oscillator Kit

The Model IG-1272 is an oscillator with both pushbutton and variable frequency selection that provides a low-distortion sine wave output over a range from 5 Hz to 100 kHz. Attenuation

accuracy is said to be \pm 0.2 dB, with hum and noise rated at 0.01 per cent. Price in kit form: \$129.95, the fully assembled kit, SG-1272, \$190.00.

Enter No. 73 on Reader Service Card

Ultralinear Speaker System

The Model ST550 is a three-way loudspeaker with a dual-ducted tuned port system, and fully tunable bass, midrange and high frequency drivers. The system components include a 12 in. woofer, a 2 in. midrange, and

a 1 in. dome tweeter, with crossover frequencies of 700- and 4300 Hz, a frequency response from 27 Hz to 22 kHz and a power handling capacity of 20 W min. and 100 W max. Price: \$389.95.

Enter No. 74 on Reader Service Card

TEAC Mixer Expander Unit

The Model 5EX is a mixer expander unit equipped with eight 201 input modules to be used with the TEAC Series 5 mixer. The self-powered 5EX can increase the inputs from eight to as many as 20

while retaining all the features of the Model 5, including four line output buses, a cue output buss, echo output buss, and a solo output. Price: \$1,300.00

Enter No. 75 on Reader Service Card



Infinity Tonearm

The Black Widow Tonearm has an effective mass of three grams as the



crossmember allows the cartridge to be attached without a headshell, thereby minimizing mistracking and distortion. The tonearm, accommodating cartridges weighing from 4 to 8.5 grams, has an anti-skating provision, and oil-damped cueing. Price: \$200.00.

Enter No. 71 on Reader Service Card

Bundy Crafts Record Cabinet

The Encore Record Cabinet, constructed of white and smoke-grey acrylic, is designed to hold up to 80 LP records in a warp-free environment. The unit, measuring 16 x 14 1/2 x 13 in. and weighing 11 lbs, can either be stacked or used as bookends. Price: \$39.95.

Enter No. 72 on Reader Service Card

Syn-Aud-Con Brochure

Synergetic Audio Concepts has a six-page brochure describing their three-day sound engineering seminars taking place in 17 different cities throughout the country during 1977.

Enter No. 76 on Reader Service Card

Nortronics Lapping Kit

The Handylap kit is designed for relapping and recounging worn magnetic heads. The kit consists of a lapping block, two cam-actuated rollers, three different grades of abrasive sheets, a magnifying glass, and a head-holder to aid in grasping the head. Price: \$65.00.

Enter No. 77 on Reader Service Card

Bigston Cassette Deck

The Model BSD-400 stereo cassette deck features a



memory rewind, automatic playback, a tape counter, an LED peak indicator, and a mechanical Pause lock. The stated tape response is 30-15,000 Hz with CrO₂ and 30-13,000 with normal tapes, with a S/N ratio of 58 dB with Dolby, THD of less than 1.5 per cent, and wow & flutter of 0.07 W rms. Price: \$250.00.

Enter No. 78 on Reader Service Card

Infinity Speaker System

The Model Quantum 2 speaker system employs three tweeters, two dome midrange drivers, a midbass, and a bass driver. Its stated frequency response is 24 to 32,000 Hz \pm 3 dB. Standing four feet high, the unit requires a minimum of 60 W power. Price: \$700.00.

Enter No. 79 on Reader Service Card

**Micro-Acoustics invites you to take
a closer look...**

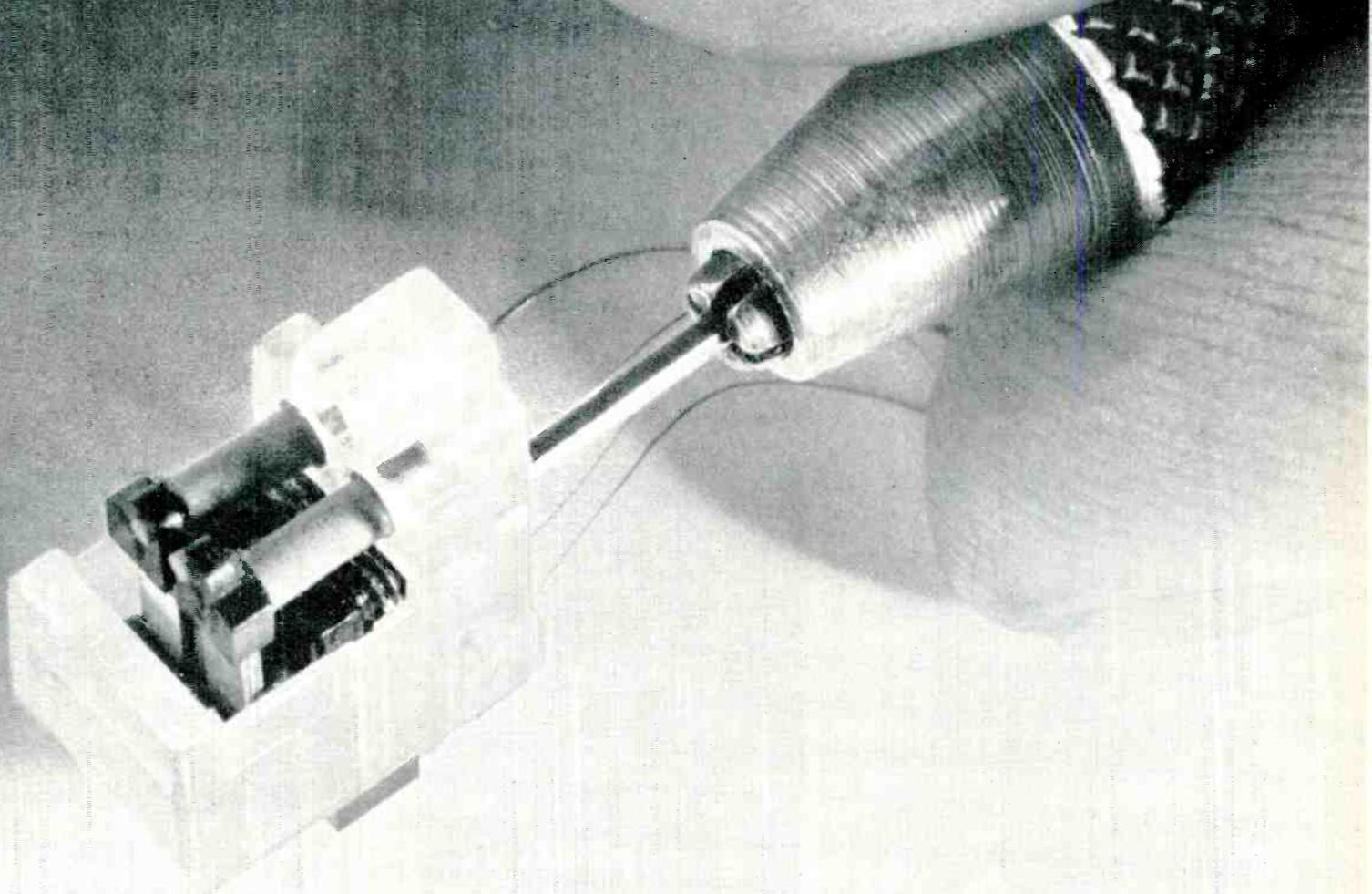

ma[®]
Micro-Acoustics

At Micro-Acoustics, we hand-assemble Because mass production

At Micro-Acoustics, we call our stereo cartridges "The high-end phono cartridge line." And we'd like you to know what stands behind this philosophy.

Micro-Acoustics cartridges sound better — and sell better — for a very good reason: they're very different from the other phono cartridges on the market.

Basically, most stereo cartridges are designed for

mass-production. And they have to be. Because they're engineered and manufactured to *meet a price*: Low enough to fit comfortably into even modestly-priced systems. And low enough in cost to be used as a promotional item in a turntable or system sale.

Considering these limitations, some manufacturers have done a remarkable job of achieving acceptable

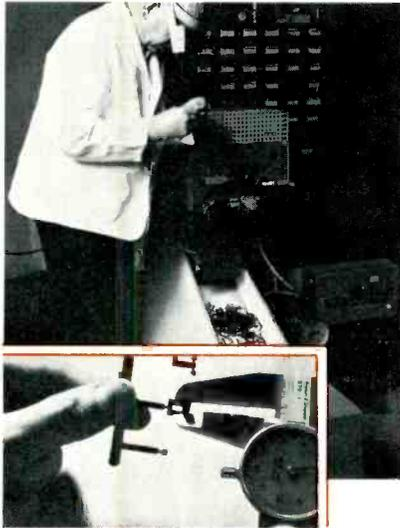

1. Injection-molding station. All plastic parts for Micro-Acoustics cartridges are individually molded in single-cavity molds for maximum uniformity. Frequent sampling and inspection assure that tight tolerances are maintained.

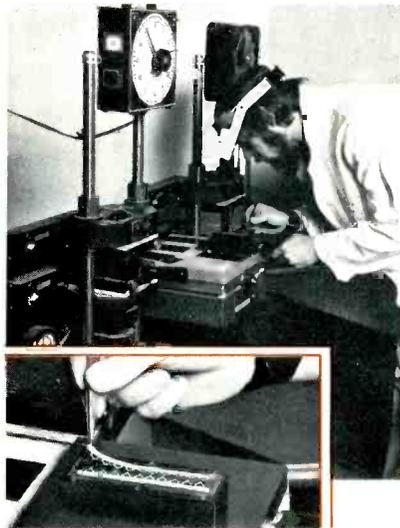

2. Rubber-molding press. Sixteen precision elastomers are employed in all Micro-Acoustics phono cartridges. Each part is individually molded; then inspected and tumbled in refrigerant to remove any excess "flash". The use of multiple elastomers provides greater long-term reliability and consistency than conventional single-bearing cartridge designs.

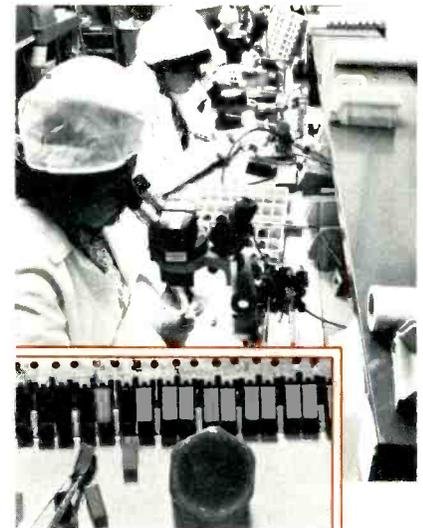

3. Microscopic assembly of damping mechanism. Each elastomeric damper is individually cemented to its own retainer block. Eight dampers are used in each cartridge.

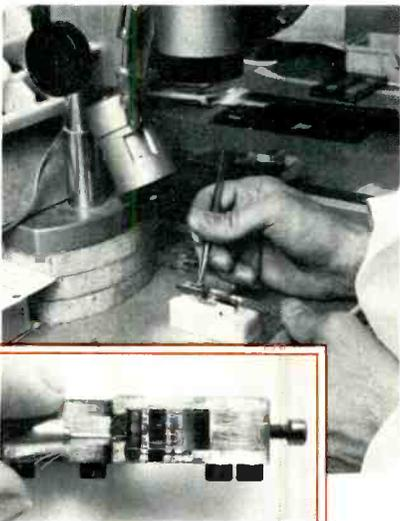

7. Microscopic assembly of complete transduction system. Here, all elastomeric parts are assembled together with transducer elements and positioned by means of three vernier alignment screws.

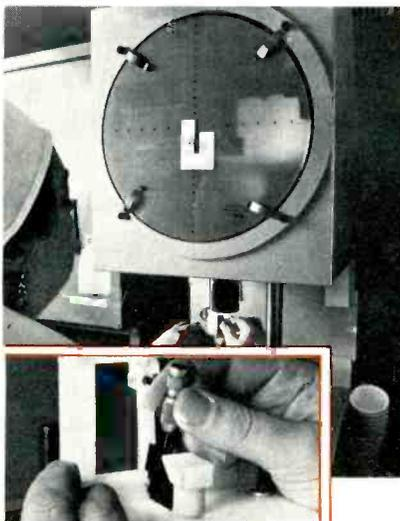

8. Final vernier adjustment. The three vernier screws are individually set so that the stylus seats symmetrically between the cartridge's twin pivots. Stylus assembly is magnified 20 times on calibrated comparator screen, to assure that all replacement styli will align identically.

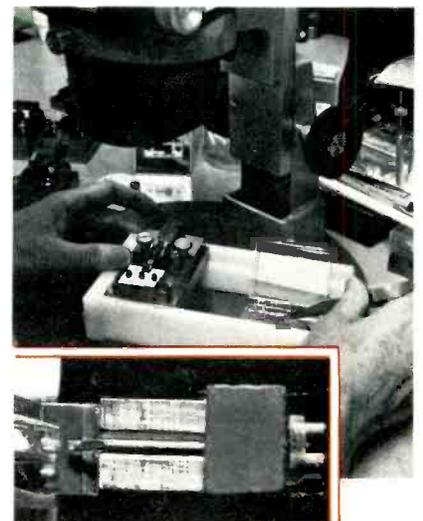

9. Microscopic hand assembly of stylus. Using the same procedure employed for Micro-Point™ recording styli, precision polished diamonds are light-beam oriented for mounting in shank and then secured with epoxy to dual-bearing platform. This low-mass, dual-bearing stylus configuration provides superior tracking ability.

Cover photo: Heart of Micro-Acoustics' patented (Pat. No. 3952171) direct-coupled system, seen with alignment tool making vernier adjustments.

our precision cartridges one-by-one. isn't good enough.

performance levels through automation and other mass-manufacturing techniques.

Problem is, when these manufacturers add *high-end* cartridges to their lines, they're still locked into manufacturing the same basic way. So aside from a change in stylus, the differences between other manufacturers' high- and low-end models are primarily cosmetic.

Micro-Acoustics' manufacturing philosophy is quite the opposite: when we design a cartridge, it is to meet *performance* goals. Not budgetary limitations. And the best way is to manufacture a hand-made, precision-crafted product. One that must be assembled under carefully-controlled conditions. Incorporating a number of critical steps which lead to the highest possible performance levels.

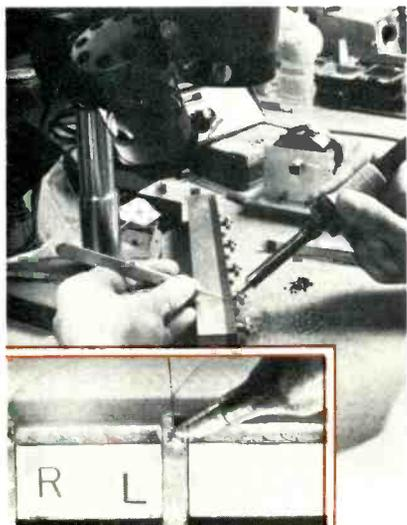

4. Microscopic soldering of transducer leads. Two pieces of pure gold wire are soldered to each electret transducer element (negative and positive poles). Thinner than a human hair, this pure gold wire is totally resistant to oxidation, for long, trouble-free cartridge life.

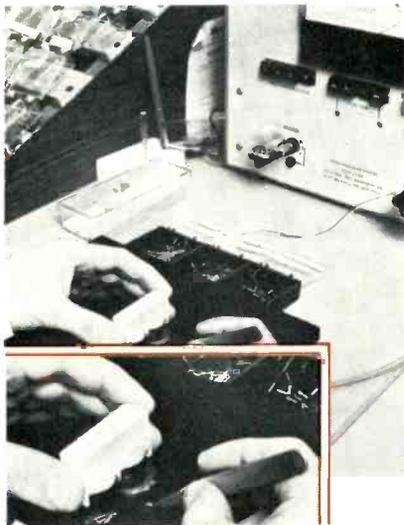

5. Matching of transducers. Electret transducers are measured for capacitance and sorted into matched pairs. This assures accurate channel balance.

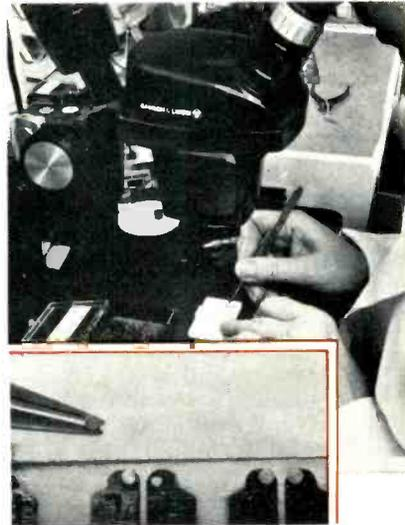

6. Microscopic assembly of pivot dampers. Each transducing element is individually fitted with an elastomeric bearing in which the stylus coupler pivots. This twin independent pivot system assures maximum transient ability.

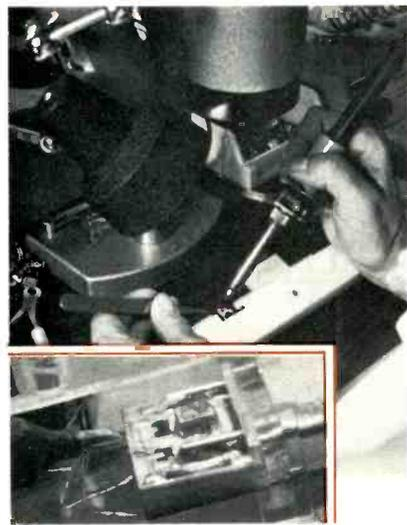

10. Microscopic assembly of microcircuits. Each cartridge has two individual passive microcircuits whose inputs are directly soldered to gold leads from transducers. These microcircuits assure perfect match with any phono cable-preamp input combination.



11. 100% quality control of all cartridges. All fully-assembled cartridges are individually played on a CBS STR-100 test record, monitored on a dual trace oscilloscope and measured with a VTVM.



12. All areas of cartridge performance are tested. Tests include frequency response, channel separation, output level, tracking and transient ability. Only cartridges that fully meet published specifications are serialized and placed in stock for shipment.

The result. The result of Micro-Acoustics' advanced design and precision manufacturing techniques is a sophisticated phono cartridge line that is non-critical to install and use. Cartridges that deliver maximum performance on manual and automatic turntables. Highly-acclaimed cartridges which work superbly, independent of cable capacity and preamplifier input loading. High-reliability stereo cartridges, with a number of unique features:

1. Ultra-low body weight. Weighs only a fraction of other manufacturers' high-end cartridges. Helps provide superior tracking of even severely-warped discs.

2. Mechanical dampers. Configuration of 8 elastomeric damping blocks (only 3 shown in this view) achieves optimum transient ability while cartridge tracks the heaviest groove modulations at low stylus forces.

3. Low-mass stylus. Shaped and polished with the same care as our world-famous Micro-Point™ recording styli.

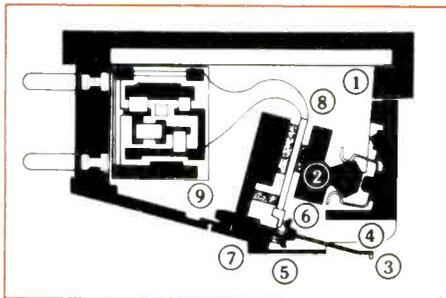

4. Ultra-lightweight stylus bar. For minimum effective tip mass.

5. Twin pivot/dual bearing resolver. For optimum tracking ability and precise signal resolution. The resolver separates the complex stylus vibrations into left and right channels.

6. Direct coupling of stylus bar to electret. Coupling the stylus bar to the electrets at this point directly transmits the undulations of the groove to the transducers.

7. User-replaceable stylus assembly.

8. Electret transducer. A permanently-polarized dielectric device best described as a low-mass electrostatic equivalent of a magnet. It provides superior response because of inherent linearity from 5Hz to 50kHz.

9. Microcircuit. Passive circuit matches the electret transducer's characteristics to preamplifier phono inputs within 1%. Also, makes output purely resistive, eliminating effect of cable capacitance on frequency response. Resistive output also shunts preamp input, reducing thermal noise.

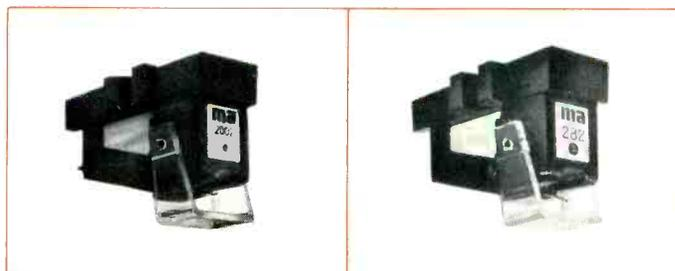

Specifications*	2002-e	282-e
Stylus Configuration** (User replaceable)	.0002 x .0007 elliptical diamond beryllium cantilever	.0002 x .0007 elliptical diamond
Frequency Response	5Hz to 20kHz ± 1.5dB	5Hz to 20kHz ± 2dB
Tracking Force Range	0.7 to 1.4 grams	.75 to 1.5 grams
Cartridge Weight	4 grams	5.2 grams
Channel Separation	Nominally 30dB at 1kHz 15dB at 10kHz	Nominally 25dB at 1kHz 15dB at 10kHz
Output Voltage	3.5 mv each channel at 5cm/sec peak recorded velocity	3.5 mv each channel at 5cm/sec peak recorded velocity
Load Requirements	10k to 100k (not critical)	10k to 100k (not critical)
Cable Capacity	100pF to 1,500pF (not critical)	100pF to 1,500pF (not critical)
Suggested List Price	\$119.00	\$89.00

* All measurements made with CBS STR 100 Test Record

** Like our Micro-Point™ recording styli, all Micro-Acoustics playback styli are light beam oriented under a microscope for optimum relationship between stylus and cantilever.

Warranty: Full 2 years (excluding stylus wear) on all models.

ma[®]
Micro-Acoustics
 Because good tracking isn't enough.

Micro-Acoustics Corporation, 8 Westchester Plaza, Elmsford NY 10523, (914) 592-7627

Advent Loudspeaker

The New Advent Loudspeaker is a two-way, acoustic suspension system with increased output in the higher frequencies and requiring a minimum of 15 watts power into 8 ohms. Featuring a 12 in. woofer and a 1-3/8 in. tweeter, a rear panel switch permits the choice of three high frequency balances above 2 kHz to match the source material and environment, the crossover frequency is normally 1.5 kHz. Price: \$149.00 in walnut, \$129.00 in vinyl.

Enter No. 80 on Reader Service Card

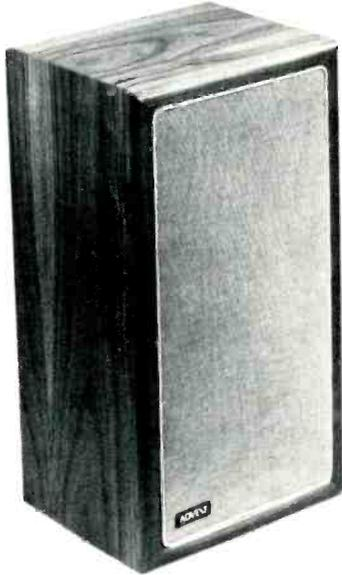

Sankyo Cassette Deck

The Model STD-1900 is a front loading cassette deck featuring Dolby noise reduction and an MPX filter. There are separate record and output level controls, two VU meters, and three-position bias and equalizer switches. Price: \$249.95.

Enter No. 81 on Reader Service Card

Professional Systems Preamplifier

The Studio One is a multiple stage preamplifier with a THD of 0.01 per cent at 2V from 20-20,000 Hz, a phono S/N greater than 88 dB below 10 mV (IHF A weighted), and a 50 V/ μ S slew rate in all stages. Facilities are provided for tape-to-tape dubbing. Price: \$495.00.

Enter No. 82 on Reader Service Card



AKG Microphone

The Model C-414EB is a studio condenser microphone with a twin-diaphragm design to provide four different polar patterns; cardioid, omnidirectional, figure-eight, and hypercardioid, for various recording situations. All switching con-



trols are incorporated within the microphone itself. Pre-attenuation levels of 0, -10, and -20 dB are provided for close-up recordings, and a base-cut filter of more than 14 dB/octave slopes provides flat 75- or 150-Hz cut-off frequencies. Price: \$495.00.

Enter No. 83 on Reader Service Card

Audioanalyst Tonearm

The Dynavector DV-505 tonearm has biaxial design for low vertical mass and improved tracking of warped records. Other design features include a mechanical anti-resonance device, magnetic eddy-current damping, and reduced susceptibility to mistracking from external subsonic vibration, an interchangeable head shell, rack and pinion height adjustment, and gold plated cable connectors. Price: \$499.00.

Enter No. 88 on Reader Service Card



Videoton Loudspeaker

The Model D-402A "Supermax" loudspeaker system incorporates six speakers in a proprietary two-way surround system. The unit has a claimed handling capacity of 50 W continuous power and 80 W music handling with a frequency range of 35-20,000 Hz. Incorporating two 8-in. woofers, two 4-in. tweeters, and two 1-in. hemispherical domes, the unit measures 15-1/8 in. x 27-1/8 in. x 11 in., and weighs 45 lbs. Price: \$199.95.

Enter No. 89 on Reader Service Card

Sansui Receiver

The Model 9090DB receiver is rated at 125 watts rms into 8 ohms from 20 to 20,000 Hz at 0.1 THD, with FM sensitivity at 9.8 dBf (1.7 μ V), capture ratio of 1.5 dB, and alternate channel selectivity better than 85 dB. The unit features Dolby encoding and

decoding circuitry for use with cassette and open-reel decks, a phase-locked-loop IC multiplex demodulator, high and low filters, and a 20 dB muting switch. The amplifier section is direct coupled with complimentary push-pull circuitry. Price: \$750.00.

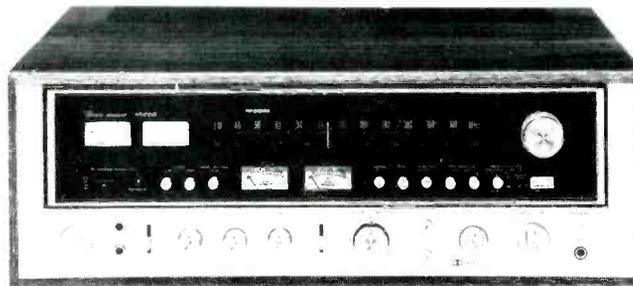

Enter No. 86 on Reader Service Card

Philips Loudspeaker

The Model AH477 is a three-way, acoustic suspension loudspeaker system with a frequency range from 32-20,000 Hz and crossover frequencies at 1.5 and 5.5 kHz. The system has mid-range and tweeter adjustments from -3 dB to +6 dB and will handle up to 80 watts rms into 8 ohms. Price: \$300.00.

Enter No. 84 on Reader Service Card

QSC Audio Rack

The QSC Audio Rack is a 19 in. rack designed to take the abuse demanded of professional equipment. Constructed of vinyl covered wood with steel corner reinforcements, the unit includes mounting hardware and a cable dressing kit. The outside measurements are 20 1/2 x 25 x 16 in. and it weighs 38 lbs. Price: \$124.00.

Enter No. 85 on Reader Service Card

Heath Audio Load Kit

The Model ID-5252 audio load kit for amplifier testing provides audio loads of 2, 4, 8, 16, or 32 ohms. A series of five-way binding posts allow it to handle up to 240 watts mono, or four 60 W inputs, both into 8 ohms. There are jacks for connecting a voltmeter, oscilloscope, or other instruments at the load in use. Price: \$44.95.

Enter No. 90 on Reader Service Card



"G" LINE

Offers Full-Range Components For
**Professional
Sound Reinforcement**

Preamplifiers-Mixers

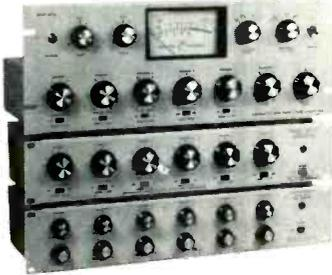

G5TA • G12T • G11T

Versatile, expandable, top-notch mixing components, perfect for large areas such as auditoriums and churches, as well as recording, broadcast, and other commercial sound applications. Ultra-low distortion, full-range performance.

Power-Amplifiers

50, 100, 200 RMS WATTS

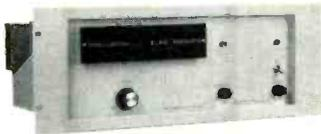

G52 • G102 • G200

Tops in continuous performance reliability for serious professional audio usage.

POWER-AMPLIFIERS

35, 50, 100 RMS WATTS



GT-35 • GT-50 • GT-100

Choose from a flexible line of solid state integrated units that will control, mix, and amplify four low impedance microphones and two auxiliary inputs. Satisfies even the most critical demands.

Background Music at Its Best



G-109B

Special high performance FM-AM monaural tuners can be used with any amplifier, since volume control is located on front panel.

To Order, Call Toll Free,
800-323-0228

or, write for complete information today.

Precision Electronics, Inc.

9101 King Street • Franklin Park, Illinois 60131

In Canada, Superior Electronics

In Caribbean, E. D. Magnus, Chicago, Ill.

Foreign, Morhan Exports, New York, N.Y.

Enter No. 24 on Reader Service Card

The bookshelf

Acoustic Techniques for Home & Studio: Text by F. Alton Everest. TAB Books, \$8.95 (paper, \$5.95).

It is impossible to state how many serious audiophiles and recording engineers are striving to get the best possible sound from their equipment and, at the same time, ignoring the characteristics of the room where the listening/mixing is done. This Everest book presents a good collection of important information for those who want to, and should, understand the performance characteristics of the room itself.

The first three chapters cover the basic elements of sound waves, hearing, speech, music, and noise. The next two chapters discuss room resonances and standing waves as they would exist in listening rooms and small studios, with a brief but clear dissertation on room modes. This is followed by a chapter on diffusion which considers preferred room-dimension ratios and approaches to reduce standing waves. The first chapter on controlling noise covers the need for insulation from outside interfering noise, and what schemes should be used, while the second such chapter is on the use of sound absorbers for control within the listening space. Good illustrations show the absorption coefficients vs. frequency for various materials and designs. A chapter on reverberation time concentrates on calculation (rather than measurement) of the decay characteristics. The text clearly relates such results with the needs and possibilities for room treatment. The author states the most-important caution that calculations are not that accurate, and that measurements are required for the best results.

Two chapters cover some of the de-

tails of studio design, with additional material on reverberation, modes and room treatment. The chapter on tuning and equalization is quite general but points out the impossibility of using electronics to solve basic acoustic problems. The final two chapters briefly cover acoustical evaluation and show pictures of existing studios.

The two appendices present the absorption coefficients for a number of well-chosen materials and constructions, and a discussion on the use of reverberation formulas. The author provides a good list of references, complete with comments on the source's value and main conclusions. The index is short, but satisfactory. The hard-cover version does have a hard cover, but it is not bound in signatures, so the lower-cost soft-cover edition seems to be a better buy. The author states that the book is more of an "understand-it-yourself" than a "do-it-yourself" text. For the serious listener, audiophile or professional, the book is strongly recommended. It will aid you in any of your own room design attempts, and also prepare you for more complete communication with a consultant, whom you should retain if there is going to be a large investment. *Howard A. Roberson*

Modern Recording Techniques: by Robert E. Runstein
367 pages, 5 1/4 in. x 8 1/2 in.
Howard W. Sams, 1974, \$9.95 (paperback).

Modern Recording Techniques has much to commend it and should not be overlooked in comparison with newer books. Even flipping the pages of the book, one is struck by the amount of text on each page, along with numerous illustrations.

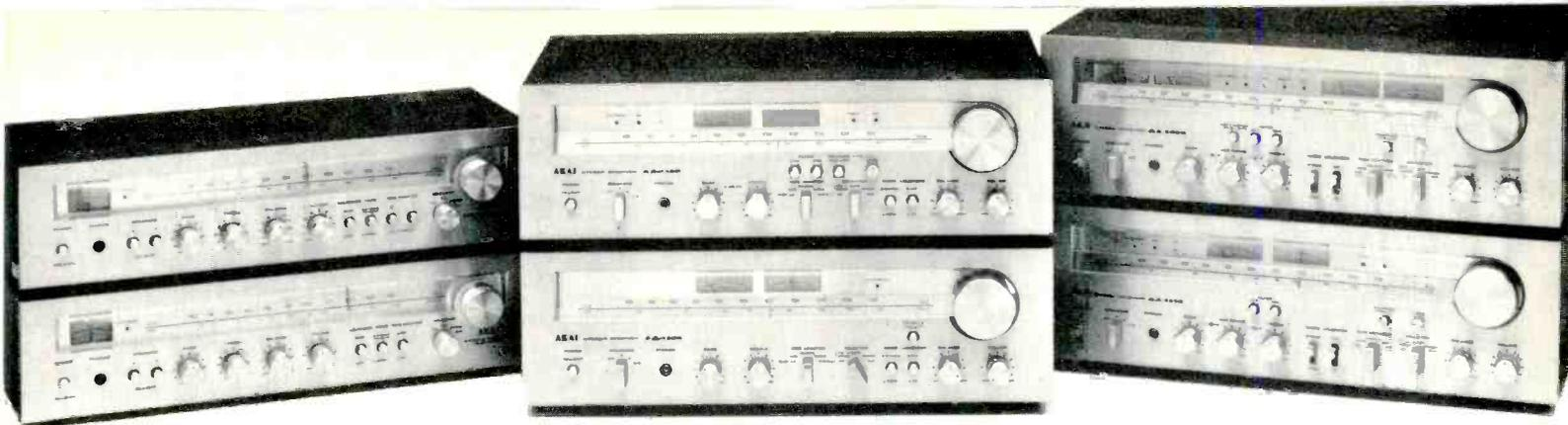

AKAI introduces just what the doctor ordered to improve your hearing: six great-sounding receivers that put real heart into your system, whether you listen to tape, records or FM.

Choose from six power ranges — 15 to 120 watts per channel — with suggested retail prices from \$189.95 to \$649.95. So now, no matter what receiver you want — a good basic unit or a unit with all the features

an audiophile demands — AKAI's for you. You can feel confident that dollar for dollar, spec for spec, you're getting the true-to-life sound you expect from the name AKAI. And a receiver that delivers better tuner sensitivity and less distortion at all volume levels is what a good receiver is all about.

Compare performance, features, design and value at your AKAI

dealer. And start hearing what you've been missing.

Model	Watts/ RMS	OHMS	Power Band Width	Total Harmonic Distortion
AA-1115	15	8	40-20,000 Hz	no more than 0.5%
AA-1125	25	8	20-20,000 Hz	no more than 0.3%
AA-1135	35	8	20-20,000 Hz	no more than 0.2%
AA-1150	50	8	20-20,000 Hz	no more than 0.1%
AA-1175	75	8	20-20,000 Hz	no more than 0.08%
AA-1200	120	8	20-20,000 Hz	no more than 0.08%



For an 18" x 24" poster of this Charles Bragg etching, send \$2 to AKAI, Dept. A, P.O. Box 6010, Compton, CA 90224. ATTN: Doctor

INTRODUCING SIX WAYS TO IMPROVE YOUR HEARING.

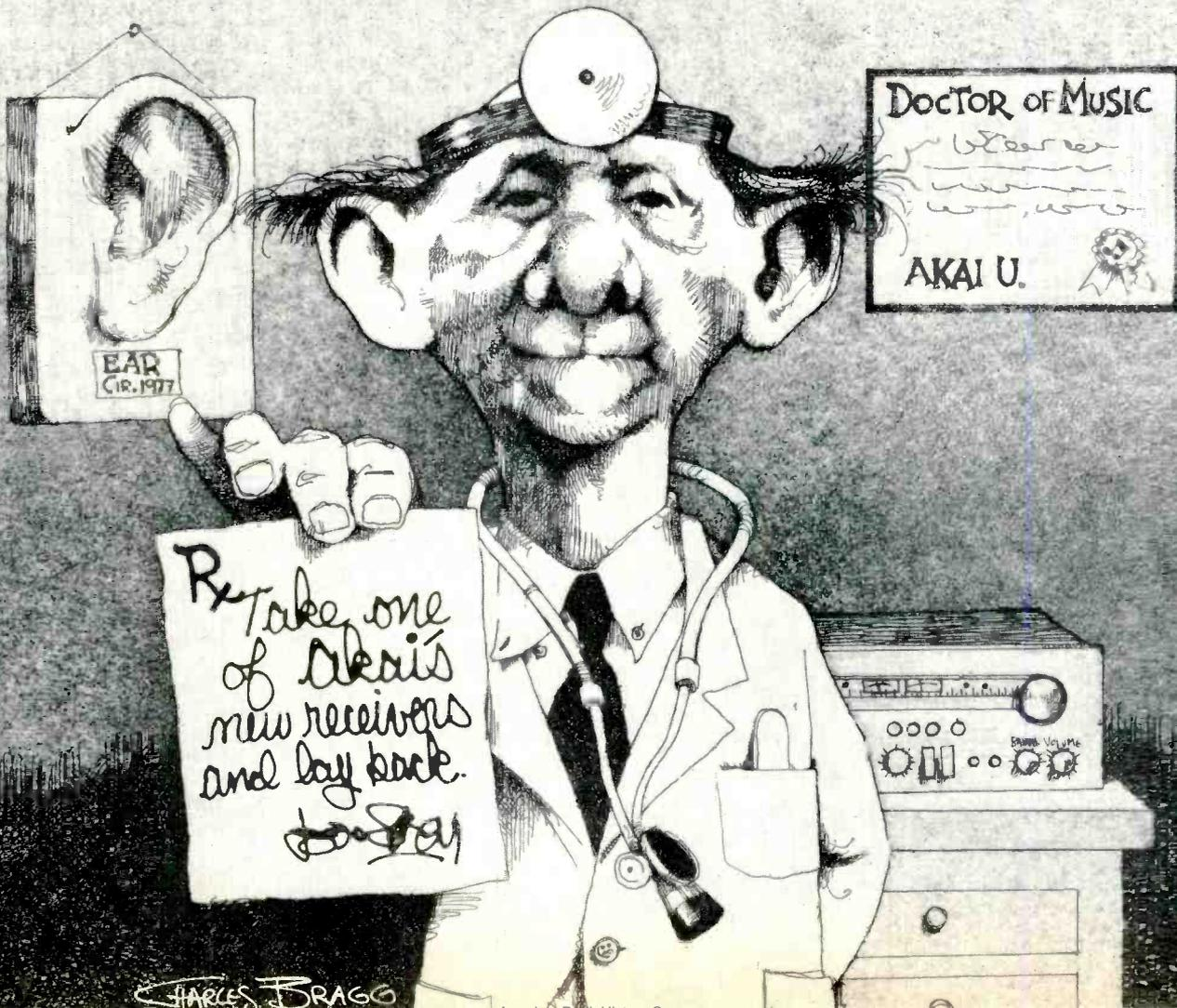

CHARLES BRAGG

The first two chapters cover some of the basics on sound, hearing, waveforms, and the elements of a recording system. An impression gained, and reinforced in later chapters, is that the author was dedicated to detail. In general, the approach is good in that subjects are discussed which other authors do not even broach. Unfortunately, Runstein is not always exactly on target. For example, he defines reverberation time as that for the sound pressure

level (which should be in dB) to decay to one-millionth (indicating the reference is to pressure, not level). Anyway, reverberation time is defined as a change in level of 60 dB, which for pressure is a change to one-thousandth of that before decay. There are also a number of comments made on the relationships among sound pressure level, intensity, and loudness which are succinct, but inaccurate.

The next two chapters on micro-

phones and tape recording seem to be more home ground for the author. The discussion on microphones is quite good, with frequency responses and polar patterns for a selection of mikes. There are specific recommendations on mike usage and choice, which some will love and others abhor. The chapter on recording is almost 40 pages long and includes descriptions of functions and operations of some of the professional machines, bias, equalization, alignment, and other subjects. A 60-page chapter on signal processing contains much information that is not available elsewhere between one set of covers. Various types of filters are explained clearly, and suggestions are made on which EQ settings to use for particular instruments. Good coverage is given to meters, compressors, limiters, and expanders, but Runstein is off base in tying rms, loudness, and VU together. Reverb and other devices are also discussed.

The next chapter, on consoles, goes over the elements of a professional unit, including patch bays, preamps, and pan pots. Multitrack recording is presented with descriptions of the controls and how they are used. Noise reduction devices are covered in a separate chapter, with added information on the limitations of the tape medium and the possibilities of digital recording. The chapter on speakers and monitoring seems much too short (13 pages) compared to other areas, but there is a useful section on crossover networks. Three short chapters cover studio sessions, tape-machine interlocking, and automated mix-down. The chapter on *Disc Cutting and Pressing* has all the basic information in this area that the studio operator might want to know for general background. The final chapter is a brief one on quadraphonic discs. The appendix consists of 30 pages worth of 3M Sound Talk Bulletins. The index is only seven pages long, quite restricted compared to the broad subject coverage and the wealth of detail contained in the text. This paperback, which could see a lot of use in and around a studio, should be bound in signatures, but it is not.

Modern Recording Techniques is a detailed source of information on studio equipment and procedures. There are some errors along the way, but there is also much of value.

Howard A. Roberson

AUDIO • September 1977

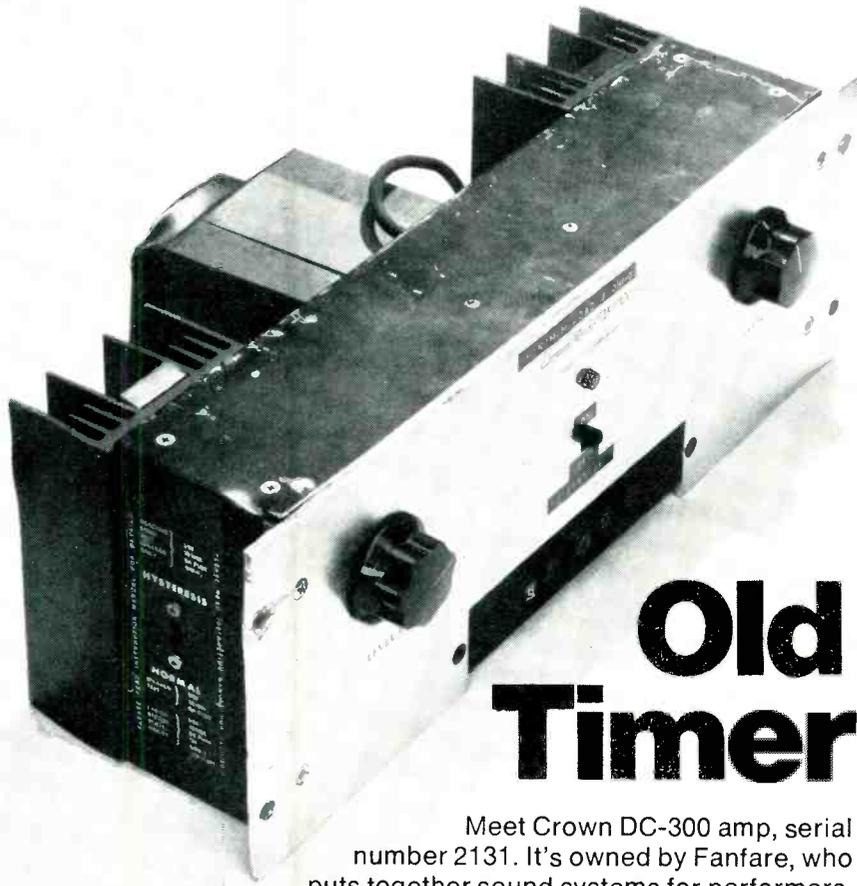

Old Timer

Meet Crown DC-300 amp, serial number 2131. It's owned by Fanfare, who puts together sound systems for performers.

Since 2131 was built, it has worked hard professionally, most of the time on the road. In and out of trucks, in and out of racks, in and out of dust, wind, rain and sun.

Once it was in a truck that rolled over three times returning from a tour. 2131 went right through the roof and landed in a puddle where Fanfare found it hours later.

That was five years ago. After cleaning and adjustment, it went right back to work, to provide more years of trouble-free, professional service.

For us, that story is not surprising. We design and build rugged, reliable, distortion-free amps and control centers — products that satisfy our own standards of performance, which may be why so many people won't accept less than Crown.

Think about 2131, about the Crown three-year full warranty that also pays round-trip shipping, about the many professionals who continue to specify Crown amps, and about the people you know who own Crown.

Then go talk business with your Crown dealer.



Enter No. 4 on Reader Service Card

THE OPTIMUM.



35

Free maxell tape just for listening to the first cassette deck that finds music automatically.

Now there's a cassette deck that plays it your way.

The Optonica RT-3535 Mark II. It's the only cassette deck with APLD, the Automatic Program Locating Device that lets you select the songs you want to hear automatically, instead of manually searching for each cut.

But that's not all.

This Optonica cassette deck also has the kind of specifications that will impress the most dedicated audiophile.

The high quality tape transport features a 2-motor drive system, and a precision polished capstan shaft. Which results in a wow and flutter of an amazingly low 0.04%. Compare that figure with other top

of the line cassette decks and you'll see why Optonica can honestly call the RT-3535 Mark II, The Optimum.

A built-in Dolby* System means you shouldn't have to worry about hiss and noise ruining the performance of your tapes. And the ultra-hard Permalloy head means you'll have greatly improved frequency response.

We invite you to listen to the optimum cassette deck and in return, we'll give you the Maxell UDC-90 cassette tape absolutely free.

Just call toll-free 800-447-4700 day or night (in Illinois dial 1-800-322-4400) for the name and address of your nearest Optonica showroom. Or write Optonica,

Dept. C9B, 10 Keystone Place, Paramus, New Jersey 07652. Then pick up your free copy of our catalog, listen to the RT-3535 Mark II and get your free Maxell cassette tape.

Come in soon... the free tape offer (good only at participating dealers while the supply lasts.) ends September 30, 1977.

From the cassette deck that finds musical selections automatically to the unique turntable built on granite, find out why throughout Europe and Japan, Optonica is one of the fastest selling lines of high fidelity components on the market today.

OPTONICA THE OPTIMUM.

*Dolby is a trademark of Dolby Laboratories, Inc.

Enter No. 30 on Reader Service Card

Dear editor

Audiophile's Renaissance

Dear Sir:

As an inveterate hobbyist, I am returning to the field of high fidelity after a lapse of many years. My first thought was to dash out and secure the current issue of *Audio*, which, for my money, is the most authoritative publication in the field.

After having done such, I was amazed at the gimmickry available in the audio field today. My own beginnings were with a Stromberg-Carlson amplifier and turntable. There were no speakers available as there are today, so I built my own enclosures using an Altec design and Wharfedale raw speakers.

One of the finest audio systems I ever heard was a Gates broadcast transcription turntable, a standard tonearm with a Grado cartridge, McIntosh amplification, and Bozak corner enclosures. The sound reproduction was unbelievable.

The program sources have certainly deteriorated. In the beginning certain companies, such as Command Records, took great pains in constructing the original source using 35

mm tape and quality pressings. The original Muzak with its vertical groove was fantastic but, of course, it was impractical with stereo.

Tube or not tu-be, in my opinion, there is no argument of the reserve power and drive and the fullness of sound in tube drive. Certainly solid state is in vogue and will continue to be, but it has a thinness and transparency to it. But, solid-state units are reliable and compact with no heat problems, so they have much going for them.

Of course, beauty is in the eye of the beholder. In photography you do not need a Hasselblad to take pictures of your Uncle Fred waving to you with a can of beer, nor do you need a \$5000.00 sound system to play the "Funky Donkeys" whose tonal range goes from 13 to 15 kHz.

I have been engaged with sound systems for nearly all of my working life, mostly with motion picture sound equipment, along with broadcasting experience with KMYR-FM and KFML in Denver Colo.

Henry LeClair
San Diego, Cal.

Pollution Pragmatics

Dear Sir:

In looking back over the Annual Equipment Directory which appeared in the October 1976 issue of *Audio*, I was fascinated by the impressive specs of the "Rabid Audiophile Bazoom 2000 Amplifier" listed on page 46. My only question is: will it pass the California emission control standards?

Walter Argus
Albertville, Ala.

Tuner Lineage

Dear Sir:

I am a long time subscriber to *Audio* magazine and am wondering whether you can help me or at least direct me to some organization that can. About 12 years ago a friend of mine gave me a tuner, and I would like to find out some information about it before attempting to use it.

The name on the tuner is "Transwave" Model TW-102. There is only a power on/off switch with no volume control. The mode is FM/MPX, with an on/off filter and an AFC control.

36

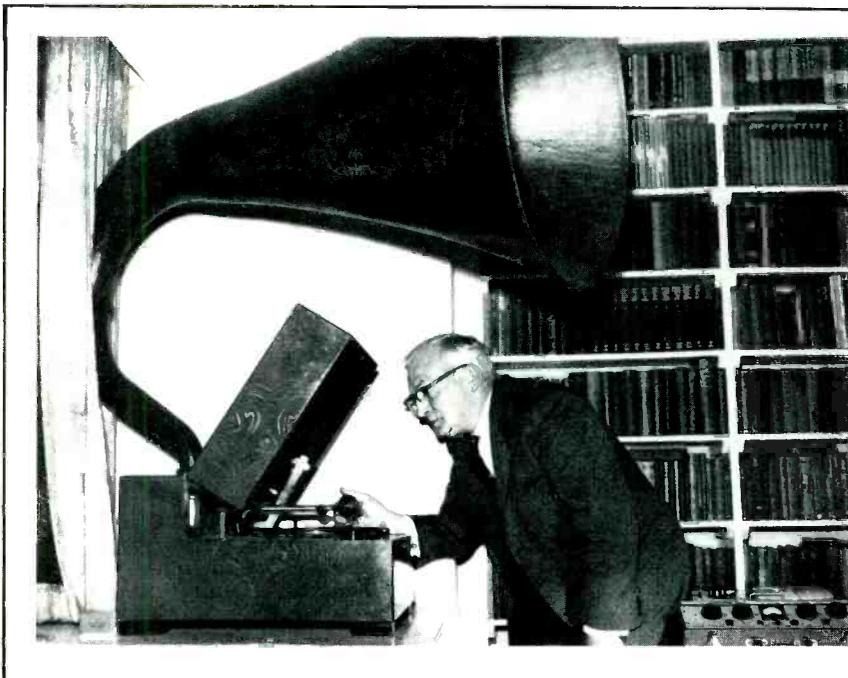

Percy Wilson

Percy Wilson, aged 84, died April 30th at his home in Oxford, England. During the 1930s he was one of the pioneers in improving the quality of electrically reproduced sound, and he was also an expert in the field of sound recording. His interest in the audio field began in 1923 when he joined the staff of the newly formed *The Gramophone* magazine where he served in the capacity of technical advisor from 1924 to 1938 and technical editor from 1953 until 1966.

In 1966 he was the second Briton to receive the Audio Engineering Society annual citation in recognition for his technical contributions to the problems of stylus alignment, horn speakers, and record cleaning. He was past president of the British branch of the AES when he became a Fellow in 1970 and an honorary member in 1972.

Onkyo plays it by ear.

We'd rather sell sound than specs.

We are proud of the specifications on our equipment. We have plenty of independent, expert audio testimony that they're good. But all you want is the best sound you can get.

That's all we want to give you.

Because you can listen to equipment with perfect specs—if they exist—and still not like the sound. We build for warmth and clarity, with as little added as is technically possible.

Onkyo has stayed a step ahead of state-of-the-art by building audio equipment for the listener not the reader of specifications. When you have pure, faithful, rich, transparent sound, the specs have to be right.

We build for a wide minimally distorted frequency range; for

uncolored electronic translation of everything that was put into the program material. If you want to change it to suit your preferences you have the facilities built in. But that's your change, not ours.

When you're buying audio equipment, look at specs if you want. But your best bet is still to play it by ear. And if we didn't have good specs to start with, we couldn't say this.

But specs are the same, whoever reads them. Only you know what you like to hear. Listen. You'll like us.

Artistry in Sound **ONKYO**

Eastern Office: 42-07 20th Ave., Long Island City, N.Y. 11105, 212 728-4639

Midwest Office: 935 Silver Drive, Wood Dale, Ill. 60191, 312 595-2970

Canada: Sole Distributor, Tri-Tel Associates Ltd., 105 Sparks Ave.,

Willowdale, Ontario, Canada M2H 2S5, 416 499-5044.



Play it by ear
with these
Onkyo components.

A-10 Solid State Integrated Amplifier

85 watts per channel, minimum RMS at 8 ohms, both channels driven from 20 Hz to 20 kHz with no more than 0.05% THD. Phono S/N 73 dB, Class A Preamp, Dual power supply, MC Head-amp.

A-7 Solid State Integrated Amplifier

65 watts per channel minimum RMS at 8 ohms, both channels driven from 20 Hz to 20 kHz with no more than 0.1% THD. Phono S/N 80 dB, Class A Preamp.

A-5 Solid State Integrated Amplifier

45 watts per channel, minimum RMS at 8 ohms, both channels driven from 20 Hz to 20 kHz with no more than 0.1% THD. Phono S/N 75 dB.

T-9 Quartz-Locked Solid State Tuner

The only Quartz-Locked component tuner, featuring pinpoint, drift-free tuning. Dual gate MOSFET front end; 1.7 μ V usable sensitivity; 3 μ V 50 dB quieting. S/N 73 dB

(mono), 65 dB (stereo), 40 dB separation.

T-4 Servo-Locked Solid State Tuner

The only component tuner featuring Servo-Locked for driftless performance. 1.5 μ V usable sensitivity; 3.5 μ V 50 dB quieting. S/N 70 dB (mono), 60 dB (stereo), 40 dB separation.

P-303 Solid State Stereo Preamplifier

Dual line construction featuring Class A push-pull circuitry with no more than 0.006% THD; frequency response 3.5 Hz to 200 kHz. +0, -1.5 dB

(tuner), S/N 70 dB (MC), 83 dB (MM). Built-in MC Head Amp.

M-505 Solid State Stereophonic Power Amplifier

105 watts per channel, minimum RMS at 8 ohms, both channels driven from 20 Hz to 20 kHz with no more than 0.05% THD. Frequency response 0-150 kHz, +0, -1.5 dB. S/N 110 dB. Protective relay circuitry.

Enter No. 19 on Reader Service Card

MAN DOES NOT LISTEN BY SPECS ALONE.



Specs and numbers by themselves can be meaningless. Take phono cartridges. Despite the fact that this state of the art has never been higher, with wide range, flat frequency response, excellent separation and superb tracking ability taken for granted, there's still room for improvement in the sound reproduction of even the best records. And in many systems, the cartridge itself is the limiting factor. We believe Sonus effectively removes this limitation.

What makes Sonus so audibly superior?

Differences in cartridges are hard to readily identify. But sensitive ears will easily recognize Sonus as having a reproductive quality that brings out the inner voices of complex musical passages with extraordinary clarity. A high definition cartridge that, because of a combination of design features, including its newly patented cantilever suspension, reproduces music with an uncanny sense of depth, ambience and realism.

So the next time you're considering an improvement in your audio system, consider upgrading your cartridge. Compare specs if you must. (You'll find that ours are equal to, if not better than anybody's.) But buy with your ears, not your eyes.

Because man does not listen by specs alone.

SONUS RESEARCH, INC., Sugar Hollow Rd.
Danbury, Conn. 06810

SONUS

High Definition Phono Cartridges

The rear of the chassis is a "level set FM" with one outlet and connections for antenna and tape output. Inside the chassis I can see part of the flywheel with the logo "Star Company Ltd." stamped on the metal. The tubes are Hitachi and other Star products.

I would greatly appreciate your assistance in helping me find out about this tuner.

Joseph Ruivo
New York, N.Y.

Leach Preamp Addenda

Dear Sir:

I hate to burden you with another preamplifier addition, however many people are writing me about a hiss problem that they are having.

It turns out that some zener diodes are noisier than others, so much so that I couldn't believe the hiss in the preamplifier I was sent. In my unit, I used two 12-volt zener diodes in series for each of the 24-volt units that I specified in the article. There were no noise problems with these. Since the problem has developed, I have worked up the regulated power supply shown on the enclosure, and will send copies to people who write me about this problem. For every person who writes or calls me, I am sure there are many more who encountered the problem and never solved it. *Audio* magazine is the only way that I can communicate with them. I only wish that these problems would show up in the design stages.

Due to excessive noise caused by the zener diode regulators D1-D4 in the wideband preamplifier, the regulated power supply shown here has

been developed. This circuit also eliminates all turn-on thump. The power transformer should be the one originally specified, or one rated at 52 to 55 volts center tapped. To use this regulator, remove D1-D4 from the circuit boards and change the value of R31-R34 to 22 ohms, ½ watt. C11-C14 should remain at their original values, as should C15-C18. The additional component values are: R46 & R47, 120 ohm, ½ watt; R48 & R49, 1.8 kilohm, ½ watt; C22 & C23, 100 µF, 50 volts; D1 & D2, 24 volt zener diodes, 1 watt; Q11 — 2N2102, and Q12 — 2N4036. Both transistors should have finned heat sinks installed on them. Three-prong plugs and jacks should be used for the interconnecting power cable instead of phone plugs and jacks, for Q11 and Q12 will be blown if the latter are used when the plugs are inserted or removed from the jacks. The complete regulator can be mounted on a 7-pin terminal strip, with the center pin grounded.

In case anyone who built the circuit didn't see my letter in the April issue of *Audio* magazine, I would like to correct a component value error that was published in the February article. The correct value for R3 in the RIAA circuit is 39 ohms, and not the published value of 390 ohms. The incorrect value will cause the circuit to be susceptible to r.f. oscillations. Do not use it by mistake. Builders of the low TIM power amplifier should use 1N4934 diodes for D6 and D7 in the protection circuit. These very low capacitance diodes will improve the operation of the VI limiter.

W. Marshall Leach
Georgia Ins. of Tech.
Atlanta, Ga.

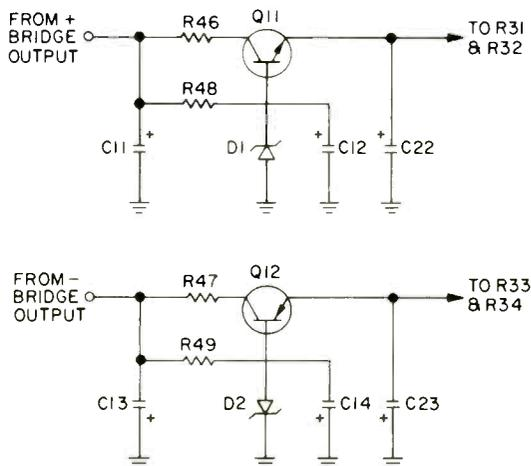

ALL INDICATED COMPONENTS SHOULD BE MOUNTED ON THE POWER SUPPLY CHASSIS

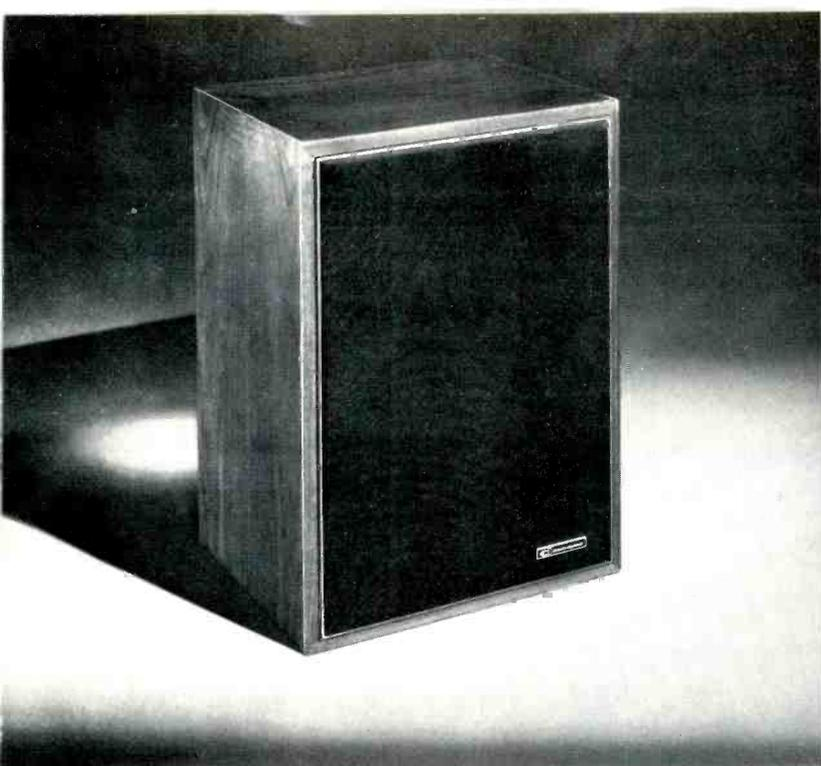

The Dahlquist System For Bass Reinforcement

Many of today's state of the art loudspeakers owe their fine performance to the care the speaker designer took in matching and blending the transient characteristics of the drivers in the system as a whole. Often, he was forced to make some difficult decisions. For example, in determining the physical requirements for his woofer, he may have chosen between: 1) achieving very low bass response, at the sacrifice of upper bass definition, or; 2) sacrificing the extreme low response by using a lighter, faster-moving cone in order to achieve smooth continuity between bass and midrange frequencies. The last is, of course, the better choice—the smoothest possible transitions throughout the specified frequency range. This is a quality that critical listeners appreciate.

However delighted we may be with the overall performance of our favorite speakers—be they Dahlquist DQ-10's, Quads, Magnepans, ADS, etc.—we sometimes miss the very low bass detail we know must be in our recordings. The practical solution is a supplementary bass reproducer designed only for that purpose. In this way we can enjoy the benefits of both design approaches. The Dahlquist DQ-1W Low-Bass Module was engineered specifically for optimum performance at the lower recorded frequencies. Its operation is based on a critically damped air-suspension system since, correctly executed, this technique offers superior performance in transient behavior and distortion.

An external crossover is required for its operation. The DQ-MX1 passive crossover is the most economical method to use, and provides excellent results. For the no-holds-barred system, the DQ-LP1 electronic filter permits biamplified operation of bass modules either in stereo or mixed L + R modes. Visit your Dahlquist dealer, or write for literature about these fine products. They will add substantially to the quality of your sound.

DAHLQUIST

27 Hanse Ave., Freeport, N. Y. 11520

Enter No. 5 on Reader Service Card

John Cage - MUSICAL RADICAL

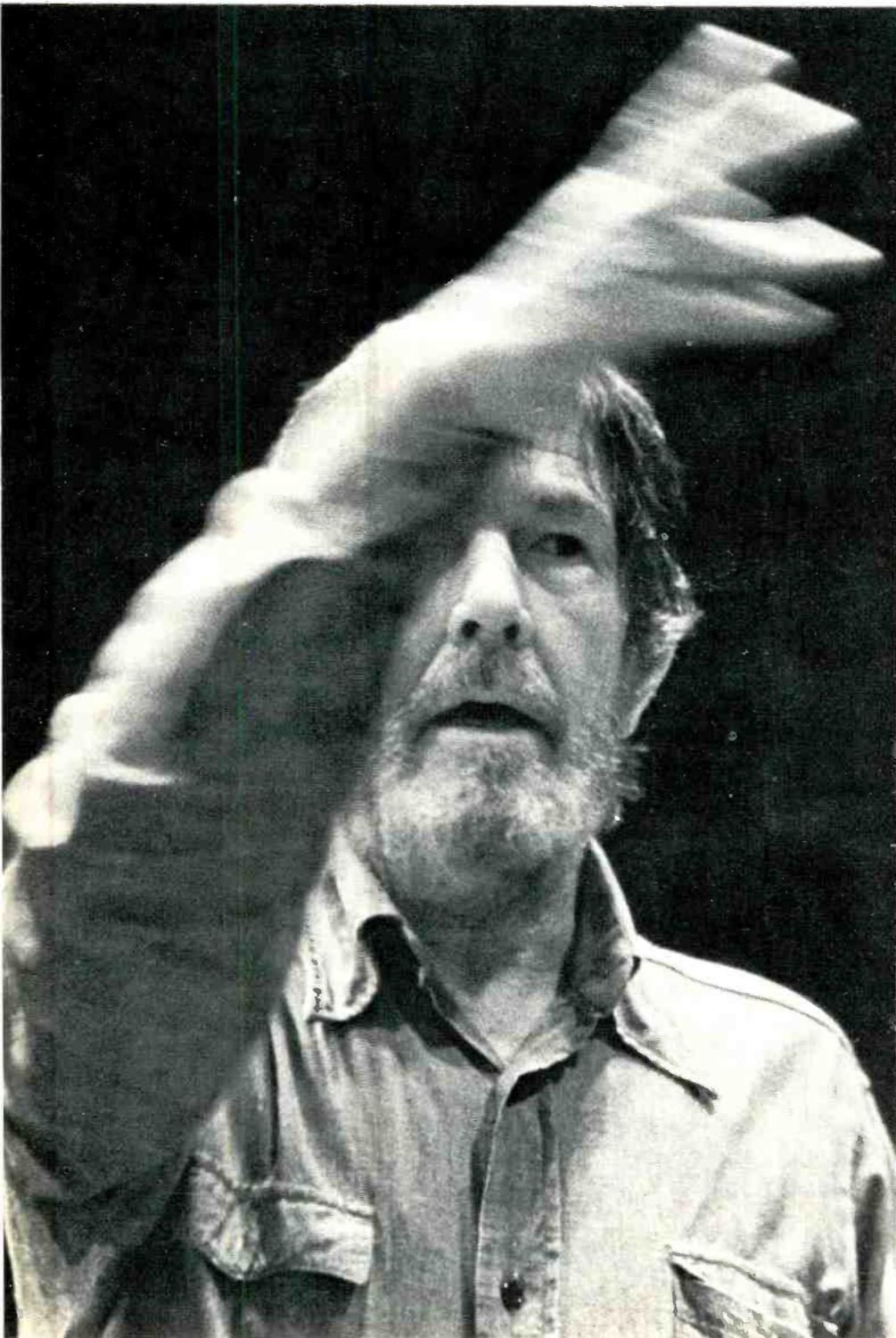

David D. Spitzer

"Everything we do is music" states John Cage, one of America's most radical avant-garde composers. Concerning music as people know it, he claims, "Left to myself, if I were the only one around, I wouldn't bother with it, because I would listen to the sounds around me, and there is always something to hear."

Appearing on college campuses for fees of a \$1,000 a day, Cage, a peaceful and reflective Westerner with an Eastern outlook, has been able to support himself from his creations only since his 50th birthday. Now in his sixties, he continues to explore the possibilities of sound and offer challenges to those with open ears and minds. Atypically he assures his listeners, "I don't write what I hear; I write in order to hear. I particularly don't want to hear what I have already heard."

Interested in using chance operations to position notes on a score sheet, Cage has applied the Eastern "I Ching" in his composing for a number of years. "I don't use it because I am incapable of making decisions. I do it because I want to find a music which is free of my likes and dislikes, which does not correspond with my taste, and which isn't held down by my memory."

As a musical anarchist, he regards symphony orchestras and traditional musical groups as "defective in spirit and imagination." Much of his challenging aesthetics has been published in three of his popular books, "Silence," "A Year From Monday," and "M." To him, even contemporary jazz is too musically limiting.

Sonic Textures

Cage has outraged many with his adventurous, avant-garde compositions throughout the years. In 1938, he penned *Bacchanale*, a score for a piano prepared with bolts and screws inserted between the strings to change the sonic textures. Using two phonographs a year later in *Imaginary*

AUDIO • September 1977

WHY MOST CRITICS USE MAXELL TAPE TO EVALUATE TAPE RECORDERS.

Any critic who wants to do a completely fair and impartial test of a tape recorder is very fussy about the tape he uses.

Because a flawed tape can lead to some very misleading results.

A tape that can't cover the full audio spectrum can keep a recorder from ever reaching its full potential.

A tape that's noisy makes it hard to measure how quiet the recorder is.

A tape that doesn't have a wide enough bias latitude can make you question the bias settings.

And a tape that doesn't sound consistently the same, from end to end, from tape to tape, can make you question the stability of the electronics.

If a cassette or 8-track jams, it can suggest some nasty, but erroneous comments about the drive mechanism.

And if a cassette or 8-track introduces wow and flutter, it's apt to produce some test results that anyone can argue with.

Fortunately, we test Maxell cassette, 8-track and reel-to-reel tape to make sure it doesn't have the



problems that plague other tapes.

So it's not surprising that most critics end up with our tape in their tape recorders.

It's one way to guarantee the equipment will get a fair hearing.

MAXELL. THE TAPE THAT'S TOO GOOD FOR MOST EQUIPMENT.

Maxell Corporation of America, 130 West Commercial Ave., Monachic, N.J. 07074



Enter No. 14 on Reader Service Card

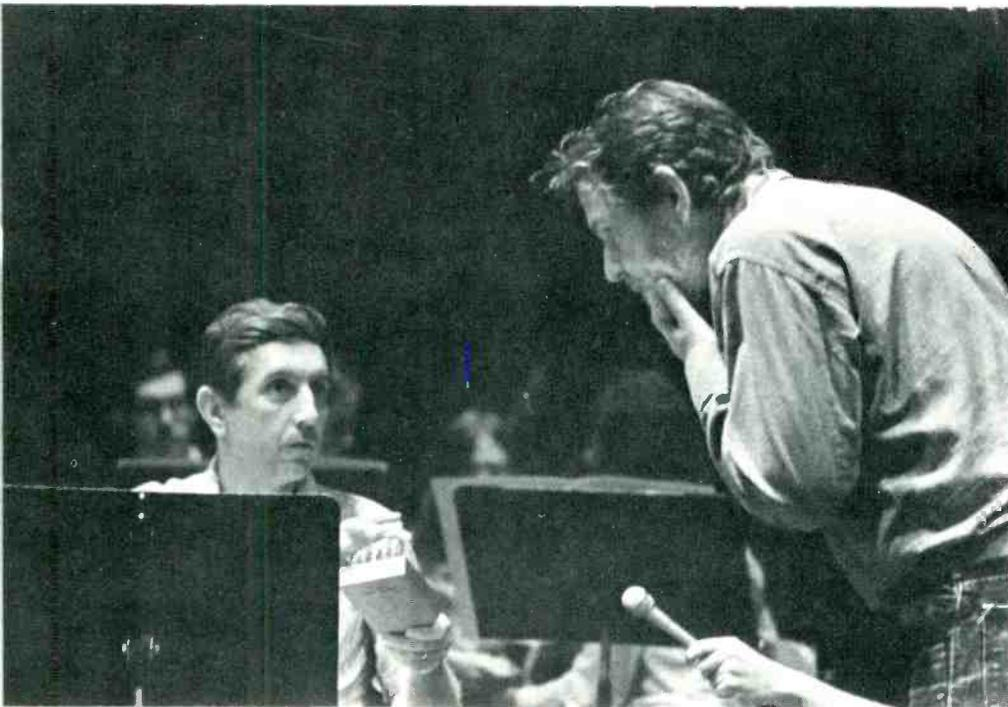

In a workshop Cage confers with one of the musicians who volunteered to play his recent composition *Score*, while a low-profile microphone gathers his words for the college archives.

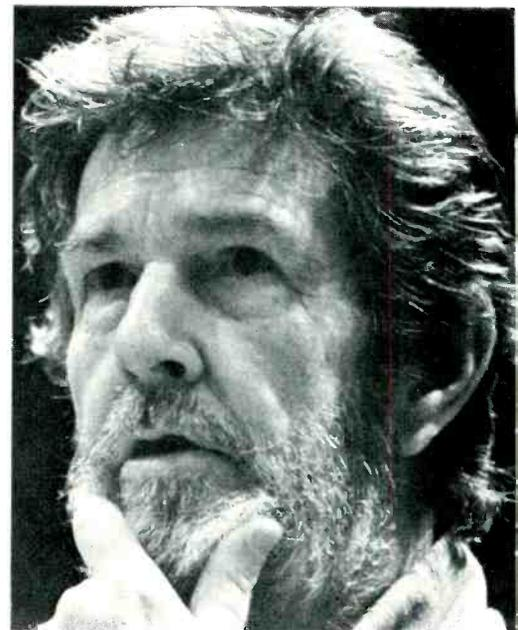

42

Landscape No. 1, he employed two sound discs, emitting sounds mixed by the composer, in a strange proto *musique concrete* expression meant for broadcast. His *Wonderful Widow Of The Eighteen Springs* spotlighted a soprano singing text from James Joyce's book "Finnegans Wake" to the accompaniment of a closed grand piano percussively played by striking the instrument's exterior with fingers or knuckles. To his knowledge, Cage composed the first example of music for magnetic tape in *Williams Mix* by laboriously splicing some 500-600 sounds and freely transforming them. Pushing art even further, David Tudor realized Cage's 4'33" in 1952 by sitting motionless before a closed piano keyboard in another assault against tradition. In the piano part of *Concert For Piano And Orchestra*, a composition without a master score, the piano section consists of 84 compositions, any number of which can be freely played by the pianist. Finished in 1968, *Hpschd* was scored for 51 electronic sound tapes and seven solo compositions for harpsichords which can be performed in numerous combinations with the actual source work determined by a throw of dice and "I Ching" change operations, with additional aesthetic decisions determined by a computer.

In Broward Community College's large lecture hall in Ft. Lauderdale, I was recently able to watch this bearded visiting artist animatedly pace around the theatre's stage as he presented the details of a recent com-

position to be performed with instruments of one's own choosing. The workshop participants carried in a wide variety of well-known and obscure instruments and objects to play, and only in a big city pawn shop could such a diversity of "musical instruments" be found.

The composer removed *Score Forty Drawings By Thoreau* and *23 Parts for Any Instrument and/or Voices: 12 Haiku* from his well-worn leather brief case. He referred to his work as having "rather odd musical notation."

The master score was derived from small drawings found in Henry David Thoreau's "Journal" which was subjected to "I Ching" chance operations to determine which ones were to be realized on the manuscript and consequently played by the musicians. Cage comments, "Score emerged from ideas in the night when I was asleep, and it is very curious because we never know when they are coming." In a regular concert, this imaginative work is to be followed by a recording of the dawn at Stoney Point, New York, where it was composed.

Underground Intrusion

During his introduction, Cage was handed a small folded "score" by a "guerilla theatre artist" in the audience who asserted it was a piece for tuba and flute and asked Cage to sing the flute part while the guerilla would vocalize the tuba lines. Regarding himself as a percussionist, Cage requested that someone else should sing the part. The guerilla continued

to interrupt. Cage finally turned to his challenger and explained why he did not want to do the piece. The crowd applauded empathetically. Directing his attention to his "new student," Cage commented, "Getting stuck in the energy, not of the Spirit but of selfish sexuality, is not going to do us any good. It will confine us to our sensations which, if anything, are too confining. They are not liberated. . . . You have a little bit of work to do, and it is not easy." Following this impromptu event, the crowd reaffirmed his views by applauding again. "The other thing that is close to this interest in sexuality," he maintained, "is the violence in our society and the coddling of ourselves with addictions of one kind or another." He continued by emphasizing that one's lifestyle and outlook should be concerned with fighting self-interest. The energies of the morning were then directed back to Cage's *Score*, and after a brief rehearsal the performers and audience were delighted by the free realization of the guest artist's music.

The following evening Cage performed the "Third Part" of his *Empty Words* which employs only syllables

WOW!

and other comments by stereo critics about Ohm loudspeakers.

Comments about the Ohm C2.

"Surely, all things considered, the design of the OHM C2 represents a fine achievement. With classical music its performance is adequate with something to spare. And with popular music — wow!"

High Fidelity - Nov./1976

Comments about the Ohm F.

"In our simulated live-vs-recorded test it rated A to A+. The sound began to warrant the use of such words as 'awesome'. The low bass, too, was extraordinarily clean and powerful. The Ohm F achieves state-of-the-art performance."

Stereo Review/November 1973

"The Ohm F's are in a class by themselves. The sound is most unusual inasmuch as it is complete, full, natural and transparent. The bass reproduction is clean and perfect."

*Hi-Fi Stereo
(Published in Germany)
October/1974*

"It may well be the finest speaker on the market and is certainly without a doubt among the top few."

*The Complete Buyer's Guide
to Stereo/Hi-Fi Equipment/1977*

Comments about the Ohm H.

"Ohm managed to get prodigious bass response out of a small box without sacrificing efficiency. The high end is handled by conventional drivers and is everything one might ask from a speaker. Dispersion is excellent and the overall sound quality is exemplary."

*The Complete Buyer's Guide
to Stereo/Hi-Fi Equipment/1977*

Comments about the Ohm D2.

"The OHM D2 is designed to provide the identical response as

the C2, sacrificing only the ultra-wide high frequency response of the latter."

*The Complete Buyer's Guide
to Stereo/Hi-Fi Equipment/1977*

Comments about the Ohm L.

"The upper mid-range and high frequencies were virtually perfect."

"In summary, the OHM L . . . is easily good enough to meet the sort of critical standards usually applied to much larger and considerably more expensive speaker systems."

*Copyright © 1977 by the Ziff-Davis
Publishing Company. Reprinted
from Stereo Review, June 1977, by
permission. All rights reserved.*

Comments about the Ohm E.

"Let me assure you, it handles Chopin and pretty well anything else from accordion to zither with equal dexterity. For anyone looking for 'just an ordinary speaker' at a modest cost as Hi-Fi speakers go — this could be it."

*Canadian Stereo Guide/Winter
1974*



You can get a free 28-page brochure and complete reprints of Ohm reviews at any Ohm dealer, or by writing us at:
OHM ACOUSTICS CORP., 241 Taaffe Place, Brooklyn N.Y. 11205

Enter No. 18 on Reader Service Card



By lamplight Cage prepares his *Empty Words* for a lengthy reading which abandons meaning and moves into non-sensical audio art.

As an avant-garde composer Cage prepares a piano to play his *Music For Marcel Duchamp* by inserting pieces of felt between the wires to change the instrument's sound.

and letters in the score. The aggregate text consisted of four parts, taking all night to perform. The bearded seer, dressed in faded jeans and a Levi work shirt, in discussing his piece said, "I gave up smoking in order to be able to read through the whole night, and

then the engagement that I had felt through." Giving the impression he was pleased with himself, he jokingly offered, "So I gave up smoking, so to speak, for no reason at all." The crowd was amused. A performance of the entire four parts is meant to be taken as a transition from language into music. Abandoning order or sense and surging into non-sensical sonic experiences is quite consistent with Cage's musical philosophy. He asked himself, "Why abandon sense or meaning in language?" and then quipped, "think too of the people you love and when you are alone, you frequently make no sense at all."

Empty Words droned on and on, trance-like, for at least 40 or 50 minutes. Cage sat behind a bulky ancient wooden desk bent over a microphone with the pages of his score illuminated by a small lamp, which looked as if it were a thrift store reject. In the eerie light, he took on the sinister appearance of a Dr. Faust. Boredom, uneasiness, and restlessness caused many listeners to emit sounds complementing the composer's musical vocalizations.

Avant-garde Freedom

Many of the persons in the audience were relieved during the second segment of Cage's evening performance, when he directed his attention to the prepared piano for his piece, *Music For Marcel Duchamp*, which was first performed some 28 years ago. In this offering, some of the piano wires were dampened with felt. Strangely enough, this piece of Cage's music sounded very traditional compared to the previous amplified, syllabic utterings. Had Cage sold out and gone commercial?

Whatever the case, John Cage's philosophy of life, persistence, and apparent peacefulness with himself are admirable. With singleness of purpose, he has held steadfastly to his basic assumption—"everything we do is music"—and consequently he has become a world renowned figure. Emancipated from self-interest, his conception of freedom has implications extending far beyond music. ▢



The most important piece of audio equipment you'll ever own.

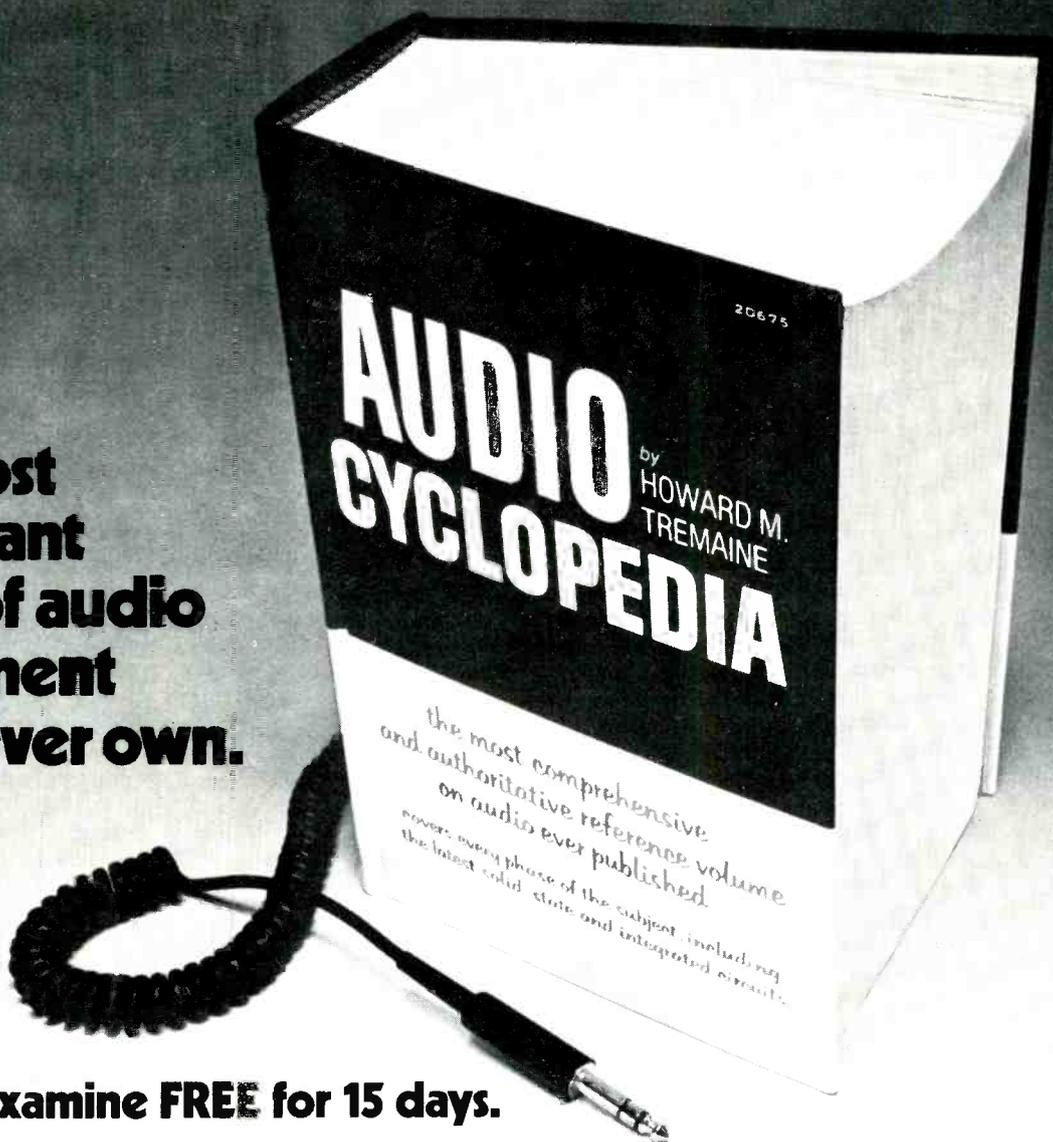

Yours to examine FREE for 15 days.

25 FACT-FILLED CHAPTERS ARRANGED IN "EASY-TO-FIND" QUESTION AND ANSWER FORM

- Basic Principles of Sound
- Acoustics, Studio techniques, and Equipment
- Constant-Speed Devices, Motors, and Generators
- Microphones
- Attenuators
- Equalizers
- Wave Filters
- Transformers and Coils
- Sound Mixers
- VU and Volume Indicator Meters
- Vacuum Tubes, Transistors, and Diodes
- Audio Amplifiers
- Disc Recording
- Cutting Heads
- Recording and Reproducing Styli
- Pickups
- Magnetic Recording
- Optical Film Recording
- Motion Picture Projection Equipment
- Loudspeakers, Enclosures, Headphones, and Hearing Aids
- Power Supplies
- Test Equipment
- Audio-Frequency Measurements
- Installation Techniques
- General Information, Charts and Tables

Be our guest. Examine the AUDIO CYCLOPEDIA free for 15 days. You'll find out why it is considered the most comprehensive and authoritative book ever written on the subject. And you'll get a FREE \$3.50 bonus book to keep no matter what!

The AUDIO CYCLOPEDIA is literally a one-book audio library. It has long been considered "the bible" by amateur stereo buffs as well as professional technicians. That's why you'll find it in constant use not only in home workshops and at stereo centers, but also in recording studios, broadcast booths and concert halls.

This giant reference book is over 3" thick,

and packed with 1,757 illustrated pages. It features 3,645 questions and answers and a 50 page "instant-find" index for subject identification. It is truly the big one in audio electronics and it puts all the information you'll ever need right at your fingertips, chapter by chapter.

Send for the AUDIO CYCLOPEDIA today. If you don't agree that it's the most important piece of audio equipment you own, just return it within 15 days. You won't owe a cent. And no matter what you decide, you'll get a free \$3.50 copy of *The ABC's of Tape Recording* to keep just for mailing the coupon.

FREE-BOOK FREE-TRIAL COUPON



Save postage & handling costs. Full payment enclosed (plus tax where applicable). 15-day return privilege still applies.

Yes, please rush me the AUDIO CYCLOPEDIA (#21455) for my free trial. I understand if not completely satisfied, I may return it within 15 days, and owe nothing. Otherwise, it's mine to keep for only \$34.00 plus postage and handling and local taxes (where applicable).

And, whatever I decide, a copy of "The ABC's of Tape Recording" (valued at \$3.50) is mine free!

Name _____
 Address _____
 City _____
 State _____ Zip _____



Mail to **Audel**
 4300 W. 62nd Street
 Indianapolis, Indiana 46206
 A Division of Howard W. Sams & Co., Inc.

CT23

European records

John S. Wright

46

I find myself in a dilemma, being confronted with two recordings of Haydn's *Symphony No. 88*; one recorded by a favorite team (Christopher Parker and Christopher Bishop) on EMI and the other of my favorite orchestral sound with the Concertgebouw Orchestra of Amsterdam conducted by Colin Davis. The EMI recording (ASD 3328) is a youthful and buoyant interpretation from André Previn conducting the London Symphony Orchestra. The performance possesses urge and drive, but yet is light in texture. The recording quality is excellent, but not outstanding, containing as it does sufficient detail with a good sense of space. The acoustics surrounding the Concertgebouw Orchestra in the Philips recording (9500138) provides an enormous sense of depth as it has nearly some three seconds reverberation. This is complimented by very full and extended bass response. Interpretation is, however, to my taste rather pedantic and grandiose for such basically frivolous music. Thus, I lean towards the Philips release on the grounds of recording, but favor the EMI version in terms of musicality. Other than this I must leave the choice to the reader, since to expand further upon these differences would only reveal personal bias. Perhaps as good a way of making a choice would depend on which other Haydn Symphony one prefers as its coupling. The André Previn record provides No. 96 **The Lyrical**, while Colin Davis conducts the lesser known No. 99.

Colin Davis made an early name for his interpretation of Beethoven. In 1961, when he was little known, he recorded a racy interpretation of Beethoven's **Symphony No. 7** (HMV Concert Classics SXLP 20038). His performance with the London Symphony Orchestra just released on Philips 9500219 possesses the same onward relentless and energetic spirit, but is less youthful than his earlier interpretation which could be criticized as being rather extreme. Sound quality is natural in a way that is now making Philips famous. The recording quality

needs no higher recommendation than this comment. I compared it with the recent Solti recording (SXL 6764) and was surprised to find a similar tempo, but with less determination and a comparatively bloated sound. There is something about a Colin Davis Beethoven interpretation, particularly of the **Seventh Symphony** that I find utterly satisfying, and to me this new Philips release is the best available.



Colin Davis

Readers will remember that in last year's round-up I highlighted Walter Weller's conducting of Dukas works recorded by James Lock in the Kingsway Hall (SXL 6770). Following Weller's career, I took the opportunity to obtain his new recording of the popular Prokofiev **Symphony No. 5**, also recorded at the Kingsway Hall (SXL 6787). This time the recording engineer is Kenneth Wilkinson, and we have a heavy, weighty bass, especially impressive on timpani, but with some strangled string tone very similar to his work abroad with Zubin Mehta. From this example alone, it would seem that the engineer has more control and influence over the recording balance than is imposed either by the

conductor or the location. However, to investigate the converse, I have a sample of James Lock recording Zubin Mehta conducting the Israel Philharmonic playing Mozart's **Symphonies Nos. 34 and 39** (SXL 6833). Almost only the music changes! Bass is not quite so heavy but the sound is still generally constricted with a lack of clean and open transients. These effects were less noticeable on the smaller ensemble of the Mozart symphonies, but the similarities between these two Decca albums recorded by Wilkinson and Lock in their changed roles are strong, and neither have much to do with the fine, albeit synthetic sound of the Dukas record originally recommended.

And now, how an orchestral recording really can sound! At last we have the Sir Adrian Boult recording of Elgar's **Symphony No. 1** (with Parker and Bishop again) on EMI ASD 3330. Apparently due to Sir Adrian's ill health, the Elgar **Second Symphony** was released before the first. That recording then received my highest praise (ASD 3266). Within the confines of commercial stereo presentations, this new recording is also difficult to fault. The first movement possesses a feeling of lightness which initially lead me to suspect restricted bass, but the drum at the opening of the second movement assures one immediately of great frequency as well as dynamic range. This music is reserved, in the British sense of the word, and this is reflected throughout the engineering to provide a home entertainment product that can best be described as being "in the very best of taste."

Worthwhile organ recordings are few and far between. Often claimed to be the "king of instruments," the organ seems the "king of beasts" when it comes to recording. This may well be because, given only two loudspeaker stereo playback, an ambiguity lies within the original in that the acoustics of the church often overwhelm the organ itself. In life, where the ears accept information from all directions (including height), the brain is easily able to differentiate be-

HIGH BIAS.

**These cassette deck
manufacturers are highly biased for SA:**

AIWA · AKAI · DOKORDER · JVC
KENWOOD · MERITON · NAKAMICHI
OPTONICA · PIONEER · SANSUI
SHARP · TANDBERG · TEAC
TOSHIBA · UHER · YAMAHA

**And are joined by these
in recommending SA for use in their decks:**

BANG & OLUFSEN · DUAL · FISHER
HARMAN/KARDON · LAFAYETTE
ROYAL SOUND · SANKYO
AND MANY OTHERS.



There's been a quiet revolution going on in the cassette world. □ Leading makers of quality cassette decks have adopted TDK SA as their reference standard tape for high (CrO₂) bias and equalization settings. Why TDK SA? Because TDK SA's advanced tape formulation and super precision cassette mechanism let them (and you) take full advantage of today's advanced cassette deck technology. □ In addition, a growing number of other companies are recommending SA for use with their machines. □ So for the ultimate in cassette sound and performance, load your deck with SA and switch to the "High" or "CrO₂" bias/EQ settings. You'll consistently get less noise, highest saturation and output levels, lowest distortion and the widest dynamic range to let you get the best performance from any quality machine. □ But you needn't believe all this just because we say so. All you have to do is check our references.

 **TDK**

The machine for your machine.

TDK Electronics Corp., 755 Eastgate Blvd., Garden City, N.Y. 11530.
In Canada: Superior Electronics Industries, Ltd.

Enter No. 36 on Reader Service Card

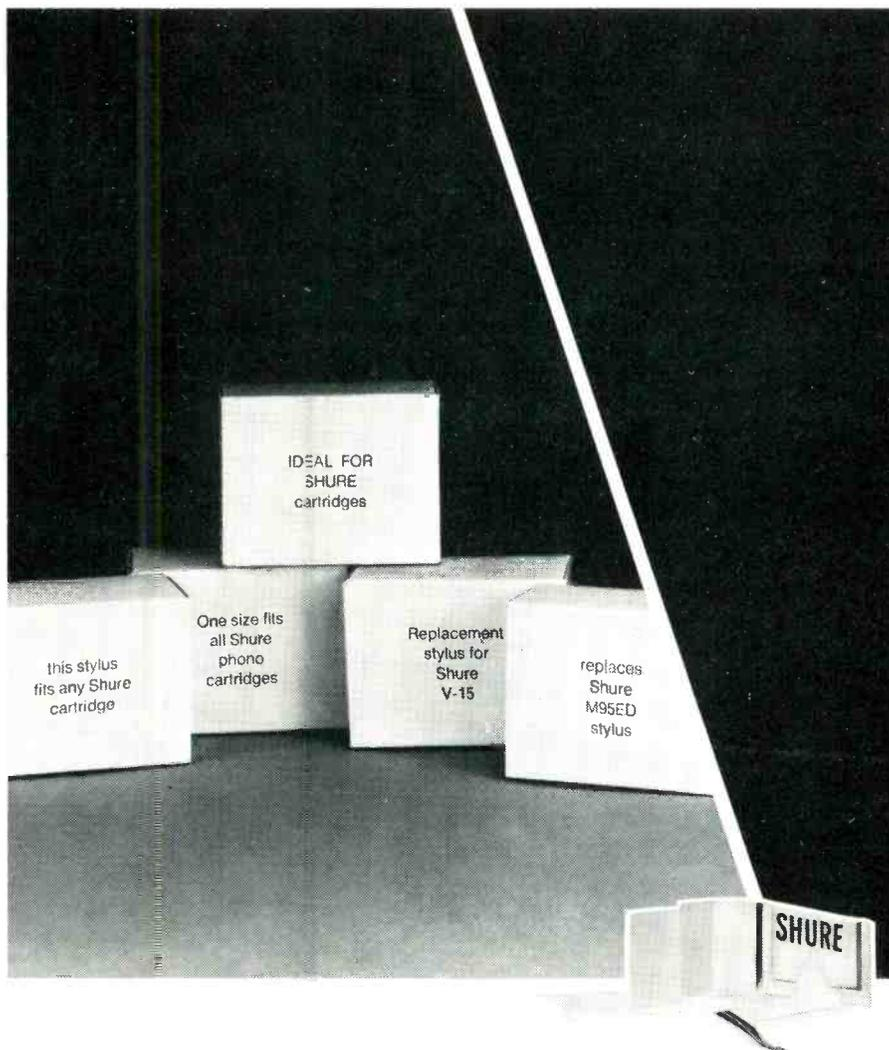

48

Needle in the hi-fi haystack.

Even we were astounded at how difficult it is to find an adequate other-brand replacement stylus for a Shure cartridge. We recently purchased 241 random styli that were not manufactured by Shure, but were being sold as replacements for our cartridges. Only ONE of these 241 styli could pass the same basic production line performance tests that ALL genuine Shure styli must pass. But don't simply accept what we say here. Send for the

documented test results we've compiled for you in data booklet #AL548. Insist on a genuine Shure stylus so that your cartridge will retain its original performance capability—and at the same time protect your records.

Shure Brothers Inc.
222 Hartrey Ave., Evanston, IL 60204
In Canada: A. C. Simmonds & Sons Limited



MANUFACTURERS OF HIGH FIDELITY COMPONENTS, MICROPHONES, SOUND SYSTEMS AND RELATED CIRCUITRY

Enter No. 31 on Reader Service Card

AmericanRadioHistory.Com

tween the direct and reverberant information. This provides an experience which is currently beyond the confines of home playback. Given the restrictions of the stereo format, a lesson in two-channel organ recording comes on the Argo label (ZRG 864) with their recording of the new organ at Hexham Abbey. Intelligibility is maintained within ambient field. Nevertheless, it is easy to detect that the organ pickup is quite close, with the acoustics of the Abbey being rather a backcloth. The new organ itself is a delight, having a wide range of available textures which are well demonstrated by an interesting selection of music. Low notes, when rarely present, surprise with their depth. Overall, the choice of music and style of playing is not one intended to provide hi-fi enthusiasts with a demonstration record, but nevertheless it is. Perhaps in these days of womens' lib, we should not be surprised to find that the organist is a woman! How much (or how little) this effects the interpretation I will leave for comment by specialist music magazines, but the whole record is a delight and a great relief from those overpowering organ presentations we have almost customarily come to expect on disc.

The second Argo recording to be mentioned is also enchanting, being songs by Aaron Copland which are sung by Robert Tear and accompanied by Phillip Ledger (piano) on ZRG 8621. I was surprised to find that many of the songs were familiar, some being in a negro spiritual idiom. Stereo imagery was stable on the voice, being in a very reverberant setting. The piano was slightly heavy in texture, particularly in the upper bass. However, the overall coloration was low. Certainly those who buy this record solely for the music will not be disappointed and those who buy it on the recommendation of the recording will certainly not be disappointed with the music.

In 1971, Vladamir Ashkenazy gave a superb Lizst recital on Decca SXL 6508. Both performance and recording was spectacular, and this record is still very worth obtaining. Since then the recording quality of Ashkenazy releases have been variable, but we now have a new release very much in that earlier vein (SXL 6739). Being of Schubert's **Sonata in D major**, the music does not contain the fireworks of Lizst, altogether having more openly expressed tenderness. Importantly the piano sounds real, existing in real space, with a true recital atmosphere that contains some particularly emotive moments. 41

AUDIO • September 1977

"Direct" to you from Radio Shack



"I'm very impressed with the way Radio Shack has translated latest technology into good looks and precision record playing in the 400."

Peter Nero
Peter Nero
Conductor/Pianist



Realistic® Direct-Drive Automatic... Finest Turntable We've Ever Offered

Features two motors, damped cue/pause, S-shape tonearm, \$39.95-value Realistic/Shure cartridge

The LAB-400 makes studio performance both affordable *and* convenient. The massive die-cast platter rests directly atop a 16-pole brushless DC servomotor. Platter and motor rotate at the same speed, either 33 1/3 or 45 RPM. No idler wheels, reduction gears or belts to alter the music that's stored in your record's grooves. The result: wow and flutter is less than 0.03% WRMS, rumble is better than -63 dB (DIN B). Fully automatic tonearm has an effective tonearm length of 8 1/16", for flawless tracking down to 1/2 gram. Handsome walnut veneer base with ultra-modern, slim design. Elliptical-stylus magnetic cartridge and detachable steel-hinged dust cover — significant "extras" that aren't extra. All for \$199.95*

Fully Automatic Tonearm Operation

You need never touch the tonearm—just select record size and push start switch. An independent motor does the rest, cueing the arm, gently lowering it onto the record, and removing it at disc's end. With repeat mode, cue/pause, anti-skate and tracking force controls.



Two speeds with controls for ±4% pitch adjustment.



Neon light with strobe disc for checking speed.



Low-profile styling with precision shock-mounts to stop acoustic feedback.



FREE! New '78 Catalog

Come in for your copy today and see what's *really* new in electronics. 164 pages, 100 in full color. Over 2000 exclusive items.

SOLD ONLY WHERE YOU SEE THIS SIGN:

Radio Shack®

A TANDY COMPANY • FORT WORTH, TX 76107 • 5000 LOCATIONS IN 9 COUNTRIES

*Price may vary at individual stores and dealers

Enter No. 26 on Reader Service Card

Be sure
to attend...

THE AUDIO ENGINEERING SOCIETY'S

58th
Technical
Meeting and
Exhibition of
Professional
Equipment
at the
Waldorf-
Astoria
November 4-7

For details,
write or phone:

AUDIO
ENGINEERING
SOCIETY

60 East 42nd Street
New York, N.Y. 10017
(212)661-8528
and 661-2355

Herman Burstein

Tape guide

Taping Choice

Q. I am using a Marantz tuner, pre-amp, and amplifier, Bose 901 speakers, a Thorens TD-125 turntable with an SME tonearm, and a Shure V15 cartridge. Will I get better quality by taping records played on FM or by taping my records directly from my turntable?—H.S. Liu, Los Angeles, Cal.

A. With your equipment, you will do better to record your phono discs directly. Too many FM stations fail to live up to the performance potential of FM and put out a miserable signal—over-compressed, distorted, and with a narrow frequency response.

Deck Thumping

Q. My Sony 630-D makes a thumping sound either when idling or in the forward position. This noise goes away at times but always returns.—Thomas Dixon, Junction City, Kans.

A. It seems that something is out-of-round, most likely the rubber idler. It is typical for the thumping to disappear after the machine has been in operation for awhile. But the idler "remembers" its original out-of-roundness and the thumping resumes when the machine is cold. Try replacing the idler. If this doesn't help, you will need the help of either the manufacturer or an authorized service agency.

Cassette Treble Response

Q. Tape cassettes today at speeds of 1-7/8 ips are capable of reproducing frequencies of 12,000 Hz or more. Yet, how can that be? Doesn't tape speed affect treble performance, the faster the better?—Howard Wong, Jackson Hgts., N.Y.

A. Cassette tapes are able to go up to 12 kHz and higher at the speed of 1-7/8 ips owing to the development of tapes with improved treble response; to playback heads with very narrow gaps to minimize playback treble losses; to reduced amounts of bias, which causes partial erasure of the higher frequencies; to improved electronics, including the Dolby noise reduction system, which reduces noise and

therefore overcomes the disadvantage of bias reduction, and the improvements in the tape formulations that provide for lower noise and increased signal level recorded on the tape.

Cassette Pressure Pads

Q. Most cassettes have pressure pads built into them. I've read that pressure pads increase the wear characteristic at one point in the tape head. How do tape manufacturers know how much pressure to apply to the tape. By buying brand name tapes would there be less head wear caused by these pressure pads?—Howard Wong, Jackson Heights, N.Y.

A. Pressure pads are adjusted for the minimum pressure that will maintain good tape-to-head contact so that the high frequency response meets its potential . . . taking into account tape speed, gap width of the playback head, bias, kind of tape, etc. By buying good tapes, you reduce the amount of head wear due to the abrasive effect of the tape.

Add-On Distortion

Q. To what degree do devices such as the Dolby unit, a four-channel decoder, or a reverberation unit introduce distortion into a music system?—Frederick Kistler, APO, San Francisco.

A. The Dolby unit introduces very little distortion. However, a reverberation unit of the home type introduces somewhat more distortion, but exactly how much depends on the unit. The four-channel decoders generally introduce little distortion, and if they are passive devices (no transistors or tubes), they introduce no distortion.

Separation Explanation

Q. Figures are often given for "channel separation" for recorders,

If you have a problem or question on tape recording, write to Mr. Herman Burstein at AUDIO, 401 North Broad Street, Philadelphia, Pa. 19108. All letters are answered. Please enclose a stamped, self-addressed envelope.

**No components have ever been so
extravagantly engineered.**

And so extravagantly praised.

What they said.

Stereo Review:

"These components show no sign of the cost-cutting techniques that are routine even in the best mass-produced audio equipment..."

"We see the Accuphase line as occupying a place in audio analagous to that of the Rolls Royce among automobiles."

Hi Fi Stereo Buyer's Guide:

"One new item in the hi fi marketplace we feel certain will join the list of legendary greats is the Accuphase P-300 Power Amplifier."

"Firstly, there's the P-300s sound quality, so good it left our listening panel arguing over who would borrow it from the test lab."

Popular Electronics:

"This preamplifier has the widest dynamic range of phono of any preamp we've ever measured."

"In its ruggedness and mechanical construction, the preamp resembles a laboratory instrument rather than a hi-fi product..."

"With tone controls and filter bypassed, this preamp comes as close to the proverbial 'straight wire with gain' as anything known to us."

Why they said it.

Accuphase components have been literally handcrafted with a devotion to excellence that borders on the fanatic.

Only aerospace quality component parts are used, with

each part hand-selected and tested for performance.

The P-300 amplifier has a heavy-duty stable power supply — regulated: 200 watts per channel RMS (both channels driven) from 20 Hz to 20,000 Hz ± 0.2 db into 4 ohms, with no more than 0.1% total harmonic distortion.

It has modular construction for simple access; complimentary push-pull symmetry in *all* input and output circuits; 3 meter ranges and power-limiting switches to protect your speakers. And more.

With its design overkill, the Accuphase amp can loaf through the most demanding and complex musical passages, maintaining exquisite precision, delicacy and warmth without sacrificing strength or power.

The Accuphase C-200 Control Preamplifier has versatility beyond belief: 10 back and front inputs, 7 outputs, 28 controls; yet it is simple in operation and appearance. (A small sample of its versatility: you can use 4 tape decks in combinations of simultaneous and independent recording, dubbing and listening.)

The motivation for all the extraordinary care and craftsmanship that produces each Accuphase amplifier, preamp and tuner is really very simple. A loving devotion to music.

If you share that devotion, please see an Accuphase Showcase dealer.

You'll enrich your life.

Accuphase

When you're really serious about your music.

Introducing New Quantum by Memorex. Four Reasons It Sounds So Good.

1. Quantum offers low distortion. You get a true recording of any type of music at high output, with virtually no distortion.

2. Quantum has very high sensitivity. This maximizes output and allows you to effectively capture all signals at a greater level.

3. Quantum provides an excellent signal-to-noise ratio because its high sensitivity is obtained with no increase in noise level. This means a pure, brilliant sound.

4. Quantum gives you high saturation, resulting in a wide dynamic range and broad recording flexibility.

Quantum achieves improved recording performance while maintaining a high degree of mechanical excellence. With long life, durability, precision edge quality and excellent oxide adhesion.

The best way to hear the Quantum difference is to try it out for yourself. Available in 7" x 1800', 7" x 2400' and 1½" x 3600' reels.

MEMOREX Recording Tape.
Is it live or is it Memorex?

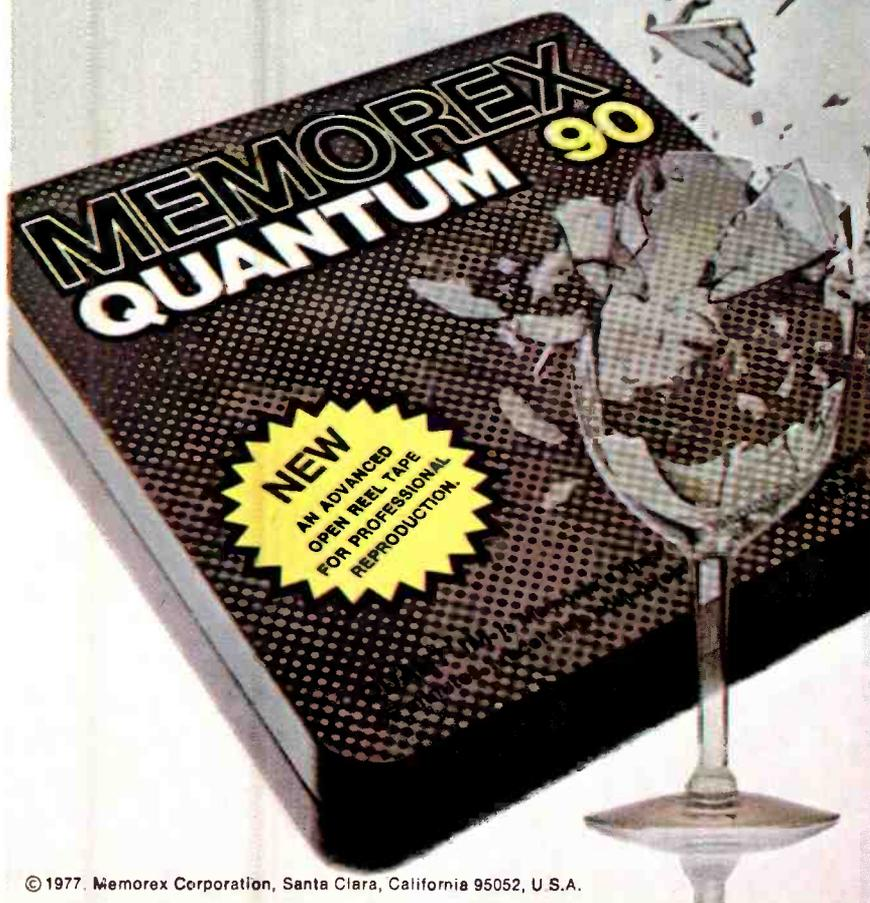

© 1977. Memorex Corporation, Santa Clara, California 95052, U.S.A.

Enter No. 17 on Reader Service Card

tuners, and amplifiers. Why wouldn't separation be complete? It would seem that if two separate microphones are used to produce two channels on the tape, there should be no reason for overlapping channels on playback.—Frederick Kistler, APO, San Francisco.

A. Let's take tape as an example. Because the tape tracks are so close together, there tends to be signal leakage from one track to another. Similarly, because the electronics for the two channels are in close proximity, or because the two sections of tape head are close together, there tends to be leakage.

Shut-off Timer

Q. Would it be harmful to my tape deck if I use a timer between the amplifier and wall socket so I might shut off the entire system at a desired time? Is turning off the power switch any different than pulling the plug?—Robert McCue, Shreveport, La.

A. Having a timer shut off the entire audio system is not harmful except for the possibility that if your tape deck is in operation when the power goes off, the tape may become snarled. However, this depends on the design of the deck, as some tape decks designs protect against tape snarl in case of power failure. If the pressure roller continues to make contact with the capstan when the power goes off, this tends to make the roller go out of round. Similarly, an idler in the transport may remain in contact with the motor shaft, causing the idler to go out of round. Again, all of this depends on the design of your particular tape deck.

Distortion Differences

Q. Three per cent harmonic distortion in an amplifier would be considered horrendous, yet the spec sheets for many tape recorders give distortion as 3 per cent at 0 VU. What is the difference between 3 per cent harmonic distortion in an amplifier and in a tape machine?—Frederick Kistler, APO, San Francisco.

A. Harmonic distortion should not exceed about 1 per cent at 0 VU in a properly calibrated tape recorder. It seems that such a level of distortion, (3 per cent) which occurs only on signal peaks and probably over a limited frequency range, is quite acceptable to the ear when coming from a tape recorder. Another reason might be that some of the higher distortion frequencies are outside the reproduction capability of the machine and/or the hearing range of the human ear.

AUDIO • September 1977

“I’ve always wanted Bose 901’s, but won’t I need a 100-watt amplifier?”

The original Direct/Reflecting® Bose 901® was one of the most acclaimed loudspeakers ever. But many people who admired the 901’s didn’t buy them because they thought they demanded a big, expensive amplifier.

The New Bose 901 Series III

Now comes the new Bose 901 Series III. It is a revolutionary speaker that combines proven Bose design concepts with startling new technology to achieve performance that is superior to the original 901 in every dimension—including even the spatial realism and spectral accuracy for which the 901 was justly famous.

Yet the 901 Series III requires less than one-third the amplifier power of the original 901. That means it can produce the same sound volume with a 15-watts-per-channel receiver as the original 901 with 50 watts. In fact, we suggest that anything over 70 watts is simply unnecessary.

No advertisement can describe fully the 901 Series III and the technology behind it. So we’ve put together a comprehensive literature package that includes a detailed 16-page color brochure, a 20-page owner’s manual, and a copy of Dr. Amar Bose’s paper on “Sound Recording and Reproduction,” reprinted from *Technology Review*. To receive this literature, send \$1.00 to Bose, Dept. AC9, The Mountain, Framingham, Mass. 01701.

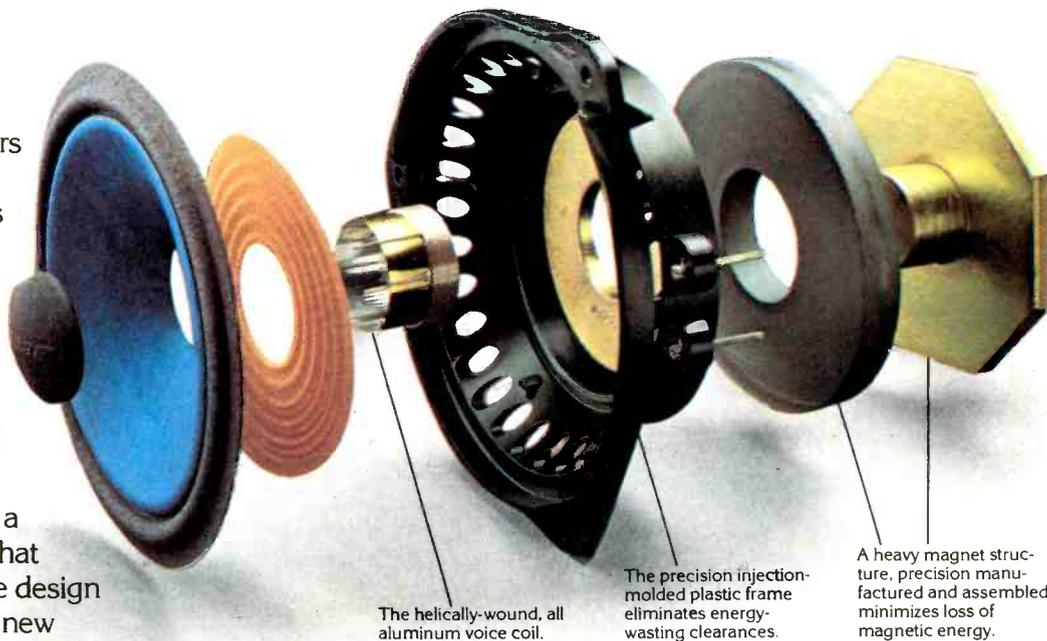
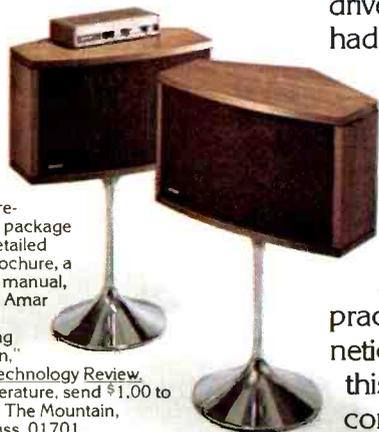

The helically-wound, all aluminum voice coil.

The precision injection-molded plastic frame eliminates energy-wasting clearances.

A heavy magnet structure, precision manufactured and assembled, minimizes loss of magnetic energy.

The New Driver

The key to the remarkable efficiency of the 901 Series III is a totally new, high performance



The voice coil consists of flat aluminum conductor wire wound on-edge on an aluminum core, eliminating the inefficient air gaps between the round copper windings of a conventional voice coil.

driver—a driver so advanced we had to build our own state-of-the-art driver manufacturing facility to produce it. It combines a light-weight, ultra-high-efficiency, helically-wound voice coil with a precision injection-molded plastic frame that practically eliminates loss of magnetic energy. Just as important, this strong plastic frame allows computer controlled assembly to tolerances far tighter than those imposed on conventional drivers.

The Payoff

This efficiency lets you enjoy the spectacular performance of the 901 Series III without a large investment in something you can’t hear: pure power. And that might make the difference between getting just good speakers, and the speakers you’ve really wanted all along.

“A speaker unlike any other.”



BOSE®

Better sound through research

Cabinets are walnut veneer. Patents issued and pending.

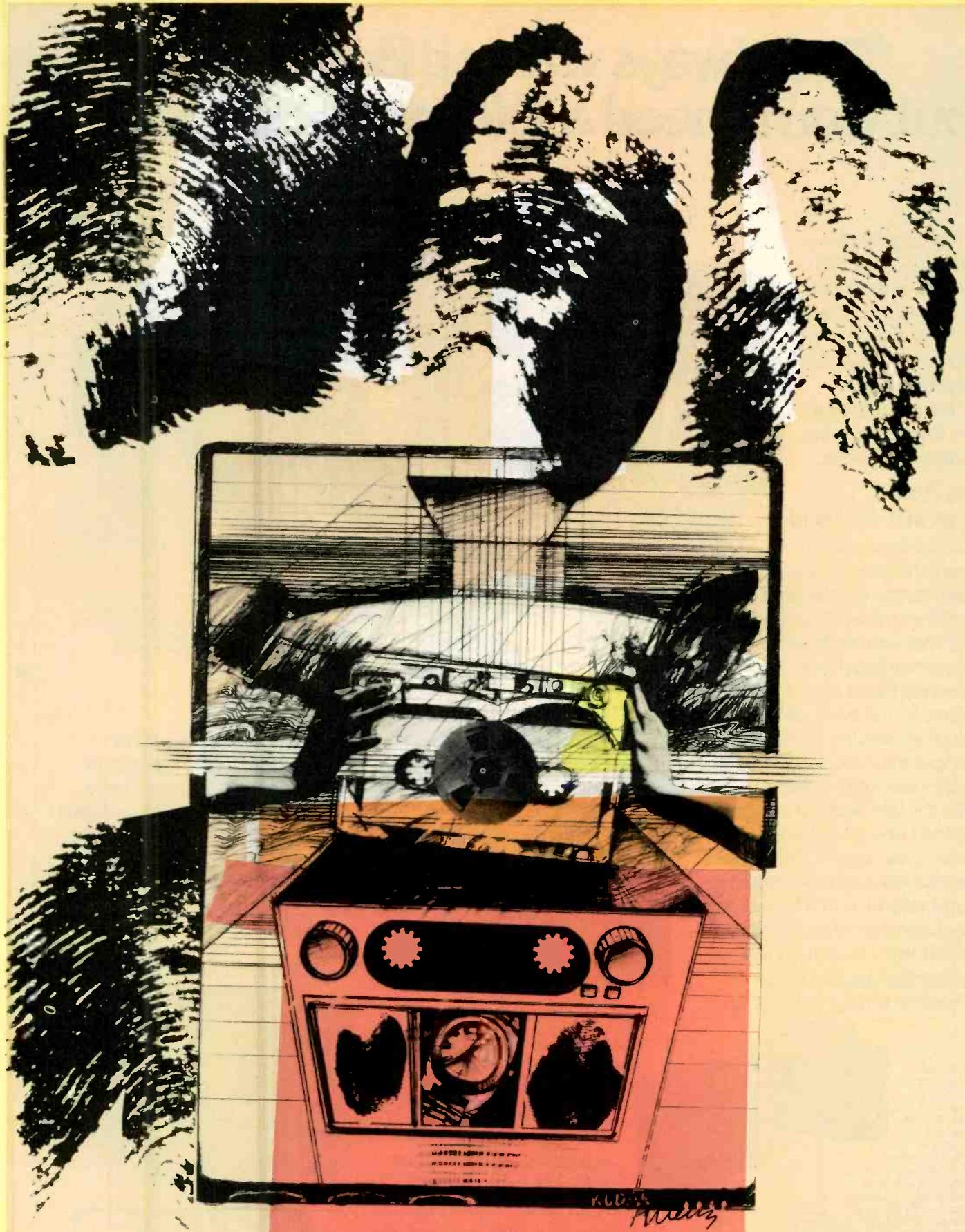

Printing effects in magnetic tape

THINKING ABOUT PRINT-THROUGH

William A. Manly*

Some years ago, when Joan Sutherland had recently burst upon the musical scene and Grand Opera was new to television, I had just settled back to watch and hear a TV network broadcast of an opera starring the aforementioned lady. The credits were run and the opera was started—whereupon my enjoyment was rudely marred by an unusual occurrence: each time just before Miss Sutherland began, her actual line was *preceded* by an echo, fainter but very clear, of what she was about to sing. After she stopped, the echo was also to be heard, but it was much less audible and almost unobtrusive. Some of the instruments had audible echoes, but not all of them, and the male singers were not appreciably affected.

My professional curiosity temporarily overcame my desire to enjoy the opera, and I moved closer to the set to examine the picture in detail. No disturbance in the stability of the picture could be seen, indicating that the TV synchronization signals were not affected. Also, there was no trace of "ghosting" at all, indicating that the video was totally unaffected. The tape, however, had about the worst case of audio print-through which I had ever observed in a professional setting, but since the whole tape had gone through the same conditions, why were certain parts of the signals disturbed and not the others?

Print-Through or the Printing Effect

All these things are not as mysterious as they may seem at first. In this article I hope to relieve some of the mystery about this effect, and show how tapes can be stored so as to keep the problem below the annoyance level of audibility.

Contact transfer of signals from layer to layer occurs in wound magnetic tapes mostly as a result of temperature cycling or exposure to external magnetic fields. The transferred signal is a function of the original signal wavelength and strength, the temperatures and magnetic fields to which the tape is exposed, the time of exposure, and the time since exposure. It happens to all tapes in storage, and since the storage conditions can be controlled, the amount of printing can be controlled as well. Printed signals are an annoyance in audio tapes, but contact printing is the basis of a growing video tape duplication business.

Printed signals can be partly erased without disturbing the original signals to any great extent. Two companies showed

how this could be done with an altered tape machine^{1,2}. At least one company made a print-through eraser for sale³, and another had such a device designed in the laboratory⁴. None of them were in existence very long. One problem was that recordists—both professionals and amateurs—were wary of doing anything which had even a slight possibility of erasing even a tiny part of their valuable recordings! Another was that tape materials underwent improvement and better storage conditions were employed, thus relieving the problem to some extent. Even with the improvements, it can certainly still occur, and the magnitude of annoyance depends strongly on how your tapes are stored.

Two Kinds of Printed Signals

There is a decided difference between the printed signals created by thermal effects and those caused by the impression of external magnetic fields (or other causes). The thermally-caused print is unstable with time and is easily erased, while the magnetically-caused print is almost as stable as a recording made on a machine and does not erase much more easily. It is thus much more important to keep magnetic fields away from your tapes than to keep them thermally comfortable. It requires only a fraction of the magnetic field to cause magnetic transfer that it does to erase signals already on the tape, so preventing magnetic transfer of signals will also ensure that you will have no other problems caused by stray magnetic fields.

Time and Temperature are the Enemy

Figure 1 is a plot of the print-through vs. time of a tape at constant ambient temperature (solid line). The dotted lines are the time plot of the printed signal amplitude after the original signal (master) is removed from the vicinity of the part of the tape having the signal printed on it (slave). The information for this figure is taken from several of the first papers on print-through^{5, 6, 7}—the tapes were of 1950 vintage, and the numbers may be somewhat exaggerated for the present day. In addition, different tapes will have different slopes and positions of the lines, so the numbers should be taken as indicative of the effect and not to apply to any particular tape or situation.

Print is Log-Linear vs. Time

In Fig. 1 and all other plots of the printed signal, the printed signal level is referred to the master signal level in dB. The reason that we can do this without stating the master signal level is that print-through is dB-linear, i.e., it doesn't

*Director, Product Development
The Cobaloy Company
Arlington, Texas 76011

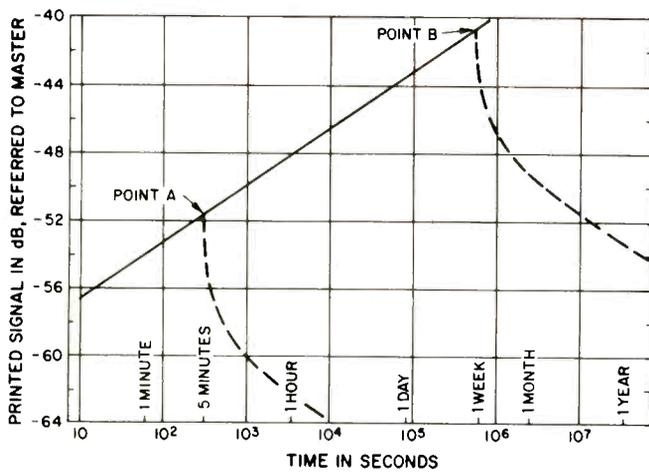

Fig. 1—Print-through vs. time at a constant ambient temperature (solid line). Dotted lines show the time decay of the printed signal after contact is lost between slave and master tapes. (Data from Lippert⁵, Daniel and Axon⁶, and Westmijze⁷.)

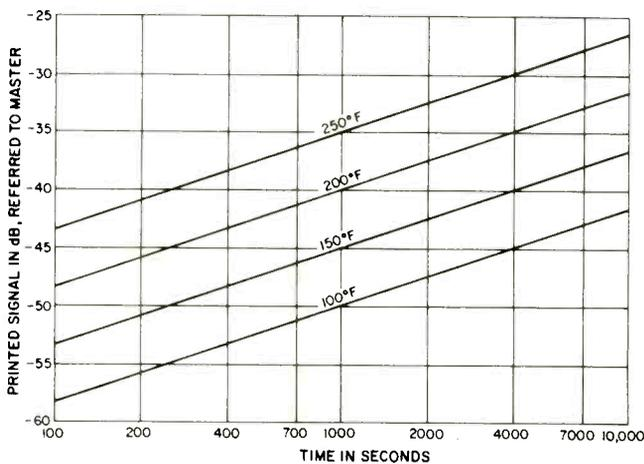

Fig. 2—Increase of printed signal with time, with curves shown for four different temperatures. Data from Daniel and Axon⁶, Westmijze⁷, and Johnson⁹.

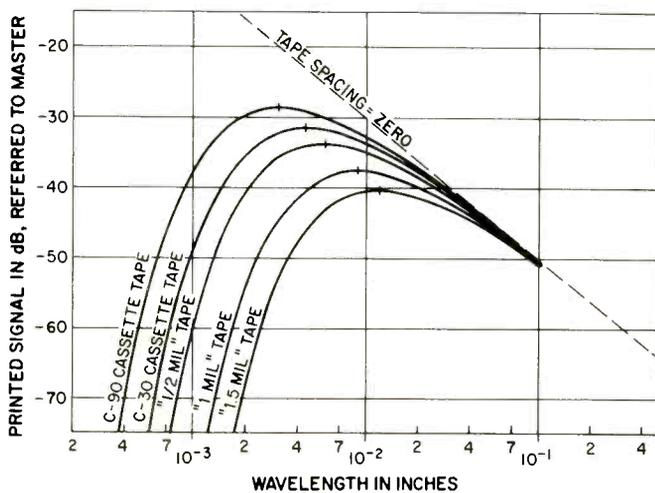

Fig. 3—Printed signal vs. wavelength for a number of different tape thicknesses. Data from Daniel and Axon⁶.

matter what the master signal level is, under the same conditions the printed signal level will be the same number of dB below it. A dB (decibel) is a logarithm, and you will note that the time is also plotted logarithmically. Such a *log-log plot* is a very powerful method of simplifying things so that laws or rules of behavior can be perceived in a glance. One must use caution in interpreting such a plot, however, since there is a strong temptation to simplify things too far.

Masters and Slaves

Two tapes are placed in contact. The master has a signal on it, while the slave has been erased. The master could simply be one turn of tape wound on a reel, and the slave is the adjacent turn (either outside or inside). After they have been in contact for five minutes, they are taken out of contact (point "A" on Fig. 1). The printed signal is then measured at intervals, and the curve dropping down from "A" is plotted. Note that the time is not restarted at zero when the slave is removed from the master, but it keeps increasing. If the experiment is repeated, but printing process is allowed to go for a week before it is interrupted, the change is made at point "B." The shape of the resulting decay curve is nearly the same, but there is a large practical difference. In each case, there is an immediate drop of 2 dB or so, and then the rate slows. In the decay curve starting at "A," there is a 6-dB drop in about three minutes, but it requires nearly a week for the decay curve starting at "B" to drop by 6 dB. The reason for this is that time is changing about 2000 times as fast at "A" as it is at "B." If those decay curves are replotted starting at zero (or near zero) when the slave is removed from the master, the shape of the curves is so different that they hardly resemble each other. In each case, the final rate of decay (after separation) is about the negative of the rate of print signal increase (before separation).

There is some advice⁸ about print-through on tapes which says that one should rewind tapes about 10 to 15 minutes before they are to be played, the purpose being to let the print signals decay previous to playing. This has an element of truth to it, but only for printed signals which are just a few hours old. If printing has been in progress a long time, decay also takes a long time. If tapes are to be in extended storage, they should be rewound once every few months (or once a year) to allow the printed signals to decay. It is better to wind just once, so that the old *inside* end is now the *outside* end. This prevents the tapes from being wound back into exactly the same geometrical arrangement as before (actually, there is not much chance of this when both ends are free from attachment to the reel). When rewinding, fast wind is satisfactory insofar as print-through prevention is concerned, but the pack will be smoother, with less distortion to the tape, if the wind is done under normal playing conditions.

Log-Linear vs. Temperature

Figure 2 illustrates the simple relationship of printed signals vs. time, with temperature as a parameter^{6, 7, 9}. For any given set of temporal conditions, the logarithm of the printed signal is a linear function of the temperature. This particular tape has print-through which increases about 5 dB for every 50° F. The slope vs. time is somewhat different from the tape whose characteristics are shown in Fig. 1. Different tapes have different slopes and also different spacing between the isothermal lines (lines of constant temperature), but most are not too far away from the one whose characteristics are shown.

Thus, another rule: Letting your tapes get hot is a definite detriment. The practice of letting cartridges and cassettes stay in a car in the hot summer sun is especially bad. I keep

THE SUPERLATIVE SONY.

THE NEW TC-766-2 HAS THE LOWEST WOW AND FLUTTER OF ANY DECK SONY EVER BUILT.



TC-766-2

AN INCREDIBLE 0.018% (WRMS) AT 15 IPS, AND 0.04% (WRMS) AT 7½ IPS. Closed Loop Dual Capstan Tape Drive System. One capstan extends from the motor shaft itself, eliminating intervening gears that can hamper speed accuracy. The other tape drive capstan connects through an extremely steady belt-drive inertia flywheel.

PHASE COMPENSATOR CIRCUIT. The goal of any recording is a "mirror image" of the original signal. Sony's exclusive Phase Compensator Circuit comes closest to achieving this by rectifying phase distortion and producing sound quality virtually identical to the original source.

PROFESSIONAL STUDIO STANDARD VU METERS. Illuminated, calibrated and ultra-clear for the best monitoring possible, are identical in size, shape, color and sensitivity to those on professional consoles.

SYMPHASE RECORDING. Because of Sony's outstanding

Ferrite & Ferrite Heads, plus the remarkably precise fabrication and alignment of the head gap, recordings retain exact positioning of signal throughout the stereo field. The "location" of individual sounds won't wander. There's no annoying phase shift.

MORE PROFESSIONAL FEATURES. The TC-766-2 has 4 incredibly durable Ferrite & Ferrite heads for 2-track recording and playback, 4-track playback and erase, **direct-coupled playback FET amplifier**, flashing **Standby Signal**, **Punch-In Record** and solenoid-operated **Logic-Controlled Transport Functions** to let you move instantly to and from any mode without stopping. Standard equipment: RM-30 full-function remote control unit with record mute and hinged head cover.

SONY®

Brought to you by

SUPERSCOPE®

You've never heard anything like it. Not from us. Not from anyone. JBL's new L212: a totally new picture of high performance sound, from the people who wrote the book.

You hear the whole sound first.

And when you catch your breath you search for words to describe the depth, the detail, the etched precision of the music.

That stunning pair of three-way speakers is sending clean, undistorted sound to every corner of the room. At every frequency. At every level. Loud or soft. High or low. It doesn't matter. The energy is constant.

You're experiencing three-dimensional imaging: Vocal up front. Lead guitar two steps back and one to the left. Drums further back. The piano closer, almost off the right edge of the sound.

Suddenly you're aware of a fullness in the music that you've heard before but never associated with recorded sound.

The bass! You've been hearing all of the bass, all of the fundamental tones you couldn't bring home from the concert. It's not only everything you've heard before. It's everything you haven't. The music is rich with sound at the lowest limit of your hearing.



Then you see the third speaker. The hero of the piece: The Ultrabass.

The Ultrabass is a system in itself—woofer, amplifier, equalizer and enclosure—designed, mated, blended to do one thing perfectly: reproduce sound at the threshold of sub-sonic frequencies.

It brings all the low frequency music within audible range, balancing it perfectly with the rest of the music. Without boominess. Without resonance. It also electronically sums left and right signals below 70 Hz—virtually eliminating turntable rumble and record warp noise. And, because of the non-directional character of the low frequency sound, the Ultrabass can be placed almost anywhere in the room. Without any loss of three-dimensional imaging.

The Ultrabass pays one final dividend: it allows the two three-way speakers to be specialists, too.

They can concentrate on the top 95% of the music. (Listen to the whole system, and you'll hear what that means. Even at a rug-curling, rock concert loudness, you'll get a clarity, a smoothness, an enthusiasm for detail you've never heard before.)

Finally, you look for the monster amplifier that's driving all that sound. There isn't one. The L212 takes one fourth the power you'd need with a conventional low efficiency loudspeaker.

That's the story. What you've been reading about is, essentially, a no-trade-off loudspeaker system. Now we'll tell you the trade-off: The price is \$1740. (The L212 may take a little while becoming a household word.)

In the meantime we have two suggestions:

If you'd like a lot more technical information, write us and we'll send you an engineering staff report on the L212. Nothing fancy except the specs.

Or call your JBL dealer and ask him when you can hear the L212. You've never heard anything like it. Not from us. Not from anyone.

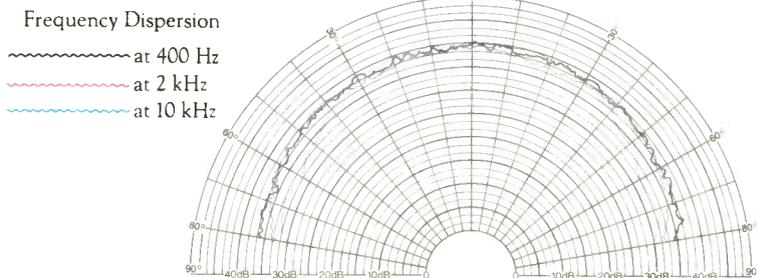

JBL CHANGES THE
PICTURE OF SOUND.

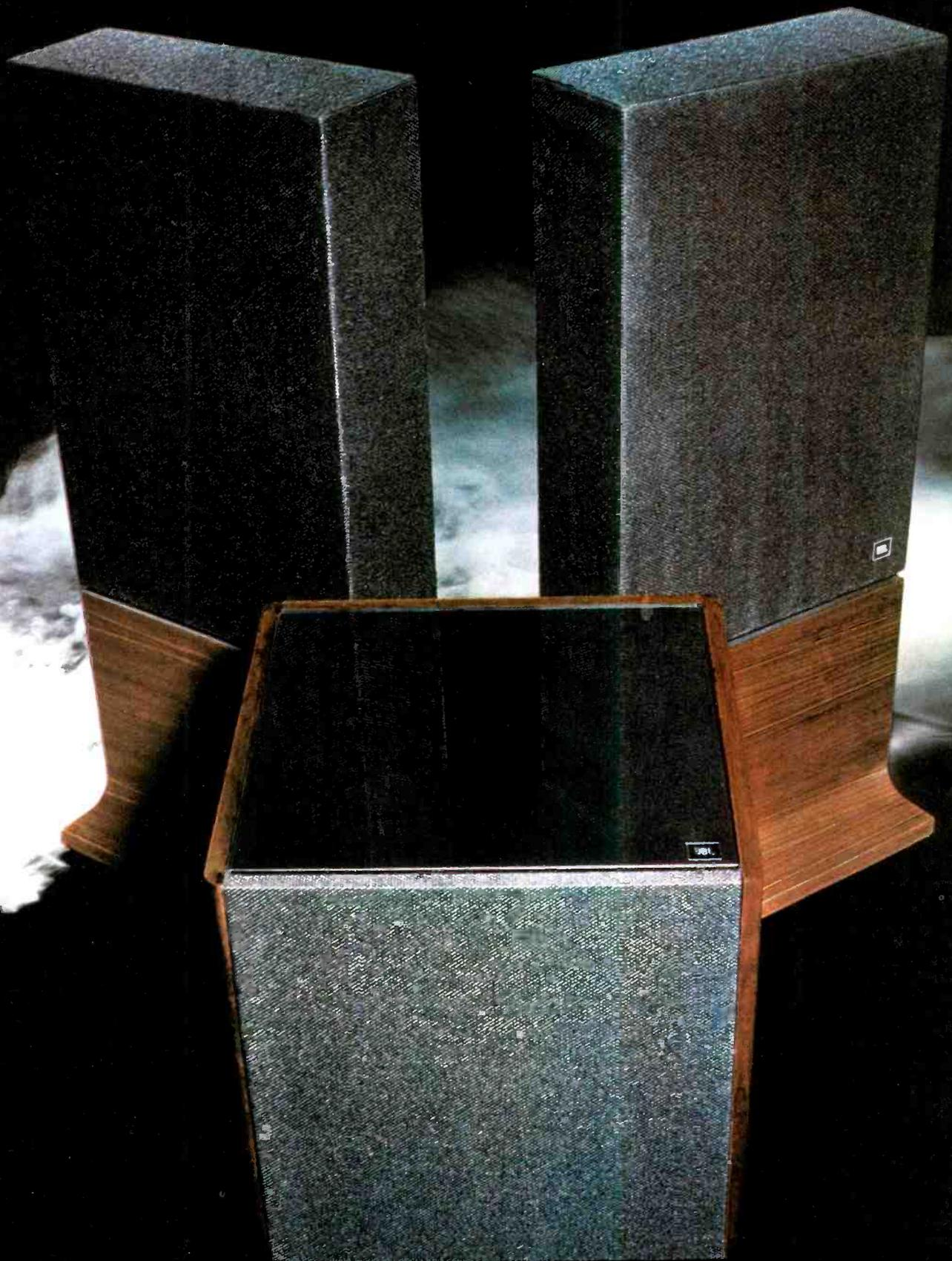

mine in a carry-case and remove them when I leave the car for any length of time during hot days. The print-through caused by exposure to heat remains when the tape is brought down to room temperature, and it is considerably more stable than print obtained near room temperature.

Geometry

There are some geometrical effects which are quite important. It seems logical that the printed signal would be strongest in the adjacent layer of tape, and this is true. However, not obvious at all and difficult to explain is the fact that the printed signal which comes off the reel in the layer before the master signal (pre-print) is stronger than the printed signal which comes off the layer after the master signal (post-print). Since the printed signal is strongest in the closest layers, one might also guess that a thin tape would have more print-through than a thick tape (since the nearest slaves are closer), and this is true. Lastly, since *everything* concerned with tape recording seems to be a function of the wavelength of the signal on the tape, we are not really surprised to find a strong functional relationship of the print to the wavelength. The signal wavelength (λ) and the head-to-tape speed (S) are related by the signal frequency (f):

$$\lambda = S \div f \quad (1)$$

so, given any two of the three, we can find the other.

Figure 3 shows the wavelength effects on the printed signal for a number of different tapes⁶. The position of the curve on the plot is controlled by the overall thickness of the tape, which is taken as follows:

60	Tape.....	Overall Thickness
	"1 1/2 mil".....	1.9 mils
	"1 mil".....	1.4 mils
	"1/2 mil".....	0.9 mils
	C-30 cassette.....	0.7 mils
	C-90 cassette.....	0.5 mils

Individual tapes will differ somewhat from these values, but this will not alter the conclusions to be drawn. The peak of each of these curves occurs at a wavelength of:

$$\lambda = 2 \pi d \quad (2)$$

where λ is the wavelength, as before, and d is the overall thickness. The tick on each of the curves indicates this peak value.

Ear, Ear

As far as the tapes are concerned, this is about the whole story on the wavelength response of the printed signal, but as far as the ear is concerned, we're not finished. The ear hears frequencies, not wavelengths. Using equation (1), we can construct a table of frequencies where the maximum print-through occurs as a function of the various tape speeds used (Table I). The ear normally hears print at a moderately low level. At such a level, the loudness response of the ear is approximately ± 3 dB from 500 Hz to 6000 Hz, and the most sensitive at about 3000 Hz. With this in mind, one can look at Table I and see just where the problems are. Obviously, no one should ever use "1/2 mil" tape at 15 ips. Equally obvious is the fact that "1 1/2 mil" tape at 1.875 ips will not cause trouble. Commercially recorded tapes are usually on 1 mil base, with reel-to-reel tapes usually running at 7.5 ips and cartridges at 3.75 ips. Note that all but one (2632 Hz) of the frequencies listed are within the fundamental range of the singing voice and also many of the orchestral instruments.

Table I—Maximum print-through frequencies as a function of tape speed.

Tape	Head-to-Tape Speed				
	1.875	3.75	7.5	15	ips
"1 1/2 mil"	158	315	630	1261	Hz
"1 mil"	213	426	852	1705	Hz
"1/2 mil"	329	658	1316	2632	Hz
C-30 cassette	426				Hz
C-90 cassette	605				Hz

Working from the 40 phon loudness contour of the Fletcher-Munson curves, I have calculated the actual loudness level of the peak printed signal for each of the cases in Table I, and they are listed in Table II. The least objectionable case is used as a reference, so the larger the number, the worse the print-through (for any set condition of the time and temperature cycling). With the levels in dB, they can be compared to each other by subtraction. For instance, a "1 mil" tape cartridge at 3.75 ips is 4 dB better than a "1 mil" recorded tape at 7.5 ips.

Pre-Print and Post-Print

Some old reel-to-reel tape machines wind their tapes with the magnetic material to the outside of the reel. This is known as an "A" wind. Almost all modern machines wind their tapes with the magnetic material to the inside of the reel, and this is known as a "B" wind. All cassettes and cartridges use an "A" wind so as to expose the magnetic material to the heads (which are on the outside). All of the material here concerning pre-print and post-print assumes a "B" wind. The effect of having an "A" wind is to exchange everything said about the pre-print with that said about the post-print.

Figure 4-A shows some of the magnetic field lines coming from a bar magnet which is fairly wide (in the direction perpendicular to the page). This bar magnet resembles a long wavelength signal on a piece of magnetic tape ("long" is with respect to the coating thickness of the tape). The two arrows, labeled "H" and "V," designate the "horizontal" and "vertical" directions. In general, each field line at any point, consists of both horizontal and vertical components. The horizontal and vertical components of the magnetic field lines are shown separately, and this separation is crucial to understanding the pre-print and post-print differences. Note that the lines nearest to the center of the magnet are mostly horizontal, while those nearest the ends of the magnet tend to have stronger vertical components.

In Figure 4-B, three of the outer layers of tape wound on a reel are shown. The middle layer (the master) is the only one containing a recorded signal. It has the bar magnets (long wavelength signal) laid end-to-end, and this accentuates the effect of the vertical field lines being near the ends, and the horizontal field lines being near the magnet centers. Only the strongest parts of the vertical lines are shown. If the con-

Table II—Loudness levels for the cases in Table I, calculated from the 40-phon loudness contour of Fletcher & Munson.

Tape	Head-to-Tape Speed				
	1.875	3.75	7.5	15	ips
"1 1/2 mil"	0	7	14	15	dB
"1 mil"	6	14	18	18	dB
"1/2 mil"	13	20	21	24	dB
C-30 cassette	20				dB
C-90 cassette					dB

INTRODUCING THE RECEIVER YOU PROBABLY THOUGHT YOU COULDN'T AFFORD.



The new Kenwood KR-4070.
It's got 40 watts of power per
channel, minimum RMS, at 8 ohms,
from 20 to 20,000 Hz, with no
more than 0.1% total harmonic
distortion.

And it costs less than \$300*.
That kind of power, along

with the famous Kenwood tuner
and other outstanding features,
at that price, is unheard of.

How did we do it?

That's what Pioneer and
Marantz would like to know.
The new Kenwood KR-4070.
Performance is now affordable.



KENWOOD

For the KENWOOD Dealer nearest you, see your yellow pages, or write KENWOOD, 15777 S. Broadway, Gardena, CA 90248

*Nationally advertised value. For information purposes only. Actual prices are established by Kenwood dealers. Handles optional.

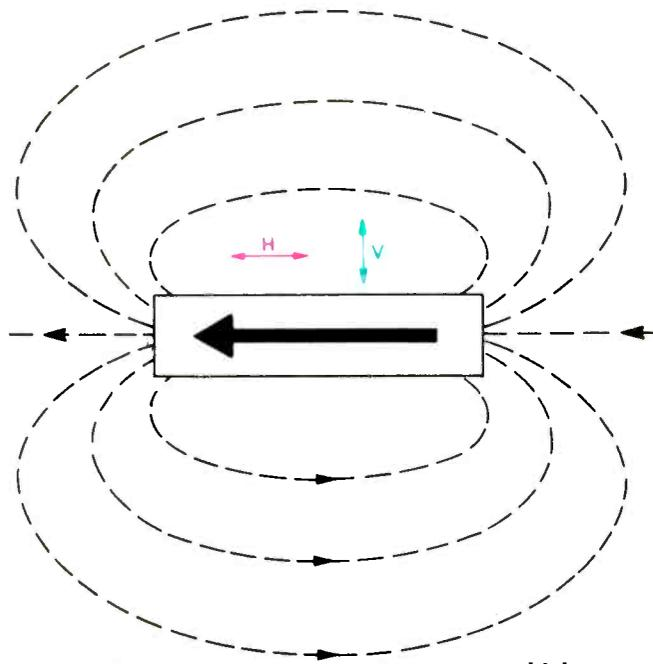

Fig. 4A—Field lines coming from a bar magnet which is wide in the direction perpendicular to the page.

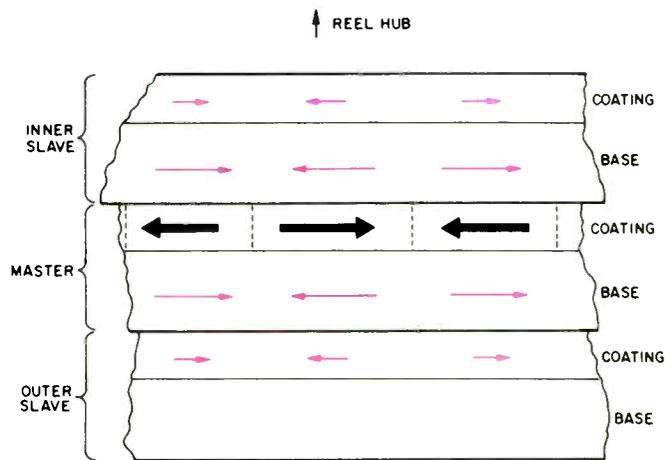

Fig. 4C—Master tape with long-wavelength signal, showing horizontal field components in two adjacent slave tapes. After Daniel¹¹.

62

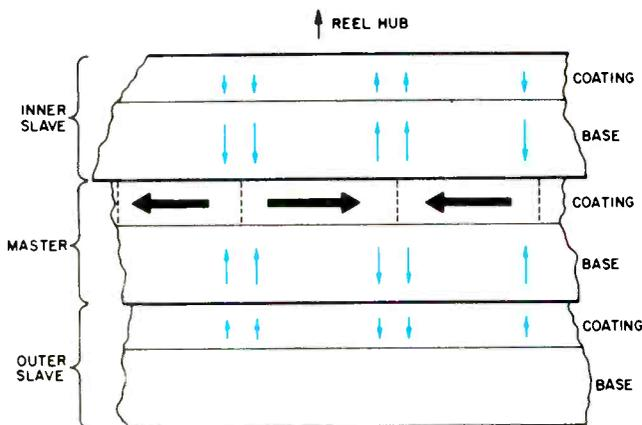

Fig. 4B—Master tape with long-wavelength signal, showing vertical field components in two adjacent slave tapes. After Daniel¹¹.

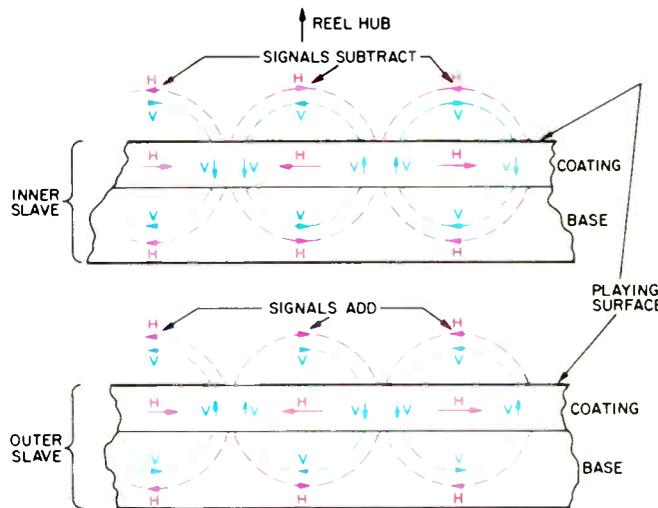

Fig. 4D—Slave tapes with master removed. Printed vertical and horizontal signals are shown, with field lines from the vertical and horizontal signals shown separately. Note how signals add on the sides closest to the master and subtract on the sides away from the master. After Daniel¹¹.

ditions are such as to cause printing, note that the front or playing side of the outer slave is printed from the back side of the master, while the back side of the inner slave is printed from the front of the master. Since the front side of the master was nearer the head when the signal was recorded, and thus has a stronger signal, a difference in the two printed signals is introduced, which should depend on the shape of the field from the record head. This difference turns out to be small, on the order of a dB^{10, 12} and is obviously not the cause of the difference between the preprint and the post-print, which sometimes is as large as 12 dB^{11, 12}.

Figure 4-C shows the same situation, but with the strongest part of the horizontal field lines shown. Again, the field lines in the slaves can be caused to print a signal there.

We assume now that the signals have been printed on the slaves, and in 4-D we remove the master and show the printed signals, along with the field lines they produce. The field lines from the horizontal printed signals are shown separately from the field lines coming from the vertical printed signals. Actually, at any point the field lines add (or subtract) vectorially. The shape of the field lines from both H and V signals are similar. Mostly

subtraction occurs near the playing side of the inner slave, and mostly addition occurs near the playing side of the outer slave. Thus, the pre-print, which comes off the outer slave, is stronger than the post-print.

The above is modified by several things. For one, some tapes are made so that vertical signals are printed poorly, if at all. In this case, the two printed signals are nearly equal. If the printing can be done equally in both H and V directions, the post-print nearly disappears, and the pre-print increases by about 6 dB. Another is that the actual master signal is not as simple as drawn—real recorded signals change direction and amplitude along their length. A third goes back to something previously stated: In case the tape is wound with an "A" wind, everything is reversed, and the post-print is stronger than the pre-print.

I have used primarily the explanation given by Daniel¹¹ for this pre-print/post-print explanation. Greiner¹⁰ was substantially correct in his explanation, but his diagrams were quite complicated. Apparently, neither Daniel nor Rhodes¹² were aware of Greiner's somewhat obscure paper when they wrote their reports.



Output shaft (Record guide)

Rotor

Magnet (8-pole)

Speed control

Drive coil x 2

Yoke

Ball

Cap

**PS-58
PHONO MOTOR**
2 Motor:

*Unitorque DC servo motor
16-pole gear motor
automatic mechanism
0.025% W. R. M. S.
74dB*

Wow & flutter:
S/N ratio:
CARTRIDGE

Type: *Vertical magnet type*
Frequency response: 20Hz-20,000Hz

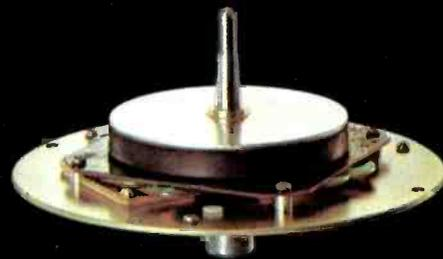

Brushless. Slotless. And Coreless. For flawless direct-drive operation.

Hitachi's Unitorque™ Motor.

Hitachi's Unitorque motor turntable is unlike any other turntable in the world.

Brushless. Slotless. And coreless. It uses two star-shaped flat coils for balancing and distributing torque evenly.

The unitorque motor is a non-commutator DC servo motor with an 8-pole rotary magnet and flat, square coil configuration. The construction is completely free from brushes, slots and cores, and free from motor "cogging" or

pulsations. In fact the performance is so perfect... tests show wow and flutter at 0.025%, an almost 40% improvement over conventional motors. The torque generated is even, balanced, almost flawless.

And when you generate flawless torque, you not only get flawless speed. You get what you really want in a turntable.

Flawless music.



HITACHI
When a company cares,
it shows.

Hitachi Sales Corporation of America, 401 West Artesia Boulevard, Compton, California 90220
Enter No. 9 on Reader Service Card

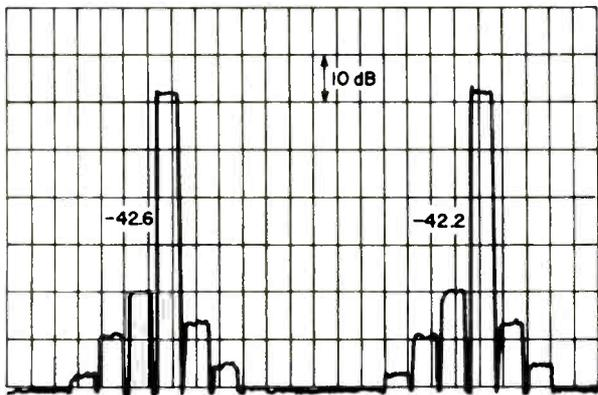

Fig. 5—Typical chart recording of a print-through measurement. Vertical scale is in dB, and horizontal scale is time.

Winding Tension

One might wonder whether the tape winding tension has any effect. Daniel and Axon⁶ reported that the tension increased the short-term print-through, but when the printing took place as long as overnight, there was essentially no difference between high and low tension. The time decrease of the printed signal after the slave was removed from the master was also affected, with the higher tension winds taking longer to fade, and fading away stops at a higher level, thus showing more stability. This tells us that print-through caused by strain is different from that caused by thermal effects. Rhodes was able to cause print-through by pressing master and slave between rollers brought together by a hydraulic press. The time of contact was a small fraction of a second. Essentially, high tension or high pressure in the tape pack will cause a small increment of print-through, but this is overwhelmed by thermally-caused print in a matter of a few hours. Nevertheless, the strain-caused printed signal is more stable than the thermally-caused print, and some remnant of it can be observed as the thermally-caused signal fades away.

Standard Print-Through Measurements

Print-through measurement is normally done on a few feet of tape wound on a 4 1/2 in. diameter precision (metal) hub. The tape is thoroughly erased before starting. The "worst case" frequency is calculated by:

$$f = S \div 2 \pi d \quad (3)$$

which is a combination of equations (1) and (2); the letters represent the same quantities as before. The tape speed S is normally kept high (7 1/2 or 15 ips), so that the decay time before measurement is kept to a minimum. A few turns of tape are wound on the hub, then a signal of a frequency given by (3) is applied for a time slightly less than that required for the hub to turn one revolution. About 15 or 20 more turns of tape are put on, and the procedure is repeated once or twice more. The tape is then cut, and the piece on the hub carefully wound onto another hub, so that the tape coming off will be going in the same direction as when it was originally recorded. The signal is normally at the 1 per cent (nominal) distortion level, and it is a sine wave. The standard heat treatment is for four hours at a temperature of 150° F, and the treated hub is cooled to room temperature before measurement. The signal from the tape is run through a bandpass filter to improve the signal-to-noise ratio, and the tape is played back at the original recording speed. The output from the filter, which is set at the proper fre-

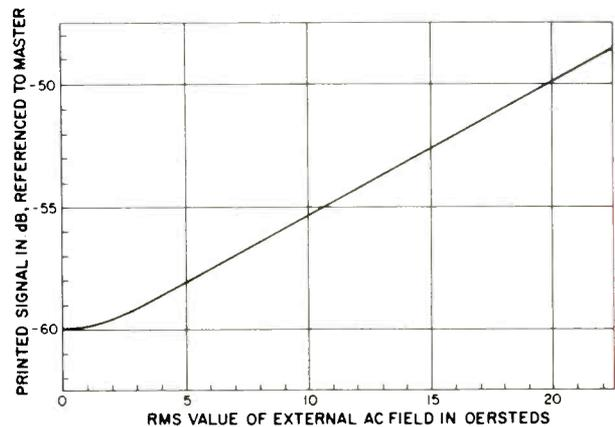

Fig. 6—Printed signal due to a superimposed a.c. field. (Data from Daniel and Axon⁶.)

quency for the tape under test, is sent to a chart recorder with a logarithmic scale. The chart recorder normally has a dynamic range of at least 80 dB, so that all signals, including the master signal and three or four post-print and pre-print signals, can be seen on the same scale. Repeatability of measurements is normally about ± 1 dB. Figure 5 shows a typical measurement from my lab. The pre-print, which is the one usually quantified, is a mediocre -42.4 dB (average for two measurements) for this tape, and the post-print is some 6 dB less than that. The tape noise caused that wiggly line just below the bottom line of the chart.

Printing by External Magnetic Fields

Exposure to magnetic fields can cause some relatively enormous print-through. Fortunately, the fields required to produce such printed signals are large compared to the fields in which a reel of tape is likely to be immersed. In contrast to the temperature-caused print-through, which uses a mode of magnetization called *thermo-remnant magnetization*, the print-through caused by a.c. magnetic fields uses a type of magnetization called *anhysteretic magnetization*. This is also the type of magnetization used by most audio recorders. There are a number of descriptions of this type of magnetization in the literature, but one written specifically for hobbyists was published in 1976¹³. Figure 6 shows how print is influenced by the presence of an a.c. magnetic field. The fig-

continued on page 81

Fig. 7—Typical size distribution curve of fine particles as used in magnetic recording tape, showing position of transition zone for normal operating temperatures.

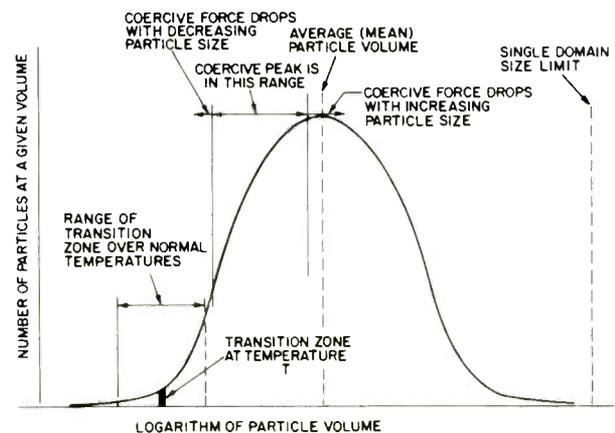

Gather the world of sound around you.



When the country boy in your soul yearns for the down home refrains of banjos, fiddles, and the sweet voice of a country girl, the best place to go is the world of sound between a pair of Koss K/145 Stereophones. Because every foot stomp, hand clappin', tambore slappin' beat comes rollin' into your head with such crystal clarity you can almost see the cowboy hats

calico dresses, and rhinestone studded suits flashing in the spotlights. All the country stars you love shine brighter than ever before. Because the Koss K/145's wide frequency response range mixes all the pickin' and strummin' inside your mind. While the volume/balance controls on each earcup let you zero right in on the stage. And the super comfortable, glove soft vinyl

headband lets you visit your country cousins for hours.

So visit your audio special s, and try a pair of Koss K/145's—or write us for a free, full-color catalog of all our products.

Because whether your brand of music comes from deep in the heart of Texas, the Louisiana Bayou, high atop the Rocky Mountains, or straight from the stage of the

Grand Ole Opry—there's no sound like the Sound of Koss. And there's no country road that'll take you home like the one that winds between a pair of Koss K/145's.

© Koss Corporation

Enter No. 13 on Reader Service Card

 **KOSS stereophones**
from the people who invented Stereophones.



Koss K/145 Stereophones

KOSS CORPORATION, 4129 N. Port Washington Ave., Milwaukee, Wisconsin 53212 • Koss International/London, Milan, Dublin, Paris, Frankfurt • Amsterdam • Koss Limited/Burlington, Ontario

Equipment profiles

Pioneer Model RT-2022 Open-Reel Tape Deck System

MANUFACTURER'S SPECIFICATIONS

Frequency Response: 30 Hz to 28 kHz @ 15 ips, 40 Hz to 20 kHz @ 7 1/2 ips.

Harmonic Distortion: 0.8 per cent @ 15 ips, 1.0 per cent @ 7 1/2 ips.

S/N Ratio: 57 dB at +6 dB level.

Separation: 53 dB.

Input Sensitivity: Mike, 0.11 mV; Line, 34 mV @ 100 kilohms.

Output Level: Line, 450 mV at reference flux level, 930 mV maximum; Headphones, 133 mV maximum.

Wow & Flutter: 0.04 W rms @ 15 ips, 0.08 W rms @ 7 1/2 ips.

Speed Deviation: 0.8 per cent.

FF & RWD Times: 110 seconds for 2,400 feet.

Dimensions: Transport, 18 1/8 in. (46 cm) W x 16 3/16 in. (41.1 cm) H x 10 13/16 in. (27.4 cm) D. Amplifier, 18 1/8 in. (46 cm) W x 5 9/16 in. (14.1 cm) H x 10 13/16 in. (27.4 cm) D.

Weight: Transport, 51.2 lbs. (23.2 kg). Amplifier, 11.3 lbs. (5.2 kg).

Price: \$1250.00.



66

The well-performing Pioneer RT-2022 system tape deck is comprised of two sections, the RTU-11 transport unit and the TAU-11 amplifier unit. The transport operates at 7 1/2 and 15 ips and takes up to 10 1/2-inch reels. The head assembly provides direct access to record and playback head adjustments and to all surfaces requiring cleaning and demagnetization. To the left are the guide roller arm and the pause switch, and above is the tape counter. The tape is metered out of the head assembly by the capstan with the pinch roller on the oxide side, with drive applied to the back of the tape, as is the case with a number of professional units. The tension arm, which guides the tape to the take-up reel, incorporates a switch controlling power to all motors. The cue lever can be used to vary the amount of signal pick-up by the playback head, even in fast winds. A pushbutton lock facilitates locating exact edit points.

In the center of the lower portion of the transport unit are provisions for several adjustments, under an easily-removed, clear-plastic cover. The test oscillator switch positions are *Off*, *1 kHz*, and *10 kHz*. *Bias* has a fixed position

plus separate *Low* and *High* ranges with a variable pot. *EQ* can be set for either NAB or IEC and to match *Std* (standard) or *LH* (low-noise) tapes. Setting the best bias for a tape is worthwhile for any class of machine, and the two-frequency oscillator provides a quick and simple means to check and peak up performance. Inclusion of these features must be considered a big plus for this deck. To the left are switches for power, reel size, and tape speed, a power indicator lamp, and a phone jack for feeding the output of the test oscillator externally. The logic-controlled tape-motion switches on the right are large pushbuttons with status lights for *Play* and *Record*. *Stop* is controlled with a long bar. These functions are all repeated on the optional remote control unit, received with the deck. The control also includes a pause button and a *Ready* lamp, which will not be *On* unless tape is threaded and holding the tension arm in play position, a desirable feature. The carry handle on top is quite commendable, as is the latch-on front cover. All too many high-performance decks are difficult to carry to a remote site.



Interconnection between the transport and amplifier units is made with a 12-pin plug/cable assembly and three sets of stereo color-and letter-coded phono cables, one set for the record head output for sync recording, an important feature for anyone who may need to over-dub. The phono jacks for line in and out are all paralleled, aiding system hookups. The front of the unit is where all of the action is, however, with attention drawn to the good-sized, well-illuminated level meters which cover a wide range from -40 to +6 dB. There are zero adjustment screws below and record indicators above. At the left are phone jacks for mike, line in and out, and headphones. These line jacks can be used in place of the back panel ones, which are disconnected with plug insertion. Mike attenuator switches introduce a 20-dB loss when needed because of high mike levels. The output level control is detented half-way, at which point the output from a tape flux level of 185 nanoWebers/meter should be at meter zero. There is also a knurled marker ring, and the pot sections are friction clutched to allow setting channel levels individually or simultaneously as desired, all good features. The mike and line inputs were easily mixed, and the pots have good-sized knobs and handy marker rings. The channel monitor switches can select either tape or source, and the record-mode selectors can be set for record, play, or sync play/recording. On top is a cable-storage compartment and a carrying handle. Hooks and latches mate with a front cover and the transport unit, when it is placed on top.

Access to the interiors of the units was obtained with removal of back and bottom metal covers. Soldering was very good, with wire wrap used for many of the off-board connections. Drive and braking systems were judged to be reasonably rugged. The hysteresis synchronous motor belt drives the capstan with its impressively-large flywheel.

Performance

Playback responses were within 3 dB at all test frequencies for both speeds, 7 1/2 and 15 ips. Selection of tape formulations to be used for testing was made with the use of a pink-noise source and a third-octave real-time analyzer on playback. NAB/LH EQ was used for all of the tests, but it should be noted the IEC EQ can gain better S/N ratios at 15 ips. Bias was varied over both ranges (-40 to -8 per cent and -15 to +38 per cent, relative to fixed) as well as trying the fixed setting. The built-in test oscillator was evaluated for use in making the same adjustments, using both the 1- and 10-kHz tones, and then checking the pink-noise response. The scheme worked very well, and its inclusion must be given a big plus rating for the deck. Most low-noise tapes could be matched for excellent responses, and Maxell UD, Memorex Quantum, Scotch 206, and TDK Audua were selected for further tests. Scotch 150 did surprisingly well for a dis-

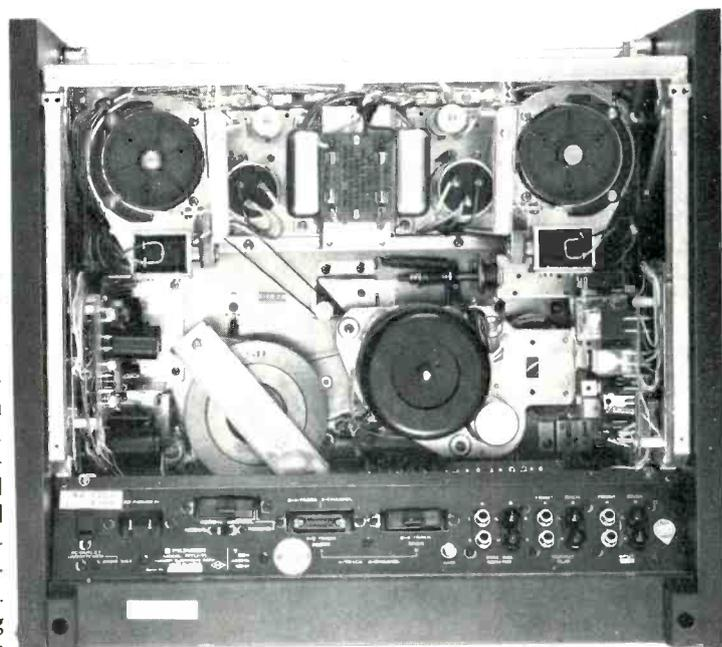

continued tape, so some swept responses were run just to check what the adjustments could do. The swept-frequency responses for Scotch 206 were run at 0, +10 and -10 VU at 15 ips, and at 0 VU at 7 1/2 ips, using the recommended fixed bias. The excellent headroom was amply demonstrated by the fact that the responses extended from about 30 Hz to 22 kHz or more at all three levels at 15 ips. As received, the high-frequency response, however, did not quite reach the specified 28 kHz, and at 7 1/2 ips the 0 VU headroom limit dropped to 14 kHz. Using variable bias, improvements were easily made, increasing the high-end limits to match the specifications. TDK Audua was used to measure the effect of varying bias in *High* from minimum to maximum in three steps. The plots clearly showed the reduction in highs with the first change, and then the level loss across the entire frequency range with maximum bias. With the medium-high bias, there was a small rise around 7 kHz, and the response extended to over 30 kHz at 0 VU, excellent performance. The Scotch 150 gave its best results with minimum-low bias, with a response from 23 Hz to 21.5 kHz at -10 VU and 7 1/2 ips.

For those who would want to over-dub on one channel in sync with the other, the RT-2022 offers the essential play-

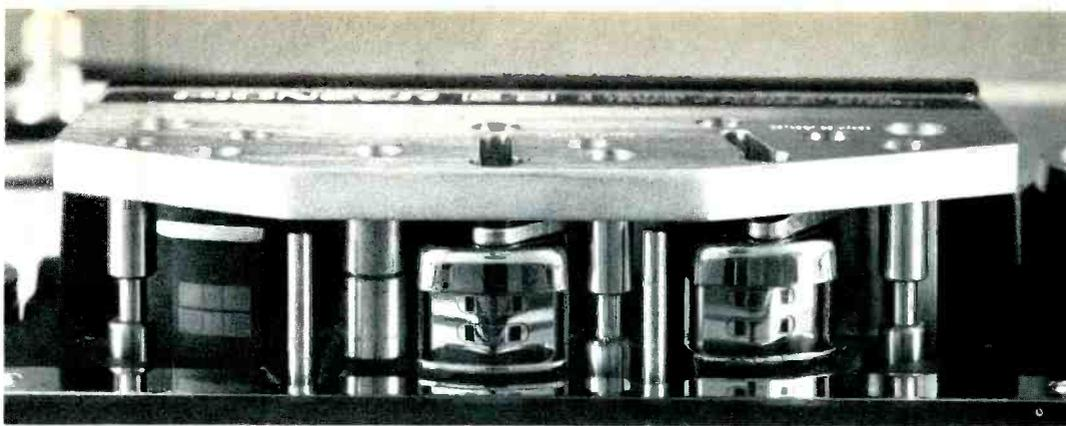

back capability from the record head. The 15-ips record/playback response was generally flat with a slight peak around 6 kHz and a rapid roll-off above 8 kHz. As would be expected, the sound had extra presence. The playback level was quite high, which would also be helpful for the feed to the performer.

The function of third-order harmonic distortion (HDL₃) versus record level was measured with a 1-kHz tone from -8 to +10 VU with Scotch 206 at both 7½ and 15 ips. The results for both speeds were quite similar, with HDL₃ = 0.27 per cent at 0 VU and 2 per cent or less at +10 VU, excellent performance. Spot checks were made with other tapes, which gave about the same results. HDL₃ was also measured over a range of frequencies from 30 Hz up for 15 ips at 0 and -10 VU and for 7½ ips at -10 VU only. There was the expected rise in relative distortion at the lowest frequencies, but the rapid drop in distortion products above 1 kHz was a surprise. Bias was not excessive, according to the wide frequency response, but the harmonics dropped below the measurement limit of the spectrum analyzer. It does appear that some of this superb performance at the high end could be given up in trade for a reduction of HDL₃ at the low end. A fast check was given to the built-in test oscillator for level and distortion. The output was 350 mV, and all distortion products for both 1kHz (1064 Hz actual) and 10 kHz (10,859 Hz actual) were less than 1 per cent of the fundamental. The distortion level was low enough for setting bias when checking frequency response, but would not be satisfactory for adjusting bias for minimum distortion.

The RT-2022 showed excellent signal-to-noise ratio with close to 58 dBA at 15 ips and over 59 dBA at 7½ ips, both at meter zero. With a HDL₃ = 2 per cent reference, the figures become 67.8 dBA at 15 ips and 72.9 dBA at 7½ ips, both for

Scotch 206. The separation between channels was 58 dB, and erase was at least 80 dB down, both excellent. Input sensitivities were 0.1 mV for mike and 44 mV for line, a good figure though a bit above the specified 34 mV. The line output level was a maximum of 1.06 V +6 on the meter, with 0 VU record, greater than the specified 930 mV. With the output pot at the reference detent, however, the output voltage was lower than specified with a meter indication of about -4 dB for playback of either an Ampex test tape or Scotch 206 with 0 VU record. Drive to the headphones was a maximum of 185 mV. The meter frequency response was down 3 dB at 23 Hz and 53 kHz. Indications were within 0.2 dB over the entire range from -40 to +6 dB, *just plain excellent*. The dynamic response of the meter was faster than a standard VU meter, swinging to +3 dB with the test 300-millisecond burst, and to zero with an 80-mS burst. The meter would be classified as a fast-response meter, but the overshoot was undesirable, and the decay seemed too rapid for easy use.

The average wow and flutter figures were 0.038 per cent Wtd peak for 15 ips and 0.072 per cent Wtd peak for 7½ ips. This was good performance, and actually well within the specified 0.04 per cent and 0.08 per cent which are on a weighted rms basis. Long-term speed accuracy was excellent with only a very slight shift when the line voltage was varied. The peak-to-peak speed variations were less than 0.05 per cent at 15 ips, but increased notably at 7½ ips to about 0.25 per cent. The sound levels at one foot were 33 dBA for 7½ ips and 39 dBA for 15 ips, perhaps a little high for recording in a quiet environment. The wind times were quite fast, just 62 seconds for a 1200-foot, 7-inch reel and 115 seconds for a 2400-foot, 10½-inch reel. It was a mixed blessing, however, as shut-off of the drive power on run-out was too slow and there was a flailing of the tape until the tension arm switch actuated.

68

Fig. 1 — Record/playback response with equalization at the NAB low-noise setting with Scotch 206 tape and fixed bias. There are three readings at 15 ips, +10, 0 and -10 VU, but only 0 VU @ 7½ ips.

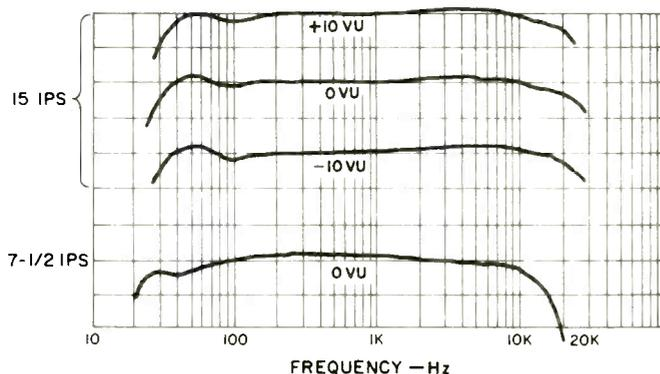
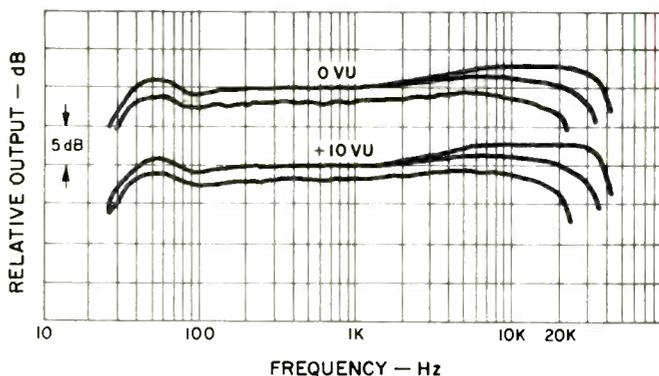

Fig. 2 — Record/playback response with TDK Audua tape with the equalization at the NAB low-noise setting and the high bias set for minimum on the top trace, medium for the middle trace, and maximum on the bottom trace with readings at both 0 and -10 VU.



In-Use Tests

The lock on the guide-roller arm was helpful in threading the tape, but the tension arm was typical in fighting the process a little. All combinations of tape motion switching were handled without any form of difficulty, including going to play from one of the fast winds. This took about one second for the unit to come to a stop and another five seconds to go into play. The instruction book states how to use *Pause* to reduce the amount of delay, but such an extra step should not be necessary. The rubber lock plug for use with the *Record* and *Play* buttons and the timer start worked fine, but the plug fought the process of insertion. The delay in turn-off of the drive power at the end of play or wind and the resultant spinning of the reels got to be an annoyance. Using wind of the opposite direction and *Stop* to get to the end of the tape smoothly was a rather fussy operation. As both 7- and 10 1/2-inch reels were used in the course of the testing, an attempt was made to reverse the reel bases as recom-

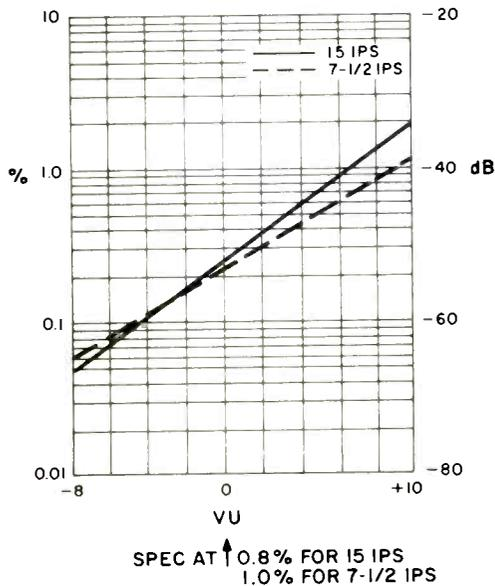

Fig. 3—Third harmonic distortion vs. record level with Scotch 206 tape, the results from other tapes are quite similar. The HDL₃ is specified as 0.8 per cent @ 15 ips and 1.0 per cent @ 7 1/2 ips at 0 VU. There was some second and fifth harmonic distortion at the higher levels which measured 0.1 per cent or less at +10 VU (lower @ 7 1/2 ips) and it was less at lower record levels.

mended, to provide the correct spacing for the respective reels. It was so difficult, however, to remove the bases from the annular retaining grooves that they were not used for their intended purpose. After the above comments on the fussing about mechanical things, I hasten to add that the pot knobs and marker rings were all of very good design and that the action of the pots themselves was very smooth. The wide-range meters were very easy to use for setting record levels, with the exception that the decay time was a little short, and some form of peak indication would have been helpful.

Different types of sources were recorded, and switching from source to tape during the process revealed no modification to the sound in playback. The instruction book is

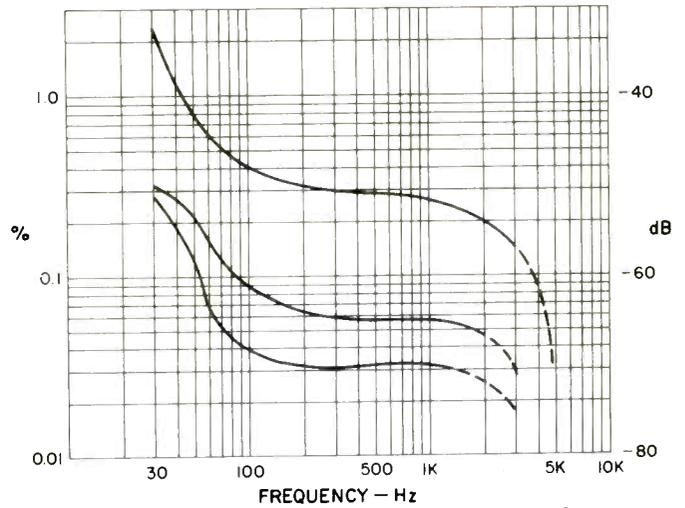

Fig. 4 — Third harmonic distortion vs. frequency. The top trace is 0 VU @ 15 ips, the middle trace is -10 VU @ 7 1/2 ips, and the bottom trace is -10 VU @ 15 ips.

very good with considerable detail in the text and coupled with excellent illustrations. It did seem a little odd, however, to see scissors shown for use in splicing tape. Detailed schematics are provided of both the transport and the amplifier units. Among the accessories were head-cleaning supplies and phone-plug cables for front-panel patching for overdubbing.

The Pioneer RT-2022 system tape deck, in general, has excellent performance. For the person who might change from tape to tape at times, the bias and EQ adjustments, in conjunction with the two-frequency test oscillator, are a very valuable combination, ensuring maximum system performance. For the sophisticated audiophile or the neophyte professional, the limitations in the area of tape handling could very well be more than compensated for by the availability of simultaneous sync and the ease of changing to four-channel operation, not to mention price.

Howard A. Roberson

Enter No. 91 on Reader Service Card

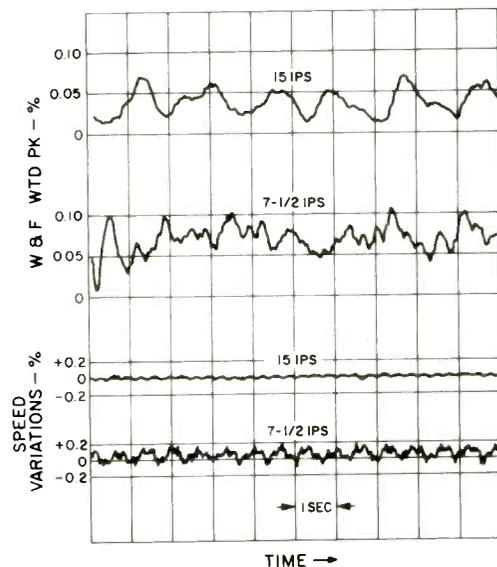
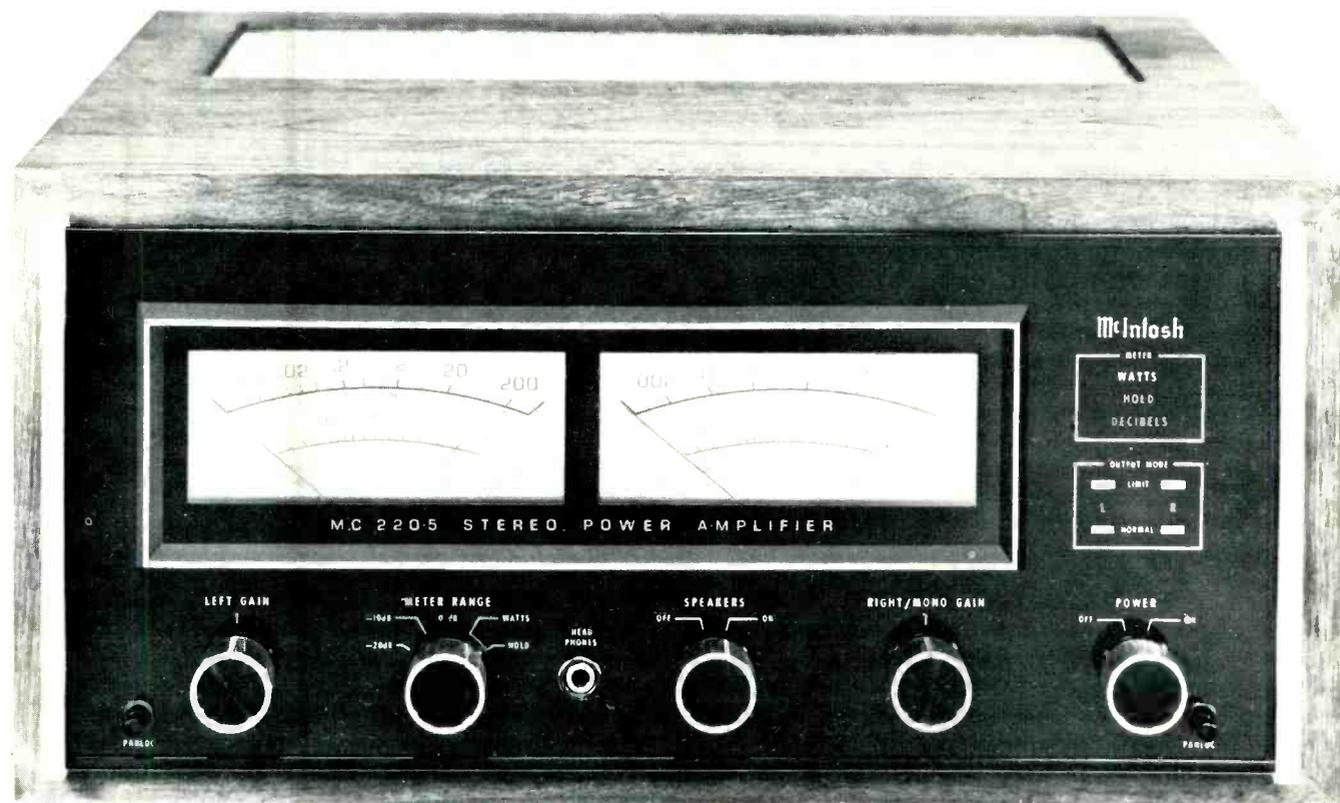

Fig. 5 — The wow and flutter and speed variations of the Pioneer RT-2022 deck. The top traces show wow and flutter at 15 and 7 1/2 ips, while the lower traces show the speed variations at both 15 and 7 1/2 ips.

McIntosh Model MC-2205 Stereo Power Amplifier



70

MANUFACTURER'S SPECIFICATIONS

Power Output: Stereo, 200 watts per channel into 1, 2, 4, or 8 ohms, 20 Hz to 20 kHz; Mono, 400 watts into 0.5, 1.0, 2.0, or 4 ohms, 20 Hz to 20 kHz.

THD: 0.1 per cent maximum from 0.25 W to rated output.

IM Distortion: 0.1 per cent maximum, any combination of frequencies from 20 Hz to 20 kHz up to instantaneous peak power of 400 W stereo, or 800 W mono.

Frequency Response @ 1 watt: 20 Hz to 20 kHz +0, -0.25 dB; 10 Hz to 100 kHz, +0, -3 dB.

Hum and Noise: 95 dB below rated output.

Damping Factor: Stereo, 16 @ 1 ohm, 50 @ 2 ohms, 30 @ 4 ohms, 16 @ 8 ohms; Mono, 16 @ 0.5 ohms, 50 @ 1 ohm, 30 @ 2 ohms, 16 @ 4 ohms.

Input Impedance: 100,000 ohms.

Input Sensitivity: 0.75 V or 2.5 V, level adjustable.

General Specifications

Power Requirements: 120 V 50/60 Hz, 70 to 550 watts.

Front Panel Dimensions: 16 3/16 in. (41 cm) W x 7-1/8 in. (18 cm) H.

Chassis Dimensions: 15 in. (38.1 cm) W x 14 1/2 in. (36.8 cm) D, including connectors; 1 1/2 in. (3.8 cm) clearance required in front of panel for knobs.

Weight: 85 lbs. (38.5 kg).

Price: \$1199.00.

It isn't often that McIntosh Laboratory Inc. introduces a completely new line of power amplifiers, but when they do, the news is generally greeted with a fair amount of excitement from dyed-in-the-wool audiophiles as well as loyal "Mac" fans. The MC-2205, pictured here, is one of a new generation of high-performance power amplifiers introduced recently, and we have now had an opportunity to put it through its paces, to listen to it, and to examine its construction and design philosophy. Detailed examination of the front panel on this impressive looking anodized gold and black panel tells us much (though by no means all) about some of the new features incorporated in this amp. Dominantly featured are a pair of large, illuminated power meters — one for each channel. Calibrated in watts as well as in decibels, the meters can be set to operate in several different modes. When the meter switch is set to watts, one uses the upper scale, which is calibrated to beyond 200 watts (the rated output of each channel of the amplifier when it is used in the stereo mode). When the 0 dB, -10 dB or -20 dB scales are selected, the meters read in decibels, relative to a

0 dB = 200 watts reference, while in the *Hold* position of the switch the meter once more indicates watts and locks to the highest power peak delivered during playing. If signals are removed while the meters are set to the *Hold* position, the meter pointers will slowly decay (at a rate of about 10 dB per minute). Lighted words to the right of the meter area indicate which meter mode has been selected. Below these illuminated words is another area containing four indicator lights — a pair of green lights for "normal" and red indicators for "limit." The limit lights are also associated with McIntosh's new *Power Guard* circuit about which we shall have much more to say presently. In addition to the meter range switch, the front panel also contains left and right/mono gain controls (when used as a mono amplifier, only the right channel input is active on the rear panel), a speaker *Off/On* switch (which can be set to *Off* to permit private headphone listening via the adjacent phone jack provided) and an a.c. power *On/Off* switch.

The rear panel is equipped with barrier-strip speaker terminal blocks for left and right speaker connection. Since the

Before Sound Guard[®], you only played a record in mint condition once.



Magnification shows the record vinyl wearing away.



Same magnification shows no record wear.

You can see how the picture has changed.

Independent tests* show that records treated regularly with Sound Guard preservative keep the same full amplitude at all frequencies, the same absence of surface noise and harmonic distortion as records played just once in mint condition.

With its patented dry-lubricant film, Sound Guard

preservative maintains sound fidelity by reducing record wear. And with its built-in, permanent anti-static property, it resists dust accumulation.

And now, two new Sound Guard products:

1. Sound Guard[™] record cleaner, developed from extensive research into record cleaning problems and

methods, removes all common record contaminants—from dust particles to oily fingerprints.

And whether your records need a light cleaning to remove surface dust or a thorough cleaning to remove deep-seated contaminants, Sound Guard record cleaner does both.

2. Sound Guard[™] Total Record Care System

puts Sound Guard record preservative and Sound Guard record cleaner in one package—for the best possible total care for all of your records.

Available in audio and record outlets.

*Tests available on request.



Sound Guard[®] keeps your good sounds sounding good.



Sound Guard preservative—Sound Guard cleaner—Sound Guard Total Record Care System
Sound Guard is Ball Corporation's registered trademark. Copyright © Ball Corporation, 1977. Muncie, IN 47302

McIntosh MC-2205 employs output transformers, a variety of impedance taps are available (1, 2, 4 or 8 ohms for stereo connection, 0.5, 1.0, 2.0 and 4.0 ohms for mono use) and, of course, full rated power is available regardless of the impedance chosen — an advantage inherent in the use of matching output transformers. An unswitched convenience a.c. receptacle is located adjacent to the line fuseholder, near which are the *Power Guard* switch (ordinarily set to the *Normal* or "On" position) and a mono/stereo switch. Left and right input jacks come next, and next to them is the input sensitivity switch which selects 0.75 or 2.5 volt sensitivity for rated output.

Construction and Circuit Features

As can be seen from the chassis view of the MC-2205, the amplifier is as ruggedly constructed as most McIntosh products. The unusual weight (85 lbs.) of the amplifier is, in part, due to the use of those famous McIntosh auto-transformers. While some may argue that the interjection of autoformers in the output circuitry of a solid-state amplifier poses performance problems, McIntosh stoutly maintains that the use of such transformers offers more advantages than disadvantages. While we will certainly not get involved in that old argument (the proof is, after all, in the listening), we should point out that, indeed, transformers used at the low impedance levels required by solid-state output devices behave quite differently from "old fashioned" step-down output transformers which were required to translate high-impedance tube output circuits to the low-impedance levels required by loudspeaker loads.

A block diagram of the MC-2205 is reproduced in Fig. 1. Each input amplifier is a two-transistor feedback amp with

unity gain. At the input to each power amplifier section is a monolithic differential transistor. Input and feedback signals are applied to this amp. The second stage is a class-A voltage amplifier with applied feedback. The predriver, driver, and output sections are fully complementary.

The output stage consists of six complementary power transistors connected in a single-ended push-pull parallel arrangement. The bias network for the output stage is temperature compensated, assuring class-B operation at any temperature or power level. Output transistors are mounted on large, black anodized aluminum heat sinks. The output of the amplifier is switched by a heavy-duty relay to the output auto-transformers. The relay is driven by a transistor switch and also provides transient-free turn-on and turn-off. Relay turn-on takes place approximately two seconds after power is applied to the amplifier. A short turn-off time constant opens the relay's contacts when power is turned off before the main power supply voltage drops. A patented "Sentry Monitoring" circuit monitors output signals. At signal levels up to rated output, this circuit has a high impedance and does not affect the output. However, if the power outputs exceed design maximum, the circuit limits signals to the output transistors. Both the positive and negative halves of the output signal are monitored independently.

Limit Indicator and Power Guard Circuits

The MC-2205 has a waveform comparator circuit which compares output and input waveforms. If waveform differences reach 0.5 per cent, the red *Limit* indicator on the front panel illuminates while a distortion content of 1.0 per cent causes the *Power Guard* circuit to act. Differences in waveform are first converted to a control voltage which is applied

B139.

The world-famous KEF bass unit, approaching perfect-piston performance right down to 20Hz.



Flat, light-weight expanded polystyrene diaphragm, aluminum-laminated, suspended on a special neoprene roll-surround. Acoustically dead, non-resonant, no chance of 'cone-edge break-up'. Hear it to perfection in the Cantata.

Cantata.

Our elegant, high-performance, 150W speakers in mirror-image matched pairs.

The cabinet is tall, to cut floor reflections; deep, to cut rear wall reflections; narrow, to permit good sound dispersion; and mounted on castors to cut resonance with the floor.

Note the special drive unit positions, with the mid unit above the treble, giving equal sound paths to the listener, with no inter-unit time delays. And the mid and treble units are both placed off-centre, to cut side wall reflections.

Both mid and treble units have acoustic balance controls and both also have fuses to prevent damage, even under fault conditions.

Altogether, the Cantata is a superb example of KEF's computerised 'target function' design approach, in which the cabinet, drive units and acoustic Butterworth dividing networks are developed together, with the electronics tuned to the other elements, to bring the overall system response function as close as possible to the theoretical ideal.

May we send full details?



Fig. 1—Block diagram of the McIntosh MC-2205 power amplifier.

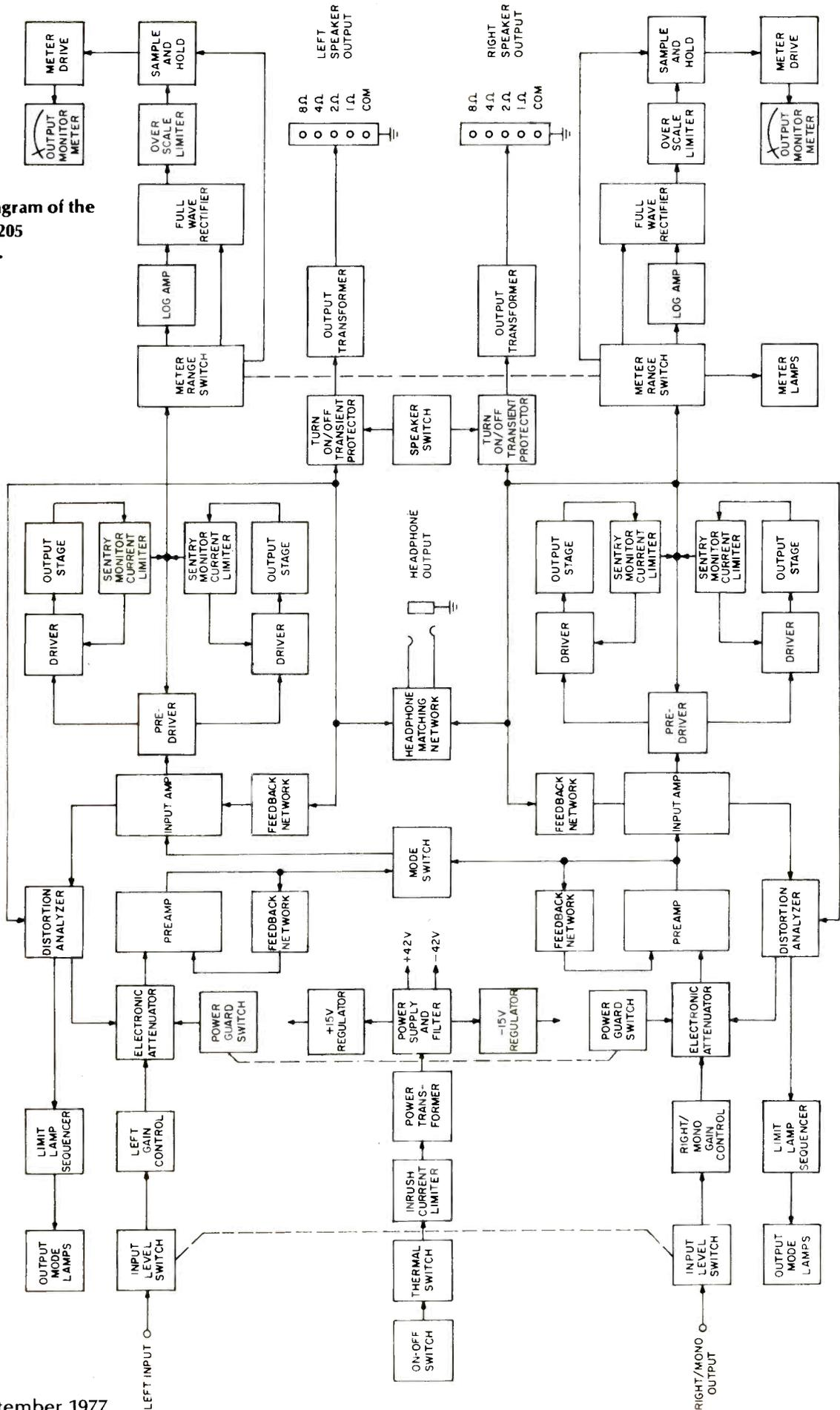



74

differentially to a high gain op-amp where it is amplified 100 times and detected by a full-wave bridge rectifier and applied to a Schmidt trigger programmed to sequence the front panel indicators. The same control voltage actuates the *Power Guard* system by operating a light emitting diode/light dependent resistor network. The LDR is part of an attenuator between the volume control and the input amplifier. Both the *Limit* indicator and *Power Guard* circuits are operated separately for each channel.

Laboratory Measurements

The graphs of Fig. 2 show harmonic distortion as a function of power output for the MC-2205 at three frequencies, 1 kHz, 20 Hz, and 20 kHz. Nominal rated harmonic distortion (0.1 per cent) was reached at an output level of 250 watts per channel at 1 kHz and approximately 225 watts per channel at the two frequency extremes. (Note that the vertical axis of this graph has been greatly expanded to better illustrate the low levels of distortion measured.) McIntosh's traditionally conservative ratings are such that this amplifier might well have been "FTC rated" at 225 watts per channel in stereo. Full rated power (200 watts per channel) is, in fact, obtainable with no more than 0.1 per cent total harmonic distortion from 17 Hz to 34 kHz, beyond the 20 Hz to 20 kHz limits stated by the manufacturer.

Intermodulation distortion is plotted as a function of power output in Fig. 3, using the standard SMPTE frequencies of 60 Hz and 7,000 Hz in a 4:1 ratio. Rated IM distortion (0.1 per cent) was reached at an output level of 280 watts per channel with both channels driven. (Note: our wattage measurements are "equivalent watts." Translated to McIntosh's "peak wattage" specification statement, output would have been in excess of 500 watts per channel, rather than the 400 watts claimed in their published specifications!) Residual noise and hum measured 100 dB below full rated output, while damping factors corresponded almost exactly

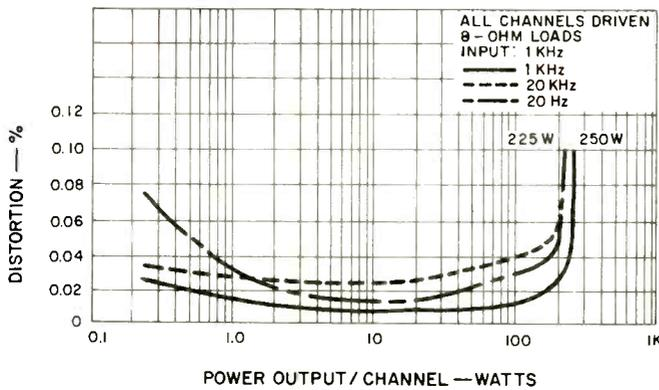

Fig. 2—Harmonic distortion characteristics.

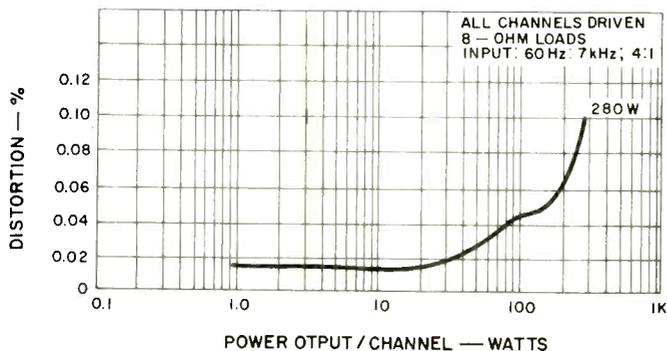

Fig. 3—Intermodulation distortion characteristics.

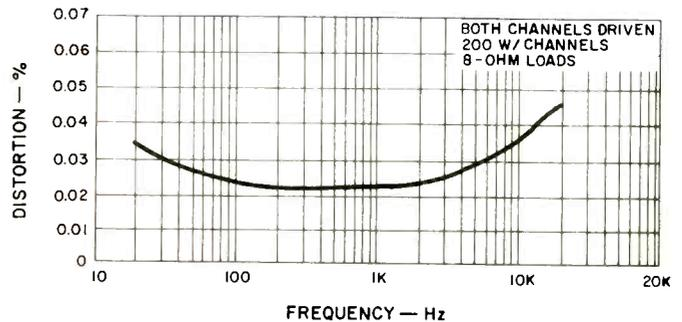

Fig. 4—Distortion vs. frequency.

to those stated for the various impedance connections. In case you are wondering why the damping factors vary the way they do, depending upon auto-transformer output taps connected to the load, bear in mind that the "looking back" impedance used in calculating damping factor includes the impedance of that portion of the auto-transformer winding which is in series with the output stage take-off point. Thus, the highest damping factor is observed at the 2-ohm tap, since that tap is closest to the input tap to the transformer, to which the output stages are connected. Although the 8-ohm damping factor may seem low (16) compared to some of the astronomical damping factor figures quoted for solid-state amplifiers that do not employ output transformers, we could not attribute any sound quality deficiencies in our subsequent listening tests to this factor. Distortion vs. frequency at rated output is plotted in Fig. 4 and reached a maximum of 0.045 per cent at 20 kHz.

Tests of The Power Guard Feature

One of the most intriguing aspects of this new amplifier from McIntosh is the novel *Power Guard* circuit which has already been described. In order to test its effectiveness, we applied a 1 kHz test signal to the amplifier, increasing its amplitude until obvious output clipping was taking place with the *Power Guard* switch turned off. The resulting output waveform is displayed in the 'scope photo of Fig. 5. With the identical signal applied, we flipped the switch to *Normal*, and observed a significant diminution in output signal clipping, as illustrated in Fig. 6. With the same overdriving signal applied to the amplifier, we analyzed signal output by means of our spectrum analyzer. With *Power Guard* off, higher level harmonics (third and fifth) were approximately 44 and 48 dB below the reference 1 kHz spike as shown in

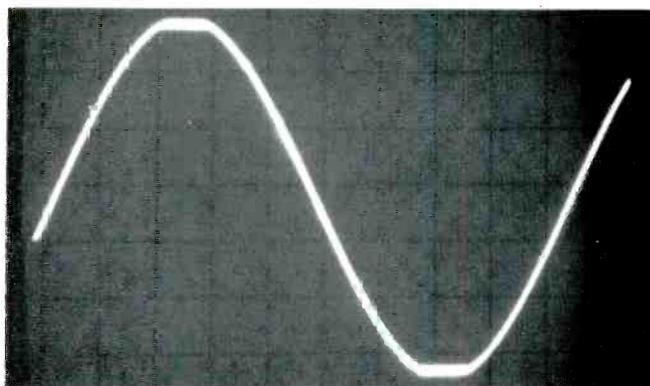

Fig. 5.—Sine wave output with amplifier driven into clipping with *Power Guard* "Off."

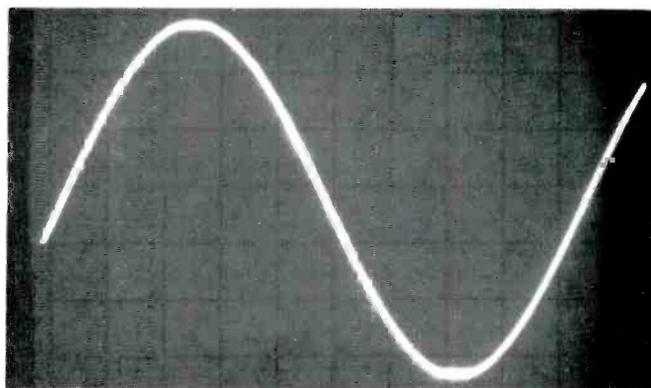
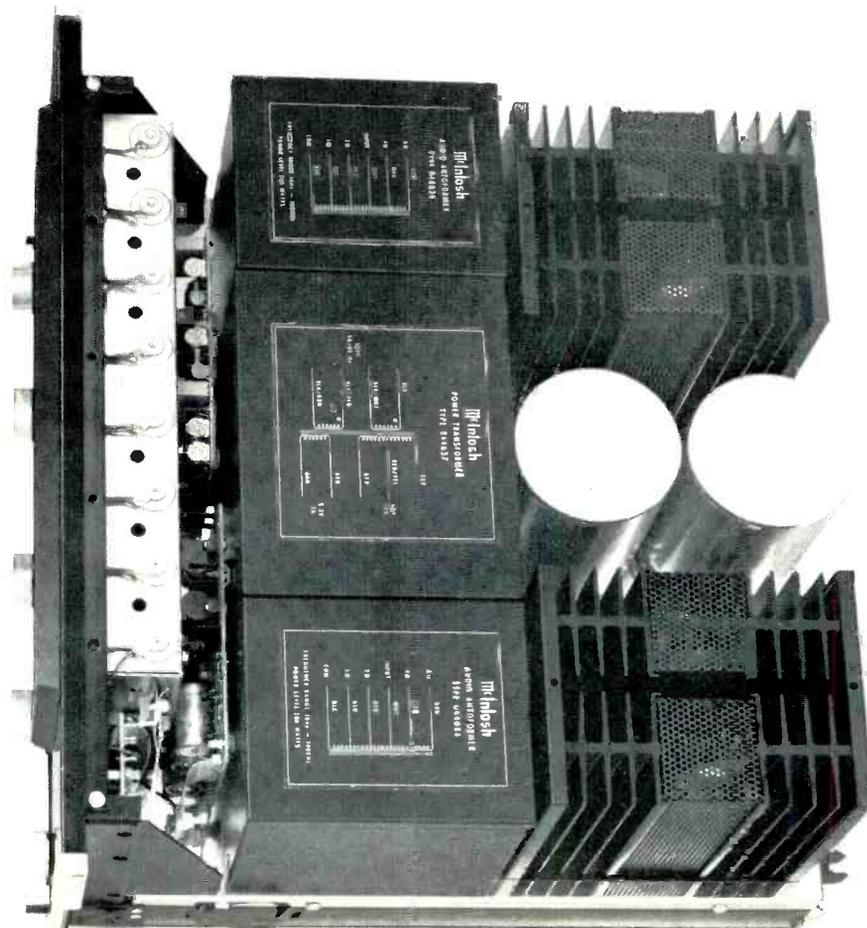

Fig. 6.—Sine wave output with amplifier driven into clipping with the *Power Guard* "On."



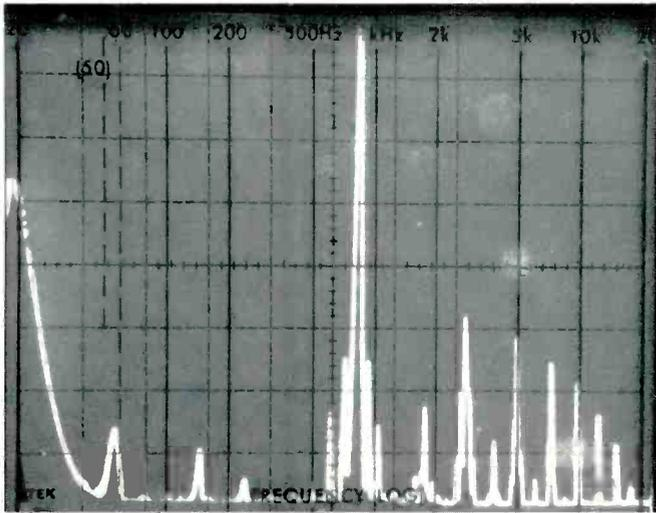

Fig. 7—Distortion components with the Power Guard "Off."

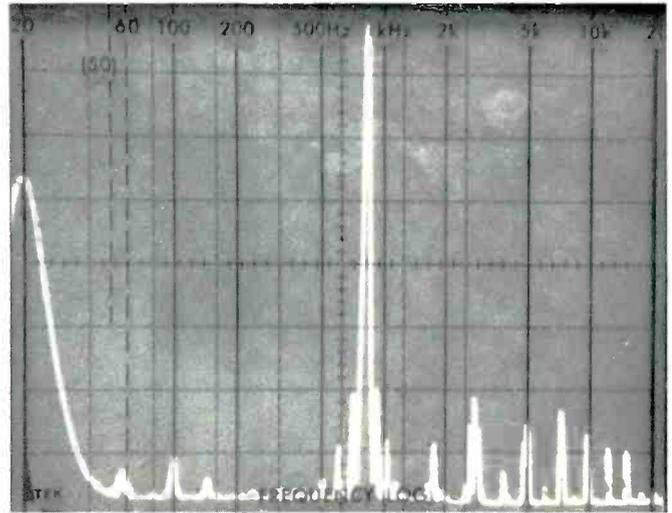

Fig. 8.—Distortion components with the Power Guard "On."

the scope photo of Fig. 7. A second analysis of the output signal was made after the *Power Guard* switch was once again set to *Normal* and, this time, the third harmonic contribution was instantly reduced to some 57 dB below rated output reference, while the fifth harmonic distortion component was reduced to some 63 dB below rated output (see Fig. 8). Impressive as these results are, we recognized, of course, that people don't generally listen to continuous sine-waves and were curious to find out what the *Power Guard* circuit could do when subjected to more complex signals.

76

Accordingly, we next applied an IM test signal to the amplifier, driving it well beyond clipping, as shown in Fig. 9. Turning on the *Power Guard* circuit once more, the waveform was instantly restored to an almost totally undistorted shape, as illustrated in the 'scope photo of Fig. 10. In fact, we discovered that the *Power Guard* circuit is fast enough to diminish the amplitude of even a single cycle of a 20,000 Hz tone burst. Further, the *Power Guard* circuit is able to reduce or attenuate input signals to as little as one-tenth their actual amplitudes, if necessary, in order to maintain low distortion in the event of inadvertent excessive input signals.

Use and Listening Tests

A full evaluation of the McIntosh MC-2205 amplifier really involves more than just musical listening tests. Certainly, this amplifier delivers clean, tight sound with an absence of any

audible coloration. Its power reserve is more than enough to handle even the most inefficient of loudspeaker systems. With so much available power, one has to be careful when selecting speakers to be used with this amplifier. But, given speakers that can handle all that power, one has a sense of security about this amp since the auto-transformers, in addition to the other built in protection circuits, protect speakers from damage in the unlikely event of an amplifier circuit failure. Should a direct current component appear at the output, it would be shunted by the auto-transformers and would not damage the speakers.

The so-called "price/performance" ratio of a high-quality stereo amplifier is not a simple thing to define. Certainly, on a dollars-per-watt basis, the MC2205 is quite costly. But how does one measure McIntosh's enviable reputation for long-lived components? How can one set a value upon the many military grade components used in the construction of this amp, or upon McIntosh's unequivocal guarantee (printed right above the published specifications) that every single unit sold will either meet or exceed those published specs or your money back? We have been told that most McIntosh product owners are extremely loyal customers and that few base that loyalty upon price alone. Having lived with and listened to the cool-running, conservatively rated, good sounding Mac MC-2205, we believe we can understand that loyalty.

Leonard Feldman

Enter No. 92 on Reader Service Card

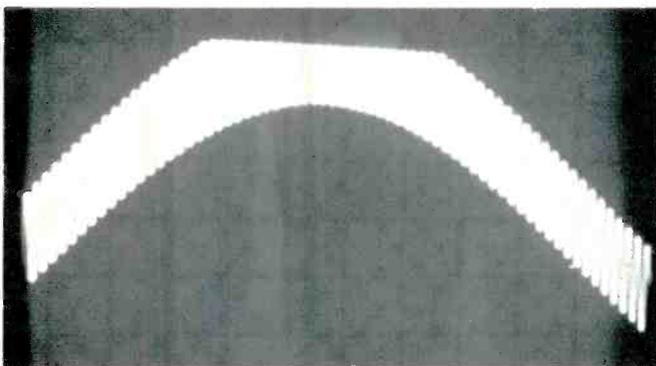

Fig. 9—Clipped complex waveform with the Power Guard "Off."

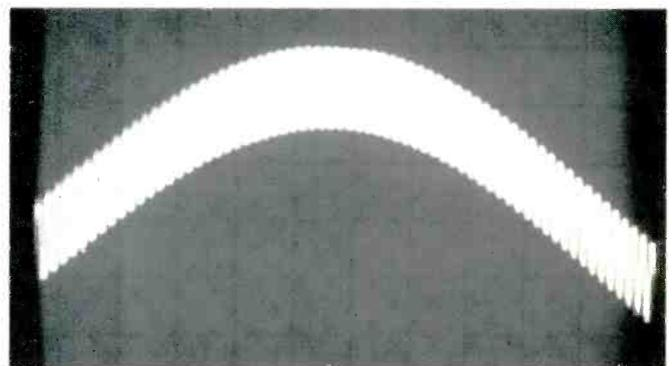
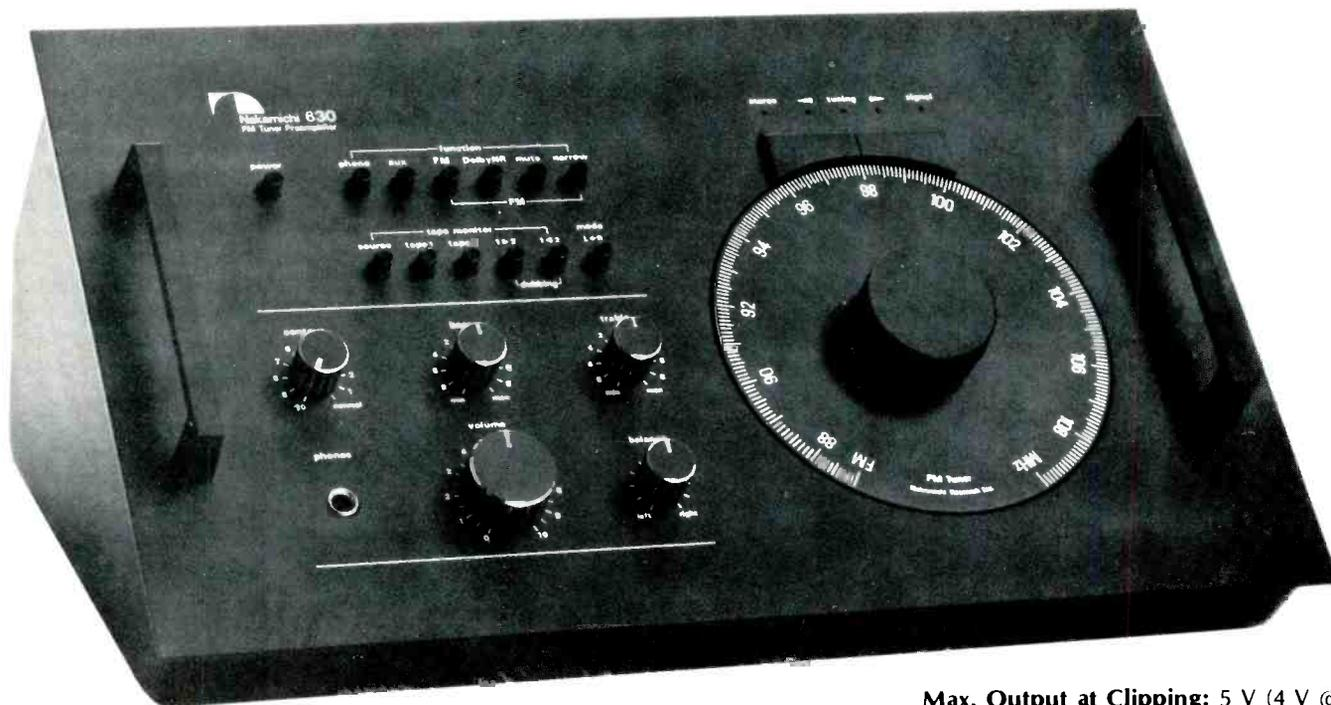

Fig. 10—Output signal of Fig. 9 as reproduced with the Power Guard "On."

Nakamichi Model 630 FM Tuner/Preamplifier



MANUFACTURER'S SPECIFICATIONS

Tuner Section

Usable Sensitivity: Mono, 2.5 μ V (13 dBf); 25 μ V (33 dBf).

50-dB Quieting: Mono, 5 μ V (19 dBf); Stereo, 50 μ V (39 dBf).

S/N: Mono, better than 70 dB, better than 75 dB w/Dolby; Stereo, better than 68 dB, better than 73 dB w/Dolby.

Selectivity: Wide, 40 dB; Narrow, 80 dB.

THD @ 1 kHz: Wide, 0.05 per cent mono, 0.08 per cent stereo; Narrow, 0.15 per cent mono, 0.5 per cent stereo.

Frequency Response: 50 Hz to 15 kHz, +0, -1.5 dB.

Capture Ratio: Wide, 1.0 dB.

Image Rejection: 100 dB.

I.F. Rejection: 100 dB.

Spurious Rejection: 100 dB.

AM Suppression: 60 dB.

SCA Suppression: 75 dB.

MPX Filter: -70 dB @ 19 kHz.

Stereo Separation: Wide, 50 dB @ 1 kHz, 35 dB @ 10 kHz; Narrow, 30 dB @ 1 kHz, 30 dB @ 10 kHz.

Tuner Output: 290 mV, 50% modulation.

Preamplifier Section

Rated Output: 1.0 V (0.2 V @ Rec. Out, 40 mW/8 ohms @ Headphone Out).

Max. Output at Clipping: 5 V (4 V @ Rec. Out, 300 mW @ Headphone Out).

Input Sensitivity: Phono, 1.0 2.0, or 5.0 mV (selectable); High Level, 100 mV.

Frequency Response: Phono, RIAA \pm 0.3 dB; High Level, 20 Hz to 50 kHz, +0, -1.5 dB.

S/N (IHF "A"): Phono, 80 dB re 1 mV in.; High Level, 102 dB.

THD: Less than 0.003 per cent.

Tone Control Range: \pm 9 dB @ 20 Hz and 20 kHz.

General Specifications

Dimensions: 16 in. (40.6 cm) W x 6 11/16 in. (17 cm) H x 9 5/16 in. (23.6 cm) D.

Weight: 15 1/2 lbs. (7 kg).

Price: \$630.00.

77

If you are familiar with Nakamichi's attractive 600 series of components which, up till now have included their Model 600 sloped-front stereo cassette deck, their 610 pre-amplifier/control unit (which emphasized the particular needs of the serious recordist), and their trim-looking 620 power amplifier, the Model 630—newest unit in this component series—will come as no surprise. What is somewhat surprising is the fact that Nakamichi chose to include a high-quality preamplifier/control section in this their first tuner design. Although this tends to present a marketing redundancy of sorts (the owner of this tuner-preamp is not likely to opt for the 610 matching unit), Nakamichi reasons (rightly, we think) that this particular configuration offers the user a wide choice of power amplifier options (including their own new 420, their matching 620, or even a pair of 620s, which can be bridged for 350 watts per channel operation into 8 ohms) while maintaining reasonable dimensions, yet avoiding the pitfalls that, the company maintains, are always present in massive, high powered, all-in-one receivers. There are surprisingly few good tuner/preamps on

the market these days (this format was popular in earlier hi-fi times), and the Nakamichi 630 is a welcome addition to the roster.

The front panel of the 630 is different from any tuner we have ever seen. The dominating control is a large-diameter linearly calibrated (at every 200 kHz) tuning knob which is vernier-turned by a concentrically located inner knob. Action is every bit as smooth (if not smoother) than that obtained from the most carefully designed conventional fly-wheel/dial pointer/dial string arrangements. Above the tuning dial is an illuminated graticule, that points to the frequency selected, while above it are five LEDs. The central LED lights up when a signal is perfectly center-tuned, while the LEDs to either side of it denote direction of tuning to be employed when the dial is slightly off-tune. Another LED at the left lights up in the presence of a stereo signal, while the rightmost LED of this quintet illuminates in the presence of fairly strong (and hence, noise-free) signals of any kind. This multi-LED arrangement obviates the need for more conventional tuning meters and pointers. Five rotary controls at the

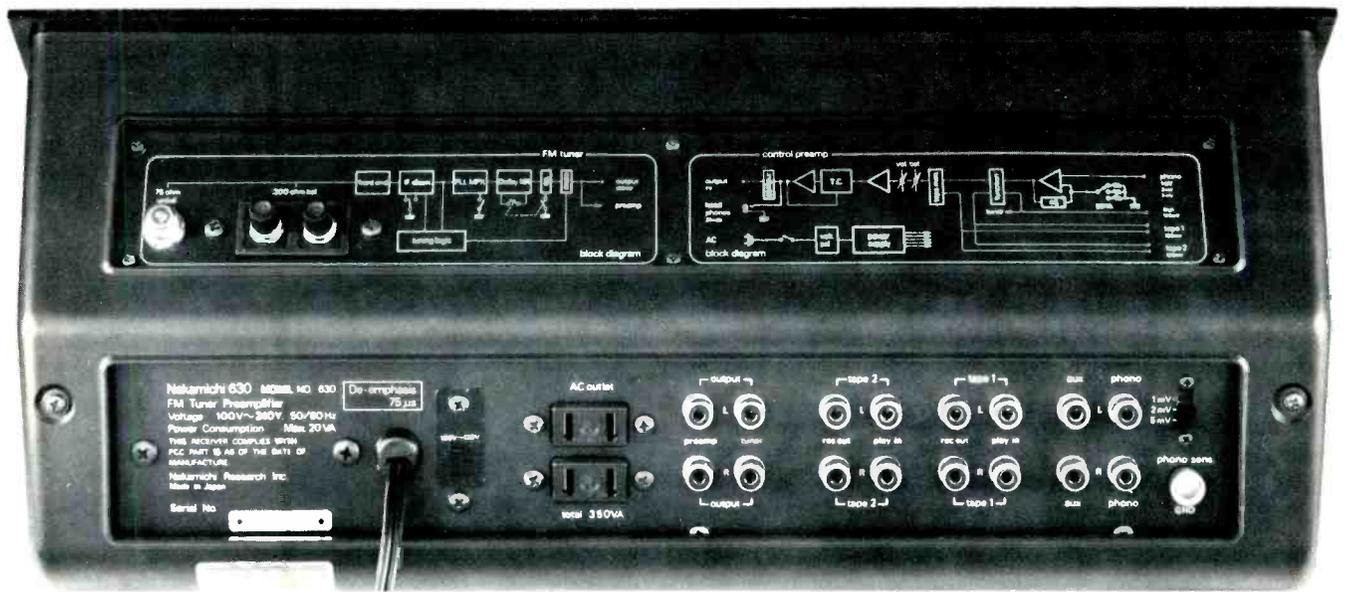

lower left of the panel include a master volume control, bass and treble tone controls, a balance control, and a contour control. The contour control, in combination with the master volume control, provides *true* loudness compensation facilities that can be used effectively regardless of the program source input levels, power amplifier gain, or loudspeaker efficiency. The combination is a welcome change from the "loudness switch/volume control" combination found on so much equipment which rarely, if ever, permits correct loudness compensation because of its arbitrarily established boost and taper characteristics. A headphone jack (driven by a built-in headphone amplifier) is also located in this lower left area of the panel.

At the upper left are a power On/Off pushbutton and two rows of six buttons each. Buttons in the upper row select phono, AUX, FM, Dolby noise reduction, FM muting, and wide or narrow i.f. circuitry. Lower row buttons take care of source or two tape monitor circuits, dubbing from either connected tape deck to the other, and mono (L+R)/stereo selection.

The rear surface of the 630 is actually two surfaces because of the sloped construction of the unit. Antenna connections

for 75- and 300-ohm antennas are located on the upper surface, along with a helpful block diagram which traces signal paths through the tuner/preamp. The lower surface contains a pair of switched power receptacles, two pairs of output jacks (one of which delivers output from the tuner section only, bypassing the preamp control section), two sets of tape-out and tape-in jacks, AUX and phono input jacks, a three-position slide switch which selects phono input sensitivity, and a chassis grounding terminal.

Circuit Highlights

As usual, Nakamichi has managed to assemble an enormous amount of high-quality circuitry within the small physical confines of the 630. The phono-preamp section utilizes a unique "triple transistor" first stage and class-A, push-pull, current-drive circuitry not unlike that used in their more elaborate Model 610 preamp/control unit. The high sensitivity of the phono input makes it suitable for direct use with several available higher-output moving coil cartridges without requiring the normal signal boosting transformer or preamp.

The front end of the 630 employs a five-gang linear vari-

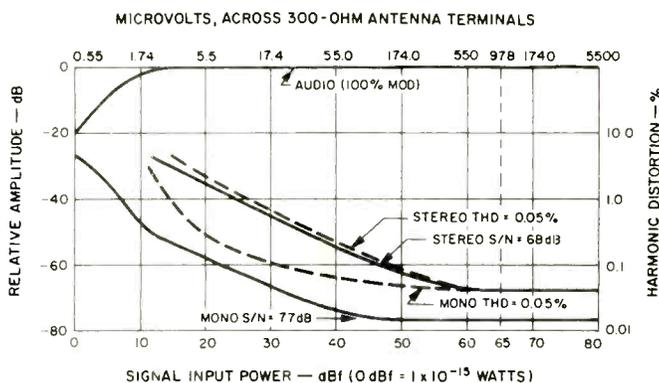

Fig. 1—Mono and stereo quieting and distortion characteristics for the FM section in the "Wide" i.f. mode without Dolby.

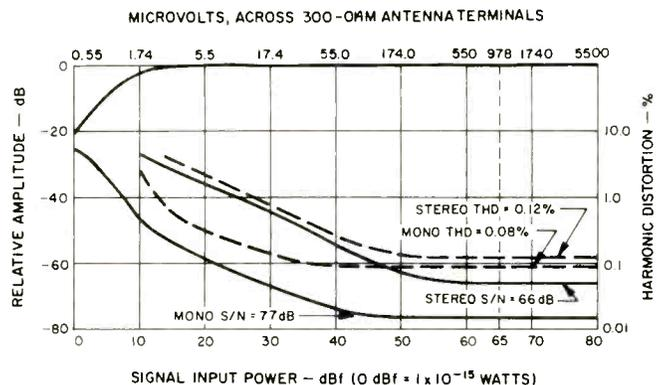

Fig. 2—Mono and stereo quieting and distortion characteristics in the "Narrow" i.f. mode without Dolby.

able capacitor, and all components are hand wired directly to the front-end chassis. Low-noise, dual-gate MOSFETs are used in the r.f. section. The i.f. section employs a six-element LC filter with linearized phase. The "narrow" i.f. filter position utilizes ceramic filters that also offer low phase shift. The entire i.f. section is fully shielded. The MPX section uses the familiar phase-lock-loop circuitry. A separate Dolby noise reduction circuit is included, and when that function is selected on the front panel, FM de-emphasis is automatically switched to the required 25 microseconds.

FM Performance Measurements

Considering the price of the 630, its FM tuner section offers unusually excellent performance. Usable sensitivity measured $1.8 \mu\text{V}$ in mono (10.3 dBf) and $3.5 \mu\text{V}$ in stereo (16.1 dBf). The 50-dB quieting point was reached with input signals of $2.6 \mu\text{V}$ (13.5 dBf) in mono and $35 \mu\text{V}$ (36.1 dBf) in stereo. Ultimate quieting in either the wide or narrow positions for mono was 77 dB, while in stereo, S/N was 68 dB in the wide i.f. position and 66 dB in the narrow setting. Distortion, using the wide setting, was an incredibly low 0.05 per cent in both mono and stereo for a 1 kHz, 100 per cent modulated signal, and even in the narrow position, THD was 0.08 per cent for mono and 0.12 per cent for stereo. These results are plotted graphically in Figs. 1 and 2. Distortion at other audio frequencies (in the wide-band position) are plotted in the curves of Fig. 3, and it should be noted that stereo THD is virtually identical to mono THD at all but the highest audio frequencies. At 6 kHz, (the highest reportable frequency for THD measurements according to the new IHF/IEEE Tuner Standards) THD was a mere 0.14 per cent with virtually no

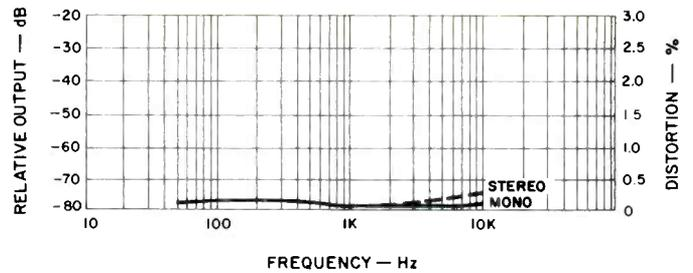
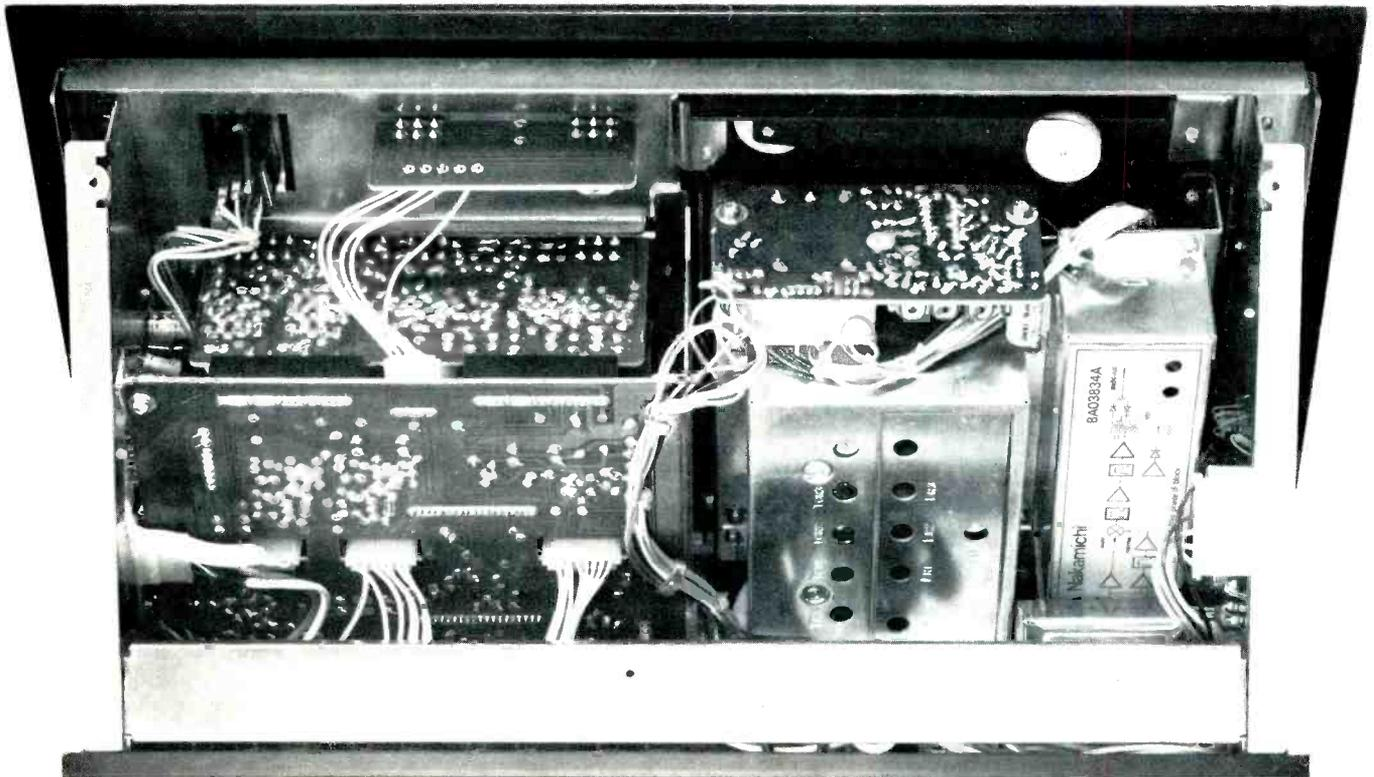

Fig. 3—Distortion vs. frequency in the "Wide" i.f. mode.

evidence of "beats." Switching to the narrow position, THD at this high audio frequency in stereo was still a very low 0.28 per cent. Spurious, image and i.f. rejection claims were all confirmed to at least 100 dB (the limit of our test facilities), while capture ratio measured 0.9 dB in the wide position. Whatever residual sub-carrier output products were present were buried "below the noise" and were indistinguishable, as such.

Figure 4 is a spectrum analyzer plot of the frequency response of the tuner section, in which the de-emphasis characteristics of 25 microseconds and 75 microseconds are displayed. Also evident, is the steep notch filtering which occurs at the 19-kHz point (sweep is from 20 Hz to 20 kHz).

Stereo separation versus modulating frequency is plotted for both the narrow and wideband i.f. positions in the 'scope photo of Fig. 5. As might be expected, results are a bit better at high frequencies using the wide position, but even in the narrow position, separation remained above 35 dB even at 10 kHz. Muting level was set on our sample to $10 \mu\text{V}$ (25.0 dBf)—a bit on the high side in view of the excellent



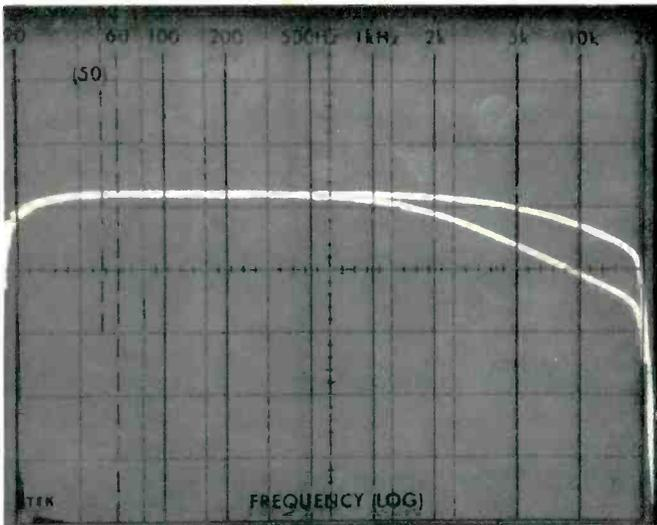

Fig. 4—Frequency response including the 25- and 75- μ s de-emphasis.

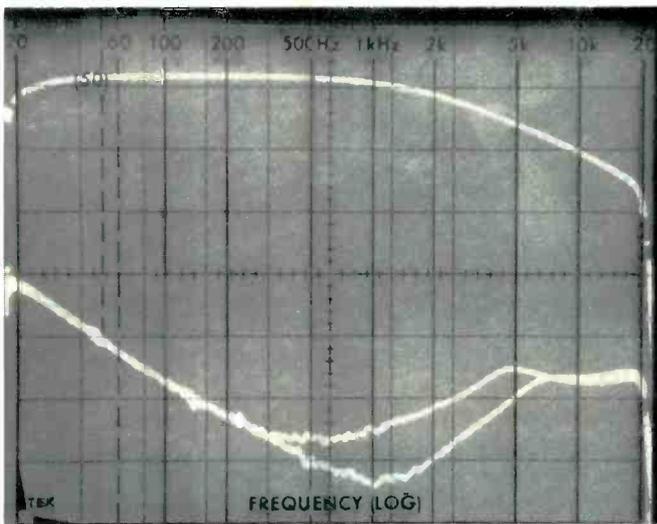

Fig. 5—Separation vs. frequency in both the "Wide" and "Narrow" i.f. positions. (Note that the unit's de-emphasis circuitry has not been compensated for.)

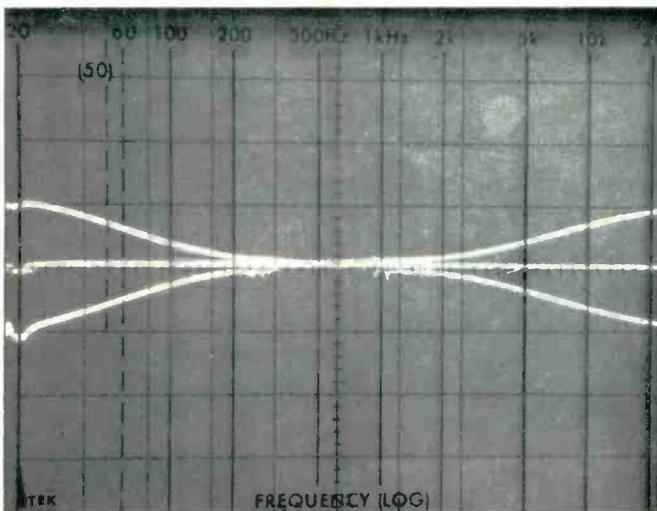

Fig. 6—Bass and treble control range of the Nakamichi 630.

quieting characteristics of the tuner. We were puzzled, too, by the fact that the "tuning" light (which indicates correct center-tuning) was effective only down to signal levels of 12 μ V (26.8 dBf), while the "signal" light required an input signal strength of 200 μ V or so before it became illuminated. Dial calibration was off by no more than 0.2 MHz from 88 to 108 MHz. Stereo signals can be received at signal levels down to below 1.0 μ V, though of course they are not usable at that signal strength.

Preamplifier Section Measurements

Available phono input sensitivities (for 1.0 volt out) measured 0.9, 1.9, and 4.6 mV, while input sensitivity at the high level inputs measured precisely 100 mV as claimed. Maximum output before clipping (at the main preamplifier output) measured 5.7 volts. RIAA equalization was accurate to within 0.2 dB from 30 Hz to 15 kHz, while frequency response, measured via the high level inputs, was flat to within 1.0 dB from below 10 Hz to 100 kHz. Phono overload (referred to the least sensitive phono input setting) measured 280 millivolts, while signal-to-noise in phono measured 75 dB (unweighted) and 81 dB (IHF "A" weighting). Range of bass and treble controls is plotted in the 'scope photo of Fig. 6. Tone control range is a bit more moderate than that found on most preamplifiers (a point in their favor, in our opinion), and, as can be clearly seen in the 'scope photo, hinge points for both the bass and treble action have been effectively set outside the critical mid-frequency region. THD measurements at both the phono and high level inputs were limited by the residual distortion of our signal generating equipment (approximately 0.002 per cent at 1 kHz).

Use and Listening Tests

The Nakamichi 630 is one of those audio components that invites auditioning. Its controls are smooth, effectively organized, and well engineered. Consider the contour control arrangement, for example. One simply sets the volume control for maximum desired loudness with a given program input, while the contour control is set fully clockwise, to "normal." Then, if lower level listening is desired, one simply reduces the setting of the contour control, without touching the volume control. Listening level is reduced while at the same time proper bass and treble emphasis are introduced for high-perfect Fletcher-Munson compensation. Makes a lot more sense than some of the other loudness compensation approaches we have seen!

As for FM reception, one can only appreciate the low distortion and signal-pulling capabilities of this tuner section when one is fortunate enough to receive signals that are worthy of the product. Tuning is effortless, positive, and stable, and we encountered absolutely no drift even after hours and hours of continuous listening. The "tuning" light offers indications that are fully as precise as those obtained with conventional center-of-channel tuning meters, and its illumination is confined to a narrow enough frequency spread to insure very-nearly lowest possible distortion so long as it remains lit. While the preamplifier section is not nearly as flexible as the separate Model 610, its audible performance cannot be faulted in any way. Furthermore, the available "tuner output" jacks permit direct connection to a tape deck or to another preamplifier if one should desire to purchase the 630 and the 610 because of its added recording flexibility. Considered as a tuner alone, the Nakamichi 630 is well worth its asking price. When one considers that it also contains a complete preamplifier control section, its value is even further enhanced.

Leonard Feldman

Enter No. 93 on Reader Service Card

ure is redrawn from the paper by Daniel and Axon⁶. They stored the tape for a total of five minutes, during two minutes of which it was rotated in an a.c. field of the value shown. The numbers are the rms values, the peak fields being higher by a factor of 2. After a field of about 5 oersted is reached, the level of the printed signal in dB is nearly a straight-line function of the applied a.c. field, with a fairly high slope. The field required to produce audible print-through is greater than will normally be found in the home, and can easily be avoided. Table III gives typical fields from various sources, and shows that a little care is all that is necessary to avoid problems from magnetic fields.

D.c. fields can give print-through too, but are not nearly so effective as a.c. fields. The earth's field is about half an oersted in intensity, negligible where magnetic recording tape is concerned. In giving values for magnetic fields, gauss and oersted are interchangeable if the field is in air or vacuum. Gauss is the name for the unit of magnetic flux density, and oersted is the name for the unit of magnetic field strength. Both these terms are outmoded by the newer international units, but both are still in commercial use in the U. S.

Unpuzzling the Print Effect

What causes print-through? This was a considerable puzzle for a while. It was well-known that a magnetic material could be magnetized by heating it above its *Curie temperature* (the temperature above which it is not ferro-magnetic) and cooling it in a magnetic field. The only trouble was that the Curie temperature (T_c) of iron oxide was known to be so high that the tape would have been destroyed. A number of magnetic "after-effects" had been described for bulk materials, but they didn't seem applicable to the fine particles used in tapes. Then, in 1959, two researchers from the General Electric Research Laboratory wrote a paper about fine magnetic particles which gave the essential clues to what was going on¹⁴. They were working on permanent magnet materials, and did not mention magnetic tape print-through in the paper, but gradually all the magneticians working in magnetic tape recording realized that the answer was here.

The explanation goes something like the following. All bulk ferromagnetic materials have their magnetism arranged in small volumes called *domains*, all about the same size. If the material is completely magnetized, all the magnetic vectors from all the domains point in the same direction and add together. If the material is demagnetized, the magnetism is not removed, but the directions of the domains are randomized, so that they add up vectorially to zero for the whole piece of material. In fine particle magnetics, the particles are so small that there can be only one domain per particle. These particles are known, interestingly enough, as *single-domain* particles. A single-domain (S.D.) particle cannot be demagnetized, though a collection of them can. The collection is demagnetized by randomizing the magnetic vector directions (the directions can be changed, or "flipped," in the particles). Single-domain particles are normally used in magnetic recording tapes.

The temperature scale for this discussion is the *Kelvin* or absolute temperature scale. A degree Kelvin is the same size as a Celsius degree, but the zero point is at absolute zero, which places the freezing point of water at about 273° K, and room temperature at about 293° K.

There is a quantum of energy associated with the Kelvin temperature by the following equation:

$$E = kT \quad (4)$$

where E is the energy quantum, T is the Kelvin temperature, and k is Boltzmann's constant ($k = 1.38 \times 10^{-16}$ erg per degree). An erg is a very small amount of energy—it takes about 2000 ergs to lift a penny one centimeter! Equation (4) defines an amount of energy which is the average amount of energy possessed by a single gas molecule when the gas is at temperature T (in degrees K). In a solid, the energy causes vibrations in the crystal lattices; in a suspension of colloidal particles in a liquid, it causes Brownian motion of the particles. In a resistor in an electronic circuit, the noise voltage ("Johnson Noise") is related to kT in a simple way. As you can see, kT is a very fundamental quantity of energy.

Getting back to our S.D. particles, each one of the particles has a magnetic energy associated with it which is easily calculated and which depends on the material and

Table III—Measured fields from various magnetic and electronic equipment.

Equipment	Magnetic Field, Oe	Distance from Unit, Inches
B-H meter	5	24
	2	30
Large 6000 Oe tape eraser	2	12
Tape head demagnetizer	2	4
Tape eraser (Ampex)	5	9
	2	12
Isolation transformer (instrument)	1	3
Vacuum cleaner (shop)	1	2
Fluorescent lights (overhead)	1	6
Large 12 lb. magnet (Edmund Scientific)	5 (d.c.)	9
	2 (d.c.)	12
Fluorescent light transformer (desk)	1	6
Electric drill (1/3 hp)	2	3
Lightning (250,000 amperes calculated)	656 (transient)	30

the volume of the particle. As the particles get smaller, the magnetic energy gets smaller, going down with the volume. At some point where the magnetic energy is in the same range as the thermal energy, the particle becomes magnetically unstable, and its magnetic vector begins to wander around randomly. Bean and Livingston¹⁴ say that this instability transition occurs at about the point where the magnetic energy is about 25 times the thermal energy. If the particles are much larger than the transition size, they are stable and will not respond to small applied fields. If they are much smaller than transition size, the magnetic vector is moving at random and a small applied field will only influence them in a statistical manner. In the transition size range, most will follow a small applied field. If the temperature then drops, some of the particles will become stable with their magnetization vectors pointing in the same direction as any applied field.

This last is what happens in thermally-caused print-through. At any average temperature, there are microscopic random temperature variations. Some of the particles are always moving into the transition range, and some are always moving out of it. With a constant applied field, as would occur in a signal-containing tape wound on a reel, more and more of the particles become aligned with the field as time goes on. Most of them be-

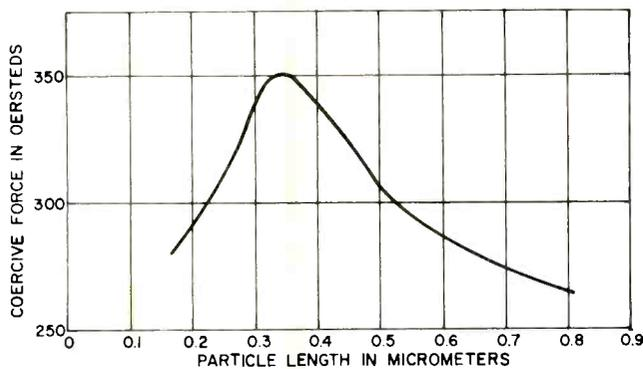

Fig. 8A—Coercive force of gamma ferric oxide particles as a function of average particle length. (Data from Tochiara, et al¹⁵.)

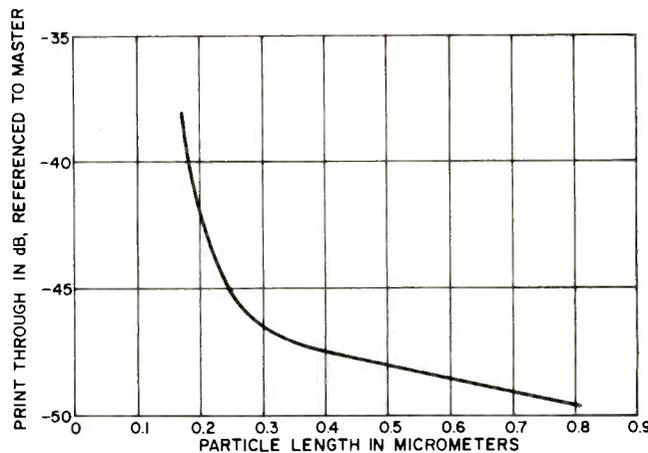

Fig. 8B—Printed signal of gamma ferric oxide particle magnetic recording tapes, as a function of the average particle length. (Data from Tochiara, et al¹⁵.)

come aligned at first, then fewer and fewer as time goes on. The ones that become aligned later result from extreme temperature fluctuations and are thus farther into the stable range than those aligned at first. Thus, the initial print is easier to get rid of than the later print, and this is exactly what is observed and plotted in Fig. 1. In print-through testing, the average temperature is deliberately raised, and many more particles are passed through the transition range. As the temperature drops, the moving transition range leaves behind a trail of particles magnetized according to the applied field.

Please note that in this explanation I have used several words which give a picture of physical movement. Very little actual movement takes place. Only the magnetization vectors rotate—not the particles, and the transition range is moving through the particle size distribution—not the volume of the tape coating.

Nature's Own Tape Recorder

It is interesting that (with thermo-remnant magnetization) a record of the earth's magnetic field over the ages has been left in rocks as they cooled down after being formed from the melt. In the center of the Atlantic Ocean, the rocks are formed in a trench from molten slag coming up from the center of the earth, and they spread out in both directions (east and west). There is a recorded signal left on the ocean floor extending hundreds of miles, showing that the earth's field has reversed itself many times. Nature actually invented the tape recorder!

Printed Signal Amplitude

Now let's look at why the signals are the size they are. Figure 7 shows a typical size distribution curve of particles used in magnetic tape. This type of distribution is called *log-normal*, and most small particle distributions are like this, no matter how they are made. The particle length corresponding to the mean particle volume is, for most oxides, from 10 millionths of an inch to 40 millionths of an inch. The actual width of the transition zone is very small, and only a few particles are involved at any given time. The transition zone moves over a larger area during normal temperature variations, but for most materials, the total volume of particles involved (the area covered by the moving transition zone) is only about 1% or less of the total particle volume (the total area under the curve). A -40 dB print-through would indicate that 1% of the particle volumes were involved, and a -60 dB print would indicate that 0.1% of the particle volumes were involved. It is now obvious how to

make a low-print tape: (1) Use a material with a narrow particle size distribution; (2) Remove most of the small particles; (3) Use a material with a transition zone located far to the left; (4) Use a material with a larger mean particle size, or (5) any combination of these. As with any engineering decision, there are tradeoffs to make in any case chosen.

Coercing Particles to Flip

The coercive force of a magnetic material is a measure of the size of the applied field that it takes to cause the material to change its magnetization. For a particle, the coercive force is the field just required to cause the particle to "flip" its magnetization vector from one direction to another. All else being equal (such as the particle shape), the coercive force goes up as the size of the particle goes down, until just before the transition zone is reached when the coercive force goes through a peak and drops to zero inside the transition zone. Some of the tiny particles near transition-zone size are influenced by small fields, as is apparent from Fig. 6 (fields so much smaller than the material coercive force theoretically should not change the magnetization of the material). A small number of larger particles may be influenced by their neighbors in the coating so that they are just about ready to flip, and all it takes is an additional push from a small field to make them go. If this happens, the magnetically caused printed signal will be difficult to erase, because the larger particle has a coercive force near the average of the material, and a small field now has no help in pushing it back the other way. Because of this effect, and the fact that the magnetic fields are flipping particles farther and farther away from the transition zone with increasing applied a.c. field strength, one should not expect to find strong fading of the magnetically printed signal after contact with the master is lost, and this is just what Daniel and Axon⁶ reported.

Figure 8-A shows how the coercive force of iron oxide particles go through a peak as the particle size is changed, and Figure 8-B shows the rapid increase in print-through as the average particle size goes below the value for peak coercive force¹⁵. The length given is the average length, and the particle size distribution extends down into the transition zone in each case. These results are more recent than those previously given. The particles were acicular (needle-like), with a ratio of length to width of about 7:1. The 0.3 micrometer (a micro-meter, or micron, is about 40 microinches) particles are about the size used for modern low-noise tapes. It is a triumph of the particle manufacturer's art to be able to make

gamma ferric oxide particles this small without unduly compromising the print-through characteristics. The reason that "smaller is better" for audio tapes is that the background noise ("tape hiss") is less the smaller the particles.

Print is Noise Too

Wideband noise, on a good audio tape recorder, is generally 45 dB or better below the 1 per cent distortion level. When a tape is stored properly, the printed signals are likely to be down 55 to 60 dB, and thus inaudible under most circumstances. Even so, a loud transient signal could be recorded as much as 10 dB above the nominal 1 per cent distortion level, and its pre-print signal might become audible when no other signal was present. It is wise to record at such a level that these heavy transients do not approach the saturation level of the tape (which is 10 to 15 dB above the minimal 1 per cent distortion level). A compromise must be sought in the recording level of the tape, since too low a level will get rid of the print, but bring in a lot of hiss. Cassette machines usually have about 10 dB less wideband S/N than do open-reel units, but a good cassette deck will have Dolby, and this equalizes the situation to a large extent and makes them comparable. In fact, Dolby should improve the print-through situation for cassettes by about the same amount that it improves the S/N ratio.

Storage for Low Print

One might think that audiophiles should rent space in a meat locker to store their tapes. This would probably avoid print-through, but would cause other problems. The wound tape pack does not change dimension with temperature change at the same rate as does the reel or hub the tape is wound on, so tapes that have changed temperature drastically will probably not be wound well, and the pack will slip, possibly damaging the tape.

Another possibility is that moisture could condense on a cold tape brought into a warm room. Modern tapes are not really very sensitive to moisture, but it would make a mess and likely bring on an attack of fungus. Best storage conditions are about 60°F to 75°F and about 35 per cent to 50 per cent RH (Relative humidity). Too dry an atmosphere will give rise to static electricity problems, especially if the tape is wound or unwound. Temperature cycling during storage is especially bad. Tapes should be periodically rewound.

Ambient Magnetic Fields

There shouldn't be much of a problem storing the tapes in a magnetic-field-free environment. Remembering that a.c. fields less than about 5 oersteds really don't cause much trouble, and that d.c. fields are less harmful than a.c. fields, look at Table III. Several instruments and devices found in my lab and at home were measured for their stray fields. All were 60 Hz a.c. except as labeled differently. The most offensive item was the B-H Meter (magnetic hysteresis loop tracer) in my lab. This instrument, used for making measurements on magnetic materials, has an unshielded coil of some 6000 turns of #12 wire. The coil weighs over 100 pounds and has an inductance of 1 Henry. The field is very nearly a pure dipole field (more about this later). This beast will disturb electronic instruments and tape recorder circuits several feet away, and I make no other measurements when it is being used. Still, my valuable standard alignment tapes are stored only about 10 feet away, and I have had no problems with them. The large tape eraser is also unshielded and consists of two coils about 14 inches in diameter, connected with a C-shaped core, 4x4-inches in cross-section, which weighs 650 pounds. The field in the gap goes to 6000 oersteds. The tape head eraser is a standard type, and the Ampex tape eraser is also a standard unit.

Compared to the B-H meter and the tape erasers, the other things are not very impressive. The point is, it is very difficult to obtain the field magnitudes which would cause any trouble with print-through. All the old tales everyone has heard about tape problems with floor polishers and vacuum cleaners are just so much nonsense. I can say this without measuring every appliance around, and I can also state that no conceivable state of disrepair could cause large fields to emanate from such appliances. The reason is that any magnetic field can be described as a combination of dipole fields, quadrupole fields, octupole fields, etc. The higher the order of the field, the faster the field falls off with increasing distance from the source. Only a simple geometry, such as a solenoid coil, can produce a dipole field. Other sources produce higher order fields and thus have fields which don't extend very far. An exception to this is the field produced by a wire extending to infinity in both directions. This produces a cylindrical field around the wire, but the model is unreal. Close to a long straight wire, the cylindrical approximation holds quite well. Two wires with currents

Printing effect has many names.

- Accidental Printing*—*
- Anhyseretic Contact Duplication*—Deliberate duplication of tapes using magnetic fields.
- Anhyseretic Contact Printing*—See last definition
- Contact Duplication*—Either type of deliberate duplication of tapes.
- Contact Printing*—See last definition
- Cross-Talk, Magnetic Tape*—* (This is not a good definition, as "cross-talk" usually refers to interference from the adjacent channel).
- Kopiereffekt (copy-effect)*—*
- Layer-to-layer Signal Transfer*—*
- Magnetic Transfer*—*
- Nachecho (Post-echo)*—Synonymous with "Post-print"
- Print*—*
- Print Effect*—*

Here is a list of the major ones:

- Print-Through, Magnetic*—All with an asterisk (*) are synonymous with this.
 - Post-Print*—The echo after the signal.
 - Pre-Print*—The echo before the signal.
 - Spurious Printing*—*
 - Thermal Contact Duplication*—Deliberate duplication of tapes by thermal methods.
 - Thermal Contact Printing*—See definition above.
 - Thermal Transfer*—Usually used to mean deliberate duplication.
 - Thermomagnetic Recording*—Deliberate duplication.
 - Thermo-remnant Magnetization*—* (Usually used with deliberate duplication).
 - Vorecho (Pre-echo)*—Synonymous with "pre-print."
- *Synonymous with print-through.

traveling in opposite directions, such as power leads, produce fields which cancel out except in between the wires.

The last entry in Table III is calculated, not measured, and it uses the cylindrical field approximation. The current is taken from the article on lightning in my encyclopedia. Two and a half feet away is extremely close to a lightning bolt of that maximum size, and the field is quite large; it would erase most audio tapes made from iron oxide, and the field is only falling off as the inverse of the distance (twice the distance gives half the field, etc.). Dipole fields fall off as the inverse cube of the distance, and quadrupole fields as the inverse distance to the fifth power! Such an occurrence as this king-size lightning bolt would be a disaster, but it's very unlikely. Yet . . . perhaps it might be a mistake to run the ground wire from your antenna mast down the other side of the wall from your tape storage shelves!

Differences in Materials

There are distinct differences in the various types of particles which are used to make magnetic tapes. The worst particle for print-through effects in commercial use is cobalt-doped gamma ferric oxide. Tapes made with magnetite or ferrite materials are somewhat better. Standard gamma ferric oxide tapes span a range from only fair to very good. Most chromium dioxide tapes are very good due to their narrow particle-size distribution. Metal-particle tapes, not yet available to the audio recordist, are generally excellent, because their transition zone is located so far down in the tail of the particle-size distribution. All the commercial tapes which I have tested that are labeled "Low Print" seem to be just that (these are all from well-known and reputable manufacturers).

Contact Recording

It is possible to use both the themomagnetic and the anhysteretic methods to duplicate magnetic tapes by contact recording. Sugaya and Kobayashi¹⁶ have published a comprehensive review which points out that these methods are old, though their first commercial use is recent.

Camras¹⁷ and Herr¹⁸ were the first to suggest commercial tape duplication (of audio tapes) using contact duplication. Both their processes used the anhysteretic copy method invented by Müller-Ernesti¹⁹. Both processes used a high-frequency a.c. field applied when master and slave tapes were in contact. Both failed to be commercialized, for several reasons. The transfer efficiency was poor (the slave signal was quite low, compared to the master signal), the long and short wavelengths rolled off badly (similar to Fig. 3), and the signal-to-noise ratio was not very good. Also, the market for duplicated tapes was not developed at that time¹⁶. The difficulty with the efficiency was that both tapes were of the same type. Any field that tended to magnetize the slave would tend to demagnetize the master. What was needed was a high coercivity master and a much lower coercivity slave.

The same problem occurs in thermo-remnant magnetization. If the tapes are of the same type, the efficiency will be poor. With gamma ferric oxide, temperatures to get usable efficiency will be high enough to destroy the tape. Even if high temperature tapes were used, bringing the transition zone up into the large part of the normal curve (see Fig. 7) would tend to destroy the magnetization of the master. In 1959 the idea arose²⁰ that tapes made of chromium dioxide be used as slaves, since the Curie temperature of this material is only slightly above the boiling point of water, a temperature which most

modern tape materials can stand. If the master (made of iron oxide) is placed in contact with the slave (made of chromium dioxide), the two are heated above the T_c of the chromium dioxide, then cooled to room temperature while in contact, the signal from the master is impressed on the slave. The transfer efficiencies of this process can exceed 100 per cent; the slave coming out with more signal than the master.

With the availability of chromium dioxide tapes in the 1960s, the thermo-remnant process became commercially feasible, and many companies began work on it. At about the same time, high coercive force tapes made of cobalt-doped gamma ferric oxide also became available, and the anhysteretic method is also now used commercially. Neither of these contact recording methods is used for duplication of audio tapes. Audio tapes are duplicated using a master tape player driving a bank of satellite recorders, all running at 120 ips, and the industry is not likely to scrap all that machinery to replace it with a process which would cost more and give poorer results. All the contact duplication equipment is now used for duplication of various types of video recordings. Video recordings, surprisingly enough, do not require such a wide wavelength bandwidth as do audio tapes! The standard audio band of 20 to 20,000 Hz is four decades of frequency (or wavelength), while most high quality video recorders get by with only one decade of frequency (or wavelength). Thus, even though there is a loss at both short and long wavelengths, it is easy to fit the video signal into a region of little loss, but almost impossible to do this with audio. The control (or servo) signals and the audio track on video tapes are recorded in the usual way, with only the video signals being transferred by contact duplication. The reason that this expensive and complicated process is so attractive to video tape duplicators is that it is even more expensive and time-consuming to copy video tapes machine to machine. Video tape machines must always be operated in "real time" (at standard speeds) and cannot be run at many times normal speeds as are the audio tape duplicators.

Resolving the Mysteries

Now to pick up some loose ends. One should explain why there are a few complaints of printing on 8-track cartridges, which lie in automobiles under the hot sun for hours; or on cassettes, which use the thinnest of base films and are also used in automobiles. Part of the answer is in the type of tape pack. Both use a very loose wind, and the cartridge pack is designed to slip. The worst heat exposure is in automobiles, which also have a lot of vibration. When a tape undergoing print-through slips its relative slave-to-master position, the printing process has to start all over again, as the fields are changed. As the tapes ride around in the automobile, this slipping is constantly happening, and the result is the same as if the tapes were being constantly rewound. Cassettes or cartridges used in the home are not normally exposed to such heat as those in automobiles. There may not be much of a problem, but I think I'll still take mine out when my car is sitting under this hot Texas sun!

There are some other mitigating circumstances for cassettes and cartridges. I've mentioned the suppressing effect that Dolby should have on the printed signals, since it should treat them like the rest of the noise. In addition, the dynamic range in a car is very limited, and printed signals probably get lost in the background noise. Also, because of the "A" wind, the post-print is worse in cassettes and cartridges. Lastly, a post-echo is less irri-

tating than a pre-echo and may not be heard in many cases.

We can now explain all of the effects which occurred on that operatic broadcast. Video tape of that era was all about 1.4 mils thick and ran at a speed of 15 ips. This is still a widely-used standard. Miss Sutherland's high notes were well within the print-through peak range at this tape speed, and the pre-print is worse, so her lines would always have the pre-echo. The instruments in the same pitch range had the same problem. The bass instruments and male singers were out of it on the low end and did not show any print effects. Since this was normal face-to-back print through, and not face-to-face as it is in deliberate copying, the video signals were of too short a wavelength to print at all, and the FM video system would not have been sensitive to them anyway. The synchronization signals were of very long wavelength and did not print. It wasn't much of a mystery after all, especially when you understand what's going on!

References

1. Lyman J. Wiggin (Reeves Sound Studios), "Magnetic Print-Through—Its Measurement and Reduction," *Journal of the SMPTE*, 58(5), May 1952, pages 410-414.
2. Robert Herr and Robert A. von Behren (3M Co.), "Selective Erasure of Magnetic Tape Cross-Talk," *Electronics* 25(8), August 1952, pages 114-115.
3. Frank Radocy (Audio Devices Inc.), "A New Device for the Reduction of Print-Through," *Journal of the Audio Engineering Society*, 7(3), July 1959, pages 129-132.
4. J.G. McKnight, "Tape Print-Through Reduction," *Ampex Research Department Report 106*, November 1957, 12 pages.
5. Werner Lippert, "Der Kopiereffekt der Magnetophonbänder—ein Beispiel für eine Verallgemeinerung des Exponentialgesetzes" (Print-Through on Magnetic Recording Tape—An Example Considered as a Generalization of an Exponential Law), *Elektrotechnik* 1(1), Part I, July 1947, pages 3-7; and 1(2), Part II, August 1947, pages 57-62.

6. E.D. Daniel and P.E. Axon, "Accidental Printing in Magnetic Recording," *BBC Quarterly*, 5(Winter), 1950, pages 241-256.
7. W.K. Westmijze, "Studies on Magnetic Recording. VI Change in the Recording with Time," *Philips Research Reports* 8, October 1953, pages 354-366.
8. Ray Smith, "Storage of Master Tapes to Minimize Print," *3M Sound Talk*, Bulletin #38, August 15, 1969, 2 pages.
9. S.W. Johnson, "Factors Affecting Spurious Printing in Magnetic Tapes," *Journal of the SMPE*, 52, June 1949, pages 619-628.
10. Joachim Greiner, "Der Unterschied zwischen Vor- und Nachecho beim Kopiereffekt" (The Difference between Before- and After-echo in the Copy-Effect), *Nachrichtentechnik*, 3(11), November 1953, pages 506-509; and 3(12), December 1953, pages 543-545.
11. E.D. Daniel, "The Relative Magnitudes of Pre- and Post-Prints," Ampex Research Department Report, 1961.
12. J. Elmer Rhodes Jr., "On Geometrical Factors, Printing Field, and Print Through," Report to Ampex Corporation, January 4, 1961. Ampex Library Accession Number 02363.
13. William A. Manly, "Magnetic Recording for Computers," *Byte*, #7, March 1976, pages 18-28.
14. C.P. Bean and J.W. Livingston, "Superparamagnetism," *Journal of Applied Physics*, 30(Supplement to 4), April 1959, pages 1205-1295.
15. Shigezo Tochiara, Yasuo Imoaka, and Mamoru Namikawa, "Accidental Printing Effect of Magnetic Recording Tapes Using Ultrafine Particles of Acicular γ -Fe₂O₃," *IEEE Transactions on Magnetics*, MAG-6(4), December 1970, pages 808-811.
16. Hiroshi Sugaya and Fukashi Kobayashi, "Magnetic Tape Duplication by Contact Printing," *Annals of the NY Academy of Sciences* 189, Advances in Magnetic Recording, January 3, 1972. (Proceedings of a conference held January 21-22, 1971)
17. Marvin Camras, "A New Magnetic Record Duplicating Process," *National Electronics Conference Proceedings* 5, September 1949, pages 258-261.
18. Robert Herr, "Duplication of Magnetic Tape Recordings by Contact Printing," *Tele-Tech*, November 1949, pages 28-30 and 57. (See also U.S. Patent 2,738,383).
19. Rolf Müller-Ernești, German Patent 910602, May 3, 1954. (The invention was made in 1941.)
20. G. Akashi, Japanese Patent S 39-4259, April 1964.



Sound System Engineering

by Don and Carolyn Davis

A new, completely up-to-date book discussing audio systems as a whole. The decibel notation system, loudspeaker directivity and coverage, the acoustic environment, designing for acoustic gain, and interfacing the electrical and acoustical systems are reviewed. Circuit levels, grounding and shielding, servicing cable, useful wiring concepts, impedance matching, fundamentals of time delay,

and proofing the installed system are explained in depth. The authors discuss equalizing the sound system, instrumentation, sample design application, and specifications. The many appendices give symbols and abbreviations, recommended installation practices, priority systems, definitions of terms, test questions and answers, and other valuable reference information.

AUDIO Book & Learning Systems Div.
401 N. Broad St.
Philadelphia, Pa. 19108

AU 9

Enclosed is check for \$19.95. Send me, postage prepaid, Sound System Engineering.

NAME _____

ADDRESS _____

CITY/STATE/ZIP _____

New Lambda Series from SpeakerKit

Featuring the newest Philips drivers with computer-assisted crossover design.

Outstanding quality at a surprisingly affordable price. Assemble it yourself. Write for details.

SpeakerKit

Box 12A, Route 2
Menomonie, WI 54751

Enter No. 43 on Reader Service Card

The column



Steve Winwood

Island ILPS 9494, stereo, \$6.98.

One of life's really great feelings is, when reunited with a dear old friend after too long, you are able to pick up things as if no time had passed. **Steve Winwood** is like that.

All through the time since *Gimme Some Lovin'* with the Spencer Davis Group first boomed out That Voice everywhere, through all the SDG hits, through his own Traffic, then Blind Faith, then through Traffic once again, and most recently through the **Go** collaboration with Stomu Yamashta... That Voice has been one of Rock's most thrilling experiences. So when Winwood's first album under his own name appears and doesn't really break any new ground, I don't let it bother me. As long as it reclaims Winwood's distinctive territory as his own, and that **Steve Winwood** does totally, I am satisfied. Why ask him to do what he'd rather not, when he's doing what he does best? This album stands as a grand reaffirmation of one of Rock's most passionate artists.

From this album's first words—"Hold on to me when you're fall-

ing"—a freshly tapped confidence and strength permeates Winwood's return. After *Hold On*, a Willie Weeks triple-tracked bass part punctuated by a sizzling Winwood guitar opener launches *Time is Running Out*. The album's only song completely written by Steve, *Midland Maniac* closes the side. It is a mystical and autobiographical revelation that extends the album's confidence as he sings, "Sending out my song to you/Hope you get it and I know you do."

Opening side two, *Vacant Chair*, written in collaboration with ex-Bonzo Dog Band looney, Vivian Stanshall, is a glorious song that invokes the ghosts of Traffic. *Luck's In* is another steamy pressure cooker balanced by the album's cathartic ballad closer *Let Me Make Something In Your Life*.

Besides Week's sterling bass work, Winwood's support includes Andy Newmark on drums abetted with extra percussion from former Traffic-mates Rebop and Jim "Brother James" Capaldi (who also co-wrote the album's other four songs) and, for one track, Bob Marley's new Wailer lead guitarist Junior Marvin; plus, of

course, the trademark Winwood keyboard and guitar work. Solid stuff throughout.

The production is also straightforward with no undue frills or gratuitous wizardry, just solid music played and delivered right.

Steve Winwood is a winner. He's finally made the music I've been waiting for ever since Traffic flew like an eagle to Valhalla. And best of all, the kid only figures to keep improving. With *That Voice*, it's hard to imagine things going wrong. M.T.

Sound: B+

Performance: A

I'm in You: Peter Frampton
A&M SP-4704, stereo, \$6.98.

What an easy album to like. The obvious pressure never got to the kid or forced him to change his game plan. Thus, *I'm in You* is a joyous, straight-ahead album of excellent pop songs that, like Fleetwood Mac's *Rumours*, risks little stylistically and reinforces the value of what preceded it. Yet, at the same time, *I'm in You* is fully capable of standing on its own as a fine work. Frampton hides nothing; his attitude is fully conveyed in such titles

as *I'm in You, Won't You Be My Friend*, and *You Don't Have to Worry*. With this disc, Peter's sense of pop is honed as sharp as it's ever likely to be.

He projects fun. He looks terrific, of course, even on the cover of *People* magazine. He writes happy melodies with clear, thoughtful words. Most of all he has been perfectly true to his own style and musical sensibilities, and it has paid off, as he well deserves.

I'm in You is an album a lot of folks will fall in love to during the summer of '77. M.T.

Sound: A Performance: A

Reggie Knighton

Columbia CBS 34685, stereo, \$6.98.

At last, the Seventies has found itself a musical force who can go wholly off the wall lyrically while remaining relatively valid on a musical basis—for if one could not make out the words on this record, he surely might be mistaken for a Humble Pie (*Jenny*), or John Lennon (*VD Got To Idi*), or more lightweight figures. But his subject matter—which can range from something like a girlfriend who glows in the dark to spirochetes in a certain Ugandan prime minister's bloodstream—certainly is what distinguishes Reg in the long run. This is not to dismiss his music, which could be classed as moderately hard rock, but his greatest creations will come on the day when he is able to deliver the music with the same attitude that inspired the lyrics.

Only when he reaches from something totally out-to-lunch musically does the record stand out sonically from the rest of the records released on the American market, but this could be partially due to mundane record production distorting far too much in the high end. A great recording artist he may some day be, while at present he's a fairly entertaining stylist who promises much—may he soon deliver. J.T.

Sound: C+ Performance: B+

Blowin': The Jess Roden Band
Island ILPS 9496, stereo, \$6.98.

To say it simply, The Jess Roden Band plays tight, funky R&B flavored stuff with hooks. The better the hooks, the better they play. *In A Circle*, *Jump Mama*, and the great oldie *Can't Get Next to You* work like that very well. Their live playing is a joy; but take off points for too little of Roden in the mix.

The Jess Roden Band plays it pure and simple. They've got the spirit, and the spirit can move you. M.T.

Sound: C+ Performance: B+

AUDIO • September 1977



Model AT15Sa/H Dual Magnet Stereo Cartridge pre-mounted in Universal tone arm head shell.

To find out how much better our cartridge sounds, play their demonstration record!

There are some very good test and demonstration records available. Some are designed to show off the capabilities of better-than-average cartridges... and reveal the weaknesses of inferior models. We love them all.

Because the tougher the record, the better our Dual Magnet™ cartridges perform. Bring on the most stringent test record you can find. Or a demanding direct-to-disc recording if you will. Choose the

Audio-Technica cartridge that meets your cost and performance objectives. Then listen.

Find out for yourself that when it comes to a duel between our cartridge and theirs... we're ready. Even when *they* choose the weapons!

What you'll hear is the best kind of proof that our Dual Magnet design and uncompromising craftsmanship is one of the most attractive values in high fidelity. For their records... and yours!



audio-technica
INNOVATION □ PRECISION □ INTEGRITY

AUDIO-TECHNICA U.S., INC.
Dept. 97A1, 33 Shiawassee Avenue, Fairlawn, Ohio 44313
In Canada: Superior Electronics, Inc.

HOW TO GET THIS MAXELL TAKE-UP REEL FREE.

Now when you buy three 7- or 10-inch, 1.0 mil, Maxell Ultra Dynamic Open Reel Tapes, aside from getting the best recording tape anywhere, you'll get a precision metal Maxell take-up reel at the best price anywhere.

Absolutely free. Offer good while supplies last.

Maxell Corporation of America, 130 West Commercial Ave., Moonachie, N.J. 07074.

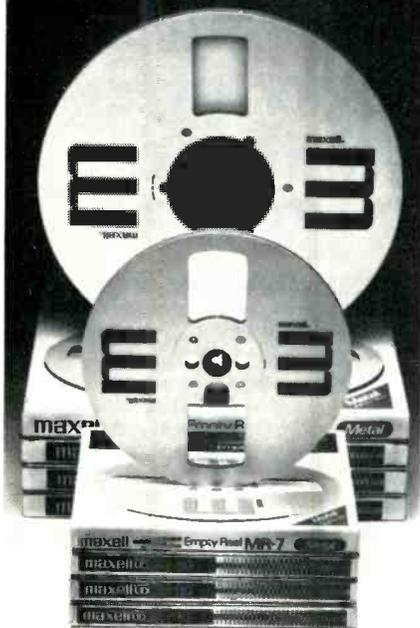

88

Did You Miss...?

A Day At The Races: Queen Elektra 6E-101, stereo, \$6.98.

As Queen have been more than slightly popular lately, their latest album *A Day At The Races* is destined to come under a lot of heavy scrutiny. Queen is on the brink of being the premier rock band in the world, and all of a sudden they're into the game of producing their own records, often a mistake of the highest order. The producer is supposed to be the objective third eye to make sure that the artist doesn't go off the beaten path, and the idea of an artist producing himself cancels out the checks and balances system of sound recording. Of course, Queen is somewhat of an exception in that they've co-produced all of their albums and won awards for best recorded album of the year, so when they go in to do it all themselves, the danger isn't that they'll not be able to "produce" (in the technological sense) themselves (because in conventional terms this may be the best-produced Queen album since the first) but rather that in terms of artistic indulgences, Queen may lose perspective and not quite be able to be totally independent.

First off, there are four members of Queen, and they all write, all have their separate musical directions, and all are at different stages of aesthetic development. Roger writes one song per album, and it's usually a fairly simple, effective one he sings himself. This time Roger's got what is potentially a fine song, *Drowse*, with an excellent backing track but a just incomprehensible vocal (and Roger does have a strong voice when used properly). John Deacon has only emerged as a composer on the past two albums,

last time coming across with a fine pop single, and this time his *You and I* stands not as a single but as one of the outstanding tracks on the album, extremely melodic and featuring one of Freddie Mercury's finest vocal deliveries to date. Then we come to Fred, the front man in Queen, the focus of mucho attention, and whose songwriting has been moving further from the rock base recently. Unfortunately, Fred seems to have paid more attention to the presentation of his songs than to the content of the songs themselves—*Somebody to Love* and *Good Old-Fashioned Lover Boy* are campy and cute, but the rest of his songs seem to be far more concerned with form than substance. As a singer he keeps getting better, but as a musical force in Queen he's pursuing a direction which doesn't seem to be taking him anywhere but in an endless circle. Brian, who is my favorite member of Queen, has come across with two of the all-time great Queen songs, *Teo Torriate* and the exquisite *Long Away*, the latter sung by Brian himself. Mr. May's guitar playing is his best since the first two Queen albums (overall, the best they've delivered to date), and on only one, *White Man* (which sounds a little too much like *The Prophet Song*) does he fall from his usual standard of quality. *Tie Your Mother Down* is his (in his own words) "stupid rock contribution," and although it doesn't exactly break new ground, it works well.

So what do we have at the final tally? Three good songs per side (out of a possible six), a very good sounding record which in the long run will still come out smelling like a rose compared with the majority of the record albums released. For the first time since the second album, Brian's pro-



Enter No. 15 on Reader Service Card

portion of creativeness and strength is on a par with Freddie's—and perhaps actually outweighs Mr. Mercury's.

It seems Brian knows better how to handle the production reins once they're handed to him, not that there are any tracks on the album which are particularly *bad*; it's just that Brian's tunes seem to hit the mark more often than not, while Freddie's toying with ideas which aren't so much Queen songs as solo excursions. As Freddie is such an excellent singer, a fine rock composer, an excellent keyboard player, and the perfect match for Brian May, I would hope that the group would hold together, but it seems more and more like Fred is leaning away from the group (who barely play on his songs anymore—it's almost all done with vocals and piano nowadays) and looking to do something on his own. I'd think a Freddie Mercury solo album might be a fine idea at this point just so that he can get all the *You Take My Breath Away*'s out of his system and get back to the frame of mind which produced great rock songs like *Ogre Battle* and *Liar*. In fact, I might venture to say that unless such an outlet is provided for Mercury, Queen is destined to split in the next few years—and I think that with endurance on their side, Queen could be one of the strongest musical institutions of the Twentieth Century.

J.T.

Sound: A Performance: B+

Volunteers

Arista 4103, stereo, \$6.98.

No Strings: Ace

Anchor AN 2020, stereo, \$6.98.

Ace and Volunteers are both fine bands with something going for them. Ace had a hit, *How Long*, about two years ago, but no successful follow-up. Two albums later they are still playing the same song with slight variations but named *I'm Not Takin' It Out on You* and *Found Out the Hard Way* this time around. They have acquired a new producer in Trevor Lawrence who has done his job well in giving the group as strong a sound as possible. But in the lifetime of all bands, there is a time when a groove becomes a rut. **No Strings** is certainly a better record than the lackluster **Time for Another** but not up to the debut **Five a Side**.

Volunteers centers on George Clinton (not the Parliament-Funkadelic one) and Wayne Berry, who cut a good solo album which appeared about 18 months ago and had a bunch

An Excellent Loudspeaker Needn't Cost A Fortune The Polk Audio Monitor Series



These three loudspeakers cost \$79, \$129, and \$199 each. They sound remarkably similar to each other. They also sound remarkably similar to speakers which sell for three, four, or five times as much.

The Polk Audio Monitor Series (even the Mini-Monitor Super car speaker) all incorporate a one-inch soft-dome high frequency unit, a phase coherent crossover using large air core coils, ultra-low mass plasticized polymer laminate upper bass-midrange drivers and fluid coupled sub-bass radiators. The sound is natural, boxless, and of consistent high definition.

We invite you to visit the finest audio salons to compare our speakers with the best made (costing up to \$4000 a pair!). Be ready for an ear-opener.

Write us to find out where.

polkaudio

1205 S. Carey St.
Baltimore, Maryland 21230

FREE McIntosh CATALOG and FM DIRECTORY

Get all the newest and latest information on the new McIntosh Solid State equipment in the McIntosh catalog. In addition you will receive an FM station directory that covers all of North America.



MX 113

FM/FM STEREO - AM TUNER AND PREAMPLIFIER

**SEND
TODAY!**

McIntosh Laboratory, Inc.
East Side Station P.O. Box 96
Binghamton, N.Y. 13904
Dept. 1

NAME _____

ADDRESS _____

CITY _____ STATE _____ ZIP _____

If you are in a hurry for your catalog please send the coupon to McIntosh.
For non rush service send the *Reader Service Card* to the magazine.

Enter No. 16 on Reader Service Card

of gems on it. The band is not unlike Firefall, and in fact shares a producer in Jim Mason. Unfortunately the songs Berry and Clinton have come up with this time around cut a promising band down to average. What Volunteers lacks now is identity, and if they can survive, time might well take care of that problem. *M.T.*

Sound: C+ Performance: C+

Sunday Street: Dave VanRonk
Philo 1036, stereo, \$6.98.

Dave Van Ronk's first album for Philo is one of his very best. The entire

album is a solo performance of many long time Van Ronk favorites, like Joni Mitchell's *That Song About the Midway* and *Would You Like to Swing on a Star?* No Van Ronk collection can be complete without some blues and Dave has included Scrapper Blackwell's *Down South Blues* and Jelly Roll Morton's *Mamie's Blues*, plus the gospel song *Jesus Met the Woman at the Well*. A pair of guitar instrumentals showcase Dave's classy abilities, Scott Joplin's famous *Maple Leaf Rag* and another very difficult Morton piece, *The Pearls*. The title track is a rare Van Ronk original song. **Sunday Street** is

basic Van Ronk, quintessential Van Ronk. *Michael Tearson*

Sound: A- Performance: A

David Allan Coe Rides Again: David Allan Coe

Columbia KC 34310, stereo, \$5.98.

David Allan Coe Rides Again has every right to be as serious a phenomenon as Willie Nelson's **Red Headed Stranger** was in 1975. It marks the full flowering of one of country music's most intense people. Each side is fully segued into a whole. The first side is the killer. Framed by Coe's hit paen to the new outlaw music *Willie, Waylon and Me*, it is as lucid a presentation of that music's power as I have heard, and an excellent example of how well an album side can be put together.

David Allan Coe is a hard dude to ignore under any circumstances, and when his music is as strong as it is on **Rides Again** he's impossible to ignore. *M.T.*

Sound: B Performance: A

Now: The Tubes

A&M SP-4632, stereo, \$6.98.

The Tubes Now is no more immediate, exciting, or listenable than its two predecessors—which, I'd suppose, isn't bad if that's your idea of a hot new thing or even, as some have suggested in print, indeed *The Next Big Thing*. Musically speaking, they play with talent and precision but have a sense of musical composition which is far more vacuous than even Ringo Starr's. They draw heavily from Frank Zappa and Todd Rundgren in terms of a musical style and often bring in outside songwriters to fill up the gaps on their albums. Unfortunately, they haven't been able to come up with any *outside* compositions which are good songs and fit their group sound/image. Onstage they're an outrageous bunch of loonies; on record they're merely dull and incredibly serious. Even the best of producers, the cutest stage show, and the most heavily-financed tours cannot make up for a lack of right musical notes. Perhaps with an entire album of unoriginal material, they could come up with at least one or two songs that could stand up all the way through, but they've struck out three times doing what they're doing, so I hope they'll try something new. *Malicious*

Sound: B+ Performance: D+

AUDIO • September 1977



the all new Spectro 500 Power Amplifier

The Spectro Model 500 power amplifier is another first in power, performance and beauty. Spectro has put it all together with 250 watts RMS per channel for quality conscious audiophiles who know what they want in a power amplifier. Put the Spectro 500 through its paces for yourself and hear what words can't describe; performance at its best. This sophisticated Spectro 500 is available in cabinet or rackmount with a highly accurate LED display. The works are mounted in Spectro SCAMP™ plug-in modules which are a standard easy access feature of the entire Spectro Acoustics power amplifier line. For complete specs on the model 500 power amplifier, contact Spectro Acoustics.

- Power Output: 250 watts RMS per channel.
- FTC Rating: Both channels driven, 8 ohms, 20Hz to 20KHz, with less than .25% THD.
- Typical Power At Clipping: 325 watts RMS per channel.
- Distortion: THD—less than .25% at any frequency between 20Hz and 20KHz and at any power level from 250mW to 250W into 8 ohms.
- IM—less than .25% standard SMPTE test frequencies, 60Hz and 7000Hz, mixed 4 to 1, at any power level from 250mW to 250W into an 8 ohm load.
- Frequency Response: 20Hz to 20KHz ± 0.1dB.
- Hum & Noise: Better than 103 dB below full output, unweighted.
- Sensitivity: 1.5V RMS input for 250 watts into 8 ohms.
- Damping Factor: -- 150+ at 20 cycles.
- Stability: -- Unconditionally stable under any load, including electrostatic speakers.

SPECTRO ACOUSTICS

3200 George Washington Way Richland, Wa. 99352 (509) 946-9608
TC ELECTRONICS 720 Marin Ave. Montreal Quebec (514) 937-9496
Overseas: FIMC 30 Greenhill Rd. Westwood, Mass. 02090

Enter No. 40 on Reader Service Card

Dickey Betts & Great Southern
Arista 4123, stereo, \$6.98.

With Great Southern, his new band, Dickey Betts unashamedly picks up the grand Allman Brothers Band tradition. The new band has the same twin lead guitar, twin drummer, keyboard, and bass line-up the original Allman's sported. Not surprisingly, the music is Southern rock 'n' roll, with a nice ballad or two thrown in. The drive of *Out to Get Me* and *Nothing You Can Do* set the pace. *Run Gypsy Run*, sounding a lot like Betts' classic *Ramblin' Man*, is a prime track, too, as is the dreamy finale *Bougainvillea*.

The album's major flaw is the lack of a thoroughly forceful, immediate sound. It's as if the cuts were wrapped in tissue and subtly muted. Still it's a good album with lots of room for growth.

It's always rewarding to see an artist return to his strengths after a period of experimentation. The result usually shows maturity and new contentment. That is certainly true here. *M.T.*

Sound: C+ Performance: B+

Get It: Dave Edmunds
Swan Song SS 8418, stereo, \$6.98.

It's hard to describe this album without getting self-conscious. But take *Here Comes the Weekend*, a wonderful mock Everly Brothers song Dave Edmunds wrote. Or his match-it-up remake of Elvis' version of *My Baby Left Me*. Or the Beach Boys vs. Phil Spector arrangement of *Where or When* (of all songs). Or the flat out rock & roll that opens the two sides, Bob Seger's *Get Out of Denver* and *Juju Man* written by Jim Ford and Redbone's *Lolly Vegas*. Dave Edmunds recreates the past in his own image, but utterly without malice while obviously brimming with joy, wit, and reverence in balancing proportions.

Dave Edmunds' *Get It* is a small masterpiece. The title says it. *M.T.*

Sound: A Performance: B+

No Reason To Cry: Eric Clapton
RSO Rs-1-3004, stereo, \$6.98.

Not too surprisingly, the new Eric Clapton album is a sometimes confusing affair. Of course, there's the obligatory all-star cast as well as quite a bit of the band Eric has had virtually intact since his comeback album **461 Ocean Boulevard**. The all-stars contain some surprises. For instance who

could have expected *Sign Language*, a Bob Dylan-Eric Clapton duet on a new Dylan song? Or the traded vocals of Clapton and Richard Manuel backed by the whole of The Band on *All Our Past Times*? Others who appear include the ubiquitous Ronnie Wood and Georgia Fame.

Carnival, *Hello Old Friend*, and *Hungry* are much like what the last several albums have been about, nice songs but with a bit more spark especially on *Hungry*. *County Jail Blues*

and Otis Rush's *Double Trouble* have the best blues work Eric has recorded in years.

Glaringly absent is a set of "who plays what and were" credits. I know I sure appreciate things like that. While question marks certainly remain, **No Reason to Cry** is surely the best post-Derek & the Dominoes work Clapton has produced. That's gotta mean something, but I'm not quite sure what. *M.T.*

Sound: A Performance: B

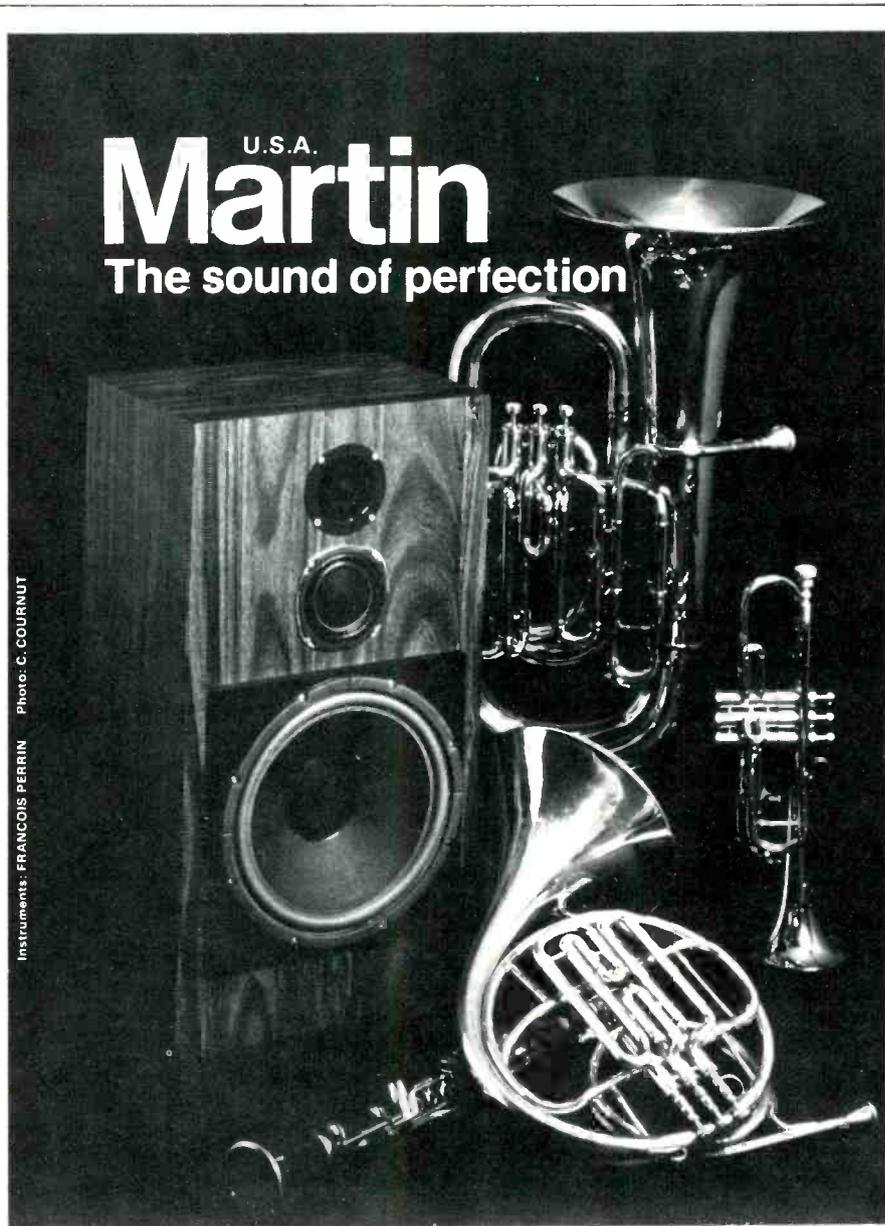

Superb speakers From \$80 to \$600

Martin Speaker Div., Eastman Sound Mfg. Co., Inc., Mickleton, NJ 08056 • 609/423-0100

Jazz & blues



92

Captain Marvel: Stan Getz
Columbia KC 32706, stereo, \$5.98

Columbia sat on these Getz recordings for three years before releasing them under the title **Captain Marvel**, and this writer kept this release under wraps (to be more accurate, under a large pile of incoming releases), for another year and a half before reviewing it for *Audio*. My apologies to Mr. Getz and to Columbia for this is a first rate collection of some of the finest Getz of the 70s. It features a key group of young contemporary jazz musicians who have been a vital part of the "crossover" jazz movement—Chick Corea on electric piano, Tony Williams, drums; Stanley Clarke, bass, and Airtio Moreira, percussion. I heard this Getz combo at New York City's Rainbow Grill in the summer of '72 and was greatly impressed, particularly with Corea; Columbia must have recorded these sessions about the same time.

Captain Marvel showcases Getz at his best; he is undoubtedly one of the most important tenor saxophonists in jazz, capable of blending a natural delicacy of tone with real fire and drive. Nowhere are these qualities better displayed than on *La Fiesta*, a fine Chick Corea original. The young composer's inventive mind and sparkling piano style seem perfectly suited to the Getz approach. *La Fiesta* shifts tempos from fast to slow choruses, with Getz blowing hot and cool, threading in and out of Corea's fluid runs and the complex rhythmic patterns woven by Williams, Clarke, and Airtio.

Captain Marvel, the title track, blends the intense, driving cross rhythms of Williams, Airtio, and Clarke with Getz' and Corea's thoughtful solo lines. The rhythmic interplay is particularly brilliant on *Waves* with Clarke's finely syncopated ostinato patterns blooming into a supple solo. Clarke's work on this track, and

throughout the album, indicates why he is one of the most admired bassists in jazz. Drummer Williams and percussionist Airtio work smoothly in tricky time signatures, providing subtle percussive power that underscores and enhances, but never detracts from Getz' and Corea's playing.

Getz also has a dreamy, melancholy, yet sinewy solo on *Lush Life*, that is a definitive interpretation of the Billy Strayhorn tune. Too bad these splendid musicians couldn't stay together as a permanent combination, but Corea, Clarke, Williams, and Airtio have moved on to become important names in contemporary jazz with successful groups of their own.

Columbia's fine recording offers impressive clarity; every solo and rhythmic nuance is sharply defined.

John Lissner

Sound: A+ Performance: A+

AUDIO • September 1977

V.S.O.P.: Herbie Hancock
Columbia PG 34688, stereo, \$8.98.

Herbie Hancock's career can be seen as a microcosm of the last 15 years of jazz with **V.S.O.P.** as a grand summary. It was recorded at a 1976 Newport Jazz Festival concert called "A Retrospective of the Music of Herbie Hancock" which ear-witnesses tell me was an outstanding event. Though Herbie's notes play down the Event angle — "Everybody just wanted to get together and play" — it was an Event indeed.

Three bands performed that night. Sides One and Two present a classic quintet of Hancock, Ron Carter, Wayne Shorter, and Tony Williams, with Freddie Hubbard in the place of the then-ailing Miles Davis. They play a spectacular *Maiden Voyage* and a gorgeous *Nefertiti*. The joy of the reunion is the only thing electric in the stage at this point. These guys Herbie calls "The Greatest."

When **Bitches' Brew** broke electric jazz wide open in 1969, Hancock was there, and when he left Miles, he formed his own amplified band, the Mwandishi band, who play on Side Three. Their intent was to explore the spacy, heady regions just opened up. This band was mainly an electrically amplified version of what had come before. This band Herbie calls "The Finest."

In 1973, Hancock's **Head Hunters** album first offered the highly controversial funk-jazz approach relying on all sorts of electronic gadgets, and Side Four showcases his current version of that band featuring Wah Wah Watson as chief motivator. Hancock is obviously aware of the distaste many of his old-line fans have for this newest form, for his notes include his description/apologia for the trend pointing out that the contrast between the dense bottom and the soaring improvisation is what propels it. And there's no denying that Herbie's band is as good as they come, playing sets driving and hot, yet uncluttered.

From acoustic to electric to electronic, Hancock has been a leader. **V.S.O.P.** is a tribute and a history, and I feel lucky it's on record.

Michael Tearson

Sound: A Performance: A

The Complete Lionel Hampton, 1937-41

RCA AXM 6 5536, mono, six records, \$23.98.

The vibraphone was not thought of as a jazz vehicle until Lionel Hampton came along and put some life into it.

AUDIO • September 1977



**Before
you buy
stereo
headphones,
get
some
good
advice.**

Theirs:

93

Julian S. Martin

HI-FI STEREO BUYERS' GUIDE, March-April, 1976

"Superb from every viewpoint. An outstanding achievement in headphone design. One of the most comfortable."

The Len Feldman Lab Report

TAPE DECK QUARTERLY, Winter, 1975

"Response of these phones extends uniformly from 20 Hz to over 22,000 Hz with no more than ± 2 dB variation over this entire range...this is nothing short of incredible."

New Equipment Reports

HIGH FIDELITY, January, 1976

"The sound quality the AT-706 presents [to you] is exceptional: very wide range and smooth...Within this excellent operating range the sound is exceedingly clean and open...an extremely fine stereo headset."

If you asked the critics they'd tell you to listen critically to a variety of products before you buy. We agree. Because the more carefully you listen, the more you'll be impressed by the sound of Audio-Technica.

AT-706

Electret Condenser

Stereo Headset \$129.95

Our finest Personal Transducer



audio-technica®

® INNOVATION □ PRECISION □ INTEGRITY

AUDIO-TECHNICA U.S., INC., Dept. 97A, 33 Shiawassee Ave., Fairlawn, Ohio 44313
Available in Canada from Superior Electronics, Inc.



DIXIE HI-FI SAVE ON
Brand Name Audio Components

BY MAIL

Write Today for Our FREE Audio Catalog

DIXIE is one of the oldest and largest stereo mail order houses in the country. Our lower prices on brand name components can save you real money. Call us today for a price quote, toll free (800) 446-7925, in Virginia call (804) 257-4241. Everything shipped in factory sealed cartons with manufacturer's warranty.

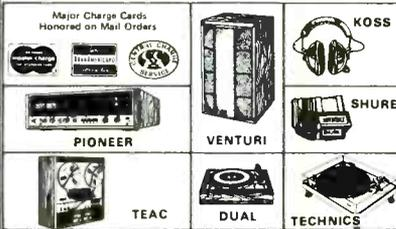

DIXIE HI-FI

P.O. Box 6496
 Richmond, Va. 23230

AM-9

Please rush me your FREE Audio Catalog and complete information. I understand there is no obligation.

Name _____
 Address _____
 City _____ State _____ Zip _____
 Phone (____) _____ A.C. _____

Enter No. 6 on Reader Service Card

Though Red Norvo was playing the xylophone in the early and mid-30s, it was Hampton who transformed the xylophone's more resonant cousin into an infectious jazz instrument.

Featured with the Benny Goodman Quartet in 1936, Hampton and his swinging vibes became nationally famous within a year. In 1937, he began a series of remarkable studio record sessions for the Victor label. This six-record boxed set, produced by Frank Driggs for RCA's Bluebird reissue series, includes all of the sides (plus alternate takes) Hamp cut between 1937 and 1941 with all star ensembles chosen from the top name bands of the Swing Era, including the Benny Goodman, Fletcher Henderson, Count Basie, Duke Ellington, and Cab Calloway orchestras.

The caliber of musicianship is consistently brilliant. The names of all the great sidemen involved would take up too much space, but one must single out Chu Berry, Benny Carter, Cootie Williams, Nat Cole, Johnny Hodges, Ben Webster, Coleman Hawkins, Herschel Evans, Rex Stewart, Harry James, and Ziggy Elman. Their work, as showcased in this collection, is exciting, authoritative Swing Era jazz played at the very peak of perfection. The fine musicians heard here combined superb technical mastery with an easy, natural bouyancy, and concise creativity.

Lionel Hampton's presence on these dates unquestionably exerted a catalytic influence. There is something intensely infectious about the man and his playing, and the incredible zest and swagger of numbers like *Gin For Christmas*, *Ring Dem Bells*, *Jivin the Vibes*, and *Rook Hill Special* is partly due to his great imagination, enthusiasm, and seemingly inexhaustible energy. This unrelenting drive made him the centrifugal figure around which these various jazz groups coalesced, his strong rhythmic feeling drawing together a remarkable collection of musicians from diverse backgrounds.

What is particularly enjoyable and incredibly stimulating is the tremendous ensemble feeling of the Hampton groups, and the brevity and pithiness of the solo work. There are none of the tedious, long-winded solo round-robins common in the modern jazz era. Saturday Review critic Stanley Dance, an acute observer of Swing Era jazz, made these astute comments about the Hampton swing sessions:

"It must be recognized that the musical discipline of the big band, coupled with the experimental opportunities of the jam session, contributed enormously to the consistently high standard

of the Hampton-Victor sessions. The leading musicians of the day were limited to the confining length of the 78 rpm disc, consequently they edited themselves, and what they had to say was consistently fresh and pithy. Moreover, their everyday band experience always kept them conscious of ensemble values and dynamics."

The June 6, 1939 session is a particularly good example of the smooth and jumping ensemble swing feeling; the finely blended sax section (tenor Chu Berry from Cab Calloway; tenor Jerry Jerome and alto Hymie Schertzer from Benny Goodman; alto saxist Russel Procope from John Kriby) is mellow and relaxed, the incisive clarity of trumpeter Ziggy Elman as he solos on *If Its Good and Ain't Cha Comin Home?* (Ziggy's gentle, muted chorus on the latter is gorgeous) is pure delight. There's tremendous pleasure in hearing the Benny Carter-arranged session of September 11, 1939 which includes the ebullient *When Lights are Low* (with Coleman Hawkins, Benny Carter and an outstanding rhythm section) and a driving *Hot Mallets* (with Dizzy Gillespie, Carter and Chu Berry); the Carter-Hawkins combination offers more kicks on the splendidly riffing *Dinah*, recorded Dec. 21, 1939. An October 12, 1939 recording session gives us *Haven't Named It Yet* featuring trumpeter Red Allen, guitarist Charlie Christian and alto man Earl Bostic plus powerful vibes work by Hamp; for sheer, bounding swing, this cut is unbeatable.

The relaxed and beautiful *On the Sunny Side of the Street*, recorded April 26, 1937, reaches another artistic peak. The elegant sweep of Johnny Hodges alto on the first chorus, Hodges sympathetic obligato behind Hampton's vocal, his intuitive support during the last vibes chorus, and Jess Stacy's perfect piano accompaniment, make this a jazz performance of classic proportions.

Hampton's vocals are the only drawback to this voluminous collection. There are too many of them; while Hamp sings with an engaging rhythmic feeling, his vocal qualities are modest to say the least. Aside from that criticism, *The Complete Lionel Hampton, 1937-41*, documents Hampton's skill at producing session after session of what can truly be called swing classics, jazz performances that have a freshness and a vitality that transcend time. The RCA sound transfer job is, as usual, first class.

John Lissner

Sound: A- Performance: A+

94

Top Discount AUDIO

Your NATIONAL HEADQUARTERS

For Famous Brand Electronics By Mail

1150 N. Powis Rd., West Chicago, Ill. 60185 • (312) 293-1825

All Orders Shipped In Factory-Sealed Cartons

Write Or Call For The Lowest Prices Anywhere!

MILLION \$\$\$ INVENTORY

LOWEST PRICES ON

- RECEIVERS
- SPEAKERS
- TAPE DECKS
- CALCULATORS
- TURNTABLES
- CHANGERS
- AMPLIFIERS
- COMPACTS
- TUNERS
- CARTRIDGES
- HEADPHONES
- CAR AUDIO

Top Discount Audio 1150 N. Powis Rd. West Chicago, Ill. 60185 (312) 293-1825

AM-9 We honor Master Charge and Bank Americard. Date _____ Please send me a quote on: _____

MR MS
 (First) (Initial) (Last)
 (Number And Street)
 (City) (State) (Zip Code)

Enter No. 23 on Reader Service Card

Folk bag

Tom Bingham

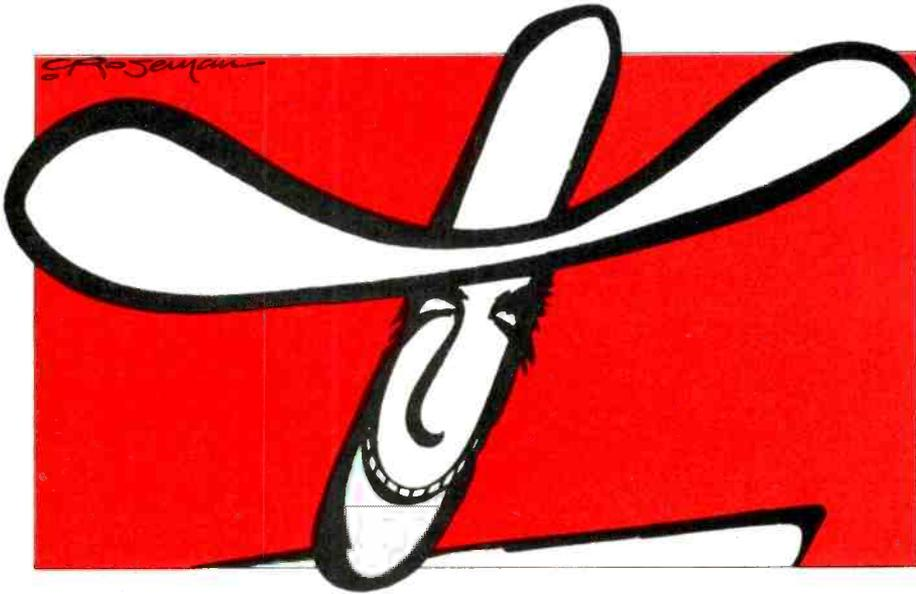

The Late Bob Wills' Original Texas Playboys Today
Capitol ST 11612, stereo, \$6.98.
Brother Al Stricklin Now
Texas Re-Cord LP 1004, stereo, \$5.00.

Despite the prominence of Bob Wills' name on the cover, Capitol's **Original Texas Playboys Today** is actually a recent recording by several former members of Wills' band under the direction of steel guitarist Leon McAuliffe. Even though Wills was not physically present, his shadow hangs over the proceedings perhaps a little too darkly.

Not all the eight musicians here can genuinely be called "original" Texas Playboys. Only three—McAuliffe, drummer Smokey Dacus, and pianist Al Stricklin—were with the Wills' band that recorded *Osage Stomp* in Dallas on September 23, 1935. Joe Ferguson joined only a year later, so he can be justified as an "original" as well. However, fiddlers Johnny Gimble and Keith Coleman didn't join until 1949, and singer-guitarist Leon Rausch came along in 1958, but I've never heard of guitarist Bob Kizer in connection with Wills.

Truth in packaging aside, this is an enjoyable session by eight veteran masters of the Western Swing idiom. Eight of the ten songs (including Ferguson's vocal feature, *You're O.K.*,

The Convict and the Rose, *Lily Dale*, and *Sugar Moon*) are all from the Bob Wills repertoire, while *T-U-L-S-A Straight Ahead* and *Panhandle Rag* represent McAuliffe's great post-Wills band.

The performances are smooth, the only bumpy edges (and I mean that as a compliment) coming from the irrepressible Al Stricklin. Everyone plays as well as ever, but the problem is that there's no real challenge to the music; everything is safe and comfortable.

What made Wills' originals so earthy and exciting was his reckless daring, his continual making of new and breaking of old rules as the mood struck him, often in mid-song. The present album, however, is overly reverent to a glorious past, and the musicians' styles are too settled. Consequently, the album comes off a bit bloodless, too "easy." Nevertheless, while no momentous surprises are forthcoming, it certainly is a pleasant, entertaining, and welcome opportunity to hear the old giants of Western Swing still keeping the faith.

The recording is as smooth and clean as the music. The rhythm section, always difficult to distinguish on Wills' old 78s, benefits in particular. Stricklin's skill as an accompanist is fully audible for the first time, but the surface of my copy is inexcusably noisy at the beginning of each side.



The B&W DM 6 linear phase dynamic loudspeaker is new, English, strange-looking (for a good reason), controllable, indestructible, powerful, "outstandingly good," "clean," "natural," "smooth," "silky," has an excellent pedigree, and requires at least six pages to explain fully. We'd like to send you copies of those pages. Write, please.

B & W Loudspeakers

c/o Anglo-American Audio Co., Inc.
P. O. Box 653
Buffalo, N.Y. 14240 U.S.A.

Enter No. 3 on Reader Service Card

Give Your Tonearm a Lift ... with the Amazing Stylift

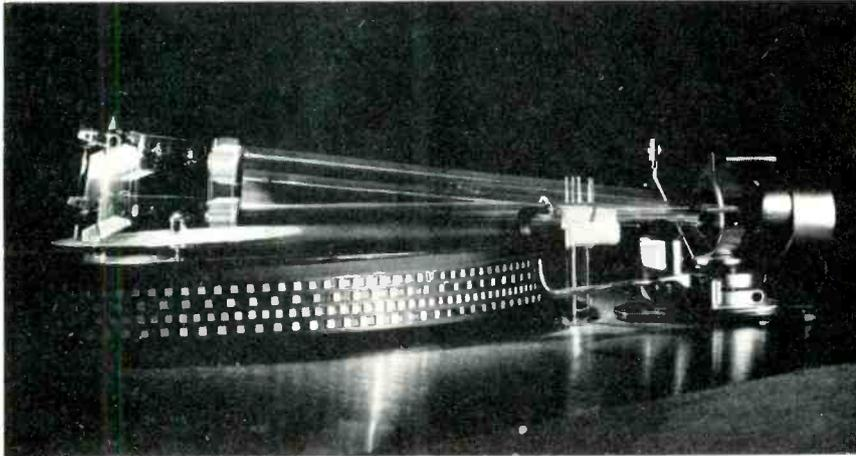

Stylift — Your records will thank you
No more dropped tonearms, damaged cartridges and records. It's the Stylift — a revolutionary new device that automatically lifts the tonearm off the record surface at the end of play.

Designed especially for manual turntables

Stylift is a unique mechanical device that uses no magnets, solenoids or photo-electric devices. The precision device is absolutely maintenance-free — no wiring is necessary and mounting the Stylift is simple and easy.

Here's how it works

The tonearm moves toward the center of the record at the end of play (Fig. 1). The

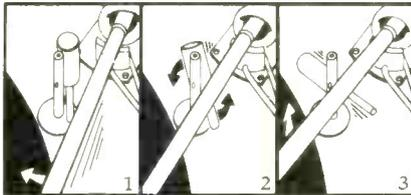

tonearm touches the Stylift, overbalancing the counterweight (Fig. 2) which revolves, gently lifting the arm directly and vertically off the record surface (Fig. 3). Stylift eliminates those annoying click-click-clicks at the end of record play; it helps prevent the stylus from scratching the grooves while lifting the tonearm.

Specifics

Stylift will work with all manual turn-

tables and their tonearms. Stylift easily lifts tonearms tracking up to two grams and even has a special counterweight attachment for heavier tracking tonearms.

A minimum of 1 $\frac{3}{8}$ " (35mm) of height between tonearm and base is required for proper functioning of the Stylift. The Stylift is made of polished chromium steel (no plastic) and will provide years of trouble-free "protection" and convenience for your tonearm and cartridge.

Order Now

To order your Stylift, enclose a check or money order (NO CASH PLEASE) for \$19.95 for each Stylift desired, plus \$1.50 for postage and handling. (California residents: add 6% for sales tax.) Use the attached coupon.

You may use your BankAmericard/Visa or Mastercharge card by entering your account number in the proper space provided. Be sure to sign the form.

Please allow three to four weeks for delivery of your Stylift.

SATISFACTION GUARANTEED. If not completely satisfied, return within 10 days.

Stylift is distributed by AudioSource, Foster City, California

AudioSource

1185 Chess Drive
Foster City, Calif. 94404

One of the many delights of Bob Wills' original band was Al Stricklin's stomping barrelhouse piano. Now in his late 60s, "The Old Piano Pounder" has finally been given the opportunity to show what he can do on his own.

Brother Al Stricklin Now is not strictly speaking a Western Swing album. Though he influenced virtually every Western Swing and country pianist who followed after him, Stricklin was a jazz musician before and during his six-year tenure with Wills, and is still more a jazz musician than anything else. On the other hand, jazz has changed a lot in 40 years, while Stricklin hasn't.

Brother Al's special Texas-jazz style fuses ragtime (the steadily pumping left hand), barrelhouse, blues (his broad intervals and the fits and spurts from the right hand), New Orleans jazz (his rhythmic sense and many of his chordal voicings), country (much of his melodic approach), and even pop (his somewhat commercialized style on standards like *The Old Piano Roll Blues* and *Dark Eyes*) piano traditions. Thankfully, he still has the playful, hard-pounding attack that made his work with Wills in the 30s so recognizable.

The album's highlights are remakes of four of Bob Wills' most famous compositions (the obligatory *San Antonio Rose*, *Maidens Prayer*, *Faded Love*, and *Take Me Back To Tulsa*). Also worthy of mention are two highly likeable Stricklin originals, *Al's Rag* and *Live Bait*.

The piano sound is excellent, but the guitarist could have used more volume in the solo spots. The bass and drums are well into the background which suits their decidedly auxiliary roles. The surface of the disc is alternately noise free and crunchy.

The Stricklin album is available from the Texas Re-Cord Co., P.O. Box 19, Bulverde, TX 78163.

Original Texas Playboys

Sound: B+ Performance: A-

Al Stricklin

Sound: B Performance: B+

Mom's Favorite/Irish Music In America: Dayhills

Biscuit City BC 1308, stereo, \$6.98.

The Dayhills are an Irish-American vocal-instrumental trio with a fresh, invigorating, contemporary approach to traditional material. Their broad repertoire includes several different types of new and old songs, plus traditional instrumental dance pieces as well.

AUDIO • September 1977

Detach and tear-off

Please send _____ Stylift(s) for \$19.95 each. Total _____
Add postage and handling of \$1.50 (each). \$1.50
(California Residents: add 6% sales tax.)
TOTAL _____

I enclose check _____ or money order _____
Charge my BankAmericard/Visa _____ Mastercharge _____
Account No. _____
Signed _____
Mail Stylift(s) to:
Name _____
Address _____
City _____ State _____ Zip _____

Place this coupon in an envelope along with your remittance and mail to AudioSource, 1185 Chess Drive, Foster City, Calif. Orders received will be processed immediately; however, please allow three to four weeks for delivery.

The trio's basic instrumentation is flute (Barbara Dahill), mandolin (Tom Dahill), and guitar (Charlie Heymann), but Tom doubles on fiddle, bodhran, and guitar, while Charlie is proficient on concertina, mandocello, and accordion. Barbara's concert flute has a lovely, bird-like tone which blends beautifully with Tom's vocal on *Step It Out Mary* and *The Homes of Donegal*, and is wispily dulcet on the jig *The Three Little Drummers* and hornpipes *Kitty's Wedding/The Echo*. On these three dance tunes, the trio fashions a sound which is delicate and finely polished without losing its traditional flavor. The other instruments are more on the rousing side, including the up-and-at-'em medley, *Barbara Dahill's Flute/Sporting Pat/Scotch Mary*, with overdubbed bodhran by Tom and reedy button accordion by guest Pat Flanagan (who also plays on the snappy *Jim Kennedy's Reel/Sandy McIntyre's Trip to Boston*); and the infectious Kerry slides *O'Keefe's Slides/Mom's Favorite*, with dancing mandolin and trilling flute over Charlie's hopping concertina.

Tom handles most of the lead vocals in a clear, carefully-phrased voice with sensitive ornamentation. He's equally at home with the lighthearted *Step It Out Mary* and more serious material, such as the historical *Come All Ye Brave and True Irishmen* and Phil Coulter's sad commentary on the harsh realities of the present Ulster conflict, *The Town I Loved So Well*. On the other hand, Tom lacks the drollness needed to pull off the comedic song-narration in *Martin Sheary's Ball*. His mandolin work is soft-toned and admirably dexterous.

Charlie sings *The Connemara Rose* and *The Nightingale*, both lovely ballads with fine lyrics and memorable tunes. Though his voice strains on the high notes, he sings with sincerity and sensitivity to the lyrics. His guitar work throughout the album is quietly understated and intelligent.

The recording is quite good, but with a few glaring flaws. Tom's unaccompanied vocals (*Come All Ye Brave and True Irishmen* and *Sean O'Dwyer of the Glen*) have an exaggerated, cavernous echo, Charlie's accordion on *The Homes of Donegal* has a murky sound to it, and Tom's fiddle on *The Nightingale* is rather distant. The reels ending side one are cluttered and somewhat hard to follow; a wider separation might have helped there. These exceptions aside, the flute and stringed instruments are neatly balanced, with the vocals clear

and upfront. The surface is respectable.

Available from Biscuit City Records, 1106 East 17th Ave., Denver, CO 80218.

Sound: B — Performance: A —

The Piper's Broken Finger: The Boys of the Lough
Philo 1042, stereo, \$6.98.

The Boys of the Lough, on this their fifth album, are as traditional as ever,

but this time they've added some extra elements for spice... Gilles Lossier's piano on *Da Sixereen/Gordon's Favourite* medley and the piping of Finlay MacNeill on several tracks. Maybe it's just that this is an excellently paced album, but the Boys have never sounded so fine. They've done the odd traditional song mixed between the jigs, reels, and hornpipes that make up the meat of their music. Their playing is both exuberant and confident. The material avoids the hackneyed and retains its freshness.

AND NOW, A WORD ABOUT OVERLOAD, FROM SENNHEISER'S MD 421:

NONE.*

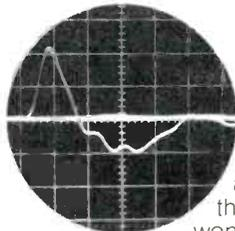

A lot of musicians are worried about overload these days. And no wonder: special effects, high amplification and combinations of acoustical and electronic instruments all make it more necessary than ever for microphones to be overload-free as well as accurate.

Like our tough MD 421 cardioid dynamic

In a test beyond what any musical instrument or voice can produce, we used a starter pistol to produce an instantaneous sound-pressure level of 175 dB, which the MD 421 handled with no trace of distortion.

*Outdoor test with Tektronix scope, set for 10V/division vertical, 0.1 μsec/div horizontal. 22 cal. starter's pistol mounted 15 cm from MD 421 measured pressure of 111,000 dynes/cm² (175 dB SPL). Smooth, rounded scope trace indicates total lack of distortion.

Whatever your application — sound reinforcement, recording or broadcasting — consider our MD 421. Besides freedom from overload, you'll discover its precise cardioid directionality, rugged design and wide, smooth response give you superb results. Even under difficult conditions.

The price won't overload you, either.

SENNHEISER

ELECTRONIC CORPORATION
10 West 37th Street, New York 10018 (212) 239-0190
Manufacturing Plant Bissendorf/Hannover, West Germany

TDK AMPEX
Minimum Order 12 Tapes

Blank Tapes
at wholesale prices!

CASSETTE TAPES

Audio Magnetics C-90 3pk	1 79 for 3
Maxell UDC-60	1 74
Maxell UDC-90	2 55
Maxell UDC-120	3 45
Maxell UDXL 1 or 2 C-60	2 22
Maxell UDXL 1 or 2 C-90	3 12
Memorex C-90 3pk	4 99 for 3
Scotch C-90 3pk	3 99 for 3
Scotch Master 1 C-90	2 79
Sony C-60	1 29
Sony C-90	1 79
Sony C-120	2 29
TDK D C-60	1 14
TDK D C-90	1 56
TDK D C-120	1 98
TDK D C-180 (180 minutes)	2 88
TDK AD C-60	1 62
TDK AD C-90	2 40
TDK AD C-120	3 30
TDK SA C-60	1 98
TDK SA C-90	2 88

REEL-TO-REEL

Maxell UD50 60 1200 ft	3 87
Maxell UD35 90 1800 ft	4 50
Maxell UD35 180 3600 ft 10 1/2	12 00
Scotch 206 1200 ft	3 99
Scotch 207 1800 ft	4 49
Scotch 212 1800 ft	3 59
Scotch 214 3600 ft	7 99
TDK L 1800	4 64

8 TRACK

Memorex 2 pk 90 min	3 59 for 2
Scotch 2 pk 90 min	3 59 for 2

J & R Music World
33 Park Row N.Y.C. 10038
[212] 732-8600

MAIL ORDERS ACCEPTED For shipment within 24 hours send money order or certified check. Two weeks delay on personal checks. Please add \$2.00 per order for shipping & handling. N.Y.S. Residents add applicable sales tax. NO C.O.D.s. Minimum Order 12 Tapes.

Write for prices on other tapes
Enter No. 38 on Reader Service Card

98

Now! Clean, Clear Sound At Higher Volume—

BEFORE

Vibrations Fed to Amplifier

AFTER

Clean Bass at Higher Volume

Lets You Use
MORE BASS
WITH LESS DISTORTION

Stereo muddy with volume up? Heavy bass causing speaker howl? These are symptoms of acoustic feedback caused by speaker vibrations being coupled to your phono cartridge, via floor and furniture. The result: distortion. Place our handsome vinyl walnut veneer **ACOUSTI-MOUNT** shock absorbing platform under your turntable for up to 30dB isolation. Helps even higher priced turntables. Hirsch-Houck Laboratories report "a record player on an Acousti-Mount can actually be placed directly on a loudspeaker cabinet with virtually no likelihood of feedback, even at a loud listening level." **Julian Hirsch for STEREO REVIEW:** "We doubt that any other \$15 investment could make such an improvement in a record-playing system." For further reduction of structure-borne vibration, use our compression-dampening polished aluminum-finish **SPEAKER PODS** under the four corners of your speakers—for up to 40dB isolation. They let you play your stereo louder without disturbing your neighbors! Use more bass, get less distortion. May allow reduced tone arm tracking pressure for longer stylus life. Guaranteed to increase your stereo's performance or your money back!

SEND TODAY

NETRONICS R&D LTD., Dept. A-9 Phone (203) 354-9375
333 Litchfield Road, New Milford, CT 06776

Please send: **SATISFACTION OR MONEY BACK**

— 16x13 1/2" Acousti-Mount turntable platform at \$15.00 plus \$1.50 postage & handling.

— 19x13 1/2" Acousti-Mount turntable platform at \$17.50 plus \$1.50 postage & handling.

— Speaker Pods at \$11.95 per speaker (4 pods) plus \$1.50 postage & handling per order. (Speakers over 45 lbs. Need 2 extra pods per 15 lbs. wgt.)

Total enclosed (Conn. res. add sales tax) \$
(Canadian residents please add \$1.00 per item.)

Name _____
Address _____
City _____ State _____ Zip _____

Check to receive information or direct drive turntable kits.

Enter No. 39 on Reader Service Card

As exponents of traditional Scottish and Irish dance music *The Boys of the Lough* are nonpareil, and *The Piper's Broken Finger* is a delightful record.
Michael Tearson

Sound: A- Performance: A

The Mac Wiseman Story
CMH 9001, stereo, two discs, \$9.98.

Mac Wiseman, "The Voice With a Heart," has recorded many bluegrass and country classics during his 30 year career. Nonetheless, he's never managed to capture the larger audience that has grown around other first-generation bluegrass idols. This is not a reissue, as the title might suggest, but a top-notch new recording of many of his hits.

Though Wiseman has done double duty as both a bluegrass traditionalist and a commercial Nashville performer (his gimmicky *Johnny's Cash* and *Charlie's Pride* was a country smash a few years back), this two-record album is pure bluegrass. Instrumental backing is provided by three members of the Shenandoah Cut-Ups, plus multi-instrumentalist Arthur Smith who concentrates mainly on mandolin, his jazz-tinged licks being perfectly suited to lightly swing-flavored tracks like *Love Letters In The Sand* and *I Wonder How The Old Folks Are At Home*. Smith also joins Cut-Up Tatter Tate for some sturdy twin fiddling on *I've Got No Use For The Women* and *The Girl In The Blue Velvet Band*, among others.

Nevertheless, this is Wiseman's show all the way. His sharp-edged voice, which by bluegrass standards is a high-baritone extending into the tenor range, is somewhat more hoarse than before, but he retains his careful, personalized phrasing, bending and extending notes so that they fairly drip with sadness. This is especially true on slow-tempoed material, like *Bringing Mary Home*, *I'll Be All Smiles Tonight*, and *Dreaming Of A Little Cabin*. Most of the songs, however, are done in varying degrees of midtempo, which perfectly suits his penchant for old-fashioned sentimental tunes.

His varied repertoire more closely resembles the country artists of the 30s more than modern-day bluegrass. He adapts traditional ballads, century-old sentimental standards, modern tragic narratives, pop songs, and occasional originals to his uniquely casual-yet-soulful style. The 19th-century sentimental song is a genre much maligned by folk historians, but Wiseman sings such tear-jerkers as *May I*

Sleep In Your Barn Tonight, Mister; *Little Blossom*, and the super-maudlin *The Baggage Coach Ahead* with a communicative story-telling sense and such genuine sensitivity that the listener cannot help but be convinced of his sincerity. This is equally true of their modern counterparts, like *The Ballad Of The Lawson Family* and *Little Box Of Pine*. Also noteworthy are remakes of the two songs most closely associated with Mac Wiseman, *Jimmie Brown The Newsboy* and *'Tis Sweet To Be Remembered*.

The recording is very good as is, though the accompaniment could have used a bit more oomph to match the vocal track. *The Baggage Coach Ahead* suffers from a crackling surface, but the rest of the album is unaffected in this regard. The four sides (20 tracks) total less than 55 minutes; Neil Rosenberg's thorough liner notes should serve as a model for future annotators.

Write to CMH Records, P. O. Box 39439, Los Angeles, CA 90039.

Sound: B Performance: A-

Journey's Edge: Robin Williamson & His Merry Men
Flying Fish 033, stereo, \$6.98.

Robin Williamson, a charter member of the Incredible String Band, stayed with them until they finally broke up in 1975. That group's increasingly show-biz approach to music gradually withered their original mystical, folky trapping base, and their music became diffused and incoherent.

With **Journey's Edge**, Robin emerges closer to the early ISB approach of **The Hangman's Beautiful Daughter** and **The 5000 Spirits** heyday albums. This album's best material could easily fit comfortably next to ISB's brilliant early work. *The Tune I Hear So Well*, *These Are The Mystic Times*, *Border Tango*, and *Voices of the Barbary Coast* nearly have a traditional, ageless feel to them, while *Rap City Rhapsody* and the music hall number *The Maharajah of Mogador* are delightfully whimsical. *Lullabye for a Rainy Night* shows a vulnerable, tender touch.

Journey's Edge marks Robin Williamson's return to the kinds of music he knows best, completing the full circle, but with more savvy and refreshed because of the times between and the lessons learned. And that can only be healthy.
Michael Tearson

Sound: A- Performance: A-

Silly Sisters: Maddy Prior & June Tabor
Chrysalis CHR 1101, stereo, \$6.98.

Released in America nearly a year after its initial release in England, **Silly Sisters** was recorded between Steel-eye Span obligations when Maddy Prior had time off. She got together with her friend June Tabor, a brilliant singer who had not previously recorded (her subsequent debut solo album **Airs and Graces** has just been released in America as Antilles 7043 and it is a recording of uncommon excellence).

Silly Sisters is an unqualified success. The program is well diversified and each sister gets a solo spot. There are three unaccompanied ballads, two hymns, and the rest are duet ballads with ever-varying accompaniment that ranges from a single additional guitar to a full consort with plenty of fiddle, pipes, mandolin, and upright bass along the way. No two songs have exactly the same accompaniment. The accompanists are among the cream of England's folk musicians, Martin Carthy, Nic Jones, Andy Irvine, John Gillespie, with the remarkable Danny Thompson chief among them.

Maddy and June have researched their material thoroughly, listing most songs' sources on the lyric sheet. All songs on **Silly Sisters** are traditional, the ballads covering a full gamut from love and murder, to topical protests of centuries ago, plus the hymns and a mummers' song for flavor. *My Husband's Got No Courage in Him* will doubtless have special appeal for some.

Maddy produced the album with engineer Robin Black, who has done several Steeleye albums. The sessions were obviously great fun, for the enthusiasm this project generated is clear. **Silly Sisters** is a superb album.

Michael Tearson

Sound: A Performance: A

Gottle O'Gear: Fairport Convention
Island ILPS 9389, stereo, \$6.98.

After about eight years and as many line-ups, Fairport Convention has streamlined itself to try for a more pop approach, but it doesn't really work. There's no focus, no firm identity, not even the roots, so obviously treasured up to now, help. Fairport, I'm afraid, is just another band.

In England, Dave Swarbrick, who led Fairport for seven years, released his first solo album. It contains strictly traditional material and is a joy (Transatlantic TRA 33). Try it instead of this.

M.T.

Sound: C Performance: C-

AUDIO • September 1977

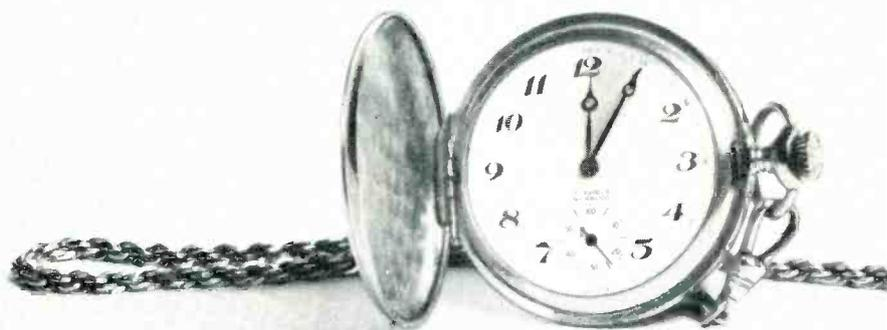

the first 5 minutes don't count

Or even ten!

Sometimes it may take a little while before you know just how good a headphone really is.

Comfort, weight, cord convenience all are vital factors in headphone wearability.

With every minute of use, any manufacturing deficiencies in these areas grow into discomfort and inconvenience.

At Beyer we know these problems and all our headphones are designed to achieve the highest possible wearability factor (Hi-Fi News, September '76, page 143, Beyer DT440 ranked 1st out of six comparative tests for comfort).

Coupled with physical comfort comes the lack of aural fatigue. That bright overdone sound associated with the

'loudspeaker-on-the-ear' concept oversold by our competitors will often give you a bad headache in minutes. It takes time to appreciate good clean sound. And with time, good sound doesn't tire (Hi-Fi News, September '76, Subjective

Headphone listening test, Beyer DT440 ranked 1st).

So visit your Beyer headphone dealer now and give yourself time to compare Beyer headphones against the competition.

**But remember—
the first
5 minutes
don't count!**



BEYER DYNAMIC

Distributed by Hammond Industries Inc.

155 Michael Drive, Syosset, New York 11791 (516) 364-1900

Enter No. 42 on Reader Service Card

Classical reviews

Edward Tatnall Canby



100

Leopold Stokowski conducts Bizet (Carmen and L'Arlésienne Suites) National Philharmonic Orch. Columbia XM 35403, stereo, \$5.98.

During these last few years Stokowski would seem to have been endlessly shuttling back and forth from one (British) orchestra to another for recordings on all sorts of labels—this new Columbia acquisition is perhaps justifiably marked “Newly Recorded”! After all, the old man started conducting in 1909 and made his first recording in 1917 (not for Columbia I’ll bet; the Stokowski rep was mainly made with RCA Victor via the Philly Orch. back in the later electrical days of the 78 disc). In terms of viable persistence as a conductor Stokowski has Toscanini beat by years.

How can he do it? Mainly because any good orchestra these days knows the basic notes of most of the music he conducts and could play it passably well without him. And, moreover, the musicians have a fair idea of what to

expect from him in the way of more detailed interpretation. In rehearsals, even in recording, he does not have to wave his arms like a windmill; his more than sixty years of experience (and without a baton, at that) mean that in a few relatively brief moments he can shape up the details of a work, set the tempi he wants, and check the instrumental balances. Though there is more than that to recording, it is still possible to do the job with less than violent physical effort. A stringent economy of motion, matched by extreme respect on the musicians’ part, is enough to make a fine record of this man’s ideas, even at 95. A concert, of course, would be another thing—and no rest periods as needed.

Enough said! Bizet was surely the best of the French composers at the end of the opulent Empire era and on into the Third Republic after 1871, and these ultra-familiar Suites (in one order or another to conductor’s choice) do indeed distill the best of the larger

works from which they are taken. Stokowski knows their subtleties as few do. Maybe a wee bit rough here and there—that necessary economy—but never enough to bother, and the spirit is right, *right*.

Ilhan Mimaroglu: Face the Windmills, Turn Left. (Electronic music). Finnadar SR 9012, stereo, \$7.98.

This all-tape music, out of the Columbia-Princeton Electronic Music Center (whose original equipment would now rate as old fashioned), is of great interest to us in audio as a sort of summing up of Phase I of electronic music, the first format it took: namely “musique concrete” or musical sounds made out of treated “real” sound, everything from voices to machinery as well as “live” instruments recorded. These works from the 1960s are not far from a quarter century after the earliest French experiments, done in the wartime period and be-

fore there was tape to work with. This composer has redone his music for this recent stereo disc, presumably from master tapes in more than two tracks.

The sound of Phase I is instantly apparent, as it ought to be. Somehow, synthesizer music is fundamentally different in impact, even though in theory it can duplicate "anything" in the sonic area. It could, but it doesn't; each medium to its own best effect. I enjoyed this collection of moderately short and concise pieces, notably the very short and classic *Preludes* on Side 2, straight out of the classical tradition for that form—brief pieces each tending to highlight a given sonic technique. There are voices here, as well as other sounds, which is very much in the Phase I tradition, too. They are even named, a "speaker" and a "vocalist".

You'll find more Mimaroglu—if you can remember the name—on Finndar/Atlantic, and also on Folkways.

Nathan Milstein. Mendelssohn/Tchaikovsky Violin Concertos. N.Y. Philharmonic, Chicago Symphony, Bruno Walter/Frederick Stock. **Odyssey Y 34604**, mono, \$3.98.

There's a lot of technical interest in this pair of LP reissues, two early LPs cut onto one modern disc. (Space doesn't allow re-review of dozens of others now flooding out). Musically, suffice it to say that the youthful Milstein fully presaged the mature violinist who has recently made a prize-winning LP (Bach) for D-G, and the pair of orchestras and conductors (if you can disentangle Columbia's usual mish-mash title!) is top rank.

What interest? Well, the Mendelssohn, with Bruno Walter and the N.Y. Philharmonic, was recorded in May of 1945—before WW II was over—and later became the very first of all LP discs, Columbia M 4001. No exact info is given, but I suspect this was one of those pre-tape pioneer jobs done on a 16-inch, 33 1/3 lacquer master recording, from which much of the early LP catalogue was built up, i.e. both the 78 release and the later LP were copied from a common source. That new technique, involving high-accuracy copying, was simply impossible in pre-WW II days—and one good reason for the failure of RCA's long play discs of the early 1930s.

In that first big pile of LP releases (Columbia wisely built a solid supply of software before launch time) there

was also M 4053, the *Tchaikovsky Concerto*. Though with a higher number it is obviously an earlier recording and almost surely made via the old pre-war 78 technique, the sides cleverly segued together for LP. It makes a fascinating comparison.

Side 1, then, is already a fully modern recording, wide range, with very low background noise, a limpid reverb, and the solo instrument at a proper modern distance, surrounded as it should be by the orchestra and sounding correctly thin and clean as a concerto violin should. The Tchaikovsky, on the other hand, is immediately audible as out of the older era (no date is given, nor do I remember when Stock retired from Chicago, but like Bruno Walter he was very active in the between-wars era of symphonic recording). There's an immediate, if slight, background hiss, beginning as the music starts. And a curiously wooden sound, minus higher highs though pleasing and never really harsh. Above all, the violin is very close and loud, inches away, the orchestra rather pointedly in the background, non-enveloping—that's how they did it in the 1930s from Melchior-Leider and Melchior-Flagstad right through to Milstein. The reverb, too, is less, in the older manner. We had not realized its full usefulness yet.

Not that the Milstein-Tchaikovsky is either substandard or nonenjoyable! I'd rate it as a first-class example of the best in the earlier recording technology. All the more interesting, then, to compare it—and the same brilliant young violinist—with one of the first of the new-type hi-fi recordings, the kind which in multiple-track versions still carries on today. Now, all you need for further comparison is one of the early frr Deccas (London), the 78 series that was contemporaneous with the Columbia lacquer recordings....

Mozart: Symphonies No. 25 in G minor K.183, No. 24 in B Flat K.182, No. 26 in E Flat K.184. Concertgebouw Orch., Amsterdam, Josep Krips. **Philips 6500 529**, stereo, \$7.98

Josef Krips has left us a "legacy" of many recorded Mozart Symphonies, and since he has been one of those celebrated Viennese elder conductors whose touch should be considered authentic for the Mozart tradition, we must listen with care.

Well, it is authentic, with a vengeance! What we have here is an old-line interpretation of three "little"

symphonies, early works and none of them of any great moment nor intended so; here they are "blown up" to significance (and thereby degraded in all truth), in the light of what was to come. Notably the *Little G Minor*, which is supposed to presage the *Great G Minor* of just fame, K.550. The little symphony is here played with exaggerated intensity, for my ear very false—and in fact this was long the style expected, when music was full of "little-did-he-know" romantic forecasts. It is a false approach because Mozart *didn't* know, and most con-

Learn professional audio recording technology at institute of audio research

Earn a CERTIFICATE after one year.

and, if desired, a four year BACHELOR of SCIENCE DEGREE via the Institute of Audio Research — New York University joint program.

Fall '77
Classes start Sept. 7th.
Winter '78
Classes start Jan. 4th.



Enter No. 10 on Reader Service Card

FOR SALE

FREE details. A DIFFERENT KIND OF RECORD CLUB

Discounts up to 73%, no "agree-to-purchase" obligations. All labels, Schwann catalog of thousands of titles; classical, pop, jazz, country, etc. Discount dividend certificates. Newsletter; accessories; quick service. 100% iron-clad guarantees. Write for free details.

DISCOUNT MUSIC CLUB, INC. DEPT. 14-0977
650 Main Street, New Rochelle, N.Y. 10801

Professional Hi-Fi Home Study Course—Instructors include Len Feldman, Julian Hirsch, Larry Klein and Larry Zide. Send \$2.00 for full color **AUDIO PRIMER** and information on joining (SAC) Society Audio Consultants, Dept. A, 49 East 34th St., New York, N.Y. 10016.

NEW SPEAKER BOOK: 232 pages of information on current European audiophile loudspeakers and designs. \$5.50 postpaid. East of Rockies: **MADISOUND SPEAKER COMPONENTS** 537 Holly Ave. Madison, Wisconsin 53711. West of Rockies: **JUST SPEAKERS** 233 Whitney St., San Francisco, California, 94131.

STOP PAYING GOOD MONEY FOR BAD RECORDINGS

Our straightforward, capsule reviews survey only those recordings worthy of your sonic consideration. Remember, the "Garbage In - Garbage Out" axiom applies regardless of system quality. Subscribe: \$15. (six issues). **AUDIOPHILE RECORDING REVIEW**, BOX 6972, Buffalo, NY 14240

DAHLQUISTS DQ-10a, mirror imaged, DQ-1W sub woofer, DQ-LP1 low pass filter, Citation 16 power amp. \$1450 (919) 276-7134

FOR SALE

MARANTZ 7C (S/N 12531) 8B (S/N 3006 & 3010). Pristine physical and operating condition 628 Warrenton Drive, Kirkwood, MO 63122. 314-966-6340.

AUDIO DEN LTD.

Long Island's finest audio dealer is proud to announce the addition of:

AUDIO RESEARCH SYSTEM
ACOUSTAT X LOUDSPEAKERS
SAEC & DYNAVECTOR TONEARMS
GALE RECORDS

To the already fine lines of Bravura, DB Systems, Rappaport, Rogers, Quatre, Infinity, Yamaha, CM, Nakamichi, Fulton (60, 80, 100 in stock), Dahlquist, RTR, Polk, Avid, Magneplanar, Quad, (ESL and electronics) Lux, Onkyo, B&O, Revox, Crown, Sonus, Grado Signature, Denon, Grace Formula Four and Sheffield Labs. **FREE INSTALLATIONS IN N.Y. AREA. NO CHARGE FOR SHIPPING.**

AUDIO DEN LTD.

1320-34 Stony Brook Road
Stony Brook, New York 11790
516-751-3350

The Uncompromised Approach

To Disc Reproduction:
"Positive Vibrations" Preamplification
& Trevor Lees Tube Preamp MK3
Mr. Audio Corporation
P.O. Box 4489, Berkeley, CA 94704

FOR SALE

PINK NOISE TAPES - reel or cassette. Test your loudspeakers in listening room without interference from room resonances. Also available—report comparing sensitivity and polar pattern of 7 FM antennas by Finco, JFD, Channel Master and Winegard. Send \$6 for tape or \$3 for report to:

Engineering Design Lab
California State University
6000 Jay St
Sacramento, Ca 95819

GOLDEN EAR'S Reference Loudspeaker system Breuer Dynamic Swissmade tonearms Sensational Denon turntables. Stax, Dynavector, SME tonearms. Futterman vacuum tube amplifiers. C/M CC-2A preamp, kitten's step's louder, \$250. C/M RR805 professional receiver, \$600. Lux No. 3045 tube amplifiers, new pair \$885. VanAlstine electronics. Verion cartridge transformers, noise filters. Swiss Musical Door Chimes play Michigan Victors, Yale's song, Anchors Away, others, only \$12.95. Stax, Denon, Supex, FR, Promethean, cartridges. Audio Research's SP3a-1N preamp, pristine \$695. Shot Glass speakers, \$295 pair. Savings, most esoteric audio gear. **WANTED:** Marantz 7C's; Audio Research D-150's; AR tuners; McIntosh C-22's; MC-350D's. **GOLDEN EAR**, Box 2189, Riverview, Michigan 48192. (313) 479-1234.

NATURAL SOUND

"Hear some of the worlds finest equipment: the new Dayton-Wright MK III, Fulton I's, Metronomes, Acoustat X speakers with Threshold Mark Levinson, GAS, Bryston, Rappaport, Quatre, Bravura, Paragon and Paoli Electronics. Hear the widely acclaimed Sleeping Beauty in Dynavector, Black Widow, Grace, Kmal, and Formula 4 arms on Linn Sondek Ariston, and Denon turntables. The new Threshold 400 class A amplifier has both peak and average reading LEDs, cost \$1147 and delivers 100 watts with sonic purities. Mark Levinson's ML-1, the uncompromised preamp has an improved power supply with an LED line voltage monitor and uses gold plated, positive acting Lemo connectors.

See but don't expect to hear the Verion transformers. Verion is the missing link company. They pay attention to those interfacing problems which plague audiophiles. The Verion triaxial cables shield against RFI. The Verion filters restore fidelity to systems suffering from subsonic and supersonic interferences. The Verion tonearm cartridge alignment systems is revolutionary. Soon you will be able to hear your cartridge properly set up.

Hear the new moderately priced line from GAS which follows their tradition of exceptional sound, construction and value. Thalia, grandson and Charlie the digital tuner who tells time. Hear the full line of Fulton speakers, the KEF 104 and the KEF C series, double Magneplanar, the mini-Rogers and the Visonik David with M and K's Goliath subwoofer. Natural sound stocks KEF drivers, Cobra cables, platter pads. Monitor Audio record lifts and has a wide selection of audiophile records, Audio Lab, Mark Levinson, Fulton, M and K, Denon PCM, Gale... Write for a catalogue. Preowned: IMF TLS 80, EPI towers, KLH9, Dahlquist DQ10, Ampzilla, Dual 100, Quad 405, Stax and Trevor Lees preamps, Marantz 10b, Panasonic SP10, Thorens TD 125 MK II, ERA turntables, SME and KMAL arms, Koss ESP6A and Infinity headphones. If you are interested in State-Of-The-Art equipment, call us 402-475-3325. The address: **THE NATURAL SOUND** 315 SO. 11 ST. LINCOLN NE 68508. Kansas City residents call us for the location of our new store.

SOUND ADVICE MAGAZINE: THE FOURTH ISSUE INCLUDES A SURVEY OF MAJOR LOUDSPEAKER SYSTEMS AND PREAMPLIFIERS INCLUDING GAS THOEBE AUDIO RESEARCH SP-4, RAPPAPORT PRE-1, PARAGON 12, AUDIRE DIFFET, PARAGON SYSTEM E, CARTRIDGES REVIEWED INCLUDE AKG P8SE, MICRO-ACOUSTICS 2002E, SATIN M18BX, GOLDRING G900SE, GRADO SIGNATURE ONE DECCA VI ELLIPTICAL, AND ORTOFON MC20. AMPLIFIERS INCLUDE: AUDIO RESEARCH D-100, AUDIRE ONE AND QUAD 405. MISCELLANEOUS COMPONENTS: VERION TRANSFORMER, JECKLIN FLOAT HEADPHONES, AND LINN-NAIM NAG20. **SOUND ADVICE:** 4 ISSUES \$12; \$15 FIRST CLASS AND \$18 OVERSEAS (SENT AIRMAIL) 68 POST STREET, SUITE 226, SAN FRANCISCO, CA 94104.

Now...Two dinners for the price of one in leading N.Y.C. restaurants!

Join the CUE Dining Society for a full year — only

\$1

Enjoy 50% discounts on dinners-for-two as a member of the CUE Dining Society. Participating New York restaurants include Luchow's, Toots Shor, Chicago, Steer Palace, Autopub, Downbeat, White Turkey, more! To enroll and receive vouchers for twelve free dinners, send \$1 with your name and address to

MEMBERSHIP DIRECTOR
CUE Dining Society
401 North Broad Street,
Philadelphia, PA 19108

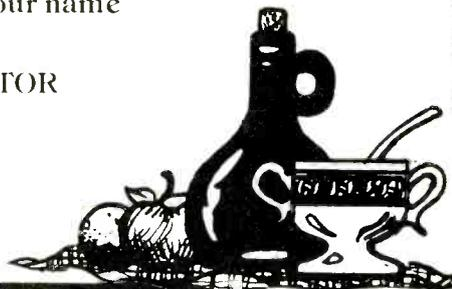

FOR SALE

LOWEST DISCOUNT PRICES ANYWHERE on audio equipment. All major brands discounted. Write for quotes, K&L Sound Services, 75 N. Beacon St., Watertown, Mass. 02172.

ATTENTION AUDIOPHILES

James Bongiorno and Oki Sugano are proud to announce the introduction of Audio Lab records to the American market. In the past some of these superb recordings have been available through limited sources at very high prices.

A-Train Ltd. is now offering the entire Audio Lab library of 35 albums with more new releases coming every month.

These superb recordings are made with advanced processing techniques and DBX noise reduction processing which is equal and in many ways superior to direct disc recording. Records are treated for static, absolutely noise free with dead silent surfaces, and of course—no tape hiss.

In addition to quality, the musical selections are much wider in scope as compared with the terribly limited musicality of other so-called state-of-the-art recordings.

The records are divided equally between classical and jazz with many variations in groups and styles to suit a wide variety of tastes.

A complete descriptive brochure is available from A-Train Ltd., 8719 Wilshire Blvd., Beverly Hills, CA 90211.

You may order direct from A-Train or visit your local dealer.

COLLECTOR'S ITEMS: MARANTZ 20B FM TUNER; two JBL N500 crossover networks (comparable to Pro No 3152); two 075 ring radiators; Acousta-Voicette 729A. Call anytime: 714-731-1312 or Mark, 1622 Sierra Alta, Santa Ana, Calif. 92705

ROGERS LS35A'S, mint, \$350. 413-586-5810

LNP2 \$1650; SG2205 equalizer \$1265, Bose 901 Series II \$400, Marantz 150 \$375, B2 \$700, Phase Linear 1000 \$190, Teac 450 \$275, Shure M68 \$60. All mint, T.J. Heberk, P.O. B. 650, Jeannerette, LA 70544

BRITISH AND EUROPEAN EQUIPMENT DIRECT TO YOU. Most quality makes of equipment available at advantageous prices. Price list and price quotes send international reply coupon. For specific brochures send \$2.00 bills. Audio T, Dept. A, 190 West End Lane, London NW6, phone 01-794 7848. Visitors welcome.

MARANTZ STRAIGHT LINE Tracking "Universal Model" Turntable. Excellent Condition. \$200 (901) 872-4296.

INTRODUCING THE PERFECTIONIST AUDIO SUB WOOFER

We have featured our own augmented stereo transmission line woofer for our clients who wanted the most accurate, natural bass response available regardless of cost. Each unit is meticulously built and finished to the client's specifications. For this, we charge a fee of \$1400. Response: ± 1 dB 8Hz to 240Hz.

Complete construction manual now available for you to build this same unit for about \$300 and your labor. Send \$15 first class mail (\$20 outside U.S.)

PERFECTIONIST AUDIO LTD.

P.O. Box 174

Pleasant Gap, Pennsylvania 16823

Call eves. (814) 238-4071

YOUR MAIL-ORDER TAPE SPECIALIST IN WASH. D.C. SAME DAY SHIPMENT-DISCOUNT PRICES-BASF, SCOTCH, MAXELL, TOK & CAPITOL. FREE PRICE LIST. SAXITONE TAPE SALES, 1776 COLUMBIA RD. N.W., WASH. D.C. 20009

"RAW LOUDSPEAKERS"—We specialize in supplying the industry with quality high wattage loudspeakers. If your current supplier cannot deliver fast enough call us. We stock what we build, sales geared for low or high volume users. LTL Electronics, 525 N. Central St., Kent, WA 98031 (206) 852-3671

STEREO REPRESENTATIVES NEEDED!!! Sell 100 brands!! Lowest Possible Prices!! Krasco—623 Campbell Ave., West Haven, Connecticut 06516

FOR SALE

PERFECTIONISTS PREFER DYNAKITS

Before Purchase You Owe Yourself Our Quote Mainline 11a 971 Fronheiser Johnstown, PA 15902

CONNECTICUT: ADC-Accutrac, Advent, Audio Pulse, B&O, B.I.C., Citation, Dahlquist, Epicure, Harman/Kardon, J.B.L., McIntosh, Nakamichi, Ortofon, Phase Linear, Sony, Stax, Tandberg, Yamaha. Will ship prepaid. Sounds Incredible, 226 White St., Danbury, Conn., 06810. (203) 748-3889 - phone quotes only.

AUDIO RESEARCH SP-3A1 OWNERS: New modification tightens bass and extends high frequency response. \$90 Williamson Laboratories, 135 N. 183rd, Seattle, WA 98133 (206) 546-1316

NORTHERN N.J.'s finest store - Lux, Mod 00-10, IM, Grace, B&W, G.A.S. Sleeping Beauty, FR, B&O and more University Stereo, 57 E. Ridgewood Ave., Ridgewood, N.J. 07450. 20 minutes from the G.W. bridge.

SHOPPERS' GUIDE TO AUDIO MAIL ORDER DISTRIBUTORS—\$3.95 Hundreds of audio distributors worldwide surveyed! Box 94-A, Colmar, PA 18915

"**STATE-OF-THE-ART** Cartridge is finally here, Ram strain gauge; Ram 512, an outstanding 200 watt channel class "A" amp. Special: Dynavector arms \$400. Upper End Audio, 4131 Ottawa, Norridge, Ill. 60634. 312-453-2305."

CROWN SX824 RECORDER, D150 amplifier, ES224 speakers. William Brennan, 2929 Winchester Court, Goshen, Indiana 46526

FISHER ST-500 loudspeakers. Four drivers, solid walnut, excellent condition. \$200 pair. 614-282-7477.

DYNA PAT-5 \$169, PAT-4 \$89 Both mint cond. Call (512) 992-6333 Evenings.

QUAD ELECTROSTATIC LOUDSPEAKERS 1 year old, mint \$750; (2) Quad 33 pre-amps \$150 ea; (2) Quad 303 amps \$165 ea. P.O. Box 297 Clarence NY. 14031; (716) 835-3504

MCINTOSH MC-2300 \$1000; MR-77 \$500; C-28 \$475; MC-2105 \$500; Thorens 125 SME arm \$250. All mint, original owner 212-274-1398 or 518-966-5132.

LOGGER, STANCIL-HOFFMAN RP-70, with telephone switch; receiver, Watkins-Johnson/CEI 701, 235 MHz-1 GHz, AM/FM/PM/Video; Vidar 720 flutter meter (internal scope); Western Electroacoustic precision sixth—and half-octave filters. 7 Hz-100 kHz; GenRad 50-250 MHz generator. Need AA 640 (WECCO) or B&K 4160 mike cartridges, DBX 119, 124, 128, 157/152. Tucker, 301-233-2300, Ext. 298. 1267 Cedarcroft Rd., Baltimore, Md. 21239.

"**A FEW COMPETITIVELY PRICED** used Revox A77 and A700 decks available. Completely reconditioned by Revox, virtually indistinguishable from new and have the standard Revox 90 day warranty for rebuilt machines. Satisfaction guaranteed. Write requirements to ESSl, Box 854, Hicksville, N.Y. 11802 (516) 921-2620"

SPEAKER KITS Philips drivers. Now available in San Francisco. Listen before you buy. (415) 647-6538.

CITATION 16 power amp, absolutely mint, \$575. R. Russell, 8232 S. Gary, Tulsa, OK. 74136 (918) 481-1660.

CLASSES IN MUSIC RECORDING. Record production, publishing, disc mastering, film recording. Taught by famous engineers and producers. Held in 16/24 track recording studios. Contact: University of Sound Arts, 2040 Ave. of the Stars, 4th Floor, Century City, CA. 90067. 213-553-4742

BANG & OLUFSEN 4002, new, in box, with warranty, spare cartridge, \$400 or offer. Skipper 301-949-2364

FOR SALE

WHAT'S ? MONCRIEFF BEEN UP TO IAR

International Audio Review

A New Genre of Audio Periodical

A Pioneering Breakthrough So Dramatically Distinctive
It Defines a New Concept of Excellence in Journalism

Everyone in the know is talking about IAR. What have they been saying of our product?

— *This is incredible! It'll put lots of people into shock.*

— *Finally, someone's given us just what we've all needed all along — every audiophile should have this to be truly informed.*

— *Easily and by far the finest periodical in audio; it's clearly in a class by itself.*

— *Totally different from everything else — it's more like a textbook & encyclopedia than a magazine.*

— *This is the best bargain in the whole field of audio.*

— *Your depth of insight and mature literate attitude are a breath of fresh air that will help all of audio.*

— *I'm holding this **** in my hands, and I still can't believe my eyes!*

IAR is that impressive. IAR is that innovative.

Educational & Comprehensive

Most periodicals merely tell you how something measures or sounds. IAR also explains *why* competing units sound and work differently; *eg. what factors influence the sound of amps & turntables.* Our essays, rich in clear diagrams, are gold mines of stimulating information; *why is a power supply vital to the sound of your amplifier?*

Sophisticated Criticism

IAR analyzes the pros and cons of the latest audio product ideas from around the world, *eg. new quartz turntables & error correction amplifiers.* We share the engineer's designs of the future with you, *eg. next decade's dynamic tracking amps.*

Advanced Research

IAR has its own research programme, probing beyond the state of the art; *what's our balance control of the future? How wide a frequency response can we actually hear in an amplifier? We show you simple tricks for improving your audio system; turn a Phase 400 into a superamp for 12 dollars.* And we help the engineer develop better products for the consumer; *what 9 crucial features are absent from virtually every pickup amp design you can buy?*

Equipment Reviews

IAR designs its own testing techniques, which are far in advance of others. In fact, IAR is the *only* publication whose reviews are scientifically correct and relevant to both music and human hearing. And IAR does not confuse objective fact with subjective opinion.

IAR's first issue is 240 pages, 8½ × 11 × ¼, and weighs 1½ pounds: the italicized examples above represent only a fraction of its contents. When you get your own copy of IAR, you'll agree with everyone else that, quite simply, *IAR defines a new prestige class in which it stands alone.*

To be included as a subscriber, you may use your bank credit card; simply copy all data from the front and sign your request to subscribe. Checks must be in U.S. dollars. The basic rate is \$25 for 4 issue numbers, \$45 for 8. Surcharges (per 4 issues) are: \$10 first class, \$10 overseas boat, \$20 air; \$10 hardcover if popular (vote!).

International Audio Review
2449a Dwight Way / Berkeley Ca 94704 USA

FOR SALE

BUY HI-FI COMPONENTS THE MODERN WAY:

ADC • AKAI • AR
DUAL • KOSS • SONY
SHERWOOD • SHURE
TEAC • TDK • HY-GAIN
(CB)

MANY OTHERS

PHONE & MAIL

Call TOLL FREE or write for LOW PRICES

Nationwide **800/854-7769**
California **800/472-1783**



Approved by Phone

MCK SALES

250 N THOMAS, PO BOX 2100
POMONA CA 91766

NEW GENERATION Crown Amplifiers, Cleanest, Smoothest sound ever produced - Crown D1200/HP1200, on demo only at Barclay Recordings, 233 E Lancaster Ave., Wynewood, PA 19096; (215) 667-3048

**STATE OF THE ART
IN
MIAMI, FLORIDA**

Quite simply, only the very finest in audio components.....
Mark Levinson Audio Systems
featuring: H.O.D. System, LNC-2,
ML-1, ML-2, LNP-2, JC-1-AC & DC

Great American Sound, Fulton Musical Industries, Quad (of England), Stax, Acoustat-X, Magnepan, Sonex, Gale, KEF, Rogers, AGI, Audio Pulse, Lentek, Yamaha, IMP Electronics, Fidelity Research, Grace, Supex, Promethean, Linn Sondek, M&K, Braun, Janis, Sequerra, Bang & Olufsen, Armstrong, KMAL, Decca, Lecson, Naim, Rabco, Otari, Uher, Sendor, and others

Also, Discwasher record care products and audiophile records such as Mark Levinson Acoustic, Sheffield, Audio Lab, M&K, Reference Recordings, Crystal Clear.

SOUND COMPONENTS INC
2710 Ponce de Leon Blvd
Coral Gables, Florida 33134
305-446-1659
TWX: 810-848-7627

Mastercharge & Bancamericard accepted. We ship mail order prepaid within U.S.

ONLY TEN MINUTES FROM THE MIAMI INTERNATIONAL AIRPORT - WE WELCOME VISITORS FROM ABROAD!!!

AUDIOGRAM, THE BI-MONTHLY newsletter that brings you reviews, news, and our views of today's audio world \$15.00/6 issues. Free information - Write - Audiogram, P.O. Box 17202, Dept. AM, Wash., D.C. 20041.

POLK AUDIO and AUDIO DEN

The Audio Den is proud to have on display and demonstration the amazing Polk Audio Monitor Series. Our customers say, "Fantastic! Compares with the finest loudspeakers I have heard. Probably the best value in the history of audio!!!" Audiogram™ from the Audio Advisor said, "We were so impressed that we could not believe the prices... Other \$200 speakers simply do not come close to the standards set by the Model 10... And at their price, they are simply a steal." Come in for an audition or write us for information on Polk or our other state-of-the-art products. Polk is shipped free in the continental U.S. Monitor 10\$ - 199.95 ea. Monitor 7\$ 129.95 ea. and the incredible Mini Monitor 79.95 ea. Audio Den Ltd. 1320-34 Stony Brook Rd., Stony Brook L.I., N.Y. 11790, 516-751-3350.

SHOP AROUND — Listen to every speaker available — then come to Cyberacoustic Laboratory and hear RTR's New Direct Drive Electrostatic DR-1 speaker system at Philadelphia's exclusive distributor — by appointment — 233 E Lancaster Ave., Wynewood, PA 19096; (215) 667-3048.

ACCUPHASE C-200 and P-300, excellent condition. Call after 2 pm, 216-792 2161.

Advertising Index

A.E.C.....	113	Eastman Sound.....	91
Stereo Amp		Loudspeaker System	
Write Direct to Advertiser		Enter No. 41 on Reader Service Card	
Audio Engineering Society.....	50	Elpa.....	19
Fall Convention		Turntable	
Write Direct to Advertiser		Write Direct to Advertiser	
Akai.....	33	Empire.....	4
Receiver		Phono Cartridge	
Write Direct to Advertiser		Enter No. 8 on Reader Service Card	
Audio Critic.....	20	Garland.....	113
Publication		Audio Store	
Write Direct to Advertiser		Write Direct to Advertiser	
Audio Source.....	96	Hammond Industries.....	99
Tonearm		Beyer Headphones	
Enter No. 1 on Reader Service Card		Enter No. 42 on Reader Service Card	
Adiomart.....	115	Hitachi.....	63
Newsletter		Hi-Fi Components	
Write Direct to Advertiser		Enter No. 9 on Reader Service Card	
Audio-technica.....	87, 93	Institute of Audio Research.....	101
Demo Record		School	
Write Direct to Advertiser		Enter No. 10 on Reader Service Card	
Headphones		International Audio Review.....	105
Write Direct to Advertiser		Publication	
Ball Corp.....	71	Write Direct to Advertiser	
Record Care Products		JBL.....	58, 59
Write Direct to Advertiser		Loudspeaker Systems	
B.I.C.....	23	Write Direct to Advertiser	
Loudspeaker Systems		J&R MUSIC.....	98
Enter No. 2 on Reader Service Card		Audio Mail Order	
Bose.....	53	Enter No. 38 on Reader Service Card	
Loudspeaker Systems		JVC.....	6, 7
Write Direct to Advertiser		Cassette Deck	
B&W.....	95	Enter No. 11 on Reader Service Card	
Loudspeaker Systems		KEF.....	72
Enter No. 3 on Reader Service Card		Loudspeaker Systems	
Crown.....	36	Enter No. 12 on Reader Service Card	
Amp		Kenwood.....	61
Enter No. 4 on Reader Service Card		Receiver	
Custom Stereo.....	111	Write Direct to Advertiser	
Audio Store		Koss.....	65
Write Direct to Advertiser		Headphones	
Dahlquist.....	39	Enter No. 13 on Reader Service Card	
Loudspeaker Systems		Listener's Review Finder.....	103
Enter No. 5 on Reader Service Card		Publication	
DeCoursey.....	112	Write Direct to Advertiser	
Electronic Crossovers		Marantz.....	118, Cov. III
Write Direct to Advertiser		Hi-Fi Components	
Discount Music.....	104	Write Direct to Advertiser	
Record Club		Maxell.....	41, 88
Write Direct to Advertiser		Magnetic Tapes	
Discwasher.....	2	Enter No. 14 on Reader Service Card	
Record Care Products		Magnetic Tapes	
Write Direct to Advertiser		Enter No. 15 on Reader Service Card	
Dixie Hi-Fi.....	94	McIntosh.....	89
Audio Mail Order		Catalog	
Enter No. 6 on Reader Service Card		Enter No. 16 on Reader Service Card	
Dual (United Audio).....	13	Mck Sales.....	106
Turntables		Audio Mail Order	
Enter No. 7 on Reader Service Card		Write Direct to Advertiser	

Advertising Index

Memorex 52 Cassette Tapes Enter No. 17 on Reader Service Card	Sansui 5 Cassette Deck Enter No. 29 on Reader Service Card
Micro Acoustics 27-30 Hi-Fi Components Write Direct to Advertiser	Sennheiser 97 Hi-Fi Components Write Direct to Advertiser
Netronics 98 Acousti-Mounts Enter No. 39 on Reader Service Card	Sharp 35 Hi-Fi Components Enter No. 30 on Reader Service Card
Nikko 21 Hi-Fi Components Write Direct to Advertiser	Shure 48 Hi-Fi Components Enter No. 31 on Reader Service Card
Ohm 43 Loudspeaker Systems Enter No. 18 on Reader Service Card	SME 24 Tonearm Enter No. 32 on Reader Service Card
Onkyo 37 Hi-Fi Components Enter No. 19 on Reader Service Card	Sonic Research 40 Hi-Fi Components Write Direct to Advertiser
Ovation 114 Audio Store Write Direct to Advertiser	Sony Corp. 11 Receiver Enter No. 33 on Reader Service Card
PAIA 102 Hi-Fi Components Enter No. 20 on Reader Service Card	Sony/Superscope 57 Reel to Reel Tape Deck Write Direct to Advertiser
Phase Linear 12 Hi-Fi Components Enter No. 21 on Reader Service Card	Soundcraftsmen 22 Hi-Fi Components Enter No. 34 on Reader Service Card
Pioneer Cov. II, Pg. 1 Turntable Enter No. 22 on Reader Service Card	SpeakerKit 85 Loudspeaker System Kits Enter No. 43 on Reader Service Card
Playback 94 Audio Mail Order Enter No. 23 on Reader Service Card	Speakerlab 117 Speaker Kits Write Direct to Advertiser
Polk Audio 89 Loudspeaker Systems Write Direct to Advertiser	Spectro Acoustics 90 Hi-Fi Components Enter No. 40 on Reader Service Card
Precision Electronics 32 Amplifiers Enter No. 24 on Reader Service Card	Stanton 3 Phono Cartridge Enter No. 35 on Reader Service Card
PS Audio 102 Hi-Fi Components Enter No. 25 on Reader Service Card	TDK 47 Cassette Tapes Enter No. 36 on Reader Service Card
Radio Shack 49 Turntable Enter No. 26 on Reader Service Card	Teac 51, Cov. IV Amp/Preamp Write Direct to Advertiser
Rhoades 117 Teledapter T.V. Sound Tuner Write Direct to Advertiser	Reel to Reel Tape Deck Write Direct to Advertiser
Rocelco 14 Decca Brush Enter No. 27 on Reader Service Card	Technics 17 Hi-Fi Components Enter No. 37 on Reader Service Card
SAE 25 Hi-Fi Components Enter No. 28 on Reader Service Card	Value Kits 116 Speaker Kits Write Direct to Advertiser
H. Sams 45 Books Write Direct to Advertiser	Yamaha 15 Hi-Fi Components Write Direct to Advertiser

FOR SALE

CENTRAL OHIO Audiophile Art Headquarters

GAS • AUDIO RESEARCH
SAE • LINN SONDEK • FONS
TASCAM • MAGNEPAN
MAGNEPLANAR • KLIPSCH
GRACE • KIETH MONKS
SUPEX • FIDELITY RESEARCH
STAX • ROGERS • LUXMAN
AUDIO PULSE

CUSTOM STEREO

1391 S. Hamilton Rd. Columbus, OH 43227
235-7575



POLK AUDIO MONITOR SERIES

AUDIO BREAKTHROUGHS now has on demonstration the remarkable new Polk loudspeakers. Compare them to the finest loudspeakers in the world. Both the Seven (\$129.95 ea.) and the Ten (\$199.95 ea.) utilize high definition polymer laminate bass/midrange drivers, wide dispersion soft dome tweeters and fluid coupled sub-bass radiators. They are capable of reproducing a highly defined phase accurate three dimensional sonic image which rivals the thousand dollar super speakers. They sound great with a small receiver, yet reveal the fine subtleties of state of the art electronics like Levinson and GAS. Shipped free in U.S. Send for free brochures on Polk or our other fine lines **AUDIO BREAKTHROUGHS**. 1681 Northern Blvd. Manhasset LI, N.Y. 11030 516-627 7333

SP4 — SP4 — SP4

New analog module preamp from Audio Research with their new D100 amp, more need not be said! Barclay Rec. & Electronics, 233 E. Lancaster Ave., Wynwood, Pa. 215-667-3048.

24 CHANNEL SOUND REINFORCEMENT MIXER, 100 foot snake, balanced input, 3 band EQ, 3 submixers, monitor, echo, solo. Also UREI Model 527A GRAPHIC EQUALIZER. Best Offer! B C & C Enterprises, P.O. Box 1036, Littleton, Colorado 80160. (303) 751-5991.

LIGHTING DIMMER SYSTEM for sale. 32 - 3K dimmers, 32 faders with 16 preset memory console. Packed for touring. Must Sell! B C & G Enterprises, P.O. Box 1036, Littleton, Colorado 80160; (303) 751-5991.

EXCELLENT DEMO AND USED EQUIPMENT: Radford ZD-22 preamp...\$395, Radford HD250 integrated amp...\$495, MAS-1 preamp...\$95, Stax SRA 12S preamp/headphone driver...\$395, Quad 405 power amp...\$295, KMAL M9BA tonearm...\$90, Audaire power amp...\$295, Stax SRA 3S...\$295, ARC: SP-3...\$395, D51...\$495, D76A...\$795, TIII or TIC...\$995. Manager, Audio Systems & Design, Inc., 5421 S. 84th, Lincoln, Nebr. 68516.. (402) 423-8732.

DAYTON WRIGHT, SPS MK 3 - Mint, six months old, factory carton and literature, \$300. (402) 331-7580, 5820 S. 100 Plaza 3B, Omaha, NE 68127, ask for Bill.

QUICK AIRMAIL SERVICE FROM TOKYO. All brands of Cartridges and Tone-Arms. Great money-saving. Write us today!! JAPAN AUDIO TRADING CO., Saikaen Bldg., 4-33-21, Kamimeguro, Meguro-ku, Tokyo.

ADVANCED NO SLEWING DISTORTION Leach amplifier, 100 w/ch, 10 day trial, 3 yr wnty, free shpg. \$449. Raw spkrs, no more paper cones, Decca Ribbon tweeters, details, TA Box 90 RR1, Surry, ME. 04684.

FOR SALE

**Western Pennsylvania's
FINEST AUDIO
DEALER**

Mark Levinson
Rogers LS3/5A
Teac
Sound Concepts Delay
Fulton Music
Dayton Wright
Harman-Kardon
Sonab
Verion
Visonik
Magneplanar
Audire
Stax
Radford
Revox
Scott
Infinity
IMF International
Great American
Sound
Ariston

Fons
Lux
Otonica
Dacca
Denon
Supex
Fidelity Research
Win Labs
ADC
Grace
Bryston
Dunlap-Clarke
Janis Woofers
M & K Woofers
Dahlquist Woofers
dbx
Connoisseur
Dynaco
SME
Audioanalyst
SAE

Headquarters for the Verion Cartridge
Alignment System™

P. US MUCH MORE

Shipping Prepaid & Insured

OVATION

6019 Broad St. Mall
Pittsburgh, Pa.

VISA



412-441-4550

114

KLH 9 Electrostat speakers, 919-286-7213

STAX UA-7, barely used \$125. G. R. Rankin, 1110 E. Gorham St., Madison, Wis. 53703. 608-256-2905 eves

GUARANTEED LOWEST PRICES in America. TDK, MAX-ELL, and others. Tape World International, 220 Spring St., Butler, PA 16001.

LEAVING COUNTRY. Sell Audio Magazine virtually complete 1948 through 1976. SASE brings exact list, make offer. Wayne Denny 1409 Park St., Grinnell, Iowa 50112.

BAY AREA AUDIOPHILES—Weingarten Stereo isn't a supermarket. We are people—"professional consumers" who sell the same equipment we'd buy ourselves. We are not concerned with "high end" status trips, but rather with fine sound—the best for your money. You will find that some of our discoveries are amazingly reasonable in price.

CURRENTLY RECOMMENDING:

Cizek, Dayton-Wright, Rogers, Innotech, Dunlap-Clarke, Sonus, Visonik/M&K, Armstrong, Denon, Grado, Connoisseur, Onkyo, and others.

For information or an appointment please call
(415) 323-5111
Weingarten Stereo
725 Santa Cruz Avenue
Menlo Park, California

PIONEER SA-9900, warranty card, \$400. Dual 704 with V-IS III, \$225. Both purchased April. Quad 33, \$200. Grado G-1+, \$45. Both purchased May. (608) 244-2363

FOR SALE

**M&K BOTTOM END SUB-WOOFERS
POWERFUL, DETAILED, TIGHT, LOW BASS FOR THE
BOTTOM TWO OCTAVES 80-20Hz.**

If you have an ear for detailed sounds in bass, and a dislike for "tubby" sound, we invite you to listen to the new BE-1A, BE-1V and the DBE-1A. We believe they are the finest available sub-woofers.

A speaker for long sustained organ notes is easy to make and the M&K BOTTOM ENDS are excellent in this regard; but, for the discriminating audiophile, the BOTTOM ENDS also have:

- Superb detail on drum skin sounds and the ability to distinguish between various bass instruments.
- Solid feel of floor shock on Flamenco
- Exceptionally smooth transition to Quads ESL's, Acoustats, Magneplanars including T/M panels, Magneplan MG-II's, Dahlquists, Dayton-Wrights, KLH-9's, and other fine audiophile speakers.
- The lowest mid-bass & mid-range coloration of any sub-woofer we have heard.
- New M&K universal matrixing & non-matrixing crossover networks allow the use of one or two woofers, no bi-amping necessary, your present stereo amp does it all.
- Extended frequency response, superb tone burst & pulse response, high power handling capacity.
- The new **DOUBLE BOTTOM END DBE-1A**, our finest audiophile super sub-woofer produces extremely high level deep bass wavefronts with thrilling detail & definition.
- New **M&K BASS RAMP** to allow **BOTTOM ENDS** to be used with high efficiency speakers such as Altec, JBL, Klipsch, Tannoy, etc. The ramp is passive, works out of your pre-amp tape in - tape out, and allows the full power of your amplifier to be available. Front knob adjustable up to 20 db. of correction.

**NEW BASS & TRANSIENT MUSICAL TEST RECORD
VOLUME II**

- The new Bass & Transient Test Record, Volume II, contains a brilliant array of musical sounds in classical, jazz, marching bands, organ and opera passages.
- Each one is specifically designed to show and test improvements you can make to your system, as well as being enjoyable on their own. A description of each of the twenty bands tells what to listen for and its significance to audiophile equipment.
- A few critical passages are excerpted and repeated several times to avoid needle lifting and plastic deformation distortion in A-B comparisons or component evaluation.
- It is having an exceptional order rate from high-end audio dealers and manufacturers. Really demonstrates tubby vs. tight bass, very low frequencies and extremely high transient peaks in high frequency crescendos. Available at your M&K Dealer or by direct mail. (\$7.50-mail orders add \$1.00 for postage.)
- Includes: 1812 Overture Finale with live cannons; Pipe Organ and Orchestra; Bells; Flamenco Dancers; Xylophone; Harp; Steam Locomotive

**BE-1V "DAVID AND GOLIATH" - THE ALMOST INVISIBLE
SYSTEM THAT SOUNDS LIKE A HUGE SPEAKER SYSTEM**

● The BE-1V is a super sub-woofer with an internally integrated matrixing crossover network designed to work with the new generation of small super speakers such as the "Visonik" David" 50's & 60's, 8&W DM 5's, Roger's LS3/5A, Jim Rogers JR-149, Polk's, AOS, KEF's, etc.

● The above mentioned small super speakers permit excellent decorator effects & when used in conjunction with the BE-1V yield dynamic range, imaging, low distortion, definition and frequency response hard to distinguish from large audiophile systems.

● Write for full descriptive literature on specifications and principles involved. Of course, we don't expect you to believe until you hear one of these systems at your M&K dealer. Please come in and hear it. We have been enjoying watching that expression of disbelief disappear.

Send for literature and dealer list.

MILLER AND KREISEL SOUND CORPORATION
8719 Wilshire Boulevard
Beverly Hills, California 90211
213-652-8318

VIENNESE WALTZES, POLKAS, OVERTURES on imported Dolby cassettes. Mostly non-Schwann. K.C. Company, Box 793, Augusta, Maine. 04330.

FOR SALE

10 1/2" Recorder Specialists: Fresh Scotch L/N 3600 ft. on new 1/4" NAB metal reels five for \$35.00. New low noise, high output Ampex tape on 10 1/2" metal reel, six for \$35.00. Reconditioned NAB metal 10 1/2" reels, \$24.00 per dozen. 10% on above for postage. Other tapes also on special, write for catalog: Sound, POB 88338, Atlanta, GA 30338.

**AMPZILLA-THAEDRA
SON OF AMPZILLA**

Sound Advice, 536 State Road, Emmaus, Pa. 18049. Hours Mon., Tues., Thur., Fr., 12-9:30, Wed. 6-9:30, Sat. 10-6. (215) 967-4418.

THOUSANDS OF LIKE NEW LP's and prerecorded tapes. Catalogue - \$1.50. House of Records, Hillburn, New York 10931.

AUDIO'S HI-FI HANDBOOK

Complete reference guide to over 1,000 components including prices and specs. All arranged in tabular form for easy comparison. Plus over 30 outstanding articles on audio topics, trends and advances. State-of-the-art reading for audiophiles. Only a limited quantity available. Over 200 pages. Send \$4.50 (including shipping and handling) to: Jean Davis, Audio Hi-Fi Handbook, 401 N. Broad St., Phila., Pa. 19108.

NAME BRAND RECORDING TAPE, custom loaded. Available in cassettes, reels, and cartridges. Huge savings direct from manufacturer. New catalogue now available, MJS, 516 Brooks, San Jose, Calif. 95125 (408) 998-2693.

HI-FI ENTHUSIASTS WANTED!! Earn more than just spare money in your spare time. We need campus representatives to sell name brand stereo components at discount prices in your area. High commission, no investment required. Serious inquiries only, please. Contact: Alan Weisberg, K&L Sound Services Co. 75 N. Beacon St., Watertown, Mass. 02172

CANADIANS: Best Hi-Fi discounts on over 96 leading Hi-Fi brands. Many exclusive factory closeout and special deals. Quotations via return mail. Nationwide mailorder service. FREE catalogs jam packed with bargains in Hi-Fi equipment, tape and recording accessories, calculators, telephones and accessories, kits, parts, etc. Hundreds of factory and government surplus specials too! American inquiries welcome. Rush free catalog request to: ETCO, Dept. AJA, Box 741, Montreal H3C 2V2

TANNOY SPEAKERS all models, Quad-405 amplifier, 33 pre-amplifier. Write to Nat, 423 South Sixth Ave., Mount Vernon, NY 10550.

PROTECT YOUR LPs. Poly sleeves for jackets 8c round bottom inner sleeves 7c Poly lined paper sleeves 15c White jackets 35c Postage \$1.50 House of Records, Hillburn, New York 10931

**CONN. AND WESTERN MASS.'S
LARGEST STEREO DEALER**

● Accuphase ● Audio Technica ● Epicure ● Dahlquist
● B&W ● dB Systems ● Crown ● Quatre ● Phase
Linear ● SAE ● ESS ● Soundcraftsmen ● Magneplanar
● Magneplanar ● Mayware ● Grace ● Tandberg ●
Technics ● SME ● Ortofon ● Revox ● TEAC ● DBX
● Beyer ● Stax ● AKG ● Nakamichi ● Sequerra ●
Hartley Woofers ● Harman-Kardon ● Rabco ● Avid and
more.

FRED LOCKE STEREO

Avon	East Hartford	New Haven
203-678-1797	203-289-3231	203-787-3469
Newington	Waterbury	Orange
203-666-0555	203-757-9296	203-795-5757
Springfield, MA.	Professional Products Division	
413-782-7111	203-828-1124	

FOR SALE

COLORADO'S AUDIO ALTERNATIVE — Boulder Sound Gallery, Ltd. — Purveyors of unusually fine audio systems and service to meet the needs of all serious music lovers. Our product selection includes the Acoustat X ESL, Allison, B & O, B & W, Dahlquist, dbx, Dynavector, Fidelity Research, Fons, Luxman, Magneplanar, Mark Levinson, M & K Sound, Quad Acoustical, Quatre, RAM Sound Concepts, Stax, Supex/Sumiko, Yamaha, and Ultraphase, Demo Lux M-6000 amp with new warranty available.
1200 Pearl, Boulder, Colorado 80302; 1-303-444-2626

AMPLIFIERS KITS AND ELECTRONICS PARTS - special-ists in advanced audio design. Computronics, Box 531, Station "H", Montreal, Canada.

LEACH LNF-1A: 100 Watt/Channel Stereo Power Amp Low TIM (Transient Intermodulation Distortion) Amplifier Available from your local dealer or from Electronics One, Inc., P. O. Box 13835, Atlanta, Georgia 30324

Buy Audio Cable For Less	250'	500'	1000'
2 Conductor 22-AWG Shielded & Jacketed	\$10.00	\$18.50	\$35.00
1 Pair Shielded			
1 Pair Unshielded			
22-AWG Jacketed	\$15.00	\$28.50	\$50.00
2 Conductor Mini Zip			
24-AWG Clear	\$ 6.00	\$11.00	\$20.00
2 Conductor Mini Zip			
22-AWG Clear	\$ 7.00	\$13.00	\$25.00
RG-59U	\$15.00	\$28.50	\$50.00
Dealer Inquiries Invited			
Economy Plus			
P.O. Box 4145			
New Windsor, N.Y. 12550			

SUPEX — ORTOFON — OENON — OTHER MOVING COIL CARTRIDGE OWNERS: Send for free literature on our Micro Preamp Superb performance at \$99.95. Huntington Electronics, Box 2009A, Huntington, Conn. 06484

CUSTOM ELECTRONIC CROSSOVERS!!! We specialize in crossover/biamp systems for subwoofer electronics and will optimize our circuitry for your high-definition components; including: Janis, Dahlquist, Dayton-Wright, Fulton, Acoustat and etc. 50 and 100 watt amplifiers are also available with built-in crossover systems for a variety of applications including sound reinforcement and bi-amplification of medium power stereo receivers. Write for brochure! MDNOLYTHIC SOUND P.O. Box 44 La Jolla, California 92038.

AKG, AMPZILLA, ARISTON, BEYER, CIZEK, CROWN, Dahlquist, DB Systems, Denon Electronics, Entre, Fons, Grace, Grado Signature, Infinity, Nakamichi, Ortpfon, PHASE LINEAR, PMI, REVOX, SAE, SAEC, Sennheiser, Sequerra, Sony, Stanton, Stax, Supex, TASCAM, Technics, Thorens, etc.

HI-FI HAVEN
28 Easton Ave.
New Brunswick, N.J. 08901
201-249-5130

ESOTERIC PRODUCTS - New and used. Audio Research, Nakamichi, Ampzilla, Luxman, B&O, Dahlquist, Quatre. Write for list. STEREO SHOP, 107 Third Ave SE, Cedar Rapids, Iowa 52401

6 SWITCHCRAFT QUADRASWITCHERS (2 630-4A Program Selectors, 2 531-4 Amp. Selectors, 2 632-4 spkr. selectors), \$99. \$189 & \$149 resp. or best offer. Call (203) 637-9824.

AMPEX 350 DECK with Nortronics 4-track plus original full track heads, Capstan motors for 3 3/4/7 1/2, 7 1/2/15 ips. reel motors just overhauled, \$400. Bill Kirkness, 8009 Chatham Dr., Manlius, N.Y. 13104.

TO CENTRAL ILLINOIS

AUDIO Ltd. is bringing the finest in components including the Rogers BBC mini-monitor, IMF, Allison, Promethean, DB Systems, Audionics, Quatre and much more. 115 N. Walnut, Champaign 61820.

FOR SALE

FREE SAMPLE

AUDIOMART THE FREE AD AUDIO NEWSLETTER BOX 821 STRATFORD CT 06497

LOW NOISE RESISTORS—1/4W, 5% from 1 to 4M7 ohms for 3 1/2c ea. 50 per value \$.85 Postage & handling \$1. Send 25c for catalog, sample & specs. Components Center, Box 134A, NY, NY 10038

INNOVATIVE AUDIO

Audio Instruments & Service for the music lover & audiophile. Drop in to experience us. You will experience a home-like atmosphere as much as you need honest & concise information, unmatched service, superb facilities & a good time. Mark Levinson, Sequerra, Dunlap Clark, IMF Intl, Innotech, Audio, Acoustat, Quatre, Spendor, AGI, DB Systems, Yamaha, SAE, Accuphase, Stax, BGW, DBX, Klipsch, ADS, OHM, Microseiki, Linn Sondek, Teac, Revox, Ortofon, Denon, Supex, Gale.

INNOVATIVE AUDIO

129 Degraw Street, Brooklyn, NY
(212) 596-0888

WESTCHESTER, FAIRFIELD COUNTY

THE LISTENING ROOM INC.

590 Central Park Avenue
Scarsdale, N.Y. 10583
914-472-4558

Cordially invites you to audition our line of equipment.
AMPZILLA II ● SON OF AMPZILLA ● AUDIOANALYST ● THRESHOLD ● DAYTON WRIGHT ● ESL ● DAHLQUIST ● DENON ● DUNLAP CLARKE ● GRACE ● JANIS ● KEF ● LUXMAN ● M & K ● NAKAMICHI ● PARAGON 12 ● S A E C ● SEQUERRA ● STAX ● TANDBERG ● THAEDRA ● THOBE ● ANTHEM ARRAY ● QUAD ESL ● YAMAHA ●

AUDIO PULSE DIGITAL DELAY SYSTEM
DYNAVECTOR TONE ARM DV 505

PEAK-DETECTING L.E.O.'s indicate amplifier's output limit; prevent clipping, distortion, speaker damage. Compact (1 1/2"x2"x3") unit adjustable 15-250 watts/channel, sent calibrated for your stereo system. Solid-state electronics in hand-milled oiled walnut block. Self-powered; connects to speaker lines, cannot affect sound quality. Send system specifications, 25 dollar bank check or money order to MICO, P.O. Box 1450, Ithaca, New York 14850. Quantity pricing available.

CYBERACOUSTIC LABORATORY is a research and development center combined with the most scientifically advanced audio acoustics lab. Exciting new product lines for 76-77 including: Audio Pulse Home Digital Delay Line, Acoustat Direct Tube Drive Electrostatic Spkr., Crown's New High Definition Series of Amps and Preamps, Fulton Systems, Infinity's New Quantum Spkr. Series, Luxman Ultra-High Fidelity Solid State & Tubes, IMF International Spkrs., RTR Point Source Direct Drive Electrostatic Spkrs., IM Fried Models H, M, D, R II, L, O, & S Spkrs., Denon Blk & Wht Carts., Stax Electrostatic Spkrs., Nakamichi's Recording Director Series of Electronics, Source Engineering's New Noise Reduction System, EMT Moving Coil Cartridges, Transcriptors TT, Sonus Carts., Otari Decks, KEF Spkrs., Spendor Spkrs., Formula 4 Tonearms, Poik Spkrs., Fons TT AND MUCH MORE!!!! 233 E. Lancaster Ave., Wynewood, PA 19096; 215-667-3048.

SAVE ON SACRED COWS-Bose, SAE, JBL, Thorens, Philips. Over 50 top brands. Write for quotes. SOUTHBOUND SOUND, P.O. Box 52508, Atlanta, Georgia 30355.

DYNAKITS, SHURE, SME, lowest prices. Underground HiFi Sales, 324 Broadwater Rd., Arnold, MD 21012. (301) 647-0919.

SAE 2500 AMP, LUX T-110 TUNER. Both new. \$950 and \$450 or offer. Bill Hobko, 201-747-5588.

FOR SALE

ROGERS LS35A's, \$340; ADS 810's, \$490; Linn-Sondek, \$285; Grace 940 arm, \$100; Micro-Acoustics QDCle, \$39; Grace f8c, \$50; Tandberg TR 1055, \$495. All equipment shipped prepaid - C.O.D. Call (703) 552-5568.

Avant-garde

14583 Big Basin Way
Suite 2B, Saratoga, CA 95070
(408) 867-6677

AMPEX TAPE—NEW 1800' on 7" reel 12 for \$18 POSTPAID, 1200' 12 for \$13 POSTPAID—free list—WIDE RESPONSE, 6114A, SANTA MONICA BLVD., HOLLYWOOD, CA 90038.

NORTHWEST AUDIOPHILES

THE TIN EAR presents high definition audio components for the discriminating music lover

AUDIO RESEARCH	NAKAMICHI	MARK LEVINSON
BEVERIDGE	MAGNEPLANAR	TREVOR LEE
YAMAHA	FULTON	AUDIDANALYST
ROGERS	AKG	TECHNICS
LUXMAN	GRACE	DAHLQUIST
SUPEX	LINN SONDEK	QUAD
FORMULA 4	QUATRE	SONEX

Also: Audio Lab, Levinson, Pathi Marconi, Sheffield recordings.

THE TIN EAR STEREO CENTER

704 SYMONS, RICHLAND, WA. 99352
(509) 946-4459 Tues.-Sat.

FOR SALE: TANDBERG 9200XD reel-to-reel with Dolby. Mint. \$650 (404) 232-1458.

AN AUDIOPHILE PREAMP FOR \$498? Can't be done? You haven't experienced the SYSTEM-E from PARAGON. This basic preamp excels at one very essential function; preserving and reproducing every last nuance and subtlety from your record grooves. Our exclusive Ultra-Linear Cascode front end will preserve and amplify ALL the information without shaving off the important depth, space, and delicate tonal information which is the true essence of live music. You may discover, as we did, that your present records are better than you thought. PARAGON, one word says it all. For more information write: PARAGDN 997 E. San Carlos Ave., San Carlos, CA 94070

LUX TUBE stereo system, perfect, \$1150. Arnold Feyh, 21 Steel St., Eureka Springs, Ark. 72632 (501) 253-9483

HELP WANTED

RECORDISTS interested in a high paying career. No experience necessary. No traveling. Modest investment required. Send resume to DGI, 551 NW 42nd Ave., Suite 304, Ft. Lauderdale, Fla. 33317.

OVERSEAS JOBS—Now hiring all Occupations. High pay. Transportation. Computerized Reports. \$2.00. TRANSWORLD, International Airport, Box 90802-K, Los Angeles 90009.

AUSTRALIA—NEW ZEALAND WANT YOU!! 50,000 Jobs! Latest Report \$2.00. Austco, Box 8489-K, Long Beach, CA 90808.

MISCELLANEOUS

RECEIVING TUBES. National Brands. Up to 80% discount. National Audio, 2500 Channing Road, Cleveland, Ohio 44118.

how to become a speaker engineer

Let us show you how to... **DO IT YOURSELF**

Now... from the only authorized distributor of **RECTILINEAR SPEAKER KITS** you can save a bundle by simply putting together the assembled components. You **DO NOT** have to do any wiring or soldering. The units are fully assembled and **TESTED** at the factory in Semi-Kit-Form. For free information and literature on this and all other **RECTILINEAR** Semi-Kits and Kits... write to:

VALUE KITS INC.
Dept. A. M.
107 Bruckner Boulevard
Bronx, New York 10454



RADIO PROGRAMS

WANTED KLH MODEL 12 speakers. D. Nevard, 2 Fort Ave. Terr., Roxbury, Mass. 02119. (617) 445-4567

OLD TIME RADIO... Catalog: \$1.25. Free flyer for SASE. BRC, 17173 Westbrook, Livonia, MI. 48152.

MIND-OPENING RADIO IS HERE, NATIONWIDE! Read comprehensive 3,000-word report on quality alternative: National Public Radio. Also list of 174 stations. \$3. Money-back guarantee. Box A79-1, Audio.

VINTAGE RADIO: Lowest rates, post free, traders welcome: shows for comics, etc. signals. Box 5063, Station E. Edmonton, Alta., Canada

RENT RADIO SHOWS: Make your own copies or just listen. Great way to build your collection reasonably. Catalog \$1 refundable. OTR Rental, Box 1146, Livermore, Ca. 94550

1930-1962 RADIO PROGRAMS. Tapes \$1.00 hour!! Established esteemed dealer. Informative 175 page catalog. \$1.25. AM Treasures, Box 192 AU, Babylon, N.Y. 11702

GOLDEN AGE RADIO - your best source for radio tapes Box 25215-0, Portland, Oregon 97225

INSTRUCTION & EDUCATION

PIANO LESSONS by mail using cassette tapes. Free details. Home Music Co., Box 13113, Louisville, KY 40213.

DEGREES, experience/credits: EMI, Inc. Box 4277, Inglewood, CA 90309

HIGH FIDELITY

PINK NOISE TAPES. Measure loudspeaker response accurately with a microphone and voltmeter. 1/3 octave bands ± 1 dB 31.5Hz to 16KHz, 15 ips-\$28 ppd 7 1/2 ips-\$23 ppd. Both 1/4" halftrack. Cassette available. Instructions included for stereo system or P.A. application. **AUDIOELECTRO** Audio Division, Box 5334-A, San Antonio, Texas 78201. **QUALITY PRODUCTS SINCE 1929.**

TAPE & TAPE RECORDERS

CASSETTES, 8-TRK & REEL TAPES, lowest prices, name brands and custom loaded w/BASF or SCOTCH. Super mastering computer cassettes loaded with LAB SERIES TAPE. Prepaid shipment. **FREE** catalog STANFORD INTERNATIONAL, AL, Box 609A, San Carlos, CA 94070

WE WILL BEAT any price sheet in America. Featuring TDK, MAXELL, and others. Tape World International, 220 Spring St., Butler, PA 16001.

SONAR'S OPEN REEL TAPES Duped one to one from the master. All formats. Highest quality available anywhere! Send \$1.00 for catalog and stereo sampler 1/4 track, 7 1/2 ips tape. Sonar, P.O. Box 455A, Kingsbridge Station, Bronx, NY 10463

RECORDING TAPE — OUTSTANDING VALUES
CASSETTES—8-TRACKS—OPEN REEL—ACCESSORIES
New, Fully Guaranteed. **FREE CATALOG.** Write:
MAGNE HOUSE
2015-17th Street, San Francisco, CA 94103

OLDIES TAPES ON OPEN REEL TAPE. Rock n' Roll songs by their year of release. Over 100 songs per year. Free brochure. Rock N' Reel Rental, Dept. C, 4 Prescott Ave., Dix Hills, NY 11746.

MAXELL, AMPEX, CAPITOL, Columbia Tape Bulk & Custom Loaded reels, cassettes. Reels, boxes, leader, splicers. For complete catalog write Omega Audio, Box 39253-B, Redford, MI 48239

TDK, MAXELL, MEMOREX, BASF, cassettes, reels 8-tracks. Lowest prices. New. Guaranteed **FREE CATALOG** S & S Audio, P.O. Box 56039, Harwood Hts. IL 60656

40,000 OLD RADIO SHOWS on Tape. Jazz/Big Band remotes, Country/Western, discographies, anthologies, chronologies. Send \$2 for huge catalog (refundable). McCoy's Recording, Box 1069A, Richland, Washington 99352.

OPEN REEL TAPES. 7 1/2 ips, Dolbyized releases from RCA, London, DG, Warner and others. Airline tapes and quad. Catalog \$1, refunded on first order. **THE REEL SOCIETY,** P.O. Box 651-A, Arlington Heights, IL 60006

BLANK TAPE BONANZA. TDK: 10 SAC-90 \$30.57, 10 SAC-60 \$21.57. MAXELL: 12 UDC-90 \$35.03, 10 UD35-90 \$49.74, 12 UDXL C90 (I or II) \$41.15. All prices include shipping. (PA add 6% sales tax). Give us a try! Tape World International, 220 Spring St., Butler, PA 16001.

WE WILL BEAT any price sheet in America. Featuring TDK, MAXELL, and others. Tape World International, 220 Spring St., Butler, PA 16001.

TAPE & TAPE RECORDERS

DISCOUNTS ON RECORDING TAPE, M.A.D. P.O. Box 532, Southfield, MI. 48037. Mastercharge and phone orders accepted (313) 559-6913.

CAVEAT EMPTOR! Microphone comparison tape auditions popular mikes before you buy, presents chorus and orchestra recorded in true stereo. Cassette or reel, \$6.50. Millers, 1896 Maywood, S. Euclid, OH 44121.

SCOTCH RECORDING TAPE, lowest prices **TAPE CENTER** Box 4305B Washington, O.C. 20012. USA. APO. FPO

EVERYTHING ON OPEN REEL! Classical. Popular. Dolby. Quadraphonic. Latest releases. For "Reel News," send \$1.00. Barclay-Crocker, Room 857 A, 11 Broadway, New York 10004.

QUADRAPHONIC OPEN REEL TAPES. Lowest Prices. Free List. Real Sound, P.O. Box 71, Shillington, PA 19607

CUSTOMIZED TAPES. Jazz. Big Band. Select standard tracks or available artists. Free catalog. 80 minute reel cassette or 8-track. \$8.00. Tapes Unlimited, Box 163, Portsmouth, RI 02871

SERVICES

CUSTOM RECORDING SERVICE, Tapes, discs, and cassettes. Stereo and mono. Live and copies. Editing. Masters and pressings. High quality at reasonable rates. Joseph Giovannelli, Audio-Tech Laboratories, 2819 Newkirk Ave., Brooklyn, N.Y. IN9-7134

CROWN INTERNATIONAL

Complete repair, overhaul, and rebuilding service for current and early model Crown tape recorders and amplifiers. New Crown recorders in stock for immediate delivery. Excellent selection of reconditioned Crown recorders for sale. Used Crown recorders purchased and accepted for trade in. **TECHNIARTS** 8555 Fenton Street, Silver Spring, MD 20910 301-585-1118

STEREO MASTERS, RECORDS AND ALBUMS. Check our prices. Newest type high level cutting equipment featuring: Neumann VMS 70 Computer control lathe, Parametric Equalization, Dolby, OBX, and the new SX74 Cutting System by Neumann. Special package prices on pure vinyl album and single record production. 1000 45 RPM stereo singles \$199.00 including mastering. 100 LP albums \$325.00 including printed jackets. Write or call for brochure. A & R Record Manufacturing Corp., 902 N. Industrial Blvd., Dallas, Texas 75207. Toll Free 1-800-527-3260.

TAPE RECORDER HEADS re-lapped \$15.00 ea. Removed from machine or stack. One day service. E. Maher, 5 Evans Place, Orinda, Calif. 94563

DISCO SOUND SYSTEMS - Installations, sales, service & rentals. Mobile DJ available. King Cobra Sound Co., 291 Kings Highway, Brooklyn, N.Y. 11223. Tel: 212-375-4062.

NASHVILLE RECORD PRODUCTIONS WILL PRESS HIGH QUALITY PURE VINYL RECORDS FROM YOUR TAPES. SEND FOR SAMPLE RECORD AND PRICE LIST ALSO FINEST DISC MASTERING. 469 Chestnut St. NASHVILLE TENNESSEE 37203.

RECORDS

OPERA TAPES-DISCS - Fantastic rare live performances. Superb quality, fast service. Free catalog. Historical Recording Enterprises, Box 12, Kew Gardens, N.Y. 11415.

QUASI-RATIONAL PRODUCTS has everything in record protection; Liners @ \$13.50/100 incl. shipping, jackets, containers, Discwasher, Watts, Maxell, Nortronic, Jensen and Pioneer auto, etcetera. Swift and Reliable. Free catalog. QUASI-RATIONAL PRODUCTS, P.O. Box 171, Prospect Heights, Illinois 60070.

CATALOGS. Broadcasts, soundtracks Personalities of Thirties, Forties. Box 225, New York, N.Y. 10028

WHILE YOU WERE LOOKING for out-of-print records, you should've been looking for us. DISContinued, 444 S. Victory Blvd., Burbank, Ca. 91502

SOUNDTRACKS, CASTS, personalities! Free newsletter! RTSA, 3700 Plaza, F211, Santa Ana, Calif. 92704.

SHOW ALBUMS—Rare Out of Print LP's. 64 page list \$1.00. **ROBBER BRIDEGROOM** 7" STEREO, 33-1/3, & songs Jerry Urbach; Virginia Vestoff \$3.95; La Strada, Mata Hari EP \$3.95; Bakers Wife cast LP \$9.95. Broadway/ Hollywood Recordings, Georgetown, Conn. 06829.

RECORD JACKETS. Replace old, torn, 12" or 10" LP jackets with new, pure white, cardboard jackets, 35c. Postage \$1.25. 78 sleeves and opera boxes, all sizes. Free catalog. CABCO A6, Box 8212, Columbus, Ohio 43201.

Jazz, Rock, Classical, Big Band LP's, Tapes, Current, Imports. Cutouts Catalogs \$1; NERT, Box 268-A, Lawrence, Mass. 01842

SOUNDTRACKS—JAZZ—POP. Vincent, Box 5202, Long Island City, N.Y. 11105.

78 RPM RECORD LISTS. (1) Popular & Jazz, (2) Americana, (3) Classical, (4) Country-Western. State category, AUCTION ONLY. Write, S.A. Langkammerer, RECORD LISTS, 3238 Stoddard, San Bernardino, Ca. 92405

INDIRECT DISCS cut from 100 dB dynamic range tapes recorded by Dick Burwen. **MISTY**—The Petty Trio. Includes Rhinestone Cowboy, Feelings, Leroy Brown, Wild Flower, and Misty. Made in Germany on Celia label. BL-3. **THIS IS THE ONE**—piano solos by Dick Wellstood. Includes Paganini's Thing, Keepin' Out of Mischief Now, You Are the Sunshine of My Life, The Steeplechase, You Go to My Head, Rosetta, Sugar, and Giant Steps. On Audiophile label, AP-120. \$15.00 each postpaid. Send check or money order. Massachusetts residents only add 5% sales tax. **DECIBEL RECORDS**, Dept. 2, P.O. Box 631, Lexington, Massachusetts 02173.

COLLECTORS RECORDS - 50,000 LPs - Sold @ Auction - International Service Since 1971 - Specify category or artists - Lists From: Ray Macknic (or) Thea's, P.O. Box 7511, Van Nuys, Calif. 91406, U.S.A.

MUSICAL INSTRUMENTS

UP TO 60% DISCOUNT. Name brand instruments. Catalog Freeport Music, 114R Mahan St., W. Babylon, N.Y. 11704.

PERSONALS

RECORDING STUDIO ENGINEER CAREER? Degree Un-necessary. Send two 13c stamps to Attainment Research, Box 45333AU, Dallas, Tex. 75245.

PLANS & KITS

SPEAKERLAB SK WALNUT Horn enclosure kit - un-assembled. Make offer. 313-794-4286

TAPE-SLIDE SYNCHRONIZER, lap-dissolve plans, \$5.50. With mixer, compressor, preamp schematics, \$8.50. The Millers, 1896 Maywood, S. Euclid, OH 44121.

FM-3 FANS: Phase locked loop multiplex demodulator meter kit soon to be available. Send for free info. VSM Audio, P.O. Box 114, Maspeth, NY 11378.

NEW HEATH MODEL IO-4540 oscilloscope kit with guarantee. Solid waveform display, 5 MHz bandwidth. List \$200, sacrifice \$150. William Willes, Apt. 442, 3443 Esplanade Ave., N.O., La. 70119.

GOVT. SURPLUS

JEEPS, TRUCKS, Typically from \$52.40 ... Automobiles, Boats, Motorcycles, Airplanes, Cameras, Tools, Clothing, Sports, Camping, Photographic, Electronics Equipment ... 200,000 Bid Bargains Direct from Government Nationwide ... Low as 2c on Dollar! Surplus Catalog and Sales Directory \$1.00 (refundable). National Surplus Center, 240 Eastcass-AUD, Joliet, Ill. 60432.

WANTED TO BUY OR TRADE

MARANTZ 7C, Z, 9, J. Fong, 1238 Green St., San Francisco, CA 94109

WANTED: JBL SIGNATURE CLASSIC EARLY EQUIPMENT: pre-1970 such as, HARLAN, HARTSFIELD, HARKNESS, ANGELUS, BELAIRE, METREGON, MINIGON, PARAGON, LANSING, etc., Also any electronics. Call anytime: 714-731-1312 or Mark, 1622 Sierra Alta, Santa Ana, Calif. 92705

WANTED—ELTRO Pitch and Tempo Changer or similar machine. Consider in any condition for parts. Easton, Hoffmeister, N.Y. 13353

WANTED—TECHNICS SH-400 CD4 OEMODULATOR. Write W. Johnson, Box 3561, Arlington, Va. 22203

CASH FOR your unwanted LPs & reel to reel tapes Records. Box 323, Hillburn, New York 10931

TO ALL MUSIC mfg. companies: Wanted to buy any type of musical instruments, drum, horns, stereos, synthesizers, etc., etc., at manufacturers cost. Send information, Gary Lewis Wholesale Co., 1813 Norwood, Toledo, Ohio 43607.

WANTED. SONY TA-3200F preamplifier. Don Abele, P.O. Box 76180, Birmingham, Ala. 35223.

BACK ISSUES OF AUDIO Magazine Pre-1969. John Reynolds, Jr. 703 Nordale Dr., Fort Wayne, Indiana 46804.

WANTED MCINTOSH MPX5 Scott 4310, 333B, 220A, Wharfedale Speakers Crossovers University C15W MPX Adapters E. C. 32 West 40 Street, New York, N.Y. 10018 Box 305

STEREO TV



The TE 200 TELEADAPTER EASILY CONNECTS TO ANY TV & STEREO SYSTEM. Using our coupling and matrix circuit, teleadapter takes a low impedance output from the television and delivers two HIGH IMPEDANCE CHANNELS OF SIMULATED STEREO, to drive any amplifier. Frequency response is maintained so you can hear the tinkle of bells or booming bass sounds as it happens on TV. With service warranty and hookup instructions \$19.95 p/d. Guaranteed to make your TV 100% more enjoyable.

OUR NEW TE-300 VHF UHF TELEVISION High Fidelity AUDIO TUNER is now available. Completely solid state. Recording and amp output jacks. Anodized Aluminum front panel and simulated Walnut Cabinet. 110 volt operation \$169.95 p/d

SEND CHECK, M.O., MASTERCHARGE, or BANKAMERICARD NO. and Expiration date TO: RHOADES NATIONAL CORP. DEPT NO. 5C BOX 817, HENDERSONVILLE, TENNESSEE 37075

NAME _____
ADDRESS _____
CITY _____ STATE _____ ZIP _____
SEND COMPLETE CATALOG

TAPE RECORDINGS

RECORDING TAPE SPECIALIST OFFERS LOW PRICES, FAST SERVICE, WIDE VARIETY OF BRANDS, UNUSUAL CATALOG. SAXITONE TAPE SHOP, 1776 COLUMBIA ROAD, N.W. WASHINGTON, D.C. 20009.

RARE OPERA TAPES. Over 3000 on reels from all over the world. Some available on cassettes too. Write: Cory, Box 1123, Malibu, California, 90265.

BUSINESS OPPORTUNITIES

CAMPUS REPRESENTATIVES - Double your profits! Contact TOKYO AUDIO LTD., Box 3241, Los Angeles, Ca. 90028

OWNER'S HEALTH FORCES SALE!!

Well-established California audiophile store, five year national reputation, top lines, superb opportunity for diversified eccentric audiophile, priced for immediate bargain sale, terms negotiable, for details write: P.O. Box 637, San Carlos, CA 94070.

\$25.00 DAILY POSSIBLE stuffing envelopes! Details FREE. SERVICE, Box-715 AU, Lynbrook, N.Y. 11563.

\$1000 MONTHLY POSSIBLE! Mailing Commission letters. Information—FREE. Opportunities, Box 721-AU, Lynbrook, N.Y. 11563

SPEAKERS

BUILD YOUR OWN SPEAKERS AND SAVE UP TO 50%

Send for our free, fact-packed 44 page catalog manual and learn how to assemble your own multi-element stereo speakers from scratch or from kits. Our catalog includes chapters on design, construction, speakers, enclosures, magnets, tweeters, tweeters and horns. Write us today.

SPEAKERLAB
Dept. AD-A 5500 35th N E
Seattle Washington 98105



HIGH FIDELITY SPEAKERS REPAIRED
AMPRITE SPEAKERS SERVICE
655 Sixth Avenue, New York, N.Y. 10010
212-CH3-4812

ELECTRO-VOICE SENTRY PRODUCTS. In stock: Sentry IV-B, Sentry III, and Sentry V monitor loudspeaker systems for professional monitoring and sound reinforcement. Immediate air freight shipment to any N. American destination. National Sound Company, Ft. Lauderdale, Florida. (305) 462-6862.

5,000 SPEAKER CABINETS

"Builders delight" finished, ready for speakers. OHIO MERCHANDISE, 2825 S. Main St. - Akron OH. 44319

The Marantz 2500 is the most powerful receiver on the face of the earth.

Model 2500



250 watts per channel

(minimum RMS at 8 Ohms, 20-20,000 Hz)

with no more than 0.05% THD*!

Not everyone can afford the Marantz 2500, but those who can will possess the world's most outstanding stereo receiver.

The Marantz 2500 handles tremendous power effortlessly. Its **Toroidal Power Transformer** has been especially designed to give you **two independent power supply sections**, allowing each channel to perform at maximum efficiency and **remain unaffected** by the power demands of the other channel. The super-efficient **tunnel "pin-fin" heat sink** design was originally developed for the Marantz 510M Professional Amplifier. All this power is generated by virtually the most

sophisticated amplifier section on the market today: a **full complementary symmetry direct-coupled output**. The result is the highest possible day-in, day-out operating reliability and lowest Total Harmonic Distortion: **no more than 0.05%**.

The Model 2500 also includes the most impressive performance feature package ever engineered into one receiver. You get a **built-in oscilloscope**, for precise signal display. **Plug-in optional Dolby** FM Noise Reduction Circuitry** for lowest noise possible with FM reception. And the most advanced noise filtering system ever developed. First, the **18 dB per octave Bessel-derived high filter**—the most advanced in audio—

reduces high frequency noise with a more natural, less colored sound. The **18 dB per octave 15 Hz sub-sonic Butterworth low filter** assures that all your power is used to reproduce only actual program material, not wasted on unwanted noise or rumble. **2 LED peak power indicators** let you know when transients drive the amplifier to full output. **5-gang FM tuning capacitor**, and **dual-gate MOS FET FM front end** ensure superior linearity and rejection of spurious signals with an IHF usable sensitivity of 1.5 microvolts and a 50 dB "quieting sensitivity" figure in stereo of **25 microvolts**—the finest such specification ever obtained in a receiver—or even a separate tuner.

In virtually every other area of performance as well, the **Marantz 2500 exceeds any other receiver on the market today.**



*Total Harmonic Distortion **TM Dolby Labs, Inc.

marantz®

©1972 Marantz Co., Inc., a subsidiary of Superscope, Inc., 20525 North Hill St., Chatsworth, CA 91311

We sound better.

BE SURE YOU CHOOSE THE ONE YOU LIKE.



A TEAC LASTS A LONG, LONG TIME.

One of the reasons is that we've been *making* them for a long, long time. In 1955, TEAC came on the scene with the first in a long line of fine open reel tape recorders.

Since then, of course, we have developed a sister line of cassette decks. But our first love remains open reel tape recording equipment: the truest method of sound reproduction available today.

Consider the alternatives. If you want top-of-the-line quality, but only need bottom-of-the-line features, the A-2300SX is the buy of the year. From there, you can add DOLBY,* larger 10½" reels, four heads, auto reverse, four-in/two-out mixer, memory stop, 15 ips, four channel Simul-Sync, and variations thereof.

In short, as long as you're getting a tape deck, can you conjure up a single reason it shouldn't be a TEAC?

TEAC®

The leader. Always has been.

TEAC Corporation of America
7733 Telegraph Road
Montebello, California 90640

In Canada TEAC is distributed by White
Electronic Development Corporation
(1966) Ltd.



*Dolby is a trademark of Dolby Laboratories, Inc.

©TEAC 1977