

# Audio

FIRST TEST  
Lirpa 1 Receiver

THE AUTHORITATIVE MAGAZINE ABOUT HIGH FIDELITY • APRIL 1977

\$1.00

47425



## Fighting Distortion In Tape Recording Open Reel vs. Cassette



U0803760 0477 60616013P0201312  
DON L HUNTER  
2608 CENTRAL BLVD  
EUGENE OR 97403

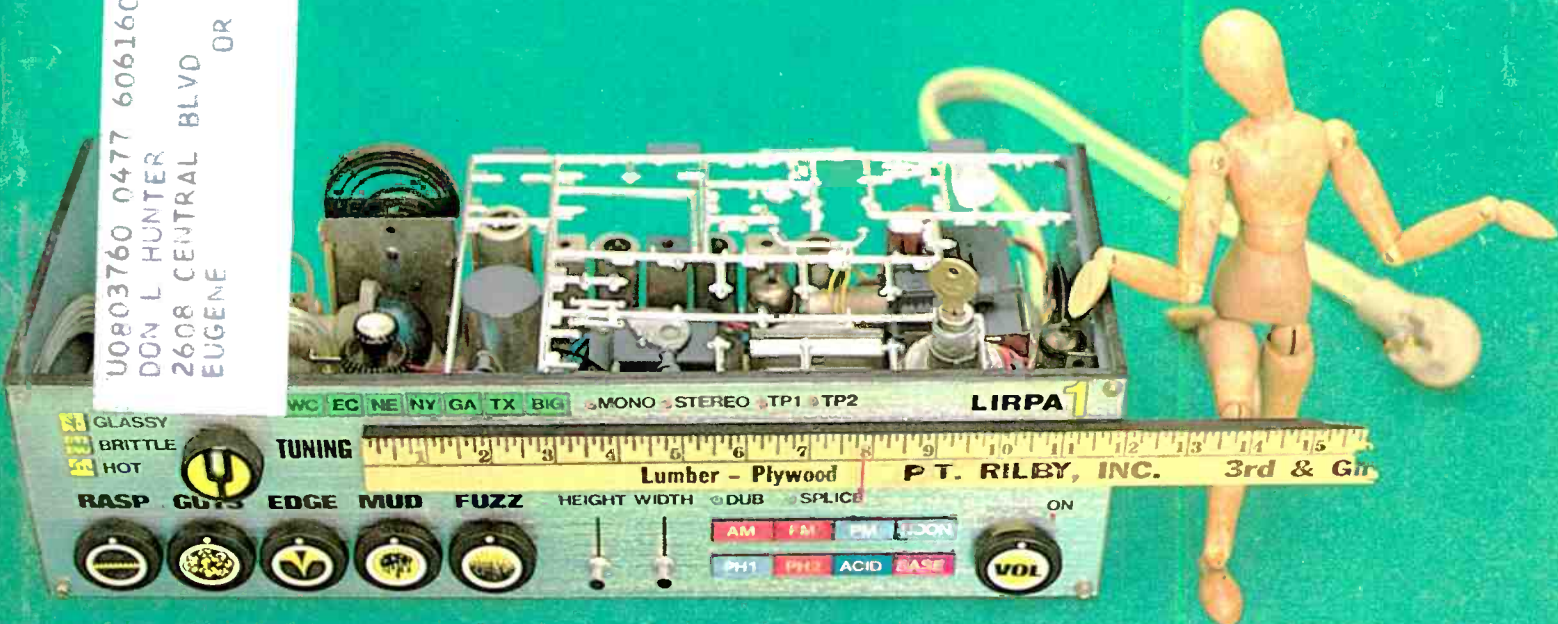

# G LIKE THIS.



incredible tolerances. Which give the 9191 the kind of wow and flutter figures that no deck in our price range can match.

Of course, having a great tape transport system means nothing if you don't have great electronics to back it up. We do.

The 9191 comes with an advanced three stage direct coupled amplifier that extends high frequency response and minimizes distortion. The built-in Dolby system can reduce tape hiss by as much as 10 decibels in high frequencies.

Our multiplex filter lets you record FM broadcasts without picking up a lot of unwanted noise, or the multiplex signal every FM stereo station sends out.

Even our ferrite solid tape head offers the

best combination of accuracy and long life you can get in a cassette head.

There's also a peak limiter that lets you cram as much onto a cassette as possible without distortion. Large VU meters and a peak indicator light that let you know if you do begin to oversaturate the tape and distort. Plus separate bias and equalization switches that let you get the most out of different brands of tape. And an automatic CrO<sub>2</sub> selector.

If all this isn't enough, you'll find that the 9191 comes with a memory that lets you go back to a favorite spot on the tape automatically. And electronic solenoid controls for going from play to rewind, or from rewind to fast forward, without hitting the stop button. And without jamming the tape.

There's also the convenience of front loading. A door over the cassette compartment to help keep the tape heads clean. And a light behind the cassette that lets you see where you are on the tape.

Go slip a cassette into a Pioneer 9191 at your local Pioneer dealer.

You'll find it hard to believe such a little thing could come out sounding so big.

#### CT-F9191 Specifications:

**Frequency Response:** Standard, LH tape: 25-16,000 Hz (35-13,000 Hz  $\pm$ 3dB); CrO<sub>2</sub> tape: 20-17,000 Hz (30-14,000 Hz  $\pm$ 3dB)

**Signal-to-Noise Ratio:** Dolby OFF: More than 52dB. Dolby ON: More than 62dB (Over 5,000 Hz, Standard and LH tapes/When chromium dioxide tape is used, signal-to-noise ratio is further improved by 4.5dB over 5kHz)

**Harmonic Distortion:** No more than 1.7% (0dB)

**Wow and Flutter:** No more than 0.07% (WRMS)

**Motor:** Electronically-controlled DC motor (built-in generator) x 1; (4.8cm/s speed drive), DC torque motor x 1; (Fast forward and rewind drive)

## PIONEER®

U.S. Pioneer Electronics Corp., 75 Oxford Drive, Moonachie, New Jersey 07074

© U.S. PIONEER ELECTRONICS CORP. 1977

# A BEAUTIFUL BIG THING



The recording tape in a cassette is only an eighth of an inch wide.

Crammed into that eighth of an inch may be as many as 64 original tracks mixed down to two. A hundred musicians. Countless overdubbings. Not to mention the entire audible frequency range.

Any cassette deck can reproduce part of what's been put down on that eighth of an inch.

The Pioneer 9191 was designed to reproduce all of it. Superlatively. Without dropouts,

unacceptable tape hiss, or noticeable wow and flutter.

Take our tape transport system.

Since the tape in a cassette moves at only 1-7/8 inches per second, even the most minute variation in tape speed will make a major variation in sound. To guard against this, where most cassette decks give you one motor, the 9191 comes with two. The first is used only for fast forward and rewind, so the second can be designed exclusively for maintaining a constant speed for play and record.

All of our tape drive components—the capstan, belt, and flywheel—are finished to

**WHAT DOES IT TAKE  
TO GET THE MOST  
BEAUTIFUL MUSIC OUT  
OF A LITTLE THING  
LIKE THIS?**



Enter No. 22 on Reader Service Card

# The Very First DIRECT-TO-DISC Of a Full Orchestral Production



A record of incredible  
fidelity from an incredible  
performance of Berlioz,  
Bizet, Falla and Tchaikovsky.

- \$16 (\$15 plus \$1 shipping & handling) from TELARC RECORDS 4150 Mayfield Road, Cleveland, Ohio 44121.

- and at the world's finest record and audio stores.

Exclusively distributed worldwide



by the Discwasher Group.

1407 N. Providence Rd.  
Columbia, MO 65201

# Audio

April 1977

"Successor to **RADIO** Est. 1917" Vol. 61, No. 4

<b>Feature Articles</b>	28	Open Reel vs. Cassette/Herman Lia
	34	Fighting Distortion on Tape/Wayne Saylor
	48	The Compleat Microphone Evaluation/Jon Sank

<b>Equipment Profiles</b>	60	Lirpa I Receiver/I. Lirpa
	67	Dynaco SE-10 Equalizer/Leonard Feldman
	70	Sonus Blue Phono Cartridge/B.V. Pisha
	72	Garrard GT55 Turntable/George W. Tillett
	74	AIWA AD-1800 Cassette Deck/George W. Tillett
76	Shure 516EQ Microphone/Jon Sank	

<b>Record Reviews</b>	80	European Records/John Wright
	84	The Column/Michael Tearson & Jon Tiven
	88	Jazz & Blues
91	Classical/Edward Tatnall Canby	

<b>Audio In General</b>	4	Audioclinic/Joseph Giovanelli
	6	Tape Guide/Herman Burstein
	8	Audio ETC/Edward Tatnall Canby
	16	Dear Editor
	24	Tape Guide II/Herman Burstein
	26	What's New In Audio
	94	Classified Advertising
98	Advertising Index	

**Editor** Eugene Pitts III  
**Associate Editors**  
Edward Tatnall Canby  
Bert Whyte

**Assistant Editor** Eugene J. Garvin Jr.  
**Marketing Director** Sanford L. Cahn  
**Design** Frank Moore  
**Circulation Manager** Jean Davis  
**Advertising Production** Gloria Klaiman

**Senior Editors**  
Richard C. Heyser  
Bascom H. King  
B.V. Pisha

**Contributing Editors:**  
Tom Bingham, Herman Burstein,  
Leonard Feldman, Joseph Giovanelli,  
C.G. McProud, Dan Morgenstern,  
Howard A. Roberson, Donald M. Spoto,  
Michael Tearson, George W. Tillett,  
Jon Tiven.

**Publisher** Jay L. Butler

**About the cover:** We couldn't resist doing a full-color cover of the fabulous Lirpa One receiver, which is our lead equipment profile this month. Since our measurement equipment doesn't begin to compare with that in Herr Doktor Lirpa's lab, it seemed best to have the receiver's test report done by Prof. Lirpa, along with two of his colleagues.

**AUDIO** (title registered U.S. Pat. Off.) is published monthly by North American Publishing Co., Irvin J. Borowsky, President; Frank Nemeyer, and Jay L. Butler, Vice Presidents; R. Kenneth Baxter, Vice President/Production; Vic Brody, Promotion Director; Mary Claffey, Circulation Director.

**RATES**—United States only: 1 year for \$8.00; 2 years for \$14.00; 3 years for \$20.00; outside the U.S.: 1 year for \$10.00; 2 years for \$18.00; and 3 years for \$26.00. Printed in U.S.A. at Columbus, Ohio. All rights reserved. Entire contents copyrighted 1977 by North American Publishing Co. Second class postage paid at Philadelphia, Pa. and additional mailing office.

Back issues, \$2.00 each. **World Library Congress Number:** ISSN 0004-752X. **Dewey Decimal Number:** 621.381 or 778.5.

**REGIONAL SALES OFFICES:** Jay L. Butler, Publisher and Sanford L. Cahn, Marketing Director, 545 Madison Ave., New York, N.Y. 10022, telephone (212) 371-4100.

Jay Martin, 2525 West 8th St., Los Angeles, California 90057, telephone (213) 385-2917.

**REPRESENTATIVES:** Europe, V. B. Sanders, International Publishers Advertising Service, Raadhuisstraat 24, P.O. Box 25, Graft-de Ryp, Holland; telephone, 02997-1303; telegrams, Euradteam—Amsterdam.



**AUDIO Editorial and Publishing Offices,**  
401 No. Broad St., Philadelphia, Pa. 19108  
**Postmaster:** Send Form 3579 to the above address.



# Two sources of perfection in stereo sound.

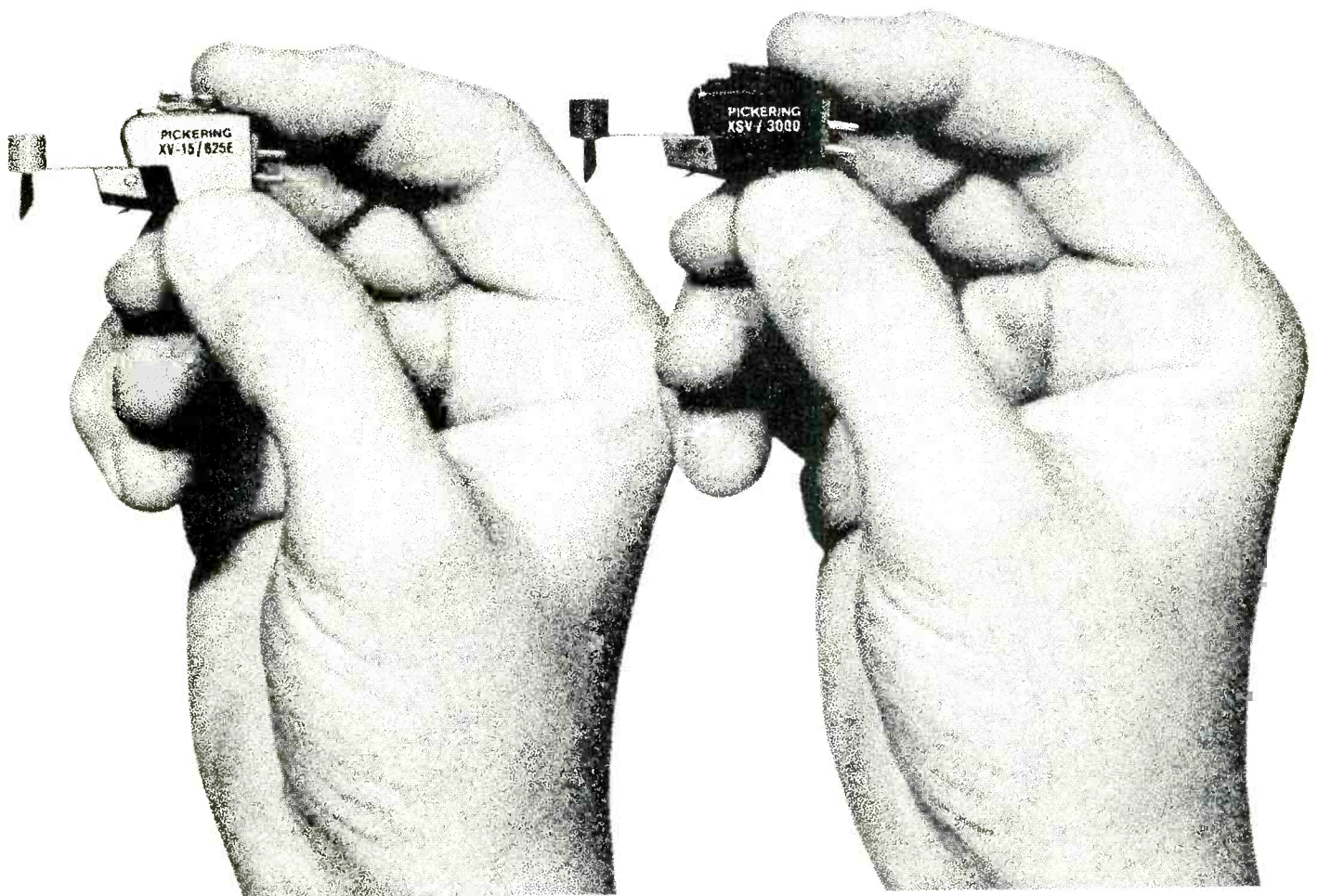

## Match one to your equipment

**"The right Pickering Cartridge for your equipment is the best Cartridge money can buy."**

We've been saying that for years; and tens of thousands of consumers have profited by applying this principle in assembling their playback systems.

If you have a fine manual turntable, the XSV/3000 is a perfect choice.

If you have a high quality automatic turntable, then installing an XV-15/625E in its tone arm is a perfect choice.

The summary advice of **Stereo's** Lab Test, in an unusual dual product review, we think brilliantly states our position: "The XV-15/625E offers performance per dollar; the XSV/3000, the higher absolute performance level." That makes both of these cartridges **best buys!**

**STEREO  
LAB TESTS**

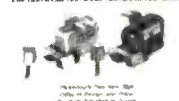

**FREE!**

Pickering's new XSV/3000 is a remarkable development. It possesses our trademarked Stereo-hedron Stylus Tip, designed to assure the least record wear and the longest stylus life achievable in these times with a stereo cartridge. Its frequency response is extraordinarily smooth and flat; its channel separation is exceptional; its transient response affords superb definition. It represents a whole new concept of excellence in stereo cartridges.

Read the whole evaluation report. Send for your free copy of the **Stereo** "Lab Test" reprint; write to Pickering & Co., Inc., 101 Sunnyside Blvd., Plainview, N.Y. 11803. Department A

 **PICKERING**

*"for those who can hear the difference"*

PICKERING & CO., INC. COPYRIGHT 1977

Enter No. 20 on Reader Service Card

## Empire's Blueprint For Better Listening

No matter what system you own, a new Empire phono cartridge is certain to improve its performance.

The advantages of Empire are threefold.

One, your records will last longer. Unlike other magnetic cartridges, Empire's moving iron design allows our diamond stylus to float free of its magnets and coils. This imposes much less weight on the record surface and insures longer record life.

Two, you get better separation. The small, hollow iron armature we use allows for a tighter fit in its positioning among the poles. So, even the most minute movement is accurately reproduced to give you the space and depth of the original recording.

Three, Empire uses 4 poles, 4 coils, and 3 magnets (more than any other cartridge) for better balance and hum rejection.

The end result is great listening. Audition one for yourself or write for our free brochure, "How To Get The Most Out Of Your Records." After you compare our performance specifications we think you'll agree that, for the money, you can't do better than Empire.



# EMPIRE

Already your system sounds better.

Empire Scientific Corp.  
Garden City, New York 11530

Enter No. 7 on Reader Service Card

# Audioclinic

Joseph Giovanelli

## Low Plate Voltage

*Q. I have two old tube-type stereo amplifiers which apparently share a similar problem. At first the problem manifested itself by the plates of the output stages glowing red—indicating excessive plate current. After replacing tubes, measuring voltages, and pondering, the main problem in one was traced to a shorted capacitor and in the other to a dirty bias adjusting pot. Still the voltages are out of spec and beyond the range of available adjustments.*

*With all the audio tubes removed and the rectifier tube left in, I have lots of volts, but insertion of the output tubes brings the voltage to below specified levels. This would indicate that I still have a plate current problem. Why?—Fred Portnoy, Owings Mills, Md.*

*A.* With old equipment as you are presently restoring, it is never a good practice to operate it with the rectifier plugged in but all the other tubes removed. The filter capacitors will charge up to peak voltage which, with many amplifiers, will be close to the capacitors' breakdown point, even when they are new. You are flirting with disaster by operating the amplifier as you described.

Vacuum tube amplifiers are designed so that if the operating voltages are 10 per cent low, they are still considered within specifications. If the voltage is substantially lower, then something is wrong. It may be that the output stage is drawing too much current, perhaps not enough to make the plates glow red, but still enough to cause the power supply to collapse under the load. It may also be that the capacitance of the filter capacitors is low. There may be sufficient capacitance to keep hum at a relatively low level, but not enough to keep the voltage up to specs.

It may also be that the rectifier tube is low in cathode emission. When called upon to supply the full current, the internal resistance of the rectifier may be high enough to produce an

excessive voltage drop within the tube itself which would account for the low operating voltages.

Some amplifiers, including yours, employ fixed bias and the rectifiers increase in internal resistance with age, which would result in low bias applied to the output stages. This results in an increase in plate current and could be the cause of your problem. Bias is often developed via a voltage divider network. Check the value of the resistors to see if they have changed in value, for if they have, the bias adjustment controls may not be enough to compensate for this problem.

## Front-End Overload

*Q. My problem is with a new tuner. I am receiving stations where there are none. There are three stations which I get all at the same time. At 95.7 MHz, I am getting 94.3, 92.1 and 97.9 MHz. What type of problem is this? Can I do anything about it? Is the tuner at fault? Is this what happens when one is close to strong signals?—R.J. Patterson II, Lake Park, Fla.*

*A.* Solid-state technology has brought us marvelous equipment, but we have also gotten some disadvantages. One of them is that sensitive solid-state r.f. amplifiers will overload much more quickly than their tube counterparts. The r.f. stages of the solid-state tuners are the most likely sources of the overload you described, which means that you hear more than one station at a time and on a frequency not occupied by any of the received stations. Sometimes these signals are so strong that by the time they are attenuated sufficiently to do any good, other signals have all but disappeared. It might be worthwhile writing to the equipment manufacturer to see if he has any modifications to reduce the magnitude of this problem.

If you have a problem or question on audio, write to Mr. Joseph Giovanelli, at AUDIO, 401 North Broad Street, Philadelphia, Pa. 19108. All letters are answered. Please enclose a stamped, self-addressed envelope.

AUDIO • April 1977



# Performance. Scott Stacks Up.

Every serious listener knows that separate tuners and amplifiers offer greater system versatility and flexibility than the all-in-one receiver. But Scott separates stack up where it really counts—performance.

Every one of Scott's complete line of tuners and amplifiers is engineered and designed to give you all the performance features you expect, at a price no higher than many receivers currently on the market.

Scott's T 526 AM/FM Stereo Tuner and A 436 Integrated Power Amplifier provide such important performance features as front panel Dolby de-emphasis switching, a phase locked loop multiplex section and linear motion calibrated controls.

And that's only part of the story. Compare these important performance features with any other medium-priced tuner and amplifier on the market today.

## The Scott T 526 Tuner

IHF sensitivity rated at  $1.9 \mu\text{V}$ , S/N ratio 68 dB and a capture ratio of 1.5 dB.

Signal strength and center channel tuning meters.

Four gang tuning capacitor for better image rejection.

AM section designed around a tuned RF amplifier using J-FET for improved signal-to-noise ratio.

AM noise suppression circuitry.

## The Scott A 436 Amplifier

42 watts RMS per channel, driven into 8 ohms from 20 Hz to 20 kHz with no more than 0.3% THD.

True logarithmic meter amplifier obviates the need for range switching. Individual channel power level meters calibrated in % of full power output capability eliminates confusing dB and VU readings.

Two completely independent tape monitors allow two tape recorders to be used simultaneously for direct tape-to-tape copying.

Instantaneous electronic protection circuit in the output stage.

IM distortion lower than 0.15% for a cleaner sound without listening fatigue.

High and Low filters, two auxiliary outlets and mic inputs.

And the Scott T 526 and A 436 come complete with professional rack-mount handles, and are backed by a three-year, parts and labor limited warranty.

For specifications on Scott's complete line of audio components, write or call H.H. Scott, Inc., 20 Commerce Way, Woburn, Mass. 01801. (617) 933-8800. In Canada: Paco Electronics, Ltd., Quebec, Canada. In Europe: Syma International S.A., 419 Avenue Louise, Brussels, Belgium.



 **SCOTT**  
The Name to listen to.

Receivers / Tuners / Amplifiers / Turntables / Speakers

Enter No. 27 on Reader Service Card

# INTRODUCING ONE MORE GREAT REASON TO OWN SENNHEISER HEADPHONES: UNDER \$35.

Our new HD-400's incorporate everything that's made Sennheiser the premier headphones in the ears of discriminating audiophiles:

Wide response. Unusual smoothness. Superior transient ability. And extremely lightweight, rugged construction.

They sound so good, they've been compared with the finest loudspeakers. And deliver such a vastly improved sound from most amplifiers and receivers that people are actually buying Sennheiser headphones instead of trading up to a more expensive system.

It's entirely practical, too.

Because their unique Open-Aire® design lets you enjoy your music with more comfort and less listener fatigue than any other style of headphone. . . in fact, it's easy to forget you've got them on.

Your dealer has the new Model HD-400 now. But don't confuse it with imitations or 'look-alikes'.

They may have our great sounding new price tag, but not our great Sennheiser sound.

**SENNHEISER**

10 West 37th Street, New York 10018 (212) 239-0190  
Manufacturing Plant: Bissendorf/Hannover, West Germany



Herman Burstein

# Tape guide

## Tape Deck Choice

*Q. I am writing the type of letter which you must dislike receiving. What brand of tape deck should I buy? When I first began investigating the decks available, I was thinking in the \$500.00 range, but I don't want to spend any more than necessary to meet my needs. I am looking for a deck to be used, primarily, for taping from a fairly extensive record library, and for playing these and pre-recorded tapes, in addition to limited live recording. What would be your choice: Revox, TEAC (several models mentioned), or Tandberg (several models mentioned)? I hope this letter doesn't ruin your whole day.—L.E. Ray, Adrian, Mich.*

A. As I have stated repeatedly, the policy of *Audio* magazine forbids me to recommend particular brands, or models, of audio equipment, although I would be happy to recommend a good Chinese restaurant or a book on statistical sampling. Hence you are thrown to your own resources which means reading equipment reviews, talking to trusted friends, talking to trusted salesmen, and most important of all using the evidence of your own ears and eyes. If the machine appears to faithfully reproduce sound, comes at a price you can afford, and stands up well in equipment reviews, it may well be a good bet. You can save a fair amount of money, without giving up quality, by sacrificing such features as reverse operation, sound on sound, and simultaneous record and playback. Don't be afraid of one-motor recorders, since with good engineering they can closely rival the performance of those with two or three motors. Also, one motor units are usually lighter and more portable. No, you haven't ruined my whole day, just half of it.

## Erase Eliminator

*Q. I would like to make multiple recordings on the same tape track and, therefore, would like to defeat*

*the erase head. Would it hurt to disconnect the erase head and hook it to an external load via a switch? This would still leave a load on the oscillator circuit without erasing the tape.—Carl Ford, APO, N.Y.*

A. If the external load presents the same impedance as the erase head, there should be no problem. But if the impedance is different, then this will tend to change the amount of bias current that reaches the record head, with consequent effects on the distortion and treble characteristics of the tape recording.

## Demagnetization Frequency

*Q. I clean my heads after five hours of use, but how often should I demagnetize them? The operating manual for my tape deck says that after long periods of operation the magnetic heads will build up a certain degree of residual magnetism. Does it hurt to demagnetize the heads, even if they don't have to be? I was told that if I touch the heads with the demagnetizer off, I could permanently magnetize them. Is this true?—Thomas Sabol, Fullerton, Pa.*

A. Ordinarily manufacturers recommend demagnetizing the heads after about eight hours of use, the same for cleaning. Sometimes the recommended period is longer, although seldom more than 15 hours. To the best of my knowledge, no harm will come from subjecting a non-magnetized head to the demagnetizing process. Of course, it is possible to scratch a head with the demagnetizer unless its tip is covered with a soft or plastic materials.

The negative effects of a magnetized head are an increase in noise and a reduction in the treble response, and both these effects are permanently impressed on the recorded tape.

If you have a problem or question on tape recording, write to Mr. Herman Burstein at *AUDIO*, 401 North Broad Street, Philadelphia, Pa. 19108. All letters are answered. Please enclose a stamped, self-addressed envelope.

"...in the same class with a number of more expensive products, including many of the direct-drive record players we have seen."

This quote, from the Hirsch-Houck Labs' report in *Stereo Review*, refers to the Dual 510, a semi-automatic belt-drive turntable. Since direct-drive models (especially our own) are accepted as *the* standard of performance, Hirsch-Houck's comparison is not to be taken lightly.

# We'll let someone else tell you how good our belt-drive turntables really are.

The 510 also benefits from comparison with other semi-automatic turntables. Dual's unique sensor locates the 12-inch and 7-inch lead-in grooves for you. You don't have to guess where they are. And there's no way to crop the tonearm accidentally; the cue-control lifts it automatically at the end of play and supports it until you release it.

You might also compare the 510 with your present turntable, or any other you may be considering. When you do, keep in mind the 510's many other features and refinements described below. Your old records will sound better, your new ones last longer.

**Dual**

**United Audio Products**, 120 So. Columbus Ave., Mt. Vernon, N.Y. 10553

**Dual 510.** Semi-automatic, single-play. True four-point gimbal tonearm suspension. Synchronous motor, precision-ground belt, unique Vario-pulley, dynamically-balanced platter. 6% pitch-control, illuminated strobe. Lead-in groove sensor. Cue-control viscous-damped in both directions. Less than \$200.

**Dual 502.** Similar except less sensor, pitch-control and strobe. Less than \$160.

**Dual 1249,** fully automatic single-play/multi-play. Less than \$280.



True four-point gimbal centers and pivots the tonearm mass at intersection of horizontal and vertical axes. Tonearm is dynamically balanced in all planes. The four needle-point pivots are first hardened, then honed, a process which produces microscopically smooth surfaces. The precision ball-bearing races are only 0.157 inch diameter. Bearing friction: vertical, <math><0.007</math> gram; horizontal, <math><0.015</math> gram.

Stylus force, applied by long coiled spring around vertical pivot, remains perpendicular to record even if turntable is not level.

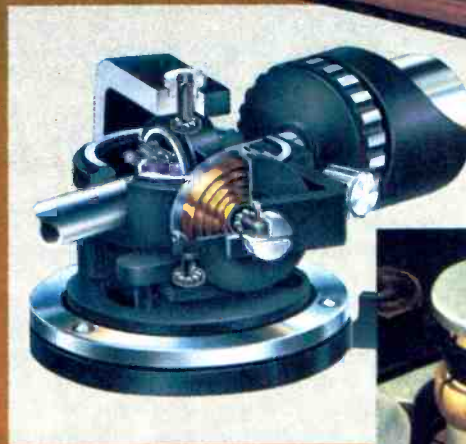

Unique Vario-pulley used in Dual's three belt-drive models is precision-machined for perfect concentricity and balance. Speeds are adjusted by expansion and contraction of pulley circumference; belt is never twisted or distorted.

Specifications (DIN B): Rumble, >math>63</math>dB; Wow and flutter, <math><math>\pm 0.05\%</math></math>

Enter No. 6 on Reader Service Card

# Audio etc.

Edward Tatnall Canby

I've been traveling. And do you think hi fi is mainly a U.S. hobby? Or maybe Japanese and German as well? I'm here to tell you that the old hi-fi bug is virulent and catchy in plenty of other places, at least among the so-called "advanced" nations, like, say, Norway. You go window shopping and you can run into old friends everywhere—familiar equipment names and models—along with an intriguing variety of "unknown" or local hi fi, adding eye appeal to the visible feast and sonicity to the sounds inside the shops. But what really is really fun for the audio man, knowing all in advance, is the nomenclature. Every country to its own language and it's guess and guess again.

*Kjenner du Dux?* If you don't, you oughta. Dux, I found, is a big Swedish outfit that sells all over Scandinavia with a vast catalogue of intermediate to advanced fi and TV. They go in for gorgeous Swedish-modern, dove gray with black ensembles, combination units of turntable, cassette, amp, under a smoked plastic cover, and they put out a stunning line of speakers to match these goodies, two way and three way with neat gray grilles and a snazzy white line around the outside, like a white-wall tire. Handsome. The three-way speakers have two bass drivers, 20 cm., one midrange (*mellom-register*), and two dome tweeters; the *delefrekvenser* are 400 og 4000 Hz and the overall *frekvensomrade* is 30-20.000 Hz. That's what it says, and you surely get the idea. I like the way the Dux people have convert-

ed all the controls to sliders, sidewise or forward and back, even to the tone controls. The generic name for such equipment is *Musikkanlegg* (well, they're for music, aren't they?), and some models have FM tuners as well as cassette and/or turntable; one model has a perfectly huge two-inch digital clock built in and connected to the tuner. Another one has a useful bit of extra *décor*, a block diagram of the inside layout, in LEDs or something, right out in front on a special

proves.) Even so, by the looks of it, these people are very much up to date. True, you super-fi addicts may look askance at the Dux *Musikkanlegg* lines but, knowing what European craftsmanship is, I think you can assume a lot more built-in quality than what we over here call mass produced. (What—you missed that 50 ar? 50 years. Easy.) One thing will please you. Dux calls its various models *Sound Projects*, in straight English though for local consumption. Like

the Japanese in Japan. *Sound Project 8540* is a Hi-Fi Stereo *Latespiller med hastighetene 33 og 45 o/min.* and this particular model has *Touchkontroller for hastighetsvalg, start/stopp*, not to mention such lovely features as *Flytende opphang* and *Automatisk og stofri stopp ved hjelp av fotocelle*—that is, with the help of a photocell.

Now don't just skip the *gibberish!* With a bit of ingenuity you can catch a lot of this curiously craggy, consonant-clogged language. The feature I really like, there, is *Flytende opphang*. I could hang onto that one forever. Sounds almost the same, too, in Norwegian and Danish—

and is that where I really got confused. I couldn't figure out which language I was seeing. Or hearing.

## Norwegian New Orleans

You see, I spent 10 happy days, not in Sweden, but in Norway, which was where I picked up the Dux catalogue. This was back awhile, when the Southern sun in Oslo, the New Orleans of Norway, just managed to break the horizon around 10:00 in the



panel. Didn't see it in action but I gather it lights up to indicate what's going on or isn't—the brochure says that *et belyst kontrollpanel gir deg alltid beskjed om hvilke funksjoner* (no, not a blue funk, a *function*, spelled Swedish style) *som er innkopleet*. So now you know. Don't you?

The Dux publicity informs us that the company has been selling its stuff *snart 50 ar*. (Pardon the missing small circle over the a. Our printer disap-

# we've got equalization all together —

and all of us are dedicated to helping you improve the sound of your fine stereo system.

Equalizers are used everywhere in the music-making chain: by live performers, recording studios, mixing consoles, AM and FM stations, and so on. In every step, each of the engineers use equalizers to make the music sound the way they think it should sound. So after everyone else makes the music sound the way they like it, it's up to you to use that same instrument — the equalizer — to make the final adjustment, and make the music sound the way you like it to sound in your own home.

We also include all the accessories and features that are a must to make equalizing easy, as well as an amazingly rewarding new experience: . . . An environmental do-it-yourself test record edited and announced by Soundcraftsmen especially for use with the Soundcraftsmen Equalizer . . . **Computer-Charts** for making a record of, and resetting in seconds, any desired EQ curve . . . a **Full-Channel Frequency-Spectrum-Level Control** on each channel, for instant "no distortion" in/out balancing . . . **Light-Emitting-Diodes** for precise visual signal level balancing . . . A **Graphic Display** of each EQ curve . . . And a minimum 24dB range of adjustment for each octave . . . **Specifications:** S/N: better than 96dB @ 2V. RMS . . . THD: less than .1% @ 2V . . . Filter type: Toroidal and Ferrite Core.

# Soundcraftsmen



## FREE 6-PAGE BROCHURE

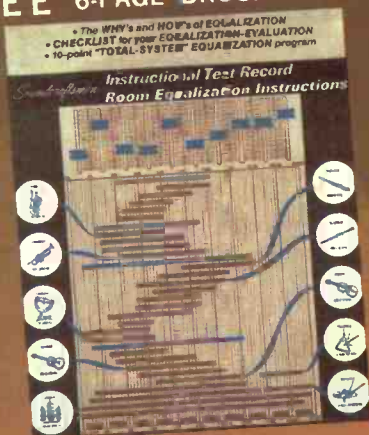

Only Soundcraftsmen offers you a choice of six models — select the equalizer that best matches your system, and your pocketbook.

Manufactured in California, U.S.A. by Soundcraftsmen, 1721 Newport Circle, Santa Ana, CA 92705 . . . For name of your nearest dealer, phone us at (714) 556-6191 . . . Suggested Prices (top to bottom): PE2217 — \$529.50, SG2205 — \$370.00, RP2212 — \$369.50, RP2204 — \$329.50, 20-12A — \$299.50 (Includes cabinets shown). TG2209 — \$550.00 (Case extra).

Enter No. 32 on Reader Service Card

# Decca Record Brush:



## No Side Effects

Most record cleaners use liquids. They do the job. But not without side effects which reduce the life of your records.

To see why, imagine you are examining a record groove through a microscope while various liquid cleaners are tried. All the cleaners remove a lot of dust, but even the best ones leave some behind. Since liquid was applied, this soft dust dries into hard grit. While the stylus could have pushed a few soft dust particles out of its way, it must now track hard grit particles like they are part of your record. The result: distortion. Not to mention stylus wear caused by the new bumps and grinds it must now traverse.

Decca's research into these liquid side effects, resulted in their pioneering of a new, electrically conductive, carbon micro-fiber - the bristles of the Decca Record Brush. Each Decca Record Brush contains one million of these ultra-thin conductive bristles - 1000 enter each groove removing dust, dirt - and draining off static for lower surface noise and expanded dynamic range.

Decca Record Brush. No fluids, no side effects. Just keeps your records sounding like the first time.

Decca Record Brush available at quality dealers across the U.S. Sugg. list \$14.95

## ROCELCO INC.

160 Ronald Dr.,  
Montreal, Canada H4X 1M8  
Phone (514) 489-6841

Enter No. 25 on Reader Service Card

morning and soon went back to bed, leaving a long, long evening to fill. In Oslo, hi fi is a natural. Electricity is so cheap that they leave the lights on the whole time and just as well—the noon sun comes in sidewise and askew, your shadow is 50 feet long in the gloaming and even the clouds are black at noon from being lit up at one end. Weird. So you have to do something to keep alive and happy. True, 95 per cent of Oslo goes skiing all night, cross country, on long wilderness trails through the nearby mountains lit up for miles with street lights, or else down horrendous ski jumps or even bigger "ski flying" horrors, and every car on the road has a ski rack on top and four studded snow tires beneath (no salt and very little sand). But you do get back indoors eventually, into those cosy electrically heated modern apartments that surround Oslo city, and that's when the hi fi opens up. Maybe not quadraphonic but plenty stereo. Also enormous TV screens, B/W and color, but that's another story. The place I stayed at had a hi-fi combo with both record player and cassette changer and the cassettes dropped down, one after the other, hour by hour.

In Oslo proper, one of the most beautiful cities-in-the-dark I ever hope to see, there are in fact numerous hi-fi outlets, as well as importers/distributors, and though I wasn't there to do interviews I did snoop around, sort of anonymously, as is my wont. Learn a lot that way. It was in Oslo that I got my languages confused—how can you tell which is which when everybody understands Swedish, Danish, and Norwegian and they can all talk to each other, or read each other, as easily as we read Queen Liz's English. Right next to the Dux display, I picked up Garrard of England—but was it in Norwegian? All about Garrard's *Nye Hi-Fi Platespiller Lyden ma du Selve Oppleve*.

Well, that's not too hard to understand. A *Platespiller* is a "plate spiler"—or if you will, a platter player. Simple. What else would you expect from Garrard?

### Audio Amicability

As we all should know, the English and Norwegians have held a good close relationship ever since the tragic

days of WWII when the English tried to dislodge Hitler and didn't make it—but kept up a constant radio communication with the old country via legions of illegal concealed little tube radios in thousands of Norwegian homes. I went to the Norwegian Resistance museum and looked at some of them; you would have been fascinated. Tubes, of course, but so ingeniously miniaturized, willy-nilly, the radio guts built into table legs, into box cameras, false drawer bottoms. And keep in mind that discovery of these wonders meant instant death . . . Anyhow, Garrard's *Platespiller* looked mighty good, decked out in *Teak, Eik, Palisander, Noett, Hvit, Sort*, as to colors. (Now let me see. . . Noett means nut-colored, but I would swear, from my kitchen experience, that *Hvit*

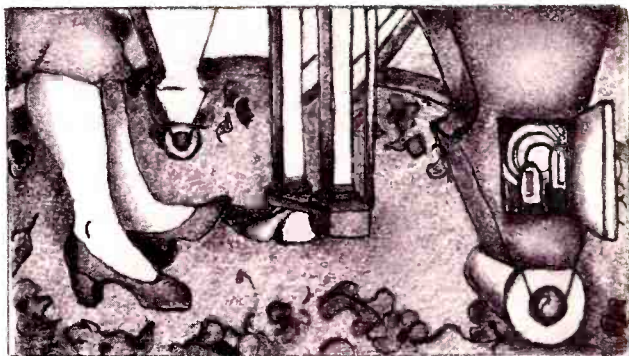

means *garlic*. OK, then, a garlic-colored Garrard changer—and indeed it is a light gray!)

Eureka, they really feature American-made hi fi, notably the Mac line and a big range of Harman/Kardon. I spotted a bill of lading from the latter in one import office listing just about everything you could want from that company. And I got the impression that the Japanese are played down, though Sony and Sankyo are strong. I rather think that Norway depends on us for its really fancy hi-fi stuff, over and beyond those common but well-built Scandinavian combo systems that are the norm. I didn't see any of the really expensive non-U.S. items so familiar at home—Nakamichi, for instance, or Yamaha. Get going, you U.S. makers. You have a market, a preferential market, over there.

Well, of course, the local producers are also featured in Oslo and most decidedly the big one, Tandberg of Norway. A whole store front plastered with Tandberg ads and stuff, though inside there were other brands. They have a plant in Oslo and I found it on the city map, a tiny black rectangle out in the suburbs not far from the new T-bane, the subway/surface electric line that runs so quietly you can't

AUDIO • April 1977



Our flywheel is larger than regular flywheels for a 0.08% wow and flutter.



Heat compressed super ferrite head for frequency response of 30-16,000 Hz and S/N of 62 dB with CrO<sub>2</sub> tape.

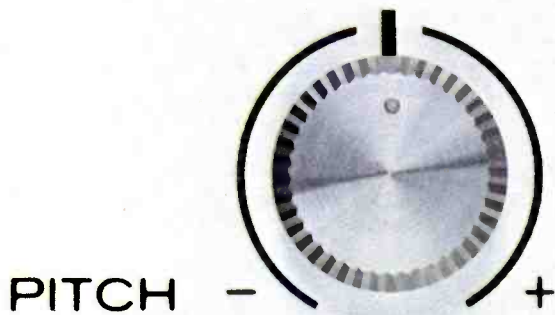

Variable pitch control to smooth out speed variations in playback.

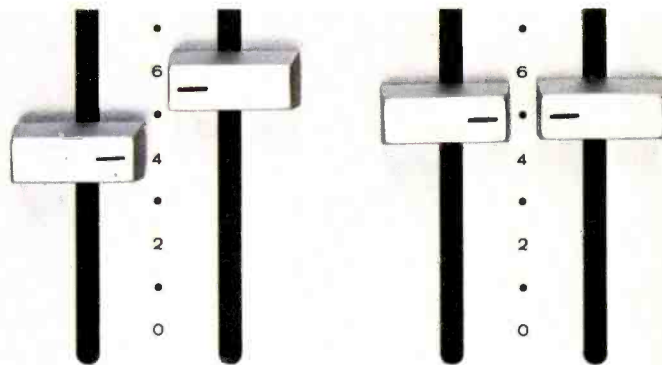

L - MIC - R ◀ RECORD ▶ L - LINE - R  
MIC/LINE mixing to mix live mic with tape or record source.



Switchable VU and Peak meters for better recordings.

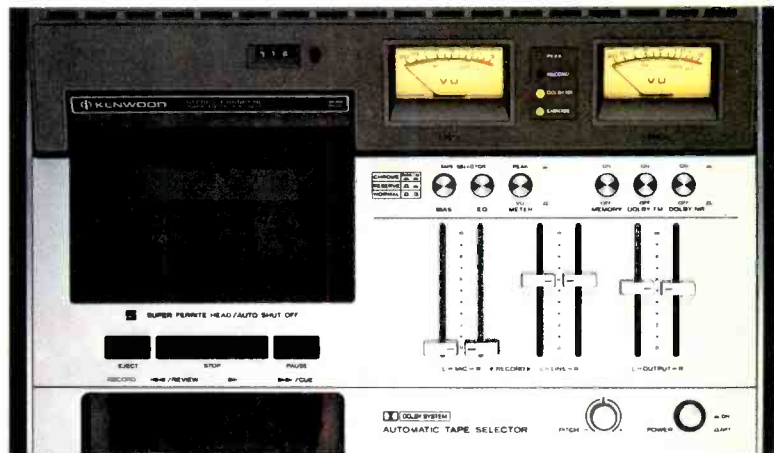

The KX-920. With cue, review and memory rewind.

## STANDARD EQUIPMENT.

Some of the above features and performance specs are found in other cassette decks. But those decks cost a lot more than ours.

Now, the new Kenwood KX-920 costs less than \$300\*, but don't let that deceive you.



Because the KX-920 is our top-of-the-line. And the way we look at it, every top-of-the-line should have these features and the KX-920's performance.

The only option you should even think about is tape.

\*Suggested resale price. Actual prices are established by Kenwood dealers.

# KENWOOD

15777 S. Broadway, Gardena, CA 90248 · 72-02 Fifty-first Avenue, Woodside, NY 11377

Enter No. 8 on Reader Service Card

hear it either come into the station or leave. Knowing in my bones that Big Bert Whyte had been there before me and cleaned out the place, I forewent a visit. But you should see the Tandberg catalogue, "Hi-Fi Stereo 76/77," all gloss and color. First come the *Band-opptakere*, the band-uptakers, i.e., tape recorders, both in cassette and reel-to-reel, five big models; then come radios, *stereoforsterkere*, radio receivers, then battery portables, and finally the impressive collection of Tandberg *Hoyttalere*. Hi-talkers, out-loud-speakers. Including the little 20-sided midget speaker in bright colors,

the Fasett (in Norway), which some of us know over here. Not much bass but a lot more than you'd expect, looking at them, and the rest of the Fasett sound is excellent, clean and un-colored and good for stereo. Or, on a larger scale, as a pair of back speakers in a budget surround-sound system. (Don't really need low bass in the rear.)

#### Hi-Fi & English

By golly, Tandberg does the English speaking world an honor, or honour, as the case may be. The descriptions in the Tandberg catalogue are, of

course, in Scandinavian for local consumption. But the equipment itself is entirely marked in English from stem to stern. An economy, maybe, but it also shows how well the Scandinavians appreciate the universal hi-fi language, our mother tongue, basic English. Almost everybody there speaks a bit of it.

Guess I'm hipped on languages; I do enjoy decoding the various jargons that come my way, like so many crossword puzzles but more useful. You just look at those funny words, at first so meaningless, *Xszympghl* or something; then you try to pronounce a bit, according to local rules, and lo, you see the light. Like a word I remember in Denmark, *Flaske*. A flask, of brandy or Aquavit? Not so! Pronounce it more or less as it should be pronounced, and you get "flesh-uh"—what else but plain old meat. And a *boghandel* isn't a species of swamp; it's pronounced "book-handle" and that's what it is, a bookstore. So it goes with hi-fi nomenclature as well, and so a final example from our friends at Tandberg. Their TR-2075 is described in such glowing Norse (?) that anybody can get the general idea—it goes like this:

The TR 2075 is *den kraftigste og mest avanserte stereo radio/forsterker Tandberg noen gang har laget*. Which is to say, if I read it, here we have the craftiest (i.e., most sophisticated) and most advanced stereo radio/strengthener (that is, receiver) that Tandberg has ever laid out. But yes! The FM section, for instance, has MOS-FET *transistorer 4-polede keramiske (ceramic) filtere og IC* and the signal/stoyforhold is *bedre enn 75 dB i stereo og 78 dB i mono (IHF)*! Exclamation point is Tandberg's. Mine too. Not bad, huh? And the stereo amp department gives *mer enn 75 watts sinus (not a cold in the head—a sine wave!) per kanal ved 8 ohms...*

#### Addenda

Hey, I didn't really mean Eldridge Gerry, back in December; it was Eldridge Johnson. Memory glitch. Johnson ran a small mechanics and model shop where Emile Berliner, inventor of the flat disc, took a design for a spring motor that would unwind at a steady fast speed for a whole disc side. Didn't work; but Johnson designed one that did, then joined up with Berliner and later founded the Victor Talking Machine Co. As for Gerry, he invented the gerrymander. Throw him out. A

AUDIO • April 1977

## Our Secret For Unmatched Performance

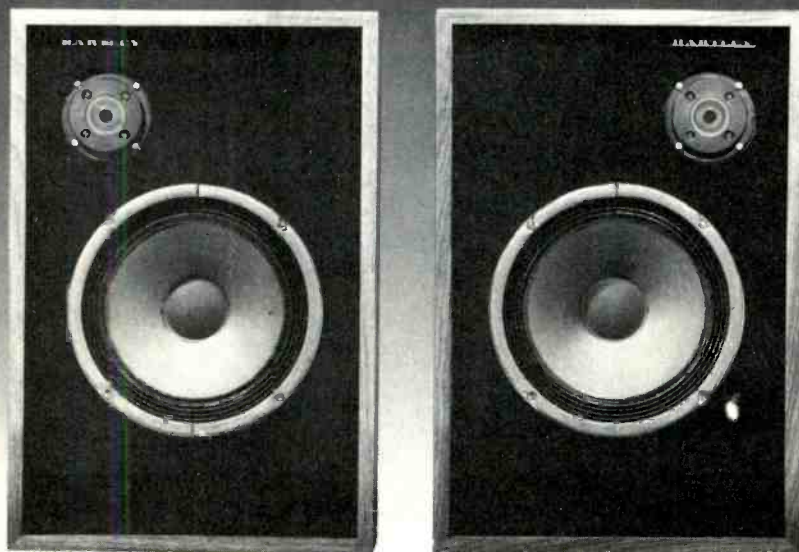

Hartley Zodiac I

We build all our speaker cabinets in asymmetrical pairs for the best sound dispersion.

Then we match each pair for wood graining and color.

Finally we match the speaker drivers to maintain perfect system balance.

We do all of this for about the same price as our competition. You see, we believe when you spend your hard earned dollars for speakers, you deserve the best sound your money can buy.

For other innovative features of Hartley speakers, write:

**HARTLEY** products corporation

620 island road, ramsey, new jersey 07446 (201) 327-4443



# Both of these are made in Elkhart, Indiana



## The one on the right provides permanent relief from the pain of headache caused by poor room response

The good sound that comes out of your speakers can be different by the time it gets to wherever your ears are. Air, walls, rugs, drapes, furniture — can all affect frequency response.

The new Crown EQ-2 Equalization System is designed to correct that particular headache. The system

includes the Crown EQ-2 eleven-band, octave-center, stereo equalizer; plus the Crown equalization record, room response chart paper, and a manual which tells you how to make it happen.

Write today for full-color brochure. The information could be very good for your system.



# CROWN

Box 1000, Elkhart IN 46514

Enter No. 50 on Reader Service Card



You can be part of the music.



© 1977 Koss Corp.

Your workday is over. You've settled back into a recliner and a pair of Koss Technician™/VFR Stereophones in anticipation of a perfect, live symphony broadcast. Now with 102 finely tuned instruments and highly talented musicians, the conductor is ready to escort you into the cozy world of symphonic brilliance. As the last slight echoes of his baton taps disappear into silence, the violin

section fills your mind with a warm, glowing hum. The cellos, violas, and bass ease into the flow, adding a reverberating depth to the mood. And as the polished power of the brass begins to court the sensual woodwinds, you find the true beauty of your Koss Technicians. Because the VFR controls at the base of each earcup enable you to fine tune the frequency response range to your idea of perfection.

Allowing you to shape the acoustic contour of the symphony to enrich the rolling lows of the timpani and bassoons, or add a chilling dimension to the high pitched violins and flutes.

So if you'd like to hear a performance that's at your command, visit your audio specialist and slip into the breathtaking Sound of Koss with Technician/VFR. Or, if you prefer, write us c/o Virginia

Lemm for a free, full color catalog of all our products. Either way, remember that with a pair of Koss Technicians, beauty is definitely at the fingertips of the beholder.

Koss Technician/VFR Stereophones



**KOSS** stereophones  
from the people who invented Stereophones.

KOSS CORPORATION, 129 N. Port Washington Ave., Milwaukee, Wisconsin 53212 • Koss International/London, Milan, Dublin, Paris, Frankfurt • Amsterdam • Koss Limited/Burlington, Ontario

Enter No. 9 on Reader Service Card

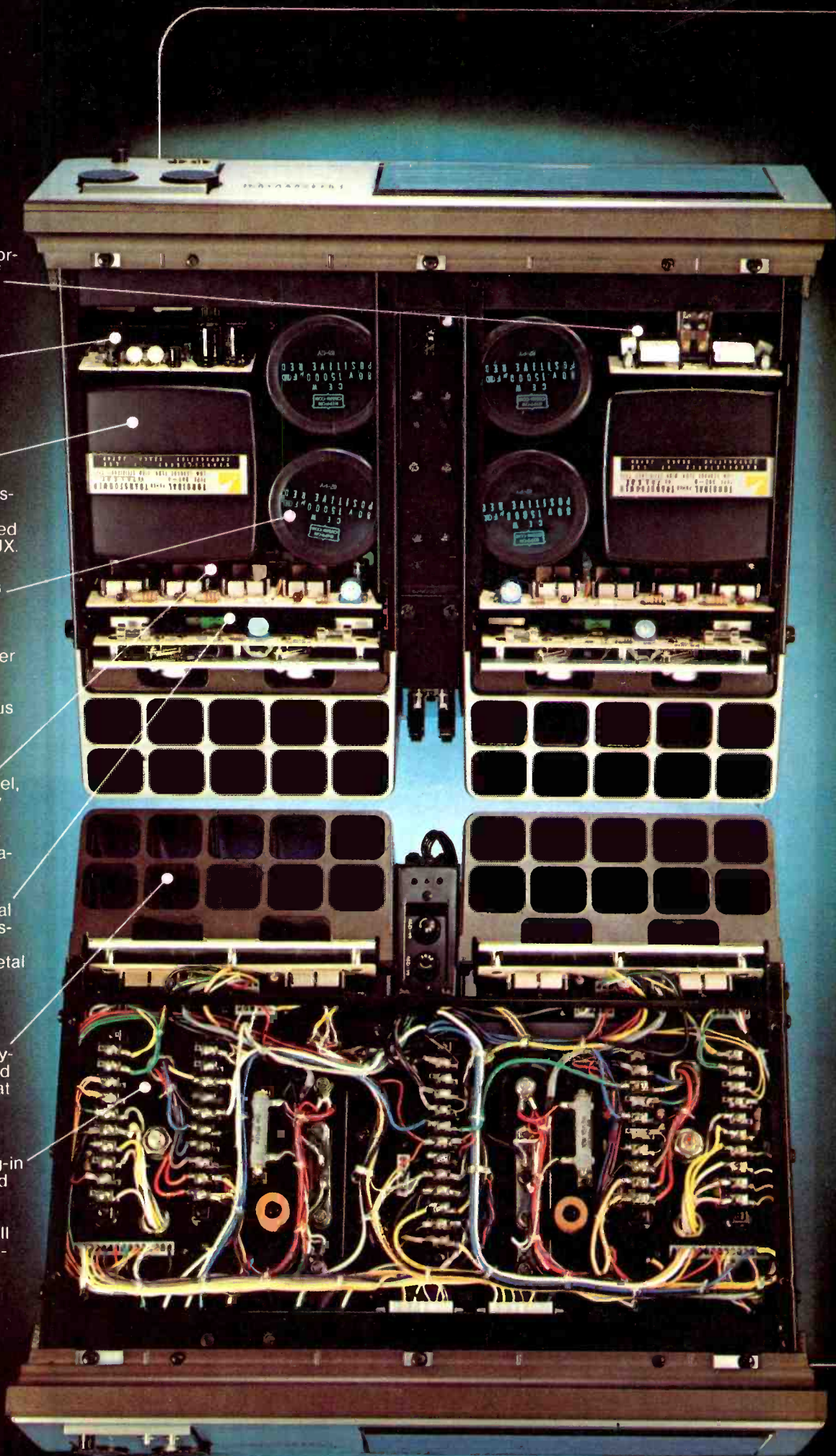

Plug-in circuit board incorporating turn-on/turn-off muting and speaker-protection components.

Plug-in printed circuit board controlling front-panel power readouts.

Each channel's hermetically-sealed toroidal power transformer is designed for maximum efficiency and lowest possible hum leakage. The transformers are designed and manufactured by LUX.

The four filter capacitors have a specified capacitance of 15,000 microfarads each, double the value found in many other high-power amplifiers. This assures high-power stability under continuous large-signal conditions.

Plug-in drive stages, separate for each channel, built onto high-reliability circuit boards. Mirror-image construction optimizes lead-length to adjacent inputs and outputs.

Output transistor terminal board. The output transistors themselves are mounted on a 1/4-inch metal plate, integral with the heatsinks for maximum thermal conduction.

Massive sand-cast honeycomb heatsinks designed to provide maximum heat dissipation.

Cabled harness wiring with terminal strips, plug-in circuit board sockets and direct point-to-point wiring, each used as appropriate to the overall design. This flexible construction approach optimizes layout and facilitates servicing.

# LUX power amplifiers are designed to provide more than merely x watts per channel.

If your interest in a power amplifier is based primarily on its dollar cost per watt, you're not likely to give much initial thought to a LUX. We don't compete in that simplistic power game. Our concerns are with every aspect of amplifier design and construction—to assure your continuing satisfaction throughout what you can expect to be a very long period of ownership. If you share these concerns, you may then find the LUX approach to have special significance and value well beyond purchase price. Especially when it comes to sonic excellence.

As *Radio-Electronics* neatly put: "There is much we still don't know about what makes one amplifier sound better than another—but LUX seems to have found some of the answers, at least."

These solutions now exist because the research that LUX audiophile/engineers conducted went far beyond the obvious questions about amplifier design to those subtle but sonically significant aspects of high-power circuit design usually bypassed or ignored by conventional thinking, test techniques, and instrumentation.

For example, ordinary protection circuits can introduce audible and unpredictable distortions when activated by certain types of loudspeaker loads. These are not disclosed, let alone cured, by the usual test procedures. LUX's solution: four separate sensing circuits sophisticated enough to distinguish the electronically subtle differences that can occur between

normal high-level output signals and abnormal voltage/current conditions.

Models M-4000 and M-6000 have fully independent power supplies employing separate toroidal power transformers for each channel. These allow the full wattage potential and signal-handling stability to be individually realized by each channel even under continuous large-signal drive conditions. Massive honeycomb heatsinks provide the thermal dissipation necessary for overall reliability and long-term performance stability.

The LUX difference goes beyond this. Every power amplifier undergoes an extensive series of tests at our New York facilities. This assures that each unit will match or exceed fourteen different published specifications. A Performance Verification Certificate attesting to the specific measurements obtained is packed with each unit. (Your dealer also has a copy and another stays with LUX as a permanent record.)

With all this in mind, plus the features and specifications listed below and the revealing internal views at left, your selection of a power amplifier can best be made only at one of our carefully selected audio dealers where LUX and other fine components can be compared and evaluated. Assuming that you have the ability to distinguish the sometimes subtle—sometimes obvious—differences among high-power amplifiers, we'll be pleased to await your considered judgment.

**Luxman M-4000 Power Amplifier.** 180 watts per channel minimum continuous power, both channels driven simultaneously into 8 ohms. Total harmonic and intermodulation distortion no more than 0.05%. Frequency response, 5-50,000 Hz,  $\pm 1$  dB. Signal-to-noise ratio: 108 dB. Features include: separate power supplies for each channel, including output and drive stages. Two meter power-output display in combination with LED peak-output indicators reveal dynamic range of program material. Output level set by precision potentiometer with 1-dB click stops. \$1,495.00.

**Luxman M-6000 Power Amplifier.** Similar features and specifications, except 300 watts per channel. \$2,995.00.



## LUX Audio of America, Ltd.

200 Aerial Way, Syosset, New York 11791 • In Canada: White Electronics Development Corp., Ontario

### Results of extensive comparative tests yours for the asking.

*What is perhaps the most exhaustive test of power amplifiers and preamplifiers ever made was recently conducted by Stereo Sound, Japan's leading audio publication. Among the many Japanese and American-made products tested were the Luxman M-4000 power amplifier and the C-1000 preamplifier. With permission of the publisher, we have translated and reprinted the complete report. We shall be pleased to send you a copy upon written request.*

# If your cartridge is more than three years old, don't replace your stylus!

Don't get us wrong. There is nothing worse than playing your records with a worn stylus. And no better way to restore your old unit to its original glory than a new diamond.

But frankly, there have been significant strides made recently in the phono cartridge field. And the new cartridges of today stand head and shoulders above even the finest of a few short years ago.

Here's the choice: Get fresh—but outdated—performance with a replacement stylus, or enjoy all the benefits of modern cartridge research and development for just a few dollars more. You'll find that you can update your system for far less than you might imagine. It's probably the most dramatic single improvement you can make.

For instance, Audio-Technica offers Universal™ cartridges equipped with a genuine Shitatsu stylus and our uniquely effective Dual Magnet™ system beginning at just \$75.00 list. Or you can replace your present cartridge with a fresh new Audio-Technica cartridge with highly-polished elliptical tip for as little as \$45.00 list.



AT-1E  
\$45.00

AT12Sa  
\$75.00

AT13Ea  
\$65.00

AT15Sa  
\$125.00

Are these new models worth the difference? Absolutely. You'll be amazed at what you hear from today's generation of phono cartridges. Improved frequency response. Lower distortion. Better separation. Less record wear. Truly better sound.

**A new Audio-Technica cartridge.  
Your best value in hi-fi.**

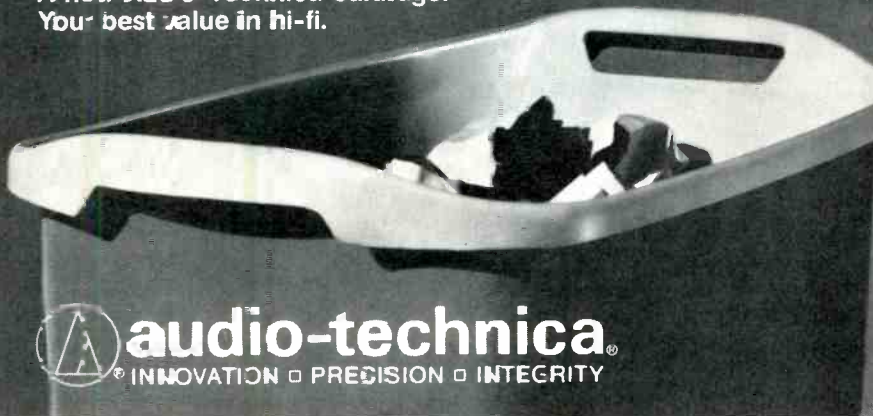

**audio-technica**  
® INNOVATION □ PRECISION □ INTEGRITY

AUDIO-TECHNICA U.S., INC., Dept. 47A, 33 Shiawasse Avenue, Fairlawn, Ohio 44313

Time and time again Bascom has remarked on his not being able to answer each letter personally.

I feel, at last, I might be able to close the information gap! While Mr. King was out of town, I removed and copied these designs from his safe. I hope they are okay. After all, what's a wife for, if she can't help out?!

For those of you who make up these designs—Happy Audioing. For those with further questions, I'm sorry I don't know any answers.

For the rest—Happy First of April!!

Nancy King  
Santa Barbara, Cal.

## Wideband Preamp Addenda

Dear Sir:

I have found an error in the parts list for the preamplifier circuit which I described in the February issue of *Audio*. By mistake, I overspecified the value of R3 in the input frequency compensation network by a factor of 10. This resistor should be 39 ohms rather than the published value of 390 ohms. If the incorrect value of R3 is used, a potential high-frequency instability problem could exist. This will manifest itself as a loud pop when the preamplifier is switched into and out of the phono mode.

Since the low TIM power amplifier was written, I have found that it is desirable to move the location of the lead compensation in the circuit from the feedback network to the forward path. This is accomplished by removing R33 and C10 from the circuit. A 0.001 microfarad capacitor should then be installed from the emitter of Q6 to the junction of R22 and C4. A capacitor of the same value should be installed from the emitter of Q7 to the junction of R23 and C5. These can easily be added to the rear of the circuit boards. This change will minimize the occurrence of any high-frequency instabilities caused by poor power supply decoupling, poor high-frequency grounding, etc. Having supervised many student projects involving amplifier construction, I am aware that these problems can exist. The solution is simple to install, and I recommend its incorporation into any amplifier built from the articles, even if no problems are known to exist.

Incidentally, the orange foil pattern under Fig. 5(a) in the preamp article was "flopped" over a horizontal line. While the component placement was

INVISIBLE SOUND  
 INVISIBLE SOUND  
 INVISIBLE SOUND

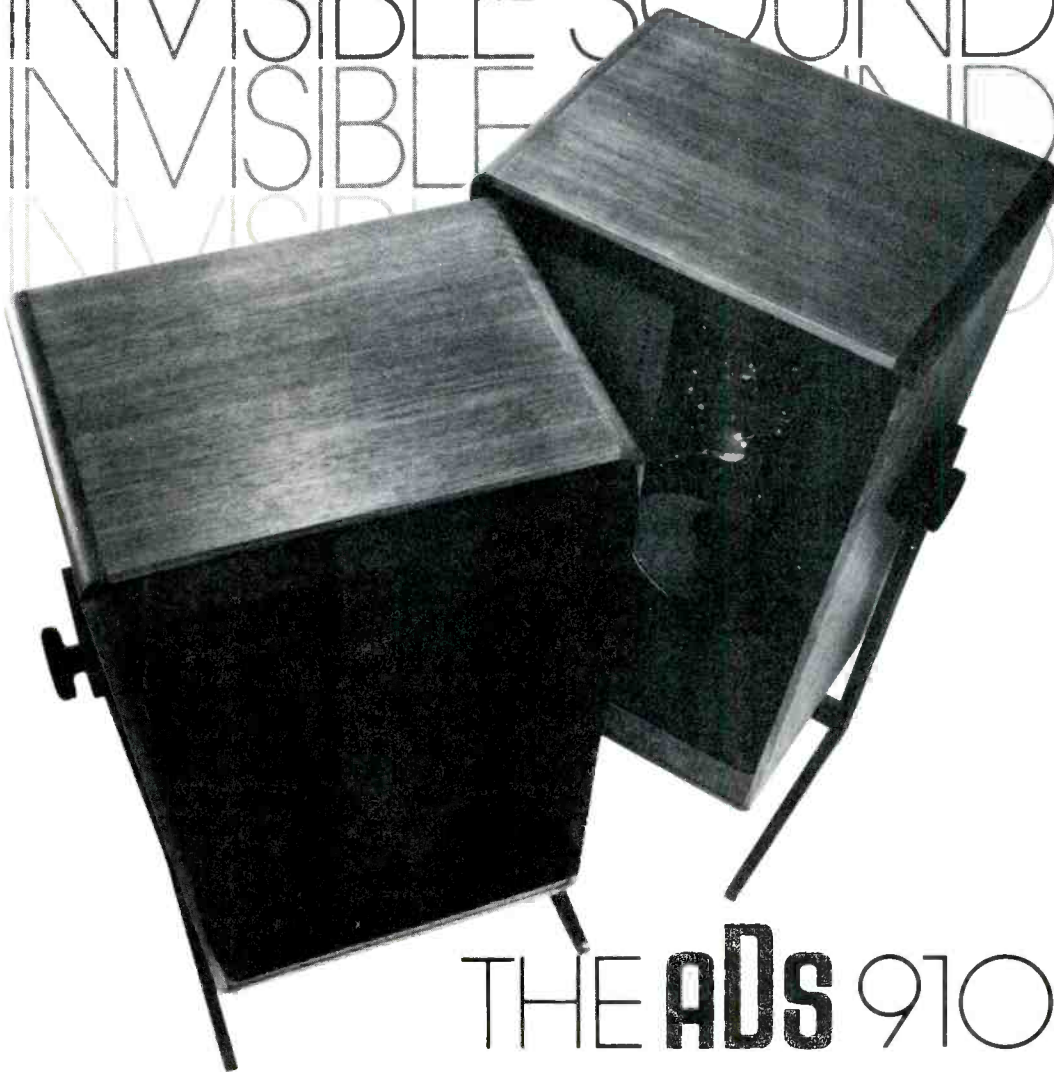

# THE ADS 910

**The ADS 910 Reference System -  
 A benchmark in loudspeaker performance.**

For the first time, awesome dynamic capacity, widest bandwidth, high efficiency, and substantial power handling have successfully been combined - in the ADS 910.

Equally important, it is a transducer of unprecedented musical merit: incredible realism (regardless of playing level), stunning clarity and openness, pinpoint definition and stable imaging, identify this new standard of sound reproduction.

State-of-the-art materials technology and brilliant audio engineering allow the speaker to fulfill the demands of both active performers and recording engineers: their demands for "true to life" musical presentation.

Tasteful, functional design, expressed through choice woods and a meticulous furniture finish, elevates the ADS 910 to a showpiece in the well-appointed home of the discerning music lover. The speaker system's integrity and built-in flexibility appeal to the dedicated audiophile.

A new cost/performance ratio has been established by which all future studio speakers will have to be measured.

Coast to Coast, the skilled and carefully selected team of ADS dealers will proudly demonstrate our new 910, as well as any of our other eight, smaller precision speakers. Listen to the ADS 910 reference system; listen to music - the way it was recorded: Live, authentic, real!



ADS 910's shown in the recording studio of Deutsche Grammophon Gesellschaft at Symphony Hall, Boston. ADS speakers range in price from \$100 to \$600. ADS 910 Dimensions: 33 1/2" (H) x 19" (W) x 15 1/4" (D) 910C - 76PG

**ADS, Analog & Digital Systems**  
 64 Industrial Way, Wilmington, MA 01887

Enter No. 1 on Reader Service Card



## Revolutionary! Sound-shaping taping mike.

Never before — a single microphone that gives you the versatility of 16 microphones! Four tiny frequency filter switches built into the new Shure 516EQ E-Qualidyne Microphone let you tailor sound for studio effects in virtually any recording situation: flick a switch to add sizzle to vocals . . . flick another switch to highlight the sound of a bass drum. You can even compensate for the acoustic response of a room — right from the microphone! In all, the 516EQ creates 16 different response variations that can add a new, professional sound to every tape you make. Available singly or in pairs for stereo recording. Ask to hear a recorded demonstration at your participating Shure dealer.

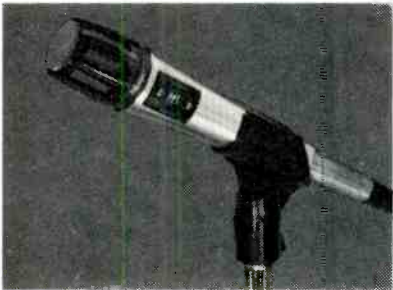

Shure Brothers Inc.  
222 Hartrey Ave., Evanston, IL 60204  
In Canada: A. C. Simmonds & Sons Limited



Manufacturers of high fidelity components, microphones, sound systems and related circuitry.

Enter No. 28 on Reader Service Card

correct, several things do not register. Figure 4(a) was flopped the same way. The reference to the first part of the article on the power amp was missing from the second part, and I hope this does not confuse anyone who missed the first part in February, 1976.

W. Marshall Leach  
Georgia Ins. of Technology  
Atlanta, Ga.

### Old Radio Repairs

Dear Sir:

A friend at work showed me a copy of the January issue of *Audio Magazine*. I was particularly interested in the article about the E.H. Scott radios. At the conclusion Mr. Stosich states, "Sadly, almost no service technician has the knowledge, experience, or patience to perform the kind of work required. . .to get these fine sets in perfect operation." I would like to provide some information which will help any readers interested in the Scott or any other antique radios.

I had heard about the E.H. Scott radios for years, and last summer I restored one for an antique dealer who had purchased it for \$20.00. There are many people who collect and restore antique radios; I've been doing it for seven years now. The main authority on Scott radios is J.W.F. Puett who publishes a newsletter about them entitled "The Classic Radio Newsletter." He also sells parts and schematics for these sets and has a book out called "Silver Ghosts" which sells for \$10.00.

I also sell schematics for just about any radio made between 1923 and 1950, plus having a few old type tubes for sale. The other parts needed to restore these radios are either still common, available in surplus outlets, or being remade. I have collected a good list of "sources" for these needs and will gladly pass along any information I have.

There are two major old radio publications. One is *Radio Age*, 1220 Meigs St., Augusta, GA 30904, which is \$7.50 per year. The other is *The Horn Speaker* published at P.O. Box 12, Kleberg, TX 75145. Mr. Puett's address is Puett Electronics, P.O. Box 28572, Dallas, TX 75228.

Although I am only 20 years old, I find that many of these collectors are audio enthusiasts of another era, and I can relate to the many stories and praises of these radios of the past.

Mark T. Oppat  
31800 Balmoral Dr.  
Livonia, Mich. 48154

AUDIO • April 1977



# THE METROPOLITAN OPERA'S NEXT PERFORMANCE COULD BE ITS SWAN SONG. UNLESS YOU GIVE A QUARTER.

The Metropolitan Opera is one of America's most important cultural institutions.

It's running out of money, but you can help.

Through matching grants, Pioneer High Fidelity and the National Endowment for the Arts will quadruple the value of your donation.

Even a quarter can make a difference.

You don't have to be a millionaire to be a patron of the arts.

## When you give a quarter, the Met gets a buck.

I have enclosed a donation of \$ \_\_\_\_\_ for the Metropolitan Opera. (Checks should be made payable to The Metropolitan Opera/Pioneer Fund.)

Name \_\_\_\_\_

Address \_\_\_\_\_

City \_\_\_\_\_ State \_\_\_\_\_ Zip \_\_\_\_\_

Mail the coupon with your donation to:

U.S. Pioneer Electronics Corp., Dept. M.E.T., 75 Oxford Drive, Moonachie, N.J. 07074.

 **PIONEER** We all owe a lot to music.  
HIGH FIDELITY

Enter No. 21 on Reader Service Card

# Tape Guide III

Herman Burstein

## Computer Tape for Audio?

Regularly we receive reader inquiries as to the suitability of computer tape for audio purposes. The problem is two-fold: (1) accurately slitting  $\frac{1}{2}$ -in. computer tape to produce a tape with  $\frac{1}{4}$ -in. (nominal) width for home tape decks, and (2) magnetic compatibility of computer tape with home tape decks in terms of bias, equalization, frequency response, etc.

We have taken a dim view on the matter, feeling that the two aspects of the problem are too serious to warrant use of computer tape even if obtained at minimal cost, as some audiophiles apparently can do. However, we don't feel that ours is a definitive view and have therefore sought the opinions of two authorities in the field of magnetic tape. Following are very helpful responses from Mr. Delos A. Eilers, Magnetic Audio/Video Products Division, 3M Company, and Mr. William A. Manly, The Cobaloy Company, Division of Graham Magnetics, Incorporated.

*Slitting*—Mr. Eilers: "The assumption that an individual can accurately reslit computer tape is not a very good one. The precision and skill required to slit tape is considerable, and then to assume that you can slit a  $\frac{1}{2}$ -in. wide tape down the center without under- or over-width problems is very naive."

Mr. Manly: "One big problem concerns the accurate slitting to  $\frac{1}{4}$ -in. The proper width for audio tape is  $0.246 \pm 0.002$  in. Computer tape is  $0.498 \pm 0.002$  in., and just cutting a  $\frac{1}{2}$ -in. computer tape down the middle means it will be too wide for proper audio use. On a new set of heads, this makes little difference, but after the heads are worn a bit, the slit-down computer tape will not fit into the groove. A better way is to slit the  $\frac{1}{4}$ -in. tape out of the center of  $\frac{1}{2}$ -in. computer tape, but of course this wastes half the tape." (We would like to add that if the tape is too wide after slitting, it may stick in the tape guides.—H.B.)

*Magnetic Compatibility*—Mr. Eilers: "Magnetic performance of computer tape is not the same as today's audio tape. Most computer tape is

made with a standard, non-low noise oxide, while most of today's audio tape is made with low noise oxide. Computer tape's electro-magnetic characteristics are similar to our obsolete #111 tape, and thus today's recorders would generally be over-biased for a computer tape (resulting in reduced treble response—H.B.). Computer tape is also quite likely to have poorer short wavelength sensitivity than today's hi-fi quality audio tape; thus most of today's recorders would be short of the proper amount of equalization (treble boost—H.B.) to give an extended, flat frequency response on computer tape. It is impossible to be more specific unless we choose a specific computer tape and a specific audio tape to compare."

Mr. Manly: "As to whether or not the bias and equalization will work properly, sometimes they will, and sometimes they won't. Most audio tape is coated to a thickness of 0.00035 in. to 0.0004 in., while computer tapes have a wider range of 0.00025 to 0.00045 in. Both bias and equalization are affected by coating thickness changes. Computer tapes are also designed to be most effective for a limited range of wavelengths on the tape (i.e., limited range of frequencies—H.B.), while audio tapes are quite wide-band in terms of wavelength. Nevertheless, some computer tapes might be satisfactory for some audio applications. To give a more definitive answer, I would have to know what tape the audio transport was set up for, and which computer tapes were to be used."

*Other comments*—Mr. Eilers: "Computer tape is designed for exceptionally good durability, which should be advantageous. However, this can also mean that the tape is highly abrasive to the heads compared to audio tape. If the recorder's heads are not extremely hard and durable, premature head failure due to severe wear could result from using reslit computer tape. Often the reason computer tape is made available for some bargain price is that it is being retired because it is worn out. It has become so scratched and battered from use that the tape is no longer reliable. To use a such a tape for audio

purposes could give this user poor reliability.

"To summarize, reslit computer tape can work for audio applications but *only* for non-critical usage. The likelihood of having performance problems on today's slow speed, four track, hi-fi quality recorders is great, and thus we do *not* recommend using a reslit computer tape for audio applications. We believe that the salvaging of old computer tape is really false economy and brings on more problems than the savings are worth."

## Cure for a Noise Problem

Steven L. Bender, Brooklyn, N.Y., has found the solution to a noise problem that may afflict owners of some reversing tape decks. He writes:

"I own two AKAI GX-230D tape decks, excellent in most respects. There was a problem that plagued both of them: an FM noise type of static on playback that occurred about 45 dB below 0 VU. Since the hiss level is some 56 dB below 0 VU, this 'static' was causing about 10 dB reduction in signal-to-noise ratio. Some six months of investigation eventually determined the cause of the disturbance.

"The deck is an auto-reversing type, and the disturbance occurred only in the forward mode of playback, and only with certain tapes. The problem was found to lie in the auto-reversing post/guide, which has a d.c. potential of about 13 volts on both my machines in the forward playback mode. In the reverse playback mode, the post-guide has only about  $\frac{1}{2}$  volt on it, so there is no noise problem then.

"When the tape passed over the charged post/guide, a field was set up that caused the static sound once the tape came to the playback head. *This occurred only on backcoated tapes*; only tapes were not susceptible to this phenomenon. When the backcoated tape was prevented from contacting the post/guide, the noise disappeared. Therefore, it is suggested that the owner not use backcoated tapes with the AKAI GX-230D. Possibly other reversing tape decks that use the foil method of automatic reversal may have a similar problem with backcoated tape." A

# ARE YOU BLAMING YOUR TAPE RECORDER FOR PROBLEMS CAUSED BY YOUR TAPES?

Every day people all over the country go into hi fi dealers with complaints about their tape recorders.

When in reality what they should be complaining about is their tapes.

Because the fact is, a lot of the problems that plague tape recorders can be attributed to bad tape.

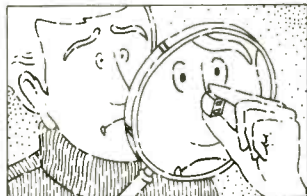

**HEAD WEAR IS CAUSED BY YOUR RECORDER. OR IS IT?**

If you have to clean your tape heads more than usual, for example, it could be your tape doesn't have a special nonabrasive head cleaner.

Maxell is the only tape that has one.

If your recorder jams, it can be any number of things. Maxell does something to prevent all of them.

We make our cassette shells of high impact polystyrene. And then so they won't crack

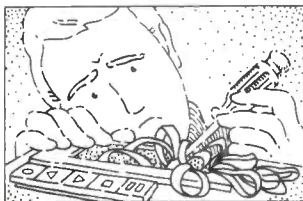

**JAMMING IS CAUSED BY YOUR RECORDER. OR IS IT?**

even after years of use, we finish them to tolerances as much as 60% higher than industry standards.

Inside, we use free rolling Delrin rollers so the tape doesn't stick.

And finally, we screw instead of weld everything together because screws make

for stronger cassettes.

If your recorder frequently suffers lapses in sound, it could be the tape is of inferior quality. And nobody's bothered testing the tape for dropouts before it leaves the factory.



**DROPOUTS ARE CAUSED BY YOUR RECORDER. OR ARE THEY?**

Maxell tape is made of only the finest polyesters. And every inch of



**POOR TRACKING IS CAUSED BY YOUR RECORDER. OR IS IT?**

it is checked for even the slightest inconsistencies.

So if you're having problems with your recorder, try a Maxell cassette, 8-track or reel-to-reel tape.

You might find there's really nothing wrong with your tape recorder, just with your tape.

25



**MAXELL. THE TAPE THAT'S TOO GOOD FOR MOST EQUIPMENT.**

Maxell Corporation of America, 130 West Commercial Ave., Moonachie, N.J. 07074

Enter No. 10 on Reader Service Card

# What's new

## Sony Cassette Deck

The TC-206SD is a front-load cassette deck with Dolby noise reduction, two VU meters, a peak level indicator, mike/line mixing, and three position EQ and bias selector switches. The deck also features ferrite and ferrite heads with Symphase capability, two convenience a.c. outlets, and a Dolby indicator lamp. Price: \$349.95.

Enter 70 on Reader Service Card

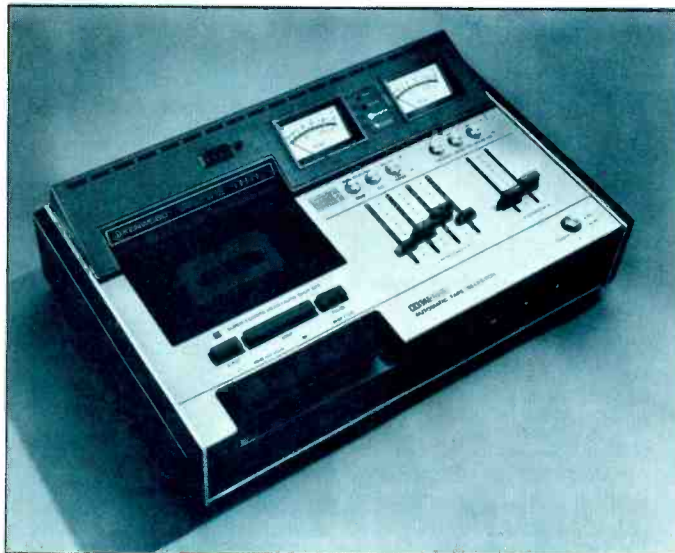

## Allison Speaker System

The Allison:Three is designed to radiate flat acoustic power into a listening room, as with other Allison systems, but is intended for use standing in a room corner. The greater radiation loading provided by the corner location allows a smaller cabinet size to be used without loss of the performance standard achieved by the larger systems sharing the Stabilized Radiation Loading design concept. Drivers are a 10-in. woofer, 3 1/2-in. midrange, and a 1-in. tweeter, with crossovers at 350 and 3750 Hz. Price: \$260.00 each.

Enter 75 on Reader Service Card

## Kenwood Cassette Deck

The Model KX-720 stereo cassette deck incorporates the Dolby noise reduction system for improved high frequency response and signal-to-noise ratio. The deck has separate two-position

bias and equalization controls, a 25  $\mu$ S de-emphasis switch for recording Dolbyized FM broadcasts, a memory switch, two VU meters, and a LED peak signal indicator. Price: \$259.95.

Enter 73 on Reader Service Card



## Pioneer Headphones

The Model SE-4 headphones use a 25  $\mu$  polyester film, dome-type dynamic speaker for a sensitivity of 96 dB per mW at 1 kHz, an impedance of 250 ohms, and a frequency response of 20 Hz to 20 kHz. Weight with cord is 9.2 oz. Price: \$50.00.

Enter 71 on Reader Service Card

## Woodward Strobe

The digital strobe is a crystal-controlled, three-digit display unit for the measurement of 16 2/3, 33 1/3 and 45 rpm turntable speeds. Ca-



pable of measuring variations of  $\pm 0.01$  per cent, it can also be adapted for the measurement of tape recorder speeds. Price: \$100.00.

Enter 76 on Reader Service Card

## ESS Speaker

The AMT-10b is a bookshelf loudspeaker utilizing the Heil air-motion transformer midrange-high frequency system. Specifications include a power capacity of 40 W continuous power and 350 W peaks, with a crossover frequency of 1500 Hz, and a frequency response of 50 Hz to 22 kHz,  $\pm 3$  dB. Price: \$286.00.

Enter 72 on Reader Service Card

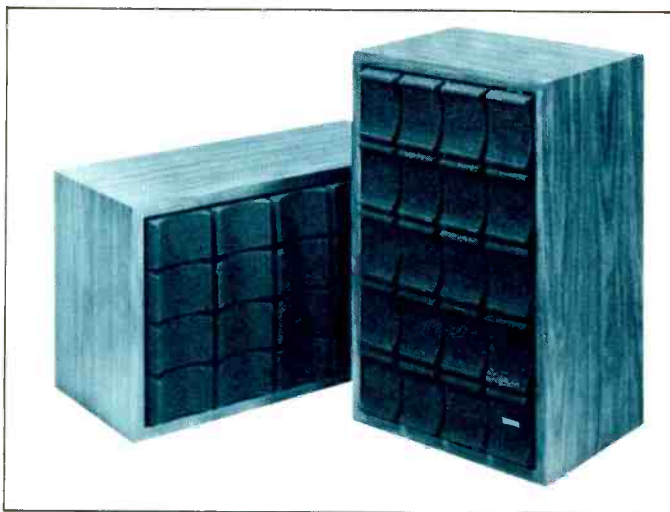

## Superscope Speaker

The Model S-312A is a three-way air-suspension speaker with a frequency response from 30 to 20,000 Hz and capable of handling up

to 50 watts program material. The speaker has a 12-in. woofer, 4 1/2-in. midrange, and a 3-in. tweeter. Price: \$119.95.

Enter 74 on Reader Service Card

## Dept. of Oops

The February "What's New In Audio" write-up of the Technics by Panasonic RS-1500US open-reel tape deck had an incorrect specification for wow and flutter. The correct figure is 0.018 per cent weighted rms at 15 ips.

# If your speakers don't sound as good as they used to, perhaps you've simply outgrown them.



The  
DITTON  
66

It happens sooner or later. Especially to those serious audiophiles who listen carefully and with discrimination. Your speakers may be as good as ever, but your taste has matured and become more difficult to satisfy. You now realize that your speakers never did have the crystal-clear highs or the solid bass promised by the specifications. And it's time to have a serious discussion with your preferred audio dealer.

We assume you'll be auditioning his finest speakers, which, of course, should include the Ditton 66 by Celestion, our top model. We'll let the British publication, *Hi-Fi Answers*, tell you why.

"The relatively high efficiency of the chosen speakers (Ditton 66) was sufficient... to cope with the loudest orchestral climaxes available (or even required)... when we wanted to provide concert levels in a large hall, 110 feet x 55 feet with a 25-foot ceiling. A most impressive performance, and... the speakers (were) perfectly ready and able to accept more power.

"Mid-range was typified by an almost complete lack of resonance, distortion or beaming effects, and certainly seemed to vindicate the new 2½ in. dome radiator. The treble end, from 5 kHz upward, was handled by the HF-2000 unit, also seen in the Rogers (BBC) monitor and several in the IMF range."

Perhaps this will help explain why the Ditton 66 by Celestion may sound better than any other speaker you audition.

Although Celestion has been designing and manufacturing individual drivers and systems in England for more than fifty years—and is well known in many other countries—distribution in the U.S. is still quite limited. If you write to us directly, we'll advise you by return mail of your nearest Celestion dealer.

And if you choose a Ditton 66, you'll find it's one speaker you're not likely to outgrow.

The HF-2000 soft-dome tweeter operates from 5,000 to 20,000 Hz. Its exceptionally smooth extended response and wide dispersion achieve an open, airy quality and accurate stereo imaging.

The MD-500 2" soft-dome mid-range operates from 500 to 5000 Hz with very low distortion, wide dispersion and correct phase relationships. An extremely powerful magnetic assembly ensures critical damping and high-power handling.

The FC-12 woofer has a heavy plasticized diaphragm that effectively suppresses resonances. The neoprene roll suspension permits considerable cone excursions without non-linear effects. A massive Feroba II magnet provides critical damping.

The Auxiliary Bass Radiator (ABR) is a highly effective proprietary Celestion device that operates in conjunction with the woofer/enclosure acoustic circuitry. The critically-damped moving system of the ABR has a carefully chosen mass and compliance, and it is mutually coupled to the woofer to control the lower range of the woofer excursion. It takes over completely at the very lowest frequencies. Result: exceptionally smooth reproduction well under 40 Hz.

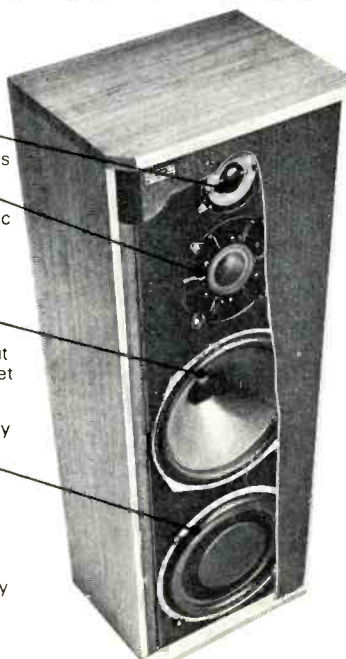

## Celestion



Loudspeakers for the perfectionist

Celestion Industries, Inc.  
Kuniholm Drive, Holiiston, Mass. 01746  
In Canada: ROCELCO INC., Montreal

# OPEN-REEL VS. CASSETTE

Herman Lia\*

The enormous sale of cassette tape recorders in the last few years is proof enough that this product meets a demand. At the same time there is a danger that people will forget the open-reel tape recorder, which in many important respects is a much better basic concept. A cassette machine's advantages are that it is easy to operate, weighs very little, and that a broad range of prerecorded tapes are widely available. On the other hand, as this article will show, cassette machines will always be inferior to open-reel machines when the major performance characteristics, such as signal-to-noise ratio, are compared. At the same time, it must be admitted that for a large number of consumers, cassette machines are usually quite good enough. However, when the very best quality recording is required, an open-reel machine must be used. To be fair and realistic, we must also say that cassette machines have expanded the total market for tape recorders, as well as capturing a portion of the open-reel market. However, they will never take over all of the open-reel market because there are fundamental differences in the quality level obtainable with the two systems, differences which result from the internationally recognized standards governing each system.

28

## General Considerations

The two most important characteristics that determine the performance of a tape recorder are signal-to-noise ratio and frequency response. In this context, frequency response means a response relative to a signal level that lies substantially below the saturation curve of the tape and substantially above the level of residual tape noise.

Let us consider a tape recorder as a black box where we connect a signal to the input and take out another signal from the output, as shown in Fig. 1.

Ideally, the only differences between the input and the output signal are time delay and possibly some scale or amplification factor,  $A$ . The lowest possible time delay is determined by the distance between the record and playback heads, together with tape speed. Unfortunately, real world tape recorders are not ideal, and we need to make some measurements to discover their characteristics. We can begin by measuring signal capacity. We do this by applying a single tone at a particular frequency to the input and then raising the input level voltage  $e_i(t)$  until the signal at the output has a particular amount of distortion, e.g. 5 per cent harmonic distortion. This can be done for a number of frequencies, and the typical results are shown in Fig. 2 for one particular tape speed. Next we remove the input signal  $e_i(t)$  and short circuit the input. There should, of course, be no signal at the output, but in practice there is a noise spectrum which is the sum of the residual tape noise and the noise from the record and playback electronics.

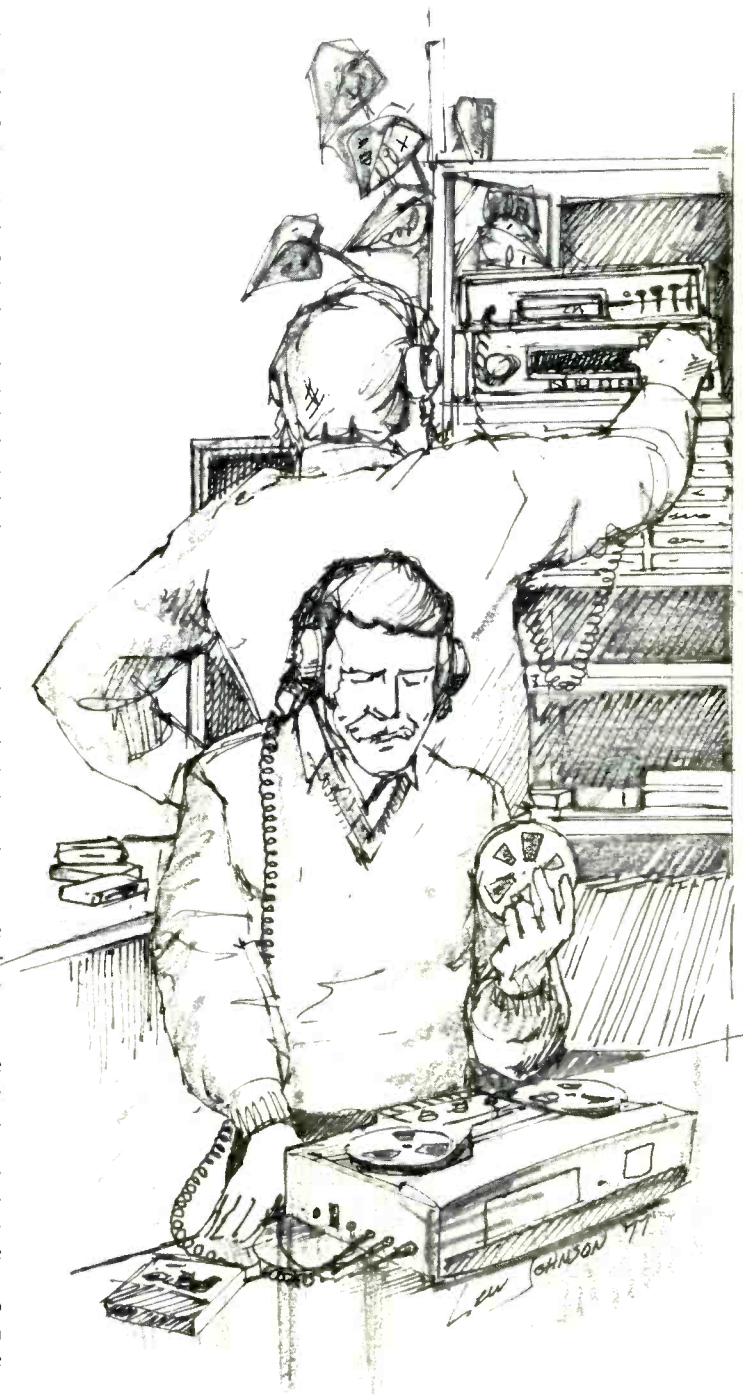

\*Senior Engineer  
Tandberg Radiofabrikk A/S Oslo, Norway

In a well-designed tape recorder, the noise from the electronics is so low that the dominant noise component is the tape noise. The noise spectrum can be analyzed by means of one-third octave filters, and this is shown in Fig. 2 along with a saturation curve.

These measurements tell us quite a lot. They tell us that there are upper and lower limits of the signal a tape can accommodate with acceptable quality. If the input signal is too high, the distortion will be above the acceptable maximum, and if the input signal is too low it will get lost in the noise. The distance between the two curves in Fig. 2 at an individual frequency is therefore a measure of the signal capacity of the tape recorder at individual frequencies, while the total area between the two curves is a measure of the signal capacity over a chosen frequency range.

Using information theory, the signal capacity can be defined for a general transmission channel by the following integral:

$$SB = \int_B \log \left( \frac{S+N}{N} \right) df \tag{1}$$

where SB is the signal bandwidth product, S is the signal, N is the noise, and B is the bandwidth. This is Shannon's definition of signal capacity, given in 1948.

Now, since  $\log \frac{S+N}{N} = \log (S+N) - \log N$ , equation (1) can therefore be rewritten as:

$$SB = \int_B \left\{ \log (S+N) - \log N \right\} df \tag{2}$$

This precisely defines the area between the signal and noise curves in Fig. 2, and therefore equation (2) gives us an opportunity to put forward a quantitative measure of a tape recorder's ability to accommodate signals. More exact theoretical considerations we have developed show that the SB product for a tape recorder is given by:

$$SB = \log \left\{ \frac{B_s \cdot d \cdot \sqrt{b}}{N_{(f)}} \cdot \frac{1}{\frac{B_r}{H_c} + \left(1 + \frac{B_r}{H_c}\right) \sqrt{1 + \left(\frac{\omega_o}{v} d\right)^2}} \right\} \cdot f_o \tag{3}$$

- $B_s$  = Induction in the tape caused by the signal (Gauss)
- $B_r$  = Maximum remanent induction (Gauss)
- $H_c$  = Coercivity (Orsted's)
- $v$  = Tape speed
- $b$  = Track width
- $d$  = Thickness of oxide coating
- $f_o$  = Highest frequency considered
- $N_{(f)}$  = A characteristic function of tape noise.

The most important conclusion to be drawn from equation (3) is that the SB product is dependent on the physical properties of the system, such as the tape speed, track

width, tape parameters, and so on, rather than the electronics, as long as we maintain the true dynamic range in the program which is to be recorded with no signal processing. We will see later that it is possible to process the signal so that the tape hiss becomes less audible to the listener.

Despite this conclusion, we find the frequency-dependent equalization in a tape recorder greatly affects the audible results. We should, therefore, take a closer look at the main requirements influencing the choice of these equalizations. These turn out to be maximum subjective signal-to-noise ratio and flat frequency response at low signal levels.

The measurements for Fig. 2 were made with one particular playback equalization (120  $\mu$ S). If we choose another equalization, say 50  $\mu$ S, and make additional measurements, we obtain the curves shown in Fig. 3. Note that the distance between the two curves is the same, but the shapes of the curves have changed. When we record a program, we are dealing with a complex signal with a particular power distribution over the frequency spectrum, and it should be obvious that we will obtain the best subjective signal-to-noise ratio if we can "pack the sound" as far as possible up under the tape's saturation curve.

Let us assume that we have a program with relatively little power in the high frequencies. We then set the input sensitivity of the system to fully load the tape at the middle and low frequencies. If we use the 120  $\mu$ S playback equalization, the high frequencies will lie far under the tape's saturation curve and therefore near to the noise level. In this case, we could advantageously alter the equalization to 50  $\mu$ S, say, and thereby drop the noise level away from the signal. If we change the equalization or time constant in this manner, to improve the signal-to-noise ratio, we must be consistent and change the input level to produce the flat test frequency response at low levels. On the other hand, if we now have a program with a lot of power in the high frequencies, a time constant that is too short will cause the high frequencies to overload the tape before the tape is saturated at the low frequencies, and low frequency noise can then become a problem. From this discussion, we can see that the SB product defined in equation (3) is an objective measure of the best signal-to-noise ratio that can be obtained.

Frequency-dependent equalizations are thus used to match the characteristics of the tape to practical conditions and produce the best signal-to-noise ratio, which means that the SB product is exploited to its maximum. At the same time, we have seen that the optimum playback equalization depends on the type of program the tape recorder must handle. We are therefore led to seek a dynamic equalization that automatically adjusts itself to the power-frequency curve of the program being recorded. This is exactly the concept behind complementary noise-reduction systems, such as Dolby, dbx, Burwen, etc. If we make the same measurements used in Fig. 2 with a Dolby circuit added, we obtain the curves shown in Fig. 4.

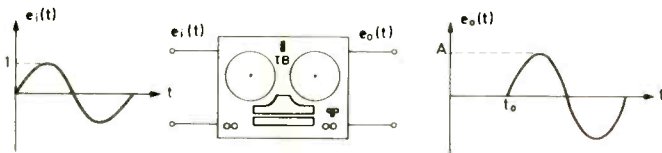

**Fig. 1—Ideally the only differences between input and output of a tape recorder are time delay and possibly amplification of signal.**

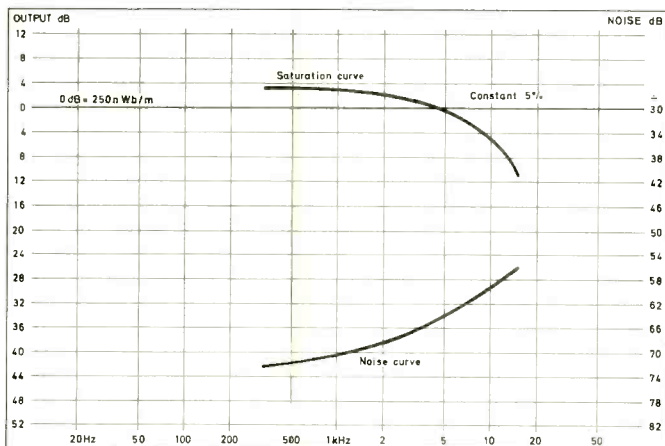

**Fig. 2—Recording system performance, showing maximum output level versus frequency at a constant 5 per cent THD and residual noise level of the system.**

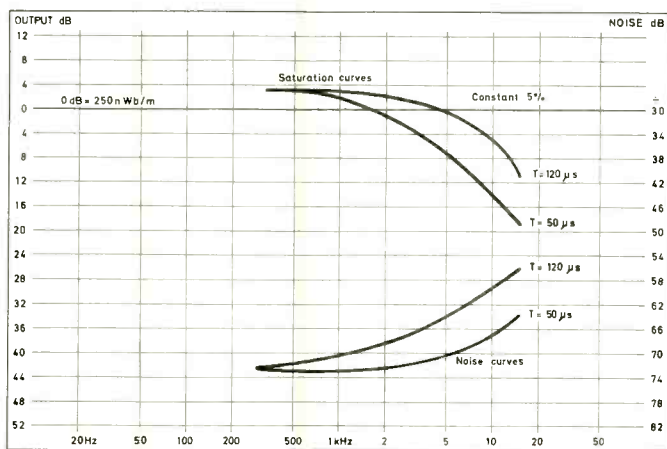

**Fig. 3—System performance, as in Fig. 2, with two different equalization time constants, showing how the shapes of the curves change. Note that the area between the pairs of curves produced by each constant remains the same.**

At the higher input levels, the signal is not processed and the tape recorder performs as if the Dolby circuit had not been included. When the signal falls, the higher frequencies receive extra amplification and are, therefore, recorded with a larger margin above the tape noise than normal. During playback the opposite process occurs, and the overall frequency response is therefore correct.

Increased amplification of the higher frequencies during recording requires reduced amplification of the same frequencies during playback (complementary system). Therefore, noise and other unwanted signals introduced in the process after encoding and before decoding are reduced. Tape noise is reduced by the same degree as the processing of the signal. Figure 4 shows typical output of a cassette machine with a time constant of  $120 \mu s$ . At the higher levels, the signal swamps the noise, and the performance is acceptable. The corresponding noise level is given by curve B. At the lower levels, curve A is of no interest, but the signal processing in the Dolby circuits yields noise curve C which is equivalent to a time constant of  $40 \mu s$  because it has the effect of reducing the noise at higher frequencies by about 10 dB. Accordingly, there is a dynamic change in the time constant from  $120 \mu s$  to about  $40 \mu s$ , depending on the amount of high frequency energy in the program.

### Measuring the Signal-to-Noise Ratio

The signal-to-noise ratio is often measured according to the German DIN and IEC standards which defines it as the ratio between the signal at 333 Hz with 3 per cent distortion and the tape noise weighted and measured according to the ANSI A weighting curve. One important weakness in these measurement methods is that they only take account of the low frequency signal capacity, and large differences in the high frequency signal capacity can be missed by the measurements.

This point is brought out in Fig. 5; the two curves A and B will show the same signal-to-noise ratio, but without a doubt you will hear the difference on a recording. From the foregoing argument, we can see that the signal bandwidth product is a better measure of the dynamic range.

Let us now make a comparison between cassette machines and open-reel machines in the light of equation (3). Experience shows that maximum remanent induction and tape noise characteristics are exactly the same for cassette and open-reel tapes because the magnetic particles, size, and density of the particles are the same for the two types of tape. (While there are differences in tape formulations actually available to the consumer, any formulation can be applied to either system.)

Assuming the same bandwidth for open-reel and cassette machines, we can use equation (3) to find an expression that shows the difference in the signal-to-noise ratio for the two systems:

$$\frac{OR}{CC} = 20 \log \left\{ \frac{d_1}{d_2} \sqrt{\frac{b_1}{b_2}} \cdot \frac{-\frac{B_r}{H_c} + (1 + \frac{B_r}{H_c}) \sqrt{1 + (\frac{\omega_0}{v_2} d_2)^2}}{-\frac{B_r}{H_c} + (1 + \frac{B_r}{H_c}) \sqrt{1 + (\frac{\omega_0}{v_1} d_1)^2}} \right\} \quad (4)$$

Where, for OR (open reel),  $d_1 = 13 \mu m$ ,  $b_1 = 1.0 \text{ mm}$ ,  $v_1 = 1\frac{1}{8}, 3\frac{3}{4}, 7\frac{1}{2}, 15 \text{ ips}$ , and for CC (compact cassette),  $d_2 = 5 \mu m$ ,  $b_2 = 0.6 \text{ mm}$ ,  $v_2 = 1\frac{1}{8} \text{ ips}$ . The numeric results of (4) for the four speeds are given in the accompanying table where  $W_0 = 2\pi \cdot 20 \text{ kHz}$ . The results show that tape speed is the dominating factor in the SB product. For cassette machines, tape



# Creative Technology!

The MXR Compander and Stereo Graphic Equalizer provide you with the ultimate in creative sounds.

The MXR Compander is a noise reduction device capable of doubling the dynamic range of most open reel and cassette tape decks, allowing professional results in home recording. In operation the Compander compresses the dynamic range of the signal going onto the tape and expands the dynamic range upon playback. With the MXR Compander noise is reduced enabling the softest sounds to be heard, while musical peaks can be reproduced without distortion.

The MXR Stereo Graphic Equalizer, a natural companion, is a two channel frequency equalizer that offers ten bands of discrete adjustment on each channel. The primary function of the MXR Equalizer is to provide precise compensation for aural tone quality discrepancies that may be caused by room acoustics, speaker inadequacies, or program sound quality. With a touch of the slide control the MXR Equalizer will tailor your playback to suit any number of variables and develop the mood you want to hear.

Both the Compander and Equalizer are compact, stylish and handsomely packaged in black anodized aluminum with walnut side panels. Their design and circuitry will complement any modern Hi-Fi system.

The MXR Compander is attractively priced at \$129.95 and its companion the MXR Stereo Graphic Equalizer at \$199.95.

MXR products have become the standard for signal processing in professional recording and live musical performances. This combination of engineering excellence and creativity provides you with superior MXR products.

For more information on MXR products, see your nearest MXR dealer or direct inquiries to MXR Innovations Inc., 277 N. Goodman Street, Rochester, New York 14607 (716) 442-5320.

**MXR** Consumer Products Group



Enter No. 14 on Reader Service Card

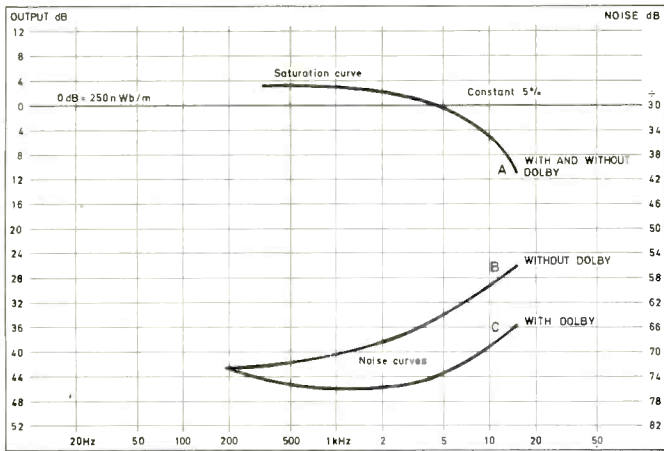

Fig. 4—System performance, as in Fig. 2, but with a Dolby NR circuit added to reduce system noise.

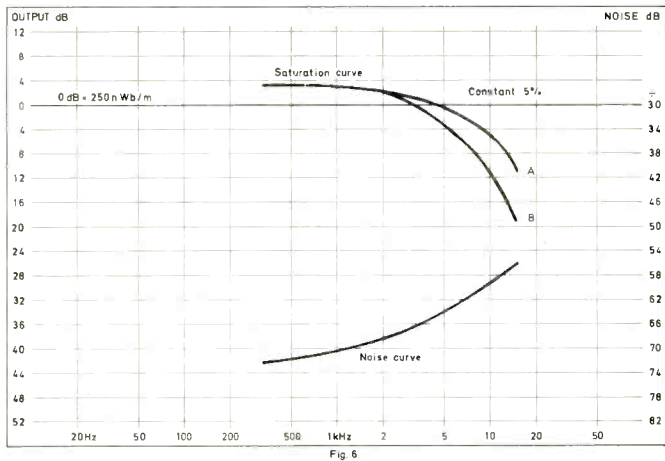

Fig. 5—Comparison of two systems with the same noise floor, but different maximum high frequency output curves. While both will have the same signal-to-noise ratio, when measured via conventional standards, system A will sound better because of its extended high frequency response.

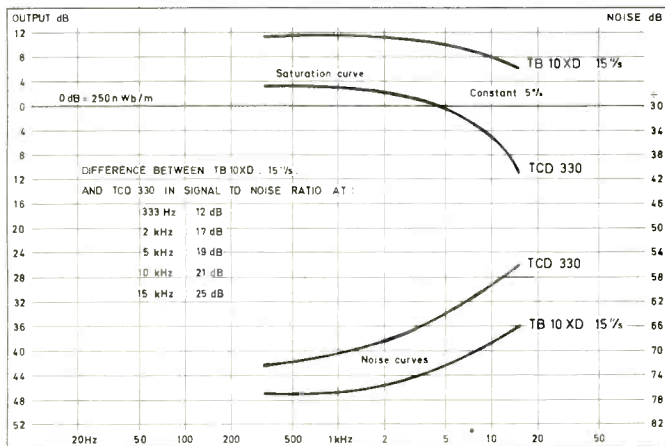

Fig. 6—Comparison of a Tandberg TB-10XB open-reel recorder with a TCD-330 cassette machine, as in Fig. 2.

speed has been prescribed at 1 7/8 ips in the standard, but for open reel the tape speed can go up to 15 ips. In addition, there is an opportunity to choose the most suitable track width with open reel. The table shows that there is 8 dB difference between cassette and open reel at 3 3/4 ips, or that an open reel machine at 3 3/4 ips without Dolby is about as good as a cassette machine with Dolby. It can be argued that it is an advantage not to use any complementary noise

Table I

v (ips)	1 7/8	3 3/4	7 1/2	15
OR (dB)	2.0	8.0	15	22
CC				

reduction system since all forms bring with them undesirable turn-on transients caused by the positive time constants in the control circuits. Furthermore, the Dolby system does not provide any noise reduction at frequencies below 500 Hz, and this is frequently a region where we require an improvement. A poor signal-to-noise ratio at low frequencies causes reproduction to sound impure and damages the quality substantially.

Let us examine equation (4) for frequencies lower than 500 Hz. This is the case where  $\frac{W}{V}d \ll 1$  and equation (4) becomes:

$$\frac{OR}{CC} = 20 \log \left\{ \frac{d_1}{d_2} \sqrt{\frac{b_1}{b_2}} \right\} \quad (5)$$

A new comparison of cassette with open reel at 3 3/4 ips gives a difference of 10.5 dB, below 500 Hz.

### Practical User Qualities

In addition to the considerations concerning recording qualities, it is important to note the differences in user qualities between the two tape recorder systems. Here is a list of points where we feel the open reel machine is superior to the cassette machine:

- 1) Better signal-to-noise ratio.
- 2) Acceptable signal-to-noise ratio without noise reduction system.
- 3) Longer playing time.
- 4) Greater tape reliability.
- 5) Better editing facilities.
- 6) Sound-on-sound recording facility.
- 7) Better copying facilities.
- 8) A-B test without adjusting the azimuth when the tape is changed.
- 9) Less wow and flutter.
- 10) Better channel separation (track-to-track).

The most important advantages of the cassette system are:

- 1) Easy to operate.
- 2) Large choice of pre-recorded tapes.
- 3) Also found in the low price category.

We conclude by presenting measurements made on our TCD 330 cassette machine and the TB 10XD open-reel machine (Fig. 6). The curves tell their own story and are a fitting conclusion to this article.

# Some \$5 blank cassettes have the nerve to tinker with Beethoven. We think it's outrageous.

**B**eethoven, even when he was deaf, knew exactly how a piccolo sounded in relation to the rest of the orchestra. Some cassette manufacturers would just as soon forget. Their cassettes give the piccolo and other high frequency sounds a distorted prominence. They appear to do this deliberately, regarding absolutely natural sound as raw material to be improved upon.

At BASF, we think this is an abomination. We're purists; we stake everything on total accuracy of sound reproduction. You will never encounter artificially enhanced high frequencies in our cassettes. We believe that if you care enough to buy an expensive audio system, the last thing you need is a cassette that imposes its own dubious tastes upon your sensitive ears.

Faithful reproduction entails more than miracle ingredients and fanciful initials on a cassette label. At BASF, we begin with the best quality ferric oxide. We mill it by a patented process to

achieve maximum packing density and uniformity of coating. We use an exclusive chemically cross-linked polymer binding which will never deteriorate and cause head-related frictional noise or wow and flutter.

We use a unique multi-stage polishing process, and our slitting technique results in an edge that's clean even when viewed under a microscope. Even our cassette case is different, incorporating our patented Special Mechanism, designed to assure smooth tape feed for years of dependable performance.

Is completely natural sound worth that kind of effort? To people who know the difference, it is.

At BASF, we're purists. We've been obsessed with total accuracy since we invented magnetic tape back in 1932. There are no shortcuts to perfection. But you knew that when you planned your own audio system. We'll give you no reason to compromise when you buy our cassettes.

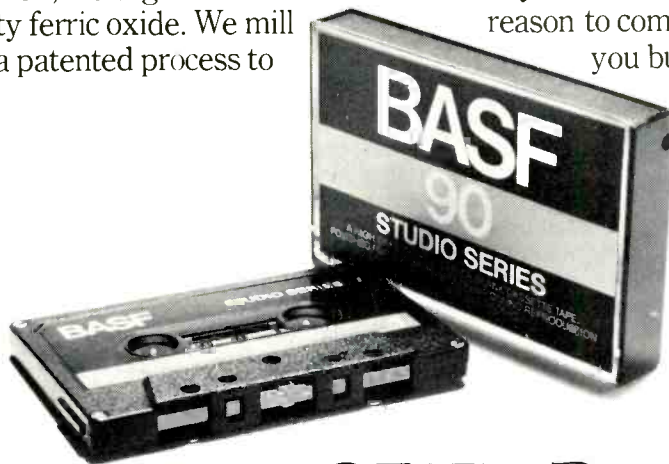

 **BASF The Purist**

Our Promise: the purest, most accurate sound that tape can reproduce.

High performance tapes being introduced in today's audiophile market are characterized by such features as low distortion, high undistorted output, more output at high frequencies before saturation, more dynamic range, and more headroom. This discussion deals with how to take advantage of those benefits; to present an understanding of how to recognize and control distortion inherent in the tape recording process so that tape recordings truly have higher fidelity.

### Understanding Distortion

Strictly speaking, distortion is the degree to which reproduced sound differs from original sound, and this definition, lack of fidelity, holds true regardless of whether the distortion is caused by equipment or by recording medium. Distortion includes amplifier overload and hum as well as tape "hiss" and any change in frequency response between input and output of the tape recorder.

The scope of this discussion will, however, focus on distortion as related to magnetic tape and how to optimize the record and playback levels to obtain minimum distortion. The particular types of distortion to be discussed are odd harmonics, compression and saturation, and intermodulation distortion.

These types of distortion are all forms of nonlinear distortion and occur when the output and input of a recorder depart from an ideal straight line relationship. The function of a tape machine's bias circuitry is to linearize the output-input relationship which otherwise would be highly non-linear (owing to magnetic hysteresis). Beyond having a unit's bias correctly set (usually done in the factory or service department), there are other things which must be done to record with minimum distortion, and these aspects of recording will be discussed here.

### Odd Harmonics Of the Input Signal

Harmonics can be described, generally, as an addition to the fundamental tone of spurious tones having frequencies that are whole number multiples of the fundamental. Thus, third harmonic distortion is a combination of the fundamental frequency and a second frequency which is three times the fundamental. The percentage level of a harmonic almost always decreases with each higher harmonic order; the fifth is much lower than the third, etc. Consequently,

# Fighting Distortion In Tape Recording

---

Wayne Saylor\*

---

only the third harmonic is generally measured in the case of odd harmonics distortion, because it usually has a substantially higher percentage level.

Since all musical instruments have rather significant amounts of their sound energy in harmonics, harmonic distortion is not, in itself, unpleasant to listen to. Third harmonic distortion is very convenient to measure, however, and is used to quantify distortion more because of its convenience and correlation with other types of distortion. Of course, third harmonic distortion, inherent in tape recording is only perceptible or measurable using fundamentals up to 1/3 of upper frequency limit of the recorder. The laboratory method of measuring third harmonic distortion involves simply recording a pure tone (single frequency) and measuring the relative level of the third harmonic of that tone.

Even harmonics are not generally characteristic of magnetic tape systems because the hysteresis curve is symmetrical, even though it is nonlinear, and asymmetry is required to generate even harmonics. However, even harmonics can occur in the recording system and are caused by any nonsymmetrical polarizing magnetization. Such even harmonics are, however, equipment related, rather than tape related, and are usually caused by either magnetized heads, a d.c. current component in the heads, one-sided amplifier overload, or asymmetrical distortion of the bias signal.

### Compression and Saturation

Compression of the recorded signal occurs when a given amount of increase in input level does not result in

as much increase in output level. Compression occurs at all frequencies, but is much more prevalent at high frequencies. Obviously, this alters frequency response. This happens principally at high input levels due to the inability of the oxide coating to be magnetized further and a phenomenon known as self-erasure occurring predominately at higher frequencies.

At the level compression begins, that is where *no* increase in output level results from increasing the input level, *saturation* has been reached. Beyond saturation, further increases in input record level result in decreases in output. Use of recording input levels *beyond* saturation alters frequency response much more adversely than compression *prior* to saturation. Compression and saturation result in non-true *level*, rather than the introduction of new or different frequencies.

### Intermodulation Distortion

Intermodulation or IM distortion occurs throughout the spectrum of frequencies which the recorder is capable of reproducing and is the generation of new frequencies *not harmonically related* to the input frequency. This form of distortion results from the combination of two or more input frequencies at the same time; the output contains not only the original two frequencies, but also the *sum* and the *difference* of the original two frequencies. These are usually referred to as *beats* of the original frequencies. IM Distortion has no musical relationship to the original frequencies from which the distortion is derived, so IM Distortion causes the greatest subjective impairment to the music. The words harsh, dissonant, and "fuzzy" are used to describe the unpleasant subjective effects of IM distortion.

### Signal-to-Noise Ratio

The main idea in making superb quality recordings is to use the highest record level possible without objectionable distortion. The higher the Record level, the more distortion, but a lower Record level results in less difference between the inherent tape noise and the level of music during Playback. Tape hiss gets louder as Playback level is increased, but does not get louder as Record level is increased. As Record level is increased, the recorded signal is increased, so

\*Audio Engineer,  
Memorex Corp., Santa Clara, Calif.

# The Sensuous Speaker.

Yamaha's new two-way beryllium dome NS-500.

A very responsive speaker with a rich, luscious sound. Highly defined, finely detailed. A deeply involving sound.

In a word, sensuous.

With the NS-500, you get all of beryllium's advantages (transparency, detail, and lack of distortion that go beyond the best electrostatic speakers), but at a price roughly half that of the NS-1000. Only \$500 the pair, suggested retail price.

## The joy of beryllium.

The ideal dome material for a high frequency driver must respond instantly to changes in amplitude and frequency of the input signal. So the ideal dome material must be virtually weightless as well as extremely rigid.

Beryllium is the lightest and most rigid metal known. Its density is less than two-thirds that of commonly used aluminum, and its rigidity is almost four times as great — thus preventing dome deformation and consequent distortion. What's more, beryllium's sound propagation velocity is twice that of aluminum.

The beryllium dome found on the NS-500's high frequency driver is the world's lightest — about half the weight of one petal of a small sweet-heart rose. Which is one of the reasons for this speaker's exceptional sensitivity and response. And for its sensuous sound.

## A closer look.

To be able to offer the sophistication of beryllium at a more affordable price, without sacrificing quality of performance, Yamaha designed the NS-500 as a two-way bass reflex system.

This gives the NS-500 a trace more emotion at the low end than the resolutely objective NS-1000. But it also gives the NS-500 more efficiency (91dB SPL at one meter with one

watt RMS input). Which means you don't have to invest in the highest powered amplifiers or receivers in order to drive the NS-500 to its full rated output.

For an optimum match with the beryllium tweeter, Yamaha developed a very light, very rigid 'shell' woofer. And a special hermetically-sealed air core LC crossover with a carefully selected 1.8kHz crossover point.

As a result of these design parameters, the NS-500 boasts an insignificant 0.03% THD below 50dB SPL, from 40Hz to 20kHz, making it the perfect complement to Yamaha's state-of-the-art low distortion electronics.

Underneath the sleek monolithic styling of its solidly crafted enclosures, the NS-500 is full of many exclusive Yamaha features and distinctive Yamaha touches of craftsmanship.

But to fully appreciate the beauty of the NS-500, you really should visit your Yamaha Audio Specialty Dealer.

And if you're not familiar with the name of your local Yamaha Audio Specialty Dealer, drop us a line. In turn, we'll also send you a free preprint of the Audio Engineering Society paper on Yamaha beryllium technology mentioned above.



 **YAMAHA**

P.O. Box 6500, Brea, CA 90622

Enter No. 37 on Reader Service Card

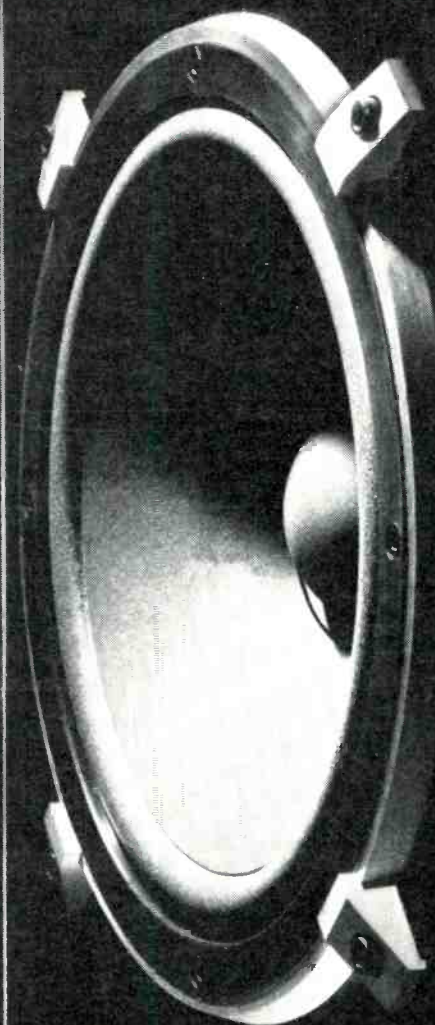
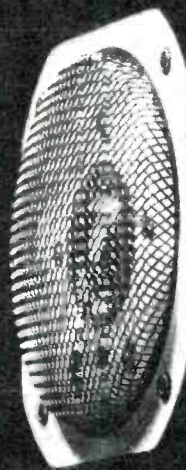

# New Standards for the World

The course of cassette history was irreversibly changed four years ago. Introduction of the Nakamichi 1000 generated an unprecedented wave of reaction, from enthusiasm to outright disbelief. But today, the Nakamichi 1000 and the equally phenomenal 700 are standards of the industry, the logical choice of recording studios, independent testing laboratories, leading cassette tape manufacturers and discriminating audiophiles the world over.

No other manufacturer has equalled the original 1000 and 700. And yet, these remarkable decks have undergone a constant evolution. Nakamichi innovations are most often subtle, but important, improvements that are not reflected in published specifications alone.

The latest refinements have produced the 10C0II and 700II—cassette decks that in no uncertain terms restate the state of the art. The audible improvement is dramatic. Recordings have an unconfined quality—an openness and breadth which elude all but the very best open reel decks.

Immediately noticeable are level meters that indicate program peaks from -40 dB to an unheard of +10 dB! Other new features include front panel access to the record level calibration controls, and independent tape bias and equalization switches.

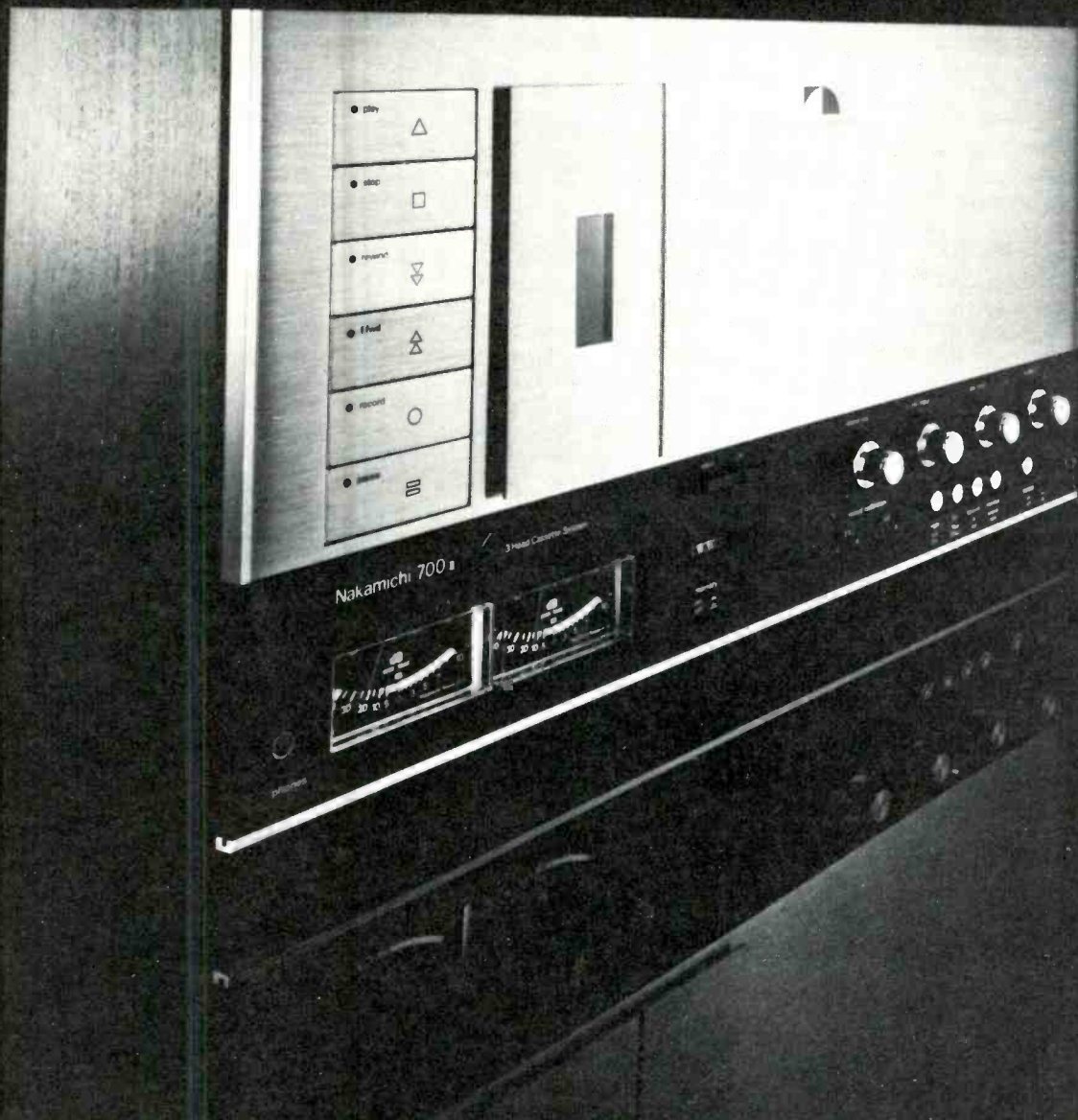

® 'Dolby' is a Trademark of Dolby Laboratories, Inc.

But the real news is *inside* the 1000II and 700II. Nakamichi's famous dual capstan DC servomotor transport now has fewer moving parts with enviably low wow and flutter (under 0.1% EIN weighted peak, 0.05% wrms). Re-designed electronics yield lower noise and distortion than ever before, with tremendous headroom. The mic preamps are highly sensitive, yet virtually impossible to overload. Phase corrected playback circuitry ensures total reproduction accuracy; refinements in Nakamichi's exclusive Crystal Permalloy playback head afford even longer life. The headphone amplifier, too, has been improved with increased output. And finally, both are designed and factory-calibrated for optimum performance with the latest generation of cassette tape formulations, such as Nakamichi SX and EXII.

But some things never change. True three-head configuration with Nakamichi's patented azimuth alignment beacon, feather-touch transport controls with full IC logic, memory rewind, Dolby® Noise Reduction, 3mic inputs with line mixing, and variable pitch control are but a few of the features the 1000II and 700II have inherited from their predecessors. The 1000 I continues to offer auto-rewind, Dynamic Noise Limiter circuitry, 19-inch rack mount capability, and the use of hand-selected components.

It's not every day that new world standards are established. Visit your Nakamichi dealer and ask for a demonstration; you can witness cassette history in the making. For more information, write Nakamichi Research (U.S.A.), Inc., 220 Westbury Avenue, Carle Place, New York 11514.



# Nakamichi

Enter No. 15 on Reader Service Card

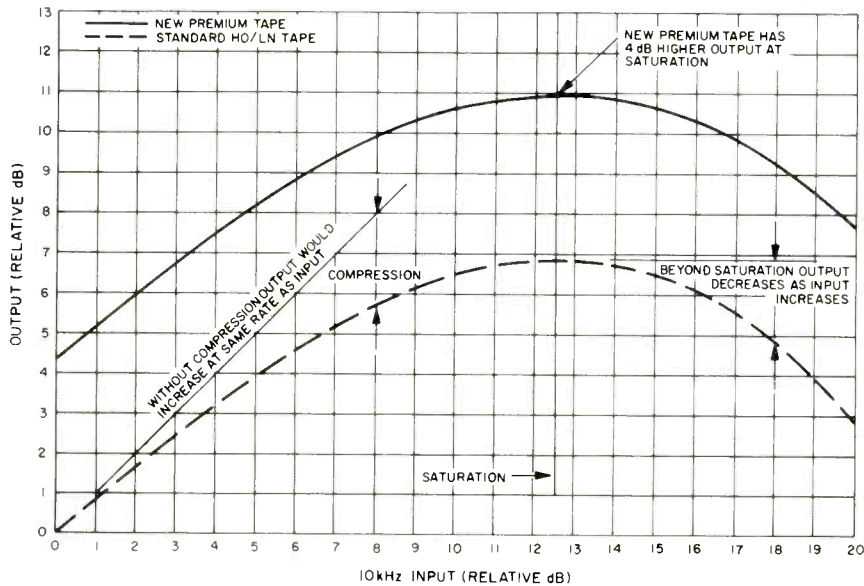

Fig. 1—Compression and saturation.

better signal-to-noise ratio is achieved by recording at the highest level possible.

Since today's superior performance tapes achieve their performance through high record level and output capability, it is necessary to know how to record at high levels and still control distortion in order to utilize the full performance capability of the tape.

Tape noise or tape "hiss" is present in all recording tape and stems from such factors as the size of the oxide particles, irregular distribution or dispersion within the coating, surface roughness, and poor orientation of the particles. Within basic categories of tape (such as high performance audiophile tape), the noise is usually

quite similar. The predominant factor in determining the relative signal-to-noise ratio of competitive tapes is maximum output signal level rather than how low is the noise.

### Optimum Recording Procedure

Optimum record level settings can be determined by the recorder user by utilizing some of the tape recorder's features to conduct an A-B comparison test as commonly used by audio engineers and other recording professionals. The easiest way to conduct an A-B test is to use a three-head tape machine with a Source-Tape switch. Most open-reel recorders sold today have separate erase, record and playback heads. Using the operating instructions for the tape deck, con-

nect the recorder to a sound source such as a phonograph record player. While in Record mode you can then switch repeatedly from source to tape, back to source, etc. In this way, you can compare the source and the tape playback. This comparison should include not only careful listening, but observing and making note of the level indicator reading on the loudest passages. There will be a slight delay in music between the Source and Tape, but this fraction of a second does not detract significantly from the A-B comparison. The delay is dependent upon tape speed and the distance between the record and play heads. Note that in the Record mode on a three-head machine, the level indicator shows Record level in Source and Playback level in Tape. For each A-B test, the playback level should be adjusted to match the loudness when listening to Tape to the loudness in Source. This is important because a difference in loudness may mask a difference in distortion.

If your machine has only two heads (erase and record/play), you can still conduct an A-B test, but it is more difficult and time consuming. The difficulty stems from the fact that you can't listen to tape playback during the same pass as record, necessitating rewinding and playing later. Such a machine doesn't need a Source-Tape switch since the level indicator reads Source during the record pass and Tape during the playback pass. To A-B compare the source and tape in this case, the phonograph record source and tape recorder playback should be connected to their respective inputs of the stereo system preamplifier. The A-B comparison is then made by switching the system pre-amp between Phono and Tape. It is, however, necessary to closely synchronize the phonograph and the tape during playback.

Once your tape machine is set up in the A-B mode previously described, you are ready to experiment. Initially adjust your recording level so that the level indicator consistently reads far into the red zone so that the recording is purposely very distorted. Match playback levels and switch between the original source and the now distorted recording and compare it with the original source. Now that you know how distortion sounds, start reducing the recording level (compensating for any drop in volume by increasing the playback level) until you reach a point where you no longer notice any distortion in the record-

Fig. 2—333 Hz maximum output level.

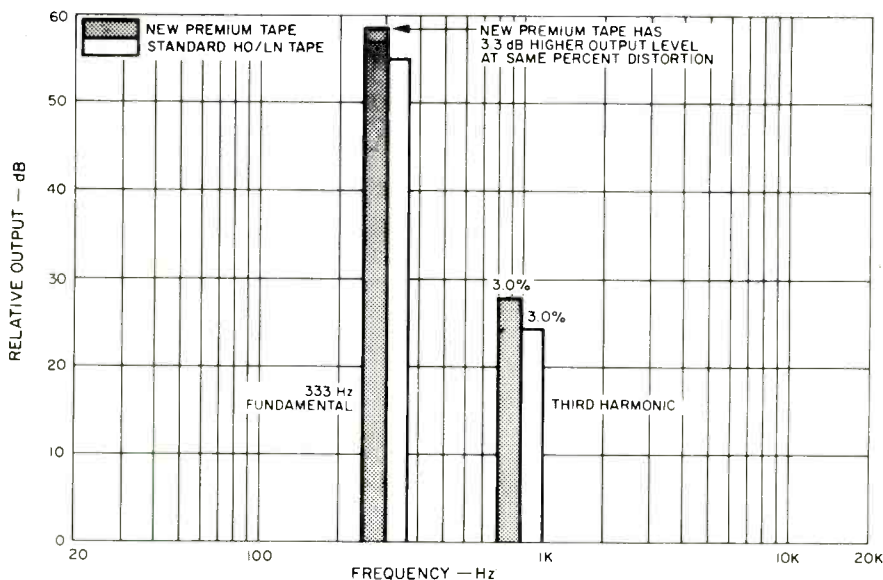



# The "Click and Pop" machine

only by **SAE**



39

Ever since the invention of the recorded disc annoying "clicks" and "pops" caused by scratches, static and imperfections have consistently disturbed the listening pleasure of music lovers.

Now, SAE introduces the unique model 5000, an Impulse Noise Reduction System which eliminates those unwanted sounds with no adverse effect on the quality of the recorded material.

This breakthrough in electronic circuitry is so demonstrably effective that the SAE 5000 is destined to become an essential part of any sound system.

The SAE 5000 is compact and sleek, built to SAE's exacting standards, and ready to enhance the performance of any system, from the standard receiver/

turntable combination, to the most sophisticated audiophile components.

SAE is proud to add the 5000 to their broad line of *Components for the Connoisseur.*

<b>SAE</b>	AM-4/77
SCIENTIFIC AUDIO ELECTRONICS, INC. P. O. Box 60271, Terminal Annex Los Angeles, Cal. 90060	
Please send more information on the 5000.	
Name _____	
Address _____	
City _____	State _____ Zip _____

Enter No. 34 on Reader Service Card

# THE GAP BETWEEN OTHER TAPES HAS

## INTRODUCING UD-XL I AND UD-XL II.

Maxell tapes have always been considered by many people to be the highest quality tapes in the world.

But instead of sitting back and resting on our laurels, we've spent the last few years looking for ways to move even further ahead.

The results of our efforts are Maxell UD-XL I and UD-XL II. Two tapes which are not only better than anything we've ever made, they're better than anything anyone's ever made.

To begin with, UD-XL I is an improved version of our own UD-XL.

More specifically, it's a ferric oxide tape designed for use with the tape selector switch in the normal position (120 microsecond equalization and standard bias).

Its performance characteristics include the lowest harmonic distortion level of any premium cassette on the market today.

An extremely flat frequency

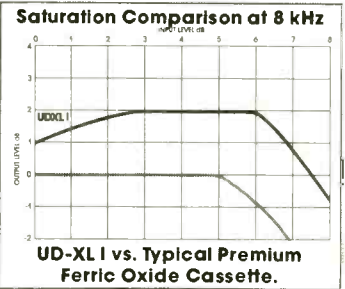

# MAXELL AND ALL JUST WIDENED.

Signal-to-Noise Ratio Comparison

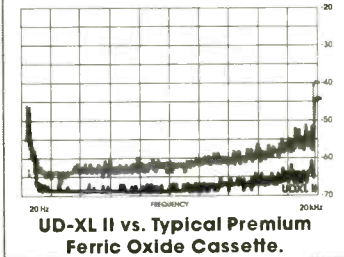

UD-XL II vs. Typical Premium Ferric Oxide Cassette.

response from the lowest to the highest frequencies.

And an exceptionally high resistance to saturation even

at the highest recording levels.

UD-XL II, on the other hand, is a ferric oxide tape specially formulated for use with the tape selector switch in the chrome position (70 microsecond equalization and high-level bias). It offers the low noise advantage of "chrome"

without the disadvantages. Its performance characteristics include extremely low modulation noise and a 5 dB signal-to-noise ratio improvement over ordinary premium tapes.

If you'd like to know more about UD-XL I and UD-XL II, stop into your local dealer and ask some questions. Not just about our tapes, but about our competitors' as well.

We think you'll soon discover something that we've always known.

The best just keeps getting better.

**MAXELL. THE TAPE THAT'S TOO GOOD FOR MOST EQUIPMENT.**

Maxell Corporation of America, 130 West Commercial Ave., Moonachie, N.J. 07074.

Enter No. 11 on Reader Service Card



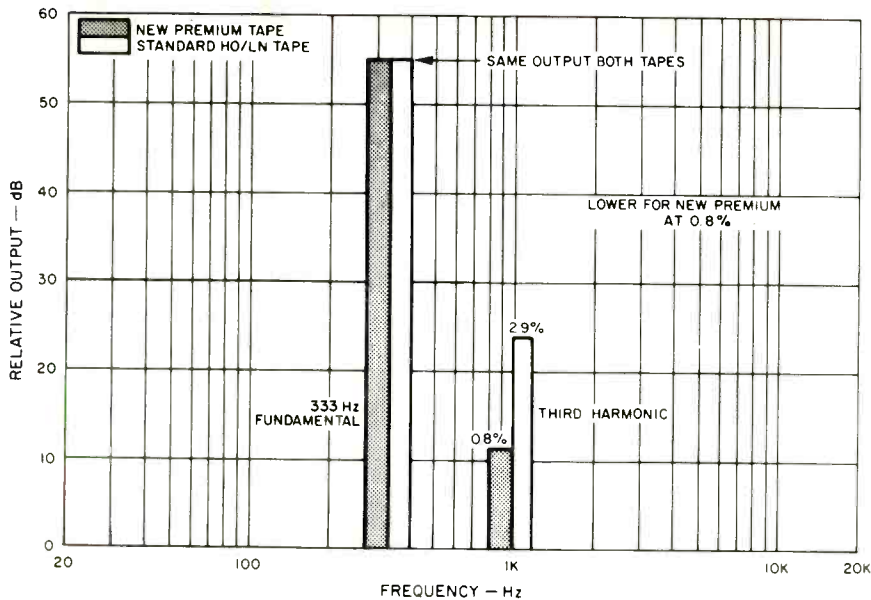

Fig. 3—Relative distortion.

ed program relative to the original program. By observing the level indicators at this point, you have identified the point on your meters where distortion becomes unnoticeable. Signals swinging further into the red zone on your meter will give noticeable distortion.

42

Ideally, you should adjust your record level to as high a level as possible without inducing distortion. And you should recognize that recordings from different program sources made at the same recording level setting may differ in distortion because they differ in dynamic range and average level. Thus, we should repeat the above experiment for various types of music. Remember that with some tape machines, you may be able to operate well in the red with no noticeable distortion. With others, you may have to keep the indication below the red even for sudden peaks. The single most valuable tool you

have in controlling distortion is the level indicator. The recordist must learn from the equipment manufacturer and from his own experience how to use his particular indicator to control distortion.

There are great differences among level indicators of which there are several types. The most well known is the VU meter which averages the signal, ignoring sudden peaks. There are also bar-graph indicators, LEDs, and peak reading meters. One type of peak reading meter measures "average" loudness much the same as VU meters except that it has a fast-attack, slow-decay ballistic response so it responds to shorter transient bursts of sound. It measures the flat response input signal when metering source. The other type of peak metering has the same peak response but meters the record signal in Source AFTER record equalization so that the actual level applied to tape is indicated.

Fig. 4—Sensitivity.

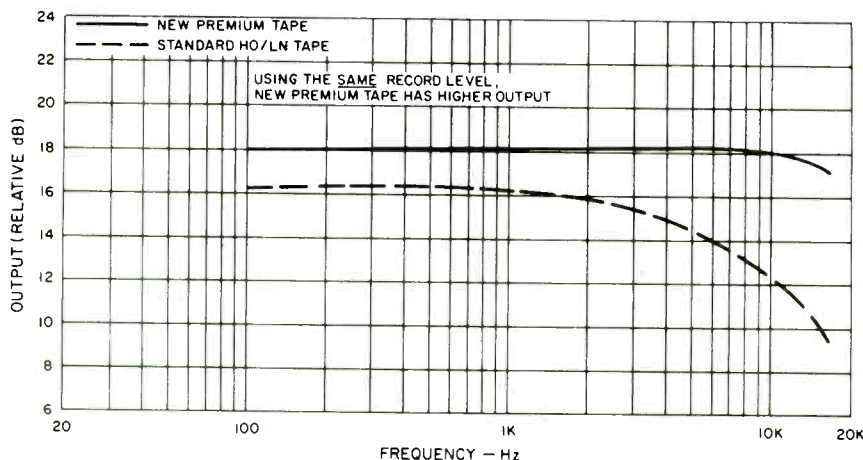

(High frequencies are recorded higher relative to low and mid-frequencies in what is known as Record equalization or Record pre-emphasis.)

With some tapes you can record at very high levels, but with some you can't. Thus, you should determine what sounds best to you, and then operate on that basis. This test will also allow you to explore different brands of open-reel tape, giving you the opportunity to determine if one brand offers better performance on your machines than another. One brand of tape may have more "headroom" than another, and this might allow the level indicator to read further into the red zone. On the other hand, if the tape also had greater sensitivity, it would give a higher undistorted output for the same reading on the level indicator. Remember that high undistorted output is the key requirement in obtaining a stronger, more dynamic recording with less hiss. While you can, of course, play it safe and always avoid distortion by recording signals at a low level, you would be recording too close to the noise floor, so you would notice more "hiss" than the recording would have if the Record level were set to its highest "distortion-free" position.

Compression is most noticeable in the high frequency end of the spectrum. Therefore, certain percussion instruments are best for observing where compression takes place. Cymbals and some tambourine sounds are good examples of this. An example of records very good for experiencing what compression really is and how to control it is *I've Got The Music In Me* on Sheffield records, **Rough Trade—Live** on Umbrella (through Audio-Technica cartridge dealers), or **Direct Disco** by Crystal Clear Records. These records are particularly clear, free of distortion, and have great high level high frequencies. A record that has great dynamic range from very soft passages to very loud ones is *Saint Saen's Organ Symphony in C Minor*, Phila. Orchestra, Columbia MS - 6469. For A-B comparison, however, the most useful type of record music is one with lots of high frequencies at high level on a sustained or repetitive basis. Other than that, you should choose music of the kind you like most and listen to most frequently.

### Ways to Control Distortion

Although wise use of your level meter and experimentation is a primary way of controlling distortion, there are other techniques to be consid-

With the new AKAI GXC-730D, great moments in music aren't shattered by those not-so-great moments in cassette rewinding and flipping.

Instead, a bi-directional GX record/playback head allows you to play both sides continuously. Automatically. And you can play or record both sides without ever having to stop and

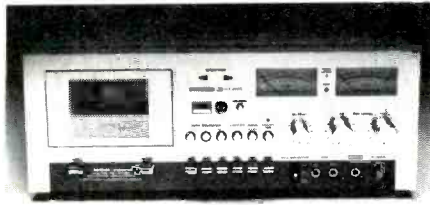

physically turn the cassette over.

The fact that the 730D is the most versatile front-loading cassette deck on the market is just the beginning. It's also loaded with some pretty fantastic features.

Like Dolby\* and AKAI's exclusive Automatic Distortion Reduction System (ADRS). Memory rewind. Pause control. Separate right and left

channel record level controls. Soft touch, direct function operating controls. Peak level indicator. Illuminated VU meters. A great-looking walnut cover. And all the specs you'd expect an AKAI top performer to deliver.

Hear it at your dealer's.

The AKAI GXC-730D. Dedicated to the proposition that some of your performances are just too good to interrupt.



For an 18" x 24" poster of this Charles Bragg etching, send \$2 to AKAI, Dept. A-4, P.O. Box 6010, Compton, CA 90224, ATTN: Lovers-

# DON'T INTERRUPT LIFE'S GREAT PERFORMANCES.

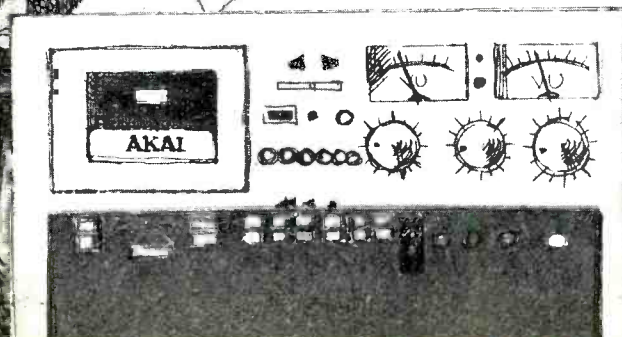

# After people learn what we've done, no one will heckle our speakers.

## **We're as close to the impossible as possible.**

Our new speakers color sound. Anybody's speakers do.

Should someone tell you otherwise, they speak with forked frequency response.

We at Sony approached the development of our new speaker line with this grim reality in mind.

Thus our goal was to create speakers with a minimum of coloration. With a frequency response flat and wide. With low distortion. And with repeatability. Which is critical. Which means that each speaker we turn out will sound like the one before and the one after.

## **Searching and researching.**

Our basic dilemma was that speaker specs don't specify much.

You can build two speakers with identical specs, and find they'll sound non-identical.

That's because your sophisticated ear can pick up differences our clumsy measurements can't.

Some examples:

*You can hear how pure water is.* The purity of the water in which the pulp for the speaker cone is pressed will influence the sound. (Spring water is the best.)

But water purity would hardly change the frequency response—or any other measureable characteristic.

Nor would the dye used to color the cone—or the glue used in gluing the cabinet.

But you'd hear the dye and the glue.

And there are dozens and dozens of elements that interact this way.

So our job was mammoth. To correlate these factors in order to reach the goal we outlined earlier. Changing one

changes the other and almost changed our minds about going into the speaker business.

But we stuck it out. And found the answer to the juggling of these variables thanks to a major technological innovation.

Trial and error.

That's why we labored for three years to bring you our speakers. While other manufacturers rushed frantically to market with theirs.

## **We keep the whole world in our hands.**

Once we understood how to control the sound of our speakers, we realized we had to control what went into our speakers.

So we did the only logical thing.

We built a plant.

And pursuing that logic, we built it at a place called Kofu. Which is at the base of Mt. Fuji. Where we can get all the spring water we want.

This factory does nothing but produce—under outrageously close control—the components for our speakers.

Whatever we do buy, we specify so carefully that our vendors have nightmares about us. (It's unfortunate that we can't make *everything* ourselves, but only God can make a tree, and only wood can make a fine cabinet.)

Few companies make this effort.

So it's safe to say that when it comes to exercising this kind of control, our speakers are a voice in the dark.

## **Don't judge a bookshelf speaker by its cover.**

As you can see, there's a lot that goes into producing a speaker that's not easily seen. (One beautiful exception—the handsome finish on our cabinets.)

That includes the carbon fiber that we mix into the speaker cone paper.

Carbon fiber is light and strong. (Why they don't use it in girdles we'll never know.)

Light, so our speaker is more efficient. Meaning you need less power to operate it. Meaning you are closer to the ideal of converting electrical energy to mechanical energy without a loss of power.

Light, so our speaker cone reacts quickly to stops and starts in the signal. The result: improved transient response.

Strong, to prevent the cone from bending out of shape in the high frequency range.

Moreover, carbon fiber doesn't resonate much. It has what's called a low Q, and it took someone with a high IQ to realize it would absorb the unwanted vibration rather than transmit it down the cone.

We also cut down on unwanted vibration (as opposed to the wanted vibration, which is music), by using a cast aluminum basket rather than a stamped, shoddy cheap metal one.

We could go on, but at this point the best thing would be for you to move on to your nearest Sony dealer. And listen.

Because the results of our three years of labor will be clear after three minutes of listening.

At which point, far from heckling our speakers, you'll be tempted to give them a standing ovation.

# SONY®

© 1977 Sony Corp. of America. Sony, 9 W. 57 St., N.Y., N.Y. 10019  
SONY is a trademark of Sony Corp.

Suggested retail prices: SSU-3000, \$300 each; SSU-4000, \$400 each.

Enter No. 29 on Reader Service Card



**The SSU-3000 and SSU-4000.  
Great speakers like these deserve an audience.**

# Super THE PROBLEM SOLVER



## THE BGW 250B DOESN'T HAVE—

- Fuses
- Knobs
- Meters
- Current limiting
- Hum
- Noise
- Thumps
- High price

## BUT, IT DOES HAVE—

- Enough muscle to drive 2-ohm loads (340-watts\*)
- Absolute speaker protection (exclusive BGW SCR crowbar)
- Virtually unmeasurable distortion\*
- Modular construction
- 12 rugged 150-watt output transistors
- High speed magnetic circuit breaker
- True op-amp front end
- Heavy 3/8" thick rack panel
- Totally enclosed heat sinks
- 660-square inches of efficient heat radiating surfaces
- Rugged steel chassis
- Mono-stereo switch

### \*Guaranteed specifications:

*Stereo mode:* 90-watts/channel into 8-ohms, 20-Hz-20-kHz with less than .1% total harmonic distortion (THD).

100-watts/channel into 4-ohms, 5-Hz-15-kHz with less than .15% THD.

*Mono mode:* 180-watts into 16-ohms, 20-Hz-20-kHz with less than .1% THD. 200-watts into 8-ohms, 5-Hz-15-kHz with less than .15% THD.

The perfect mate is our new model 202 stereo preamplifier featuring the industry's most accurate phono system—82-dB S/N, .01% THD, active 18-dB/OCT. Hi-Lo filters, studio type graphic controls. See all 6 BGW power amps and our new preamplifier at your local dealer.



BGW Systems  
P.O. Box 3742  
Beverly Hills  
CA 90212  
(213) 973-8090

Enter No. 4 on Reader Service Card

ered. They fall into two general categories, machine adjustments and tape selection.

As mentioned earlier, the sole purpose of bias in audio tape recording is to promote a linear relationship between reproduced output and recording input. Ideally, this should be done for each different type of tape to minimize distortion. Too little bias causes non-linear distortion and increases high frequency output. (This is due to bias field strength gradient throughout the oxide coating thickness, the strength being higher nearer the surface where high frequencies are recorded.) Too much bias effects the frequency response, decreasing the high frequencies more than the lows.

Very few tapes decks provide a convenient means of bias adjustment by the user. Unless your deck provides such a means, it is unwise to tamper with bias if you are not equipped with proper external test equipment to measure the degree of adjustment. If you purchase a new machine or change brands of tape, you might find a worthwhile improvement by having a service agent rebias your machine. Many new machines are not properly biased for the brand of tape being used. Some machines have a switch with more than one fixed bias setting, labeled *Standard/High, Normal /LN*, etc. You should use the position recommended by the recorder manufacturer or tape manufacturer.

The higher the tape speed, the easier it is to get good signal output versus noise, without getting into distortion. The slower speeds place the most demands upon the tape performance, and it is at these speeds where the differences among tapes are the most apparent.

Dirt on the record head separates the tape from intimate contact with the head and causes distortion because the separation effectively lowers the bias as well as the record signal. A dirty playback head can cause distortion mainly through recordist confusion if you erroneously increase record drive to make up for lower playback level caused by head to tape separation.

Magnetized heads cause even harmonic distortion and increased noise level, so periodic degaussing is recommended.

### Tape Selection

For best results you must select the tape which will provide the greatest

performance parameters with minimal distortion. Even among premium tapes, it is important to try out various brands and experiment with record levels in order to find out which offers the best performance on your tape deck. Generally speaking the important characteristics to consider include:

**Distortion.** If your tape has relatively low distortion, you will be able to record higher levels while still maintaining high quality reproduction.

**Signal-to-noise ratio.** The higher you can record above the tape noise, the less "hiss" you will hear even on soft, quiet music since the output level setting can be lower relative to the record level setting.

**Saturation.** A high output before onset of saturation results in a greater dynamic range and, most important, provides assurance against over recording high frequencies to the point where higher input results in lowered output.

**Sensitivity.** A tape with higher sensitivity is one which has *higher* output than another tape for the *same* record level. While the M.O.L. (Maximum Output Level, usually quoted relative to a certain percentage distortion) is the more important parameter, sensitivity is ordinarily a reliable indicator of relative M.O.L. among tapes of similar bias requirement. A more sensitive tape usually has higher M.O.L., especially at low or mid-frequencies. To check this out yourself, record some music which has a sustained level from a phonograph record at about -5 to -10 on your level meter. With the same record level settings, check which brand of tape plays back at the highest level. You may find 2 or 3 dB difference between major premium brands. More sensitive tape usually has lower relative distortion as well. This lets you capture all signals at a higher level relative to the noise.

### Conclusion

In conclusion, it should be evident from this discussion that any recording enthusiast can control distortion if, first, he has a good basic understanding of the mechanics and limitations of his tape recorder and its meters; and secondly, if he understands the performance characteristics of the tape and how it interacts with the recorder. Both conditions necessitate a certain amount of recording experience and experimentation, but once this is acquired you have the tools you need to control distortion. A



# We made the first Ortofon cartridge for us.

As far back as 1945, Ortofon was making the cutterheads used throughout the world to cut the grooves in master phonograph records. But the phono playback cartridges then available could not put our cutterheads to the test for sensitivity and capacity.

So we made our first phono cartridge. For us.



Since then our cutterheads have moved ahead—with a quality we couldn't even imagine in 1945. So have our phono cartridges.

The new MC20 moving coil phono cartridge is the best we've ever made. We believe it is the finest available for professional or home use.

The MC20 has the lowest stylus tip mass ever attained on a phono cartridge. A flawless, fine line diamond stylus is fixed directly (without the usual sleeve) to a stepped, low mass cantilever. Beryllium filling enables the cantilever to attain rigidity despite its minute dimensions. The moving coils are wound with wire one-fifth the thickness of a human hair.

The moving coil principle, with its low inertial mass, wider frequency response, low distortion as well as low tracking force, has clearly established its sonic superiority over any other phono cartridge system. Our new pre-preamplifier, the MCA-76, is also available to process the signal of the MC20 or any other moving coil cartridge. The MCA-76 features low-noise circuitry, a subsonic filter and a by-pass switch which accommodates all magnetic cartridges.

We'll be pleased to forward data on the entire Ortofon line. We suggest that you write to us directly. Ortofon, Dept. C, 122 Dupont Street, Plainview, New York 11803.

## ortofon



## The Compleat Microphone Evaluation

48

Starting with this issue, I am privileged to share with you the results of a series of tests and evaluations of various microphones. This is a pleasure, as it allows me to pass along some of what I learned as an engineer in RCA's Acoustics Laboratory. You may well recall from the recent historical article in *Audio* by Bob Paquette (Dec., 1974) that RCA and Western Electric were leaders in microphone development in the 1920s and '30s. I was a latecomer, joining RCA in 1957, but was fortunate to work with several of the great pioneers in acoustics.

I discovered that development of specialized precision test apparatus had paralleled developments of commercial microphones. These instruments were never described in the literature, probably because they are less interesting than commercial microphones or other products. We use some of these unique instruments in our testing, and I will attempt to fill in the literature void by describing them in detail.

Our title hints that our evaluations may not be as thorough as we'd like. A microphone is a personal instrument, handled, fondled, dropped, or used as a hammer by humans. Our test may show that a microphone has superior technical characteristics for a given application, but the user must be the final judge. If the microphone does not look, feel, or sound right to you, then it is not the best instrument for your purpose. Sometimes your application may involve stresses or environmental factors that we did not anticipate in our testing. Microphone performance requirements are varied and numerous, and only rarely does one particular model fulfill all requirements.

Looking at the brighter side, I have been testing microphones for 20 years and have no connection with any product manufacturer. I am under no pressure to "go easy" on advertisers. (Editor's Note: Oh, drat!) Therefore, I can serve

you, the reader, as a qualified and unbiased consultant on microphone selection. Our tests will be as accurate and complete as possible. I hope to earn your confidence. Reader comments and questions are invited and will be welcome.

### Testing Methods—Standard or Special?

General principles and methods of testing microphones are well established in the standards literature, which is listed in the table. The ANSI document, in particular, is a detailed and up-to-date "cookbook." There is no need to develop additional, more sophisticated tests. This situation is different from evaluation of loudspeakers, where the standards literature leaves much to be desired. We hope that the novel and excellent methods developed by Dick Heyser and presented in *Audio* will, in the future, be adopted as national and international standards.

However, even a reader with an engineering degree can learn few specifics of microphone testing from the standards documents. This is good because standards must allow for continuing refinement in test apparatus. Each laboratory must engineer their own test facilities. You will find a mixture of off-the-shelf instruments plus numerous custom instruments and test fixtures. Each lab claims conformance to standards, but the differences between laboratories are great enough to account for significant inconsistency in published data. Add to this the sales department's very natural desire to smooth out the wiggles in the frequency response curves, and you end up with catalog literature that cannot be used for reliable comparisons of performance. (Editor's Note: I wish you hadn't said that; it means another ulcer.)

Our tests may not be more accurate than Manufacturer "X," but we use the same instrumentation to test brands "X," "Y," and "Z," so the results may be precisely compared. In addition, we promise to publish all of the wiggles we find!

### Sensitivity Ratings

According to ANSI S1.10 the Free-Field Response  $M_f$  of a microphone at a particular frequency is defined as:

$$M_f = \frac{e}{P_f}$$

where  $e$  is the open-circuit output voltage and  $P_f$  is the free-field sound pressure which existed *prior to introduction of the microphone.*

This must be converted to decibels so that the data can be plotted on a standard graph of a dB versus frequency. The desired quantity is the Free-Field Response Level  $R_f$  (unit is the decibel.)

$$R_f = 20 \log_{10} \frac{M_f}{M_r}$$

$M_r$  is the reference level which is 1 volt per newton per square meter. The Pascal (Pa) is equal to one newton per square meter.  $R_f$  is expressed in decibels with reference to 1 volt per Pascal. This may be abbreviated to dBV/Pa.

*Example:* A rated sensitivity of -60 dBV/Pa means that for an input of 1 Pascal (+94 dB Sound Pressure Level re 20 micro pascals), the open-circuit output of the microphone is 60 dB less than 1 volt, or 1 millivolt.

Note: The above are S.I. (International) units. You will find many specifications use the older c.g.s. units where  $M_r$  equals 1 dyne per square centimeter or 1 microbar. 1 Pascal equals 10 microbars. Thus, with 20 dB less input, the microphone will have 20 dB less output ( $R_f$ ), and the sensitivity figure becomes -80 dBV/microbar.

The open-circuit output  $e$  is essentially equal to that obtained with a preamp whose actual input impedance is

much greater, say 10 times, the actual impedance of the microphone at any frequency. This is known as an "unloaded input" circuit. Most audio equipment designed for low impedance microphones has "unloaded inputs." Infrequently we find equipment where the manufacturer has provided "matched" input impedance. You should generally avoid purchase of such equipment because the frequency response of such microphones may be degraded.

The open-circuit response level in dBV/Pa is the fundamental microphone sensitivity rating. The others were described in great detail by A. Lorona in the December, 1976, issue, and I will not cover the same material. I will however correct some errors and omissions and emphasize just two of the ratings.

You have observed that sensitivity is rated for 1 Pascal or 94 dB Sound Pressure Level, which as indicated corresponds to a very loud voice at one foot. The important correction to be made to Lorona's article is that standard speed level (per ANSI Standard S1.8-1969) is 65 dB at one meter, which results in 75 dB at one foot. The discrepancy between the 75 and 94 dB levels is a well-known bit of non-realism in the Standards.

The dBV rating works for both high or low impedance microphones. There is an additional useful rating for low impedance microphones that I call "Power Sensitivity," which is expressed in dBm:

*Power Sensitivity equals the power output level in decibels with reference to 1 milliwatt (dBm) that would theoretically be obtained if the microphone was operated into a matched load with a sound pressure input of 1 Pascal.*

"Theoretically" refers to the assumption that the microphone impedance is equal to rated value, and that the load value equals this value. In practice, the microphone is unloaded, so the dBm value is thought of as "power available" to a matched load.

**Table 1—Standards relevant to microphone testing.**

**ANSI S1.10-1966 R1971: Calibration of microphones.**  
**EIA SE-105: Microphones for sound equipment.**  
**EIA RS-221: Broadcast microphones, Polarization or phasing of.**

**ANSI—American National Standards Institute.**  
**EIA—Electronic Industries Association.**

*Example:* Assume our -60 dBV/Pa microphone is 250 ohms impedance. (This yields round numbers, unlike the 150 ohm value that is widely used.) 1 milliwatt into 250 ohms develops 0.5 volts. The open circuit value is 1 volt. Thus, -60 dBV equals -60 dBm. *The Power Sensitivity or dBm rating equals the dBV rating if the microphone impedance is 250 ohms.*

The third sensitivity rating of significance to all microphones is the EIA Sensitivity rating (GM). It is calculated from our (S.I. units) dBV rating  $R_f$ :

$$GM = R_f - 20 - X$$

$X$  is from a table in EIA Standard SE-105. For microphone rating impedances from 75 to 300 ohms,  $X$  equals 71.8.

*Example:* Our microphone with  $R_f = -60$  dBV/Pa and (150 or) 250 ohms impedance has  $GM = -60 - 20 - 71.8 = -151.8$  dB

What is the utility of this strange number? It turns out to be very useful for by adding the Sound Pressure Level (SPL) input to the GM value, you obtain the approximate dBm output (into that fictitious matched load).

*Example:* You are expecting to record a rock group with the above microphone and anticipate a maximum SPL of 120

Fig. 1—Microphone frequency response and sensitivity test.

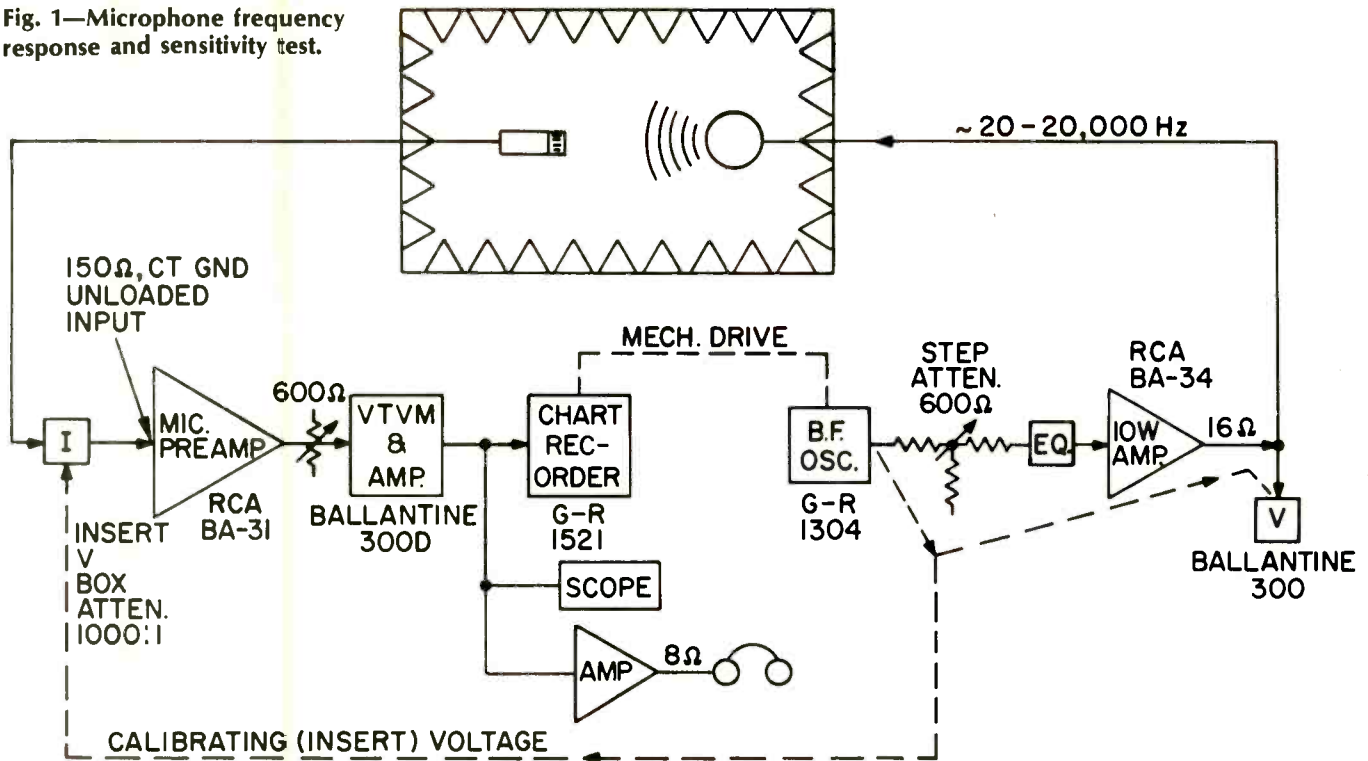

dB. Your recorder overloads at 15 millivolts input. Do you need an attenuator between mike and recorder? Adding +120 to -151.8 we obtain -31.8 dBm "Power Output." Recalling that dBm equals dBV for a 250 ohm impedance, the open circuit output of the mike is -31.8 dBV or 25 millivolts. This will overload your recorder so you need an attenuator. (You may check this result by noting that 120 dB is 26 dB greater than 94 dB (1 Pascal). The mike output is -60 dBV for 1 Pa, and thus the output for 120 db SPL is -60 + 26 or -34 dBV. This is close enough to 31.8 dBV for practical purposes.)

In the event that arithmetic is not your bag, I suggest the Shure SRC-1 Sound Reinforcement Calculator. This excellent cardboard computer relates all three of these sensitivity ratings and will tell you millivolts output versus SPL. Just remember to add 20 to the dBV numbers; Shure uses c.g.s. instead of S.I. units.

### Frequency Response and Sensitivity Test

The object of this test is to measure microphone response level,  $R_f$  versus frequency. The 1000 Hz value of  $R_f$  is generally the published sensitivity. The frequency response is simply the plus or minus variation of  $R_f$  compared to its 1000 Hz value. (Fig. 6).

Figure 1 shows a diagram of our instrumentation, and Fig. 2 shows the author at the controls. The heart of this system is the precision Spherical Sound Source shown in Figs. 3 and 4. It was developed 29 years ago by A.L. Witchey. It consists of a 2-in. diameter aluminum dome diaphragm attached to its periphery to a tapered thickness aluminum coil form that was machined from bar or tubing. The coil is long compared to the magnetic gap. The moving system is suspended by three loops of nylon thread which fasten at six points around the front and rear of the coil form.

Precise tension adjustment is provided by adjustable pull-eyes and screws accessible from the outside. In the photos,

you can see the suspension housings projecting radically from the dome. The resonance of the moving system is extremely low; if you displace it by a d.c. current, it may take a minute to return to rest position! Damping is high because of eddy currents induced in the solid metal coil form.

This source is essentially a combination of a dome radiator and an acoustic suspension low frequency speaker. (And you thought these were new concepts.) This arrangement results in low frequency response in excess of that normally expected from a 2-in. radiator, and in very smooth frequency response.

The calibration of this source is shown in Fig. 5. Some broad band equalization is employed, but it is not practical to flatten the response below 100 Hz. Microphones, particularly directional types, have a proximity effect (see Fig. 9) that provides "bass boost" which offsets the source response below 100 Hz. Thus, we can calibrate some microphones down to 40 Hz with this source. The rising high frequency response is an artifact resulting from an old error. This could be equalized flat if we choose to do so.

Returning to Fig. 1, note that the "EQ" for the sound source is inserted ahead of the power amplifier. The oscillator is driven by the recorder and slides slowly from 20 to 20,000 Hz. The frequency is synchronized with the chart. A sample chart is shown as Fig. 6. How do we calibrate the decibel scale so we can calculate the dBV and other sensitivity numbers? All we need is a dBV calibration on the chart. This is accomplished by the "insert voltage" method of ANSI S1.10. To calibrate the scale in terms of open circuit microphone output, the method requires "inserting" a known voltage in series with the microphone (with the Sound Source "off"). (The voltage source impedance must be low compared to the microphone impedance.) I found long ago that the ANSI method wouldn't work with a balanced input broadcast type preamp such as the RCA BA-31. I invented a little gadget which I call a "balanced calibrator" to solve this problem, the "Insert V Box" shown in Fig. 1. To make a -60

# HOW NOT TO RUIN YOUR RECORDS

## PART I

### *Don't "play" over micro-dust*

#### THE PROBLEM:

The greatest cause of record degeneration is micro-dust. All records possess a static charge which attracts a very fine, virtually invisible micro-dust from room air. A record may "look clean" but contain a fine coating of micro-dust. When you play over this coating, even at one gram of stylus pressure, you grind the micro-dust into the record walls, often forever. Your record then gets "noisy."

#### COMMON ERRORS:

Most record cleaners are "pushers", and simply line up dirt without removing it from the disc. Skating a pusher off the record only spreads micro-dust into a tangent line of danger. Extra arm devices and all cloths are too coarse to do anything but pass over micro-dust—or gently spread it out.

#### AN ANSWER FROM RESEARCH:

The exclusive Discwasher System removes micro-dust better than any other method.

1. The slanted pile lifts up rather than lines up debris. The pile fibers are fixed in the fabric better than any other record cleaner, and "track" record grooves rather than scrape them (see figure 1).
2. Alternating "open rows" of highly absorbent backing hold micro-dust taken off the record, and demonstrate Discwasher's effectiveness over long term use (see figure 2).
3. The inherently safe D3 fluid delivery system and capillary fluid removal allows the most researched record cleaner to be the world's best.



Fig. 1 Line of micro-dust removed from a "clean" record.

UNRETOUCHED PHOTOS  
OF DISCWASHER BRUSH



Fig. 2 Accumulated micro-dust from long, effective use of the Discwasher System.



 **Discwasher Group**

1407 N. PROVIDENCE RD.  
COLUMBIA, MISSOURI 65201

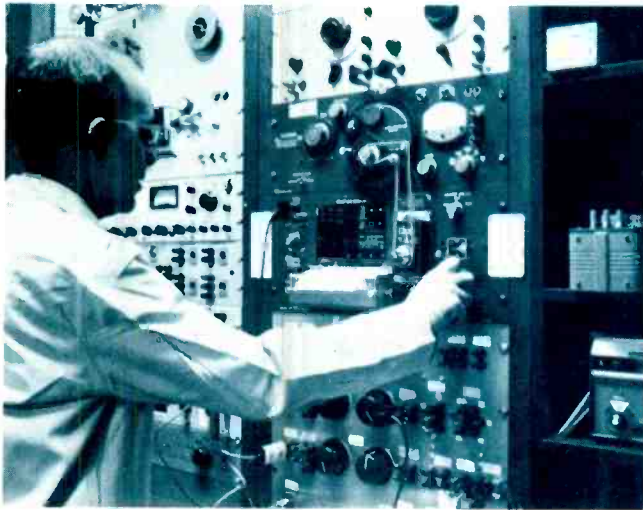

Fig. 2—Photo of measuring rack.

52 dBV (1 millivolt) mark on the chart requires 1 volt into the box. Now if I vary the oscillator frequency and draw a curve with the insert voltage I have what I call a "cal curve," Fig. 7. The test equipment between microphone and recorder has flat response except for these loading effects on the microphone by the preamp. On some directional microphones, such as the BK-5B, the impedance peak at the low frequency resonance may be four or five times the nominal impedance value. This causes loading of about 3 dB at 50 Hz for the RCA BK-5B/BA-31 combination, and the acoustical response data must be corrected for this deviation. Obviously I could use an op-amp in the preamp input and eliminate microphone loading, but the commercial preamp permits detection of electrical defects in the microphone.

Let's assume that we've calibrated the dB scale of Fig. 6, and drawn the axial response curve, denoted by 0°. The BK-5B has wider and smoother response than many unidirectionals. It is my favorite for all classical or pop music recording. All of the minor "wiggles" or response variations of this excellent microphone are revealed because the smoothness of the Source response exceeds that of the microphone! For everyday work, no corrections for Source response variation need be made to the Fig. 6 curve.

For publication or other purposes requiring accuracy, we need to correct Fig. 6 for Source variations and the "cal" curve. Directional microphone data must be corrected for proximity effect. Certain infidel acousticians would refer to Fig. 4 as the "holy cow" curve, a term that usually refers to calibration curves of commercial speaker sources. These

Fig. 3—Small sound source and 640AA.

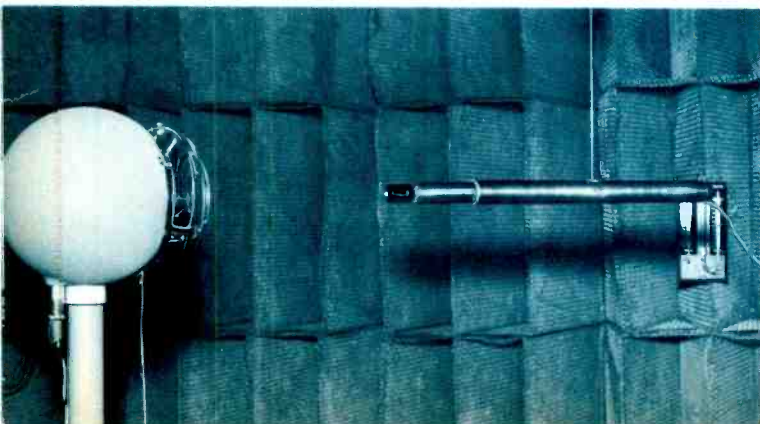

sources have irregular response so that you must constantly compare test curves to the "holy cow," which is a poor testing method.

Most laboratories do not have custom built sound sources with uniform response, so that various artificial means of "flattening" the SPL versus frequency are employed. One method is to insert a small condenser microphone along side of the microphone being tested. The condenser output is used to regulate the oscillator and speaker output by an AGC circuit resulting in uniform SPL versus frequency at the condenser microphone. This method does not conform to ANSI S1.10 and results in variable errors depending on how much the test microphone disturbs the sound field at the condenser. A better method involves tape recording the condenser mike output *with no test microphone in place*. Then the test microphone is substituted for the condenser. The tape is played and controls the speaker output by AGC action. This method appears to meet ANSI S1.10 but requires periodic re-recording of the tape, plus careful attention to maintenance.

The Source in Fig. 5 was calibrated in 1967. It is current because no significant changes have been observed in the Source since then! The stability and precision of the Source calls for equally precise calibration. Figure 3 shows calibration by our Western Electric 640-AA microphone. The condenser capsule (the forward most inch of cylinder) is calibrated by the National Bureau of Standards (NBS) and is a Prime Reference Standard Microphone. It is our working standard. Our other 640-AA, also NBS calibrated, remains in the dessicator, unless we suspect a change in the working standard and need a cross-check. Calibration by 640-AA involves a preamp, power supply, and potentiometric d.c. meter. Nearly a full day's time is required, so this is not done frequently.

For a quick, every-day calibration check, a secondary standard microphone is used that plugs in place of dynamic or ribbon types. This is the SPX-II Standard Ribbon Velocity Microphone (Fig. 4), developed by A.L. Witchey about 1956. It was based on the SPX microphone, which was built about 1936 by L.J. Anderson. At that time, there were no good laboratory condenser microphones. The figure-8 pattern of the velocity microphone discriminates against room reflections which cause "wiggles" on speaker response curves. This frequency results in the curves drawn by the SPX-II being smoother than those obtained with an (omnidirectional) laboratory condenser microphone, in real world imperfect anechoic chambers. With a condenser microphone, you frequently go outdoors to obtain a smooth curve. (The velocity microphone is a better choice for testing speakers and "room equalization" adjustments as its discrimination is not unlike binaural hearing. If you want to hear like an omnidirectional condenser, close one ear!) The SPX-II has flat response to 20,000 Hz on or off axis. The 640-AA, or any one-inch condenser, undergoes a change of about 8 dB at 8000 Hz from 0° to 90°. Thus, SPX-II data requires no response correction.

Proximity effect with the velocity microphones close up to sources of spherical waves is easily corrected by RC rolloff equalizing that matches the curves of Fig. 8. You must be in the far field, which means at least twice the source diameter, so your estimate of distance to (equivalent) point source is accurate. Since our Sound Source (diaphragm) diameter is only 2 inches, the far field begins at 4 inches. This permits measurement of the proximity effect of the microphone under test at realistic close-talking distances.

I have applied the corrections for source, preamp loading, and proximity effect to the sample microphone curve of Fig.



# FISHER INTRODUCES THE WORLD'S FINEST RECEIVER.

This headline from any other manufacturer might sound like just so many words. But, it's by Fisher, the company that started the high fidelity industry back in 1937. And the company who introduced the very first AM/FM stereo receiver 18 years ago.

In a sense, we've been building the RS1080 for 40 years . . . researching, engineering, inventing, and refining our technology to finally develop what is surely the world's finest receiver at any price.

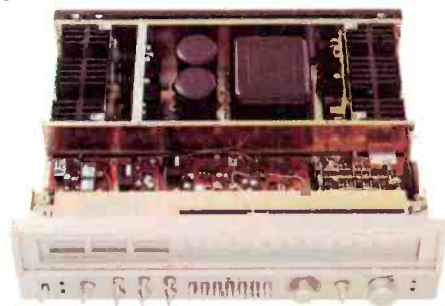

Our RS1080 is rated at an enormous 170 watts per channel, minimum RMS into 8 ohms, from 20 to 20,000Hz with no more than 0.1% total harmonic distortion. There is lots of pure, clean power to give you lots of pure, clean sound at any listening level. But power is only part of why the RS1080 is the world's finest.

**Tuning.** Precise, accurate tuning is a must for FM listening. And the RS1080 includes 3 separate tuning meters: signal strength, center-of-channel, and most

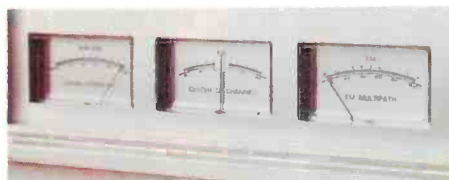

important, a multipath meter with phase-locked-loop circuitry.

**FM Dolby.** For the ultimate FM listening experience, the RS1080 has built-in, factory calibrated FM Dolby decoder circuitry. This feature lets you hear the full dynamic range of Dolby broadcasted music. Another *must* if a receiver is designed to be the world's finest.

Other state-of-the-art features and specifications include 8-gang tuning, 1.7  $\mu$ V FM sensitivity, plus all the front panel controls and rear panel input/output jacks you'll ever need.



**Bass Extender.** A major exclusive feature of the RS1080 not found in any other receiver is our bass extender and bass range level control. At a flip of a control you can boost bass response up to 12dB at either 45 or 80Hz. Electrically tuned circuits assure sharp roll-off characteristics, and a tremendously

noticeable improvement in bass response without muddying-up the mid range or increasing hum or rumble. The result is a truly sensational improvement in sound quality in your listening room with any speaker system.

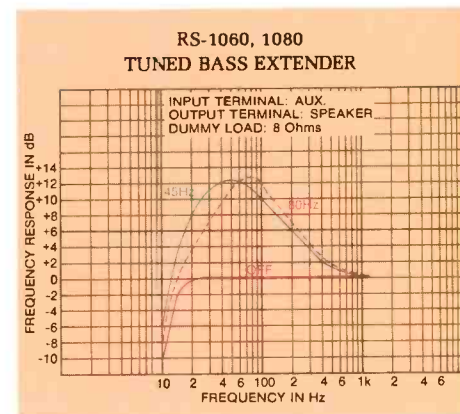

Sure, maybe some late-comer audio manufacturers have good receivers on the market, but at Fisher, we are convinced that our RS1080, priced at \$900\*, is the world's finest. Look at and listen to the Fisher 1080. Available at fine audio stores or department store audio departments.

©1977 Fisher Corporation, 21314 Lassen Street Chatsworth, California 91311



## FISHER

The first name in high fidelity.

6 with the result in Fig. 7. Only the axial response is shown. The (M) response at low frequencies is essentially flat as shown, for plane wave or distant sources. "M" response is intended for (Music) sources more than 2 feet distant. For close up (voice) the V1 and V2 equalizers compensate for proximity effect.

### Directional Pattern

The familiar polar pattern is measured at a single frequency by rotating the microphone and recording on a circular chart. The alternative is to draw frequency response curves at selected angles, such as Fig. 6. This method is easier and emphasizes the importance of uniform frequency response versus angle.

The microphone may be rotated in the horizontal or vertical plane. The horizontal plane is generally selected because of the obvious symmetry of a round diaphragm. The larger the diaphragm, the more high frequency rolloff occurs off-

because no rear lobe has developed to accompany the increased "sharpness" of the frontal pattern. It turns out that this is the so-called "uniaxial" characteristic described in a patent by Dr. H.F. Olson. This characteristic provides more reduction of reverberation or noise than a cardioid or super-cardioid.

Using the same mental process, note how the polar pattern becomes poorer than a cardioid at 3000 Hz. Variation of directional pattern with frequency is undesirable and is often observed at high frequencies. Good discrimination at low frequencies is relatively more important. The sound absorption of rooms usually increases with frequency, so that the undesired reverberation and noise are much more intense at lower frequencies.

### Impedance Test

The very simple test arrangement of Fig. 10 was used for many years at RCA in the manufacture of ribbon microphones. The a.c. current is generally 10 microamperes, which will not harm any type of microphone. The current remains constant so that

$$V = IZ = 10^{-5} Z$$

Voltage is the analog of impedance. When Z equals 1000 ohms, V equals 0.01 volts. If Z is 150 ohms, V is 0.0015 volts. By varying the frequency, the curve of Fig. 7 is obtained. The BK-5B has large magnets, and at low frequencies the exaggerated peak is entirely related to ribbon motional impedance. The curve does not settle down to the nominal 250 ohm value until 5000 Hz! The impedance in this region is attributable to the d.c. resistance of the ribbon (multiplied by a transformer). Before you get upset, recall that microphones should work into unloaded inputs. The "Cal" curve of Fig. 7 shows rather negligible loading even with a mismatch in nominal impedances. This test uses a broadcast preamp, but I obtain equally good results with a Revox recorder and Shure line transformers.

Omnidirectional dynamic microphones generally have a flat impedance curve, and a response doesn't vary with (resistive) loading. A matched load may be used. These remarks also apply to a condenser or any microphone having built-in electronics.

Cardioid dynamics will have an impedance curve similar to the ribbon type, with the resonant peak generally higher in frequency and lower in amplitude. The resonance corresponds to the low acoustical cutoff frequency of either dynamic or ribbon directional microphones.

### Phasing

Correct phasing of microphones is of obvious importance. Phase reversals when using similar microphones generally result from user error. If you mix up types, then you should rely on the manufacturer's data for correct corrections.

All microphones should conform to EIA RS-221 but some do not. The standard does not mention 3-pin XL-type connectors except to require that the plus terminal be marked with a red dot or stripe, but I have never observed this marking on any microphone. The standard also requires the red (or non-black) cable conductor to be a plus, with positive sound pressure.

The test methods suggested in RS-221 are not practical, though I have found the EMT Polarity Tester to be accurate and easy to use. Its operation is shown in Fig. 10. The detector reacts to the polarity of the pulse leading edge.

### Hum Sensitivity

In the 1950s an RCA study of broadcast studios revealed that 1 milligauss was a reasonable number for the flux density

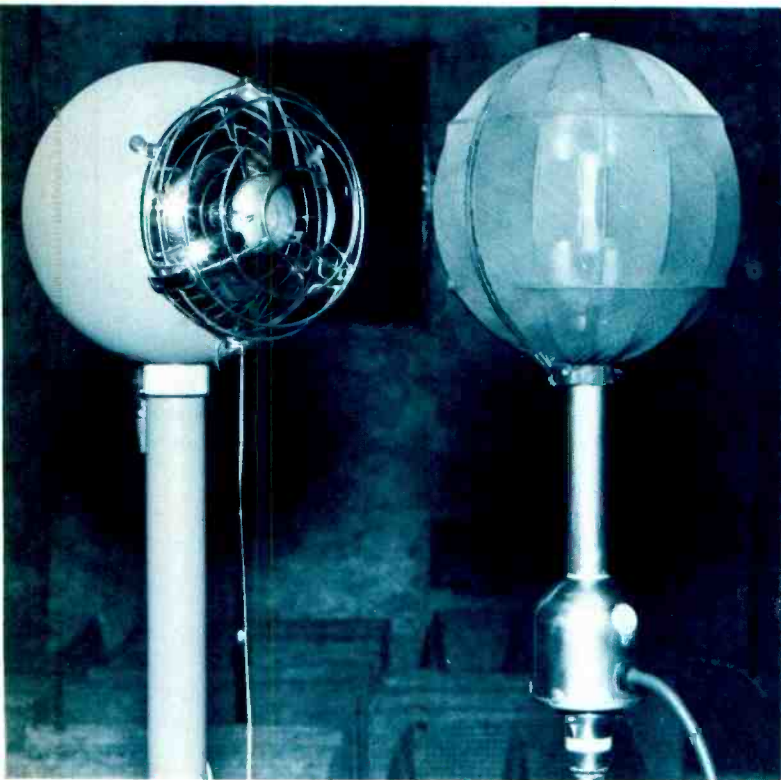

Fig. 4—Small sound source and SPX.

axis. If you have a ribbon 0.060 x 1.0 inch and a 1.0 inch diameter diaphragm, the off-axis response of the ribbon will have much less high frequency loss in the horizontal plane. But in the vertical plane where the "diaphragms" are similar in dimension, each will have a similar loss. Microphones with physical asymmetry should be tested for both horizontal and vertical directivity. The horizontal pattern is, in most applications, more important than the vertical.

We will use the response versus angle test method in all of our tests. It is not too difficult to translate this mentally into a polar pattern. Look at our example in Fig. 6, in the 500 Hz frequency range, the 0° or front response is the reference and through symmetry, is identical to the 270° response. The 180° response is more than 15 dB down, which is a null or zero response for practical purposes. This is a tricky example: Your mental polar pattern is not a cardioid because the 90° response is more than 6 dB down. It is not a super-cardioid



# "'Super' FM tuners are usually priced from \$1000 up. Sansui's new model TU-9900 tuner, at (under) \$450\*, matches (their) performance..., at least in the most important respects".

Julian Hirsch, Hirsch/Houck Laboratories

These are excerpts from the Julian Hirsch test report on Sansui's new Model TU-9900 as it appeared in Popular Electronics, January 1977.

"The Model TU-9900 ... is an ideal mate for the highest quality amplifiers and speaker systems ... [It is] esthetically impressive ... The S/N at 65 dBf (1000 $\mu$ V) was 74 dB in mono and 71.5 dB in stereo while distortion measured an incredible 0.021% and 0.052% respectively. (These figures ... leave no doubt that the tuner has stretched the capabilities of our test equipment to its limits) ... Image rejection was unmeasurable, exceeding the 100 dB range of our test equipment ... Stereo channel separation was almost as unbelievable as the distortion figures, exceeding 60 dB from 60 - 600 Hz ... The alternate

channel selectivity [narrow mode] was unmeasurable (greater than 100 dB) and the adjacent-channel selectivity of 17 dB was one of the best we have ever measured on a tuner ...

"Clearly, the Sansui Model TU-9900 tuner is a very superior performer ... [and] any untoward sounds heard via this tuner originate from the FM station ... In sum, this separate tuner excels in virtually every area of FM performance ... It's a top value unit."

Visit your nearest Sansui franchised dealer today for a demonstration of the TU-9900 or any of the other models in Sansui's impressive line of amplifiers and matched tuners, the AU/TU series.

**A whole new world of beautiful music.**



**Sansui**

**SANSUI ELECTRONICS CORP.**

Woodside, New York 11377 • Gardena, California 90247

SANSUI ELECTRIC CO., LTD., Tokyo, Japan

SANSUI AUDIO EUROPE S.A., Antwerp, Belgium • In Canada: Electronic Distributors

\*Approximate nationally advertised value. The actual retail price will be set by the individual dealer at his option.

Enter No. 26 on Reader Service Card

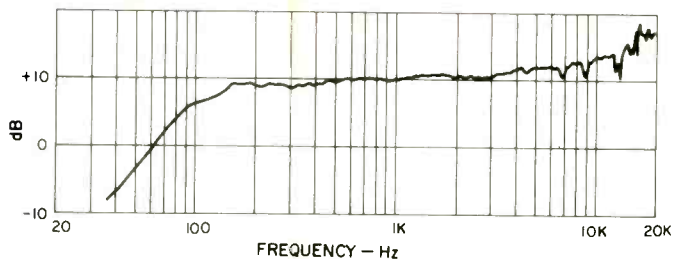

Fig. 5—Calibration of small sound source.

of an ambient 60 Hz magnetic field. Since then, broadcast and professional grade microphones have published Hum Sensitivity Ratings. This rating is the same as Power Sensitivity, except an input of 1 milligauss 60 Hz is specified. The rating should be comparable to the equivalent noise input of the preamp. A low noise preamp would have a rating of -125 to -130 dBm for 15 kHz bandwidth. The microphone thermal noise is on the order of -132 dBm, and studio microphones should have -125 to -135 dBm hum sensitivity. Lavalier or hand-held microphones should be -115 to -120 dBm.

I find that microphones for non-professional applications may not have a rating, so I feel that a quantitative test is a waste of time. I will make subjective comparisons with a microphone I know to be good (BK-5B, -130 dBm), using a hum field of approximately 1 gauss. Any microphone that appears to have high hum will be so indicated. This would be an important consideration only if you plan to use the microphone for distant speech or classical music, or for any application in a high hum field.

### Wind and "Pop" Sensitivity

There is much confusion concerning these phenomena. To begin with, I shall quote Dr. Harry Olson, who said to me

on more than one occasion that "wind sensitivity is proportional to microphone sensitivity." This means that wind sensitivity, with other things equal, is not a function of the type of transducer element. There is subjective appeal in believing that a fragile ribbon, for instance, is more wind sensitive than a plastic diaphragm. Not so! I have observed high wind sensitivity in microphones of all types. Wind sensitivity is related to the performance of the microphone screens, grilles, and case. A good aerodynamic shape, such as a sphere on the end of a cylinder, encourages non-turbulent flow of air which results in low wind noise. I have also encountered a misconception regarding the mode of noise generation, the sound of wind flowing around trees or houses is *not* the noise with which we are concerned. That is ordinary airborne sound. Wind noise is generated at the microphone by a steady or "d.c." flow of air (or at least it was before you introduced the microphone.) "Pop" noise is closely related, but it is noise generated at the microphone by a pulse of air from the talker, usually a "p" sound.

In addition to a good aerodynamic shape, a microphone needs wind protection in the form of layers of cloth or open-cell acoustical foam and the wind screen should be as large as possible. A small diameter foam screen is often as effective as a large cloth covered screen. Objective tests of wind sensitivity are difficult. Usually you must swing the microphone in a circle at the end of a boom. Blowers are not suitable because they are not quiet. I have seen a small, easy to use, "pop" generator at one laboratory, but none of these methods is "standard."

It is quite easy to subjectively rate microphones for "pop" by reciting "Peter Piper picked..." at close range. "Low" noise is evidenced by the non-existence of "pop." "High" noise causes loss of speech intelligibility and is very objectionable. "Medium" is somewhere in between. Although a performance standard is not really needed, I usually refer to the BK-5B as a standard as it has low wind sensitivity and an integral blast filter (which resists gun shots) plus a large accessory windscreen.

### Vibration Sensitivity

Unlike wind noise, vibration sensitivity is primarily related to the mass, and the noise is generated by motion of the case relative to the moving system. A massive diaphragm, such as found in dynamic cardioid microphones, will tend to stand still while the case vibrates, generating high noise. A lightweight ribbon will tend to vibrate with the case, generating low noise.

A secondary mode found in certain microphones involves a bell-like "ringing" of the case or housing. This is generated differently. The vibration case generates airborne sound, which is picked up as ordinary sound by the transducer element. "Ringing" can be quite severe in die cast aluminum housings. In this instance, vibration sensitivity is, like wind noise, proportional to microphone sensitivity. Obviously all types of transducers will pickup the ringing sound equally.

The mass-related or "seismic" type vibration noise can be reduced by cushioning the transducer within the case. The "bell" noise cannot be reduced by cushioning. This noise can be reduced by "detuning," adding mass or stiffness to the case or by adding viscous, damping material to the case. "Detuning" usually involves expensive tooling changes and is rarely considered. Damping is less expensive and is often a by-product of materials such as silicone compounds used to secure transformers or other parts inside the case.

Vibration sensitivity is another peripheral item where objective testing can be complex and no standards exist. I will

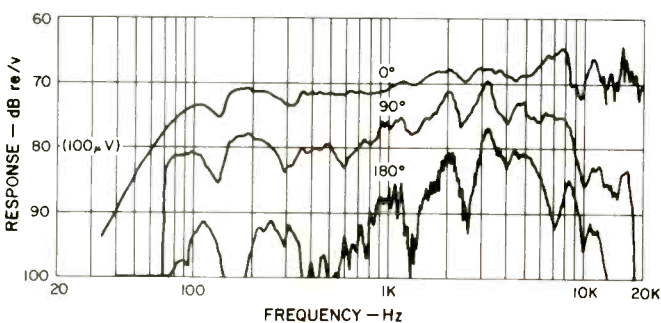

Fig. 6—Chart record of test—BK-5B.

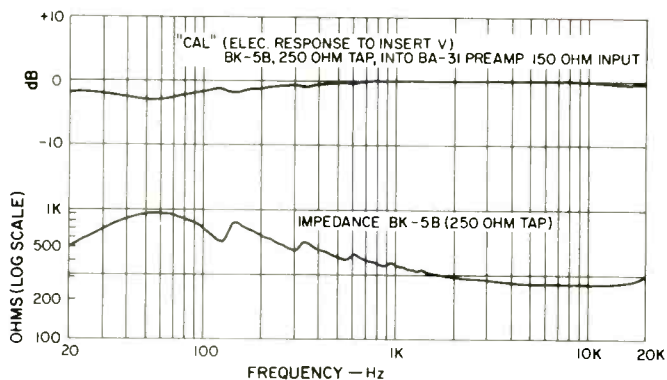
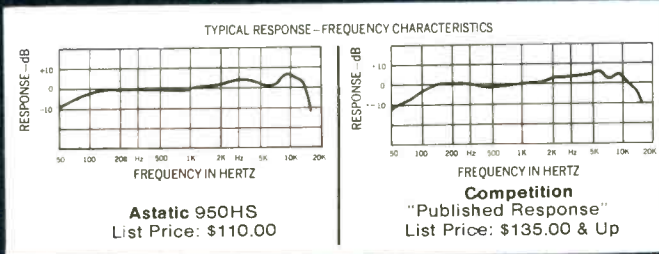

Fig. 7—"Cal" and impedance curves.

# We're the other fine response, high performance microphone.

## The one that costs less!



Now there is another fine response, high performance microphone you can buy at a lower cost! Astatic's Music Mike. . . Professional aesthetics and acoustic characteristics for the most demanding performer. Attractive design with brushed satin chrome finish.

The Music Mike comes in two basic models. One has a contoured response for the discreet listener, providing crisp sound that every artist will appreciate. A second model offers a flat response for the independent entertainer who prefers natural sound. Both cardioid mikes come with high and low impedance versions, each complete with switch and easy-on swivel stand adaptor. Packaging includes a modern plastic carrying case.

Astatic's Music Mike. Why buy any other microphone when quality and style are available now at a lower cost.



- High impedance models **950HS** (Contoured response)  
**952HS** (Flat response)  
List Price \$110.00
- Low impedance models **950LS** (Contoured response)  
**952LS** (Flat response)  
List Price \$100.00



*Imagination in communications*

**THE ASTATIC CORPORATION**

CONNEAUT, OHIO 44030 (216) 593-1111

IN CANADA:

1820 Ellesmere Road, Scarborough, Ontario M1H 2VE, (416) 438-6384

Enter No. 2 on Reader Service Card

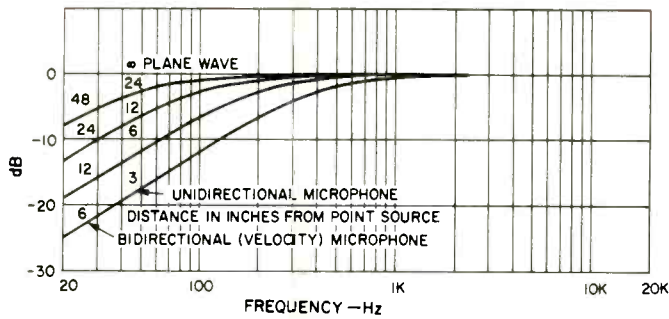

Fig. 8—Inverse of proximity effect.

therefore perform a subjective test, comparing the test unit to the BK-5B as a standard; I have never tested a microphone with lower vibration sensitivity than the BK-5B.

**Distortion**

I recall from studies by Olson that dynamic or ribbon microphones have low distortion levels well up past the overload of any known preamp. The margin is such that a 10 or 20 dB attenuator on the microphone does not change this conclusion. Microphones incorporating electronic amplifiers, such as condensers, have a clipping level that is frequently below preamp overload, depending on gain factors. The only way to generate the required pure tones at 110 to 130 dB SPL is with a resonant pipe. This is not worth the effort, because the voice can generate peaks up to 130 dB at close distance. Peak clipping is easily observed on a scope. Knowing the acoustic sensitivity, the clipping SPL can be calculated. If your application is rock music, then a clipping (peak) level of 130 dB is desirable. For classical music, 120 dB is satisfactory.

**Biomechanics**

This is, I believe, a new term which refers to human factors involved in the physical operation of tools or machines. It is currently being applied as a science by Ingersoll-Rand in design of hand tools, and they have published some results which can be applied to microphone evaluation. These concern the motions and positions of the fingers, hand, wrist, and arms. Microphones that "feel" awkward to use probably violate some of the rules of biomechanics. As an example, the fork mount on our favorite BK-5B microphone is so awkward to use that it will be our standard for "poor" biomechanics. Microphones that are easy to use and have a good "feel factor" will be rated "good." The "fair" rating will apply to others.

Fig. 9—Frequency response of BK-5B.

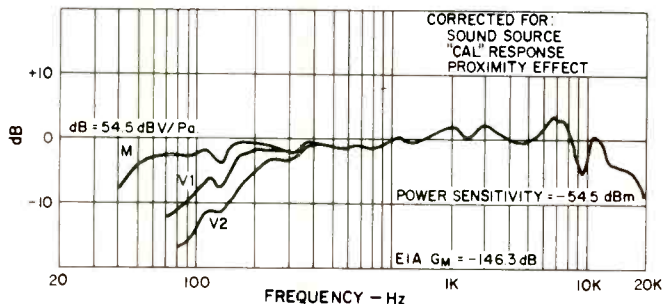

**Listening Test—Audio Quality**

Listening tests of microphones are best performed by making an A-B test, comparing the unit on test to a reference microphone. The reference microphone, theoretically, is an arbitrary choice, but I will choose a high quality unit of similar type that is familiar to me. (A comparison of an omnidirectional to a cardioid type is not valid, for instance.) You may object to my choice of an RCA broadcast microphone, for example. There might be a large difference in price, it is sold primarily to broadcast stations and practically impossible for an audiophile to obtain. However, if I choose a well-known microphone, my experience is that if the test unit is rated poorer than the reference, people will conclude I am "selling" the reference microphone. I can more easily maintain an unbiased posture by choice of a reference that is not generally available to the market. If I always use

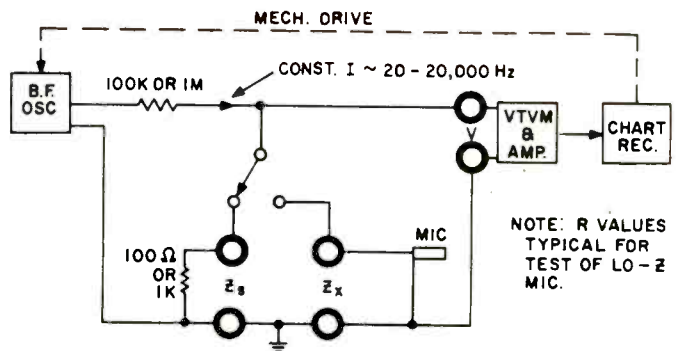
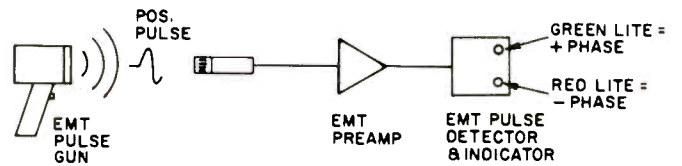

Fig. 10—Impedance and phasing test.



the same reference, the ratings between microphones can be accurately compared, just the same as hum, wind, and vibration ratings.

**Quality and Durability**

This is the most subjective rating. You must rely on my judgment as an expert. The "standards" will be existing samples or mental images of microphones tested in the past. If I suspect fragility, I may drop the microphone or pull on the cord. Ratings of poor, fair, and good will be assigned.

**Conclusion**

I have described how we will test microphones and how to interpret our ratings. Sufficient tutorial material is included to enable the audiophile to sort out the many performance factors and make a more intelligent choice of a microphone for a particular application. The increasing sophistication, cost, and complexity of home audio equipment will result in wider use of professional grade microphones. The user will therefore require more knowledge and technical information about microphones, and we hope that such articles and tests as these will provide such knowledge.

# WOW!

(High Fidelity magazine commenting on the new Ohm C2)

"The sound of the C2 resembles that of a much larger system, in dynamic range as well as bass output... the system does phenomenally well at 80 Hz, reaching 100 dB SPL (Sound Pressure Level) with distortion quite low.

... the low frequency output falls away between 30 and 40 Hz — just where Ohm claims it will.

... Located on a shelf and at least two feet from the corners of the room, the speakers produce a sound that is clear and well detailed — and if you like it that way — loud.

... Surely, all things considered, the design of the Ohm C2 represents a fine achievement... With classical music its performance is adequate with something to spare. And with popular music — wow!"

The Ohm logo consists of the word "Ohm" in a white, sans-serif font, set against a solid blue rectangular background.

Enter No. 16 on Reader Service Card

For a reprint of the entire Ohm review from High Fidelity

(November 1976), write: Ohm Acoustics Corporation, 241 Taaffe Place, Brooklyn, N.Y. 11205

# Equipment profiles

## The Lirpa I, Mark I Hi-Fi Stereo Receiver

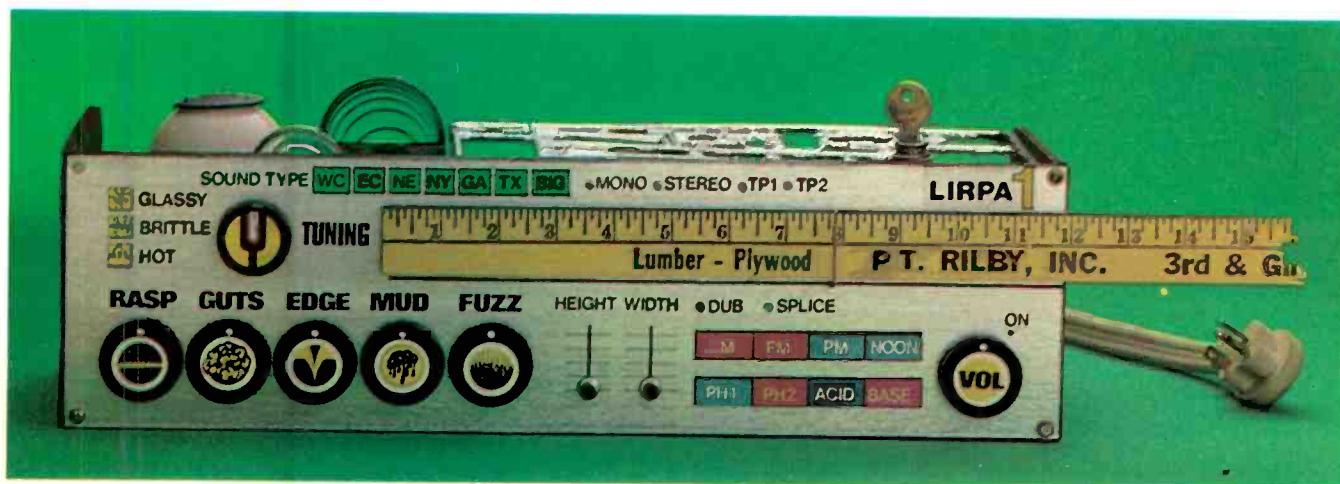

60

### MANUFACTURER'S SPECIFICATIONS

#### Tuner Section

**Usable Sensitivity:** 1.0  $\mu$ V (5.2 dBf) in mono, somewhat poorer in stereo.

**50-dB Quieting Sensitivity:** Variable (depending upon climatic conditions).

**Ultimate S/N Ratio:** Mono, 103 dB (A+B+C+ CCIR weighting); Stereo, considerably noisier.

**THD:** Mono, variable (depending upon setting of fuzz and rasp controls, but generally under 10 per cent.); Stereo, who wants to know?

**AM Suppression:** Infinite, you dummy, this is an FM-only set!

**Stereo Separation:** C. 10 feet (in anechoic chamber).

#### Amplifier Section

**Power output:** 5 FTC watts per channel (100 W measured by the Lirpa ears-only method when coupled to our ribbon-microphone speaker system) into shorted loads, from 800 Hz to 1200 Hz at not really much more than 0.0003 per cent harmonic distortion.

**Hum:** Some.

**Noise:** Depends upon room conversation level.

**Frequency Response:** Flat from -15 Hz (when fed with out-of-phase signals) to -40,000 Hz, within 3 DBFWMVS.

#### General Specifications

**Power Consumption:** 50 watts (less pilot lamp); 150 watts (pilot lamp included).

**Suggested, Nationally Advertised, retail, non-listed, hoped for price (at option of dealer, of course):** Whatever the traffic will bear.

It may seem odd to readers of *Audio* magazine that I have been asked to test and report on a product which I designed myself, but I know of no one more qualified to describe the design features of my Lirpa I receiver, with the possible exception of my two colleagues, Mr. I. M. Toidi—who will represent the East Coast Sound fans—and Mr. U. R. Dennoc who will analyze the performance of the unit from the West Coast and Southern point of view. There is the added advantage too, that since the three samples which we used in this evaluation were prototypes from my lab (which provides, among other things, an averaging effect on results obtained), the factory will have had no opportunity to tweak up the sets for improved performance or unrealizable specifications—if I make myself clear.

Let us examine the front panel of the Lirpa I. As you can see, we have solved the problem of inadequate dial scale length by incorporating an attractive wood-grain finished scale which measures nearly a half yard in length and pro-

jects beyond the right end of the receiver proper. Should the FCC decide in the future to narrow channel width from its present 200 kHz to 100 kHz, 50 kHz, or even 10 kHz, this dial scale is sufficiently extended to permit precise tuning. Furthermore, if, in the future, a TV channel were to be added, displacing the upper end of the FM dial, you need simply cut off the end of the dial with a sharp hack-saw.

As readers are aware, I, as well as several other golden-eared audio experts, have long felt that laboratory measurements on hi-fi equipment are meaningless. After all, if the good Lord had wanted us to measure sounds on instruments, we would all have been born with oscilloscopes where our eyes are and a distortion analyzer somewhere else. Thus, while *Audio* magazine insisted on publishing the specs shown above and while we present some graphs in this report, the real essence of this unique product can be best appreciated only by carefully examining its front panel, its rear panel and—if you will forgive the expression—its

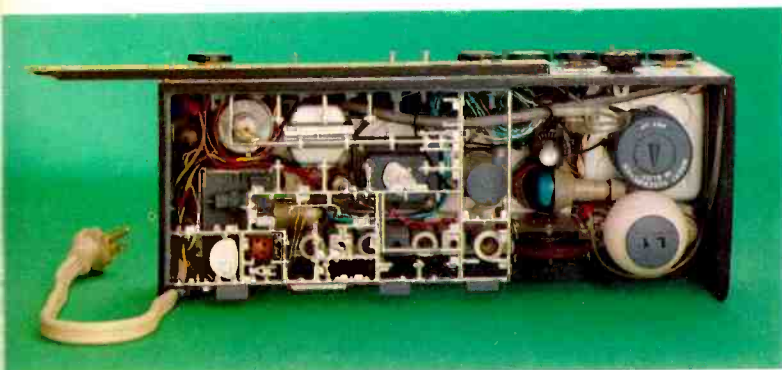

guts! Also, you can listen to the product if you feel that you are as qualified to judge audible performance as I and my associates are.

In any case, at the left of the panel are three push-buttons which may be depressed (singly or together) for glassy, brittle, or hot sound. Depressing all three at once yields a hot-brittle-glassy sound, unless the thermal protection circuit goes first.

Major controls along the left bottom of the panel include rotary knobs which adjust the degree of raspiness, gutsiness, edginess, muddiness, and fuzziness of the reproduced sound. Depending upon the setting of these controls, a series of lights above the left end of the dial scale indicate type of sound achieved. While the abbreviations should be obvious to any true audiophile, for the benefit of the neophytes we must explain that WC is West Coast, EC stands for East Coast, NE is Northeast, and if you haven't figured out the others by now, this product is simply too sophisticated for you. The height and width control slides to the right of the fuzz control are really unrelated to the receiver but are useful if you decide to turn the set off and watch TV instead.

Two rows of push buttons adjacent to the volume control at the lower left take care of all program sources. The spelling of "base" on the lower right—most of these buttons is not a production error. When this button is depressed along with the "acid" button, sound is effectively neutralized. This feature beats the new audio muting controls found on some receivers by a mile.

You may have noticed that although there are several indicator areas on the face of the front panel, none of these is, in fact, illuminated in the photo of the front panel. This is not because the unit was not plugged in. It was, via our heavy duty power cord, but we decided that instead of wasting so many individual pilot lamps to light the indicators, a single, 100 watt bulb would do nicely and would also illuminate the entire listening room to exactly the right intensity for serious listening.

The rear panel is distinguished by its antenna input and its two outputs. Since all good receivers should have at least one control which is non user-adjustable, a small hole in the rear panel is provided for gaining access to this special non-adjustable control.

### Internal Construction and Features

As you can see from the internal view of the Lipra I, a power reservoir is located just in front of the all-in-one pilot lamp. It is designed to permit a powerful flow of all the electrons you will ever need via the coiled tube just to the right. Care should be taken to keep the set in an upright position, however, as electron flow is, in part, regulated by gravity. The coiled spring, just to the right of the row of vacuum tubes, uncoils at predetermined periods and causes a small mallet to strike the side of the nearest adjacent tube. This provides

that well known "tube sound" for which this receiver is gaining an enviable reputation.

The entire front end of the tuner section is free-floating which gives the FM sound that "ethereal" or airy quality. Instead of FETs, we used much more musical FRETs. A specially selected MOSSY-FRET is used in the first stage to provide that soft, green sound so many of us like so much. A block diagram of the entire circuitry is shown in Fig. 1 and should be read from front to back in a downward direction unless you believe the current flows from positive to negative. I had wanted to publish the complete schematic of the receiver, but even if reduced in size for minimum legibility, it would occupy an area of 1270 m by 932 m—a bit too large to fit on these pages.

### Measurement Results

Very good. If, as we said earlier, you insist upon knowing more about laboratory measurements, you may consult Figs. 2, 3, 4, 5 & 6. As for Mr. Toidi, Mr. Dennoc and myself, we prefer at this point to discuss the listenability of the receiver.

### A Word About My Colleagues

As many of you know, my design headquarters are located in the mid-West, while Mr. Toidi's listening rooms are set up just off Route 128, in the Boston area and Mr. Dennoc operates—or rather listens—in Texas. Despite my own predilection for mid-West sound, I have deliberately avoided adding a "graininess" control to this particular product since there is already a surplus of grain where I come from.

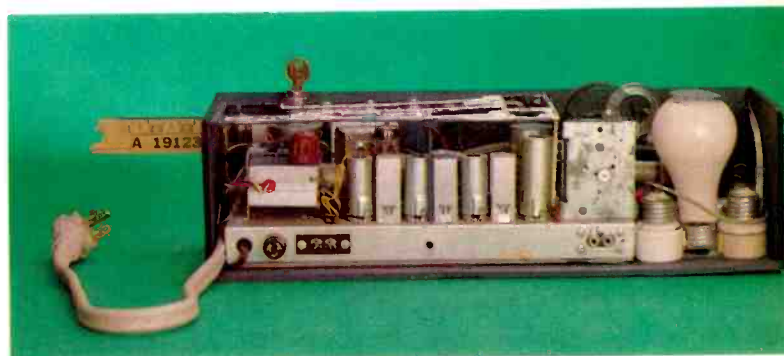

In order to be fair to every product we test, my associates and I seldom talk to each other—as will be evident when you read their comments along with mine. We all use different loudspeaker systems for listening purposes. The dimensions of my listening room are 6 x 4 x 5 x 3 feet so I am necessarily confined to using rather small speakers for all my tests. Mr. Toidi (the last I heard) continues to favor a pair of ultra-high efficiency "Heretic" bi-focal, uni-omni-directional systems in his oversized barn-like listening room which measures 50 x 30 x 83 feet high, while Mr. Dennoc uses headphones primarily, preferring the acoustics of his inner ears, though occasionally he will fire up his Bazoom 4000s from Rabid Audiophile Systems, a highly efficient system capable of 210 dB SPL at 1500 meters with a 0.1 watt input.

First my own listening experiences. All controls were at first set absolutely flat. After a few moments of listening, I discovered that the entire receiver was on an inclined surface and had to compensate the control settings accordingly. The FM section of the Lipra I proved to be more sensitive than I had thought. Stations were received at every 1/16th inch-mark on the dial, but some signals had a definite woody quality to them. After carefully synchronizing the PH 1 and PH 2 inputs, I was able to compare my two favorite

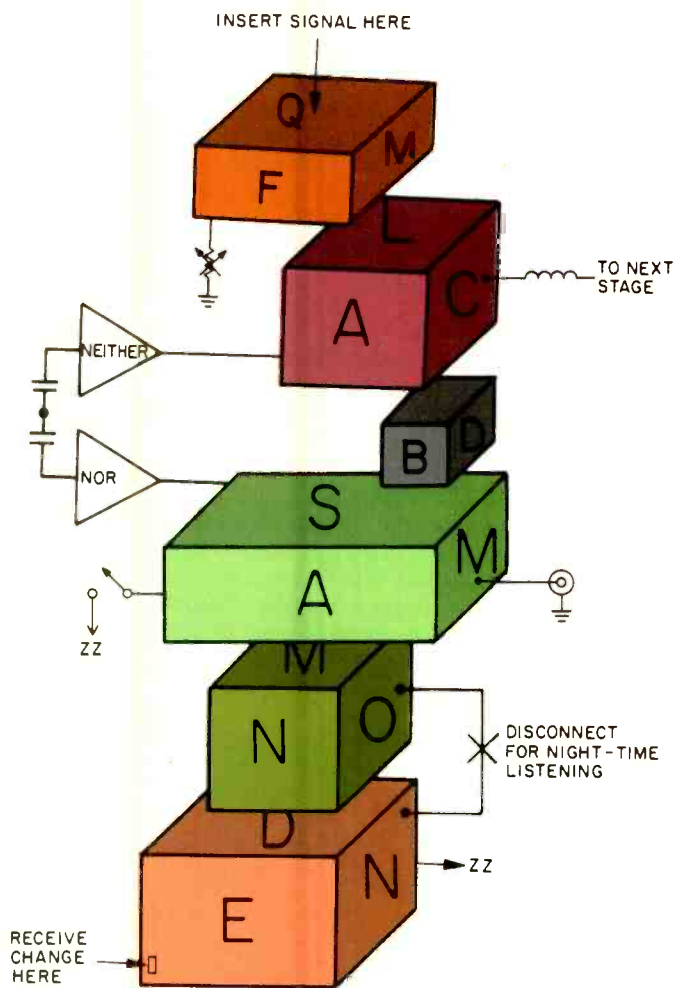

Fig. 1—Complete diagram of the Lirpa I.

cartridges without an A-B switch, since both played the same material simultaneously (at least two identical records are necessary for this test). I must confess that despite my best efforts during the design of this product, I could hear TIM. That is probably because my son (whose full name is Timothy) was just outside the listening room door (he thoroughly enjoys bass below 200 Hz and has no use for treble at all—hence his favored listening position outside the listening room). Best results in my listening room were obtained with the *Guts* control set to a quarter past three, the *Edge* control at MAX and the *Mud* control at three and one half minutes after eight. Only once, during my entire listening tests (which extended well into next month), did the general-purpose light-bulb indicator lamp flicker—as if to warn me that the music I had selected was not suitable for the equipment. (This is a feature about which I have said and can say very little as there are still three patents pending in Outer Mongolia.)

After several glorious hours of enraptured listening, I decided that the *Dub* and *Splice* indicators on the front panel really don't belong there at all but are left over designations from the front panel of an Emcaset tape system I hope to re-

lease next year. (For those interested in the derivation of the word Emcaset, I originally called it a monster-cassette—it uses two inch wide tape travelling at 130 ips and has one audio track and eight control tracks—but I soon abbreviated that to M-Cassette which later became Emcaset.) Anyway, to get back to the listening tests, I can only say, in summation, that the Lirpa I did more for my listening pleasure than even I had expected. Talk about transparency of sound! Suddenly, I could see right through and past the speakers—all the way into my bedroom, in fact, which faces my listening room. Overall frequency response, according to my ears at least, was definitely responsive, while dynamic range was—how shall I say it—very dynamic and certainly very rangy. In conclusion, I would say that the Lirpa I will remain my standard of comparison for all future listening tests—at least until it is superseded by the Lirpa II which is currently in its last design stages.

### Mr. I. M. Toidi Reports

In my opinion, Professor Lirpa has finally done it. While I cannot fully agree with his control settings nor with his impressions regarding the transparency of the sound he heard, nor with the layout of the controls, nor with the placement of the power reservoir, pilot lamp or choice of circuitry, in all other respects I believe he has done an outstanding job. In my view, the tuning knob of the receiver is slightly off-pitch, but this may be due to a Doppler effect because I generally like to run around the room at a fast pace whenever I evaluate a new piece of equipment. I find that doing this helps to integrate the sound or average it in a much better way than would be possible if I used test equipment to measure a thousand or more points in space in the room. In this manner, any standing waves are left standing, since I move too quickly to hear them. Considering the large size of my own listening room, the fact that my antenna faces straight out over the Atlantic and that one of its wires is broken, and taking into the account the fact that one of my speakers is known to have a defective mid-range driver (I have temporarily installed a light-weight Japanese fan in place of its cone and find that air motion at these frequencies is just as smooth and is also devoid of those bothersome ripples), I would say that the sound heard from the Lirpa I, while certainly not definitive in every sense of the word, was totally recognizable as music—and then some. I'm not prepared to make a final judgment at this time, simply because three months is not enough time in which to completely evaluate

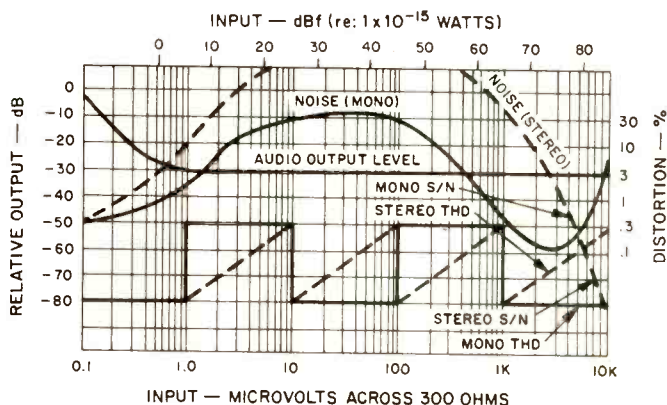

Fig. 2—FM quieting and distortion characteristics.



# Get yourself the big one!



1,757 illustrated pages of detailed audio reference for the working technician... the student... the hi-fi buff!

Here's a comprehensive volume especially designed for the man or woman who has an understanding of electronics and an interest in audio technology.

The Audio Cyclopeda is the most authoritative reference book ever published on this subject. It includes every phase of audio technology—plus the latest information on solid-state and integrated circuits.

**25 informative chapters... convenient format so you find what you're looking for... quickly... easily!**

Each of the big, information-filled chapters covers in depth one of the major areas of audio electronics. You'll find anything you could want to know about everything—amplifiers, acoustics, meters, transformers, coils, transistors, diodes, filters... plus much, much more!

All information is presented in easy-to-understand, question-and-answer format. For "instant find," there's a unique index and reference system so the information you need is always at your fingertips.

Send for this complete reference library today for **\$34<sup>00</sup>** just

## Complete your reference library with this Modern Dictionary of ELECTRONICS!

This handy volume is a convenient way for you to keep abreast of all the latest happenings in the ever-changing field of electronics. *Modern Dictionary of Electronics* gives you clear, concise definitions of 18,500 terms commonly in use today in the fields of communications, microelectronics, fiberoptics, semiconductors, reliability, computers and medical electronics.

It's yours for only **\$14.50**

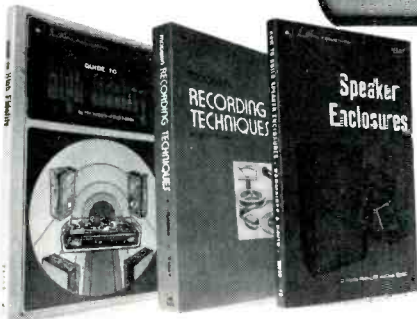
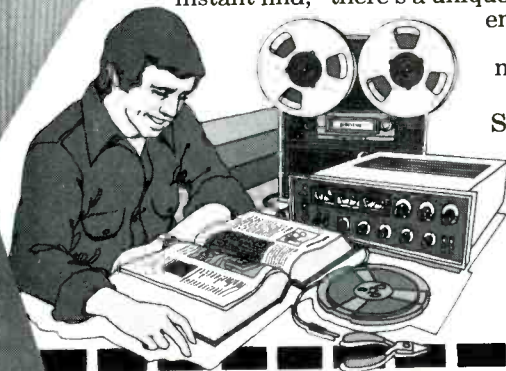
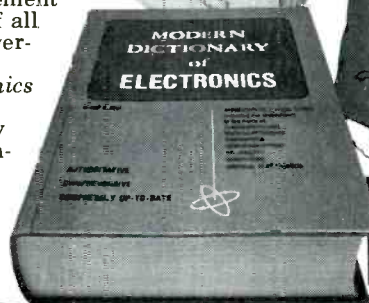

**For more audio information... Take one or more of these handy paperback guides.**

### Guide to High Fidelity

Here's a convenient guide to help you select a hi-fi system that not only meets your needs but fits your budget besides. If you ever plan to invest in any hi-fi equipment at all, this book is a must.

Yours for a low **\$4.50**

### Modern Recording Techniques

Now, whether you're a would-be recording artist or an experienced engineer, you can find out all about the techniques that are being used today in pop recording. Learn how to cut your own records, and how to use equipment and controls creatively.

Just **\$9.95**

### How To Build Speaker Enclosures

Here's *the* book to use if you want to build enclosures that give you realistic sound reproduction. Includes directions for enclosures to fit any application... any price range.

Yours for a low **\$4.50**

107R1

## MAIL TODAY FOR 15-DAY FREE TRIAL

**YES**—send me the book(s) checked below to examine for 15 days free. If not completely satisfied, I may return my order and owe absolutely nothing. Otherwise, I will pay the amount on the invoice accompanying my book(s), including shipping and handling.

- Audio Cyclopeda** (20675) ..... \$34.00
- Modern Dictionary of Electronics** (20852) ..... \$14.50
- Modern Recording Techniques** (21037) . \$9.95
- Guide to High Fidelity** (21154) ..... \$4.50
- How to Build Speaker Enclosures** (20520) ..... \$4.50

Name \_\_\_\_\_ (PLEASE PRINT)

Address \_\_\_\_\_

City \_\_\_\_\_

State \_\_\_\_\_ Zip \_\_\_\_\_

Save shipping and handling costs. Full payment enclosed. (Plus sales tax, if any.)

MAIL TO: Howard W. Sams & Co., Inc., 4300 W. 62nd Street  
Indianapolis, Indiana 46206

CT28

# Onkyo — A step ahead

State-of-the-Art is for everyone else. Onkyo design and construction is for tomorrow. Today.

We don't just claim innovation, quality and value. We prove it when independent test laboratories publish their unbiased reports in your favorite audio magazines.

Of our TX-4500, one test report said, "...one of the finest receivers available today at any price."

Of our TX-2500, another said, "...sounds a good deal better than the data suggest—and better than one has a right to expect at \$300."

If the data don't suggest the total quality, it may be we're too cautious in our claims. But, we have other equipment too new to have been reported on as yet. All are built to the same exacting standards, featuring exclusive Onkyo advances. We'll try to be a bit less modest as we tell about:

**Quartz-Locked Tuning**—This is the tuning system of which the most famous testing lab said, "...a new system that completely eliminates tuning errors in FM reception." This is done by using a quartz crystal oscillator which takes advantage of the unique capability of precisely ground quartz to maintain a fixed frequency.

The Quartz-Locked circuitry compares the tuner's IF frequency with the frequency generated in the Quartz-Locked oscillator, continually compensating for frequency differences that would cause distortion or poor reception, and additionally compensating the FM tuning meter at the same time.

**Servo-Locked Tuning**—An economy version of the Quartz-Locked system with similar characteristics in a different configuration. While essentially an automatic frequency control circuit, Servo-Lock is more sophisticated in design and performance and in actual lab tests has held stations for at least 24 hours without perceptible drift.

## Quartz-Locked AM/FM Stereo Receiver

**TX-8500**—Power output 110 watts per channel, minimum RMS at 8 ohms, both channels driven from 20 Hz to 20 kHz with no more than 0.1% Total Harmonic Distortion.

Direct coupled differential pure complementary main amplifier with ultra wide frequency response, 2 Hz to 60 kHz  $\pm$  1 dB at main amp. Total Harmonic Distortion less than 0.1% at rated output; 0.08% at 1 watt output. Rated FM sensitivity 1.7  $\mu$ V (mono), 4  $\mu$ V (stereo). 50 dB quieting sensitivity 3  $\mu$ V (mono), 35  $\mu$ V (stereo). Image rejection ratio 83 dB; alternate channel selectivity 70 dB; IF reject on ratio 100 dB. S/N ratio 70 dB (mono), 65 dB (stereo).

**TX-4500**—Power output 55 watts per channel, minimum RMS at 8 ohms, both channels driven from 20 Hz to 20 kHz with no more than 0.1% Total Harmonic Distortion.

Direct coupled differential complementary main amplifier with ultra wide frequency response, 2 Hz to 80 kHz  $\pm$  1 dB at main amp. Rated FM sensitivity 1.8  $\mu$ V (stereo). Image rejection and alternate channel selectivity 70 dB. IM distortion 0.3% at rated power; 0.1% at 1 watt output.

## Servo-Locked AM/FM Stereo Receivers

**TX-2500**—Power output 27 watts per channel, minimum RMS at 8 ohms, both channels driven from 40 Hz to 20 kHz with no more than 0.5% Total Harmonic Distortion.

Direct coupled differential main amplifier with frequency response of 2 Hz to 60 kHz  $\pm$  1 dB. Total Harmonic Distortion no more than 0.5% at rated output; 0.2% at 1 watt output. IM distortion 0.5% at rated power; 0.3% at 1 watt output. Usable sensitivity in FM, 2  $\mu$ V (mono), 5  $\mu$ V (stereo). Image rejection 45 dB; alternate channel attenuation 60 dB; S/N 65 dB (mono), 60 dB (stereo). IF rejection 80 dB.

**TX-1500**—Power output 15 watts per channel, minimum RMS at 8 ohms, both channels driven from 20 Hz to 20 kHz with no more than 0.5% Total Harmonic Distortion.

Direct coupled differential amplifier with overall frequency response 20 Hz to 20 kHz  $\pm$  1 dB. Total Harmonic Distortion no more than 0.5% at rated power; no more than 0.3% at 1 watt output. Usable FM sensitivity 2.3  $\mu$ V (mono), 5  $\mu$ V (stereo). 50 dB quieting sensitivity 4.5  $\mu$ V (mono), 50  $\mu$ V (stereo). S/N ratio 65 dB (mono), 60 dB (stereo). IF rejection 80 dB. Alternate channel attenuation 60 dB.

All of Onkyo's receivers feature multiple speaker outputs as well as multiple tape inputs and outputs including tape to tape dubbing. All are built to specification which often exceed their price ranges with special features, including Phase Locked Loop Mu tiplex.

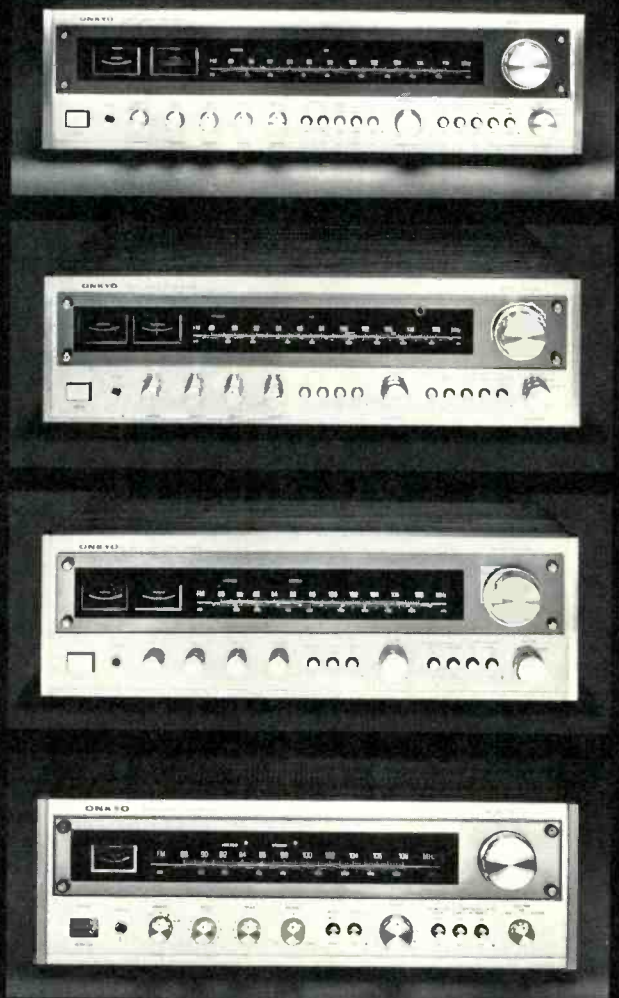

# of State-of-the-Art.

## Quartz-Locked AM/FM Stereo Tuner

For those who are satisfied with their present amplifier but want the distinct benefits of Quartz-Locked tuning, Onkyo offers the T-9, the only component tuner in the world that has Quartz-Lock.

In addition to the precision tuning capabilities of the T-9, it features a dual gate MOSFET/gang-variable capacitor front end with usable sensitivity  $1.7 \mu V$ , 50 dB quieting sensitivity of  $3 \mu V$ , 83 dB image rejection and 73 dB S/N in stereo.

The T-9 uses Phase Locked Loop Multiplex for low distortion, high separation stereo reception. At 1 kHz, stereo separation is 40 dB; at 100-10,000 Hz, separation is 35 dB.

Assuring continuous drift-free tuning, the FM oscillator circuitry is hermetically sealed to prevent environmental influence on the components.

Other specifications include an IF rejection ratio of 100 dB and AM suppression ratio of 50 dB. In addition to Quartz-Locked tuning and exceptional performance characteristics, the Onkyo T-9 provides a special feature for tape recording directly from the tuner.

Known as the Tape Recording Level Check Switch, activation injects a 440 Hz tone to set recording level through the tape deck. Modulation of the incoming FM signal is reduced to 50%, preventing overloading and distortion. Onkyo's T-9 provides some of the cleanest tape recording possible.



## Solid State Integrated Amplifiers

Having the only Quartz-Locked Tuner in captivity, Onkyo felt the need to provide amplifiers capable of delivering the same quality. There are at present, two amplifiers in this series... A-5 and A-7. Both have been designed for their power handling quality, featuring reserve power for optimum sound reproduction with absolute minimum distortion.

Because of this basic, very low distortion design, these amplifiers require exceptionally muscular and stable power supplies with more power than needed for normal operation, and a lot available when needed for peak demands. These needs are met through massive transformers and oversized electrolytic capacitors. Thus, an extremely stable power supply is assured for hours of continuous operation. Further, specially selected power transistors are mounted in oversized heat sinks and the entire unit is enclosed in a more than ample cabinet which allows for the flow of cooling air.

A final Onkyo touch for clear, clear highs and deep-down lows is design approach and construction that approaches the theoretical zero point in equivalent series resistance (ESR). Through circuitry which uses copper plates instead of wires called the bus feeder ground system and unusually heavy gauge wiring to the power transformer the overall frequency response is greatly enhanced. Because of these and other considerations the following ratings are established conservatively:

**A-5**—Power output of 45 watts per channel, minimum RMS into 8 ohms, both channels driven, from 20 Hz to 20 kHz with no more than 0.1% Total Harmonic Distortion.

Onkyo avoids the primary distortion found in solid state amplifiers with Class A, push-pull driver stage differential direct coupled, pure complementary circuitry. The A-5 delivers exceptional frequency response of 2 Hz to 70 kHz  $\pm 1$  dB, with system square wave response showing less than 5% tilt at 50 Hz. S/N ratio is extraordinary at 110 dB (IHF A Network).

Features include two Phono inputs and two tape monitors and dubbing, as well as tone controls and defeat, muting and a subsonic filter plus transient killer circuitry.

**A-7**—Power output 35 watts per channel, minimum RMS at 8 ohms, both channels driven, from 20 Hz to 20 kHz, with no more than 0.1% Total Harmonic Distortion.

Onkyo's A-7 integrated amplifier also uses a Class A driver stage differential direct-coupled pure complementary circuitry. The A-7 frequency response is 2 Hz to 80 kHz  $\pm 1$  dB with square wave response showing less than 5% tilt at 50 Hz. At no point does the A-7 exceed 0.1% Total Harmonic Distortion at rated power, and at 1 watt output, Total Harmonic Distortion is as low as 0.08%.

In the amplifier section, the phono equalizers are based on Class A, differential push-pull circuitry with exceptionally low noise characteristics. e.g., the A-7 shows an impressive S/N ratio of 110 dB.

A number of special features are included, such as a subsonic filter and a high frequency filter as well as transient killer circuitry. Stepped tone controls are provided with two turnover frequency switches and tone control defeat. Phono overload is exceptional at 230 mV RMS at 1 kHz, 0.1% Total Harmonic Distortion, and the RIAA Curve Deviation of  $\pm 2$  dB, 30 Hz to 15 kHz produces superb reproduction of your records.

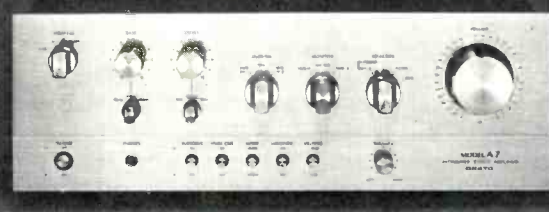
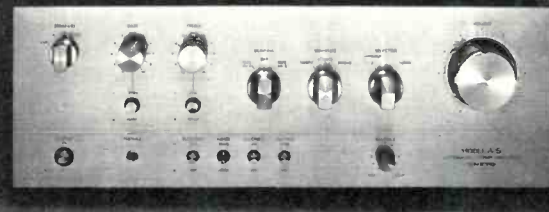

## What does it all mean?

You've read a lot of our claims—understated though they may be—and some of the claims made for us. But the best test is still your own ears. And the only way to use them is at your local Onkyo dealer. If you want more information, including reprints of independent test reports... or the name of your nearest Onkyo dealer, drop us a line. After all, a thirteen cents stamp is a lot better than guesswork.

Artistry in Sound **ONKYO**

Eastern Office: 42-27 20th Ave., Long Island City, N.Y. 11105, 212 728-4639 Midwest Office: 935 Sivert Drive, Wood Dale, Ill. 60191, 312 595-2970  
Canada: Sole Distributor, Tri-Tel Associates Ltd., Willowdale, Ontario M2H 2S5

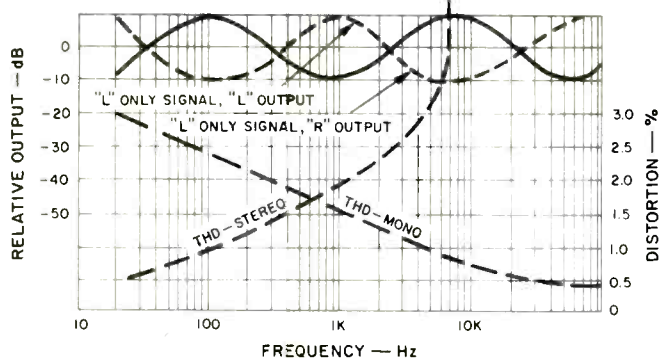

Fig. 3—Separation and distortion vs. frequency.

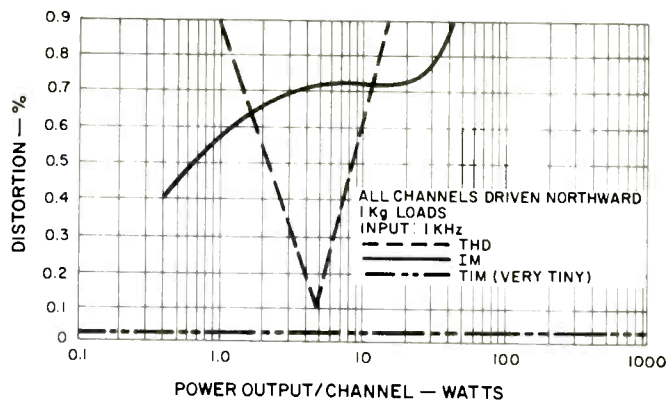

Fig. 5—Distortion vs. frequency.

a set of this complexity. I shall have further comments to make in a future issue. In the meantime—keep wondering!

### Mr. U. R. Dennoc Reports

I basically had one problem with the unit. Since I prefer to do all my listening via headphones, I was at a loss here because I could not find a stereo headphone jack on the front panel. Only after carefully reading the owner's manual (still in rough draft form) did I realize that the phones must be connected to the speaker output jacks. MY INITIAL REACTION THEN, IS THAT THE SET PLAYS TOO LOUDLY!!!! But then, as one leading manufacturer in our beloved industry has proclaimed for years, "Loud Is Beautiful—If It's Clean"—and goodness knows, the Lirpa I was as clean as any set I've owned. One could still detect the brush marks where final testers had cleaned away the last fragments of loose solder. That's what I call clean. From an aesthetic point of view, the set is flawless. Consider, for a moment, what the designation on the master volume control says when you view it in a mirror. It says LOV, that's what it says—and it's clear that Lirpa has put all the LOV and CAR and other good things into this design, consistent with its suggested, nationally advertised, retail, non-listed, hoped for price. One could not ask for more!

**EDITOR'S NOTE:** In the interest of fairness, we permitted the designer of the Lirpa I to have the last word by replying to the comments of his colleagues after he had an opportunity to read their remarks. His final comments follow:

"It is obvious that both Mr. Toidi and Mr. Dennoc had something wrong with their associated equipment when they tested the Lirpa I. While I respect their views, I suggest that they borrow another pair of sets from me or, better still, purchase a pair from their nearest dealers so that there can be no doubt about anything—and repeat their listening tests. In fact, it would probably be a good idea if Toidi would fly down to Texas and listen in Dennoc's room while Dennoc travels East and does the same at our Boston location. If after they have repeated their tests they still come to the same conclusions, it is my intention to place an ad in the classified section of one of the hi-fi magazines (perhaps even *Audio*, if I can get a good rate) which will read about as follows:

"WANTED: AUDIO TESTERS TO EVALUATE NEW HI-FI PRODUCTS. NO TEST EQUIPMENT REQUIRED. ONLY GOLDEN-EARED APPLICANTS NEED APPLY BUT WILL CONSIDER SILVER-EARED APPLICANTS IF THEY OWN THEIR OWN SPEAKERS AND TURNTABLE. REPLY TO I. LIRPA, P.O.B. 10-4, LAKE CLIFF, NEBRASKA." Prof. I. Lirpa

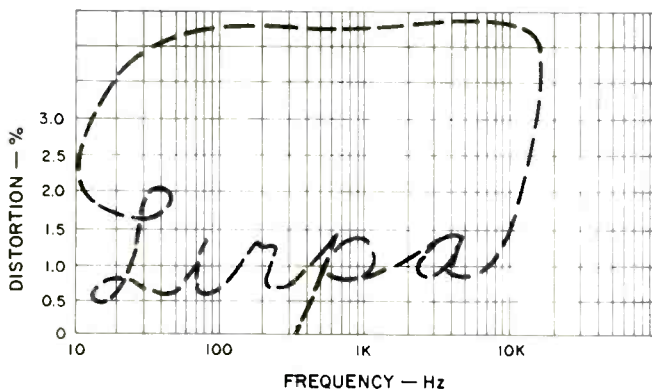

Fig. 4—Harmonic and intermodulation distortion characteristics.

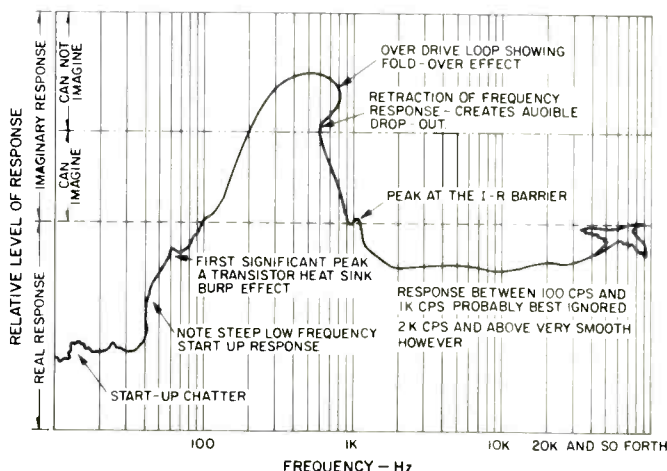
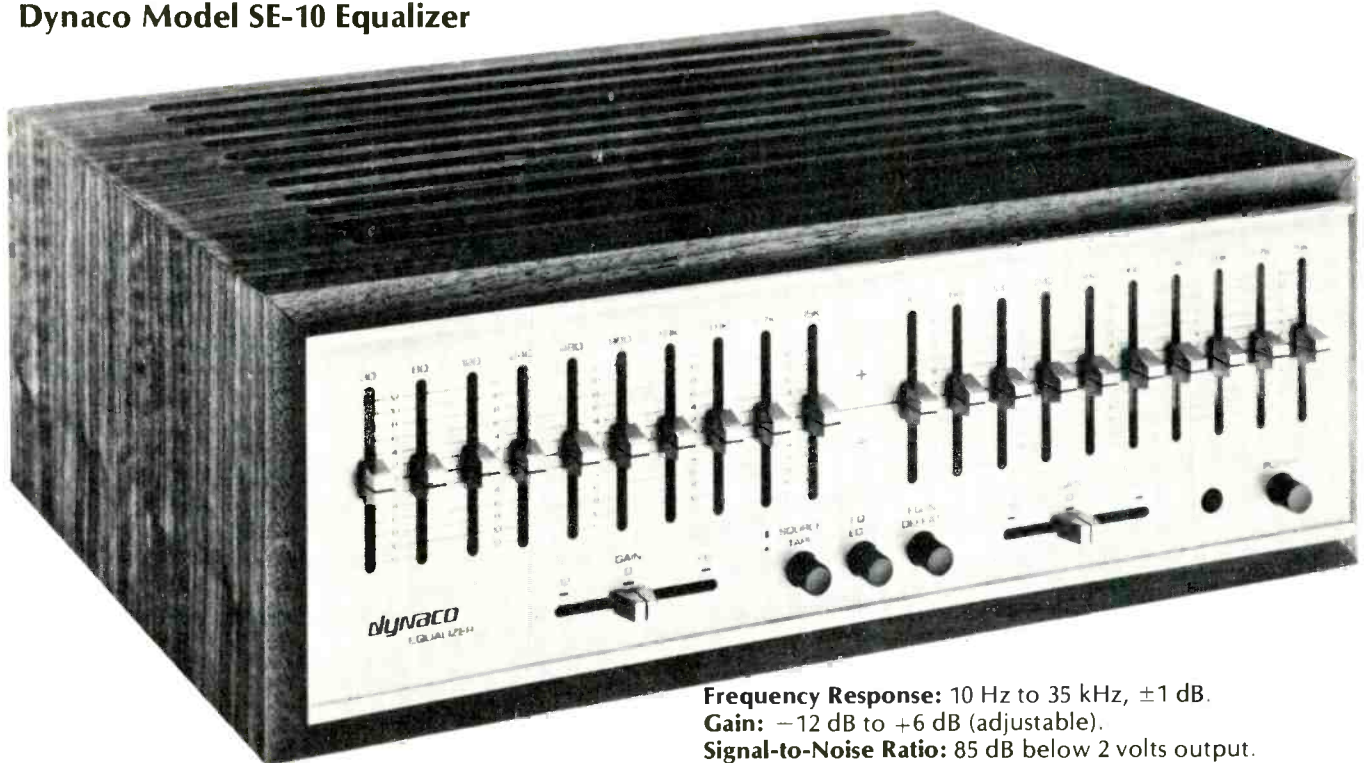

Fig. 6—Real and imaginary response vs. frequency. Measurement by NLK Electronics, Santa Barbara.

## Dynaco Model SE-10 Equalizer



### MANUFACTURER'S SPECIFICATIONS

**Nominal Rated Output:** 2.0 volts.

**Maximum Output:** 8.0 volts.

**Equalizer Range:**  $\pm 12$  dB at octave intervals, 30 Hz to 15 kHz.

**Total Harmonic Distortion:** 0.04 per cent.

**Intermodulation Distortion:** 0.02 per cent.

**Frequency Response:** 10 Hz to 35 kHz,  $\pm 1$  dB.

**Gain:**  $-12$  dB to  $+6$  dB (adjustable).

**Signal-to-Noise Ratio:** 85 dB below 2 volts output.

**Output Impedance:** 600 ohms.

**Input Impedance:** 50 kilohms.

**Dimensions:**  $13\frac{1}{2}$  in. (34.3 cm) W x  $4\frac{1}{4}$  in. (10.8 cm) H x 11 in. (27.9 cm) D.

**Weight:** 10 lbs. (4.536 kg).

**Price:** \$349.00 (249.00 in kit form).

The graphic or octave equalizer seems destined to become as important a high fidelity component as bass and treble controls or high and low cut filters. One would have thought that every facet of the audio equalizer had been explored by now, but, surprisingly, Dynaco has come up with a 10-octave equalizer that boasts a few features not normally found on similar products. Like so many other Dynaco products, the SE-10 is available either in kit form or fully wired, and, judging by the finished product we tested and evaluated, the \$100.00 incremental difference between the wired and unwired versions does not seem out of line. Furthermore, as is true of just about every Dynaco product we have examined in the past, if you elect to wire the unit yourself from a kit, your chances of coming up with a working unit that meets or exceeds specifications are very good indeed. Wiring and assembly instructions are excellently written, and the now well-established step-by-step kit building techniques which Dynaco and Heath have developed over the years can be followed by just about anyone who can wield a pencil-tip soldering iron.

As for the finished product itself, it resembles a great many other equalizers, in that the most outstanding elements on the front panel are the 20 slide controls (10 for each stereo channel) spread across the face of the panel. Nominal center frequencies listed atop each slide control are 30 Hz, 60 Hz, 120 Hz, 240 Hz, 480 Hz, 960 Hz, 1.9 kHz, 3.8 kHz, 7.7 kHz, and 15 kHz. The slide controls are smooth-operating, and each slider pair is separately calibrated from  $-12$  to  $+12$  with "0" corresponding to the flat response position of that control. Click-stop center positions for each slider are not provided, making it a bit difficult to establish exact center of motion unless you face the control head-on.

Beneath each bank of 10 controls is a horizontally mounted overall gain control for that channel which varies gain of the system from  $-12$  dB (with respect to input level) to  $+6$  dB. A "0" notation near the center of each gain control's range indicated the setting for unity gain. Three push-buttons located at the lower center of the panel handle tape/source selection (equivalent to having an additional tape monitor position in your system), equalization/defeat (whereby equalized reproduction can be instantly compared with unequalized program source sounds), and *Line 1/Line 2* selection. With this last switch set to the *Line 1* setting, normal operation of the equalizer takes place. But, in addition, an independent line 2 input/output stereo pair is available for equalizing a second program. Thus, without plugging and unplugging cables, you can switch either of two sources through the equalizer and one of them can be equalized *prior* to recording onto your tape deck.

A power *On/Off* switch and an a.c. power-on indicator lamp are located at the lower right corner of the front panel.

The rear panel of the Dynaco equalizer contains six pairs of input and output jacks. The three input pairs include tape in, line 1 in and line 2 in, while output pairs include tape out, line 2 out and line 1 out. Two a.c. outlets (one switched, the other unswitched) are also located on the rear panel.

### Internal Construction and Circuitry

All of the audio components and power supply components, with the exception of the power transformer, are contained on a single large p.c. board. A total of eight integrated circuits, plus four transistors provide an IC-regulated power supply, independent channel gain control over an 18

## SONUS Blue Label Phono Cartridge

### MANUFACTURER'S SPECIFICATIONS

**Frequency Response:** 5 Hz to 20 kHz  $\pm 1.5$  dB.

**Voltage Output at 1 kHz/cm/sec:** 0.8 mV  $\pm 2$  dB.

**Compliance:** 50cms/dyne  $\times 10^{-6}$ .

**Stylus Force Range:** 0.75 to 1.25 grams.

**Vertical Tracking Angle:** 20 degrees nominal.

**Channel Balance:** 2 dB.



**Nominal Channel Separation at 1 kHz:** 30 dB.

**Recommended Load Impedance per Channel:** 47 kilohms resistance in parallel with not more than 400 pF. When used for CD-4, capacitance should not exceed 250 pF.

**Cartridge Weight:** 5 1/2 grams.

**Price:** \$125.00; replacement stylus, \$62.00.

The SONUS cartridge is available in three models, the Blue Label, tested here, with a multi-radial stylus; the Red Label, with a elliptical (bi-radial) stylus, and the Green Label with a spherical stylus. The choice of stylus determines the model since all three models utilize a common cartridge body. Our review is restricted to the Blue Label cartridge with the multi-radial stylus, which incidently is capable of playing Quadradisc records.

When we first listened to this cartridge, we were impressed by the sound emanating from our speakers; this obviously wasn't an average cartridge. During the 10 hours of listening we normally do prior to measuring a cartridge, we became acutely aware of the fact that this was an exceptionally good cartridge. Continued listening convinced us that Peter E. Pritchard has indeed developed a cartridge that is superior to all his previous designs.

The SONUS Blue Label certainly ranks among the best cartridges we have tested for stereo, SQ, QS, CD-4, and UD-4. The audiophile in search of a cartridge to play all types of recording formats should seriously consider the SONUS Blue Label cartridge for this purpose.

### Measurements

The manufacturer's specifications recommend an input impedance of 47 kohms per channel, paralleled by no more than 400 pF, and for CD-4 use no more than 250 pF capacitance. We made all of our measurements using a 100-kohm load and less than 100 pF capacitance, since the Sonus Blue Label is meant to be used for reproducing CD-4 records. Because CD-4 demodulators have a 100-kohm load resistor in each magnetic phono input channel and their recommended phono cable input capacitance is less than 100 pF, it appeared most appropriate to make measurements under the

actual loading conditions present at the demodulator. The maker informs us his measurements were made with a 47-kohm load, since they feel most set ups will have such a load with only CD-4 requiring the 100-kohm load. The measured response should then be flatter above 10 kHz, though beginning to rise slowly.

The frequency response of the cartridge, using the B & K QR-2009 test record, is  $\pm 1.5$  dB from 20 Hz to about 13 kHz and +6.25 dB at 20 kHz at an optimum tracking force of 1.25 grams and anti-skating at 2 grams. Separation generally averages 20 dB through 14 kHz and 18.5 dB at 20 kHz. Checking the frequency response above 20 kHz with the JVC TRS-1005 test record, the cartridge has a peak of +7 dB at approximately 28 kHz and then drops to +5 dB at 30 kHz and -5 dB at 40 kHz. Separation at these high frequencies is excellent, e.g. 19 dB at about 28 kHz, 18 dB at 30 kHz, and 15 dB at 40 kHz. From these data, one can conclude that the cartridge has an excellent frequency response and separation for stereo, matrixed four channel, as well as discrete quadraphony. This proved to be the case, especially for discrete quadraphony where we encountered no difficulty in locking the cartridge to either a CD-4 or UD-4 demodulator.

Although the square-wave response at 1 kHz shows a fair amount of ringing present, the frequency of the undamped peak in the carrier range is beyond hearing. Using the Audio-Technica AT-1009 arm, the cartridge-arm low frequency resonance was less the 10 Hz.

As is our practice, measurements are made on both channels, but only the left channel is reported. During the test period the average temperature was 70°F  $\pm 1^\circ$  (21°C) and the relative humidity 61 per cent  $\pm 3$  per cent.

The following adjustment and test records were used in making the reported measurements: Technics MA-4009; Micro-Acoustics TT2002; Shure TTR-103, TTR-109, TTR-110; Columbia STR-100, STR-112, SQT-1100; JVC TRS-1004, TRS-1005; Stereo Review SR-12; B & K QR-2009; Deutsches Hi Fi No. 2; Denon (UD-4) ST-5003; Ovation OVQS/4000, and Nippon Columbia Audio Technical Records (Pulse Code Modulation) XL-7004-6.

Wt. 5.52 g; d.c. res. 214.7 ohms; ind. 145 mH; opt. tracking force, 1.25 g; opt. anti-skating force, 2 g; output, 0.875 mV/1 cm/sec; IM dist. (4:1) + 9 dB lateral, 200/4000: 1.2% = + 6 dB vertical, 200/4000: 4.2%; crosstalk, -28 dB; ch. bal., 0.25 dB; trackability: high freq. (10.8 kHz pulsed), 24 cm/sec; mid-freq. (1000 + 1500 Hz lat. cut), 25 cm/sec; low freq. (400 + 4000 Hz lat. cut), 19 cm/sec; 30 kHz mono signal, 2.2 mV; Deutsches Hi Fi No. 2: 300 Hz test bands tracked to 67 microns (.0067 cm) horizontal and 20.6 microns (.00206 cm) vertical; passed all bands of the Shure TTR-110 (Era III) test

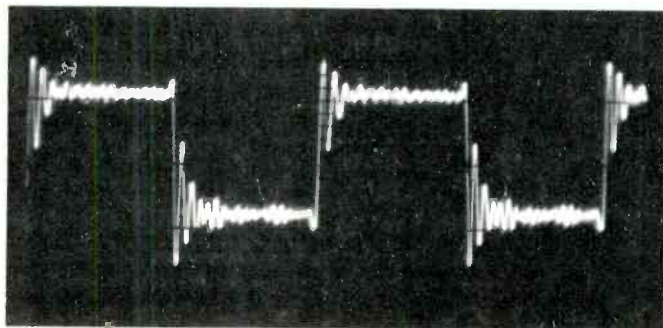

Fig. 1—1 kHz square wave response of the SONUS Blue Label.

record; tracks warped records without difficulty. Passed all bands of the Micro-Acoustics Transient and Tracking test record.

### Listening Evaluation

Since one does not listen to laboratory measurements, it is important to perform a cartridge listening evaluation by listening to a wide variety of recordings over a reasonable length of time. While listening to the various records played with the SONUS Blue Label cartridge, we noted the fine definition of the individual instruments, good sonic clarity, excellent transient response and applause definition, superb bass response, and a tracing and tracking ability which was exceptionally good. All this in spite of the odd rise from about 10 kHz to about 28 kHz in the frequency response curve. It shows that there are factors in phonograph record reproduction which we do not yet understand.

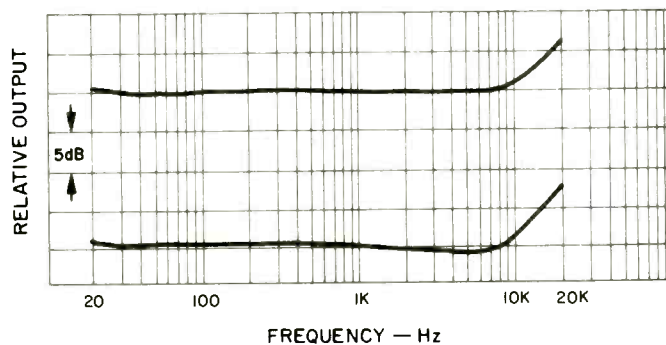

Fig. 2—Amplitude-frequency response and separation from 20 Hz to 20 kHz using B&K QR-2009.

As is the case with numerous records today, many of those we used in our listening evaluation exhibited various degrees of warpage. Particularly annoying is the prevalence of dish warpage. Others have such noisy surfaces that they are difficult to use in a listening evaluation. The problem isn't only of domestic origin since we find many of the foreign labels to be plagued by the same problems. We wonder if the time will ever come when the majority of records will be available without warp and with quiet surfaces.

The following equipment was used for the listening evaluation: Technics SP-10 turntable, Audio-Technica AT-1009 tone arm, two Phase Linear 4000 preamplifiers, Crown DC-300A amplifier for the front channels and Crown D-150 amplifier for the rear channels, two Duntech DL-15B speakers for the front channels and two Cerwin-Vega 211 (R) speakers for the rear channels, and two Janis Audio Associates W-1 subwoofers along with a Crown VFX-2 crossover network. The matrix quadraphonic decoders used were the Lafayette SQ-W, the Sansui QSD-1, and the SQ and QS positions of the Denon UDA-100. The CD-4 demodulator was the Technics SH-400 and the UD-4 demodulator was the Denon UDA-100.

As is our practice, a rigorous listening evaluation was conducted utilizing the records listed in our reports in *Audio*, September 1975, November 1975, and January 1976 and the following excellent recordings which demonstrate quite effectively the ability of the SONUS Blue Label cartridge to reproduce difficult recordings faithfully. All records were cleaned with the Keith Monks Record Cleaning Machine

and/or the Discwasher and destaticized with the Zerostat. Although we list records in the various quadraphonic formats, all of them are compatible and may be played without exception as stereo recordings.

### Stereo

Michael Murray: *Dupré—Organ Recital*; Advent Records 5014

Stravinsky: *The Rite of Spring*—Vienna Philharmonic Orchestra; Maazel, London CS6954

Handel: *Overtures and Sinfonias*; London CSA 2247

Stanely Clarke: *Journey to Love*; Nempor Records NE 433

*Earthquake: Special Sound Effects*; MCA-2081

*Percussion Music*; Nonesuch H-71291

*Virgil Fox Plays the Classics—Heavy to Light*; Angel S-36052

Orff: *Carmina Burana*; Royal Philharmonic Orchestra, Dorati, London SPC 21153

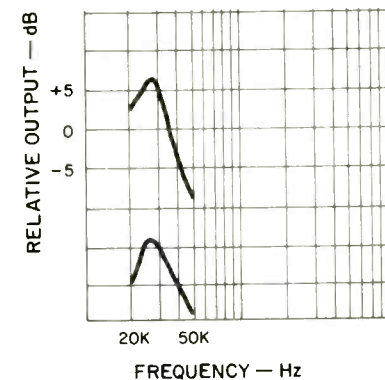

Fig. 3—Amplitude-frequency response and separation from 20 to 50 kHz using JVC TRS-1005.

### Direct-to-Disc Recording (Stereo)

*Rough Trade: Live!*; Umbrella UMB DD1

(This recording is superb and may be obtained only through your local Audio-technica dealer.)

### Pulse Code Modulation Recording (PCM) (Stereo)

*Virtuosos For Strings*; Sofia Chamber Orchestra, Kasandjiev, Denon PCM OX-704ND

### SQ

*George Gershwin Plays Rhapsody in Blue*; Thomas, Columbia XM34205

*Concert of the Century Recorded Live at Carnegie Hall*; Columbia M2X 34256

Massenet: *Thais*; Angel SCLX 3832

*Karajan Conducts Wagner—Album 1*; Angel S-37097

*O'Jays: Message in the Music*; Columbia PZQ 34245

### QS

David Liebman: *Sweet Hands*; A & M (Horizon 2) SP-702

*The Winds of Alamar by Iguana*; Quadratrak A 101

Rufus: *Rags to Rufus*; ABC CDQ 40024

*Tchaikovsky: The Complete Orchestral Music—Volume II*;

Vox QSVBX 5130

### CD-4

Tomita: *Firebird*; RCA ARD1-1312

Mancini: *Symphonic Soul*, RCA APD1-1025

*The Drum Session*: Philips 4 DX-52-3  
*Stowkowski Conducts Mahler—Symphony No. 2 ("Resurrection")*; RCA ARD2-0852

The SONUS Blue Label cartridge reproduced all of the above records exceptionally well and without any noticeable coloration. Organ music, particularly the bass pedal notes, is reproduced with a weight and solidity which is quite outstanding. For exceptionally good bass, the first two bands of side one of the Stanley Clarke recording are exceptional. Not every cartridge can reproduce the *Percussion Music*, *Earthquake: Special Sound Effects*, and *The Drum Session* records cleanly in their entirety. The Stravinsky: *Rite of Spring* recording will give any cartridge a real workout. In the fiendishly difficult final passages of the work, with its high amplitudes and velocities in the inner grooves, the record was tracked by this cartridge with absolute ease. The direct-to-disc recording is of rock music and is a superb disc

with very quiet surfaces. Voice reproduction with the SONUS Blue is extremely good, as evidenced by the Masetti: *Thais* recording. The Pulse Code Modulation (PCM) recording is the new direction of recording technology. Using a 13-bit natural binary code, the master tape has a wide dynamic range, exceeding 85 dB, very low distortion, and crosstalk of  $-80$  dB. In the very near future, more releases will be available in the PCM format. This type of mastering results in a superior analog disc recording, as is evident from the sound of these records.

In summation, we were quite impressed with the SONUS Blue Label cartridge. It is a cartridge that does not cause fatigue during extended listening sessions, a factor which reflects the technical excellence of the design. For the discerning music lover, this cartridge merits their serious consideration.

B.V. Pisha

Enter No. 91 on Reader Service Card

## Garrard Model GT55 Automatic Turntable

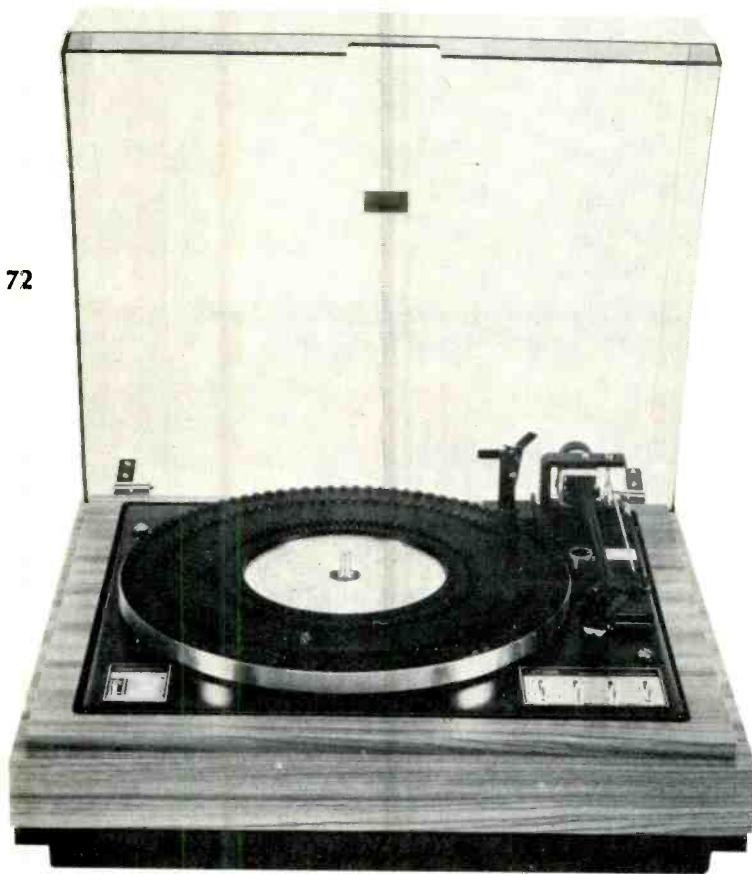

### MANUFACTURER'S SPECIFICATIONS

**Speeds:** 33-1/3 & 45 rpm.  
**Number of Records:** 6.  
**Wow & Flutter:** 0.05 percent.  
**Rumble:**  $-66$  dB (DIN B).  
**Motor:** D.C. servo.  
**Tonearm:** Magnesium, low mass.  
**Dimensions:** 15-5/16 in. (38.9 cm) x  
14-1/8 in. (35.8 cm).  
**Price:** \$249.95, base & dustcover \$39.95.

The GT55 is now the top-of-the-line Garrard automatic turntable and, at the moment anyway, is the only one using the tangential tracking arm. Unlike other straight-line tracking systems such as the Rabco, Schlumberger and B & O, which use a mechanism to move the pick-up arm across the record on a bar, the GT55 has a twin articulated arm. This kind of arm was first used, if my memory serves me correctly, by Burne-Jones in England in the 1950s but the advantages were more than nullified by the high friction from the various bearings. The Garrard Zero 100, introduced about seven years ago, was the first example of a successful unit using a twin arm in which the angle between the cartridge holder and arm was varied to maintain a true tangential relationship with the record groove. The arm used on the GT55 is a greatly improved version made of magnesium to bring the mass down to the incredibly low figure of 14 grams. It is mounted by a gimbal suspension having jewel bearings in the vertical pivot and double ball bearings in the horizontal mode. The motor is a high speed d.c. servo type coupled to the turntable by a belt. Styling is attractive with a charcoal black and silver finish, making a nice contrast with the well-made walnut base. (Both base and dustcover are optional.)

Quite apart from the tangential arm, the GT55 has a number of rather unusual features. The cueing rate is variable in both directions, being controlled by a small knob located just behind the arm rest, and the anti-skating device consists of a magnet which is offset so the force decreases as the stylus moves towards the center of the turntable because skating force decreases towards the center of the record. The adjustment control, which governs the spacing of the magnet relative to the arm, is just behind the arm base, and it is calibrated for both elliptical and conical styli. The arm itself has another interesting design feature which is not apparent at first sight; the rear section with the balance weight is set below the axis of the main portion. This is said to improve trackability with warped records. "Trackability" is not a word I like to use here but, well, there it is!

On the left hand side, at the front, is a small panel on which are mounted the two-position speed change lever and a neat thumb-wheel variable speed control. Over to the right is a group of four controls set in a similar panel. The first one is the cue lift lever, and the second is the auto start control. Number three adjusts the mechanism for record size, 7, 10 or 12 inches, and the last one is the mode switch with positions for *Repeat*, *Auto*, *Manual*, and *Off*. The strobe window is located dead center, right in front of the platter, which incidentally, is dynamically balanced and weighs four pounds. It is driven by a belt from the 1000 rpm



motor mentioned earlier. At the rear, to the left of the arm base, is a small plastic platform on which the records rest in the automatic playing mode. Two center spindles are supplied, a short one for manual play and a longer one for automatic. Accessories supplied include cartridge mounting hardware, alignment gauge, 45-rpm adaptor, and a tiny container of oil for the spindle.

### Measurements

The cartridge holder is the flat slide-in type used on other Garrard models, and an Audio-Technica AT-12S was used for most of the tests which included CD-4 records as the connecting cables are special low-capacity types. The anti-skating dial is calibrated for CD-4 styli, and both it and tracking force were set to 1½ grams—the highest recommended figure.

The first test was for wow and flutter, and the figure came out at 0.04 per cent, slightly better than claimed. Rumble measured -59 dB (ARRL) which is about 2 dB better than the 66 dB DIN B figure quoted as the DIN standard is something like 9 dB higher than the ARRL figure. The stylus force adjustment on the counterweight was found to be 5 per cent low which is well within normal tolerances, and the anti-skating dial was quite accurate. Both lateral and vertical arm friction were too low to measure accurately, but they were certainly less than 30 mg. Tonearm resonance, with the AT-12S cartridge was 8.5 Hz. Speed variation was +4 and -3 per cent and because of the servo control it was not affected by power line variations.

### Listening and Use Tests

Tangential tracking is important for the lowest distortion but it is even more important for CD-4 discs, which is why I

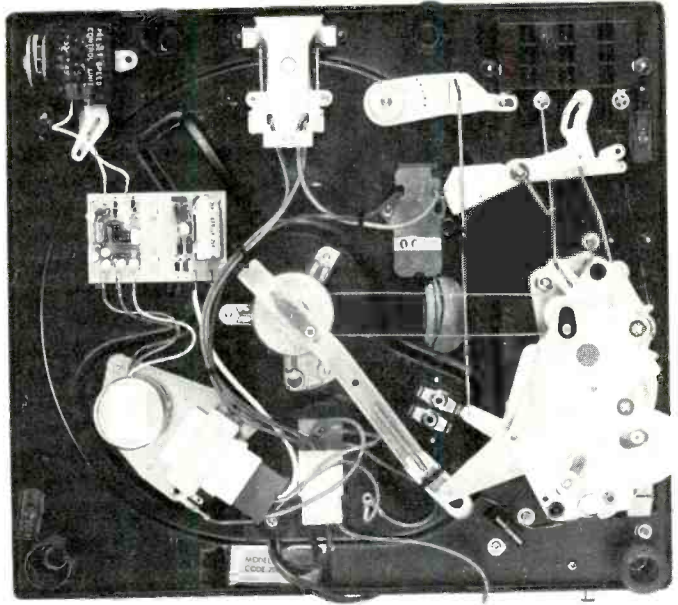

selected a CD-4 cartridge for most of the tests. Some of my early RCA releases are a little warped and are difficult to play with many turntable-arm combinations but the GT55 coped with them all, except for the worst specimen, with no trouble. It would seem that the vertical offset arm with accurate tangential tracking really works! In the automatic mode, cycling time is about 10 seconds, and the records are handled very gently. The cue lift is nice and positive with heavy damping in both directions and of course, the adjustment control is a refinement not found on many turntables.

# IF YOU DON'T LIKE THE WAY YOUR SPEAKERS SOUND COVER YOUR EARS.



Nothing can improve the sound of a set of speakers better than a set of Sony ECR-500 electrostatic stereo headphones.

Because unlike most headphones, ECR-500's have an asymmetrical pentagon shaped diaphragm for wider and smoother frequency response, as well as greater bass response.

They have a push-pull driver system for higher sensitivity and less distortion.

They have a simple open-back design that lets you turn on music without shutting off the rest of the world.

But best of all, they have a price tag of only \$150.

Which might be a little more than you'd want to spend for a set of headphones. But it's a lot less than you'd have to spend for a good set of speakers.

**SONY**

Manufacturer's suggested list price. © 1976 Sony Corp. of America. Sony, 9 W. 57th St., N.Y., N.Y. 10019. SONY is a trademark of Sony Corp.

Enter No. 30 on Reader Service Card

All-in-all, the Garrard GT55 is a worthy successor to this long line of high quality units. It is well-made, very quiet in operation and the carefully engineered mechanism with the minimum of moving parts should give years of trouble-free service. The total design concept is called "Generation Two" and many of the features will be incorporated in future models. We look forward to testing them.

George W. Tillett

Enter No. 92 on Reader Service Card

## AIWA Model 1800 Cassette Deck

### MANUFACTURER'S SPECIFICATIONS

**Frequency Response:** 30-14,000 Hz LH tape, 30-18,000 Hz FeCr tape, 30-17,000 Hz CrO<sub>2</sub> tape.

**S/N Ratio:** 65 dB with Dolby and DNL.

**Wow and Flutter:** 0.05 per cent W<sub>rms</sub>.

**Features:** DNL and Dolby noise reduction systems, FeCr equalization, variable bias for LH tapes.

**Dimensions:** 17 in. (43.2 cm) x 6 in. (15.2 cm) x 11½ in. (29.5 cm).

**Price:** \$450.00 with dustcover.

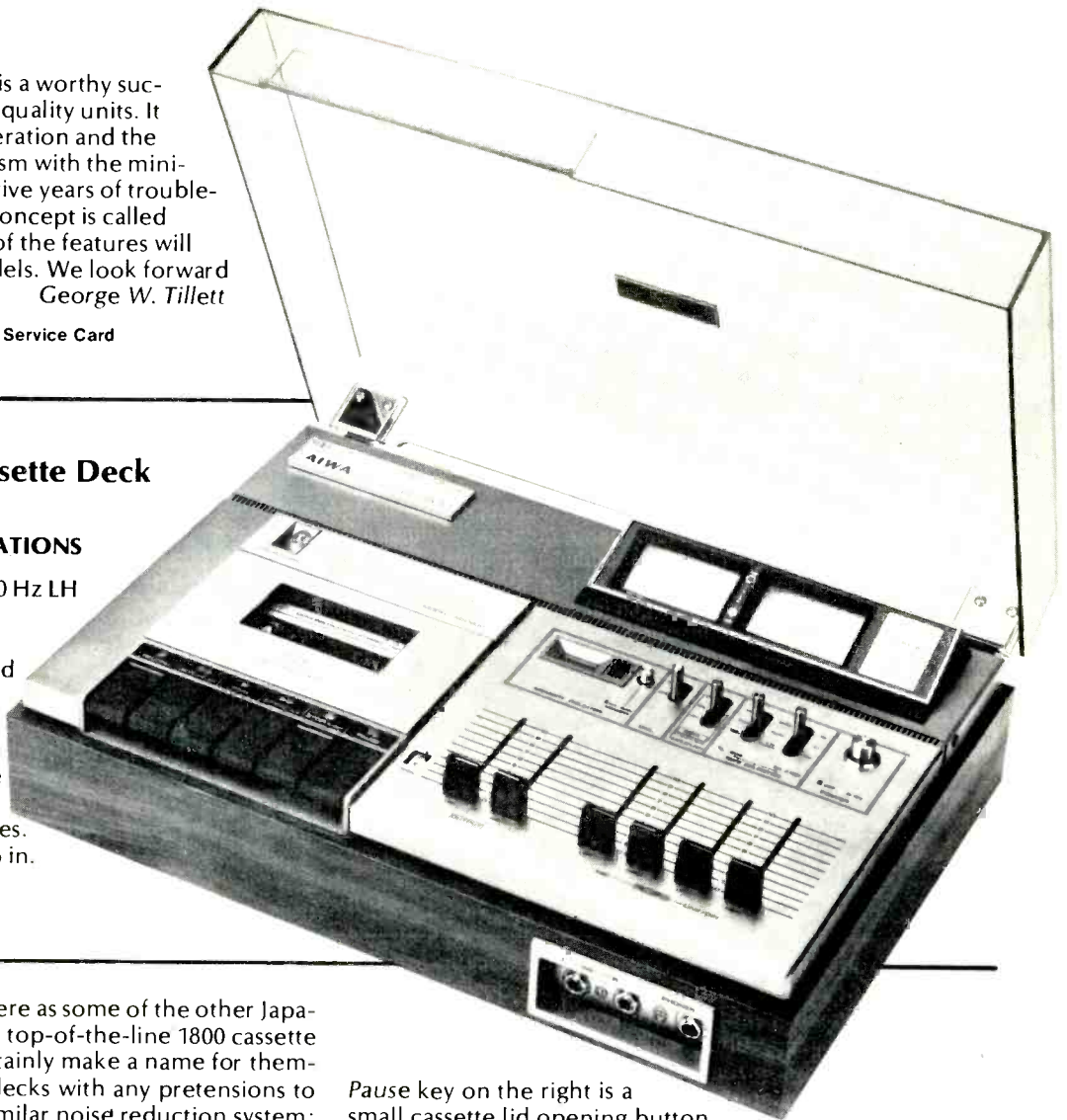

74

AIWA is not as well-known here as some of the other Japanese concerns, but if their new top-of-the-line 1800 cassette deck is any guide, they will certainly make a name for themselves very soon. All cassette decks with any pretensions to high fidelity have a Dolby or similar noise reduction system; but few can boast of a Dolby system *plus* a DNL circuit. It might be asked, why *two* noise reduction systems? Isn't this rather unnecessary? And isn't the Dolby sufficient on its own? But, of course, the two systems are complimentary as the Dolby is a record-playback expansion compression system while the DNL only works during playback so it can be pressed into service for just about everything. Can both systems be used together—in tandem as it were? The answer is yes, although the improvement in signal to noise is not additive as we shall see later.

Let us have a look at the controls of this unusual machine. On the left hand side in front of the cassette compartment is a row of six tape control keys as follows: *Record*, *Rewind*, *Forward*, *Fast Forward*, *Stop/Eject* and *Pause*. Next to the

*Pause* key on the right is a small cassette lid opening button and a group of six vertical slider controls. The first two control the output levels and the second and third pair are the microphone and line input controls. Behind the sliders is the digital counter, memory button, and a set of four lever switches for DNL, Dolby, bias, and equalization. The power *On/Off* switch is over to the right, and at the rear are the two VU meters mounted at an angle with illuminated indicators for record, Dolby, DNL and CrO<sub>2</sub>. In between the meters are two peak reading LEDs which light up at 3 and 7 dB above 0 VU. At the rear of the cassette compartment, which by the way is illuminated, is a tape run indicator lamp mounted at an angle for good visibility. The headphone and microphone jacks are located in a recessed panel on the front edge, just below the recording controls. The line input and output sockets are at the rear together with a preset control which can vary the bias by about 20 per cent. A DIN socket is also included. Now for a few words about the four lever switches: the DNL switch needs no explanation, but the Dolby switch has three positions: *Off*, *On* with a MPX filter, and *On* without the filter. The bias and equalization switches have positions for CrO<sub>2</sub>, FeCr and LH which is called normal.

The motor is an a.c. hysteresis synchronous type, and it is coupled to a heavy flywheel weighing 448 grams (16 ounces). Styling is fairly conventional with a black and gold panel and controls. The base is finished in simulated walnut, and the 1800 comes complete with a transparent plastic dustcover, attached to hinges at the rear.

Fig. 1—Playback response with the standard test tape.

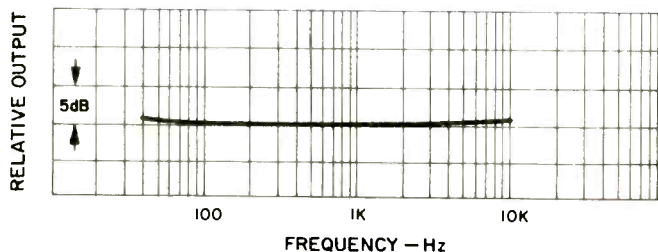

## Measurements

The first measurements were made with a standard 40 Hz to 10 kHz test tape as shown in Fig. 1. Then, a record-replay response curve at two levels was made with Maxell high energy UDXL tape (see Fig. 2). The 3 dB point was at 15.8 kHz, and the low end was well-maintained without fringing effects. Next, a C-90 TDK SA tape was tried, using the CrO<sub>2</sub> equalization position as recommended. The results were within 0.5 dB of the Maxell, so the graph is not shown. Then a BASF CrO<sub>2</sub> C-90 tape was checked, and again the response was very similar (see Fig. 3) with the upper 3 dB point extended slightly, to 16.1 kHz. Various other tapes were then tried, and among those giving excellent results (without touching the pre-set bias control) was the Fuji FX-60, Maxell UD, TDK Audua, Nakamichi SX-60, and Scotch Classic. The last tape to be tested was a Ferrichrome, the Meriton FeCr-60, and it will be seen that the frequency response is extended to 20 kHz! The actual 3 dB point was 19.8 kHz but just as significant—note the increased headroom at 0 VU. Next, distortion measurements were made and are shown in Fig. 5. The high-energy tapes (Scotch Classic, TDK SA and Maxell UDXL) were almost identical, so only one curve is shown for this group. Distortion versus frequency is indicated in Fig. 6. Signal-to-noise ratio measurement was more complicated than usual owing to the different efficiencies and the use of the two noise reduction systems. These are shown in Table 1.

Note that all the figures use the "A" weighting and are referenced to 3 per cent distortion. As mentioned earlier, don't expect to just add the Dolby and DNL figures and come up with the right answer! Having checked the Dolby

**Table 1**  
Signal-to-Noise ratio in dB.

	Basic S/N	With DNL	With Dolby	With DNL & Dolby
Maxell UDXL	60.0	65.0	69.0	71.0
TDK SA	60.5	65.5	69.5	71.5
BASF CrO <sub>2</sub>	57.0	62.0	66.0	69.0
Meriton FeCr	58.0	64.0	68.0	71.0

tracking and confirmed that the maximum error was 1 dB, the erase efficiency was measured at better than 70 dB. Wow and flutter was the next test, and the combined figure was 0.04 per cent which is exceptionally good. The Dolby MPX filter was 1 dB down at 16 kHz, with the attenuation increasing to 15 dB at 19 kHz. Input signal for 0 VU was 39 mV, and the output was then between 480 and 690 mV, depending on the tape. Microphone sensitivity was 180 μV, and the signal to noise decreased by 13 dB with the input control at maximum. For most low impedance microphones, the control would be turned down somewhat so the figure in practise would be nearer 6 or 8 dB. Speed was found to be "right on the nose," and rewind time was 140 seconds for a C-90 cassette.

## Listening Tests

Before making any tapes, some prerecorded tapes were played, including the new Nakamichi recording of Men-

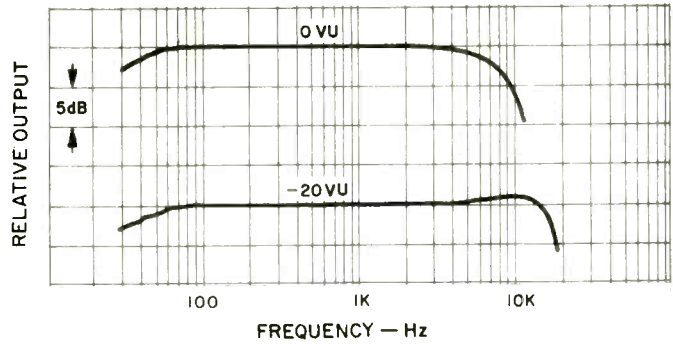

Fig. 2—Record/replay response with Maxell UDXL tape.

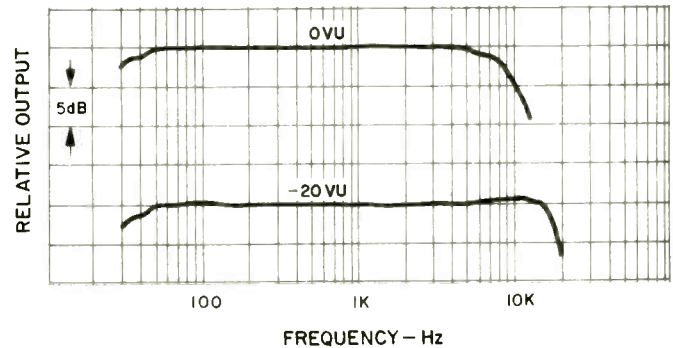

Fig. 3—Record/replay response with BASF CrO<sub>2</sub> tape.

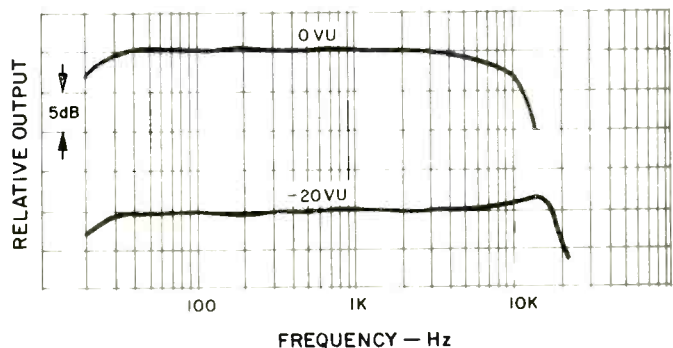

Fig. 4—Record/replay response with Meriton FeCr tape.

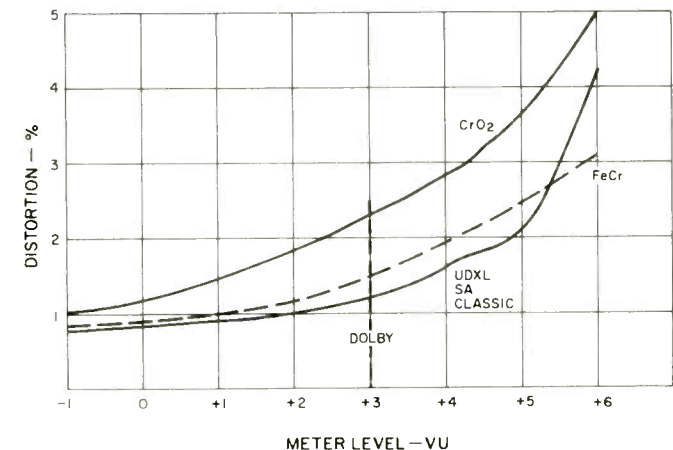

Fig. 5—THD at 1 kHz.

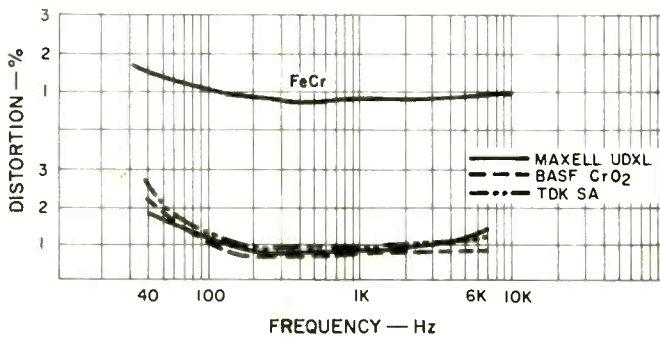

Fig. 6—Distortion vs. frequency at 0 VU.

delsohn's **Trio in D Minor** which is notable for its overall sound quality and low background noise. Next a tape was made using a spoken commentary, and here I found the twin peak indicators most useful. I would have liked some provision for a center microphone, but other than that, I have no criticisms to make. The controls all handled well, and the eject mechanism treated the cassette very, very gently, as it merely opened the compartment lid where-

upon the cassette moved slowly upwards. Aiwa calls this idea "oil damped elevation," and I have noticed something of the sort on one or two other decks. Much better than the devices which toss the cassette right out of the deck! As far as the electronics is concerned, in terms of frequency response, signal-to-noise ratio and distortion, the Aiwa 1800 is in the highest class, irrespective of price. Not only is the high-frequency response excellent, but the low end is better than average too—a tribute to good head design. The variable bias control is a refinement that will certainly appeal to the enthusiast who wants optimum results from any tape—although I must confess I only had to change the setting for one—the Scotch Master 90. However, a list of many other tapes with recommended bias settings is given in the instruction manual.

How about the DNL system? Well, it does help in reducing background noise, although the effects are not as dramatic as with the Dolby. The losses are not significant, and I imagine many people will leave the DNL switch on more or less permanently.

Summing up: the Aiwa 1800 is not particularly cheap, at about \$450, but it does offer excellent performance and a lot of extras for the money.

George W. Tillett

Enter No. 93 on Reader Service Card

## 76 Shure Model 516EQ Microphone

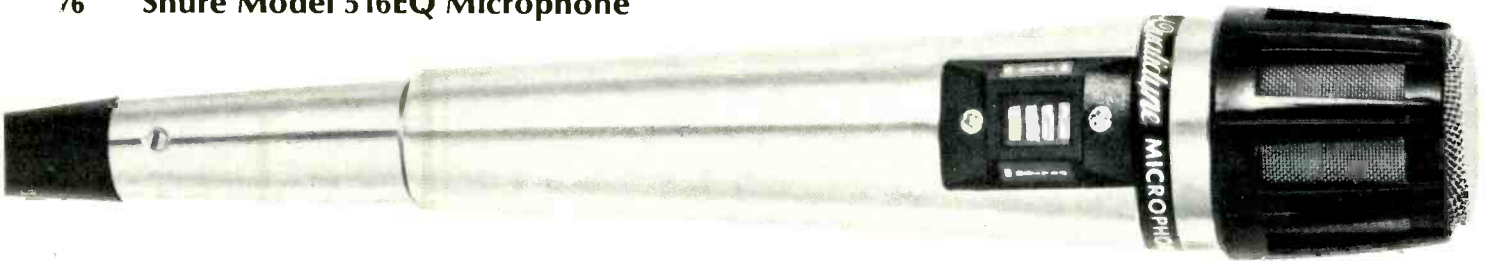

### MANUFACTURER'S SPECIFICATIONS

**Type:** Dynamic, equalizer (switch-selectable).

**Frequency Response:** 50 to 15,000 Hz.

**Polar Pattern:** Cardioid (unidirectional), uniform with frequency, symmetrical about axis.

**Impedance:** Rated 150 ohms (170 ohms actual). For microphone inputs rated 25 to 600 ohms. (For optimum filter operation, load impedance should be 100 ohms or greater.)

**Output Level At 1000 Hz:** Open circuit voltage - 81 dBV/microbar (-61 dBV/Pa); power level, -59 dBm.

**Phasing:** Positive pressure on diaphragm produces positive voltage on pin 2 of plug.

**Filter Switches:** Four filter switches in case. Switches provide approximately 6 dB cut at 190 (LO), 560, 1650, and 4900 (HI) Hz. (See Fig. 3.) Filter attenuation varies slightly with load impedance.

**Cables:** 4.6 m (15 ft.) single conductor shielded, 3 pin, fe-

male A3-type plug on microphone end and ¼ in. phone plug on equipment end. 910 mm (36") adaptor cable with ¼" phone jack and 1/8" mini-phone plug connectors.

**Swivel Adaptor:** Adjustable through 90° from vertical to horizontal, permits easy removal for hand-held use, mounts on stands having 5/8"-27 thread.

**Operating Temperature:** 40° to 74°C (130° to 190°F).

**Case:** Satin chrome die casting with Armo-Dur grille.

**Cartridge Shock Mount:** Internal rubber vibration isolator.

**Dimensions:** Head end 35.7 mm (1-13/32") Dia., plug end 20.6 mm (13/16") Dia., overall length 159.5 mm (6 9/32").

**Weight:** 268 g (9 ½ oz.) less cable.

**Model 516EQ-PR:** Same as Model 516EQ, except designed for stereo tape recording. Two microphones, windscreens, swivel adaptors, microphone cables, and mini-plug cables are supplied in a single carrying case.

**Prices:** Model 516EQ, \$75.00; Model 516EQ-PR, \$135.00.

The Shure 516EQ microphone is similar to those of the familiar Unidyne series, but is specifically intended for home recording. The dynamic cartridge is smaller and lighter in weight than those in the Unidyne microphones, which results in lower sensitivity and a somewhat poorer directional pattern, but a more uniform frequency response. The left-over space has been used to advantage by incorporating a large, compliant vibration isolator surrounding the cart-

ridge, and a tiny equalizer circuit and switch assembly in the side of the case. The result is a microphone *plus* equalizer that is comparable in size, weight, and cost to a Unidyne microphone.

The 516EQ-PR is a complete microphone outfit for stereo recording. The cables are supplied complete with plugs to mate with jacks on most popular types of tape recorders. Foam windscreens are provided which are large enough to

keep vocalists from swallowing the microphone, as well as providing excellent "pop" and wind protection. The 516EQ is designed for use with low impedance inputs only. The 3-pin plug on the microphone permits use with standard extension cables and matching transformers that would be needed if your recorder has high impedance inputs. It may also be used with balanced low impedance inputs, if you provide suitable cables.

The 516EQ-PR set, with the short cables supplied, is ideal for the person with a stereo cassette recorder. Monitor phones are needed if you are to hear the effects of changing the equalizers. If the microphones are not too far from the recorder, you can conveniently experiment with the equalizer switches.

The 516EQ could be used in multiple microphone recording or reinforcement applications. Each microphone could be "tuned" specifically for each musical instrument or vocalist. Of course, a lot of time would be required for experimentation.

The equalizer assembly consists of four very small two-position switches mounted on a small circuit board. This assembly comprises four dip equalizers spaced about 1 1/2 octaves apart. Any or all may be switched "in" or "out." The switches are so small that a pencil may be required to activate them. Up to 16 different combinations may be selected.

### Laboratory Tests

We anticipated some irregularities in impedance, as the manufacturer recommends a minimum load impedance of 100 ohms. The complete family of curves is shown in Fig. 1. Total variation with frequency is 70 to 240 ohms. For optimum results, actual load should be about 1000 ohms, which corresponds to an unloaded 150-200 ohm input. Our numbering of equalizer switches is from low to high frequency, proceeding from the rear to the front switch. We decided

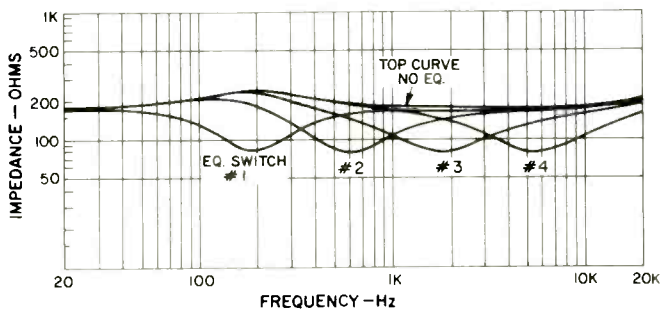

Fig. 1—Impedance composite of the Shure 516EQ.

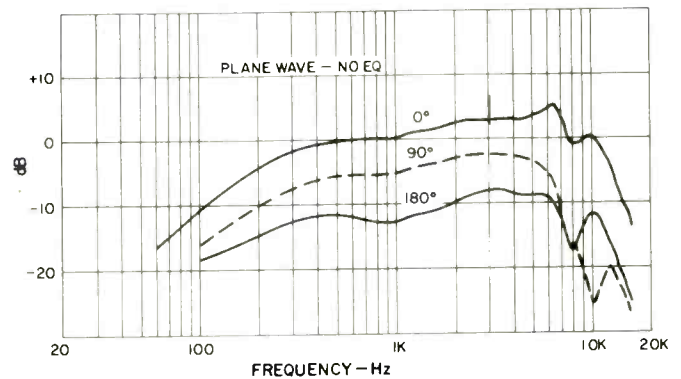

Fig. 3—Response vs. angle.

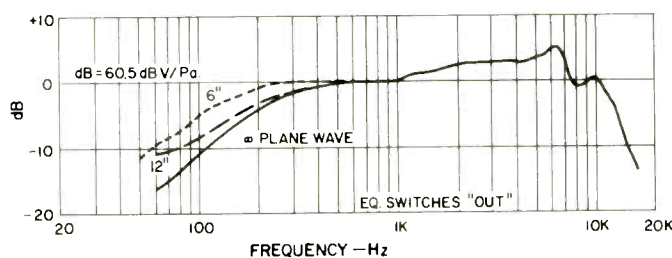

Fig. 2—Frequency response vs. distance.

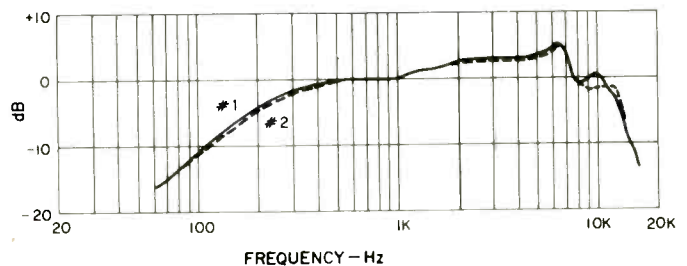

Fig. 4—Response of unit #1 vs. unit #2.

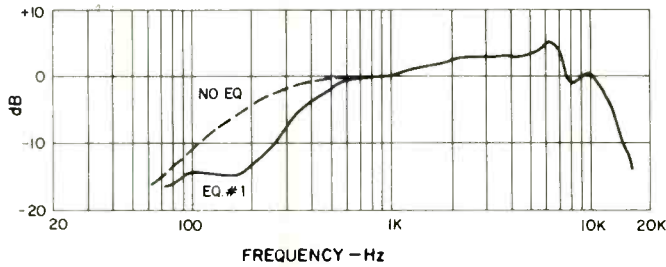

Fig. 5—Frequency response with equalization #1.

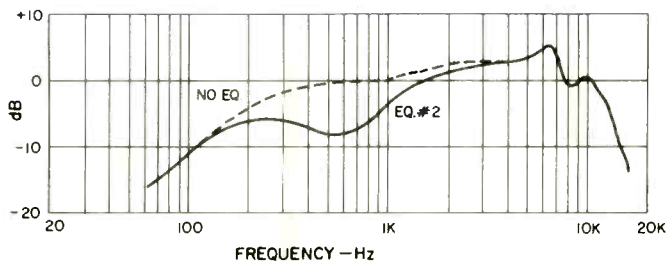

Fig. 6—Frequency response with equalization #2.

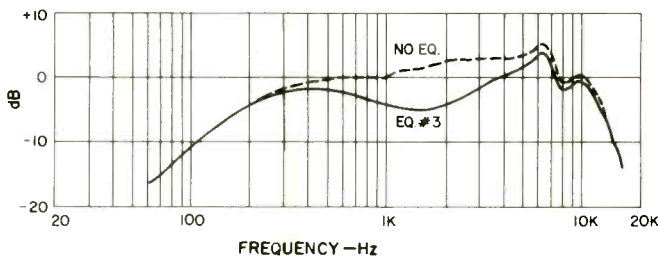

Fig. 7—Frequency response with equalization #3.

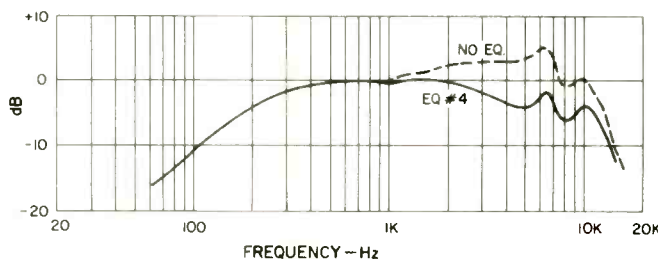

Fig. 8—Frequency response with equalization #4.

that testing all 16 equalization selections was not necessary. It was sufficient to make tests with no equalization, and with each switch in turn, for a total of five selections.

All of the frequency response tests were performed on the unit we designated number one, except for the test of stereo matching of both microphones. The frequency response without equalization is shown in Fig. 2. The response for plane wave (microphone 3 feet or more from source) agreed with the published curve. The quoted response of 50 to 15,000 Hz is erroneous under this standard test condition. We believe a rating, for 10 dB down points, of 100 to 15,000 Hz is appropriate. To achieve minimum low frequency response for satisfactory results with cassette recorders and bookshelf speakers, the microphone must be close to the sound source. Our tests show that six inches is satisfactory. There may be no problem with electronic instruments or drums in pop groups because the sound level at low frequencies is usually high. The 516EQ is not suited to distant miking of symphony orchestras. You may also encounter noise from your recorder if the sound level is low because of the low sensitivity of the microphone. Observe that our measured sensitivity was very close to the rated number. The sensitivity is effectively lowered by use of the "dip" equalizers. With all equalizers "in," pickup of low sound levels may be difficult. See Fig. 3.

The frequency response remains rather uniform with angle, but the polar pattern is poor. The 90° response is only about 5 dB down, and the 180° is only 10 to 13 dB down. This will not mar the audio quality if the microphone is close to the source, but you might have problems with distant miking in reverberant rooms which is another reason to keep the 516EQ close to the source.

The two microphones are incredibly well matched in frequency response—see Fig. 4. This indicates excellent production uniformity plus a possibility of some selection and pairing of microphones. This result is a good reason to purchase the 516EQ-PR stereo pair, rather than individual 516EQ microphones.

Next, we measured the response for each equalization. Each curve is shown with the unequalized curve for comparison. The dip frequencies are reasonably close to those quoted, but the depth is generally a little greater than the 6 dB quoted. A change of 10 dB is perceived as a doubling of loudness. Six dB, in our opinion, is marginally low, and we are glad to see the greater amount of equalization. We believe the equalizers represent the best choice of frequencies and amplitudes that can be made with four On/Off switches. We checked loading effects on the equalizers with a 240-ohm load as shown in Fig. 9. I think you will agree that 240 ohms is about the lowest you would want to use.

Our phasing test revealed that the phasing at the phone plug tip (white wire) is negative. EIA standards RS-221 has no phasing requirements relative to microphones with single conductor shielded cable; we like the choice of pin #2 on the microphone for the positive terminal. If you mix the 516EQ with other microphones, be sure to check relative phasing, particularly if you're using the single conductor cables Shure has provided.

### Subjective and Listening Tests

Wind and "pop" sensitivity is low without the windscreen and the same as our two reference microphones, an RCA BK-5B ribbon and a Shure 548. It is extremely low with the windscreen and the windscreen causes no perceptible change in voice quality. (A measurement, which is not shown, revealed only very small changes in high frequency response.) We rate the hum pickup as medium. It was high-

er than the BK-5B, but the same as the 548. Vibration sensitivity was medium, lower than the 548, but higher than the BK-5B. We are pleased with this result, because vibration sensitivity is quite a problem with dynamic cardioid microphones.

The biomechanics or "feel factor" is good. When the microphone is hand-held, there is no danger of the performer changing equalizers as the switches are well recessed and difficult to activate with the fingers alone. The equalizers are mounted well forward and do not interfere when you replace the microphone in its swivel. The quality and durability of the microphone is excellent. The cables supplied are a little thin and fragile but properly strain relieved at the plugs. For heavy duty applications, we recommend you use heavy 2-conductor shielded rubber or neoprene cable.

The carrying case of the 516EQ-PR set is attractive and has foam inserts to hold the microphones. An instruction and data sheet is enclosed which should help the user to maximize performance in his particular applications. All 16 choices of equalization are shown by response curves and described with relation to effects on specific musical instruments. This shows that Shure has done a lot of application research on the 516EQ.

We could not hope to checkout all of Shure's results by our listening tests. We found that the equalizer changes are easily perceived on voice. Vocals at 1 or 2 inches sounded best with equalizers number 1 and 4, but at six inches we preferred no equalization as the sound compared favorably to our standard BK-5B microphone with V2 response compensation. The 516EQ sounds "thin" compared to our BK-5B ("M" or flat response) when both are three feet or more from voices or musical instruments and we do not recommend it for distant miking of classical music for this reason,

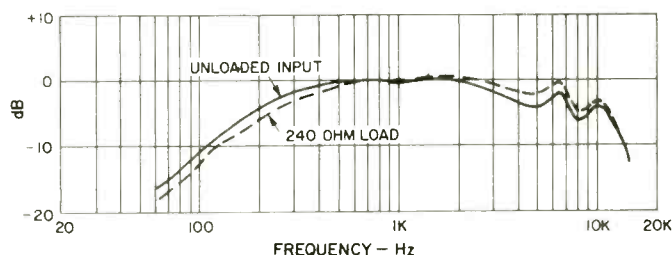

Fig. 9—Response vs. load at equalization #4 setting.

plus the possibility of signal-to-noise problems with some users.

The 516EQ sounds best when used close up to instruments or vocalists. You may also find the sound to be acceptable with the microphone three feet from musical groups having amplified or electronic instruments, if the sound level is high enough to prevent signal-to-noise problems. The loud bass instruments can usually benefit from some attenuation.

The 516EQ satisfies many requirements of home tape recording. The built-in equalizers make it a good buy for people who do not possess expensive equalization equipment, and we can recommend it for that purpose. *Jon Sank*

Enter No. 94 on Reader Service Card

# The straight and narrow path to safe record cleaning . . .

Dust particles accumulate on records as they are played, and all sound systems reproduce dust as crackles and distortion. Cleaning arms prevent particles from reaching the stylus, but conventional arms often display severe problems involving excessive mass (makes proper tracking-cleaning difficult), tracking force (can affect turntable speed), weight, and size (some arms are too large for many turntables). These disadvantages can result in pressure that grinds dust into record grooves — rather like killing a patient to cure the Flu.

Now METROSOUND introduces linear tracking — on a cleaning arm. The LIN-TRACK™ has its own suspension system which results in negligible mass and amazingly low tracking force of only .5 gram (less force than that required for most phono cartridges). The cleaning assembly moves across the record in a straight line (the way records are originally made), so tracking is accurate for complete dust removal. The lightweight LIN-TRACK swings out of the way when not in use, and will fit most turntables.

The METROSOUND™ LIN-TRACK . . . The safe one.

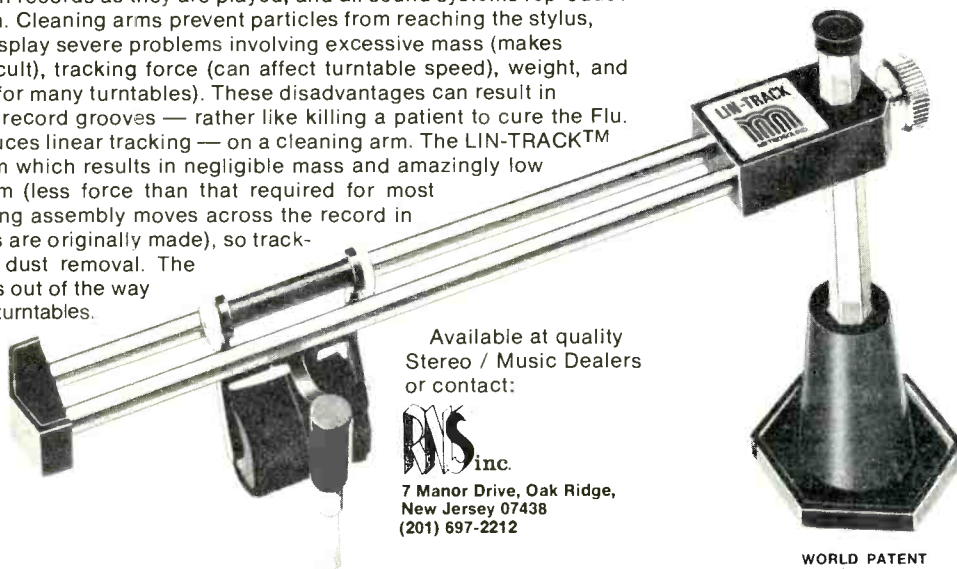

Available at quality Stereo / Music Dealers or contact:



7 Manor Drive, Oak Ridge, New Jersey 07438 (201) 697-2212

WORLD PATENT PENDING

Enter No. 40 on Reader Service Card

# European records

John S. Wright

A new recording of the Monteverdi **Vespers** appears on EMI SLS 5064. Directed by David Munroe, a force of artists accompany the King's College Choir, Cambridge. There has been a complete revival in interest in the works of Monteverdi and other composers around the early seventeenth century, and this record can do nothing but encourage its continuation. The work is arranged for voices to be situated around and within the Chapel and provided ideal material for proper surround sound. The recording is made in SQ, but after my experience with quadraphonic logic circuits, I await a "straight" SQ decoder with which to evaluate results. In stereo, the recording has an overall light and airy texture, lightness being the appropriate word. There is fine detail,

and the distance effects are well presented, although to maintain acoustic perspective I did find some of the closer voice parts a little too close. Nevertheless, this is a very minor criticism of a recording that is undoubtedly going to be purchased primarily for the music, and in this respect it receives my highest praise.

Lazar Berman is not a familiar name in concert pianists within the Western World, most of his performances and recordings being so far restricted to Russian audiences. It thus came as a surprise to discover such a maestro on the Melodiya label from EMI, of Liszt's **Sonata in B minor**, coupled with the **Mephisto Waltz** (ASD 3228). To me this piano sonata is the single musical offering of Liszt which establishes him as one of the "great" composers. It is not in strict sonata form, being more variations upon a descending bass motif, demanding the utmost from the performer both technically and interpretively. Of the many recordings I have of this work, this performance is by far the most important. Berman is such a master of the instrument that there is no sense of hesitation even in the most complex passages, his tempo being chosen exactly as he deems it necessary for the music and never to compromise his abilities. Recording standard is very high for this Russian series, having less phasiness than is usual on Melodiya. The piano is closely recorded and tightly strung, and on less than completely stable turntables a slight suggestion of recorded wow can just be detected, but for such a musically impressive album, the sound quality is more than adequate.

*Editor's Note:* This quarterly column was scheduled to appear in the March issue, but due to a mixup over the final closing date for copy, this edition arrived late from England...hence it's appearance in the April issue.

A sparkling piano tone accompanies a sparkling performance in a popular coupling of the Liszt and Tchaikovsky **First Piano Concertos**. This is a recording debut for soloist Horacio Gutierrez playing with the London Symphony Orchestra conducted by Andre Previn on EMI ASD 3262. If these performances are typical of his musical technique and competence, he obviously has a successful recording career ahead of him. To add to the line up, the engineering is by Christopher Parker and is difficult to fault except for slight dryness and a lack of warmth in the extreme bass, which probably is an accurate reproduction of the actual recording environment.

Of rather minority interest comes a record of the **Sacred Music of Samuel Wesley**, who died a hundred years ago (RCA LRLI 5126). This church music is performed by the choir of Hereford Cathedral under Roy Massey. Although Victorian music may not be to your particular taste, this record is worthy of very special mention. The microphone pick-up is very distant, retaining the utmost of sound of the cathedral so intrinsic of such music. The dynamic range seems unlimited, as demonstrated by the high velocities encountered in the natural intermodulation of choir voices contrasting with passages almost submerged in traffic and background noise. In fact, the disc is of below average cutting level to maintain this range, and if Dolby NR was used for mastering, it hardly coped. Thus, this is a connoisseurs' record, reserved for only the best equipment. It is exceptional in "purest" terms, but with reservations as to its commercial acceptability. Try it if you dare.

In contrast we have a slick European recording, **16th Century Dance Music from Court and Village** on CBS Masterworks 76183. This rare music of the renaissance provides a musical lollipop. Full of interesting serpent-like early instruments, the Moog synthesizer has nothing on it. So catchy are



Malgoire/16th Century Dance Music

AUDIO • April 1977



the rhythms that this record quickly became a favorite with my children. Presentation is bright, sounding ultra clean with good attack and pin-point stereo. Ambience is of the blended variety, and although balance is obviously contrived, it is in the best of taste. Having a silent surface, this unusual record may well end up as being one of our selected records of this year.

Continuing with the bicentennial celebrations, Zubin Mehta plays music by Bernstein (**Overture Candide**), Gershwin (**An American in Paris**) and Copeland (**Appalachian Spring**) on Decca SXL 6811. Recording by James Lock is not entirely typical of the Mehta series, being not as warm and providing false perspective. But I am sure that this is deliberate and aimed at commercial appeal. A much better orchestral sound, to my taste, is of James Lock's recording with Zubin Mehta and the Israel Philharmonic Orchestra of Brahms's **Piano Concerto No. 1** on Decca SXL 6797. The most noteworthy aspect of this disc is that the soloist is none other than Artur Schnabel, recording in 1976 at over the age of ninety. He has recently signed a contract with Decca! It would be an exaggeration to claim the playing is without flaws, but not editing them out makes for a more spontaneous interpretation. The insight of the performance is beyond question, but I cannot entirely excuse James Lock for recording the piano as if it were in a different studio than the orchestra.

It is not merely my opinion that the middle 1960s proved a vintage period for Decca records. The sound was generally warm yet detailed and avoided the brashness of some of the more recent discs from that company. A new recording of Kodaly's **Hary Janos Suite** reminds me of that time (SXL 6713). The proper sense of front-to-back perspective is especially notable in the timpani, and the overall sound is neither exaggerated nor bloated. The interpretation is really without question since Antal Dorati, who conducted the Philharmonic Hungaria Orchestra, was himself a student of Kodaly. Although the coupling of the **Symphony in C** is not as musically inspiring, the whole album is well worth obtaining, if only for the humorous **Hary Janos Suite** alone.

Parker and Bishop of EMI maintain their standards with yet another superb recording in the Boult series, this time of Elgar's **Symphony No. 2**, played by the London Philharmonic Orches-

tra on ASD 3266. Sir Adrian had recorded this work a few times in the past, but we now believe that this is probably to be his last definitive interpretation on disc. The sound is full blooded yet crisp and spacious in a way that it seems only this particular combination of production, musicianship and engineering can achieve. The only minor blemish on the review copy was a surface click on the first side, but we are getting far fewer of these problems since EMI has mainly changed to a new type of plastic in-

ner-sleeve, which also seems to be less prone to producing static.

With Barenboim conducting the Orchestra de Paris we have a gem, both of performance and recording, in his record of Bizet's **Symphony in C**, coupled with the suite from the **Fair Maid of Perth** and the **Patrie Overture** (EMI ASD 3277). I must refer back to a 1973 recording made by Daniel Barenboim with this orchestra, also of Bizet's music (including the **Carmen Suite**) on ASD 2915. It has been one of my "reference record-

INTRODUCES  
**TRIPHONIC®**

the professional signature

No more speakers required with 3A's Triphonic

**A complete revolution in sound reproduction**

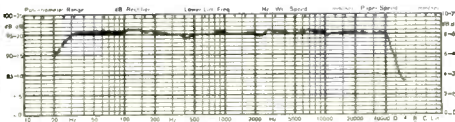

3A now announces the disappearance of loudspeakers

The Triphonic® System is a completely integrated system; whatever the size of the room one will be able to listen to live level reproduction without seeing any "speakers".

The system will use 3A's exclusive A.P.F. (acoustic pressure feedback) all around. That means deep tight bass, clean, accurate, open sound and absence of coloration.

The only electronics required will be a 15 to 30 watt RMS amplifier that will send the information to an electrical centralisation unit that will dispatch the spectrum to the three sources.

Frequency response 25 - 40,000 Hz ± 3dB

Name \_\_\_\_\_  
Address \_\_\_\_\_  
City \_\_\_\_\_ Zip Code \_\_\_\_\_

Please send me free detailed literature on:

<input type="checkbox"/> TRIPHONIC®	<input type="checkbox"/> ARIOSO "Monitor"
<input type="checkbox"/> ANDANTE Master Control	<input type="checkbox"/> ALLEGRETTO
<input type="checkbox"/> ANDANTE "Linéaire"	<input type="checkbox"/> APOGEE "Monitor"
<input type="checkbox"/> ANDANTE "Studio"	<input type="checkbox"/> APOGEE
<input type="checkbox"/> ADAGIO	<input type="checkbox"/> ALPHA



Triphonic® is a registered trade mark of Acoustic 3A International.

The new reference in sound reproduction

Canada: 871 Montée de Liesse, St. Laurent, Montreal, Que.  
U.S.A.: 172 Madison Avenue, Suite 802, New York, N.Y. 10016  
France: Zone Industrielle, 06600 Antibes

Enter No. 41 on Reader Service Card

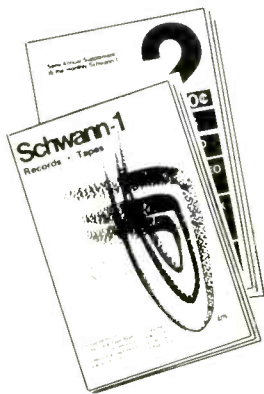

## Enjoy Music More

If the recorded music you purchase and listen to is important in the way you enjoy life . . . you ought to know about a goldmine of helpful information for every record collector.

### Schwann Record & Tape Guide

is a compilation of information about records and tapes of many classifications. This wonderfully useful catalog uncovers titles you didn't know were available, helps you select versions by conductors and artists whose work you prefer . . . shows you money-saving reprints on budget labels . . . and much, much more.

More than 65,000 records and 8-track and cassette tapes are listed in the monthly *Schwann-1* and its semi-annual companion, *Schwann-2*. All are available through your record dealer if you ask for them by Schwann title and number. Schwann opens up rich rewards in your record collecting hobby. See your record dealer for latest copies.

82

**Schwann-1** Monthly. Lists the month's new releases in every category. Also nearly 45,000 available recordings on 702 record labels, 231 tape labels, 82 quadraphonic labels, in classical, recent popular, rock, jazz, musical shows, country, opera, ballet, electronic, etc. \$1.00 at your dealer's.

**Schwann-2** The semi-annual companion catalog for specialized categories: pop more than two years old, classic jazz, classical classics of the pre-stereo era, also the great re-issue catalogs; international pop & folk on domestic labels, spoken, educational, religious, etc. 95c at your dealer's.

#### SPECIAL PRICE SAMPLE OFFER

If your favorite store doesn't carry Schwann, order samples by mail, but please try your dealer first. Prices include postage and handling.

- Latest Schwann-1 (monthly) ..... \$1.60
- Latest Schwann-2 (semi-annual)..... \$1.40
- Combination Offer: latest Schwann-1 (monthly) and latest Schwann-2 (semi-annual)..... \$2.75

- Basic Record Library booklet.  
Lists 1,000 suggestions in classical music by musical periods for your enjoyment.  
Send 50c for cost of handling and postage.

I enclose \$ \_\_\_\_\_ for the items checked above.

Name \_\_\_\_\_

Address \_\_\_\_\_

City \_\_\_\_\_ State \_\_\_\_\_ Zip \_\_\_\_\_

Dealer's Name & Address \_\_\_\_\_

### Schwann Record & Tape Guide

137 Newbury Street, Boston, Mass. 02116

AU

ings." Interestingly, we have here the same producer and engineer providing the same gloriously open sound. Musically this record also provides very easy listening. Why can't all records be like this?

Staying with Bizet we have the complete boxed set recording of *Carmen*, conducted by Sir George Solti, on Decca D11D3. Contrastingly, the orchestral balance here is heavy in comparison, but this may be a by-product of the fact that stage effects, chorus, and soloists are in perfect balance. Knowing as we do that such presentations are heavily microphoned, this is probably the price one has to pay. Thus, if your prime interest lies in the orchestral interludes, this would not be the recording to choose; under those circumstances, one would opt for an excerpts record such as the Barenboim mentioned above. However, if your interests lie in the complete opera, being full of popular vocal and operatic material of universal appeal, then it is difficult to envisage a more satisfying presentation. This is indeed a sparkling performance if not always a sparkling recording, with only occasional episodes of French dialogue being unfamiliar. There are many fine qualities about this recording, such as the realism in the final side where distinct footsteps can be heard. These effects, contrary to popular belief, add to one's enjoyment rather than detract from it.

I have consistently praised the quality of Philips Chamber music recordings to the point of apparent bias. It is therefore with great relief and joy that I can thoroughly recommend an Argo recording of the Aeolian String Quartet in the penultimate box set of string quartets by Haydn (HDNU 76 to 81). A lot of records, but well worth the money! Firstly, the performance is in every respect enjoyable, yet profound. No wonder many musicians see this string quartet as being a direct competitor to the Quarteto Italiano. Having gone that far musically, I would not say that it is quite up to the cream of the Philips releases, but it is certainly approaching the very best for Argo. A possible criticism is a tendency towards brightness and that varies slightly between sides. In all other respects the recording is immaculate, with the quartet clearly positioned in space, with that space clearly representing the acoustics of the recording environment.

Recently we have no less than three recordings of Berlioz *Symphony Fantastique*, one on EMI at full price, one

on the Philips Universo series, and the third on Decca Ace of Diamonds. Conductors are Jean Martinon, Colin Davis, and Leopold Stokowski, respectively. By means of comparison, I referred to the Decca recording by Sir George Solti, being a weighty, brash, synthetic but a very thrilling performance and recording. The Stokowski on Ace of Diamonds SDD 495 has similarities but with fat brass sounds and a more deliberate interpretation. The Martinon recording (ASD 3263) takes a much more natural attitude towards the engineering and I note that Paul Varasseur is again the engineer. (He also recorded the superb Bizet discs referred to earlier.) The musical approach is less onward and relentless than either of the Decca recordings but the orchestra represents a real performance taking place in an actual hall. This is not as impressive although more real. Bass and brass are not so forward, but although range is actually more extended, this leads to an overall lighter quality. The Colin Davis performance on Universo 6580 127 walks a dividing line between the contrived and natural approaches, leaning more towards EMI sound than Decca. It is a warm and weighty performance. In summary, the Solti recording (SXL 6571) and the Ace of Diamonds record are both deliberately contrived in a manner which makes great sonic and emotional impact, all be it strictly incorrect. Of these two discs, the Solti is the preferable but the Ace of Diamonds provides the best value. Of the EMI versus the Philips, undoubtedly the EMI, from the purist view point, is the superior of the recordings mentioned.

In the Christmas round-up of the best records of 1976, I highlighted King's Singers **Concert Collection** (CSD 3766) for entertainment coupled with a clean, natural openness of sound quality. Since then I have received a new release from the King's Singers: **Lollipops** on EMC 3093. The record contains an endearing selection of folk-like music with highlights of *Widdicombe Fair* and *Phil the Fluter's Ball*. Sheer precision! I cannot pretend that the recording has quite that uncanny airiness of the **Concert Collection**, but it is nevertheless of a very high quality. Highly recommended.

Earlier I enthused about the Russian pianist Lazar Berman playing Liszt on the EMI Melodiya label. He is now contracted to CBS and on of the first releases (76533) is of the **Beethoven Sonatas Nos. 18 and 23 (Appassionata)**. Again I must report on this man's incredible technique. Just listening, it

seems impossible that human hands could be responsible for such speed and accuracy—unbelievable! Regrettably the tone of the piano, as recorded, is also unbelievable. Not so the recorded piano of Alfred Brendel playing Beethoven sonatas including the *Pathetique* on Philips 9500 077. When I first reported on the record quality at the time Brendel changed from Decca to Philips, I was disappointed, but this new release is really super. The ambience has a convincing bloom, yet with the piano well defined at front center stage.

The Philip Jones Brass Ensemble celebrated their Silver Jubilee by issuing a selection of excerpts from their past recordings. Entitled **The World of Brass**, it lives up to the best Argo standards (SPA 464) and demonstrates the consistently high standards of performance and recording over the years. Readers may remember my rave review of **Renaissance Brass** (ZRG 823), where I admired the crisp "saw tooth" rasp of the natural sounding brass. At a bargain price, this Jubilee collection is a musical treat and a hi-fi *must*.

## This is Number 1. Number 2 is just off the press.

Volume 1, Number 1 of The Audio Critic, a limited quantity of which is still left for new subscribers, proves that noncommercial audio journalism has come of age.

There has never been anything like the comparative survey of 23 preamplifiers in this issue, nor like the uncompromisingly consumer-oriented editorial philosophy of The Audio Critic.

Six times a year, by subscription only, The Audio Critic tells you in print what has so far been only spoken of in private among a few knowledgeable insiders. What's the best. What isn't. What's smart. What's dumb. And why.

Since The Audio Critic accepts no commercial advertising, not even by retail stores, and since it has no connections with the audio industry, it has nothing to gain from toadying to manufacturers. It names names, calls bluffs, praises and criticizes without restraint. Even if you read some of the "underground" audiophile reviews, you'll find that The Audio Critic speaks with a new and unfamiliar voice.

What's more, The Audio Critic doesn't just listen, wineglass in hand. It also measures. In its own laboratory, complete with spectrum analyzer, every kind of signal generator, calibrated microphone and other sophisticated test equipment. A very serious effort is made to correlate the lab findings with the listening tests.

One year's subscription to The Audio Critic (six issues) costs \$28, first-class mail only. For overseas

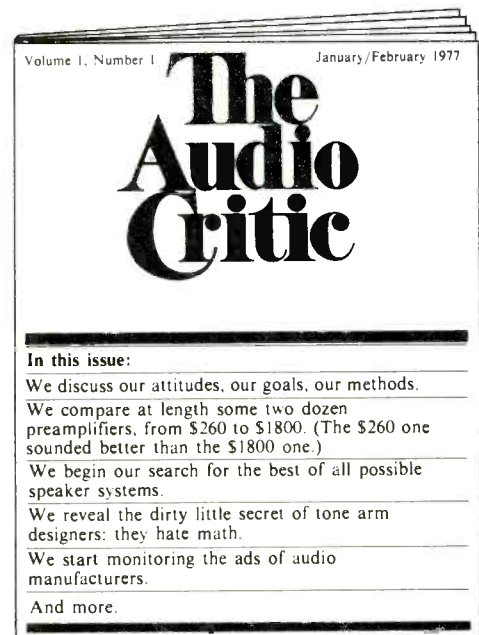

airmail, add \$5. No single copies are sold for any reason whatsoever, but the unused portion of canceled subscriptions will be cheerfully refunded.

Volume 1, Number 2, the March/April issue, fine-tunes the preamp survey, adding new units, zeroing in on pre-preamps and head amps, and going deeper into correlatable electronic tests. It also begins in-depth comparative surveys of power amplifiers and subwoofers.

If you act now, you can still begin your subscription with Number 1 and own a complete set. Number 2 will follow immediately.

Send your \$28 for the first six issues today to The Audio Critic, Box 392, Bronxville, New York 10708.

# The column

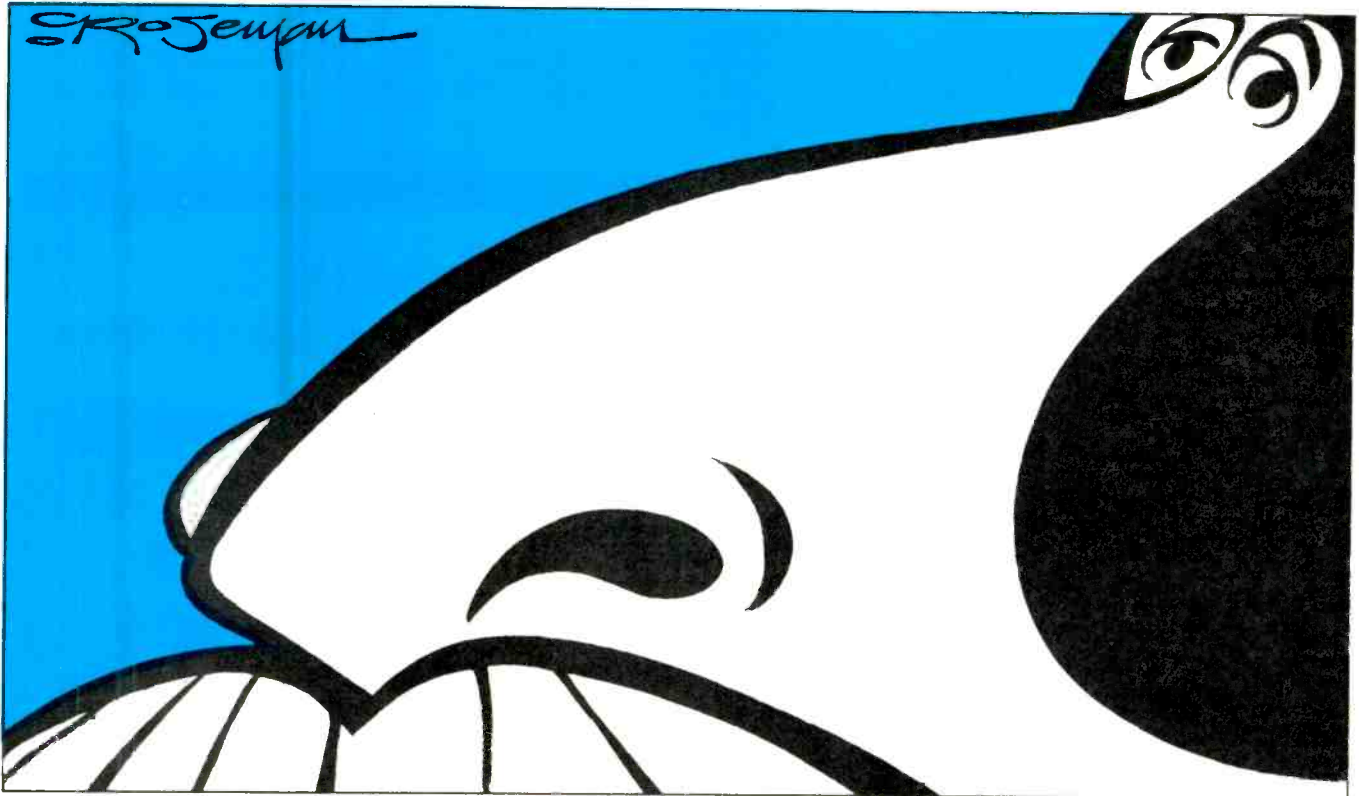

84

**Ra:** Todd Rundgren's Utopia  
**Bearsville BR 6965**, stereo, \$6.98.

I don't think words can do any sort of justice to this album, because in essence it is the start of a new career for Todd. In the past, Todd made albums on his own which (except if they featured a hit single) didn't really connect with those outside of his legion of admirers; when his group, Utopia, made records, they were usually more Seventies rock/jazz oriented but a little lacking in consistency/content. This time, we find the consolidation of all of the better elements of Utopia (fine playing) and Todd (the vision) without the excesses both were prone to. In addition, Todd's assembled the best band he's ever had, with three composers (including one who sounds like a potentially major song-writing talent) who can all handle their instruments more than adequately. Side two of **Ra** has an 18 minute plus rock'n'roll fairytale entitled *Singring and the Glass Guitar*,

which goes the Small Faces' *Ogden's Nut Gone Flake* one better. The songs on side one are all strong in their own right, my favorites being *Communion With The Sun* and *Jealousy* along with *Hiroshima*, the first track on the second side.

Todd's recording prowess (otherwise known as "Production") is in fine form here, using overdubbing to the Nth degree and producing some of the finest acoustic guitar sounds (something he's neglected lately) he's ever been responsible for. With over 50 minutes of music, **Ra** is more than a bargain—it's one of the best records I've ever owned, and I would suggest that you hasten to acquire it. *J.T.*

Sound: A                      Performance: A+

**What's Wrong With This Picture?:**

Andrew Gold  
**Elektra 7E-1086**, stereo, \$6.98.

I've had the proverbial high hopes for Andrew Gold—especially since

I'm not Linda Rondstadt's biggest fan. Every Linda Rondstadt record of the past two years or so has been relatively dull save for the blistering guitar solo by Andrew Gold, which usually verges on being so absolutely incredible it saves the song until the sound of Linda's voices renews the verse and brings the listener back to zero level of good taste. I mean let's face facts—anyone with good ears can tell that Linda's voice has had better days, and anyone who can read can tell she doesn't write the songs, but her voice is enough to bring the songs over and her good looks manage to put her over the top just far enough so that she's "a big hit singer." But hardly what you'd call an artist. If there's any artistry on a Linda Rondstadt, it's due to her producer Peter Asher (one half of Peter & Gordon and though his sister is better-looking, he's not a half-bad pop producer) and the present and accounted for guitar whiz Andrew Gold.

AUDIO • April 1977

Unfortunately, his solo career to date has not been astounding, as the guitar playing is laced minimally throughout the albums (and his soloing on his own records doesn't touch his work on Ms. Ronstadt's), the songs are erratic (to say the least), and his singing is no great shakes. One minute he's Barry Manilow and the next minute he's rocking out—it's hard to believe a singer who's so inconsistent. His ballads are OK but highly derivative (bordering on plagiarism), and his rockers aren't bad but they don't exactly stay with you. His treatment of non-original material is as if he deliberately is trying to make singles, and singles are born easier than they are contrived; however, his treatment of *Do Wah Diddy* has its moments.

All in all, a bunch of very good backing tracks that would be very comfortable in the hands of the right artists. No one artist could sing all 11 of these tunes even if he had the greatest set of pipes in the world, and Andrew Gold, a fair singer at best, shouldn't attempt it. I'd like to see him make an album someday—but for now he's just a sometimes gifted songwriter, Linda Ronstadt's guitarist, and yet another carrot top frustrated by a world run by those with blond, brunette, or grey hair. J.T.

Sound: B Performance: B —

**Gulf Winds**, Joan Baez  
A&M SP-4603, stereo, \$6.98.

**33 1/3**: George Harrison

**Dark Horse DH 3005**, stereo, \$6.98.

Both of these albums have some really fine moments on them. *Dear One* is as touching a love song as George Harrison has ever written. And Joan Baez has rarely sounded this sure and confident in the studio—the success of the **Diamonds and Rust** album has surely buoyed her both as singer and writer. The Jackson Browne-like *Kingdom of Childhood* is undeniable; *Still Waters at Night* is lovely.

However, considered as wholes, both albums finally leave me absolutely cold. They may be solidly constructed, but somehow neither really matters to me. Both are songwriter albums—the only non-original, oddly enough, is on **33 1/3**, Cole Porter's *True Love*. Both records are personal, often confessional and usually cathartic. The entire weight is on the songs, and they have to connect for the listener personally, one after another, for the whole to become more than

assembled parts. Sorry, I remain unmoved this time around. M.T.

**Both Discs:**

Sound: B Performance: C+

**Music Fuh Ya' (Musica Para Ti)**: Taj Mahal

Warner BS 2994, stereo, \$6.98.

With a new label to make him happy, Taj Mahal has issued the most satisfying album he has yet made with his Jamaican-inspired band. What is peculiar is that the band's Jamaican reggae roots have receded before the influence of the calypso of Trinidad.

The biggest differences are the addition of a full-time steel drum player, who makes Elizabeth Peavy's standard *Freight Train* new and numbers like Taj's own *You Got It* and *Sailing into Walker's Cay* work.

The music on *Fuh Ya'* is catchy and nearly irresistibly tuneful. The album is a total departure from the mainstream of pop and a refreshing dip at that. *Walker's Cay* gives the geographical coordinates. The unlikely fusion of calypso and blues as predominant strains marks the welcome return of one of our most continually

# Listen to the music.

PHASE LINEAR 1000



Noise in the form of hiss, hum and rumble—all the things that effectively cloud the clarity of records, tapes and FM broadcasts. Ideally, music should be heard against a silent background. The Phase Linear 1000 achieves just that with two unique systems: AutoCorrelator Noise Reduction and Dynamic Range Recovery. The AutoCorrelator reduces noise by 10 dB without the loss of high frequency music and without pre-encoding. The Dynamic Range Recovery System restores 7.5 dB of the overall dynamic range, without the pumping and swishing associated with other systems. The Phase Linear 1000 represents the most significant improvement in sound reproduction for the money... more than any other single piece of equipment you could add to your system. It is easily installed to any stereo receiver or preamplifier.

Ask your dealer for an audition, and listen to the music.

# Not the noise.

*Phase Linear*

The Powerful Difference

Enter No. 19 on Reader Service Card

Manufactured in the USA. Distributed in Canada by H. Roy Gray, LTD.

# dynaco's sound starter



Learn what Dynaco's legendary sound quality and ease of assembly is all about. Save \$100 in 3 or 4 evenings and hear the finest sounding low cost amp/preamp ever! Dynaco's SCA-50. Get the satisfaction of the famed PAT-5 and Stereo 150, at 50 watts power (though it seems much more) and a price that's even lower than that! Optional wood cabinet shown.

**dynaco**  
**dynakit**



For free catalog, write Dept. S-3  
Box 88, Blackwood, N.J. 08012  
Enter No. 51 on Reader Service Card

86

## the audio amateur ?

THE AUDIO AMATEUR is a quarterly for the enthusiast who enjoys hands-on work in building or customizing his audio equipment, or technical savvy about his hi fi gear. TYPICAL ARTICLES: Octave equalizers. Transmission line loudspeakers with 8" to 24" drivers. Electrostatic speakers with a 900 Watt direct drive amplifier. Mixers, preamps, parametric equalizers, stock equipment modifications for Heath and many Dynaco units. Completely tested circuits, construction aids, etched circuit boards, parts sources. "Craig Stark of Stereo Review says: "Those interests of the 'home constructor' The Audio Amateur serves are... absolutely top quality. The magazine is, I think, the only American publication devoted to the really serious audiophile constructor."

DEPT A P.O. BOX 176  
PETERBOROUGH  
NH 03458 U.S.A.

**the Audio  
Amateur**

- Check here for free prospectus.  
 I enclose \$9.00 for 4 quarterly issues.  
 I enclose \$25.00 for twelve issues.

NAME \_\_\_\_\_  
ADDRESS \_\_\_\_\_  
CITY \_\_\_\_\_ STATE \_\_\_\_\_  
ZIP CODE \_\_\_\_\_

Please allow six weeks for delivery. Rates above are for the U.S.A. only. Rates for other areas available on request.

Enter No. 3 on Reader Service Card

## HEAR IT YOURSELF KIT

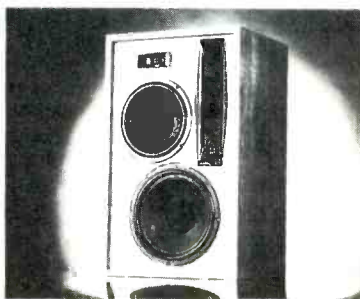

This is a Speakerlab 7, a 4-element acoustic suspension speaker kit you can assemble yourself in an hour with simple tools.

It saves you up to 50% over comparable ready made systems. Read about the S7 and other systems and raw speakers we sell in a new 40 page catalog. It's a fact-packed manual with chapters on acoustic theory, enclosures, choosing drivers and design principles.

And it's free. Just write us and ask for the most complete catalog/manual ever written on speaker building.

**Speakerlab®**  
Dept. AD-2 / 5500 35th N.E. / Seattle, WA 98105

fascinating and illuminating eclectics to the top of his stride. *M.T.*

Sound: B+ Performance: B+

**When Scopes Collide:** Kaleidoscope Pacific Arts/Island ILPA 9462, stereo, \$6.98.

Kaleidoscope was one of the original eclectic bands to emerge from San Francisco in the late '60s. In the course of several albums, they covered musical types ranging from various traditional American folk and country forms through Middle Eastern and Eastern European music to straight-out rock'n'roll and on to pure "space" music.

**Collide** is the group's first reunion disc in over five years, and they ambitiously cover lots of ground again, all the way from Duke Ellington's *Black & Tan Fantasy* to *Ghost Riders in the Sky*, from this year's most fashionable Chuck Berry song *You Never Can Tell* (in at least its fourth recording in a year) to *Man of Constant Sorrow* and a *Balkan Blues* number. Kaleidoscope does them all with ease.

**When Scopes Collide** has all of the original group members including David Lindley pseudonomously as DeParis Letante. The group plays with joy and intelligence. Even if they never become more than a very tasteful curiosity, they are the kind of band that makes the whole more worthwhile just by being there. *M.T.*

Sound: B Performance: B

**Photographic Smile:** Mr. Big Arista 4083, stereo, \$6.98.

In 1976, Mr. Big was perhaps the most promising new group from Britain. In 1977, Mr. Big has blown it.

Their first album, released only in Britain was hard-hitting, intelligent, gutsy English rock produced very well by the very English John Punter. Featured was the Steve Marriottesque voice of Dicken, who also happened to play guitar very well and write nifty songs. Somewhere in between London and Los Angeles one Mr. Big died and another was created.

You see, their record company teamed them up with a new producer (Val Garay) to make hit records (they didn't hear hits on the first album), and so we have a Mr. Big that doesn't rock, that does not feature the lead guitar of Dicken except in a few choice spots, that sounds like your typically reprocessed band, that features the drums of the very American and quite boring Jim Keltner, and that has very little to distinguish them out-

AUDIO • April 1977

side of Dicken's voice. Which, if it were to be found singing Small Faces or Humble Pie songs, could not be distinguished from Steve Marriott's set of pipes. Aside from that, everything's OK.

The only saving grace on this album is that *Wonderful Creation*, *Sweet Silence*, and *Zambia* have been saved from the first English album (along with *I Ain't Been A Man*, a lesser track) and transplanted here amongst the easy listening trash so you can hear the old Mr. Big before they were tampered with. The one new rock 'n'roll track, *Easy*, pales next to the grand *Wonderful Creation*, so you can judge for yourself the superiority of the English Production Sound to that of the American. Someone is steering this group wrong, and unless they sell a phenomenal number of albums—which is possible but not particularly probable—it's all for nothing. I guess that Mr. Big, instead of being the new exciting band that they could have been, will just serve as a lesson to all of us that minding your manners and toning down your rock'n'roll doesn't necessarily portend a change for the better. In this case, I'd guess that the next move will be for Dicken to go solo and leave Mr. Big behind, along with his only real chance to be the new rock'n'roll leader. How dreadfully boring!

J.T.

Sound: C — Performance: C

**Leo Kottke**

**Chrysalis CHR 1106**, stereo, \$6.98.

Leo Kottke's first for Chrysalis is a totally instrumental set which fully showcases the scope of Leo's alternately exuberant and graceful virtuosity. Jack Nitzsche did the arrangements in magical fashion, like a disappearing act or the interlocking rings illusion. Elements appear and vanish in the twinkle of a note, sometimes an overdubbed guitar or two, maybe a bass fill or a single flute or oboe to sonically offset Leo's liquid guitar ideas. Yet most importantly Nitzsche never pushes Leo out of the sonic focus; Kottke is ever at the core.

For an album like this clarity of sound is essential, and it has been well achieved. With occasional Old West imagery in the titles and music, **Leo Kottke** ultimately most resembles some subtle soundtrack music for a John Ford movie never shot. It might even have starred Gregory Peck and Susan Hayward.

M.T.

Sound: A — Performance: A —

AUDIO • April 1977

# You and 9 other people... that's all for today.

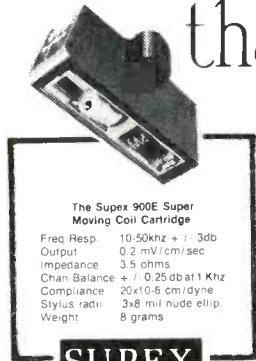

The Supex 900E Super Moving Coil Cartridge  
 Freq. Resp. 10-50kHz + / - 3db  
 Output 0.2 mV/cm/sec  
 Impedance 3.5 ohms  
 Chan. Balance + / - 0.25 db at 1 KHz  
 Compliance 20x10<sup>-6</sup> cm/dyne  
 Stylus radii 3x8 mil. nude ellip.  
 Weight 8 grams

**SUPEX**

About \$150 at America's leading component shops.  
 Brought to you by Sumiko, Inc.  
 Box 5046 Berkeley, Ca. 94705

The performance criteria and quality of the Supex 900 Super are such that only about 10 a day are completed for the USA. Each is constructed, tested and adjusted, by hand. For years, the most discerning music listeners have preferred a Moving Coil cartridge. Supex Super's Uni-Axial Unipivot stylus stands clearly above in even this elite group. Read what it revealed to High Fidelity in their recent test/review:

"... the transients are separately reproduced, rather than smeared together... the listener, and not the cartridge, decides what features of the music are worthy of attention."  
 "... one terrific phono cartridge... Supex Super makes it all seem easy."

And that is the mark of greatness! Hear it today, with your music, through your system. We're certain you'll join the nines of others who choose Supex daily above all others.

They know what they're hearing!

## See What You've Been Missing... Read Audio's Classified

87

What you don't know  
about effective tip mass  
won't hurt you,  
just your records.



You can find out what you don't know by contacting us for our comprehensive cartridge brochure.

**Bang & Olufsen**

Bang & Olufsen of America, Inc., Dept. 10F  
 515 Busse Road, Elk Grove Village 60007

Enter No. 39 on Reader Service Card

# Jazz & blues



88

**Secrets:** Herbie Hancock

**Musicians:** Herbie Hancock, miscellaneous keyboards; Bennie Maupin, tenor sax, soprano sax, bass clarinet...; Wah Wah Watson, guitars; Ray Parker, guitar; James Levi, drums; Paul Jackson, bass; Kenneth Nash, percussion.

**Songs:** *Doin' It, People Music, Cantelope Island, Spider, Gentle Thoughts, Swamp Rat, Sansho Shima.* Columbia PC-34280, stereo, \$6.98.

The biggest and actually the only secret about **Secrets** is the obscurity of Hancock's consistently superb keyboard presence. This secret ripens into full-fledged disappointment as soon as the stylus runs through side one of the disc.

The keyboard brilliance, so readily identifiable as Herbie Hancock's, is disappointingly lost in a quagmire of *ostinato* bass lines and in similarly uninspiring keyboard, guitar, and percussive accompaniment. The few moments we are allotted to savor Hancock's ivory journeys are firmly rooted in the musical success of his album **Headhunters**. *Sansho Shima* is high-

lighted by an acoustic solo, and, reminiscent of his cut *Sly, Swamp Rat* brings to mind *Chameleon*, while *Gentle Thoughts* is a laid-back, a funky cut which is also acceptable listening.

While no one can expect Hancock to go back and make more albums like **Maiden Voyage** or **Speak Like A Child**, we should expect the albums he does release to be as smokin' musically as some of his previously released platters. It isn't worth chancing the exorbitant price for an album such as **Secrets** when less than one side of the music may be acceptable.

Eric Henry

**Oscar Peterson in Russia:** Oscar Peterson

**Pablo 2625-711**, stereo, two discs, \$7.98.

**Oscar Peterson in Russia** is a two-record set recorded on a concert stage in Tallinn, USSR, and it is probably the finest this pianist has produced in concert.

Peterson, the heir to Art Tatum's

style, who has all of Tatum's digital dexterity, can also convey the full impact of a classic Tatum performance with its subtle phrasing and dazzling use of dynamics. Peterson has more of an orchestral approach to the piano than Tatum had (he is closer to Errol Garner in this respect), in fact, he is a complete orchestra when he sits at the keyboard, functioning brilliantly without a rhythm section.

The opening tracks on side one—*I've Got It Bad, I Concentrate on You, Hogtown Blues* and *Place St. Henri*—are Peterson solo excursions, and they are mini masterpieces. On side two he is joined by the fine Swedish bassist Niels Pedersen, then, for most of the second record, the drummer Jake Hanna joins in. With the addition of the rhythm section, the character of the music changes somewhat. On pieces like *Green Dolphin St.* and *Take the A Train*, Peterson shifts to a swinging, sharply percussive attack, more in the horizontal, single-note linear approach of the Bop school.

I have reviewed several Oscar Peterson albums on these pages, but Os-



car Peterson in Russia is particularly outstanding and should be heard by anyone who has a liking for or an interest in jazz piano. The on-the-spot recording, incidentally, is crisp and clean. *John Lissner*

Sound: A Performance: A+

**House of Byrd:** Donald Byrd

**Musicians:** Byrd, trumpet; Art Farmer, trumpet; Jackie McLean, alto sax; Barry Harris, piano; Doug Watkins, bass; Art Taylor, drums; Phil Woods, alto sax; Al Haig, piano; Teddy Kotick, bass, Charlie Persip, drums.

**Songs:** 'Round Midnight, Dig, The Third, Contour, When Your Lover Has Gone, Dewey Square, Dupletook, Once More, House of Chan, In Walked George, Lover Man.

**Prestige P-24066**, stereo, \$7.98.

The **House of Byrd** twofer, particularly important in light of Byrd's commercial success, are reissues from two 1956 dates. The first spotlights the trumpets of Byrd and Art Farmer with altoist Jackie McLean. While both trumpeters perform exceptional solos, Farmer takes a slight edge as the two trade fours in trumpet chases on Miles Davis' *Dig* and Byrd's own composition, *The Third*. Farmer has a cleaner sound with flawless articulation, while Byrd tends to jump into a number of his own fours with jaggedness that interrupts the pinpoint continuity of the attacks set up by Farmer.

Byrd shines in a very personal rendition of Monk's *'Round Midnight* in which Barry Harris' appropriate comping of chords proves to be the perfect accompanist.

The only "beef" about the first session of this twofer is the apparent tape saturation of the three horns, which is evident as they play the heads of the tunes though not necessarily on the solos. The ensembles come across in a somewhat brash reproduction, in the direction of a white noise, though not as extreme. This is a fine point, but it caught my attention.

The second session should have proved more enjoyable to me since I prefer Phil Woods over Jackie McLean, though at the time of this recording both were on musical ground not too far from Charlie Parker. Note Woods sparkling solos on *Dewey Square* and *Lover Man*, recorded two years before Byrd's death.

On the back cover of the album, Ira Steingroot writes: "Donald Byrd came out of Detroit as part of an astonishing burst of talent to hit New

## An Excellent Loudspeaker Needn't Cost A Fortune The Polk Audio Monitor Series



These three loudspeakers cost \$79, \$129, and \$199 each. They sound remarkably similar to each other. They also sound remarkably similar to speakers which sell for three, four, or five times as much.

The Polk Audio Monitor Series (even the Mini-Monitor Super car speaker) all incorporate a one-inch soft-dome high frequency unit, a phase coherent crossover using large air core coils, ultra-low mass plasticized polymer laminate upper bass-midrange drivers and fluid coupled sub-bass radiators. The sound is natural, boxless, and of consistent high definition.

We invite you to visit the finest audio salons to compare our speakers with the best made (costing up to \$4000 a pair!). Be ready for an ear-opener.

Write us to find out where.

**polkaudio**

4900 Wetheredsville Road  
Baltimore, Maryland 21207

## FREE McIntosh CATALOG and FM DIRECTORY

Get all the newest and latest information on the new McIntosh Solid State equipment in the McIntosh catalog. In addition you will receive an FM station directory that covers all of North America.



### MX 113

FM/FM STEREO - AM TUNER AND PREAMPLIFIER

**SEND  
TODAY!**

McIntosh Laboratory, Inc.  
East Side Station P.O. Box 96  
Binghamton, N.Y. 13904  
Dept. 1

NAME \_\_\_\_\_

ADDRESS \_\_\_\_\_

CITY \_\_\_\_\_ STATE \_\_\_\_\_ ZIP \_\_\_\_\_

If you are in a hurry for your catalog please send the coupon to McIntosh.  
For non rush service send the *Reader Service Card* to the magazine.

—Leader in the Microphone Field—

# Primo

**Professional Studio Unidirectional Electret Condenser Microphone EMU-4520**

- ◆ The EMU-4520 offers top studio quality within the reach of even the smallest studio integral 10dB level pad and low frequency control. Flat line response and great cancellation. High signal-to-noise ratio. Quality detachable us. Easily converted to omnidirectional or super-cardioid.

**Omnidirectional Dynamic Microphone DM-1525**

- ◆ Perfect feel and balance for all handheld use. Ideal all around entertainers microphone.
- ◆ Unique head design eliminates popping and handling noise.

**SPECIFICATIONS:**

MODEL	EMU-4520	DM-1525
Frequency Response	20~20,000Hz	40~15,000Hz
Output Level	-71dB ±2.5dB	-76dB ±3dB
Output Impedance	200Ω Balanced	

MODEL ▶ DM-1525

MODEL ▶ EMU-4520

• For further information write or call us today.  
**PRIMO MICROPHONE INC.**  
 2468 DELTA LANE, ELK GROVE VILLAGE, ILL. 60007  
 PHONE: 312-595-1022

**PRIMO COMPANY LTD.**  
 TOKYO, JAPAN

Enter No. 23 on Reader Service Card

90



## Is your name and address correct?

Please check the address label on this issue of Audio. If not accurate, please send corrected label, with this notice, to:

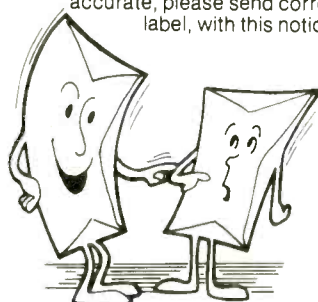

**Circulation Department**  
**Audio**  
 North American Building  
 401 N. Broad St., Philadelphia, PA 19108

## REDISCOVER your RECORDS

There's much you don't know about your favorite music. How many voices were in that chorus? What kind of piano did you hear? PS AUDIO's new one of a kind phono preamplifier offers receiver and integrated amp owners a unique alternative to expensive components. We guarantee records played thru this state-of-the-art preamp and your system will sound clearer, with more detail than before. Write us for a free brochure on our preamp and money back guarantee.

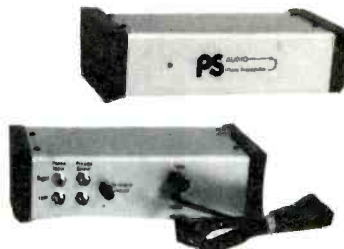

\$59.95\*

\*Introductory offer

PS AUDIO 2734 Industrial Parkway, Santa Maria Calif. 93454

Enter No. 24 on Reader Service Card

York... Since then he has remained in the spotlight, reaching peaks of success far beyond most of his contemporaries." The **House of Byrd** holds a solid place in any jazz library.

Eric Henry

### One and Two: Mal Waldron Prestige P-24068, mono, \$6.98.

Prestige presents an interesting double-set focusing on pianist Mal Waldron working in the late 50s with various cool/bop, hard bop, and neo-bop musicians. Personnels shift, but include tenor John Coltrane; alto saxists Gigi Gryce, Sahib Sahib, and Jackie McLean; trumpeters Bill Hardiman and Idrees Sulieman; and drummers Art Taylor and Ed Thigpen. Waldron is a highly skilled pianist out of the bop tradition who shows the influence of Monk and Bud Powell, but whose playing has a character very much his own.

What is most striking is Waldron's highly individualistic and often unorthodox approach. Many of the fine pianists out of Bud Powell proceed along predictable lines, rarely shading their playing or offering much in the way of surprises. Waldron makes discerning and unusual use of piano pedals, and is not afraid to wander in and out of tempo. His lines, as on *Bud Study*, for example, with the Gryce/Sulieman group, are complex and full of rhythmic suspense. He likes to give the impression of working in two time signatures at once. A slow mournful reading of Billie Holiday's *Don't Explain* by Waldron and the Coltrane-McLean-Hardiman group is another outstanding side, with horns supplying the eerie, modal textures for the pianist's adventurous solo.

Most of the music on this Prestige "twofer" has a hard bop flavor, which is not to say that it's emphasis is on frenetic, whirlwind tempos and mechanical changes. The arrangements are cleverly organized and the solos imaginative. Coltrane and McLean swing hard and bristle with ideas within the neo-bop framework. This is a good cross section of the modern jazz of the late 50s, and a fine showcase for Waldron, a pianist of quality and originality.

The sterling recording job done by Prestige engineer Rudy van Gelder in 1956 and '57 has been preserved and indeed enriched by David Turner's excellent remastering of the original recordings and tapes in the Fantasy studios. The sound is clear and sharp.

John Lissner

Sound: A+ Performance: A+

AUDIO • April 1977

# Classical reviews

Edward Tatnall Canby

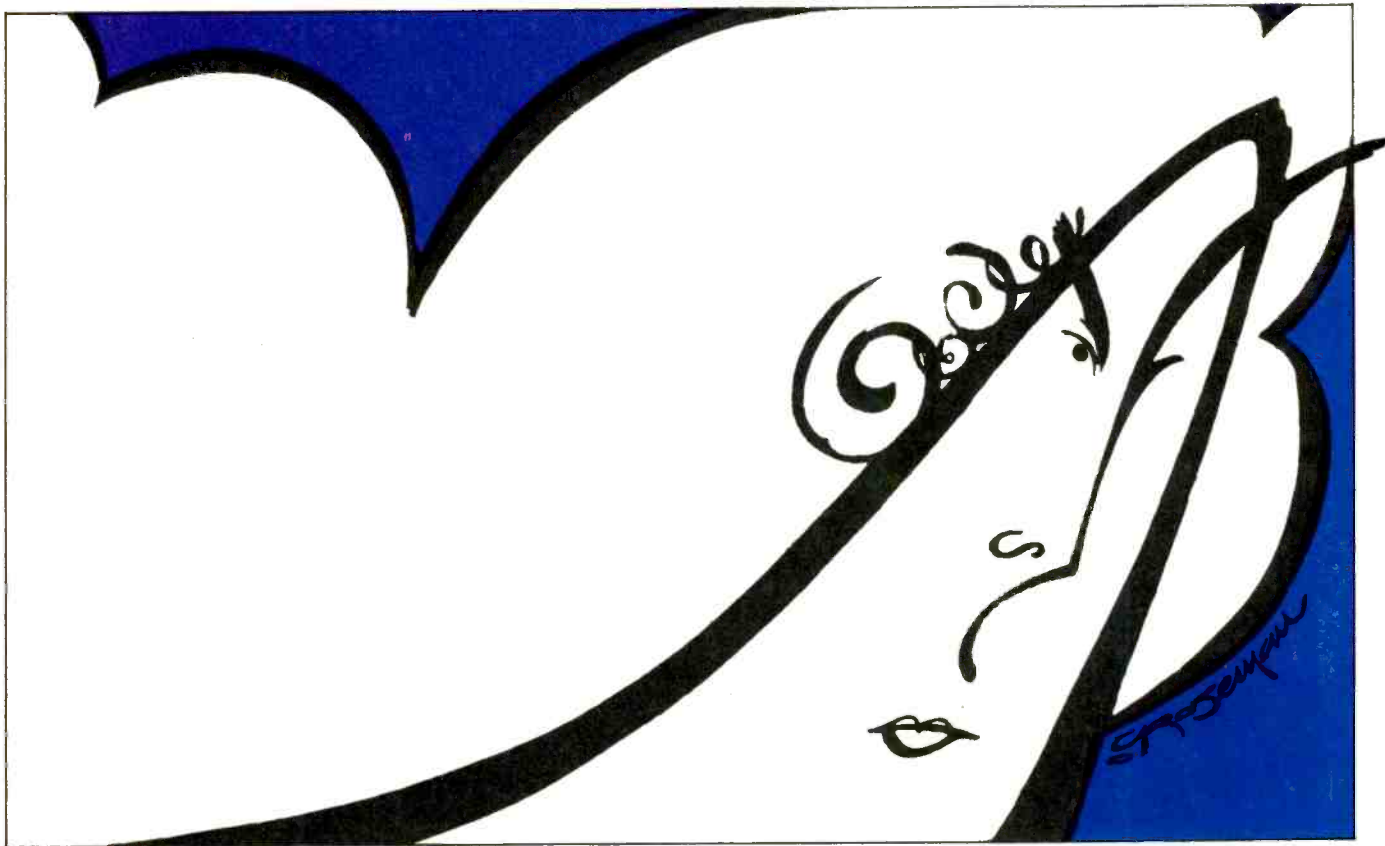

91

**Handel: The 16 Organ Concertos.** Daniel Chorzempa; Concerto Amsterdam, Jaap Schroeder.

**Philips 6709 009**, 5 discs, stereo, \$39.90.

**Handel: Complete Organ Concertos (Saemtliche Orgelkonzerte), Op. 4, Op. 7.** Herbert Tachezi; Concentus Musicus Wien, Harnoncourt.

**Telefunken 6.35282**, 3 discs, stereo, \$20.94.

Extraordinary. Two complete European sets of these splendid Handel works in a single year, both done in the new "authentic" manner with updated lively tempi, quantities of added ornamentation, improvised cadenzas, even whole improvised movements—and, above all, the music played on instruments of Handel's own time, notably the Baroque oboe, old-type strings, and natural, valveless wind instruments. It figures. It had to be this way. And the sound is great! But two albums? Even if Philips adds an extra four concertos over Tele-

funken's standard 12.

An extraordinary problem, interpreting these, perhaps the toughest in all Baroque music. Not only did Handel himself play them with all sorts of added ornamentation not in the written notes, but he made up whole movements on the spot—and then left blanks, marked merely *organo ad lib*, for later organists to make up their own music. Imagine that, today! Like a jazz improvisation session. One concerto, for instance, has four movements two of which are to be composed by the organist.

Well, believe it or not, one of these organistic obliques, via Telefunken. Mr. Tachezi makes up his own movements on the spot—he did it differently, they say, in each "take." It works pretty well except that, being such a feat, it tends to get overdone. Too much, too intense, the made-up music more like heavy Bach or Buxtehude (!), all preludes and fugues and overbalancing

the more relaxed and easy Handel. Still—a remarkable feat. But another way to cope, as Handel surely did himself, being notorious for borrowing his own and others' music, is to make use of another work by the composer, chosen for the right mood and key. Mr. Chorzempa on Philips takes this wiser course, and I find the results very satisfying—think of the bonus Handel you get, too. Somehow, the Tachezi improvising makes me nervous. Too stumpy, a tightrope sort of thing.

I enjoyed both albums, even so, and both are on the highest level. Either way, you will find the best baroque imaginable and the easiest, enough for many a long evening without a bit of trouble. It flows so easily, this music, and it is so genial! Good to see how widely the two versions agree on the fundamentals of the new style of performance, while rightly diverging in the ornamental detail. If you have

# Hello, gorgeous!



92

If this looks good to you, you've come to the right place. The Roosevelt.

You're here on business? Small world! So are we.

We're right in the middle of the reason you came to New York.

Easy in, easy out, super fast service from the best people in the business.

And you've gotta love the neighborhood.

Out your window in the morning? BBDO! Union Carbide! Pan Am! Brooks Brothers!

If you came to New York to do a little business, get a room with a view: The Roosevelt, Madison at 45th, New York City.

## THE ROOSEVELT

What we are is where we are.

(800) 221-2690. In New York State, call (800) 522-6449. In the city 661-1717.  
Call your corporate travel office or travel agent.

the cash and the time you might buy both, for endless interesting comparisons.

If you must choose, then take Philips. Much as I admire that pioneer of the "authentic" orchestra, Nicholas Harnoncourt, I find his Handel just a bit more nervous and driving than the genial but precise Dutch playing on Philips. Nor is the sound as limpidly clear. As for the organ, the Philips instrument is absolutely lovely in the sonics, and very English-Handelian, whereas the Telefunken organ is more conventionally continental Baroque, a bit thin and squealy in the recording. Tachezi is good—but Daniel Chorzempa on Philips is a superb Handel organist. Even beyond all this, the sheer coordination between organ and orchestra, both in the incredibly accurate playing and in the ideal "dialog" of the recorded balance, is just not to be believed on Philips. Never heard anything like it! On the grounds both of art and science, this is one of the great recordings.

**Leo Ornstein: Three Moods; Quintette for Piano & Strings, Op. 92.** Westney, pf., D. Stepner, M. Strauss, vls., P. J. Sacco, vla., T. Mansbacher, cello.

**CRI SD 339**, stereo, \$6.95.

The first recording of a curious genius of the early part of this century who "faded out" suddenly in 1920 but still lives on, composing away, in his mid-eighties. Ornstein in the 'teens was one of those flaming youthful radicals who turn the musical world upside-down with sheer fascination—he was not only a shockingly violent composer but a super-brilliant pianist and critics put him up along with Schoenberg and Stravinsky among the towering figures of the "futurist" world. The first works on this record quickly tell you why, the *Three Moods* from around 1914.—Phew, what a growling and a roaring and a pounding! Super ferocity, I'd call it. Significantly, the music wasn't written down for 30 years—like Mozart, Ornstein had total musical recall and could write any quantity of music in his head and just keep it there. We can suppose he still does.

But the *Quintette*, composed much later, in 1927, pretty much tells the story; it is a noisy but quite tame piece, of late-Romantic cast, only superficially dissonant and not at all forward looking. Ornstein had been passed by... Well, the record liner notes disagree with me on this, calling

AUDIO • April 1977

the *Quintette* one of Ornstein's major works. You try. I'll content myself with wondering what the old man has been composing, right along, all these many years since! Strange disappearance, but it can happen.

We must understand that genius *potential* appears right along, again and again, in the human race. But it takes the right man/woman plus the right time and place to do genius work. Mozart, Edison, Einstein, Beethoven, Armstrong???? You name them.

**Sentimental Songs of the Mid-Nineteenth Century.** (Foster, Work, Root.) American Music Consort, Joseph Byrd.

**Takoma A-1048**, stereo, \$6.98.

A very right idea gone wrong here. The sentimental parlor music of the last century is indeed worth reviving, and especially the music of that superb tune writer Stephen Foster, who is peerless in any company. Six of his tunes are on this record, and it was a pleasure to hear them after so long. (Glory be—when did I last hear *My Old Kentucky Home*?) Too, the careful, tastefully varied arrangements, for a modest instrumental ensemble and, occasionally, a solo harp, are excellent as post-biceronial fare, minus all razzle dazzle except, understandably, in a couple of patriotic-type items. Ok there.

But the Parlor? Yes, these ditties were indeed sung in the family circle, in hundreds of quiet homes without benefit of hi fi, TV or any sort of high powered professionalism. WHY, then, pick a quartet of big, loud, operatically trained voices to bellow the music out at us until our ears ring? (And why over-record them to the point of ugly edginess?) Only the mezzo voice, in one solo song, gives us some approximation of the modest, simple kind of singing for which the music was meant. Really distressing.

Look—this was high-level "pop" before there was pop. Any number of current pop singers, young or old, folksy, jazz, musical comedy, could do a lovely job on these, with small voices and being unbelligerent! Why—then? Voices, voices everywhere and the one type NOT to use for this music is the big classical-trained singer! Even a "Pro Musica" group, the old-music specialists, would do it well. Or maybe just your aunt Jemima and Uncle Bill down the street. NOT these singers. Sorry, folks, because I love this music.

AUDIO • April 1977

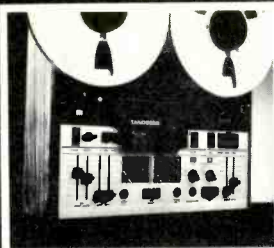

The new Tandberg 3500X



The first Tandberg tape recorder, 1952.

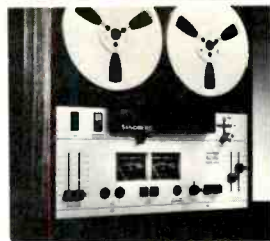

The new Tandberg 10XD.

## We still make them the way we used to.

Tandberg tape recorders have changed in many ways since we first began building them 25 years ago. But one thing has never changed—the Tandberg philosophy. It has always been our goal . . .

- To produce the finest possible sound reproduction equipment
- To build in the best possible combination of high performance and product reliability
- To create designs that make

repair service as easy as possible

- To improve our performance standards whenever possible

**Quality. Honesty. Precision.**

**Reliability.** Those are the principles that guide the design and manufacture of every Tandberg product. And every instrument we have produced during the last quarter-century has added to our reputation as the maker of the world's finest consumer tape recorders.

For a color catalog of facts and figures, write to us. It's worth \$1.50—but we'll send you a copy absolutely free.

### TANDBERG

of America, Inc., Labriola Court, Armonk, New York 10504

Enter No. 35 on Reader Service Card

Listening to your favorite records and tapes through the dbx 117 dynamic range enhancer is like having a new record collection. Now you can hear up to 20 dB of the missing dynamics the record or tape manufacturer sacrificed (for reasons we explain in our literature).

## new record collection for \$175

With the dbx 117 in your system you'll hear the higher harmonics of strings, the incisive bite of brasses, and the sharp attacks of cymbals and percussion as you've never heard them before except in live performance. As an added bonus, the dbx 117 substantially reduces record surface noise and tape hiss on playback, and adds dynamic range to records, tapes, and FM broadcasts.

To experience a totally new dimension in recorded music listening take your favorite record or tape to your high quality component dealer and ask him to play it through the dbx 117. For complete product information and list of demonstrating dealers in your area, contact:



# dbx

dbx, Incorporated  
296 Newton Street  
Waltham, Massachusetts 02154

Enter No. 5 on Reader Service Card

# Classified

## FOR SALE

### FREE details... A DIFFERENT KIND OF RECORD CLUB

Discounts up to 73%, no "agree-to-purchase" obligations. All labels, Schwann catalog of thousands of titles; classical, pop, jazz, country, etc. Discount dividend certificates. Newsletter; accessories; quick service. 100% iron-clad guarantees. Write for free details.

**dmc** DISCOUNT MUSIC CLUB, INC. DEPT. 14-0477  
650 Main Street, New Rochelle, N.Y. 10801

**DON'T PAY THE HIGH MAIL ORDER PRICES.**  
THIEVES WAREHOUSE OF HIALEAH, 6741 WEST 4TH AVENUE, HIALEAH, FLORIDA 33012

**RECORDING TAPE** - Money saving values! Maxell, TDK, Scotch, Cassettes, 8 tracks, reels. Free price list. Northhill Sales, Box 98014-A, Des Moines, Wa. 98188.

### REMEMBER MY NAME!

By air parcel post in a short time you'll be able to get at a lower price, audio components and cords, kits of digital frequency display and multi-tester, etc. K. SDEDA, No. 5-9-503 Toshima 5-chome, Kita-ku, Tokyo 114, Japan

### STEREO SAVINGS!!

Most popular and esoteric brands.  
WILLNER, 223-B #4 Thayer, Providence, RI 02906.

94

**LOWEST DISCOUNT PRICES ANYWHERE** on audio equipment. All major brands discounted. Write for quotes, K&L Sound Services, 75 N. Beacon St., Watertown, Mass. 02172.

**DIAMOND NEEDLES** and Stereo Cartridges at Discount prices for Shure, Pickering, Stanton, Empire, Grado and ADC. Send for free catalog. LYLE CARTRIDGES, Dept. A, Box 69, Kensington Station, Brooklyn, New York 11218.

### NATURAL SOUND

invites you to hear the Sleeping Beauty, a new moving coil cartridge from Great American Sound, the amazing Rogers mini-monitors with the M & K Bottom End, the new KEF 'C' Series and the KEF Reference 104 with the improved aB crossover. Hear the new Ampzilla II...the world's finest amplifier.

Hear some of the world's finest equipment: Fulton, KEF, Quad, IMF International, Lentek, Magnepan, M & K subwoofers, Rogers and Visonik speakers, Great American Sound, Mark Levinson, Bravura, Paoli, Naim and DB Systems electronics, Linn Sondek and Connoisseur turntables with Grace, KMAL and Formula 4 arms and Shure V-15 III-G Satin, Denon and Fidelity Research cartridges, Onkyo tuners and Otari tape decks.

If you are interested in THE state-of-the-art system, contact us for details on the soon to be released Fulton Musical System. Write for our newsletters, catalog of audiophile records and a current listing of used equipment. NATURAL SOUND, 315 South 11th Street, Lincoln, Nebr. 68508. Call (402) 475-3325 noon to midnight.

**MODIFICATION MANUAL FOR VACUUM TUBE AUDIO EQUIPMENT** 190+ pages of audio philosophy, design criteria, general instructions for all tubed equipment, and step-by-step procedures for optimizing performance of many components. "Proprietary" modifications detailed. If you can build a kit, this will enable you to upgrade hardware once doomed to garage sales. Latest printing includes new information, including a construction project for a QUIET Nuvistor sub-preamplifier...and more! Includes free consultation service - \$25.00. California residents add \$1.50. AUDIO DIMENSIONS, 8898 Clairemont Mesa, San Diego, Cal. 92123.

## FOR SALE

### ILLINOIS - PRO MUSICA

We are pleased to offer listeners in this area the opportunity to experience the rewards of fine hi-fidelity components. We are the **EXCLUSIVE FULTON/FMI DEALERS** in Illinois and extend to you an invitation to hear the celebrated FMI J Modulars.

**PRO MUSICA - (217) 384-5415**  
603A W. California St., Urbana, Ill. 61801

**FUTTERMAN CAPACITOR COUPLED** output transformerless vacuum tube amplifiers; we're manufacturers-patentees; esoteric audio dealers sought. Golden Ear's Reference Loudspeaker system using KEF drivers; professionally assembled or kit. Promethean rare "Silk Purse" cartridge, exceptional clarity, \$150. C/M Labs CC-1 preamplifier, new \$360. English TriChannel mono tube amplifiers, new pair \$495. English Leak stereo preamp complete with case only \$165.00. Esoteric recordings, free list. **WANTED:** Used Marantz-McIntosh, Audio Research D-150 tubed equipment. GOLDEN EAR, Box 2189, Riverview, Michigan 48192. (313) 479-1234.

### INNOVATIVE AUDIO

The major reasons for YOU to participate in the "Innovative Experience."

- 1) We don't look at our watches while demonstrating.
- 2) We try to gently guide you in your selection by offering you information that is honest & concise.
- 3) We are NOT SNOBS.
- 4) We offer a wide range of super-quality equipment in all price categories.
- 5) We give service that most everyone else promises. We LEND units while your s is being serviced.
- 6) We are nice people.

Mark Levinson

Accuphase

Quintessance

DB Systems

SAE

STAX

Klipsch

OHM

Spendor

Celestion

Linn-Sondek

Technics

Ortofon

Supex

Grace

KMAL

Revox

TEAC

Sequerra

Dunlap-Clarke

Audire

Audio-General

BGW

Innotech

ADS

IMF International

Gale

Micro Seiki

Thorens

ADL

Denon

Satin

SME

SAEC

Beyer

DBX

After reading this weird but "Innovative" ad, we seriously hope you'll come by and "Experience" us.

129 Degraw Street  
Brooklyn, New York 11231  
(212) 596-0888

**CAMPUS REPS! CONSUMERS! DEALERS!** Most medium and many high end lines available at lowest wholesale. Make 10%/40% Repping/Demonstrating high quality loudspeaker line. Prices, info. \$1 (refundable w/order) + SASE. (812) 332-4252. AUDIO 1010 S. Dunn, Bloomington, Indiana 47401.

**ELECTRONIC CROSSOVERS—ALL TYPES.** Updated definitive booklet describes applications, how to improve speaker systems, \$5.00 postpaid, credited to first purchase. Huntington Electronics, Box 2009A, Huntington, Conn. 06484.

## FOR SALE

**HIGH END SPEAKERS IN KIT FORM.** High accuracy transmission line speaker systems featuring the best drive units by KEF, Celestion, Hartley and Philips.

**SYSTEMS AND SUBWOOFERS:** Commode type subwoofer with dual channel transmission line and two KEF B200 (SP1022 or SP1039) woofers with 100 Hz crossover. \$175 for kit, \$395 assembled.

**COMPACT TWO\*** and Compact Three\* two and three way systems with KEF and Celestion drivers in unique wool damped transmission line. From \$68 in kit form to \$215 assembled. \*Patent pending.

**WEBB** transmission line speaker. KEF B139, B110, T27, Celestion HR2000, wool, crossover. \$180 kit, \$350 assembled. Other systems at comparably low prices.

**RAW SPEAKERS:** KEF B139, \$60; B110, \$26; T27, \$18; Celestion HF2000, \$30; Peerless K040, \$17; K010 DT, \$13; Philips AD10100, \$40; Coles 4001, \$22; best prices on Hartley drivers. Prices include shipping.

**ODDS 'N' ENDS:** Long fiber wool, well teased and moth-proofed, \$5.75 to \$6.75 per pound; air core coils up to 22 millihenry, \$1.75 each plus 80¢ per millihenry. Mylar capacitors to 10 mfd, 75¢ to \$2.50; other capacitors to 160 mfd; walnut and rosewood veneer.

**WARRANTY AND POLICY:** Sixty day return privileges and five year warranty on all products.

Send two 13c stamps for complete catalog to:

TRANSLINE SOUND CO.  
Box 567  
Wyandotte, MI 48192  
313-382-2205

**DON'T PAY THE HIGH MAIL ORDER PRICES.** THIEVES WAREHOUSE OF MIAMI, 1756 S.W. 8th STREET. # 201, MIAMI, FLORIDA 33135.

## CLASSIFIED ADVERTISING RATES

**BUSINESS ADS** - For Sale, Help Wanted, Services, Business Opportunities, Shortwave, Tape Recordings, etc. etc. 60¢ per word (minimum charge for eight words per line, \$4.80 per line). First line set in bold face type at no extra charge. Extra lines set in bold face type: \$1.20 per word (minimum charge for eight words per line, \$9.60 per line). One point ruled box, extra charge \$8.00. Full payment must accompany order.

**NON BUSINESS ADS** - Situations Wanted, used equipment for sale by private individuals: 35¢ per word (minimum charge for eight words per line, \$2.80 per line). First line set in bold face type at no extra charge. Extra lines set in bold face type, 70¢ per word (minimum charge for eight words per line, \$5.60 per line). Full payment must accompany order.

**FREQUENCY DISCOUNT** - 3 times, less 10%. 6 times, less 15%. 12 times, less 20%.

**BLIND ADS** - Box numbers may be used at \$2.00 extra for handling and postage.

### DISPLAY CLASSIFIED RATE

1 col x 1"	\$85
1 col x 2"	\$125
1 col x 3"	\$175
2 col x 1"	\$125
2 col x 2"	\$225

Advertiser must supply complete film negative ready for printing for mail order and display ads.

**AUDIO Magazine**  
401 North Broad Street  
Philadelphia, Penna 19108

**HOW TO ANSWER BOX NUMBER ADS**  
When replying to an Audio Box Number Ad, please use this address Box No. .... c/o Audio, 401 No. Broad Street, Philadelphia, Pa 19108.

## FOR SALE

**ATTENTION DYNACO PAT 5 OWNERS!** Our Pat 5 phono board update kit provides better definition, cleaner highs, tighter bass. Parts list and instructions-\$5.00. Complete Kit \$55.00 postpaid. Musical Sound Lab, Box 5503, Preston King Station, Arlington, Virginia 22205

### PALO ALTO CALIFORNIA

Dedicated to the proposition that audible differences between hi-fidelity components must form the ultimate basis for choosing among them.

Threshold	Rogers BBC
DB Systems	Dahlquist
Audionics	Linn Sondek
Ariston	Sonex
Connoisseur	Grace
Goldring	Onkyo
Supex	J.H. Formula 4
A.E.A.	Dunlap Clarke
Koss Model Two	Stax
Decca Brush	Discwasher
Decca Cleaner	Denon

### THE AUDIBLE DIFFERENCE

435 Tasso  
Palo Alto, Ca. 94301  
(415) 328-1081

**SUPEX — ORTOFON — DENON — OTHER MOVING COIL CARTRIDGE OWNERS:** Send for free literature on our Micro Preamp Superb performance at \$99.95. Huntington Electronics, Box 2009A, Huntington, Conn. 06484

**ANTI-SKATING for AR TURNTABLES!!** Proven counter-weight design of nickel steel & aluminum construction. Install yourself in minutes. \$7.00 postpaid. (Dealer inquiries invited.) AUDIO INNOVATIONAL PRODUCTS, P.O. Box 1607, Portsmouth, N.H. 03801.

## FOR SALE

### ENGLISH HI FI

B&W, Celestion, Decca, Tannoy, Garrard, Radford, SME, KEF, and very famous Transmission Line speakers for sale. Also, AEL Mini Monitors at £ 110.00 pair; Zeepa Anti-Static Gun for £ 6.50 + P/P £ 2.50; Formula 4 arm at £ 45.00 + P/P £ 4.00. All from stock. Write for immediate airmail reply on all prices. Mrs. Ling, Southern Audio Services Ltd., 43 High Street, Kingston, Surrey, UK. Tel: 01-549 3194. Telex - 929679 AEL G.

**NO COMPROMISE ENGINEERING IN THE TIME ALIGN™** drivers gives the SONEX TWO speaker system detail and focus comparable to the finest electrostatics, with the dispersion necessary for enjoyment throughout the room. Impeccably linear down to very deep percussive bass. The SONEX TWO will delight even the jaded audio fanatic. Absolute Audio, 305 E. 17th, Santa Ana, CA 92706.

**SOUND ADVICE MAGAZINE - THE FOURTH ISSUE** REVIEWS THE NEW SOLID STATE ELECTRONICS FROM AUDIO RESEARCH: THE SP-4 PREAMP, D-100 AMPLIFIER AND UPDATED TYMPANI I-D SPEAKERS. THE REMARKABLE NEW VERION TRANSFORMER IS COMPARED TO OTHER TOP MOVING COIL PREAMPS: DB SYSTEMS, DENON TRANSFORMER AND MAS-1. WE'LL LOOK AT SOME NEW CARTRIDGES: GRADO SIGNATURE ONE, GOLDRING 900, MICROACOUSTICS 2002E, ORTOFON MC-20 AND GRACE F9L. PARAGON HAS IMPROVED THEIR TUBE PREAMP NOW CALLED THE 12 AND ADDED A SIMPLIFIED NEW MODEL FOR UNDER \$500. THERE'S MUCH MORE INCLUDING RECORD REVIEWS AND A COMPREHENSIVE SURVEY OF LOUD SPEAKERS. FOUR ISSUES FOR \$12, \$15 FIRST CLASS AND \$16 FOREIGN (SENT AIRMAIL), SOUND ADVICE, 225 KEARNY STREET, SAN FRANCISCO, CALIFORNIA 94108.

**TANNOY SPEAKERS** all models, Quad-405 amplifier, 33 pre-amplifier. Write to Nat, 423 South Sixth Ave., Mount Vernon, NY 10550.

Western Pennsylvania's

## FINEST AUDIO DEALER

Lux	Optonica
Fulton Music J. System	Decca
Great American Sound	Denon
Ampzilla, Thædra	Supex
Mark Levinson Audio Systems	Fidelity Research
IMF International	Win Labs
B & W	ADC
Rodgers	Grace
Magnepan	J. A. Michell
Audire	Lecson
Stax	Armstrong
Radford	SME
M & K	Audiobanalyst
Ark Reference Record	Mark Levinson Reference
Revox	Records
Scott	dbx
Infinity	Connoisseur
	Dynaco

PLUS MUCH MORE

Shipping Prepaid & Insured

## OVATION

6019 Broad St. Mall

Pittsburgh, Pa.



412-441-4550

95

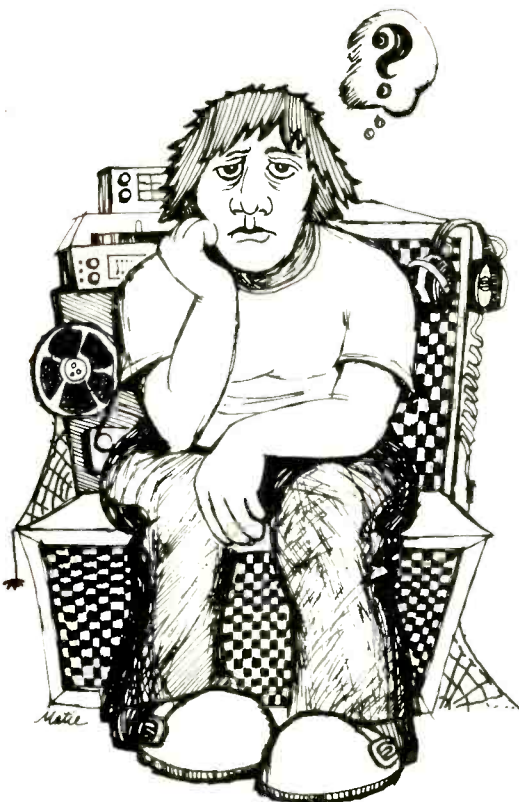

# Audio Classified Ads

Want to buy, trade or sell components? Want to offer or buy a service? Want a job in the audio field? Your ad belongs in Audio. Rates are low—results high.

RATES: Commercial, 60¢ per word; situation wanted or non-commercial, 35¢ per word. We reserve the right to determine classification as commercial or non-commercial. **Payment must accompany all orders.**

Place your ad today!

Send copy to:  
**Audio Magazine**  
401 N. Broad Street,  
Philadelphia, PA 19108  
Attn: Classified Dept.





## FOR SALE

!!HEART OF AMERICA AUDIOPHILES!!

Nebraska  
Kansas  
Colorado Oklahoma Missouri

AUDIO EXCITEMENT

from

SOUNDS GREAT STEREO, INC.

We are dedicated to matching your musical tastes with the finest audio equipment modern technology can provide.

Accutrack	Shure
ADC	Formula 4
ADS/Braun	Grace
AKG	Great American Sound
Audio Lab	JBL
Audio Pulse	Kenwood
BGW	Kenwood Pro
Dahlquist	KLH Research X
dbx	Koss ESL
Denon	McIntosh
Discwasher	Nakamichi
Epicure	Ortofon
ESS	Otari

+Great Products +Great Warranty  
+Great Service +Great People

SOUNDS GREAT STEREO, INC.

White Lakes Plaza Shopping Center

911A W. 37th ST. TOPEKA, KS. 66609  
CALL COLLECT: 1-913-267-1933

**DON'T PAY THE HIGH MAIL ORDER PRICES**  
THIEVES WAREHOUSE OF TAMPA

1531 SOUTH DALE MABRY, TAMPA, FLORIDA 33609

**DON'T PAY THE HIGH MAIL ORDER PRICES.**

THIEVES WAREHOUSE OF PLANTATION, 231 SOUTH STATE ROAD 7, PLANTATION, FLORIDA 33317

**BIGGEST DISCOUNTS** on audio - high-end components.  
Over 125 brands. Audio Unlimited, 466 Hawthorn, Sunnyvale, CA 94086 408/737-0828 evenings

**DON'T PAY THE HIGH MAIL ORDER PRICES** THIEVES WAREHOUSE OF FAIR LAWN, 34-09 BROADWAY, FAIR LAWN, NEW JERSEY 07410.

**BRITISH COLUMBIA, CANADA**

THE SOUND ROOM IS an organization dedicated to provide discerning audiophiles with the finest matched components to reproduce the most accurate sound available. We currently recommend the following products:

Audio Research	Dayton-Wright
FMI (Fulton)	Mark Levinson
Magneplanar	Dunlap-Clarke
Rogers (BBC Monitors)	Lux (Luxman)
mqvud	Phase Linear
BGW	Bose
Dahlquist	Infinity
KEF ('Super C' & 'Reference' series)	Thorens
Stax	Ariston Audio
Bozak	Linn Sondek
AR (Advanced Development Division)	Grace
Soundcraftsmen	SME
Micro-Acoustics	Goldring
KMAL (Keith Monks)	Denon

**FEATURE OF THE MONTH:** New Magneplanar Tympani IC loudspeakers now in stock and available for in-home demonstration.

THE SOUND ROOM  
2803 West Broadway  
Vancouver, British Columbia  
Canada V6K 2G6  
(604) 736-7771

## FOR SALE

**M&K BOTTOM END SUB-WOOFERS**  
POWERFUL, DETAILED, TIGHT, LOW BASS FOR THE  
BOTTOM TWO OCTAVES 80-20Hz.

If you have an ear for detailed sounds in bass, and a dislike for "tubby" sound, we invite you to listen to the new BE-1A, BE-1V and the DBE-1A. We believe they are the finest available sub-woofers.

A speaker for long sustained organ notes is easy to make and the M&K BOTTOM ENDS are excellent in this regard; but, for the discriminating audiophile, the BOTTOM ENDS also have:

- Superb detail on drum skin sounds and the ability to distinguish between various bass instruments.

- Solid feel of floor shock on Flamenco

- Exceptionally smooth transition to Quads ESL's, Acoustats, Magneplanars including T/M panels, Magneplan MG-II's, Dahlquists, Dayton-Wrights, KLH-9's, and other fine audiophile speakers.

- The lowest mid-bass & mid-range coloration of any sub-woofer we have heard.

- New M&K universal matrixing & non-matrixing crossover networks allow the use of one or two woofers, no bi-amping necessary, your present stereo amp does it all.

- Extended frequency response, superb tone burst & pulse response, high power handling capacity.

- The new DOUBLE BOTTOM END DBE-1A, our finest audiophile super sub-woofer produces extremely high level deep bass waveforms with thrilling detail & definition.

- New M&K BASS RAMP to allow BOTTOM ENDS to be used with high efficiency speakers such as Altec, JBL, Klipsch, Tannoy, etc. The ramp is passive, works out of your pre-amp tape in - tape out, and allows the full power of your amplifier to be available. Front knob adjustable up to 20 db. of correction.

**NEW BASS & TRANSIENT MUSICAL TEST RECORD VOLUME II**

- The new Bass & Transient Test Record, Volume II, contains a brilliant array of musical sounds in classical, jazz, marching bands, organ and opera passages.

- Each one is specifically designed to show and test improvements you can make to your system, as well as being enjoyable on their own. A description of each of the twenty bands tells what to listen for and its significance to audiophile equipment.

- A few critical passages are excerpted and repeated several times to avoid needle lifting and plastic deformation distortion in A-B comparisons or component evaluation.

- It is having an exceptional order rate from high-end audio dealers and manufacturers. Really demonstrates tubby vs. tight bass, very low frequencies and extremely high transient peaks in high frequency crescendos. Available at your M&K Dealer or by direct mail. (\$7.50-mail orders add \$1.00 for postage.)

- Includes: 1812 Overture Finale with live cannons; Pipe Organ and Orchestra; Bells; Flamenco Dancers; Xylophone; Harp; Steam Locomotive

**BE-1V "DAVID AND GOLIATH" - THE ALMOST INVISIBLE SYSTEM THAT SOUNDS LIKE A HUGE SPEAKER SYSTEM**

- The BE-1V is a super sub-woofer with an internally integrated matrixing crossover network designed to work with the new generation of small super speakers such as the "Visonic "David" 50's & 60's, B&W DM 5's, Roger's LS3/5A, Jim Rogers JR-149, Polk's, ADS', KEF's, etc.

- The above mentioned small super speakers permit excellent decorator effects & when used in conjunction with the BE-1V yield dynamic range, imaging, low distortion, definition and frequency response hard to distinguish from large audiophile systems.

- Write for full descriptive literature on specifications and principles involved. Of course, we don't expect you to believe until you hear one of these systems at your M&K dealer. Please come in and hear it. We have been enjoying watching that expression of disbelief disappear.

Send for literature and dealer list.

MILLER AND KREISL SOUND CORPORATION  
8719 Wilshire Boulevard  
Beverly Hills, California 90211  
213-652-8318

**DON'T PAY THE HIGH MAIL ORDER PRICES**  
THIEVES WAREHOUSE OF NORTH MIAMI BEACH, 1807 N.E. 164th STREET, MIAMI BEACH, FLORIDA 33162.

## FOR SALE

**BIG Turntables & Speakers**  
at Wholesale Prices

DIRECT TO PUBLIC!

Factory Sealed - Full Manufacturer's Warranty

TURNTABLES	LIST	YOUR COST	SPEAKERS	LIST	YOUR COST
1000	\$280	\$186	FORMULA 1	\$ 75	\$ 47
980	\$200	\$119	FORMULA 2	\$120	\$ 75
960	\$160	\$ 95	FORMULA 4	\$160	\$100
940	\$110	\$ 65	FORMULA 5	\$220	\$138
920	\$ 80	\$ 48	FORMULA 6	\$300	\$185
(Std. Base & Cover add \$15)			FORMULA 7	\$445	\$280
(w. wd base add \$20)					

Send check or money order. No. C. O. D.'s

N. J. Residents add 5% ST

FREE CATALOG Of Our Equally Amazing  
Money Saving Stereo Equipment

**the warehouse**

187 N. Main St., Milltown, N. J. 08850

**AUDIO BREAKTHROUGHS**

Long Island's finest audio dealer offers you the world's most advanced and audio components.

**ELECTRONICS,** Levinson JC-2 Preamp & LNC-2 Electronic Crossover G.A.S. (Ampzilla, son of Ampzilla, Thaedra & Thoebe) Paragon model 12 Preamp, Yamaha, AGI, D-B systems, preamp, sound concepts, Luxman, Marantz prof.

**SPEAKERS,** Koss model one, Magneplanar, Dahlquist, Fulton Model J, Spendor, B&W (DM-6) Polk, Janis woofer, M&K woofer, Kef drivers, AR pi, B&O, Epicure, Yamaha.

**TURNTABLES & CARTRIDGES** Linn Sondek, Lux, Formula 4 am, Technics, B&D, Transcriptors, Satin, A.D.C., Grado J.G. signature series, Denon, Supex, Stax, Grace, SME, Rabco.

**AUDIOPHILE RECORDS,** Sheffield, M&K, Fulton, Audio Lab, Levinson, AR, B&O

Free delivery and installation in Long Island and New York City

**AUDIO BREAKTHROUGHS,** 1681 Northern Blvd., Manhasset, New York 11030, (516) 627-7333; **AUDIO BREAKTHROUGHS** Huntington 129 Route 110, 516-423-7755

**CROWN DC-300-A;** one year old-\$575. S.A.E. MK 2700 equalizer, new with warranty-\$400. Phase Linear auto-correlator/noise reduction unit, mint-\$250. (804) 296-5305 E.S.T.

**DON'T PAY THE HIGH MAIL ORDER PRICES**

THIEVES WAREHOUSE OF PANAMA CITY, 5220 W HWY. 98, SUITE D, PANAMA CITY, FLA 32401

**DON'T PAY THE HIGH MAIL ORDER PRICES**

THIEVES WAREHOUSE OF MONTGOMERY  
3386 NORMAN BRIDGE RD., MONTGOMERY, ALA 36105

**FORMULA 4** model PLS4/D the best sounding universal tone arm available at U.S. audio dealers. Literature \$1 bill. Mayware Ltd. 15 Heather Walk, Edgware, Middlesex, HA8 9TS England.

**LEACH LNF-1:** 100 Watt/Channel Stereo Power Amp Low TIM (Transient Intermodulation Distortion) Amplifier Available from your local dealer or from Electronics Onc, Inc., P.O. Box 13835, Atlanta, Georgia 30324

**SONY 8450 VFET PREAMP \$800;** Phase Linear 2000 pre-amp \$200; Phase Linear 700B \$550; Ampzilla \$600; pair Allison 1 speakers \$600; pair AR LST speakers \$750. Dr. Sachs, Box 1719, Ann Arbor, Michigan. 313-665-9388

**TANBERG TR 2075,** mint used, \$700; Son of Ampzilla, mint used, \$350; 2 Tannoy Devon, new with warranty, \$450, 2 Dahlquist DD-10, new with warranty, \$650. All prices negotiable. C. Allen Durham, (703) 552-5568 Evenings.

**TURNTABLE CHECK-O-KUT OELUXE,** 16" Empire arm, Stanton Cartridge, \$100. David Fonseca, 555 Notre Dame Ave., Chattanooga, Tenn. 37412.

**FOR SALE**

**BUILD YOUR OWN SPEAKERS  
AND SAVE UP TO 50%.**

Send for our free, fact-packed 40-page catalog/manual and learn how to assemble your own multi-element stereo speakers on design, construction, covers, enclosures, midranges, woofers, tweeters and horns. Write us today.

**SPEAKERLAB**  
Dept. AD-4, 5500 35th N.E.  
Seattle, Washington 98105



**DON'T PAY THE HIGH MAIL ORDER PRICES. THIEVES WAREHOUSE OF JACKSONVILLE, 6078 OLD ST. AUGUSTINE ROAD, JACKSONVILLE, FLORIDA 32217.**

**DON'T PAY THE HIGH MAIL ORDER PRICES. THIEVES WAREHOUSE OF KNOXVILLE, 5710 KINGSTON PIKE, KNOXVILLE, TN 37919**

**NEW GENERATION** Crown Amplifiers, Cleanest, Smoothest sound ever produced - Crown D1200/HP1200, on demo only at Barclay Recordings, 233 E. Lancaster Ave., Wynewood, PA 19096; (215) 667-3048.

**DON'T PAY THE HIGH MAIL ORDER PRICES. THIEVES WAREHOUSE OF JACKSONVILLE, 1239 ARLINGTON ROAD & LONE STAR JACKSONVILLE, FLORIDA 32211**

**WESTERN NEW YORK AUDIOPHILES**

**THE STEREO EMPORIUM**

Visit our new, expanded facilities and experience the finest in audio components with the same personalized, honest service we have always maintained.

- |                  |                   |
|------------------|-------------------|
| AUDIO RESEARCH   | MARK LEVINSON     |
| AMPZILLA-G A S   | DUNLAP CLARKE     |
| QUATRE           | MAGNEPLANAR       |
| MAGNEPAN         | QAHLOQUIST        |
| QUAD             | FIDELITY RESEARCH |
| YAMAHA           | EMT               |
| DENON            | FORMULA FOUR      |
| GRADO SIGNATURE  | HADCOCK ARM       |
| BANG & OLUFSEN   | WIN LABS          |
| GRACE            | IMF               |
| STAX             | M&K SOUND         |
| BOWERS & WILKENS | ONKYD             |
| RTR              | LINN SONDEK       |
| SONUS            | KMAL              |
| WIN LABS         | CONNESIEUR        |
| TECHNICS         | TRANSCRIPTORS     |

CALL, WRITE, OR VISIT US TODAY.

**THE STEREO EMPORIUM**  
3407 Delaware Ave.  
Buffalo, N.Y. 14217  
716-874-3372

**QUAD 33/303** \$275 for the pair; Dynaco FM-5 walnut, \$150, Rogers LS 3/5A monitors, teak, \$250 pr. All units perfect with little use. Original cartons. Any reasonable offer. Shipped prepaid, insured. Greg Trimble Kirkwood, Pa. 17536, 717-529-2497

**THE AUDIOPHILE**, home of the renowned DB preamp, the little black boxes everyone has heard about and nobody's seen, is happy to help with your search for musical excellence - offering products which, even if not the most widely known, provide musical honesty. Dayton-Wright loudspeaker, CM Labs amplifier, Dunlop-Clark, Fulton J. ERA, I.M. Fried, Power Research loudspeaker, Paoli, Quad - including the exciting new 405 amplifier, AID, Denon (expensive but excellent), Win Labs, KMAL, Revox, ADS, and the Feature of the Month

the Promethean cartridge, obscure but offering exceptional clarity at only \$95. Sales and service, 582 N. Frederick Ave., Gaithersburg, Md. 20760. (301) 948-2999. Ask for Gene, Bob, or Albert

**SIEMENS, TELEFUNKEN AND AMPEREX** and other top quality audio tubes available at very competitive prices. Contact Jim Wallace at 201 McMasters Drive, Monroeville, Penna. 15146 or (412) 373-2602.

# Advertising Index

ADVERTISER	PAGE	ADVERTISER	PAGE
Acoustique 3A	81	Dual (United Audio)	7
Loudspeakers		Turntable	
Enter No. 41 on Reader Service Card		Enter No. 6 on Reader Service Card	
Akai	43	Dynamic Specialties	105
Hi-Fi Components		Audio Store	
Write Direct to Advertiser		Write Direct to Advertiser	
Analog & Digital Systems	21	Dynaco	86
Loudspeaker Systems		Hi-Fi Components	
Enter No. 1 on Reader Service Card		Enter No. 51 on Reader Service Card	
Astatic Corp.	57	Empire	4
Hi-Fi Components		Phono Cartridge	
Enter No. 2 on Reader Service Card		Enter No. 7 on Reader Service Card	
The Audio Amateur	86	Fantasy Sound	97
Publication		Audio Store	
Enter No. 3 on Reader Service Card		Write Direct to Advertiser	
The Audio Critic	83	Fisher	53
Publication		Hi-Fi Components	
Write Direct to Advertiser		Write Direct to Advertiser	
Audio-technica	20	Garland Audio	96
Hi-Fi Components		Audio Store	
Write Direct to Advertiser		Write Direct to Advertiser	
BASF	33	Hartley	14
Cassette Tapes		Loudspeaker Systems	
Write Direct to Advertiser		Write Direct to Advertiser	
BGW	46	Kenwood	13
Amplifiers		Hi-Fi Components	
Enter No. 4 on Reader Service Card		Enter No. 8 on Reader Service Card	
Bang & Olufsen	87	Koss	17
Hi-Fi Components		Hi-Fi Components	
Enter No. 39 on Reader Service Card		Enter No. 9 on Reader Service Card	
Celestion	27	Lux	18, 19
Loudspeaker Systems		Amplifiers	
Write Direct to Advertiser		Write Direct to Advertiser	
Crown International	15	Maxell	25, 40, 41
Equalization System		Magnetic Tapes	
Enter No. 50 on Reader Service Card		Enter No. 10 on Reader Service Card	
Custom Stereo	107	Magnetic Tapes	
Audio Store		Enter No. 11 on Reader Service Card	
Write Direct to Advertiser		McIntosh Labs	89
dbx, Inc.	93	Catalog	
Dynamic Range Enhancer		Enter No. 12 on Reader Service Card	
Enter No. 5 on Reader Service Card		The Millers	103
Designatron	106	Tape & Cassette	
Audio Store		Write Direct to Advertiser	
Write Direct to Advertiser		MXR	31
Discount Music	106, 107, 108, 109	Compander & Equalizer	
Record Club		Enter No. 14 on Reader Service Card	
Write Direct to Advertiser		Nakamichi	36, 37
Discwasher	2, 51	Hi-Fi Components	
Hi-Fi Components		Enter No. 15 on Reader Service Card	
Write Direct to Advertiser			

# Advertising Index

## FOR SALE



"Come listen with me. Demand quality!" Don't buy records or microphones until you've heard The Thrill Factor! This chorus and orchestra tape tells it like it is, shows how many stereo recordings are actually mono. Learn what to listen for in buying the few honest stereo records made. Tape also compares brand-name mikes in live listening tests. Reel or cassette. \$6.50, post paid in USA.  
**THE MILLERS**  
 1896 Maywood, S Euclid OH 44121

ADVERTISER	PAGE	ADVERTISER	PAGE
Ohm.....	59	Sansui.....	55
Loudspeaker Systems		Hi-Fi Components	
Enter No. 16 on Reader Service Card		Enter No. 26 on Reader Service Card	
Onkyo.....	64, 65	Schwann.....	62
Hi-Fi Components		Catalog	
Enter No. 38 on Reader Service Card		Write Direct to Advertiser	
PAIA.....	16	H.H. Scott.....	5
Programmable Drum Set		Tuner & Amplifier	
Enter No. 18 on Reader Service Card		Enter No. 27 on Reader Service Card	
Phase Linear.....	85	Sennheiser.....	6
Hi-Fi Components		Hi-Fi Components	
Enter No. 19 on Reader Service Card		Write Direct to Advertiser	
Pickering.....	3	Shure Brothers.....	22
Hi-Fi Components		Hi-Fi Components	
Enter No. 20 on Reader Service Card		Enter No. 28 on Reader Service Card	
Pioneer.....	Cover II, 1, 23	Sony Corp.....	44, 45, 73
Hi-Fi Components		Hi-Fi Components	
Enter No. 22 on Reader Service Card		Enter No. 29 on Reader Service Card	
Metropolitan Opera		Headphones	
Enter No. 21 on Reader Service Card		Enter No. 30 on Reader Service Card	
Polk.....	89	Sony/Superscope.....	110, Cover III
Loudspeaker Systems		Elcaset System	
Write Direct to Advertiser		Write Direct to Advertiser	
Primo.....	90	Sound Concepts.....	16
Microphones		Hi-Fi Components	
Enter No. 23 on Reader Service Card		Enter No. 31 on Reader Service Card	
P.S. Audio.....	90	Soundcraftsman.....	11
Hi-Fi Components		Hi-Fi Components	
Enter No. 24 on Reader Service Card		Enter No. 32 on Reader Service Card	
RNS Marketing.....	79	Speakerlab.....	86, 98
Record Cleaner		Speaker Kit	
Enter No. 40 on Reader Service Card		Write Direct to Advertiser	
Rhoades.....	104	Speaker Kit	
Teledapter T.V. Sound Tuner		Write Direct to Advertiser	
Write Direct to Advertiser		Sumiko.....	87
Rocelco.....	12	Hi-Fi Components	
Decca Brush		Write Direct to Advertiser	
Enter No. 25 on Reader Service Card		Tandberg.....	93
Roosevelt.....	92	Hi-Fi Components	
Hotel		Enter No. 35 on Reader Service Card	
Write Direct to Advertiser		Tannoy (Ortofon).....	47
SAE.....	39	Hi-Fi Components	
Hi-Fi Components		Enter No. 17 on Reader Service Card	
Enter No. 34 on Reader Service Card		Technics.....	Cover IV
H. Sams.....	63	Turntable	
Books		Enter No. 36 on Reader Service Card	
Write Direct to Advertiser		Yamaha.....	35
		Loudspeaker Systems	
		Enter No. 37 on Reader Service Card	

**SHOP AROUND** — Listen to every speaker available — then come to Cyberacoustic Laboratory and hear RTR's New Direct Drive Electrostatic DR-1 speaker system at Philadelphia's exclusive distributor — by appointment — 233 E. Lancaster Ave., Wynwood, PA 19098; (215) 887-3048.

"Two Crown DC - 300-A's. Strapped, 800 Watts rms per channel, 1975 vintage, mounted in single Crown walnut enclosure. \$1100 FOB Corpus Christi, Texas. Ferferman 512/884-1981, 854/3445."

The objective: **THE BEST SOUND FOR YOUR DOLLARS** "State of the Art" systems: \$895 to \$3449. **AUDIO HOUSE**, 5232 Sagamore Dr., Swartz Creek, Mich. 48473

**WE HAVE FRAZIER SPEAKERS!** Models for every system in stock. Custom Sound, 1480 Wharton Way, Concord California 94521. 415-887-5860.

**INCREDIBLE FRAZIER 11 LOUDSPEAKER!!!! 18Hz - 40Khz flat! 103Db SPL for one watt! \$2,400 pair.** Other Fraziers on display from \$99.00. Northern California dealer. **RTV**, 7512 Elphick Road, Sebastopol California 95472. (707) 823-3701

**BRAUN TG-1000/4-Tape machine.** Good condition needs record head. Best offer. John Evans, 214-886-7357

**Receiver and Integrated Amp Owners.** Our phono amp sounds better than yours. Play your records thru our phono pre-amp into your aux. input for a phenomenal improvement. If not amazed, return in ten days. Introductory price \$59.95. Calif. residents add 6% sales tax. Write to us at PS Audio to order or ask for details. 2734 Industrial Way, Santa Maria, Ca 93454.

### SP4 — SP4 — SP4

New analog module preamp from Audio Research with their new D100 amp, more need not be said! Barclay Rec. & Electronics, 233 E. Lancaster Ave., Wynwood, Pa. 215-877-3048

**FANTASTIC SOUND IMPROVEMENT** on your present system without additional investment. Instructions \$5.00. Unconditional guarantee. L. Matan, 815 R. Cherry St., Scranton, Pa. 18505

**CABINETS FOR DYNACO** preamps, tuners, Quadaptor, Stereo 120, Literature, Geometrix, Box 612, Mexico, MO 65265

**AMBIENCE DECODER FOR REAR CHANNELS**, \$149.95. Free literature. Huntington Electronics, Box 2009-A, Huntington, Conn. 06484.

**SAE IB \$475, Pioneer TX9100 \$200; V15TIII \$35, Dyna St80 \$90.** 404-241-2519

### TECHNIARTS

Professional Audio Equipment Showroom. Ampex, AKG, DBX, Crown International, Malatchi, Orban Parasound, Sescam on display and in stock for immediate delivery. 8555 Fenton Street, Silver Spring, MD 20910; 301-585-1118.

**MICHIGAN AREA AUDIOPHILES:** Perfectionist Stereo now on display at the **EQUINOX STUDIO**. Fulton FMI, Magneplanar, Magnepan, Rogers Monitors, Great American Sound GAS, Ampzilla, Paoli, DB Systems, Linn Sondek, KMAL, Grace, Win Labs, Denon, Fidelity Research, Promethean and more. 27838, 44th St. S.E., Wyoming, Mi. 49508; 616-531-4530, 313-482-4801.

**FOR SALE**

**STEREO TV**



The TE-200 TELEADAPTER EASILY CONNECTS TO ANY TV & STEREO SYSTEM. Using our coupling and matrix circuit, teleadapter takes a low impedance output from the television and delivers two HIGH IMPEDANCE CHANNELS OF SIMULATED STEREO to drive any amplifier. Frequency response is maintained so you can hear the trills of bells or booming bass sounds as it happens on TV. With service warranty and hookup instructions \$19.95 ppd. Guaranteed to make your TV 100% more enjoyable.

OUR NEW TE-300 VHF UHF TELEVISION High Fidelity AUDIO TUNER is now available. Completely solid-state Recording and amp output jacks. Anodized Aluminum front panel and simulated Walnut Cabinet. 110 volt operation. \$169.95 ppd.

SEND CHECK, M.O., MASTERCHARGE, or BANKAMERICARD NO. and Expiration date TO RHOADES NATIONAL CORP. DEPT NO. 5C BOX 817, HENDERSONVILLE, TENNESSEE 37075

NAME \_\_\_\_\_

ADDRESS \_\_\_\_\_

CITY \_\_\_\_\_ STATE \_\_\_\_\_ ZIP \_\_\_\_\_

SEND COMPLETE CATALOG

**DON'T PAY THE HIGH MAIL ORDER PRICES. THIEVES WAREHOUSE OF HOLLYWOOD, 5719 HOLLYWOOD BOULEVARD, HOLLYWOOD, FLORIDA 33021.**

**RABCO ST-4** straight line arm/turntable. Shure VI5III cart-ridge \$80. Lafayette LA-25 amplifier for teen system \$25. Box A74-1 Audio.

**TOURING SOUND SYSTEMS, 2, 4, and 8 Track Studios.** Disco Sound, Cerwin Vega BGW, Altec, Shure, AKG, Tapco, Dyna, Revox, EV, Beyer, Cetec, etc. K & L Sound Service, 75 North Beacon St., Watertown, Mass. 02172. (617) 787-4072. Art Ken Berger.

**PERFECTIONISTS PREFER DYNAKITS**

Before Purchase You Owe Yourself Our Quote Mainline 11a 971 Fronheiser Johnstown, PA 15902

**ATTENTION DYNA OWNERS:** Our Dyna Double 400 modification with 16 output transistors, front end bypass, and 80,000 mfd power supply is twice as fast and twice as strong as a stock ST-400. Our Super PAT-5 has lightning fast ICs and improved high gain phono section. With a Denon DL103S straight in, these Super Dynakits show you just how great our Fulton Js and Magneplanars will play. JENSENS STEREO SHOP, where State of the Art is affordable. 2202 River Hills Drive, Burnsville, Minnesota, 55337. 612-890-3517.

**SEATTLE, WASHINGTON**

— Seriously Pursuing The State of the Art —

- |                   |             |
|-------------------|-------------|
| Audio Research    | Magneplanar |
| G.A.S./Ampzilla   | Fulton/FMI  |
| Quatre            | Quad ESL    |
| Mark Levinson     | Beveridge   |
| Bravura           | Yamaha      |
| Dynaco (MODIFIED) | Nakamichi   |
| Connoisseur       | AKG         |
| Linn Sondek       | ERA Mk6     |
| Formula 4         | Grace       |
| Denon             | Shure IIG   |

**DEFINITIVE AUDIO**

3414 NE 55th  
Seattle, Washington  
(206) 524-6633  
Tuesday-Saturday

**INFINITY SERVO-STATICS** Is \$1100; Levinson JC-2 \$850; Marantz 7C, 8B and 10B make offer. Paul, Rt. 4 Box 431-B, Chapel Hill, N.C. 27514; 919-929-6250.

**MCINTOSH 275** amplifier. Excellent condition, \$355; McIntosh 110 FM tuner-preamp \$120. Call 614-837-3868 evenings.

**ACOUSTAT-X, FULL RANGE** electrostatic speaker. Brand new, Teac finish, off-white grill; with integral amps. Call 919-449-4132 (days). Also: ERA, Grace 707 combo.

**DON'T PAY THE HIGH MAIL ORDER PRICES**  
THIEVES WAREHOUSE OF FT. WALTON BEACH  
652-D BEAL PKWY, N.W., FT. WALTON BEACH, FL 32548

**FOR SALE**

**WESTCHESTER, FAIRFIELD COUNTY**  
**THE LISTENING ROOM INC.**  
590 Central Park Avenue  
Scarsdale, N.Y. 10583  
(914) 472-4558

Cordially invites you to audition our fine line of equipment.  
AMPZILLA II \* SON OF AMPZILLA \* AUDIO ANALYST \* B & O \* DAHLQUIST \* DAYTON WRIGHT E.L.S. \* DENON \* DUNLAP CLARKE \* GRACE \* JANIS \* KEF \* LUXMAN \* M & K \* NAKAMICHI \* PARAGON 12 \* RAPPOPORT PRE-1 \* S.A.E.C. \* SEQUARRA \* STAX \* TANDBERG \* THAEDRA \* THOEBE \* QUAD E.L.S. \* YAMAHA

**AUDIO PULSE DIGITAL DELAY SYSTEM**

**BOSE 1801** w/o led mint! \$500. McIntosh C-28 preamp mint! \$450. (414) 782-4704.

**HAVE YOU HEARD THE DB SYSTEMS** Crossover that you specify to match your system? It comes in bi- or tri-amped versions (with either stereo or common bass) at any crossover frequencies you order. It has the same low distortion — less than eight parts per million — that you've come to expect from a DB Systems product. 12 dB rolloff standard, 18 dB optional on bass and treble channels. For more information, contact your local DB Systems dealer, or write direct DB Systems, P.O. Box 187, Jaffrey Center, NH 03454.

**AUDIOPHILES**  
**AUDIOPHILES**  
**AUDIOPHILES**

We are dedicated to offering you, the audiophile and music lover, the most sonically accurate components in every price range. All products are tested and include free shipping and insurance. Now is the time to write, call or visit Audio One. We recommend the following:

- SPEAKERS**.....IM Fried "H"/"M"/"R"/"Q"  
Beveridge Electrostatic  
BBC LS 3/5A  
Audionics  
Sonex  
B&W
- AMPLIFIERS**.....Quatre "gain cell"  
C/M Labs 912a/914  
Electro Research  
Audionics  
Paoli
- PRE AMPS**.....Paragon Model 12  
Trevor Lees  
DB Systems  
C/M Labs  
Schilling  
Quatre
- TURNTABLES**.....Technics SP-10 MKII  
Transcriptors  
Connoisseur  
Rabco  
Era
- TONEARMS**.....Formula 4  
Stax
- CARTRIDGES**.....Promethean  
Win Labs  
Denon  
Supex  
Sonus

Also Ace, BGW, Dynaco, Grace, H-K/Citation, Hitachi, KEF, Philips, Quintessence, RTR Electrostatics and more.

**AUDIO ONE**  
**AUDIO ONE**  
**AUDIO ONE**

"Where it all began in Michigan"  
Box 1001  
Birmingham, Michigan 48012  
(313) 646-6666

**MAKING HIS MOVE** — Mel Schilling, formerly of Willow Grove, Pa., has taken his knowledge of music and sound to California, where he will continue to serve a select nationwide clientele devoted to ultra state-of-the-art stereo. All shipments prepaid and insured. Write or call — 20929 Ventura Blvd., Woodland Hills, Calif. (213) 348-4600.

**FOR SALE**

**DON'T PAY THE HIGH MAIL ORDER PRICES.** THIEVES WAREHOUSE OF FT. LAUDERDALE, 3347 NORTH FEDERAL HIGHWAY, FT. LAUDERDALE, FLORIDA 33306.

**DYNA STEREO 70 MOD KIT.** Tighter bass, improved transient response, higher definition. Complete instructions, schematics, parts list, \$500. With parts kit, including all new tubes, \$58.00 all postpaid. Audio Designers, Box 122, Led yard, Conn 06339.

**DON'T PAY THE HIGH MAIL ORDER PRICES.** THIEVES WAREHOUSE OF WESTMINSTER, 2969 WEST 72ND AVENUE, WESTMINSTER, COLORADO 80030.

**DON'T PAY THE HIGH MAIL ORDER PRICES.** THIEVES WAREHOUSE OF MACON, 1564 EISENHOWER PARKWAY, MACON, GEORGIA 31206.

**GALE MAXIMUM FIDELITY RECORDS.** Gale turntable and speakers, now available at the Audio Cage, 3329 Balmoral Drive, Sacramento, Calif. 95821. 916-482-8346

**OUR TA-1 TONEARM IMPROVES RECORD SOUND** with low effective mass (<25 grams with most cartridges) and pivot friction (all pivots jeweled), optimum silicone damping, vertical pivots at record level, anti-skate bias, damped cueing, and low capacitance cables. Money-back guarantee \$149.00 postpaid. JML Company, 39,000 Highway 128, Cloverdale, CA 95425

**AUDIO PULSE DIGITAL DELAY SYSTEM:** quantum step closer to the live experience. AUDIOCOM, Old Greenwich Ct. 06870. (203) 637-3621

**FOR SALE** - dbx 124, purchased new on 12/10/76; sacrifice \$225. Barry Trifiletti, 5312 Saint Gabriel Lane, Louisville, KY. 40291.

**S.A.E. Mk1B** Preamp, \$500; S.A.E. Mk4CM Poweramp, \$400. Dokorder 7140, \$400. David Joos, 4525 Fairmount, Kansas City, MO 64111, 816-753-3822.

**24 CHANNEL SOUND REINFORCEMENT MIXER** 100 foot snake, balanced input, 3 band EQ, 3 submixers, monitor, echo, solo. B & G Enterprises, P.O. Box 1036, Littleton, Colorado 80160; (303) 751-5991

**BACK ISSUE HI-FI MAGAZINES** for sale. Audio, Stereo Review, Etc. send SASE, for complete listing. J. Bingham, 1212 Cordell, Denton, Texas 76201.

**SONEX TWO SPEAKER SYSTEM.** The Tin Ear Stereo Center has on demonstration the remarkable SONEX TWO speaker system. This TIME ALIGNED™ design provides exceptional clarity and definition with a sense of dimension and depth that is truly outstanding. The Tin Ear Stereo Center, 704 Symons, Richland, Wash. 99352; (509) 946-4459.

**TANDBERG 3641XD** Open-reel, Pioneer SA-9500 w/UA-2 sleeve. Both mint. Best reasonable offers. Mike (317) 257-5683. Eves.

**PREAMPLIFIERS:** Dynaco factory wired PAS-2, \$75, PAT-4, \$125 perfect. David Fonseca, 555 Notre Dame Ave. East Ridge, Tenn. 37412 (615) 622-6182.

Garland Audio, Inc. cordially invites you to audition the SONEX TWO TIME ALIGNED™ speaker designed by E.M. Long. Openess, depth, detail, imaging, and musical transparency, in short, best describe the SONEX TWO.

Garland Audio, Inc. 3101 Telegraph Ave. Berkeley, Cal. 94705 (415) 841-1591	Garland Audio, Inc. 2960 Stevens Creek Blvd. # D San Jose, Cal. 95128 (408) 244-6724
--	---

**YAMAHA B-1/UC-1** \$1,100. 6 months mint (513) 421-9190

**BOSE SUPERSYSTEM** - Beautiful! 4 901 Series II speakers \$800, 1801 Bose power amp 250 watts \$800, Dynaco PAT-5 factory wired with cabinet \$215. All one year old in mint condition. Used infrequently and all with original cartons. 404-857-3336 after 3 P.M.

## FOR SALE

**DON'T PAY THE HIGH MAIL ORDER PRICES. THIEVES WAREHOUSE OF RIDGEWOOD, 25 GODWIN AVENUE, RIDGEWOOD, NEW JERSEY 07450.**

### WISCONSIN AND THE MIDWEST

AUDIOPHILE'S SOUND STUDIO IS AN ESTABLISHED DEALER IN SOPHISTICATED COMPONENTS FOR THE SERIOUS MUSIC LISTENER. WE OFFER FIVE INDEPENDENT AND FULLY-EQUIPPED LISTENING ROOMS. AND A TECHNICALLY COMPETENT STAFF WHO ARE WILLING TO APPRAISE HONESTLY ANY AND ALL EQUIPMENT. ALL OUR PRODUCTS ARE BACKED BY OUR SUPERB, PROFESSIONALLY EQUIPPED, AND STAFFED, SERVICE DEPARTMENT.

We are exclusive Wisconsin Dealers for: Mark Levinson \* Great American Sound Co. \* Bower & Wilkins \* Dayton Wright \* Quad.

Our carefully selected product lines also include: Denon \* I.M. Fried \* Fulton \* Lux Audio \* B&O \* Dahlquist \* Magnepan \* and many more outstanding products.

ALL OUR EQUIPMENT IS PRETESTED AND GUARANTEED TO MEET SPECIFICATIONS. WE ALSO SHIP PREPAID AND INSURED WITHIN THE CONTINENTAL U.S.

AUDIOPHILE'S SOUND STUDIO  
7459 Elmwood Avenue  
Middleton, Wisconsin 53562  
Phone 608-836-3807

### CHARLESTON, SOUTH CAROLINA: SUNLOFT AUDIO

has Fulton J Modular and E Modular, Luxman, G.A.S., Nakamichi, Infinity, Epicure, Stax, B&O, Fidelity Research, Technics, Otari, dbx, Nexus Bravura, etc. SUNLOFT AUDIO, 825 Savannah Highway, Charleston, SC 29407 803-556-8623

**STEREO REPRESENTATIVES NEEDED!!!** Sell 100 brands!! Lowest Possible Prices!! Krasco 623 Campbell Ave West Haven Connecticut 06516

**PHASE LINEAR 700 watt amplifier and 4000 auto-correlator preamp.** Checked mint, with cases, \$525 and \$450. 607-272-6480.

**SAE MK-6-B \$850, SAE MK-3CM \$700.** Bozak 8-305's \$600., Quintessence Preamp \$350, Equalizer \$300, Burwen DNF-1201 \$250, OBX-119 \$125, Cluck 313-653-7192.

**2 - SWTP Tiger .01's built & tested \$240 or will swap for Pioneer TX9500 or AR tuner.** Wilson, Box 90, RR1, Surry, ME 04684.

**MINNESOTA—GREAT AMERICAN SOUND, FMI, Bravura, Electro Research, Sequerra, Janis woofer, DB Systems, Paoli, Grace, Linn-Sondek, Shreve Rabco, more. AUDIO PERFECTION, 822 Regent Drive, Apple Valley, MN 55124; (612) 432-3222."**

**CONNOESSEUR SYSTEM - Phase Linear 400 amp and Soundcraftsmen 2217 preamp \$700; Pioneer TX-9100 Tuner \$225. Will sell entire one year old system for \$900.** Robert Cook, P.O. Box 8282, Denver, Colorado 80201.

**MINT: YAMAHA CA-1000, CT-800, SAE IICM, SME Tonearm (detach), NEW: Luxman P-121 turntable.** (518) 783-6890, Albany, N.Y.

**THE NEW PARAGON SYSTEM—E PREAMP.** Starting musical reproduction at the right price. Also the highly acclaimed Paragon Model 12 preamp. Both at Paragon of Sound. Call 301-229-2676 after 6:30 p.m. for an appointment to hear the difference.

**STAX DA300 CLASS A power amp.** New. P.O. Box 93, Beverly, N.J. 08010, (609) 386-7041.

**JANSZEN Z412HP \$350 pr.** Ampzilla \$500; Audio Research EC-4 \$200; Sony TTS-3000 \$150; 912-746-0037 after 6pm EST.

**QUICK AIRMAIL SERVICE FROM TOKYO.** All brands of Cartridges and Tone-Arms. Great money-saving. Write us today!! JAPAN AUDIO TRADING CO., Saikaen Bldg., 4-33-21, Kamimeguro, Meguro-ku, Tokyo.

**ELECTRO-VOICE** Patrician speaker. Make offer. Call 614-837-3868 evenings.

## FOR SALE

~ SAN FRANCISCO BAY AREA ~

~ DYNAMIC SPECIALTIES ~ AUDIOPHILE ITEMS DIV. ~

PARAGON, ANALOG ENG, LEES, AUDIONICS, SOUNDCRAFTSMEN, FUTTERMAN, DYNACO, DAHLQUIST, FMI, M&K, RTR, HARTLEY, ERA, FR, GRACE, SUPLEX, PROMETHEAN, SHURE, ALSO QUALITY USED EQUIPMENT VINTAGE & CURRENT: MARANTZ, QUAD, AUDIO RESEARCH, CITATION, MCINTOSH ETC. VACUUM TUBES: TELEFUNKEN, AMPEREX, MULLARD, VALVO, SIEMENS, GENELEX ETC. BANKAMERICARD ~ BUY ~ SELL ~ TRADE ~ MASTERCHARGE

2261 SPRING ST, REDWOOD CITY, CA 94063  
415-364-6634 364-2494

**5% OVER COST - Any new AKAI, DYNACO, MARANTZ, SANSUI stereo components.** Free Catalogs: Audio Discount World, P.O. Box 99147, San Francisco, California 94109

**THE TREVOR LEES** tube preamp kit for the Dynaco PAS reviewed in *Sound Advice* has dynamic range surpassing solid state units and openness heard only from tubes. A completely new circuit requiring one hour for construction, kit \$175, faceplate \$25. Foreign \$185 and \$30. CA. residents add sales tax. MR. AUDIO, P.O. Box 4489, Berkeley, CA 94704

**CONNECTICUT:** ADC-Accutrac, Advent, Audio Pulse, B&O, B.I.C., Citation, Epicure, Harman/Kardon, J.B.L., McIntosh, Nakamichi, Ortofon, Phase Linear, Sony, Stax, Tandberg, Yamaha. Will ship prepaid. Sounds Incredible, 226 White St., Danbury, Conn., 06810. (203) 748-3889 - phone quotes only.

**AKG, AMPZILLA, BEYER, CROWN, DB Systems, DAHLQUIST, DBX, DECCA, DENON, INFINITY, KLH 9s, Koss, Nakamichi, Ortofon, PHASE LINEAR, PMI, REVOX, SAE, SAEC, Sennheiser, Sequerra, Sony, Stanton, Stax, Supex, TASCAM, Technics, Thorens, etc.**

**HI-FI HAVEN**  
28 Easton Ave.  
New Brunswick, N.J. 08901  
201-249-5130

**SAVE UP TO 69% ON OVER 100 TOP BRAND AUDIO COMPONENTS FROM CARSTON STUDIOS.** NEW ENGLAND'S AUDIO SUPERMARKET. ONE OF THE OLDEST MAIL ORDER FIRMS (EST. 1952) AND CERTAINLY ONE OF THE MOST RELIABLE. ALL ORDERS SHIPPED FROM STOCKED WAREHOUSE. SEND FOR PRICE QUOTE AND PRICE LIST. CARSTON STUDIOS, OLD BROOKFIELD ROAD, DANBURY, CONN 06810

**HIGHEST QUALITY STATE-OF-THE-ART** audio components from one of the oldest esoteric dealers in the country. We carry... Audio Research, B&O, Dahlquist, Gale, Mitsubishi, Dayton-Wright, Threshold, Denon, Supex, Micro-Acoustics, Formula 4, Audio-Craft, Grace, Audio Pulse, ERA, Advent, Magnepan, ADS, etc.

**THE GRAMOPHONE LTD.**  
50 Penn Place, Oklahoma City, OK 73118  
405-840-1559  
757 Asp St., Norman OK 73069  
405-364-9477  
6568b E. 51st St., Tulsa, OK 74145  
918-663-1511

### STEREO ONE FAIRFIELD, CONN.

For the exceptional listener who demands purity and fidelity of sound, we have carefully evaluated and offer:

MARK LEVINSON	STEREOTECH
MCINTOSH	ROTEL
BOZAK	DAHLQUIST
NAKAMICHI	LINN SONDEK
ADS/BRAUN	AKG
YAMAHA	STAX
BANG & OLUFSEN	TDK
DENON	MAXELL
SUPLEX-GRACE	DISCWASHER
ORTOFON	M-K BOTTOM END
AGI	AUDIO PULSE
ARISTON	AMPEX

We pay freight. . . . .  
**STEREO ONE INC.**  
1229 POST RD. FAIRFIELD, CONN 06430  
PHONE 203-255-5939

## FOR SALE

MARK LEVINSON	DAYTON WRIGHT
KEITH MONKS	LINN SONDEK
DAHLQUIST	MAGNEPAN
AMPZILLA	THAEOIRA
POLK	STAX
FR	MK

### ABSOLUTE SOUND ABSOLUTE SOUND ABSOLUTE SOUND

SAE	ESS
AVID	GALE
RABCO	GRACE
DENON	REVOX
LUXMAN	L35CON
TANDBERG	KOSS ESL
DUNLAP CLARK	SONY V-FET
HARMAN KARDON	SOUNDCRAFTSMAN

### ABSOLUTE SOUND - HIGH ACCURACY AUDIO COMPONENTS

(313) 527-2244 12400 Morang Detroit, Mich 48224  
(313) 549-7550 4354 N Woodward Rd. Mich 48072  
(313) 662-2026 312 S State St. Ann Arbor 48104

**FULTON J MODULARS** Current "SH" Type. Shipped Prepaid \$1,850. Randy (206) 525-7593 or (206) 524-6633.

### AMPZILLA-THAEOIRA SON OF AMPZILLA

Sound Advice, 536 State Road, Emmaus, Pa. 18049. Hours Mon., Tues., Thurs., Fr., 12-9:30, Wed. 6-9:30, Sat. 10-6. (215) 967-4418.

**DON'T PAY THE HIGH MAIL ORDER PRICES. THIEVES WAREHOUSE OF GAINESVILLE, 434 N.W. 13th STREET, GAINESVILLE, FLORIDA 32601.**

**DON'T PAY THE HIGH MAIL ORDER PRICES. THIEVES WAREHOUSE OF DUMONT, 78 WASHINGTON AVENUE, DUMONT, NEW JERSEY 07628.**

### CONN. AND WESTERN MASS'S LARGEST STEREO DEALER

ACCUPHASE	SME
AUDIO TECHNICA	SUPLEX
EPICURE	ORTOFON
DAHLQUIST	FIDELITY RESEARCH
AUDIONICS	REVOX
dB SYSTEMS	B&O
CROWN	TEAC
QUATRE	TRANSCRIPTORS
PHASE LINEAR	DBX
SAE	BEYER
CITATION	STAX
MARK LEVINSON	AKG
SOUNDCRAFTSMAN	NAKAMICHI
ESS	SEQUERRA
MAGNEPLANAR	BURWEN
MAGNEPAN	HARTLEY WOOFPERS
THORENS	QUAD
TECHNICS	LUX
	& MORE

<b>Newington</b>	<b>FRED LOCKE STEREO Professional Products Division</b>	<b>Greenwich</b>
203-667-2277	203-828-1124	203-637-5439
<b>New Haven</b>	<b>Orange</b>	<b>Avon</b>
203-787-0183	203-795-0701	203-678-1797
<b>Waterbury</b>	<b>Springfield, Mass.</b>	<b>Fairfield</b>
203-757-9296	413-782-7111	203-366-5246
<b>Stratford</b>	<b>East Hartford</b>	<b>New London</b>
203-377-1771	203-528-9479	203-443-1835

## FOR SALE

**J. N.Y. — Long Island**  
**DESIGNATRON**  
*is your franchised dealer for:*  
 ADC \* Advent \* Allison \* Audio/Pulse  
 \* AKG \* Bose \* Cizek \* Dahlquist \*  
 dbx \* Harman/Kardon \* JBL \* Luxman  
 \* McIntosh \* Ortofon \* Revox \* SME \*  
 Soundcraftsmen \* Tandberg \* Technics  
 \* Thorens . . . and more \*  
 Stereo Components for the  
 quality-conscious buyer. Talk to our  
 friendly, knowledgeable staff.  
 Compare components in our spacious,  
 professionally designed showrooms.  
 Have your music system pretested and  
 aligned in our \$20,000 *Quality Control*  
 and *Precision Tuning Laboratory*.

**DESIGNATRON'S  
 STEREO STORES** INC.  
 Hicksville: 260 Old Country Rd.  
 (Zip 11801) (516) 822-5277  
 Setauket: 748 Route 25A  
 (Zip 11733) (516) 751-0253

**DON'T PAY THE HIGH MAIL ORDER PRICES**  
 THIEVES WAREHOUSE OF SARASOTA  
 8564 GATEWAY AVENUE, SARASOTA, FLORIDA 33581

**BUILD YOUR OWN SPEAKERS AND SAVE UP TO 50%.**  
 You can assemble your own high quality, multi-element stereo speakers in a few hours and save up to half the cost of comparable speakers. Send for our free 32-page catalog of speaker kits, raw speakers and accessories. **SPEAKERLAB**, Dept. A2, 5500—35th N.E., Seattle, WA 98105.

**DON'T PAY THE HIGH MAIL ORDER PRICES.** THIEVES WAREHOUSE OF FT. MEYERS, 3081 CLEVELAND AVENUE, FT. MYERS, FLORIDA 33901.

**POLK AUDIO MONITOR SERIES**  
**AUDIO BREAKTHROUGHS** now has on demonstration the remarkable new Polk loudspeakers. Compare them to the finest loudspeakers in the world. Both the Seven (\$129.95 ea.) and the Ten (\$199.95 ea.) utilize high definition polymer laminate bass-midrange drivers, wide dispersion soft dome tweeters and fluid coupled sub-bass radiators. They are capable of reproducing a highly defined phase accurate three dimensional sonic image which rivals the thousand dollar super speakers. They sound great with a small receiver, yet reveal the fine subtleties of state of the art electronics like Levinson and G.A.S. Shipped free in U.S. Send for free brochures on Polk or our other fine lines **AUDIO BREAKTHROUGHS**, 1681 Northern Blvd., Manhasset L.I., N.Y. 11030 516-627-7333

**POLK AUDIO and AUDIO DEN**  
 The Audio Den is proud to have on display and demonstration the amazing Polk Audio Monitor Series. Our customers say, "Fantastic! Compares with the finest loudspeakers I have heard. Probably the best value in the history of audio!!!" Audiogram™, from the Audio Advisor said, "We were so impressed that we could not believe the prices. . . Other \$200 speakers simply do not come close to the standards set by the Model 10. . . And at their price, they are simply a steal." Come in for an audition or write us for information on Polk or our other state-of-the-art products. Polk is shipped free in the continental U.S. Monitor 10S - 199.95 ea. Monitor 7S 129.95 ea. and the incredible Mini Monitor 79.95 ea. Audio Den Ltd. 1320-34 Stony Brook Rd., Stony Brook L.I., N.Y. 11790, 516-751-3350.

**DEMO SPECIALS:** Ohm F \$700./pair; Dahlquist DQ-10 \$650./pair; Transcripator skeleton \$300 w/vestigal arm Mint used equipment: Thorens TD 125 w/nondetachable SME \$295.; ADS L700 \$220./pair  
 Audio Reproduction, 217 College Ave., Blacksburg, Va. 24060, (703) 552-6850

**McINTOSH MR-78 tuner** (\$585) mint (614) 297-1753

## FOR SALE

**PROTECT YOUR LPs.** Poly sleeves for jackets 8c round bottom inner sleeves 7c Poly lined paper sleeves 15c White jackets 35c Postage \$1.50 House of Records, Hillburn, New York 10931

**ATTENTION CANADIANS**  
 Over 100 top brands, stereo components. Write for quote. ADCO Sales, Box 13359, Kanata, Ontario K2K 1X5.

**DON'T PAY THE HIGH MAIL ORDER PRICES.** THIEVES WAREHOUSE OF BIRMINGHAM #3, 203 South 18th Street, BIRMINGHAM, ALABAMA 35233.

**McINTOSH—XR7, A6 King \$1500 pr, MQ101 \$175, C28 \$400, MR74 \$500, MC33 \$1000.** Call Collect After 3 PM weekdays. (N.Y.) 516-221-0511 J. Redmond.

**Professional Hi-Fi Home Study Course**—Instructors include Len Feldman, Julian Hirsch, Larry Klein and Larry Zide. Send \$2.00 for full color **AUDIO PRIMER** and information on joining (SAC) Society Audio Consultants, Dept. A, NY, NY 10018

**CONN. AND WESTERN MASS.'S  
 LARGEST STEREO DEALER**  
 ● Accuphase ● Audio Technica ● Epicure ● Dahlquist  
 ● B&W ● dB Systems ● Crown ● Quatre ● Phase  
 Linear ● SAE ● ESS ● Soundcraftsmen ● Magnepan  
 ● Magneplaner ● Mayware ● Grace ● Tandberg ●  
 Technics ● SME ● Ortofon ● Revox ● TEAC ● DBX  
 ● Beyer ● Stax ● AKG ● Nakamichi ● Sequerra ●  
 Hartley Woofers ● Harman-Kardon ● Rabco ● Avid and  
 more.

**FRED LOCKE STEREO**  
 Avon East Hartford New Haven  
 203-678-1797 203-289-3231 203-787-3469  
 Newington Waterbury Orange  
 203-868-0555 203-757-9296 203-795-5757  
 Springfield, MA. Professional Products Division  
 413-782-7111 203-828-1124

**LOW MASS NYLON CARTRIDGE** mounting hardware. 14 piece set, \$2.50 ppd. Component Systems, 5556 Personality Ct., Indianapolis, Indiana 46227

**DON'T PAY THE HIGH MAIL ORDER PRICES.**  
 THIEVES WAREHOUSE OF BIRMINGHAM,  
 123 ROEBUCK PLAZA DR., BIRMINGHAM, ALA 35206

**TACOMA, WASHINGTON  
 AUDIO-TECH ELECTRONICS**  
**STATE-OF-THE-ART SPEAKER KITS**  
 \$65.00 to \$700.00. Plans. Raw Drivers. Complete Lab Facility. \$50,000 in Test Equipment.  
 ADC Philips  
 Dyna-Mk-8 Pioneer  
 mhervic Sonus  
 Marantz Transcripator  
 McIntosh  
 Special: Marantz Receivers 25% off if purchased with any pair of speaker kits.  
 3863 Steilacoom Blvd. S.W.  
 Tacoma, Washington 98499  
 206-584-0332

**RABCO SL-8E OWNERS** - Newsletter 3 describes many modifications you can make to your arm, color photos and details. \$2. **AUDIOETC**, Box 55, Lansing, Iowa 52151

**NORTHWEST AUDIOPHILES**  
 The finest in Audio Components - Audio Research, Beveridge, Celestion, db systems, Dahlquist, Dayton Wright, Decca, Denon, Dunalp Clarke, Dynaco, ERA, Fidelity Research, Fulton, Formula 4, Grace, Hartley, Linn Sondek, Luxman, Magnepan, Mark Levinson, Nakamichi, Quad, Quatre, Sonex, Soundcraftsmen, Shure, Spondor, Stax, Supex, Tandberg, Technics, Yamaha and more.

**THE TIN EAR STEREO CENTER**  
 704 Symons  
 Richland, Wa. 99352  
 (509) 946-4459

## FOR SALE

**10 1/2" Recorder Specialists:** Fresh Scotch L/N 3600 ft. on new 1/4" NAB metal reels five for \$35.00. New low noise, high output Ampex tape on 10 1/2" metal reel, six for \$35.00. Reconditioned NAB metal 10 1/2" reels, \$24.00 per dozen. 10% on above for postage. Other tapes also on special. Write for catalog: Sound, POB 88338, Atlanta, GA 30338.

**THOUSANDS OF LIKE NEW LP's** and prerecorded tapes. Catalogue - \$1.50. House of Records, Hillburn, New York 10931.

**AUDIO'S HI-FI HANDBOOK**  
 Complete reference guide to over 1,000 components including prices and specs. All arranged in tabular form for easy comparison. Plus over 30 outstanding articles on audio topics, trends and advances. State-of-the-art reading for audiophiles. Only a limited quantity available. Over 200 pages. Send \$4.50 (including shipping and handling) to: Jean Davis, Audio Hi-Fi Handbook, 401 N. Broad St., Phila., Pa. 19108.

**NAME BRAND RECORDING TAPE**, custom loaded. Available in cassettes, reels, and cartridges. Huge savings direct from manufacturer. New catalogue now available, MJS, 516 Brooks, San Jose, Calif. 95125 (408) 998-2693.

**HI-FI ENTHUSIASTS WANTED!!** Earn more than just spare money in your spare time. We need campus representatives to sell name brand stereo components at discount prices in your area. High commission, no investment required. Serious inquiries only, please. Contact: Alan Weisberg, K&L Sound Services Co. 75 N. Beacon St., Watertown, Mass 02172.

**AMPEX TAPES**  
 Ampex Audio Studio Mastering Tapes. 631-641, 406-407, and "GRAND MASTER" in stock for immediate shipment 1/4", 1/2", 1" & 2" Factory fresh. Best Prices. **TECHNIARTS**, 8555 Fenton St., Silver Spring, MD 20910 (301) 585-1118.

**DON'T PAY THE HIGH MAIL ORDER PRICES**  
 THIEVES WAREHOUSE OF PENSACOLA  
 3731 NAVY BOULEVARD, PENSACOLA, FLORIDA 32507

**CARBON FILM RESISTORS**—1/4W, 5% from 10—4.7 megohms for 3 1/2c each. Fifty per value \$85. Discounts available. **FREE** samples/specifications. Other quality components. Components Center, Box 134A, N.Y. N.Y. 10038

**DON'T PAY THE HIGH MAIL ORDER PRICES**  
 THIEVES WAREHOUSE OF ORLANDO,  
 1915 EAST COLONIAL DRIVE, ORLANDO, FL 32803

**CANADIANS:** Best Hi-Fi discounts on over 96 leading Hi-Fi brands. Many exclusive factory closeout and special deals. Quotations via return mail. Nationwide mailorder service. **FREE** catalogs jam packed with bargains in Hi-Fi equipment, tape and recording accessories, calculators, telephones and accessories, kits, parts, etc. Hundreds of factory and government surplus specials too! American inquiries welcome. Rush free catalog request to: **ETCO**, Dept. AUA, Box 741, Montreal H3C 2V2

**SMALL RECORDING STUDIO** Crown 800 & 700 series tape decks, Tascam Model 10 Board Master Room Reverbation unit AKG Mikes one year old. Bob Swan — 704-982-4726, Albemarle, N.C.

**MXR's 10 Band equalizer, Discwasher Systems, Maxell Tape.** Discounted. N.A.B. Audio, Box 7 Ottawa, IL 61350

**DON'T PAY THE HIGH MAIL ORDER PRICES** THIEVES WAREHOUSE OF BOCA RATON, 499 N.E. 20th STREET, BOCA RATON, FLORIDA 33431

**TOP RATED HEATH RECEIVERS** AR-15 \$275, AR-1500A \$375. Mint Condition. RS, 98 Saddlewood Dr., Hillsdale, NJ 07642

**SDNY TAN-8550, TAE-8450, PS-8750 w/Shure V15-III,** and pr. Infinity Monitor II's. All mint. \$4,200 value for \$2,600. 1-217-523-0769.

**SERVICE EQUIPMENT:** B-K 1431 oscilloscope, B-K 280 DVM. (919) 967-4781.

## FOR SALE

**DON'T PAY THE HIGH MAIL ORDER PRICES**  
THIEVES WAREHOUSE OF PENSACOLA # 2, 3820 NORTH  
9TH AVENUE, PENSACOLA, FLORIDA 32503.

**AUDIO RESEARCH EC-4a** electronic crossover; SP-3a-4  
preamp; Dual 76a, Dual 75a amplifiers. (919) 967-4781 af-  
ter 9:00 PM EST.

**DON'T PAY THE HIGH MAIL ORDER PRICES**  
THIEVES WAREHOUSE OF ATLANTA, 4162 JONESBORO  
RD., ZAYRE CENTER, FOREST PARK, GA 30050

**COLORADO'S AUDIO ALTERNATIVE** — Boulder Sound  
Gallery, Ltd. — Purveyors of unusually fine audio systems  
and service to meet the needs of all serious music lovers. Our  
product selection includes the Acoustat X ESL, Allison, B & O,  
B & W, Dahlquist, dbx, Fidelity Research, Fons, Luxman, Mag-  
neplanar, Mark Levinson, M & K Sound, Quad Acoustical,  
Quatre, Sound Concepts, Stax, Supex/Sumiko, Yamaha, and  
Ultrapase. Demo Lux M-6000 amp with new warranty avail-  
able.  
1200 Pearl, Boulder, Colorado 80302, 1-303-444-2626

**EVERYTHING ON OPEN REEL!** Classical, Popular, Olby,  
Quadraphonic. Latest releases. For "Reel News," send \$1.00.  
Barclay-Crocker, Room 857 A, 11 Broadway, New York  
10004.

**DON'T PAY THE HIGH MAIL ORDER PRICES.** THIEVES  
WAREHOUSE OF NORTH TAMPA, 1441 EAST FLETCHER AV-  
ENUE, TAMPA, FLORIDA 33612

**DECOURSEY ACTIVE ELECTRONIC CROSSOVERS**  
Model 110 dividing network, complete with regulated power  
supply, for bi-amp, tri-amp, or quad-amp. Custom assembled  
to meet your specifications. Monaural, stereo or with derived  
third channel. Plug-in Butterworth (maximally flat) filters; 6,  
12, or 18 db per octave at any desired audio frequency. OP-  
TIONS: Summer for single woofer systems. VLF hi-pass filters  
for elimination of subsonic noise, derived third channel.  
**FOR OEM OR HOME ASSEMBLERS:** Model 500 or 600 dual  
filters. Regulated power supplies. Write for new brochure.  
**DECOURSEY ENGINEERING LABORATORY,** 11828 Jef-  
ferson Blvd., Culver City, CA 90230. Ph. (213) 397-9668

**DON'T PAY THE HIGH MAIL ORDER PRICES**  
THIEVES WAREHOUSE OF ATLANTA  
3164 PEACHTREE RD., N.E., ATLANTA, GEORGIA 30303

**DON'T PAY THE HIGH MAIL ORDER PRICES**  
THIEVES WAREHOUSE OF ATLANTA  
2769 LAKEWOOD AVE., S.W., ATLANTA, GEORGIA 30315

**DON'T PAY THE HIGH MAIL ORDER PRICES**  
THIEVES WAREHOUSE OF ATLANTA  
4166 BUFORD HIGHWAY, N.E., ATLANTA, GEORGIA 30345

- \* Looking for the finest new & used audio components?
- \* Want the inside info on the latest stereo projects?
- \* Got a gripe, an idea, or something important to say?
- \* Want audiophile opinion from across the country?

### THE AUDIO FORUM

is for YOU! In our first issue:

- \* The nation's finest audio dealers select: "The Worlds Best  
(Ungradeable) \$1000 Music System!"

\* David Fletcher (Grace, Supex) on: "Tonearm-Cartridge  
Compatibility".

\* John Iverson (Electro-Research) on: "The Force Field Loud-  
speaker". (With NO moving parts!)

\* E. M. Long (Sonex) on: "Time Alignment Techniques".

\* Mark Deneen (Paragon) on: "Wide Band Tube Design".

\* John Curl (Levinson) on "Ultra low noise design".

\* Plus: "Reviewing the Reviewers"; The "Womens View-  
point"; Reader reviews; Free subscriber classified ads; and  
much, much more! Send \$15 for six bimonthly issues to:  
**AUDIO FORUM, BOX 578, Fairfax CA 94930 415-453-  
9530**

## FOR SALE

**DON'T PAY THE HIGH MAIL ORDER PRICES**  
THIEVES WAREHOUSE OF ST. PETERSBURG  
9151 Park Boulevard, North Largo, Florida

**ESOTERIC PRODUCTS**—ARC, Magnaplanar, Nakamichi,  
GAS, IM Fried, Luxman, Quatre, others. STEREO(ophile) SHDP,  
107 Third Ave. SE, Cedar Rapids, Iowa 52401/Village Shop-  
ping Center, Davenport, Iowa 52806.

**IN CONNECTICUT AUDIO RESEARCH** is available at FRED  
LOCKE STEREO Hear the *incomparable new* D 100, SP 4 and  
Tympani I-D in acoustically designed rooms! FRED LOCKE  
STEREO, 216 W. Main St., Avon (203-678-1797), and 1533  
State St., New Haven (203-787-3469)

### AUDIO DEN LTD

After careful auditioning we are proud to add to our already  
fine line of audio products,  
the BRAVURA preamp  
RAPPOPORT preamp  
INFINITY & BLACK WIDOW tonearm  
ROGERS speakers  
YAMAHA and CM  
NAKAMICHI

We also carry Fulton (60, 80, 100 in stock), Dahlquist, RTR,  
Polk, Avid, Magneplanar, Quad (ESL and electronics), Lux,  
Onkyo, B&O, Revox, Crown, Sonus, Grado Signature, Denon,  
Grace Formula Four and Sheffield Labs.  
FREE INSTALLATIONS IN N.Y. AREA. NO CHARGE FOR SHIP-  
PING.

### AUDIO DEN LTD

1320-34 Stony Brook Road  
Stony Brook, New York 11790  
516-751-3350

**INFINITY SERVO** Statik I with Dyna Stereo 70 \$1100  
404-241-2519

**DON'T PAY THE HIGH MAIL ORDER PRICES**  
THIEVES WAREHOUSE OF ATLANTA  
1030-3 CHERDKEE ROAD, SMYRNA, GEORGIA 30080

**VARIETY USED RECORDERS** amplifiers, microphones,  
speakers, bargain prices call 215-947-6217, write S Spiel-  
man 2440 Walton Rd. Huntingdon Valley Pa. 19006

**AMPZILLA** metered, warranted, \$600 or trade for ARC  
T-1C's. (919) 722-4566.

**IMF "H" SPEAKER SYSTEM**, rosewood finish, Paoli 60m  
power amplifiers mint, Rogers BBC monitor speakers. All  
priced to sell 215-642-1022, 215-896-6515.

**ALTEC SPEAKER SYSTEM** - Barcelona Model 2873-A. Pair  
available with or without electronic crossover biamps.  
Biamps also for sale separately. Best offer. 301-557-9387.

### SOUND STORAGE DISC & TAPE RECORDINGS

Specializing in accurately capturing music within it's acoustic  
environment. Correct width, distance, balance, and ambience  
are retained offering an alternative to people whose playback  
systems are capable of reproducing more realism than what  
is currently being offered in source material.

### SOUND STORAGE

6232 Robin Hood Way  
Oakland, Calif. 94611

### ATTENTION!

#### DAYTON WRIGHT ELECTROSTATIC OWNERS

You have not heard the full potential of your loudspeakers  
until you have a Threshold of your very own. The Threshold  
800A Class A amplifier will provide more clean power into  
your loudspeakers than any other amplifier. You have spent a  
lot of money on your loudspeakers. Now finally, there is an  
amplifier to drive them. Write or call AUDIO EXCELLENCE,  
Box 10253, Pittsburgh, Pa. 15232. (412) 683-9550.

**AUDIO RESEARCH D-100s** \$850 each; EC-4A, \$275; III-A  
TM, \$600; Janis-styled subwoofers, \$250 each; Rabco SL-  
8E, \$100; Dave, 614-474-6697 after 10 pm.

**FOR SALE: NEUMANN LATHE AM-131;** Grampian Heads  
Type "D" Feedback, Gotham Amplifier; Power Supply. Am-  
pexes 300-3; 351-2:350. Call 212-874-7660-0274. Good  
buys.

## FOR SALE

### CENTRAL OHIO Audiophile Headquarters

GAS • AUDIO RESEARCH  
SAE • LINN SONDEK • FONS  
TASCAM • MAGNEPLANAR  
MAGNEPLANAR • KLIPSCH  
GRACE • KIETH MONKS  
SUPEX • FIDELITY RESEARCH  
STAX • ROGERS • LUXMAN  
AUDIO PULSE

### Custom Stereo

1391 S. Hamilton Rd. Columbus, OH 43227  
235-7575

**DON'T PAY THE HIGH MAIL ORDER PRICES.** THIEVES  
WAREHOUSE OF BETHESDA, P.O. Box 34251, WEST BETH-  
ESDA, MD 20034.

**AMPEX TAPE**—NEW 1800' on 7" reel 12 for \$18 POST-  
PAID, 1200' 12 for \$13 POSTPAID—free list—WIDE RE-  
SPONSE, 6114A, SANTA MONICA BLVD., HOLLYWOOD, CA,  
90038.

**DON'T PAY THE HIGH MAIL ORDER PRICES.**  
THIEVES WAREHOUSE OF TALLAHASSEE, 1119 APALACHEE  
PARKWAY, PARKWAY SHOPPING CENTER, TALLAHASSEE,  
FLORIDA 32301.

**DON'T PAY THE HIGH MAIL ORDER PRICES.** THIEVES  
WAREHOUSE OF DAYTONA, 1769 SOUTH RIDGEWOOD,  
SOUTH DAYTONA, FLORIDA 32019.

### LOUDSPEAKER DESIGN COOKBOOK

9 graphs, 12 tables, 34 illustrations, and 33 references  
makes this one of the most comprehensive source guides  
available. Covers A.S., reflex, passive radiator, and T.L. design  
technique. Shows how to calculate driver parameters as "Q"  
and compliance ratio. Also covers cone doping, testing and  
cosmetics. Great for amateur builders, excellent reference for  
audio stores and limited production speaker manufacturers.  
\$6.50 to SPEAKER RESEARCH ASSOCIATES (SRA), 3959  
S.E. Hawthorne Blvd., Portland, Ore. 97214.

### NORTHWEST AUDIOPHILES

THE TIN EAR presents high definition audio components for  
the discriminating music lover

AUDIO RESEARCH	NAKAMICHI	MARK LEVINSON
BEVERIDGE	MAGNEPLANAR	TREVOR LEE
YAMAHA	FULTON	AUDIDANALYST
ROGERS	AKG	TECHNICS
LUXMAN	GRACE	DAHLOUIST
SUPEX	LINN SONDEK	QUAD
FORMULA 4	QUATRE	SONEX

Also: Audio Lab, Levinson, Pathi Marconi, Sheffield record-  
ings.

THE TIN EAR STEREO CENTER  
704 SYMONS, RICHLAND, WA. 99352  
(509) 946-4459 Tues.-Sat.

**DON'T PAY THE HIGH MAIL ORDER PRICES.** THIEVES  
WAREHOUSE OF AURORA, 10218 EAST COLEFAX, AURORA,  
COLORADO 80010.

**DON'T PAY THE HIGH MAIL ORDER PRICES.** THIEVES  
WAREHOUSE OF PENSACOLA # 3, TOWN & COUNTRY  
PLAZA, PENSACOLA, FLORIDA 32505.

**DON'T PAY THE HIGH MAIL ORDER PRICES.** THIEVES  
WAREHOUSE OF MOBILE/VILLAGE SQUARE, 301 SOUTH  
CRAFT HIGHWAY, MOBILE, ALABAMA.

### OPAMP POWER SUPPLY

For Opamp filters, amplifiers, etc. Delivers +15 volts at 50  
ma, regulated. Compact; suitable for PC board mounting. Each  
\$27.50. DeCoursey Engineering Laboratory, 11828 Jefferson  
Blvd., Culver City, CA 90230. Ph. (213) 397-9668.

**AKAI-GX4000** 4 Channel Reel to Reel Tape Deck \$900.  
Roger Cheaton, 8325 S. Throop St., Chicago, Ill. 60620.

## EQUIPMENT WANTED

**TANN0Y** 15 inch monitor gold unit. JBLSG-520E. SE-400S, SE-460 F-22. Marantz 7C#9S pair. Kazuo Takashimadaira 2 chome, Itabashi-ku, Tokyo 175 Japan.

## GOVT. SURPLUS

**JEEPS, TRUCKS**, Typically from \$52.40 ... Automobiles, Boats, Motorcycles, Airplanes, Cameras, Tools, Clothing, Sports, Camping, Photographic, Electronics Equipment ... 200,000 Bid Bargains Direct from Government Nationwide ... Low as 2c on Dollar! Surplus Catalog and Sales Directory \$1.00 (refundable). National Surplus Center, 240 Eastcass-AUD, Joliet, Ill. 60432.

## MUSICAL INSTRUMENTS

**ATTENTION MUSICIANS!** Low prices on special effects devices and accessories. Name brand. Price sheet. C&D Music Co., Box 5128, Willowick, Ohio 44094.

## PLANS & KITS

**FM-3 FANS:** Phase locked loop multiplex demodulator meter kit soon to be available. Send for free info. VSM Audio, P.O. Box 114, Maspeth, NY 11378.

**BUILD YOUR OWN** klipschorns. Complete plans. Send \$5.00 to JJB 4907 P 1/2 Galveston, Texas 77550.

**LINEAR AMPLIFIER, 2 — 30 MHz, 140 watt mobile.** Construction plans, \$3.00. IGOR, Box 5516-N4, Walnut Creek, CA 94596

**BUILD YOUR OWN** state of the art systems, enclosures, & devices. Complete plans. Send one dollar (redemnable) for complete information. SLATER DESIGNS, P.O. Box 14466, Long Beach, CA 90814

**ACCURATE SOUND** now offers seven high accuracy speaker kits, including an exceptional car or van speaker and ultimate transmission line with ribbon tweeter top end. Prices range from \$115./pair to \$785./pair. Kits include drivers (KEF, Coles & Decca), crossovers using film capacitors, air core inductors, and high quality L-pads, back plate with binding posts and fuse holder, and cabinet plans. Drivers and crossovers available separately. Domestic and exotic wood veneers available. For more information: Accurate Sound, 1213 "M" Street, Lincoln, Nebraska 68508. (402) 489-1218.

## SERVICES

**NEW BAND FROM NORTH LITTLE ROCK**, Arkansas, looking for studio work. Can handle any type of music. Willing to relocate. We have six pieces. Drums, Lead Guitar, Rhythm Guitar, Bass Piano (Elec.) Organ. All are vocalists. Box No. A3-1.

**COLLECTORS' CONTACT GUIDE**, \$4; Sound Search \$7; Unauthorized Duplication of Sound Recordings, \$6. Searches and referrals \$10 minimum prepaid. P. Jackson, Recorded Sound Research, 1506 W. Barker, Peoria, IL 61606.

**CUSTOM RECORDING SERVICE**, Tapes, discs, and cassettes. Stereo and mono. Live and copies. Editing. Masters and pressings. High quality at reasonable rates. Joseph Giovanelli, Audio-Tech Laboratories, 2819 Newkirk Ave., Brooklyn, NY 119-7134.

**TAPE RECORDER HEADS** re-lapped \$15.00 ea. Removed from machine or stack. One day service. E. Maher, 5 Evans Place, Orinda, Calif. 94563

## SERVICES

### STEREO SOUND LABS

Factory specs or better by 10% on all repairs on major brands. Warranty 90 days parts and labor. Ship us your gear properly packed and insured. 4419 John Marr Drive, Annandale, Virginia 22003 (703) 941-5707.

### CROWN INTERNATIONAL

Complete repair, overhaul, and rebuilding service for current and early model Crown tape recorders and amplifiers. New Crown recorders in stock for immediate delivery. Excellent selection of reconditioned Crown recorders for sale. Used Crown recorders purchased and accepted for trade in. TECHNARTS 8555 Fenton Street, Silver Spring, MD 20910 301-585-1118

**TAPE DUPLICATION**, 8 track & cassette. Rates write: Custom Audio, 4226 Robert St., Red Wing, Minn. 55066.

**STERED MASTERS, RECORDS AND ALBUMS**. Check our prices. Newest type high level cutting equipment featuring: Neumann VMS 70 Computer control lathe, Parametric Equalization, Dolby, DBX, and the new SX74 Cutting System by Neumann. Special package prices on pure vinyl album and single record production. 1000 45 RPM stereo singles \$199.00 including mastering. 100 LP albums \$325.00 including printed jackets. Write or call for brochure. A & R Record Manufacturing Corp., 902 N. Industrial Blvd., Dallas, Texas 75207 Toll Free 1-800-527-3260.

**NASHVILLE RECORD PRODUCTIONS** WILL PRESS HIGH QUALITY PURE VINYL RECORDS FROM YOUR TAPES. SEND FOR SAMPLE RECORD AND PRICE LIST. ALSO FINEST DISC MASTERING. 469 Chestnut St. NASHVILLE TENNESSEE 37203

## PERSONALS

**RECORDING STUDIO ENGINEER CAREER?** Degree unnecessary. Send two 13c stamps to Attainment Research, Box 45333AU, Dallas, Tex. 75245.

## WANTED TO BUY OR TRADE

**OPEN REEL** pre-recorded tapes. Rock, folk, jazz, classical. Ray, 2282 Woodward, Lakewood, Ohio 44107.

**WANTED:** Kenwood Audio De-Noiser Model KF8011. Write: Eddie Thornton, 809 Laguna, Denton, Texas 76201; Call (817) 387-7787

**3 PIONEER OSCILLATOR** scopes Model SD-1100, either 2-channel or 4-channel version. Please call or write with best price and condition. David Beatty Stereo, 1616 W. 43rd, Kansas City, Mo. 816-531-3109.

**WANTED:** Harman-Kardon Citation II (tube-type) Power Amp. Any Condition. William Rankin, 128 Commonwealth Ave., Merrick, NY 11566.

**INFINITY 2000A** loudspeakers. Write to: Per Morten Josefson, Ostskogen Terr. 11, 3470 Slemmestad, Norway.

**RABCO SL-8E** need not be in working condition. Dean Slindee Box 55, Lansing, Iowa 52151

**WANTED - RARE, OUT OF PRINT LPs** with organ music popular and semi classic. Played by George Wright, Leon Berry, Don Baker, Al Melgrade and Buddy Cole. First order will be worth \$100 to supplier. Mr. C.M. Walton, Jr., 317 E. 67th St., N.Y., N.Y. 10021

**MCINTOSH MC-3500** power amplifiers. Charles Kappesser, 101 Earl Avenue, Syracuse, NY. 13211, 315-455-1563.

**CASH FOR** your unwanted LPs & reel to reel tapes. Records. Box 323, Hillburn, New York 10931

**QUAD** electrostatic speakers (any condition), electronics (including Model III). Mention lowest price. OMS, 1360 Lake Shore, No. 2202, Chicago, IL 60610.

## WANTED TO BUY OR TRADE

**REMOTE CONTROL** for series "900" Heathkit television. 301 Pine Hill La., York, Pa. 17403 717-845-4003

**WANTED: TASCAM 4 OR 8-TRACK 1/2"** recorder with 501 or 701 electronics (and model 10 consoles & modules.) Wanted: Revox 1/2 track 1/4" recorder, 15 IPS, SEL sync. V. Bond, Box 2159, Winnipeg, Manitoba, Canada R3C 3R2 (204) 888-6099

## TAPE RECORDINGS

**OLDIES TAPES ON OPEN REEL TAPE**. Rock n' Roll songs by their year of release. Over 100 songs per year. Free brochure. Rock N' Reel Rental, Dept. C, 4 Prescott Ave., Dix Hills, NY 11746.

**WE WILL BEAT** any price sheet in America. Featuring TDK, Maxell, BASF, and Ampex. Tape World International, 220 Spring Street, Butler, PA. 16001

**OLD RADIO PROGRAMS ON CASSETTE 1-HOUR ONLY** \$1.10 EACH. BIG LIST FREE.

NOSTALGIA SOUNDS  
BOX 3584  
SIMI VALLEY, CALIF. 93063

**RECORDING TAPE SPECIALIST OFFERS LOW PRICES, FAST SERVICE, WIDE VARIETY OF BRANDS, UNUSUAL CATALOG.** SAXITONE TAPE SHOP, 1776 COLUMBIA ROAD, N.W. WASHINGTON, D.C. 20009.

## SITUATION WANTED

**SOCIETY AUDIO CONSULTANTS** member and dedicated audiophile wishes purchase of, or active partnership in, small to medium sized audio store. Audio Box A74-2.

**BROADCAST TECHNICIAN** wishing to break into professional recording industry. Would like to learn mixing, dubbing, disc-cutting, etc. 4 1/2 years experience in maintenance and operation of various equipments — audio, video, transmitter. No prior professional recording experience. Would prefer western U.S. area if possible. Bob Carr, 480 E. 26th Place, Yuma, Arizona 85364. (602) 726-8929.

## TAPE & TAPE RECORDERS

**CASSETTES, REEL TAPES**, bottom prices, name brands and custom loaded with BASF or SCOTCH. Super mastering computer cassettes loaded with AGFA-GAVAERT. Prepaid shipments. Free catalog. STANFORD INTERNATIONAL, Box 609A, San Carlos, CA 94070

**SONAR'S OPEN REEL TAPES** Duped one to one from the master. All formats. Highest quality available anywhere! Send \$1.00 for catalog and stereo sampler 1/4 track, 7 1/2ips tape. Sonar, P.O. Box 455A, Kingsbridge Station, Bronx, NY 10463

**MAXELL, AMPEX, CAPITOL**, Columbia Tape Bulk & Custom Loaded reels, cassettes, Reels, boxes, leader, splicers. For complete catalog write Omega Audio, Box 39253-B, Redford, MI 48239

**T.V. CAMERAS FOR SALE** (new) \$200. each. Also all accessories. Master Antenna Systems, Box 248, Branford, Conn. 06405

**OLDTIME RADIO BROADCASTS** on quality tapes. Free catalogue. Carl P. Froelich, Route One, New Freedom, Pennsylvania 17349.

**TDK, MAXELL, MEMOREX, BASF**, cassettes, reels 8-tracks. Lowest prices. New. Guaranteed FREE CATALOG S & S Audio P.O. Box 56039, Harwood Hts. IL 60656

**CUSTOMIZED TAPES**. Jazz Big Band. Select standard tracks or available artists. Free catalog. 80 minute reel cassette or 8-track. \$8.00. Tapes Unlimited, Box 163, Portsmouth RI 02871



## TAPE & TAPE RECORDERS

**SCOTCH RECORDING TAPE**, lowest prices TAPE CENTER Box 4305B, Washington, D.C. 20012

**EVERYTHING ON OPEN REEL!** Classical, Popular, Dolby Quadraphonic. Latest releases. For "Reel News," send \$1.00 Barclay-Crocker, Room 857 A, 11 Broadway, New York 10004.

### RECORDING TAPE—OUTSTANDING VALUES

Write to: MAGNE HOUSE, 2271 Union # 4, San Francisco, CA. 94123

## RECORDS

**SOUNDTRACK RECORD ALBUMS**—Mail Auction—Free List Whalon, 2321A Hill Redondo Beach Calif 90278

**CATALOGS**, Broadcasts, soundtracks, Personalities of Thirties, Forties, Box 225, New York, N.Y. 10028

**WHILE YOU WERE LOOKING** for out-of-print records, you should've been looking for us. DISContinued, 444 S. Victory Blvd., Burbank, Ca. 91502

**QUASI-RATIONAL PRODUCTS** has everything in record protection. Liners- covers- Discwasher- Watts. Also Maxell, TOK tape - Pioneer auto stereo - Jensen car speakers - Royce CB's, etcetera. Reasonable, Swift, Reliable. Free catalog. QUASI-RATIONAL PRODUCTS, P.O. Box 171, Prospect Heights, Ill. 60070.

**QUADRAPHONIC RECORDS AND TAPES** - World's largest selection - all labels, over 1000 titles - at discount prices! For your free illustrated quad catalog, write SOUND CONCEPTS, Box 654-C, Peoria, Illinois 61601.

**DISCOUNTS ON LP's**, Tapes, Cutouts, Imports. Huge Catalogs. One Dollar. Record Finder Services NERT, Box 268, Lawrence, Mass. 01842

**SOUNDTRACKS, CASTS**, personalities! Free newsletter! RTSA, 3700 Plaza, F211, Santa Ana, Calif. 92704.

**COLLECTORS RECORDS** - 50,000 LPs - Sold @ Auction - International Service Since 1971 - Specify category or artists - Lists From: Ray Macknic (or) Thea's, P.O. Box 7511, Van Nuys, Calif. 91406, U.S.A.

**OLDIES** — 45 RPM Original hits. Catalog 50c C&S Record Sales, Box 197, Wampsville, NY 13163

**SHOW ALBUMS**—Rare. Out of Print LP's. 52 page list 50c. ROBBER BRIDEGROOM 7" STEREO, 33-1/3, & songs - Jerry Orbach, Virginia Vestoff \$3.95. Broadway/Hollywood Recordings, Georgetown, Conn. 06829.

## SPEAKERS

### B&W

Now the incomparable quality of B&W Loudspeakers from England is available in the Western U.S. Send name and address for information and the name of your nearest dealer.

CORINTHIAN MARKETING  
P.O. Box 5948  
Incline Village, NV 89450  
(702) 831-3174

**CUSTOM SPEAKER ENCLOSURES**, systems, kits, foam grills, crossovers, raw speakers. Best prices. Info—15c. CSS, Algonac, Mich. 48001.

### HIGH FIDELITY SPEAKERS REPAIRED AMPRITE SPEAKERS SERVICE

655 Sixth Avenue, New York, N.Y. 10010  
212-CH3-4812

**YOUR #1 SOURCE** for custom speaker systems, kits, enclosures, foam grills, crossovers, raw speakers, veneers, vinyl. Warehouse prices. Surprising info - 13c. CSS, Algonac, Mich. 48001

## SPEAKERS

**ELECTRO-VOICE SENTRY PRODUCTS**. In stock: Sentry IV-B, Sentry III, and Sentry V monitor loudspeaker systems for professional monitoring and sound reinforcement. Immediate air freight shipment to any N. American destination. National Sound Company, Ft. Lauderdale, Florida. (305) 462-6862.

## BOOKS

**YELLOW PAGES OF AUDIO**—\$3.95 Reference to over 5000 audio products and 1,000 publications. Box 94-A, Colmar, PA 18915.

## PHOTOGRAPHY

**TAPE-SLIDE SYNCHRONIZER**, lap-dissolve plans, \$5.50. With mixer, compressor, preamp schematics, \$8.50. The Millers, 1896 Maywood, S. Euclid, OH 44121.

## AUTO ACCESSORIES

**FUZZBUSTER POLICE RADAR DETECTORS**. Latest Model, big discount. Hughes Electronics, 45 Dunn Street, Asheville, N.C. 28806

## INSTRUCTION & EDUCATION

**GET INTO BROADCASTING!** Become a DJ, earn big money! Start your own station! Free details, Broadcasting, Box 5516-N4, Walnut Creek, CA 94596

**DEGREES**, experience/credits: EMI, Inc. Box 4277, Inglewood, CA. 90309

**GET INTO BROADCASTING!** Become a DJ, earn big money! Start your own station! Free details, Broadcasting, Box 5516-N4, Walnut Creek, CA 94596

## MISCELLANEOUS

**SELF-HYPNOSIS** cassette by Counseling Psychologist, 2828 Chestnut Street, Montgomery, Alabama 36107. \$5.95 check or money order.

**TWO PIN SET**—write—perfume guaranteed. \$4.95. Famous Jewelry Company, 12608 Rawsonville Rd., Belleville, Michigan 48111.

**IMPROVEMENT IDEA FOR TUBULAR S** shaped arms. Will correspond with interested manufacturer. Please state your policy on accepting design changes from outside. N. Wilson, Box 90, RI. Surry, ME. 04684

## HIGH FIDELITY

**PINK NOISE TAPES**. Measure loudspeaker response accurately with a microphone and voltmeter, 1/3 octave bands +1dB 31.5Hz to 16KHz, 15 ips-\$28 ppd 7 1/2 ips-\$23 ppd. Both 1/4" halftrack. Cassette available. Instructions included for stereo system or P.A. application. STATEX, Audio Division, Box 5334-A, San Antonio, Texas 78201. QUALITY PRODUCTS SINCE 1929.

## BUSINESS OPPORTUNITIES

### OWNER'S HEALTH FORCES SALE!!

Well-established California audiophile store, five year national reputation, top lines, superb opportunity for diversified eccentric audiophile, priced for immediate bargain sale, terms negotiable, for details write: P.O. Box 637, San Carlos, CA. 94070.

## BUSINESS OPPORTUNITIES

**YOU CAN GET IT! NEW** ways to make a fortune! Home and business. Write for exciting FREE details! D.M.H. Enterprises Ltd., Box 3974, Regina, Sask., S4P 3R9, Dept. 15, Canada.

**OUR PORTABLE DISCO SYSTEMS** could make you rich. Earn \$150 night and more, playing records for parties, bars, weddings. Get in on one of the fastest growing best paying jobs. Free information. American Audio, 103 Ohio Ave, Fremont, Ohio 43420, 419-334-3326

**\$500 WEEKLY** Mailing Circulars - Foolproof Program - Start Immediately! Write: FORTUNITY (1P4), 46 Cardwell, Orangeville, Ontario L9W 2V6

**"EARN \$30.00** per hundred, stuffing envelopes. Immediate earnings. Send \$2.50 for beginners kit. Don, P.O. Box 10033, Houston, Texas 77206."

**CAMPUS REPRESENTATIVES** - Double your profits! Contact TOKYO AUDIO LTD., Box 3241, Los Angeles, Ca. 90028

**MAKE TOP QUALITY** blank tape cassettes and sell them to us. Details: Amcob Ind. Co. 65 Titmus Dr., Mastic, N.Y. 11950

**HOMEWORKERS! BIG MONEY** addressing, mailing envelopes. Valuable offer 10c. Linco, Dept. A00, 3636 Peterson, Chicago 60659.

**TREMENDOUS PROFITS** from used stereo equipment! Details, \$3.00. Lepus, Box 486, Rockville, Maryland 20850.

## RADIO PROGRAMS

**OLD RADIO ON TAPE AND CASSETTES**. THOUSANDS AVAILABLE. 6 HOURS \$8.00 Immediate Service. Catalogue 50c. Nostalgic Radio, Box 29K, Peoria, IL 61601

**VINTAGE RADIO**: Lowest rates, post free, traders welcome; shows for comics, etc. signals. Box 5063, Station E, Edmonton, Alta., Canada

**1930-1962 RADIO PROGRAMS**, Reels, \$1.00 hour! Cassettes, \$1.00 show! Mammoth catalog \$1.25 AM TREASURES, Box 192 AU, Babylon, New York 11702

**GOLDEN AGE RADIO** - your best source for radio tapes. Box 25215-D, Portland, Oregon 97225

**YESTERDAY'S RADIO PROGRAMS ON TAPE**. Reels, Cassettes. Fast-Reliable Service. Catalog \$1.00 - refundable with first order. ADVENTURES, Box 4822-A, Inglewood, California 90302

**RENT RADIO SHOWS** Make your own copies or just listen. Great way to build your collection reasonably. Catalog \$1 refundable. OTR Rental, Box 1146, Livermore, Ca. 94550

## HELP WANTED

**BLACK HAWK COLLEGE, MOLINE, IL** has an immediate opening for a Television Maintenance Engineer. Should have 1st phone, three to five years experience in television maintenance. Excellent fringe benefits. Send resume stating qualifications and experience to: Acie B. Earl, Director of Personnel, Black Hawk College, 6600 34th Ave., Moline, IL 61265. We are an equal opportunity employer.

**WANTED: SOMEONE IN WASHINGTON D.C.** area to record historical material from National Archives Library. Will pay reasonable rates. Contact: Pioneer Audio Lab, Box 29255, Parma, Ohio 44129.

**RECORDISTS** interested in a high paying career. No experience necessary. No traveling. Modest investment required. Send resume to DGI, 551 NW 42nd Ave., Suite 304, Ft. Lauderdale, Fla. 33317.

# The Revolutionary

Wow & flutter: .04%\*. Signal/noise ratio: 62 dB.\*\*

Introducing the incredible Elcaset system. Developed by Sony to bring you unsurpassed cassette sound.

1. The Elcaset tape is as wide as reel-to-reel tape: 1/4".
2. Tape moves twice as fast: 3 3/4 ips. Result: the widest dynamic range, the widest frequency response, the cleanest sound ever offered in a cassette format. Unlike the standard cassette, the Sony Elcaset sound is not compressed, constrained. It's expansive and full. It "breathes." It's true high fidelity.
3. The tape is lifted out from the cassette and guided across the heads by a stabilizing pin in the deck

itself — just as in reel-to-reel.

Result: lowest wow and flutter, superior tape/head alignment, even better frequency response. (See diagram).

4. All-new tape formulation with thicker oxide coating and thicker polyester for highest quality sound.

5. Automatic tape formulation adjustment. Small holes encoded on the cassette case "tell" the Elcaset deck what type of tape is being used (SLH, FeCr). The Elcaset then automatically adjusts both bias and EQ for optimum performance.

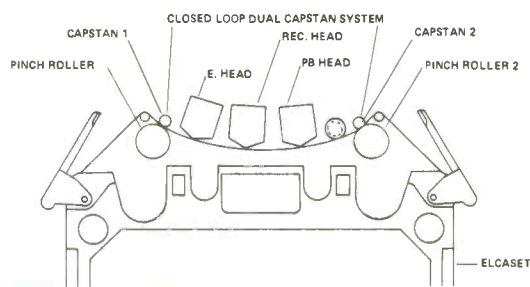

**Tape** (Actual Size)



# Sony Elcaset System

Frequency response: 25 Hz-22 kHz,  $\pm 3$  dB\*\*\*

An engineering triumph, the Sony EL-7 Stereo Elcaset Deck was designed exclusively for the new Elcaset tape.

**1. Closed-loop dual capstan tape drive.** One of the most advanced tape drive systems now available, it assures constant tape-to-head contact pressure, low wow and flutter and virtually nonexistent modulation noise.

**2. The 3-motor system starts with a DC servo motor** for utmost reliability. A sophisticated feedback circuit corrects for line voltage fluctuations, and other speed-altering factors. This is the finest tape recorder motor system money can buy. Proof? Wow and flutter of only .04%.

**3. Sony's 3-head system** offers the most precise tape/head alignment possible. All three heads are made of ferrite and ferrite—a super-strong formulation that lasts up to 200 times longer than standard perm-alloy. Head surfaces are mirror-smooth for friction-free tape travel and optimum tape/head contact. Incredibly close tolerances in the head gap assure widest frequency response.

**4. Direct coupling of playback head with the FET first-stage reproduction amplifier** significantly reduces distortion, improves signal/noise ratio and frequency response linearity.

Also available: The Sony EL-5 Stereo Elcaset Deck. Includes many of the same high performance features of the Sony EL-7, at a lower price.

## Deck

Brought to you by  
**SUPERSCOPE**



Memory tape counter provides automatic sequential rewind and playback immediately after recording from a specific spot on the tape.

Timer activating capability, in conjunction with an external timer, turns on/off playback or record mode unattended.

Illuminated "feather-touch" solenoid operation. Logic-controlled system allows instantaneous mode change, bypassing stop.

Air-cushion eject slowly, softly opens tape compartment door, thus minimizing wear on eject system.

Dolby Noise Reduction System includes 25  $\mu$ S de-emphasis circuit for Dolby FM, as well as controls for standard Dolby applications.

\*WRMS \*\*FeCr tape, Dolby\*\*\*\*out. \*\*\*FeCr tape. \*\*\*\*TM Dolby Labs, Inc. (Source: Sony Corp.)

© 1977 Superscope, Inc., 20525 Nordhoff St., Chatsworth, CA 91311. Prices and models subject to change without notice. Consult the Yellow Pages for your nearest Superscope dealer.

# Technics introduces a 321 element IC or, in plain English, more torque.

It's in the SL-1400, Technics' semi-automatic direct-drive turntable. With our latest advance: The one-chip 321 element IC with three high-capacity power transistors. Those 321 elements translate to one reason why the SL-1400 will reach the exact playing speed within  $\frac{1}{3}$  of a revolution at  $33\frac{1}{3}$  RPM. That's torque.

But equally important, the SL-1400 has the Technics direct-drive system. The same system radio stations use. And disc abuse.

Professionals prefer our direct-drive system for the same reasons you will. Like inaudible wow and flutter (0.03% WRMS). Because with our system the platter is part of the motor. So there aren't any belts, gears or idlers to produce speed variations.

You won't hear any rumble, either. Because our DC motor introduces so little vibration into the system that rumble remains inaudible (-70dB DIN B).

And load changes in AC line voltage or frequency

won't affect turntable speed. The reason: A frequency generator servo control. But direct drive isn't all the

SL-1400 has going for it. For outstanding low tracking error, there's an ultra-sensitive gimbal-suspended tone arm. With an effective pivot-to-stylus length of  $9\frac{1}{16}$ ".

And all you do is place the stylus on the record and the SL-1400 does the rest. From auto cut. To auto return. To auto shutoff.

You'll also get one anti-skating adjustment for all types of styli. Variable pitch controls. An easy-view stroboscope.

Viscous-damped cueing. Feedback-insulated legs. As well as a hinged detachable dust cover and integral base.

So get the SL-1400. And get the precision of Technics direct drive. The convenience of semi-automatic operation. And the advantage of increased torque.



Direct Drive System



## Technics

by Panasonic

Enter No. 36 on Reader Service Card