

Audio

THE AUTHORITATIVE MAGAZINE ABOUT HIGH FIDELITY • DECEMBER 1976

\$1.00

47425

Scenes Visits
Revox/Studer

Microphone
Sensitivity
Ratings

Time Delay
for Ambience

U0803760 0477 60616013P0201312
DON L HUNTER
2608 CENTRAL BLVD OR 97403
EUGENE



The high price.

For under \$200*, you can
now own the direct-drive PL-510.



*For informational purposes only. The actual resale prices will be set by the individual Pioneer dealer at his option.

Pioneer has
conquered the one
big problem of
high-priced
turntables.



The best way to judge the new Pioneer PL-510 turntable is to pretend it costs about \$100 more. Then see for yourself if it's worth that kind of money.

First, note the precision-machined look and feel of the PL-510.

The massive, die-cast, aluminum-alloy platter gives an immediate impression of quality. The strobe marks on the rim tell you that you don't have to worry about perfect accuracy of speed. The tone arm is made like a scientific instrument and seems to have practically no mass when you lift it off the arm rest. The controls are a sensuous delight to touch and are functionally grouped for one-handed operation.

But the most expensive feature of the PL-510 is hidden under the platter. Direct drive. With a brushless DC servo-controlled motor. The same as in the costliest turntables.

That's why the rumble level is down to -60 dB by the JIS standard. (This is considerably more stringent than the more commonly used DIN "B" standard, which would yield an even more impressive figure.) And that's why the wow and flutter remain below 0.03%. You can't get performance like that with idler

drive or even belt drive. The PL-510 is truly the inaudible component a turntable should be.

Vibrations due to external causes, such as heavy footsteps, are completely damped out by the PL-510's double-floating suspension. The base floats on rubber insulators inside the four feet. And the turntable chassis floats on springs suspended from the top panel of the base. Stylus hopping and tone arm skittering become virtually impossible. (Even the turntable mat is made of a special vibration-absorbing material.)

But if all this won't persuade you to buy a high-priced turntable, even without the high price, Pioneer has three other new models for even less.

The PL-117D for under \$175*. The PL-115D for under \$125*. And the amazing PL-112D for under \$100*.

None of these has a rumble level above -50 dB (JIS). None of them has more wow and flutter than 0.07%.

So it seems that Pioneer has also conquered the one big problem of low-priced turntables.

The low performance.

U.S. Pioneer Electronics Corp.,
75 Oxford Drive, Moonachie,
New Jersey 07074.

Turntable:

- Direct drive
- Brushless DC servo-controlled motor
- 33 $\frac{1}{3}$ and 45 RPM speeds
- Strobe light
- Strobe-calibrated platter rim
- $\pm 2\%$ fine adjustment of speeds
- Double-floating system of suspension
- Turntable mat of high-internal-loss rubber
- One-handed operation of controls

Tone arm:

- Lightweight S-shaped tubular design
- Static balance
- Ball-bearing pivot with angular contact
- Anti-skating device
- Lateral balancer
- Direct-readout counterweight
- Viscous-damped cueing
- Lightweight plug-in headshell

 **PIONEER**[®]

Anyone can hear the difference.

Check No. 32 on Reader Service Card



DIRECT DRIVE
STEREO TURNTABLE
PL-510

Audio

December 1976 "Successor to **RADIO** Est. 1917" Vol. 60, No. 12

Feature Articles 32 Microphone Sensitivity Ratings/Alfred Lorona
40 Time Delay for Ambience/Leonard Feldman
52 Equipment Directory Addenda
122 Annual Index

Equipment Profiles 58 Onkyo TX-4500 Receiver/Leonard Feldman
65 JVC CD-1970 Cassette Deck/George W. Tillet
68 Kenwood KA-3500 Amplifier/Leonard Feldman
71 BSR FEW-3 Graphic Equalizer/Leonard Feldman
73 Technics RS-630US Cassette Deck/Howard A. Roberson
76 Harman/Kardon Citation 16 Amplifier/Bascom H. King

Record Reviews 80 The Column/Michael Tearson & Jon Tiven
86 Classical/Edward Tatnall Canby
91 European Recordings/John Wright
94 Jazz & Blues/John Lissner & Eric Henry
100 The Folk Bag/Tom Bingham

Audio In General 4 Audioclinic/Joseph Giovanelli
6 Tape Guide/Herman Burstein
12 Audio ETC/Edward Tatnall Canby
20 Behind the Scenes/Bert Whyte
28 Dear Editor
105 Classified Advertising
112 Advertising Index

Editor Eugene Pitts III
Associate Editors
Edward Tatnall Canby
Bert Whyte
Assistant Editor Eugene J. Garvin Jr.
Marketing Director Sanford L. Cahn
Design Frank Moore
Circulation Manager Jean Davis
Advertising Production Gloria Klaiman

Senior Editors
Richard C. Heyser
Bascom H. King
B.V. Pisha

Contributing Editors:
Tom Bingham, Herman Burstein,
Leonard Feldman, Joseph Giovanelli,
C.G. McProud, Dan Morgenstern,
Howard A. Roberson, Donald M. Spoto,
Michael Tearson, George W. Tillet,
Jon Tiven.

Publisher Jay L. Butler

About the cover: Santa left microphones this year in some lucky audiophile's stocking; clockwise, from upper-left, Sennheiser MD-441, AKG D-1000E, Shure 516EQ, 3M, and Electro-Voice 671.

AUDIO (title registered U.S. Pat. Off.) is published monthly by North American Publishing Co., Irvin J. Borowsky, President; Frank Nemeyer, and Jay L. Butler, Vice Presidents; R. Kenneth Baxter, Vice President/Production; Vic Brody, Promotion Director; Mary Claffey, Circulation Director.

RATES—United States only: 1 year for \$7.00, 2 years for \$12.00; 3 years for \$17.00; outside the U.S.: 1 year for \$9.00, 2 years for \$16.00, and 3 years for \$23.00. Printed in U.S.A. at Columbus, Ohio. All rights reserved. Entire contents copyrighted 1976 by North American Publishing Co. Second class postage paid at Philadelphia, Pa. and additional mailing office.

Back issues, \$2.00 each. **World Library Congress Number:** ISSN 0004-752X. **Dewey Decimal Number:** 621.381 or 778.5.

REGIONAL SALES OFFICES: Jay L. Butler, Publisher and Sanford L. Cahn, Marketing Director, 545 Madison Ave., New York, N.Y. 10022, telephone (212) 371-4100.

Jay Martin, 2525 West 8th St., Los Angeles, California 90057, telephone (213) 385-2917.

REPRESENTATIVES: Europe, V. B. Sanders, International Publishers Advertising Service, Raadhuisstraat 24, P.O. Box 25, Graft-de-Ryp, Holland; telephone, 02997-1303; telegrams, Euradteam—Amsterdam.

Japan: Japan Printing News Co., Ltd., No. 13.2 Chome Ginza Higasi, Chuo-ku, Tokyo, telephone 541-5795.



AUDIO Editorial and Publishing Offices, 401 No. Broad St., Philadelphia, Pa. 19108
Postmaster: Send Form 3579 to the above address.



Actual, unretouched photo of an oscillograph test.

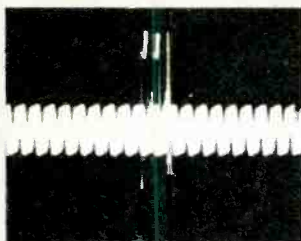

The oscillograph you see is an actual photo of a high-quality audio system "playing" a fingerprint.

You're hearing fingerprints now through your speaker system. Instead of the sound your precious discs are capable of. And no vacuum record cleaner, brush-arm or treated cloth will remove them. None.

The sound of your fingerprint

But Discwasher™—with new **du** fluid—removes fingerprints completely. Along with dust. And manufacturing lubricants (added to make pressing faster) that can act like groove-blocking fingerprints. All this cleaning without pulling polymer stabilizers from your vinyl discs.

Discwasher™. The only safe, effective way to silence the printed finger. At Audio specialists world wide.



Discwasher, Inc.
Columbia, Mo. 65201



THE SOURCE OF PERFECTION **IN STEREO SOUND...** **PICKERING'S ALL NEW** **XSV/3000**



3

It features a totally unique construction (developed by Pickering through our pioneering efforts in discrete, 4-channel) plus a totally new stylus tip shape, the Stereohedron™, which has superior tracing ability and assures longer stylus and record life!

This new cartridge makes possible a wider, more open, finer sound — because it maximizes stereo tracing capabilities with the slightest, lightest touch a record ever had. It increases record life because force is spread over a greater contact area. And that means the least record wear achievable in these times (with a stereo cartridge).

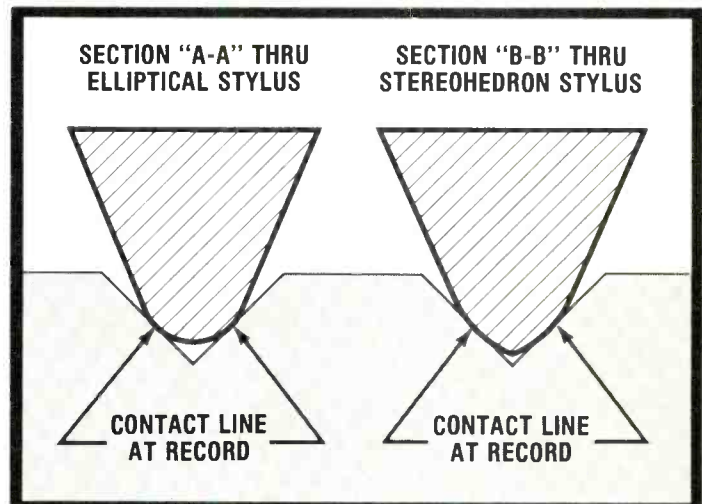

Conventional elliptical styli have a relatively limited bearing radius at the contact area with the groove. The Stereohedron combines the elliptical and Quadrhedron concepts to create a stylus having a larger bearing contact radius at the area in order to reduce stylus wear and prolong record life.

For further information write to:
 Pickering & Co., Inc. Dept. A
 101 Sunnyside Blvd., Plainview, New York 11803

Check No. 31 on Reader Service Card



*"for those who can **hear** the difference"*

Audioclinic

The Best Way To Show You What You'll Get Out Of An Empire Phono Cartridge Is To Show You What Goes Into One.



At Empire we make a complete line of phono cartridges. Each one has slightly different performance characteristics which allow you to choose the cartridge most compatible to your turntable.

There are, however, certain advantages, provided by Empire's unique design, that apply to all our cartridges.

One is less wear on your records. Unlike other magnetic cartridges, Empire's moving iron design allows the diamond stylus to float free of its magnets and coils, imposing much less weight on your record's surface and insuring longer record life.

Another advantage is the better channel separation you get with Empire cartridges. We use a small, hollow iron armature which allows for a tighter fit in its positioning among the poles. So, even the most minute movement is accurately reproduced to give you the space and depth of the original recording.

Finally, Empire uses 4 coils, 4 poles, and 3 magnets (more than any other cartridge) for better balance and hum rejection.

The end result is great listening. Audition one for yourself or write for our free brochure, "How To Get The Most Out Of Your Records". After you compare our performance specifications we think you'll agree that, for the money, you can't do better than Empire.

Empire Scientific Corp.
Garden City, New York 11530

EMPIRE

Already your system sounds better.

Record Groove Deformation

Q. I recently read that after playing a record you should wait at least an hour before replaying it. Is there anything to this?—T.C. Williams, Alamosa, Colo.

A. Vinyl material, used as the main ingredient in phonograph records, is soft. The force exerted on the groove walls by the stylus, especially at high frequencies, can be tremendous. This force results in a deformation of the groove walls. Vinyl, however, has a memory and will slowly return to its original position after a time.

When the disc is played over and over again, however, the material will not have an opportunity to "spring back" into its normal shape. The longer it is prevented from doing so, the less likely it can ever completely return to its original condition.

Deformations of the kind we are discussing will ultimately result in distortion at high frequencies, much like the sound of a worn stylus. This deformation will produce audible effects even though the disc will still play with little background surface noise.

Microphones and Transformers

Q. On most commercially made PA mixers, there are both lo-Z and Hi-Z mike inputs. Is the purpose of these transformers on the Lo-Z inputs to step up the signal from a Lo-Z mike for the Hi-Z inputs of the mixer/preamp? What then is the relationship of the mike, the line transformer, and the two inputs?—T. Young, Thomaston, Conn.

A. A Lo-Z mike with a long run of cable will need the transformer for feeding into the Hi-Z input because of the need for higher input voltage and to insure against loss of the signal. With a long run of cable, Hi-Z mikes should not be used because with lengths of 20 feet there will be a high frequency loss of up to 6 dB at 10 kHz.

If you have a Lo-Z mike and mixer with the option of using low impedance inputs, by all means use them.

This will mean that you don't need the transformer. The transformer may actually be located in the mixer already, or at least the functions of the transformer are taken care of by appropriate circuitry.

Hiss In a Reverb Amplifier

Q. I have a reverberation amplifier which produces a bad "hiss" when the "reverb time" control is turned up to its halfway point or higher. If the reverb is off but the power is still on, there is no "hiss." Once the reverb has been turned either to its "on" or to its "record" mode, and with the "reverb time" control turned up as described, the "hiss" starts again. I've tried changing my inputs and tried grounding arrangements, but this "hiss" is always there. Is there anything I can do to overcome this problem?—Sgt. Herm Rosario, APO, San Francisco, Cal.

A. When the reverberation control is advanced, what actually takes place is that a signal from a high-gain amplifier is mixed with the "non-reverberant" signal. High-gain amplifiers can often be noisy, either because of inherently poor design or defective circuit elements. The most common problem is a noisy input transistor. I suggest, therefore, that you change this transistor. If the circuit is still "hissy," see if you can locate a transistor which has equivalent electrical characteristics, but an inherently lower noise level.

While any amplifier generates noise, if there is a sufficient amount of signal present, the noise will be masked. Thus, there is the possibility that you are not feeding a sufficient amount of signal into your reverberation system. Check the specs on the unit and the source to see whether this is the case. ▲

If you have a problem or question on tape recording, write to Mr. Herman Burstein at AUDIO, 401 North Broad Street, Philadelphia, Pa. 19108. All letters are answered. Please enclose a stamped, self-addressed envelope.

AUDIO • DECEMBER, 1976

Dual owners generally are more experienced than typical component owners. More than half have owned another brand. Usually they have spent more for records than all the other audio equipment combined. Thus, they need no reminder that the turntable is the only component that handles the record. Or that to compromise with quality here can risk damage to their record collection.

What Dual owners know about their turntables that you should know about yours.

(And there is no way to repair a damaged record.)

Dual owners also know that the true measure of a turntable's quality and long-term reliability is not merely in its features, but is inherent in the materials used, the care in their assembly and the quality control employed in testing.

The mechanical feel of controls and switches, smoothness of tonearm movement and overall evidence of solidity are excellent clues to a turntable's general performance. Other clues are internal and not so easily appreciated. If you own a Dual, you know precisely what we mean. If you don't, the examples of Dual refinements described below may be of interest and enlightenment. They indicate why you will appreciate some things about Dual right away, and why others may take years.

United Audio Products, 120 So. Columbus Ave., Mt. Vernon, N.Y. 10553

Exclusive U.S. Distribution Agency for Dual

Dual

Dual 1249. Single-play/multi-play, belt-drive turntable with fully automatic start and stop, plus continuous play. Mode Selector parallels tonearm to record in single-play for accurate vertical tracking. Other features: 6% pitch control; illuminated strobe; cue-control viscous-damped in both directions; anti-skating calibrated for conical, elliptical and CD-4 stylus. Less than \$280.



True, four-point gimbal centers and pivots the tonearm mass at intersection of horizontal and vertical axes. Tonearm is dynamically balanced in all planes. The four needle-point pivots are first hardened, then honed, a process which produces microscopically smooth surfaces. The precision ball-bearing races are only 0.157 inch diameter.

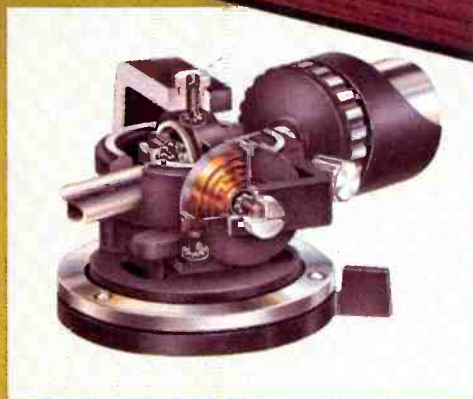

Unique "Vario-pulley" used in Dual's three belt-drive models is precision-machined for perfect concentricity and balance. Speeds are adjusted by expansion and contraction of pulley circumference; belt is never twisted or distorted.



Dual single-play/multi-play models: 1225, less than \$140; 1226, less than \$170; 1228, less than \$200; 1249, less than \$280.
Dual single-play models: 502, less than \$160; 510, less than \$200; CS704, less than \$310; CS721, less than \$400.

Check No. 13 on Reader Service Card

The \$750 alternative.

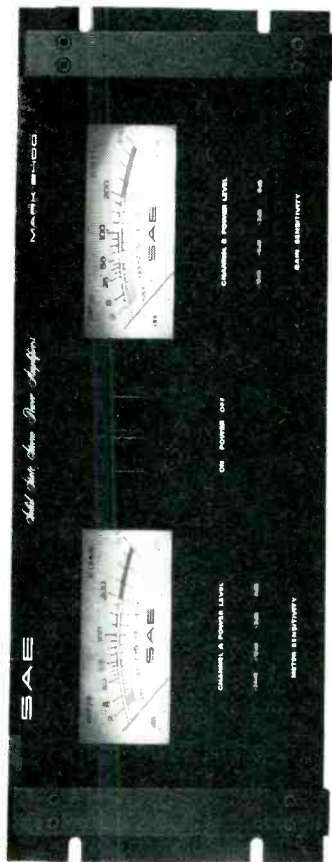

SAE 2400 Professional Dual-Channel Power Amplifier

- 200 Watts RMS, per channel, both channels driven into 4 or 8 Ohms from 20Hz to 20KHz at no more than 0.05% Total Harmonic Distortion.
 - 0.05% IM into 4 or 8 Ohms
 - (signal to noise) greater than 100dB
 - plug-in board modules
 - forced air cooling
 - only 11" deep
 - weighs less than 42 lbs.
 - superb construction using only the finest materials and component parts
 - available in black rack mount (as shown) or our traditional satin gold and black
- You'd have to look a long time to find a power amplifier that delivers this much value.



Scientific Audio Electronics, Inc.
P.O. Box 60271, Terminal Annex
Los Angeles, California 90060
Please send me the reasons (including available literature) why the SAE 2400 Professional Amplifier is the "\$750 Alternative."

NAME _____
ADDRESS _____
CITY _____ STATE _____ ZIP _____

Check No. 36 on Reader Service Card

Tape Guide

Herman Burstein

Dolby Update

Q. With the advent of Dolby equipment and 4-channel stereo, I am wondering what will happen with the pre-recorded open-reel tapes? Will the record companies be issuing a lot of their former tapes now Dolbyized and later in a 4-channel format? If they might, would it be better to wait and not buy the tapes at the present moment?—W. D. Robertson, Vancouver, B.C., Canada

A. I think that the present 2-channel stereo format, using non-Dolby tapes, will be around for a while. There is, of course, a trend to the 4-channel format and to Dolbyizing everything in sight, but it takes time to work out problems and to secure industry agreement on standards. Moreover, it is not clear that the Dolby noise reduction system has permanently sewed up the audio market. There are some competitive systems, like dbx or Burwen, which promise even greater noise reduction than Dolby. Or, conceivably, the Dolby system might be modified to further reduce noise, but all this takes time. In the meantime, it seems a pity to consign yourself to an indefinite waiting period and deny yourself the pleasure of listening to tapes you would enjoy. Furthermore, when changes do come, there is usually a strong attempt to maintain compatibility with previous procedures, so that there is a good chance that your previously acquired audio equipment, tapes, etc. will not be made obsolete.

Dolby vs. Burwen

Q. I have read articles on the Dolby and Burwen noise reduction systems, but I'm confused as to how the Burwen system works. What enables it to give such a greater noise reduction than the Dolby system and at the same time allow much lower recording levels?—Wallace Bacon, FPO San Francisco, Cal.

A. The Dolby system operates on the principle of boosting the treble frequencies at low signal levels in recording, and correspondingly de-emphasizing the treble frequencies at low signal levels in playback, thereby restoring flat response and at the same time reducing noise that occurs in recording and playback. The Burwen system similarly employs treble boost in recording and treble cut in playback. In addition, it compresses the recording signal and correspondingly expands the playback signal. Such compression permits a greater degree of treble pre-emphasis in recording, without overloading the tape, than does the Dolby system. Hence the Burwen system can apparently achieve greater noise reduction. In the above I have been referring to the Dolby-B system widely used for home application. For professional use, the full-scale Dolby system divides the audio range into four bands and applies its noise reduction technique to each. Since noise is most apparent in the treble range, the Dolby-B system is quite effective.

Whistle Filter

Q. Could you please refer me to some source which would give details on making a filter to cope with my tape recorder whistle? I have realigned my tuner, a Dynakit FM-3, according to the instruction manual, but I get a high-frequency whistle on tape when recording a stereo broadcast. There is no whistling on mono broadcasts. I tried feeding the tape recorder from the "main output" jacks of my preamp, with the scratch filter on. This eliminated the whistle, but also eliminated the high frequencies of the audio signal. I'd appreciate your help.—Sheldon Isaac, Phila, Pa.

A. When you have a specific problem with a specific component, it is a

Beauty in sound. By Fuji.

Every Fuji cassette means beauty and purity in sound. No hiss, no dropouts. Widest frequency response and dynamic range. Total reliability. Fuji high-fidelity cassettes such as the FX will give you the best performance possible on your tape recorder. Already widely recognized by experts as the finest cassette in the world. Fuji. The cassette of the pro.



FUJI

Fuji Photo Film U.S.A., Inc., The Empire State Building, New York, N.Y. 10001

Check No. 16 on Reader Service Card

good idea to write first to the manufacturer of that component. In the meantime, I suggest that you place a trap tuned to 19 kHz across each output of your tuner. This would consist of an inductance and capacitance in series, placed between the hot and ground terminals. If you use an inductance of about 10 mH, then you would need a capacitance of about 0.007 μ F. Given the value of inductance, the required capacitance is calculated from $C = 25,000,000/L^2F$, where C is capacitance in pF, L is inductance in mH, and F is frequency in kHz.

Preamp Problem

Q. I have been having a problem with the record preamps of my tape deck, which uses tubes. They have been producing a quite audible distortion. The distortion is present before the signal enters the record heads; it is audible in the "source" position of the monitor switch. The distortion increases as the record gain control is turned up and is equally bad on both channels. My first inclination would be that there is a bad tube in the first stage(s) of the preamps. However, no one tube (except the oscillator) is shared by the two channels.—Foster Action, Nashville, Tenn.

A. Your problem may be due to a defect in the power supply. Have you checked the rectifier tube and other power supply components? If voltages have seriously changed owing to a defect in either the power supply or coupling circuits, this may cause one or more tubes to distort, and distortion would increase as gain was increased.

Tape Developer

Q. Please describe the "developing" process by which recorded signals are made visible on the tape.—Reg Fulton, Phila., Pa.

A. The information I have on Magna-See, made by Reeves Soundcraft Corp., Great Pasture Rd., Danbury, Conn., states: "Magna-See is a non-toxic and non-inflammable fluid into which you simply dip a strip of recorded tape, let it dry, and you can actually see the track recorded on the tape. By doing so, you can check azimuth, head alignment, and track uniformity." For more information, I suggest you write to them.

Track Comparison

Q. Is half-track that much better than quarter-track? Can you get quality performance from an automatic reversing deck?—Sheldon Neider, Houston, Tex.

A. Half-track operation permits a higher signal-to-noise ratio—about 3 or 4 dB better than quarter-track.

The top quality reversing tape machines provide about equally good performance in either direction on automatic reverse. When such machines first came out, there were problems in maintaining equally good performance in each direction, but these problems appear to have been largely surmounted.

If you have a problem or question on audio, write to Mr. Joseph Giovanelli, at AUDIO, 401 North Broad Street, Philadelphia, Pa. 19108. All letters are answered. Please enclose a stamped, self-addressed envelope.

Soundcraftsmen THE PERFECT PRE-AMP

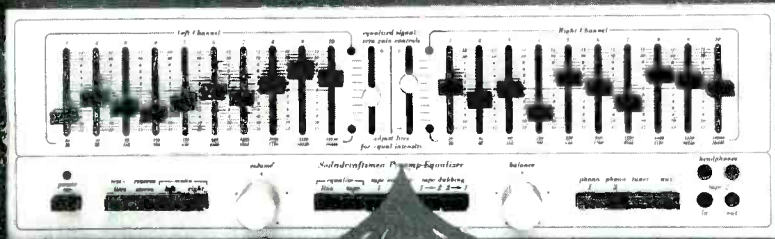

FOR THE GREAT NEW SUPER-POWER AMPS!

For a SUPER-SYSTEM, match the 2217 with any of these TRUE "State-of-the-Art" amps—

- PHASE LINEAR • SAE • CROWN • DYNACO • AUDIO RESEARCH • CITATION •
- ESS • MARANTZ • SONY • KENWOOD • BOSE • QUATRE • BGW •

"FANTASTIC! I CAN HARDLY BELIEVE MY EARS... VERY VERSATILE & CLEAN-SOUNDING AND I REALLY LIKE THE SWITCHABLE PATCHING."

SPECIAL FEATURES

- ALL PUSHBUTTONS INTERLOCKED to prevent inadvertent program destruction
- DISCRETE-OCTAVE EQUALIZATION CONTROL of ten octaves on each channel, -12db each octave
- FULL-SPECTRUM LEVEL CONTROL for each channel
- AUTOMATIC CONTINUOUS MONITORING by light-emitting diodes for visual warning of overload in output circuits
- VISUAL ZERO-GAIN EQUALIZATION BALANCING on music, white noise or pink noise
- SELECTION OF TEST LITES on or off
- TAPE DOUBBING BETWEEN TWO MACHINES, with optional simultaneous equalizing and monitoring
- DOUBLE-DUBBING into two recorders simultaneously
- SEPARATE SYSTEM-SELECTION enables full use of all other functions during the dubbing operation
- LINE OR TAPE equalization selector
- AUTOMATIC EQUALIZER-DEFEAT when line or tape equalizer is not in use
- FRONT PANEL TAPE input-output jacks for easy 2nd and 3rd tape recorder hookup access
- TAPE MONITORING of either tape at any time
- TWO stereo headphone jacks
- MONO SELECTOR for left, right or both channels to both outputs
- REVERSE STEREO mode
- TWO low-level phono inputs
- FOUR independent phono preamps
- SIX A/C outlets, 4 switched, 2 unswitched
- ELECTRO-PLATED FERROUS CHASSIS—(eight sections)—provides optimum shielding to minimize magnetic field-coupling
- SINGLE-POINT system ground connector minimizes ground-loops
- TWO REGULATED power supplies

(CUSTOMER COMMENT CARDS ARE ON FILE AT SOUND-CRAFTSMEN)

FANTASTIC! I CAN HARDLY BELIEVE MY EARS... VERY VERSATILE & CLEAN-SOUNDING AND I REALLY LIKE THE SWITCHABLE PATCHING.

Fantastic unit & I'm glad my first audio purchase feature it in a central position... I'll be sure to recommend it to my friends & you must be kidding!

Please list any suggested improvements, changes, or

Soundcraftsmen EQUALIZERS

HOW YOU CAN MAKE YOUR SYSTEM SOUND EXACTLY THE WAY YOU WANT IT TO SOUND! In a few minutes, YOU can accurately "tune" the frequency response of YOUR stereo system and room environment to a flat ± 2 db! All you need are YOUR OWN EARS and the Soundcraftsmen Equalizer (WITH ITS STEP-BY-STEP INSTRUCTION RECORD) to transform any stereo system and room environment into an acoustically perfect concert hall! Or, to provide any special acoustical effects you desire! The Soundcraftsmen Equalizer enables YOU to instantly compensate for frequency response variations, IN SYSTEM AND ROOM.

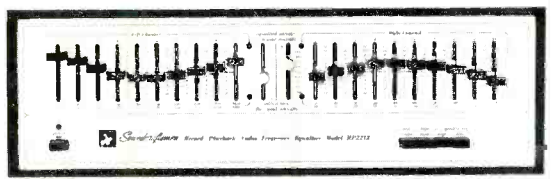

GUARANTEED to enhance and improve any fine system!

- RP2212 (Includes Cabinet or Rack Mounts) \$369.50
- RP2204 (Same as 2212, except no LEDs) \$329.50
- 20-12A (Same as 2212, except no LEDs and Tape EQ thru rear panel patching) \$299.50

GUARANTEED SPECIFICATIONS

FREQ. RESPONSE — HI level: ± 1 db, 5 Hz to 100 KHz
 FREQ. RESPONSE — PHONO: $\pm 1/2$ db, 20 Hz to 20 KHz
 THD: less than .05% at 1 volt (Typ. .01% at 1 volt)
 IM: less than .05% at 1 volt (Typ. .01% at 1 volt)
 PHONO INPUT CAPABILITY: 100mv
 SIGNAL-TO-NOISE — HI level: 100 db below full output
 SIGNAL-TO-NOISE — PHONO: 84 db below a 10mv input
 SIGNAL-TO-NOISE — EQUALIZER: 106 db \pm full output
 GAIN — PHONO: 60 db
 90 db \pm 2 v. RMS
 GAIN — HI level: 21 db
 OUTPUT IMPEDANCE: 600 ohms
 EQUALIZER LEVEL: Zero gain controls for left and right continuously variable, for unity gain compensation
 INDIVIDUAL OCTAVE-CONTROL RANGE: Minimum ± 12 db (Typ. ± 14 db), each octave centered at 30, 60, 120, 240, 480, 960, 1920, 3840, 7680, and 15,360 Hz.
 MAX. OUTPUT SIGNAL: Variable master volume control allows adjustment of optimum output to match amplifier.
 GOLD SWITCHES: All contacts are gold plated for low noise, long life, and resistance to oxidation and corrosion
 CIRCUIT BOARDS: Military grade G-10 glass epoxy
 RESISTORS: Low-noise selected carbon-film
 CABINET SIZE: 7 1/4" x 20" x 11 1/2" deep
 SHIPPING WEIGHT: 28 lbs.
 MADE IN U.S.A. includes cabinet or rack mounts.

PE2217 — \$529.50

FREE!

THE "WHY'S AND HOW'S OF EQUALIZATION,"

an easy to understand explanation of the relationship of acoustics to your environment. This 6 page booklet also contains many unique ideas on "How the Soundcraftsmen Equalizer can measurably enhance your listening pleasures." "How typical room problems are eliminated by Equalization," and a "10-point self-rated Equalization Evaluation Check List."

Soundcraftsmen • 1721 Newport Circle, Santa Ana, California 92705 Prices and specifications subject to change without notice.

Tannoy of London

By appointment to broadcast and recording studios around the world

The heritage. A half century of continuous research and production of high fidelity transducers. For fifty years, a standard for the reproduction of music in the most demanding professional environments.

The here and now. A new Tannoy produced in the best tradition of proud craftsmanship. The crowning achievement of our British designers and sound engineers.

Ingenuity. At first glance, the Tannoy appears to be a conventional speaker. It is a great deal more. It is a fully integrated loudspeaker system. Sound is reproduced, phase coherent, throughout the total audio range from one transducer matrix. Both the high and low frequency drivers are combined within a single, powerful magnetic structure.

The system. The unique combination of the extended low frequency direct radiator, its highly damped cone, the precisely tailored crossover network and the extraordinary phase compensated, wide range horn-loaded high frequency unit, achieves exceptionally linear response — throughout the entire audio spectrum. The system is housed in a rigid, non resonant enclosure that reveals the hand of the master cabinetmaker.

Performance. The Tannoy is highly efficient and remarkably accurate. Music is reproduced with utter naturalness and clarity. Stereo Review listened too: "... smooth and musical... as easy to listen to as to look at..."

Since Tannoy will only be found in the displays of a limited number of selected dealers of established reputation, won't you write us directly? We'll forward a list of those appointed high fidelity dealers who will be pleased to provide a listening demonstration. We'll include a luxurious, full color brochure with the technical details of each model in the Tannoy line; each an unparalleled loudspeaker system.

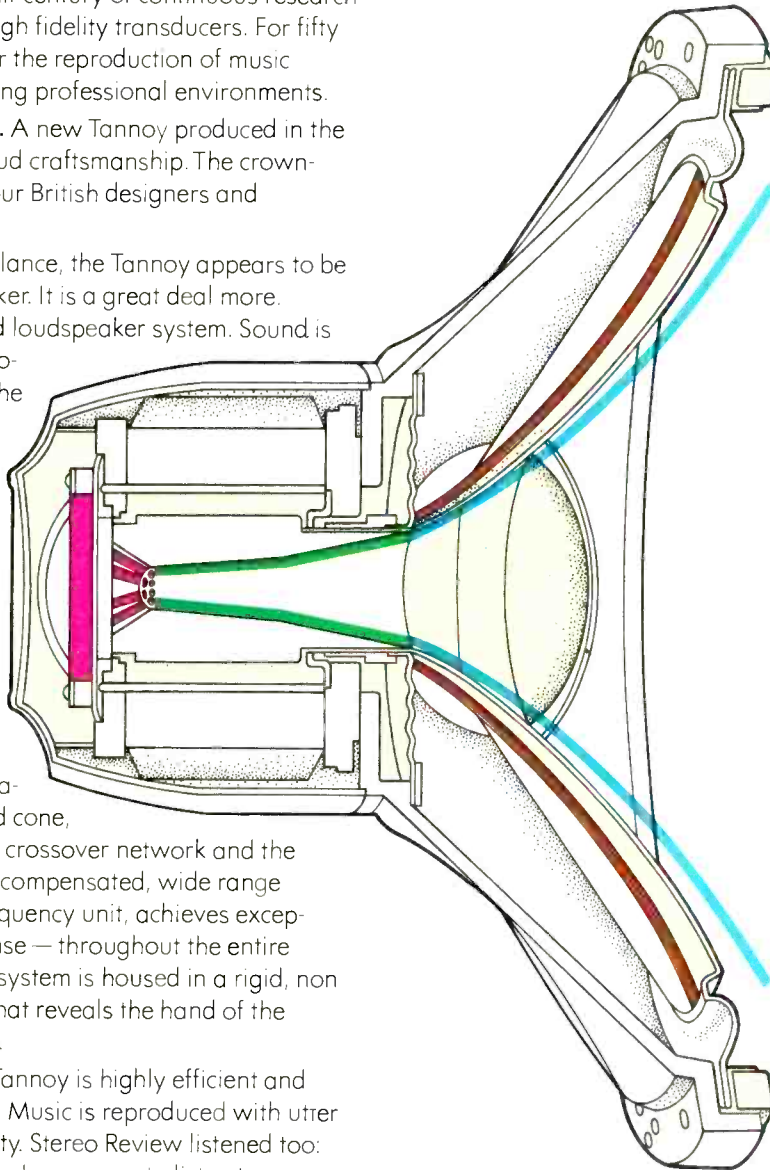

1. High frequencies, produced by a specially formed duraluminum diaphragm, are captured and passed through the many throats of a phase compensator.

2. Sound energy, balanced and phase coherent, its rate of flow and frequency/time relationships meticulously controlled, enters a short, high frequency exponential horn.

3. The curvilinear low frequency cone extends from the exponential horn, providing an unbroken audio spectrum as well as widely dispersed high frequencies.

4. The low frequency cone is a rigid piston, operating from the lowest bass range to one thousand Hertz. At this point, there is a smooth crossover into the range of the high frequency horn which extends beyond audibility.

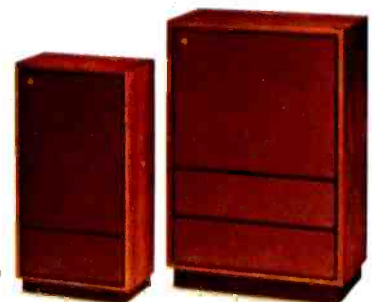

TANNOY®

Tannoy of London, 55 Ames Court, Plainview, N.Y. 11803

Audio etc.

Edward Tatnall Canby

Live vs. recorded? The biggest thing in audio, now, tomorrow, and back in the past. For most of our history and even before, I've always placed this as the first interest, clearly beyond all others, in terms of the *signal* significance of our art, if not its commercial sales figures.

Live vs. recorded is the ultimate, the inevitable, the always-present comparison. Those numerous A/B audio events which dot our history and have been big drawing cards every time, ever since the good Mr. Bell said, "Dr. Watson, come here. . ." (he had accidentally spilled something, and just said it, unlike Samuel F. B. Morse, who carefully planned out his "What hath God wrought?" deal) and the time, in this century, when early vintage opera stars appeared in public, live, in competition with the acoustic phono and were adjudged to be no more life-like than the mechanical machine which reproduced their voices (according to accounts, few in the audience could tell any difference), all the way forward to Edgar Vilchur's sophisticated live vs. recorded hi-fi show demos—the string quartet which stopped playing while the music went right on (rather, they mocked at playing music which, in fact, came from loudspeakers right behind them)—and so onward to our latest and maybe final contradiction, the "live on tape" broadcast now the rule in the U.S.—all these have fascinated

me as points of crucial interest, turning points, if you want, in what is really a smooth continuum of expansion in the understanding of audio's always improving message. The very word *reproduce* gives us the clue. We use it today, and use it even incongruously for the "reproduction" of electronic music that has no previous message existence, either in sound or on paper, in the form which reaches us.

We count on this duality, we take it for granted, and we find it extremely difficult—all of us, audio engineers included, not to mention musicians—to think of audio as, so to speak, a mono art, not dual. Just itself. The only true "mono" sounds in audio are test tones. They are *themselves*. They are a virgin, original messages, signals, with a purpose, a meaning and use. There are only two other major audio categories. Music and speech. Both are dual, even if we must somehow manufacture an original in our minds like, say, a performance in a concert hall, to satisfy the matrix of our thinking.

Audio, as we know it, started as speech, if you will discount the measured clicks (later beeps) of the telegraph language. Did I hear someone say digital? But yes. The rendering of an audio "original," from a "score," a written-down message, into discrete on-off digital units. That was where Morse was a genius, while numerous other telegraph inventors of his time merely plodded along familiar and fruitless analog paths, like the several systems with a separate wire for each letter of the alphabet.

The telegraph did not *reproduce* speech, though it did transmit it. That was for the telephone. "My God, it speaks!" exclaimed the astounded Emperor of Brazil, I think in Philadelphia at the Centennial. There was such an Emperor at the time and he had a magnificent beard. The very idea that a machine could talk actual words was as difficult to conceive, at that moment, as was the later thought that messages might travel from point to point through—nothing—or the insubstantial "ether," whatever that was, minus any sort of visible and tangible connection. Speech came first in audio for excellent reasons, as did opera when we got to music. The good Lord plus Darwin and Wallace saw to it that human speech makes, for the human ear, the most efficient use of sound that we can know, a maximum of content on a minimum of signal shape. "Mary had a little lamb," said

12

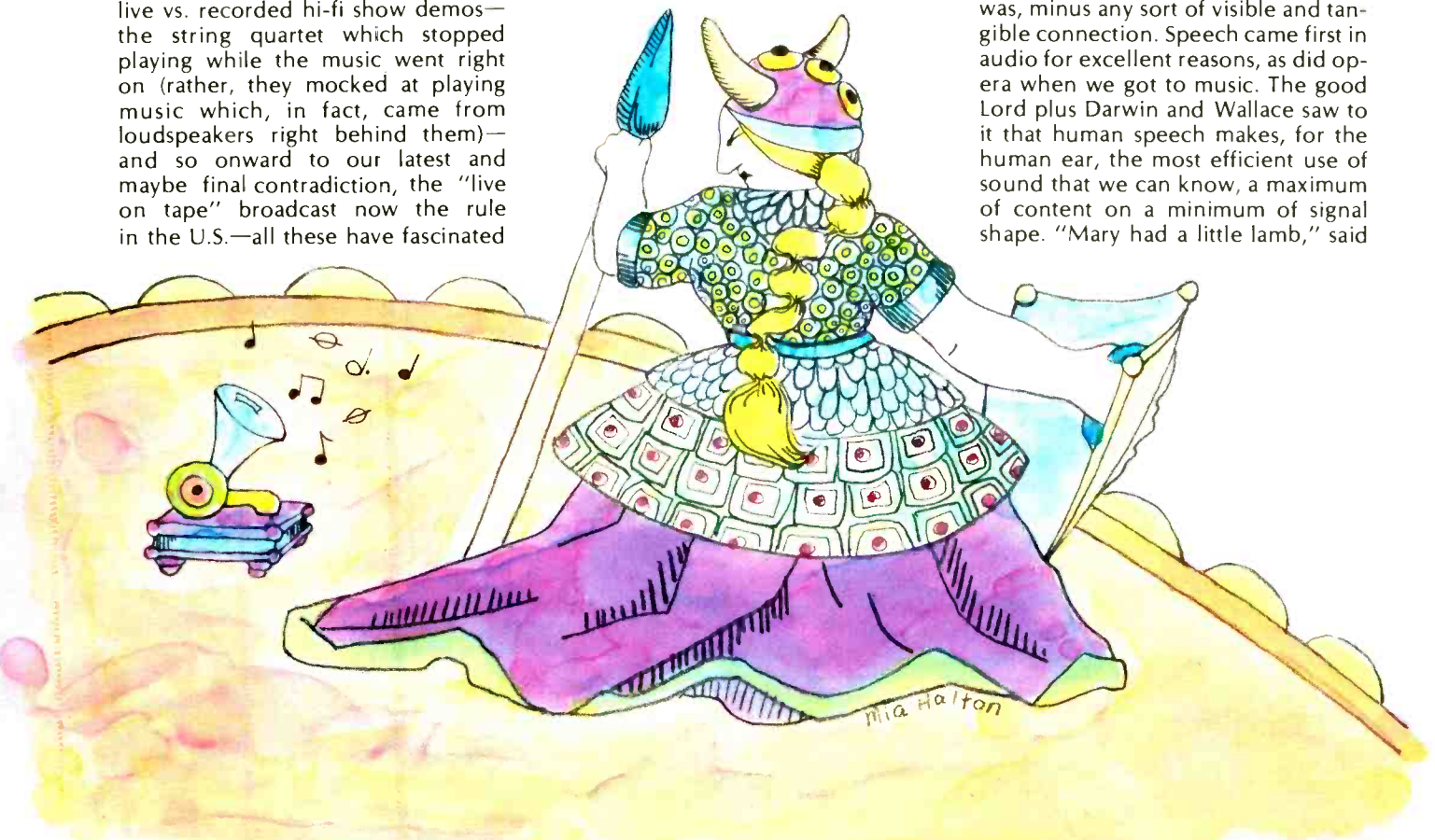



NO ONE PUTS A TURNTABLE ON TOP OF A SPEAKER, RIGHT?

We realize no sane person ever puts their turntable even close to their speakers, but we did it to prove a point.

Which is, it's now possible to build turntables that effectively deal with that unbearable "howl" known as mechanical and acoustic feedback.

The first of these new turntables are the Kenwood KD-3055 and KD-2055.

How did we do it?

With a special base made of an anti-resonance concrete so dense it absorbs vibrations from the speakers and the floor before they get to our new S-shaped tone arm.

To prove it, we did the unheard of.

We put the turntable right on the speaker box. The worst place for vibrations. Then we turned up the music.

Nothing happened. No howl. No screech. Just music, loud and clear.

To make a believer out of you, ask your Kenwood dealer for a demonstration comparing the Kenwoods with any other turntable in the store.

And once you've made the comparison based on performance, make a comparison based on price.

The semi-automatic KD-2055 is only \$139.* The fully-automatic KD-3055, only \$179.*

And that's amazing, right?



KENWOOD

15777 South Broadway, Gardena, CA 90248 72-02 Fifty-First Ave., Woodside, NY 11377

*Suggested resale price. Actual prices are established by Kenwood dealers.
Check No. 21 on Reader Service Card

Cartridge not included.

Edison, and played it back, intelligibly, from tin foil.

Musical Limits

But music, though the ear can take it in very nicely, is enormously less efficient and, of course, stretches the audible medium to its very limits—perhaps the best reason for music's existence. The Mount Everest of the ear. Music of any sort requires a vastly more capable transmission medium than does the basic speech, which came through the early telephone and the first phonographs, whose fidelity by any parameters you choose was measurably just above zero, i.e., sheer noise. Music via the first phonograph, or gramophone, was funny as all get-out because of the matter of pitch, which was one of those unexpected and overwhelming natural obstacles to audio sense, and one which had never existed before. Astonishing discovery, how rock-like, how *faithful*, the reproduced pitch level had to be if musical reproduction was to be accepted as intelligible! And how difficult to achieve. So many big things came along in the 1870s and 80s that the electric motor wasn't even around in practical form when the phono appeared, except via bulky battery power. Something much simpler had to be latched onto, and was. You turned a crank. Hand power. Just try it on your own 1976 turntable and judge the result. Acceptable, at least then, for basic speech. Not for music, once you got tired of giggling at the fire-siren horrors that came out via hand cranking.

Thus, one of the very great inventions in our audio field was the clockwork motor that didn't run down. Not at least for some minutes. That was by Eldridge Gerry, the mechanic who turned into the Victor company soon afterwards. He solved the insoluble problem, how to persuade a spring to unwind itself at an even speed, even though its stored power fell off continuously. A matter for a governor, and we all know that governors, even electronic (feed-back type) tend to oscillate; music does not appreciate any sort of oscillation unless it's part of the "original." Nor any sagging in pitch. The Gerry motor kept right on for as much as four minutes, more if necessary, before it gave up. Yes, true, the chronometer, the household clock, the watch, had solved the unchanging speed problem long since, back in the 17th century; but that was via a mechanical

square wave, the escapement, or a hung weight plus sine wave, the pendulum. Neither would do for an unchanging *continuous* motion. So count clockwork as a part of audio, a basic invention. It was inventions such as these which brought us the possibility of a useful dual role for audio, live sound reflected in sound that was reproduced.

Odd how the basic difference between the telegraph, invented in the 1830s, or the speaking telegraph of the 1870s, and the far more revolutionary phonograph, the first machine to record and reproduce actual sonic intelligence, is still directly reflected in a basic difference today between broadcasting and recording. What seems to me most significant in our

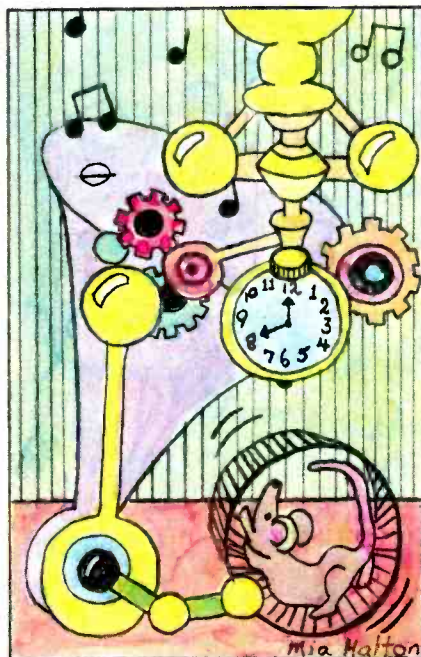

entire industry at this time is that, at last, even *this* basic distinction is beginning to blur and fade, though nature continues to be implacable in its distinctions between *NOW* and any other moment. Live on tape! We postpone time and think nothing of it. Don't suppose, either, that this is exclusively the province of audio. Far from it! How about those speeches which the President or the Secretary of State will make, of which somehow or other we always get to know the entire contents before they are so much as uttered. It is the way of our day, a lot more than just politics. We *think* that way. We move about in time.

Sonic Memorabilia

When a great figure dies, these days, the very first thing we hear is the

incessant sound of his voice, hale and hearty, hour after hour *in memoriam*. Poor old LB! I think I heard more of him the day he died than in all his presidential years. Live vs. recorded. Yes, and the chilling way in which a man's past utterances are brought back to mock him with contradiction, live on tape! The impact of the *living sound* of what he once said is far more powerful than the mere reflection of the printed word. You might say that this is Audio for Truth (and Consistency) in Politics, a telling use of our developed time-displacement sense. Will the Bill of Rights catch up—the segment which says that a man may not be compelled to testify against himself? I am not aware that a test case has yet appeared. It will. For we now take the recorded sound as virtually equivalent to the live, and isn't a man's testimony normally live, in the flesh? Just wait and see.

I know that these thoughts of mine do not exactly reflect the normal day-and-night concerns of the audio fraternity. That's why I write them down, to remind, and to titillate perhaps. If not, then you may turn to the rest of our admirable magazine. (We do cover the field, if I say so myself; ain't it the truth, Editor?) (Editor's Note: No, Ed, I'm afraid it ain't; there are more things in this field remaining yet uncovered than those to which we have barely begun to give coverage. It's like having too small a blanket on a cold night; there's always some part which sticks out.) As for me, I can never get away. I am always involved, even out in what some call the field, the general field. So I conclude with merely a bit of the sort of thing which brings so forcibly to mind this business of the essential audio comparison, live vs. recorded.

Number one. I went to Yerp last summer, just to get away for a bit of perspective. Always helps. I was off for three whole weeks in a VW Polo (a smaller Rabbit) just moseying around in traffic, Belgian, Swiss, French. En route, I stopped in at friends on the Loire, who have bought themselves a peasant farm house, approximately dating back to 1200-and-something, the norm for the region. Three big stone rooms on end, each with an enormous three-foot, solid, 13th century beam across the top and assorted crazy-curve rafters, natural tree shapes. I lived in the "living room" with walk-in stone fireplace; we sat there in the evening. Irrelevant? Oh no. Out comes, on the first evening,

During the last 40 years, Tandberg receivers have earned a world-wide reputation for integrity of design. Clean, clear sound. And outstanding specifications.

Now that reputation for Norwegian quality, precision and reliability shines brighter than ever. Because Tandberg offers you the widest selection of receivers in its history. So you can enjoy brilliant Tandberg performance. And still choose exactly the features you want, at the price you want to pay. See them, hear them at your

Tandberg dealer. They range in price from \$430 to \$1100. And it's comforting to know that whichever one you choose, you've chosen wisely.

NEW TR-2075. Rated among the world's finest in European and American lab test reports. (Loaded with features, it equals or betters the performance of more expensive separate chassis components.)

NEW TR-2055. Made specially for those who don't need all the power of the TR-2075. But who still want to enjoy all the

convenience of its many features, all the pleasure of its performance.

NEW TR-2025. Now you can enjoy Tandberg performance with push-button ease. (This FM stereo receiver includes pre-tuning for 5 stations among its many desirable features.)

NEW TR-1040. Another push-button Tandberg. This one offers more power than TR-2025 plus a full array of the features that have made Tandberg an international favorite.

NOW MORE THAN EVER—THE CHOICE IS TANDBERG!



TANDBERG

For a color catalog of facts and figures, write to us. It's worth \$1.50—but we'll send you a copy absolutely free!
Tandberg of America, Inc., Labriola Court, Armonk, New York 10504. A. Allen Pringle, Ltd., Ontario, Canada

You know what you get

JBL's new L166 doesn't add anything to the music. It doesn't take anything away. That's what all the excitement's about.

It's the most accurate loudspeaker JBL has ever made, and that makes it pretty good. Half our

business is with recording studios and professional musicians who live in a hundred decibel, twenty kiloHertz, twenty-four track world where accuracy isn't a standard; it's an obsession.

There are four reasons to hear the L166:

One, a new, one-of-a-kind dome tweeter. It can handle all the highs your amplifier can throw at it and deliver them to any corner of a room. Like a drumstick and a cymbal. Stand anywhere and witness the crash.

Two, an exclusive, new low fre-

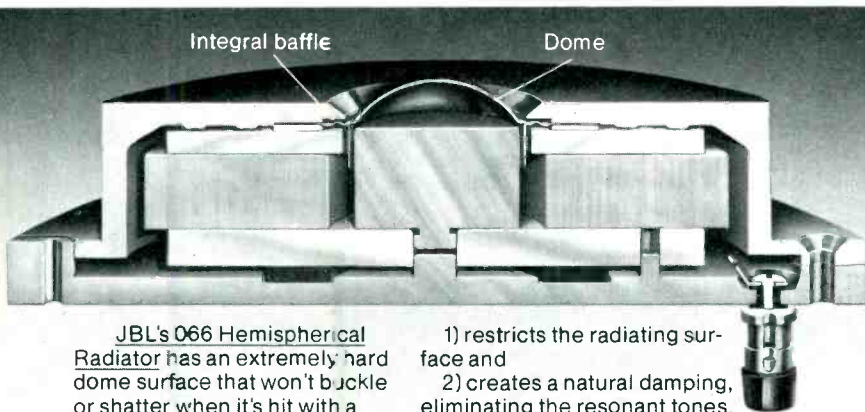

JBL's 066 Hemispherical Radiator has an extremely hard dome surface that won't buckle or shatter when it's hit with a high, hard transient. And—as if that weren't enough—there's a unique integral baffle that

- 1) restricts the radiating surface and
 - 2) creates a natural damping, eliminating the resonant tones.
- Result? Pure sound, dispersed 150° horizontal and vertical at 20 kiloHertz.

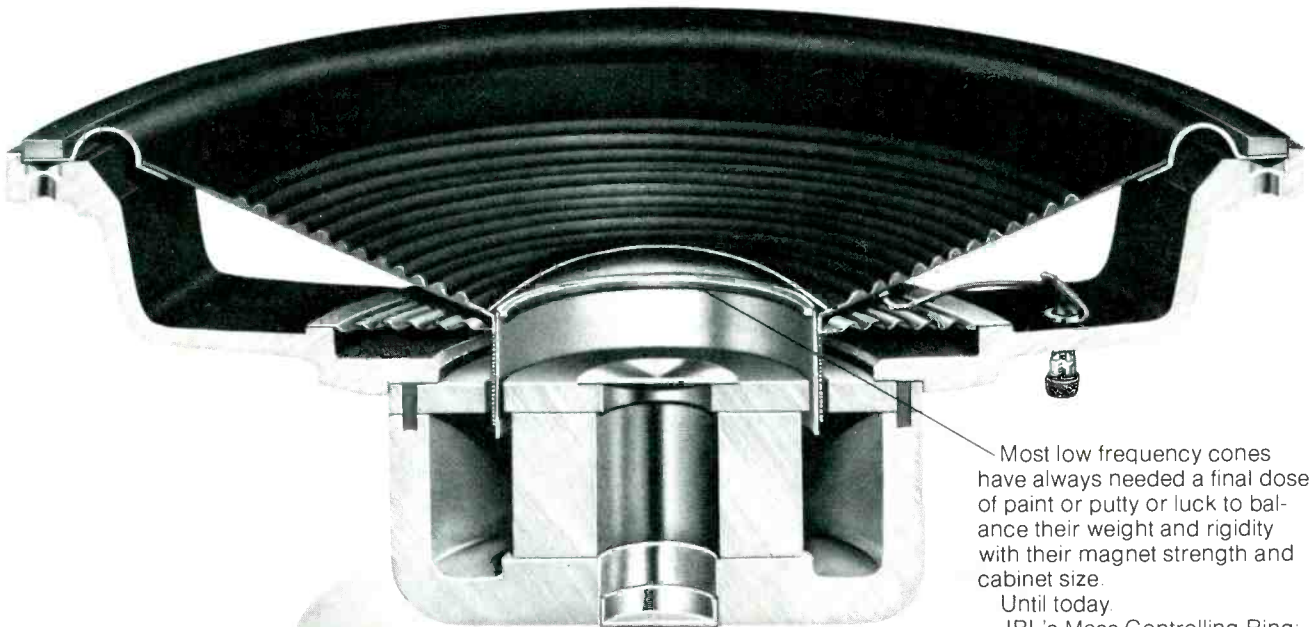
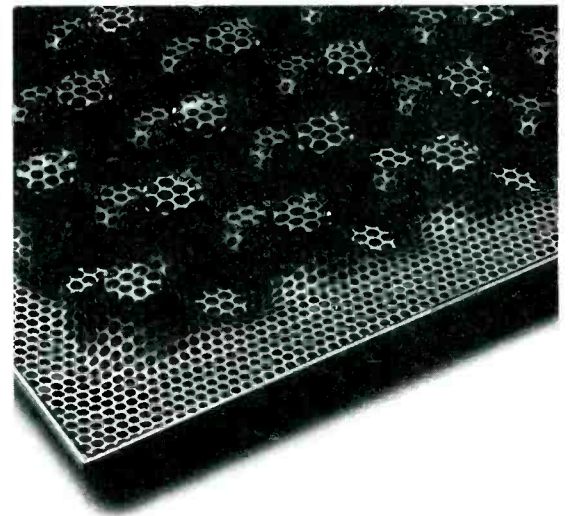

Most low frequency cones have always needed a final dose of paint or putty or luck to balance their weight and rigidity with their magnet strength and cabinet size.

Until today.
JBL's Mass Controlling Ring: Perfect balance. Perfect bass response. Every time.

for your \$800? Nothing.

quency transducer. It has the tightest, cleanest bass you've ever heard — all the way down down down to the lowest audible note. (Ask the L166 to play an amplified cello, an organ pedal, a kickdrum. Nice.)

Three, a new grille material.

It's not just another pretty face. Through it pass the purest highs ever heard. It's the most acoustically transparent grille ever created.

Let your JBL dealer explain the first three reasons. We'll explain the fourth. It's JBL.

JBL has been at this for more than thirty years, and one thing we've learned to make with the greatest care is a promise.

Promise: If you haven't heard JBL's L166, you haven't heard nothing.



JBL's new L166. \$400 each.

James B. Lansing Sound, Inc., 8500 Balboa Blvd., Northridge, Calif. 91329

SONUS



SONUS PHONOGRAPH CARTRIDGES

*In just a few minutes
your "subconscious"
tells you they're the best!*

An insidious form of distortion you may not even be aware of, is causing "listening fatigue" as you play your records. After about 15 minutes of a complex, musically demanding record, it shows up. You feel vaguely anxious, irritable, and ready to turn off the music. That's "listening fatigue"—**virtually eliminated at last** with the new Sonus phono cartridges.

You can hear and feel the difference in the time it takes to play one side of a record. Sonus has reduced Intermodulation and related distortions to previously unachieved levels, reducing these sources of "listening fatigue" to the vanishing point. As you listen, you discover that the emotional tension formerly caused by this distortion is gone. The music comes through with an effortless clarity and definition, as you listen with more attention, more relaxation, and far more pleasure than ever before.

The new Sonus cartridges take you closer to an actual performance than any other cartridges have been able to, until now.

"At one gram, the SONUS Blue Label was audibly superior . . . the sound was excellent in every respect."

Stereo Review/Hirsch-Houck Laboratories

**High Definition Phono
Cartridges for The Most
Accurate Sound Reproduction
Possible.**

Write for further information

SONIC RESEARCH INC.

27 Sugar Hollow Rd., Danbury, Ct. 06810

the traveling cassette, GE model, four or five years back. My hosts wanted to play me their "record collection," taped and handily transported on the plane—the airline didn't even weigh the cassette player. Probably thought it was a camera.

So off we go, into a batch of flute and harpsichord music (the husband once built a Zuckerman harpsichord from a kit) and then on to an orchestra. The cassette was on a table to one side and in the stone-and-plaster room the sound was astonishingly good. Was it GE? Could be. I was amazed at how effective the music was, minus just about everything except the essentials (never forget them), which do not include either stereo or quadraphonic, much as I love these last. Not the basic essentials, which do include the same old ones of steady pitch and an intelligible frequency response, neither of which the first phonograph had.

Bass in absentia

But one semi-basic parameter was weak and you know what. Bass. NO bass. Low notes in the harmony. Totally absent, and the ear had to work against shrill highs in order mentally to reconstruct them. Well, boys, I do know my audio. The old corner horn trick. I said hey, put that thing over there, right down in the far corner, on the floor, facing out diagonally and up diagonally, in the center of a horn—not exponential but still very much a horn. Wow! Even I was surprised. There was at least a full octave more bass, immediately audible. My friends were astonished and maybe, like the Emperor of Brazil, astounded. Of course, this was an unusually neat case, *net* as the French would say. No rugs, very little furniture, but enough distant dispersal via a few chairs and those splendid overhead beams and joists to spread the reinforced sound evenly out. A solid bass. You could hear it. As any good listener knows, a better bass makes any treble sound better.

Live vs. recorded? For several years I have listened to the splendid series of choral recordings by the Oxford-based Christ Church Cathedral Choir of England. I was in Oxford again last summer and by a miracle (in the summer months) there was a major musical event scheduled by that very same choir, which sings all of a mile or so away from where I was staying. This was special. A Palestrina Mass, *Ascendit Maria Virgo in Caelum*, sung as part of a full Anglican service with communion. So we went.

I almost wept, so beautiful was the music and so superbly done; I had myself sung in the same work, in concert form. But imagine the scene—this was the *live* scene and what an extraordinary contrast to the recorded playback in my home living room!

Musical Prayers

Now I probably knew that music as well as all but a handful in that cathedral full of worshippers; but, alas, I did not know the Service. Phew! The Kyrie began and I belatedly struggled to my knees along with my neighbors—this was no concert, this was a prayer, in music. Phew again. Comes the Gloria, and everybody stands up. Same here, if a bit late. Two lovely English girls on each side of me took compassion at my obvious plight and began to coach me. A bit like that first time you tried skis on a ski slope full of experts. Or skates on a public rink. There were intervening hymns and I was fumbling for the right hymn long after they got to verse 3; the ladies to left and right pointed and whispered and I found the page—words only! No music. You are supposed to know the tune, and I am no expert on hymns, except maybe Bach chorales. Wish I had a private recording of my brave attempts to fake the hymn tunes; along about verse 8 (they sing them all), I would begin to get the drift but the rest was pure agony. And those girls were so nice. They went off at the end to join the long lines taking communion, while I stayed on in my place, not even daring to get up and disappear, politely. . . .

So, you see, there still exist immense differences between live music and that which is recorded. A matter of situation and of function. Very little of our musical heritage, in the large, is so-called "concert hall" music. A great deal of it, with no thought whatsoever for audio, was very much part of some current event *not* reproducible via any audio on earth, and mostly not even via TV. What I say, to end with, is what I have always said: when we deal with Live vs. Recorded, we must always give the two forms separate billing, separate and *equal*, each in its own context. Not too many musicians, understandably, are yet willing to think in these terms, but we in audio *know* what immense subtleties of technique we have ourselves developed, and are developing, in the transference of common information from one to the other, live into recorded. I myself do not think there has been any more important art than ours can be, in our world today. **A**

Any LUX amplifier or tuner that doesn't meet or exceed every rated specification won't ever reach you.

It's one thing to produce components with an impressive list of published specifications. It's quite another matter to ensure that every unit will meet or exceed each of those specifications. But this is precisely what LUX does with its entire line of power amplifiers, preamplifiers, integrated amplifiers and tuners.

LUX components were conceived and designed for that very special breed of audiophile whose critical requirements for accurate music reproduction are met only by separate amplifiers and tuners. And of those products, the very best that the state of the art can provide.

Hence, the following procedure takes place at our facilities in Syosset, New York.

Every unit received from the factory in Japan is removed from its carton and placed on a test bench where it is connected to an array of test equipment, which includes a Sound Technology 1700A Distortion Measurement System and 1000A FM Alignment Generator, McAdam 2000A Digital Audio Analyzer System, and Iwatsu Electric SS5100 and 5057Z Synchroscope.

Every control, switch, meter and indicator undergoes an operational check-out. There's nothing unusual about this. Any reputable manufacturer can be expected to do the same. Or at least spot check a shipment.

But LUX has only begun. Every specification is then measured against its published rating. That means 14 individual tests for a power amplifier, 14 for a preamplifier, 20 for an integrated amplifier and 7 for a tuner.

Each verified specification is entered by hand on a Performance Verification Certificate. Any unit that doesn't

match or exceed every published specification is given the appropriate remedy. When a unit passes, it is returned to its carton together with a copy of the Certificate for the information of its future owner. Another copy stays with us as a permanent record.

As for the specifications themselves, here are some examples. The Luxman M-4000 power amplifier has no more than 0.05% total harmonic distortion at any frequency from 20 to 20,000 Hz, even with both channels driven simultaneously to its rated output of 180 watts per channel minimum continuous average power into 8 ohms. Another M-4000 specification: signal-to-noise ratio beyond 100 dB.

Another example is the C-1000 preamplifier. Its phono-input circuits are virtually overload proof, accepting almost half a volt of audio signal at 1000 Hz. The distortion of its phono-preamplifier circuits is an astonishingly low 0.006%, and the rest of the preamplifier circuits add only 0.001% more.

There's one more expression of our confidence in our products. If any of them malfunctions during the first three years, let us know. We'll not only fix it promptly, but will pay the freight both ways, as well as supply a shipping carton if needed.

Some day, all manufacturers may adopt these procedures. For LUX, it's the only way to go. From the very beginning.

With all this, we think that neither our specifications nor our procedures for verifying them is nearly so important as your satisfaction with the end result: the most accurate and musical reproduction you can hear.

The end result can be best appreciated at a select number of dealers whom we guarantee to be as dedicated to fine music reproduction as we are.

One of these Performance Verification Certificates is included with every unit.

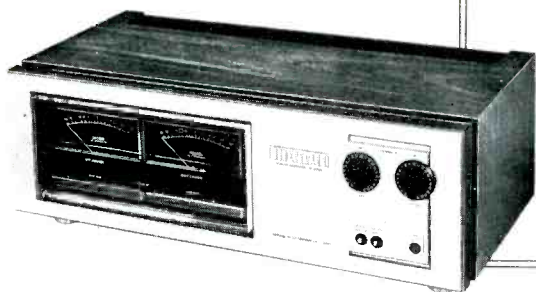
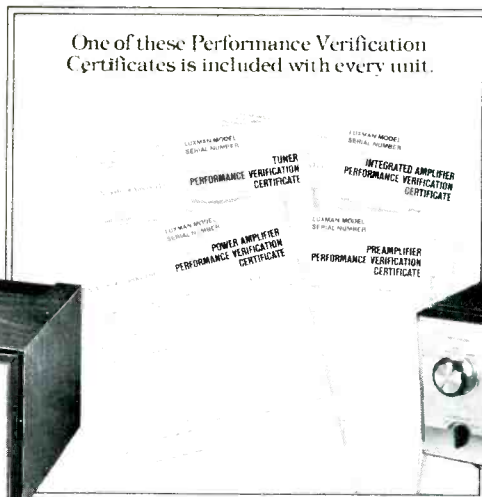

Luxman M-4000 Power Amplifier—180 watts per channel minimum continuous power, both channels driven simultaneously into 8 ohms. Total harmonic distortion no more than 0.05% at any frequency from 20 to 20,000 Hz. Frequency response: 5-50,000 Hz, ± 1 dB. Signal-to-noise ratio: 108 dB. Features include: separate power supplies for each channel, including output and drive stages. Two-meter power-output display in combination with LED peak-output indicators reveal dynamic range of program material. Output level set by precision potentiometer with 1-dB click stops. \$1,495



Luxman C-1000 Preamplifier—Total harmonic and intermodulation distortion: 0.007% at 2.5 V, 20 Hz-20 kHz, all output signals. Frequency response: 2 Hz-80 kHz, +0, -0.5 dB. Signal-to-noise: >65 dB. Phono overload: 450 mV @ 1 kHz, 3.5 V @ 20 kHz. RIAA equalization: ± 0.2 dB. Features include: tape-monitoring and dubbing for two decks, six selectable tone control turnover frequencies, linear equalizer, twin high and low noise filters, variable phono-input impedance, variable input sensitivities, "touch-mute" attenuator, speaker selectors. \$895

LUX Audio of America, Ltd.

200 Aerial Way, Syosset, New York 11791
In Canada: AMX Sound Corp. Ltd., British Columbia; Gentronic Ltd., Quebec

Behind the scenes

Bert Whyte

Last February, I attended the Detroit High Fidelity Show, and at one of the inevitable pre-Show cocktail parties I met Michael Noakes, the new director for Revox operations in the United States. We had a very pleasant chat, and quite naturally the emphasis was on tape recorders. I remarked that in 1976 the Revox tape machines had been on the market for 25 years, and this anniversary should not pass unnoticed. I said that some sort of special article might be appropriate to the occasion. Mr. Noakes suggested that if I was interested in how Revox tape recorders were manufactured, he would arrange a visit to the Revox plants in Switzerland and Germany. To use that well-worn cliché, I accepted with alacrity!

Thus early in July we were at Zurich airport, where we were greeted by

Revox public relations man, Joe Dornier. Joe is a good-natured Viennese who with typical courtesy presented my wife Ruth with a lovely bouquet of roses. Joe was our very knowledgeable host and guide throughout our visit to Revox. After a memorable dinner at the Baur au Lac, it was time to plan our itinerary, since we would be visiting a number of factories in Germany, as well as in Switzerland.

At this point, some notes on the background of the Revox company would be pertinent. Revox is actually a companion company of Studer-Revox, founded in 1948 by Willi Studer. The first products of the company were special high-voltage oscilloscopes designed by Mr. Studer. What happened in 1949 I find particularly fascinating. . . for Willi Studer got into the manufacture of tape recorders virtually by happenstance. Of all

things, an importer brought some

American-made consumer-type tape recorders into Switzerland. Because of the voltage and line frequency differences between the two countries, the units could not be used. Somehow the importer contacted Mr. Studer, who checked over the machines and made new drive-pucks and capstan shafts so they would function properly. These tape machines inspired Mr. Studer to design an improved and better version of them, and when the importer placed an order for 500 of the Studer "Dynavox" machines, Mr. Studer was truly launched in the manufacture of tape recorders. To say that they had problems in producing these Dynavox machines is an understatement. They had to make their own recording heads . . . cobble up most of the test equipment since such items were not "off-the-shelf" equipment at that time. Most amusing is that wow and flutter performance was checked by utilizing the "stability" of the telephone dialtone! The Dynavox production continued through 1950. In 1951 it was

20

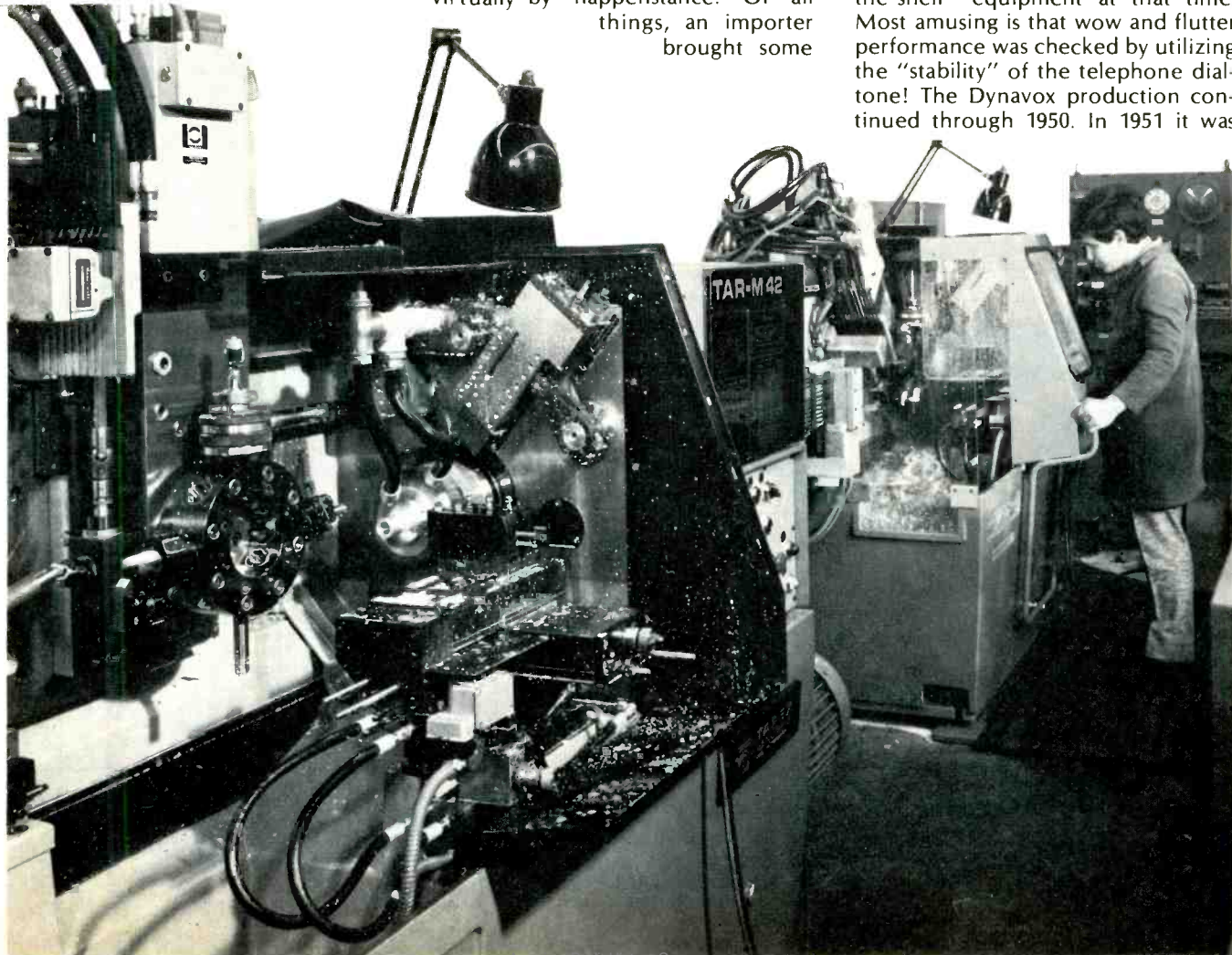

Celestion and Decca

A century of leadership bridging audio's two widest gaps



Celestion UL8

Widest gap number 1: Between the signal at your amplifier's output and the sound you hear. The loudspeaker must fill this gap via mechanical translation. The vibrating element of every speaker possesses mass and inertia—and will therefore by definition be an imperfect reproducer. This is why loudspeaker distortion, frequency and transient response specifications are much poorer than those of good amplifiers.

Celestion's 52 years of building nothing but speakers has evolved an integrated design approach which bridges this gap to an extent few other companies can match. First, Celestion system engineers design a complete speaker system, juggling all variables including driver design. Next, Celestion component engineers design the drivers to fill system engineering's requirements. In most speaker companies, designers must compromise insofar as they must make do with commercially available drive units. By designing and building their own drivers to precisely meet the demands of any particular application, Celestion engineers dramatically reduce compromise other designers must accept. The result is maximum possible performance for given size and price ranges.

From Celestion's UL6 winning the 5th Japan Stereo Components Grand Prix contest, to the Celestion "Power-Range" models used by the Beatles, to the Ditton 66 studio monitors of the Olympic Radio and Television Organization, Montreal /76, people who know how to best bridge the speaker gap—insist on Celestion.



Decca MKV1 Gold Elliptical Cartridge

Widest gap number 2: Between vinyl record grooves and the signal at your phono preamp's input. Like the vibrating element of every speaker, the phono cartridge, stylus and tonearm possess mass, inertia and friction—and can thus approach but not attain correct translation of what is really recorded on the disk.

From Decca, the world's most experienced producer of high quality phonograph records, comes the world's highest fidelity means of playing them: the Decca System. Consisting of:

- 1) Decca London MKV1 Gold Elliptical or Plum Spherical Cartridges employing Decca's legendary "Positive Scanning" system. Featuring lower stylus mass, higher compliance, lower tracking force than the Decca MKV series. Decca MKV1 models offer the best transient response of all cartridges—regardless of price.
- 2) New Decca International Arm. Magnetic antiskating and damped unipivot jewelled bearing of original International Arm, plus several modifications and improvements. As close as you can get to zero friction and zero groove pressure unbalance.
- 3) Decca Record Brush and Record cleaner, "dry clean" devices utilizing Decca's unique conductive micro-fiber to clean records and drain static without the destructive properties liquid cleaners exhibit on cartridges and records. Designed especially for Decca's state-of-the-art MKV1 cartridges.

Bridge the phono gap and hear what is *really* on your records—insist on Decca.



Sole North American Distributors.
ROCELCO INC., 160 Ronald Dr., Montreal, Canada H4X 1M8 Phone (514) 489-6842

decided that all consumer tape recorders would henceforth be marketed under the name Revox. Studer decided to go into the manufacture of professional tape recorders, and later that year the Studer 27 was introduced. 1954 saw the debut of the Revox A36 recorder with a three-motor transport featuring direct tape drive. In 1955, the professional line of recorders was expanded with the Studer A37 and B37. In 1956, the Revox B36 became the first consumer recorder with three-head "off the tape" monitoring. By 1958, the Studer staff numbered 120 and a new factory was built in Regensdorf, a suburb of Zurich. 1960 marked the production of the first stereo Revox, the D36. The professional Studer C37 recorder was introduced and among its features was a real-time tape timer. (In 1965, when I was with RCA, I made the first several hundred classical music masters for 8-track cartridges on the C37, and the timer was invaluable in the sequencing operation.)

Black Forest Assembly

Through 1964, Studer-Revox business continued to expand, necessitating the opening of production facilities in Loffingen, Germany, the first of four similar installations throughout the Black Forest area in the intervening years up to 1974. The Studer-Revox facilities in Regensdorf are expanded, and it becomes the company headquarters. In 1967, the last of 80 thousand Revox 36 series recorders comes off the line and Revox A77 stereo recorder was introduced. The modular construction of this machine and its new servo-controlled a.c. capstan tape drive motor are the beginning of a new era.

In 1968, Revox produced an FM tuner and amplifier, and designed special language laboratory equipment based on the A77. The Studer professional line expands to include mixing consoles. 1970 is a banner year for Studer with the production of the Studer A80 recorders, which are available up to 16 and 24 tracks. Through 1973 Studer-Revox keeps up the introduction of new recorders and associated equipment. Near the end of the year, the Revox A700, an advanced recorder with crystal-controlled capstan servo, is introduced. Studer later makes a professional version of this recorder, the A67. Now in 1976, in their 28th year, Studer-Revox enjoys a worldwide reputation for the manufacture of high precision tape recorders.

The day after our arrival at Zurich, Joe Doner picked us up early in the morning, as we had a long drive through the Black Forest to the Studer-Revox plants. We were to take a circular route, stopping at one plant on the outgoing leg, and two more plants on the return leg. The Black Forest is beautiful country, quite isolated from the hordes of tourists, and in some areas we didn't see another car in a half-hour of driving. Our first stop was at the little village of Ewattingen, where a smallish Revox plant is devoted entirely to the production of three models of loudspeakers. Yes, Revox makes speakers, even though none of them are presently exported to the U.S. All three speakers are the air suspension types. . .the smallest is a two-way system, said to handle 40 watts program material. . .the others are three-way systems, of 60 and 80 watts rating. Although small, the factory is well equipped with a good sized anechoic chamber, and B&K graphic level recorders, etc. The baskets, cones and surrounds, spiders, and magnet structures are from vendors which are assembled in the plant, along with the voice coil and crossover networks which are wound on the premises. In their demonstration room, I kept everyone happy by choosing their top speaker over competing units in a blind A/B test.

Modular Artisans

Our next stop should have been Loffingen, but we went on to Bonndorf, and then back to Loffingen. I'll explain. The construction philosophy on all Studer and Revox tape recorders is the modular concept. Various electronic modules, along with motors and mechanical sub-assemblies are made in the various plants in Germany and Switzerland. All of these elements are pre-tested, then shipped to the plants which assemble a specific tape recorder, such as a Revox A77 or a Studer A80, etc. There are, of course, basic starting points for many of these components, which is why we went on to Bonndorf. In a 56,000 sq. ft. plant, capstan and spooling motors, and printed circuit boards are manufactured from scratch. All Studer-Revox recorders use motors using the outside rotor principle. These rotors are fairly heavy chunks of metal. In the initial operation, metal discs about four in. in diameter and a half-inch thick are placed in a special hy-

draulic deep-drawing press. This monster machine then gives a mighty 100-ton press, and the disc is then formed into a rotor. Then hydraulically controlled automatic lathes rough turn the rotors, which are subsequently finely finished on yet another lathe. The stators of the motors are assembled with the plates and the complex electrical windings. Then the windings are impregnated with epoxy resin in an automatic dripping machine, and the resin is cured by electrically heating the windings. Finally, the stator is precision ground. In another section of the plant capstan shafts undergo precision honing. A proprietary electronic test apparatus measures the run-out accuracy of the capstan shafts. Maximum permissible eccentricity for a Revox A77 is one micrometer and the Studer A80 is half of that! When the capstan and spooling motors are fully assembled and statically and dynamically balanced, they are placed in a special rack and "run in" for many hours being checked for torque, bearing noise, hum, etc.

In still another area in the Bonndorf plant, printed circuit boards are fabricated, starting with the drawing, making the photo negatives, silk screen printing. Then into huge automatic galvanizing and etching tanks. Then the large multiple-print panels are automatically positioned with an accuracy of one-half thousandth of an inch, and then drilled and punched and into individual PC boards. Finally, the electronic components are added to the board and then dip-soldered.

Computer Positioning

After quenching our thirst with some of the local "Furstenburgerbrau", it was on to Loffingen. This sizable plant is where specific electronic modules, motors and sub-assemblies flow, to wind up on the production lines assembling Revox A77 tape recorders and its several variants, and the Revox A700 recorder. I should mention that all Studer-Revox recorders use a die-cast chassis, which is supplied from a vendor foundry, then finished at which time all holes are precision drilled in one operation by numerically-controlled drill presses. Incidentally, all through the Studer-Revox plants, you will find these numerically controlled drills, lathes, grinders, punch presses, etc. These units are given a punched-tape programmed from blueprints with the aid of a computer. With an integral computer

Introducing the B-I-C Electronic Drive 1000. With two motors. Electronic controls. "Pause cueing." Remote control. And a waiting list a mile long.



23

Sorry about the waiting list, but when you see it you'll understand. Here you have a purist's tone arm and superb playback in a "bee eye cee" belt drive unit which we believe promises better long-run performance than a direct drive unit. At about \$279, we think it's irresistible. See what you think at your high-fidelity dealer's. You'll find our 5 turntables folder there. Or write to British Industries Co., Dept. IA, Westbury, N.Y. 11590.

5 Turntables B I C

After people learn what we've done, no one will heckle our speakers.

We're as close to the impossible as possible.

Our new speakers color sound. Anybody's speakers do.

Should someone tell you otherwise, they speak with forked frequency response.

We at Sony approached the development of the SSU-2000 with this grim reality in mind.

Thus our goal was to create a line of speakers with a minimum of coloration. With a frequency response flat and wide. With low distortion. And with repeatability. Which is critical. Which means that each speaker we turn out will sound like the one before and the one after.

Searching and researching.

Our basic dilemma was that speaker specs don't specify much.

You can build two speakers with identical specs, and find they'll sound non-identical.

That's because your sophisticated ear can pick up differences our clumsy measurements can't.

Some examples:

You can hear how pure water is.

The purity of the water in which the pulp for the speaker cone is pressed will influence the sound. (Spring water is the best.)

But water purity would hardly change the frequency response—or any other measureable characteristic.

Nor would the dye used to color the cone—or the glue used in gluing the cabinet.

But you'd hear the dye and the glue.

And there are dozens and dozens of elements that interact this way.

So our job was mammoth. To correlate these factors in order to

reach the goal we outlined earlier. Changing one changes the other and almost changed our minds about going into the speaker business.

But we stuck it out. And found the answer to the juggling of these variables thanks to a major technological innovation.

Trial and error.

That's why we labored for three years to bring you our speakers. While other manufacturers rushed frantically to market with theirs.

We keep the whole world in our hands.

Once we understood how to control the sound of our speakers, we realized we had to control what went into our speakers.

So we did the only logical thing.

We built a plant.

And pursuing that logic, we built it at a place called Cofu. Which is at the base of Mt. Fuji. Where we can get all the spring water we want.

This factory does nothing but produce—under outrageously close control—the components for our speakers.

Whatever we do buy, we specify so carefully that our vendors have nightmares about us. (It's unfortunate that we can't make *everything* ourselves, but only God can make a tree, and only wood can make a fine cabinet.)

Few companies make this effort.

So it's safe to say that when it comes to exercising this kind of control, our speakers are a voice in the dark.

Don't judge a bookshelf speaker by its cover.

As you can see, there's a lot that goes into producing a speaker that's

not easily seen. (One beautiful exception—the handsome finish on our cabinets.)

That includes the carbon fiber that we mix into the speaker cone paper.

Carbon fiber is light and strong. (Why they don't use it in girdles we'll never know.)

Light, so our speaker is more efficient. Meaning you need less power to operate it. Meaning you are closer to the ideal of converting electrical energy to mechanical energy without a loss of power.

Strong, to prevent the cone from bending out of shape in the high frequency range.

Moreover, carbon fiber doesn't resonate much. It has what's called a low Q, and it took someone with a high IQ to realize it would absorb the unwanted vibration rather than transmit it down the cone.

We also cut down on unwanted vibration (as opposed to the wanted vibration, which is music), by using a cast aluminum basket rather than a stamped, shoddy cheap metal one.

We could go on, but at this point the best thing would be for you to move on to your nearest Sony dealer. And listen.

Because the results of our three years of labor will be clear after three minutes of listening.

At which point, far from heckling our speakers, you'll be tempted to give them a standing ovation.

SONY[®]

© 1976 Sony Corp. of America, Sony, 9 W. 57 St., N.Y., N.Y. 10019
SONY is a trademark of Sony Corp.

Suggested retail prices: SSU-2000 \$150 each; SSU-1250 \$100 each; SSU-1050 \$130 a pair.

Check No. 40 on Reader Service Card



converting coded signals into control impulses, these machines will perform their various work functions with unflinching precision.

In one small room at the Regensdorf plant are three special machines, with toolchanger units that can accept 15 different tools, position them along three axes, and change tools within three seconds. The aggregate investment here is over a million dollars. In the Loffingen plant it is quite a sight to see dozens of Revox A77 recorders in the process of assembly. The girls on line test check every

module in the machines with special test equipment developed by Studer for this purpose...there is no spot checking. A written log of all performance specifications is kept on file for each recorder. After all modules test OK, the entire recorder is given an alignment and final check.

It should be noted that it is a policy of Studer-Revox to make as many of their own parts as possible. In addition to those items I have already mentioned, they don't make transistors, resistors, resistors, capacitors, etc. A few small plastic parts are made

by outside vendors, but almost everything else is under Studer-Revox control...and that is the way they want it!

Another vitally important function of the Loffingen plant is the manufacture of the erase, record and playback heads for Revox recorders. Here again, they start from scratch...making the laminations for the C-shaped core sections, using proprietary machines for winding the cores, another special machine to precision work the head shell halves. Each assembled half section of the head shell must be lapped to a surface roughness of less than one-tenth micrometer. When the two half shells are assembled to make a complete head, a super thin "foil" of non-magnetic material is placed between the pole pieces to ensure exact gap dimensions.

Regensdorf Rendezvous

Our heads swimming from all we had seen, we left the Black Forest and returned to Regensdorf. Next morning we went to the main Studer-Revox plant in Regensdorf. This is the headquarters of the entire organization, and contains administrative offices, sales offices, etc. in addition to the manufacturing facilities.

Many ultra-precise machining operations take place here, and while modules and parts are made for Revox, this is where the loving care is lavished on the big professional Studer recorders ranging from quarter-inch two-channel units to the two inch jobs handling 16 and 24 channels. The incredibly difficult-to-make multi-track heads are made in this plant, even to the vacuum deposition of silicon monoxide on the pole pieces to ensure precise gap dimension. Here is where you see some poor technician, doing the absolutely arduous job of final electronic checkout and alignment of 24 channels! Better him than me. A highlight of this visit to Regensdorf was a meeting with Willi Studer himself, and his son-in-law, Michel Rey, who is director of the Revox operation. Speaking through an interpreter, we discussed various aspects of magnetic recording. Mr. Studer very graciously took me through the research and development section and complex of laboratories. I saw some future developments there that would boggle your mind, but I had been asked to maintain secrecy for the present...so no can tell! I really enjoyed my visit to Studer-Revox. It was a fascinating and illuminating experience. I met a lot of nice people and their dedication to high standards of quality was most refreshing. 

Anatomy of a 1/4" tape recorder

Automatic shut-off

Hysteresis three-motor drive

Electro-magnetic braking prevents tape spillage

Rugged

Neoprene head mount for good alignment

Heavy, 3/16" plate for good alignment

Pressure brush improves contact

Plug-in electronics



10" NAB reels (or 5" or 7" standard)

Only seven moving parts

One-piece, 4 1/2 pound flywheel-and-capstan

Computer logic permits any command sequence

Remotable

Remote record for no-thump recording

Two channel record/playback capability. (Other models with four, two or one channels; 1/4, 1/2 or full track; playback only. Extra performance options available.)

Compare all the features of the Crown CX-824 with any other reel-to-reel recorder you may be considering. And then compare the price. Crown represents the real value.

Fast playback coupon

Send directly to Crown for specifications on Crown tape recorders. A-9

When listening becomes an art,

Name _____

Address _____

City _____

State _____ Zip _____



CROWN

Box 1000, Elkhart IN 46514

Check No. 9 on Reader Service Card

AUDIO • DECEMBER, 1976

Sansui's economically-priced SC-3000 compares in performance with any high-quality reel-to-reel... except for its superior convenience.

So you want to move up to reel-to-reel performance but your budget will only get you as far as cassette. Sounds like you want Sansui's SC-3000.

The SC-3000 offers you the same high quality performance you'd expect from reel-to-reel but with the convenience of cassette front-loading and without burning a hole in your pocket.

When we say high quality performance we're talking about an electronically controlled DC motor and a specially designed drive system with wow & flutter as low as 0.09% (WRMS). A signal-to-noise ratio of better than 60 dB with Dolby*. And a frequency response of well up to 16,000 Hz.

Want more? The SC-3000 has two large easy-to-read VU meters with a peak-level indicator.

Separate left and right record level controls for both microphone and line inputs. Memory Rewind. Dolby. Selectable tape equalization. Front-panel microphone jacks and a good-looking front panel. Don't need separate level controls, peak-level indicator and Memory Rewind? Then you want the SC-2000.

Well there you have it, a high-priced, high-quality reel-to-reel or Sansui's low-priced, high-quality SC-3000 and SC-2000 ... Let your pocket be your guide.

*Dolby is a trademark of Dolby Laboratories Inc.

SANSUI ELECTRONICS CORP.

Woodside, New York 11377 • Gardena, California 90247

SANSUI ELECTRIC CO., LTD., Tokyo, Japan • SANSUI AUDIO EUROPE S.A., Antwerp, Belgium

In Canada: Electronic Distributors

Sansui



Simulated woodgrain cabinet.

ALLISON: ONE

Press comment:



ALLISON: ONE \$360*

Stereo Review

NOVEMBER 1975

By Hirsch-Houck Laboratories

"Laboratory Measurements. The averaged frequency response in the reverberant field of our test room, with the speakers installed as recommended, was within approximately ± 2 dB from 35 to 15,000 Hz, with the slope switch set for flattest response. The woofer response matched Allison's published curves within better than 0.5 dB over its operating range, and its overall response was a startling — and excellent — ± 1 dB from 40 to 400 Hz."

"Judging only from its sound and the measurements we made, the Allison:One easily merits a place among today's finest speaker systems."

HIGH FIDELITY

OCTOBER 1975

"The prevailing impression is one of transparency, minimum coloration effects, and a broad sound-front — in short, the kind of highly accurate sound-reproducer that would attract the serious listener who is both musically oriented and technically astute enough to appreciate really fine sound. In our view, the Allison One is among the best speaker systems available."

Descriptive literature on ALLISON loudspeaker systems which includes technical specifications is available on request.

ALLISON ACOUSTICS INC.
7 Tech Circle, Natick, Massachusetts 01760

*Higher in West and South

Check No. 3 on Reader Service Card

Dear editor

VU Meter Standards

Dear Sir:

Regarding C.E. Moule's article on VU meters in your September, 1976, issue, I agree there is much abuse of the VU meter, but I abhor the consequences of any new standard or scale.

The most important fact about the VU meter is that it *is*, in fact, a standard. It has standard electro-mechanical response to the input program material. Its chief value is that two differing pieces of equipment may be connected, levels adjusted, and the performance of both will be as nearly alike as the specific equipment will allow.

It is important to recognize that the Volume Unit, like the decibel, is a ratio of powers. As originally defined, 0 VU is 1.228 volts into a 600-ohm circuit (4 dB above 1 milliwatt or 0 dBm). In recording equipment, the exact level impressed across the meter circuit is unimportant as 0 VU in tape recording is defined as that level of a pure sine wave signal at 400 Hz that will produce one per cent THD using a standard tape. The original standard was Scotch Brand 111A, 1.5 mil acetate. However, most recorder manufacturers use 1.0 mil tape because of present user preference. Once having established this reference, all other measurements become meaningful.

Speech in an uncompressed system will produce instantaneous peaks that reach 12 dB above 0 VU (rms), which will not be indicated by the meter. Good recorder design takes this into account so that the tape used, and not the electronics, becomes the limiting factor as to how much distortion will result from these peaks. It should be noted that the one per cent distortion figure, mentioned above, is primarily the result of tape characteristics and the bias signal.

Good recording practice for original material should allow average peaks in loud passages to reach 0 VU with only occasional peaks above, but none higher than +3 VU. Limitations of home listening equipment cause most record companies to use two reference levels, 0 VU for loud passages and -10 VU for soft passage peaks.

It is part of the recordist's art to know what type of material is being recorded, his equipment, and the dynamic range required. By careful placement of the microphone's level setting and work with the director (conductor or individual artist), a recording will be produced with the desired dynamic range.

To gain maximum equipment efficiency for both the listener and the recording devices, the best signal-to-noise ratio, the least distortion, and a 20 dB VU range in peak program levels are desirable.

In summation, do not tamper with the standard VU meter. Learn to use it, understand its performance, and accept it. Make the choice of A or B scale as you prefer, but leave a good standard alone.

James R. Hougen
San Anselmo, Cal.

VU = Volume Indicator

The article by C.E. Moule in your September, 1976, issue is well done and brings up many interesting points.

During my many years in the communications R&D field, I have observed much misuse of the "volume unit." Engineers who should have known better used the VU interchangeably with the dBm on non-steady state signals; they have not recognized that the VU is a VU only when read on a standard "Volume Indicator" bridged across a 600-ohm circuit, and they were as confused as anyone in reading the instrument.

To the best of my knowledge, there has been no work done by experimental psychologists to determine how people average meter deflections over time intervals, and if there is a better way to solve the reading problem.

It would seem to me that with modern circuit knowledge, somebody ought to develop a means for determining volume of speech and program waves which would be applicable to modern tape equipment and would be less of an "after-the-fact" indication of level. After all, the volume indicator was developed using the then available techniques of

OUR SECOND BEST IS BETTER THAN MOST OTHERS' FIRST BEST.

AUDUA is one of the world's finest cassette tapes. But it's not the best cassette tape made by TDK.

Our SUPER AVILYN (TDK SA) has the edge. And that's only if you're using the special bias/equalization setting on your tape deck.

However, if you're using the normal or standard setting, you'll have to settle for AUDUA—second best.

Chances are you won't find anything better, or with more consistent sound quality, for decks with normal tape selector settings. In other words, even if you don't own extravagant equipment, with AUDUA you can still hear extravagant sound reproduction.

You see, because of AUDUA's superior dynamic range at the critical high-end, you'll hear any music that features exciting "highs" with an amazing brilliance and clarity you won't get with any other tape. (And when it comes to open-reel tape, you'll probably find nothing comes close to AUDUA open-reel for reproducing highs.)

Whatever AUDUA you use—cassette or open-reel—you'll hear your system like you've never heard it before.

But there is something else you should hear before you try AUDUA. The price.

Unlike other so-called "super premium" cassettes, AUDUA's price is down to earth. (That should make AUDUA sound even better.)

Compared to what others consider their best, there's just no comparison.

So try the second-best cassette we've ever made.

You won't find much better.

TDK Electronics Corp.,
755 Eastgate Boulevard,
Garden City, New York 11530.
Also available in Canada.

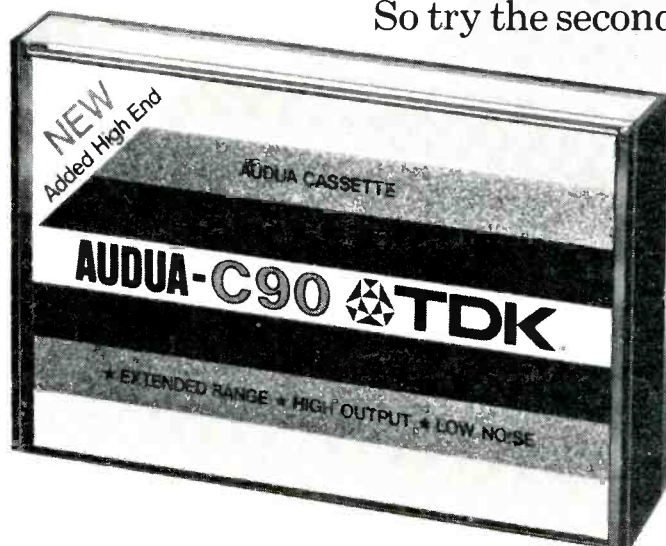

TDK[®]

Wait till you hear
what you've been missing.

Check No. 43 on Reader Service Card

The phono cartridge that doesn't compromise any modern record.

AT15Sa

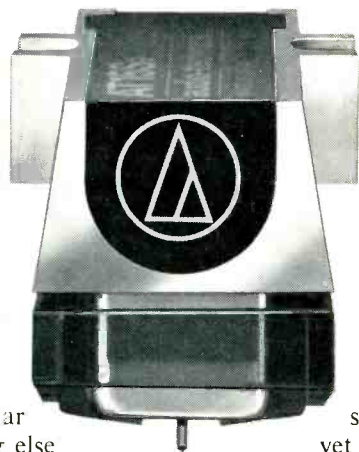

30

Choosing an AT15Sa can add more listening pleasure per dollar than almost anything else in your hi-fi system. First, because it is one of our UNIVERSAL phono cartridges. Ideally suited for every record of today: mono, stereo, matrix or discrete 4-channel. And look at what you get.

Uniform response from 5 to 45,000 Hz. Proof of audible performance is on an individually-run curve, packed with every cartridge.

Stereo separation is outstanding. Not only at 1 kHz (where everyone is pretty good) but also at 10 kHz and above (where others fail). It's a result of our exclusive Dual Magnet* design that uses an individual low-mass magnet for each side of the record groove. Logical, simple and very effective.

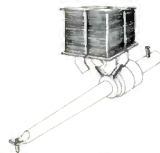

Now, add up the benefits of a genuine Shibata stylus. It's truly the stylus of the future, and a major improvement over any elliptical stylus. The AT15Sa can track the highest recorded frequencies with ease, works in

*TM. U.S. Patent Nos. 3,720,796 and 3,761,647.

any good tone arm or player at reasonable settings (1-2 grams), yet sharply reduces record wear. Even compared to ellipticals tracking at a fraction of a gram. Your records will last longer, sound better.



Stress analysis photos show concentrated high pressure with elliptical stylus (left), reduced pressure, less groove distortion with Shibata stylus (right).

The AT15Sa even helps improve the sound of old, worn records. Because the Shibata stylus uses parts of the groove wall probably untouched by other elliptical or spherical styli. And the AT15Sa Shibata stylus is mounted on a thin-wall tapered tube, using a nude square-shank mounting. The result is less mass and greater precision than with common round-shank styli. It all adds up to lower distortion and smoother response. Differences you can hear on every record you play.

Don't choose a cartridge by name or price alone. Listen. With all kinds of records. Then choose. The AT15Sa UNIVERSAL Audio-Technica cartridge. Anything less is a compromise.

about 40 years ago, approximately the same time period in which the fore-runner of the modern tape system, the German Magnetophone, was being developed.

Certainly, a pilot tone recorded at the beginning of each track would enable the user of a tape to set his tone levels closely. All that would be needed in any playback system would be a standardized level indicator. The remaining problem would be the recording volume measurement and adjustment procedure.

I wonder whether any consumer-type audio equipment which uses meters labelled VU comes equipped with certification that the meters meet the prescribed requirements for dynamic characteristics. If not, the manufacturers are missing a bet—think of how much more they could get for equipment with "certified VU meters."

The author's thoughts about a different scale and, perhaps, a different unit are fine. In my opinion, let's turn the VU back to the broadcast and long lines people and come up with a new method of volume measurement tied in with the characteristics of modern equipment and using methodologies unknown 40 years ago. Of course, there would have to be a new reference standard correlated with the 0 VU reference volume, but that should be easy. And the basic knowledge developed in coming up with the volume indicator should not be wasted.

Paul E. Griffith
Black Mountain, N.C.

ADDENDA Rumble Filter/ Bass Boost Circuit

Dear Sir:

I would like to correct my article "Build a Rumble-Filter/Bass-Boost Circuit" which appeared in the July, 1976 issue of *Audio*.

In Example #2 the ratio of R2/R1 is equal to 2. In the section on Design Adoption, the reference to Fig. 7 is meant to apply to Example #2. In Fig. 1 the values of C1 and C2 are .047 μ F, and R2 is 100K. In Fig. 4 the caption for the horizontal axis should read "Ratio of R2/R1." In Fig. 5 the vertical axis should begin at 100 Hz and go up to 1000 Hz.

For those wishing a more detailed analysis of this circuit, I can recommend *Active Filter Cook Book* written by Don Lancaster and published by Howard W. Sams and Co., Inc.

Dick Crawford
Los Altos, Calif.

audio-technica 
INNOVATION □ PRECISION □ INTEGRITY

AUDIO-TECHNICA U.S., INC., Dept 126A 33 Shiawassee Ave., Fairlawn, Ohio 44313

AUDIO • DECEMBER, 1976

The Sensuous Speaker.

Yamaha's new two-way beryllium dome NS-500.

A very responsive speaker with a rich, luscious sound. A deeply involving sound. Highly defined, finely detailed.

The NS-500 is created from the same advanced beryllium technology that's made Yamaha's revolutionary NS-1000 Series speakers, in the eyes and ears of many audio experts, the highest standard of sound accuracy. (Specific benefits of Yamaha's beryllium technology have been documented in a paper presented to the 52nd Convention of the Audio Engineering Society.)

With the NS-500, you get all of beryllium's advantages (transparency, detail, and lack of distortion that go beyond the best electrostatic speakers), but at a price roughly half that of the NS-1000. Only \$500 the pair, suggested retail price.

The joy of beryllium.

The ideal cone material for a high frequency driver must respond instantly to changes in amplitude and frequency of the input signal. So the ideal dome material must be virtually weightless as well as extremely rigid.

Beryllium is the lightest and most rigid metal known. Its density is less than two-thirds that of commonly used aluminum, and its rigidity is almost four times as great — thus preventing dome deformation and consequent distortion. What's more, beryllium's sound propagation velocity is twice that of aluminum.

The beryllium dome found on the NS-500's high frequency driver is the world's lightest — about half the weight of the petal of a small sweetheart rose. Which is one of the reasons for this speaker's exceptional sensitivity and response. And for its sensuous sound.

A closer look.

To be able to offer the sophistication of beryllium at a more affordable price, without sacrificing quality of performance, Yamaha designed the NS-500 as a two-way bass reflex system.

This gives the NS-500 a trace more emotion at the low end than the resolutely objective NS-1000. But it also gives the NS-500 more efficiency (91dB SPL at one meter with one watt RMS input). Which means you don't have to invest in the highest powered amplifiers or receivers in order to drive the NS-500 to its full rated output.

For an optimum match with the beryllium tweeter Yamaha developed a very light, very rigid "shell" woofer. And a special hermetically-sealed air-core LC crossover with a carefully selected 1.8kHz crossover point.

As a result of these design parameters, the NS-500 boasts an insignificant 0.03% THD below 50 dB SPL, from 40 Hz to 20 kHz — making it the perfect complement

to Yamaha's state-of-the-art low distortion electronics.

Underneath the sleek monolithic styling of its solidly crafted enclosures, the NS-500 is full of many exclusive Yamaha features and distinctive Yamaha touches of craftsmanship.

But to fully appreciate the beauty of the NS-500, you really should visit your Yamaha Audio Specialty Dealer.

Which brings us to something else.

Something more than just another speaker pamphlet.

Yamaha's *Reference Handbook of Speaker Systems* is a very thorough guide encompassing all aspects of speaker design, performance, and evaluation. Starting with a detailed explanation of speaker design principles, the discussion then turns to a solid base of objective criteria, written in easily understood language, to help you properly evaluate any speaker in any listening environment. Already a much sought-after reference work among audio professionals, Yamaha's *Reference Handbook of Speaker Systems* is available at your Yamaha Audio Specialty Dealer.

At \$5.00 a copy, it's well worth the cost. However, if you clip out the coupon in the bottom corner of this page, take it to your Yamaha Audio Specialty Dealer and hear a demonstration of the exciting NS-500 or any other Yamaha speaker the book is yours for half the price.

And if you're not familiar with the name of your local Yamaha Audio Specialty Dealer, drop us a line. In turn we'll also send you a free preprint of the Audio Engineering Society paper on Yamaha beryllium technology mentioned above.



This coupon is worth \$2.50 off the \$5.00 suggested retail price of Yamaha's *Reference Handbook of Speaker Systems*, when presented to any participating Yamaha audio dealer, with a demonstration of any Yamaha speaker system. Offer expires March 1, 1977.



E. O. Box 6600, Buena Park, CA 90621

Check No. 45 on Reader Service Card

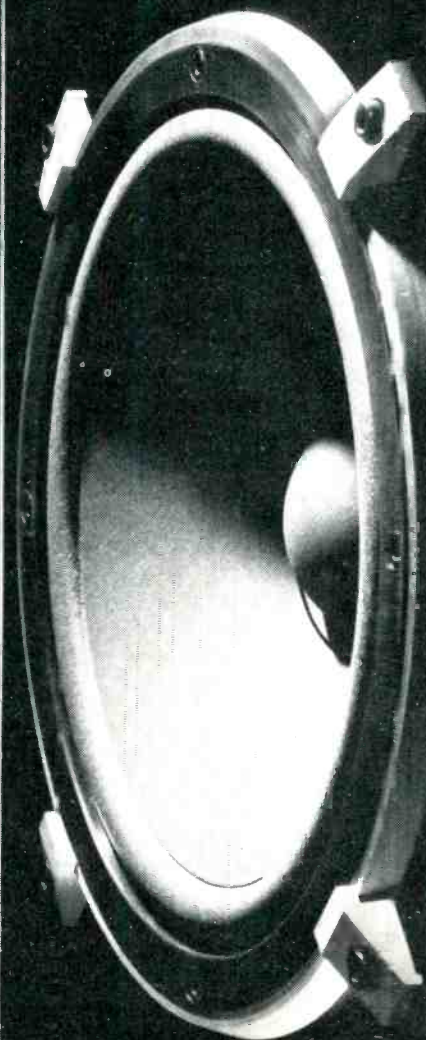
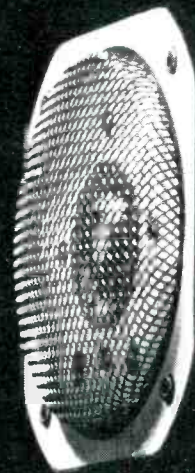

Microphone SENSITIVITY Ratings

Alfred Lorona

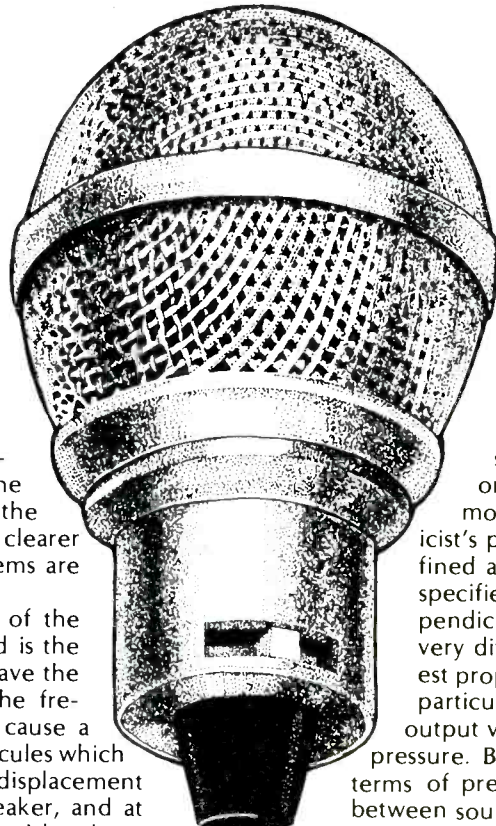

32

One of the more commonly used concepts in sound reinforcement, recording, and reproduction and one which often causes a great deal of confusion is the microphone sensitivity rating. This article will examine the various methods used beginning with the first principles, in order to provide a clearer understanding of what the rating systems are all about.

From our familiar experience, one of the most common manifestations of sound is the human voice. When speech sounds leave the mouth at a normal speaking level, the frequency components around 100 hertz cause a to-and-fro displacement of the air molecules which amounts to about 1/1,000 inch. This displacement diminishes with distance from the speaker, and at a distance of about 10 feet, it is reduced by about 60 times and the molecule displacement is 1/60,000 inch. The displacement can be reduced again by a factor of 200 before it becomes undetectable by the human ear. At this threshold level, when sound is just barely discernible, the displacement is about 1/10,000,000 of an inch. The voice frequency components around 1 kHz cause displacements which are about 1/10 of the above, while frequencies around 2 to 4 kHz cause displacements in the order of 1/10 the diameter of an air molecule! While these figures are indeed interesting, displacement amplitude is not used directly in sound work. Instead, another relationship of air with sound is used.

What Mikes Measure

A microphone is an electroacoustic transducer used to convert acoustic energy into electrical energy. Microphones convert the periodic variations in air pressure into proportional variations of current or voltage. Let us therefore consider some facts concerning air pressure variations before we get into the microphone sensitivity ratings, and make some basic definitions as well.

Sound waves cause variations in the physical properties of air. These properties are air pressure, particle velocity, pressure gradient (rate of pressure change), density, tempera-

ture, intensity (flow of energy), and static pressure build-up at a reflecting surface. In order to gain a knowledge of the strength or magnitude of a sound wave, we have to measure one or more of these physical properties. The most fundamental property from a physicist's point of view is intensity, and this is defined as the flow of energy per unit time in a specified direction through a unit area perpendicular to the direction of flow. This is a very difficult measurement to make. The easiest property to measure is pressure, which is particularly fortunate because microphone output voltage is directly proportional to sound pressure. Being able to express a sound wave in terms of pressure units facilitates the relationship between sound waves and microphone output.

Sound wave pressure is expressed in units of force per unit area. The unit of force is the dyne. One dyne is a force of such magnitude as will cause a mass of one gram to acquire an acceleration of one centimeter per second per second. The unit of area is the square centimeter, which is a square one centimeter on each side. Because pressure is defined as force per unit area, it is expressed in dynes per square centimeter, and it is written dynes/cm². Sometimes you encounter the term microbar, which will cause no confusion if it is kept in mind that this term simply means one dyne per square centimeter.

We are now in a better position to talk about sound pressure in a more exact way, but it might be well to pause for a moment and consider the sound pressures found in our everyday experience and surroundings. Normal atmospheric pressure at sea level is about 1,000,000 dynes per square centimeter. Upon this steady or static pressure are superimposed the sound wave's molecular displacements. At the threshold of hearing, where sound is just perceptible to the ear, the sound air pressure due to molecular displacement is 0.0002 dynes per square centimeter. The highest tolerable sound pressure, that is where sound becomes painful, is typically 640 dynes per square centimeter. This is called the threshold of pain. The sound pressure resulting from a normal speaking male voice at a dis-

tance of 12 inches from the mouth is about 10 dynes per square centimeter, while the pressure right at the same speaker mouth is about 100 dynes per square centimeter.

Rating a microphone or finding microphone sensitivity means expressing the output voltage or output power from the microphone as a function of a certain acoustic excitation or pressure. This procedure results in an unambiguous and reproducible method, with results that allow comparison between different microphones from a given manufacturer or between microphones from different manufacturers.

Intensity and Pressure

It now is necessary to determine how sound pressure varies with distance from the sound source. Sound intensity has been defined as the rate of flow of energy per unit area. The unit of sound intensity is 1 erg per second per square centimeter and is written erg/sec/cm². The intensity represents the power in the wave so that intensity can also be expressed in watts per unit area which is the square centimeter. In other words, intensity is power transmitted per unit area. From a consideration of the energy properties in a sound wave, the intensity is given by:

$$I_0 = P^2/Ra \text{ watts per square centimeter} \quad (1)$$

where I_0 = intensity in watts/cm²,

P = sound pressure in dynes/cm², and

Ra = acoustical resistance and is given by $Ra = \rho c$,

where ρ = density of air in grams/cm³, and

c = velocity of propagation of sound in air in centimeters per second.

At normal atmospheric pressure of 1,000,000 dynes/cm² and at a normal temperature of 20° C, $\rho = 0.0012$ grams/cm³ and $c = 34,400$ cm/sec. Their product is 42 and equation (1) becomes:

$$I_0 = p^2/42 \text{ watts/cm}^2 \quad (2)$$

Sound intensity decreases inversely as the square of the distance according to the relationship

$$I_0 = Pa/4r^2 \quad (3)$$

where Pa = rate of production of sound energy at the source (acoustic power).

r = distance from the source.

I_0 is seen to be power per surface area of a sphere because the wavefront expands spherically as it moves away from the source. Since the total energy in the wave must remain constant, the energy per unit area must decrease as the wavefront expands.

Equating (1) and (3)

$$Pa/4r^2 = P^2/Ra \text{ so that } Ra Pa = P^2 4 r^2,$$

$$\text{from which } P = 1 Pa Ra/4r \quad (4)$$

We now see that intensity is inversely proportional to the square of the distance r from the source (equation 3) and that pressure is inversely proportional to r (equation 4). The decay of sound pressure and intensity with distance r from the source is shown in Fig. 1. It is interesting to note that the decrease of sound pressure is much more rapid when the distance is small, and that outside a range of about four feet, the rate of decrease is much less. Since the output from a microphone is proportional to the pressure, it is seen that the electrical output will vary in a like manner. At normal microphone speaking distances, the output varies greatly with small changes in distance, yet the microphone will pick up background sounds at a surprisingly even level at what appears to be widely varying distances from the source.

The concept of acoustic power is occasionally encountered in the literature, so we should note some typical power levels found about us. The rms speech power emitted by a speaker at normal conversational level is about 10

microwatts acoustic power. When a person speaks as loudly as possible, the power rises to about 200 microwatts, and when shouting, to about 1,000 microwatts. When whispering, the speech power is only about 0.001 microwatt. The power corresponding to the threshold of hearing (where the sound pressure is 0.0002 dynes/cm²) is 10⁻¹⁶ watts per square centimeter.

Relative Levels

So far, we have been talking in terms of absolute values of sound pressure and intensity. In sound work, intensity and pressure levels are usually given with respect to some reference or standard level, and the ratio of the actual value to the reference value is given in decibels.

Acoustic intensity level is the average rate of sound energy transmission through a unit area referred to an arbitrary intensity usually specified to be 10⁻¹⁶ watt/cm², with the result is expressed in decibels. The expression for the intensity level is similar to the expression for the power ratio in decibels with which we are all familiar, thus

$$I_1 = 10 \log I/I_0 \text{ decibels} \quad (5)$$

I_1 = intensity level,

I = sound intensity, and

I_0 = reference intensity (as in equation 1) and is 10⁻¹⁶ watts/cm² as an arbitrary value.

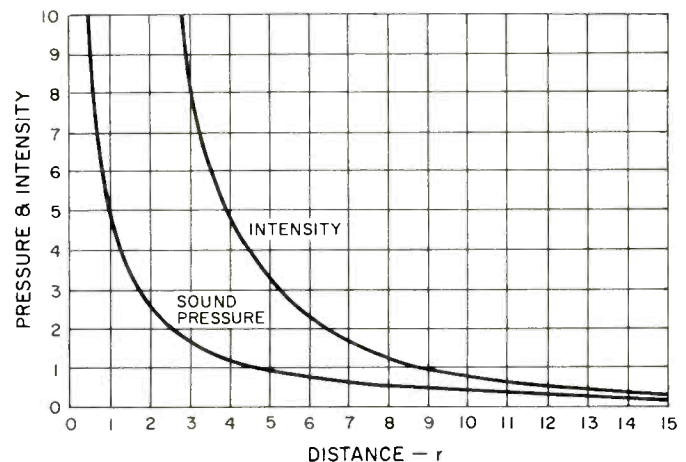

Fig. 1—Intensity and pressure vs. distance.

Sound pressure level is the effective sound pressure at a point in the medium, referred to an arbitrary reference pressure usually taken to be 0.0002 dynes/cm², and expressed in decibels. The expression for pressure level is similar to the expression for voltage ratios and is

$$SPL = 20 \log Pe/P_0 \text{ decibels} \quad (6)$$

where SPL = sound pressure level,

Pe = effective sound pressure in dynes/cm², and

P_0 = reference sound pressure and is 0.0002 dynes/cm².

Note that the reference levels in (5) and (6) are those levels occurring at the threshold of hearing and that 0.0002 dynes/cm² is equal to a power of 10⁻¹⁶ watts/cm².

By what we have seen so far, we note that any sound pressure can be stated as so many decibels above the defined threshold of hearing reference level. This relationship forms the basis for such statements as "the threshold of pain is 140 dB," "the rustle of leaves is 10 dB," "ordinary conversation

at three feet is 65 dB," etc. Table I shows some of these typical values.

The following brief example will show how the table is constructed. We know that the sound pressure level for ordinary conversational speech is about 10 dynes/cm² at a distance of one foot from the mouth. Referring to Fig. 1, at a distance of three feet the pressure has decreased from a relative value of 5 at the one-foot distance to about a value of 2 at the three-foot distance. The value at three feet is therefore 2/5 times the value at one foot. The value at one foot is 10 dynes/cm², so that the value at three feet is 2/5(10) = 4 dynes/cm². From equation (6), SPL = 20 log 4/0.0002 = 66 decibels. This is the value given in Table I for conversation at three feet.

Deriving Sensitivity Ratings

There are basically two methods by which microphone sensitivity is rated, in terms of voltage or in terms of power. Within these two main categories are several different methods in common use. These are listed below.

1. Open-circuit voltage output relative to a reference voltage level for a sound pressure of 1 dyne/cm². The result is expressed in dBV where the V means that 0 dB is taken at a 1 volt level.

2. Open-circuit voltage output relative to a reference voltage level for a sound pressure of 10 dynes/cm² expressed in dBV.

3. Voltage output relative to a reference voltage level for a sound pressure of 1 dyne/cm² when the microphone is connected to a 40,000-ohm terminating resistor. The result is expressed in dBV.

4. Output power relative to a reference power level for a sound pressure of 1 dyne/cm² expressed in dBm where the m means that 0 dB is 1 milliwatt.

5. Output power relative to a reference power level for a sound pressure of 10 dynes/cm² expressed in dBm.

6. Output power relative to a reference power level for a sound pressure of 0.0002 dynes/cm² expressed in dBm. The result is called Gm and is the EIA microphone sensitivity rating.

Unfortunately, there is little mutual agreement among the microphone manufacturers as to which rating system is preferable, and manufacturers have employed one or more rating systems for their products. Often, the manufacturers utilize the voltage output rating for high impedance microphones and the power rating for low impedance microphones. Among the voltage output ratings, method 1 is the more popular, and among the power output ratings, method 5 is the more popular. Method 6 is also used by many manufacturers.

Voltage Method

When the microphone response is given in terms of output voltage, the open-circuit (unloaded or unterminated) voltage is given relative to a reference of 1 volt for a 1 dyne/cm² sound pressure and is the more commonly used system for rating high impedance microphones, as explained above. The result is expressed in decibels and is given by

$$n = 20 \log E/P \quad (7)$$

where n = response in decibels,

E = open-circuit voltage in volts,

P = sound pressure relative to 1 dyne/cm², and

$$P = P_e/P_o \quad (8)$$

where P = sound pressure relative to 1 dyne/cm²,

P_e = actual sound pressure in dynes/cm², and

P_o = reference sound pressure and is 1 dyne/cm².

As an illustration of the rating method, consider a microphone that delivers a voltage output of 0.1 millivolt for a sound pressure of 1 dyne/cm². Then

$$n = 20 \log \frac{0.1 \times 10^{-3}}{1} = -80 \text{ dBm.}$$

Now suppose that the sound pressure is increased to 10 dynes/cm². Since the voltage response is linearly proportional to the pressure, we should expect the voltage to be 10 times as much or 1 millivolt. Under these conditions

$$n = 20 \log \frac{1 \times 10^{-3}}{1} = -80 \text{ dBm.}$$

One of the beauties of the rating system is that it is independent of the test pressure level and is a property of the microphone itself. Of course, when testing or rating the microphone, the standard pressure is applied. The example clearly illustrates the value of the system when different microphones are compared.

Table I—Sound vs. relative levels above defined threshold of hearing.

Source or description of sound	Sound level (dB)
Threshold of pain	140
Speech with lips at microphone	114
Speech with lips 12 inches from microphone	94
Conversation at 3 feet	66
Average office	60
Country house	30
Rustle of leaves	10 to 18
Threshold of hearing	0

When a microphone sensitivity is given as -80 dBm in a catalog, the actual output voltage can be found by calculating it from (9).

$$\text{dBm} = 20 \log \frac{E_{\text{ref}}}{E_{\text{out}}} \quad (9)$$

$$80 = 20 \log \frac{1}{E_{\text{out}}} \text{ from which } E_{\text{out}} = 0.0001 \text{ volt.}$$

Remember that this is an open-circuit (unloaded or unterminated) voltage. When the microphone is connected to a terminating or load resistor, usually the input resistor of a preamplifier, this voltage will be less. In the case where this input resistor is the same as the microphone resistance, the voltage will divide equally across each resistor, as shown in Fig. 2. The voltage across the load resistor will be half the microphone open-circuit output voltage, which amounts to a 6-dB voltage loss. In practice, most high impedance microphones are not terminated with a resistance equal to the internal or nominal resistance. Usually the terminating resistance is much higher in value. Under these conditions, the loss of available microphone open-circuit output voltage will be less than 6 dB.

The voltage loss due to terminating a microphone with a finite resistor is called the voltage loss due to the coupling factor, which is found from the following relationship:

$$\text{Coupling factor} = 20 \log R_i/R + R_i \quad (10)$$

where R_i = terminating or amplifier input resistor and

R = microphone resistance given by manufacturer.

Typical values of the Coupling Factor are given in Table II.

A microphone will occasionally be rated using method number 2. In the example illustrating the use of method

A speaker unlike any other.

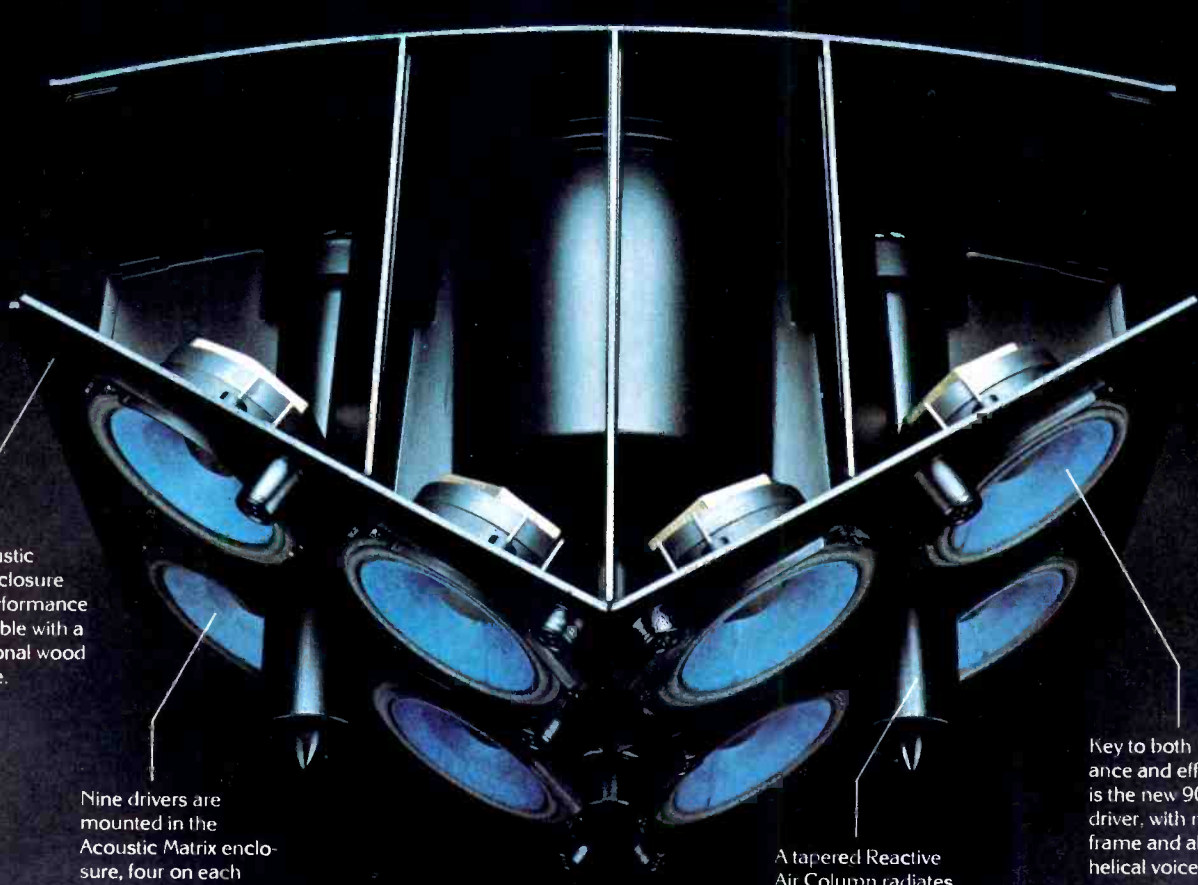

The Acoustic Matrix enclosure yields performance unattainable with a conventional wood enclosure.

Nine drivers are mounted in the Acoustic Matrix enclosure, four on each rear panel and one facing forward.

A tapered Reactive Air Column radiates the lowest bass from the four drivers on each rear panel.

Key to both performance and efficiency is the new 901 III driver, with molded frame and aluminum helical voice coil.

Introducing the Bose 901[®] Series III.

In 1968, Bose introduced an unconventional loud-speaker system: the legendary Bose 901. Now, we are introducing a new speaker of revolutionary concept, design, materials, and performance: the Bose 901 Series III.

What you will hear.

You will be struck by a sense of immediacy and presence, spaciousness of sound, and accurate stereo image almost anywhere in the room. Equally startling are the realism and accuracy of the timbre of each instrument, the clarity and dynamic range of the deepest bass

notes, and the precise definition of individual instruments.

Efficiency

Most dramatic, however, is the remarkable efficiency with which this level of performance is achieved: the new 901 Series III can produce the same volume of sound with a 15 watt amplifier as the original 901 with a 50 watt amplifier.

This dramatic breakthrough in the basic economics of high-fidelity makes it possible to put together a high performance component system at a lower price than was previously possible, even though the 901 Series III is a more expensive speaker than its predecessor.

Technology

Spectacular performance and efficiency are the results of proven Bose design concepts and technological innovations that include the unique, injection-molded Acoustic Matrix[™] enclosure and a new, ultra-high-efficiency driver.

At the same time, the 901 Series III is (as is the original 901), a Direct/Reflecting[™] speaker with a separate electronic equalizer.

To appreciate the spectacular performance of the Bose 901 Series III, simply ask a Bose dealer to play the 901 III in comparison to any other speaker, regardless of size or price.

For a full color 901 III

brochure, write Bose, Box AU12, The Mountain, Framingham, Mass. 01701. For the nearest Bose dealer, call (800) 447-4700. In Illinois call (800) 322-4400.



BOSE[®]
The Mountain, Framingham,
Mass. 01701.

Patents issued and pending. Cabinets are walnut veneer.

Table II—Voltage loss in dB for various ratios of input impedance and mike impedance.

Ri/R+Ri Coupling Factor (loss in dB)	0.5	0.56	0.63	0.71	0.79	0.89
	-6	-5	-4	-3	-2	-1

number 1, the microphone was seen to deliver 0.1 millivolt output for a 1 dyne/cm² applied sound pressure (or 1 mV output for 10 dynes/cm²) and reference level of 1 dyne per cm². If the reference is 10 dynes/cm² as for method number 2, using (7) and (8) with Po = 10 dynes/cm² will yield a sensitivity rating of -60 dBm. This is shown as follows

$$n = 20 \log \frac{1 \times 10^{-3}}{10/10} = -60 \text{ dBm.}$$

Therefore, to convert from method 1 to method 2, merely add 20 dB. Conversely, to convert from method 2 to method 1, subtract 20 dB from the given rating sensitivity. These conversions are useful when comparing microphones from different manufacturers who use different ratings.

Power Method

When the microphone response is given in terms of power, the power output is given relative to a reference of 1 milliwatt and relative to a sound pressure level of 10 dynes per cm². This method always assumes that the microphone is connected to a matched load. This is the most commonly used method for rating low impedance microphones and the result is expressed in decibels.

Consider a microphone connected to a matched load resistor. When the load resistor Ri in Table II is equal in value to the microphone resistance, half the open-circuit voltage output appears across the resistor. Under these conditions, the voltage across Ri is 1/2E. The power in the load resistor is found from W=E²/R. In our example

$$W = (1/2E)^2/R = E^2/4Ri \text{ watts} \quad (11)$$

In order to express the power in decibels, we take the log of the power ratio according to the well-known relationship

$$\text{dB} = 10 \log W/Wo \quad (12)$$

where W = power in the load as found from (11) and
Wo = reference power level and is 0.001 watt.

Taking the reference power level as 0.001 watt (1 milliwatt) is in accordance with the definition for microphone

Table III—Nominal microphone impedances vs. rating impedances.

Nominal impedance, ohms	Rating impedance, ohms
19 to 75	38
75 to 300	150
300 to 1,200	600
1,200 to 4,800	2,400
4,800 to 20,000	9,600
20,000 to 80,000	40,000
80,000 or more	100,000

sensitivity by the power method. Also, according to the definition, E must be taken relative to the reference sound pressure level of 10 dynes/cm². The relation of E to sound pressure P is E/P,

where E = microphone open-circuit voltage output and
P = Pe/Po as in (8).

where Pe = actual sound pressure in dynes/cm² and
Po = reference sound pressure and is 10 dynes/cm².

Substituting these foregoing relationships into (12) where

$$W = \frac{(E/Po)^2}{4 Ri} \text{ and}$$

$$Wo = 0.001 \text{ results in dB}$$

$$= 10 \log \frac{(E/10)^2}{4 Ri \cdot 0.001}$$

Which simplifies to

$$\text{dB} = 20 \log \frac{E}{Pe} - 10 \log Ri + 44 \quad (13)$$

from which the sensitivity rating is found directly. This method is also called the open circuit power or effective output level.

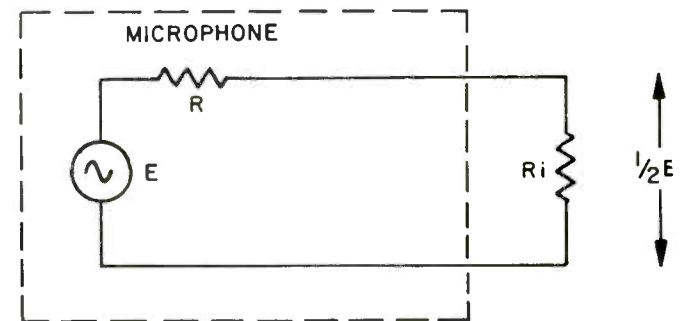

Fig. 2—Voltage loss when microphone impedance is equal to terminating impedance (usually the input resistor of a preamp or mixer).

In (13), Ri is the microphone nominal impedance as given by the manufacturer in the catalog description. When evaluating (13) to find the microphone rating, the manufacturer applies test pressure Pe, measures the voltage output E, and inserts the rating impedance into the formula to calculate the answer. The rating impedance for use in this determination is not the catalog nominal impedance but the impedance as found from Table III.

Equation (13) is based on a reference pressure level of 10 dynes/cm². If the reference pressure level is taken as the threshold of hearing where it is 0.0002 dynes/cm², then the expression for the microphone sensitivity rating becomes

$$\text{dB} = 20 \log \frac{E}{Pe} - 10 \log Ri - 50 \quad (14)$$

And is called the Gm microphone system rating.

The difference between (14) and (13) is

$$20 \log \frac{E}{Pe} - 10 \log Ri + 44 - (20 \log \frac{E}{Pe} - 10 \log Ri - 50)$$

$$= 94 \text{ db.}$$

Therefore to convert from Gm to method number 5, add 94 dB. To convert from method 5 to Gm, subtract 94 dB.



LOOK AT US NOW

Three head recording makes a difference.

Whether you choose the top-loading Hitachi D/3500 or the front-loading D/800 Stereo Cassette Tape Deck, you'll get all the benefits of three-head recording and playback.

Three-heads give you separate record and playback capability with separate and optimum gap widths—a wider gap for more magnetizing on recording, a narrow gap for improved frequency response on playback.

Three-heads provide other benefits, too. You can monitor the tape while recording. The double Dolby® feature gives you improved signal-to-noise ratio on both the tape and the monitor output simultaneously.

Naturally, there are other features that will make these two Hitachi cassette decks attractive to you. They're listed below.

• *Front-loading convenience (D/800 only)*

- Double Dolby circuit for recording and playback
- Dolby calibration control
- Dolby FM broadcast decoder
- Signal-to-noise ratio of 63 db with Dolby in
- Wow and flutter—0.05% WRMS
- Peak-reading/VU meters
- Mic/line mixing (D/3500 only)
- CrO₂ bias switch
- MPX filter

We make a full line of quality stereo cassette decks starting from just \$149.95. See them all at your Hitachi dealer.



HITACHI
Believably Better

Dolby System under license from Dolby Laboratories, Inc. Prices subject to change without notice. Audio Components Division, Hitachi Sales Corporation of America, 401 West Artesia Blvd., Compton, CA 90220. Check No. 19 on Reader Service Card

System Gain

When a microphone, rated in terms of voltage, is connected to an amplifier which is rated in decibels of voltage gain, the output of the combination can be easily found from

System Gain = microphone rating in dBV + coupling factor + amplifier gain in dBVg, where dBVg is the amplifier voltage gain in decibels.

For example, consider a microphone with a dBV rating of -58 dB connected to an amplifier input with an input resistance equal to the microphone impedance and a voltage gain of +80, which is typical. The coupling factor is -6 dB, and the system gain is then

$$\text{S.G.} = -58 -6 +80 = +16 \text{ dBV}$$

where 1 volt is taken as 0 dB (that's what the V in dBV means) so that +16 dBV is equal to 6.3 volts.

It should be noted that the calculated output applies only when the rated sound pressure (for example, 1 dyne/cm² using method number 1) is applied to the microphone. At other sound pressures, the voltage is proportional to the sound pressure, as we have seen. Thus, if the microphone is used with a normal conversational voice at the nominal 12-in. distance, the applied pressure will be 10 dynes/cm² and the voltage will increase by a factor of ten. Precautions should be taken, however, to see that the amplifier does not overload.

When a microphone, rated in terms of power, is connected to an amplifier whose gain is expressed in decibels of power gain, the output of the combination can be found from

System Gain = microphone rating in dBm + amplifier gain in dB.

For example, consider a microphone power rating of -60 dBm connected to an amplifier with a power gain of +40 dB. Then

$$\text{S.G.} = -60 +40 = -20 \text{ dBm}$$

where -20 dBm = 0.00001 watt.

If the output load resistance is 600 ohms, the voltage across the load will be 0.077 volts.

The G_m sensitivity rating is used most frequently when the sound system rating includes the acoustic output from a loudspeaker at the output of the system. Otherwise the G_m rating is converted to method number 5 by adding 94 dB as has been explained.

Actually, the easiest way to figure system gain when confronted with microphones rated in dBV and amplifiers rated in dB of power gain is to convert the amplifier power gain into the equivalent voltage gain.

It is, of course, possible to convert a given microphone voltage rating to the equivalent power rating from

$$20 \log E/P - 10 \log R_i + 44$$

which is the power rating response where 20 log E/P is the voltage response, as in equation (7). For example, if we have a microphone with a dBV rating of -70 dB and R_i is 150 ohms, then

$$\text{dB} = -70 -10 \log 150 + 44 = -47.76 \text{ dBm.}$$

If the foregoing principles are kept in mind, converting from one rating system to another will be facilitated and valid comparisons can be made between the microphones produced by the different microphone manufacturers. Δ

What have Quad been up to recently?

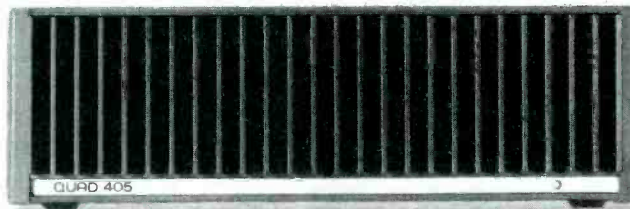

Current Dumping that's what

Current Dumping is the name given to a totally new power amplifier circuit developed by QUAD.

A current dumping amplifier basically consists of a low power amplifier of very high quality, which controls the loudspeaker at all times and a high powered heavy duty amplifier which provides most of the muscle.

The small amplifier is so arranged - it carries an error signal - that provided the heavy duty transistors (the dumpers) stay within the target area of the required output current, it will fill in the remainder accurately and completely.

The reproduced quality is solely dependent on the baby

amplifier, which because of its low power, can be made very good indeed.

The QUAD 405 is the first amplifier to incorporate current dumping.

There are no internal adjustments, so nothing to go out of alignment.

There are no crossover distortion problems and performance is unaffected by thermal tracking.

The QUAD 405 offers impeccable performance, reliably and predictably.

Send postcard for illustrated leaflet to Acoustical Manufacturing Co. Ltd., Huntingdon, Cambs., PE18 7DB, England.

QUAD

for the closest approach to the original sound

QUAD is a Registered Trade Mark

The new SCXA. Demonstrably better. Eminently affordable.

The SCXA may very well be the best "performance-to-value" loudspeaker the high fidelity industry has ever produced.

A bold statement?

Consider the details of the SCXA. Let's start with the tweeter array. What will strike you immediately is the flat tweeter known as the DVR. Here is a device that combines the best attributes of dynamic and electrostatic tweeters. What it is exactly is an ultra-thin Kapton[®] membrane with an etched printed circuit "voice coil" suspended between twenty rare-earth samarium cobalt magnets (the most powerful magnet material in the world). How thin is ultra-thin? One mil to be exact. Which translates into a membrane which weighs approximately the same as the air you'd find in a whiskey shot glass. Because the membrane mass is so low and the magnets have such extraordinary force, the inertial qualities are exceptional. The membrane can be accelerated and stopped with *extreme accuracy*. This results in very extended response (well beyond the limits of normal test equipment). It also means a response that is transient perfect. And phase perfect, as well. All forms of distortion, including odd order harmonic distortion, are reduced to an absolute minimum.



The DVR Tweeter

In addition to the DVR tweeter, the array also features a specially designed one-inch dome tweeter that works in exactly the same frequency range as the DVR. This dome complements the exquisite linearity of the DVR with its own splendid dispersion characteristics. The results are awesome. Fuzziness disappears. The inner voices of the orchestra come alive. There's the kind of airiness and transparency you find only in the concert hall. Indeed, it is almost disconcerting to have that kind of reality in your home. But it's an experience that's worth getting used to.

The SCXA's midrange needs very little discussion. It is considered by most experts to be the best 4" cone that has ever been made—and it easily lives up to its reputation.

As for the SCXA's 12" Megaflux™ Woofer, it is probably the most unique magnetic structure avail-



able today. Its amazing magnet design creates and focuses magnetic energy (flux) with essentially no external stray field. Since all of the energy is directed to an exact and predetermined area of the voice coil, very large woofer excursions are possible. Also, the magnetic field produced is so uniform that many non-linear types of distortion found in conventional designs simply are no factor in this configuration. And this woofer can handle a staggering amount of power—over 200 watts RMS at 30 Hertz.

What we're obviously trying to say is that the SCXA is an exceptional loudspeaker—a demonstrably better way to listen to music. It's also an affordable way to listen to music. To find out just *how* affordable, we suggest you visit your KLH Research Ten dealer soon. We're sure you'll be pleasantly surprised.

For more technical information, write to KLH Research & Development Corp., 30 Cross St., Cambridge, Mass. 02139. (Distributed in Canada by S. Ailen Pringle Ltd., Ontario, Canada.)



KLH Research Ten Division
KLH Research & Development Corp.
30 Cross St., Cambridge, Mass. 02139

Check No. 22 on Reader Service Card

Time Delay for Ambience

Leonard Feldman

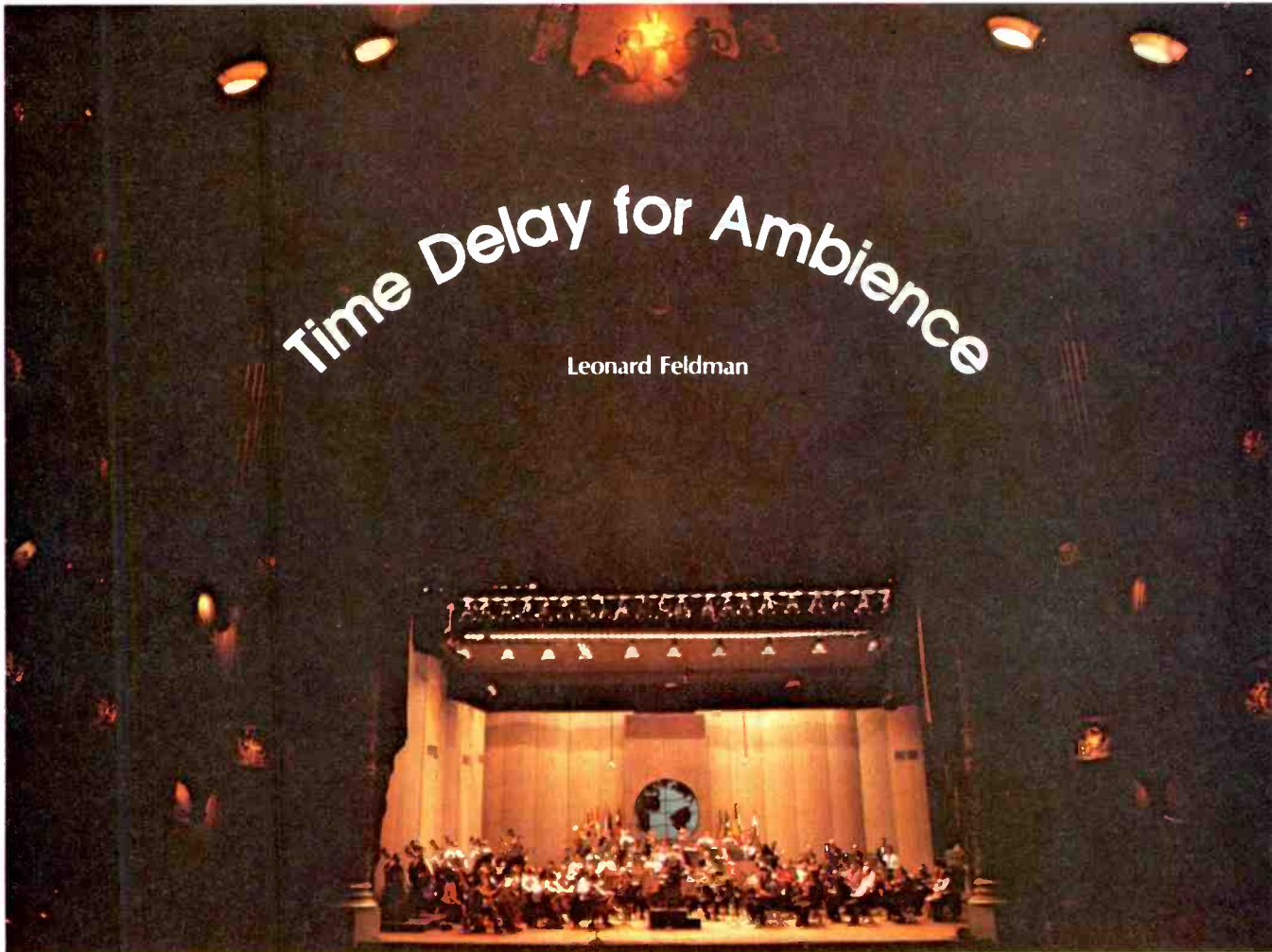

40

Nearly a year ago, I heard an early prototype of a consumer electronic audio time-delay unit developed by a company called Audio Pulse, Inc. This first audition was conducted in a rather small hotel room in Chicago and, by the time I had spent an hour or so listening to that room "expand" into various sized and configured concert halls, I was convinced that audio time delay would be the next major "wave" in the advancement of the audio art as it relates to home high-fidelity equipment. After several months delay, the Audio Pulse Model One digital time-delay system is in production and available to high-fidelity enthusiasts. A company called Sound Concepts, Inc. has come up with the Model SD-50 Audio Delay unit, which is also in production and available. Both units purport to offer the same end results but, as we learned from a hands-on, in-depth study of each, both the circuitry and approach of each unit differs widely from that of its competitor. In terms of price, the Sound Concepts unit has a slight edge, with a suggested retail price of

\$600 as against Audio Pulse's current retail price of around \$630.

Why Time Delay?

Some of the sound we hear at a live concert performed in a large space comes not from the stage where the performers are located, but reaches the audience after repeated bouncing or reflection from walls, ceiling, and floor. As sounds leave the stage, they begin to mix with reflections from almost every available surface in the hall. This process is so complete and complex that the listener sometimes hears as much or more reflected, delayed or reverberant sound than he hears direct sound from the players. For realistic recreation of what has come to be called "hall ambience," it is necessary to both delay and reverberate the original music signals. A pictorial representation of a typical sound field is shown in Fig. 1. In addition to the time delays of the early and later reflections, the rate of decay of the entire sound field plays a part in our ability to identify a given hall.

Finally, as sound travels about the

hall, bouncing off surfaces, its high-frequency content is progressively absorbed and irregularly attenuated. So, to simulate this aspect of a hall's characteristics, any electronic time-delay device designed for home use must "roll off" the high frequencies reproduced by the additional channels that will be used to recreate the delayed/reverberant sound fields desired. Both the Sound Concepts and Audio Pulse units take care of these requirements in varying degrees by means of totally different circuit approaches.

Digital Time Delay

One way to electronically delay an audio signal is to first convert it into a digital code by means of an A/D (Analog-to-digital) converter. The digital signal is then passed through a series of shift-registers to introduce required delay, after which the digital signals are reconverted, by means of a D/A converter, back to analog signals suitable for amplification and application to the extra rear or side speaker systems. This is the basis of the ap-

Meet Your Record Collections' New Best Friend—

TOTAL CONCEPT!

Fine recordings have many enemies. The moment a recording is taken from the jacket, it must face them—dust, dirt, grime. All do their best to turn your new recordings into old, worn-out ones. That's why Audiotex Laboratories developed Total Concept—specially formulated record care products for your record collection. Products designed to prolong the life of your records. So get acquainted with Total Concept. With all the dust, dirt, and grime that's around, your records need all the friends they can get.



Total Concept—Sophisticated record maintenance accessories, preferred by the discriminating listener.

Total Concept Kit

All the record maintenance accessories you need for total record care. Kit contains one each of Record Plus, Record Basic, Record Purifier and Blue Max. Cat. No. 30-8500



Record Basic

Aerosol foam dissolves hardened contaminants and restores records to original condition. Simply spray on record, allow to bubble, then wipe dry with Record Purifier. Cat. No. 30-8530



Record Plus

Dual purpose spray dissolves finger smudges and other harmful deposits as well as lubricating record grooves to prevent wear. Leaves a microscopic layer of silicone lubricant that contains an anti-static agent and fungus inhibitor. Simply spray record, then gently wipe surface. Cat. No. 30-8525



Record Purifier

Super-soft, super absorbent cleaning cloth. Fibrous texture gently and safely wipes record surface dry in an instant. Plastic tube contains 6 Record Purifiers. Cat. No. 30-8535



Blue Max

Velous fibers remove dust and other foreign particles from record grooves as well as absorbing excess lubricating liquid. May be used hand held or while record is on turntable. Comes complete with storage container and nylon brush for cleaning Blue Max. Cat. No. 30-8540

Available At Audio Specialists Everywhere.

AL Audiotex Laboratories

DIVISION OF HYDROMETALS, INC.
400 SOUTH WYMAN STREET
ROCKFORD, ILLINOIS 61101 U.S.A.

Check No. 17 on Reader Service Card

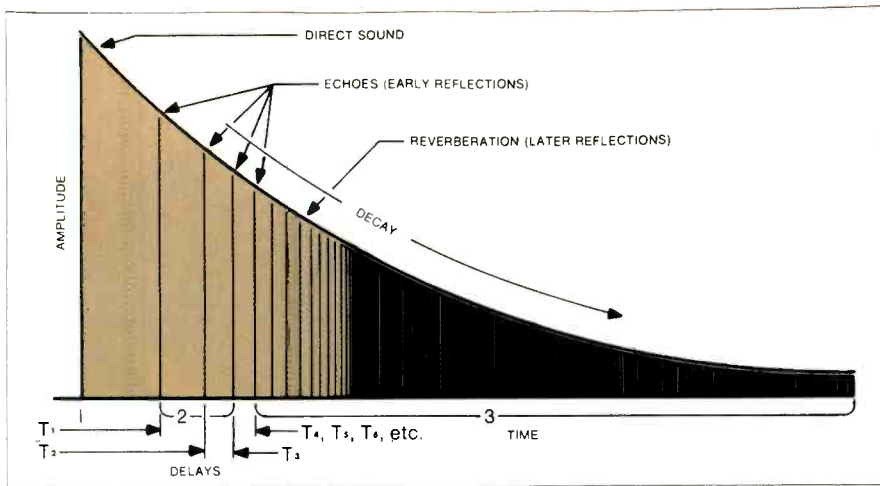

Fig. 1—Representation of a sound field showing direct sound, echoes, and reverberation.

proach used by Audio Pulse in their Model One. An overall block diagram of one channel of the unit is shown in Fig. 2. *Main Input* jacks are coupled directly to the *Tape Out* jacks and to the *Monitor* switch, where either the *Main* or *Tape* input signal is passed to an input buffer stage. Its output goes to the *Primary* output switch and to a contour circuit which applies a boost of 6 dB/octave below 100 Hz when the back-panel *Contour* switch selects that option.

Seven-step, switchable-gain amplifiers precede and follow the delay/reverberation circuits (about

which more in a moment) so that the level of the incoming signal is matched to the dynamic range of the digital delay circuits. The use of input and output gain controls (which are matched) provides unity gain operation of the system. The level-adjusted signal at the input to the digital delay circuits also feeds a series of 12 front-panel LEDs which show when the user has selected that gain setting which is ideal for the digital delay circuitry. The delayed and reverberated signal is then fed to a mixer where it is mixed with the primary (undelayed) signal and fed to the *Delay* position of

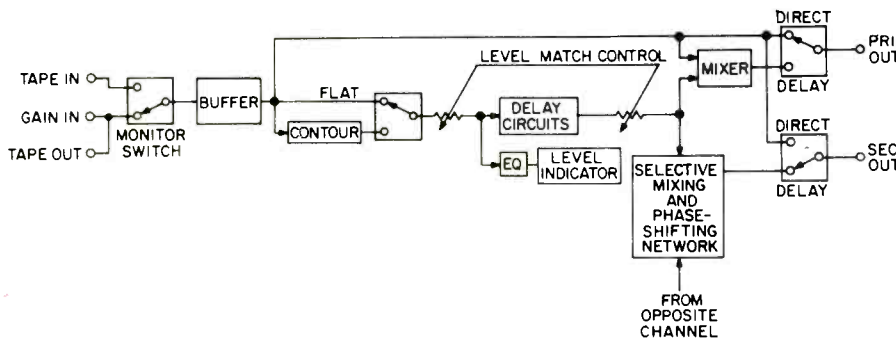
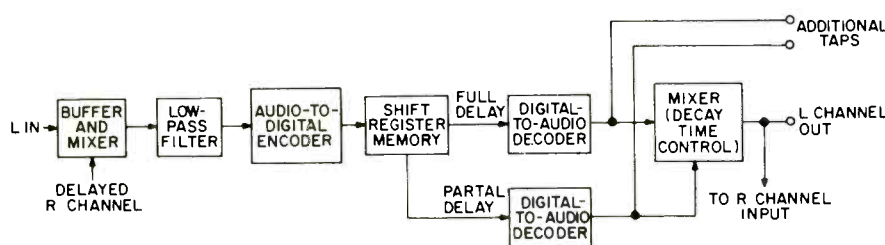

Fig. 2—Block diagram of the Audio Pulse Model One circuitry.

Fig. 3—Block diagram of the Audio Pulse Model One Delay/Reverberation circuitry.



the *Primary* (main channel) output switch.

The delayed and reverberated signals in both channels are also fed to an inter-channel mixing and phase-shifting circuit. Audio Pulse maintains that the reverberant-field energy arriving at a listener's ears is largely incoherent and random-phase in nature. The output circuitry of the Model One therefore includes a phase-shifting matrix intended to ensure that the delayed signals will have a non-localizable character. The resultant output signals are fed to the *Secondary* output switch, where the user may select either the direct or delayed signal to be fed to the secondary channels and speakers.

A detailed block diagram of the "Delay Circuits" block of Fig. 2 is shown in Fig. 3. Again, only one channel is shown. The input signal from the *Level Match* controls goes to a buffer where it is mixed with recycled opposite-channel signals. A low-pass filter attenuates frequencies above 8 kHz. The audio signals are then encoded into digital on-off pulses which are then fed into shift registers. When the pulses emerge from the shift registers (time delay is proportional to the number of shift registers used), they are decoded to recover the audio signal. Four different delays are obtained, two in each channel. The delayed pulse trains are decoded to yield audio signals. In each channel the fully and partially delayed audio signals are fed to a variable mixer. The relative proportions of partial and full delays are controlled via a front-panel bank of selectable *Decay Time* switches. When any of the *Decay Time* switches is engaged, the delayed output from each channel is fed back and mixed into the output of the opposite channel, where it is further delayed and then fed back to the input of its original channel and so on. In addition to the cross-channel recycling loops, there are also recycling loops within each channel (not shown in the block diagram). When each signal is recycled, it is mixed into the input at a reduced level, corresponding to the attenuation of a sound wave as it is reflected off the walls of a concert hall.

In addition to being fed to the decay time mixer, the fully delayed and partially delayed outputs of the digital-to-audio decoders are also fed to additional rear-panel *Long* and *Short* output jacks. These taps are within the recycling loop and contain reverberant signals, but their echo patterns are different from those at the Sec-

WHY MOST CRITICS USE MAXELL TAPE TO EVALUATE TAPE RECORDERS.

Any critic who wants to do a completely fair and impartial test of a tape recorder is very fussy about the tape he uses.

Because a flawed tape can lead to some very misleading results.

A tape that can't cover the full audio spectrum can keep a recorder from ever reaching its full potential.

A tape that's noisy makes it hard to measure how quiet the recorder is.

A tape that doesn't have a wide enough bias latitude can make you question the bias settings.

And a tape that doesn't sound consistently the same, from end to end, from tape to tape, can make you question the stability of the electronics.

If a cassette or 8-track jams, it can suggest some nasty but erroneous comments about the drive mechanism.

And if a cassette or 8-track introduces wow and flutter, it's apt to produce some test results that anyone can argue with.

Fortunately, we test every inch of every Maxell cassette, 8-track and reel-to-reel tape to make sure



they don't have the problems that plague other tapes.

So it's not surprising that most critics end up with our tape in their tape recorders.

It's one way to guarantee the equipment will get a fair hearing.

Maxell. The tape that's too good for most equipment.

Maxell Corporation of America, 150 West Commercial Ave., Moonachie, New Jersey 07074.

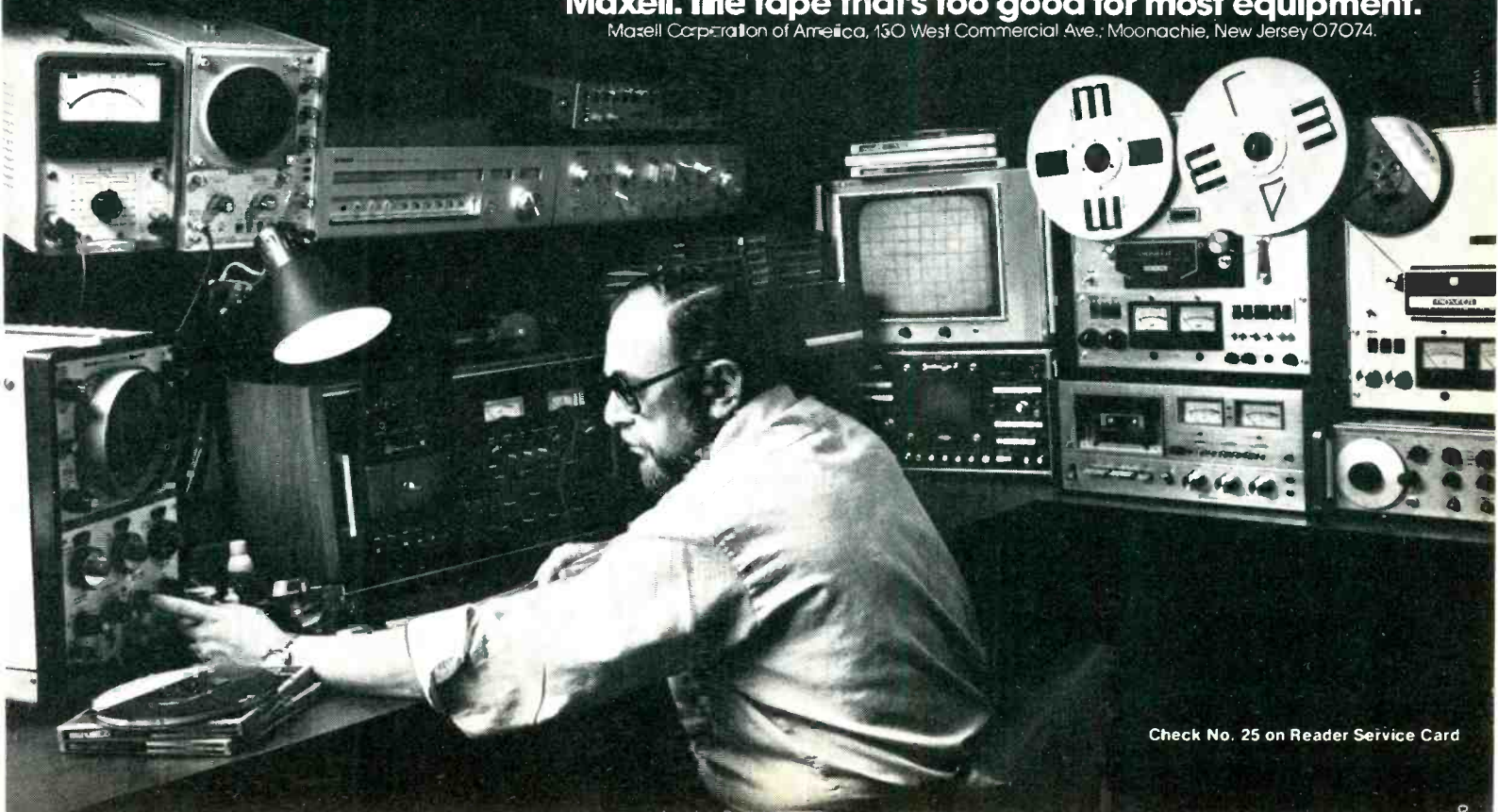

Check No. 25 on Reader Service Card

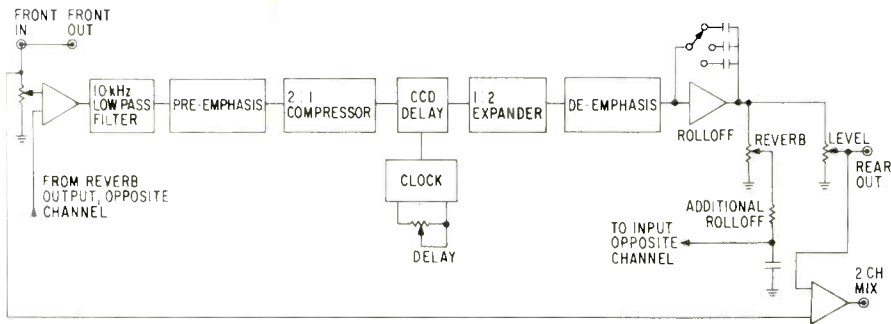

Fig. 4—Block diagram of the Sound Concepts SD-50 with one channel in the Stereo mode.

ondary outputs. The extra taps may be used to create a six-channel or eight-channel system or, when the recycling is cut off (by disengaging all the *Decay Time* switches on the front panel), the taps may be used to provide discrete, non-reverberant time delays for use in sound reinforcement applications.

Analog Time Delay

The Sound Concepts SD-50 uses a completely different electronic approach to achieve discrete time delay. A block diagram of one channel of this unit is reproduced in Fig. 4. A high input-impedance, operational amplifier stage, including the input level-set control, is followed by a low-

pass filter to block out any distortion-causing FM subcarriers or other high frequency leakage signals. Next comes a high-frequency pre-emphasis stage and a 2-to-1 compression circuit. This circuit halves the dynamic range of material presented to the SD-50 input and helps to reduce internally generated noise to below audibility. The compressed signals are passed to a delay chain of charge-coupled devices in large-scale integrated circuit (LSI) form. These so-called bucket-brigade chips operate at a rate determined by a digital clock, with the clock's frequency determined by the front-panel *Delay* control.

From the bucket-brigade chips, the delayed signals (which have remained in analog or true audio form through the process) pass through appropriate buffering to a 1-to-2 expander circuit — the complement of the compression circuit on the input side of the delay chain. Here, the signal is restored to its original dynamic range and de-emphasized. The combined compander action serves to effectively double the signal-to-noise ratio of the SD-50's delay chain.

At the output of the expander, the reverb signal is picked off, buffered, additionally rolled off, and its level chosen by the front-panel *Reverb* control. This reverberation component signal is passed on to the input of the opposite channel's compressor system. Thus, the reverb input to the right channel is the delayed left-channel signal, and vice versa. In this regard, the design philosophy of the Sound Concepts unit differs fundamentally from that of the Audio Pulse, since rear channel delayed and reverberant information remains coherent, rather than random. Following beyond the reverb pickoff point, there is a ganged potentiometer which serves as a level control operating on both channels simultaneously.

Table I—Audio Pulse Model One specifications.

- Input sensitivity for 0 dB:** Seven levels, selectable via Level Match control—0.12, 0.2, 0.3, 0.5, 0.8, 1.2, 2.0 Volts rms.
- Input impedance:** 50 kOhms.
- Output level:** Primary output identical to input level (unity gain); Secondary output variable from no output up to the input level.
- Output impedance:** Primary output, 500 ohms; Secondary output, 1000 ohms.
- Maximum undistorted input level:** Direct outputs (both Primary and Secondary) 4.5 volts rms; Delayed output, frequency-dependent, 5 dB above "0 dB" at 1 kHz.
- Noise level (20 Hz-20kHz, A-weighted):** Direct outputs, 85 dB below 1 volt; Delayed output; better than 65 dB below max. input level at 1 kHz (typically 68-70 dB).
- Frequency response:** Direct outputs, 10 Hz-40 kHz ± 0.5 dB; Delayed output, 20 Hz - 8 kHz ± 3 dB; frequencies above 8 kHz are attenuated by 18 dB/octave filter.
- Distortion:** Direct outputs, 0.05% THD; Delayed output, under 1.0% THD (measured with 1 kHz 0 dB input).
- Initial delay:** Four simultaneous delays ranging from 8 to 94 mS.
- Reverberation decay time:** Variable from 0.2 to 1.2 seconds (measured as the time required for "reverberant" output to fall by 60 dB following a transient).
- Echo density:** Maximum interval between successive delays is 20 milliseconds; typical interval at most settings of the *Decay* control is under 10 milliseconds. (Echoes spaced more than 30 mS apart would be heard separately; closely-spaced multiple delays blend into a lifelike ambience.)
- Coherence of delayed outputs:** Frequency dependent, typically under 20%. (A low percentage is desirable, reflecting the fact that in a real acoustic space the reverberant-field energy arriving at the listener's ears is largely incoherent and random phase in nature.)
- Dimensions:** 14 1/2 in. W x 10 in. D x 4 1/2 in. H. Weight, 10 lbs.
- Power requirements:** 110 Va.c., 60 Hz, 20 Watts.

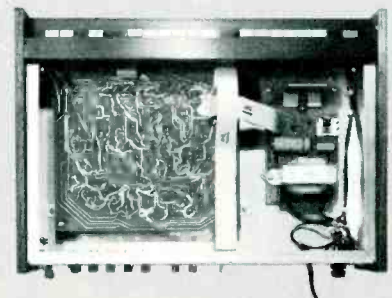

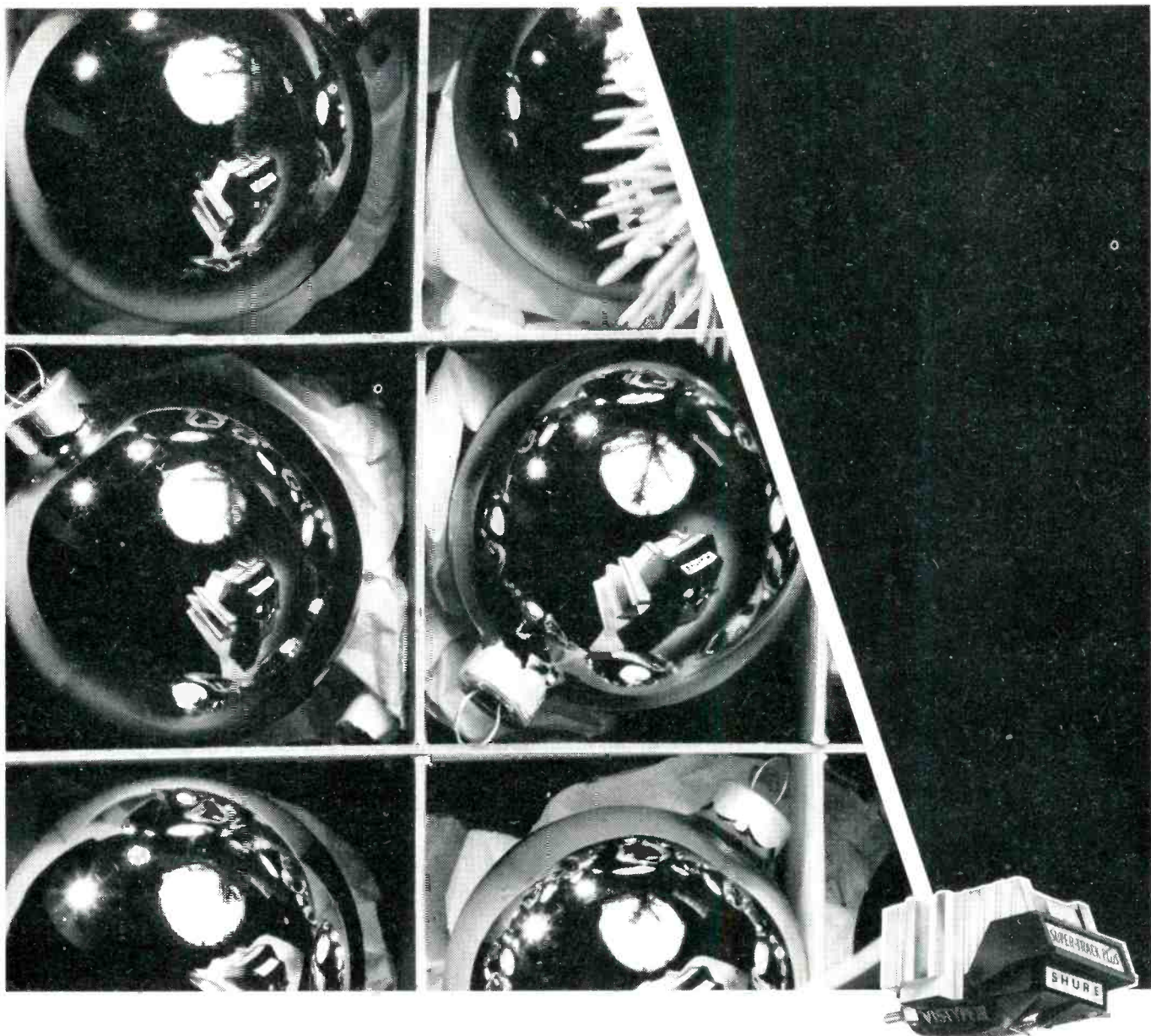

A cartridge in a pear tree.

A gift of the Shure V-15 Type III stereo phono cartridge will earn you the eternal endearment of the discriminating audiophile who receives it. What makes the V-15 such a predictable Yuletide success, of course, is its ability to extract the real sound of pipers piping, drummers drumming, rings ringing, et cetera, et cetera. In test reports that express more superlatives than a Christmas dinner, the performance of the V-15 Type III has been described as "... a virtually flat frequency response... Its sound is as neutral and uncolored as can be

desired." All of which means that if you're the giver, you can make a hi-fi enthusiast deliriously happy. (If you'd like to receive it yourself, keep your fingers crossed!)

Shure Brothers Inc.
222 Hartrey Ave.,
Evanston, IL 60204
In Canada:
A. C. Simmonds & Sons Limited

TECHNICORNER
MODEL V-15 TYPE III
Tracking Force Range: 1/4 to 1 1/4 grams
Frequency Response: 10 to 25,000 Hz
Output: 3.5 mV per channel at 1 KHz, 5 cm/sec peak recorded velocity
Typical Tracking (in cm/sec peak recorded velocity at 1 gram in a Shure-SME Tone Arm):
400 Hz 26 cm/sec
1,000 Hz 38 cm/sec
5,000 Hz 35 cm/sec
10,000 Hz 26 cm/sec
Channel Separation (Minimum): 25 dB at 1 KHz; 15 dB at 10 KHz
Stylus: Model VN35E Biradial Elliptical, 5 x 18 microns (.0002 x .0007 inches)
Also available: Model V-15 III G with the VN3-G Spherical stylus, 15 microns (.0006 inches)
Model VN78E Biradial Elliptical stylus, 13 x 63 microns (.0005 x .0025 inches) for mono 78 rpm.



Manufacturers of high fidelity components, microphones, sound systems and related circuitry.

Check No. 38 on Reader Service Card

From the description of the two circuits just given (and they are by no means complete, in the interest of brevity), it is clear that the Sound Concepts unit is somewhat simpler in overall design than the Audio Pulse unit. The front panel arrangement of each tends to confirm this (see photos). The added complexity of the Audio Pulse unit arises, in part, from the nature of the digital encoding and decoding system which requires, among other things, a careful level match (more critical than in the case of the Sound Concepts SD-50) and which utilizes discrete steps of delay and reverberation or decay as opposed to the continuously variable delay and reverb controls featured in the Sound Concepts unit. A reading of each manufacturer's published specs sheds some additional light on the operation and performance capabilities of each of the units, so these have been reproduced in their entirety in Tables I and II. Though not stated in Sound Concept's listed specifications, elsewhere in their owner's manual we are told that delay is variable from 5 to 50 milliseconds in stereo, from 10 to 100 milliseconds when used monophonically.

Laboratory Measurements

Units such as the Audio Pulse Model One and the Sound Concepts SD-50 do not lend themselves to very many meaningful test measurements. Ultimately, both of these units are

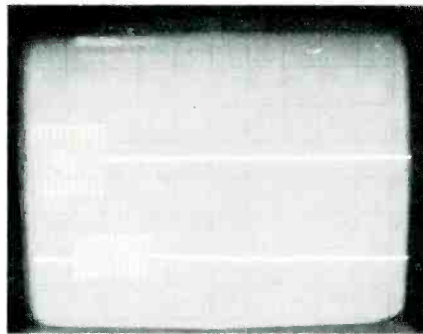

(a)

Fig. 5—Time delay of tone burst with the Sound Concepts SD-50 Delay control set to (a) 5 mS and (b) 50 mS.

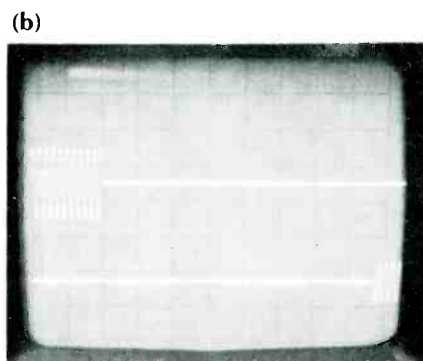

(b)

best judged by studied listening tests, since their primary objective is to provide the spacious feeling of a concert hall when music is reproduced in more confined listening environments. Nevertheless, before proceed-

ing to our protracted listening experiments, we checked out certain basic performance criteria of the two units, such as distortion (of the secondary channels only since front-channel signals, in both cases, remain unaltered), signal-to-noise ratios and frequency response. We examined the primary delay action of these two units with dual-trace scope photos and tone bursts to depict the delays.

In all of the scope photos that follow, sweep rate was set so that the time of a single trace is approximately 50 milliseconds. The upper trace represents an input signal, while the lower trace represents the output from a delayed channel. In Fig. 5(a) we see approximately 5 milliseconds of delay when the SD-50's *Delay* control was set to its minimum point, while in Fig. 5(b) the delayed signal has shifted over so that it occurs approximately 50 milliseconds after the input signal—the result obtained when the *Delay* control is moved to its maximum setting. In both cases, the *Reverb* control was set fully counter-clockwise to the zero position. To examine the action of the *Reverb* control of the Sound Concepts SD-50, we rotated it to about mid-point and reset the *Delay* control to its minimum (5 milliseconds). The resulting photo (Fig. 6) clearly shows how a series of pulse-trains appear following the initial delay, each diminished in amplitude and spaced apart by the basic 5 milliseconds.

Table II—Sound Concepts SD-50 specifications.

- Power Requirements:** 115 \pm 7 V a.c. at 3.5 watts.
- Front-channel input impedance:** 100 kOhms nominal, 60 kOhms minimum.
- Front-channel input voltage for full output:** Set for 1 Volt, adjustable from 0.2 to 20 Volts.
- Front output:** Connected directly to front input for connection convenience.
- Rear-channel output impedance:** 6 kOhms nominal, 10 kOhms maximum.
- Rear-channel output voltage:** 10 Volts rms maximum.
- Rear-channel output gain:** Set for 3.3 (10 dB) at maximum setting of *Level* control; adjustable with *Adj. Peak* and *Adj. Bal.* controls.
- Rear-channel frequency response:** \pm 1.0 dB 30 Hz to 4 kHz with *Delay* control at 5 milliseconds and *Rolloff* set at *Flat*.
- Rear input:** Connected directly to rear output in *Ext.* mode, otherwise no connection.
- 2-Ch. mix output impedance:** 300 ohms nominal.
- 2-Ch. mix output voltage:** Twice the front input voltage plus amount of signal set with *Level* control.
- Signal-to-noise ratio:** Typically over 70 dB* depending on settings of *Level*, *Rolloff* and *Delay* controls. Over 55 dB* at maximum settings (affected by *Peak* and *Bal.* adjustments).
- Distortion:** Under 1% most frequencies and listening levels.

*Early owner's manuals listed these S/N figures; the current manual specifies 90 dBA and 85 dBA, respectively, for these two figures.

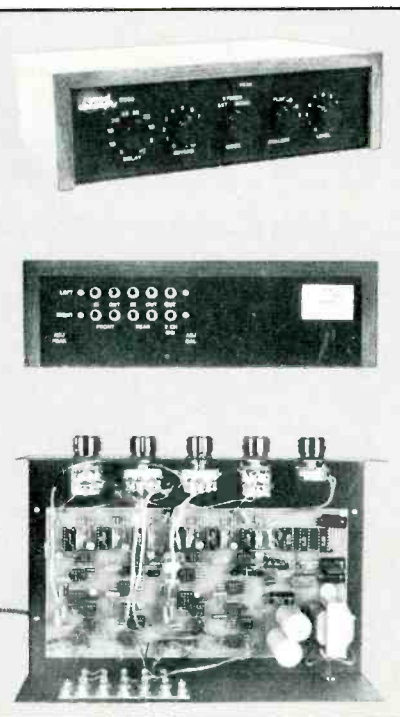

Introducing the AIWA AD-1250.

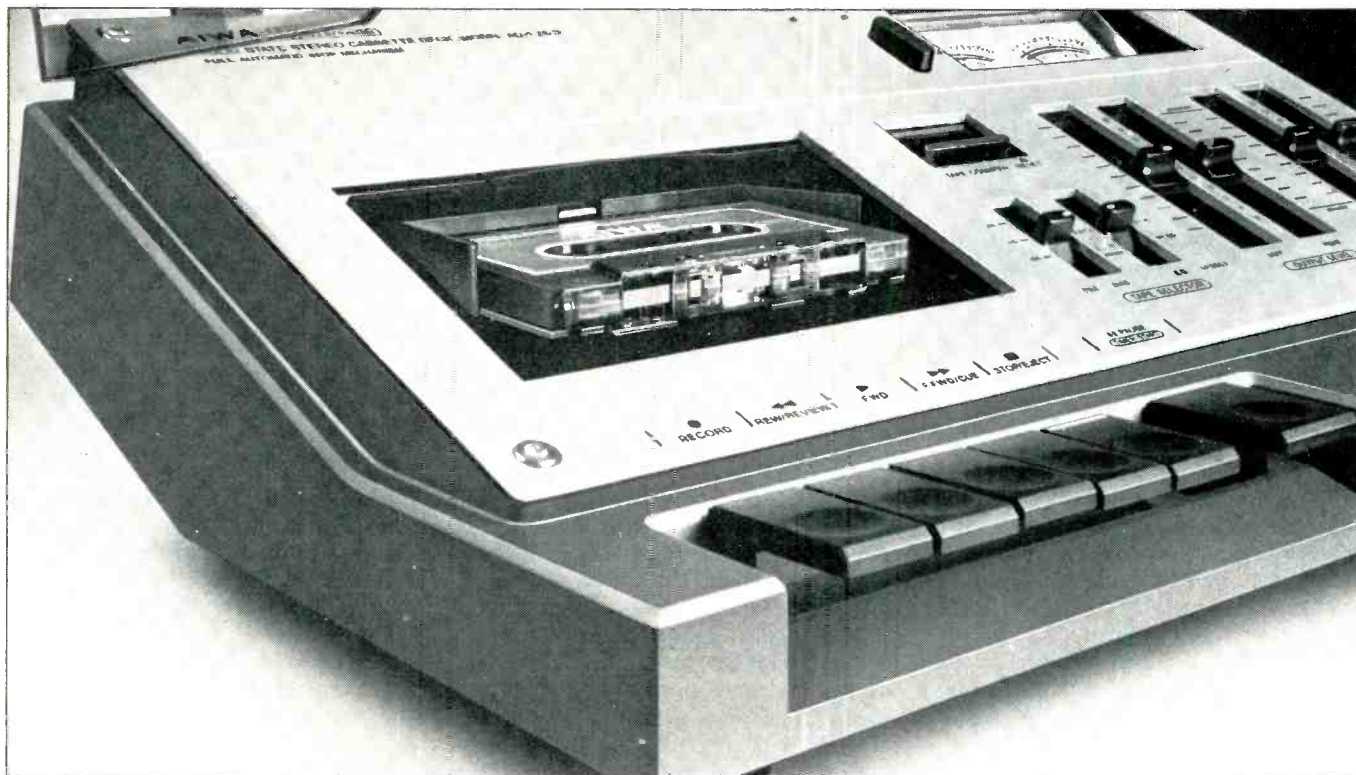

So beautifully built, it makes the other decks look flat.

47

AIWA's new ultra-modern slant backed deck with its 20° angle stands out in a crowd. And up. So you can see what you're doing. And enjoy what you see. Conveniently.

And with AIWA's exclusive oil-dampened elevation and ejection feature, you can put your cassettes in and out, without getting your fingers bitten off.

Simple, that's what innovative design is all about. To be utilitarian and beautiful at the same time.

And of course underneath all this streamlined beauty, lies the pride and joy of our AIWA engineers. The technical genius that has made AIWA famous for quality worldwide.

Our built-in Dolby*

and interlocked Dolby-MPX filter switch have a 60dB S/N ratio. The 30Hz to 16kHz (Fe-Cr tape) frequency response insures the vividness and clarity of sound you expect from AIWA. Our other features include:

- Oil-dampened cassette elevation and ejection (our special feature which we mentioned above)
- Full automatic stop-all positions
- Quick review/cue control
- 3-step independent bias and equalization
- Peak level indicator
- Low .09% WRMS wow-and-flutter
- Dust cover and more.

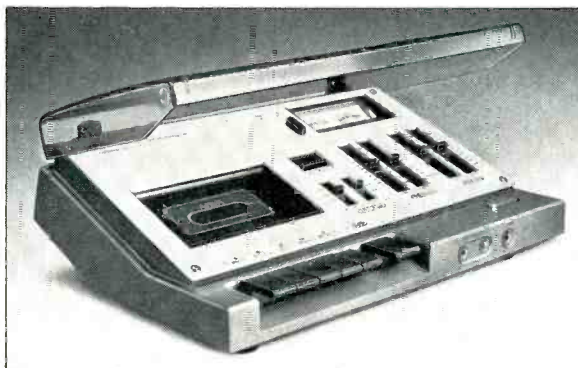

The AIWA AD-1250.
The body beautiful.

*Dolby is a Trademark of Dolby Laboratories, Inc.

AIWA®

Distributed in the U. S. by: **MERITON ELECTRONICS INC.**, 35 Oxford Drive, Moonachie, N.J. 07074

Distributed in Canada by: **SHRIRO (CANADA) LTD.**, Montreal 256, P.Q. Canada

Check No. 2 on Reader Service Card

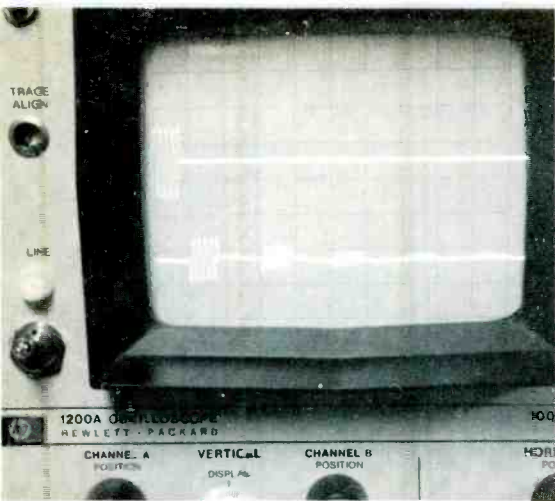

Fig. 6—A 5-mS Delay plus Reverb on the Sound Concepts SD-50.

In the case of the Audio Pulse unit, in order to obtain equivalent time-delay-only photos, it was necessary to disengage the *Decay* buttons and to measure output at the extra taps (where the time-delayed but unreverberated or mixed signals are available). Figure 7(a) shows one of the four delays obtained with the *Delay*

button in the *Short* position, while in Fig. 7(b) we see the additional displacement of the output signal when the *Long* delay position is selected. The random nature of the decay and cross-mixing of signals is depicted to some degree in the scope photos of Figs. 8(a) and 8(b) which were taken with different *Decay* buttons depressed, but with the basic *Decay* button set to the *Short* position.

While the rear or secondary channel frequency response of the Audio Pulse unit is essentially constant regardless of decay and delay settings, as shown in the graph of Fig. 9 (roll-off occurs, as specified, above around 8 kHz), the high-frequency response of the Sound Concepts unit is dependent upon the amount of delay introduced. The curves in Fig. 10 depict this rear-channel response with the roll-off front panel control set to *Flat* and with the delay control set to its two extreme positions, 5 milliseconds and 50 milliseconds and it is clear that the SD-50 rolls off at the high end much earlier than does the fixed response of the Audio Pulse unit.

Distortion measurements were also made for both units. In the case of the Sound Concepts SD-50, distortion varied both with frequency and setting of delay. At 1 kHz, THD ranged from 0.21 per cent (at maximum delay) to 0.45 per cent (for minimum delay) for an input of 1 Volt and gain adjusted to unity by means of the front-panel level control. As received, the unit is adjusted so that a maximum of 10 dB of gain is realizable by means of this level control, but if signals tend to cause the peak-LED indicator to flash excessively, it is possible to readjust the input level match and thereby to change the overall gain-range achievable by means of the front-panel control.

In attempting to measure THD of the delayed channels of the Audio Pulse unit, we found that the lengthy discussion and cautionary advice regarding the level-match buttons and associated LED indicator bank were well worth reading. The digital circuitry of this unit is easily overdriven and can deliver reconstituted audio signals containing high levels of distortion unless care is taken to select the correct level-match button on the front panel. Of course, we were using as a source a signal generator capable of putting out a very wide range of signal amplitudes and so, perhaps, this problem was a bit more tricky for us than would be the case once you installed

the unit with a given set of components where signals (from *Tape Out* or *Preamplifier Out*) are likely to be more nearly constant. In any event, once we got over that hurdle and optimized the *Level Match*, THD at 1 kHz varied from 0.3 to 0.65 per cent, depending upon the combined settings of the *Initial Delay* or *Decay* buttons.

With 1 Volt into the SD-50, signal to noise ranged from 78 to 80 dB depending upon the setting of the *Delay* potentiometer. For the same signal input level, the S/N of the Audio Pulse unit ranged from 67 to 71 dB, depending upon *Delay* and *Decay* button settings. Overload of the SD-50 occurred with an input voltage of 3.0 Volts, a signal level not likely to be encountered in actual use with an integrated amplifier, receiver or separate preamp/power amplifier setup.

It should be noted that in addition to the normal high-frequency roll-off of the Sound Concepts unit, a front-panel control offers addition high-fre-

48

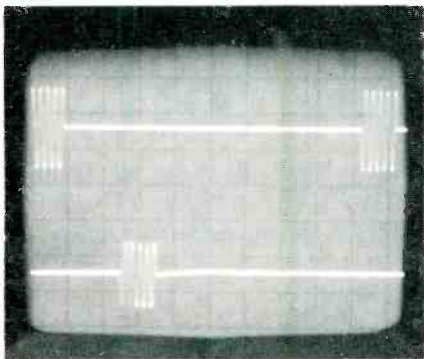

(a)

Fig. 7—Delay observed with the Audio Pulse Model One when *Delay* button is set in (a) *Short* and (b) *Long* positions.

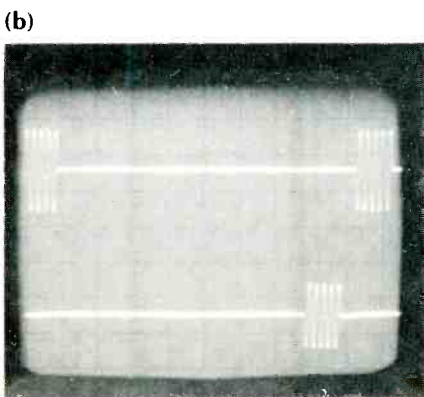

(b)

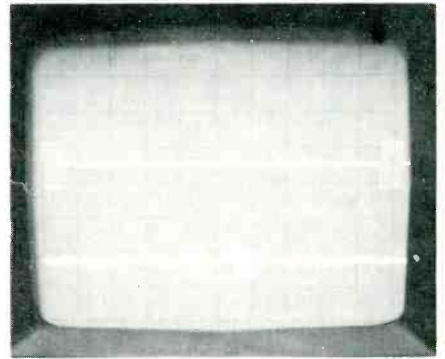

(a)

Fig. 8—Random nature of lower amplitude decay signals (lower traces a and b) show the echo density of reverberant signals obtained with the Audio Pulse Model One.

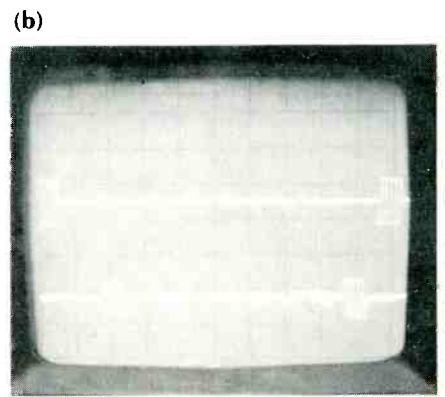

(b)

Get yourself the big one!

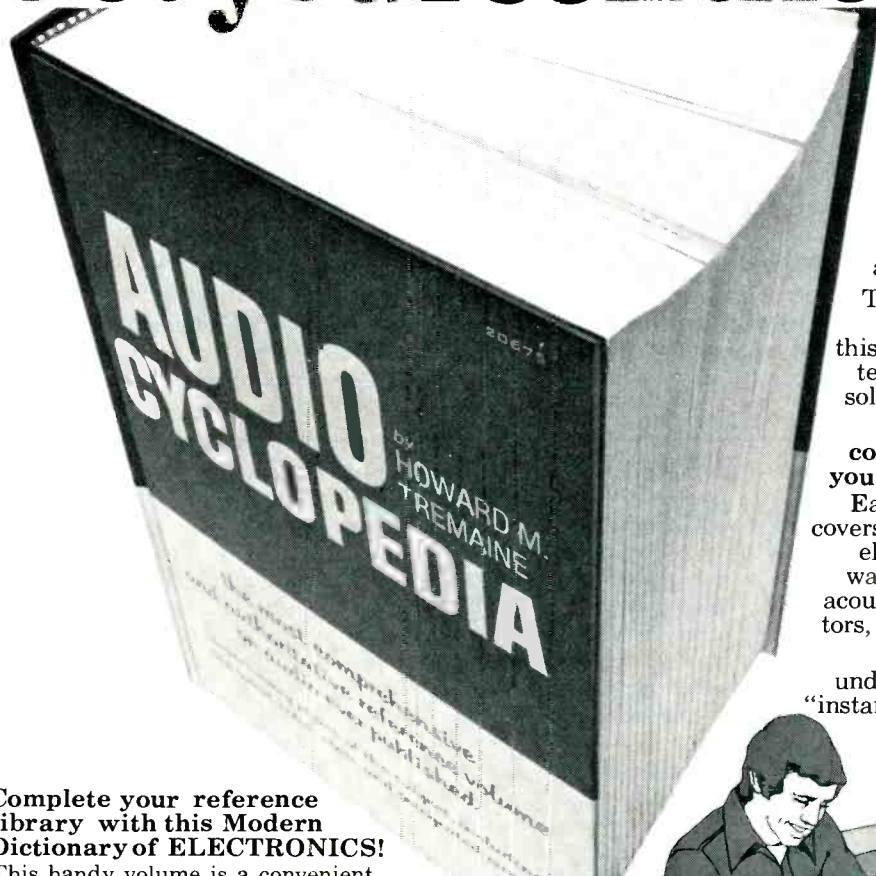

1757 illustrated pages of detailed audio reference for the working technician... the student... the hi-fi buff!

Here's a comprehensive volume especially designed for the man or woman who has an understanding of electronics and an interest in audio technology.

The Audio Cyclopedea is the most authoritative reference book ever published on this subject. It includes every phase of audio technology—plus the latest information on solid-state and integrated circuits.

25 informative chapters... convenient format so you find what you're looking for... quickly... easily!

Each of the big, information-filled chapters covers in depth one of the major areas of audio electronics. You'll find anything you could want to know about everything—amplifiers, acoustics, meters, transformers, coils, transistors, diodes, filters... plus much, much more!

All information is presented in easy-to-understand, question-and-answer format. For "instant find," there's a unique index and refer-

ence system so the information you need is always at your fingertips.

Send for this complete reference library today for just \$34.00

Complete your reference library with this Modern Dictionary of ELECTRONICS!

This handy volume is a convenient way for you to keep abreast of all the latest happenings in the ever-changing field of electronics. *Modern Dictionary of Electronics* gives you clear, concise definitions of 18,500 terms commonly in use today in the fields of communications, microelectronics, fiberoptics, semiconductors, reliability, computers and medical electronics.

It's yours for only \$14.50



49

107R1

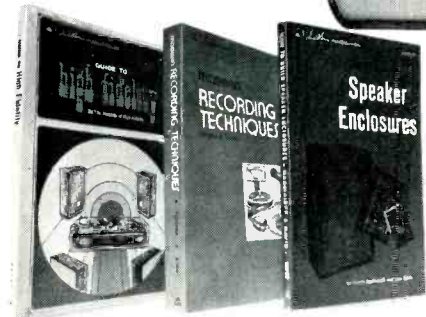

For more audio information... Take one or more of these handy paperback guides.

Guide to High Fidelity

Here's a convenient guide to help you select a hi-fi system that not only meets your needs but fits your budget besides. If you ever plan to invest in any hi-fi equipment at all, this book is a must. Yours for a low \$4.50

Modern Recording Techniques

Now, whether you're a would-be recording artist or an experienced engineer, you can find out all about the techniques that are being used today in pop recording. Learn how to cut your own records, and how to use equipment and controls creatively. Just \$9.95

How To Build Speaker Enclosures

Here's the book to use if you want to build enclosures that give you realistic sound reproduction. Includes directions for enclosures to fit any application... any price range. Yours for a low \$4.50

MAIL TODAY FOR 15-DAY FREE TRIAL

YES — send me the book(s) checked below to examine for 15 days free. If not completely satisfied, I may return my order and owe absolutely nothing. Otherwise, I will pay the amount on the invoice accompanying my book(s), including shipping and handling.

- Audio Cyclopedea (20675) \$34.00
- Modern Dictionary of Electronics (20852) \$14.50
- Modern Recording Techniques (21037) . \$9.95
- Guide to High Fidelity (21154) \$4.50
- How to Build Speaker Enclosures (20520) \$4.50

Name _____ (PLEASE PRINT)

Address _____

City _____

State _____ Zip _____

Save shipping and handling costs. Full payment enclosed. (Plus sales tax, if any.)

MAIL TO: Howard W. Sams & Co., Inc., 4300 W. 62nd Street Indianapolis, Indiana 46206

CT 24

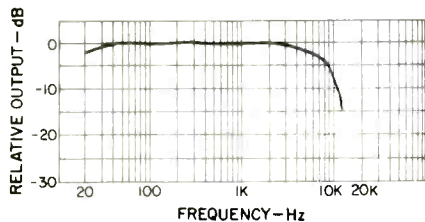

Fig. 9—Response at outputs of secondary channels with the Audio Pulse Model One.

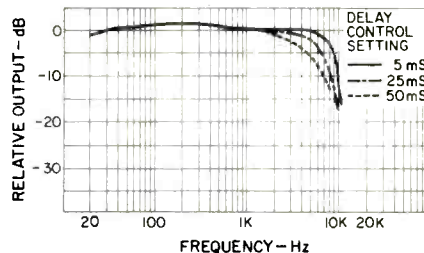

Fig. 10—Response at the rear channel outputs of the Sound Concepts SD-50 varies with setting of the delay control. The front panel Roll-off control is set to Flat.

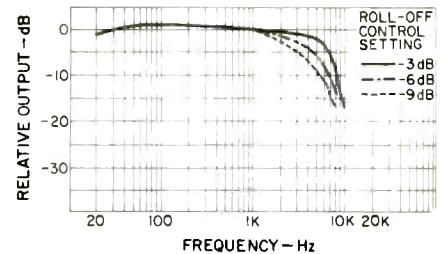

Fig. 11—Variation of the rear channel response of the Sound Concepts SD-50, with the different Roll-off settings on the front panel control. (Delay set to 5 mS.)

quency attenuation settings labeled -3, -6 and -9. With the delay control set to minimum, the rear channel response for these various roll-off settings is plotted in Fig. 11.

Use and Listening Tests

The question of speaker placement when using extra channels of time delay is dealt with somewhat differently by these two manufacturers. While they do not say so outright, we gathered that the Sound Concepts people favor the familiar two-in-front, two-in-the-rear speaker arrangement common to four-channel setups. Audio Pulse, on the other hand, seems to favor side-firing arrangement of the secondary channel speakers and suggests that they be placed above listener's ear level. Needless to say, we experimented with these and several alternate speaker settings in our tests. Our own conclusions (and they are far from the last word) were that we liked the results obtained with the Audio Pulse unit when rear speakers were positioned as recommended by that company, namely slightly behind us, side firing from the two side walls, and positioned about six feet above floor level. In the case of the Sound Concepts units, while we started with the speakers at the rear, in the usual four-channel arrangement, we quickly altered that arrangement so that the rear speakers, though still against the rear wall, were angled inward and somewhat removed from side wall surfaces (front radiating speakers were used in both cases).

One thing we quickly discovered is that the illusion of a large space can be readily obtained with lower-cost, lower-quality speakers than those used for the primary stereo channels. The units we used for the secondary channels had little useful response

below 60 Hz. There is, of course, a tendency to over-use the rear channels before one becomes familiar with how effective the system can be without those rear channels becoming obtrusive or overly discrete in the sounds they produce. With the aid of our handy Russound/FMP QT-1 switch box (which accommodates as many as four 4-channel devices all via a single tape-out/tape-in facility on our main reference system), we were able to make direct comparisons between the two units on an A-B basis. Of course, the number of control permutations on each delay unit is almost countless, and it took some time to adjust each unit so that the variables reduced to design approach, rather than level or basic timing differences. The only instrumentation used to make such adjustments was our own two ears.

For relatively short decay times, we were able to obtain what we considered to be amazing hall realism with either unit. There are differences, to be sure, primarily we think because of the incoherency of the rear-channel information of the Audio Pulse units and the discrete left-right sense of rear channels on the Sound Concepts unit, but both expand the apparent listening room in a quite dramatic manner.

The Sound Concepts unit, when played with maximum delay and nearly maximum reverb or decay, tends to take on a bit of artificiality—suggesting almost that something “electronic” rather than a natural phenomenon is taking place. In its Long delay and extreme Decay position, the Audio Pulse unit fared better in this respect, as we seemed to be transported to a cavernous cathedral.

The Sound Concepts unit is, for the most part, easier for a consumer to use properly, we feel, requiring little

indoctrination and experimentation. The Audio Pulse unit is a bit trickier, simply because so many sonic things are happening at once, but it is that very feature of the unit which provides so many subtle variations in the apparent sound field.

There was no clear winner in this back-to-back evaluation of these two interesting and innovative components. Both the Audio Pulse and Sound Concepts time-delay units seem destined to find consumer acceptance from those who recognize the limitations of a home listening environment (as compared with concert hall music listening) and are prepared to take the trouble and spend the money to augment their stereo systems with a device of this kind plus the necessary extra channels of amplification and the extra pair of speakers required. Although \$600 or \$630 may seem like a high price to pay for this added dimension and realism in sound, when you consider the fact that just a couple of years ago any electronic time-delay system (even those which did nothing but offer discrete time delay without reverb/decay capability) available for use in studio applications cost several thousand dollars, the accomplishments of both Audio Pulse and Sound Concepts are considerable. Audio time delay has been described by some as a viable alternative to four-channel sound. From our brief experience with these two units in our lab we would say that, at least as executed in the Audio Pulse Model One and the Sound Concepts SD-50, it offers a realization of four-channel's original goal—that of recreating the live listening experience—a goal that was regrettably passed over by four-channel's very earliest proponents in favor of spectacular effects that had little in common with real music. A

These new Dahlquist products will greatly improve the performance of your speaker system.

We are pleased to offer you four important new products and accessories that will add considerably to your listening enjoyment. Included are a remarkable subwoofer system and two crossover units, electronic and passive. Also available is an attractive stand for our popular Dahlquist DQ-10 loudspeaker, which will improve both performance and appearance. Ask for a demonstration at your Dahlquist dealer.

1 **DQ-1W LOW-BASS MODULE.** A superior subwoofer design. Adds an octave or more of extremely tight, well defined low response to most speakers. Propagates considerable acoustic output to 20 Hz and below. Its fast rise/decay times assure excellent coherence with high-definition speakers. Use with either the passive or active Dahlquist crossovers below. High quality 13" driver with heavy cast frame and 12,000 Gauss magnet. Oiled walnut finish with satin aluminum trim.

2 **DQ-MX1 PASSIVE CROSS-OVER.** For connecting any 8 ohm center-channel subwoofer without requiring another amplifier. Features: 3-position bass level switch; phase switch; frequency selector for 60 or 80 Hz crossover.

3 **DQ-LP1 ELECTRONIC LOW-PASS FILTER.** For optimum results as a no-compromise,

bi-amplified system. Features: continuously variable crossover settings from 40 to 400 Hz, @ 18dB/octave; bass level adjustments with up to 15dB gain; 0 to +5dB equalization at 20 Hz; bypass switches silence subwoofer and restore full-range response to main speakers; separate outputs for stereo and mixed-center-channel subwoofers; A unique combination of active low-pass and passive high-pass sections prevents any degradation of high frequency performance quality.

4 **ST-10 OPTIONAL STANDS.** For owners of our Dahlquist DQ-10 speakers. Improve radiation characteristics, especially noticeable in the lower-midrange/upper-bass regions. Packed two to a carton. Assembles with six screws.

DAHLQUIST

27 Hanse Ave., Freeport, N.Y. 11520

Check No. 10 on Reader Service Card

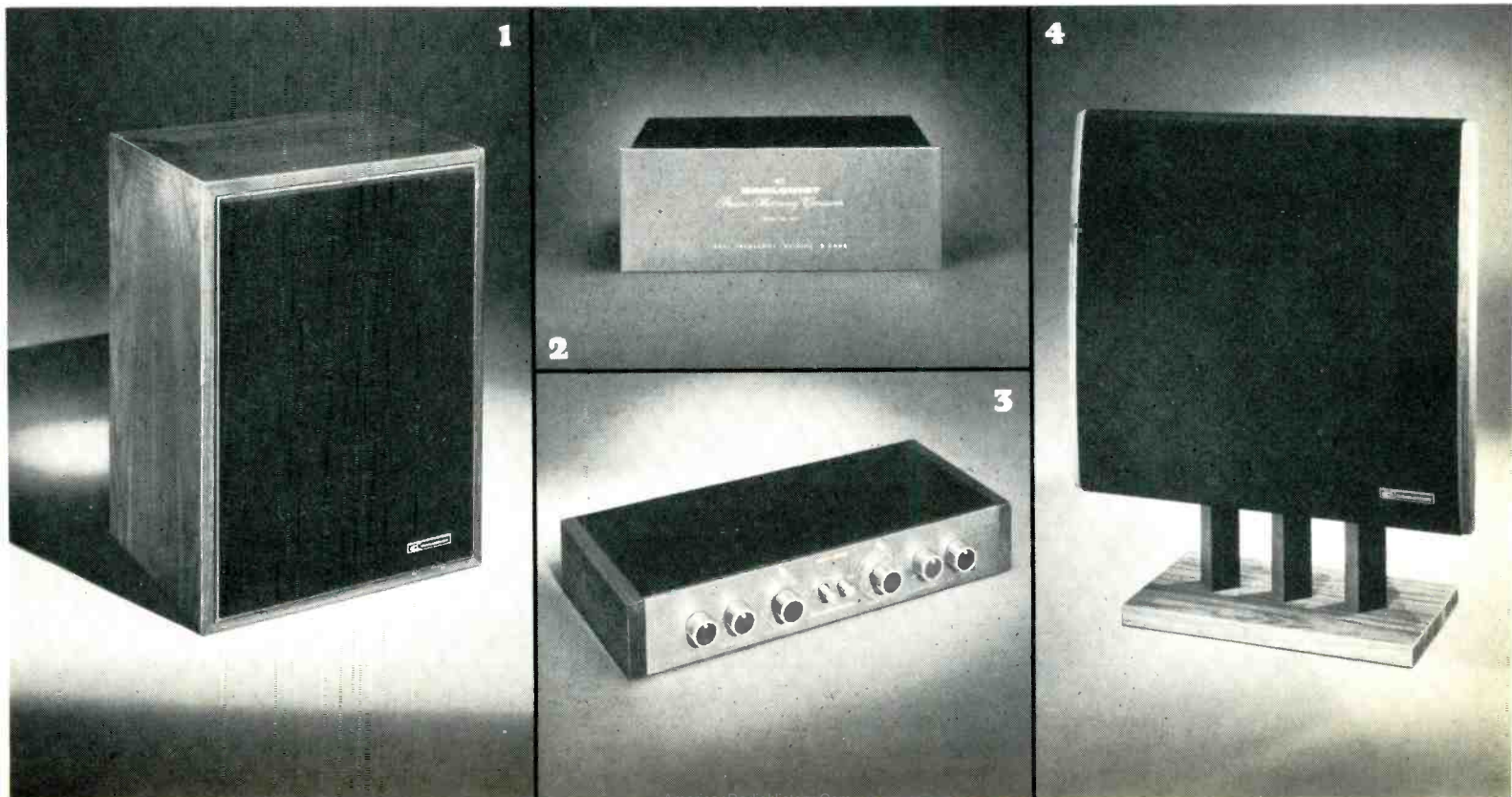

Annual Directory Addenda

Manufacturer Directory

All-Test Devices Corp.
150 W. Pine St.
Long Beach, NY 11561

Cizek Audio Systems
149 California St.
Newton, MA 02158

Delta-Graph
P.O. Box 741
Pasco, WA 99301

Fried Products
7616 City Line Ave.
Phila., PA 19151

MXR Innovations
P.O. Box 722
Rochester, NY 14603

Miida Electronics
205 Chubb Rd.
Lyndhurst, NJ 07071

Under the AKG headphones there were several errors. The frequency response for the K-240 is from 16 Hz to 20 kHz, the weight 10 1/2 oz., and the price \$69.50. For the K-140, the frequency response is from 20 Hz to 20 kHz, and the weight is 6.2 Oz.

The listing for Sonic Systems Model One speaker contains an error in the fact that the tweeters are "compression drivers" and not dome.

Two errors occurred in the listings for Polk Audio. Their speakers have passive radiators, rather than being vented, and the Formula Four tone-arm they distribute has a pivot-stylus distance of 8 3/4 inches.



Cizek I



Miida SP-3150

Loudspeakers

MANUFACTURER	MODEL	Enclosure type	Woofer dia., inches		Midrange dia., inches	Midrange type	Tweeter dia., inches		Tweeter type	Level control (M=midrange, T=tweeter)	Acoustic resp. response Hz to kHz +/-dB	dB SPL 1 watt input, 1 mtr. on axis, 100Hz-10KHz	Recommended min amp. power	Crossover frequencies, Hz	Impedance, ohms; Nominal/minimum	Dimensions, inches	Finish	Grille Material? Colour?	Weight, lbs.	Price, \$	NOTES
			W	D			T	D													
B & W	DM6	ac sus	9	5	cone	.8	dome	B,M, T			50-20 ±3	85	25	500, 5k	8/2	16x15 x37	wal.*	clth, blk	80	595.00	*Rose, teak or white. Linear phase
CIZEK AUDIO SYSTEMS	Cizek I	ac sus	10			1		T*			35-18 ±2	88	10	1500	4%	25x15 1/2 x9 1/2	wal.	foam blk		200.00	*5 pos switch adj 0.6-1.0
I.M. FRIED	Super Monitor H	trans. line trans line	12	8	5	cone	3/4	dome	M		93	25	200	8	36x18 x60	oil wal oil wal	foam blk foam blk	270	4000.00 pair 1900.00 system	Dual channel woofer & 2 satellites	
	M	trans line	8	5	5	cone	3/4	dome			90	25	110, 3.5k	8	23x12 x43	oil wal oil wal	foam blk foam blk	90	800.00		
	D	line tunnel	(2) 8	5	5	cone	3/4	dome			90	25	110, 3.5k	8	15x14 x24	oil wal oil wal	foam blk foam blk		550.00		
	R/II	line tunnel	8x 12	5	5	cone	3/4	dome	M		89	30	200, 3.5k	8	16x14 x28	oil wal oil wal	knit brn foam blk	65	375.00		
	L	line tunnel	10	8	8	cone	3/4	dome	M		93	25	150, 2k	8	15x14 x34	oil. wal oil wal	foam blk foam blk		320.00		
	Q	line tunnel	8		8	cone	3/4	dome	T		90	25	150, 2k	8	11 1/2 x 9 3/4 x 19 3/4	oil wal oil wal	foam blk foam blk	23	140.00		
MIIDA	SP-3150	ac sus	12	4 1/2	4 1/2	cone	(2) 2 1/2 2 1/2	cone			25-22 ±5		55	1.8k 7.5k 12k	8	17x10 1/2 x27	wood vinyl	clth blk	51	200.00 pair	
	SP-3140	ac sus	12	4 1/2	4 1/2	cone	2 1/2	cone	ST		30-20 ±5			1.8k 7.5k 1.8k	8	15x10 1/2 x24	wood vinyl	clth blk	41	160.00 pair	
	SP-3130	ac sus	10			cone	2 1/2	cone			40-18 ±5			1.8k	8	11 1/2 x 10 x 18 3/4	wood vinyl	clth blk	25	120.00 pair	

Creative Technology!

Introducing The MXR Compander

The MXR Compander is a noise reduction device capable of doubling the dynamic range of most open reel and cassette tape decks, allowing professional results in home recording. In operation, the Compander compresses the dynamic range of the signal going onto the tape, and expands the dynamic range upon playback. This compression/expansion process increases the overall fidelity of your system. Noise is reduced, enabling the softest sounds to be heard, while musical peaks can be reproduced without distortion.

The Compander joins our Stereo Graphic Equalizer as the latest addition to the MXR Consumer Products Group, and is manufactured with the same care we give to our Pro-

fessional Products which have become the standard for signal processing in professional recording and live musical performances.

The MXR Compander is compact, stylish and handsomely packaged in black anodized aluminum with walnut side panels. Its design and circuitry will complement any modern hi-fi system at the attractive price of \$129.95. At MXR, we combine engineering excellence and creativity to provide you with superior products. For more information see your nearest MXR dealer or direct inquiries to MXR Innovations Inc., 277 N. Goodman St., Rochester, New York 14607, (716) 442-5320.

MXR Consumer Products Group





Miida HX-140

Headphones

MANUFACTURER	MODEL	Type (dynamic, electrostatic, etc.)	Freq. response, Hz-kHz, ± 2 dB	Impedance, ohms	Sensitivity, dB SPL for 1 mV input	Maximum input, mV	% THD at 95 dB SPL	Cord length, ft.	Weight, oz.	Price, \$	NOTES
MIIDA	HX-140 HX-130 HX-100	es dyn. dyn.	20-20 80-20 20-20	4-32 8	90* 112*	300* 300*	0.5	6.5 8 8.2	9.2 11.2 10.3	129.00 79.00 59.00	* in mW * as above



Miida T-3115

Turntables

SPEEOS

- A - 33, 45, 78
- B - 33, 45
- C - 33 only
- D - 16, 33, 45, 78
- E - 16, 33, 45
- F - Cont. variable

54

MANUFACTURER	MODEL	Speeds (see letter code)	Wow & flutter at 33 1/3, % (W RMS)	± dB rumble, DIN 45 507	Motor type	Speed adjustment, ±%	Drive system	Speed accuracy, ±%	Dimensions, in inches	Built-in strobe light?	Mogel (for separate arm)	Overall length, in	Pivot-stylus dist., in	Vertical bearing type	Lateral bearing type	Max. tracking error, deg/in	Anti-skate adjustment?	Arm resonance, Hz	Stylus force range, gms	Sold w. base and cover?	Damped cueing?	Price, \$	NOTES
MIIDA	T-3115	B 0.0:1	-70	D.C.	5	direct		19 1/4 x 15 1/4 x 6 1/4	yes	9.25	9.16			0.5	yes	0.5	yes	yes	yes	yes	199.95		
	T-3112	B 0.0:1	-55	Hys. sync		belt		18 1/2 x 14 1/2 x 7	no	8.5	8.3			0.7	yes	0.5	yes	yes	yes	yes	129.95		

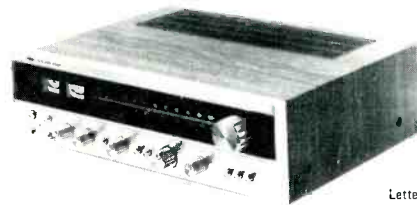

Miida 3140

Receivers

Letter Key: (T) with model indicates tube-type; (K) with model indicates kit; (D) with model indicates 4-channel; (W) with model indicates wired; (F) with model indicates FM only;

MANUFACTURER	Model	Avg. power/channel, into 8 ohms, mW, as per FTC rule	Max. THD 0.25 W, rated power, %	Max. IAW 0.25 W, rated power, %	Freq. range for FTC-rated power, Hz-kHz	S/N, phono, re 10 mV input, dB	Phono sens., mV	Phono overload, mV	IHF sens. tuner, monostereo microvolts	Capture ratio, dB	Signal for 50 dB quieting, µV, monostereo	% THD 100% modulation of 1 kHz, monostereo	De-emphasis ±5	Att. chain selectivity, dB	Tuning aids, no. & type	dB, best S/N, monostereo	Dimensions, in.	Weight, lbs.	Price, \$	NOTES
MIIDA	3140	43	0.4	0.4	10-30	70	2.5	1.8	1.5	0.2/0.3	75	60	2 mtrs	72	19x14x5 1/2	25	349.95			
	3125	22	0.5	0.5	20-20	70	2.5	2.5	3	0.3/0.5	75	50	2 mtrs	70	19 1/4 x 14 x 5 1/2	22	249.95			
	3120	17	0.5	0.75	20-20	70	2.5	2.5	3	0.3/0.5	75	50	1 mtr	70	19 1/4 x 13 1/2 x 5 1/2	19	219.95			
	3100	8	0.5	0.75	20-22	70	2.0	2.5	3	0.3/0.5	75	50		70	19 1/4 x 13 1/2 x 5 1/2	19	179.95			

Dolby FM Ends The High-Frequency Power Shortage

Look at this graph. You wouldn't tolerate an amplifier that did this to your music. So why put up with an FM system that does this to your amplifier?

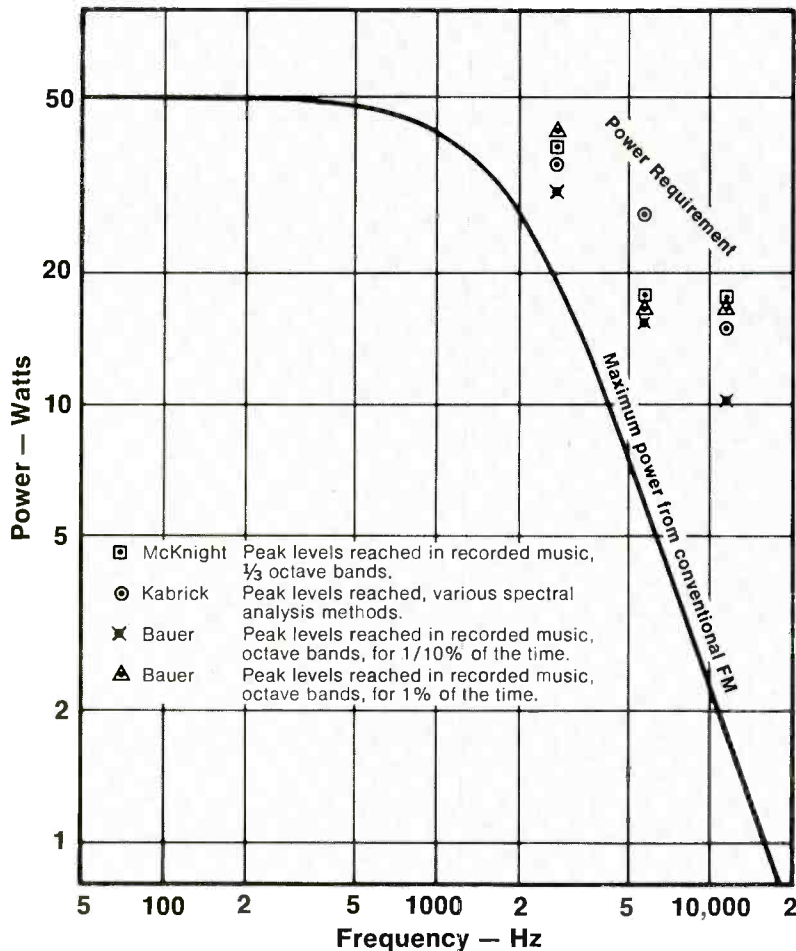

This curve shows the maximum power output of a 50-watt amplifier when fed from conventional FM. The power curve and the power requirement points are all shown with respect to full mid-frequency modulation at the transmitter and 50 watts peak power from the amplifier.

Take a typical state of the art 50-watt amplifier. It will deliver its full 50 watts over the whole audio bandwidth. Well, what would you think of a system that treated the high frequencies like the one pictured above? A droop to half-power at only 2 kHz? Or a pitiful 2 watts at 10 kHz? It sounds ridiculous. And yet this is what the conventional 75 microsecond FM broadcasting system does to the signal. It is impossible for a conventional station and a conventional receiver to do better than this.

Of course, the full 50 watts isn't needed at high frequencies. The graph

points in the high-frequency region of the drawing show how much power is actually required, according to researchers who have investigated this matter. Obviously, there is a significant difference between the requirement and what conventional FM can provide.

What does this have to do with Dolby FM? Plenty. Dolby FM provides not only lower noise but a dramatically improved power capability. In fact, the power curve of a Dolby FM receiver runs right through the power requirement points on the graph above (which is no accident). Thus Dolby FM gives you the full high-frequency power

needed for accurate reproduction of music. Brasses retain their bite. Cymbal crashes don't collapse.

If this improvement in FM broadcasting and reception interests you, then you may like to write to us for further technical details. We also invite you to consider purchasing one of the more than 30 new models of receivers with built-in Dolby FM circuits (write for receiver list and Dolby FM station list). Check with your hi-fi component dealer for details on the specific receiver models available in your area.



Dolby Laboratories Inc

'Dolby,' 'Dolbyized' and the double-D symbol are trade marks of Dolby Laboratories Inc.

731 Sansome Street
 San Francisco, CA 94111
 Telephone (415) 392-0300
 Telex 34409
 Cable Dolbylabs

346 Clapham Road
 London SW9
 Telephone 01-720 1111
 Telex 919109
 Cable Dolbylabs London

Preamplifiers

MANUFACTURER	MODEL	Frequency response Hz - 2kHz ±2 dB	Rated output, V	THD at rated output, %	IM at rated output, %	S/N ratio, phono, dB re 10 mV input	Phono sens., mV, phono 1/phono 2	Phono overload, mV, phono 1/phono 2	Mike input sens., mV	High-level sens., V	Tape mon. impedance, ohms	Tape mon. output level, V	Dimensions, in.	Weight, lbs.	Price, \$	NOTES
ALL-TEST DEVICES	ATD-25	20-20		0.01	80		130								170.00	Phono preamp only



ATD-25



Equalizers

MXR Equalizer

MANUFACTURER	MODEL	No. of Channels	No. of Bands	Bandwidth, octaves	Boost/cut range, ±dB	Max. output, rms V	% THD at Max. output	dB S/N at Max. output	Dimensions, in.	Weight	Price, \$	NOTES
DELTA-GRAPH	EQ10M	1	10	1	15	10/20	0.05	100	9½x5¼x2	3	56.00(K)	Modular system, center detent, bal. & unbal. line facilities, Gytrator inductors, universal Mtg., EQ10WC, \$20.00
	EQ10SP	2	10	1	15	10/20	0.05	100	19x5¼x2	7	130.00(K)	
	EQ10QP	4	10	1	15	10/20	0.05	100	19x10½x2	13	235.00(K)	
	EQ1082P	8	10	1	15	10/20	0.05	100	19x21x2	26	460.00(K)	
MXR	Stereo Equalizer	2	10	1	12	10	0.05	110	2x7x9	4½	199.95	Tape monitor, level controls, and EQ bypass

56

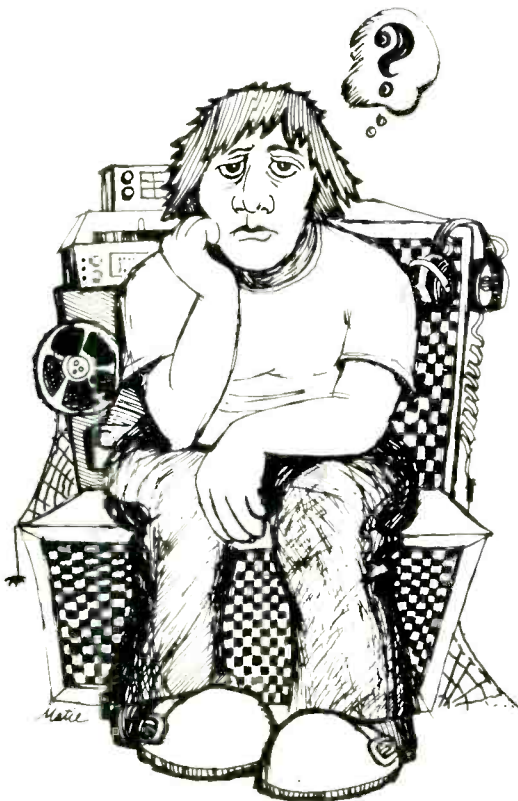

Audio Classified Ads

Want to buy, trade or sell components? Want to offer or buy a service? Want a job in the audio field? Your ad belongs in Audio. Rates are low—results high.

RATES: Commercial, 60¢ per word; situation wanted or non-commercial, 35¢ per word. We reserve the right to determine classification as commercial or non-commercial. **Payment must accompany all orders.**

Place your ad today!

Send copy to:
Audio Magazine
 401 N. Broad Street,
 Philadelphia, PA 19108
 Attn: Classified Dept.



Design and performance that knows no equal.

Introducing our new "T" series single-play turntables. Their development was based upon one premise; that something can be as beautiful to look at as it is to listen to. You can see by the clean, uncluttered styling and the impressive list of features that we have succeeded. The T-2000 offers the beginning audiophile a taste of excellence without getting bitten. The T-4000 allows the audiophile of intermediate standing to enjoy the kind of performance that he will one day learn to appreciate. The T-6000 fulfills the most discriminating audiophile like he's never been fulfilled before. These new turntables are part of an entire new line of components that can be found at your nearest Lafayette store or dealer. And since we have stores and dealers coast to coast, finding us and the kind of design and performance that knows no equal, becomes rather easy.

Specifications	T-6000	T-4000	T-2000
Drive Mechanism	Direct drive ball bearing 72-pole frequency generator AC servo motor	Belt drive 4 pole DC servo motor	Belt drive 4-pole hysteresis synchronous motor
Speeds	33 1/3 & 45 RPM	33 1/3 & 45 RPM	33 1/3 & 45 RPM
Wow/Flutter	.03%	.08%	.08%
Variable Speed Adjustment	±4.0%	±2.5%	±1.3%
Finish	Black & Chrome	Gray Matte	Woodgrain Vinyl Overlay
Price	\$229.95	\$179.95	\$129.95

57



Lafayette

There is no competition.

For more information and a free catalog please write: Lafayette Radio Electronics, Box 171, 111 Jericho Tpke., Syosset, N.Y. 11791
 Copyright 1976 Lafayette Radio Electronics
 Check No. 23 on Reader Service Card

Equipment profiles

Onkyo Model TX-4500 Stereo Receiver

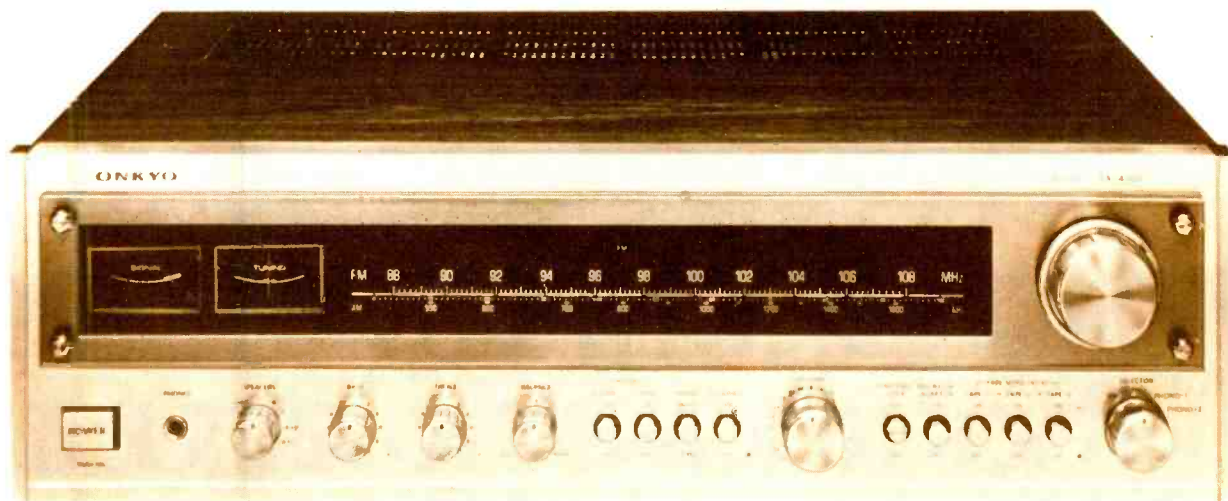

58

MANUFACTURER'S SPECIFICATIONS

FM Tuner Section

Usable Sensitivity: 1.8 μ V (10.3 dBf) mono; 5 μ V (19.2 dBf) stereo.

50-dB Quieting: 4 μ V (17.2 dBf) mono; 40 μ V (37.2 dBf) stereo.

S/N: 70 dB mono; 65 dB stereo.

Selectivity: 70 dB.

Capture Ratio: 1.5 dB.

AM Suppression: 50 dB.

THD, 1 kHz: 0.2% mono; 0.4% stereo.

Image Rejection: 70 dB.

I.F. Rejection: 100 dB.

Stereo Separation: 1 kHz, 40 dB; 30 dB from 100 Hz to 10 kHz.

Mute, Stereo & Quartz Lock Level:

4 μ V (17.2 dBf).

Frequency Response: 30 Hz to 15 kHz,

+0.5, -2.0 dB.

AM Tuner Section

Image Rejection: 40 dB.

I.F. Rejection: 40 dB.

S/N: 40 dB.

THD: 0.8%

Amplifier Section

Power Output: 55 watts per channel, 8

ohms; 65 Watts at 4 ohms, 20 Hz to 20

kHz, with no more than 0.1% THD.

IM Distortion: 0.3%.

Damping Factor: 50 at 8 ohms.

Frequency Response: High Level, 15-30,000 Hz \pm 1 dB.

Input Sensitivity: Phono 1 & 2, 2.5 mV;

Tape 1 & 2, 150 mV.

Phono Overload: 200 mV.

Tone Control Range: Bass, \pm 10 dB @

100 Hz; Treble, \pm 10 dB at 10 kHz.

S/N: Phono, 65 dB (IHF C network);

high level, 80 dB (IHF C network).

Filters: 100 Hz and 6 kHz, 6 dB/octave.

General Specifications

Dimensions: 21 3/16 (53.82 cm) W x

16 15/16 (43.02 cm) D x 6 7/16

(16.35 cm) H.

Weight: 36 1/2 lbs (16.6 kg).

Suggested Retail Price: \$449.95.

It has been quite some time since we last examined a piece of Onkyo high fidelity equipment, and our first reaction upon unpacking their new Model TX-4500 was that they have come a long way in the styling and appearance of their products. A protruding clear panel covers the upper dial area, adding to the massive overall look. Tuning and center-of-channel meters are located to the right of the linearly calibrated FM and conventional AM frequency scales, while above the scales are a series of four illuminated words to denote program source selection. Three additional lights denote stereo reception, "locked" station range (which will be explained shortly), and "tuned" condition. A large tuning knob at the right of the dial area is coupled to an effective flywheel arrangement.

Rotary controls along the bottom of the panel include speaker selector switch, 21-click-position bass and treble controls, balance control, 41-click-position volume control, and program selector. The program selector has positions

for two phono input pairs, AM, and FM, so that any other high-level program sources must be selected via the tape monitor switches. A rectangular push-button turns on power, while a series of nine smaller circular pushbuttons handle such functions as low- and high-cut filter selection, stereo - mono selection, loudness, FM muting, three tape monitor circuits, plus a fourth circuit interruption point for addition of a Dolby decoder. This fourth circuit, in addition to interposing a Dolby accessory connected at the appropriate rear panel jacks, also modifies the FM output signal from the tuner section from its standard 75 microsecond de-emphasis characteristic to the 25 microsecond de-emphasis required when listening to Dolby FM broadcasts. The usual headphone jack is located near the power on/off switch.

Antenna terminals on the rear panel, accept 300-ohm, 75-ohm, and external AM antenna connections, and a pivotable AM ferrite bar antenna and ground terminal are located in the same area. In addition to the two sets of phono

input jacks and the four sets of input and output jacks associated with the tape monitor (and adaptor) circuitry, there is an output jack for future connection to a 4-channel FM adaptor, plus preamp-out/main amp-in jacks interconnected by means of wire jumpers. A three position switch, which Onkyo identifies as a "sensor" control, determines the signal level at which the automatic tuning system operates and has positions labelled *Low*, *Normal*, and *High*. Speaker connection terminals are of the spring-loaded type which only require that the stripped ends of speaker cables be inserted in a small hole for proper connection. Up to three pairs of speakers can be connected, but no more than two pairs can be selected for simultaneous play by means of the front panel speaker-selector switch so that sufficiently high load impedances on the amplifiers are maintained. Two unswitched and one switched a.c. convenience outlets and a line fuseholder complete the rear panel layout.

The entire AM, FM, and multiplex circuitry of the Onkyo TX-4500 is contained on a massive single, circuit board. Additional circuit boards are used for the preamplifier and tone amplifier sections, and vertically mounted modules with self-contained heat-sink structures are used for the power amplifier circuits. A four-section tuning capacitor is used for FM tuning, while a minimal two-sections of tuning capacitance are used for the AM tuning circuits.

Unfortunately, Onkyo did not supply a schematic diagram with this receiver, so we can only guess at how the novel tuning circuit of the unit operates. The company calls this tuning system "Quartz Locked Tuning," and we did, indeed, locate a small crystal on the tuner board which is obviously a part of a fixed frequency oscillator used as a reference frequency. Since conventional front-end tuning is used, we suspect that the crystal oscillator must be used to compare the superheterodyned 10.7 MHz i.f. frequency derived from the mixer and i.f. stages with its own generated frequency. Once the set is manually tuned close enough to center of frequency, an error voltage must be developed based upon the difference between the quartz crystal oscillator frequency and the i.f. frequency (which is close to, but not equal to 10.7 MHz at that time). This voltage is then used as a sophisticated form of a.f.c. correction while "pulls" the local os-

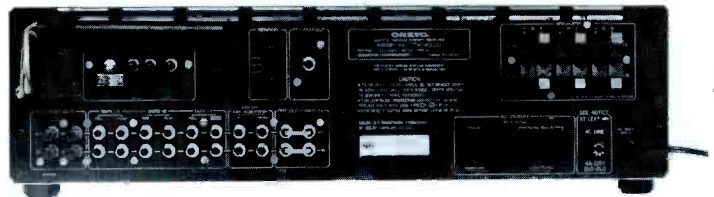
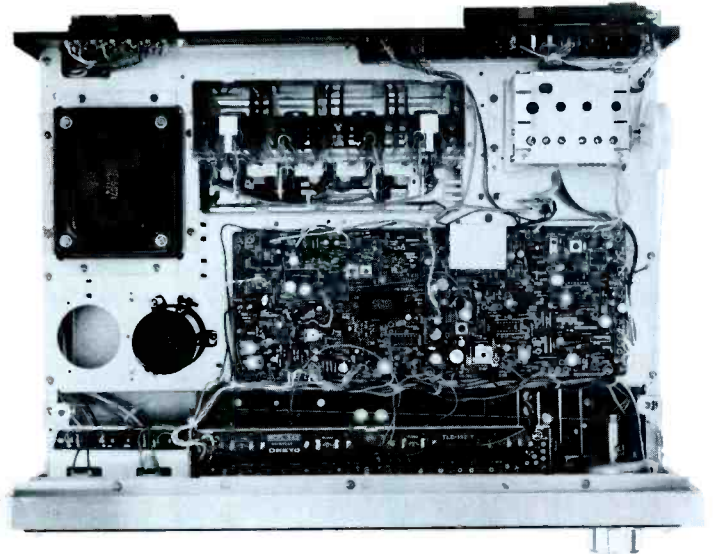
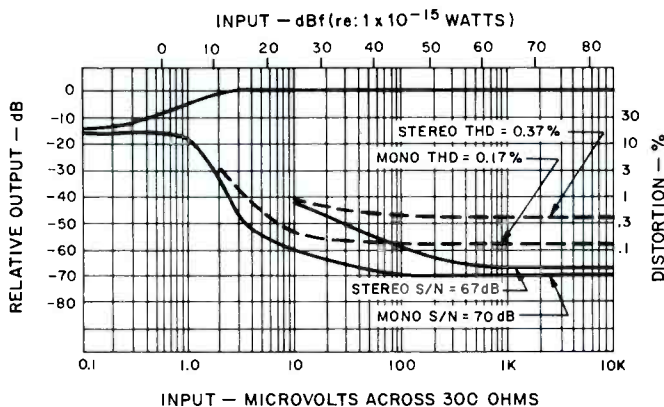

Fig. 1—FM quieting and distortion characteristics.



illator over to a frequency that does result in 10.7 MHz or perfect tuning. The entire action is defeated when one touches the tuning knob, permitting "unlocked" tuning until the "locked" light tells the user that locking range has been reached. Once the tuning knob is released, the above described corrective action takes place almost immediately.

As for the amplifier section, it is entirely direct coupled, though filtering of the positive and negative supplies is accomplished by a single rather smallish, dual-section electrolytic capacitor, having a pair of 10,000 μF sections for each side of the supply voltage. The power transformer seemed a bit on the small side for the power output claimed for this receiver too. It was apparent from inspecting the chassis layout that it was designed to be used with several of Onkyo's receiver models, since unfilled mounting holes were evident.

FM Tuner Section Measurements

Figure 1 is a graphic plot of several important FM measurements. Signal-to-noise ratio in mono exactly equalled the -70 dB claimed, while in stereo, S/N was a bit better than claimed, measuring -68 dB. Distortion in both mono and stereo were considerably lower than claimed, with 0.19% in mono and 0.2% in stereo for a 1-kHz test signal at 65 dBf input signal strength. Usable sensitivity measured 1.7 μV (9.8 dBf) in mono, 3.9 μV (17.0 dBf) in stereo. The 50-dB quieting point occurred with an input signal strength of 2.6 μV (13.5 dBf) for mono, 38 μV (36.8 dBf) for stereo. We were



A. The computer-designed True Tangent Tonearm keeps the stylus at a constant 90° tangent to the record groove, by means of an articulated head. The angle between the head (holding cartridge and stylus) and the shaft of the tonearm changes with each groove. Thus, while the tonearm swings in an arc over the record, the stylus is kept at a constant, true tangent. Tracking error is eliminated, with its consequent problems of record wear and harmonic distortion.

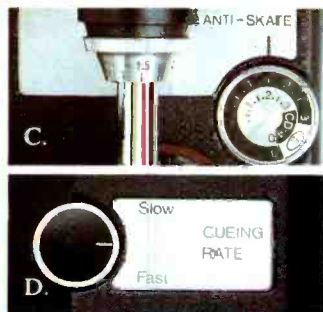

B. Made of modern, low-mass magnesium, the GT55's tonearm weighs an astonishing 14 grams. It rides on jewel vertical pivots and horizontal ballbearings. Inertial drag and friction are reduced to absolute minimum levels.

C. Anti-skating protection on the GT55 is provided by a unique, patented system. Completely non-mechanical, it operates magnetically, and varies in proportion to the actual skating force across the surface of the disc. It is calibrated for elliptical and CD4 styli.

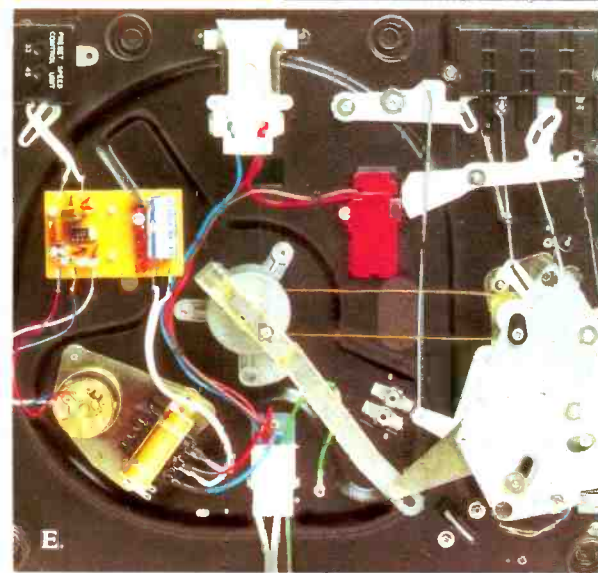

D. Cueing rate is variable, and the cueing operation is damped in both directions by the main cam of the turntable.

E. The GT55 is the only belt drive multiple play turntable with a DC servo motor. Both the motor and the belt-driven automatic mechanism are completely new. The speed of the motor is continuously governed and regulated by an electronic servo system. The automatic mechanism is smooth and silent in both single and multiple play. It is also completely disengaged from the tonearm when the record is playing.

F. Speed control is variable $\pm 3\%$, and is electronically governed by the servo which controls the motor. Read-out is monitored by an illuminated stroboscope.

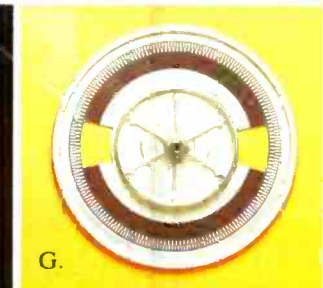

G. The platter is four pounds, die cast and dynamically balanced for smooth, precise rotation. It is driven by a flexible belt, which insulates it from any possible motor vibration.

H. The precision controls are conveniently grouped, and include selectors for single or multiple play, as well as a repeat-play option for use in either mode.

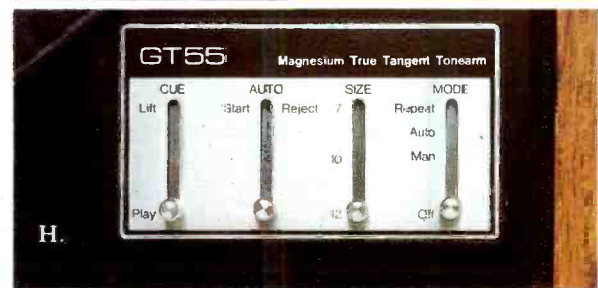

Garrard
Turntable specialist for 50 years.

Check No. 33 on Reader Service Card

Only three turntables in
the world offer

True Tangent Tracking.

Bang & Olufsen, Rabco,
and the new Garrard GT55.

They play your records
precisely the way the
original masters were cut,
with the stylus held at a
90° tangent to the groove.
They eliminate harmonic
distortion caused
by tracking error.

One of the three is
also fully automatic in
both single and multiple
play. Its tonearm is low-
mass magnesium, balanced
on jewel pivots.

Yet it sells for the lowest
price of all three —
as much as \$400 lower!

The new GT55.

By Garrard.

The GT55

Generation Two Turntable with True Tangent Tracking.

Since the first flat disc record was made, just about 90 years ago, audio engineers have been searching for a way to eliminate tracking error.

The master record is cut with a stylus that maintains a constant 90° tangent to the groove it is inscribing. Problem: play it back the same way. Anything else produces tracking error (maybe a little, maybe a fair amount), and that means distortion.

In 90 years of search, turntable manufacturers have proposed an array of solutions. Some have been inventive, even ingenious; others have verged on the ridiculous. None until quite recently have been successful.

Now there are three, all as different from any other turntable as the flat disc is from Edison's cylinder. Two of them solve the problem by a radical departure from traditional design: they move the entire tonearm across the record—pivot, counterweight and all.

Ingenious. Complex. And expensive.

Garrard found another way. Our half-century of turntable engineering culminated in a solution that retains the pivoted tonearm yet keeps the stylus in an absolutely true 90° tangent to the groove at every point from the record's outer rim right to the label.

Further, we did this with a computer-designed tonearm made of the ultimate in lightweight, rigid metals: magnesium. It has the lowest mass (14 grams)—and the lowest inertial drag—of any multiple-play turntable.

And it *is* automatic. Fully automatic. Silky-smooth, silently automatic, and therefore gentler and safer than the steadiest hand, whether you use it as a single play or a multiple play turntable.

Garrard's solution—the GT55—delivers other advantages, as well. Some small, some quite large, depending on what's important to you.

And one overriding advantage. The others sell for prices up to \$700. The GT55 is under \$250. Which makes True Tracking not a costly privilege but an available benefit. To everybody.



For your free copy of the new Garrard Guide, please write:
Garrard, Division of Plessey Consumer Products,
Dept. C, 100 Commercial Street, Plainview, N.Y. 11803



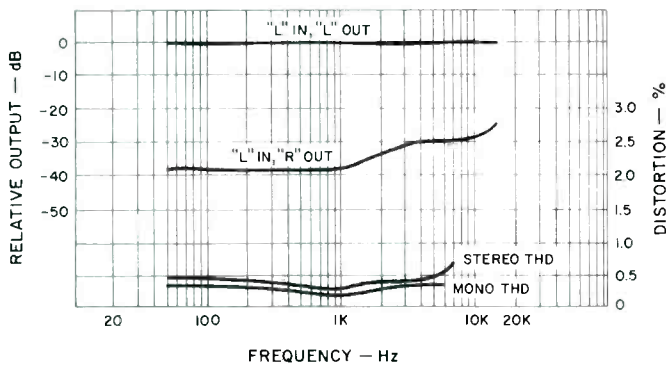

Fig. 2—Separation and distortion vs. frequency.

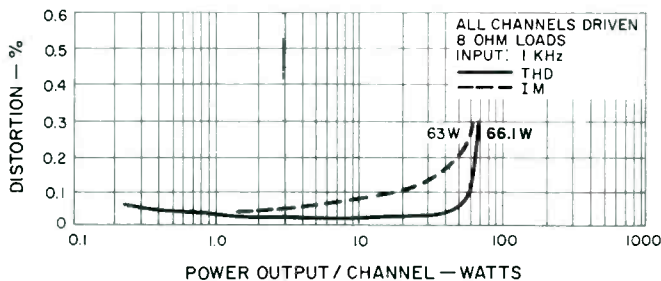

Fig. 3—Harmonic and intermodulation distortion characteristics.

64

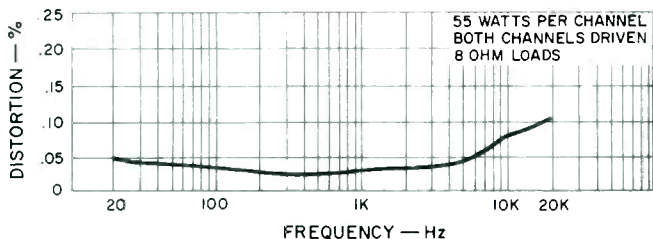
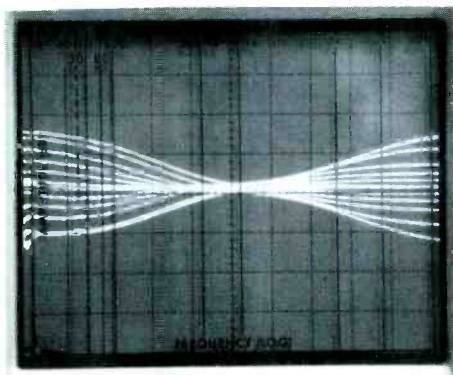

Fig. 4—Distortion vs. frequency at 55 W per channel with both channels driven with 8 ohm loads.

Fig. 5—Tone control range with alternate click-stop settings shown for clarity (even finer fixed gradations are possible).



quite pleased to note that as we tuned for minimum distortion (with our hand on the tuning knob to prevent the "lock" feature from working), releasing our fingers resulted in absolutely no change in the minimum distortion reading and center-of-channel tuning meter indication corresponded perfectly. Evidently the "Quartz Lock" tuning developed by Onkyo really works well. To confirm this, we rechecked the action at several points on the FM dial and results were just as good.

Alternate channel selectivity measured 73 dB, while capture ratio measured exactly 1.5 dB as claimed. Image rejection was a bit short of claims, with 68 dB measured, while i.f. rejection was better than 100 dB (the limit of our measurement capability). AM suppression was 51 dB, while spurious response rejection (for which Onkyo makes no claims) was a bit over 80 dB. Only the 75 microsecond de-emphasis is built into the receiver's FM section, so that the Dolby push-button on the front panel should not be misinterpreted as applying to Dolby FM reception. Both an adaptor and a change in de-emphasis would be required with this receiver to properly receive Dolby FM broadcasts.

Separation, though falling short of the claimed 40 dB at mid frequencies, did remain high (30 dB or better) all the way from 50 Hz to 10 kHz, as shown in the graphs of Fig. 2. Distortion at the 6 kHz extreme point of required measurement was also uniformly low in both mono and stereo. As many readers surely realize, proper tuning is important in maintaining good separation in FM stereo, and the novel locked-tuning feature of the Onkyo TX-4500 is definitely beneficial in this regard.

Muting threshold measured 7.0 μ V (22.1 dBf), while switching to stereo occurred with an input signal strength of 4.0 μ V (17.2 dBf), as claimed. Frequency response was off by only 1 dB at 15 kHz, and sub-carrier product rejection measured 63 dB.

As for the AM section, we measured a signal input of 40 μ V for usable sensitivity (external antenna connection), and a S/N of 42 dB with strong signal inputs. Image rejection was 38 dB, while i.f. rejection was 40 dB as claimed. THD at 30% modulation was 1.2%, a bit higher than the 0.8% claimed. Response of the AM section was down 3 dB at 3 kHz, typical of this minimal type of circuit so often found in even some of the best receivers in the high fidelity category.

Amplifier Measurements

Onkyo elected to quote power output ratings at both 4 and 8 ohms for this receiver. At 4 ohms, a claim of 65 watts per channel is made. In fact, at mid frequencies we were able to pump out nearly 80 watts before reaching the 0.1% rated THD using 4 ohm loads. The unit could not operate for the required one hour preconditioning time at one-third this power level without triggering its protective circuits however. While such triggering of protective circuits is allowed by the new interpretation of the FTC rule, we did not make further measurements under the 4-ohm load condition. Driving 8 ohms, the amplifier delivered 64 watts of power per channel at 0.1% THD. Rated IM (0.3%) was observed at an equivalent output of 55 watts per channel. Distortion was well below these levels for all lower power output measurements, as shown in the plots of Fig. 3. As can be seen in Fig. 4, the limiting factor as far as power rating and distortion of this receiver occurs at the high frequency end, rather than at 20 Hz, and at 20 kHz, distortion was exactly 0.1% for rated 55 watts of output per channel. Power band extended from 18 Hz to 20 kHz. Frequency response using the tape inputs was flat within 1 dB from 12 Hz to 50 kHz, and input sensitivity was 150 mV as claimed. Phono input sensitivity was exactly 2.5 mV, and a signal of 220 mV was applied to the phono inputs before any evidence of first-stage

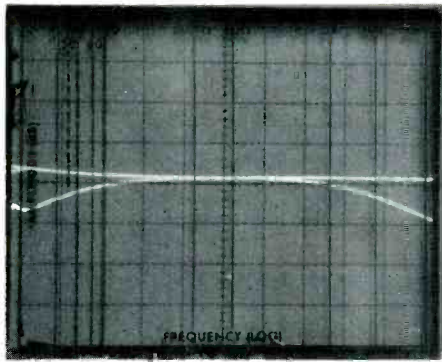

Fig. 6—Low-cut and high-cut filter response.

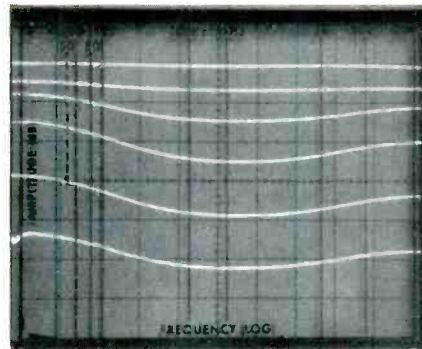

Fig. 7—Loudness compensation characteristics.

overload was noted. RIAA equalization was accurate within 1.2 dB. Unweighted hum in phono was -70 dB, while for the high level inputs it measured 91 dB; at minimum volume, a reading of -95 dB below rated output was obtained.

Tone control range was plotted by means of our spectrum analyzer/storage scope combination, and results are pictured in the scope photo of Fig. 5. High- and low-filter response, plotted in Fig. 6, is of the 6-dB-per-octave type. Loudness control action is plotted in the sequential frequency sweeps at progressively lower and lower volume control settings in Fig. 7, and Onkyo has chosen to boost both bass and treble frequencies in the loudness circuits of the TX-4500. The click-stop detents on the bass and treble control are a quite worthwhile refinement since they do permit exact repeatability of settings, as claimed.

Use and Listening Tests

Controls on the Onkyo TX-4500 have a good feel to them and are well positioned for easy familiarity and use. Clearly,

the outstanding feature of this receiver is the tuning-lock system which was as effective under actual listening conditions as it was on the test bench. We judged the power output capability of this receiver to be just about enough for reasonably loud listening with medium efficiency speakers. The abundance of tape monitoring facilities will appeal to the serious recordist who owns both an open-reel machine and a cassette deck. Even with two decks connected, there is room for additional accessories such as a noise-reduction system or even a graphic equalizer. The thermal-protection circuits, plus relay protection, offer as much of a safeguard to the equipment as anyone is ever likely to need in normal use of the receiver. Competitively speaking, the Onkyo TX-4500 offers rather good value for its price, and if some of the less important FM specifications are not quite up to state-of-the-art performance, that fact is not likely to intrude upon the pleasurable listening which can be done in most receiving areas with this unit.

Leonard Feldman

Check No. 80 on Reader Service Card

65

JVC Model CD-1970 Cassette Deck

MANUFACTURER'S SPECIFICATIONS

Frequency Response: 30 to 16,000 Hz ± 3 dB with CrO₂, 40-1500 Hz ± 3 dB with normal tape.

S/N: 52 dB, 57 dB (at 1 kHz) with ANRS.

Wow and Flutter: 0.09 per cent W rms.

THD: 1.2 per cent.

Bias: 95 kHz.

Motor: D.c. servo.

Dimensions: 16 1/2 in. (41.9 cm) W x 6 1/4 in. (15.9 cm) H x 11 in. (27.9 cm) D.

Weight: 18.7 lb. (8.16 kg).

Price: \$399.95.



The JVC CD-1970 is a good example of present day cassette recorder design, with front-loading, noise reduction, and other facilities, including provision for a timer. The array of controls, in addition to the polished handle and metal case, give it a very professional appearance, and it is obviously intended to form part of a component system.

The cassette compartment is on the right just above the seven tape transport controls, which are comprised of six lever switches and a push-button for eject. On the extreme left is the power *On/Off* switch, followed by three dual-concentric controls for mike and line level inputs, plus a playback level control. Next comes a memory switch, digital

counter, and a tape run indicator. The two VU meters are mounted in a black recessed panel, together with the ANRS noise reduction switch and a two-position meter switch. On the left of the two meters are two lever switches for tape bias and equalization, one of which is marked CrO₂ and the other normal, which means either Low Noise or High Efficiency tapes.

Standard jacks for either headphones or microphones are located just under the input controls. The rear panel con-

tains the input and output sockets, a DIN socket, and an unswitched a.c. outlet.

One of the features of the Model 1970 is the timer facility, and it works like this. The controls are set to the record mode and the pause button is depressed. Then the recording levels are set, using the desired program source, such as a tuner. Next, both the deck and tuner power plugs are connected to a timer (many electronic parts stores carry these which plug directly into a wall socket). When the timer switches on, the deck automatically starts recording—that's all there is to it.

The heads are made of Sen-alloy, which is claimed to have the low distortion characteristics of permalloy, along with the high wear resistance characteristics of ferrite. The motor is the popular d.c. servo type. The instruction manual, written in three languages, is unusually detailed and accompanied by many photographs and diagrams.

Measurements

The first measurement was made using a standard playback test tape, and the results are shown in Fig. 1. Next, record/replay measurements were taken with a C-60 Maxell UD tape at two levels as illustrated in Fig. 2. It will be seen that the overall response is within 2 dB from 30 Hz to 16 kHz, with the 3 dB point at 16.5 kHz. FujiChrome CrO₂ tape is recommended for use with this machine, and so a Fuji cassette was checked out for Fig. 3. The high frequency response was extended up to 17.5 kHz (-3 dB) with a slight reduction in headroom.

Distortion at 1 kHz can be seen in Fig. 4, with the Maxell tape being marginally superior. The differences are emphasized at the lower frequencies as can be readily seen in Fig. 5. The VU meters can be switched to read either peak or average (marked VU) values, and their response is attenuated below 100 Hz. In other words, a constant amplitude 1-kHz signal reading 0 VU would read less at low frequencies, and the graph at the top of Fig. 5 shows how much less for both meter functions. In practice, it means that care must be taken to avoid overloading when recording organ, electronic music, or any signal with a significant low frequency content—especially when using CrO₂ tapes.

At this stage in the tests, a number of other tapes were tried, and excellent results were obtained with the Fuji FXT-60, TDK-SA, Scotch Classic and Master, BASF-Pro, and Sony Low-Noise. Three CrO₂ tapes were also tested, TDK KROM, Advent, and BASF, and all had results almost identical with the FujiChrome, the latter having a dB or so lower noise.

It should be mentioned here that the playback time constants used on the Model 1970 are 3180 μ S and 120 μ S for the normal Low-Noise tapes, and 3180 μ S and 70 μ S for the CrO₂ tapes.

The frequency measurements were repeated with the ANRS noise reduction circuit on and the change was insignificant—less than 0.5 dB. The signal-to-noise ratio was 54 dB without ANRS and 59 dB, A weighting, with the Maxell tape. With the CrO₂ tape, the figures were 55 dB and 60 dB. Input required for 0 VU was 78 mV in the line, and the output was then 290 mV for Low-Noise tapes and 320 mV for the CrO₂. The signal required for 0 VU at the microphone input was 200 μ V, and the noise increase with the level control turned to maximum was 10 dB. In practice, however, the input control would be turned down considerably, so the noise increase would be normally on the order of about 5 dB.

As the machine had been working for several hours, it seemed like a good time to test for wow and flutter, and the DIN figure was a very good 0.07 per cent. Tape speed was

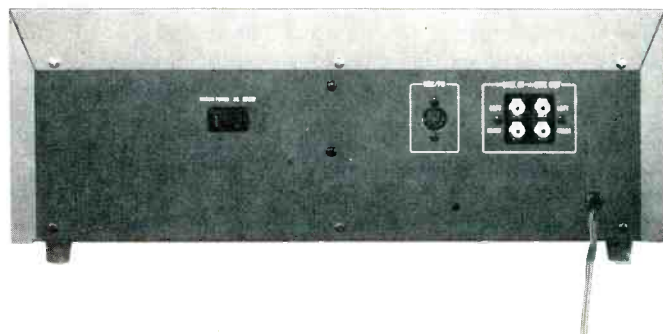
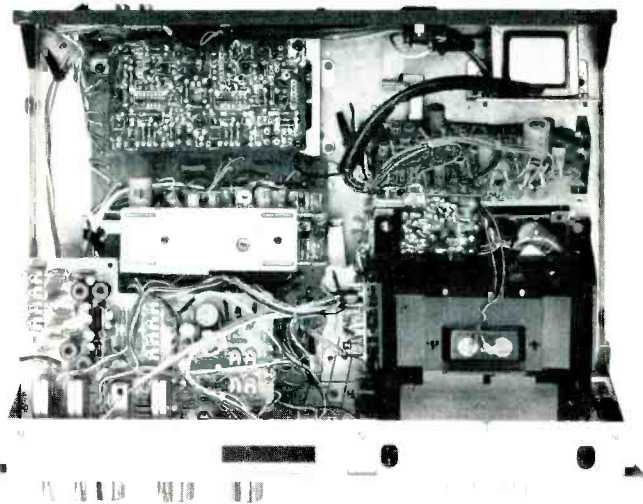

Fig. 1—Playback response with a standard (40 Hz to 10 kHz) test tape.

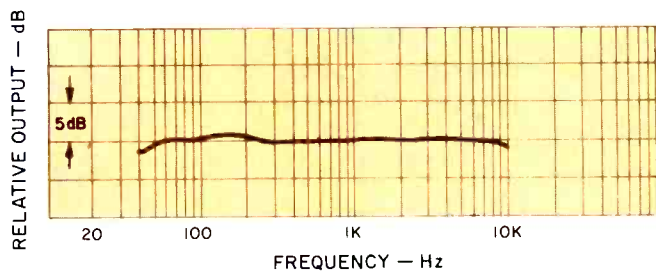
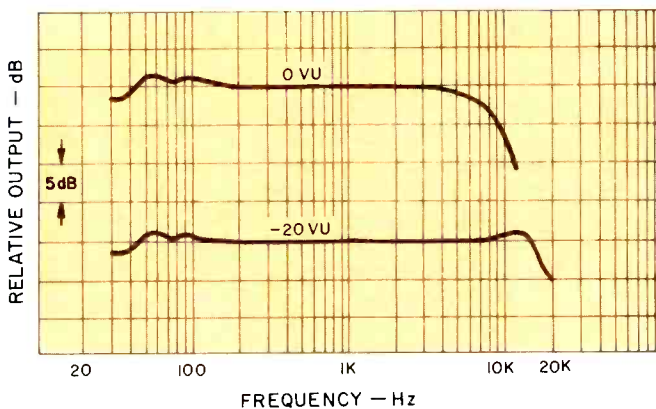

Fig. 2—Record/replay response with Maxell UD tape.



The first direct-drive full range electrostatic speaker system... the Acoustat X

The promise and the quest

It has long been believed that if an electrostatic speaker could be made to reproduce the full audio spectrum at high power levels, with its inherent advantages of lightning fast transient response, vanishingly low levels of harmonic and IM distortion, high definition, no time delay distortion, and its distinctive transparency of sound, this would be indeed, "the ultimate transducer." This elusive goal has been pursued by speaker design engineers for many years, and they have been thwarted in their quest by problems which were insoluble by the application of conventional speaker design technology.

The problems

There have been, and are now on the market, a number of so-called "full-range" electrostatic speakers. They have suffered in common from what has been charitably described as "inadequate bass response," which translates into, "they have no bottom end." Some of these units take an abrupt "nosedive" as high as 65 Hz. Others, even when used in staggeringly expensive multiple arrays, roll-off rapidly below 50 Hz. Another failing of these speakers is their requirement for amplifiers with enormously high power outputs, and even with these expensive brutes, the sound pressure levels obtained are inadequate to the demands of program material of wide dynamic range. Most of these amplifier shortcomings are caused by the great capacitive load, often as much as 800-1000 picofarads, presented by the electrostatic screens. This necessitates using 100 to 1 step-up transformers to obtain the high voltage to drive the electrostatic diaphragms. For most amplifiers, which normally handle resistive loads in conventional dynamic speakers, this huge mis-match taxes the stability of these units and often leads to destructive failure of the electrostatic panel elements. In addition, the use of high voltage step-up transformers introduces hysteresis and "ringing" effects, and non-linearities due to poor control and damping of the signal. Although using the electrostatic principle, some of these speakers nonetheless are divided into woofer, mid-range and tweeter sections, necessitating the use of crossover networks with their inherent problems of phase shift and time delay distortion.

The realization... the Acoustat X direct drive full range electrostatic speaker system.

The full potential of the electrostatic speaker principle is finally brought to fruition in the Acoustat X. Acoustat research revealed that the electrostatic screen/ amplifier interface problem could be solved by designing a special "servo-charge" amplifier, which would be compatible with the 800 picofarad capacitive load of the Acoustat electrostatic panels. This unique amplifier employs solid-state low voltage input circuitry, with an output section using special long-life tubes in a four quadrant "push-pull" configuration which drives the electrostatic panels directly from the high voltage tube elements. Thus better than 3000 volts are available to drive the transducer grids without the use of intermediate step-up transformers. In addition, a servo negative feedback loop, deriving its information from the point the panels are energized, corrects any anomalies and provides optimum control and waveform purity. There is also an "instant-on" relay circuit which eliminates power umbilicals from a pre-amp source. The amplifier is concealed in the base of the speaker.

Acoustat manufactures its own electrostatic panels, which are immune from climatic effects and completely free of arcing. They cannot be damaged by over-driving. Although three panels are used in the Acoustat X, electrically they are one. Considering the dipole radiation, there are over 17 square feet of diaphragm in each Acoustat X, and when each speaker is driven with its own 100 watt servo-charge amplifier, sound pressure levels of 110 dB at one meter on axis are produced. (105 dB for two speakers at 20 feet).

Thus in the Acoustat X is the ultimate expression of the electrostatic speaker, with **no** woofers, **no** mid-range, **no** tweeters, **no** crossover networks, **no** step-up transformers ... with frequency response plus or minus 3 dB from 30 to 20,000 Hz and harmonic distortion less than 1% at 3 dB below full output, from 30-20,000 Hz. Since the Acoustat X speakers have their own integral amplifiers, all one need do is add a high quality pre-amplifier, sit back, and enjoy a new dimension of realism in the reproduction of music. The Acoustat X is 28 inches wide, 48 inches high, 19 inches deep at base, and 7 $\frac{3}{8}$ inches deep at the top.

Acoustat Corporation

4020 N. 29th Ave. / Hollywood, Fla. 33021

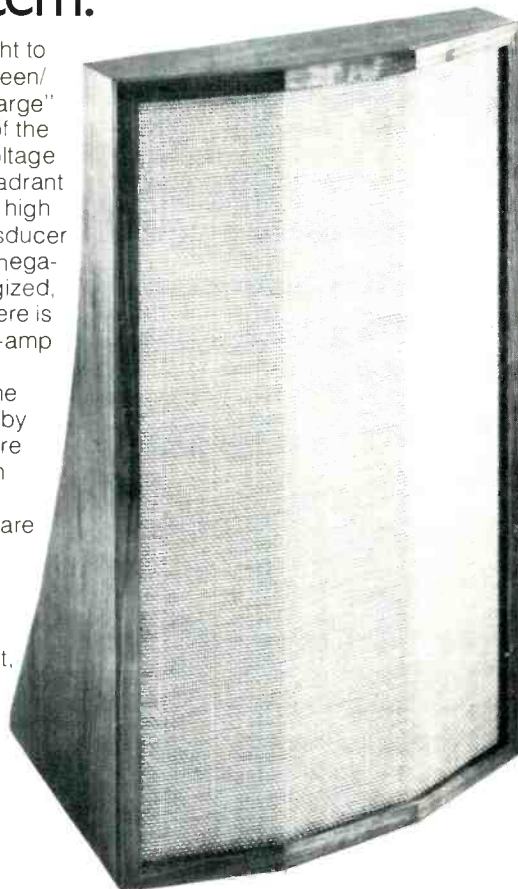

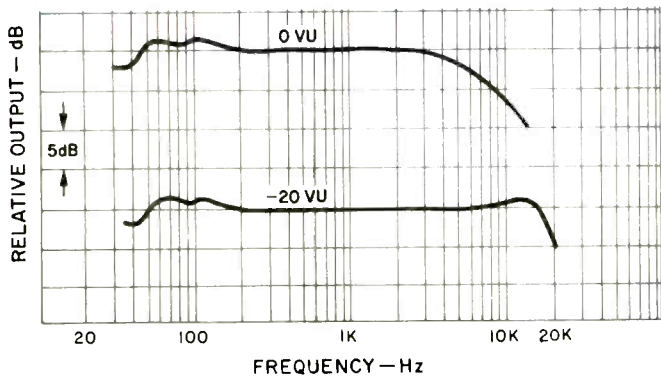

Fig. 3—Record/replay response with FujiChrome CrO₂ tape.

Fig. 4—Distortion at 1 kHz.

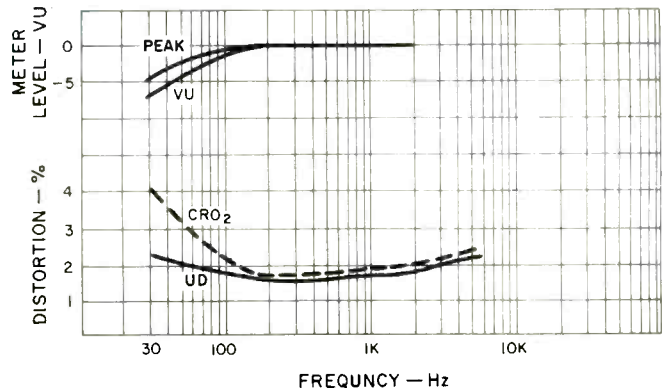
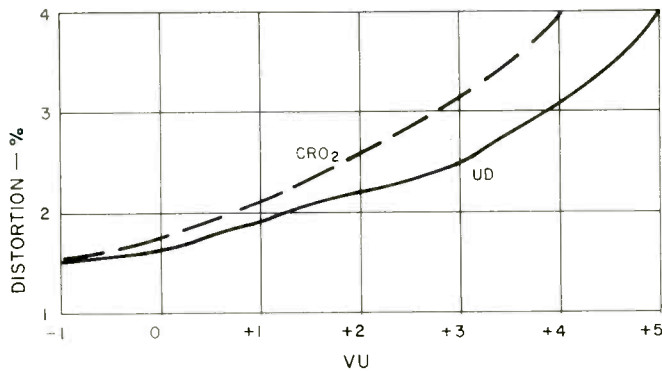

Fig. 5—Distortion vs. frequency at 0 VU. The upper curves show meter response with switch set to peak and VU positions.

68 found to be 0.4 per cent fast, and cassette rewind time for the C-60 tape was 83 seconds.

Use and Listening Tests

The CD-1970 proved to be a very easy machine to use, and I'm sure the absolute beginner will be able to make first-class tapes with a little practice. The instruction manual rec-

ommends that the VU meter switch be set for peak reading when recording music with a high transient content, as this will give a more accurate indication of sound levels.

The manual also suggests the use of the ANRS noise reduction system when playing Dolby tapes. Both operate from 500 Hz up, with their parameters constantly changing according to frequency and amplitude of the signal. And I must say that several of the Dolby encoded tapes I tried sounded remarkably good when played via ANRS.

The microphone and line inputs are independent and, as mentioned earlier, both controls are the dual-concentric type with separate controls for each channel, so several mixing arrangements are possible.

The deck is mechanically quiet and the tape transport controls worked smoothly, without fuss—and this includes the eject button. When the eject button is depressed, the cassette does not spring out like an unguided missile—it just lays there while the door opens slowly. The reason for this is the mechanism is air-damped, and the idea is patented.

George W. Tillett

Check No. 81 on Reader Service Card

Kenwood Model KA-3500 Integrated Stereo Amplifier

MANUFACTURER'S SPECIFICATIONS

Power Output: 40 watts continuous power per channel, 8 ohm loads, from 20 Hz to 20 kHz.

THD: 0.2 per cent at all power levels from 0.25 watts to rated output.

IM Distortion: 0.2 per cent at rated output.

Damping Factor: 50.

Input Sensitivity: Phono, 2.5 mV; Aux and tuner, 200 mV.

S/N: Phono, 76 dB referred to 5 mV input; High Level Inputs, 90 dB.

Bass & Treble Control Range: ±8 dB @ 100 Hz and 10 kHz.

High Filter Cut: -6 dB @ 10 kHz.



Dimensions: 14 1/2 in. (36.8 cm) W x 5 1/2 in. (14 cm) H x 10-3/8 in. (26.35 cm) D.

Weight: 16 1/2 lb. (7.48 kg).

Price: \$159.95.

So much emphasis has been placed, of late, on those super-performance, super-powered integrated and basic amplifiers (with their 0.002 per cent distortion figures and almost-infinite slewing rates) that we tend to overlook what, to many, are products which offer a great value for their

price and, in fact, represent greater value in today's hi-fi marketplace than anything that was available in their categories just a few short years ago. Such a product is Kenwood's little integrated amplifier, Model KA-3500. If you crave 100 watts plus per channel, ne-plus-ultra measured

specs, and bandwidth from d.c. to channel 5, read no further and save your pennies. But if an honest 40 watts per channel with reasonably low distortion, intelligent layout, and good indications of reliable long-term performance are what you are after and you have less than \$200.00 to spend on your preamp/amp components, read on.

The most prominent control on the front panel of the KA-3500 is a giant master volume control. It is a conventional potentiometer, of course, but one which is mechanically coupled to no less than 40 "click-stop" positions for easy re-setability (augmented by evenly spaced calibration marks from 0 to 10). At the upper left is a rotary speaker selector switch, with *Off*, *A*, *B* and *A+B* positions, along with *Bass* and *Treble* controls, each screened with + and - dB calibration marks and fitted with 11 click-stop detent positions. Three interlocked push-buttons at the upper right select *Phono*, *Tuner* or *Aux* program sources, while just below them are a pair of three-position toggle switches which take care of either of two tape monitor circuits, plus A-to-B and B-to-A tape deck dubbing. Controls at the lower left include a toggle power *On/Off* switch, a balance control (with an easily defined center position) and yet another three-position toggle switch with positions for *loudness* compensation, *Off* or *High Filter*. This combined arrangement precludes the possibility of selecting both loudness circuits and high-cut filtering at the same time.

The rear panel of the KA-3500 is equipped with the usual phono-tip input jacks for all program sources, tape record output jacks for two tape decks, plus a DIN socket for one of the two tape out/in circuits. Two sets of speaker terminals are of the thumb screw type, with polarizing notations screened nearby. Two switched and one unswitched a.c. receptacles are located as far away from the input circuits as possible, while a chassis ground terminal is positioned just below the phono input jacks.

Internal Construction and Layout

While Kenwood does not supply a schematic diagram with this amplifier, they do indicate in their literature that the power amplifier section is a direct-coupled, pure complementary circuit with an FET differential first-stage amplifier. In addition to time-delayed turn on, the amplifier is equipped with protection circuitry which Kenwood calls ASO (for Area of Safe Operation) and which the company uses in its more expensive, more powerful amplifiers and receivers.

Circuitry is essentially distributed between three p.c. modules, with the largest containing the power amplifier section. A U-shaped heat sink structure runs almost the full width of the chassis and is coupled directly to the output devices which are plugged right into the main circuit board. Preamp-equalizer parts are on the small p.c. board up front, while tone and voltage amplifier circuitry is mounted on a

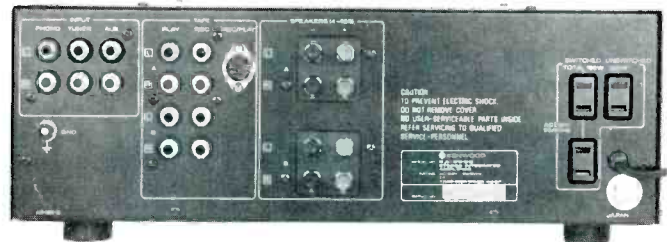
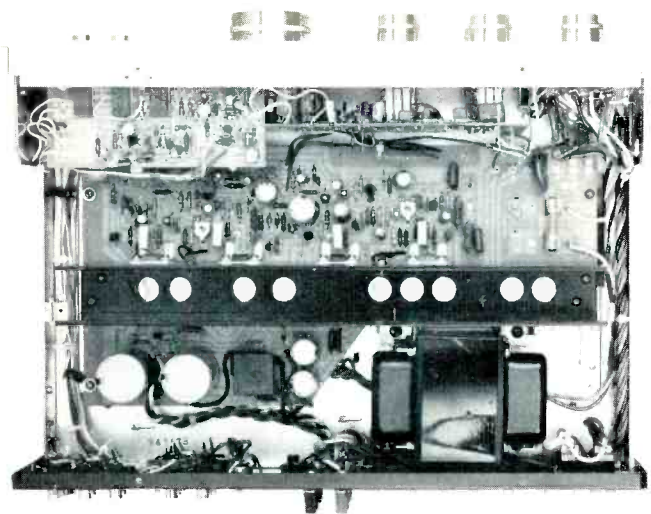

third, vertically oriented module also up front. Power supply parts, mounted on the main amplifier board, include a pair of 6800 μ F filter capacitors for the required positive and negative voltage supplies of the direct-coupled output circuitry. Judging by size alone, the power transformer, well isolated from input circuits, seemed adequate for the power rating of the unit and, during the course of our tests, remained cool enough to be touched.

Laboratory Measurements

At mid frequencies, the KA-3500 delivered 45.3 watts per channel before reaching its rated THD level of 0.2 per cent. At 40 watts per channel output into 8 ohms, THD measured a low 0.043 per cent THD and 0.075 per cent IM. Distortion versus power output into 8-ohm loads is plotted in Fig. 1 and, at all power levels below rated output, THD and IM were well below 0.1 per cent. The slight rise in the THD curve of Fig. 1 was occasioned more by the influence of wideband noise than by actual harmonic distortion com-

Fig. 1—Harmonic and Intermodulation distortion characteristics.

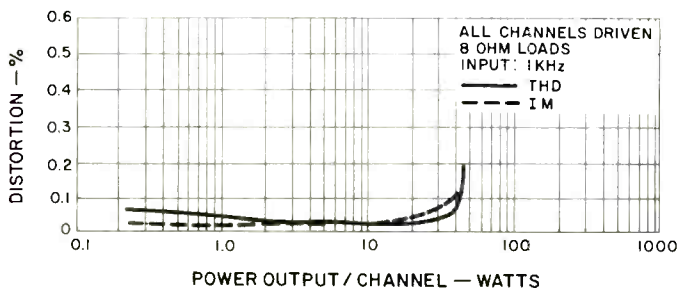
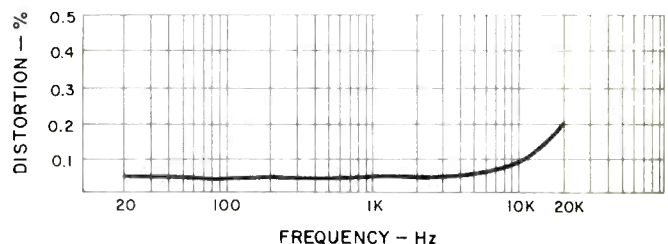

Fig. 2—Distortion vs. frequency in the Kenwood KA-3500 amp.



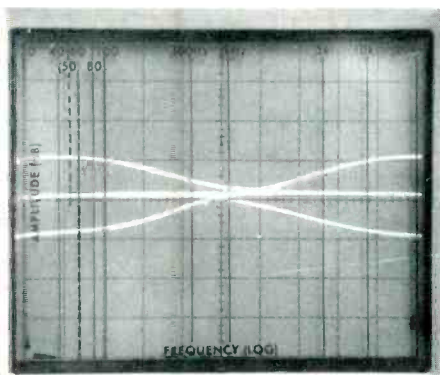

Fig. 3—Bass and treble control range.

Fig. 4—High-cut filter action (upper trace) compared with response in the full treble-cut position.

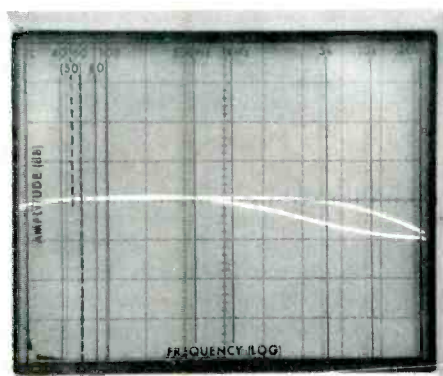
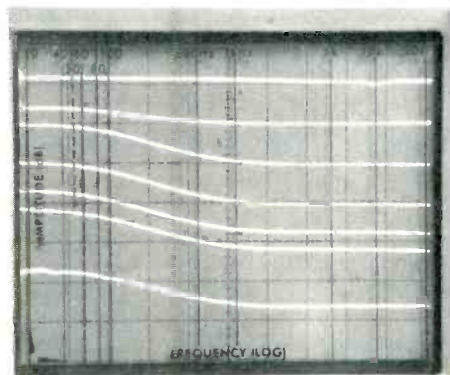

Fig. 5—Loudness control compensation at the various volume control settings.



ponents, good evidence that the amplifier has no cross-over or notch distortion at such low listening levels.

Were it not for high frequency power limitations, this amplifier might well have been rated at a few more watts than the 40 specified, but, as shown in the graph of Fig. 2, the unit barely delivered its rated 40 watts per channel with a test frequency of 20 kHz, and distortion climbed rapidly beyond that power level or at higher test frequencies. We measured a damping factor of 40, short of the 50 claimed by Kenwood, but certainly high enough for all practical purposes. Residual hum and noise (with the volume control at minimum) measured 92 dB below rated output, unweighted.

Frequency response measured via the Aux or tuner inputs extended from 19 Hz to 54 kHz for the -1 dB rolloff points, from 11 Hz to 65 kHz for a -3 dB dropoff. Tone control range of bass and treble controls was "graphed" using a spectrum analyzer, and the resulting scope photo is reproduced in Fig. 3. Note that Kenwood wisely "shelved" the boost characteristics of both the treble and bass controls, so that they do not increase extreme low- or high-frequency response by more than about 9 dB, even beyond the limits of the audio spectrum. Figure 4 shows the attenuation characteristic of the high-cut filter as compared with the attenuation of the treble control when the latter is set to its maximum cut position. Notice that despite the fact that the high-cut filter has a slope of only 6 dB per octave, it would be more effective in moderately reducing high-frequency scratch and noise than would the tone control, because its turnover or cut-off point is set at a higher frequency. The action of the loudness circuitry is graphed in the scope photo of Fig. 5 and involves bass boost only at progressively lower volume control settings, with no treble emphasis employed.

Phono input sensitivity measured 2.8 mV for full output and, with a signal input frequency of 1 kHz, there was no evidence of overload distortion until the amplitude of the input signal reached a high 225 millivolts. RIAA equalization was accurate to within 1 dB, with that deviation occurring at the extreme 30-Hz test frequency. At all frequencies above 50 Hz, RIAA accuracy was better than 0.5 dB. Measured S/N in phono (unweighted) was -67 dB referred to rated input sensitivity (2.5 mV). Kenwood quotes the phono S/N referred to 5.0 mV, but translated to that reference input level, we would still come up with a reading of -73 dB compared to the -76 dB claimed. Our measured figure is certainly not a poor one, but simply falls short of their claims by 3 dB.

Use and Listening Tests

We found that the KA-3500s rather simple front panel control arrangement offered as much flexibility and adjustment capability as most hi-fi listeners might require. Control action was smooth and repeatable, rivaling that of many more costly integrated amplifiers. Kenwood was wise in sacrificing power bandwidth at the high end of the spectrum, if they had to sacrifice anything, for they have retained good tight bass all the way down to below audible frequencies, and that honest power reserve at the low end makes the amplifier suitable for use with a variety of medium-to-high efficiency speakers, some of which might be expected to require more nominal power to produce clean, loud levels. As we mentioned at the outset, all of us tend to overlook some of the inexpensive products that still abound in this rapidly expanding industry. It is nice to occasionally come back down to earth and take a good hard look at a low-priced integrated amplifier that can be counted on to form the control and amplifying center for a very respectable, yet low-cost high fidelity component system. *Leonard Feldman*

Check No. 82 on Reader Service Card

BSR Model FEW-3 Graphic Equalizer



MANUFACTURER'S SPECIFICATIONS

Number of Channels: 2.

Number of Bands per Channel: 12.

Bandwidth per Band: 1 octave.

Adjustment Range per Band: ± 12 dB.

Maximum Output Voltage: 10 V rms.

THD: 0.05 per cent.

S/N: 80 dB.

Rated Output: 2.0 V rms.

Dimensions: 17 $\frac{3}{4}$ in. (45 cm) W x 7 in. (17.8 cm) D x 5 $\frac{1}{4}$ in. (13.3 cm) H.

Weight: 10 lb. (4.54 kg).

Available Accessories: SLM-1 Sound Level Meter and test record.

Price: \$199.95.

Readers of *Audio Magazine* need no lengthy explanation regarding the usefulness of a graphic equalizer. The use of these separate add-on boxes (first popularized by Altec with their professional acousta-voicing filters, and later reduced to consumer product level with the introduction of their still available Acousta-Voicette) in home hi-fi systems is increasing at a fairly rapid rate. Most readers will agree that, used in moderation, a graphic equalizer, which simply alters overall frequency response of a sound system to compensate for response variations in equipment or room acoustics, can be a worthwhile addition to any good system *providing* that the equalizer itself introduces no new distortion of its own.

One may, of course, argue about the number of separate frequency bands or segments required to do a good, smooth job of equalizing, but this, too, depends upon the degree to which you want to "trim" overall response and the amount of money you have available for this type of accessory product. There are equalizers which have as few as five bands and some (like the Altec unit) which divide the audio spectrum into 24 third-octave segments. The BSR Model FEW-3 falls mid-way between those two extremes. It has divided the audio range into 12 bands, some of which are a bit more than one-half octave apart, others spanning nearly a full octave. Center frequencies listed are 30, 50, 90, 160, 300, 500, and 900 Hz, and 1.6, 3.0, 5.0, 9.0, and 16.0 kHz. Pairs of vertically movable slide controls are neatly arranged across most of the plastic molded front panel, recessed behind a hinged transparent plastic door which can be shut after equalization has been accomplished to prevent in-

quisitive fingers from arbitrarily upsetting the carefully chosen settings of each of the 24 controls (12 per channel). Also contained in the recessed area of the panel are a pair of meter sensitivity controls which can be varied to insure mid-band (0 dB) readings of the twin meters at the right of the panel, regardless of the actual input level fed into the FEW-3. The twin meter movements are calibrated from -12 dB to $+12$ dB, the approximate adjustment range of each of the equalizer's separate-band controls and a power on/off light is positioned between these two meter pointers. The power on/off switch of the unit is located below the meter area, while directly above it are four push-to-make/push-to-release buttons. One of these buttons activates the meter circuits (which users may not want fluctuating at all times), another bypasses signals around the equalization circuitry for instant A-B comparisons of sound with and without EQ applied, the third activates a tape monitor circuit (the presumption being that the user will have used up the normal tape monitor circuit on the amplifier or receiver with which the equalizer is used), while the final button, identified as *Eq-Rec* permits the user to record a pre-equalized signal onto tape. This last feature is quite useful, particularly since the tape-out jacks of most preamps and receivers usually come ahead of any tone control circuits, thus preventing tonal coloring of signals to be recorded onto tape.

The rear panel of the BSR FEW-3 also features a fully recessed area which contains input, output, tape-out and tape-in (monitor) jacks mounted so that audio cables drape downward from the underside of the cabinet top. The shallow mounting space required for the FEW-3 is therefore not increased by any projecting pin plugs behind the unit.

No schematic diagram was supplied with the FEW-3, but a view of the inside of the unit shows that construction is on two major p.c. boards mounted at right angles to each other. One of the boards contains all the slide controls, meter adjustment pots, and push-button switches, while the second board contains the active-filter circuit components. ICs are used extensively in the circuitry, which requires no mas-

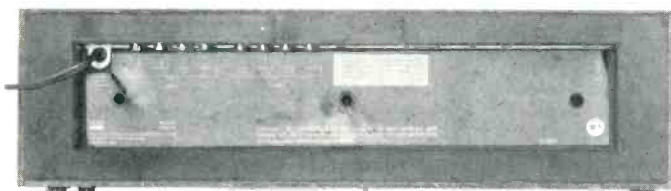

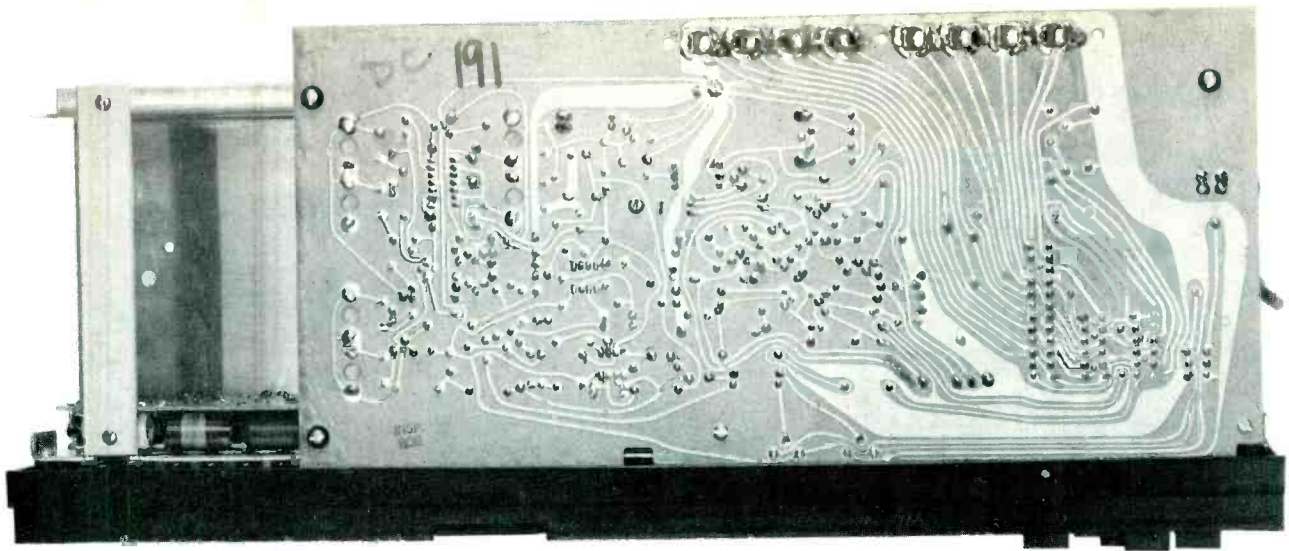

sive inductances thanks to the use of active solid-state filter circuitry. Extensive metal shielding is used to prevent extraneous hum pickup in the main circuit board, and the small power transformer is mounted as far away from critical low-level input stages as possible.

Tests and Measurements

The first test one would wish to perform with any graphic equalizer is to determine how accurately the center points of each band are set and whether the "plus and minus" range claimed is accurately maintained for each of those bands. With 24 separate knobs available, individual hand or point-by-point frequency response plotting of the entire system could take many hours, if not days. Thanks to our Tektronix 5L4N low-frequency spectrum analyzer, this odious job is reduced to a matter of a few minutes. Successive sweeps (from 20 Hz to 20 kHz) are made with each "band slide" first adjusted for maximum boost, then for maximum cut. That slider is then returned to its mid or flat position, and the procedure is repeated until all 12 "boost" and "cut" response curves have been traced and stored on the face of the analyzer's storage scope face. Results are pictured in the final composite photo of Fig. 1. Vertical sensitivity was adjusted so that one division on the scope face equals exactly 10 dB and, as can be seen, overall amplitude from any given "peak" to its corresponding "dip" is almost precisely 24 dB (the ± 12 dB adjustment range claimed by the manufacturer). Center frequencies of each band corresponded closely to the frequencies enumerated earlier (sweep is logarithmic in frequency from left to right, with key frequencies labelled on the scope face at the top). Before the avalanche of letters comes pouring into the editorial offices of *Audio* pointing out the fact that there are only 11 sets of band curves in Fig. 1 instead of 12, let me hasten to explain that when we attempted to reproduce the 30 Hz band action, much of the resulting curve fell "off-screen" because of the slight frequency inaccuracy of the analyzer at its extreme low end. Plotting response of the 30-Hz band (in its extreme positions) the "hard way" confirmed that it behaves pretty much like the other 11 displayed.

With so many separate filter circuits all lined up in "series," we were curious to see just how "flat" response of the system would be if all the levers or slides were carefully set *mechanically* to their "zero" points on the front panel. To accentuate any deviation from flat response, we changed the sensitivity of the analyzer so that in the sweep response photo of Fig. 2, each vertical division corresponds to a change of only 2 dB. Aside from the very slight roll-off ob-

served at 20 Hz (less than 1 dB), response was flat to within 0.25 dB all the way up to 20 kHz.

With the analyzer still set for this more sensitive vertical indication, we wanted to see how complex (if arbitrary) a response curve we could "tailor" with the FEW-3. Results, pictured in Fig. 3, show a response curve that, while admittedly a bit unusual, could never have been achieved using conventional treble and bass (or even treble, bass, and mid-range) controls which graphic equalizers are intended to replace. While the curve seems a bit odd, remember that vertical sensitivity is only 2 dB per box, so that actually we applied no more than 4 dB of boost or cut at any frequency over the entire audio range—a not unlikely requirement in many electronic/acoustic sound reproducing situations.

Other Measurements

As we said earlier, graphic equalizers are fine if they don't introduce new distortion components of their own. With all controls set flat, and with 3 volt input and output, THD measured 0.022 per cent at 1 kHz, 0.023 per cent at 100 Hz and 0.019 per cent at 10 kHz. With 1 volt input and appropriate slide controls boosted to provide 12 dB of gain at 100 Hz, 1 kHz, and 10 kHz, distortion increased to 0.6 per cent, 0.2 per cent, and 0.14 per cent respectively. Considering the fact that the equalizer will ordinarily be connected at that tape monitor circuit (where voltage levels are usually well under 0.5 volts), harmonic distortion contributed by the FEW-3 is obviously not going to be a problem.

As for the meters, we found that an input of 50 millivolts was required (with meter sensitivity controls set fully clockwise) to obtain a "0 dB" reading. With higher input levels, meter pots are simply turned down to position the meter pointers for average readings of 0 dB.

With a signal input of 1 volt and all controls set flat, signal-to-noise ratio measured 78 dB.

Using The FEW-3

We found the FEW-3 easy to use and install, but felt that a couple minor points of human engineering might have made it even more convenient to use. It is quite difficult to set each slider for exact "0" and a mechanical detent or "stop" would have been a very useful addition. Some slide potentiometers have such a mechanical "click stop" notch in their center positions of travel. Finally, we feel that the "pairing" of left and right controls for each frequency band was not an ideal physical arrangement. More often than not, one wants equalization of the left channel to be different from equalization of the right channel, but the sets of band

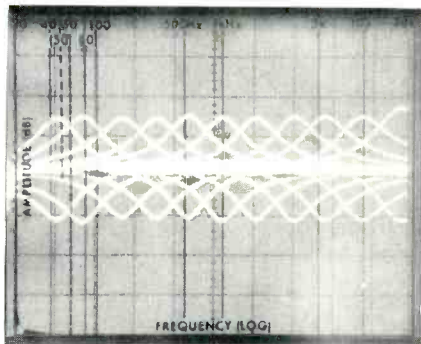

Fig. 1—Boost and cut range for each band of the BSR FEW-3 Equalizer.

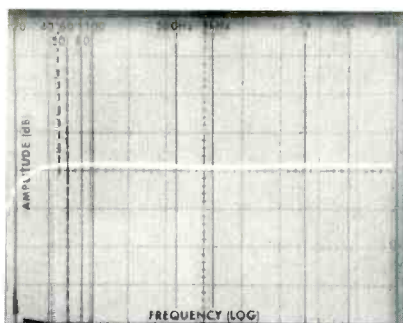

Fig. 2—With equalizer controls set to Flat position, response is within 0.25 dB of uniform to 20 kHz.

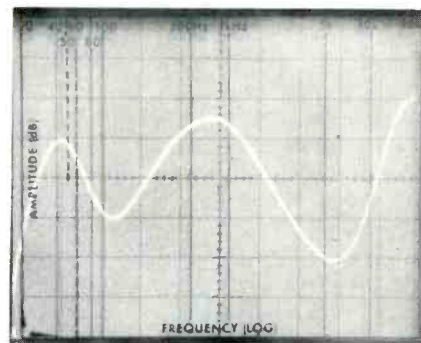

Fig. 3—Complex response curve achieved with the FEW-3 Equalizer; each vertical division on scope equals 2 dB.

controls are arranged so that they can easily be moved together (with one fingertip), but they are not so easy to move separately. Other manufacturers of equalizers of this type have generally mounted the slide controls as two separate banks—one for each channel—instead of side by side as in the case of the FEW-3.

Perhaps we are being a bit overly critical of these physical layout considerations because in testing the unit we did an inordinate amount of fiddling with each of the 24 controls. A typical user is much more likely to set up the controls once, for best results, and leave them there (hence the plastic cover door). Under those circumstances, the difficulty in handling the closely spaced left and right controls becomes minor.

With most of the slide controls adjusted to the "plus" side, overall gain of the FEW-3 becomes greater than unity, making it difficult to perform the desirable A-B test which the EQ Bypass switch encourages (one has to manually compensate for overall level change by means of the amplifier's volume control), a problem which some more expensive equalizers overcome by providing overall gain controls in the equalizer circuitry. In terms of its very reasonable price, however, the FEW-3 offers more frequency bands than similarly priced competitive units and certainly introduces no audible distortion or noise of its own. What more could one ask of a frequency response tailoring device that is so neatly crafted and does its intended task so well? Leonard Feldman

Check No. 83 on Reader Service Card

Technics Model RS-630US Stereo Cassette Deck

MANUFACTURER'S SPECIFICATIONS

Frequency Response: 30 Hz to 14 kHz, 30 Hz to 16 kHz with CrO₂ tape.

S/N Ratio: 50 dB, 63 dB with Dolby and CrO₂ tape.

Input Sensitivity: Mike, 0.25 mV; Line, 60 mV @ 47 kOhms.

Output Level: Line, 420 mV; Headphone, 60 mV @ 8 ohms.

Wow and Flutter: 0.09 per cent weighted rms.

Fast Forward & Rewind Time: 90 seconds with C-60 tape.

Dimensions: 17 1/8 in. (43.5 cm) W x 5 5/8 in. (14.29 cm) H x 12 5/8 in. (32.1 cm) D.

Weight: 17.5 lb. (7.9 kg).

Price: \$249.95.



The Technics RS-630US front-loading cassette deck presents an attractive appearance and provides good performance. The compartment for the cassette is one of the better designs, as the cassette can be observed directly from the front, or from above by means of two chrome-strip mirrors. Illumination is well placed for either checking tape motion or maintenance tasks. The dust-cover door slides along the front of the unit, with the bottom lip of the compartment serving as both the lower track for the door and a stop for the ejected cassette. The tape-motion controls, im-

mediately below the compartment, have limited interlocking, permitting going from Play to other modes including Record. There are both visual and tactile clues to proper operation with colored pads on Eject and Record, and with greater widths for both Play and Stop..

To the right of the cassette compartment are the function switches and the time counter with its reset button. Selection can be made of Dolby in-out, CrO₂ or normal tape, mike or line input, and meter mode, either normal VU or peak check. The large, well-illuminated level meters domi-

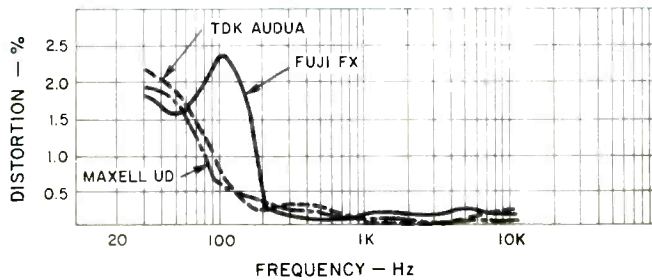

Fig. 1—Distortion vs. frequency at -10 VU showing the Fuji FX, Maxell UD, and TDK Audua tapes.

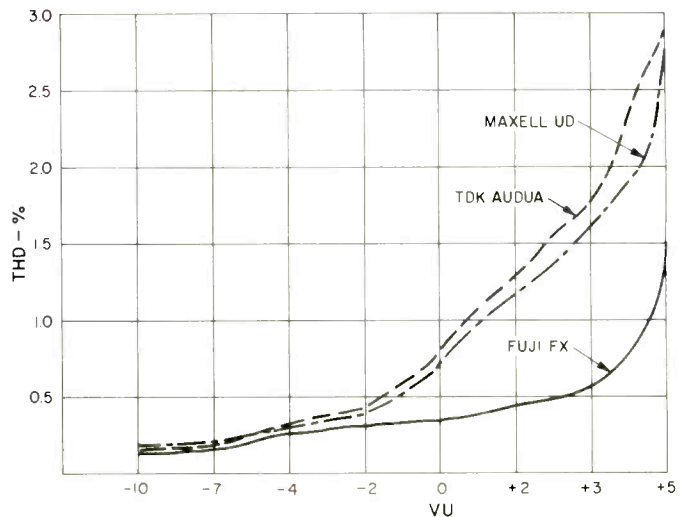

Fig. 2—THD vs. recording level with three tapes.

nate the right side of the front panel. These meters provide a most useful feature in being capable of working as either regular VU-type or peak-reading meters. The peak scale on top is offset 3 dB relative to the normal scale, but the actual difference in the reading is dependent on the dynamic character of the source. The record indicator is between and below the two meters.

Input and output levels are controlled by dual-section pots which are friction clutched to permit channel level adjustments individually or simultaneously as desired, a worthwhile feature. To the left are the phono jacks for stereo headphones and microphone inputs. To the right is the power On-Off switch. The clear-plastic compartment cover and the front panel elements are so proportioned that the door covers the meters, but not any of the switches, when pushed to the right. A minor point perhaps, but it is good human engineering, aiding in the practical operation of the unit. The attractive appearance of the front panel is continued with the wood end pieces and the simulated wood top cover.

Input and output line connections are made with phono jacks on the back of the unit. Removal of the metal bottom

cover revealed that one large circuit board contained the great majority of the circuitry. Soldering on the board was very good, and there were limited external connections, mostly to the tape-drive control and the various function switches. Adjustments are accessible from the bottom of the board, but are not identified.

Performance

Playback responses for both equalizations were within 3 dB, with the exception of the lowest frequency. The DIN standard 0 VU level produced +4 dB meter responses. A pink-noise source and a 1/3-octave real-time analyzer were used to check the record/playback responses for 20 different tape formulations. The best tapes in this regard were then used for these and all following tests. Fuji FX had generally flat responses at -20 dB (relative to meter zero) from 40 Hz to 15.1 kHz, with a +2 dB rise from 1.2 to 11 kHz and a 14.1 kHz limit when in Dolby. Headroom was 6.8 kHz, 6.2 kHz with Dolby. TDK Audua and Maxell UD had wider frequency response, but also a greater rise in the higher frequencies. The 3-dB down low-frequency limits measured were not as low as the specified 30 Hz, but response curves

Fig. 3—Record-replay response with the Fuji tape with Dolby and without Dolby.

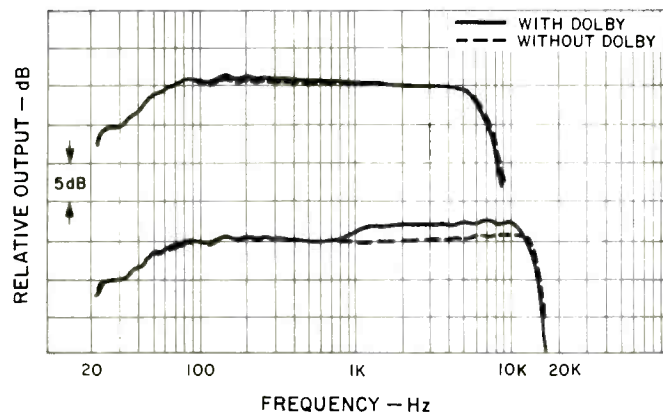
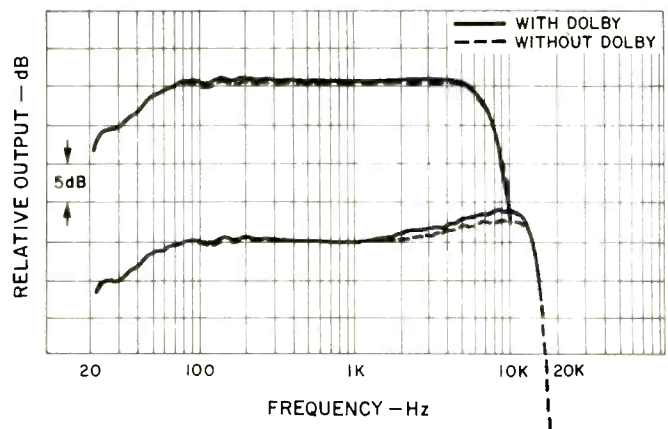

Fig. 4—Record-replay response with the Maxell UD tape with Dolby and without Dolby.



presented by Panasonic showed that they used a 5-dB down reference, a confusing practice. The best of the chrome-type tapes was actually the TDK SA, with a 15.0 kHz limit, 13.0 kHz with Dolby, both at -20 dB. The response of the two channels was substantially the same under all conditions.

Measurements were made of harmonic distortion with a 1 kHz test signal when recorded over a range from -10 to +10 dB. Attention was directed at the levels of the third harmonic normally predominant, but examination was made of the spectrum-analyzer display for other components. Distortion levels were low with Fuji FX tape with just 0.28 per cent at 0 dB. The three per cent point was more than 7 dB above meter zero. With TDK SA, the distortion was generally higher than the Fuji tape, with 1.3 per cent third harmonic at 0 dB. Distortion was measured in similar fashion with test frequencies from 30 Hz to 10 kHz with record levels of zero and -10 dB. No readings were possible at 10 kHz and 0 dB, and just 2nd harmonic was in evidence with the 7 kHz test frequency. Distortion was noticeably less at the lower record level.

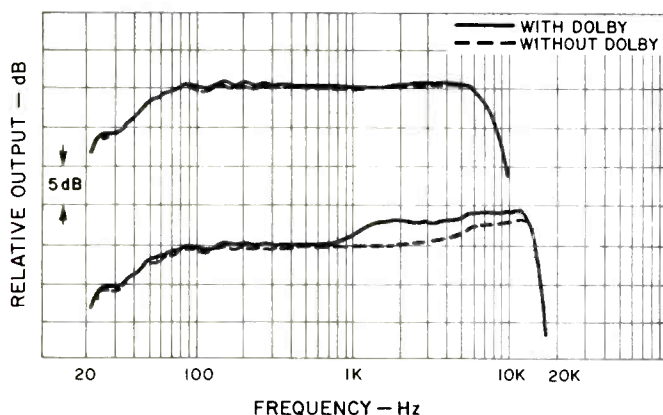

Fig. 5—Record-replay response with the TDK Audua tape with Dolby and without Dolby.

The A weighted signal-to-noise ratio was an average of 51.7 dBA for the three low-noise tapes with a meter zero reference, and 60.6 dBA with Dolby. With a three per cent distortion reference, the average ratios were 57.3 dBA, and 66.9 dBA with Dolby. The TDK SA had ratios of 59.5 dBA and 68.6 dBA, with Dolby, both referenced to the three per cent distortion level. Separation between tracks was 39 dB, which is quite good. Crosstalk between adjacent tracks of opposite play direction and erase were both more than 80 dB down, an excellent performance. Input sensitivities were 0.27 mV for mike, substantially as specified, and 60 mV for line, exactly as specified. The Technics 630 does not have a switchable multiplex filter, but a response notch at 19 kHz provides 36 dB rejection. The line output with a 0 dB record level was 420 mV, exactly as specified. The playback level, however, was dependent on the tape used, but the output was easily set with the control. The level at the headphone jack across 8 ohms was 69 mV, above that specified. The large, legible meters of this unit provide the desirable and

useful feature of selectable meter response. In regular VU mode, the response to the standard 300 mS burst was well within limits. In the Peak Check mode, response to the 300 mS burst was to +2 dB on the peak scale. Response to a 10 mS burst was to 0 dB and to -3 dB for a 1 mS burst. Although the decay was judged to be somewhat fast, the deck does provide true peak-reading meters. Scale markings were accurate, and tracking in conjunction with the record level pot was excellent.

The lowest measured flutter was 0.07 per cent DIN weighted peak, with an average of 0.18 per cent, roughly approximate to the manufacturer's specified 0.09 per cent weighted rms. The deck was one per cent fast at the standard test 120 V a.c., 0.6 per cent fast at 100 V and 1.3 per cent fast at 130 V. Rewind time was 88 seconds, within the specified 90 seconds.

In-Use Tests

Insertion and removal of cassettes was easily accomplished, and ejection gave the cassette a gentle slide to the front retaining lip. The dust cover door was easily positioned over the compartment or the meters as preferred. Cleaning and demagnetization was better than many front-loading machines. Examination of the faces of the head required a dental mirror, and head alignment did not appear possible from the outside. Interlocking of the tape motion controls is limited, as mentioned before. Being able to go from Play directly to Record was helpful in using the deck for some re-copying, but unwanted mistakes could occur. Auto-stop worked on Play/Record, but not on the fast winds, a minor limitation for most. The mike or line input is selected by switch, without the usual change from plugging in a mike. The accompanying brochure makes the valid point that separate circuits can obtain improved signal-to-noise ratios. The drive to the headphones was determined by the record/playback level. The output pot had no control of headphone drive as would be desired in some cases.

Listening tests utilized **The Sound of Musical Instruments** from the Acoustic Research demonstration record series. Levels were easily adjusted with the dual-section record pot. Good friction coupling allowed adjusting either channel when desired and then using the control as the master gain for both channels. The readability of the meters was excellent, and the normal VU and peak-check modes were both used to advantage. The display facilitated setting levels well up-scale with checks on the peaks to prevent noticeable distortion. This particular capability would be immediately instructive to the user on the dynamic character of various types of music. With the low-noise tapes, the sound on playback was very good, with the cello sounding slightly bright and some presence added to the voice. Some deficiencies in the playback of the TDK SA tape were loss of some of the transient sound of the guitar and constriction in the sound of the flute. With the low distortion and the good signal-to-noise ratio of the deck, the dynamic range of the music was preserved and the listening experience was most satisfactory.

My own judgment gave the deck a much higher price than \$249.95, particularly with some of its advantages such as the meters. Within that framework, though, the absence of the automatic shut-off at the end of the fast wind, and other limitations seemed odd. But in summation, this reviewer found the modest price somewhat of a pleasant surprise considering the features and the overall performance.

Howard A. Roberson

Check No. 84 on Reader Service Card

Harman/Kardon Citation 16 Basic Amplifier

MANUFACTURER'S SPECIFICATIONS

Power Output: 150 watts minimum rms per channel, both channels driven into 8 ohms from 20 Hz to 20 kHz, with less than 0.05 per cent THD.

Power Bandwidth: From 5 Hz to 110 kHz at less than 0.1 per cent THD into 8 ohms, both channels driven simultaneously at 75 watts per channel.

One-Watt Frequency Response: 0.5 Hz to 120 kHz with less than 0.2 per cent THD.

Square Wave Rise Time: Better than $3 \mu\text{s}$.

Phase Shift: Less than 0.5 degrees at 20 Hz; less than 12 degrees at 20 kHz.

Slew Rate: Greater than 30 V per μs .

Total Harmonic Distortion: Less than 0.05 per cent from 1 watt to 150 watts rms, both channels driven simultaneously into 8 ohms from 0.5 Hz to 20 kHz.

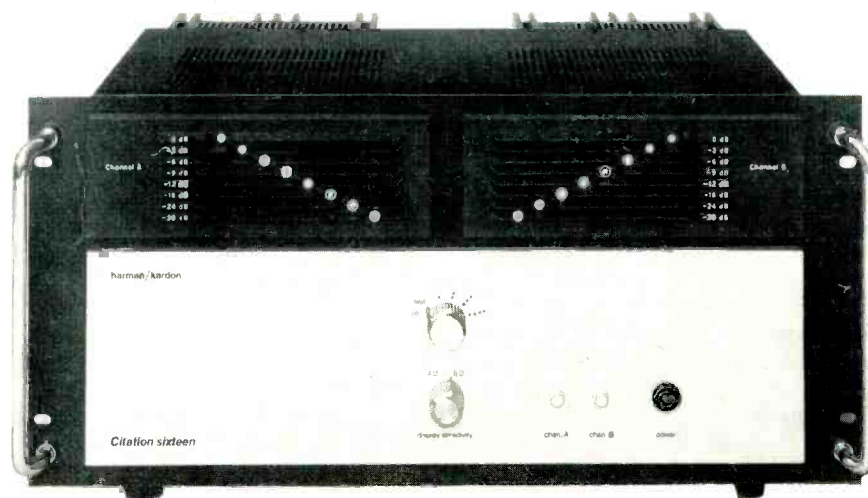

IM: Less than 0.05 per cent from 0.015 watts to 150 watts.

Hum and Noise: Better than 100 dB below 150 watts.

Damping Factor: Greater than 300 to 1.

Input Impedance: 10k ohms.

Input Sensitivity: 1.25 V for 150 watts.

Dimensions: 9 1/4 in. (23.5 cm) H by 19 in. (48.3 cm) by 14 in. (35.6 cm) D.

Weight: 55 lbs. (24.9 kg).

Price: \$795.00.

76

Harman/Kardon's Citation 16 is a basic, 150 watt per channel power amplifier with an appearance rather different from most other power amplifiers in that it has a logarithmic-based LED output amplitude display, instead of the usual analog meters. This amplifier has large wire handles for ease of handling, and it can be rack mounted.

Construction is in the form of a basic chassis with a front and back panel attached. Fore and aft side-angle pieces connect the front and back panels to the chassis and lend mechanical rigidity to the structure. A cover enclosing top and side ties the tops of the front and rear panels to the chassis, resulting in a package with excellent mechanical integrity. Mounted on the main chassis are two power transformers, four 10,000 μF /85V filter capacitors, and two primary voltage selector plug arrangements. Underneath the main chassis are the main power rectifiers and the rectifier and filter capacitors for the LED circuits.

On the outside of the rear panel are two large heat sinks, two signal input (RCA jack) connectors, two sets of five-watt binding post output connectors, two primary a.c. line fuses, and the a.c. line cord. On the inside of the rear panel and behind the heat sinks are the two main amplifier circuit boards. Mounted between the circuit boards are the output buffer inductors. Front panel features consist of the two LED

output level displays, two knobs for controlling display sensitivity, two power-on indicators, and the primary power switch.

Circuit Description

Referring to the schematic diagrams in Figs. 1 and 2, the input stage of the Citation 16 is half of a $\mu\text{a}739$ op-amp operated with a supply voltage of ± 10 V. Next is a complementary pair of transistors, Q_1 and Q_2 , operated in common-emitter mode, with their bases tied together and driven from the output of the op-amp. Current in these transistors is set by their emitter resistors and is about 1 mA. The outputs of Q_1 and Q_2 are direct coupled to Q_5 and Q_6 which form a complementary predriver for the output stage. Quiescent current in this stage is about 9 mA. The advantage of a fully complementary predriver is that it can drive the output in a symmetrical manner, providing equal drive ability in either the plus or minus direction. Connected between the collectors of Q_5 and Q_6 is the bias network with the bias regulator transistor, Q_{16} , mounted on the output stage heat sink.

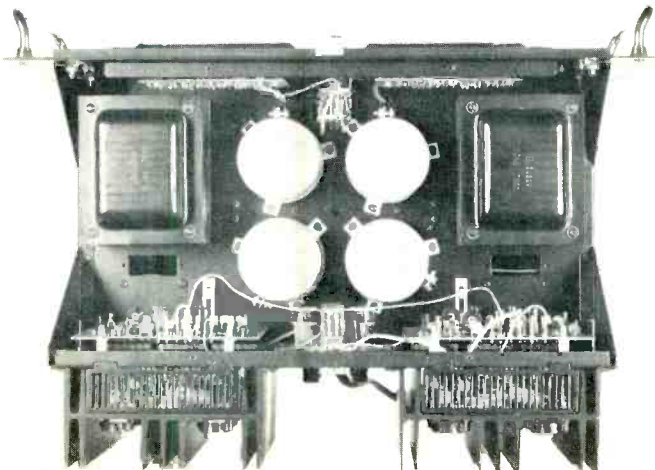

AUDIO • DECEMBER, 1976

Output stage configuration of the Citation 16 is a quasi-complementary one and of a form used by a number of other manufacturers. The usual operation of such a stage is to have the output devices completely cut off under idling conditions and for the drivers to be conducting some 30 to 100 mA. In this particular design, each output device is conducting about 20 mA at idle, resulting in an output stage total quiescent current of about 80 mA. This mode of operation has the potential advantage of eliminating two discontinuities per half cycle when cutoff output devices would come into and out of conduction.

Volt-amp limiting is of the usual form that shunts away base drive to the output stage when dissipation is considered to be excessive.

In the LED display circuit, the output signal of the amplifier is first passed through a voltage divider that produces a reference full-scale voltage for amplifier output powers of 4, 16, 64, and 160 watts average equivalent for a sine wave. A resistor at the top of this divider is shorted or not shorted for these power levels for 4 or 8 ohms. The input to the LED circuit picks up one of the four outputs of this divider, +12 V for full scale test or an open circuit to disable the display. This input is split off to two peak detectors that respond to positive-going waveforms only. The first of these, a simple emitter-follower, with a storage capacitor in the emitter circuit, is involved with the indicators from 0 dB down to -12 dB. The second has an op-amp with a closed-loop gain of +9.5 preceding a diode peak detector and is used to drive the indicator circuits for -30 to -18 dB.

LED drive is through transistor switches that have graded voltage dividers to their bases from the outputs of the peak detectors. As the input signal to the LED display circuit increases from some low value, the amplified and peak-detected output across C_2 becomes sufficient to provide enough base current to turn on Q_9 , the driver for the -30 dB indicator. As the input signal continues to increase, Q_9 stays on and soon Q_8 turns on. Further increases in input signal will turn on Q_7 , and finally the input level will be suf-

Table I—Output noise and signal-to-noise ratio vs. measurement bandwidth.

Bandwidth	Left Ch.	Right Ch.
20 Hz to 20 kHz	100 μ V	290 μ V
S/N	110.8 dB	101.5 dB
400 Hz to 20 kHz	77 μ V	170 μ V
S/N	113.1 dB	106.2 dB

ficient for the output of Q_1 to turn on Q_6 , the -12 dB indicator driver. Further increases in input level finally cause all the indicators to come on. The only objection to this circuit, and a relatively minor one, is that music is rather asymmetrical much of the time, and it is possible for higher peak output voltages to occur in the minus direction, in which case the readings on the Citation 16 indicators would be lower than their true values. (Editor's Note: One item not mentioned above is that the Citation 16 has turn-on, turn-off relays to prevent thumps when a.c. power is being switched.)

The Citation 16 has a separate power supply for each channel. Main power amp supply voltage is ± 60 V. A separate rectifier and filter system provides unregulated ± 12 V for the LED indicator circuitry.

Listening Tests

Listening tests on the Citation 16 were done with Dahlquist DQ-10s and Magnepans, both on loan from the manufacturer, Stax SRX MK3 electrostatic phones, and a pair of Tannoy Gold 12s in a friend's system. Pickups used were an EMT XSD-15 and a Fidelity Research FR-1 MK2. Preamps used included a Dyna PAS-3 with one of the reviewer's FET pre-preamps for the FR-1 MK2 and several of the reviewer's new solid-state designs, along with a GAS Thaedra.

The general consensus of the reviewer and a number of other highly critical listeners was that the Citation 16 had ex-

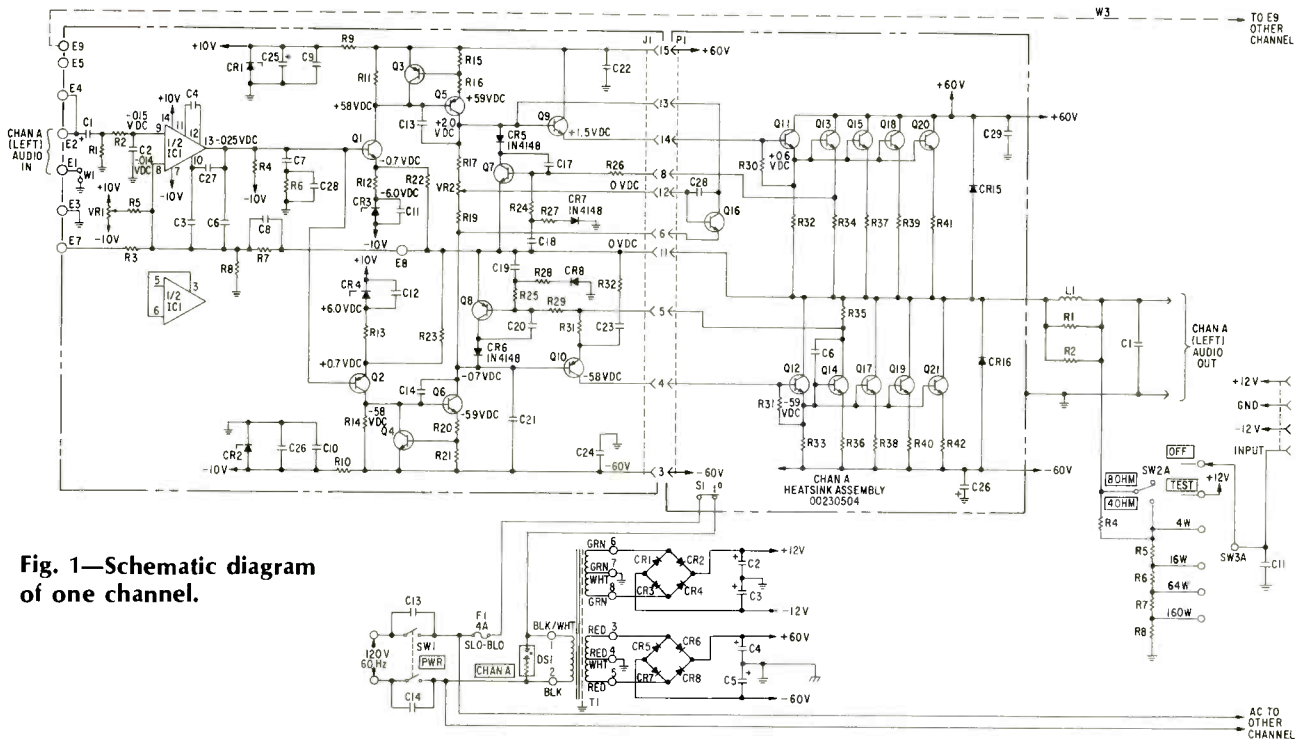

Fig. 1—Schematic diagram of one channel.

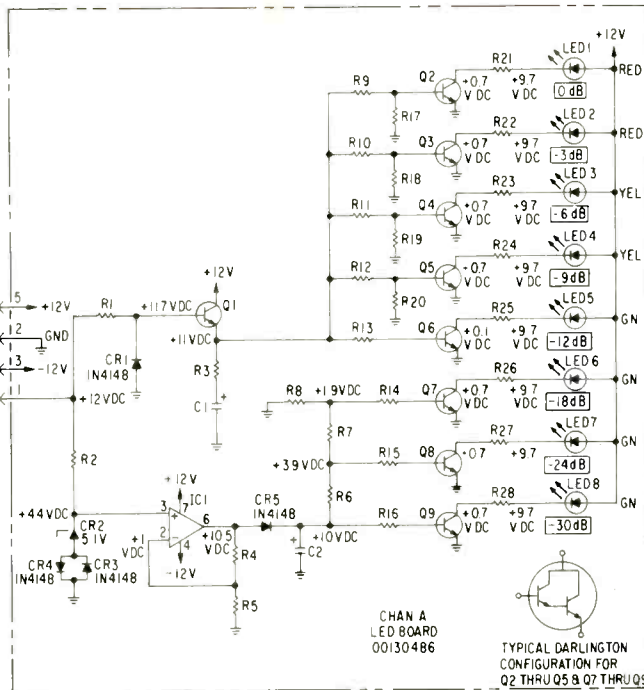

Fig. 2—Circuitry of LED display.

cellent, very tight, and very powerful bass response, and good mid and high end definition, though it sounded more two dimensional spatially with more graininess and edginess than the very best solid-state amplifiers reviewed so far. The LED output level display functioned very well and was judged to be a most useful tool for determining how much amplifier excursion was being used.

Measurements

The Citation 16 was run for one hour with a 1-kHz test signal driving both channels to one third of rated power (i.e. 50 watts) into 8-ohm loads. Heat sink temperature at the end of the hour was hot, as expected, but not excessively so.

Voltage gain was measured and found to be 27.5X or 28.8 dB for both channels. Input voltage for rated output into 8 ohms is therefore 34.64/27.5 or 1.26 V.

Harmonic distortion at 1 kHz and IM distortion as a function of output power into 8-ohm loads are shown in Fig. 3. Figure 4 has THD plotted vs. frequency and power, along with the one-watt frequency response. The Citation 16, as can be seen in Fig. 4, has excellent low frequency response and

Fig. 3—Distortion vs. power output.

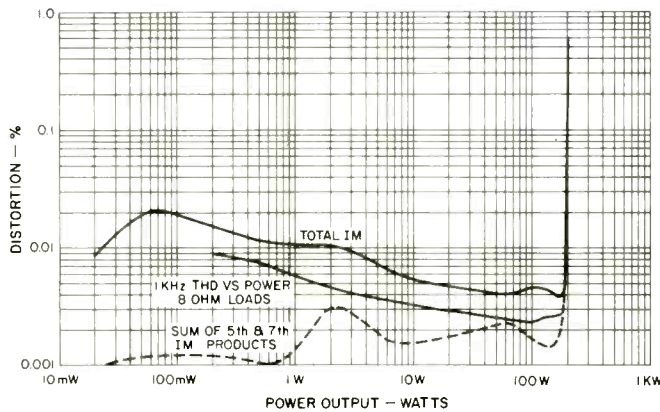

is one of three amps reviewed so far that has such extended low frequency response.

Scope pictures of amplifier response with various test signals and loads are shown in Figs. 5-8. The top trace of Fig. 5 is for a 10-kHz, 10 V p-p square wave into a load of 2 ohms in series with 2 μ F. The bottom trace of this figure is for a 50-Hz, 80 V p-p (200 watt) square wave into 8-ohms. Note the low amount of tilt in this waveform indicating the amp's excellent low frequency response. In Fig. 6, response for a 10 V p-p, 10-kHz square wave is shown for 8-ohm loads (top trace) and 2- μ F loads (bottom trace).

The top trace of Fig. 7 is for an 80 V p-p, 20-kHz square wave into 8-ohm loads. Recovery from slewing is very smooth although not quite as rapid (i.e. with sharp corners) as a few other amps reviewed. Measured slew rate from this trace is about 27 V/ μ S. Harman Kardon drives the amplifier to some 100 V/ μ S for this test and comes up with 30 V/ μ S for their spec. Under this measurement condition, the measured slew rate was 30.8 and 36.4 V/ μ S for the left and the right channels, respectively. A 150 VA, 20 kHz sine wave into 1 μ F is shown in the bottom trace of Fig. 7. THD was about 0.08% under these conditions, which is excellent. Figure 8, top trace, is an attempt to drive a 20 kHz square wave into 1 μ F. Behavior is reasonable up to about 40 V p-p and then the output starts to become asymmetrical as shown. Output V1 limiting is probably the cause. The bottom trace of Fig. 8 is for a 20 kHz sine wave into 8-ohm loads with a 2 dB input overdrive beyond the onset of visual output clipping. Not evident in the trace is the fact that the peak amplitude has dropped some 8 to 10 per cent from the just-clipping value, indicating some considerable common mode conduction in the output stage under these conditions.

Damping factor was measured for both channels, and, as usual, one channel has a higher damping factor than the other. The left channel was about 425 at low frequencies, decreasing to 290 at 1 kHz and to 22 at 20 kHz. The right channel was around 750 at low frequencies, 450 at 1 kHz, and 25 at 20 kHz. Possible causes include slightly different wire lengths from amp outputs to speaker terminals and variable series resistance of any element between the output of the board and the speaker terminals themselves, such as relays terminal cutouts, and push-on connectors.

Output noise with shorted inputs and signal-to-noise ratio as a function of measurement bandwidth appears in Table I. The noise was composed of random components plus some higher order harmonics of 60 Hz in the form of pulses every 9.3 mS.

Fig. 4—One-watt frequency response (note break at 100 Hz/10 kHz) and THD vs. frequency and power.

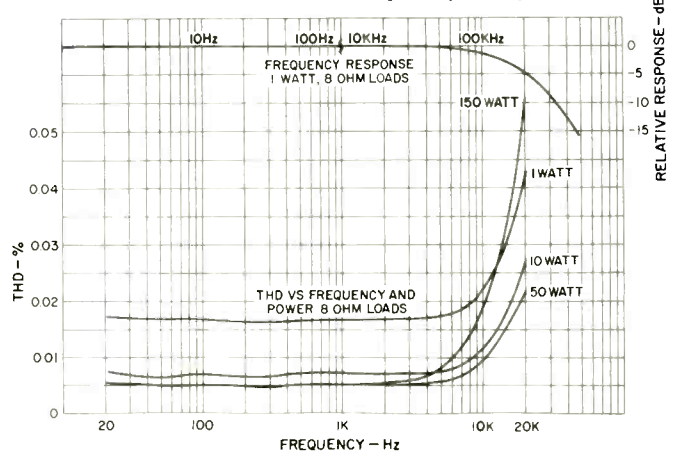

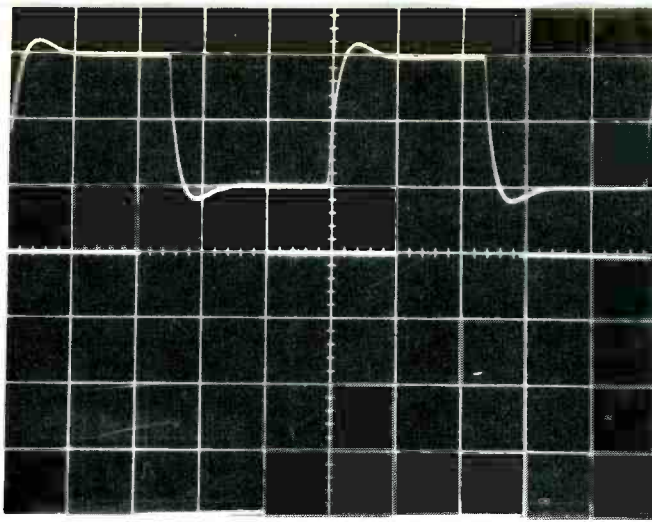

Fig. 5—Top trace, 10-kHz square wave into 2 ohms in series with 2 μ F, scales are 5 V/cm and 20 μ S/cm; bottom trace, 50-Hz, 200-watt square wave into 8 ohms, scales are 20 V/cm and 5 mS/cm.

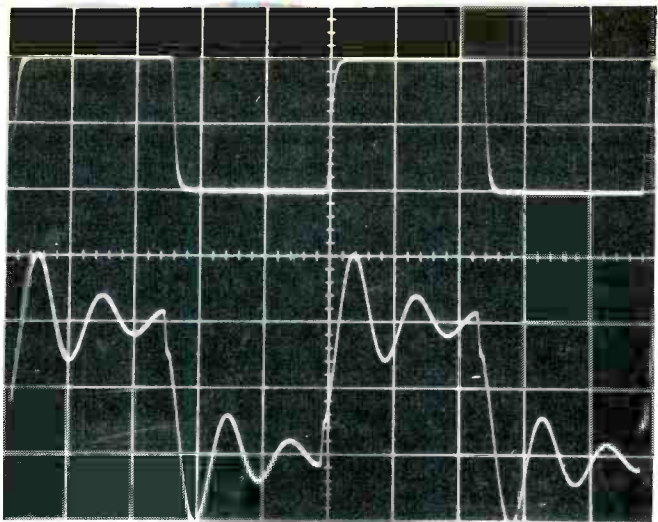

Fig. 6—10-kHz square waves into 8 ohms, top trace, and 2 μ F, bottom trace. Scales for both are 5 V/cm and 20 μ S/cm.

Power output at the onset of visual clipping was found to be 289.0, 190.1, and 110.3 watts for 4-, 8-, and 16-ohms, respectively, for a 1-kHz test signal. Not shown in any of the photos is a reverse spike that occurs on these 1-kHz clipping waveforms. At the end of the clipped portion of the waveform, the amplifier "sticks" or holds on longer than it should, and during the stick time, a narrow spike of considerable magnitude appears going towards the zero axis. This happens for both plus and minus half cycles and for loads ranging from 4 to 16 ohms. The cause of this is probably, again, some action of the protection circuit. (Editor's Note: Harman/Kardon believes that the spike is a function of the IC driver, rather than the protection circuit, since the spike still exists when the protection circuitry is disconnected.)

The LED display system was checked for accuracy with a precision dB attenuator feeding the input of the amplifier. The 0 dB point was set for 34.6 volts at the amplifier output. The LED on and off point was measured in terms of dB down from 0 to the nearest dB. Results are in Table II. Attenuation accuracy of the four position range attenuator and the 4/8 ohm switch was found to be satisfactory.

Summing up, the Harman/Kardon Citation 16 is a well-built amplifier that should prove to be reliable in use. This amp should have particular appeal to those whose passion is tight, clean bass response in a high power unit. The flashing LED power output display is a quite modern level indication system which should also attract potential purchasers.

Bascom H. King

Check No. 85 on Reader Service Card

Fig. 7—Top trace, 20-kHz square wave into 8 ohms. Bottom trace, 20-kHz sine wave into 1 μ F. Scales for both are 20 V/cm and 10 μ S/cm.

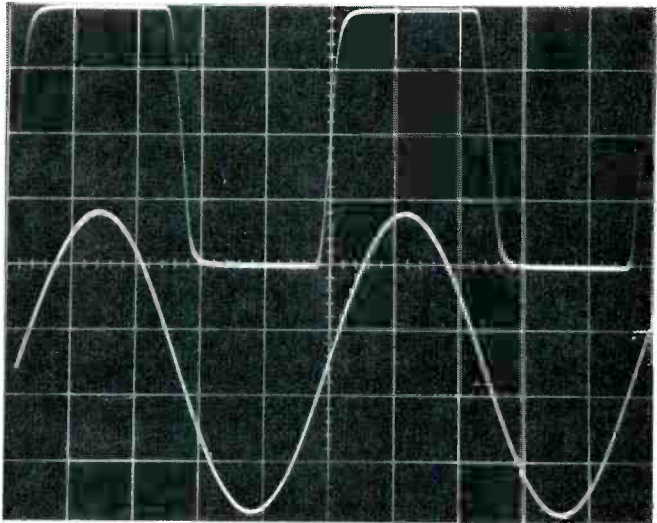

Fig. 8—Top trace, 20-kHz square wave into 1 μ F. Bottom trace, 20-kHz sine wave into 8 ohms with about 2 dB overdrive. Scales for both are 20 V/cm and 10 μ S/cm.

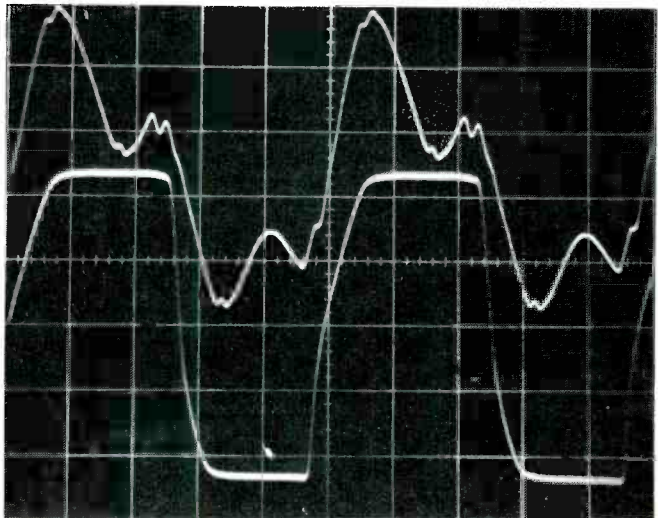

Table II—LED indicator on and off points vs. output level.

Output Level	LED Indicator			
	Left Ch.	Off	On	Right Ch.
0	0	-3	0	-4
-3	-3	-6	-4	-6
-6	-6	-9	-6	-9
-9	-9	-12	-8	-11
-12	-12	-15	-11	-15
-18	-19	-22	-19	-23
-24	-25	-28	-24	-27
-30	-31	-33	-30	-33

The column



30

Sibling Rivalry: The Rowans
Asylum 7E-1073, stereo, \$6.98.
Chicken Skin Music: Ry Cooder
Reprise MS 2257, stereo, \$6.98.

I dropped into *Audio's* office to talk over the new releases with the editor to try to figure what I should write about this month, and possibly choose one for lead review spot. One we both dug on was the Rowans' album. He remarked how clean and strong the sound felt to him, and I agreed with that. It sports some beautiful songs, particularly Peter Rowan's two new-Mexican songs, the outlaw ballad *Joaquin Murrieta* and the love song *No Desanimas Amor*, and Lorin Rowan's *Sword of Faith/Soldier of the Cross*. Generally, the strongest songs are gathered at the end of the sides which means that a lot of the professional FM listeners may not get to them. The Beatle-esque *Ooh My Love* is nice enough, but most of the early

stuff on either side lacks substance. The brothers' harmonies are marked by that special family feel that goes back to the Everly family and even earlier to the Carters, but ultimately **Sibling Rivalry** is a half realized album although a healthy step in strong directions.

The Ry Cooder album came out about 10 days later, and it set me down listening. Ry Cooder has such a marvelously personal vision of music, at once eclectic and eccentric. His last one **Paradise and Lunch** had been his best yet, so the new one, delayed as it was by six months, couldn't help but be awaited. **Chicken Skin Music** is yet another incredible adventure... bridging the gaps between Cajun and Hawaiian music via South Texas deftly. For studio work Ry assembled his usual crew, including Milt Holland, Jim Keltner, Chris Ethridge, and George Bohannon, plus guests Flaco

Jimenez, a great accordian player from South Texas, and the legendary Hawaiian musicians, Gabby Pahinui and Atta Isaacs. The songs, as usual for Cooder, contain surprises and delights including *He'll Have to Go* with Flaco and *Stand By Me* adding on gospel voices besides. Two Lead-belly songs appear, *Goodnight Irene* and *Bourgeois Blues*, done as an overdund extravaganza with Cooder on four diverse instruments plus vocal. *Chloe* and *Yellow Roses* feature Hawaiian style.

Ry Cooder has been an astonishing musician, unafraid of foreign forms and master of juxtaposition. "Quality in the face of all odds" is a motto I believe in, and it fits Ry Cooder. M.T.

Rowans

Sound: A Performance: B-

Cooder

Sound: A- Performance: A

Year of The Cat: Al Stewart
Janus JXS-7022, stereo, \$6.94.

A superior album. Al Stewart's songs are a much better bunch than those of **Modern Times**, his last outing. Alan Parsons' production is stunning, state-of-the-art work with bright sound leaping from the speakers and clearly diverse arrangements.

In the end it all comes down to Stewart's meticulous craft as songwriter that gives **Cat** its depth. He leaves thoughts with you that expand as they bounce around your head. **Year of the Cat**, by rights, should be the album to bring Al Stewart the recognition he richly deserves. *M.T.*
 Sound: A+ Performance: A

Viva! Roxy Music!: Roxy Music
Atco SD 36-139, stereo, \$6.98.

Let's Stick Together: Bryan Ferry
Atlantic SD 18187, stereo, \$6.98.

This is an odd pair of patchwork albums released little more than a month apart, both covering 1973 to the present. Neither dates the performances or makes it very clear who plays what, which is unfortunate.

The Roxy Music album is a live one originally intended as a basic history of the group's live touring. That intent has been forever lost by the selection of unmemorable parts of various tours, the murky, rambling, and most indulgent numbers, such as *Bogus Man*, *If There Is Something*, and *In Every Dream Home a Heartache*, all from the first two Roxy albums. The

demanding music is met by a metallic sound that emphasizes the group's mechanical side as a live show. It's difficult to get involved with the music of **Viva!**

Roxy spearhead Bryan Ferry's third solo is titled ironically since there are serious rumbles of dissent among the Roxy Music members over Ferry's handling of the live album. What makes up **Let's Stick Together** is a patchwork of B-side remakes of Roxy Music songs that all fare better the second time around, particularly *2 HB*, the touching Bogart tribute that sums up a surprising amount of the Ferry pose. *Sea Breezes*, *Chance Meeting*, and *Re-Make/Re-Model* as well as *2HB* all originally appeared on the first Roxy Album in sketchy versions, all improvements.

In addition Ferry has transformed some unlikely oldies to his own vision. An obscure Everly Brothers song, *The Price of Love*, gets a glorious treatment, while the late Jimmy Reed's *Shame, Shame, Shame* is a joy, rocking for all it's worth. Then there's the title track, originally by Wilbert Harrison, and the Beatles' *It's Only Love*.

The strangest part is that this patchwork of four years' work is the most consistently entertaining and pleasing solo Bryan has done without sacrificing a bit of his emotive lunacy. *M.T.*

Roxy
 Sound: D+ Performance: C-
Ferry
 Sound: B Performance: A-

Hard Rain: Bob Dylan
Columbia PC 34349, stereo, \$6.98.

Mostly this is a soundtrack of the Dylan TV special *Hard Rain*, with some stuff left out of the show, notably *Stuck Inside of Mobile with the Memphis Blues Again*. Rolling Thunder was an apt name for the tour on the basis of this recording. The band is charging from the gate and pushing Dylan's performance.

However, the recording quality is perhaps slightly better than television sound. Magnified, it gets pretty ugly at times with a terribly annoying treble buzz through much of the album, plus static for flavoring. It's your basic soundboard mix, clearly uncosmetized by studio overdubs.

Hard Rain is basically inconsequential Dylan. Good show, awful sound, still packed with power. But don't bother me with questions; I just put **Blood on the Tracks** back on. *M.T.*
 Sound: Unacceptable
 Performance: B

the First 5 Minutes Don't Count

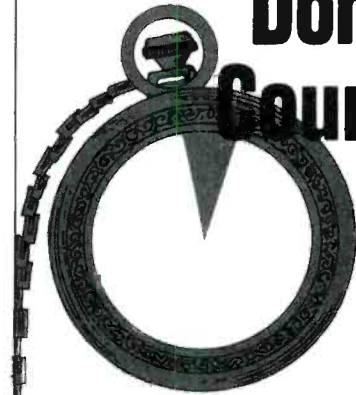

Or Even Ten!

Sometimes it may take a little while before you know just how good a headphone really is. Comfort, weight, cord convenience all are vital factors in headphone wearability.

With every minute of use, any manufacturing deficiencies in these areas grow into discomfort and inconvenience.

At Beyer we know these problems and all our headphones are designed to achieve the highest possible wearability factor (Hi Fi News, Sept. '76, p. 143, Beyer DT440 ranked 1st out of six comparative tests for comfort).

Coupled with physical comfort comes the lack of aural fatigue. That bright overdone sound associated with the 'loudspeaker-on-the-ear' concept oversold by our competitors will often give you a bad headache in minutes. It takes time to appreciate good clean sound. And with time good sound doesn't tire (Hi Fi News, Sept. '76, Subjective Headphone Listening test Beyer DT440 ranked 1st).

So visit your Beyer Headphone Dealer now and give yourself time to compare Beyer Headphones against the competition.

But remember - the first 5 minutes don't count.....



Beyer Dynamic
 155 Michael Drive
 Syosset, New York 11791
 (516) 364-1900

Check No. 7 on Reader Service Card

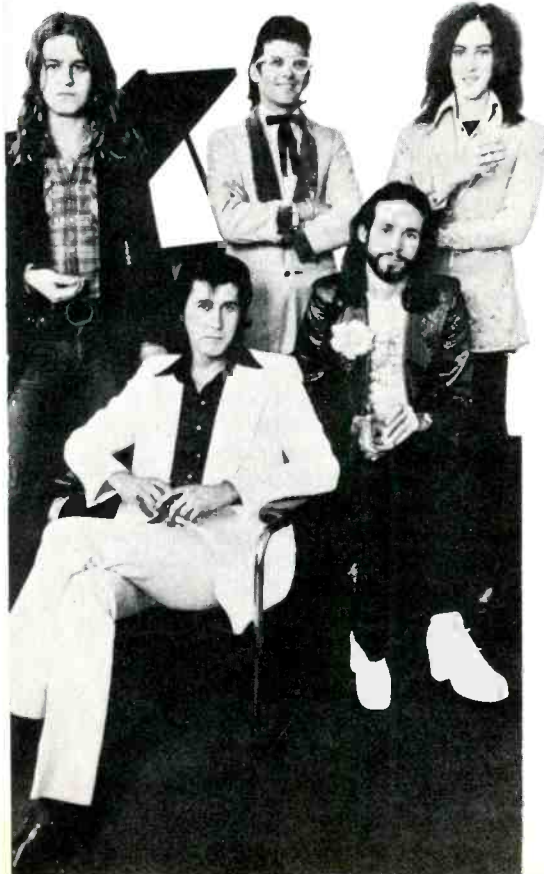

Clearly

Nakamichi proudly introduces its first all-electronic components, backed by world-famous Nakamichi engineering and manufacture. The 610 Control Preamp and the 620 Power Amplifier offer no-compromise performance and flexibility that is clearly Nakamichi. Grouped with the exciting new 600 Cassette Console, they comprise the Recording Director Series—elegantly styled with identical profiles, each is a study in human engineering.

The 610 Control Preamp is three devices in one. As a stereo preamp, its performance and color-free sound invite comparison with the finest units available. It also functions as an advanced test center, with built-in test tones, pink noise generator and precision meters—just to name a few. As a studio-quality mixer, any 5 of 19 different inputs can be selected in many combinations. The creative audiophile will find no end to the 610's capabilities.

Phono S/N Ratio (IHF-A): Better than 80 dB (0 dB=1 mV); THD: Less than 0.005%
Meters: -40 dB to +10 dB range, peak reading; Frequency Response: 5 Hz-150 kHz ±0.75 dB

610

82

Joan Armatrading: Joan Armatrading
A&M SP-4588, stereo, \$6.98.

The album **Joan Armatrading** is quite an achievement, for Joan the artist, for Glyn Johns producer, and all concerned. Joan Armatrading is a West Indian transplanted to England with an absolutely personal compelling style of her own, which finally achieves focus on this album.

Joan's musical turf is not far removed from Cat Stevens' though she sounds not at all like him. Her husky alto glides and soars, with power. Her songs *Down to Zero*, *Water with the Wine*, *Love and Affection* and *Tall in the Saddle* have a common strength derived from knocks taken and wisdom gained. Even the let's-form-a-band song *Join the Boys* has a strong wariness.

The supporting cast is eminently chosen to the emotional manner of the material with Kenney Jones and Dave Mattacks alternating as drummer, Jerry Donahue on guitar, Peter Wood piano, and Dave Markee bassist. The band shines while giving Joan the room she needs.

Joan Armatrading is an album I do not expect to tire of easily. *M.T.*
Sound: A Performance: A

Pat Travers: Pat Travers
Polydor PD-1-6079, stereo, \$6.98.

Jump On It: Montrose
Warners BS 2963, stereo, \$6.98.

Night Man: Dirty Tricks
Polydor PD-1-6082, stereo, \$6.98.

Trapeze: Trapeze
Warners BS 2887, stereo, \$6.98.

Being one of the world's foremost hardrock music fans, I anxiously lie awake nights waiting for the next horde of guitars to descend upon my turntable, for the next Led Zeppelin album to reach release, and for Ritchie Blackmore to cut a record that's truly as good as his guitar playing. I'm not really that fussy about sound quality, as long as those distortion units are doing their bits, then I couldn't be happier.

But really listeners, none of these albums really rises above being second-rate metal music, each worth about a dollar to a buck and a half. To think that each of these albums sell for the same price of two pizzas, or seven Big Macs, or 15 large orders of McFrench Fries is a crime. Dirty Tricks is produced by the same guy who produced Black Sabbath and sounds like Son of Sabbath, Montrose is trying very hard to be Deep Purple meets

Led Zeppelin and is produced by the same guy who does Arrowsmith. Pat Travers is most amusing of the bunch but hardly the most musical, and Trapeze is the longest-lived of this group and, as such, can occasionally come across with a track vaguely musical (if not beholding in personality). But none of these has the appeal of any of the great masters. Let them tour their butts off, and eventually one of them might end up second billed to Foghat, or a guy in one of these bands might be asked to join Uriah Heep. But please don't expect anything astounding here. *J.T.*

Sound: B Performance: C+

Morning Comes: Buckacre
MCA-2218, stereo, \$6.98.

American Flyer: American Flyer
United Artists UALA650, stereo, \$6.98.

Unfortunately, there's a rule somewhere in the music world that says everybody English decides, after they've created their great works, that the time has come for them to sound American. This affliction strikes not only musicians but record producers as well, case in point being these two albums produced by George Martin

Nakamichi!

The 620 Power Amplifier boasts harmonic and IM distortions so low they cannot be reliably measured with the best test instruments. It is unconditionally stable under any load, including a direct short circuit. The power supply packs more punch than units several times its size. A unique biasing circuit cuts idling current by 1/20 and keeps the bold heat sink fins cool to the touch. Peak indicator lamps glow green or red for each channel at pre-settable power output levels.

For complete information, write Nakamichi Research (U.S.A.), Inc., 220 Westbury Ave., Carle Place, N.Y. 11514 or see your Nakamichi dealer soon and ask for a demonstration of the 610 and 620 together with the incredible 600 Cassette Console (now also available in matte black finish).

620 Power Output: 100 watts per channel min. RMS, 8 ohms, 5 Hz-20 kHz, with no more than 0.01% THD
IM Distortion: Less than 0.002% at 100W/8 ohms (60 Hz: 7 kHz, 4:1); S/N Ratio: Better than 120 dB (IHF-A)

Check No. 28 on Reader Service Card

(formerly producer for The Beatles) and Glyn Johns (a familiar name to Rolling Stones fans). Both of these groups sound like they've been listening to Jackson Browne and The Eagles too long, and the only surprise is that neither of these is on Asylum records. Then again, Asylum seems to be cleaning their act up a touch lately, and neither of these groups seems particularly talented, distinctive, or original.

American Flyer is your limp and lame Stateside supergroup—former members of Blood, Sweat & Tears (perhaps one of the most annoying aggregate ever to put a record out), Pure Prairie League (a group whose talents I've yet to recognize), the Blues Magoos (surely a milestone band), and The Velvet Underground. The thought of the remnants of these four groups playing imitation-Jackson Browne music boggles the imagination. There is a big hype behind this, and perhaps it's sell a few copies, proving that some people will believe that a notable past, no matter how vapid, can stir up current interest. Buckacre is slightly more anonymous, which means easy to ignore but if you put your mind to it you could proba-

bly learn to dislike them. Personally, I'd rather listen to environmental or sound effects records if I need background schlock.

J.T.

Sound: B Performance: Z

Man to Man: Hot Chocolate
Big Tree BT 89519, stereo, \$6.98.
Waking & Dreaming: Orleans
Asylum 7E-1070, stereo, \$6.98.

Six months to a year ago I would have felt very comfortable saying that these two groups were the shining hopes of funky music for the Seventies. Both of these entities were blitzing the charts with superb singles and had made albums which displayed, if nothing else, a promising abundance of energy. Orleans was the all-white band from the East Coast who seemed to have just about everything going for them; from the already proven talents of guitarist/songwriter John Hall to the fine drumming of Wells Kelly, they seemed to have the jump on the situation. And Hot Chocolate, a black-and-white group from England, who were the sensation of top 40 with *You Sexy Thing*, has already penned several hits for other groups and were

starting to come into an instrumental sound of their own.

Where did they go wrong?

Each of these groups has a new album, and each of these albums has no more than two redeeming tracks. The rest of these albums suffer from the same syndrome, a condition prevalent in the late Fifties and early Sixties when top-forty radio reigned. You'd remember when a one-hit wonder would put out an album, and all it would be would be a delightful single which sounded like a lot of time and effort was put both into its composition and recording, but the rest of the album sounded like it was recorded in about 40 minutes and written in half that. This is what **Man to Man** and **Waking & Dreaming** resemble; the best recommendation I can give is buy the singles and skip the albums because they're utterly worthless. *Don't Stop It Now* and *You Could've Been A Lady* are both enjoyable, but Hot Chocolate sounds like they're virtually incapable of writing any but bland Seventies r&b on the remainder of their album. *Still the One* is an incredibly potent single, but only the most devoted Orleans fan could even stand to listen to the rest of the album.



SME

The best pick-up arm
in the world

84

Chancing your arm!*

Looking about that's what some folk are still doing.

Fit your deck with an SME the *original* precision pick-up arm. Now with improved lift, the most sensible, most precisely engineered arm ever built.

SME arms are different, you can see it, feel it, . . . hear it. Change now and have the good will of your cartridge.

For complete specifications and independent reports write to:
Dept 1437A, SME Limited
Steyning, Sussex, England, BN4 3GY

Exclusive distributors for the U.S.:
Shure Brothers Incorporated
222 Hartrey Avenue
Evanston, Illinois 60204
U.S.A.

and in Canada:
A. C. Simmonds and Sons Ltd
975 Dillingham Road
Pickering, Ontario, L1W 3B2
Canada

* a British Army expression meaning taking a risk

Check No. 39 on Reader Service Card

I thought I was a pretty big fan of the group until I heard this, which is the most miserable and disheartening dreck to reach my ears in a dog's age.

It's not like they're lacking in talent—both of these groups not only wrote the garbage on the albums but the good songs as well—so it must be a matter of self-contained bands who simply don't know where their true talents lie. All this writer can add is that both of these bands have had their share of success in the past and are currently riding the charts smoothly, but if they continue to produce garbage such as this, they should prepare to be abandoned by the public as soon as they make an album like this and forget the hit single. *J.T.*

Sound: B Performance: D

Agents of Fortune: Blue Oyster Cult
Columbia PC 34164, stereo, \$6.98.

From its inception Blue Oyster Cult has been a thunderstorm of a band with macabre humor for kicks. However with **Agents of Fortune**, where they had been manic yet clever, they are mannered and coy. In short, the Cult has gone soft.

This Ain't the Summer of Love is an interesting thought that sounds unfinished. That one segues into *True Confessions*, a sly salute to those magazines. Longtime Cult crony Patti Smith co-wrote a pair of the album's songs, appearing on one *The Revenge of Vera Gemini*, which though confusing is one of the album's really ominous moments at a time when they become all too apparent.

All through **Agents**, vocals are peculiarly blurry and diffuse. The new-found dependence on keyboards for a sustaining sound is a real departure from the utter guitar domination of the past. **Agents of Fortune** is clearly a transition, but I don't think the Cult knows where it's leading them.

M.T.

Sound: C- Performance: D

Sammy Walker: Sammy Walker
Warner BS 2961, stereo, \$6.98.

It's as if some guy just decided he was Bob Dylan and that was that. If you thought Badfinger sounded like the Beatles, or if you thought Starcastle sounded like Yes, and if you thought Uriah Heep sounded like Deep Purple/Vanilla Fudge, then get a load of Sammy Walker. A protege of the late Phil Ochs, Walker is, if nothing else, a curiosity item for the moment, and nothing more. *J.T.*

Sound: B- Performance: B-



Coney Island Baby, Lou Reed
RCA APL1-0915, stereo, \$6.98.
Station to Station, David Bowie
RCA APL1-1327, stereo, \$6.98.

Here they are, the latest albums by the decadent boys of the Seventies, actually the first of the glitter-rock singer/songwriters. Both came onto audiences expecting to be received as the new Messiah and when they found that they were just another spotlight hogger in the eyes of the public, Bowie and Reed panicked. Bowie deserted rock 'n' roll first for the self-spawned illegitimate theatre and later for "disco music," while Reed initially turned toward a limp rhythm & blues, later releasing an electronic noise album in the hopes of once again becoming a dear fave in the eyes of the avant-garde. Because that's what both Lou and David are after, trendsetter-type approval; neither really has much commitment to being any kind of rock talent. Both have a tendency to use the term "artist" when being self-descriptive, and they have stronger filmstar aspirations than rockstar dreams. The reason for this is very simple: neither could be

AUDIO • DECEMBER, 1976



accused of being a musician/instrumentalist. They gave up playing instruments onstage a long time ago, not that either was a particularly able guitarist in the first place, and ever since their songwriting talents have pulled a disappearing act. Neither has written even one good song in at least two years.

So there's no reason to start now. **Station to Station** and **Coney Island Baby** don't have a decent melody between them, as both "artists" seem to indulge in monotonal readings of self-indulgent lyrics. Bowie's album is still fairly soul-oriented; where once he didn't know what sex he was, now he doesn't know what race he belongs to. Lou's style is imitating himself, a fairly commercial proposition in the light of Patti Smith's recent success and the New York rock scene's affectation for the Velvet Underground set. I'm certain somebody's getting some pleasure from these records, but I'd hate to think of how. Lord knows I tried, but they're so terribly boring I was tempted to pick up a book while listening. If these two persist in putting out records of their lyrics put to music solely because there's more money to be made from albums than poetry books—and I don't begrudge the greed and profit motive—I only wish they'd find a talented musician to provide the musical compositions and melodic sensibility so at least they can be enjoyed rather than endured.

Jon Tiven

Sound: C — Performance: Zzzz

AUDIO • DECEMBER, 1976

Well-Matched

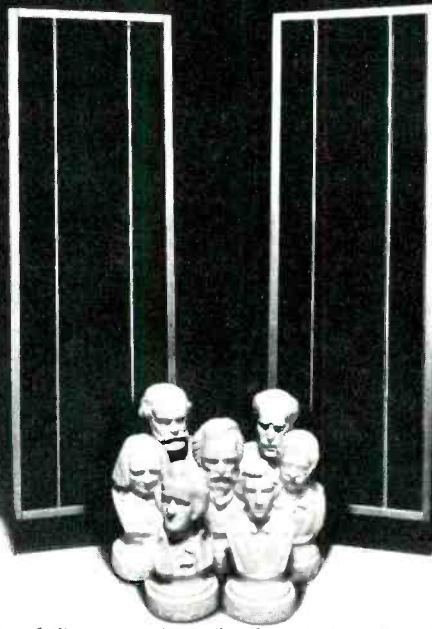

Connoisseurs of fine music, whether it be classical, rock or jazz, require a standard of performance from their audio systems that is nothing less than superb.

Magneplanars, the result of a unique combination of engineering skill and creativity, meet that standard. Accurate phase response is provided by woofer, tweeter, diaphragm and voice grids all in the same plane. The low mass of diaphragm results in excellent transient response and definition throughout the entire audio range. **Magneplanars** are designed so that the qualities that distinguish great music can be fully appreciated. \$625 a pair.

Experience their exceptional performance at the following dealers.

EAST

The Stereo Emporium
Buffalo, NY
Paul Heath Audio
Rochester, NY
Hi-Fi America
Vestal & Utica, NY
Audio Breakthroughs
Manhasset, NY
Audio Den
Stony Brook, NY
Lyric Hi-Fi
New York &
White Plains, NY
Audio Workshop
Albany, NY
Fred Locke Stereo
Conn. & Mass.
Natural Sound
Framingham, MA
Sound Studio
Newark & Dover, DE
& Salisbury, MD
Barnett Audio Video
Jenkintown, PA
Bryn Mawr Stereo
Bryn Mawr &
Malvern, PA
Barnett Bros. Radio
Philadelphia, PA
Sound Advice
Emmaus, PA
Ovation Audio
Pittsburgh, PA
DKL Laboratories
Silver Spring, MD
Sight & Sound Ltd.
Bel Air, MD
Sound Scape
Baltimore, MD
Myer Emco
Falls Church, VA &
Rockville, MD &
Washington, D.C.
Music Center Hi-Fi
Charlottesville, VA
The Sound Shop
Norfolk, VA
Sound Approach
Newport News, VA
Audio Art
Richmond, VA
Wheeling Sound
Wheeling, WV

High Fidelity Center
Huntington, WV &
Charleston, WV
Sounds Impressive
Charlotte, NC
Vickers Audio
Chapel Hill, NC
Brookshire Music Mach.
Anderson, SC
Read Brothers
Charleston, SC
Fat Julian's Audio
Atlanta, GA
Audio Etc.
Gainesville, FL
Frutchey Audio
Winter Park, FL
Interiors Plus Sound
Ft. Lauderdale, FL
Sound Components Inc.
Coral Gables, FL
House of Sound & Sight
West Palm Beach, FL
Stereo World
Ft. Meyers, FL

CENTRAL

Hi-Fi Audio
Cincinnati, OH
Hoffman's House of Stereo
Brookpark & Wickliffe, OH
Carlin Audio
Dayton & Fairfield, OH
Audio Systems
Akron, OH
Specialized Sounds
Louisville, KY
Anderson Audio
Nashville, TN
Opus II
Memphis, TN
England Sound
Knoxville, TN
Audio Climax
New Orleans, LA
Brute Force
Lafayette, LA
Absolute Sound
Detroit, MI
Audio Dimensions
Birmingham, MI

Hi-Fi Buys
East Lansing &
Ann Arbor, MI
Kurtz Sound
Traverse City, MI
Hi-Fi Gallery
Indianapolis &
Evansville, IN
Good Vibes Sound
Champaign, IL &
W. Lafayette, IN
Systematic Sound
Rockton, IL
Paul Heath Audio
Chicago, IL
Victor's Stereo
Chicago, IL
Audiophile Sound Stud'o
Middleton, WI
Sound Environment
Minneapolis, MN
Jensen's Stereo
Burnsville, MN
Audio Odyssey
Davenport, IA
The Stereo Shop
Davenport &
Cedar Rapids, IA
Audio Labs
Des Moines, IA
Creative Audio
Columbia, MO
J. C. Gordon Co.
St. Louis, MO
David Beatty Stereo
Kansas City, MO
The Gramophone Ltd.
Norman & Tulsa, OK
Audio Concepts
Houston, TX
Audio Concepts
Austin, TX
Hillcrest Hi-Fi
Dallas, TX

WEST

Sound Ideas
Albuquerque, NM
Listen Up
Denver, CO
Boulder Sound Gallery
Boulder, CO

Winterton's Audio
Salt Lake City, UT
Interior Systems
Las Vegas, NV
Tin Ear Sound Co.
Reno, NV
Hal's Stereo
Spokane, WA
The Tin Ear
Richland, WA
Definitive Audio
Seattle, WA
Hawthorne Stereo
Portland &
Beaverton, OR
Day's TV
Corvallis, OR
Toad Hall Hi-Fi
Eugene, OR
House of Music
San Francisco, CA
Garland Audio
San Jose, CA &
Berkeley, CA
Boyd-Wonn Hi-Fi
Vallejo, CA
Stereo Showcase
Sacramento, CA
Jonas Miller Stereo
Beverly Hills, CA
Music & Sounds of Calif
Woodland Hills, CA
Absolute Audio
Santa Ana, CA
Stereo Hi-Fi Center
Gardena & Torrance, CA
Hi-Fi-Matic Stereo
Culver City, CA
The Sound Company
San Diego, CA
Stereo Shoppe
Boise, ID

CANADA

S. R. Sound Room Ltd.
Vancouver, B.C.
Advance TV & Stereo
Winnipeg, Manitoba
Ottawa Studio Sound
Ottawa, Ontario
Bay Bloor Radio
Toronto, Ontario
Opus Audio Ltd.
Montreal, Ontario

MAGNEPLANAR
MAGNEPLANAR® PRODUCTS
P.O. BOX 8642, WHITE BEAR LAKE, MINNESOTA 55110

Check No. 24 on Reader Service Card

THE LEAST EXPENSIVE ALTERNATIVE TO A MORE EXPENSIVE SYSTEM.

Sennheiser headphones deliver such vastly improved sound from most amplifiers and receivers, they're an economical alternative to a more expensive system.

Their wide response, unusual smoothness and superior transient abilities have been compared with the finest loudspeakers. But they don't need *monster* power for optimal results.

For a gradual way to move up, first add a pair of Sennheiser headphones to your present system. Then add an expensive amp or receiver to your Sennheiser headphones.

(Finally, if you feel the need, add expensive speakers. Or spend the money on a hundred or so albums.)

Since there are three models to choose from, all featuring our uniquely comfortable Open-Aire* design, even our alternative has alternatives.



SENNHEISER

10 West 37th Street, New York 10018 (212) 239-019C
Manufacturing Plant: Bissendorf/Hannover, West Germany,
*Manufacturer's suggested list

Classical Reviews

Edward Tatnall Canby



Chopin: The Four Scherzi; Fantasy in F Minor, Op. 49. François Duchâble, piano.

Connoisseur CSQ 2086, quadraphonic (SQ), \$6.98.

Connoisseur's impressive piano list is being augmented by a big batch of Pathé-Marconi-EMI imports, coded in SQ, from France. No doubt about it, this label (i.e. one Alan Silver) has taste and discrimination. My curiosity is always whetted by anything new they put out, and rightly so. As witness this disc.

Duchâble is an all-French piano prize winner at 24, and very much a product of the French system of music training, which has always stressed accuracy and finish in the technical aspects of performance. He is just that—accurate, finished, a beautiful technician, a somewhat cool player (in the old sense) but absolutely faultless both in finger work and in his sense for the important musical lines, the ideas. His pedal work—the essence of musicality—is particularly clean and precise, which is decidedly

not the case with many of the young neo-Romantic players, those not from France! No grand blur here, and no pseudo-heroics either. Just excellent conservatoire playing. I like his light touch in many places; also his very smooth legato in the softer parts.

Recording just a bit distant, as you first listen (you quickly adjust) and rather light on the bass end. (Much piano recording exaggerates the bass, often to very good playback effect.) Wide dynamic range, very likely untouched in the taping, and maybe cutting. SQ gives a bit of extra ambience, if you decode it into four speakers. Modestly worthwhile, which is exactly what a good four-way coding should be.

Schumann: Sonata No. 3 in F Minor, Op. 14; Impromptu, Op. 5, on a Theme by Clara Wieck. Jean-Philippe Collard, piano.

Connoisseur CS 2081, stereo, \$6.98.

This young French pianist's picture-postcard face, in turtleneck and long hair, has been sleekly looking out at me (*past me, I should say*) from a

AUDIO • DECEMBER, 1976

They're new from **Bozak**.

They're specially designed for the average-sized room.

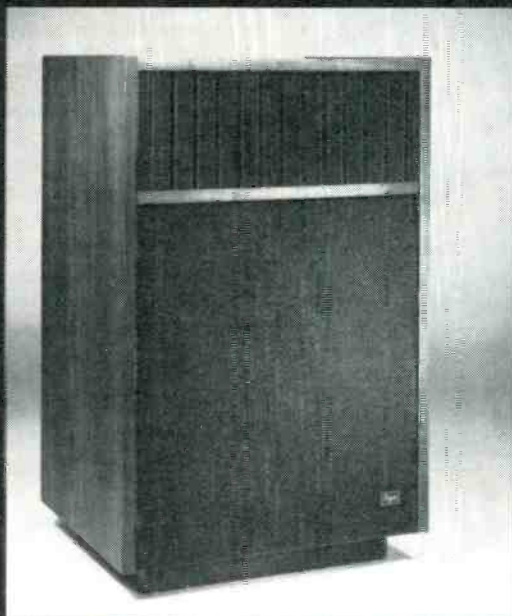

Realizing that it takes a special room to house and take full advantage of the power handling capabilities of the magnificent Concert Grand speaker system and its companion electronics, Bozak has designed a new trio of speakers, preamplifier and amplifier for the typical living room.

The quality and circuitry of these new models is typically Bozak — the best we can build. Indeed, the component speakers are identical to those in the Concert Grand. Only the number of component speakers and the power of the amplifier has been scaled down.

Model B-501 Concerto VII Speaker System

Combining the robust, true bass of a Model B-199A woofer with the clear, definite mid-range of a B-209B driver and three of Bozak's new B-200Z tweeters "with the Golden Voice" for the most thrilling, shrill-free treble you've ever heard, this magnificent three-way system will make your listening room the envy of your knowledgeable music loving friends and the source of a lifetime of pleasure.



Model 909 Deluxe Stereo Preamplifier

Complete flexibility for handling a variety of stereo inputs — two phono, two tape, tuner and auxiliary — provides almost professional control for mixing, tape dubbing and other functions most commonly encountered in home music systems. The audio signal quality, however, far exceeds many professional systems. Frequency response is $\pm 0.25\text{dB}$ with 0.1% harmonic distortion and 0.1% intermodulation distortion over the frequency band from 20 Hz to 20kHz at 10 volts RMS into 200 ohms.



Model 939 Stereo Power Amplifier

Using circuitry adapted from commercial power amplifiers supplied by Bozak for concert halls across the nation, this magnificent unit supplies 70-watts per channel continuous minimum sine wave power into 8 ohms from 20 to 20,000 Hz at less than 0.2% total harmonic distortion. Employs full electronic protection against short circuits and overloads and to prevent DC damage to speakers.

For information on any or all three of these magnificent units, see your Bozak dealer or ask by model number from



BOZAK

Box 1166, Darien, Connecticut 06820

There Were Many Ways To Clean Records...

The incredible new Electro-duster! The "clean while it plays" dust remover. Electro-duster's velour fibers lift dust and dirt from record grooves and deposit the particles on a statically charged plastic belt. See for yourself why, with Electro-duster around, other record cleaning methods are all "washed-up."

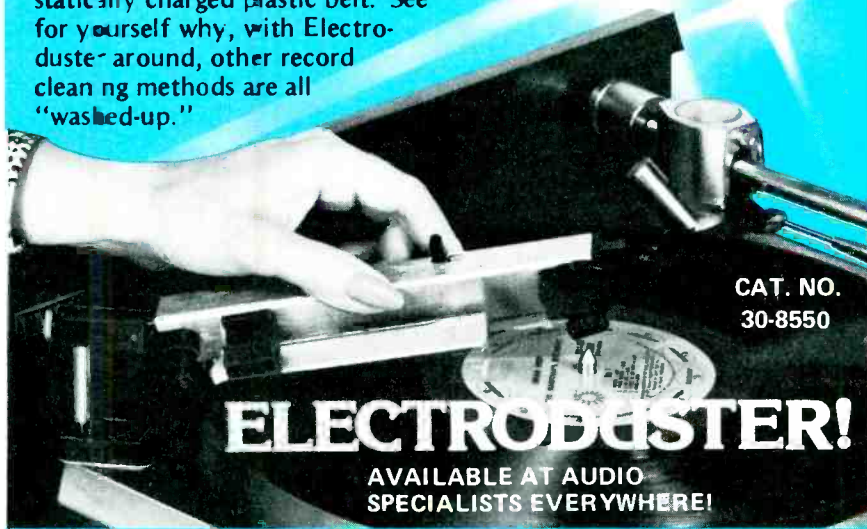

CAT. NO.
30-8550

ELECTRODUSTER!

AVAILABLE AT AUDIO
SPECIALISTS EVERYWHERE!



**Audiotex
Laboratories**

DIVISION OF HYDROMETALS, INC.
400 SOUTH WYMAN STREET
ROCKFORD, ILLINOIS 61101 U.S.A.

Check No. 18 on Reader Service Card

88

The Avid 103.

Few people would expect more in a loudspeaker.



For most people, the Avid Model 103 really is the ultimate speaker.

Not that you can't pay more for a speaker. You can. A lot more.

But, for most audio enthusiasts any difference between the Avid 103 and more expensive speakers just isn't going to justify the added cost. As it is, the 103 clearly outperforms speakers costing up to twice their price.

The Avid 103.

You owe it to yourself to find out why it is rapidly becoming the popular new reference standard for 3-way systems. For your nearest Avid dealer, please write:

AVID[®]
CORPORATION

10 Tripps Lane, East Prov., R.I. 02914

Sound products for Avid listeners.

Check No. 5 on Reader Service Card

series of his recordings, as though by sheer facial publicity to say "Play me." Well, I finally did, and he is good, come-on or no.

He is a bigger, more grandiloquent, and muscular pianist than his French colleague on this label, François Duchâble, and his piano sound is recorded, too, in a heavier, grander fashion. The Collard Schumann is excellent—fluent, expressive, yet highly personal as Schumann must always be. Not easy! Plenty of pianists have floundered, or even foundered, on this composer's music. Not Collard. It comes easy—you'd think he was born to be a German Romantic. I'd say that in spite of the insinuating face he is a more mature pianist than Duchâble; Collard does his own thinking, very clearly; he is far out of the early "contest" type of imitative brilliance by which all these young pianists get started in the music biz. One does not play Schumann without maturity, not of the fingers but in the mind. In respect to musical sense and expression, Collard has it.

Pretty high recorded levels; so a worn stylus is likely to buzz. If you can play this disc cleanly, your equipment is quite all right. And you'll find more of the same—Fauré, Rachmaninoff, to your choice. Also, with another French youth, Michel Béroff, Brahms for two pianos and 20 fingers.

Leo Ornstein: Danse Sauvage (Early Piano Music). Michael Sellers, pf.

Orion ORS 75194, stereo, \$6.98.

Leo Ornstein: Sonata for Cello and Piano; 3 Preludes. Bonnie Hampton, cello, Nathan Schwarz, piano.

Orion ORS 76211, stereo, \$6.98.

Orion has latched onto an interesting musical personality here, a radical pianist/composer back in the teens of this century, celebrated in his time both for introducing new far-out music in his recitals—Debussy, Schoenberg, Bartók—and for his own spectacularly dissonant music; he had the music critics gasping. Strangely, he retired around 1930, still young, and simply vanished from the larger music scene, but, as of last report, is still around in his 80s. Here is some of his youthful music, and let me tell you, it is an instructive sound, because it shows how quickly our ears change. All of us.

Yes—it's easy enough to hear that he was a wild radical! The piano pieces are almost purely dissonant, the sort where you write melodies in acid minor seconds, the kind where most people would have said, "Sure,

AUDIO • DECEMBER, 1976

just walk up and down the keyboard; that'll sound even better." I can hear their voices! (They still exist.)

And yet—most of us will find not a thing to shock, and a lot to enjoy, so absolutely of *its time* is this music. Far from keyboard walking, the man used every conventional trick of the radicals of his day, right along with Bartók, Schoenberg, even old Charles Ives. *Wild Men's Dance* or *Danse Sauvage*—how about Prokofieff's *Scythian Suite*, Ravel's *Gaspard de la Nuit*, Stravinsky's *Sacre* and *Les Noces*, & on & on? No criticism! The opposite! Under all the radical noise is a very firm sense of current styling, a canny understanding of the latest Trends. And especially, there is always (for us now) that tell-tale lurking of the old Romantic idiom, carefully swathed in dissonances but unmistakable. Keeps peeping out, in spite of him—the others of the day were of the very same mind, including Stravinsky and Schoenberg. But people then had ears only for the dissonance, which was outrage. The Romantic part was taken for granted, because people didn't really know any other sound. We do.

Just try the *Cello Sonata*, and this particular kitty-cat comes right out of the bag. *Much* more Romantic! (The composer says he doesn't know why, but I do. The cello is a Romantic instrument and Ornstein was writing cello music.) The big piece could, in the cello part, come right out of late Brahms. It has those Ornstein dissonances all right, but even so I'd put it slightly to the right of Sibelius. I found it a bit boring. There are too many competent late-Romantic sonatas around already. However, the three shorter cello/piano Preludes are better stuff, more dissonant and hence, oddly, more interesting.

Out of all this, I think what counts is, as always, pure musical sense. The guy did have a very definite feel for dissonant sound-relationships, along with Bartok and Stravinsky in particular, as well as Hindemith. He could make good "themes," musical ideas you can remember, out of those dissonances. He knew how to surround such an idea with a meaningful dissonant frame, which we can now also appreciate in the listening. So—not bad. No top composer, I'd say. He lacks the furious energy and compactness of Bartók, for instance, or the enormous logic and professionalism of Stravinsky. But he is definitely worth bringing back and a lot of people who are enjoying the very late-Romantic mystic stuff now, Scria-



Theirs:

Julian S. Martin
HI-FI STEREO BUYERS' GUIDE, March-April, 1976

"Superb from every viewpoint. An outstanding achievement in headphone design. One of the most comfortable."

The Len Feldman Lab Report
TAPE DECK QUARTERLY, Winter, 1975

"Response of these phones extends uniformly from 20 Hz to over 22,000 Hz with no more than ± 2 dB variation over this entire range...this is nothing short of incredible."

New Equipment Reports
HIGH FIDELITY, January, 1976

"The sound quality the AT-706 presents [to you] is exceptional: very wide range and smooth...Within this excellent operating range the sound is exceedingly clean and open...an extremely fine stereo headset."

If you asked the critics they'd tell you to listen critically to a variety of products before you buy. We agree. Because the more carefully you listen, the more you'll be impressed by the sound of Audio-Technica.

AT-706

Electret Condenser
Stereo Headset \$129.95
Our finest Personal Transducer



audio-technica
® INNOVATION □ PRECISION □ INTEGRITY



dbx your cassettes



90

and get studio quality live recordings with absolutely no audible tape hiss. Preserve the full dynamic range of the music. With dbx 122 noise reduction you get 30 dB better signal-to-noise ratio and enjoy the bonus of 10 dB extra headroom in recording. Use the dbx 122 to make copies on cassette that cannot be distinguished from the originals.

dbx 122 noise reduction nearly doubles the dynamic range, and increases the signal-to-noise ratio of any cassette machine by 30 dB, allowing cassette sound to approach open-reel quality for the first time. The unique dbx system prevents the normal high frequency tape saturation which plagues standard cassette recordings and transforms your cassette recorder into a genuine high fidelity instrument.

Ask the dbxpert at your dealer to show you how the dbx 122 noise reduction system makes a miracle machine out of your present cassette recorder. For complete product information and a list of demonstrating dbx dealers in your area, circle reader service number or contact:

bin and so on will find this music of the same period quite to their ears' taste.

All three performers here are competent and musically self-effacing—that is, they bring you Ornstein, not their own egos. Good.

Gala Concert, International Piano Library. Royal Festival Hall. **Desmar DSM 1005**, stereo, \$6.98.

A live concert on discs can be excellent—if it is honestly and skillfully presented, like this one. 14 pianists, male, female, young, mature, variably famed, solo, in pairs, eight at a time; much serious work but also some lovely slapstick—a travesty of Beethoven's *Turkish March* for 8 pianos, a session with Victor Borge and the Portuguese (who have Portugoslings...). Excellent editing, the applause natural and unfaded, only the interim sonic clutter (and a few musical numbers) removed. Mostly good piano sound, too, though inevitably somewhat variable, depending.

Purcell: Dido and Aeneas. Thomas, Sheppard, Watts, Tear, Oriana Concert Choir & Orch., Deller. **Vanguard Bach Guild HM 46 SD**, \$3.98.

Part of Vanguard's immense and mostly reissue Historical Anthology series, this is typical, I'd say. A lovely but by now rather dated performance, "authentic" in the instruments (harpsichord, etc.) but still late-Romantic in sound. The overture, for instance, is almost Stokowski, very slow and minus the obligatory double-dotted rhythm now standard (and correct). But the price is right and the Vanguard recording, as always, is excellent. Good bargain.

Musica, The First Guide to Classical Music on American Radio Stations. Box 1266(A), Edison, N.J. 08817, \$3.00.

Listen to classical radio? There are 14 stations that play classical—some sort—24 hours a day. But (it says) more than 500 are on part time and the question is—when?

This little pamphlet gives you your working papers. No mention of any specific music and I'm not one for classical wallpaper. But at least this is a step on the way; you can find out what hours every station plays classical, type unspecified; then either listen in or write for a program booklet, which most have. Could save you hours. Later editions seem to be envisioned.

dbx, Incorporated, 296 Newton Street
Waltham, Massachusetts 02154 • (617) 899-8090

dbx

Check No. 11 on Reader Service Card

AUDIO • DECEMBER, 1976

European records

John S. Wright

This is the first edition of a quarterly column to appear in *Audio*, each explicitly dealing with European record releases likely to be of special interest to the U.S. hi-fi enthusiast.

It is now over one year since I started writing a similar monthly column for a British publication, in which current record releases have been reviewed with particular emphasis on their technical merit. As far as was reasonable, the musical content has been objectively reported without undue criticism, this being left to the more specialist record magazines. Such an undertaking has tended towards "serious" music, since popular presentations largely exist only in their recorded format and therefore no direct comparison with reality is possible. Even so, the remaining releases can be broadly sub-divided into two categories: those recordings attempting to recreate the original performance with minimum of addition and subtraction and those deliberately contrived to create a new musical ex-

perience within the confines of the medium. Both approaches have their merit. In this issue, I have looked back over the previous 12 months to select highlights epitomizing the best of each.

For extraordinary consistency of high standards, the "John Wright Award 1976" must be given to Philips. Indeed, it is difficult to choose a *best*, especially in chamber music recordings, since their results are so fine, and it is difficult to envisage how improvements could be made within the confines of commercial stereo and without facilities for proper surround sound. The whole series of Beethoven string quartets from the *Quartello Italiano* has been a sheer delight, not only in the sensitive and unsentimental interpretation, but also as fine sound. The quartet is not only brought into the listening room, but the ambience in the recording allows the room to be extended back to accommodate it. String tone therefore has bite and attack, yet does not suffer

from the dryness often associated with such techniques. The *Rasumovsky Quartets* on two records illustrate this well with only slight variations between sides, while the later recording of *Quartets Nos. 2 and 4* on one disc (6500 646) provides the perfect sampler for the whole series. Turning to Mozart, the complete string quintets played by the Grumiaux Trio with Gerecz and Lexueur (6747 107, three records) is slightly brighter, yet is as rich in ambience. The performance is impeccable.

Music of the Renaissance has had its own renaissance by the recording companies and of special merit is a varied and interesting selection of music written during this period played by the Philip Jones Brass Ensemble (Argo ZRG 823). When listening to brass instruments live, I am always astounded by the comparative lack of fundamental, almost implied by vast extension of overtones, which causes the notes to cut through the air as if saw-tooth in waveform. Very

91

The King's Singers



What you don't know
about effective tip mass
won't hurt you,
just your records.



You can find out
what you don't know
by contacting us for our
comprehensive
cartridge brochure.

Bang & Olufsen

Bang & Olufsen of America, Inc., Dept. 10G
515 Busse Road, Elk Grove Village 60007

Check No. 6 on Reader Service Card

rarely is this captured on tape, let alone on disc, yet this record is such a one, presenting horrendous accelerations to the stylus which secondarily provide a severe tracking test. However, all good pick-ups, properly set up, should be able to cope with it.

Fine brass sounds also from Philips, naturally. The Don Smithers' Consort recording of **The Trumpet Shall Sound** got a rave review for crisp brass, extended organ, and convincing perspective. A second album has since been released. Entitled **Bach's Trumpet** (6500 925), Don Smithers plays the natural brass instruments of Bach's time, together with his ensemble of viols, percussion, and organ, in arrangements of chorals. To be heard to be believed, it outpaces the earlier release demonstrating vast dynamic range and extended frequency response. If you don't like Bach, get it just the same.

From the sublime to the astonishing comes the latest recording of the **Sorcerer's Apprentice** (on Decca SXL 6770) conducted by Weller. A gut wrenching bass drum, glistening cymbals, and an analytical balance makes this a hi-fi spectacular well supported by the fresh, animated performance. Guaranteed to impress, whatever the playback equipment, it's all great fun.

EMI has also been producing their share of demonstration standard orchestral material, and the Ravel album containing *Bolero*, *La Valse*, et al, immediately springs to mind (ASD 3215). This embodies enormous dynamic and frequency range yet with a proper sense of distance. Exciting performances too...

I have repeatedly complained that works encompassing voice and orchestra are unconvincingly recorded. This has been partly due to an inability to recreate the full range presented by these works, especially with Mahler, and also to the persistence of record companies in close microphoning soloists to bring them forward, as if isolated in their own acoustic environment. There are pathetically few exceptions to these criticisms, but the glaring contradiction has been the Boult series of Elgar oratorios culminating in this year's release of **Dream of Gerontious** (EMI SLS 987, three records). The dynamics, perspective, range, and a particularly relaxed balance are so eminently suitable to such a production that one wonders why it should be so rare.

In fact, vocal recordings have not fared too well and the only other truly outstanding vocal also comes on EMI

let's
make it
dynakit

Stereo components . . . easy to make kits or assembled.

Write for free 24 page color catalog



Dept. S-1, Box 88, Blackwood, N.J. 08012

dynaco
dynakit

with unaccompanied part songs from the King's Singers in their **Concert Collection** (CDS 3766). Not surprisingly, the engineering of both these and the Elgar is by Christopher Parker, and arrangements of *Billy Boy* and *The Mermaid* are performed in the King's Singers' inimitable manner. Voices are firmly positioned across and within the stereo stage to provide a "carved in space" effect. Although not apparent, the dynamic range is large and high velocities on sibilants can cause tracking problems. However, I had no insuperable difficulties and can thoroughly recommend the disc, low frequency traffic noise and all.

There has lately been a revived interest in the music of Vivaldi, and I Musici, recording with Philips, has done much to encourage this. We have had both bassoon and oboe concertos, but the former is my favorite both musically and technically (6500 919). The bassoon forms a very solid, central image, slightly forward of the orchestra, which remains stable even when one walks between the loudspeakers. Slightly contrived, but very charming. In similar engineering vein is a Decca recording of waltzes by Emile Waldteufel (SXL 6740). With razor sharp images and a general studio-type presentation, such well known items as *The Skaters Waltz* provide ideal light music demonstration pieces. For a similarly high standard of musical wall paper try also the **Rossini Overtures** recording by Neville Marriner and the Academy of St. Martin-in-the-Fields (Philips 6500 878). Turn up the volume to a realistic level.

I gave a particularly enthusiastic review to Bernard Haitink's performance of the Tchaikovsky **Fifth Symphony** and can find no reason to change my mind. Another Philips record (6500 922), this rates as one of the outstanding orchestral discs of all times. I concede that some people would prefer something more obvious, particularly on inferior equipment, but the incredible dynamic range coupled with an enormous sense of space is presently second only to a live performance when played on a monitor class system.

With next year just around the corner, I must refer to the last New Year's Concert performed by Willi Boskovsky (Decca SXL 6740). Audience reaction to the usual selection of Strauss favorites adds to the atmosphere. Best listened to right through, rather than picking out odd items, the recording has a superbly neutral qual-

ity; looking down on the performance, as it were. The party spirit is captured in detail while special effects towards the end of the concert leaves one in no doubt that full range has been preserved. If Decca were to record it again this year, I doubt if they could do better.

Just over a dozen records then, each specially selected for particular interest to the audiophile from over 100 reviews during the year... Even

so I have only listened to a small cross section of the total releases, but this illustrates the difficulty an enthusiast is likely to encounter, even in England, when choosing really fine recordings from the dealer's rack. Indeed, I hope that these recommendations do not disappoint. At least you have someone to blame if they do. In the March issue of *Audio* I shall bring to your attention those worthwhile European discs received in the meantime. **A**

THE BEST EQ KIT VALUE ANYWHERE!

A Quiet* Announcement, Based On The Undistorted* Truth About Equalizers

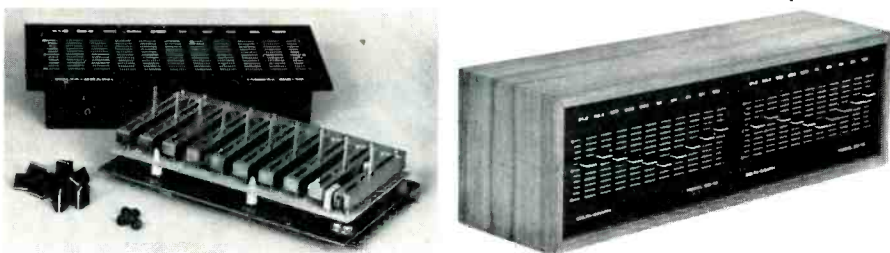

Does the equalizer you're considering offer full ten band control with symmetrical "mirror-image" boost and cut responses centered on ISO preferred octave bands? Does it have permanently-lubricated 60mm metal-cased sliders with metal shafts and center click detents? Do the specs tell you what to expect at **all** settings...or only at the "flat" setting, where the critical tuned networks are bypassed? Does it employ advanced hum & saturation-free "gyrator" simulated inductors on **all** low and mid-frequency bands? How about truly differential balanced and unbalanced inputs and outputs for use in **any** audio system, amateur or pro? And "fit anywhere" packaging designed for 19" rack, in-wall, in-console or optional wood cabinet mounting? What about truly **flat** response (both amplitude and phase angle) at the center reference setting?

WE BELIEVE IN OUR PRODUCTS. We want you to see them...read our fully-illustrated assembly and applications guide...inspect the quality of the components... **at no risk to you!** Simply use the coupon below to indicate the item(s) you want, your name and address and enclose a check or money order (no COD or bankcards) for the full amount. Upon receipt of your completed order, we'll rush your kit(s) to you, pre-paid shipping in the U.S.A.

After careful inspection of the kit(s), you may return any or all items in their original unassembled condition for a full immediate refund if you are not totally satisfied...(no questions asked.) And, if you decide to keep and build the kit(s), our normal guarantee on the specs and parts still applies...if your properly assembled kit(s) fail to operate as stated, we will exchange any defective parts free for the first 30 days.

*QUIET 90dB below 1 volt input, 20 to 20K, set flat or fully boosted *UNDISTORTED...Below 0.1%THD & 0.05%IM at **any** EQ setting...below 0.05%THD and 0.0075%IM set flat.

ORDER BLANK

QUAN.	ITEM	DESCRIPTION	PRICE
()	EQ-10M	Single EQ module kit (mono) less power supply	\$ 56.00
()	EQ-10SP	Two EQ module kits (stereo) plus PS-4 power supply kit	\$130.00
()	EQ-10QP	Four EQ module kits (quad) plus PS-4 power supply kit	\$235.00
()	EQ-1082P	Eight EQ module kits plus two PS-4 power supply kits	\$460.00
()	PS-4	Power supply kit(open frame)power up to four modules	\$ 20.00
()	EQ-10WC	Walnut veneer (genuine wood) cabinet fits EQ-10SP kit	\$ 20.00

AMOUNT ENCLOSED \$ _____

NAME _____
 ADDRESS _____
 CITY _____ STATE _____
 ZIP _____ COUNTRY _____

Washington State residents add 5% state sales tax. Returns of unassembled kits for refund must be made within 10 days of receipt and returned items must be packed in original condition, using original packing materials. Prices and "trial offer" valid for orders postmarked on or before January 31, 1977. Outside U.S. check reader service card for ordering information.

Delta-Graph Electronics Company P.O. Box 741 Dept. AM Pasco, WA 99301

JAZZ & blues

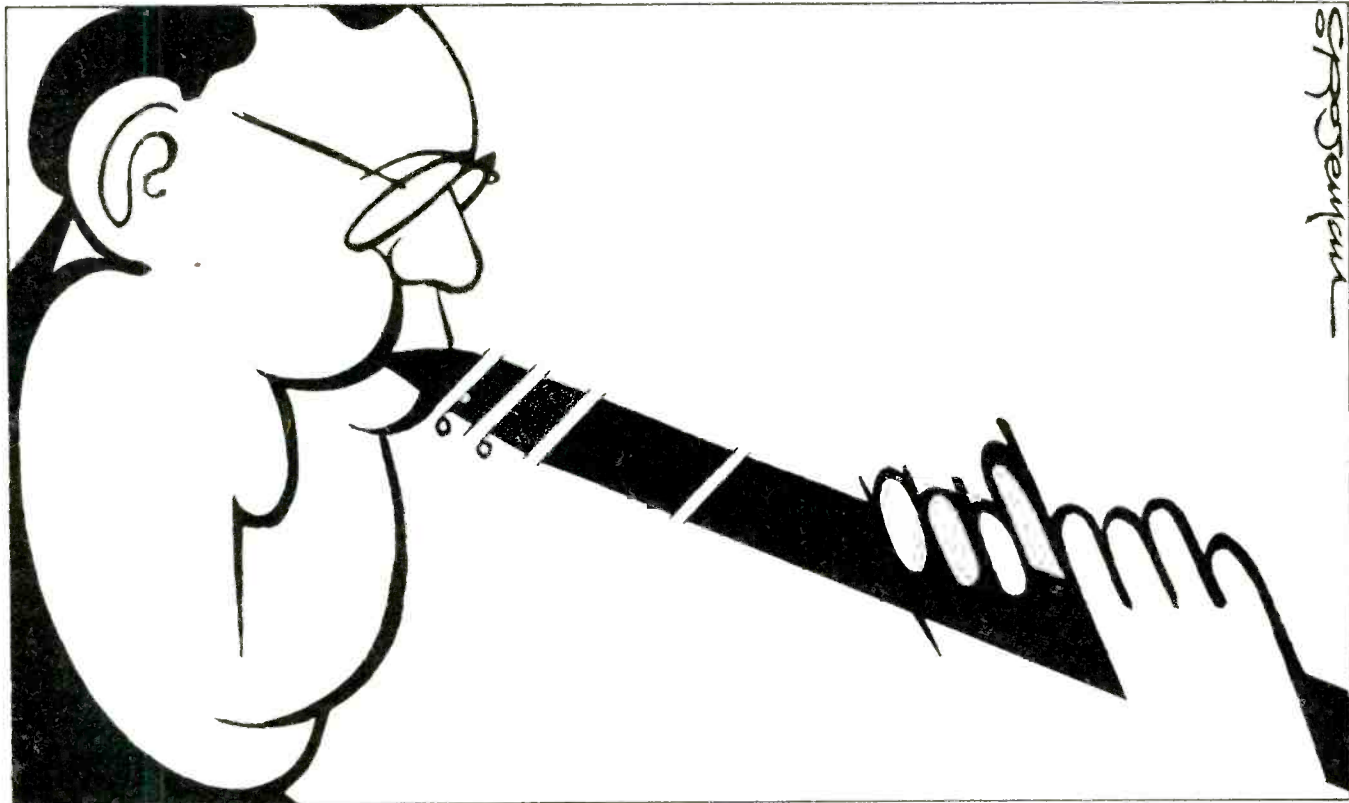

94

The Complete Benny Goodman

Vol. 2: RCA AXM2 5515, mono, \$7.98.

Vol. 3: RCA AXM2 5532, mono, \$7.98.

Volumes Two and Three in RCA's **Complete Benny Goodman** series represent what may be considered the peak period of the first and greatest Benny Goodman band. The sessions on these two double sets cover recordings made for Victor from late 1935 through 1936, and as a bonus, Volume Two offers four superb 1936 sides cut by the Gene Krupa Swing Band, an informal group of jazz giants under Krupa's nominal leadership which included Goodman, trumpeter Roy Eldridge, and tenor saxist Chu Berry. In addition, Volume Three boasts five vibrant recordings by the original Benny Goodman Quartet.

This is truly a feast for the jazz fan who loves the Swing Era. Here is bright, zestful music; here are the lilting melodies and driving rhythms which ignited the country in the mid-30s. Volume Three is a brilliant cross-section of the kind of music played by the Goodman band as it swung its way cross-country, playing night after

night for dancers and listeners at the Paramount, Palamoor, Manhattan Room, and at hundreds of other dance pavilions and ballrooms. There are so many high points—Helen Ward's infectious vocals on *Goody Goody*, *Sing Me a Swing Song*, *It's Been So Long*, and *You Can't Pull the Wool Over My Eyes*; the spirited bounce and swaggering, collective good feeling of the Goodman troops on *Stompin' at the Savoy* and *Breakin' in a Pair of Shoes*; the sheer exuberance and drive of instrumentals like *Swingtime in the Rockies* and *I Found a New Baby*; the scorching solos by trumpeters Harry James, Ziggy Elman, Chris Griffin, and Pee Wee Erwin; a powerhouse brass team unmatched by any white band during the Swing Era; there's Goodman's marvelous pianist Jess Stacy, whose sharp, staccato solo lines can be heard skipping nimbly in and out of the riffing sections. And there's Goodman's powerful, virile playing on clarinet, the blistering tone and flaming intensity that made him the idol of a generation. (BG sounds like a man-pos-

sessed on the Krupa pick-up band sides, particularly *Swing is Here* and *I Hope Gabriel Likes My Music*, and there are equally wild solos by Chu Berry and Roy Eldridge.)

Volume Three of the **Complete Benny Goodman** features the magnificent Goodman Quartet formed in August of 1936 when BG asked vibist Lionel Hampton to sit in on some sessions with Krupa and Pianist Teddy Wilson. These Goodman quartet sides—*Moonglow*, *Dinah*, *Whispering*, *Tiger Rag* and *Vibraphone Blues*—are exuberant yet sensitive examples of chamber jazz at its finest; the extraordinary musical and emotional empathy between this classic foursome is evident to anyone with ears.

Three Ella Fitzgerald-Goodman rarities were also supposed to be included in Volume Three—*Goodnight My Love*, *Did You Mean It?* and *Take Another Guess*—these collaborations came about when Goodman's regular vocalist Helen Ward fell ill. Ella, then in her second year with Chick Webb, was called in. Neither she nor Good-

man thought about her contract with Decca, and when the Goodman/Fitzgerald records hit the market, Decca insisted they be withdrawn. Goodman then re-recorded one tune, *Goodnight My Love* with Margaret McRae, a relatively stiff, pompous singer. In the 60s the contractual differences were resolved, and the Ella sides were reissued on two Goodman long-playing collections. But somebody goofed at RCA when they assembled **The Complete Benny Goodman Vol. 3**—although the liner text lists *Goodnight My Love* as the Fitzgerald version, what we get, recycled, is the dull McRae vocal. However, *Did You Mean It* and *Take Another Guess* are the long-suppressed Ellas, and she sounds remarkably authoritative for 17 years of age, swinging nonchalantly, with the warmth, suppleness and easy phrasing of a fine jazz instrumentalist. *Did You Mean It?* also features 16 stomping bars by tenor sax man Vido Musso, and *Take Another Guess* is a fine example of the Goodman crew's jazz-inflected way of working over a flimsy pop tune and turning it into a gem; the airy saxes and biting brass are beautifully conveyed in the crisp monaural sound. Indeed, the remarkable clarity of these 40-year-old Goodman discs appears to be due to a fine remastering job by RCA's Don Miller.

John Lissner

Sound: A Performance: A+

The World of Duke Ellington, Vol. 2 Columbia KG 33341, two discs, monaural, \$5.98.

Duke Ellington was the only jazz leader able to keep a big band together for over 40 years. From 1927 until his death in 1974, the Ellington band continued to work—and record. Even during the difficult period of the late 40s and early 50s that saw the demise of most of the great bands, Ellington gigged steadily and turned out a stream of records for Columbia. Some of these have already been reissued on **The World of Duke Ellington, Vol. 1**, reviewed in these pages last year. **Volume Two** is an agreeable compendium, and, while some of the material is inconsequential, the playing remains on a consistently high level. Outstanding are three cuts from a Dec. 30, 1947, recording date. *The Clothed Woman*, the opening track on side one, is a blithe, striding piano romp by the Duke; *New York City Blues* (how prophetic!) is a sensuous and moody piece with rippling pas-

sages by Duke, lovely, pastel shadings by the ensemble, and eight tasty bars by trumpeter Shorty Baker and altoist Johnny Hodges. *Let's Go Blues* is an informal blues jam with punching, spontaneous solos by Duke, Hodges, trumpeter Al Killian, saxophonist Al Sears, trombonist Tyree Glenn, and clarinetist Jimmy Hamilton. For an Ellington collector, these three tracks will be worth the price of the album.

A September 1, 1949 date brings us a taut reworking of the haunting *Creole Song* with an exquisite wordless vocal by Kay Davis and fine growl trumpet by Ray Nance; something called *The Greatest There Is* is a jaunty blues with an OK vocal by a lady named Lu Elliot.

Record one, side two offers us more of Lu Elliot on *Good Woman Blues* with splendid obligato passages by

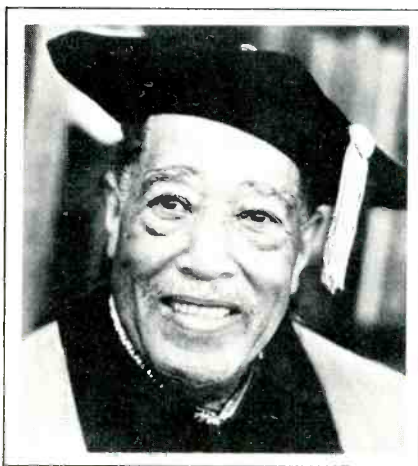

Johnny Hodges. The ubiquitous Ms. Elliot turns up again on a horror titled *Joog Joog*, a pop tune which features an ooh and aah-ing vocal group; Elliot's vocal on *The Sunny Side of the Street* is helped by a strutting alto solo by Johnny Hodges. *Snibor* is a galloping Billy Strayhorn instrumental, and *B Flat Blues* has funky solos by Glenn, Carney, Nance, and Hamilton.

Side two, record two is a mixed bag with trite pop stuff such as *Love You Madly* and *Build That Railroad*, along with the flashy, flamboyant 1951 recording of *The Hawk Talks* with Louis Bellson's powerful drumming and Cat Anderson's sky-high trumpet. *Jam With Sam*, a 1951 tune that became a standard at Ellington concerts, is mainly an indulgence in trumpeter Anderson's pyrotechnics, and though it has always created concert excitement, it comes over on one's audio system as a shrill, noisy bore. *The VIP Boogie*, on the other hand, is one of Ellington's finest recordings of the 50s with a rich, sonorous cadenza by

The Audio Critic is coming!

The Audio Critic will be the first regularly published, noncommercial review of high-priced ("exotic") audio equipment.

Nothing remotely like it has been available so far. It's more like an investment advisory service than an audio publication.

Six times a year, by subscription only, The Audio Critic brings you comparative test reports in depth, bluntly naming by name what's best, what isn't and why.

Unlike the commercial, mass-circulation hi-fi magazines, The Audio Critic can't be inhibited in its outspokenness by advertisers, since it carries no advertising. (The only exception will be small-space classified ads placed by subscribers.)

And unlike the free-lance equipment reviewers and columnists of these magazines, The Audio Critic has no career-serving interest in being buddies with manufacturers. So it can be merciless in its criticism of the most powerful names, should the occasion arise.

On the other hand, unlike the little "underground" audiophile reviews, The Audio Critic recognizes the journalistic obligation to meet deadlines and show up in your mailbox on schedule. Not at six-month or nine-month intervals, or possibly never again . . .

Also unlike the undergrounds, The Audio Critic has the professional depth (and capital) to operate its own, in-house laboratory facility, complete with spectrum analyzer, highly specialized signal generators and other sophisticated test equipment. These are used as an indispensable check on The Audio Critic's subjective, "golden-ear" evaluations, which of course have top priority.

One year's subscription to The Audio Critic (six issues) costs \$28, first-class mail only. That's cheaper than any Wall Street advisory service of comparable scope and quality.

Volume 1, Number 1, to be mailed the first week of January, features a giant survey of some two dozen preamplifiers with pretensions to state-of-the-art. (Yes, they're all there, from AGI 511 to Yamaha C-1 and C-2, all identically tested under the same roof over the same period of time.) Plus exclusive information on speakers, tone arms and other equipment.

To make sure you can get a copy of this necessarily limited-run issue, send your \$28 subscription for the first six issues today to The Audio Critic, Box 392, Bronxville, New York 10708.

baritonist Harry Carney. *Pretty and The Wolf* is a witty and urbane monologue by Duke on women, but offers little of musical interest. All in all, this Ellington potpourri has enough good material to make it a worthwhile issue.

John Lissner

Sound: B+

Performance: A

Big Bad Band—Live: Clark Terry

Musicians: Jimmy Heath, Ernie Wilkins, Phil Woods, Arnie Lawrence, Charles Davis, reeds; Clark Terry, Jim-

my Nottingham, Oscar Gamby, Richard Williams, Greg Bobulinski, trumpets; Sonny Costanza, Jack Jeffers, Janice Robinson, Jimmy Wilkins, Chuck Connors, trombones; Ed Soph, drums; Wilbur Little, bass; Duke Jordan, bass.

Songs: *Una Mas, Nefertiti, Take The A Train, Randi, Mumbles, Sheba, Cold Tater Stomp.*

Vanguard VSD 79355, stereo, \$6.98.

Live at the Wichita Jazz Festival is definitely one of the better big band releases of recent months. Clark Ter-

ry's vibrant personality, unmistakable fluegelhorn playing, and legendary mumbling give the band a solid jazz foundation.

Like the Thad Jones-Mel Lewis Big Band, the Terry group is stocked with the heaviest heavyweights and studio musicians that could be mustered. Thad's band, of course, plays arrangements by Thad almost exclusively. The Jones-Lewis organization has a most distinguishable sound even on the few arrangements that aren't Thad's. Mumbles repertoire consists of arrangements from the pens of Ernie Wilkins, Jimmy Heath, Phil Woods, etc. While Mumbles book is also a punchy arsenal of music, the band sounds like a top-notch studio band, without an identifiable sound, which for some curious reason I am unable to pinpoint. Nevertheless, it remains a dynamo of an ensemble and the album is a big band necessity.

Jimmy Heath's arrangement of *Una Mas*, by the late trumpeter Kenny Dorham, captures all the pizzazz of the original in a noteworthy samba, bossa, rhythm, and brass performance. The Big Bad Band is a monster on Wayne Shorter's "fantastically beautiful composition" *Nefertiti*, arranged by Phil Woods. Another one of the Woods' arrangements is also performed herein, *Randi*. Dedicated to Randi Hultin, jazz writer, correspondent, music lover from Norway, *Randi* features the sax section in an a capella section out front and in a swinging solo backed by rhythm along the way. Paradoxically, the sax solo is studded with bop figures, while being modally based, melodically and harmonically speaking. Obviously, it's a result of Woods' experience growing up on bop and evolving ever since.

A Clark Terry concert is just not a Clark Terry concert without some mumbling. He can mumble about anything and does just that in seizing the opportunity to do some editorial mumbling about Watergate among other things.

Ed Soph is the drummer on this album and is a remarkable asset to any big band. Soph replaces Mousy Alexander who was on Terry's previous big band release. As the drummer is so often almost the conductor of the band, Soph's replacement of Alexander proves to have been a musical prerequisite. The energy and precision with which a drummer must elevate a big band are most exposed on a kicking chart such as Wilkins' arrangement of Ellington's classic *A*

Listen to the music.

Noise in the form of hiss, hum and rumble—all the things that effectively cloud the clarity of records, tapes and FM broadcasts.

Ideally, music should be heard against a silent background. The Phase Linear 1000 achieves just that with two unique systems: AutoCorrelator Noise Reduction and Dynamic Range Recovery.

PHASE LINEAR 1000



The AutoCorrelator reduces noise by 10 dB without the loss of high frequency music and without pre-encoding.

The Dynamic Range Recovery System restores 7.5 dB of the overall dynamic range,

without the pumping and swishing associated with other systems.

The Phase Linear 1000 represents the most significant improvement in sound reproduction for the money... more than any other single piece of equipment you could add to your system. It is easily installed to any stereo receiver or preamplifier.

Ask your dealer for an audition, and listen to the music.

Not the noise.

Phase Linear

The Powerful Difference

Check No. 30 on Reader Service Card

Manufactured in the USA. Distributed in Canada by H. Roy Gray, LTD.

Train. Soph was an excellent choice as his credits on Woody Herman's Grammy winning **Giant Steps** and Bill Watrous' **Manhattan Wildlife Refuse** LPs prove. Also worth mentioning about *A Train* is Duke Jordan's piano solo. Jordan is a most percussive and melodically articulate bopper, who has been sparsely heard from in the past 10 years. He is again beginning to receive proper recognition through his **Brooklyn Brothers** LP (Muse 5015) with brilliant baritone saxophonist Cecil Payne, as well as several overseas releases on the Steeplechase label.

Big Bad Band—Live is even more successful when one compares it to Terry's last big band release. That one was a testimony to what mediocrity in recording and mixing can do to basically good music. **Live** is a fine recording which needs somewhat more bass and more band in the results. Perhaps live recordings are difficult to capture properly because random diffusion and dispersal of sound in directions other than towards the mike, as well as concert hall acoustic drawbacks. This is an OK recording, however, Vanguard has done somewhat better elsewhere. *Eric Henry*

Performance: B+ Sound: C+

Identity: Airto

Musicians: Airto, drums, percussion, vocal; Roberto, drums, percussion; John Heard, John Williams, Louis Johnson, bass; David Amaro, guitar, 12-string guitar, Elberto Gismonti, piano, synthesizers; Raoul De Souza, trombone; Flora Purim, vocals; Ted Lo, organ; Wayne Shorter, sop. sax; Herbie Hancock, Arp.

Songs: *Flora On My Mind, Wake Up Song, Cafe, Encounter, Tales From Home, Identity,, Mae Cambina, The Magicians.*

Arista 4063, stereo, \$6.98.

If one considers Krupa, Max Roach, Tony Williams, Elvin Jones, Billy Cobham archetypal figures in the development of the drummer in the rhythm section, the same accolade should also be awarded Airto. While it is always debatable who the very first, the primary pioneer of each style may have been, it is certainly understood that the success of the various developments should be associated with these and a very few other names.

Airto has taken things a step further. While drummers have generally been expected to be familiar and even competent with a variety of percussion instruments, it was on **Bitches**

Brew (supposedly "the session that swung jazz over to its percussive, polyrhythmic, bass heavy situation") that Airto's percussive directions and indirections catalyzed the idea for added percussion as the rule and not the exception.

Produced by Herbie Hancock, **Identity** is the latest of several Brazilian inspired albums by Airto. The repertoire contains a menu of samba flavored compositions. The use of electronics is somewhat more prevalent than on previous efforts. The

acoustic sound so much in the lime-light on **Natural Feelings** (Buddah BDS 21-SK), and in the music of Brazil itself, surfaces despite the overwhelming amount of electronic gadgetry (not all used at the same times, of course). Don't get the impression the music is loud and electrified. It's not! It's intense. There's a lot of feeling and fire. . . rhythmic explosions. In fact, the tasteful employment of Arp by Hancock, electric piano by Gismonti, string ensemble, etc. make the acoustics more evident and more

SUPER TUNE!



SPECTRO ACOUSTICS
Model 217 - Model 210

If you want total control over the audible spectrum to compensate for room acoustics, speaker deficiencies, etc., you want a graphic equalizer. If you want total control over phono cartridge preamplification, function selection and taping facilities, you want a preamplifier.

GET THE BEST OF BOTH!

The Model 217 is the first preamp to provide complete facility for "loading" phono cartridges to their manufacturer's specifications. Besides giving you gain selection, subsonic filter and function selection, the Model 217 has two phono inputs and bidirectional bypass copying for two tape decks. . . . and no tone controls.

WITH THE SPECTRO ACOUSTICS, MODEL 210 GRAPHIC EQUALIZER WHO NEEDS "TONE" CONTROL?

With ten bands per channel of ± 15 db boost and cut equalization the Model 210 can "tune up almost any room or speakers to YOUR taste" . . . all without adding any audible noise or distortion through the use of gyrator synthesized inductors. Full switching facilities for EQ line/tape/bypass and tape monitor as well as full range unity gain adjustments give you complete interface for professional control.

MODEL 217 Straightline Preamplifier

Specifications:
THD 0.05% 20Hz-20KHz
IMD 0.0075% SMPTE
Phono S/N 82db "A" weighted
High Level S/N 110db "A" weighted
Freq. Response 10Hz-100KHz ± 1 db

Suggested Retail \$250.00

Model 210 Graphic Equalizer

Specifications:
IMD 0.0075% SMPTE
S/N 90db below 1 volt
Over 100db dynamic range
600 ohm outputs

Suggested Retail \$295.00

SPECTRO ACOUSTICS INC.

1309 E. Spokane Pasco, Washington
(509) 545-1829 99301

The Model 217/210 combination lets you "put it together" for maximum performance of your listening environment. . . you can SUPER TUNE it.

Check No. 42 on Reader Service Card

pleasing, a powerful foil within the musical story of **Identity**. It is a perfectly invigorating blend of the two.

Various cuts on **Identity** are pleasant reminders of Brazilian tinged music elsewhere and should lead you to a host of other albums. The combination of vocals and soprano sax brings to mind **Native Dancer** (Columbia PC 33418). Airtó's vocals on *Flora On My Mind* express his longing for his better half (Flora) who had been away. The leader also vocalizes the ballad *Mae Cambina*, which in tandem with his accompanying performance on *Berimbau* (percussion instrument, with string that has a guitar-like sound), sets the mood for a rather thoughtful, relaxing few moments.

The rest of **Identity** is concerned with lively foot stomping, hip shaking, hand-clapping street music. *Encounter* brings together the vocal talents of Airtó and Flora in a breezy samba. *The Magicians*, a bubbling cauldron of instrumental potions and vocalized spells, is a brisker and busier cut time trip than *Encounter*.

Airtó is a most versatile drum set player as evidenced on the funky *Tales From Home*. His recorded per-

formances with *Return To Forever* shed additional light on his heavily exposed talents. If there is one thing for which percussionists owe credit to the likes of Airtó and his senior Brazilian Dom Um Romão, it is for opening the door for the percussionist to be visibly and acceptably versatile.

Wally Heider's recording (this one from the Record Plant in LA) demonstrates, as usual, excellent balance, capturing just the right things at the right time and in the proper proportions. **Identity** is another credit to the Arista label (the label with the fewest boobs per batch, so far) which has brought forth some excellent jazz in its first year's operation. *Eric Henry*

Sound: B+ Performance: B+

The Complete Fletcher Henderson, 1927-36: Fletcher Henderson
RCA AXM2 5507, mono, \$7.98.

As far as RCA goes, this is the complete Fletcher Henderson in one reissue. The 36 sides in this two-record set cover everything he did on the Victor and Bluebird labels from 1927 to 1936, and omits, of course, the many historically important discs he cut for Columbia and Decca. Selec-

tions range from the 1927 *Shuffle Sadie*, which sounds as lumbering and as ponderous as anything by the much maligned Paul Whiteman, to the shouting, gutbucket brilliance of the 1931 *Sugarfoot Stomp* through the fast-moving tension of the 1936 swinger, *Jangled Nerves*.

Henderson, of course, was the trailblazer for the big band jazz style popularized by Goodman, Shaw, and Dorsey during the Swing Era (Goodman's fame in the mid-30s rested strongly on his use of 50 or so Henderson arrangements and similar sounding charts by black arrangers Jimmy Mundy and Edgar Sampson). Through the Henderson bands passed such superb jazz soloists as trumpeters Tommy Ladnier, Joe Smith, Rex Stewart, Bobby Stark, Henry "Red" Allen, and Roy Eldridge; trombonists Jimmy Harrison and J. C. Higgenbotham; reed men Coleman Hawkins, Buster Bailey and Leon "Chu" Berry. All of these gentlemen are heard here to splendid advantage—Harrison concise and pungent on *St. Louis Shuffle* and *Variety Stomp*; Hawkins with a magnificent bravura chorus that climaxes *Sugarfoot Stomp*. Many of the numbers, such as *Hocus Pocus*, *Roll On*

The straight and narrow path to safe record cleaning . . .

Dust particles accumulate on records as they are played, and all sound systems reproduce dust as crackles and distortion. Cleaning arms prevent particles from reaching the stylus, but conventional arms often display severe problems involving excessive mass (makes proper tracking-cleaning difficult), tracking force (can affect turntable speed), weight, and size (some arms are too large for many turntables). These disadvantages can result in pressure that grinds dust into record grooves — rather like killing a patient to cure the Flu.

Now METROSOUND introduces linear tracking — on a cleaning arm. The LIN-TRACK™ has its own suspension system which results in negligible mass and amazingly low tracking force of only .5 gram (less force than that required for most phono cartridges). The cleaning assembly moves across the record in a straight line (the way records are originally made), so tracking is accurate for complete dust removal. The lightweight LIN-TRACK swings out of the way when not in use, and will fit any turntable.

The METROSOUND™ LIN-TRACK . . . The safe one.

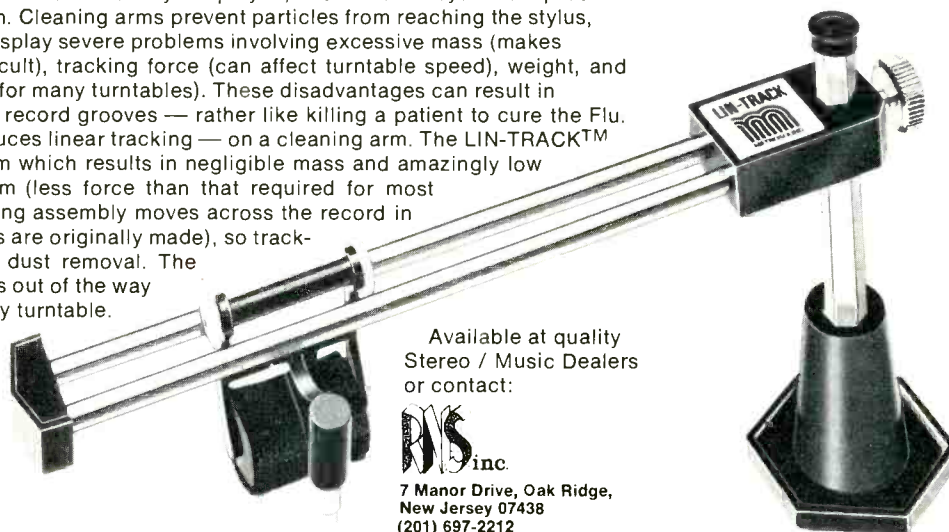

Available at quality Stereo / Music Dealers or contact:



7 Manor Drive, Oak Ridge,
New Jersey 07438
(201) 697-2212

WORLD PATENT
PENDING

Check No. 35 on Reader Service Card

Mississippi Roll On, and *Take Me From the River*, present the paradox of the Fletcher Henderson bands—soloists and ensembles that play with immense elan, with a lift, drive and guttyness rarely found in the white swing bands, yet with moments of sloppiness and faulty dynamics that drillmasters such as Goodman, Shaw or Glen Miller would never have permitted. Despite its immense reserve of jazz talent, the fortunes of the Henderson band declined as Swing grew in popularity—the band suffered partly as a result of Henderson's casualness, and because of his failure to establish a code of discipline. By 1938 Henderson was in such decline that he placed only 25th in a *Down Beat* swing poll, behind such innocuous bands as Mal Hallet's and Al Donahue's.

In 1939 Henderson dropped his bandleading career to join Goodman for a few months as staff arranger and pianist. After an abortive try with another big band in 1941 and a few special location dates during World War II, he toured as an arranger and pianist with Ethel Waters during the late 40s. In 1950 he was working at New York's Cafe Society with a sextet when

he was felled by a stroke. He recuperated, retiring to his home in Cuthbert, Georgia, then returned to New York City where he died in 1952 at the age of 54.

Henderson's career has been called a study in frustration and rightly so. For it was Henderson, as demonstrated on these recordings, who, along with Don Redmen, first explored the exciting possibilities of using large dance bands as a collective jazz instrument, thus paving the way for the enormous successes of the Kings of Swing who followed.

John Lissner

Sound: B+ Performance: A

The Essential Louis Armstrong: Louis Armstrong
Vanguard VSD 91/92, stereo, \$6.98.

The sophisticated jazz record buyer has learned that many of these "essential" collections are nothing of the sort. This two-record Vanguard set, issued from tapes of a 1965 concert at the Palais des Sports in Paris, is anything but essential, as it is Armstrong in the last decade of his performing career, sapped of most of his musical

prowess and coasting on the greatness that was once his.

While most of his admirers in the jazz world didn't like to admit it, in the last few years of his life, age had taken a heavy toll, the power, energy, and artistry that previously overflowed in each note Satchmo blew, had inevitably declined. It was because of his extravagant performing personality that Armstrong retained his enormous popularity. His genial interpretation of *Hello Dolly* in 1965 was his last big hit. These French recordings, made the same year, are unworthy of this titan of jazz and American music. The playing on tunes like *Muskrat Ramble*, *Tiger Rag*, *St. James Infirmary Blues* and *When the Saints Go Marchin' In* (selections grown threadbare by continual Armstrong All Star performances) is ragged and often out of tune. Louis the trumpet player is the faintest shadow of the genius who brought the classic jazz solo to a creative peak. If you really want the essential Armstrong, get Columbia's five-record **Louis Armstrong Story** and skip this disappointing release.

John Lissner

Sound: A— Performance: C

Live sound. Your reference and ours.

If you judge speakers by their ability to reproduce live sound, accurately... then KEF created Reference Series *for you*. Taking their latest advances in drive unit technology and applying the same uncompromising KEF standards to enclosure design and dividing networks. Right through development, live sound is the reference point. Drive units use advanced laminated diaphragms that prevent colouration by absorbing unwanted energy. At every point, the Reference Series benefits from KEF experience in building professional monitors, and from important new computer evaluation techniques. Now, two compact systems are winning world acclaim for the accurate, uncoloured quality they maintain even at high sound pressure levels...

Reference Model 104 Shelf or stand mounting 3-speaker system. High-power KEF tweeter, mid-range unit and acoustically coupled bass radiator all use latest materials technology. High-performance 6-element dividing network and, under the distinctive sculptured grille, an acoustic contour control.

Reference Model 103 Bookshelf system, with KEF tweeter and bass driver closely centre-line mounted on a unique steel baffle that rotates to keep ideal stereo image in any cabinet position. Again, the latest thinking in drive unit design, and high-density anti-resonant linings to the enclosure.

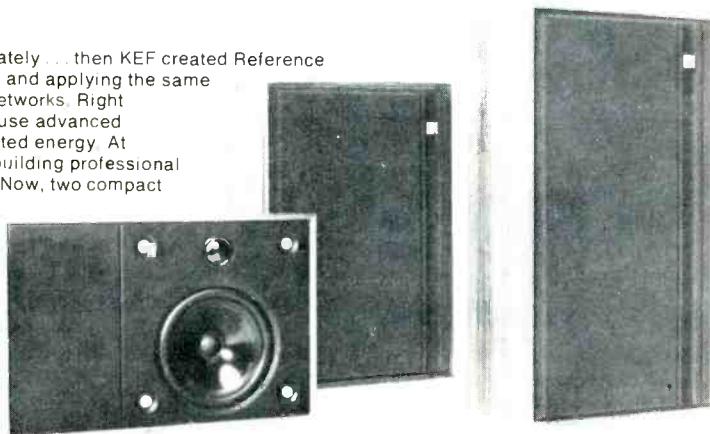

KEF REFERENCE SERIES
...if you are serious about sound

Distributed in the U.S.A. in conjunction with

INTRATEC

399 Jefferson Davis Highway
Arlington Virginia 22202
Telephone (703) 979 1400



KEF Electronics Limited Tovil Maidstone Kent ME15 6QP
Telex 96140

Check No. 20 on Reader Service Card



the Audio Amateur

THE AUDIO AMATEUR is a quarterly for the enthusiast who enjoys hands-on work in building or customizing his audio equipment, or technical savvy about his hi fi gear.

TYPICAL ARTICLES: Octave equalizers. Transmission line loudspeakers with 8" to 24" drivers. Electrostatic speakers with a 900 Watt direct drive amplifier. Mixers, preamps, parametric equalizers, stock equipment modifications for Heath and many Dynaco units. Completely tested circuits, construction aids, etched circuit boards, parts sources.

READERS SAY: "A hit here at WLWT Television ...provided several useful ideas for our engineers" "Craig Stark of Stereo Review says: "Those interests of the home constructor The Audio Amateur serves are absolutely top quality. The magazine is, I think, the only American publication devoted to the really serious audiophile constructor."

DEPT. P.O. BOX 176
PETERBOROUGH
N.H. 03458 U.S.A.



- Check here for free prospectus.
- I enclose \$9.00 for 4 quarterly issues.
- I enclose \$25.00 for twelve issues.

NAME _____
ADDRESS _____
CITY _____ STATE _____
ZIP CODE _____

Please allow six weeks for delivery. Rates above are for the U.S.A. only. Rates for other areas available on request.

Check No. 4 on Reader Service Card

Folk bag



The Master Musicians of Jajouka Adelphi AD 3000, stereo, \$7.95.

Music of Morocco
Library of Congress L63-L64, 2 discs, mono, (price unknown). Available from the Library of Congress, Music Division, Recording Laboratory, Washington, D.C. 20540.

The music of the Moroccan Berbers gained its first non-scholarly Western exposure (albeit on an underground level) with the 1971 release of **Brian Jones Presents the Pipes of Pan at Jajouka** (sic), Rolling Stones COC 49100.

The late Stones guitarist visited Jajouka, a village in northern Morocco's Rif Mountains, in the late sixties. He was so struck with the immensely powerful religio-musical force of the villagers' hillside rituals that he attempted to capture the mass spectacle on tape. Unfortunately, his recordings sounded so puny and distant when compared with the real thing that Jones souped up his tapes with phase mixing and echo effects. Although the resulting album was musically overwhelming, the sound was so distorted that it was sometimes difficult to distinguish between the original ritual itself and the electronic hype (this is especially true of the extended women's chorus on side one).

The Adelphi album, recorded in 1972 by Mark and Joel Rubiner, is intended to give a more accurate repre-

sentation of the music of Jajouka. The Rubiner brothers wisely decided to concentrate on village music as performed by a handful of virtuosi, music which much more easily survives the transition from Rif hillsides to American living-room stereos. Instead of excerpting rituals which may run for hours, the Master Musicians provide varied approaches to the most popular tunes in their repertoire (including three vastly different versions each of *Jajouka Black Eyes* and *Boujeloud*) in 3 to 6 minute doses. Those who've heard the Brian Jones album will recognize a few of the melodic themes, though again they are heard in new versions.

The music itself is a mixture of Berber and Arabic influences, while the performance style is decidedly Berber, with a forceful rhythmic insistence and energy accumulation never hinted at by purely Arabic Moroccan music. The most noteworthy tracks are performed on the *rhaita*, an oboe-like instrument with a nasal, droning wail, playing short melodic lines, sinuously twisting and turning with astounding hypnotic power over intense drumming which sucks the listener into its relentless rhythm patterns. The *rhaitas* are heard in pairs, as are the flutes, small cane instruments with a surprisingly piercing tone, swirling around each other in a whirl-



A Completely Portable, Polytonic Synthesizer System For Under \$140.00

CONJURE IT UP FROM:
THE GNOME MICRO-SYNTHESIZER kit
no. 3740 \$48.95 + 4 lbs. shipping
AND
OZ-MINI-ORGAN & POLYTONIC PITCH SOURCE
kit no. 3760 \$84.95 + 12 lbs. shipping
Hear them on our 24 hr. Demo-Line (405)843-7396
and get our FREE CATALOG with more

Magical Musical Kits

FROM: **RAIA** ELECTRONICS DEPT. 12-A
1020 WEST WILSHIRE BLVD
OKLAHOMA CITY, OK 73116

Check No. 29 on Reader Service Card

ing dash around the drum rhythms. Also heard is the *gimbri* (undoubtedly the same as the *guinbri* heard below; spellings of Moroccan instruments and styles are far from standardized), a sharp-toned lute which has a banjo-like quality to it, as the tune *Waving* demonstrates. In addition, a women's chorus sings *Teasing Bouejloud* to catchy Berber handclapping rhythms. Interestingly, the villagers have even set a repeated chant about Brian Jones to a popular village tune, sung here to violin, *gimbri*, and drum accompaniment, and also played by the *rhaitas*.

The sound is a 1000% improvement over Jones' album, despite being recorded under less-than-ideal conditions. So, even though Brian Jones got there first, **The Master Musicians of Jajouka** is a one-of-a-kind experience which should prove to be of great interest far beyond the usual academically-oriented ethnomusicological audience.

Of course, Jajouka is only one small village, and far from representative of the entire range of Moroccan music. The Library of Congress' two volume **Music of Morocco**, recorded in 1959 by Paul Bowles who also edited the anthology, reveals the existence of a surprisingly diverse range of Moroccan musical styles.

The Atlas Mountains to the south are the stronghold of the purer Berber culture, represented on sides one and two. If one can generalize from the variety of music heard here, Berber music has a very strong rhythmic content but uses very simple, repetitive melodies. These two elements are combined for maximum hypnotic power, so that the simplicity of the songs and the fervor of the performances become increasingly captivating rather than boring.

One of the most intriguing aspects of Berber music (both pure and Arabic-influenced) is the unique manner of handclapping. The hands are clapped with a quick snap, almost savagely, in strongly syncopated rhythms. On the track labeled *Chorus and Dance* from Tamaran, foot-stomping is heard in conjunction with the clapping in a dazzling display of body percussion. The handclapping most usually accompanies tight-voiced choral singing and drumming.

There are several melodic instruments of special interest as well. *El Baz Ouichen* features Rais Ahmed ben Bakrim with a strange *sprechgesang* vocal, accompanying himself with brief spurts on the one-string *rabab* fiddle. There is also a trio of *ouadas*, dog-whistle-pitched recorders; the

An Excellent Loudspeaker Needn't Cost A Fortune The Polk Audio Monitor Series



These three loudspeakers cost \$79, \$129, and \$199 each. They sound remarkably similar to each other. They also sound remarkably similar to speakers which sell for three, four, or five times as much.

The Polk Audio Monitor Series (even the Mini-Monitor Super car speaker) all incorporate a one-inch soft-dome high frequency unit, a phase coherent crossover using large air core coils, ultra-low mass plasticized polymer laminate upper bass-midrange drivers and fluid coupled sub-bass radiators. The sound is natural, boxless, and of consistent high definition.

We invite you to visit the finest audio salons to compare our speakers with the best made (costing up to \$4000 a pair!). Be ready for an ear-opener.

Write us to find out where.

polkaudio

4900 Wetheredsville Road
Baltimore, Maryland 21207

FREE McIntosh CATALOG and FM DIRECTORY

Get all the newest and latest information on the new McIntosh Solid State equipment in the McIntosh catalog. In addition you will receive an FM station directory that covers all of North America.



MX 113

FM/FM STEREO - AM TUNER AND PREAMPLIFIER

**SEND
TODAY!**

McIntosh Laboratory, Inc.
East Side Station P.O. Box 96
Binghamton, N.Y. 13904
Dept. 1

NAME _____

ADDRESS _____

CITY _____ STATE _____ ZIP _____

If you are in a hurry for your catalog please send the coupon to McIntosh.
For non rush service send the *Reader Service Card* to the magazine.

Check No. 26 on Reader Service Card

—Leader in the Microphone Field—

PRIMO

Professional Studio Unidirectional Electret Condenser Microphone EMU-4520

MODEL ▶ DM-1525

MODEL ▶ EMU-4520

◆ The EMU-4520 offers top studio quality within the reach of even the smallest studio integral 10dB level pad and low frequency control. Flat line response and great cancellation. High signal-to-noise ratio. Quality detachable us. Easily converted to omnidirectional or super-cardioid.

Omnidirectional Dynamic Microphone DM-1525

◆ Perfect feel and balance for all handheld use. Ideal all around entertainers microphone.

◆ Unique head design eliminates popping and handling noise.

SPECIFICATIONS:

MODEL	EMU-4520	DM-1525
Frequency Response	20~20,000Hz	40~15,000Hz
Output Level	-71dB -2.5dB	-76dB ±3dB
Output Impedance	200Ω Balanced	

◆ For further information write or call us today.
PRIMO MICROPHONE INC.
 2488 DELTA LANE, ELK GROVE VILLAGE, ILL. 60007
 PHONE: 312-595-1022

PRIMO COMPANY LTD.
 TOKYO, JAPAN

Check No. 34 on Reader Service Card

low-pitched, sinuous *qsbah* flute and a shrill metal flute called the *taaouadit*.

The third and fourth sides include the music of the lowland Arabs and town-dwelling Berbers, music which reflects Moorish, modern Arab, Berber, and more southerly African influences. These various styles are less noticeably rhythmic, but more developed melodically than the highland Berber music. One very short track of *Rhaitas and Tbola* is reminiscent of *Jajouka*, and there are examples of *guinbri* music in a more pan-Islamic style (i.e., in the style of popular music which has spread throughout North Africa and the Arab nations of the Middle East). Two examples are included of Gnaouan music, representing a cult of healers whose roots are in sub-Saharan West Africa. (A full side of Gnaouan music, featuring *guinbri*, drums, and loudly clacking metal castenets called *qarqabats*, can be heard on Lyrichord's **The Pan-Islamic Tradition: Music of Morocco, Vol. 3**, LLST 7240, even though Gnaouan music is outside that tradition. That album includes the *soursal* rattle which was removed from the *guinbri* for the Library of Congress album because of recording difficulties.)

Side four includes a lengthy example of Sephardic Jewish music, superbly sung by Hazan Isaac Ouannounou, plus two samples of the Moroccan classical music, known as *Andaluz*. *Andaluz* in its true form (*El Hgaz el Mcharqi* on this set) is a survival of the Moorish art music developed during the Muslim occupation of southern Spain. Since the Moors' return to Morocco, *Andaluz* has spawned a less complex, popular form called *qsida* (*Qsida Midh* included here), with some Berber influence. Both genres are performed by ensembles of stringed instruments and percussion with a more restrained singing style than is common in other popular and folk music. *Andaluz* and its offspring provide a purely Moroccan Arabic music arising from the Arab tradition.

The sound quality of the Library of Congress set is variable, with larger choruses and ensembles faring less well than solo or small-group tracks. The sound rating given below takes into account the circumstances of the recordings. The music, though, is too valuable to overlook. *Tom Bingham*

The Master Musicians of Jajouka
 Sound: A- Performance: A
Music of Morocco
 Sound: B- Performance: A

102

See What You've Been Missing... Read Audio's Classified



Introducing EXCELLENCE in mobile sound **POWERPUNCH**

- 35 watts per channel 4-ohm load.
- THD less than 0.3% @ 10 watts output.
- Patented active equalizer provides maximum boost of +18DB @ 55 hz and +12DB @ 20 KHZ.
- Rock solid regulated Ultrasonic power supply.
- Input provisions for any signal source.
- Direct coupled power amp incorporates I.C. circuitry.
- Available with custom woofers and tweeters.

FOSGATE ELECTRONICS
 2034 N. 3rd St., Phoenix, AZ 85004. (602) 257-9705
 National Marketing Division—Made in U.S.A.

Check No. 15 on Reader Service Card

AUDIO • DECEMBER, 1976

The Compleat Dancing Master: John Kirkpatrick and Ashley Hutchings
Antilles AN 7003, stereo, \$4.98.

Ever since Fairport Convention established "electric-folk" (or "rocked folk"—traditional folk and country-dance music played on electric instruments with a rock rhythm section) as a genre distinct from the more conventional "folk-rock," several British and Irish bands—from Steeleye Span to Horslips—have been refining and extending this approach into new, often experimental areas.

Perhaps the most unusual application of this concept yet is a curious, but compelling entertainment called **The Compleat Dancing Master**, put together by concertina/accordion player John Kirkpatrick and former Fairport bassist Ashley Hutchings. With the help of several highly-respected British actors (Gary Watson, Michael Gough, Michael Hordern, Alec McCown, and others) and a motley assortment of British folk, classical, and rock musicians (including former Fairport Conventioners Simon Nicol and Dave Mattacks), **The Compleat Dancing Master** provides a short, informal overview of British dancing and dance music.

The dances cover several centuries and cultural levels, from the lively stantipes of the medieval period, to the stately dances of the Tudor court, up to the "vulgar" country dances of the 18th and 19th centuries. The music is split between authentic period styles and the Fairport electric-folk approach, drawing a wide assortment of unusual combinations from a large pool of instruments (including such far-flung resources as pipe and tabor, bass crumhorn, rebec, hurdy-gurdy, viols, serpent, hammered dulcimer, right up to the modern-day alto sax, electric guitar, bass guitar, and drums, among many others). The actors read brief, pertinent excerpts from works by Chaucer (in middle English), Shakespeare, Dickens, and other writers (including a Puritan command against the wanton depravity of the lustful sin of dancing); the Dickens is particularly interesting for its lurid portrayal of a country dancehall that brings to mind a modern disco!

As a mosaic of English dance music through the centuries, along with contemporary opinions on the subject—or simply as a casual diversion—**The Compleat Dancing Master** is a tuneful, toe-tapping, in-

structive, and thoroughly delightful record.

The recording is excellent, with the historic and folk instruments balanced for maximum clarity above the bite and sock of the rock rhythm section. However, the readings are either just too loud or too quiet in relation to the music.

Tom Bingham

Sound: A—

Performance: A

Fresh Produce: Hickory Wind
Flying Fish 018, stereo, \$5.98.

After their first album, **At The Wednesday Night Waltz**, which was traditional American music with eclectic arrangements, Hickory Wind's second comes as a total but pleasant surprise. **Fresh Produce** sounds like an anthology of international folk music dances recorded in a haunted house. The spooky, oblique harmonies along with their general concept of arranging puts them in the same category as the recent English groups, Ti Ra Nog and Lindisfarne.

From the opening *Everybody Loves My Baby to Turkey In The Straw*, this album keeps on cookin'. As always, the slow cuts like *Moonshine Girl*

Could Your Speaker Pass This Test?

Conventional speakers all use some form of paper for the cone. The problem with paper is that it's not stable in terms of performance. It's affected by humidity and dryness.

Did you ever notice how your newspaper feels on a rainy day?

So our Chief Engineer spent years seeking out a new and different material having the lightness of paper, but with stability that would not change characteristics as the weather changed.

Our cone is only one of many innovative design features of Hartley speakers.

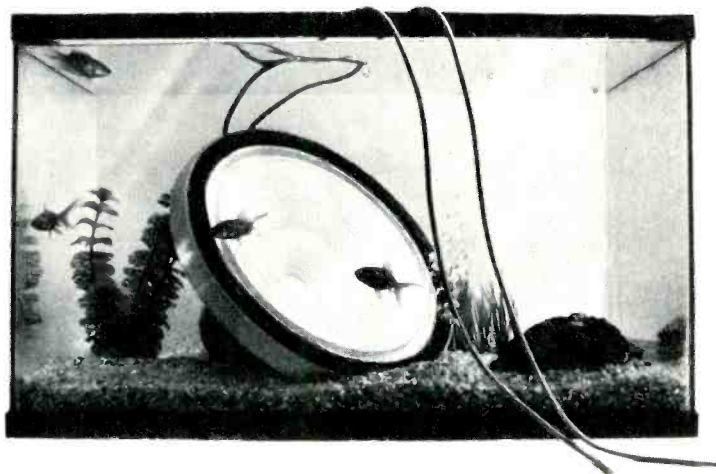

THE HARTLEY POLYMER SPEAKER IS SO IMPERVIOUS TO MOISTURE, IT CAN BE PLAYED UNDERWATER WITHOUT DAMAGING THE CONE.

To learn about the others, write:

Hartley Products Corporation

620 Island Rd. Ramsey, N.J. 07446

201-327-4443

provide the best test of a group's ability, and Hickory Wind passes with flying colors.

Like all Flying Fish productions, the sound quality is superb and **Fresh Produce** turns your whole wall into a stage. Check out *Shaking Down The Acorns* for a real test of recording quality; there are two fiddles, one on each channel. Snares, congas, harp, hammered dulcimer, mandolin—every instrument comes out clearly, with presence, and the vocals are

equally precise. These folks know what they're doing. *Daniel P. Dern*

Sound: A Performance: A-

Ragtime Guitar: Paul Lolax
Titanic T1-13, stereo, \$7.00.

Ragtime, as created by Scott Joplin, quickly lost its classical grace in the honky-tonks of Storyville where it gave birth to jazz. While syncopation does lend itself to footstomping,

much of the music contains a lightness and grace too good to stay lost. Played on classical guitar, Joplin's works regain their Chopinesque delicacy.

Lolax's approach succeeds; in all the tempo changes he never loses a note and, at the same time, conjures up the feeling of a lazy afternoon while listening to some court troubador play during an idle hour.

Technically, this album has two particular merits. First is the mixing by producer Ralph Dopmeyer, and the other is the use of dbx in the recording process, which makes the disc remarkably noise-free and the tones pure. *Titanic* is considering further releases of its original instrumental recordings of classical music in two editions, one regular and the other dbx-encoded.

While there is no shortage of ragtime piano or banjo, this album manages to fill a previously empty niche and is not to be missed.

Daniel P. Dern

Sound: A Performance: A-

Satisfied 'N Tickled Too: Taj Mahal
Columbia PC 34103, stereo, \$6.98.

Something's wrong with Taj Mahal's latest. Like the previous **Music Keeps Me Together** he is mostly backed by a slightly expanded version of the reggae-based band he's toured with for over a year.

The lengthy (25+ minutes) first side is all Taj songs while the flip is a skimpy (under 14 minutes) four songs supplied by members of the band with Taj himself all but absent. And all of the few highlights are on the Taj side.

The title song, by Mississippi John Hurt, and the traditional updated *Ain't Nobody's Business* have been staples of Taj's live show for years and have finally reached one of his albums. To tell the truth, however, a superior solo *Ain't Nobody's Business* appeared on the Big Sur Festival album, **One Hand Clapping** (Columbia KC 31138). *Black Man Brown Man* hits a groove similar to the twice-recorded *West Indian Revelation* as a gently lapping reggae song. Unfortunately the elongated jam *Baby Love* never goes anywhere and almost single-handedly torpedoes the first side.

The second side is a waste. That leaves **Satisfied** as a shoddy album from a fine musician. I'm not satisfied at all.

Michael Tearson

Sound: C Performance: D+

AUDIO • DECEMBER, 1976

"An Invaluable Reference"

— High Fidelity Magazine, Leonard Marcus, Editor



1976 Schwann Artist Issue

"Whether you're a novice classical disc collector or a jaded music critic, this elegant, easy to read, clearly ordered catalog is all together invaluable."

— *The Boston Phoenix*, David Moran, Music Reviewer

"A Godsend . . . wonderful aid for music writers and researchers . . . people have yet another reason to be grateful to Schwann."

— *Record World*, Speight Jenkins, Classical Editor

The 1976 Schwann Artist Issue lists classical records and tapes (as in Schwann-1 and -2 through January 1976) by performing artists. It contains some 25,000 entries and is in six sections:

- 1) Orchestras, Quartets, etc.
- 2) Conductors
- 3) Instrumental Soloists (Violinists, Pianists — performers on 52 different instruments.)
- 4) Choral Groups
- 5) Operatic Groups
- 6) Vocalists

Be sure to get your own copy of this 280 page book. It is in record shops throughout the U.S.A. If your dealer has run out of copies, ask him to order more from us while limited supplies last.

\$3.95
at your dealer's
\$4.50 by mail

If your dealer cannot supply you, send this coupon, but PLEASE try your dealer first. If you do not wish to cut out this coupon, use plain paper giving the information requested.

Schwann Publications AU
137 Newbury St., Boston, Ma. 02116

Please send me a copy of the 1976 Artist Issue.

I am enclosing \$4.50 cash or check (no stamps) to cover cost plus postage and handling.

Name _____

Address _____

City _____ State _____ Zip _____

Classified

FOR SALE

ANTI-SKATING for AR TURNTABLES!! Proven counterweight design of nickel steel & aluminum construction. Install yourself in minutes. \$7.00 postpaid. (Dealer inquiries invited.) AUDID INNOVATIONAL PRODUCTS, P.O. Box 1607, Portsmouth, N.H. 03801.

SUPEX — ORTOFON — OTHER MOVING COIL CARTRIDGE OWNERS: Send for free literature on our Micro-Preamp Superb performance at \$99.95. Huntington Electronics, Box 2009-A, Huntington, Conn. 06484

ELECTRONIC CROSSOVERS—ALL TYPES. Updated definitive booklet describes applications, how to improve speaker systems; \$5.00 postpaid, credited to first purchase. Huntington Electronics, Box 2009-A, Huntington, Conn. 06484.

LOWEST DISCOUNT PRICES ANYWHERE on audio equipment. All major brands discounted. Write for quotes, K&L Sound Services, 75 N. Beacon St., Watertown, Mass. 02172

DIAMOND NEEDLES and Stereo Cartridges at Discount prices for Shure, Pickering, Stanton, Empire, Grado and ADC. Send for free catalog, LYLE CARTRIDGES, Dept. A, Box 69 Kensington Station, Brooklyn, New York 11218.

GRAPHIC EQUALIZER PLANS: Novel circuit very effective/inexpensive, requires no inductors. Ten knobs (octave bands) compensate your Hi-Fi/Tape providing better listening. Complete plans rushed only \$3.49. GREEN BANK SCIENTIFIC, Box 100C, Green Bank, W.Va. 24944.

BAUMAN RESEARCH INSTRUMENTS CO. Low noise—low distortion, stereo preamps. Why buy our preamps? Free info, write B.R.I.C., 1400 Gardenia Circle, Rosenberg, Tex. 77471

DON'T PAY THE HIGH MAIL ORDER PRICES
THIEVES WAREHOUSE OF FT. WALTON BEACH
652-D BEAL PKWY., N.W., FT. WALTON BEACH, FL 32548

VERY HIGH DEFINITION 4 1/2" cone mid-range. Liquid magnet viscous stamped suspension. 200-12K response. 8 ohms 40 watts. I build speakers, no time to answer letters. \$12.50 each postage paid in USA. Baily Mfg., Box 7, Rockwell, NC 28138.

DON'T PAY THE HIGH MAIL ORDER PRICES.
THIEVES WAREHOUSE OF ATLANTA # 6,
BELVEDERE PLAZA SHOPPING CENTER,
1203 COLUMBIA DRIVE, DECATUR, GA 30032.

ONE STOP for all your professional audio requirements. Bottom line oriented. F.T.C. Brewer Company, P.O. Box 8057, Pensacola, Florida 32505.

DON'T PAY THE HIGH MAIL ORDER PRICES
THIEVES WAREHOUSE OF SARASOTA
6564 GATEWAY AVENUE, SARASOTA, FLORIDA 33581

BUILD YOUR OWN SPEAKERS AND SAVE UP TO 50%. You can assemble your own high quality, multi-element stereo speakers in a few hours and save up to half the cost of comparable speakers. Send for our free 32-page catalog of speaker kits, raw speakers and accessories. SPEAKERLAB, Dept. A2, 5500—35th N.E., Seattle, WA 98105.

DON'T PAY THE HIGH MAIL ORDER PRICES. THIEVES WAREHOUSE OF FT. MEYERS, 3081 CLEVELAND AVENUE, FT. MEYERS, FLORIDA 33901

FOR SALE

FAIRFIELD AND WESTCHESTER COUNTY AUDIOPHILES TAKE NOTE! THE AUDIOPHILE, 201 BEDFORD STREET, STAMFORD, CONN. specializes in equipment for the connoisseur. G.A.S., Koss Model One, ADC, Crown, Dahlquist, Dyna, Epicure, Infinity, Philips, SAE, SME, Stax, TEAC, Technics, Thorens, Soundcraftsmen, Denon, Sonus and many more. (203) 348-3551 (Closed Mondays).

BUILD THE WORLD'S FINEST TRANSMISSION LINE SPEAKER — KEF B-139 woofer, \$64 each; B-200 8-inch plastic cone woofer, \$28; B-110 5-inch plastic cone mid-range, \$25.50; T-27 tweeter, \$33.50. Free plans and shipping with purchase.

AUDID BREAKTHROUGHS
1681 Northern Boulevard, Manhasset, New York 11030
(516) 627-7333

BUY DIRECT from England's Hi-Fi mail order specialists! Save on B&O, Celestion, Tandberg, Revox, Transcriptors, Jordan-Watts, Lowther, KEF, Rogers, SME, Ariston, HPD, Sugden, Radford, Neal, Technics, Sony, Alwa, Yamaha, Pioneer, etc. Shipping list free or send \$3 bills to include literature. Goodwins, 7 The Broadway, WoodGreen, London N22. Phone 888 0077. Visitors welcome.

CANADIANS — DYNACO COMPONENTS AT TREMENDOUS DISCOUNTS. Write En-Jay Sales, Hornepayne, Ontario.

TANDBERG 6040 Deck, IMF "R" Speakers, Soundcraftsmen RP2212 EQ. All mint. (215) 822-2369 evenings.

INNOVATIVE AUDIO

The major reasons for YOU to participate in the "Innovative Experience":

- 1) We don't look at our watches while demonstrating.
- 2) We try to gently guide you in your selection by offering you information that is honest & concise.
- 3) We are NOT SNDBS.
- 4) We offer a wide range of super-quality equipment in all price categories.
- 5) We give service that most everyone else promises. We LEND units while your s is being serviced.
- 6) We are nice people.

Mark Levinson
Accuphase
Quintessence
DB Systems
SAE
STAX
Klipsch
OHM
Spendor
Celestion
Linn-Sondek
Technics
Ortofon
Supex
Grace
KMAL
Revox
TEAC

Sequerra
Dunlap-Clarke
Audire
Audio-General
BGW
Innotech
ADS
IMF International
Gale
Micro Seiki
Thorens
ADL
Denon
Satin
SME
SAEC
Beyer
DBX

After reading this weird but "Innovative" ad, we seriously hope you'll come by and "Experience" us.
129 Degraw Street
Brooklyn, New York 11231
(212) 596-0888

FOR SALE

CYBERACOUSTIC LABORATORY is a research and development center combined with the most scientifically advanced audio acoustics lab. Exciting new product lines for 76-77 including: Audio Pulse Home Digital Delay Line, Acoustat Direct Tube Drive Electrostatic Spkr., Crown's New High Definition Series of Amps and Preamps, Fulton Systems, Infinity's New Quantum Spkr. Series, Luxman Ultra-High Fidelity Solid State & Tubes, IMF International Spkrs., RTR Point Source Direct Drive Electrostatic Spkrs., IM Fried Models H, M, D, R II, L, Q, & S Spkrs., Denon Blk. & Wht. Carts., Stax Electrostatic Spkrs., Nakamichi's Recording Director Series of Electronics, Source Engineering's New Noise Reduction System, EMT Moving Coil Cartridges, Transcriptors TT, Sonus Carts., Otari Decks, KEF Spkrs., Spendor Spkrs., Formula 4 Tonearms, Polk Spkrs., Fons TT AND MUCH MORE!!! 233 E. Lancaster Ave., Wynewood, PA 19096; 215-667-3048.

THE SENSIBLE SOUND reviews Jennings, Janszen, JBL, Fried, Technics, Lafayette, Advent, Acoustat, ESS, Ezekiel, Shure, more in current issue. Subscribe, \$10 (4 issues) \$11. Canada, \$16. Foreign, 403 Darwin, Snyder, N.Y. 14228.

CHARLESTON, SOUTH CAROLINA—Sunloft Audio Has: Fulton J Mod. Emod, 80's, 60's, 100's, Modified RTR ESR-6, Stax, Grace, ERA, Ampzilla, Son of Ampzilla, Thaedra, Thoebe, EMT, Denon, Fidelity Research, dbx, B&D, Otari, Nexus Soundcraftsmen, Quad, Sunloft Audio, 825 Savannah Highway, Charleston, SC 29407. Phone 803-556-8623.

ARE YOU AMONG THE FEW to whom cost is subordinate to quality? If so, the Brauer Dynamic Tonearm may be for you. The 120 individual parts, most of them aluminum, are crafted by hand. This is the only way to guarantee uniform tracking quality for each tonearm. The improvement in dynamic response and tonal definition of this tonearm results from the unique combination of ideal dynamic mass and total weight, playfree prestressed bearings, balance of inertia, geometrical equilibrium, distortion-proof design and simple operability. The optional viscous damping, effective in two axis, eliminates all vibrations and resonances. For full details write: The Audio Company, Box 13038, Oakland, Ca. 94661.

CABINETS FOR DYNACO. Preamps, Tuners, Quadaptor, Stereo 120. Literature. Geometrix, Box 612, Mexico, MO 65265.

NATURAL SOUND-LINCOLN

cordially invites you to hear the incomparable Fulton Js, the Beveridge full range electrostatics, the Lentek and the IMF International Monitors and the sensational new KEF Corellis.

Hear them on the world's finest electronics: Thaedra/Thoebe, Bravura preamps and Ampzilla II/Son of Ampzilla and Paoli amplifiers.

Hear the full line of Fulton speakers and the best of the British speakers. Hear the new and exciting equipment, DB Systems preamps and Naim electronics. Hear the inherent naturalness of the conical V15III/Grace/Linn Sondek combination.

Preowned: ARC SP3a-1, Dual 76A, Dual 150, Tympani IIIa, Tympani IC, Classic Marantz tube system, Braun TG 1000, Thorens TD125 MK II / Decca and SME arms, KMAL arm, Koss ESP 9s.

NATURAL SOUND, 315 South 11th Street, Lincoln, Nebraska 68508; (402) 475-3325

Rates: 35¢ per word per insertion for noncommercial advertisements; 60¢ per word for commercial advertisements. Frequency discounts as follows: 3 times, less 10%; 6 times, less 15%; 12 times, less 20%. Closing date is the FIRST of the second month preceding the date of issue. Payment must accompany all orders. Use the handy self-addressed, postage paid card at the back of this issue. When replying to Audio box number ads, send letters c/o Audio, 401 N. Broad Street, Philadelphia, Pa. 19108. For more information about classified advertising, circle Reader Service Card #135.

FOR SALE

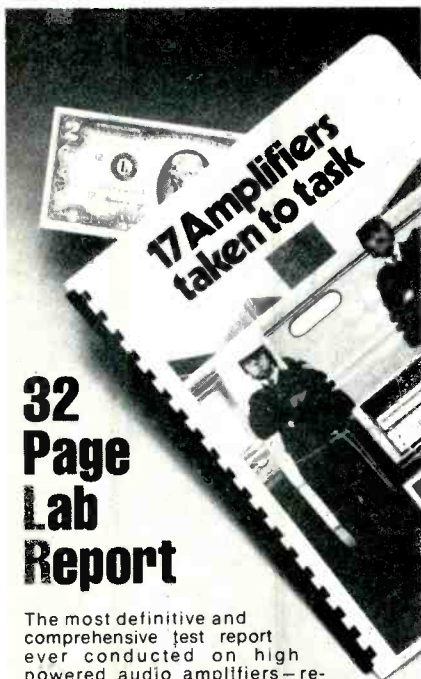

32 Page Lab Report

The most definitive and comprehensive test report ever conducted on high powered audio amplifiers—reprinted from the prestigious English journal, *Hi-Fi For Pleasure*. The spiral bound, hard-cover report presents readable research data taken from exhaustive subjective listening panel evaluations corroborated by standard laboratory tests. Some of the products reviewed in this Spring '76 report:

- Accuphase P250 • Crown D150A
- BGW Model 250 • Lux M6000
- Yamaha B1

Mailed first class upon receipt of two dollars and your full address.

Amplifier Reports, P.O. Box 3742, Dept. A
Beverly Hills, Ca., 90212

Citation 1 preamp. (814) 234-2542.

FREE SAMPLE! World's foremost audio newsletter. AUDI-DMART! Box 821, Stratford, Connecticut 06497.

JBL PARAGON, walnut, mint, perfect; \$2495.00, 203-929-5255 or write Box 9, Huntington, Conn. 06484.

CUSTOM 6 channel stereo mixer! Similar Gately, much more versatile! Mint! \$205! 602-997-1056.

STANTON 681EEE, used 18 hours, perfect - \$36.00. David Fonseca, 555 Notre Dame Ave., Chattanooga, Tenn. 37412.

CAMPUS REPS! CONSUMERS! DEALERS! Most medium and many high end lines available at lowest wholesale. Make 10%/40% Repping/Demonstrating high quality loudspeaker line. Prices, info. \$1 (refundable w/order) + SASE. (812) 332-4252. AUDIO 1010 S. Dunn, Bloomington, Indiana 47401.

ELECTROSTATIC SPEAKER designs have previously fallen short of their optimal performance due to placement problems, tweeter directionality and time delay distortion. These and other traditional limitations have been brilliantly defeated in the **BEVERIDGE CYLINDRICAL SOUND SYSTEM**. Call GENERAL ACOUSTICS in Silver Spring, Maryland at (301) 587-0346 for your appointment. Associated quality components: AGI preamp, Denon and Stax.

SOUNDCRAFTSMEN PE2217-\$1300, SME 3009 detachable-\$75, unused **AOC XLM-\$30, Garrard Zero 100c/wood base/dust cover-\$60, 912-746-0037.**

ADC XLM, original - \$40, 912-746-1669.

PANASONIC SP-10, base, dust cover, SME 3009 II, \$475 (614) 882-2077.

E-V PATRICIANS (4 way 18" Klipschorns) Porter 203 Woodmere, Raritan, NJ 08869, 201-725-9188.

FOR SALE

ALONE WITH OUR HI-FI? We have a solution. For details contact: Chicago Audio Society, 387 N. Edgewood Ave., Lombard, Ill. 60148.

CANADIANS! AR Corp. SP-3A-1; Ampzilla; Dayton-Wright XG-8's (1/2 price); Sony ST 5000FW; Quad AM11/3. Offers 519-945-8486.

AUDIO RESEARCH SP 3 A-1, Mint. Transferable warranty. Best offer. Evenings New York (212) 796-1478.

DON'T PAY THE HIGH MAIL ORDER PRICES. THIEVES WAREHOUSE OF DAYTONA, 1769 SOUTH RIDGEWOOD, SOUTH DAYTONA, FLORIDA 32019

DISCOUNT PRICES on stereo components. All major brands. Write for quote. Seashore Stereo Sales, 204 Woodcrest Ave., Absecon, N.J. 08201.

IN PURSUIT OF EXCELLENCE WE OFFER: Infinity, Crown, Revox, Fulton, Sennheiser, Philips, Ortofon, ESS, SAE, Beyer, DBX, Altec, Technics direct drives, RTR, McIntosh, JBL, Transcriptors, Klipsch, Citation, Decca, SME, Sequerra, Micro/Acoustics, Lamb, Dahlquist, Tannoy, Yamaha, Soundcraftsmen, Marantz, and more. Also custom room equalization, individually damped Altec & JBL Monitors and an on-going equipment evaluation program, The House of Sound, 821 Kent Ave., Baltimore, Md. 21228.

NAME BRAND RECORDING TAPE, custom loaded. Available in cassettes, reels, and cartridges. Huge savings direct from manufacturer. New catalogue now available, MJS, 516 Brooks, San Jose, Calif. 95125 (408) 998-2693.

NO GIMMICK! Buy new components at dealer cost using highly innovative purchasing methods. Fully legal. Request **FREE** information packet. Stereo Cost Cutters, Box 8014, Canton, OH 44711.

IF YOU HAVE A LARGE LISTENING ROOM, 200 watts per channel and understanding neighbors, please give these well broken-in custom equalized speaker arrays a new home. Janszen Z-138 top end units are combined with custom B-zak low end. Soundcraftsmen RP-2212 eq included. Also available - Crown IC-150 and Bose 1800. For details, contact Jeff Van Hise (703) 437-1373, After 5 pm (EDT).

THOUSANDS OF LIKE NEW LP's and prerecorded tapes. Catalogue - \$1.50. House of Records, Hillburn, New York 10931.

TAPE DUPLICATOR

Pentagon Model C1323-8, serial number 2339. Original cost new \$3,995. Have complete instruction manual with machine. Best offer over \$1,000 takes it. Shipping extra. North American Publishing, Education Dept. 401 North Broad Street, Philadelphia, Pa 19108. Att: F.L. Nemeyer

10 1/2" Recorder Specialists: Fresh Scotch L/N 3600 ft. on new 1/4" NAB metal reels five for \$35.00. New low noise, high output Ampex tape on 10 1/2" metal reel, six for \$35.00. Reconditioned NAB metal 10 1/2" reels, \$24.00 per dozen, 10% on above for postage. Other tapes also on special, write for catalog: Sound, POB 88338, Atlanta, GA 30338.

GOOD NEWS FROM MR. AUDIO

A new era of tube electronics is upon us! Vacuum tubes, far from being finished, as certain ex-state-of-the-art manufacturers would have you believe, are potentially capable of performance levels unheard of in the past. Trevor Lees, maverick Australian designer, has developed the world's first successful tube pre-amp, the cheapest and best tube pre-amp ever, and introduced to America the car battery power supply concept. In MR. AUDIO'S BIMONTHLY he will explain in depth the revolutionary theories behind these startling new products. NOT another always-late subjective equipment review quarterly, MR. AUDIO'S BIMONTHLY will enlighten you as to all the whys and hows, including circuit diagrams, and supply you with the know-how to modify existing equipment to surpass the performance of even the latest epoxy-module marvels. Send \$12 US (\$15 overseas) for six issues to: MR. AUDIO'S BIMONTHLY, Box 77907, San Francisco, Ca. USA 94107. Sceptics who want more information send self-addressed envelope for prospectus.

IN ILLINOIS, Allison and Chicago Acoustic speakers are available at AUDIO Ltd., The Sound Shop, 115 N. Walnut, Champaign, 217-359-3774.

FOR SALE

INCREDIBLY BETTER SOUND from your present system with no additional investment. Send \$10.00 for instructions. Unqualified Money Back Guarantee. THE WIZARD, 109 Alpine Road, Yonkers, N.Y. 10710

THE NEW GALE LOUSPEAKER SYSTEMS ARE HERE AND THEY SOUND GREAT! HARMONY STEREO, 222 WEST PORTAL, SAN FRANCISCO, CALIFORNIA 94127 (415) 661-2525. 3237 SACRAMENTO, SAN FRANCISCO, CALIFORNIA 94115 (415) 921-7333

BUILD A HIGH ACCURACY, monitor quality speaker for much less than comparable brand name speakers. Two-way kit uses KEF B110 and T27 drivers. Cabinet plans for small air suspension speaker. \$115/pair. Three-way kit uses KEF B139, B110, and T27 drivers. Bass reflex and two transmission plans. \$265/pair.

Kits come with wired crossover and backplate with controls, fuseholder, and binding posts. Separate drivers: B139-\$62, B110-\$24, T27-\$15

Accurate Sound, 1213 "M" Street, Lincoln, Nebraska 68508 (402) 489-1218.

* RAW DRIVERS *

SPEAKERS USED IN MANY NATIONALLY DISTRIBUTED SYSTEMS ARE NOW AVAILABLE DIRECTLY TO YOU!

HIGH QUALITY RAW DRIVERS FEATURING HI-POWER CAPABILITY AND LOW DISTORTION

INCH	WATT	OZ.	V.C.	F.A.R.	PRICE
12	70	40	2"	25 H3	\$28.00
10	35	20	1 1/2"	19 H3	\$20.00
8	20	10	1"	35 H3	\$ 8.00

PRE-PAYMENT ONLY—FREIGHT PAID

S.T.A.R. INDUSTRIES INCORPORATED

P.D. BOX 22525

SACRAMENTO, CALIFORNIA 95822

THE NEW PARAGON PREAMPLIFIER highly acclaimed recently in an audiophile magazine is now available at Paragon of Sound. You are invited to call, 301-229-2676 (Bethesda, Md.) for an appointment to hear the difference.

ALPHA/THETA/EEG BIOFEEDBACK Precision Performance. 5 Year Guarantee. Efficient Design. Detailed information: M.O.E. M #20, P.D. Box 2693, Santa Cruz, CA 95063 (408) 423-9271.

MARANTZ 32 power amp \$100. Panasonic 405 CD4 demod. \$75. Sony SQ2020 decoder \$115. Altec 604E speaker \$100. Altec 604c speaker \$35. Mac 75 amp \$150. Electrovoice 30W woofer \$150 or best offer.

REVOX A-700 1/2 track, Nakamichi 1000, 4 AKG 505 electret microphones, mic stands, assorted cables and accessories. All less than one year old. Best reasonable offer. F. Witte (Jr.), (evenings 519-579-6786), Box 2582, Postal Station "B", Kitchener, Ontario, Canada.

HIGHEST QUALITY USED EQUIPMENT: Bowers & Wilkins DM70 spks \$400 ea; IMF Studio 3B spks, \$300 ea; IMF ALS40A spks, \$250 ea; Fried Model R spks, \$250 ea; AR LST2 spks (new), \$250 ea; JBL S8R spks in encl. \$750 ea; ReVox A700 deck, \$1200; McIntosh 2100, \$450; McIntosh 2105, \$600; McIntosh MX110 pre-amp/tuner, \$250; Thorens TD125/SME arm, \$300; AR 11 spks, \$195 ea; Marantz 18 rcvr, \$425; JBL SE401 amp, \$150; Crown DC300A amp, \$600; Sony 3200F amp, \$275; Tandberg 9041X deck, \$550; McIntosh MR55 mono tuner, \$150; Audio Research SP3A-1 pre-amp, \$650; Audio Research SP3 pre-amp, \$450; Marantz 3300 pre-amp, \$280; Marantz 250 amp, \$350; Citation "A" pre-amp, \$225; Transcriptors Skeleton Intbl w/vestigal arm, \$250; Decca "London" ribbon tweeters, \$50 ea; Sony SQ2020 decoder, \$150; McIntosh ML2M spks, \$425 ea; Four (4) Dayton-Wright XG8 MkII spks w/power supply, \$2000 complete. All used items guaranteed 90 days parts/labor. Audio Consultants, Inc., 517 Davis St., Evanston, IL 60201. (312) 864-9565.

IF YOU LIKE GOOD MUSIC and good sound, consider joining the Chicago Audio Society, 387 N. Edgewood Ave., Lombard, Ill. 60148.

FOR SALE

DON'T PAY THE HIGH MAIL ORDER PRICES. THIEVES WAREHOUSE OF BOCA RATON. 499 N.E. 20th STREET. BOCA RATON, FLORIDA 33431

FOR SALE: REVOX A77-1104 3 3/4-7 1/2 ips. Original shipping container, cleaning kit, and instruction manual. Mint. \$800. or will trade for Technics SU9600-SE9600 combination. Call Kevin before 5 pm weekdays 815-672-1792. Sreator, Ill. 61364.

DON'T PAY THE HIGH MAIL ORDER PRICES. THIEVES WAREHOUSE OF BETHESDA. P.D. Box 34251. WEST BETHESDA, MD 20034

IN STOCK & ON DEMONSTRATION: Audio Research Tymphani 1-C, SP-3a-1. Dual 76a; Dayton-Wright XG-B Mk III, SPS, SPL, 535; Dahlquist DD-10; Gale GS 401 A; Luxman, Sequerra; Yamaha B-1, CT-7000, NS-1000; Dunlop-Clarke, SAE, Stax; I. M. Fried; Nakamichi; Revox; Magnepan; ADS; BGW; RTR; B & O; Crown; Advent Video-Beam; Tandberg; Citation; IAD; R.B. Audio; Denon; Supex; Satin; Grace 707; Occa; Rabco; Connoisseur; Thorens; Transcripator; others.

THE GRAMOPHONE, LTD.

757 ASP St., Norman, OK 73069
405-364-9477
6568 b East 51st, Tulsa, OK 74145
918-663-1511

MISSOURI-KANSAS audiophiles! Audio Research, Audio Pulse, Allison, DBX, Dahlquist, Denon, Formula 4, Lux, McIntosh, Magnepan, Magneplanar, Neumann, Nakamichi, Revox, Sequerra, Stax, Tascam, Yamaha. Home of Audio Lab Records and the Wide Wall of Sound™. Exceptional service, warranty, and guaranteed prepaid safe arrival. David Beatty Stereo, 1616 W. 43, Kansas City, Mo. 64111. 816-531-3109.

DON'T PAY THE HIGH MAIL ORDER PRICES

THIEVES WAREHOUSE OF MOBILE

1770 BELTLINE HIGHWAY, MOBILE, ALABAMA 36609

E-V PATRICIAN IV, excellent condition \$275, you freight. 814-899-9827. S.R. Sellaro, 252 West 11th St., Erie, Pa. 16511.

CAROLINA AUDIOPHILES

We currently recommend the following products:

IM Fried	Denon
Luxman	SAE
Stax	SME
Linn Sondek	ADC
Keith Monks	Accutrack
Crown	Goldring
Sonus	Avid
Connoisseur	Ohm
Micro-Acoustics	Philips
Soundcraftsmen	Thorens
Technics	Audioanalyst

STEREO SOUND

122 Oakwood Dr. 175 E. Franklin St.
Winston-Salem Chapel Hill
919-722-9201 919-942-8546

DAYTON WRIGHT XG8 MKIII 6 mos. old - \$1700. J. Lynch, 822 Lincoln Rd., Bellevue, Neb. 68005 (402) 291-0999.

MARANTZ 8B, mint. Best offer over \$300.00. Will ship. P.O. Box 13130. Wauwatosa, Wis. 53226.

BEVERIDGE SPEAKERS and amps absolute mint condition. Current model \$3,000.00 Mark Plourd 12075 S.W. Lincoln, Tigard, OR. 97223; (503) 639-7787.

MARANTZ MODEL 9 AMPLIFIERS (2), KLH Speakers Model 9 two pair, Hartley 24" Super Woofer in cabinet, Crown VFX-2 crossover, Dynakit 400 w/meters, Dyna PAT-5. Best offer. All or part. Write F.C. Floriani, 529 Eighth Ave., Bethlehem, Pa. 18018.

AVAILABLE NOW!!!

Vacuum tube audio equipment modification manual. If you can build a kit you can improve your vacuum tube equipment. Text includes over 180 pages of modification philosophy, schematics, and step-by-step procedures applicable to Dyna, Heath, Marantz, Audio Research, etc., etc. \$25 postpaid, includes consultation service. AUDIO DIMENSIONS, 8898-K Clairemont Mesa Boulevard, San Diego, Calif. 92123.

FOR SALE

ARIZONA AUDIOPHILES

Crown * ESS * Accuphase * SAE * Revox * S.M.E. * Grace * Stax * Tandberg * Burwen * Rabco Sequerra * Bose * Thorens * Stanton * Uher * Klipsch Phase Linear * Sennheiser * J.B.L. * Sony V-F.E.T. * Beyer * Jennings Research * Nakamichi * Yamaha * Dahlquist * Supex * C-N Labs * Fidelity Research Gale * TEAC * Sansui * Transcripator * Harmon Kardon * Yamaha * Beveridge * Supex * Mark Levinson * ADS * H.K. Citation.

JERRY'S AUDIO EXCHANGE

Phoenix-334 E. Camelback Rd. 85012 602-263-9410
Tempe-130 E. University Dr. 85281 602-968-3491
Tucson-1037 N. Park Ave. 85719 602-622-7407

DUNLAP-CLARKE ANALOG-ENGINEERING

ARISTON TURN-TABLES GRACE-GOLDRING

WINN LABS

and many more

Where in the MD-DC area do you audition these products? Only at BETTER SOUND Inc. Also listen to the NEW EZEKIEL LOUDSPEAKERS using aluminum dome tweeter and cone drivers, offering the high definition of electrostatics with wider dynamic range and FLAT FREQUENCY response. FROM 119 Ea.

Call or Write
2710 Garfield Ave Silver Spring Md. 20910
301-587-7877

DON'T PAY THE HIGH MAIL ORDER PRICES. THIEVES WAREHOUSE OF BIRMINGHAM # 3, 203 South 18th STREET, BIRMINGHAM, ALABAMA 35233

MARK LEVINSON JC-2 with all the latest improvements excellent condition \$925. or best offer. Mark Levinson JCI-AC head amp \$200. or best offer 203-929-0647 or write Kenneth Joseph, 6 Shelview Dr., Shelton, Conn. 06484

POLK AUDIO MONITOR SERIES

AUDIO BREAKTHROUGHS now has on demonstration the remarkable new Polk loudspeakers. Compare them to the finest loudspeakers in the world. Both the Seven (\$199.95 ea.) and the Ten (\$189.00 ea.) utilize high definition polymer laminate bass-midrange drivers, wide dispersion soft dome tweeters and fluid coupled sub-bass radiators. They are capable of reproducing a highly defined phase accurate three dimensional sonic image which rivals the thousand dollar super speakers. They sound great with a small receiver, yet reveal the fine subtleties of state of the art electronics like Levinson and G.A.S. Shipped free in U.S. Send for free brochures on Polk or our other fine lines. **AUDIO BREAKTHROUGHS**, 1681 Northern Blvd., Manhasset L.I., N.Y. 11030 516-627-7333

DON'T PAY THE HIGH MAIL ORDER PRICES. THIEVES WAREHOUSE OF ATLANTA NO. 7, 215 COPELAND ROAD ATLANTA, GEORGIA 30342

!!HEART OF AMERICA AUDIOPHILES!!

SOUNDS GREAT STEREO, INC.

OFFERS MIDWESTERNERS SOME OF THE BEST AUDIO EQUIPMENT IN THE WORLD.

ADS	Otari
Braun	Pickering 45000
Dahlquist	Shure
dbx	SME
Epicure	Sonus
ESS	Sony
Great American Sound	Stanton
JBL	Stax
Kenwood	Tandberg
Koss Model One	TEAC
McIntosh	Technics
Nakamichi	Thorens
Ortofon	Yamaha

HEAR OUR INCOMPARABLE AMPZILA/
THAEDRA/ SON OF AMPZILLA COMBINATIONS WE NOW
FEATURE IN OUR LISTENING ROOMS.

+GREAT PRODUCTS +GREAT WARRANTY
+GREAT SERVICE GREAT PEOPLE

SOUNDS GREAT STEREO, INC.

White Lakes Plaza
911A W. 37th ST. TOPEKA, KS. 66609
(913) 267-1933

FOR SALE

TAPE RECORDERS

40 MODELS
AS LOW
AS . . .

5%

ABOVE
DEALER
COST

Send for discount sheets — also
see our giant ad in next week's New York
Times MAIL ORDER SECTION.

SAXITONE

1776 Columbia Rd NW Wash. D.C. 20009

CITATION 11, 12 con. cord. Dual 1209 turntable. Akai 365D reversing tape deck, remote control, DM-13 mics, 30 reel tapes. Good condition. S. Hash, Box 245, Linwood, N.J. 08221 (609) 927-7434.

SOUNDTRACKS, CASTS, personalities! Free newsletter! RTSA, 3700 Plaza, F211, Santa Ana, Calif. 92704.

ATTENTION CANADIANS

Over 100 top brands, stereo components. Write for quote. ADCO Sales, Box 13359, Kanata, Ontario K2K 1X5.

SOUNDCRAFTSMEN PE2217 PREAMP-EQUALIZER \$300. 203-795-6533.

WESTERN CANADIANS

For the Home Constructor: Kef, Hartley, Coles 4001, Occa Ribbons, Deforest, Tannoy, Jordan Watts, Lowther, Peerless Also: Quad (England), IMF, Tannoy CBC Monitors, Lecson, Cambridge Audio, Dynaco Spectro Acoustics, Kenwood; Transcripators (both kinds), Linn Sondek; KMAL, SME, Formula 4, Vestigal, Michell tonearms; Decca, Micro Acoustics, Grado, Fidelity Research. Much more.

Super Service T.V. Ltd. & SuperSound
10627 - 101 St.

Edmonton, Alberta T5H 2S2 Canada
(403) 429-4302

HELP!

Anytime you have a question about your Audio subscription, please include a mailing label to insure prompt service on your inquiry.

AFFIX
LABEL
HERE

CHANGE OF ADDRESS

If you're about to move, please let us know approximately four weeks before the move comes about. Or, if there is anything wrong with your current mailing label, please let us know on this form also. Simply affix your present label here, and carefully print the updated information below.

PLEASE HELP US TO SERVE YOU BETTER

AUDIO MAGAZINE

401 N. Broad Street • Phila., Pa. 19108

Name _____
(Please Print)

Company _____

Address _____

City _____ State _____ Zip _____

AU/12/76

FOR SALE

ILLINOIS
ILLINOIS
ILLINOIS

CHICAGO
PEORIA
BLOOMINGTON
ROCKFORD

ST. LOUIS
SPRINGFIELD
DECATUR
QUAD CITIES

We are pleased to offer listeners in this area the opportunity to experience the rewards of the fine high fidelity components.

Audio Research, Fulton J Modular, FMI, Great American Sound including Ampzilla and Son of Ampzilla, Grace, ERA, Stax, Connoisseur, Bravura, Formula 4, Linn Sondek, modified Dyna Vacuum Tube Amplifiers, and others.

We are the **EXCLUSIVE FULTON-FMI DEALERS** in this area and extend to you the invitation to hear the celebrated Fulton J Modular loudspeakers at their best.

We will also be happy to set up your equipment with you in your listening room to assure its best performance.

PRO MUSICA
HIGH FIDELITY FOR SERIOUS LISTENERS
603A WEST CALIFORNIA
URBANA, ILLINOIS 61801
(217) 384-5415

ILLINOIS
ILLINOIS

We invite you to our listening room to hear the Audio Research components, and since we are the exclusive Fulton-FMI dealer in Illinois, it is the only opportunity to hear the super Audio Research electronics on all the Fulton Modular speakers. J Mod, E Mod, and B Mod.

PRO MUSICA
603A West California
Urbana, Illinois 61801
(217) 384-5415

ELIMINATE DISTORTION! Bypass unused portions of your preamp, integrated amp or receiver with an inexpensive accessory. Plans, \$3.00. Regan Design Services, P.O. Box 34045, Washington, D.C. 20034.

Paragon the finest sounding preamplifier at any price! Threshold 1000 watt peak per channel Class A amplifier. Beverage full range electrostatic loudspeaker and integral amplifier—180 degree dispersion, no beaming, no crossovers, deep bass.

Spendor loudspeakers the BBC standard for quality control and program monitoring.

Audionics loudspeakers - compare the M-32B (\$310 pair) to \$3000 electrostatics!

DB Systems preamplifier, cartridge preamp, and electronic crossovers.

Era turntable and other selected components.

AUDIO EXCELLENCE is dedicated to demonstrating only the most accurate components available.

Call or write now for your personal appointment to hear them.

AUDIO EXCELLENCE
Box 10253
Pittsburgh, PA 15232

WICHITA, KANSAS

Custom Sound presents audio components for the critical music lover. Every product has been totally reviewed and tested, including:

Audio Research	Maxell
Accuphase	Meriton
Aiwa	Nakamichi
Bank & Olufsen	Revox
B.I.C.	Shure
Blaupunkt	Sony Hi-Fi
Discwasher	Sound Craftsmen
ESS	Stax
Genesis	Technics
Klipsch	Yamaha

Financing available. We service what we sell.

Custom Sound
4926 East Lincoln
Wichita, Kansas
67218
(316) 681-3555

FOR SALE

TAPE CLOSEOUT dozen reels. 1200' \$800 postpaid guaranteed. Mitchell, Box 132A, Flushing, N.Y. 11367.

DON'T PAY THE HIGH MAIL ORDER PRICES
THIEVES WAREHOUSE OF ST. PETERSBURG.
9151 Park Boulevard, North Largo, Florida.

ESOTERIC PRODUCTS—ARC, Magnaplanar, Nakamichi, GAS, IM Fried, Luxman, Quatre, others. STEREO(ophile) SHOP, 107 Third Ave. SE, Cedar Rapids, Iowa 52401/Village Shopping Center, Davenport, Iowa 52806.

CITATION 12. Excellent condition. \$185. Audio Box A610-1.

WE OFFER ACCURATE ADVICE, PERSONAL SERVICE, AND SUPERIOR COMPONENTS. Including AKG, Allison, Armstrong, Audiocraft, Audio General, Audionics, Audire, Beyer, B&W, Cambridge, Celestion, Connoisseur, CM, Dayton Wright, DB, dbx, DCE, Decca, Denon, EMT, ERA, Formula 4, Fulton, FR, Gale, Grace, Hadcock, Hartley, Innotech, Jocklin, KEF, KMAL, Lecson, Mark Levinson, Linn Sondek, Lux, Micro, M&K, Naim, Neal, Neumann, Onkyo, Quad, Quatre, Quintessence, Radford, Revox, Rogers, Stain, Schoeps, Sennheiser, Spendor, Stax, Stellavox, Studer, Sugden, Supex, Win, inter alia. **ALL COMPONENTS INSTALLED PROFESSIONALLY TO YOUR SATISFACTION. SHIPMENTS PREPAID & INSURED. MUSIC SYSTEMS, 34 NORTH GORE, ST. LOUIS, MO 63119. (314) 968-4880.**

THE HADCOCK ARM

No tone arm is truly universal, but the **HADCOCK GH228** elicits better performance from all cartridges save EMT and Stax, and features a unipivot with optional viscous damping, double decoupling, and the lowest effective mass at the stylus point (4g) of any pivoted arm. The price of \$150 includes the adjustable GH Unilift. Dealer inquiries invited. **IMPEX, 34 North Gore, St. Louis, MO 63119. (314) 968-4880.**

BAY AREA AUDIOPHILES

Now you can find the fine products and quality service you've been seeking - in Menlo Park at Weingarten Stereo where we feature-

AKAI	GRACE
AUDIOANALYST	SHURE
LUXMAN	SME
SONUS	GRADO
AKG	MAXELL
BEYER	PIONEER
SHEFFIELD	ELECTRO-VOICE
FRESH AIRE	DISCWASHER

and many more
WEINGARTEN STEREO
725 SANTA CRUZ AVE.
MENLO PARK, CALIF. 94025
(415) 323-5111

ENGLISH HI FI

Radford, AEL (Rogers) Export Monitors, B&W, Rola Celestion, Monitor Audio, SME, Decca Mk V, Tannoy, Garrard and very famous Transmission Line speakers, other continental products also available. Please write or telex, your quote will be by returned Air Mail. Southern Audio Services Ltd., 43 High Street, Kingston, Surrey, UK. Tel. 01-549-3194 Telex 929679 AEL G.

SUBSTANTIAL SAVINGS on practically all high-quality components, e.g. Accuphase, Bozak, Dahlquist, Lux, Nakamichi, Sonus, Tandberg, and many unmentionables. **THE SOUND AFFAIR, 364 Mission Court, St. Louis, MO 63130.**

5% OVER COST - any stereo components. Free Catalog: Audio Discount World, 1022 Bush Street, Box 213, San Francisco, California 94109.

THE GALE 2101 TURNTABLE and the Gale improved loudspeaker systems are now featured at **GARLAND AUDIO, INC.**, 2960 Stevens Crk. Blvd., San Jose, California 95128. (408) 244-6724. Visit our new store at 3101 Telegraph Ave., Berkeley, California 94705. (415) 841-1591.

B.E.S. (BERTAGNI GEOSTATIC d-120's. Mint, full warranty. \$725. (919) 373-0418; (404) 252-7960.

FOR SALE

DON'T PAY THE HIGH MAIL ORDER PRICES.

THIEVES WAREHOUSE OF TALLAHASSEE, 1119 APALACHEE PARKWAY, PARKWAY SHOPPING CENTER, TALLAHASSEE, FLORIDA 32301.

AMPEX TAPE—NEW 1800' on 7" reel 12 for \$18 POSTPAID; 1200' 12 for \$13 POSTPAID—free list—WIDE RESPONSE, 6114A SANTA MONICA BLVD., HOLLYWOOD, CA 90038.

MINNEAPOLIS

—Dedicated To The Reproduction Of The Original Sound—Audio Research, Bang & Olufsen, Klipsch, Audionics, Radford, Revox, Linn Sondek, Crown, dbx, Sequerra and others.

THE SOUND ENVIRONMENT

Butler Square, Suite 114, 100 North Sixth Street, Minneapolis, Minn. 55403, (612) 339-4641

SEATTLE, WASHINGTON

Definitive Audio is a group of engineers and audiophiles whose primary goal is to provide the discriminating listener with the finest sound reproduction that current technology can produce.

We are currently recommending the following products-

Audio Research	Mark Levinson
Fulton "J"	Dynaco (modified)
Magneplaner	Dunlap-Clarke
Dahlquist	Quatre
Quad	Yamaha
FMI 80	Audionics
Stax	Paoli
Denon	Radford
Fidelity Research	Nakamichi
SME (modified)	Sequerra
Linn Sondek	Revox
Shure IIG	Philips
Grace	DBX
ERA Mk6	Decca

If you enjoy music and are interested in the finest reproduction, you will appreciate

DEFINITIVE AUDIO

3414 N.E. 55th
Seattle, Washington
98105
(206) 524-6633

Tues-Fri 12-8 Sat 10-6 Appointments on Sun&Mon

OYNAKITS. Ace Audio, Philips Drivers. Lowest quotes. Al Kits, Box 864, Destin, Florida 32541

DON'T PAY THE HIGH MAIL ORDER PRICES.

THIEVES WAREHOUSE OF BIRMINGHAM,
123 ROEBUCK PLAZA DR., BIRMINGHAM, ALA 35206

Some of the dealers who sell quality systems and **INSIGHT RECORDS** are:

The Music Box	Boston, Ma.
Paul Heath	Rochester, N.Y.
Paul Heath	Chicago, Ill
Audiophile's Sound Studio	Madison, Wis.
Don and Kathy's House of Music	St. Louis, Mo.
Interior Systems	Las Vegas, Nv.
Garland Audio	San Francisco
Serra Stereo	San Francisco
Garland Audio	San Jose, Ca.
Victor's Stereo	Chicago

Ask your quality audio dealer or write:

INSIGHT RECORDS

Dept. 2A
7726 Morgan Av. S.
Minneapolis, Mn. 55423

"MICROPHONE RECORDING TECHNIQUES"

New handbook covers professional microphone techniques for all types of musical instruments. Also sections on microphone principles, types and connections. \$3.95 ppd. MTA-Dept. AM 4260 Lankershim Blvd. No. Hollywood, Ca. 91602. California residents add 24 tax.

FOR SALE

IF YOUR HAVE A LARGE LISTENING ROOM, 200 watts per channel and understanding neighbors, please give these well broken-in custom equalized speaker arrays a new home. Janszen Z-138 top end units are combined with custom Boszak low end. Soundcraftsmen RP-2212 EQ included. Also available - Crown IC-150 and Bose 1800. For details, contact Jeff Van Hise (703) 437-1373, after 5 pm (EDT)

CUEING DEVICE for AR turntable and others. Precision machined, silicon damped. Easily installed. \$16.00 postpaid. Lyrelift, 582 Franklin Street, Cambridge, Mass. 02139.

HI-FI ENTHUSIASTS WANTED!! Earn more than just spare money in your spare time. We need campus representatives to sell name brand stereo components at discount prices in your area. High commission, no investment required. Serious inquiries only, please. Contact: Alan Weisberg, K&L Sound Services Co. 75 N. Beacon St., Watertown, Mass. 02172.

AMPEX TAPES

AmpeX Audio Studio Mastering Tapes. 631 641, 406 407, and "GRAND MASTER" in stock for immediate shipment. 1/4", 1/2", 1" & 2" Factor fresh Best Prices. TECHNARTS, 8555 Fenton St., Silver Spring, MD 20910 (301) 585-1118

STEREO CARTRIDGES AND STYLUS REPLACEMENTS FOR: ADC, Audio Technica, B&O, Grado, Empire, Micro/Acoustics, Pickering, Ortofon, Shure, Stanton, Supex. Write for free catalog: NEEDLE IN A HAYSTACK, Dept. MA, P.D. Box 17436, Washington, DC 20041.

PROTECT YOUR LPs. Poly sleeves for jackets 8c round bottom inner sleeves 7c Poly lined paper sleeves 15c White jackets 35c Postage \$1.50 House of Records, Hillburn, New York 10931

AUDIO'S HI-FI HANDBOOK

Complete reference guide to over 1,000 components, including prices and specs. All arranged in tabular form for easy comparison. Plus over 30 outstanding articles on audio topics, trends and advances. State-of-the-art reading for audiophiles. Only a limited quantity available. Over 200 pages. Send \$4.50 (includes shipping and handling) to: Jean Davis, Audio Hi-Fi Handbook, 401 N. Broad St., Phila., Pa. 19108

CARBON FILM RESISTORS—1/4W, 5% from 10—4.7 megohms for 3 1/2c each. Fifty per value \$85. Discounts available. FREE samples/specifications. Other quality components. Components Center, Box 134A, N.Y., N.Y. 10038

BACK ISSUE MAGAZINES. Over 200 titles, 1890 to 1976. Send Stamped Envelope. Free List. Everybody's Bookshop Dept AU, 317 West 6th, Los Angeles, Calif. 90014.

DON'T PAY THE HIGH MAIL ORDER PRICES.
THIEVES WAREHOUSE OF ORLANDO,
1915 EAST COLONIAL DRIVE, ORLANDO, FL 32803

SYN-AUD-CON 3-Day Sound Engineering Seminar For more information about the seminar in your area, write Don Davis, Synergetic Audio Concepts, P.O. Box 1134, Tustin, Ca 92680 Ph (714) 838-2288

CANADIANS: Best Hi-Fi discounts on over 96 leading Hi-Fi brands. Many exclusive factory closeout and special deals. Quotations via return mail. Nationwide mailorder service. FREE catalogs jam packed with bargains in Hi-Fi equipment, tape and recording accessories, calculators, telephones and accessories, kits, parts, etc. Hundreds of factory and government surplus specials too! American inquiries welcome. Rush free catalog request to: ETCO, Dept. AUA, Box 741, Montreal H3C 2V2

THE ULTIMATE PAS newly developed circuitry converts Dynaco PAS to stunning state-of-the-art contender. Far surpasses any other modification service! Comparisons confidentially invited, particularly with the DKL LAB's product. Cosmetically improved with new anodized faceplate and knobs. \$200 for use with tube amps, \$225 for solid state compatibility, \$25 extra for walnut case. STEREO 70 and Mk III modifications equally unique and spectacular; cathode coupled, internally fan cooled, and tailored phase margin. Write for information. AUDIO DIMENSIONS, 8898-K Clairmont Mesa Boulevard, San Diego, California 92123.

RADIO & T.V. RECEIVING TUBES. We have all tube types that are mfg. for \$1.50 each. One year fully guaranteed! Rush \$1.00 today for complete information to: R.D. Kreps Electronics, P.O. Box 41, Augusta, Ohio 44607.

FOR SALE

CORNER HORN SPEAKER ENCLOSURE KITS. Send for free brochure. Kneller Audio Cabinets, Dept. "A", 6428 W. 27th Pl. Berwyn, Illinois 60402

DON'T PAY THE HIGH MAIL ORDER PRICES. THIEVES WAREHOUSE OF NORTH TAMPA, 1441 EAST FLETCHER AVENUE, TAMPA, FLORIDA 33612

DECOURSEY ACTIVE ELECTRONIC CROSSOVERS
Model 110 dividing network, complete with regulated power supply, for bi-amp, tri-amp, or quad-amp. Custom assembled to meet your specifications. Monaural, stereo or with derived third channel. Plug-in Butterworth (maximally flat) filters; 6, 12, or 18 db per octave at any desired audio frequency. OPTIONS: Summer for single woofer systems, VLF hi-pass filters for elimination of subsonic noise, derived third channel FOR OEM OR HOME ASSEMBLERS. Model 500 or 600 dual filters. Regulated power supplies. Write for new brochure. DECOURSEY ENGINEERING LABORATORY, 11828 Jefferson Blvd., Culver City, CA 90230 Ph. (213) 397-9668

DON'T PAY THE HIGH MAIL ORDER PRICES
THIEVES WAREHOUSE OF ATLANTA
2769 LAKEWOOD AVE. S.W., ATLANTA, GEORGIA 30315

DON'T PAY THE HIGH MAIL ORDER PRICES
THIEVES WAREHOUSE OF ATLANTA
3164 PEACHTREE RD. N.E. ATLANTA, GEORGIA 30303

DON'T PAY THE HIGH MAIL ORDER PRICES
THIEVES WAREHOUSE OF ATLANTA
4166 BUFORD HIGHWAY, N.E. ATLANTA, GEORGIA 30345

DON'T PAY THE HIGH MAIL ORDER PRICES
THIEVES WAREHOUSE OF ATLANTA
1030-3 CHEROKEE ROAD, SMYRNA, GEORGIA 30080

DIRECT DRIVE ELECTROSTATICS

The Best of both worlds: Tubes and Solid State! RTR's DR-1 Point Source and Acoustat's Full Range System combined with the individually hand tuned Cyberacoustat Sub-woofer!!! Available exclusively at: Barclay Recording & Electronics, 233 E. Lancaster Ave., Wynewood, PA 19096. For Appointment Call: (215) 667-3048.

TYPE YOUR SLIDES! Sizes 3 1/4 x 4 \$2.35 per 50 and 2 x 2 \$2.85 per 100 plus postage. Radio Mat Slide Co., 444 N. Peninsula Drive, Daytona Beach, Fla. 32118

ATTENTION AUDIOPHILES

Amptilla, Burwen, Dahlquist, Decca, Denon, Dynaco (Modified), Ferragraph, Fulton E and J Systems, Grace, IMF, Koss Speaker, Lecson, Lux, Magnepan, Mark Levinson, Fons, M & K, Quad, Quintessence, Quatre, SAE, Satin, Stax, Sonus, Technics, Transcriptor, and many others. All equipment pretested and guaranteed to meet specifications, and shipped prepaid and insured in continental US. AUDIOPHILE'S SOUND STUDIO 7459 Elmwood Ave. Middleton (Madison), Wisconsin 53562 Phone 608-836-3807

THE NEW PARAGON PREAMPLIFIER highly acclaimed recently in an audiophile magazine is now available at Paragon of Sound. You are invited to call, 301-229-2676 (Bethesda, Md.) for an appointment to hear the difference.

PROFESSIONAL HI-FI COURSE - Instructors include Len Feldman, Julian Hirsch, Larry Klein and Larry Zide. Home study course available. Send \$2 for full color AUDIO PRIMER and full information on joining SAC, Society Audio consultants, 49 East 34th St., Dept. A, New York, NY 10016

FUTTERMAN DIRECT-COUPLED output transformerless vacuum tube amplifiers, world's purest, nearly zero distortion. Golden Ear's Reference loudspeaker system utilizing KEF or Hartley drivers; assembled or kit, free information. Dealers for C/M, DB Systems, DBX, Decca, Denon, Dynaco, FR, Stax, Supex, Russound Patching Centers. Swiss Door Chimes, plays "Dixie" others, \$12.95. Sonically pure recordings, latest Sheffield, free list. Crown 824 tapedeck, mint \$900. DUAL-76 amplifier, mint \$777.50. SP3a-1N preamplifier, nearly new \$695. IMF Studio-IIIa loudspeakers, mint \$550 pair. WANTED: Old Futterman, McIntosh, Marantz tubed equipment. GOLDEN EAR, Box 2189, Riverview, Michigan 48192. (313) 479-1234.

DON'T PAY THE HIGH MAIL ORDER PRICES
THIEVES WAREHOUSE OF PENSACOLA
3731 NAVY BOULEVARD, PENSACOLA, FLORIDA 32507

FOR SALE

DON'T PAY THE HIGH MAIL ORDER PRICES
THIEVES WAREHOUSE OF PENSACOLA #2 3820 NORTH 9TH AVENUE, PENSACOLA, FLORIDA 32503

TECHNICS SP-10 with SME, like new, \$400. ADC-XLM/II, never used, \$30. Toulme, 2527 Hydraulic 35, Charlottesville, Va. 22901, (804) 977-4618 after midnight

DON'T PAY THE HIGH MAIL ORDER PRICES
THIEVES WAREHOUSE OF ATLANTA, 4162 JONESBORO RD., ZAYRE CENTER, FOREST PARK, GA. 30050

FACTORY SEALED CARTONS: SC 2012A, 2212, 2217 Sony 788-4, 388-4, TC 177, B&O 5700's Hegeman 1, 1a, 2, Sub Woofer Sansui CA 3000, BA 5000 Dyna 150, 303, 400, 400M, 410 IMF ALS 40a, ALS 50 Studio III C, R, H & Q, Janszen 412 A, 412 HP, 600 a Fairfax WALL OF SOUND. Other gear Inquire. Hal Duvall 4715 Wieuca Rd NE Atlanta Ga. 30342 (404) 255-4207 or 325-7352 (Oays).

DON'T PAY THE HIGH MAIL ORDER PRICES. THIEVES WAREHOUSE OF MOBILE/VILLAGE SQUARE, 301 SOUTH CRAFT HIGHWAY, MOBILE, ALABAMA

REVOX A77 Recorder Mint - Best Offer Over \$650. Mike Scheehle, 4103 Halifax Rd., Wilmington, N.C. 28401.

FOUR TEAC AN-180 outboard Dolby units Superb condition. \$225 each. 816-966-1775, 254-7889

LOUDSPEAKER DESIGN COOKBOOK - specific design information for air suspension, reflex, resistive port, passive radiator, and T.L.'s using available drivers. Includes chapters on passive and active crossovers, low cost empirical test procedures, plus construction and cosmetic technique. Practical application for builders, profusely referenced for theory freaks. \$5.95 to Speaker Research Associates (SRA), 3959 S.E. Hawthorne Blvd., Portland, Ore. 97214

ALLEN & HEATH 6-channel stereo mini-mixer. List \$544. Demo price \$450. NAB Audio, Box 7, Ottawa, Ill. 61350.

MARANTZ 7T - mint, will ship, insured, anywhere continental USA - \$165. (612) 831-2872 after 6 pm CST.

COLORADO'S AUDIO ALTERNATIVE — Boulder Sound Gallery, Ltd. — Purveyors of unusually fine audio systems and service to meet the needs of all serious music lovers. Our product selection includes the Acoustat X ESL, Allison, B & O, B & W, Dahlquist, dbx, Fidelity Research, Fons, Luxman, Magneplanar, Mark Levinson, M & K Sound, Quad Acoustical, Quatre, Sound Concepts, Stax, Supex/Sumiko, Yamaha, and Ultraphase. 1200 Pearl, Boulder, Colorado 80302; 1-303-444-2626

LUX TUBE amplifiers 3045's, mint condition. \$800. 216-856-4532.

MINT CONDITION Technics SH-400 CD-4 Demodulator \$85. Contact B.A. Moura, 417 Perkins Dr., Hayward, CA 94541

NAME BRAND RECORDING TAPE, custom loaded. Available in cassettes, reels, and cartridges. Huge savings direct from manufacturer. New catalogue now available. MJS, 516 Brooks, San Jose, Calif. 95125 (408) 998-2693.

EVERYTHING ON OPEN REEL! Classical. Popular. Dolby. Quadraphonic. Latest releases. For "Reel News," send \$1.00. Barclay-Crocker, Room 857 A, 11 Broadway, New York 10004.

FORMULA 4 ARM. NEW S110, 313-732-4670.

HIGH END DEMO & USED: IMF TLS-80 \$1250, Super-Compact \$275, Denon 103C \$95, AU-320 \$90, KMAL III (new) \$80, D.B. Systems \$375, Quad 303 \$195, Dreadnaught 250 \$575, MA2002-E \$65, (new) Zerostat \$24, Burwen 1201 \$240, Technics 1300 \$150, Linn Sandek \$225, Thorens 145C (new) \$185, Chartwell LS3/5A \$275, Terry Duffy, 5232 Sagamore Dr., Swartz Creek, Mich. 48473. 313-732-4670.

MINNESOTA—Great American Sound, FMI, Bravura, Electro-Research, DB Systems, Paoli, Grace, Linn-Sondek, Shreve Rabco, more. AUDIO PERFECTION, 822 Regent Drive, Apple Valley, MN 55124; (612) 432-3222

FOR SALE

FREE CATALOG of outstanding audio kits

Get big savings and top performance from world-famous Heathkit equipment. Choose from nearly 400 kits — including stereo and 4-channel components, speakers, color TV, audio test and service equipment, lots more. Our step-by-step instruction manuals are world-famous for their completeness, clarity and accuracy. "We won't let you fail" is our customer-proven pledge! For a FREE color catalog, write Heath Company, Dept. 41-24, Benton Harbor, Michigan, 49022.

A FEW COMPETITIVELY priced used Revox A77 and A700 decks available. Completely reconditioned by Revox, virtually indistinguishable from new and have the standard Revox 90 day warranty for rebuilt machines. Satisfaction guaranteed. Example, A77 with Dolby, plus shipping. Write re-PAGE 159 requirements to ESS!, Box 854, Hicksville, N.Y. 11802 (516) 921-2620

MAS1 - A UNIQUE MOVING COIL PREAMPLIFIER THAT VIRTUALLY WILL NOT ALTER SOUND. VARIABLE IMPEDANCE SWITCH EXACTLY MATCHES YOUR DENON - SUPLEX - EMT - ORTOFON - FIDELITY RESEARCH ETC. CARTRIDGE FOR OPTIMUM PERFORMANCE \$229.00 - DEALER INQUIRIES INVITED. MEL SCHILLING ENTERPRISES, 7205 POMERO DRIVE, CANOGA PARK, CA. 91307 (213) 348-4600

JANIS WOOFERS, Mint. \$450. R. Bailey, 216 Slade Ave., Baltimore, Md. 21208

AUTO STEREO SPEAKERS - The finest system available. Compare and be convinced. SCOTT SOUND SYSTEMS, PO Box 44402, Panorama City, CA 91412.

FAIRFIELD AND WESTCHESTER COUNTY AUDIOPHILES TAKE NOTE! THE AUDIOPHILE, 201 BEDFORD STREET, STAMFORD, CONN. specializes in equipment for the connoisseur. G.A.S., Koss Model One, ADC, Crown, Dahlquist, Dyna, Epicure, Infinity, Philips, SAE, SME, Stax, TEAC, Technics, Thorens, Soundcraftsmen, Denon, Sonus and many more. (203) 348-3551 (Closed Mondays).

TOURING SOUND SYSTEMS, 2, 4, and 8 Track Studios, Disco Sound, Cerwin Vega BGW, Altec, Shure, AKG, Tapco, Dyna, Revox, EV, Beyer, Cetec, etc. K & L Sound Service, 75 North Beacon At., Watertown, Mass. 02172. (617) 787-4072-Att: Ken Berger.

DYNACO CABINETS. For Dynaco preamps, tuners, stereo 120. Literature. Geometrix, Box 612, Mexico, MD 65265

PERFECTIONISTS PREFER DYNAKITS

Before Purchase You Owe Yourself Our Quote Mainline 11a 971 Fronheiser Johnstown, PA 15902

VIKING TAPE EQUIPMENT # 75 Transport w/2 track Sony P/B head, \$15; PB70 mono P/B preamp, \$5; pair, RP83 REC/PB preamps, \$125 pr; # 86 type transport with 2 PB 10 P/B preamps switchable 2 or 4 track, \$150; 86 type transport with 2 track stereo R/P/E heads, no electronics, \$125. Also, Ampex Micro 85 cassette transport, no electronics, \$25; 4 Bozak 209B midrange speakers, \$30 ea; 2 Altec 452/300SL balanced line transformers, \$15 pr; 2 Altec balanced 300S2/Hi Z input transformers, \$10 pr; 2 Hitachi 6BM8 output transformers, \$5.00 pr.

ATTENTION DYNA OWNERS: Our Dyna Double 400 modification with 16 output transistors, front end bypass, and 80,000 mfd power supply is twice as fast and twice as strong as a stock ST-400. Our Super PAT-5 has lightning fast ICs and improved high gain phono section. With a Denon DL103S straight in, these Super Dynakits show you just how great our Fulton Js and Magneplanars will play. JENSENS STEREO SHOP, where State of the Art is affordable. 2202 River Hills Drive, Burnsville, Minnesota, 55337. 612-890-3517.

SAN FRANCISCO - Lecson AC-1, AP-3; FR1 Mark II moving coil; dbx 119; Yamaha YP800, CT800, TC800 GL, and NS1000 Ebony, 6 months old, mint. Ooug 415-661-2526.

HOW TO: Install your car stereo and save money. Send \$150 to: G.A.S., 4419 John Marr Dr., Annandale, VA 22003.

FOR SALE

ATTENTION LATIN AMERICAN AUDIOPHILES
ATTENTION VACATIONERS VISITING THE MIAMI AREA
ATTENTION RESIDENTS OF SOUTH FLORIDA
SOUND COMPONENTS, INC. is THE place for state of the art stereo. Some of our products include:

LOUDSPEAKERS: Spendor BCII and BCIII, Audio Research Magneplanars, Quads, Magneplans, Allison, Bowers & Wilkins, FMI including the J System, Gale, M&K sub-woofer, Dayton-Wright XG-8 Mk III, KLH CL-4, KEF 104, B&O, Acoustat-X, Chartwells

TURNABLES: Linn-Sondek, The Michell Engineering Co. Transcriptors, B&O 3000 and 4002, Yamaha, Era, Fons

PICKUPS AND TONEARMS: Ultimo OV38/20A, Denon 103-S and 103-C, Prometheus, Ortofon, Fidelity Research, B&O MMC series, Sonus, SME, Audiocraft, KMAL, Grace 707, Stax UA7-M tonearms, Satin M-117, Dayton-Wright 535 Infranoise Cartridge pre-preamp, Levinson pre-preamps Denon AU-320, Ortofon transformers, Hoffman transformers

ELECTRONICS: Audio Research, Lecson, Quad, Ampzilla, Thaedra, Son of Ampzilla, Dayton-Wright, Paoli, Luxman, Naim, Genesis, Yamaha, B&O, Stax, Radford, Citation, Levinson JC 2

TAPE RECORDERS: Uher, Otari, Braun, B&O Beocord, Yamaha RECORDINGS: A range of selected British, French, and German pressings. Also, the Fulton, Sheffield, and Audio Lab discs

All of the above products are in stock and on demonstration in our 1100 sq. ft. showroom

HOURS: 10-6 Monday through Thursday & Saturday
10-9 Friday

We accept Bancamericard and Mastercharge
We ship mail order in continental U.S. prepaid.
SOUND COMPONENTS, INC.
2710 Ponce de Leon Boulevard
Coral Gables, Fl. 33134
Telephone: 305-446-1659 TWX: 810-848-7627
SUPERB PRODUCTS FOR THE DISCRIMINATING AUDIOPHILE AND MUSIC LOVER.

WESTERN NEW YORK AUDIOPHILES

THE STEREO EMPORIUM

Visit our new, expanded facilities and experience the finest in audio components with the same personalized, honest service we have always maintained.

AUDIO RESEARCH
AMPZILLA-G.A.S.
QUATRE
MAGNEPAN
QUAD
YAMAHA
DENON
GRACO SIGNATURE
BANG & OLUFSEN
GRACE
STAX
BOWERS & WILKENS
RTR
SONUS
WIN LABS
TECHNICS

MARK LEVINSON
DUNLAP CLARKE
MAGNEPLANAR
DAHLQUIST
FIDELITY RESEARCH
EMT
FORMULA FOUR
HADCOCK ARM
WIN LABS
IMF
M&K SOUND
ONKYO
LINN SONDEK
KMAL
CONNESIEUR
TRANSCRIPTORS

CALL, WRITE, OR VISIT US TODAY.

THE STEREO EMPORIUM

3407 Delaware Ave.
Buffalo, N.Y. 14217
716-874-3372

MAKING HIS MOVE — Mel Schilling, formerly of Willow Grove, Pa., has taken his knowledge of music and sound to California where he will continue to serve a select nationwide clientele devoted to ultra state-of-the-art stereo. All shipments prepaid and insured. Write or call — 20929 Ventura Blvd., Woodland Hills, Calif. (213) 348-4600.

DON'T PAY THE HIGH MAIL ORDER PRICES.
THIEVES WAREHOUSE OF HIALEAH, 6741 WEST 4TH AVE.
NUE HIALEAH, FLORIDA 33012

FOR SALE

DON'T PAY THE HIGH MAIL ORDER PRICES.
THIEVES WAREHOUSE OF FT LAUDERDALE, 3347 NORTH
FEDERAL HIGHWAY, FT LAUDERDALE, FLORIDA 33306

DYNA STEREO 70 MOD KIT. Tighter bass, improved transient response, higher definition. Complete instructions, schematics, parts list, \$5.00. With parts kit, including all new tubes, \$58.00 all postpaid. Audio Designers, Box 122, Led yard, Conn. 06339.

DON'T PAY THE HIGH MAIL ORDER PRICES. THIEVES WAREHOUSE OF WESTMINSTER, 2969 WEST 72ND AVE. NUE, WESTMINSTER, COLORADO 80030

DON'T PAY THE HIGH MAIL ORDER PRICES. THIEVES WAREHOUSE OF MACON, 1564 EISENHOWER PARKWAY, MACON, GEORGIA 31206

QUEST OF PERFECTION. The one stop for all your audio needs, and associate psychedelic items. \$6.00 for catalog redeemable Audio Box A610-2

PROFL QUALITY E.M. SYNTHESIS kits, components, plans, etc. Send S.A.S.E. for free info, write now: CFR Associates P.O. Box Newton N.H. 03858. The oldest name in Synthesis for the Serious Experimenter.

OUR TA-1 TONEARM IMPROVES RECORD SOUND with low effective mass (<2.5 grams with most cartridges) and pivot friction (all pivots jeweled), optimum silicone damping, vertical pivots at record level, anti-skate bias, damped cueing, and low capacitance cables. Money-back guarantee. \$149.00 postpaid. JML Company, 39,000 Highway 128, Cloverdale, CA 95425.

AUDIO PULSE DIGITAL DELAY SYSTEM: quantum step closer to the live experience. AUDIOCOM, Old Greenwich, Ct. 06870, (203) 637-3621.

CROWN D-150 AMP, IC-150 Pre-amp, SX-724 Tape Recorder; JBL S-7R Speakers; Dual 1229 Turntable with V-15III cart.; Altec 729A, 24 channel, 1/3 octave equalizer. All mint condition. Staley, 7804 Academy Trl., N.E., Albuquerque, N.M. 87109. (505) 821-4311.

SAE MK VII Stereo octave equalizer with wood cabinet, eleven stereo ganged controls, \$300. Wood cabinet: size 9-7/16" depth behind panel, panel opening, 15 3/8" x 5 3/4". Excellent condition. \$20. Shipping for both at buyer's expense from NYC. Audio Box A612-1.

PAIR INFINITY 2000A speakers (4 electrostatic tweeters each), stands, original boxes, \$325. Soundcraftsmen 20-12 octave equalizer, \$150. All in absolute mint condition. (901) 754-7925 P.O. Box 17598, Memphis, TN.

STAK SRA-125 pre-amp and SR-X-Mk3 headphones \$450. Mint cond., Marantz 500 \$750. Kent 505-268-0333.

WISCONSIN AND THE MIDWEST

AUDIOPHILE'S SOUND STUDIO IS AN ESTABLISHED DEALER IN SOPHISTICATED COMPONENTS FOR THE SERIOUS MUSIC LISTENER. WE OFFER FIVE INDEPENDENT AND FULLY-EQUIPPED LISTENING ROOMS, AND A TECHNICALLY COMPETENT STAFF WHO ARE WILLING TO APPRAISE HONESTLY ANY AND ALL EQUIPMENT. ALL OUR PRODUCTS ARE BACKED BY OUR SUPERB, PROFESSIONALLY EQUIPPED, AND STAFFED, SERVICE DEPARTMENT.

We are exclusive Wisconsin Dealers for: Mark Levinson * Great American Sound Co. * Bower & Wilkins * Dayton Wright * Quad.

Our carefully selected product lines also include: Denon * I.M. Fried * Fulton * Lux Audio * B&O * Dahlquist * Magneplanar * and many more outstanding products.

ALL OUR EQUIPMENT IS PRETESTED AND GUARANTEED TO MEET SPECIFICATIONS. WE ALSO SHIP PREPAID AND INSURED WITHIN THE CONTINENTAL U.S.

AUDIOPHILE'S SOUND STUDIO
7459 Elmwood Avenue
Middleton, Wisconsin 53562
Phone 608-836-3807

DIRECTIONAL MICS. - Electro-Voice Mod. 644 Used very little. Both for \$125. S. Bowly 3534 Conquista Ave., Long Beach, CA. 90808

FOR SALE

DON'T PAY THE HIGH MAIL ORDER PRICES. THIEVES WAREHOUSE OF RIDGEWOOD, 25 GODWIN AVENUE, RIDGEWOOD, NEW JERSEY 07450

ACOUSTIC RESEARCH LST-2's 18 mos. old. Excellent condition, best offer. Call Wayne 609-667-1441 evs

DON'T PAY THE HIGH MAIL ORDER PRICES
THIEVES WAREHOUSE OF TAMPA

1531 SOUTH DALE MABRY, TAMPA, FLORIDA 33609

DON'T PAY THE HIGH MAIL ORDER PRICES.
THIEVES WAREHOUSE OF PLANTATION, 231 SOUTH STATE ROAD 7, PLANTATION, FLORIDA 33317

BIGGEST DISCOUNTS on audio - high-end components. Over 125 brands. Audio Unlimited, 466 Hawthorn, Sunnyvale, CA 94086 408/737-0828 evenings

HONG KONG, TAIWAN, JAPAN, Asia Directory World products information. Mail-orders, bulk-orders, Listings. Directory and information \$1 00 today. World Trade Inquiries, Box 6224, Spokane, Wash 99207

—OHIO AUDIO ENTHUSIASTS—

Akron's AUDIO SYSTEMS—Audio Research Speakers and Electronics, Nakamichi, Magnapan, Linn Sondek, ADS, Ortofon, Sonus, SAE, Grace, Vestigol, Denon, Stax, Technics, and many other fine audio components. 2858 W. Market St., Akron, Ohio 44313 216-864-4411.

DON'T PAY THE HIGH MAIL ORDER PRICES. THIEVES WAREHOUSE OF FAIR LAWN, 34-09 BROADWAY FAIR LAWN, NEW JERSEY 07410

ANNOUNCING THE NEW, EXPANDED OKL SOUND LAB
A completely new approach to long distance/mail order sales of **PERFECTIONIST AUDIO COMPONENTS.**

Featuring -

A) A continual evaluation program of new products to maintain a selection of only the finer audio components at several price levels

B) At your request, a complete **WRITTEN LABORATORY CHECK-OUT** and listening tests performed on your component purchase by the **OKL LABORATORY, INCORPORATED.**

C) All items **IN STOCK** for immediate shipment; **PRICES INCLUDE SHIPPING INSURANCE** by surface **TO ANYWHERE** in continental United States; air freight and foreign shipments also available.

D) A wide selection of goods considered **"STATE-OF-THE-ART"** by leading audiophile authorities plus components judged **"BEST SOUND PER DOLLAR"** including:

AUDIO RESEARCH	DBX
IMF (FRIED)	PADLI
MAGNEPAN	STAX
REVOX	KEITH MONKS (KMAL)
OENON	OKL CUSTOM PRODUCTS
LUS AUDIO (LUXMAN)	QUATRE
LINN-SONDEK	FULTON (FMI)
DYNACO	"HAND-TUNED" DECCA MKV
OKL CUSTOM RABCO	AMBIPHON
BGW	SHEFFIELD LABS
DAMPENED SME	SOUNDCRAFTSMEN
M&K SOUND (BOTTOM END)	SUPEX
TANNY	SONIC RESEARCH (SONUS)
RTR INDUSTRIES	

"MAKE YOUR MUSIC COME ALIVE"

THE **OKL SOUND LAB** SPECIALIZES IN COMPATIBLE COMPONENT COMBINATIONS OF EVERY DESCRIPTION DESIGNED TO **MAXIMIZE THE SONIC POTENTIAL** OF YOUR SOUND SYSTEM. **CALL OR CORRESPOND WITH US** WHEN YOU ARE READY TO **UPGRADE.** WE GIVE **AUTHORITATIVE EQUIPMENT RECOMMENDATIONS TO DRAMATICALLY INCREASE THE DEFINITION AND DETAIL** OF YOUR PRESENT SYSTEM.

OKL SOUND LAB
OUR NEW SHOWROOM LOCATION:
804 BURLINGTON AVE
(EAST WEST HWY (RT. 410),
JUST EAST OF GEORGIA AVE.)
SILVER SPRING, MARYLAND 20910
301-588-6257

HOURS: MONDAY THRU FRIDAY 12 NOON-8P.M.
SATURDAY 10 A.M.-6 P.M.
CLOSED SUNDAY

"WE MAKE YOUR MUSIC COME ALIVE"

FOR SALE

PALO ALTO, CALIFORNIA
PROFESSIONAL RECORDING EQUIPMENT

REVOX
CROWN
TANDBERG
UHER
SONY
TEAC
DBX

LAMB
SENNEISER
BEYER
AKG
SHURE
MB
VEGA

WESTERN AUDIO IMPORTS
2233 EL CAMINO REAL
PALO ALTO, CALIFORNIA 94306
(415) 321-0664

SHOP THE YELLOW PAGES OF AUDIO Comprehensive directory to consumer as well as professional. Audio products and periodicals. Box 94-A, Colmar, Pa., 18915.

MARK LEVINSON	OAYTON WRIGHT
KEITH MONKS	LINN SONDEK
DAHLQUIST	MAGNEPAN
AMPZILLA	THAEDRA
POLK	STAX
FR	MK

ABSOLUTE SOUND
ABSOLUTE SOUND
ABSOLUTE SOUND

SAE	ESS
FONS	GALE
RABCO	GRACE
DENON	REVOX
LUXMAN	LESCON
TANDBERG	KOSS ESL
OUNLAP CLARK	SONY V-FET
HARMAN KARDON	SOUNDCRAFTSMAN

ABSOLUTE SOUND - HIGH ACCURACY AUDIO COMPONENTS

(313) 527-2244 12400 Morang Detroit, Mich 48224
(313) 549-7550 4354 N. Woodward RD. Mich 48072

MINT USED COMPONENTS: Audio Research Tympani III T/M \$600. Audio Research D75A \$650. Decca 4RC \$60. Dynaco PAT 4 \$100. Thorens TO-124 w/audio & design are \$250. Dynaco Stereo 80 \$90. Bose 4401 \$400. Ortofon SL15E \$45. Citation 12 \$225. Epicure 1 \$525. Thorens TD 125 ABMKII \$300. Quad FM3 \$215 (new). Quad 303 \$215 (new). ABC XLM MKII \$50 (new). AR3A \$250 pr. Marantz 2240 \$350. Sherwood S3300 \$100. Audionics TL30B \$275 pr. Audionics TL50 \$325 pr. **QUALITY DEMOS W/WARRANTIES** Hartley Concertmasters Jrs. \$550 pr. Hartley Concertmasters w/24" woofers \$1200 pr. IMF TLS80 \$1425 pr. Crown IC150 \$225 Sound Advice, 536 State Road, Emmaus Pa 18049 Mon., Tues., Thurs., Fri., 12:30. Wed 6:30-30. Sat. 10-6 (215) 967-4418

SAVE UP TO 69% ON OVER 100 TOP BRAND AUDIO COMPONENTS FROM CARSTON STUDIOS, NEW ENGLAND'S AUDIO SUPERMARKET, ONE OF THE OLDEST MAIL ORDER FIRMS (EST. 1952) AND CERTAINLY ONE OF THE MOST RELIABLE. ALL ORDERS SHIPPED FROM STOCKED WAREHOUSE. SEND FOR PRICE QUOTE AND PRICE LIST. CARSTON STUDIOS, OLD BROOKFIELD ROAD, DANBURY, CONN. 06810

MIDRANGE COMPRESSION DRIVER modification reduces distortion 300% improvement over original mfg. specs. Write to ISI, 1200 Gough Street, San Francisco, California 94109

AKG, ALTEC, BEYER, CROWN, DAHLQUIST, DBX, DECCA, INFINITY, KLH 9s Koss, Nakamichi, Ortofon, PHASE LINEAR, PMI, REVOX, SAE, Sennheiser, Sequerra, Sony, Stanton, Stax, Supex, TASCAM, Technics, Thorens, etc.

HI-FI HAVEN
28 Easton Ave.
New Brunswick, N.J. 08901
201 249-5130

FOR SALE

STEREO TV



The TE-200 TELEADAPTER EASILY CONNECTS TO ANY TV & STEREO SYSTEM. Using our coupling and matrix circuit, teleadapter takes a low impedance output from the television and delivers two HIGH IMPEDANCE CHANNELS OF SIMULATED STEREO, to drive any amplifier. Frequency response is maintained so you can hear the tinkle of bells or booming bass sounds as it happens on TV. With service warranty and hookup instructions \$19.95 p/d. Guaranteed to make your TV 100% more enjoyable.

OUR NEW TE-300 VHF-UHF TELEVISION High Fidelity AUDIO TUNER is now available. Completely solid-state Recording and amp output jacks - Anodized Aluminum front panel and simulated Walnut Cabinet. 110 volt operation \$169.95 p/d.

SEND CHECK, M.O., MASTERCHARGE, or BANKAMERICARD, NO. and Expiration date TO: RHOADES NATIONAL CORP. DEPT NO. 5C BOX 817, HENDERSONVILLE, TENNESSEE 37075

NAME _____

ADDRESS _____

CITY _____

STATE _____

ZIP _____

SEND COMPLETE CATALOG

CONNECTICUT: Yamaha, Advent, JBL, Bose, Citation, McIntosh, Tandberg, B&O, Harman/Kardon, Ortofon, Epicure, Design Acoustics. Will ship prepaid. Sounds Incredible, 226 White St., Danbury, Conn. 06810 (203) 748-3889 — phone quotes only.

DON'T PAY THE HIGH MAIL ORDER PRICES. THIEVES WAREHOUSE OF DUMONT, 78 WASHINGTON AVENUE, OUMONT, NEW JERSEY 07628

AMPZILLA-THAEDRA
SON OF AMPZILLA

Sound Advice 536 State Road, Emmaus, Pa 18049 Hours
Mon., Tues., Thur., Fri., 12-9:30 Wed. 6-9:30 Sat. 10-6
(215) 967-4418

DON'T PAY THE HIGH MAIL ORDER PRICES THIEVES WAREHOUSE OF GAINESVILLE, 434 N W 13th STREET, GAINESVILLE, FLORIDA 32601

MILWAUKEE & WISCONSIN'S
ONLY AUDIOPHILE DEALER

Specialists in components by Dahlquist, Transcriptors, SAE, Nakamichi, Epicure, Bozak, Citation, Ohm, SME, Ampzilla, DBX, Infinity, Revox, RTR, Phase Linear, Quintessence, Advent, Tandberg and over 50 others. Wisconsin's first Audio Research dealer with the complete product line on demonstration. PLUS-one of the truly largest display of tape decks in the entire country. Over 130 machines on display. WACK ELECTRONICS INC. 5722 W. NORTH AVE. MILWAUKEE 53208 414-442-3441

CONN. AND WESTERN MASS'S
LARGEST STEREO DEALER

ACCPHASE	SUPEX
AUDIO TECHNICA	ORTOFON
EPICURE	FIDELITY RESEARCH
DAHLQUIST	REVOX
AUDIONICS	B&O
dB SYSTEMS	TEAC
CROWN	TRANSCRIPTORS
QUATRE	OBX
PHASE LINEAR	BEYER
SAE	STAX
CITATION	AKG
MARK LEVINSON	NAKAMICHI
SOUNDCRAFTSMAN	SEQUERRA
ESS	BURWEN
MAGNEPLANAR	HARTLEY WOOFERS
MAGNEPAN	QUAD
THORENS	LUX
TECHNICS	& MORE

FRED LOCKE STEREO

Newington	Professional Products	Greenwich
203-667-2277	Division	203-637-5439
New Haven	203-828-1124	Avon
203-787-0183	Orange	203-678-1797
Waterbury	203-795-0701	Fairfield
203-757-9296	Springfield, Mass.	203-366-5246
Stratford	413-782-7111	
203-377-1771	East Hartford	New London
	203-528-9479	203-443-1835

FACTORY SEALED UNITS - Luxman P-121 turntable, Sherwood 7210, mint SAE IICM (used) (518) 783-6890, evs.

FOR SALE

**BUILD YOUR OWN SPEAKERS AND
SAVE UP TO 50%**



You can assemble your own high quality multi-element stereo speakers in a few hours and save up to half the cost of comparable speakers. Send for our free 32-page catalogue of speaker kits, raw speakers and accessories.

SPEAKERLAB
Dept. A-3, 5500 35th N E
Seattle, Washington 98105

LINCOLN — OMAHA

— Dedicated To The Reproduction Of The Original Sound —
Audio Research, Bang & Olufsen, Klipsch, Audionics, Radford, Revox, Linn Sondek, Crown, dbx, Sequerra and others.

AUDIO SYSTEMS & DESIGN

5421 South 84th St., Lincoln, Nebr. 68516 (402) 489-9888
4408 Capitol Avenue, Omaha, Nebr. 68131 (402) 556-7559

**DON'T PAY THE HIGH MAIL ORDER PRICES. THIEVES
WAREHOUSE OF JACKSONVILLE, 6078 OLD ST. AUGUSTINE
ROAD, JACKSONVILLE, FLORIDA 32217**

**DON'T PAY THE HIGH MAIL ORDER PRICES.
THIEVES WAREHOUSE OF KNOXVILLE,
5710 KINGSTON PIKE, KNOXVILLE, TN 37919**

SAN DIEGO

Audio Research, Fulton (FM), Audio Pulse Time Delay, Bravura, KMAL Record Cleaning, Discwasher, ERA, Grace, Shure V15-G, Mission Bay Audio, 4533 Mission Bay Drive, San Diego, Ca. 92109.

**DON'T PAY THE HIGH MAIL ORDER PRICES. THIEVES
WAREHOUSE OF AURORA, 10218 EAST COLEFAX, AURORA,
COLORADO 80010**

**DON'T PAY THE HIGH MAIL ORDER PRICES. THIEVES
WAREHOUSE OF PENSACOLA # 3, TOWN & COUNTRY
PLAZA, PENSACOLA, FLORIDA 32505**

**EQUINOX EAST - Hear Fulton J's, Linn Sondek, Grace, Fr.
813 Hemphill, Ypsilanti, Mich. 48197; (313) 482-4801.**

**NEW GENERATION Crown Amplifiers, Cleanest, Smoothest
sound ever produced - Crown O1200/HP1200, on demo
only at Barclay Recordings, 233 E. Lancaster Ave., Wyne-
wood, PA 19096; (215) 667-3048.**

**DON'T PAY THE HIGH MAIL ORDER PRICES.
THIEVES WAREHOUSE OF JACKSONVILLE,
1239 ARLINGTON ROAD & LONE STAR
JACKSONVILLE, FLORIDA, 32211**

"FULTON J"

Mint, demo pair of the latest version of this unique loud-
speaker; including shrouds. List is now \$2166.00/pair. Spe-
cial \$1495.00, freight pre-paid anywhere in U.S. other used
and demo equipment.

PAUL HEATH AUDIO, LTD.
2036 N. Clark
Chicago, Ill. 60614
312-549-8100

**TACOMA, WASHINGTON
AUDIO-TECH ELECTRONICS
STATE-OF-THE-ART SPEAKER KITS**

\$65.00 to \$700.00. Plans, Raw Drivers, Complete Lab Facil-
ity, \$50,000 in Test Equipment.

ADC Philips
Dyna-Mk-6 Pioneer
Hervic Sonus
Marantz Transcriptor
McIntosh

Special: Marantz Receivers 25% off if purchased with any
pair of speaker kits.

3863 Steilacoom Blvd. S.W.
Tacoma, Washington 98499
206-584-0332

AR-LST1 \$725 pair, Soundcraftsmen PE2217 \$325, H-K
Citation 12 \$200, SME 3009/2 \$100, Celestion HF 2000
60 pair, Shure M-64 \$20, Stanton 681 EEE \$40, ADC XLM
\$20. (617) 648-4191.

Advertising Index

ADVERTISER	PAGE	ADVERTISER	PAGE
Acoustat	67	Delta-Graph	93
Loudspeaker Systems		Graphic Equalizer System	
Check No. 1 on Reader Service Card		Check No. 12 on Reader Service Card	
Acoustical Mfg.	38	Designatron	119
Amplifiers		Stereo Equipment	
Write Direct to Advertiser		Write Direct to Advertiser	
AIWA	47	Discount Music	117
Hi-Fi Components		Record Club	
Check No. 2 on Reader Service Card		Write Direct to Advertiser	
Allison Acoustics	28	Discwasher	2
Loudspeaker Systems		Hi-Fi Components	
Check No. 3 on Reader Service Card		Write Direct to Advertiser	
The Audio Amateur	100	Dolby Labs	55
Publication		FM	
Check No. 4 on Reader Service Card		Write Direct to Advertiser	
The Audio Critic	95	Dual (United Audio)	5
Publication		Turntable	
Write Direct to Advertiser		Check No. 13 on Reader Service Card	
Audio Recording Center	120	Dynaco	92
Cassette Attache Case		Stereo Components	
Write Direct to Advertiser		Write Direct to Advertiser	
Audio-technica	30, 89	Empire	4
Phono-cartridge		Phono Cartridge	
Write Direct to Advertiser		Check No. 14 on Reader Service Card	
Headphones		Fosgate Electronics	102
Write Direct to Advertiser		Mobile Equalization System	
Avid	88	Check No. 15 on Reader Service Card	
Loudspeaker System		Fuji	7
Check No. 5 on Reader Service Card		Magnetic Tapes	
Bang & Olufsen	92	Check No. 16 on Reader Service Card	
Phono Cartridges		G.C. Electronics	41, 88
Check No. 6 on Reader Service Card		Hi-Fi Components	
Beyer Dynamic	81	Check No. 17 on Reader Service Card	
Headphone		Hi-Fi Components	
Check No. 7 on Reader Service Card		Check No. 18 on Reader Service Card	
BGW	106	Hartley Products	103
Amplifier		Loudspeaker Systems	
Write Direct to Advertiser		Write Direct to Advertiser	
B.I.C.	23	Heath Co.	110
Turntables		Catalog	
Check No. 8 on Reader Service Card		Write Direct to Advertiser	
Bose	35	Henry's	118
Loudspeaker Systems		Audio Store	
Write Direct to Advertiser		Write Direct to Advertiser	
Bozak	87	Hitachi	37
Hi-Fi Components		Hi-Fi Components	
Write Direct to Advertiser		Check No. 19 on Reader Service Card	
Crown International	26	JBL	16, 17
Tape Recorder		Loudspeaker Systems	
Check No. 9 on Reader Service Card		Write Direct to Advertiser	
Dahlquist	51	KEF	99
Hi-Fi Components		Loudspeaker Systems	
Check No. 10 on Reader Service Card		Check No. 20 on Reader Service Card	
dbx, Inc.	90	Kenwood	13
Noise Reduction System		Turntables	
Check No. 11 on Reader Service Card		Check No. 21 on Reader Service Card	

Advertising Index

ADVERTISER	PAGE	ADVERTISER	PAGE
KLH.....	39	RNS, Inc.....	98
Loudspeaker Systems		Hi-Fi Components	
Check No. 22 on Reader Service Card		Check No. 35 on Reader Service Card	
Lafayette Radio.....	57	SAE.....	6
Turntable		Hi-Fi Components	
Check No. 23 on Reader Service Card		Check No. 36 on Reader Service Card	
Lux.....	19	Howard M. Sams Co.....	49
Amplifier		Audio Cyclopeda	
Write Direct to Advertiser		Write Direct to Advertiser	
Magnepan, Inc.....	85	Sansui.....	27
Hi-Fi Components		Hi-Fi Components	
Check No. 24 on Reader Service Card		Check No. 37 on Reader Service Card	
Marantz.....	122, Cov. III	Saxitone.....	107
Turntable		Tapes	
Write Direct to Advertiser		Write Direct to Advertiser	
Maxell.....	43	Schwann.....	104
Magnetic Tapes		Publication	
Check No. 25 on Reader Service Card		Write Direct to Advertiser	
McIntosh Labs.....	101	Sennheiser.....	86
Catalog		Headphones	
Check No. 26 on Reader Service Card		Write Direct to Advertiser	
MXR.....	53	Shure Brothers.....	45
Hi-Fi Components		Phono Cartridge	
Check No. 27 on Reader Service Card		Check No. 38 on Reader Service Card	
Nakamichi.....	82, 83	SME Limited.....	84
Amplifier, Pre-amplifier		Tonearm	
Check No. 28 on Reader Service Card		Check No. 39 on Reader Service Card	
PAIA.....	100	Sonic Research.....	18
Synthesizer		Phono Cartridge	
Check No. 29 on Reader Service Card		Write Direct to Advertiser	
Phase Linear.....	96	Sony Corp.....	24, 25
Amps & Preamps		Hi-Fi Components	
Check No. 30 on Reader Service Card		Check No. 40 on Reader Service Card	
Pickering.....	3	Soundcraftsmen.....	8
Phono Cartridge		Hi-Fi Components	
Check No. 31 on Reader Service Card		Check No. 41 on Reader Service Card	
Pioneer.....	Cov. II, Pg. 1	Speakerlab.....	112
Turntable		Speaker Kits	
Check No. 32 on Reader Service Card		Write Direct to Advertiser	
Plessey.....	60, 61, 62, 63	Spectro Acoustics.....	97
Turntable		Hi-Fi Components	
Check No. 33 on Reader Service Card		Check No. 42 on Reader Service Card	
Polk.....	101	Tandberg.....	15
Loudspeaker Systems		Receiver	
Write Direct to Advertiser		Write Direct to Advertiser	
Primo.....	102	Tannoy.....	11
Microphones		Hi-Fi Components	
Check No. 34 on Reader Service Card		Write Direct to Advertiser	
Rhoades.....	111	TDK.....	29
Teledapter T.V. Sound Tuner		Magnetic Tape	
Write Direct to Advertiser		Check No. 43 on Reader Service Card	
Rocelco.....	21	Technics.....	Cov. IV
Loudspeaker Systems		Turntable	
Write Direct to Advertiser		Check No. 44 on Reader Service Card	
		Yamaha.....	31
		Loudspeaker Systems	
		Check No. 45 on Reader Service Card	

FOR SALE

FREE details... A DIFFERENT KIND OF RECORD CLUB

Discounts up to 73%, no "agree-to-purchase" obligations. All labels, Schwann catalog of thousands of titles; classical, pop, jazz, country, etc. Discount dividend certificates. Newsletter; accessories; quick service. 100% iron-clad guarantees. Write for free details.

dmc DISCOUNT MUSIC CLUB, INC. DEPT. 14-1276
650 Main Street, New Rochelle, N.Y. 10801

MARANTZ CLASSIC: 7T Preamplifier - with full documentation, S/N 14001, metal case, mint \$225.00 - J. Mitchell, 1113 W. Comanche, Norman, Okla. 73069.

STOP LOOKING for a good deal on hi-fi equipment — you've found it here — at your hi-fi headquarters in the heart of the Midwest. We are factory-authorized dealers for all major brands. Write or call today for our low quote and become one of our many happy and satisfied customers. HOOSIER ELECTRONICS, P.O. Box 2001, Terre Haute, Indiana 47802. (812) 238-1456.

YAMAHA V-FET B-1 power amp, μ -1 meter panel C-1 pre-amp. Less than one year old, never registered, \$2700.00. Magnecord 1024, \$550.00. Scott receiver, model 399, \$199.00. Sony TTS 3000 with Rabco arm, best offer over \$250.00. Marantz SLT-12, \$150.00. Huntington pre-amp with tri-amp network, \$395.00. Call (203) 248-5671.

SHOP AROUND — Listen to every speaker available — then come to Cyberacoustic Laboratory and hear RTR's New Direct Drive Electrostatic DR-1 speaker system at Philadelphia's exclusive distributor — by appointment — 233 E. Lancaster Ave., Wynewood, PA 19096; (215) 667-3048.

SOUND ADVICE MAGAZINE - IN ITS THIRD ISSUE OFFERS A CLASSICALLY SIMPLE MODIFICATION THAT ANY AUDIOPHILE CAN MAKE TO NOTICEABLY IMPROVE THE SOUND QUALITY OF ANY STEREO SYSTEM. WE'LL ALSO EXAMINE THE HIGHLY TOUTED AUDIO RESEARCH D-150 AMPLIFIER, THE PRESTIGIOUS MCINTOSH MC2205 AND THE THRESHOLD-A NEW, SUPERB SOUNDING 300 WATT PER CHANNEL CLASS A AMPLIFIER. AUDIOPHILES WILL ALSO BE STUNNED BY A NEW MODIFICATION KIT FOR THE DYNACO PAS-3X THAT SWAMPS EVERY OTHER PRE AMP WE HAVE HEARD. FOR COMPARISON, WE LOOK AT THE PERFORMANCE CHARACTERISTICS OF THE DB SYSTEMS AUDIO GENERAL, STAX, NAKAMICHI 610 AND ACE AUDIO CARTRIDGE BUFFS WILL BE INTERESTED IN OUR COMMENTS ON THE EMT XSD-15, JVC X-1, SUPEX 900 SUPER, NAKAMICHI MC1000, FIDELITY RESEARCH FR-1, MKIII, SONUS BLUE AND RED AND GRADO G-1+. FOR THOSE MOVING COILS, YOU'LL NEED A STEP-UP DEVICE AND WE EVALUATE AND COMPARE 3 OF THE BEST: MEL SCHILLING'S MAS-1, QUATRE GAIN CELL DG-1 AND HUNTINGTON MICRO, WITH OUR FAVORITE THE DENON TRANSFORMER. THERE'S ALSO THE LUXMAN PD-121 TURNTABLE AND A COMPARISON OF THE DAMPED GRACE G-940 WITH THE UNDAMPED G-707. FINALLY, THERE'S A THOROUGH EVALUATION OF THE MAGNEPLANAR TYMPANII 1-C LOUDSPEAKER. SOUND ADVICE-FOUR ISSUES FOR \$10 (\$13 FIRST CLASS; \$15.00 FOREIGN-SENT AIRMAIL) SOUND ADVICE, 225 KEARNY STREET, SUITE 200M, SAN FRANCISCO, CALIFORNIA 94108.

PORTLAND, OREGON HAWTHORNE STEREO

An uncommon Hi-Fi store serving Portland for thirty years with the finest in products, service, and people.

Audio Research	Radford
Quad	Crown
Audaire	Harmon-Kardon
Sony V-FET	Yamaha
Marantz	McIntosh
Oahlquist	Magneplanar
Beveridge	Fulton
Polk	Advent
Audronics	Phase Linear
Technics	SME
Grace	Oenon
Mark Levinson	Stax
Nakamichi	Fidelity Research
GAS	Philips

West 8680 S.W. Canyon Rd. Portland, Oregon 97225
East 3580 S.E. Hawthorne Blvd., Portland, Oregon 97214
503-292-4401

FOR SALE

90% FOR LESS

CALL JS TO GET ALMOST EVERY HI-FI BRAND YOU SEE FOR LESS MONEY

TOLL FREE ORDER LINE 800 421-8537

Pioneer KP4000 In-dash AM/FM/Cass.	\$ 108.00
Sony # 7200 Betamax with timer	1072.00
Dokorder MK-50 Dolby Cass. Deck	139.00
AR-XB Turntable w/Shure M91ED	108.00
Dynaco A25 Speaker in walnut	56.00
Marantz 2270 AM-FM Receiver	349.00
Wolfe'sak 8080 8-Track Dolby Deck	169.00
Dual 1249 w/Base, Cover & Shure V15III	199.00
Superscope CD302A Dolby Cass.	108.00
Marantz SE-IS Headphones	49.00

Henry's
CAMERA HI-FI-VIDEO
316 W. 8th St. Downtown L.A., Ca. 90014

DYNAMIC SPECIALTIES IS A WEST COAST STORE DEALING PRIMARILY IN USED AUDIO EQUIPMENT

1. We sell and offer service for vintage tube equipment: Marantz, McIntosh, Citation, Quad, Scott, Fisher, Revox, Ampex, etc. Also Audio Research, Futterman
2. We carry a wide range of used components, vintage and current.
3. We also sell and demonstrate certain new equipment: Fulton, Grace, Supex, F.R., Dahlquist, M&K Subwoofers, Connoisseur, PARAGON AUDIO, ERA
4. We stock Telefunken, Mullard, Amperex, Genelux, G.E., Sylvania vacuum tubes.
5. We are the exclusive dealer for PARAGON AUDIO vacuum tube electronics. Audition the new Model 10 High-Gain Wide Band tube preamplifier at our store. Phone for appointment.

We Buy Sell Trade
DYNAMIC SPECIALTIES
2261 Spring Street
Redwood City, CA
94063
415-364-6634

MICHIGAN AREA AUDIOPHILES: Win Labs, Denon, Paoli, Ampzilla, Transcriptors, Magneplanar, Fulton, KMAL, Linn Soudex. Available at Equinox Systems, (616) 457-2117 or Box 333, Grandville, Michigan 49418.

DON'T PAY THE HIGH MAIL ORDER PRICES. THIEVES WAREHOUSE OF MOBILE # 2, 301 SOUTH CRAFT HIGHWAY, CHICKASAW, ALABAMA 36105

DON'T PAY THE HIGH MAIL ORDER PRICES. THIEVES WAREHOUSE OF MIAMI, 1756 S.W. 8th STREET, # 201, MIAMI, FLORIDA 33135

DON'T PAY THE HIGH MAIL ORDER PRICES. THIEVES WAREHOUSE OF HOLLYWOOD, 5719 HOLLYWOOD BOULEVARD, HOLLYWOOD, FLORIDA 33021

CROWN ES-224 electrostatic speakers - like new \$1600. Owner (916) 332-2100

DON'T PAY THE HIGH MAIL ORDER PRICES. THIEVES WAREHOUSE OF BILOXI, 441 PORTER AVENUE, BILOXI, MISSISSIPPI 39530

DON'T PAY THE HIGH MAIL ORDER PRICES. THIEVES WAREHOUSE OF CLEARWATER, 1502A GULF TO BAY BOULEVARD, CLEARWATER, FLORIDA 33515

DON'T PAY THE HIGH MAIL ORDER PRICES. THIEVES WAREHOUSE OF BIRMINGHAM # 2, 203 SOUTH 18TH STREET, BIRMINGHAM, ALABAMA 35233

SAVE ON SACRED COWS

BOSE, JBL, SAE, Thorens, Philips, Over 50 Top Brands - Write for quote - Answered in 24 hrs. SOUTHBOUND SOUND P.O. Box 52508 Atlanta, Georgia 30305

CONTROL 1 - Signal Activated automatic power shut-off for Component Systems, \$49.95. Electromedia Design, Inc., Box 26, Livingston, N.J. 07039.

DON'T PAY THE HIGH MAIL ORDER PRICES. THIEVES WAREHOUSE OF JACKSONVILLE NO 3, CEDAR HILLS SHOPPING CENTER, 3716 BLANDING BLVD, JACKSONVILLE, FLORIDA 32210

FOR SALE

DYNAKITS, DYNASPEAKERS, SHURE, SME—lowest prices. **FRIED LOUDSPEAKERS** (not discounted). Perfectionist modifications. Underground HiFi Sales, 324c Broadwater Road, Arnold, Md. 21012. (301) 647-0919.

CHICAGO CHICAGO CHICAGO

State-Of-The-Art has finally come to the windy city. Stereo Emporium of Buffalo, N.Y. and Paul Heath Audio of Rochester, N.Y., have joined together to form

PAUL HEATH AUDIO, LTD.

One of the most complete audio salons in the country. Acoustically designed demonstration facilities, instant A-B comparisons, experienced personnel, and honest money back policies all combine to make this **THE** place to audition the finest in audio.

WE HAVE, ON DEMONSTRATION: SPEAKERS

Magneplanar T IIIA, tri amp'd
Magneplanar T-IC (8I or single amp'd) --
Dahlquist DQ-10
Magneplans-single and double
Acoustat X
Dayton Wright XG8III series II
Beveridge cylindrical
IMF Monitor IV, TLS80, TLS50
Fried Model "H", "R"
Rogers BBC
Koss Model 2
B&O M-70
Gale 401A
Spendor BCI
Quad ESL
M&K subwoofer-single and double-(set up to be bi-amp'd with Magneplans, (1 or 2 pair); Dahlquists, Dayton Wrights, Quads, or Magneplanar T-IIIa-TM)

PRE-AMPS

Mark Levinson LNP-2, JC-2
Audio Research
Thaedra
Thoebe
Dayton Wright
DB Systems
Quatre
Quad
Stax
Yamaha

TURNTABLES

Linn Sondex
Technics
Lux
Bank & Olufsen
Connesieur
Fons

CARTRIDGES

EMT
Grado Signature
Denon
Fidelity Research
Sonus
Satin
ADC
B&O

TAPE DECKS

Revox
Bang & Olufsen

RECEIVERS

Onkyo
Yamaha
Bang & Olufsen

AMPLIFIERS

Audio Research
Ampzilla
Son of Ampzilla
Dunlap Clarke
Mark Levinson
Dayton Wright
Quatre
Quad
Yamaha
ARMS
Formula Four

TUNERS

Sequerra
Yamaha
Onkyo
Quad
Dynaco

WE OFFER A FULL 5 YEARS PARTS AND LABOR WARRANTY ON EVERYTHING WE SELL, A 30 DAY REFUND POLICY, AND PRE-PAID FREIGHT IN THE CONTINENTAL U.S. PLEASE CALL OR WRITE FOR MORE INFORMATION.

PAUL HEATH AUDIO, LTD.
2036 N. Clark
Chicago, Ill. 60614

CONNECTICUT: Yamaha, Advent, JBL, Bose, Citation, McIntosh, Tandberg, B&O, Harman/Kardon, Ortofon, Epicure, Design Acoustics. Will ship prepaid. Sounds Incredible, 226 White St., Danbury, Conn. 06810. (203) 748-3889 - phone quotes only.

FOR SALE

DON'T PAY THE HIGH MAIL ORDER PRICES. THIEVES WAREHOUSE OF NORTH MIAMI BEACH, 1807 N.E. 164TH STREET, MIAMI BEACH, FLORIDA 33162

DON'T PAY THE HIGH MAIL ORDER PRICES THIEVES WAREHOUSE OF PANAMA CITY, 5220 W HWY 98 SUITE D, PANAMA CITY, FLA 32401

DON'T PAY THE HIGH MAIL ORDER PRICES THIEVES WAREHOUSE OF MONTGOMERY 3386 NORMAN BRIDGE RD. MONTGOMERY, ALA 36105

AUDIOPHILES AUDIOPHILES AUDIOPHILES

We are dedicated to offering you, the audiophile and music lover, the most sonically accurate components in every price range. All products are tested and include free shipping and insurance. Now is the time to write, call or visit Audio one.

SPEAKERS Beveridge Electrostatic
IMFried "H"/"M"/"R"/"Q"
Dahlquist DQ-10
AEL (Rodgers)
Audionics
B&W
DMC6
KEF Drivers
DB Systems Preamp
Electro Research
Modified Dynaco
H-K/Citation
Quintessence
C/M Labs
Schilling
Paragon
Quatre
Paoli
8GW
ACE

ELECTRONICS

TURNABLES Technics SP-10 MkII
Transcriptors
Rabco ST-7
Philips
ERA
Formula 4
TONEARMS Win Labs
CARTRIDGES Denon
Sonus
Supex
Grace
Stax

Also prime used equipment such as Quad, Magneplanar, Audio Research, Mark Levinson, Etc.

AUDIO ONE AUDIO ONE AUDIO ONE

Michigan's Original State of the Art Dealer
Box 1001
Birmingham, Michigan 48012
313-646-6666

THE AUDIOPHILE, home of the renowned DB preamp, the little black boxes everyone has heard about and nobody's seen, is happy to help with your search for musical excellence - offering products which, even if not the most widely known, provide musical honesty: Dayton-Wright loudspeaker, CM Labs amplifier, Dunlap-Clark, Fulton J. ERA, I.M. Fried, Power Research loudspeaker, Paoli, Quad - including the exciting new 405 amplifier, AID, Denon (expensive but excellent), Win Labs, KMAL, Revox, ADS, and the Feature of the Month

the Promethean cartridge, obscure but offering exceptional clarity at only \$95. Sales and service: 582 N. Frederick Ave., Gaithersburg, Md. 20760. (301) 948-2999. Ask for Gene, Bob, or Albert

THE JANIS WOOFER IS ABSOLUTELY FLAT TO 30 Hz. The specifications can only hint at the effortless, ultra-clear and detailed bass reproduction to the limits of hearing. Typical response 30 - 100 Hz. + 1/2dB, distortion about 1% max. About 60 W is enough to drive this speaker. Elegant in size (22"x22"x18" high) and appearance. Full details: Janis Audio Associates, Inc., Box 88 Throgs Neck Station, New York, N.Y. 10465.

FOR SALE

PALO ALTO, CALIFORNIA

An important new store for Bay Area audiophiles—THE AUDIBLE DIFFERENCE—is currently recommending:

KOSS MODEL ONE and **MODEL TWO** electrostatic loudspeakers. Excellent bass. High power handling. Model One, \$1075 ea. Model Two, \$650 ea.

DUNLAP CLARKE Dreadnaught power amplifiers. Stable, conservatively designed amps of extraordinary performance.

Dreadnaught 500, \$980. Dreadnaught 1000, \$1500.

SONEX TWO. Patented time-aligned design by Ed Long. Exceptional midrange clarity and high-frequency definition. A perfectionist loudspeaker. \$550.

ARISTON and **LINN SONDEK** turntables. Belt drive. Superior suspension systems. \$250 and \$360.

FR MK III. Fidelity Research's deluxe moving coil cartridge, now available. \$200. FRT-4 transformer, \$250.

ROGERS LS3/5A. Legendary BBC mini-monitor. As good as its reputation. \$215 ea.

DECCA GOLD. The Decca has been tamed. Life-like sound, reasonable tracking. \$150.

DECCA TONEARM. New version of this classic damped arm. Now mounts easily on more turntables. \$139.

GRACE 9 series cartridges, from \$80. Grace 707 low mass tonearm, \$129. Grace 940 oil-damped, uni-pivot arm, \$149.

DECCA BRUSH. One million conductive bristles eliminate need for liquids and reduce static. \$15.

We also feature selected products from Celestion, Audionics, Supex, Lux, Sony, Yamaha and others. Coming soon: Dunlap Clarke preamp with built-in moving coil amp.

Prepaid/insured shipment in U.S. and Canada.

THE AUDIBLE DIFFERENCE

435 Tasso, Palo Alto, California 94301 (415) 328-1081

AUDIO BREAKTHROUGHS

Long Island's finest audio dealer offers you the world's most advanced and audio components.

ELECTRONICS. Levinson JC-2 Preamp & LNC-2 Electronic Crossover G.A.S. (Ampzilla, son of Ampzilla, Thaedra & Thoebe) Paragon model 12 Preamp, Yamaha, AGI, D-B systems, preamp, sound concepts time delay, Luxman, Marantz prof.

SPEAKERS. Koss model one, Magneplanar, Dahlquist, Fulton Model J, Spendor, B&W (DM-6) Polk, Janis woofer, M&K woofer, Kef speakers and drivers, AR pr series, B&O, Epicure, Yamaha.

TURNTABLES & CARTRIDGES. Linn Sondek, Lux, Formula 4 am, Technics, B&O, Transcriptors, Satin, A.D.C. Decca, Grado J.G. signature series, Denon, Supex, stax, Grace, SME, Rabco.

AUDIOPHILE RECORDS. Sheffield, M&K, Fulton, Audio Lab, Levinson, AR, B&O.

Free delivery and installation in Long Island and New York City.

AUDIO BREAKTHROUGHS

1681 Northern Blvd.
Manhasset, New York 11030
(516) 627-7333

AUDIO BREAKTHROUGHS

Huntington
129 Route 110
Huntington Station, N.Y.

WESTCHESTER, FAIRFIELD COUNTY

THE LISTENING ROOM INC.

590 Central Park Avenue
Scarsdale, N.Y. 10583
(914) 472-4558

Cordially invites you to audition our fine line of equipment.

DAHLQUIST	YAMAHA
AMPZILLA	LUX
SON OF AMPZILLA	B & O
THAEDRA	KEF
SOUNDCRAFTSMAN	ESS
M & K	PHASE LINEAR
THORENS	DENON
ADS BRAUN	TANDBERG
STAX	NAKAMICHI
DUNLAP CLARK	DAYTON WRIGHT
QUAD ELS	JANIS
BOZAK	GRACE

AUDIO PULSE DIGITAL DELAY SYSTEM

AUDITION FOR THE FIRST TIME

LUX TUBE-TYPE MONAURAL POWER AMP & PRE-AMP

FOR SALE

TELEFUNKEN tubes in stock ECC83/12AX7 \$3.00 each at Victor's Stereo Inc., 8 E. Erie, Chicago, Ill. 60611 312. 642 6349

ATTENTION!

AUDIOPHILE ITEMS DIV. (Division of Dynamic Specialties) Announces its new exclusive sound room specializing in vacuum tube and current solid state equipment.

We are dealers for:

PARAGON AUDIO ELECTRONICS, Futterman, Dahlquist, Fulton (FMI), RTR, M&K subwoofers and Rabco mod., ERA, Connoisseur, Grace 707, 940, 8L, 8C, etc., Fidelity Research, Supex, Dynaco, Soundcraftsman, Stax, Telefunken, Amperex, Valvo, Genelex, GE, Sylvania vacuum tubes.

Also quality used gear sales and service: Marantz, McIntosh, Audio Research, Quad, Magneplanar, Dynaco, Citation, etc.

We Buy—Sell—Trade
AUDIOPHILE ITEMS DIV.
(Division of Dynamic Specialties)

2269 Spring Street
Redwood City, Calif. 94063
U.S.A.

415-364-2494

415-364-6634

SERV STATIK I: Rosewood, Beautiful Condition. Call Evenings. 512/854-3521.

INFINITY 2000A's: Walnut. Under Warranty. Beautiful. Call Evenings. 512/854-3521.

AUDIO RESEARCH SP-3A-1(N) Four year transferable warranty, \$550. Ampzilla, \$575. Thorens TD-125 with SME non-detachable, \$250. Robert Busk, 1203 N.W. 4th Ave., Gainesville, Fla. 32601. (904) 373-3043.

CHICAGO, ILL.

Now serving Continental North America from our Central location with the finest in Audio Equipment & Supplies, exclusive & hard to attain perfectionist equipment.

8 years of unpresided sound & service.

Free insured shipping and technical assistance upon request.

ADS	Grace	BGW
Allison Acoustics	Grado	Phillips
B&W	KEF	Quad
Chicago Acoustics	Kmal	Revox
Dahlquist	Formula 4	Sonus
Dayton Wright	Linn Sondek	Stax
Decca	Luxman	Supex
Denon	Magneplanar	Transcriptor
Discwasher	Microacoustic	Ortofon
Great Amer. Sound	Nakamichi	
E.R.A.	Onkyo	

State of the Art Audio

Victor's Stereo Inc., 8 E. Erie, Chicago, Ill. 60611 312.642 6349

AUDIO CAGE

3329 BALMORAL DR.
SACRAMENTO, CALIF. 95821
916-48AUDIO
916-482-8346

ADS	GRACE
B & O	LUXMAN
CONNOISSEUR	PHASE
DAHLQUIST	STAX
DECCA	SUPEX
DOKORDER	NAKAMICHI-CAR
	XLM

KLH-18 stereo tuner. Excellent cond. \$85. Warwick, 8812 Kennelly, Anaheim, CA 92804

PHASE LINEAR 4000 \$450. 700B \$550. DC300A \$550. MR71 \$215. KC60-60 \$110. ALTEC-802D \$90 pair. 511A \$75 pair (1) 515 B \$65. N500F Xover \$100. All Altec units new - ARLST - Factory tweaked. 800 - pair - \$318-276-4576.

AUDIO RESEARCH D-76A, EC-3A electronic crossover, both mint. Magneplanar MG-2 speakers, new, with warranty cards; Dyna 400 with meters and fan. 919 449-4132.

FOR SALE



DESIGNATRON'S STEREO STORES INC.

N.Y. — Long Island

Designatron is your franchised dealer for:

Accuphase * ADC * Advent
* Audio/Pulse * AKG * dbx *
Dahlquist * ESS * Infinity
* Harman/Kardon * JBL *
McIntosh * Ortofon * Revox
* SME * Soundcraftsman *
Tandberg * Teac * Technics
* Thorens * and more *

We feature:

* A \$20,000 Quality Control
and Precision Tuning Lab.
* Expert advice.

New Advent Stereo Receiver
and New Audio Pulse Space
Expander

ADC Accutrac Turntable

260 Old Country Rd.

Hicksville, N.Y. 11801

(516) 822-5277

DISCOUNT. Sound Guard. Memorex. Watts. Write: Coastal, Box 37365, Jax, Fl. 32205.

FOR SALE TO CLASSIC COLLECTORS

-Edison 1919 Hiboy phono with 50 1/4" disks, \$100.00 asking.

-Cinaudograph circa 1927 theater speaker heavy, 14", needs AC for 5Z3 tube, \$25.00 asking;

-Electrovoice Patrician circa 1948, 18" woofer, theater black, 56x35x28, \$100.00 asking;

-Lansing D-130 15" in RJ Cabinet, \$50.00;

-Frazier utility grey folded horn two way 27x23x16, \$50.00;

-Package deal: Crown IC150 preamp, Dyna 120 pwr amp,

Fisher FM-1000FM tube tuner, only \$300.

COME HEAR AND HAUL AWAY

J.H. Harger, RD, Annandale, NJ 08801

201-735-5817

CROWN TAPE RECORDERS

Reconditioned Crown International tape recorders: SSCX 822, \$1300.00; SSCX 824, \$1200.00; 714C, \$400.00; 714SP, \$350.00; TECHNIARTS 8555 Fenton Street, Silver Spring, MD 20910

TECHNIARTS

Professional Audio Equipment, Ampex, AKG, DBX, Crown International, Malatchi, Urban Parasound, Sescom, in stock for immediate delivery 8555 Fenton Street, Silver Spring MD 20910. 301-585-1118.

INCREDIBLY BETTER SOUND from your present system with no additional investment. Send \$10.00 for instructions. Unqualified Money Back Guarantee. **THE WIZARD**, 109 Alpine Road, Yonkers, N.Y. 10710.

CLASSICAL recordings old/current list. ARS Musica, 13 Dante St., Larchmont, N.Y. 10538.

TEAC TASCAM MDD. # 10 mixing console, 4 in, 4 out w/line amp & traveling case, \$2,700. Sonically excellent but a few scratches. (216) 369-6774.

MARANTZ 7T w/case \$250. WANTED: Ampzilla, Thaedra, Marantz 7C. S. Shimizu, 1629 W. 158th St., Gardena, Calif., 90247.

MCINTOSH MC-60 Pair \$500. JBL SG520 mint cond. \$450. Marantz 2270 \$350. 406-727-4115.

AFTER MORE THAN A YEAR, the Grace G-707 Tonearm continues to outperform all competition. This unique tonearm combines extremely low mass construction with precision low-friction, vibration-free bearings to provide a tonearm that allows every cartridge to perform at it maximum. The improvement in clarity and definition is immediately apparent. For the name of your dealer, write: Sumiko, Box 5046, Berkeley, Ca. 94705.

FOR SALE

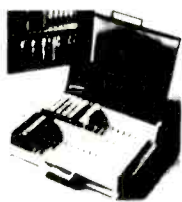

Cassette Attaché case. Holds 32 cassettes. Hi-impact plastic. Brown or Ivory. Info write Audio Recording Center, Box 194, Pittsford, NY 14534 Dept A

STEREO REPRESENTATIVES NEEDED!!! Sell 100 brands!! Lowest Possible Prices!! Krasco - 623 Campbell Ave. West Haven, Connecticut. 06516

'74 HONDA MT-250 Elsmore excel. cond. \$575 OR trade for stereo equip., receiver & turntable, and/or speakers. Brad 317-283-4776 (Indiana)

SIEMENS, TELEFUNKEN, and other top quality audio tubes available at very competitive prices. Contact Jim Wallace at 201 McMasters Drive, Monroeville, Penna. 15146 or (412) 373-2602.

DENON CARTRIDGES, Transformers, and INCOMPARABLE Denon 307 arm. Also, Fidelity Research, Satin. Lowest prices in U.S.A. Fast Service. Call or write for information. Dealer Inquiries invited. F&R AUDIO IMPORTS, P.O. Box 212, Somerset, New Jersey 08873. 201-828-8075.

AUDIO RESEARCH D-150 power amp. \$2,000 and SP3A-1 pre-amp \$400. Call 658-4675.

TEAC 3340S \$750.00, Peavey 1200 Mixer \$700.00, dbx 124 \$280.00, all only 40 hrs. use; excellent, package for \$1600.00. 603-878-1078.

NORTHWEST AUDIOPHILES

The finest in Audio Components - Audio Research, Beveridge, Celestion, db systems, Dahlquist, Dayton Wright, Decca, Denon, Dunlap Clarke, Dynaco, ERA, Fidelity Research, Fulton, Formula 4, Grace, Hartley, Linn Sondek, Luxman, Magnepan, Mark Levinson, Nakamichi, Quad, Quatre, Sonex, Soundcraftsmen, Shure, Spondor, Stax, Supex, Tandberg, Technics, Yamaha and more.

THE TIN EAR STEREO CENTER
704 Symons
Richland, Wa. 99352
(509) 946-4459

HIGH QUALITY USED EQUIPMENT

Audio Research SP-3A1, \$580; Radford 2D22 preamp, \$249; Mark Levinson JC-2 preamp, \$795; Yamaha B1 amp, \$895; Dayton Wright SPS preamp, \$249; Dayton Wright 535 preamp, \$249; Tandberg 3541X, \$399; Tandberg 10X0, \$1015; Fidelity Research MkII, \$64.

THE TIN EAR STEREO CENTER
704 Symons
Richland, Wa. 99352
(509) 946-4459

IMF TLS 80 \$1195, IMF super compact \$295, DCM "Time Windows," Formula 4 Arm \$110, economy "State-of-the Art" system \$799. Audio House, 5232 Sagamore Dr., Swartz Creek, Mich. 48073. 313-732-4670.

SPEAKERS

TAPE DUPLICATING. Professional standards. Half Track, Quarter Track Reel; Cassettes. Low Prices. Write for rates. Moonlight Recording, P.O. Box 22635, San Francisco, Ca. 94122.

DAMPING DEVICE - clean up your sound. Send model of turntable including auto to DEX 311 Canterbury Ct., Sharpville, Pa. 16150 with check or m.o. for \$19.95. Allow 4 weeks for delivery.

STC(Coles) Tweeters repaired for modest charge. New Tweeters 4001K (8 ohms) or G (15 ohms) available. Linear Research, 4500 South 56th Street, Lincoln, Nebr. 68516; (402) 488-4569.

SERVICES

CROWN INTERNATIONAL

Complete repair, overhaul, and rebuilding service for current and early model Crown tape recorders and amplifiers. New Crown recorders in stock for immediate delivery. Excellent selection of reconditioned Crown recorders for sale. Used Crown recorders purchased and accepted for trade in. TECHNARTS 8555 Fenton Street, Silver Spring, MD 20910 301-585-1118

AUDIOPHILE EQUIPMENT Sales and expert service - THE STEREO SHOP, 3907 Washington Rd., Martinez, GA 30907 (404) 863-9143

SOUND SENSATION. The Traveling Multimedia & Disco Light Show. We have the baddest-loudest-bassiest quadraphonic sound system anywhere—12,000 watt light show. Sony-Pioneer-Technics 4 channel sound system—IT **COOKS**. Terry Parker, Box 43, Holland Patent, NY 13354

DYNACO, A-R, TRANSISTORS, REPAIRS BOARDS & units, speaker service. Send for prices & details: BEAR ELECTRONICS, 177-A Hillcrest Road, Mt. Vernon, NY. 10552

ALL HI-FI SPEAKERS REPAIRED. Technical expertise has been acquired by servicing our customers four decades. AUDIO SPEAKER TECHNICS, 281 CHURCH ST., NEW YORK, N.Y. 10013 (212) 226-7781.

HOW TO: Install your car stereo and save money. Send \$1.50 to G.A.S., 4419 John Marr Dr., Annandale, Va. 22003.

TAPE RECORDER HEADS re-lapped \$15.00 ea. Removed from machine or stack. One day service. E. Maher, 5 Evans Place, Orinda, Calif. 94563

CUSTOM RECORDING SERVICE. Tapes, discs, and cassettes. Stereo and mono. Live and copies. Editing. Masters and pressings. High quality at reasonable rates. Joseph Giovanelli, Audio-Tech Laboratories, 2819 Newkirk Ave., Brooklyn, NY 119-7134

STEREO MASTERS, RECORDS AND ALBUMS. Check our prices. Newest type high level cutting equipment featuring: Neumann VMS 70 Computer control lathe, Parametric Equalization, Dolby, DBX, and the new SX74 Cutting System by Neumann. Special package prices on pure vinyl album and single record production. 1000 45 RPM stereo singles \$199.00 including mastering. 100 LP albums \$325.00 including printed jackets. Write or call for brochure. A & R Record Manufacturing Corp., 902 N. Industrial Blvd., Dallas, Texas 75207. Toll Free 1-800-527-3260.

NASHVILLE RECORD PRODUCTIONS WILL PRESS HIGH QUALITY PURE VINYL RECORDS FROM YOUR TAPES SEND FOR SAMPLE RECORD AND PRICE LIST ALSO FINEST DISC MASTERING. 469 Chestnut St. NASHVILLE TENNESSEE 37203

RECORDS

SOUNDTRACKS - Large catalog 25c. Star-167, Box 387, Owings Mills, Maryland 21117.

QUASI-RATIONAL PRODUCTS has everything in record protection. Liners - covers - Discwasher - Watts. Also Maxell, TDK tape - Pioneer auto stereo - Jensen car speakers - Royce CB's, etcetera. Reasonable, Swift, Reliable. Free catalog. QUASI-RATIONAL PRODUCTS, P.O. Box 171, Prospect Heights, Ill. 60070.

CLASSICAL LPs bought - sold. Junker, 583 6th Ave., San Francisco, Ca 94118

QUADRAPHONIC RECORDS AND TAPES - World's largest selection - all labels, over 1000 titles - at discount prices! For your free illustrated quad catalog, write: SOUND CONCEPTS, Box 654-C, Peoria, Illinois 61601.

RECORDS

SHOW ALBUMS—Rare. Out of Print LP's. 52 page list 50c. Broadway/Hollywood Recordings Georgetown, Conn. 06829.

2,000 RECORDS 25 pages—Blues, Bluegrass, Cajun Fiddle. \$1.00 gets catalog. Mailorder only. KANAWHA, P.O. Box 267, Dayton, Ohio 45420.

DISCOUNTS ON LP's, Tapes, Cutouts, Imports. Huge Catalogs. One Dollar. Record Finder Services NERT, Box 268, Lawrence, Mass. 01842

JAZZ, BLUES, ROCK. Out of Print LP's, 45's. Free Lists. Crazy Rhythms, 4 Newman Ave., Verona, N.J. 07044

SOUNDTRACK RECORD ALBUMS—Mail Auction—Free List. Whalon, 2321A Hill, Redondo Beach, Calif. 90278.

OLDIES — 45 RPM Original hits Catalog 50c C&S Record Sales Box 197, Wampsville, NY 13163.

RARE 78's. State Category Record Lists. 3238 Stoddard, San Bernardino, CA 92405.

CATALOGS. Broadcasts, soundtracks, Personalities of Thirties, Forties. Box 225, New York, NY 10028

WHILE YOU WERE LOOKING for out-of-print records, you should've been looking for us. DISContinued, 216 N. Rose, Burbank, California 91505.

SOUNDTRACKS/OC, JAZZ/PERSONALITY — FREE NEWSLETTER! RTSA, 3700 S. Plaza Drive, Bldg. F/211, Santa Ana, California 92704.

TAPE & TAPE RECORDERS

OPEN REEL prerecorded tapes. Catalog 50c. West Coast Tape Sales, P.O. Box 4323, Modesto, CA. 95352.

TDK, MAXELL, MEMOREX, BASF, cassettes, reels 8-tracks. Lowest prices. New, Guaranteed. FREE CATALOG S & S Audio, P.O. Box 56039, Harwood Hts., IL 60656.

CUSTOMIZED TAPES. Jazz. Big-Band. Select standard tracks or available artists. Free catalog. 80 minute reel cassette or 8-track. \$8.00. Tapes Unlimited, Box 163, Portsmouth, RI 02871

SCOTCH RECORDING TAPE, lowest prices TAPE CENTER Box 4305B, Washington, DC 20012

MAXELL RECORDING TAPE. All widths. Lowest prices. N.A.B. Audio, Box 7, Ottawa, Illinois 61350

RENT OLDIES TAPES by year, over 100 songs per year. Free brochure. Rock 'n' Reel Rental, 4 Prescott Ave., Dix Hills, NY 11746

EVERYTHING ON OPEN REEL! Classical. Popular. Dolby. Quadraphonic. Latest releases. For "Reel News," send \$1.00. Barclay-Crocker, Room 857 A, 11 Broadway, New York 10004.

TOP LINE CASSETTES at an unbeatable price. C-90 \$1.50. Includes box and postage. Quality guaranteed. Other sizes available. FDFA, P.O. Box 7316, Stanford, CA 94305

RECORDING TAPE—OUTSTANDING VALUES Write to: MAGNE HOUSE, 2271 Union # 4, San Francisco, CA. 94123

BUILDING A STRONG MARRIAGE. Sixty minute audio cassette by Edward Ford, author WHY MARRIAGE and WHY BE LONELY, certified Reality Therapist. Send \$7.95. E. Ford, 10209 N. 56th Street, Scottsdale, Arizona 85253.

HELP WANTED

BUSINESS MANAGER/PARTNER needed for small audio products manufacturing company relocating in S.F. Bay area. Should have M.B.A. degree or equivalent experience as manufacturing mgr, strong sales/marketing skills, and minimum investment capital, potential of \$25K. Send resume to address:

HAYNES Microelectronics
Box 413
625 Post St.
S.F., CA 94109

SPEAKERS

SAVE 50% build stereo speakers and save money. Send \$1 for new catalog and construction manual. Refundable. Speaker kit, Box 12A, Menomonie, WI. 54751.

HIGH FIDELITY SPEAKERS REPAIRED
AMPRITE SPEAKERS SERVICE
655 Sixth Avenue, New York, N.Y. 10010
212-CH3-4812

ELECTRO-VOICE SENTRY PRODUCTS. In stock: Sentry IV-B, Sentry III, and Sentry V monitor loudspeaker systems for professional monitoring and sound reinforcement. Immediate air freight shipment to any N. American destination. Naonal Sound Company, Ft. Lauderdale, Florida. (305) 462-6862.

STC(Coles) Tweeters repaired for modest charge. New Tweeters 4001K (8 ohms) or G (15 ohms) available. Linear Research, 4500 South 56th Street, Lincoln, Nebr. 68516; (402) 488-4569.

MISCELLANEOUS

100-CARD BIBLE GAME!!!! \$1.00. ANYWHERE! BIBLE GAMES. 5837 STEWART, SYLVANIA, OHIO 43560

ATTENTION: LONG ISLAND AUDIPHILES - Anyone interested in starting Hi-Fi Club please contact: Mike DeLuca 516-585-4878

RECORDING STUDIO ENGINEER CAREER? 13c stamp to Attainment Research, Box 45333AU, Dallas, Texas 75245

FREE Pricelist, Global Seashells, Box 13288, Tampa, FL 33681, book \$2

FREE MAGAZINE featuring 450 books - natural health, gardening, occult, other interesting subjects. Provoker Press, Lakeshore Rd., St. Catharines 565, Ontario L2R 7C9

BIORHYTHMS at reduced rates. Full year \$3.95. Two years \$7.00. Mail birthdate to: Biorhythms, P.O. Box 137, New Milford, New Jersey 07646

TWO PIN SET—write—perfume guaranteed \$4.95. Famous Jewelry Company, 12608 Rawsonville Rd., Belleville, Michigan 48111.

DISCO EQUIP

DON'T MISS THE 'DISCO WAGON'! Excellent complete line of discotheque equipment is available to fulfill your needs. Request your information package today. Write to D.T.S., Dept. DISCO, P.O. Box 16049, SEATTLE, WA 98116. Reserve your dealer territory in time!

MOBILE DISCO AND P/A EQUIPMENT could make money for you. Information \$1. Musitek Audio, PO Box 116A Acushnet, Ma. 02743.

INSTRUCTION & EDUCATION

SELF-HYPNOSIS cassette by Counseling Psychologist, 2828 Chestnut Street, Montgomery, Alabama 36107. \$5.95 check or money order.

WANTED TO BUY OR TRADE

WANTED: JBL HARTSFIELD. JBL 400, 600 series electronics, JBL compression drivers and 075. 406-727-4115

WANTED: ALTEC 729A stereo equalizer. Ph. 204-943-8820, Write 1814 - 411 Cumberland, Winnipeg, Manitoba, Canada.

WANTED!! ITEMS MANUFACTURED BEFORE 1929: Battery radios, crystal sets, military radios, wireless gear, electronic books and parts. Pre-1940 television sets. Top Prices Paid!! Jacobs 1 - 8th Street, Pelham, N.Y. 10803

WANTED: WARFEDALE W/10/FSB and Super-3 Speakers. Chas. McCurdy, 3005 Oakhurst Rd., Bethel Park, Pa. 15102. 412-833-6651.

QUAD electrostatic speakers (any condition), electronics (including Model II). Mention lowest price. DMS, 1360 Lake Shore, No. 2202, Chicago, IL 60610

EUPHONICS semiconductor cartridge. State model, condition, price. G. Minter, 9/77 Benson St., Toowong Q. Australia 4066

CASH FOR your unwanted LPs & reel to reel tapes. Records. Box 323, Hillburn, New York 10931

JBL D130. Bob Keeler, 1013 Vaness, N.W., Grand Rapids, Mich. 49504

KLEMPERER. Collector seeks any Vox recordings - Vienna Symphony, Paris Pro Musica, Lamoureux Orchestra. Also early Columbia recordings with Philharmonia. In addition any Klemperer concert programmes with U.S. orchestras and tapes. All details welcome. M. Peters, 385 Woodstock Road, Oxford, England.

BUSINESS OPPORTUNITIES

OUR PORTABLE DISCO SYSTEMS could make you rich. Earn \$150 night and more, playing records for parties, bars, weddings. Get in on one of the fastest growing best paying jobs. Free information American Audio 103 Ohio Ave. Fremont, Ohio 43420 419-334-3326

\$10.00 PROFIT on every \$15.00 sale! Write: IPS, Box 371, Spring Lake, N.C. 28390

RENT SOUND SYSTEMS, including disco, to schools, churches, bands, organizations, and government. We will train and distribute equipment. Excellent profits. Information \$1. Musitek Audio PO Box 116A, Acushnet, Ma. 02743.

INVESTORS WANTED: \$5,000 and \$10,000 subscriptions available. Aid the growth of an esoteric audio equipment designer and manufacturer. Product line includes preamplifiers, power amplifiers, electronic crossover and a speaker system. Write for details to Box A612-2 Audio.

TAPE RECORDINGS

SONAR'S OPEN REEL TAPES. Duped one-to-one from the master. Quad and stereo; ¼, ½ track; 7½, 15 ips; 7", 10½" reels. Highest quality anywhere! Sonar Records Corp., P.O. Box 455A, Kingsbridge Station, Bronx, NY 10463

MUSICAL INSTRUMENTS

UP TO 60% DISCOUNT. Name brand instruments Catalog Freeport Music, 114R Mahan St. W. Babylon, N.Y. 11704

RADIO PROGRAMS

1930-1962 RADIO PROGRAMS. Reels, \$1.00 hour! Cassettes, \$1.00 show! Mammoth catalog \$1.25. AM TREASURES Box 192 AU, Babylon, New York 11702

GOLDEN AGE RADIO - your best source for radio tapes Box 25215-D, Portland, Oregon 97225

YESTEROAY'S RADIO PROGRAMS ON TAPE Reels, Cassettes. Fast-Reliable Service Catalog \$1.00 - refundable with first order. ADVENTURES, Box 4822-A, Inglewood, California 90302

RENT RADIO SHOWS Make your own copies or just listen. Great way to build your collection reasonably. Catalog \$1.00 refundable. DTR Rental, Box 1146, Livermore, Ca. 94550

OLD RADIO PROGRAMS. 2 Catalogs, Cassettes \$1.59 hour, Reels 4 Hours \$5.00, Nostalgia Sounds, Box 3584, Santa Susana, Ca. 93063

OLD RADIO ON TAPE AND CASSETTES. THOUSANDS AVAILABLE. 6 HOURS \$8.00. Immediate Service Catalogue 50c. Nostalgic Radio, Box 29K, Peoria, IL 61601

VINTAGE RADIO PROGRAMS. Sales, rentals. Top quality, good selection, competitive prices. Catalog: \$1.00. BRC QUALITY DUBS, 17173 Westbrook, Livonia, MI 48152

OLDTIME RADIO - On tape lowest prices; free supplement, Golden Years of Radio, c/o A.W. Blatt, 8 Rockville Ave., Staten Island, N.Y. 10314

RADIO CLASSICS - Catalog, preselected reels, cassettes; adventure, comedy, terror, more, 25c master catalog, reels, custom cassettes; thousands of shows - Dolbyed, frequency equalized \$1.00. Competitive prices. P.O. Box 1649, Evanston, Ill. 60204

HIGH FIDELITY

CONTROL I—AUTOMATIC SIGNAL ACTIVATED Shut Off for Hi-Fi components. \$49.95. Details, ElectroMedia Design, Inc. Box 26, Livingston, NJ 07039

PINK NOISE TAPES. Measure loudspeaker response accurately with a microphone and voltmeter. 1/3 octave bands ±1dB 31.5Hz to 16KHz. 15 ips - \$28 ppd. 7½ ips - \$23 ppd. Both ¼" halftrack. Cassette available. Instructions included for stereo system or P.A. application. STATEX, Audio Division, Box 5334-A, San Antonio, Texas 78201. QUALITY PRODUCTS SINCE 1929.

Hiss-s the Villian, & "LOST HIGHS" result from running tape on magnetized equipment. Now you can actually measure and eliminate damaging magnetic build-up. Standard Audiophile Han-D-Kit \$34.25. Deluxe Professional Han-D-Kit \$58.50 delivered in USA on prepaid orders. Ask for literature and "Notes on Demagnetizing" ANNISCO 1103 N. Delaware, Indianapolis, Ind. 46202 Phone 317 637 9282.

AUTO ACCESSORIES

FUZZBUSTER POLICE RADAR DETECTORS. Latest Model, big discount. Hughes Electronics, 45 Dunn Street, Asheville, N.C. 28806

SHORTWAVE

HEAR POLICE FIRE Dispatchers. Catalogs show receivers, exclusive directories of "confidential" channels. Send 10c stamp. Communications, Box 56AU, Commack, New York 11725.

PLANS & KITS

SCHEMATICS: Multiprojector tape-slide synchronizers, lap-dissolve systems, \$5.50. With mixers, compressors, preamps, \$8.50. The Millers, 1896 Maywood, South Euclid, Ohio 44121.

Annual Index

Subject Index

AM/FM Radio

New Standards for Tuners and Receivers, Leonard Feldman, Jan. 30.
Syndication of Quadraphonic Radio Programs, Martin Clifford, Nov., 46.

Amplifiers

Build a Low TIM Amplifier, Marshall Leach, Feb. 30; Addenda, April, 12.

Construction Articles

Build A Boost/Rumble Filter, Dick Crawford, June, 44; Addenda, Dec., 30.

Build a Low TIM Amplifier, Marshall Leach, Feb., 30; Addenda, April, 12.

Build a Mike for Binarual Listening, Gene A. Nelson, May, 34; Addenda, Sept., 16.

Joseph Giovenco, Nov., 46.

Switched-On Bass, W.J.J. Hoge, Aug., 34.

Designing Custom Installations, Paul Seydor, Jan., 30.

20,000 Watt Home Hi-Fi, Richard S. Burwen, April, 44.

Car Speaker Placement, Tomlinson Holman, July, 54.

Christmas Buying Guide, Nov., 26.

Directories

Annual Product Directory, Oct.

Directory of Manufacturers, Oct., 16.
Amplifiers, 36; Preamplifiers, 48; Tuners, 54; Receivers, 58; Single Play Turntables and Tonearms, 66; Multi-Play Turntables, 76; Phono Cartridges, 78; Loudspeakers, 86; Open-Reel Tape Decks, 110; Cassette & Cartridge Tape Decks, 113; Headphones, 118; Microphones, 120; Equalizers, 126.
Annual Product Directory Addenda, Dec. 52.

Addenda II to 1975 Equipment Directory, Jan. 46.

Car Stereo Radio/Tape Player Directory, July, 36.

Car Speakers Directory, July, 50.

Discounts

A Dealer's View of Discounts and Ser-

vice, Martin Clifford & Margaret Eisen, Oct., 28.

Equipment Profiles

Advent 400 Table Radio, Jan., 52.

Akai AA-1050 Receiver, June, 50.

Allison:One Speaker System, April, 70.

Audioanalyst A-100X Speaker, Sept., 62.

Audio Pulse Model One Time Delay Unit, Dec., 40.

B•I•C 960 Turntable, June, 58.

BSR FEW-3 Equalizer, Dec., 71.

Crown M-600 Amp, Nov., 92.

Dual Auto/Reverse Cassette Deck, May, 55.

Dual 601 Turntable, Jan., 50.

Duntech DL-15 Speaker, Aug. 60.

Dynaco A-25XL Speaker, Nov., 85.

Dynaco PAT-5 Preamp, Feb., 64.

Electro-Voice Interface: A Speaker, March, 58.

ESS "Eclipse" 2240 Crossover, July, 64.

GTE Sylvania RS4744 Receiver, Feb. 48.

Garrard 86 SB Turntable, July, 64.

Harman/Kardon Citation 16 Amplifier, Dec., 76.

Heath AA-1640 Amp, Nov., 76.

Information Terminals Cassette

Gauge, March, 56.

JVC S-300 Receiver, Sept., 48.

JVC CD-1970 Cassette Deck, Dec., 65.

Kenwood KA-3500 Amp, Dec., 68.

Lux 310 Tuner, Jan., 48.

Marantz 1150D Amp, March, 52.

Mark Levinson JC-2 Preamp, April, 62.

McIntosh C-28 Preamp, Nov., 60.

McIntosh MAC1900 Receiver, June, 66.

McKay-Dymek AM-5 Tuner & DA-5 Antenna, Aug., 54.

Micro-Acoustics QDC-1e Phono Cartridge, Jan., 56.

Motorola TC877AX Car Stereo, July, 31.

Nakamichi 600 Cassette Deck, Sept., 66.

Onkyo TX-4500 Receiver, Dec., 58.

Otari MX-5050-2SH Tape Deck, April, 60.

Phase Linear 2000 Preamp, Sept., 56.

Panasonic CQ-840EU Car Stereo, July, 30.

Pioneer PL-71 Turntable, Feb., 74.

Pioneer KP-500 Car Stereo, July, 29.

Pioneer RG-1 Processor, May, 62.

Quintessence Equalizer 1, Feb., 54.

SAE Mk VII Tuner, Feb., 58.

Sansui SR-717 Turntable, May, 60.

Sonab C-500 Cassette Deck, Nov., 52.

Sound Concepts SD-50 Time Delay, Dec., 40.

Sound Guard Record Preservative, April, 62.

Spectro-Acoustics 210 Equalizer, Nov., 54.

Tandberg TR-2075 Receiver, March, 44.

Technics RS-630US Cassette Deck, Dec., 73.

Technics SA-5550 Receiver, May, 52.

Thorens TD-145C Turntable, March, 57.

White 140 Analyzer, Nov., 89.

Yamaha HP-1 Headphones, Nov., 74.

Hearing

Hearing Loss in Rock Musicians, Dr. David M. Lipscomb, March, 32.

Loudspeakers

Speaker Tests: THD, Richard C. Heyser, Feb., 18.

IM Distortion in Speaker Systems, Richard C. Heyser, March, 38.

Audio's Crescendo Test, Richard C. Heyser, May, 30.

Energy-Time Test, Richard C. Heyser, June, 74.

Summer Sound Systems, Glen M. Ballou, Aug., 24.

Switched-On Bass, W.J.J. Hoge, Aug., 34; Addenda, Nov., 24.

Doppler Distortion in Loudspeakers, James Moir, Aug., 42.

Memorabilia

Mills Vilano-Virtuoso, Oct. 24.

Microphones

Microphone Sensitivity Ratings, Alfred Lorona, Dec. 32.

Music

Let's Be Fair to Our Favorite Composers, Felix Arnstein, Feb., 76.

Of Rosie, Mame, Liza, Ellen, and Rod, Donald M. Spoto, Feb., 79.

Dr. John—The Gris-Gris Man, Andy Doherty, May, 64.

Newport Jazz Festival, Martha Sanders Gilmore, May, 72.

Celebrating the Duke, Dan Morgen-

stern, April, 74.
The Feast Is Yours, Michael Tearson,
 Sept., 70.

Phono Styli

A New Suspension System for Phono Styli, Werner Fidi & Geoffrey M. Langdon, March, 24.

Quadrphony

Build the Latest CD-4 Demodulator, Joseph Gioenco, Nov., 36.
Syndication of Quadrasonic Radio Programs, Martin Clifford, Nov., 46.

Record Cleaners

Record Cleaners Revisited, B.V. Pisha, May, 40.

Records

Making Records, Ralph Cousino, June, 38.

Tape

Understanding the NAB EQ Standard, Herman Burstein, April, 32.
Understanding S/N Ratios, Herman Burstein, Sept., 32.
Reading VU Meters, C.E. Moule, Sept., 42.

Three Car Radios Tested, Leonard Feldman, July, 28.

Time Delay for Ambience, Leonard Feldman, Dec., 40.

Author Index

Arnstein, Felix, *Let's Be Fair to Our Favorite Composers*, Feb., 76.

Ballou, Glen M., *Summer Sound Systems*, Aug. 24.

Burstein, Herman, *Understanding the NAB EQ Standard*, April, 32; *Understanding S/N Ratios*, Sept., 32.

Burwen, Richard S., *20,000 Watt Home Hi-Fi*, April, 44.

Clifford, Martin, *Syndication of Quadrasonic Radio Programs*, Nov., 46; and Margaret Eisen, *A Dealer's View of Discounts and Service*, Oct., 28.

Cousino, Ralph J., *Making Records*, June, 38.

Crawford, Dick, *Build a Boost-Rumble Filter*, June, 44; *Addenda*, Dec., 30.

Doherty, Andy, *Dr. John—The Gris-Gris Man*, May, 64.

Eisen, Margaret, and Martin Clifford, *A Dealer's View of Discounts and Service*, Oct., 28.

Feldman, Leonard, *New Standards For Tuners and Receiver*, Jan., 38; *Three Car Radios Tested*, July, 28; *Time Delay for Ambience*, Dec. 40.

Fidi, Werner and Geoffrey M. Langdon, *A New Suspension System for Phono Styli*, March, 24.

Gilmore, Martha Sanders, *Newport Jazz Festival*, May, 72.

Gioenco, Joseph, *Build the Latest CD-4 Demodulator*, Nov., 36.

Heyser, Richard C., *Speaker Tests: THD*, Feb., 18; *IM Distortion in Speaker Systems*, March, 38; *Audio's Crescendo Test*, May, 30; *Energy-Time Test*, June 74.

Hoge, W.J.J., *Switched-On Bass*, Aug., 34; *Addenda*, Nov., 24.

Holman, Tomlinson, *Car Speaker Placement*, July, 54.

Langdon, Geoffrey M., and Werner Fidi, *A New Suspension System for Phono Styli*, March, 24.

Leach, Marshall, *Build a Low TIM Amplifier*, Feb., 30.

Lipscomb, Dr. David M., *Hearing Loss in Rock Musicians*, March, 32.

Lorona, Alfred, *Microphone Sensitivity Ratings*, Dec., 32.

Moir, James, *Doppler Distortion in Loudspeakers*, Aug., 42.

Morgenstern, Dan, *Celebrating the Duke*, April, 74.

Moule, C.E., *Reading VU Meters*, Sept., 42.

Nelson, Gene A., *Build a Mike for Binocular Listening*, May, 34.

Pisha, B.V., *Record Cleaners Revisited*, May, 40.

Seydor, Paul, *Designing a Custom Installation*, Jan., 30.

Spoto, Donald M., *Of Rosie, Mame, Liza, Ellen, and Rod*, Feb., 79.

Tearson, Michael, *The Feast Is Yours*, Sept., 70.

Addenda — 1975

Shanefield, Daniel, *What Do You Really Hear in Quadrphony?*, Nov. 1975, 44.

STATEMENT OF OWNERSHIP, MANAGEMENT AND CIRCULATION, Act of August 12, 1970; Section 3685, Title 39, United States Code.

1. Date of Filing, September 20, 1976; 2. Title of Publication, AUDIO; 3. Frequency of Issue, Monthly; 4. Location of Known Office of Publication, 401 N. Broad St., Philadelphia, Penna. 19108; 5. Location of the Headquarters or General Business Offices of The Publishers, 401 N. Broad St., Philadelphia, Penna. 19108.

6. Names and Addresses of Publisher, Editor, and Managing Editor: Publisher, Jay L. Butler, 401 N. Broad St., Philadelphia, Penna. 19108; Editor, Eugene Pitts III, 401 N. Broad St., Philadelphia, Penna. 19108; Managing Editor, none.

7. Owner, North American Publishing Company, 401 N. Broad St., Philadelphia, Penna. 19108. I. J. Borowsky, 401 N. Broad St., Philadelphia, Penna. 19108.

8. Known Bondholders, Mortgagees, and Other Security Holders Owning or Holding 1 Percent or More of Total Amount of Bonds, Mortgages or Other Securities: None.

9. Paragraphs 7 and 8 include, in cases where the stockholder or security holder appears upon the books of the company as trustee or in any other fiduciary relation, the name of the person or corporation for whom such trustee is acting, also the statements in the two paragraphs show the affiant's full knowledge and belief as to the circumstances and conditions under which stockholders and security holders who do not appear upon the books of the company as trustees, hold stock and securities in a capacity other than that of a bona-fide owner. Names and addresses of individuals who are stockholders of a corporation which itself is a stockholder or holder of bonds, mortgages, or other securities of the publishing corporation have been included in paragraphs 7 and 8 when the interests of such individuals are equivalent to 1 percent or more of the total amount of the stock or securities of the publishing corporation.

10. This item must be completed for all publications except those which do not carry advertising other than the publisher's own and which are named in Sections 132,231, 132,232 and 132,233. Postal Manual (Sections 4355a, 4355b, and 4356 of Title 39, United States Code).

	Average no. copies each issue during preceding 12 months	Single issue nearest to filing date
A. Total no. copies printed (Net Press Run)	135,543	147,245
B. Paid circulation		
1. Sales through dealers and carriers, street vendors and counter sales	23,292	25,271
2. Mail Subscriptions	92,292	100,817
C. Total paid circulation	115,584	126,088
D. Free Distribution by Mail, Carrier or other means		
1. Samples, complimentary, and other free copies	2,344	2,025
E. Total distribution (Sum of C and D)	117,928	128,113
F. 1. Office use, left-over unaccounted, spoiled after printing	945	1,073
2. Copies distributed to news after printing	16,670	18,059
G. Total (Sum of E and F—should equal net press run shown in A)	135,543	147,245

I certify that the statements made by me above are correct and complete.

JAY L. BUTLER, Publisher

THE MARANTZ

FOR THE BUDGET-MINDED PERFECTIONIST. THE 6100.

High on performance, the belt-drive 6100 features a super-dependable AC synchronous motor. The convenience of auto return and shut off. Plus full protection of your valuable records with a precision S-shaped tone arm, gentle-action viscous-damped cueing and anti-skate.

FOR THE BUTTON-PUSHER. THE TOTALLY AUTOMATIC 6200.

It's auto-everything. Auto start. Auto return and shut off. Auto repeat. Operates manually, as well. A servo motor, coupled

with belt drive, assures optimum speed accuracy. Stroboscopic pitch control "fine-tunes" speed to compensate for off-pitch records or for playing along with a musical instrument. The 6200 cares for your records, too, with a precision S-shaped tone arm, gentle-action viscous-damped cueing and anti-skate.



Model 6100/\$129.95*



Model 6200/\$199.95*

*Suggested list prices. Actual selling prices at dealer's discretion. All models come complete with anti-static turntable mat, plastic hinged dust cover, base enclosure, and low capacitance phono cables that assure 4-channel capability whenever you need it. The base enclosure for the 6300 is constructed of plywood, finished in genuine walnut veneer. The enclosures for the 6200 and 6100 are finished in walnut grain vinyl veneer.

TURNTABLES

FOR THE TOP-OF-THE-LINER. THE DIRECT DRIVE, OPTO-COUPLED AUTO LIFT 6300.

Features and technological excellence galore. Starting with **absolute speed accuracy** assured by a combination of **direct drive** design and **DC servo motor** that automatically compensates for voltage/speed fluctuations. Of course, there's **auto lift** and **shut off**, but on the 6300 it's **opto-coupled** — a significant Marantz exclusive. It means no tracking distortion caused by mechanical linkage between auto mechanism and tone arm. The secret: a tiny beam from a light-emitting diode maintains constant contact with a photo transistor during play.

At record's end, a sliding blade cuts contact, activating a circuit that lifts the tone arm and shuts off the motor. There's more. **Stroboscopic pitch control** "fine-tunes" speed to your personal preference. And **viscous damped cueing** gently, smoothly lowers the precision **S-shaped tone arm** onto the sensitive disk surface. **Vertical/lateral counterbalancing** and **anti-skate** result in lowest distortion and tracking error.

marantz®
We sound better.



Model 6300/\$269.95

Only Technics gives you the world's most precise drive system all these ways.

Technics direct drive. Radio stations use it. Discos abuse it. And now you can get it in virtually any kind of turntable you want. Because Technics puts direct drive into more kinds of turntables than anyone else.

You'll find it in three manuals that start at under \$200* with the SL-500. Or for a little more money you can get a lot more convenience with our newest turntable, the semi-automatic SL-1400. The world's first turntable with a one-chip 321 element IC. That gets the platter to exact speed in only 1/3 of a revolution. There is also the fully automatic single disc SL-1300. And the world's first direct-drive changer, the SL-1350.

But there's a lot more to Technics direct drive than just more kinds of turntables. There's also more precision, better performance and greater reliability.

Because in our direct-drive system the platter is an extension of the motor shaft. That means there aren't any belts, gears or idlers to produce variations in speed. And that means all our turntables have less than 0.03% wow and flutter (WRMS), (0.04% for the SL-1350).

You'll also find an electronically controlled DC motor that spins at exactly 33 1/3 or 45 RPM. Regardless of fluctuations in AC line voltage or frequency. What's more, unlike high-speed, rumble-producing motors, our motor introduces so little vibration into the system that any rumble remains inaudible (-70 dB DIN B).

And it doesn't matter which Technics turntable you choose. Because they all have the extras you need. Like variable pitch controls. A built-in stroboscope. Viscous-damped cueing. Feedback-insulated legs. As well as a dust cover and integral base.

So if you want a turntable good enough for professionals, get the turntables radio stations use and discos abuse. Technics direct drive.

*Suggested retail price.

Technics by Panasonic

Check No. 44 on Reader Service Card

