

**Seven  
Equipment  
Reviews**

# Audio

THE AUTHORITATIVE MAGAZINE ABOUT HIGH FIDELITY • DECEMBER 1975 75¢

47425

ON THE  
AIR

**Miking with the  
Three-Point  
System**

**Language  
of High Fidelity**

U0803760 0476 30725005P0101212  
DON L HUNTER  
2608 CENTRAL BLVD  
EUGENE OR 97403

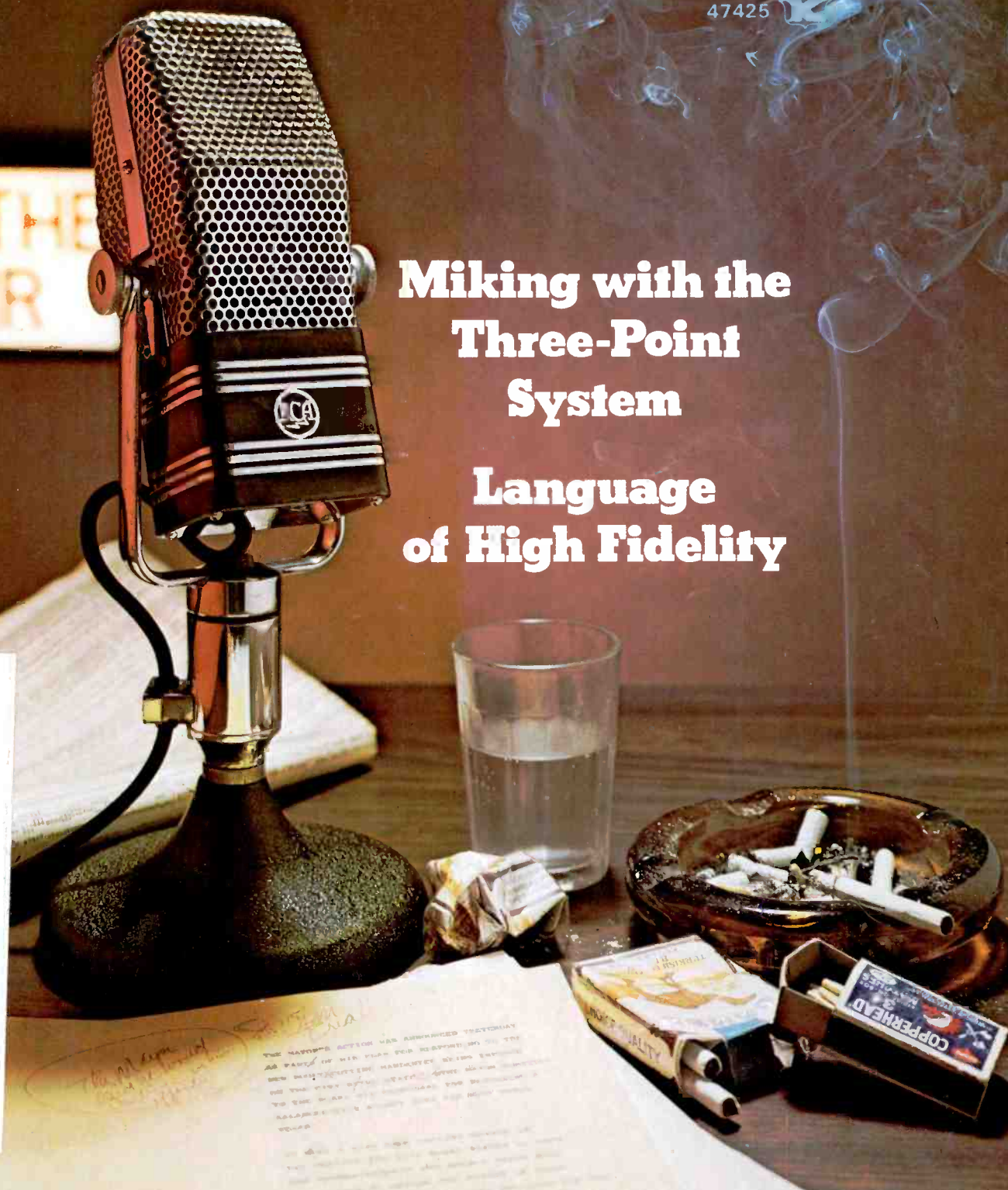





PL-A45D

PL-55X

# The best e, get a Pioneer.

Both units are even equipped with a strobe light directed at the strobe marks for easy viewing.

## Combine the best automatic features with manual operation

While many hi-fi enthusiasts demand completely manual turntable operation, there are many purists who prefer semi-automatic operation. Pioneer provides this extra convenience in the PL-55X and PL-15D/II. Both models incorporate automatic tonearm return and shutoff. When the record has finished playing, the tonearm automatically returns to the arm rest and the power is turned off.



Automatic tonearm return and shutoff



Fully automatic operation in single-play

The PL-A45D is completely automatic. You don't ever have to touch the tonearm when you play your records. This 2-motor model has a special precision

gear motor to exclusively handle automatic tonearm lead-in, automatic return, automatic shutoff and repeat play. And when you prefer, you can switch to fully manual operation.

The PL-71 and PL-12D/II, at both ends of Pioneer's turntable lineup, offer the total involvement that can only be attained by completely manual operation.

## Superb S-shaped tonearms for better tracking

The tonearm of every Pioneer turntable system is the S-shape design, for optimum groove tracking. All are statically balanced and all use adjustable counterweights with direct reading of tracking force. All have adjustable anti-skate control and oil-damped cueing for the gentlest application of stylus tip to record groove. Lightweight plug-in cartridge shells insure positive electrical contact and optimum stylus position and angle for lower distortion and reduced record wear.



S-shaped tonearm for better tracking

## Unexcelled performance

Still, all of these features and refinements do not guarantee the performance specifications of Pioneer's new turntables. Each tonearm and turntable platter combination is shock mounted in its specially designed natural grain base (with hinged dust cover). Precision machining of all rotational parts plus continuous quality control insure that each will meet or exceed its published specifications — a time honored tradition with all Pioneer components.

## Choice of the professionals

Engineers, experts and enthusiasts agree: to get the best performance, select a manual turntable. And to get the best manual turntable, you need a Pioneer. Every Pioneer manual turntable offers a level of precision and performance unparalleled in its price range. And every one is a total system — with dust cover and base — designed for years of professional, trouble-free sound reproduction.

U.S. Pioneer Electronics Corp.,  
75 Oxford Drive, Moonachie,  
New Jersey 07074 / West: 13300 S.  
Estrella, Los Angeles 90248 / Midwest:  
1500 Greenleaf, Elk Grove Village,  
Ill. 60007 / Canada: S. H. Parker Co.





PL-12D/II

PL-15D/II

# For the manual turntable

The manual turntable is rapidly becoming the first choice of hi-fi enthusiasts everywhere. The reason why is quite simple. Today's enthusiasts are more knowledgeable, more sophisticated and more involved with their music. And only the manual turntable can provide the involvement and performance they demand.

At Pioneer, this trend comes as no surprise. We have long recognized the superiority of the manual turntable. And long recognized a simple fact: a record changer in no way improves performance. It can detract from it.

As a result, we now offer the finest and most complete line of manual turntables available. Manual turntables that are designed with the needs of today's hi-fi enthusiast in mind. Turntables that are engineered for precision response.

When you get right down to it, good record playing equipment really has only two requirements: uniform rotation of a turntable, and accurate tracing of a record groove by a tonearm and its cartridge.

Pioneer's engineers have long recognized that these requirements are best met by single-play turntables

and precision engineered tonearms. Our five new belt-drive and direct-drive turntable systems mean you needn't settle for the higher wow and flutter and the poorer signal-to-noise ratios (rumble) of record changers. Whether you've budgeted \$100 or \$300 for this vital element of your high fidelity system, there's a Pioneer turntable that outperforms any record changer in its price class.

### Consider the performance advantages

Belt-drive, featured in Pioneer's PL-12D/II, PL-15D/II and PL-A45D, means smoother, more uniform platter rotation than can be achieved with typical idler-wheel/pulley arrangements normally found in record changers. Even changers



Belt-drive for rumble-free rotation



Direct-drive motor reduces friction

equipped with synchronous motors transmit vibration to the turntable platter. This is picked up as low-frequency rumble by the tonearm and

cartridge. By driving the platter with a precision-finished belt, vibration is effectively absorbed before it can be translated to audible rumble.

Pioneer's direct-drive models, PL-55X and PL-71 go even a step further in achieving noise-free, precision platter rotation. The DC electronically controlled servo-motors used in these models rotate at exactly the required 33 $\frac{1}{3}$  and 45 rpm platter speeds. Their shafts are directly connected to the center of the turntable, with no intermediate pulleys or other speed reduction devices. This means no extra friction-producing bearing surfaces.

Because of the unique technology embodied in these new, direct-drive motors, it's possible to control their speed electronically. This is more precise than any mechanical drive system. Both our PL-55X and PL-71 offer individual pitch control for both 33 $\frac{1}{3}$  and 45 rpm speeds. Their turntable platters are edge-fitted with stroboscopic marks, so you can adjust precise speed while a record is playing.



Electronic speed adjustment for each speed



**For  
the best  
performance,  
get a manual  
turntable.**





PL-71

There's a Pioneer turntable that's just right for your needs

Model	PL-12D/II	PL-15D/II	PL-A45D	PL-55X	PL-71
Type	Manual	Semi-Auto.	Fully Auto.	Semi-Auto.	Manual
Drive System	Belt	Belt	Belt	Direct	Direct
Drive Motor	4-pole synch.	4-pole synch.	4-pole synch.	DC servo	DC servo
Speed Control	---	---	---	±2%	±2%
S/N (RUMBLE)	Over 48dB	Over 48dB	Over 47dB	Over 53dB	Over 60dB
Wow & Flutter (WRMS)	0.08%	0.08%	0.07%	0.05%	0.05%
Tonearm Type	Static Bal. "S"	Static Bal. "S"	Static Bal. "S"	Static Bal. "S"	Static Bal. "S"
Tonearm Length	8 <sup>1</sup> / <sub>16</sub> "	8 <sup>1</sup> / <sub>16</sub> "	8 <sup>1</sup> / <sub>16</sub> "	8 <sup>1</sup> / <sub>16</sub> "	8 <sup>3</sup> / <sub>4</sub> "
Turntable Dia.	12"	12"	12"	12 <sup>1</sup> / <sub>4</sub> "	12 <sup>1</sup> / <sub>4</sub> "
Priced Under*:	\$100	\$125	\$175	\$250	\$300

\*The values shown are for informational purposes only.  
 The actual resale prices will be set by the individual Pioneer dealer at his option.  
 The PL-71 includes a walnut veneered base; all other models include a base of walnut grained vinyl.

**PIONEER**<sup>®</sup>  
 when you want something better

Check No. 34 on Reader Service Card



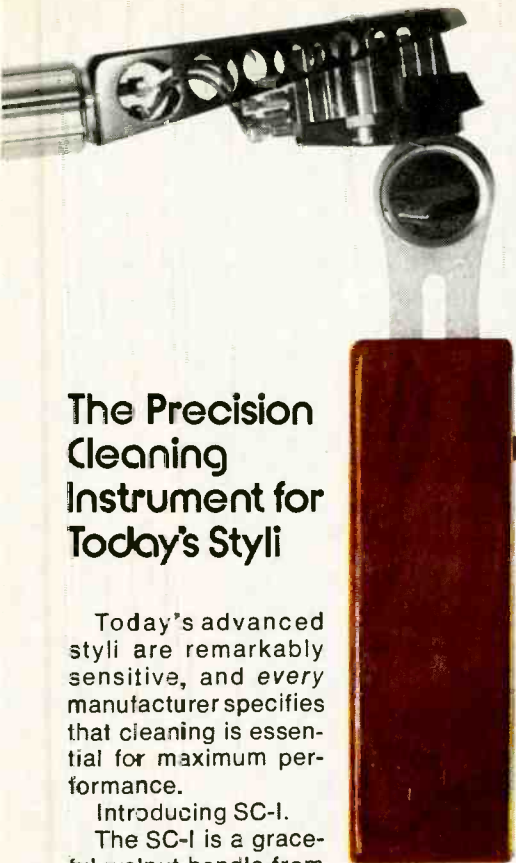

## The Precision Cleaning Instrument for Today's Styli

Today's advanced styli are remarkably sensitive, and every manufacturer specifies that cleaning is essential for maximum performance.

Introducing SC-I.

The SC-I is a graceful walnut handle from which you can push a

MAGNIFYING SIDE

small tang. At the end of this tang is a calculated-density brush of black nylon with enough rigidity to clean waxy deposits—yet with enough "give" to eliminate cantilever damage. There is also a silvered mirror that magnifies the stylus, cantilever, and cartridge mounting for total perception of your pickup system.

BRUSH SIDE

All of this retracts into the walnut handle for elegant protection.

The new SC-I for only \$6.00, at audio specialists nationwide that carry Discwasher products.



DISC WASHER GROUP  
**DISC WASHER, INC.**  
 909 University  
 Columbia, Mo.

# Audio

December, 1975

"Successor to **RADIO** Est. 1917"

Vol. 59, No. 12

## Feature Articles

- 28 Miking with the Three-Point System
- 38 Language of High Fidelity, Part XIII/Martin Clifford
- 80 Addenda to Annual Equipment Directory
- 117 Annual Index

## Equipment Profiles

- 46 Radio Shack STA-225 Receiver/Leonard Feldman
- 54 Technics T-400 Loudspeaker System/Richard C. Heyser
- 64 Yamaha CT-7000 FM Tuner/Leonard Feldman
- 68 Koss HV/1A Stereo Phones/C.G. McProud
- 72 Nakamichi Reference Monitor Loudspeaker System/Richard C. Heyser
- 76 BGW 500D Basic Amplifier/Bascom H. King

## Record Reviews

- 82 The Column/Fred De Van & Jon Tiven
- 93 Jazz & Blues/Dan Morgenstern & John Lissner & Eric Henry
- 104 Classical/Edward Tatnall Canby

## Audio In General

- 6 Audioclinic/Joseph Giovanelli
- 12 Tape Guide/Herman Burstein
- 16 Behind The Scenes/Bert Whyte
- 22 Audio ETC/Edward Tatnall Canby
- 26 Dear Editor
- 98 Advertising Index
- 108 Classified Advertising
- 103 What's New In Audio

**EDITOR** Eugene Pitts III  
**ASSOCIATE EDITOR** Edward Tatnall Canby  
**ASSOCIATE EDITOR** Bert Whyte  
**EDITORIAL ASSISTANT** Vickie Rock

**PUBLISHER** Jay L. Butler  
**MARKETING DIRECTOR** Sanford L. Cahn  
**DESIGN** Janet Lee  
**CIRCULATION MANAGER** Jean Davis  
**ADVERTISING PRODUCTION** Lynn Lyons

Contributing Editors: Herman Burstein, Martin Clifford, Fred De Van, Leonard Feldman, Martha Sanders Gilmore, Joseph Giovanelli, Richard C. Heyser, Bascom H. King, C.G. McProud, B.V. Pisha, Donald M. Spoto, George W. Tillett, Jon Tiven.

**AUDIO** (title registered U.S. Pat. Off.) is published monthly by North American Publishing Co., Irvin J. Borowsky, President; Frank Nemeyer, and Jay L. Butler, Vice Presidents; R. Kenneth Baxter, Vice President/Production; Nate Rosenblatt, Promotion Director; Mary Claffey, Circulation Director.

**RATES**—United States only: 1 year for \$7.00, 2 years for \$12.00, 3 years for \$17.00; outside the U.S.: 1 year for \$9.00, 2 years for \$16.00, and 3 years for \$23.00. Printed in U.S.A. at Columbus, Ohio. All rights reserved. Entire contents copyrighted 1975 by North American Publishing Co. Second class postage paid at Philadelphia, Pa. and additional mailing office. Back issues, \$2.00 each. **World Library Congress** number: ISSN 0004-752X. **Dewey Decimal** number: 621.381 or 778.5.

**REGIONAL SALES OFFICES:** Jay L. Butler, Publisher and Sanford L. Cahn, Marketing Director, 41 East 42nd St., New York, N.Y. 10017, telephone (212) 687-8924.

Jay Martin, 2525 West 8th St., Los Angeles, California, 90057, telephone (213) 385-2917.

**REPRESENTATIVES:** **Continental Europe:** John Ashcraft, 12 Bear St., Leicester-Square, London W.C.2, telephone 930-0525.

For Benelux and Germany, W.J.M. Saunders, Mgr., Herengracht 365. Amsterdam, Holland, telephone 24.09.08.

Japan: Japan Printing News Co., Ltd., No. 13.2 Chome Ginza Higasi, Chuo-ku, Tokyo, telephone 541-5795.

**AUDIO** Editorial and Publishing Offices, 401 No. Broad St., Philadelphia, Pa. 19108

**Postmaster: Send Form 3579 to the above address**





# a brilliant new achievement in Heil air-motion transformer technology

Since introduction of the ESS amt 1 three years ago, to world-wide acclaim as the first really new development in loudspeaker technology in over 50 years, the Heil air-motion transformer has guided knowledgeable audiophiles to new horizons of sound clarity. Now after two year's research the extraordinary loudspeaker classic has been further perfected to achieve virtually flawless accuracy over a substantially increased range with:

A NEW Heil air-motion transformer configuration that achieves greater vertical sound dispersion and permits penetrating, unified magnetization of each transformer with special equipment designed and built by ESS expressly for this purpose.

A NEW 12 inch high acceleration woofer manufactured by ESS under the strictest quality control, incorporates a 7.4 pound magnet assembly mounted on a rigid, open backed, cast aluminum frame. Its cone is made of a newly developed rubber impregnated pulp and is contoured to provide extreme definition and clarity through the critical midrange crossover point with dynamic, overhang-free bass. Its high temperature voice coil assembly allows massive power handling.

A NEW aluminum frame 12 inch passive radiator with a diaphragm of laminated styrofoam and neoprene suspended by a compliant half-roll foam surround, operates in conjunction with the woofer to provide useful output in the typical listening environment, extending as low as 25 Hz.

The new ESS amt 1a reaches a level of performance impossible to achieve without full manufacturing control over all system elements so you can recreate the excitement, immediacy and grandeur of a live performance with a clarity and dynamic power never before experienced. Hear this new ESS standard of excellence, yourself at a franchised ESS dealer—a dealer who understands the loudspeaker of tomorrow, the ESS Heil air-motion transformer amt 1a. You'll experience sound as clear as light.

**ESS inc.** 9613 oates drive · sacramento, califonia 95827

ESS products available in Canada through ESS CANADA



the new

**ESS**

amt 1a

Heil air-motion transformer system



**First there was  
vacuum tube amplification  
then the solid state transistor  
and now...**

**Infinity announces  
the Third Era of Amplification.**

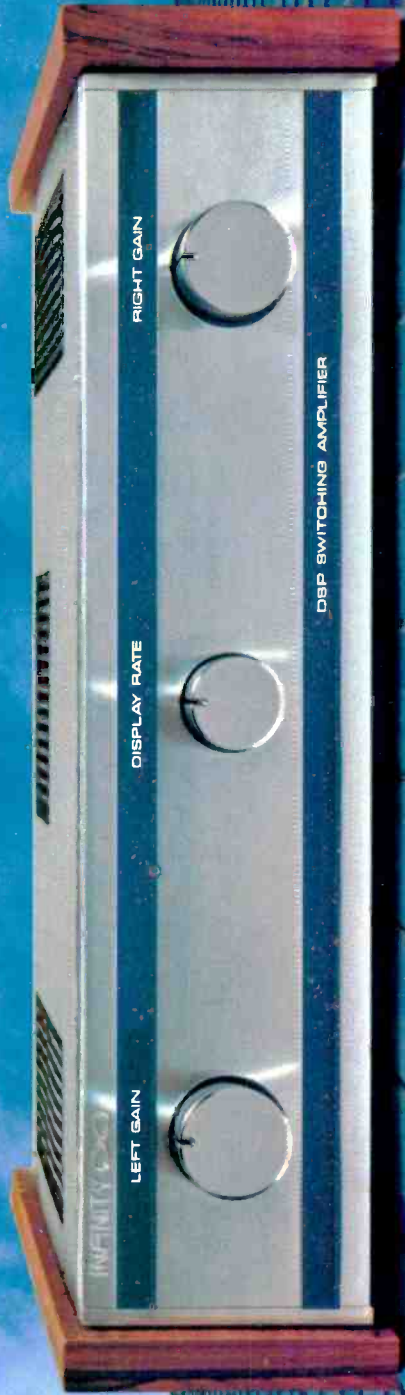



# The Infinity DSP Switching Amplifier™

## It makes all previous amplifier technologies obsolete.

For some years now, the audio world has heard rumors of the advanced work in Class D amplification going on at Infinity, a young, and, if we do say so ourselves, rather imaginative group in Canoga Park, California. These rumors told of a major new audio technology based upon mathematic and electronic principles in use only in exotic aerospace applications. The rumor is fact.

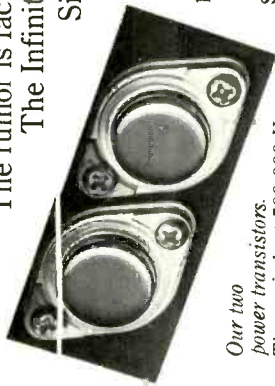

Our two power transistors. They switch at 500,000 Hz.

The Infinity DSP (Digital Signal Processing) Switching Amplifier™ has nothing in common with existing amplifiers. The sophistication of its computer technology and the unprecedented, lifelike purity of its sound are totally new. In performance, it eclipses anything ever seen — or heard — in the audio world. Including vacuum tubes and the Vertical FET which have produced the finest sound available — until now.

All amplifiers to date, whether vacuum tube or transistor (including the evolutionary V-FET), have used their device for amplification. The DSP Switching Amplifier however, employs a truly revolutionary mode of operation; it uses the transistor not for amplification, but as a *switch*. It simply switches the signal on and off 500,000 times per second — or, at the rate of two millionths of a second.

We know that the concept of Class D switching sounds offbeat and a little opaque. But take our word for it; mathematically, it calculates as an amplifier.

Essentially, the DSP Switching Amplifier performs as a digital computer.

### How it works: a not-so-simple explanation

Considerably understated, the Infinity DSP switching circuitry works like this: The power supply delivers 750 watts of regulated power by converting the 60 cycle line to DC, then to a regulated voltage level DC, and then square-wave-modulating that voltage, by switching at 25kHz. (These are the first switching elements in our circuitry.)

The amp section converts the audio analogue signal to a computer-coded pulse-width modulation and a filtering network then decodes the modulation from the switched audio signal.

The entire function is controlled by an exotic 2½" by 2½" digital chip "brain center" — the Ulrick-Henderson DSP Hybrid™ — a plug-in module

containing the logic which processes the signal and the controls performance functions; in effect, connecting the power supply directly to the speakers.

### Nifty.

### But what does it do?

It does what all previous types of amplification have tried to do and failed. It brings you the ambient, warm, life-quality of live music in a way that makes it virtually indistinguishable from the original sound.

It produces a transient-perfect signal that is literally incapable of overshooting or

undershooting. It lifts the veils and bypasses the edgy colorations and transient intermodulation distortions that are inherent limitations in all conventional amplifiers.

It totally eliminates the thermal degradation that plagues all transistors, vacuum tubes and V-FETs; therefore it can run virtually forever at full music power and still remain cool. It delivers a rock-steady 250 RMS watts continuous per channel, with power bandwidth from 20Hz to 20kHz, and harmonic distortion of less than 0.1%; under any line conditions from 96 to 240 volts, anywhere in the world. With no degradation power in output, quality or performance.

Yet it measures only 18¼ by 4½ by 12 inches and weighs less than 40 pounds!

There has never been an amplifier even remotely resembling the Infinity DSP Switching Amplifier — whether or in breadth of tonal quality, or in depth of technological advances. It's a stunning scientific achievement. It cost us six exciting, exhilarating years; it will cost you \$1850. (Our FET Preamplifier, soon, will be \$1000.)

The DSP Switching Amplifier is ready for you at selected Infinity dealers. Are you ready for the Third Era?



Our digital chip brain-center: the Ulrick-Henderson DSP Hybrid.

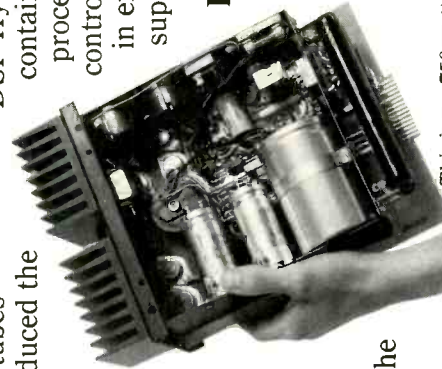

This is our 750 watt regulated power supply.



We get you back to what it's all about. Music.

© 1975 Infinity Systems, Inc.  
7930 Deering Avenue, Canoga Park 91403 T.W.X. 910-949-4919



# The \$300 alternative.

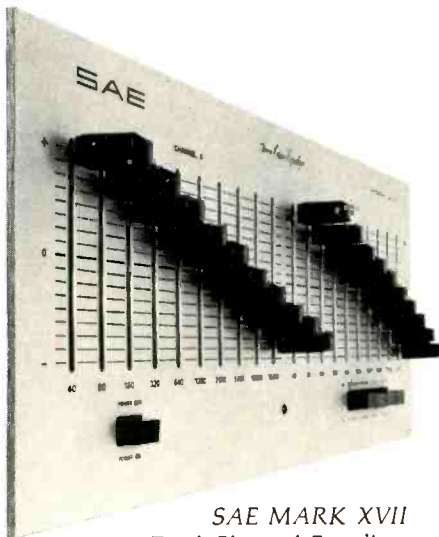

SAE MARK XVII  
Dual-Channel Equalizer

Your tone controls are just not designed to compensate for

- Room acoustics
- Speaker placement
- Old or bad recordings

We built the Mark XVII Equalizer to solve these problems and more.

These are some of the ways:

- Individual Octave Control for each channel
- Long throw, oil-damped linear slide pots for greater accuracy
- Dual range operation (controls operate over either  $\pm 8\text{dB}$  or  $\pm 16\text{dB}$ )

#### Plus

- Capable of driving any system
- Low distortion—less than 0.03% THD and IM
- Low noise—greater than 90dB
- 5-year parts and labor service contract
- SAE's reputation as the finest manufacturer in the audio field

You'd have to look a long time to find an EQ that delivers this much value. SAE innovation has done it.

Components for the connoisseur.



Scientific Audio Electronics, Inc.  
P.O. Box 60271, Terminal Annex  
Los Angeles, California 90060

Please send me the reasons (including available literature) why the SAE MARK XVII Dual-Channel Equalizer is the "\$300 Alternative."

NAME \_\_\_\_\_

ADDRESS \_\_\_\_\_

CITY \_\_\_\_\_ STATE \_\_\_\_\_ ZIP \_\_\_\_\_

Check No. 41 on Reader Service Card

# Audioclinic

Joseph Giovanelli

## 50- and 75- $\mu\text{s}$ Pre- and De-emphasis

**Q.** Please explain 50-microsecond and 75-microsecond pre-emphasis at the FM transmitter and 50-microsecond and 75-microsecond de-emphasis at the FM receiver. I have noticed that some receivers and tuners have a switch for selecting either one. Does the 50-microsecond de-emphasis circuit produce a brighter sound? /Larry Cook, Albany, Ga.

**A.** In FM broadcasting, as with tape and disc, we boost treble during production or broadcast and reduce it during reproduction to compensate for the boost. This results in less noise, but the amount of initial boost must equal the amount of later frequency cut or the frequency response will be altered. This is accomplished with a combination of a resistor and a capacitor. Any network of this kind will have a specific frequency boost or cut, starting at a given point and continuing at the given rate to the desired frequency. Beyond the designed-in frequencies, however, the network may not remain effective.

Simply, when a capacitor and resistor are connected in series and a voltage is impressed across it, it takes time for the capacitor to charge. If the capacitor is already charged and then connected in parallel with the resistor, it will take time for the capacitor to discharge into the resistor. These charge and discharge periods are said to be the "time constant" of the combination. Since several combinations of resistor/capacitor elements will produce this same time constant, the amount of boost or cut can be stated by using the time constant of the

components which make up the circuit, rather than the amount of boost or cut involved and at what frequency.

Most FM stations use a 75-microsecond boost requiring 75/1,000,000 of a second to charge or discharge a network. (Actually, the formula is based on a charge of 68 percent of the maximum possible charge that the capacitor can hold, and a discharge to 32 percent of the full original charge.)

Using a 50-microsecond cut while listening to a station broadcasting with a 75-microsecond boost, the treble will be a bit brighter than otherwise. FM stations which broadcast in the Dolby system use a 25-microsecond frequency boost at their transmitters for increased listener compatibility between Dolby and non-Dolby equipped receivers.

## Loudspeaker Flux

**Q.** Please explain what the word "flux" means, as applied to loudspeakers. Does more flux make a speaker sound better?—Richard McHale, Upper Darby, PA.

**A.** Flux describes the amount of magnetism, in this case, in the voice-coil gap of a loudspeaker. It is measured in oersteds (the old term was gauss). Generally, the more gauss present, the better. The amount of flux will affect the efficiency of a speaker and the amount of control which amplifier damping can exert on the motion of the speaker cone.

## Direct-coupled Amplifiers

**Q.** What is a "direct-coupled" amplifier and how is it different from other amplifiers?

Ronald L. Ambrogi  
Brooklyn, N.Y.

**A.** A direct-coupled amplifier is one in which the signal is transferred from one stage to the next without coupling capacitors. Because capaci-

**About The Cover:** For this impressionistic cover depicting microphone use during WW II, we borrowed an RCA Model 44B mike from Bob Paquette. Introduced about 1937, most radio stations used the 44B throughout the 40s, and it was standard for network radio.

If you have a problem or question on audio, write to Mr. Joseph Giovanelli, at AUDIO, 401 North Broad Street, Philadelphia, Pa. 19108. All letters are answered. Please enclose a stamped, self-addressed envelope.



# The Dual cassette deck.



**The first  
high-performance  
precision deck  
with  
automatic  
reverse.**

Automatic reverse has not been generally associated with high quality in tape recording. But as Dual has long proven with automatic turntables, convenience can accompany precision performance.

Since the primary reason for selecting a cassette deck is its performance quality, let's consider this first. With standard tapes, the frequency response of the Dual cassette deck extends from 20 to 14,000 Hz at  $\pm 1.5$  dB and to 17,000 Hz at  $\pm 3$  dB. Wow and flutter (DIN weighted) is 0.07%. Harmonic distortion is less than 1.5%, and signal-to-noise is greater than 50 dB; 59 dB when the Dolby system is switched in.

The motor is Dual's well-known Continuous-Pole/synchronous motor which has long proven its reliability in our finest automatic turntables. A precision-ground flat belt transmits power to the capstans. A separate drive belt powers tape take-up. The VU meters are ballistically damped to provide precisely the rise time and overshoot characteristics specified for broadcast quality meters.

Now for convenience. Automatic reverse lets you double the playback time of any cassette. Continuous-play lets you hear both sides over and over until you shut the machine off. Recording is bi-directional, eliminating the need to turn the cassette over at the end of side one. Rewind time for a C-60 cassette is 60 seconds flat.

You can see the rest for yourself in the photograph. This cassette deck is also typically Dual in appearance: clean, functional, uncluttered. If you own a Dual turntable, you've come to appreciate these qualities. And if you're about to own a cassette, you'll appreciate some additional niceties of the Dual. The meters tilt up for viewing from across the room. The viscous-damped cassette holder rises smoothly and silently when the eject button is pressed. The built-in Dolby test oscillator precisely adjusts for any tapes, today's or those of the future.

In short, this cassette deck was designed with the same philosophy that Dual has espoused for years: the most serious audio equipment can also be the easiest and most convenient to use. Price: \$450.

**United Audio Products**

120 So. Columbus Ave., Mt. Vernon, N.Y. 10553

Exclusive U.S. Distribution Agency for Dual

**Dual**

Check No. 11 on Reader Service Card



tors introduce phase shift, their elimination removes this problem. Their elimination also saves parts and therefore lowers cost a bit.

The disadvantage is that the voltage of the early stages affects the operating point of the later stages. A failure in any of the early stages may bring about failure of the later stages. This can prove costly. Fortunately small-signal transistors and ICs used in these early stages are not highly prone to failure.

Direct-coupling is widespread in transistor amp circuitry. It was used only very occasionally in tube amp circuitry.

## Equalizers

**Q.** Please explain the use of an equalizer in a four-channel component system. Are two equalizers necessary? Where is the equalizer connected within the system? Some manufacturers claim their equalizer enables the user to increase the volume of certain instrumental sections and enhance the performance of a given soloist. If this claim is true, how does an equalizer accomplish this?/Roy Clark, Chicago, Ill.

**A.** Amplifiers have bass and treble tone controls. They enhance the sound quality of the system by enabling the listener to add or remove

bass or treble from specific program sources. Such controls are a form of equalizer. Today's "full" equalizers are more sophisticated. Rather than dividing the audio spectrum into just two segments, these devices take narrower segments of the response and boost or cut them. A segment usually is one octave wide, but can be narrower depending on the design of the equalizer and the desired uses.

Considering we can hear over a frequency range of perhaps 10 octaves, we might have 10 separate tone controls for each channel. If we divide the spectrum into even smaller segments, we would have even more controls and, in so doing, can correct peaks or dips in room or speaker response. But this flexibility brings with it the complications involved in trying to use all these controls effectively.

If an equalizer can correct for problems in a stereo or mono system, it can also be used successfully for four-channel sound systems. It would probably be easiest to install the equalizer after the matrix decoder on a matrix four-channel system. For discrete channels, it would be placed between the discrete source (decoder, tape machine, etc.) and the individual channel inputs.

Most equalizers sold are stereo units. Such a unit can be used to control the equalizations for two channels, requiring two such units for a four-channel unit. Some equalizers have a set of controls which affect both channels at one time. But if each channel has its own set of controls to adjust for room acoustics, more flexibility is available. Some equalizers are sold as single-channel units. You would then need four of them, one for each channel.

Equalizers can occasionally be used to increase the volume of certain instrumental and vocal timbres, though this is not always successful. If an instrument has most of its acoustical energy concentrated in a certain portion of the frequency spectrum, the equalizer can be adjusted to bring up only the portion containing that instrument. Conversely, an instrument can be subdued by turning down its portion of the spectrum. But if more than one instrument or vocalist shares a portion of the spectrum, everything will be affected when that portion is adjusted.

Equalizers can totally destroy the sound of a system when used improperly. The highest quality sound system can be made to sound like a table radio if the equalizer is not adjusted properly.

**We just made you an important part of our new speakers.**

Ever wish you could add a little more rock to a pop tune? Or a bit more pizzazz to some jazz? It's easy with Jensen's all-new OPC speaker systems. Each comes with exclusive front-mounted Optimum Performance Controls that allow you to adjust speaker frequency response to any kind of music or mood. No matter what type of listening environment you're in.

**One thing that never changes—the rich crystal-clear Jensen sound.**

No matter how you set your OPC controls, you're going to hear sound quality you can't find in any comparably priced speaker systems. That's because inside we've placed features like

Flexair® woofer suspension for distortion-free bass. Sonodome® ultra tweeter for improved high frequency response. And much more.

**Make Jensen OPC speakers a part of your system.**

When you add these new Jensens to your new or existing component system, it's not only going to add quality to the sound. It's going to add a little bit of you.

See and hear the new Jensen OPC speakers for yourself. For a free catalog and listing of Jensen dealers in your area, write: Jensen Sound Laboratories, 4310 Trans World Road, Schiller Park, Illinois 60176.

**JENSEN**  
SOUND LABORATORIES  
Division of Pemco Inc.  
Schiller Park, Illinois 60176

Check No. 21 on Reader Service Card



# "The Sony TC-756 set new records for performance of home tape decks!"

(Stereo Review, February, 1975)

Hirsch-Houck Laboratories further noted, "The dynamic range, distortion, flutter and frequency-response performance are so far beyond the limitations of conventional program material that its virtues can hardly be appreciated."

The Sony TC-756-2 features a **closed loop dual capstan tape drive system** that reduces wow and flutter to a minimum of 0.03%, **logic controlled transport functions** that permit the feather-touch control buttons to be operated in any sequence, at any time without spilling or damaging tape; an **AC servo control capstan motor** and an eight-pole induction motor for

each of the two reels; a record equalization selector switch for maximum record and playback characteristics with either normal or special tapes; mic attenuators that eliminate distortion caused by overdriving the microphone pre-amplifier stage when using sensitive condenser mics; tape/source monitoring switches that allow instantaneous comparison of program source to the actual recording; a mechanical memory capability that allows the machine to turn itself on and off automatically for unattended recording.

In addition, the TC-756-2 offers 15 and 7½ ips tape speeds; Ferrite & Ferrite 2-track/2-channel stereo

three-head configuration; and symphase recording that allows you to record FM matrix or SQ\* 4-channel sources for playback through a decoder-equipped 4-channel amplifier with virtually non-existent phase differences between channels.

The Sony TC-756-2 is representative of the prestigious Sony 700 Series — the five best three-motor 10½-inch reel home tape decks that Sony has ever engineered. See the entire Sony 700 Series now at your nearest Superscope dealer starting at \$699.99.

**SONY**® Brought to you by  
**SUPERSCOPE.**



\*SQ is a trademark of CBS, Inc. © 1975 Superscope, Inc., 8150 Vineland Ave., Sun Valley, CA 91352. Prices and models subject to change without notice. Consult the Yellow Pages for your nearest Superscope dealer.



# You're looking at our attitudes

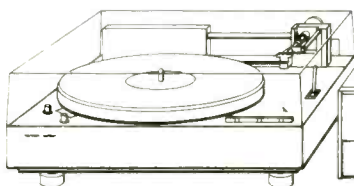

Rabco ST 7

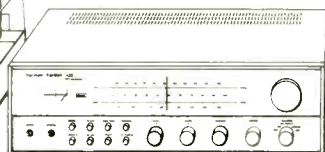

430

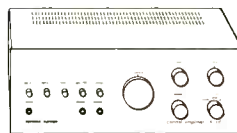

A401

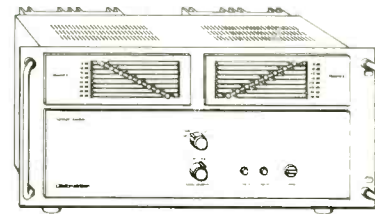

Citation 16

We've been at the business of high fidelity for a long time. And still, every so often we ask ourselves, "What's it all about?"

For us, it's certainly *not* about mass production, nor about squeezing products into traditional "price points". What we *are* about is to find, without qualification, the best way to reproduce music in the home.

Of course we've had our disappointments. We remember a "shelf" unit that couldn't fit on any shelf known to mankind.

But then there have been our triumphs.

We believe the products in this advertisement are the finest expressions of the attitudes that motivate us. They are *diverse*, but *consistent* with our commitment to bring the highest quality to every function of music reproduction.

The new Harman/Kardon Rabco ST-7 turntable is an excellent example. It plays a disc in precisely the way the cutting head made the master record. The arm, carried by the remarkable "rolamite" bearing, moves across the disc in a straight line. The result is a cascade of zeroes. Tracking error? Zero. Skating force? Zero. Stylus overhang? Zero. Horizontal friction? Zero. Vertical friction? Zero.

Simply stated, the new ST-7 provides a way of playing music in the home that obsoletes conventional pivoted arm turntables.

*Diverse and consistent.* The Citation 16 amplifier is a remarkable synthesis of brute force, technological precision and sonic sensitivity: awesome power with flawless performance. When measured by the criteria that *together* most accurately predict musical results—square wave response, slew rate and rise time—Citation 16 is without peer. The excitement we feel at Harman/Kardon these days is in part due to the reaction from audiophiles who have experienced Citation 16.

*Diverse and consistent.* The ST-7 and Citation 16 expand the boundaries of state-of-the-art. The resulting new technology is soon incorporated in other products. The new A401 integrated pre-amplifier and power amplifier does not produce the absolute power levels of Citation 16. But its square wave response, slew rate and rise time reveal its genealogy. We can conceive of no better recommendation for the first time "investor" in high fidelity.

*Diverse and consistent.* As the 430 receiver vies for visual attention on your dealer's shelf, it may seem almost diffident. Don't believe it! For within its graceful contour lies such power as to meet truly demanding dynamic conditions—without compromise of sound quality.

The source of the 430's energy is not the conventional single power supply. It has *two* discretely separate power supplies—one for each channel. Consequently, no matter how much energy is called for by dynamic music passages, performance of one channel is not affected by the other. The features of the amplifier section (twin power, square wave response, phase linearity, instantaneous transient response) and many elements of the tuner and preamplifier sections are inherited from our Citation series of components.

There is simply no comparison between the 430 and other modestly priced receivers. Its performance can be appreciated most by direct comparison with expensive individual components. The 430 demonstrates, upon the very first hearing, that quality need not be sacrificed to achieve the economy of size, convenience and price.

Of course you're looking at new high fidelity instruments. But the attitudes with which they were conceived and built are their very essence. We'd like to tell you much more about them—directly—without circled numbers or coupons. Write to us. We'll respond promptly. Harman/Kardon, 55 Ames Court, Plainview, N.Y. 11803

Harman/Kardon Canada Ltd. Montreal

## harman/kardon





Check No. 18 on Reader Service Card



# THE FIRST! PREAMP BY BGW

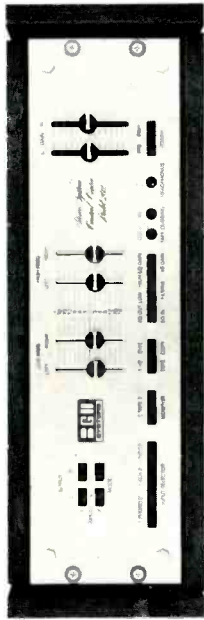

## THE BGW 202 HAS —

- Dual discrete OP amp phono stage for unprecedented accuracy
- Active tone controls using sliding step switches
- Active 18-dB/OCT. High and low pass filters
- Two phono inputs plus accessory socket for moving coil pre-preamp converter
- Separate power amp switching
- Remote AC switching unit accessory available

### Guaranteed specifications:

*Phono stage:* Gain=42-dB,  $\pm$  25-dB of RIAA, S/N=82-dB, THD=.01%.

*Tone controls:* Active baxandall controls add virtually no distortion.  $\pm$ 18-dB at 50-Hz and 15-kHz in 3-dB steps.

*High and low pass filters:* Active 3-pole, 18-dB/OCT. Low frequency at 40-Hz, high frequency at 12-kHz.

*Maximum output voltage:* At line output, 8-volts RMS into 600-ohms (+20-dBm). Phono at tape output, 10-volts RMS into 5-kohms. Rated output, 4-volts RMS into 5-kohms.

*Total harmonic distortion:* Less than .01% at rated output, 20-Hz-20-kHz.

Write for the location of your nearest dealer.



in Canada...

**BGW Systems**  
P.O. Box 3742  
Beverly Hills  
CA 90212  
(213) 973-8090

**Recrion, Limited**  
105 Denison St.  
Markham, Ont.  
(416) 495-0880

Check No. 4 on Reader Service Card

# Tape Guide

Herman Burstein

## Tape Recording Problem

**Q.** *The quality and volume of the sound from tapes I record on my TEAC 6010 are much lower and poorer than the program material, even though the VU meter shows proper deflection. When I play tapes on other machines the sound is OK. What can the trouble be?*—P. Y. Kosol, Winnipeg, Canada.

**A.** Your VU meter may be miscalibrated, causing it to give too high a reading, thus leading you to record at too low a level. Or you may have insufficient bias current feeding to the head, due to a defect in the bias oscillator and the record head, or to a misadjustment of the control which sets the bias current. If your recordings also include excessive high frequencies, you probably have insufficient bias. Another possibility is that there is a defect in the record electronics following the point where the signal is tapped off for the VU meter. This could cause insufficient record signal at the record head.

## Tape Recorder Care and Operation

**Q.** *Where can I get a book telling me how to get the best results from my tape recorder? The instructions which came with my Radio Shack 909 are very brief. I also need to know what is correct routine maintenance.*—A. L. Hall, Portsmouth, N.H.

**A.** Every tape recorder maker I know of produces a service manual for his machines, either available free or for a dollar or two (although service manuals for very new models sometimes are not available for some months after they are first on the market). For books dealing with tape recorder use and maintenance, go to the largest parts distributor near you. If none are within your area, write to: (1) Howard W. Sams & Co., Inc., 4300 West 62nd St., Indianapolis, Ind. 46206, (2) TAB Books, Blue Ridge Summit, PA. 17214, (3) Audio Book Club, 134 N. 13th St., Phila. Pa., 19107. Sams may be best for specific service information on a particular machine.

## Adding Dolby to O-R Tape Deck

**Q.** *I am considering adding a Crown SX824 tape deck to my system. This machine has excellent specifications, but since money is no object I am considering adding the Advent Dolby B unit to it. Will I be helping or hurting the sound otherwise obtainable with the Crown?*—Lee A. Swoboda, Long Beach, California.

**A.** The Advent should not degrade the quality of the recordings you make with the Crown, but it's not likely to improve them audibly at the higher speeds. If you use the Crown at low speeds, there should be some improvement. The rule is, the better the tape machine to begin with and the higher the tape speed, the less improvement Dolby will make.

Cassette machines, running at 1-7/8 ips, and with very narrow tracks, four across a 1/7-in. wide tape (!), get much more help from Dolby noise reduction than do open-reel machines using 1/4-in. tapes, at higher speeds.

## Which Tape to Use?

**Q.** *I own a Sony TC630 machine. I'm getting into some serious recording using Sony FCM-22 mikes. I understand that Sony adjusts bias to its own tapes. Until now I have preferred to use Audiotape. Do you think I should either use Sony tapes, which are more expensive, or readjust the bias to Audiotape?*—Neil Davidson, Stamford, Conn.

**A.** Are you sure that you must have bias adjusted in order to use Audiotape? If bias does indeed have to be changed, consider the following. Unless you have the instruments and technical knowledge, the adjustment must be made by a competent technician. His charge will be between \$15.00 and \$25.00, perhaps more, and this could pay for the price differential of quite a number of reels of tape.

If you have a problem or question on tape recording, write to Mr. Herman Burstein at AUDIO, 401 North Broad Street, Philadelphia, Pa. 19108. All letters are answered. Please enclose a stamped, self-addressed envelope.



# 60% of BOSE Owners Changed Our Mind

While we enjoy talking about the technology that distinguishes the BOSE 901<sup>®</sup>, and about the unprecedented series of rave reviews by leading critics, the purpose of an advertisement is to increase sales by introducing more people to the product.

A surprising result of a customer survey changed our mind as to the most effective use of advertising funds. It revealed that 60% of the people who select the BOSE 901 do so at the recommendation of a 901 owner! This told us that the best advertisement is the product, and the best salesman is the enthusiastic owner.

We concluded that an excellent use of advertising funds would be to help set up an absolutely phenomenal music system in as many owners' homes as possible. Known as the SUPER BOSE SYSTEM, it consists of the 1801<sup>™</sup> power amplifier and two pairs of 901 speakers. One pair of 901s is placed to reflect sound off a front wall, and the second pair reflects off side walls, producing sound with spatial realism and presence that is simply astounding.



Our program in setting up these systems in owners' homes is to provide the **SECOND PAIR OF 901s FREE** to all those serious enough to purchase a component system consisting of the 1801 amplifier and a pair of 901s. We have allocated sufficient advertising funds to cover all purchases made from October 15, 1975 to January 15, 1976.

We believe that the SUPER BOSE SYSTEM is the best music system available today.

And we believe that its owners will be the best BOSE salesmen tomorrow.

One equalizer is required for the Super Bose system, and accordingly the second pair is supplied without equalizer.

This offer is good in continental U.S.A., Alaska and Hawaii only.  
901 cabinet is walnut veneer.

## **BOSE**<sup>®</sup>

The Mountain, Framingham, MA 01701



# Four questions you multiple-play

## 1. Does it perform as well as any single-play turntable?

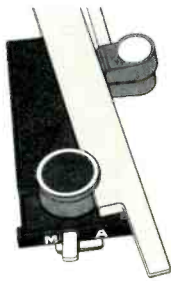

There are some who believe that a single-play turntable is somehow inherently better than a multiple-play unit. All right—the Z2000B *is* a single-play turntable. Its capacity to function as a multiple-play unit offers convenience with no compromise of performance. The *automatic* mechanism which gently indexes the arm, lifts it at the end of play, returns it to the arm rest and shuts off the motor—is completely disengaged during record play. A 2-position control sets the proper vertical tracking angle for single or multiple play. The Z2000B can truly be called the automated, single-play turntable with multiple-play capability.

## 2. Does it have belt-drive and variable speed?

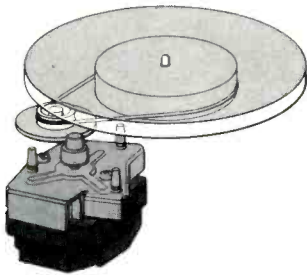

Garrard engineers have attained remarkable results by combining the world famous Synchro-Lab motor and an inventive belt/idler drive combination. A 5 lb., die-cast, dynamically balanced platter is rotated via a flexible belt. Not only are the tiniest fluctuations of speed smoothed out, but an extraordinary -64dB rumble is only one example of the impressive specifications achieved. A variable speed control corrects out-of-pitch recordings and an illuminated stroboscope provides optical confirmation. The Z2000B combines all of these elements to achieve the main goal of Garrard engineering: superior performance at reasonable cost.

## 3. Does it handle records gently?

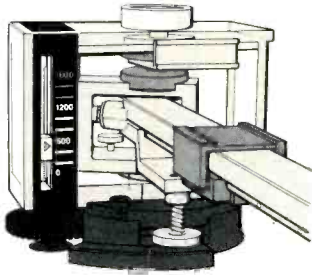

All responsible turntable manufacturers are concerned with protecting your records. With Garrard, it's an obsession. The Z2000B boasts an array of features designed solely to prolong the life of your records. In addition to the exclusive, articulated tonearm, it incorporates an exceptionally accurate magnetic anti-skating device. Cueing is viscous damped in *both* directions. The ingenious built-in automatic record counter keeps track of how many LP sides the stylus has played. And unlike some of the highest priced changers that support records only at the center hole, the Z2000B supports them at the hole *and* edge, and the release mechanism operates at *both* points. Protection for your records indeed!

## 4. Does it eliminate tracking error?

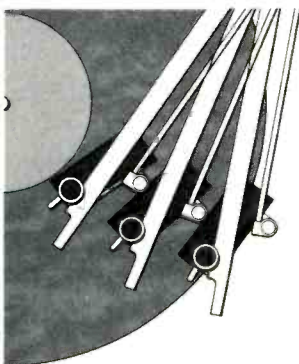

The grooves of a record are cut by a stylus that travels in a straight line. Conventional playback tonearms move in an arc. The difference between these two paths is called "tracking error." Simply stated, tracking error launches a cycle of distortion and record wear. In good design, the error is averaged over the record so that distortion is minimal. But such compromise was unacceptable in the Z2000B. What Garrard engineers did about it was summed up by High Fidelity Magazine which described the Zero Tracking Error Tonearm as "... the best arm yet offered as an integral part of an automatic player." The Z2000B is the *only* automatic turntable in the world without tracking error.

For your free copy of the New Garrard Guide, write to Garrard, Division of Plessey Consumer Products, Dept A, Plainview, New York 11803.

Check No. 16 on Reader Service Card



# must ask about any turntable.



## The Garrard Z2000B. Yes. Yes. Yes. Yes.



\$229.95

**Garrard**  
The Automatic Choice



# Behind The Scenes

Bert Whyte

SEE BY my calendar that December has arrived for its appointed round, and the end of the year is nigh, and it is time for the rotund little chap in the red suit and "Ho, Ho, Ho" and all that jazz.

How did the hi-fi industry fare in 1975? It certainly wasn't "the best of all years," but it was a great deal better than most people expected. That the industry weathered this recession year as well as it has is continuing proof of its basic strength. Yet there were warning flags flying in 1975, and the industry will jeopardize this strength if these signals are ignored.

In 1974, the FTC ruling on power amplifier rating, with its controversial "burn-in" provision, became law. That it caused consternation within the hi-fi industry is to put it mildly. Audio engineers *en masse*, led by colleague Len Feldman, Chairman of the IHF technical committee, denounced the "burn-in" period as "harmful" and not "relevant to the normal mode of amplifier usage in the home." In spite of documenting to the FTC that compliance to the "conditioning" provision would in most cases require technical modifications to the amplifiers that would ultimately mean higher costs to the consumer, the FTC has barely budged from its position. It appears the FTC knows that they made a bad ruling and in fact have been looking for a way to retreat from their position without causing themselves too much embarrassment. What we must remember is that part of their intransigence is due to the fact that they consider that they gave ample time for the hi-fi industry to study the power amplifier ruling and suggest possible changes or amendments. It must be admitted that by and large the industry ignored this matter, and when they finally did become aware of the perils of this ruling, it was already too late.

The latest word is—and this is only at the "opinion" level, not the full "promulgated ruling" level—is that the FTC will allow an amp's thermal

cutout to operate during the pre-conditioning until the required one-hour burn-in time has been accumulated.

I have a feeling that the power amplifier ruling of the FTC is just the tip of the iceberg. Government agencies are always trying to perpetuate themselves and justify their existence. Inevitably, other aspects of the advertising and promotional activities of the hi-fi industry will come under FTC scrutiny. Now please don't misunderstand me... I'm not saying the hi-fi industry has anything to hide or is in any way engaged in any chicanerous practices. In fact, as I have said many times before, the industry is virtually unique as one of the last bastions of the "good value for the money" philosophy. Nonetheless, it is conceivable that the wording and even the validity of product specifications and performance parameters might be questioned. Let us not delude ourselves that manufacturers do not interpret specifications to their competitive advantage in their advertising. This is, of course, entirely due to a lack of hi-fi industry standards for the various aspects of product performance. One cannot blame the manufacturer for taking the "leeway" this affords in quoting specifications.

For some time now, there has been a groundswell of opinion in favor of the establishment of performance standards for all audio equipment. In view of the unfortunate experience with the FTC power amplifier ruling, the industry should act now to establish these standards. The IHF could be the regulatory body for such standards and, as noted previously, has already in existence a technical committee which could initiate this program. It is realized that there are many types of audio components, with many different performance parameters and formulating standards for them will be technically difficult and a most arduous task. However the need is obvious, and the time for action is now, if further brouhahas with the FTC are to be avoided.

Writing in the September, 1975 edition of *Radio-Electronics*, Len Feldman points out some of the "inconsistencies" in the quoting of signal-to-noise ratio figures for phono pre-amps and turntables. For example, if a phono pre-amp stage has a true input sensitivity of 2 millivolts at 1 kHz with the usual test procedure, the S/N ratio may turn out to be -55 dB, and be accurately quoted as "-55 dB below 2 mV." However, for some years now, in this country and abroad there seems to be a "tacit agreement or acceptance" among manufacturers to the use of a "reference" phono input sensitivity of 10 mV. Thus, while the manufacturer states the true input sensitivity (i.e. 2 mV), they quote the S/N ratio at the "reference" input of 10 mV, which magically improves the S/N ratio by 14 dB and enables them to state the specification as "-69 dB below 10 mV." While this may seem a deplorable practice, most of the manufacturers do it in self-defense, much in the same fashion of using the term "rms" in rating power amplifiers, in which the use of rms is not really relevant. Len also relates a similar situation in the manufacturers specifications for the rumble content of turntables. There are four different methods of measuring rumble... the NAB, CBS/ARLL, and the German DIN A (unweighted), and DIN B (weighted). (And don't forget the CCIR standard, Bert.—Ed.) In all of these methods, the turnover frequencies are different, the rate of attenuation for the filters is different, and they do not employ the same "reference" frequency or amplitude in establishing the "0 dB" point, below which the rumble is measured. Thus, depending on the actual distribution and amplitude of the rumble frequencies in a turntable, the manufacturer can choose from among the four methods, that which gives the highest "number" and therefore the most favorable rumble specification.

Another provocative and informative article on the use and abuse of test procedures and the interpretation

# TWICE AGAIN, HISTORY REPEATS ITSELF.

Carrying on the innovative tradition of our almost  
ninety year involvement in music,  
Yamaha announces a double breakthrough in all-FET technology.

## Yamaha's C-1.

At \$1800, you've never seen a preamplifier like this before.

It's so different we call it the Master Control Center. You'll call it well worth waiting for.

From input to output, it's the first to use advanced FET's exclusively throughout the signal path.

Yamaha's C-1 is made for perfectionists who appreciate the superb clear tonality and exceedingly low distortion that only FET's can bring.

For advanced audiophiles who want the complete control over literally thousands of audio variables that only the most advanced circuits and features can offer.

### A built-in oscillator.

Consider the C-1's unique built-in oscillator with level control, a professional test instrument that's usually found only in sophisticated audio labs.

By generating both random "pink" noise as well as the four most useful test tones (70 Hz, 333 Hz, 1 kHz and 10 kHz), the C-1's oscillator can be put to a variety of tasks:

Determining the precise phono impedance loading, checking the frequency response of speakers, A-B speaker comparisons, setting up a tape deck, balancing the output level of an entire system, and balancing room acoustics. You'll discover more and more uses as you go along.

(A word of caution: because the C-1's oscillator can be used externally, all your audiophile friends will want to use it to test their own components.)

Where most other manufacturers use a negative feedback design in their phono equalizer amplifiers, Yamaha specified the more sophisticated passive interstage equalizer (CR-type). The results were worth it:

Greater stability, lower distortion, superior tonality.

In our all-out effort to reduce noise at all preamp output levels (not just at

maximum output), the C-1 features a unique four-gang volume control that simultaneously adjusts inputs and outputs.

### You're totally in control.

With the C-1's selectable equalization controls for presence and acoustic balance, you enjoy the equivalent of a separate equalizer. For those occasions when you don't want to use equalization controls, the C-1's special circuitry lets you bypass them completely.

Another unique feature that sets the Yamaha C-1 Master Control Center apart from other so-called state-of-the-art preamplifiers:

Six-position selectable phono impedance that allows your cartridge to be precisely loaded for optimum high frequency performance.

The Yamaha C-1's absolute control over sound also includes a pair of extra wide-range (-50 db to +6 db) peak reading meters. Electronic damping provides both faster peak readings and slower decay, assuring precise monitoring. You can also use the C-1's meters to monitor any external component that doesn't have meters.

Writing in *Audio* about our unique metering system, Bascom H. King stated:

"...by far the most accurate and meaningful of any meter set-up seen thus far"

Individual level controls let you balance the input from all signal sources, except the tuner. (Yamaha's companion tuner, the CT-7000, has its own variable output level adjustment.) So the volume level stays the same when you switch, for example, from tape to phono, tuner to aux, etc.

And there's more.

Enough that once you hear the Yamaha C-1, you'll never be satisfied with another preamplifier again.

## Yamaha's B-1.

At \$1600, it's already redefined state-of-the-art amplifier performance in a lot of people's minds. Yours might be next.

Revolutionary Vertical-FET design produces a completely different kind of sound. Clean, open and transparent. With a richness that goes beyond the best vacuum tube amplifiers.

And, up to now, unavailable.

### Worth the wait.

As late as a few years ago, there existed only two types of transistors: bipolar and horizontal FET. Each operated in a completely different manner.

The bipolar device uses input current to control output current. On the other hand, the horizontal FET uses input voltage to control output current—a more suitable audio technique that's quite similar to vacuum triode tube design. (Both use input voltage to control output current; both have sharp cut-off characteristics which eliminate high-order harmonics and notch distortion.)

Only there was a small problem.

Because current passage was restricted to a single path, the horizontal FET didn't produce enough power to be used in the output stages of a power amplifier.

Then, in 1971, Prof. Nishizawa of Tohoku University drastically changed the FET's internal structure. The shape of the voltage-controlled constriction was altered to let the current take an almost infinite number of paths.

And so, the Vertical-FET was born.

During the past three years, working exclusively with Prof. Nishizawa, Yamaha's engineers have brought the Vertical-FET to the forefront of audio technology, where it serves as both driving and output devices in our new B-1 amplifier.

The B-1's rated 150 watts per chan-

nel (20 Hz to 20 kHz, less than 0.1% THD) are produced by only two Vertical-FET output devices per channel.

Compare that with the minimum of six to eight output devices per channel found on most other amps!

Yamaha knows that fewer output devices minimize the distortion caused by out-of-balance power output devices during transistor switching cycles. And maximize tonality.

### People are talking.

Here's what Julian Hirsch of *Stereo Review* had to say about the power-handling capacity of Yamaha's new Vertical-FET:

"Each of the FET's is about the size of an ordinary power transistor, but it can dissipate 300 watts!"

*Audio's* Bascom H. King observed that the B-1's power output at visual onset of clipping for an 8-ohm load was 220 watts—46% over spec!

So you can see that our 8-ohm rating of 150 watts is quite conservative indeed!

Because the B-1 is used as a reference amp by many of our dealers, we supply an optional control unit that can A-B up to five pairs of speakers and balance them for efficiency at the head amp. Without the insertion of T-pads that degrade low-end response by decreasing damping characteristics.

It's called the UC-1. It costs \$250. And you don't have to be a Yamaha audio dealer to own one.

Besides speaker switching, the UC-1's extra wide-range peak delay meters, with faster peak and slower decay like those on the C-1 (but calibrated in both dB's and watts of power output), offer an extremely precise monitoring capability to your system.

Yamaha's C-1 and B-1. \$3650 the pair, with the UC-1 control unit.

After you hear them together, you'll never be satisfied with anything less.



International Corp., P.O. Box 6600, Buena Park, Calif. 90620

Check No. 53 on Reader Service Card



# The CROWN VFX-2

## electronic crossover

Commercial sound contractors across America have been asking for an electronic crossover for use on sophisticated sound installations. There's no more waiting. And the Crown VFX-2 embodies all you expect in high quality and performance capabilities from the people at Crown.

Only the Crown VFX-2 electronic crossover will give every installation **maximum** versatility. Such **flexibility** for so little cost. And never before has an electronic crossover been offered that can be easily and readily adjusted with front panel controls.

Tunable from 20- to 20,000 Hz, this solid state component is compatible with 600 ohms loads and up, and features both balanced and unbalanced inputs and outputs.

Overall noise and distortion are extremely low. IM distortion is less than 0.01% at rated output, and noise is more than 97dB below rated output with open inputs.

Providing either crossover or bandpass functions, the VFX-2 utilizes two continuously variable filters per channel, and filter roll-off is at a fixed 18 dB/octave.

Applications include stereo bi-amping, mono tri-amping, and combining the bandpass filter with the normal two-way crossover on a mono signal. And all connections are quarter-inch phone jacks for positive electrical contact.

The VFX-2 is designed for standard 19" rack mounting and measures in at 3 1/2" high by 5 3/4" deep and includes a clear plastic cover for protecting control settings.



Write for complete specifications.

  
**crown**

BOX 1000 • ELKHART, IN. 46514 • 219/294-5571

Check No. 6 on Reader Service Card

of manufacturers specifications appears under the title of "The Specification Says . . ." by Hugh Ford, writing in the September, 1975 issue of that most estimable British journal, *Studio Sound*. Mr. Ford examines in depth, measurement techniques for frequency response, S/N ratio, input and output sensitivities, total harmonic distortion, and intermodulation distortion, as applied to various audio equipment and warns us about interpretive pitfalls. Speaking of *Studio Sound*, if you are into professional audio or if you are a very advanced audiophile, this is a "must" publication providing comprehensive coverage on audio subjects simply not available elsewhere. Recent issues on quadraphonic sound and ambisonic recording were real gems. If you want to subscribe to *Studio Sound*, which is published monthly, it will cost you the dollar equivalent of 4 pounds, 20 pence; write to the magazine at Link House, Dingwall Avenue, Croydon CR9 2TA, England.

The authors of the aforementioned articles have given us very cogent arguments on the need for the establishment of internationally accepted standards of audio measurement and performance. Needless to say, this has been true for many years . . . let us hope that we will have an end to procrastination and assorted excuses, the "backing and filling," and finally get some action.

As mentioned at the beginning of this article, it seems that Christmas is upon us. Although I may be stretching the term a little, herewith some "super stocking stuffers" that should gladden the Christmas spirits of any audiophile. . . .

With the winter months ahead of us, the heat will be turned on in homes and apartments (Allah willing) and the humidity will drop, and all that dry air will bedevil our vinyl records with static. The use of a humidifier helps some (supposed to be better for your health, too) but I have been testing a Jim Dandy gadget that positively eliminates the static charge on your precious discs. It is called a Zerostat, and looks at first glance to be similar to a white plastic toy water pistol, with a large, elongated metal trigger. The action is quite mysterious, and the construction of the unit does not encourage explorations into its innards. However, as far as I can determine, it seems to be some sort of "strain gauge" affair. In any case, it takes a fair amount of pressure to squeeze the trigger. The instructions

state that you must exert a slow constant pressure on the trigger. If you are too fast you will hear a "click" and the desired reaction will not happen. What is happening is that when you fully depress the trigger in the proper manner, a stream of positive ions is flowing from the tip of the gun. By then releasing the trigger in the same slow controlled motion, negative ions are produced. To test the Zerostat, I briskly rubbed a record with a dry cloth, and created enough static that when I passed the disc just above my arm, the hair on my arm was attracted to it. Then, holding the Zerostat about 4 in. above the center of the record (as per instructions), I went through the squeezing operation. When I passed the now "treated" disc over my arm, I could neither observe nor feel any attraction . . . the static charge had been completely removed. The Zerostat is a British product and is imported by the Discwasher Company. It retails for \$29.95. In my view, when you use Dr. Bruce Meier's Discwasher system, which really does a superlative job of cleaning a record, followed by a treatment with the Zerostat, your record will be in pristine condition.

For those fortunate audiophiles who own professional tape machines, they will appreciate the AKG K-140 headphones, whose 600-ohm impedance allows you to hear a signal at a good level from the headphone jacks of the tape machine amplifier. Add an ingenious headband that easily adjusts to different shaped "nogginns," a light weight of 6 oz., and an extremely smooth and extended frequency response, all for around \$34.00, and you have a worthwhile gift. There are other phones in the 600-ohm category, but I happen to like the combination of features on the K-140.

Another stocking stuffer that would be a welcome gift for the tape recording enthusiast is a professional quality alignment tape, such as those made by Magnetic Reference Laboratory, on which I reported some months ago. Price, around \$30.00.

Lastly, the well-known CBS Labs Technical series test records have recently been updated and remastered. There are nine of them covering such areas as square wave, tracking and intermodulation tests, wide range pickup test, RIAA pink noise acoustical test, RIAA frequency response, stereo frequency test, etc. For the serious audiophile, they are an inexpensive, but most thoughtful gift. See the ad elsewhere in this issue for details on how to order.

# Introducing A new family of loudspeakers from Acoustic Research

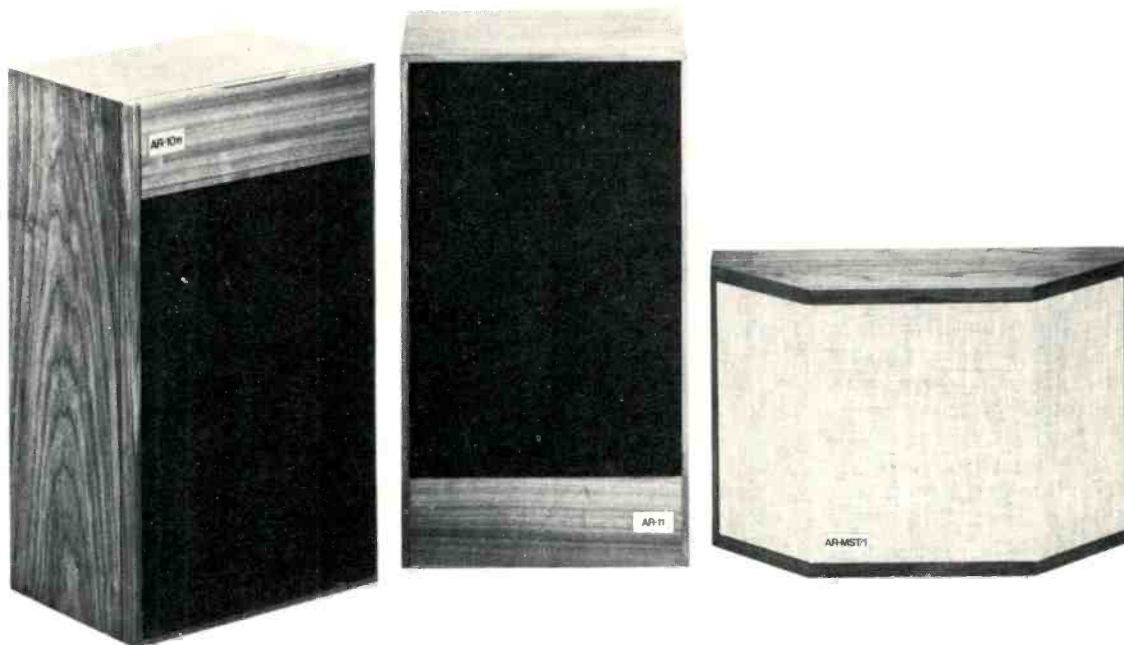

### AR-10π

The AR-10π is the most accurate musical reproducer that Acoustic Research has ever made. It shares the characteristics of AR's previous speaker systems, smoothness of response, uniform dispersion, and low distortion. A significant additional feature of the AR-10π is its ability to deliver uniform flat energy response in most listening rooms.

Further, the designed-in performance of the AR-10π is preserved, whether the speaker is positioned against a wall, in a corner, or even in the middle of a room. Setting a single switch, called the 'Woofer Environmental Control', will ensure the correct level of bass energy for any of these positions. It is not possible to do this accurately with conventional loudspeaker designs or equalization techniques.

### AR-11

The performance, drivers, and crossover of the AR-11 are identical to those of the AR-10π, except that the AR-11 does not incorporate a Woofer Environmental Control and the associated crossover components.

The AR-11 is designed for optimum performance when placed against a wall, as in the conventional bookshelf position, or slightly away from two adjoining room surfaces.

Both the AR-10π and the AR-11 use a 12 inch acoustic suspension woofer, a 1½ inch dome midrange, and a newly designed ¾ inch dome highrange.

### AR-MST/1

The AR Miniature Studio Transducer offers at moderate cost the flat energy response of AR's other new speaker systems, together with the high power-handling capability required in many professional applications. Along with the AR-MST/1's small size, light weight, and shallow depth, these characteristics make the speaker especially appropriate for the monitoring of remote-location recordings as well as the accurate reproduction of music in the home, even at relatively high sound levels.

### Guarantee

The workmanship and performance of all AR speaker systems are guaranteed for five years.

A complete description of the new family of AR speakers is available free. Mail us the coupon today.

### Acoustic Research

10 American Drive  
Norwood  
Massachusetts 02062  
Telephone 617 769 4200



Please send me a complete description of the AR-10π, AR-11, and AR-MST/1 speaker systems.

Please send me the AR demonstration record 'The Sound of Musical Instruments' (check for \$5 enclosed)

Name \_\_\_\_\_

Address \_\_\_\_\_

AU12



# Audio ETC

Edward Tatnall Canby

**A**T FIRST glance, it might have been no more than a technical shift in merchandizing, that casual announcement a few months ago from EMI, Electrical & Musical Industries of England. Far from it! Profound implications for quadrasonic. A major record company on the move. And look! There's light at the end of the tunnel.

Interesting that it should come from EMI, the sobersided giant of British conservatism, the same outfit that took a leisurely five years or so to make up its mind about the LP record after 1948. Inertia! Big companies have it. They can afford it. But also—momentum, once they get going. Being conservative in England, after all, generally means being absolutely unflappable. That's EMI. EMI's momentum can shake the record world. The new EMI decision: no more quadrasonic records.

Don't jump. —That is, no separate quadrasonic records sold parallel to stereo in a dual inventory. Instead, once again we have a single basic EMI classical disc, and history is timelessly reversed, back to where we were before we had ever heard of four channels. And as things were before we had stereo. And as they were before the LP. Each of these technical innovations brought with it, for awhile, an uncomfortable dual inventory, two types of disc and a sort of workable compatibility, more or less. But within years, in each case, the industry returned to the traditional single release—just as soon as conditions permitted. So it is happening again. How very much in the old tradition, then, is EMI's present move! Positively classical. Here's how it works.

EMI's classical discs (the pop field

evidently is left open) will no longer carry any special quadrasonic label or number or price. However, almost all classical releases—across the board, the whole production—will bear a new standard designation, "stereo/quadrasonic." Every one of those records will be encoded for SQ quadrasonic and there will be no stereo equivalent at all. Does that, in a casual British way, go far beyond Columbia itself, the SQ mother hen! Rather. Quite breathtaking.

Depending on circumstance, some EMI releases will be marked "stereo." No encoding. Solo instruments and the like, where it is felt to be unnecessary. No implications of better or worse, just a matter of aesthetic judgment. All the EMI classics are in there together now, whether they happen to be stereo or quadrasonic. *Single inventory.* That is the key phrase. The quadrasonic aspect, you see, is both played up and played down. On the one hand it is now taken for granted, as though there were no further argument, and is routinely applied to the entire production—that plays it up, all right. On the other hand, quadrasonic is pointedly integrated into the larger aspects of record production, just another useful tool among many that bring us good music and hi fi on discs. That correctly plays it down.

So infinitely reasonable! I'll bet the mother hen is in a flap, over here. We've had no such clear thinking (and action) from anybody on this side of the water, either from SQ or CD-4. In fact, for all our quadrasonic trumpetings hereabouts, we are still floundering all over the place, or sitting on uncomfortable fences with sharp points that keep getting sharp-

er. An agony of noisy indecision and dangerous for all concerned. Imperturbable EMI! Cooler heads over there. EMI has stepped right in where, er, Angel fears to tread. Not to mention Columbia and RCA.

Curious, for instance that, though the EMI story appeared in the trade papers, CBS itself flashed out the news in an "SQ Newsletter" to dealers and hi-fi writers. Curious that in that letter there wasn't a word about CBS's own thoughts and intentions—and would we all like to know them. Curiouser still that the word "Columbia" did not appear. The Newsletter came from the CBS Records Division. From which segment of CBS, in all its complexity, did we actually receive this interesting communication? And where was Columbia Records, the old mother hen herself? Odd. Could we read a veiled mini-hint here of some internal distress within the CBS empire? Could be. Because, as you know, from the very beginning of SQ the Columbia policy has been precisely the opposite of that now promulgated from EMI. A dual inventory, separate stereo and quadrasonic releases, side by side at a dollar's difference, the SQ product conspicuously promoted as deluxe, even to those gaudy gold labels.

Could it even be, I thought to myself, that the big British SQ tail was beginning to wag at least a part of the U.S. (Columbia) dog? (*Here now, enough of those mixed metaphors, Canby. What would Nipper think? —Editor.*) Hmmmm. An interesting thought. EMI is plenty big enough. EMI is by far the largest of Columbia's SQ licensees and worth a hundred of the others. *Something* must be going on there back behind the scenes.

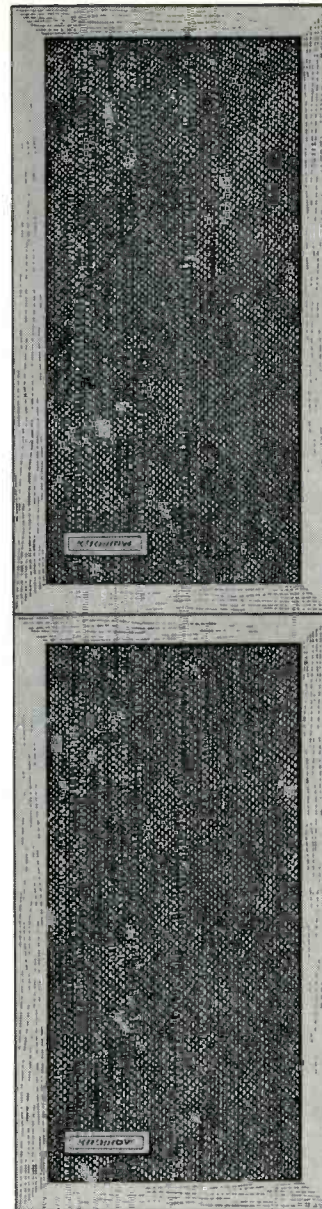
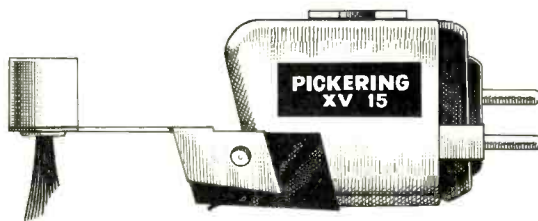
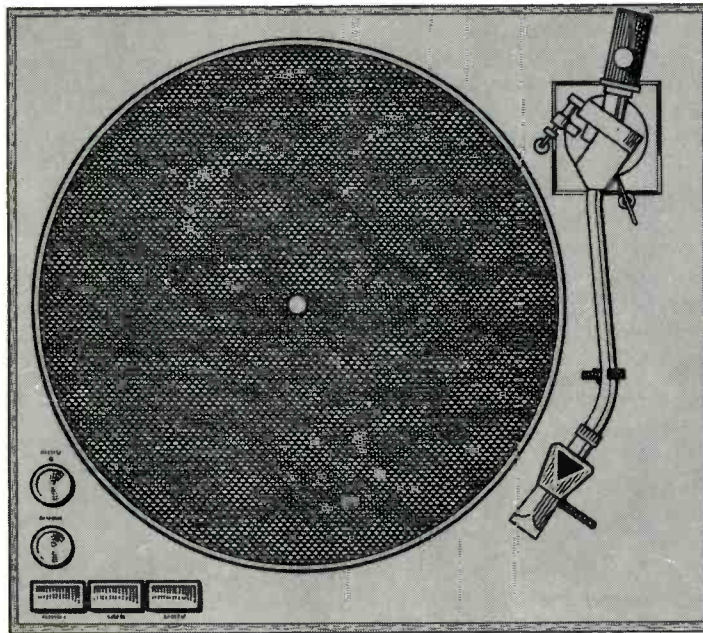
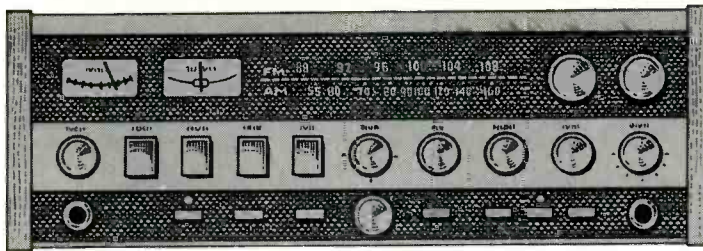

## Discover The Fourth Component!

**You have a receiver. You have a turntable. You have your speakers. You think you have it made.**

Well, think again. Think about the cartridge, because your pick-up can make or break the performance of your audio system. It's the part too many stereo beginners forget. That important fourth part where the music begins.

You may not realize it, but your cartridge and its stylus has first contact with the music in the grooves of your records. But it doesn't just plod along round and round producing all that sound. It's actually vibrating along the sides of the grooves in an incredibly complex dance that represents all the music on the record. And all too quickly for your eye to see, but not for your ear to hear. Because if your cartridge is faulty, no amount of expensive equipment... speakers, turntable or receiver... will make up for the distortion it can produce.

That's why you need a cartridge you can depend on. One that's the best your money can buy. Specifically, a Pickering:

**Because** a Pickering cartridge has the superior ability to "move in the groove" ... from side to side and up and down without shattering the sound of your music ... on your records.

**Because** a Pickering cartridge possesses low frequency tracking ability and high frequency tracing ability (which Pickering calls *traceAbility*™). It picks up the highest highs and the lowest lows of musical tones to reveal the distinctive quality of each instrument.

**Because** only a Pickering cartridge can be individually and easily suited to your music system. Each is rated with a Dynamic Coupling Factor which tells the dealer immediately what kind of turntable or separate arm the pick-up needs whether your system is stereo or discrete quad.

Your stereo cartridge. It's the fourth part of your music system that's too important to forget. And so is a Pickering.

For further information see reader service card or write to Pickering & Co., Inc.  
Dept A, 101 Sunnyside Blvd.  
Plainview, N. Y. 11803



Check No. 33 on Reader Service Card



With that SQ Newsletter there was enclosed a Columbia ad offprint showing a model who is buying up dual-inventory SQ discs, conspicuously marked quadrasonic. Was this sent along just to contradict EMI? I wouldn't know.

### Compatibility

In all the quadrasonic camps since the beginning of four-channel disc the loudest tune has been COMPATIBILITY. Every quadrasonic disc always plays on any sort of equipment. True, true. But oversimplified. Trouble is, the sales people have found themselves somewhat limited as to what they can say on this subject. Limited to superlatives. The fact is that total compatibility is a very rare bird, unless, let's say, you mean one stereo

cally enough, the separate stereo record which, at least in theory, sounds better as stereo than the quadrasonic disc, even though both will produce stereo on stereo equipment—compatibility. That's the argument. And it can get to seem very important to the engineers and producers involved.

Yet, as EMI understands, time is on the side of the quadrasonic engineer. If quadrasonic remains viable, then the emphasis is bound to shift. A stereo disc with quadrasonic encoding becomes, slowly but surely, a quadrasonic disc that will play as stereo. Stereo mixdown becomes the secondary factor, as mono once did when stereo took over. Moreover, "compromise" recording techniques, for both types at once, most certainly

"compatible." It could rescue all of them from collective extinction. It seems to be that the question of single versus dual inventory is now far more vital than the whole time honored argument as to which system is best. All systems are threatened! This we have got to understand.

So if quadrasonic's time has come, it must either die or cease being a hepped-up special-order extra at extra cost. At all costs, in order to live, it must somehow blend itself into the great existing body of the art of recording, just as every other technical innovation in records always has. There, it seems to me, is the EMI message. Back to normalcy.

And so we are shaken. One of the Big Companies has moved. If the other world record companies (including our own) will now please get right on this bandwagon, in whatever fashion they may choose (and via their own chosen euphemisms and slogans), if all will universally adopt the basic idea of one classical inventory and no duplication—then, I think, we will have reason to hope that quadrasonic on disc will survive and grow. Without disc, you understand, there will be no quadrasonic.

I know—the pop field is bigger. But pop is also more flexible, as well as more demanding, and requires more leeway. If the classical disc is firmly established in the single inventory pattern, one disc per release, whatever type it may be, then pop music and all the rest will find an easy relationship within the same framework. After all, EMI isn't exactly an all-classic company. EMI recorded the Beatles, don't you remember. They still own a few little properties of that sort. They have pop plans too. But first—get classical on the rails. Done.

The beauty of the single classical release is that it takes you off the hook, gives you flexibility. Cheaper, and so much easier to merchandize! Once again you sell records, period. You promote the most important thing you have to sell, the artistic product. Throw in as much or as little quadrasonic as you want, or none at all, without shaking any foundations. And are your dealers happy! Not to mention the customers. The whole systems is fluid again, things move, sales tracks are re-greased, there's confidence (no more of that painful confusion of choice), the aisles are clear (more room), the cash registers noisier. So much simpler, the whole deal. And the pay-off: merely a *workable* compromise in the sound, and not a bad one at all. I'm for it.

---

### *Single inventory is the way out. It can be applied to any compatible system.*

---

disc and its twin, hot from the press. "Compatible," as everyone knows who plays discs and tapes, means a technical *marriage de convenance*, a convenient marriage (with divorce more or less taken for granted)—we can get along together as long as we have to. A working arrangement, for the time being, and don't tell me otherwise. So we have assorted compatible quadrasonic discs, but there's nothing permanent about the relationship. Indeed, compatibility has an important silver lining—it is dynamic, it changes as the scene changes. The emphasis is shiftable, right across from one side to the other as necessity requires. That applies to stereo/quadrasonic compatibility.

It is true, then, that EMI's new combined stereo and quadrasonic disc involves a give and take, call it a compromise, between the ideal stereo sound and the ideal quadrasonic. They aren't the same, and it is here that Columbia, I think, gets very hot under the collar at the thought of a single inventory. Columbia has developed an experienced and dedicated SQ team over the years; it keeps its quadrasonic operations remarkably apart from stereo, right down the line from master tapes through separate mixdown and pressing (and often in the recording, where it all begins). This is a valid idea and can be applied to any quadrasonic production, as opposed to stereo. So we have, logi-

will develop—EMI has already satisfied itself on this score. So the quadrasonic boys will come back into their own. Seems to me, this is a worthwhile compromise to make, *if it will keep the quadrasonic art alive.*

"If" is the word! Can the four-channel disc, any type, survive at all as things now stand? I am beginning to doubt it. So does EMI.

We have worked ourselves into such an unyielding impasse over quadrasonic that the corporate batteries are running dangerously low. If the big fellows pull out, we are in deathly trouble. There is an explosively exact limit to big-corporation patience in such impasses, as we know all too well. The major record producers are but the slaves of bigger entities whose bosses are not interested in aesthetics that do not pay. The danger limit has now been reached. It is an emergency. No question about it. Something has to be done very soon, or else. EMI has done it already.

The proposition is, can we swallow a mild loss of technical flexibility, can we endure a major upheaval in production and distribution, in order to avoid a tragically greater loss—the whole shebang? It has come to that. Not for SQ alone but for all quadrasonic disc production—the whole bit. The EMI single inventory is the way out. It can be applied to any system, to all present systems that are

Our warranty records show that on average only one Revox buyer in six has never had a tape recorder before.

The remaining five have all owned one or more makes previously. Since our warranty application invites comment, we are frequently told how happy our customers are with their Revox, especially when they compare it with their previous purchases.

But too often we hear the lament:

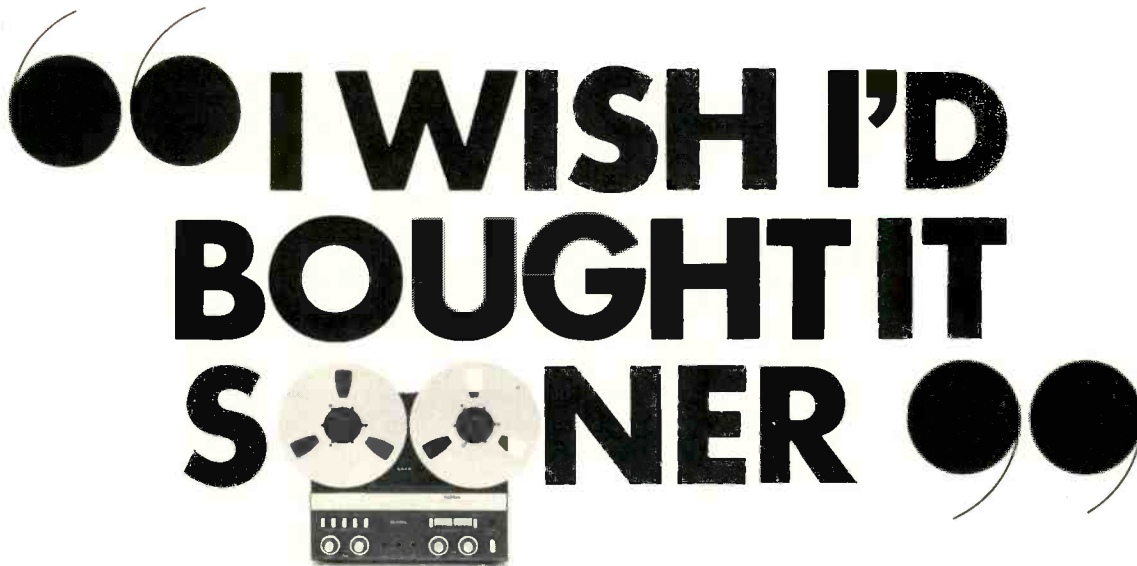

**The incomparable  
Revox A77  
priced from \$899**

Save yourself the cost of experimentation in tape recording. Select a recorder that will neither add nor detract from the original.

Choose the A77 - and if your finances don't quite run to a new machine, try to find one second hand - in standard condition it will out perform other makes of new equipment at the same price.

# REVOX

Buy it first - it's built to last

**Revox Corporation**  
155 Michael Drive  
Syosset  
N.Y. 11791  
U.S.A.

**Revox International**  
Regensdorf 8105 ZH  
Althardstrasse 146  
Switzerland

**Revox**  
C. E. Hammond Co. Ltd.  
Lamb House  
Church Street  
Chiswick  
London W4 2PB  
England

Please tell me where I can see and buy

Name

Address

Revox  A77

Revox  Good used machines\*

Illustration may contain optional extras.

\*As and when available from our dealers

BIW



# MAGNEPLANAR® loudspeakers are . . .

extremely realistic sounding --  
and they've only 1" thick. Hear  
the Magnepan MG-11, exclu-  
sively at the following Magne-  
pan dealers:

## EAST

Audio Breakthroughs/Manhasset, NY  
Audio Etc./Gainesville, FL  
J. Brookshire Music Machine/Anderson, SC  
Bryn Mawr Stereo/Bryn Mawr, PA  
Creative Audio/Colonia, NY  
DKL Laboratories/Silver Spring, MD  
D.S. Audio/Wyomissing, PA  
Electronic Workshop/New York  
Hi-Fidelity Center/Charleston & Huntington, WV  
Paul Heath Audio/Rochester, NY  
House of Sound & Sight/W. Palm Beach, FL  
Fred Locke Stereo/CT & Springfield, MA  
Lyric Hi-Fi/New York & White Plains, NY  
Music & Sound Ltd./Willow Grove, PA  
Music Center Hi-Fi/Charlottesville, VA  
Music Systems, Inc./Charlotte, NC  
Myer Emco/Falls Church, VA & Wash. D.C.  
Myriad Sound/Garrison, MD  
Sight & Sound Ltd./Bel Air, MD  
Sound Components/Coral Gables, FL  
Sound Experience/Huntington & Stony Brook, NY  
The Sound Shop/Norfolk, VA  
Sound & Sight/Boca Raton, FL  
Sound Room/Plattsburgh, NY  
Stereo Emporium/Bufalo, NY  
Stereo World/Ft. Myers, FL  
Taylor House/Iron Station, NC  
Vickers Audio/Chapel Hill, NC

## CENTRAL

Absolute Sound/Detroit, MI  
Audio Concepts/Houston, TX  
Audio Electronics/Prairie Village, KS  
Audio Labs/Des Moines, IA  
Audio Systems & Design/Omaha & Lincoln, NB  
Audio Specialities/Baton Rouge, LA  
Carlin Audio/Dayton, OH  
Equinox Systems/Grandville, MI  
Gill Custom House/Palos Hills, IL  
The Gramophone Ltd./Norman, OK  
Hi-Fi Audio/Cincinnati, OH  
Hi-Fi Buys/E. Lansing & Ann Arbor, MI  
Hi-Fi Gallery/Indianapolis & Evansville, IN  
Hillcrest High Fidelity/Dallas, TX  
Hoffman's House of Stereo/Brookpark & Wickliffe, OH  
I/O Systems/Chicago, IL  
Jensen's Stereo/Burnsville, MN  
Opus II/Memphis, TN  
Sound Environment/Mpls., MN  
Sound Shoppe/Green Bay, WI  
Stereo Shop/Cedar Rapids, IA  
Stereo Studio/Terre Haute, IN  
Swallen's Audio/Columbus, OH  
Victor's Stereo/Chicago, IL  
J. Westplahl Audio Consult./Rockton, IL

## WEST

Audio Arts/Livermore, CA  
Boulder Sound Gallery/Boulder, CO  
Coffee, Tea or Stereo/Salem, OR  
Definitive Audio/Seattle, WA  
Garland Audio/San Jose, CA  
Hawthorne Stereo/Beaverton & Portland, OR  
Hi-Fi Matic/Culver City, CA  
Interior Systems/Las Vegas, NV  
Listen-Up/Denver, CO  
Magnolia Hi-Fi/Seattle, WA  
Jonas Miller Stereo/Beverly Hills, CA  
Music & Sound of Calif./Woodland Hills, CA  
Quad Corner/Bellingham, WA  
Sound Company/San Diego, CA  
Stereo Hi-Fi Center/Gardena & Torrance, CA  
Stereo Showcase/Vallejo & Sacramento, CA  
Stereo Workshop/Berkeley, CA  
Tin Ear/Richland, WA  
Toad Hall/Corvallis & Eugene, OR

## CANADA

Bay Blood Radio/Toronto  
Ottawa Studio Sound/Ottawa  
The Sound Box/Vancouver

Contact us if there is no dealer in your area.

**MAGNEPAN**  
MAGNEPLANAR® PRODUCTS  
P.O. BOX 8642, WHITE BEAR LAKE, MINNESOTA 55110

Dealer inquiries welcome

Check No. 22 on Reader Service Card

# Dear Editor:

## One + One = Four

Dear Sir:

We favor the technique described in the article on bi-amplification by Lovda and Muchow in the September issue of *Audio*. We recently designed a 1-kilowatt system for a stadium using bi-amplification and Shure SR105 amplifiers with two low-frequency and six high-frequency horns.

By connecting our speakers individually to the amplifiers, we missed the advantages of the "bridged-pair series connection" scheme that the authors mention will double the power output of each amplifier. With this technique, we could have halved the number of amplifiers and saved our client substantial cost.

We congratulate the authors' honesty in bringing this cost- and energy-saving technique to the public's attention. Unfortunately, the a.c. input power is rated at more than twice the audio output, so this method cannot be used to generate electricity. However, by a slight increase in efficiency, an important solution to the energy crisis would result.

Jon R. Sank  
Cross Country Engineering  
Haddonfield, N.J.

## The authors reply

We believe that Mr. Sank is referring to the comments in the "Summary" and, in particular, to Fig. 8A, the "Typical Bi-amplified Sound Reinforcement System for High SPL Operation."

The intent of this portion of the article is to illustrate in general terms how to most efficiently utilize the components of a bi-amplified sound system. In the example described, the four 16-ohm, wide-range loudspeaker systems are two-way systems with

bi-amplification capability. Both the 16-ohm, high-frequency section and the 16-ohm, low-frequency section of each system are made available for external connection. The Shure SR105 amplifiers used in this example, if operated at the mentioned maximum output-voltage capability of 28 volts rms, will deliver approximately 200 watts continuous to a 4-ohm load or 100 watts to an 8-ohm load. In addition, two SR105 amplifiers may be "bridged" to provide approximately 57 V rms output resulting in a total power of 400 watts to an 8-ohm load. The question, then, is what circuit configuration of amplifiers and speakers will most efficiently drive the speakers for highest SPL operation? Analysis reveals that the optimum combination consists of four SR105 amplifiers split into two bridged pairs, with each pair driving two parallel-connected, low-frequency speakers. (Please note that due to a typographical error, the two low frequency speakers are shown series-connected instead of parallel-connected in Fig. 8A.) In this way, each pair of speakers constitutes an 8-ohm load. A bridged amplifier pair will deliver 400 watts to this 8-ohm load, while a single amplifier will deliver 100 watts to this 8-ohm speaker combination.

In the article, we elected not to explain in great detail the subject of amplifier bridging. Rather, it was included to inform readers that his technique was available with amplifiers offering this feature. We certainly hope that this explanation will clear up any confusion that may have resulted.

John M. Lovda  
Stephen Muchow  
Senior Development Engineers  
Shure Bros., Inc.  
Evanston, Ill.

# Any LUX amplifier or tuner that doesn't meet or exceed every rated specification won't ever reach you.

It's one thing to produce components with an impressive list of published specifications. It's quite another matter to ensure that every unit will meet or exceed each of those specifications. But this is precisely what LUX does with its entire line of power amplifiers, preamplifiers, integrated amplifiers and tuners.

LUX components were conceived and designed for that very special breed of audiophile whose critical requirements for accurate music reproduction are met only by separate amplifiers and tuners. And of those products, the very best that the state of the art can provide.

Hence, the following procedure takes place at our facilities in Syosset, New York.

Every unit received from the factory in Japan is removed from its carton and placed on a test bench where it is connected to an array of test equipment, which includes a Sound Technology 1700A Distortion Measurement System and 1000A FM Alignment Generator, McAdam 2000A Digital Audio Analyzer System, and Iwatsu Electric SS5100 and 5057Z 5057Z Synchroscope.

Every control, switch, meter and indicator undergoes an operational check-out. There's nothing unusual about this. Any reputable manufacturer can be expected to do the same. Or at least spot check a shipment.

But LUX has only begun. Every specification is then measured against its published rating. That means 14 individual tests for a power amplifier, 14 for a preamplifier, 20 for an integrated amplifier and 7 for a tuner.

Each verified specification is entered by hand on a Performance Verification Certificate. Any unit that doesn't

match or exceed every published specification is given the appropriate remedy. When a unit passes, it is returned to its carton together with a copy of the Certificate for the information of its future owner. Another copy stays with us as a permanent record.

As for the specifications themselves, here are some examples. The Luxman M-4000 power amplifier has less than 0.05% harmonic and intermodulation distortion at any frequency from 20 to 20,000 Hz, even with both channels driven simultaneously to its rated output of 180 watts per channel into 8 ohms. Another M-4000 specification: signal-to-noise ratio beyond 100 dB.

Another example is the C-1000 preamplifier. Its phono-input circuits are virtually overload proof, accepting almost half a volt of audio signal at 1000 Hz. The distortion of its phono-preamplifier circuits is an astonishingly low 0.006%, and the rest of the preamplifier circuits add only 0.001% more.

There's one more expression of our confidence in our products. If any of them malfunctions during the first three years, let us know. We'll not only fix it promptly, but will pay the freight both ways, as well as supply a shipping carton if needed.

Some day, all manufacturers may adopt these procedures. For LUX, it's the only way to go. From the very beginning.

With all this, we think that neither our specifications nor our procedures for verifying them is nearly so important as your satisfaction with the end result: the most accurate and musical reproduction you can hear.

The end result can be best appreciated at a select number of dealers whom we guarantee to be as dedicated to fine music reproduction as we are.

One of these Performance Verification Certificates is included with every unit.

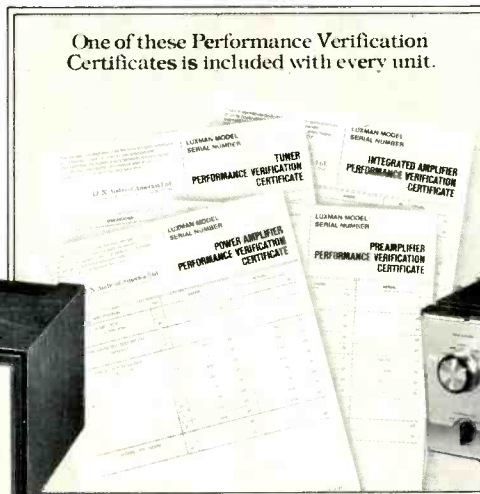

Luxman M-4000 Power Amplifier—180 watts per channel minimum continuous power, both channels driven simultaneously into 8 ohms. Total harmonic and intermodulation distortion less than 0.05%. Frequency response: 5-50,000 Hz,  $\pm 1$  dB. Signal-to-noise ratio: 108 dB. Features include: separate power supplies for each channel, including output and drive stages. Two-meter power-output display in combination with LED peak-output indicators reveal dynamic range of program material. Output level set by precision potentiometer with 1-dB click stops. \$1,495.00.



Luxman C-1000 Preamplifier—Total harmonic and intermodulation distortion: 0.007% at 2.5 V, 20 Hz-20 kHz, all output signals. Frequency response: 2 Hz-80 kHz, +0, -0.5 dB. Signal-to-noise: >65 dB. Phono overload: 450 mV @ 1 kHz, 3.5 V @ 20 kHz. RIAA equalization:  $\pm 0.2$  dB. Features include: tape-monitoring and dubbing for two decks, six selectable tone control turnover frequencies, linear equalizer, twin high and low noise filters, variable phono-input impedance, variable input sensitivities, "touch-mute" attenuator, speaker system selectors. \$895.00.

## LUX Audio of America, Ltd.

200 Aerial Way, Syosset, New York 11791  
In Canada: AMX Sound Corp. Ltd., British Columbia; Gentronic Ltd., Quebec



# Miking With The 3-Point System

**I**N ORDER to understand the advantages of the three point pick-up system, it is necessary to be aware of the distinction between binaural and stereo. A good binaural recording makes a poor stereo recording and vice versa. The fact is that situations in which acceptable stereo recordings can be made with two microphones are severely limited in number.

The seemingly simple case of a solo instrumental performer on stage serves to illustrate this point. A recording made with two cardioid (uni-directional) microphones, when

played back over monitoring loudspeakers, will in most cases approach one of two extremes depending on microphone placement: if the microphones were fairly close to the performer, the instrument will seem 10 feet wide; if they were placed farther away, there will be a left and a right but a hollow middle, creating the illusion that the performer is in two places at one time. A proper three point pick-up would produce a recording not only with correct left-right perspective but with depth as well. The performer will be heard oc-

cupying the correct amount of space at the correct point on the stage.

The effect becomes easier to understand when one realizes that the success of binaural reproduction is largely dependent on certain psychoacoustic phenomena. Stated simply, the human brain, when isolated from external factors as in binaural reproduction, is amazingly capable of filling in details. Stereo reproduction cannot take advantage of these psychoacoustic effects. It becomes necessary, therefore, to take special steps in the recording process to insure that the sound, when reproduced over monitor loudspeakers, will be an accurate rendition of the performance.

Many amateur recordists will use multiple microphones (more than 3) in an attempt to produce a "professional" recording. While it must be acknowledged that certain situations call for multiple microphone techniques, it must also be pointed out that such situations are rare and that such techniques are quite difficult to master. Phase interference between microphones (resulting in peaks and cancellation of certain frequencies)

**EDITOR'S NOTE:** *The Nakamichi folks have recently released a small booklet on the three-point recording system, entitled "The Nakamichi Live Recording System," several parts of which are reprinted here. This technique makes use of a third or blend mic in addition to the more usual stereo pair to produce a greater sense of depth or space in the recording. The system also allows a wider latitude in placing the basic mic pair*

*to achieve the correct stereo or left-right image. While the basic technique calls for the use of a recorder with a third or blend mic input, tape decks with only a pair of inputs can be adopted to the technique if a mixer with a blend feature is used. The Nakamichi booklet also gives many valuable tips on relative levels and placement of mics for various instruments. It is available through the firm's dealers.*

# Keep on trackin'

## With an Empire wide response cartridge.

A lot of people have started "trackin'" with Empire cartridges for more or less the same reasons.

**More separation:** "Separation, measured between right and left channels at a frequency of 1 kHz, did indeed measure 35 dB (rather remarkable for any cartridge)." **FM Guide, The Feldman Lab Report.**

**Less distortion:** "...the Empire 4000D/III produced the flattest overall response yet measured from a CD-4 cartridge—within  $\pm 2$  dB from 1,000 to 50,000 Hz." **Stereo Review.**

**More versatile:** "Not only does the 4000D/III provide excellent sound in both stereo and quadriphonic reproduction, but we had no difficulty whatever getting satisfactory quad playback through any demodulator or with any turntable of appropriate quality at our disposal." **High Fidelity.**

**Less tracking force:** "The Empire 4000D/III has a surprisingly low tracking force in the  $\frac{1}{4}$  gram to  $1\frac{1}{4}$  gram region. This is surprising because other cartridges, and I mean 4 channel types, seem to hover around the 2 gram class." **Modern Hi Fi & Stereo Guide.**

For the complete test reviews from these major audio magazines and a free catalogue, write: Empire Scientific Corp., Garden City, N.Y. 11530. Mfd. U.S.A.

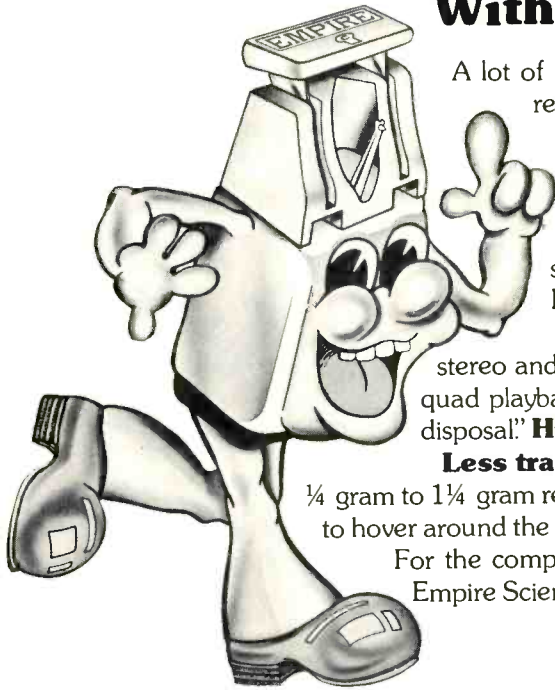









# EMPIRE

### Choose the Cartridge Designed to Play Best in Your System

Plays 4 Channel Discrete (CD4) and Super Stereo

Plays 2 Channel Stereo

Plays All 4 Channel Matrix Systems (SQ, QS, RM)

	4000 D/III	4000 D/II	4000 D/I	2000 E/III	2000 E/II	2000 E/I	2000 E	2000
Model								
Frequency Response in Hz:	5-50,000	5-45,000	10-40,000	5-35,000	6-33,000	8-32,000	10-30,000	10-28,000
Output Voltage per Channel at 3.54 cm/sec groove velocity:	3.0	3.0	3.0	5.0	5.0	5.0	5.0	5.0
Channel Separation	more than 35dB	more than 35dB	35dB	35dB	35dB	35dB	30dB	30dB
Tracking Force in Grams:	$\frac{1}{4}$ to $1\frac{1}{4}$	$\frac{1}{2}$ to $1\frac{1}{2}$	$\frac{3}{4}$ to $1\frac{1}{2}$	$\frac{1}{2}$ to $1\frac{1}{2}$	$\frac{1}{2}$ to $1\frac{1}{2}$	$\frac{3}{4}$ to $1\frac{1}{2}$	1 to 3	1 to 3
Stylus Tip:	miniature nude diamond with .1 mil tracing radius ™4 Dimensional	miniature nude diamond with .1 mil tracing radius ™4 Dimensional	miniature nude diamond with .1 mil tracing radius ™4 Dimensional	nude elliptical diamond .2 x .7 mil	nude elliptical diamond .2 x .7 mil	nude elliptical diamond .2 x .7 mil	elliptical diamond 3 x .7 mil	spherical diamond .7 mil
For Use In:	turntable only	turntable only	turntable or changer	turntable or changer	turntable or changer	turntable or changer	changer only	changer only
								
	(White)	(Yellow)	(Black)	(Clear)	(Blue)	(Green)	(Red)	(Smoke)

Check No. 12 on Reader Service Card



becomes more of a problem as the number of pick-ups is increased. Many professional live multi-mike recordings, in fact, suffer from this phenomenon and end up bearing little resemblance to the actual performance. With practice and experimentation the recordist will soon discover that the three point pick-up system is ideal for the large majority of live recording situations.

### Microphone Choice

While perhaps it need not be said that a successful live recording invariably depends on the use of high quality microphones, a few general guidelines on the use of uni-directional (cardioid) versus omni-directional (non-directional) microphones in the three point system should be helpful to the amateur recordist. Cardioid is usually the choice for the two stereo microphones. In general, however, unless there is good reason to use cardioid microphones, omni-directional microphones are preferable as they will yield superior results. If wide separation is physically impossible, for example, directional microphones may be desirable to establish stereo left and right. Cardioid microphones will also help to suppress audience noise, very often a problem in live recording.

The blend microphone can be either uni-directional or omni-directional depending on the recording situation. An omni-directional microphone circumvents the proximity effect (boosting of lower frequencies) which one encounters when close-miking with a uni-directional unit. An omni-directional microphone also solves the problem of uneven sound caused by slight movements by an instrumental or vocal performer. It is occasionally necessary to suppress information behind the microphone. In such cases a uni-directional device must be employed. Most high quality uni-directional microphones, fortunately, are equipped with a switchable low-frequency attenuating network to minimize proximity effect. There are a few select cases where proximity effect may actually be desirable. Here again, the uni-directional microphone is the solution (the attenuating network, if provided, should be bypassed, of course). If time permits, it is best to try both types and choose the one that yields the most natural sound.

The advanced recordist will most probably want to experiment with more sophisticated microphones,

such as the super-directional (shotgun type) or the super-nondirectional (pinpoint pick-up type) microphone. Super-directional microphones are not only useful for picking up sounds from a distant source but also for stereo pickup in halls or churches with excessive and prolonged reverberation, which tends to make recordings sound muddled and cavernous. Super-nondirectional microphones are highly refined omni-directional microphones. The expert recordist will often use a pinpoint microphone in place of a standard omni-directional unit, even though the former requires much more critical placement. The pinpoint microphone has the advantage of smoother high frequency response (almost no diffraction effects because of reduced pick-up element size) and truer omni-directional response at higher frequencies.

It is usually the case, unfortunately, that monitoring during a live recording session must be performed with headphones. This causes no difficulties for the binaural recordist, but the stereo recordist is confronted with the rather complex problem of creating a tape which will faithfully reproduce the performance over stereo loudspeakers while monitoring on-location with headphones. Clearly there is no substitute for experience in this matter. The seasoned recordist is able to extrapolate the binaural information and thereby position the microphones and set levels to produce a perfect stereo recording.

It should be pointed out, nevertheless, that choice of headphones can have a profound effect on the end result. Certain headphones are not suited to the purpose of on-location stereo monitoring because of their physical and/or acoustical characteristics. Open-air type headphone provides no isolation from external sound making it relatively difficult to monitor live recordings unless the recordist situates himself in a rather sound-proof room. Generally poor results in terms of balance can be expected when one monitors with headphones which have boosted low and high frequency responses (in other words a suppressed midrange). It is much more preferable to use headphones which have slightly attenuated responses at the lower and higher ends of the audio spectrum.

Finding the optimum positions and setting the levels for proper balance among the microphones are the most important and the most difficult tasks in live recording. There are numerous

factors to be taken into account. Type of instrument, type of ensemble, type of microphone, and acoustical characteristics of the room or hall (which are affected by factors such as size, shape, material, size of audience, etc.) are but a few of the details which must be considered in positioning the microphones. Once the microphones are optimally located, the levels must be set so as to achieve the most natural balance between the stereo and blend microphones. It would be impossible to postulate exact microphone locations and level settings for any given recording situation. If it were possible to do so, live recording would not be quite so enjoyable. There is regrettably little time, however, for one to experiment with microphone placement and level setting at an actual performance. The successful live recordist, therefore, relies heavily on experience gained from past recordings and on knowledge gained from those sessions in which there was ample time to experiment.

The following examples of specific recording situations are intended as a guide. Combined with the availability and proper use of top-performing equipment and some time to experiment with the variables, these diagrams and suggestions should enable the serious amateur to produce highly successful live recordings.

### Piano Solo

In recording a solo performance the blend microphone is used to pick up the primary sounds emanating from the instrument while the stereo microphones are used to pick up the piano's natural ambience and room reverberations.

*Blend mic:* Place the microphone to pick up direct sounds from the piano as shown in the diagram. This microphone must be placed rather close in order to capture the percussive qualities which lend clarity to the piano. If the microphone is placed too close to the strings, however, single notes will stand out and the resulting recording will sound uneven. Correct placement can actually depend on the composition being performed! If the piece limits playing to the lower half of the keyboard, for example, the microphone should be placed farther away from the keyboard than usual.

*Stereo mics:* Placement of these microphones depends largely on room acoustics. As a general rule of thumb, they should be at least 6 ft. high and 3 ft. apart. The axis formed by the two microphones, however, should always

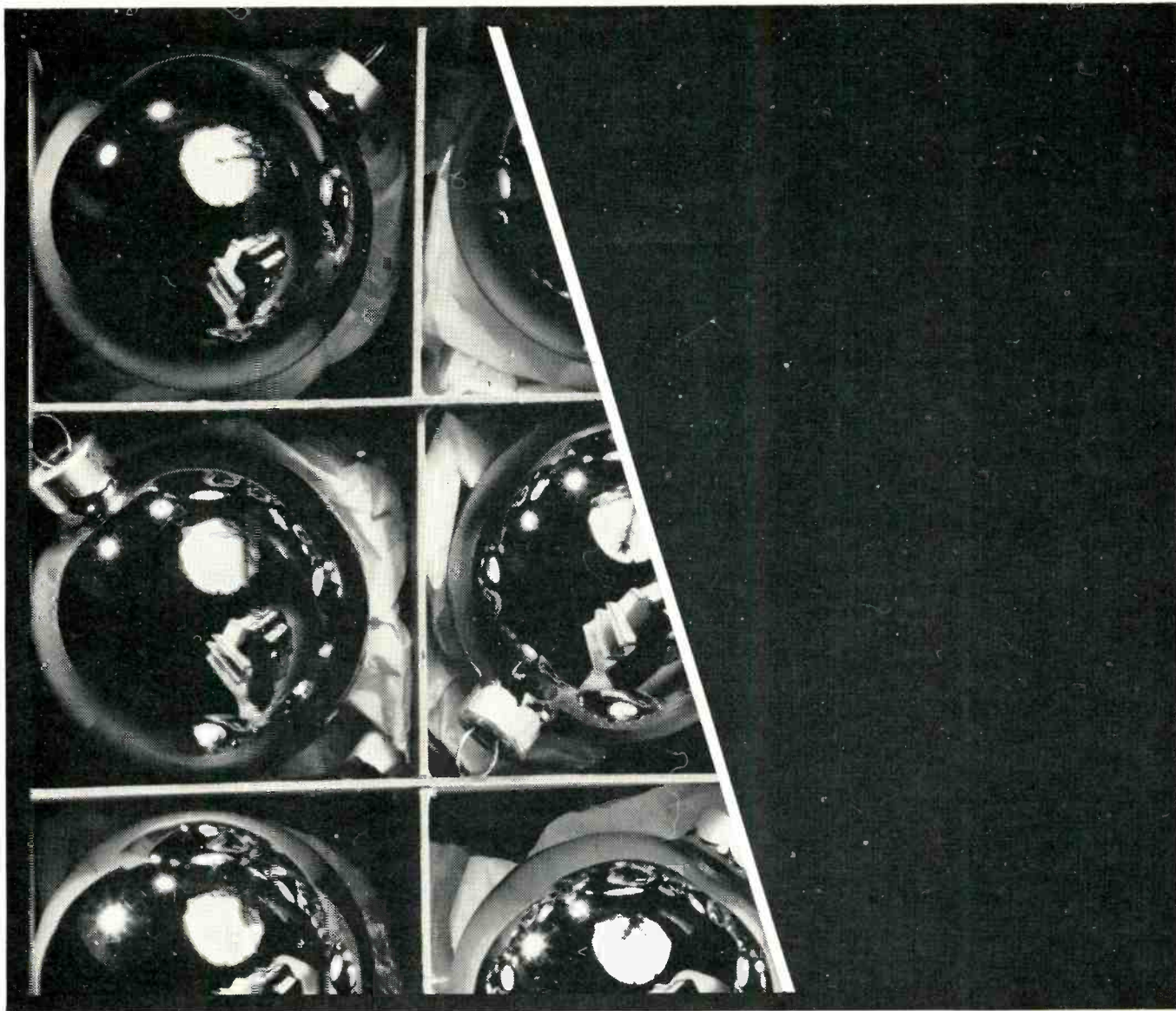

## A cartridge in a pear tree.



A gift of the *Shure V-15 Type III* stereo phono cartridge will earn you the eternal endearment of the discriminating audiophile who receives it. What makes the V-15 such a predictable Yuletide success, of course, is its ability to extract the real sound of pipers piping, drummers drumming, rings ringing, et cetera, et cetera. In test reports that express more superlatives than a Christmas dinner, the performance of the V-15 Type III has been described as "... a virtually flat frequency response ... Its sound is as neutral and uncolored as can be desired." All of which means that if you're the giver, you can make a hi-fi enthusiast deliriously happy. (If you'd like to receive it yourself, keep your fingers crossed!)

**Shure Brothers Inc.**  
 222 Hartrey Ave., Evanston, IL 60204  
 In Canada: A. C. Simmonds & Sons Limited



\* FREE! 1976 Stereo Directory & Buying Guide with the purchase of a Shure V-15 Type III, or the M95 series, M75 Type II or M91 series of cartridges. Simply send us your warranty card with the notation "Send Free Buying Guide" before Dec. 31, 1975. (Offer subject to supply and may be withdrawn at any time.)

Check No. 43 on Reader Service Card



be parallel to the strings (perpendicular to the keyboard). To give an example of how room acoustics affect placement, it can be stated that a large hall would call for the stereo mi-

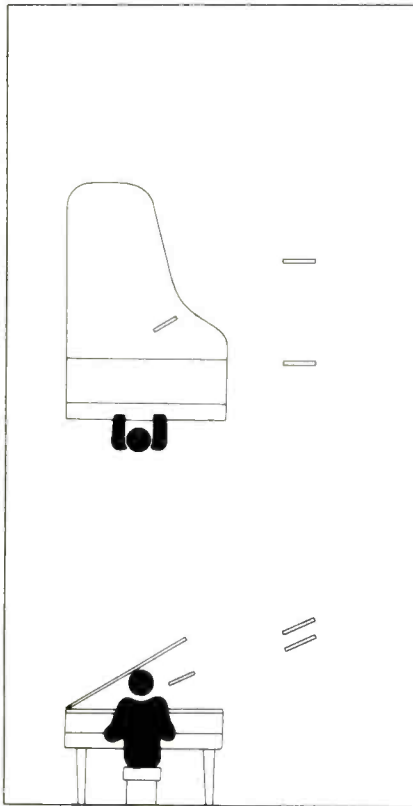

crophones being positioned farther away and more toward the keyboard than they would be for a smaller hall or room.

**Levels:** The blend microphone is the main source. The stereo microphones, therefore, should not be allowed to overpower the blend mic.

### Vocals with Piano Accompaniment

The main source is the vocalist and the blend mic is once again the primary pick-up.

**Blend mic:** Place the mic at a level just above the vocalist's head. Be careful not to place it too close. It is highly recommended that a windscreen be used to minimize pops and blasts. A dynamic microphone is generally preferable to a condenser type for vocal recording.

**Stereo mics:** These must be positioned to pick up the piano accompaniment in addition to the reverberant sounds. Placement will once again largely depend on the room or hall acoustics.

**Levels:** The balance between the vocals and the accompaniment can be

controlled quite well by adjusting the level of the blend mic with respect to

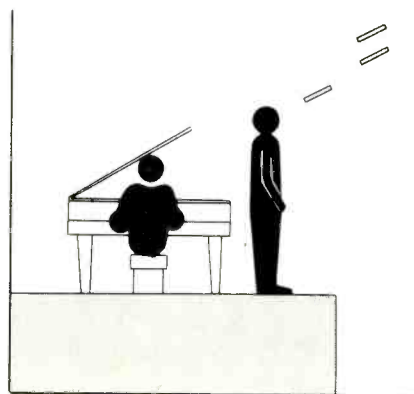
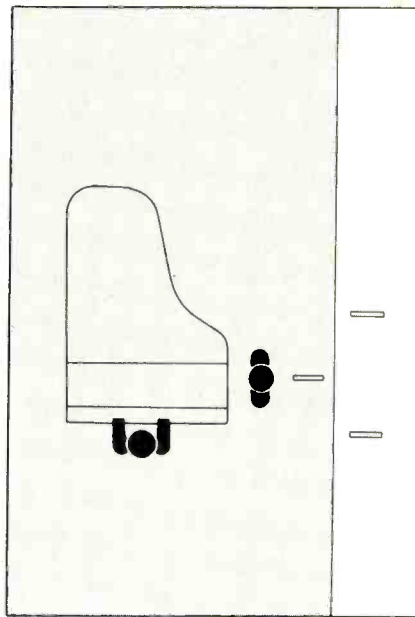

the stereo mics. The level of the accompaniment should generally be between 45-50 percent of the vocal level. If the blend mic is too high, the recording will sound monaural and balance will suffer. If the stereo mics are too high, the result will be a muddy sound, lacking localization of the vocalist.

### Vocal Quartet With Piano Accompaniment

In the examples given earlier the blend microphone performed the primary function of picking up the direct sounds from the solo instrument or vocalist. In the following example, the stereo microphones must take over this function since the main source, the vocal quartet, is spread out and requires increased coverage.

**Blend mic:** This must not be set too close to the singers. Place the mic at least 2 ft. higher and 3 ft. farther away

from the soloists than the stereo mics. Exact placement will, of course, depend on the room or hall. Be careful not to place this mic too far from the stage as it must pick up the piano accompaniment.

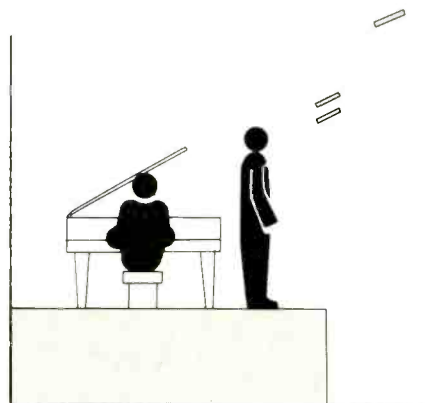
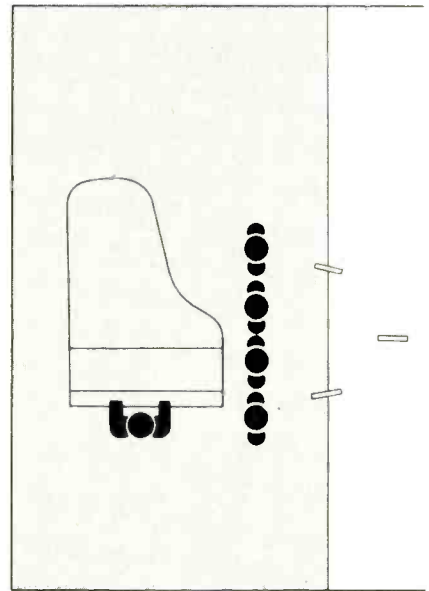

**Stereo mics:** Use the guidelines given for the blend mic in the example of the vocal solo with piano accompaniment.

**Levels:** Since the stereo mics are the primary pick-ups, levels must be set so that the blend mic does not overpower the direct sounds from the vocalists.

### String Quartet

Recording a string quartet calls for microphone placement quite different from that of the preceding example. There are several reasons for this. There is, firstly, no piano accompaniment; secondly, balance among the instruments is more likely to be a problem than in the case of the vocal quartet. There is, thirdly, the added

It's all here! The power, the precision, the purity. One look at that heat sink will convince you that no one puts your money where it counts, like Dynaco, into the guts of the Stereo 400. And what comes out is perfection.

Every wanted feature, plus these optional accessories:

- Ultra high power mono conversion kit.
- Meters to watch the music.
- A fan to play it really cool.
- Rack mounts to keep it in suspense.

Loaded with protection circuits, so the power is only where you want it, including the unique Dynaguard™ speaker saver. One reviewer said, "excellent . . . a similar device should be a part of any high power amplifier." Join the thousands who have built this kit in 3 or 4 evenings, and save over \$200.

To see how easy it really is, send \$2.50 for detailed manual and performance data. It's a small investment in Dynakits—the leader in the world of sound value.

# power play



Write Dynaco, Box 88,  
Blackwood, N.J. 08012  
for free literature.

**dynaco**  
**dynakit**



requirement of picking up instrumental ambience as well as the room or hall ambience.

**Blend mic:** Start with this mic in a central position with respect to the four instruments. If a problem with balance exists, the mic should be placed toward the weaker instrument. The mic should be placed high enough to clear the heads of the play-

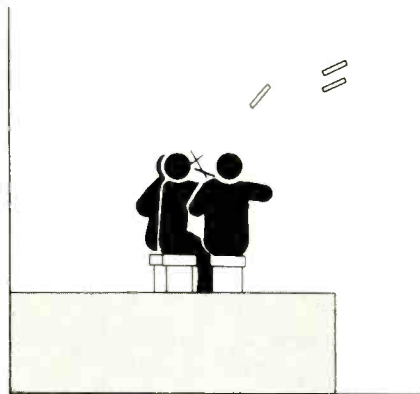
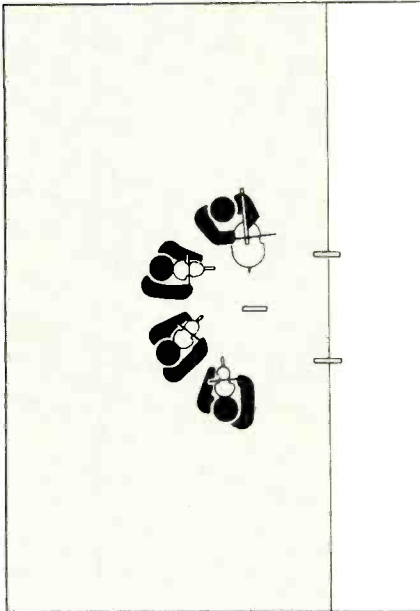

ers. If the mic is placed too low, the music stands will interfere with pick-up of direct sounds from the instruments.

**Stereo mics:** Place these microphones according to the room or hall acoustics. They will generally be placed higher than the blend mic and at least 3 ft. from the frontmost players.

**Levels:** Although the blend mic is picking up the direct sounds from the instruments, care must be taken to avoid setting this mic too high in level as the resulting sound will be overly monophonic. Start with roughly equal levels for both the blend and stereo mics.

### Jazz Trio

Many of the basic principles underlying the previous example apply to this case as well.

**Blend mic:** This mic should initially be set in a central position (usually near the drums) and then repositioned, if necessary, to achieve proper balance. It should be placed high enough to clear the cymbals of the drum set.

**Stereo mics:** The spacing and distance from the ensemble of these mics will of course depend on room acoustics, but the spacing between the instruments will also be a factor. If

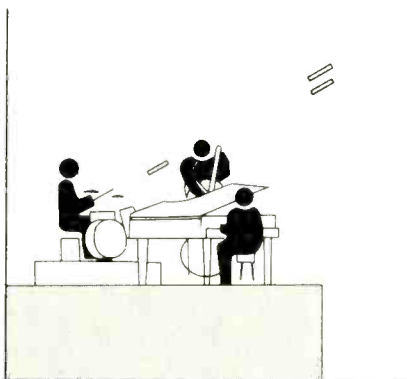
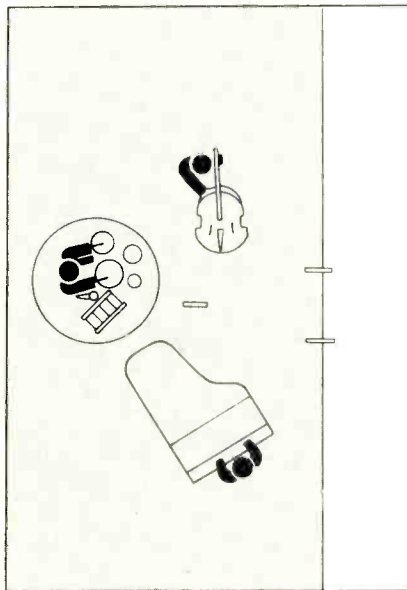

the piano and bass, for example, are set very far apart, the stereo mics will have to be separated a little wider, placed a bit lower and closer to the ensemble than if the group were compact. Care should be taken, though, to avoid placing them so close that the recording loses "liveness" or the sense that the trio is performing in a room or hall.

**Levels:** Follow the guidelines given in the previous example.

### Church Choir with Organ

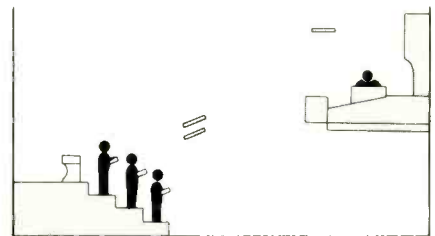
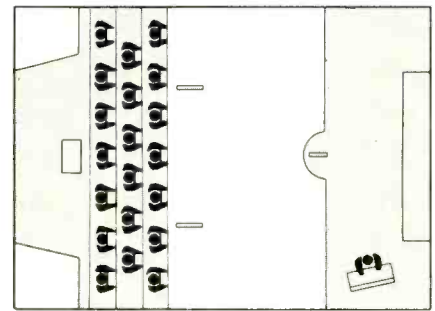

Because of the highly reverberant acoustical nature of most churches, critical microphone placement becomes particularly difficult.

**Blend mic:** Use this mic to pick up direct sounds from the organ. Distance from the pipes, height, and lateral position will depend on the characteristics of the church and the organ. Under most circumstances, an omni-directional microphone would be preferable.

**Stereo mics:** Place these mics in front of and above the choir. Experiment carefully with placement to achieve a full, rich sound with the right amount of reverberance. The mics must be close enough to capture the diction and far enough to avoid highlighting individual singers.

**Levels:** Balance between the organ and the choir can be easily achieved by the proper setting of levels.

### Church Organ Solo

Most church altars are constructed in such a way that they make ideal pick-up points for reverberant sound.

**Blend mic:** Place this mic facing the altar. Experiment with height and distance to obtain a broad reverberant sound free from harshness caused by local resonances.

**Stereo mics:** Position these mics to pick up direct sounds from the organ pipes. They must be close enough to capture all the overtones which give

# Drop in a Fuji



## and you'll drop all the others.

There is a new cassette on the market. The FUJI FX, a Pure Ferrix cassette that soon will be the standard of excellence for top quality, truly high fidelity reproduction. It already is in many parts of the world.

FUJI FX gives you the music you want, the way you want your music. Clear, crisp sound over the entire audio frequency range without perceptible distortion. A signal-to-noise ratio of better than 58 db. No hiss. Virtually failure-proof. The finest music at your fingertips without the need for any special bias. Drop in at your FUJI dealer today; then drop in a FUJI and hear music as you have never heard it before.

FUJI FX cassettes come in lengths of 46, 60 and 90. Also available, a full line of FUJI FL Low Noise cassettes in lengths of 30, 60, 90 and 120 minutes. FUJI Photo Film U.S.A., Inc. The Empire State Building, New York, New York 10001.



**FUJI FILM**

**THE TAPE THAT'S HEARD AROUND THE WORLD**

Check No. 15 on Reader Service-Card



the various stops their particular sound qualities.

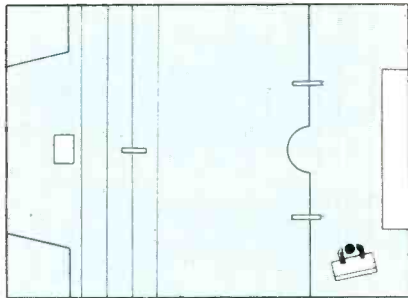

*Levels:* Relative levels will vary greatly according to the acoustical properties of the church and organ. Keep in mind that the stereo mics are the primary pick-ups.

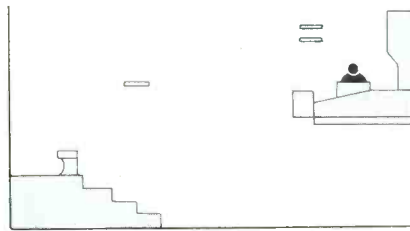

## Outdoor Recording

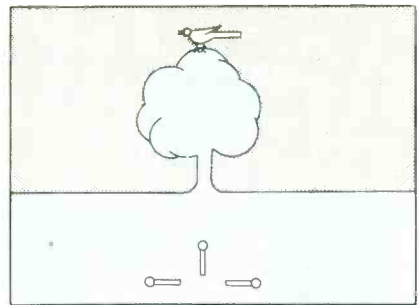
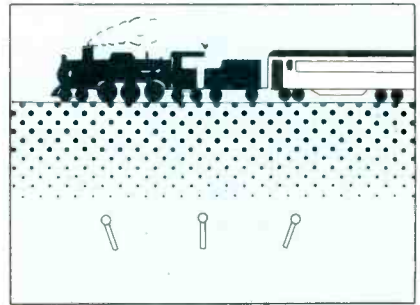
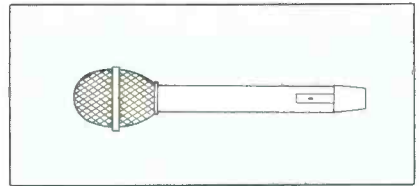

# institute of audio research

offers an ongoing program in

## multitrack — music recording

New classes for the winter quarter begin January 6, February 2, 1976

### recording technology

PDR-102 — Practical Disc Recording - 39 hrs. Hands-on study of tape to disc transfer.  
 STP-111 — Studio Technology and Practice - 60 hrs. The nucleus of our multitrack recording curriculum.  
 CR-110 — Control Room Lab - 30 hrs. Students utilize professional equipment performing operation and test procedures.  
 RSW-300 — Recording Studio Workshop - 30 hrs. Ten 3-hour sessions operating a 16 track studio.

### audio — music

FAT-100 — Fundamentals of Audio Technology 1 - 30 hrs. Study of fundamental audio concepts.  
 FAT-200 — Fundamentals of Audio Technology 2 - 36 hrs. Operation and theory of audio amplifiers, filters, feedback systems, etc.  
 SST-200 — Synthesizer Studio Techniques -

33 hrs. The synthesizer as an instrument and "special effects" device. Includes lab.

### seminars

Digital Logical Design Seminar - 3 Days. Elements of digital circuit design. Meaningful applications.  
 Producers's/Arranger's Workshop - 3 Days. Institute of Audio Research laboratory facilities develop techniques of multitrack recording.  
 Audio Systems Design - 4 Days. Theory and methods for interface design of audio systems. Design sessions aided by programmable calculators reinforce class discussions.

### institute of audio research

64 University Place  
 New York, N.Y. 10003  
 212 677-7580

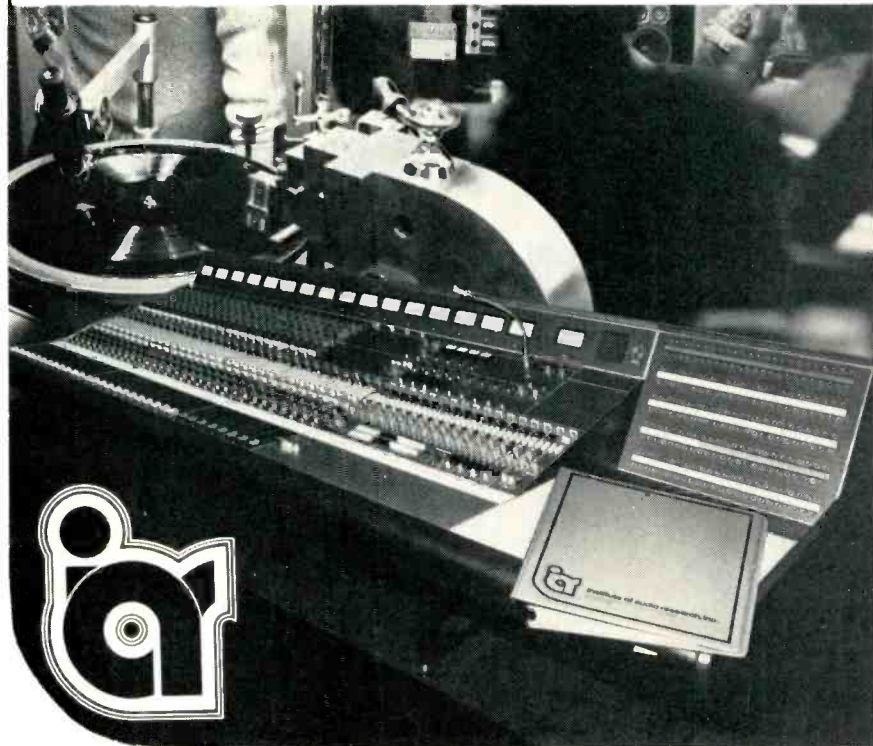

Check No. 20 on Reader Service Card

Windscreens are a must for outdoor recording. In some cases the standard windscreen supplied with the microphone may be inadequate. If so, take the thick part of a nylon stocking and wrap it tightly around the standard windscreen.

*Moving sound sources:* Place the left, blend, and right microphones in line along the axis of motion. Spacing of the mics will depend on the speed of the source. The faster the source, the farther apart the microphones should be. When recording a fast moving steam locomotive, for example, if the mics are placed too close together, there will be very little stereo effect.

*Static sound sources:* Place the three microphones in a horizontal plane fairly close to each other at 90 degree angles to each other. When recording sounds, such as bird or insect noises, which tend to come from all directions, three cardioid microphones placed in this manner will yield a very natural stereo effect.

*Levels:* In each case above, set levels to obtain the most realistic balance and separation.



# THE NEW ACTION-LOOK AT ASTATIC

Means New Profits For You

OVER 100 ITEMS IN THE NEW  
ASTATIC AUDIO ACCESSORY LINE

- NEW MICROPHONE ACCESSORIES
- STEREO HEADPHONES • AUDIO CABLES, PLUGS  
AND ADAPTORS • RECORD ACCESSORIES
- 45 RPM SPINDLE ADAPTORS



**THE ASTATIC CORPORATION**

Conneaut, Ohio 44030 U.S.A.

In Canada: Canadian Astatic Ltd., Scarborough, Ontario M1H 2V5

Export Sales: Morhan Exporting Corp.  
270 Newtown Road, Plainview, New York 11803, U.S.A.

**THE NATION'S ONLY MANUFACTURER OF ALL 4:  
MICROPHONES, PHONO CARTRIDGES, NEEDLES AND TONE ARMS**

Check No. 1 on Reader Service Card



# Language of High Fidelity

## Part XIII

Martin Clifford

**E**VERY ELECTRONIC SIGNAL from whatever source ultimately appears at the signal input of the *main* or *power amplifier*. The FM signal has shucked off the cocoon supplied by the radio-frequency carrier wave; the phono signal becomes the electronic equivalent of the twists and gyrations of the stylus in the record grooves; the tape signal has emerged from the magnetic whirls that produced it. Thus, at the input to the main amplifier, all of these signals resemble each other closely, and you can select any one of them for processing by the main amp.

Up to this point, we have been interested only in the voltage amplitude of the signal, and we've talked in terms of signal voltage, not signal current or power. It is true that the

main amp will provide some further voltage amplification, but that is incidental to its main job. What we need is electrical power for our speakers. In this sense, we may regard the amp as an appliance—a device for turning electrical power into some other kind of energy—just as a toaster, broiler, or a steam iron is an appliance which converts electrical energy into heat.

Although the terms "power amp" and "main amp" are often used interchangeably, "power amp" unfortunately suggests that it somehow manages to *amplify* power; this is wrong. This amplifier takes electrical energy out of the household electrical outlet and delivers it to one's loudspeakers. However, it doesn't do this directly—changes must first be made in the frequency and amplitude of the electrical power. These changes will be dictated by the audio signal input to the main amp.

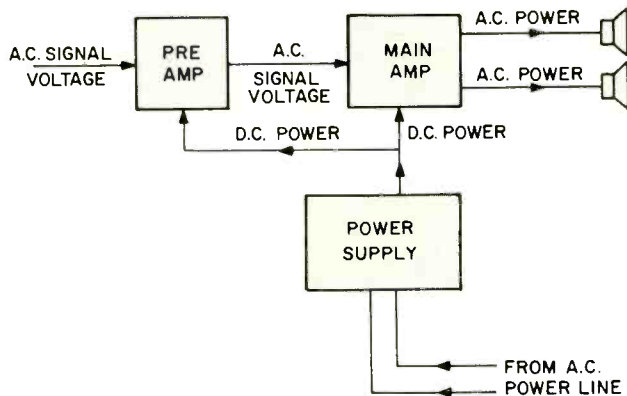

**Fig. 1**—The power delivered to the speakers by the power amplifier comes from the power supply, but is controlled by the signal voltage.

### Whence the Power

While the signal at the input to the power amp is a complex a.c. waveform, it is just a voltage and can exist at the amp's input without any sound coming out of the speakers. This is comparable to the case in your home in which an a.c. voltage is present at every power outlet along the baseboard, yet whether power is used or not is your decision. The moment you decide to use it (by plugging in an appliance), we are no longer dealing just with voltage (which is *pressure*), but with voltage and *current* (electrons flowing). Taken together, these two constitute power.

The power amp does not generate power—it is simply a device for controlling the power made available to it by its power supply (usually on the same chassis). (See Fig. 1.) And that power supply gets *its* power from your a.c. power line outlet. This may seem like a Rube Goldberg way of doing things, but it's the only way we have. The ideal method



# SONUS

STEREO PHONO CARTRIDGE

**suddenly there is  
the definition  
you have never been  
able to get before!**

**AH! DEFINITION—That elusive quality of clearness and accuracy never quite attainable before. (If you can't extract it at the point of contact with the record, the rest of your equipment won't deliver it to you.)**

The design philosophy of the SONUS cartridge is to use the latest refinements in material and techniques to convert the motion of the record groove into a precise electrical replica, thus assuring the highest possible sonic accuracy and definition.

The electromagnetic structure of the cartridge is exceptionally efficient and has been arranged in such a way that the point of transduction is placed as close as possible to the record surface. This enables the distance from the stylus tip to the energized armature to be kept extremely short, thereby minimizing the chances of the motion being significantly changed, and/or extraneous resonances introduced. It further enables the moving element to be kept exceedingly light and rigid. Indeed, we believe the total moving structure to be lighter than that of any other magnetic cartridge of which we are aware.

Great care has been taken with the cartridge geometry, not only to minimize vertical tracking error but also to ensure accurate transmission of the stylus motion to the generating armature. This has been

achieved by (among other things) positioning the stylus tip on the same axis as the armature so that none of the stylus motion is lost in rotation or affected by any possible rotational resonances.

The stylus pivot is located at the dynamic center of rotation of the moving system and is fabricated from material having optimum elastomeric properties, providing an extremely linear and highly compliant suspension.

In sum, we have a transducer system characterized by reproduction of exceptional accuracy, clarity and definition, and capable of perfect tracking and tracing at very low stylus forces.

*Write to SONUS customer service for full line catalog and the name of the franchised dealer nearest you.*

*Your franchised dealer will be happy to demonstrate the superior qualities of this cartridge.*



**SONIC RESEARCH INC.**

27 Sugar Hollow Rd., Danbury, Ct. 06810

Represented in Canada by:  
PACO Ltd. 45 Stinson St.  
Montreal, Quebec

Check No. 46 on Reader Service Card



would be to eliminate the amplifier by connecting the signal voltage to the a.c. power line, and connect the result to the speakers. Instead we must take from the a.c. line the a.c. power, which consists of a sine wave voltage and a sine wave current, and convert it to d.c. This is the function of the amplifier's power supply.

The power amp, then, is a component which receives d.c. power from its power supply section and reconverts it to a.c., which varies in frequency and amplitude according to the input signal (program material). The power line supplies current which is a sine wave, usually 60 Hz in frequency. The audio power coming out of the amplifier varies from about 30 to 20,000 Hz (depending on the amp design), and its amplitude is continuously changing. This current, flowing through the voice coil of the speaker, accomplishes work. It's forced into the voice coil by voltage. Together the two may be measured to compute the amount of power the speaker uses.

### Function of the Audio Signal

One way to describe the relationship between the audio input signal voltage and the amplifier is to say that the amp is a faucet and the input signal voltage is the valve in that faucet. While the amplifier directs the current to its appointed location, the input signal controls how much of that signal will reach the locations. The current flowing through the speaker voice coil should also have the same waveshape as the controlling signal. If it's exactly the same (it can never be a perfect copy—that would mean zero distortion!), the amp has done its job perfectly. If it changes very little, it's done a good job. If the output power has things in it that weren't in the input signal, or if it changes their relative amplitude, we have distortion.

### Power Amp and Power Supply

Since the power amp gets its power from the power supply, it should be obvious that it cannot deliver more power than it receives from the house current a.c. line. The function of the power supply is quite simple—to rectify the power line a.c. current and deliver d.c. to the power amp. It may help if you consider the power supply as a d.c. power reservoir. The power supply consists of three important parts: a transformer, a rectifier, and the filters. The transformer changes the house current at 115 volts to whatever the amp requires (in tube days it was 300 to 500 volts; generally today it's between 30 and 80 volts). In addition the transformer isolates the amplifier from the power line. If it did not, we'd have the good possibility of lethal shock, which is present in most small TV sets and many other appliances connected *directly* to the power line (they all have insulated cabinets to protect the user). The rectifier converts the a.c. into pulsating d.c. And the filters, consisting mostly of large capacitors,

smoothes the pulsating d.c. supplied by the rectifier into nearly perfectly smooth d.c. In the days of tube equipment, power-supply capacitors ranged up to 500 microfarads ( $\mu\text{F}$ ). But today, with much lower working voltages, the size of many capacitors is in the 10,000  $\mu\text{F}$  range and up.

### Describing Power

Measuring d.c. power is easy. Nor is it all that difficult to measure sinewave a.c. power. But it becomes troublesome when we are talking about complex wave signal currents and signal voltages—that is, signal power. For d.c., we just multiply voltage and current to get power in watts. For example, two amperes of current at 30 volts equals 60 watts power. Simple. For sine wave a.c. (if the voltage and current are in phase), the same simple multiplication process is used: Voltage (E) times current (I) equals watts power (W). The formula is written  $I \times E = W$ . However, because we use a.c. power in many ways, we make several different measurements of a.c. waves, as may be seen in Fig. 2.

There are three main points at which a sine wave is usually measured. One is at the top, called the *peak* (though it could as well be the bottom). Another is the *rms* value, which is equal to 70.7% of the peak value. This is also called the effective value. Finally we come to the average, which is equal to 63.7% of the peak value. Note that the sine wave values we're discussing here may be either voltage or current but not power.

Remember that except for test purposes, the wave shapes a speaker receives are very rarely simple sine waves. Instead they're complex shapes produced by voices and instruments. Further, the speaker doesn't use just need voltage, or just current, but both, which is power. Now, while many measuring instruments are calibrated in rms units (voltmeters and ammeters), a wattmeter measures average watts. That's because the product of rms volts and rms amperes (voltage and current) is *not* rms watts, as you might imagine, but average watts. Thus, when you read a spec sheet saying so many watts rms, think average watts instead. While rms watts is thus a misnomer, you might also hear rms power sometimes also called continuous power because this is the amount of power the amp can handle for an indefinite period of time without interruption.

Power amps are able to deliver more than their average (so-called rms) power for short periods of time, depending on the demands of the program material. If there is a pianissimo passage followed by a sudden clash of cymbals, the demand for additional power is comparable to momentarily turning on the air conditioner in your room—either the power company delivers or you will remain just as warm as you were. Ditto with the power amp. It will deliver more than the average power, but how much more depends on the size of the filter capacitor reservoir and the current-passing ability of the rectifiers (and the transformer) in the power supply. This emergency power is variously called *maximum* power, *dynamic* output, or *music* power. Music power is the maximum power available for a very short period from the main amp and used to be seen fairly widely on spec sheets and in catalogs until late 1974 when the Federal Trade Commission (FTC) power-rating rule went into effect. Music power described the amp's ability to handle brief power peaks as compared to sustained power levels. Thus, an amplifier capable of delivering 50 watts of power continuously might also be capable of delivering 80 watts for a short period of time. It was this 80 watts which would have been the amp's music power rating. With the FTC amplifier power-rating rule in effect now, only one kind of power rating, continuous, will be used for good high fidelity equipment. All other ratings are now obsolete.

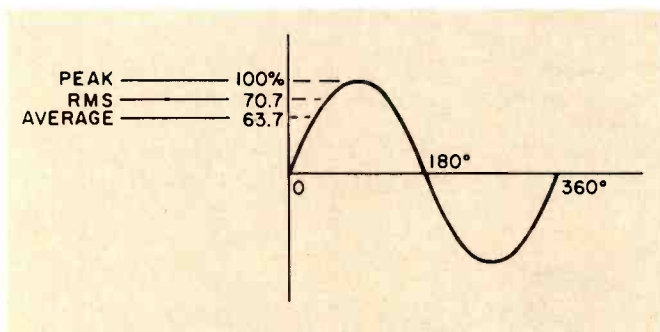

Fig. 2—Peak, rms, and average amplitude points on a sine wave of voltage or current.

# We're not afraid to turn our back on you.



## The Sylvania RS 4744

We can afford to be very forward about our back.

Because the back of our RS 4744 stereo receiver is one of the most versatile you'll ever see. We've got phono inputs for two different turntables. And two sets of tape monitor input and output jacks. And terminals for main speakers, remote speakers, and PQ4 speakers. And three AC power outlets, one switched and two unswitched. The rest you can see for yourself in the picture above.

But what's behind our back is just as impressive as the back itself.

As *Popular Electronics*\* put it, the RS 4744 "met or surpassed all the published specifications we were able to test" and was



"...well above average in the important performance aspects."

Take power, for example. *Popular Electronics* found the RS 4744 "conservatively rated" at 60 watts per channel, min. RMS at 8 ohms from 20Hz to 20kHz with no more than .25% Total Harmonic Distortion. Which made it "outstanding for a receiver in the RS 4744's price range." FM 50 dB quieting sensitivity was equally impressive—"a very good  $3\mu\text{v}$  in mono and  $35\mu\text{v}$  in stereo."

But don't take our word for it. Or their word for it. Go see the RS 4744 for yourself.

Back or front, any way you look at it, the RS 4744 is one fine stereo receiver.

\**Popular Electronics*, December 1974 Issue.

**GTE SYLVANIA**

Check No. 17 on Reader Service Card



## Power Output vs. Frequency

Ideally, for a fixed amplitude input signal, a power amp should be able to deliver the same amount of output power over a wide frequency range, extending from subaudible to superaudible, say 20 Hz to 20,000 Hz. Maximum available power output can vary within these limits, sometimes dropping off substantially at the ends of the spectrum or having various peaks in between. At the ends, the power may even decrease by 50 percent or more. In fact, the frequencies at which available power is 3-dB down (which happens to be 50 percent) at each end of the audio spectrum were called the half-power points, and they were used to define the useful power bandwidth of an amplifier previous to the FTC ruling. Under the new ruling, however, the full power of the amplifier must be available at all frequencies mentioned, with no decrease allowed at the ends of the frequency spectrum.

## Power Handling Capability

Speakers, as well as power amps, may be treated in terms of their power-handling capabilities, just as electric light bulbs are marked 10, 60, or 75 watts. We cannot draw further parallels between speakers, amps, and light bulbs, however, because the marking on a light bulb means that it always dissipates just that number of watts, not less, not more (provided it's being fed the nominal 115 V a.c.). However, if a speaker is rated at, say, 60 watts, that means it can handle power up to (but not exceeding) that level. It doesn't demand (as does the light bulb) that much power when it's hooked up to the amplifier. If we try to run more power through the speaker (by feeding it signals of higher voltage pressure), thus resulting in too much power being dissipated in its voice coil, one of three undesirable things is likely to transpire. Either the voice coil will move too far out

of its magnetic gap and stick, never to return, the voice coil may just burn out, or the speaker will just make horribly distorted sounds.

## Impedance Matching

A high quality power amp will deliver its rated power provided the load (the speaker) is designed to accept this amount of power. One of the problems here is that the impedance of the speaker is not a fixed value. It varies from its nominal value all over the lot, changing as it goes up and down the audio spectrum; at 70, 80, or 100 Hz the impedance may be five times higher than nominal, and it may also measure 40 ohms or more at the high end of the frequency range. This may sound discouraging, and it is, because the result of the peak is a droop in power transfer. If the peak occurs at the low frequency end, there is a reduction in the transfer of power from the amplifier by the speaker, just where we need extra power for those deep bass notes. There is an even bigger problem with impedance dips which, if deep enough, will give the amplifier fits.

Figure 3 is an impedance curve for a hypothetical loudspeaker. At about 100 Hertz this unit does indeed have an impedance of 8 ohms. However, the curve shows that the impedance of this speaker wanders all over the place, with a peak somewhere around 60 Hertz. This peak decreases the amount of current delivered to the speaker at that frequency, resulting in lowered acoustic output. Fortunately, the peak in the curve at that point is due to speaker resonance. Now, a speaker is more efficient around its resonant frequency than anywhere else on its curve. Thus, even though less current is delivered to the unit at resonance, the bass loss there isn't as severe as it might otherwise be, due to its increased mechanical efficiency at that point.

Note also the severe dip in the mid-range region around 1 kHz. The low impedance at that frequency can put excessive current drain on the amplifier, possibly causing the amp's protective relay or fuse to open. Whether this happens or not will depend on the setting of the preamp's gain control as well as the signal level fed into the preamp.

## Damping Factor

Many speaker terminals are labelled 4-8 ohms so you might think that this represents the impedance of the amplifier. Not so at all! This is simply a direction to the installer, "Attach the two speaker wires here." There is actually a tremendous mismatch, since the internal impedance of the amp may be measured in tenths of an ohm. The ratio of the impedance of the amplifier to the speaker's voice coil impedance is called the *damping factor*, which describes the amp's ability to control or minimize unwanted, residual speaker movements such as hangover and ringing. If a speaker has an impedance of 4 ohms and the amplifier has an internal impedance of 0.04 ohms, the damping factor would be 100.

## Total Harmonic Distortion (THD)

The amplifier must not only deliver power to the speakers, but should do so with the least possible distortion. To indicate that an amp has a certain amount of THD at a particular frequency is analogous to saying that an auto gets 18 miles per gallon when moving along at 10 MPH. But what about 40 MPH, or more relevantly, 60 MPH? An amp that is listed as having less than 1 percent THD at 1 kHz could easily have several percentage points of THD elsewhere in the sound spectrum. With amps it is best to know the maximum THD over the entire frequency range at maximum power. Then you can be certain that at most frequencies and power

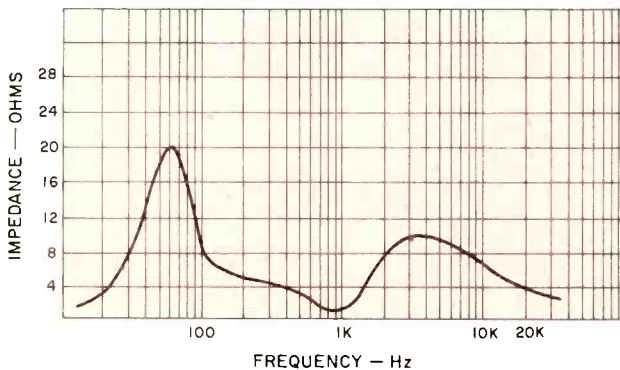

Fig. 3—Impedance versus frequency response for a speaker.

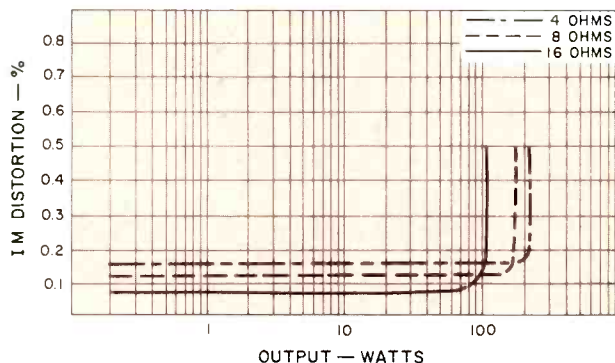

Fig. 4—Intermodulation distortion versus power output for three impedances.

# Celestion



loudspeaker

specialists

since

1924

New Celestion UL6. Compact enclosure provides 35 Hz-29 kHz overall response; +3.5 db 80 Hz-20 kHz. Power handling 20 watts continuous RMS sine wave. Can be used with amplifiers up to 80 watts RMS per channel.



UL6

New Celestion Ditton 33. Overall response 40 Hz-28 kHz; +3 db 60 Hz-20 kHz. Power handling 33 watts DIN continuous.



DITTON 33

New Celestion UL8. Overall response 30 Hz-28 kHz; +3 db 70 Hz-20 kHz. Power handling 25 watts continuous RMS sine wave. Can be used with amplifiers up to 100 watts RMS per channel.

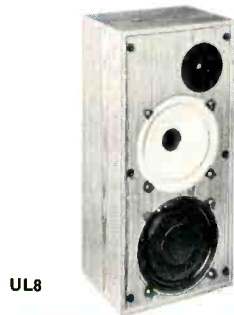

UL8

Ditton 44 Monitor. Power handling 44 watts DIN continuous. "It could take 100 watts (at 300 Hz on a steady-state basis) to produce an output of 106 db, and a power pulse of 486.5 watts (973 watts peak) to yield an output of 116 db. These figures attest to both the Ditton's robustness and to its excellent dynamic range . . ." —High Fidelity, June 1973.



DITTON 44

New Celestion UL10. Overall response 20 Hz-40 kHz; +2 db 40 Hz-20 kHz. Power handling 50 watts continuous RMS sine wave. Can be used with amplifiers up to 200 watts RMS per channel.

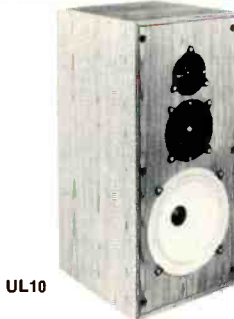

UL10

Ditton 66 Studio Monitor is top of Celestion Ditton Series and has received rave reviews worldwide. Appointed "Reference Standard" by "Revue du Son" of France. Features 16 Hz-40 kHz overall response, ultra-low distortion, high efficiency. Power handling 80 watts DIN continuous.



DITTON 66

Also available: Ditton 15 "Bookshelf Classic"  
Ditton 25 floor standing luxury loudspeaker

The following quality drivers, used in the 8 models listed above, were totally researched, designed, and built by Celestion—Britain's most experienced loudspeaker manufacturer.

- HF2000 ¾" pressure-dome supertweeter specified for B.B.C. monitors.
- HD1000 New 1" pressure-dome tweeter ensures extended treble response, excellent dispersion and complete freedom from listener fatigue.
- HD700 New 2" pressure-dome midrange unit.
- MD500 2" soft-dome midrange unit covers 500 Hz-5kHz with very low distortion, exceptional dispersion. Extremely powerful magnetic field ensures critical damping and high power handling.
- MC5 New 5" midrange unit with low mass fibrous cone for outstanding transient response.
- MC6 6" plasticized midrange unit in damped hermetically sealed transmission line.
- BASS UNITS UL bass units have 1.5" voicecoil, massive magnet system and specially treated Bextrene diaphragm. Ditton bass units have specially plasticized fibrous cone to prevent resonances; neoprene roll front suspension permits long linear axial movement for low distortion bass reproduction.
- ABR's Auxiliary bass radiators ensure excellent bass response, raise sensitivity, and reduce distortion to negligible limits.

Sole North American Distributors:

**ROCELCO INC. 160 Ronald Dr. Montreal, Canada H4X 1M8 Phone[514] 489-6842**

Los Angeles: (213) 985-5707 Chicago: (312) 381-4559 New York: (516) 938-4057

Check No. 10 on Reader Service Card



levels there will be less distortion than maximum—a reassuring feeling.

Distortion is also related to the power output in watts (Fig. 4). Maximum distortion appears at the maximum power output of the amplifier, where waveform clipping begins to take place as the distortion rises sharply. Figure 5 shows percentages of total harmonic distortion for 4- and 8-ohm arrangements working single channel and dual channel.

THD is a main limiting factor in power amp ratings. If there were no specified THD, then power output would become a "numbers game" and have no real meaning. The power specification of amplifiers, then, must list, in addition to THD, the sine wave continuous or average power output, in watts per channel, for each load impedance, with all channels driven, and with the power bandwidth in Hertz.

### Frequency Response

At one time the frequency response of an amp was a sacred cow, and for good reason. The amp, in those olden days, was about as guilty as the phono cartridge (or other signal source) or the speaker in contributing to degradation of sound. But not any more, so far as amps are concerned, since the frequency response of a quality amplifier can range from a low of 7 Hertz or so to a high of 80 or more kHz with a variation of +0, -1 dB, usually measured at a 1-watt level. Now that is a mighty flat response. When plotted on a graph, it looks as though it was drawn with a straightedge. But before you clap your hands with joy, consider that the load (the speaker) has a response curve quite different—more like a mountain range.

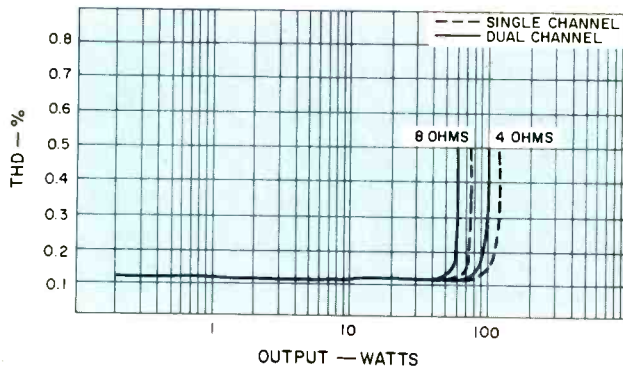

Fig. 5—Total harmonic distortion versus power output for two impedances, showing effect of single- versus dual-channel operation on power output.

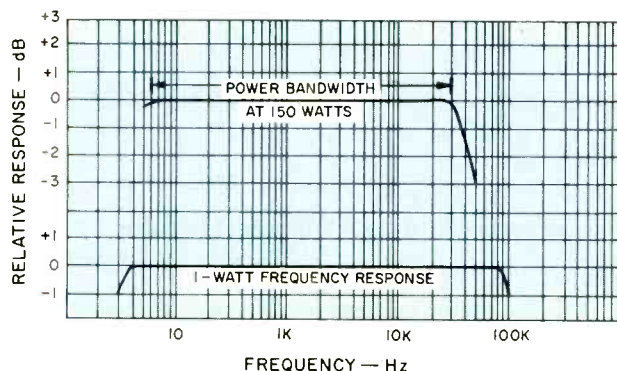

Fig. 6—One-watt frequency response and bandwidth at full power for a 150-watt amplifier.

And if you are going to use low and high filters and tone controls before the signal reaches the main amp, getting terribly perturbed about a 1-dB variation in an amp's frequency response is fretting unnecessarily. This doesn't mean you shouldn't pay attention to frequency response. You should, for having an amp with a flat frequency response eliminates an undesired variable from at least one component. But it does *not* mean you are automatically guaranteed an equally automatically faithful sound output. High fidelity is more than a goal; it is a proper perspective. (See Fig. 6).

### Two-Channel Amplifiers

Stereo amps are two-channel devices, that is, two amplifiers built on one chassis, with the power supply for both also on that chassis. In the past specification sheets often indicated the total wattage of both channels when specifying power output. Usually, too, there is less power available when both channels are driven simultaneously, than if one channel is operated alone. The new FTC power statement ruling requires that they be stated *per channel* and with both channels driven at once.

### Amplifier Protection Circuits

At one time speakers were isolated from the output stages of the main amp by transformers. These devices transferred the audio current to speaker voice coil while they blocked d.c. current (coming from the power supply). The main amp needs d.c. for its transistor elements and gets this from the power supply. What the speaker voice coil requires, however, is an alternating current whose waveform resembles that of the voltage signal input to the main amp. But while transformers perform the separation function admirably, they are frequency-sensitive devices and so pass some frequencies on easily to the loudspeaker while impeding others.

A direct-coupled stage, now used in most modern amps, is one in which the output stage is directly coupled to the speakers. A problem arising from this practice is that failure of an output transistor may produce a heavy flow of current through the speaker's voice coil, damaging or destroying it. Another possible cause of trouble can be damage to the transistor amplifier output stage caused by a short circuit across the speaker leads.

To prevent these problems, amps now have a variety of protection circuits which shut down the power amp at the first sign of trouble. These can be simple thermal fuses or complex circuits which detect any severe drop in output load impedance, especially a short circuit. Some power amplifiers use protective relays which can open the connection between the amp and the speakers, a somewhat more expensive arrangement than a simple fuse. Silicon controlled rectifiers (SCRs), which are faster and thus protect more quickly, are also used to protect the output stage. Still other and even more sophisticated circuits sense the levels of voltage and/or amperage and can shut down the amplifier very quickly should an excessive level of either occur.

Yet another form of protection exists in the speaker relay found in most amplifiers and receivers nowadays. You've probably noticed the few second delay between the time the unit is turned on and when sound begins to be produced by the speakers; this is the action of the relay, which prevents transient current peaks which occur at turn-on from reaching and possibly damaging the speakers.

Speakers and power amplifiers are hi fi's electronically married couple. They not only work together closely, but the actions of one affects the other. It is this relationship we will explore in the next installment.





# Introducing one of the finest collections of stereo receivers in the world: the MX 1580.

Power\* of the Sony 7065. FM Sensitivity\* of the Pioneer 838. Selectivity\* of the Sherwood 7900A. Capture ratio\* of the Marantz 2270. Total Harmonic Distortion\* of the JVC VR-5660.

With so many excellent AM/FM stereo receivers around these days, who needs another? So instead of making just "another" we collected the most significant specs and useful features of five of the best, and "combined" them in one: the MX 1580.

Of course, some of these five receivers have features our one doesn't have (we think you can manage without two phono inputs).

But then, ours has features they don't have; features you shouldn't do without.

## You pay for—and get—what you really need.

The MX 1580 has exclusive ASNC, which automatically reduces the noise level on weak stereo stations without reducing separation on strong ones.

And special thermal protection for output transistors and the power transformer.

Plus lots more we were able to include and, at \$479.95,\*\* save you a few bucks in the bargain.

How? It wasn't easy. But we had help.

## The oldest new company in the business.

Although we're a completely separate group, we were able to draw on the resources of a company that's been a leader in the industry since 1915. So we could afford to wait until we had the MX 1580 right.

And now it's so right, we insist that every single one be inspected twice before it's shipped. After all, we have one of the world's finest stereo collections to protect.

## Features and Specs\*

- Sensitive front-end with three dual gate MOSFET's and 4-gang tuning capacitor.
- Two 6-pole linear phase filters for improved selectivity and phase response
- High gain IC quadrature FM detector.
- Switchable signal-strength/center-tuned meter.
- Phase lock loop IC circuit for FM stereo multiplex.
- Computer-designed low pass audio filters for suppression of ultrasonic frequencies.

• OCL direct-coupled differential amplifier for extended frequency response and wide bandwidth

Power . . . . . 60 watts per channel, min. RMS

Power Bandwidth . . . . . 20Hz-20kHz

Total Harmonic Distortion . . . . . 0.5%

Load . . . . . 8 ohms

IM distortion . . . . . 0.8%

Frequency response . . . . . 20Hz-20kHz

Usable sensitivity (IHF) . . . . . 1.8uV

Selectivity (IHF) . . . . . 75dB

Capture ratio (IHF) . . . . . 1.5dB

50dB signal to noise mono . . . . . 2.5uV

Stereo separation @ 1kHz . . . . . 50dB

@ 10kHz . . . . . 40dB

All specs subject to change without notice. Specs of competitive receivers taken from manufacturers own published data sheets.

\*\*Manufacturer's suggested retail price; optional with dealer.



**We're being heard from.**

MX High Fidelity Components, Ft. Wayne, Indiana 46804

Check No. 23 on Reader Service Card

www.americanradiohistory.com



# Equipment Profiles

## Realistic (Radio Shack) Model STA-225 AM/FM Stereo Receiver

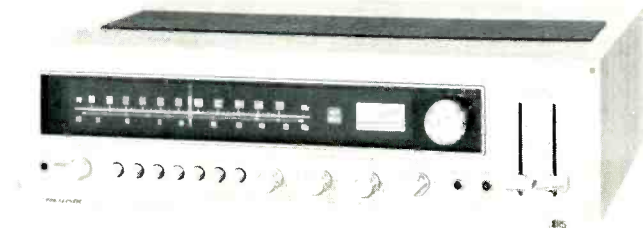

### MANUFACTURER'S SPECIFICATIONS

#### FM Section

**IHF Sensitivity:** 1.9  $\mu$ V. **S/N Ratio:** 65 dB. **Capture Ratio:** 1.2 dB. **THD:** Mono, 0.6%; Stereo, 0.8%. **Image Rejection:** 70 dB.

#### AM Section

**Sensitivity:** 250  $\mu$ V/M, internal antenna. **Image Rejection:** 55 dB.

#### Amplifier Section

**Power Output:** 50 watts per channel into 8 ohms from 20 Hz to 20 kHz (continuous); THD over entire power band, no more than 1.0%. **IM Distortion:** Less than 0.6%. **S/N:** Phono, 60 dB; Aux, 70 dB.

#### General Specifications

**Dimensions:** 19-1/8 in. W x 5-3/4 in. H x 15 in. D. **Price:** \$399.95.

There is a good deal to commend in this Realistic stereo receiver distributed by Radio Shack stores, but at the same time we surely would like to have seen Radio Shack give more than a minimum number of specifications. After all, not every prospective buyer gets a chance to read an equipment profile in *Audio* to find out what phono cartridge output matches up best or what the input sensitivities of the *AUX* and *Tape Inputs* are. With too many other firms, such a scarcity of specs suggest poor performance, yet in this case Radio Shack is hiding its light under a bushel since the parameters we measured turned out too good to hide.

The STA-225's front panel has the now-familiar long, black-out dial area, which occupies all but a couple of inch-

es of the panel. When illuminated, the dial area displays a linear FM frequency scale, a 0-100 logging or reference scale, and an AM frequency scale. To the right is a single signal-strength meter, adjacent to which are the illuminated words "Auto Magic" about which we will speak shortly. A good sized tuning knob is located within the blacked-out dial area as well. Two slide controls at the extreme right operate vertically to control volume level for each channel, thereby eliminating the need for a separate balance control. If input program sources are balanced, the two sliders can be operated in unison with a single finger—a nice touch that works as well in practice as in theory.

Below the dial scale area are a phone jack (at the extreme left), seven small push-buttons; dual-concentric clutch-type bass, mid-range, and treble controls; a program selector switch; a dubbing-out jack, and a tape input jack (these are in addition to the usual tape monitoring in and out jacks on the rear panel). A speaker selector switch also turns on power, selects main or remote speakers, or chooses Radio Shack's "Quatravox" passive decoder circuit which synthesizes a four-channel effect from two-channel sources and is not unlike the Dynaco matrix introduced during the earliest days of four-channel excitement.

Those seven push buttons mentioned above take care of such things as switching on the Auto-Magic feature, introducing low and high filter circuits (at a 6 dB/octave slope rate), activating the tape monitor circuitry associated with the rear panel tape jacks (to gain access to the *Tape 2* front-panel jack, the main program selector must be switched to the *Tape 2* position), loudness circuit activation, mono stereo switching, and tone control bypass or defeat.

The rear panel of the STA-225 has screw-terminals for connection of two pairs of speakers, with pin-jacks paralleling the "main" speaker terminals in case your speaker systems come equipped with cables and built-in phono

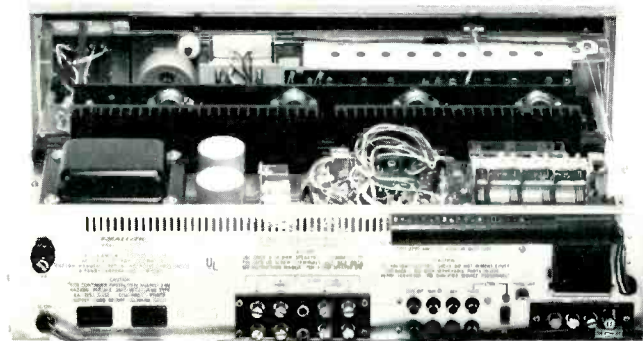

Fig. 1—Rear panel.

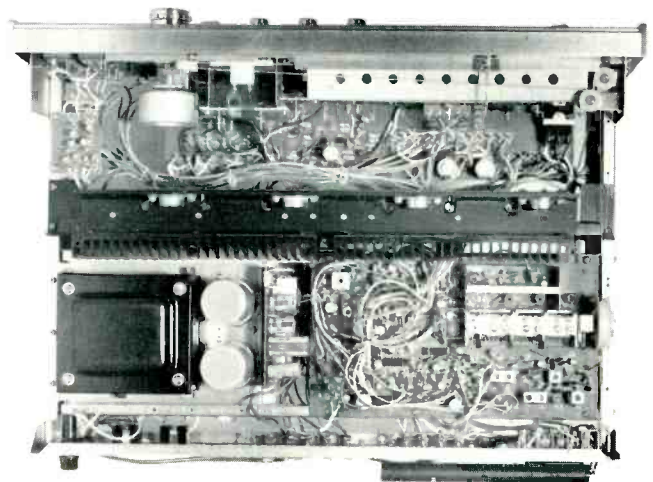

Fig. 2—Interior view.

plugs. Antenna screw terminals are provided for 75-ohm, 300-ohm, and external AM antenna connections, and would you believe that this \$400.00 receiver has one of those "capacitor clips" that couples the line cord to one of the 300-ohm terminals to serve as an indoor FM antenna? Since this rather minimal antenna arrangement does a poor job of rejecting multipath, we disconnected the clip for our tests and connected an outdoor FM antenna. Tape out and in jacks, AUX inputs, and phono input jacks are arranged between the speaker terminals and the antenna connections, and a switch near the phono jacks selects high and low input sensitivity. The rear panel also has a pair of a.c. convenience outlets, a line fuse, and a pivotable ferrite bar AM antenna. The rear panel is shown in the photo of Fig. 1.

### Circuit Features

The chassis layout and circuitry of the STA-225 is shown in Fig. 2. All tuner parts, including the AM and FM stereo decoder sections, are contained on a single large PC board. The other three major PC modules contain the pre-amplifiers, the tone control circuitry, and the main power amplifier circuits. The FM front-end is equipped with a four-gang tuning capacitor, an FET r.f. amplifier, and bi-polar oscillator and mixer stages. FM i.f. circuitry includes four IC stages (each tuned to 10.7 MHz with a ceramic filter between stages), a bi-polar input stage, and a conventional ratio detector. Multiplex decoding is accomplished by a single IC which utilizes the well accepted phase-lock loop approach to stereo demodulation. Several additional stages

# From Microvolts To Femtowatts

Len Feldman

**A**S MANY of our readers may already know, new standards for measurement of FM tuners and receivers were recently approved by the three major electronic organizations in this country, The Institute of High Fidelity, The Electronic Industry Association, and the Institute of Electrical and Electronic Engineers. Many new measurements of FM products are now called for in the new standard, including a host of previously omitted performance specifications having to do with stereo FM performance. (We will publish a definitive article on the new standards in the near future; meanwhile, those interested in the new standard can obtain a copy by sending \$6.00 to the Institute of High Fidelity, 489 Fifth Avenue, New York, N.Y. 10017 and requesting a copy of Standard IHF-T-200, 1975.)

One important change in terminology needs a bit of explaining right now, since our test reports dealing with FM products already reflect the use of this term—the dBf. dBf stands for "dB referred to 1 Femtowatt" and, for the uninitiated, a Femtowatt is  $1 \times 10^{-15}$  watts—a very small power figure indeed. The new standards require that signal strengths, formerly given in microvolts, now be given in terms of power—or actually in dB referred to 1 Femtowatt. The purpose of this change is to avoid certain ambiguities which were possible so long as the "microvolt" was used. It is the power of an incoming radio signal that really counts, and power involves a voltage developed across a known impedance. Clearly, 2 microvolts across 75 ohms represents exactly twice as much power as 2 microvolts across a 300-ohm impedance ( $P = E^2/Z$ ). A manufacturer who chooses to measure his microvolts by feeding them into the 75-ohm antenna terminals of his FM product will therefore come up looking twice as good (or having half as much signal requirement) as a competitor in terms of such specifications as usable sensitivity (IHF sensitivity), 50-dB quieting signal, stereo threshold signal strength, etc.

By converting to statements of power rather than voltage, such ambiguities are eliminated, since power is power no matter what the impedance involved. The new dBf system

will take some getting used to, and in fact, in our test reports of FM product performance we plan to give both  $\mu V$  numbers as the reference, and the resulting dBf numbers that correspond when the most popularly used 300-ohm antenna terminals are used.

To determine the dBf value for microvolt readings not listed (assuming a 300-ohm impedance and the old IHF "terminated" microvolts), the following formula should prove useful:

$$\text{dBf} = 20 \log_{10} \frac{\mu V}{0.55}$$

in which  $\mu V$  equals the number of "terminated microvolts" you wish to translate to dBf.

**Table I:** MicroVolts versus dB re 1 Femtowatt. "Familiar" Equivalent

Microvolt Readings (across 300 ohms)	dBf
1.6	9.28
1.7	9.80
1.8	10.30
1.9	10.77
2.0	11.21
2.1	11.64
2.2	12.04
2.5	13.15
2.7	13.82
3.0	14.74
5.0	19.17
7.0	22.09
10.0	25.19
100.0	45.19
500.0	59.17
1000.0	65.19
10,000	85.19
100,000	105.19



are employed in connection with the aforementioned Auto-Magic feature of this tuner section. When the user touches the tuning knob, an a.f.c. circuit is defeated, enabling you to accurately tune in desired FM stations (by ear, since the tuning meter acts only as a signal-strength meter). Releasing the tuning knob turns on the a.f.c., which then "pulls in" to center of channel, according to the instruction booklet. While we generally do not favor a.f.c. circuits, we must comment that during our distortion measurements, we weren't able to improve upon the "lock in" of this circuitry, which did home in on the minimum distortion point of received (or generated) signals. We found, too, that unlike less so-

phisticated a.f.c. circuits, the presence of this circuit did not prevent us from tuning to weak stations which were fairly close to strong ones. Obviously, not *all* a.f.c. circuits are alike, and the one in the STA-225 is worth having. Preamplifier-equalizer circuitry uses discrete devices (two per channel), and the tone controls are of the conventional feedback type. We were delighted to note that each of the slide-volume controls contains two potentiometers—one just ahead of the tone control-circuitry, the other at the input to the power amplifier section. This arrangement makes for best signal-to-noise at any listening level. The main power amplifier circuits feature direct coupling from input to output, a differential input stage, and complementary symmetry output stages. Also included is automatic circuit protection/amplifier shut-down circuitry which will trip if the amplifier is overdriven into too low a speaker impedance.

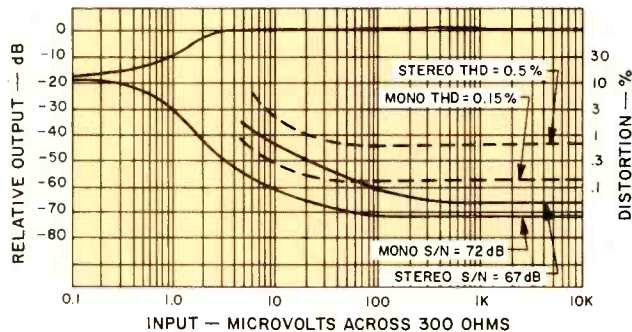

Fig. 3—FM quieting and distortion characteristics.

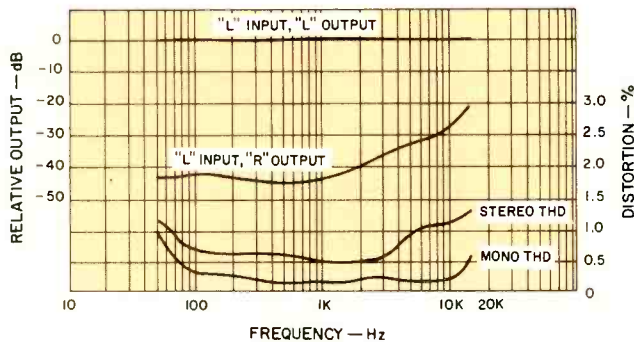

Fig. 4—Separation and distortion versus frequency.

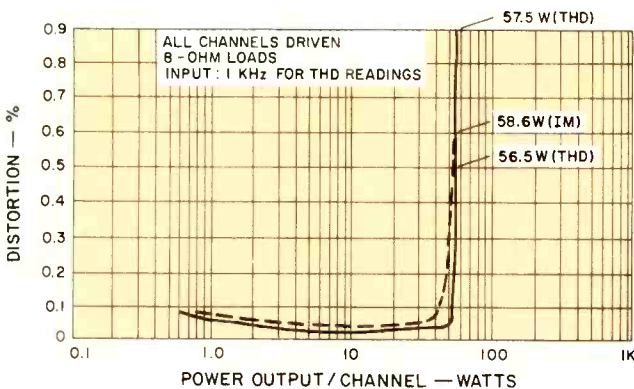

Fig. 5—Harmonic and intermodulation distortion versus power output.

### Tuner Measurements

Major tuner performance curves are shown in Fig. 3. IHF sensitivity in mono measured 2.6  $\mu$ V (equivalent to 13.7 dBf), while in stereo, usable sensitivity measured 6.0  $\mu$ V, or 20.9 dBf. The 50 dB quieting peak in mono was attained with a signal input of 3.0  $\mu$ V (14.93 dBf), while in stereo the same level of quieting was reached with a signal strength of 24  $\mu$ V (33 dBf). Ultimate S/N in mono was 72 dB, while in stereo, maximum quieting measured 67 dB. Mono THD measured a low 0.15%, but was 0.5% in stereo for the same 1 kHz audio signal at full modulation. Capture ratio measured 1.5 dB, while selectivity (alternate channel) was 70 dB as claimed. Image rejection was 73 dB, a bit better than claimed. Muting threshold (which is not adjustable by the user) was a bit higher than we deemed necessary, allowing signals to break through at levels of 10  $\mu$ V (25.4 dBf). Stereo switching occurs at signal inputs of 6.0  $\mu$ V (20.9 dBf) or higher—a well chosen threshold that corresponds exactly to the signal strength required to obtain usable stereo sensitivity.

As shown in the graph of Fig. 4, stereo separation was in excess of 40 dB from 50 Hz to 2 kHz, decreasing to 28 dB at 10 kHz. Distortion at frequencies other than mid-band are also shown in this graph.

### Amplifier Measurements

At mid-frequencies, the STA-225 delivered 57.3 watts for its rated harmonic distortion of 1.0%. At rated output (50 watts per channel), a 1 kHz output signal contained only 0.147% THD and IM measured 0.33% for this same output level. The rated 0.6% IM was reached at a power output level of 58.6 watts. At all lower output levels, THD and IM were both well below the 0.1% mark, as shown in the curves of Fig. 5.

Distortion was well within FTC limits over the entire frequency band, measuring 0.3% at 20 Hz and 0.63 at 20 kHz. In order to meet claims, the unit could have had as much as

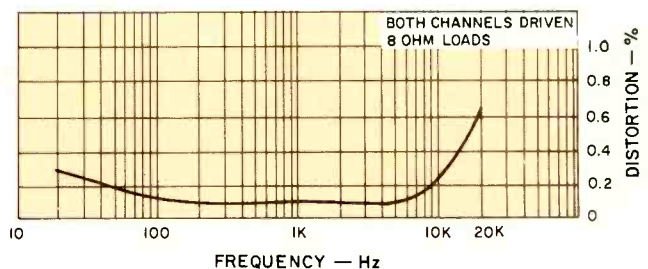

Fig. 6—THD versus frequency.

# INVISIBLE SOUND, CLEAN AND FAITHFUL.

Our two-way speaker systems ADS L400, L500 and L700 were developed right along with our more expensive studio speakers for the best possible reason: we wanted to create a coherent line of loudspeakers where every model, regardless of price, would have to reproduce musical sound with an optimum of clarity and a total absence of coloration.

When our engineers finally were able to meet these criteria, we called this remarkably open quality the 'Invisible Sound' of ADS. Since its introduction only two years ago, it has become the standard of excellence for many professionals and dedicated audiophiles.

Our lowest priced speaker, the ADS L400, costs less than \$100. Yet it shares with all other ADS systems the 'Invisible Sound' and the technical refinements that make this faithful response to the input signal possible. For instance, we install only one type of soft-dome tweeter, a masterpiece

in sophisticated audio design. Also, all ADS speakers utilize similar small-diameter woofers and the same computer-grade materials for the crossover networks. The craftsmanship and materials that go into every cabinet are of uniform, high quality.

When you listen to one of our two-way speakers for the first time, please note how the virtually massless tweeter meticulously renders every treble detail. Discover how smoothly the woofers take over the midrange frequencies, feel the strength and precision of their compliance to a sudden bass signal.

As a total value, we believe the ADS L400, L500, and L700 are without competition in their respective categories. Your local ADS dealer will proudly prove this claim in his sound studio. Take the time to test our speakers critically. Take the step beyond transparency. Experience 'Invisible Sound.' It will then be impossible for you to accept anything less.

Analog & Digital Systems, 64 Industrial Way, Wilmington, Massachusetts 01887.

400C-76 PG

**ADS** L700

**ADS** L500

**ADS** L400





1.0% THD at either of those two frequency extremes, and is therefore conservatively rated by any standards as far as audio power output is concerned. A plot of distortion versus frequency for full rated (50 watt) output is shown in Fig. 6.

Phono input sensitivity measured 1.5 mV in the "high sensitivity" position of the phono rear panel switch and 2.5 mV in the "low" setting. Overload of phono inputs took place with signal inputs of 180 mV or 90 mV, again depending upon the setting of the phono sensitivity switch. Hum and noise was generally much better than claimed, measuring 67 dB for phono (referred to the 2.5 millivolt input sensitivity and full output) and 76 dB in the high-level AUX setting. Input sensitivity for the AUX input measured 200 mV for full rated output. At minimum volume control settings, residual hum measured 102 dB below full output. Overall frequency

response of the amplifier section was flat within 1 dB from 20 Hz to 20,000 Hz.

Having recently acquired a spectrum analyzer in our laboratory, we decided to display tone control characteristics "live" instead of plotting them on graph paper. The photo of Fig. 7 is a composite, taken by producing sequential frequency sweeps from 20 Hz to 20,000 Hz. Each sweep is retained on a storage oscilloscope so that by successively boosting and cutting the bass, treble, and mid-range controls on the Realistic STA-225, we were able to assemble this composite display and record it photographically. Beats pushing a pencil on graph paper anytime, and it's far more accurate since every point is shown, instead of the relatively few points we usually take to plot a "continuous" pencil curve.

Inspired by the results (you may expect to see much more sophisticated applications of spectrum analysis in future test reports, including analysis of the spectral content of harmonic distortion), we decided to "plot" the action of the loudness circuit on our rather expensive version of an "etch-a-sketch" toy and the results, for reader's amazement and amusement, are shown in the 'scope photo of Fig. 8. As you can see, the loudness circuit is continuously variable, but what isn't readily apparent is that the circuit is tied in through the volume controls—an interesting arrangement.

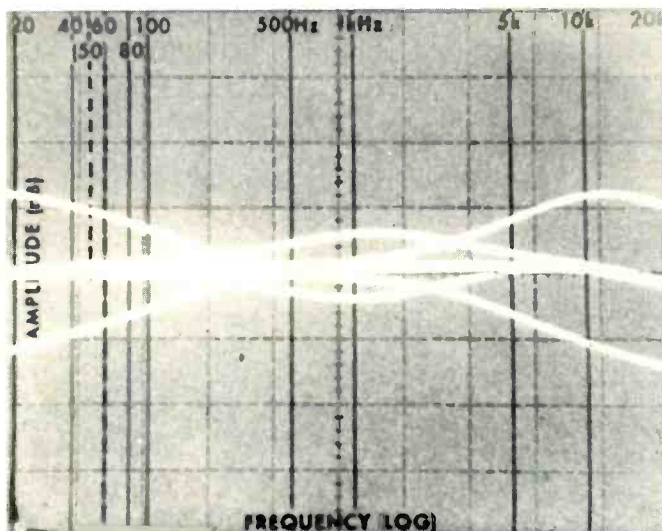

Fig. 7—Bass, midrange, and treble control range shown on spectrum analyzer sweep display. (Scale: 10 dB per vertical division.)

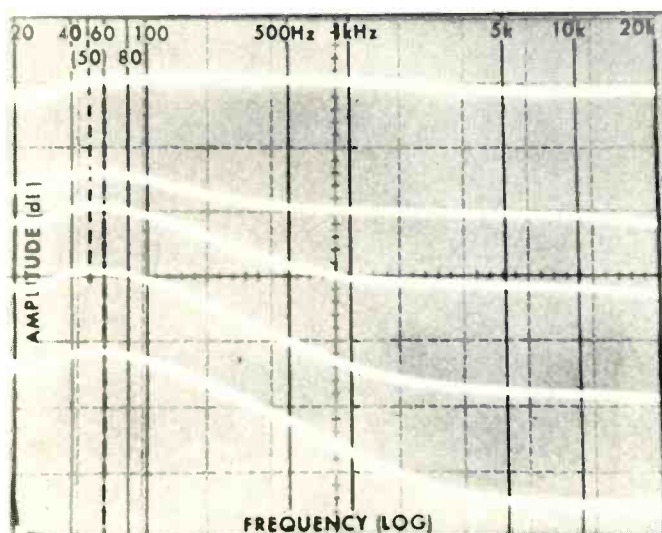

Fig. 8—Action of loudness control shown on spectrum analyzer sweep display. (Scale: 10 dB per vertical division.)

### Listening and Use Tests

Getting back to the STA-225, we hooked it up to a pair of low-efficiency, air-suspension speakers and put it through its paces. FM performance was quite good and, if you were wondering about the absence of a stereo indicator light, rest assured it was not forgotten. The dial pointer itself changes color (it glows a bright red) whenever a stereo signal is intercepted on the FM dial. Controls are easy to use and good to the touch, particularly those dual slide volume controls. The mid-range tone control is a useful feature usually found only on separate preamps and amps or much more expensive receivers. Sometimes called a "presence" control (because it can be used to enhance vocalist's sounds and to "bring the vocalist forward" in the stereo sound field), its range in the STA-225 is just right for its intended purpose—about +5 or +6 dB at maximum rotation.

After satisfying ourselves that the STA-225 performed well with our test speakers and a variety of program sources, we attached two more speakers and switched to the Quatravox mode. Depending upon the recordings used, synthesized four-channel effects ranged from barely audible to highly pronounced. Certainly, this circuit isn't intended to substitute for true four-channel but it is of some interest, especially if you own a large record collection and have some discs with sufficient out-of-phase "ambience" information to show off the passive circuit to its best advantage.

In summary, the Realistic STA-225 offers a great deal of value for its modest (these days) price of under \$400.00. Power output is solid all the way down to the nether-bass regions, and there was no evidence of excessive heat at the output stages even after several hours of use at loud volume levels. Perhaps Radio Shack is right in promoting the receiver for the more casual user by omitting some important specs and treating the connection panel in a "compact system" way, but we think the audio enthusiast seeking 50 watts per channel has graduated from that level and expects a more audiophilic approach to product presentation. When it comes right down to it, the STA-225 is just too good for anything less than an enthusiastic treatment from its makers and distributors.

Leonard Feldman

Check No. 90 on Reader Service Card

# A tribute to appreciation.

Music appreciation. Art appreciation. Appreciation for excellence in performance. A fulfillment that comes from the experience, not from the parameters by which it was created.

The Contrara Group of loudspeakers is a tribute to that appreciation. We should not deliberate how Amilio Contrara has sculpted the walnut, blended it with cloth and merged it with technology to bring visual satisfaction. Nor, how he has balanced the electronics with physics to provide audible gratification.

Ours is only to enjoy. To appreciate. To savor. Something only our ears and eyes can savor for themselves.

If you enjoy your music and quality craftsmanship, you'll appreciate the Contrara Group; it's a tribute to your sensitivity. Write us for additional information. We'll send you a booklet on appreciation and a list of locations where you can enjoy Contrara.



**CONTRARA GROUP**

**JENNINGS RESEARCH INC.** 64 N. Fair Oaks Ave. Pasadena, Calif. 91103

CIRCLE 25 ON READER-SERVICE CARD

Canadian Distributors: THE AUDIO GROUP, INC., Ontario.

For name of nearest dealer, call toll free area code (800) 447-4700. In Illinois, call (800) 322-4400.





DOLBY NR

RECORD



1 7 0



BIAS



EQ

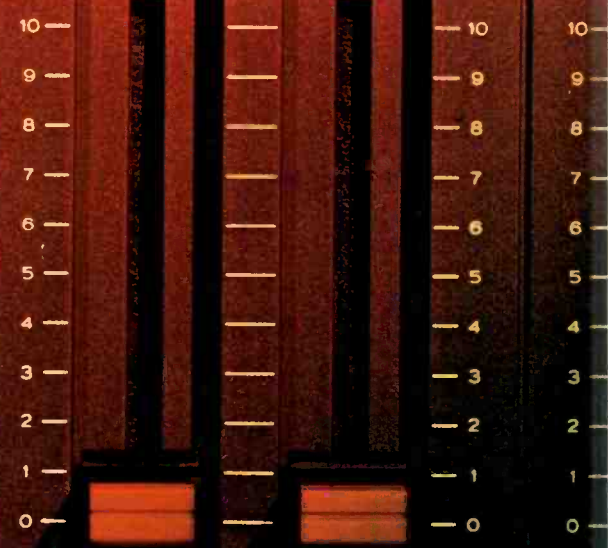

L

R

RECORD



STOP

PAUSE

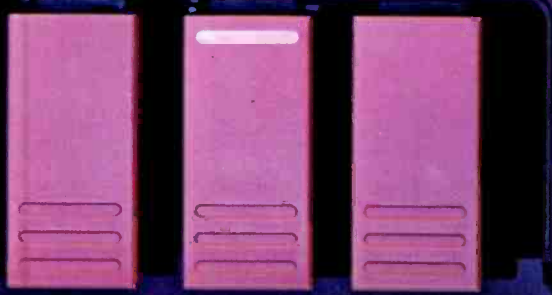

# TEAC performance and reliability ...

**how can you really afford anything less?**

At TEAC, our fundamental mandate for any new product is performance and reliability. First and finally. Qualities that are measurable in terms of mechanical stability and inherent design integrity.

These are essentials. Because our technological resources established the cassette deck as a true high fidelity component. So we demand that a new product possess that measure of TEAC quality.

And that's what distinguishes the A-170. Compare it with other inexpensive cassette decks, please. Just call (800) 447-4700\* for the name of your nearest TEAC retailer. We think you'll agree it's a value you can rely on. \*In Illinois, call (800) 322-4400.



## A-170

### TEAC®

The leader. Always has been.

TEAC Corporation of America/7733 Telegraph Road, Montebello, Ca. 90640/©TEAC 1975

Check No. 51 on Reader Service Card



## Technics T-400 Speaker System



### MANUFACTURER'S SPECIFICATIONS

**Frequency Response:** 38 to 20,000 Hz  $\pm$  3 dB, down 10 dB at 28 Hz, free field. **Dispersion:** 180° at 10 kHz. **Impedance:** 8 ohms. **Drivers:** 12-in. woofer, 5-in. midrange, 3 1/2-in. tweeter, two angled 2-in. super tweeters. **Crossover Frequencies:** 700 Hz, 3 kHz, and 7.5 kHz. **Enclosure:** Oiled walnut finish, fully sealed. **Dimensions:** 27 in. H x 15 in. W x 13 1/4 in. D. **Shipping Weight:** 53 lbs. **Price:** \$279.95.

Technics by Panasonic is not new in high-quality consumer audio. One of the better loudspeaker systems made under this trademark is the Model T-400, a four-way, five-driver system intended for floor mounting. The enclosure measures 68.6 cm. H x 38.1 cm. W x 33.7 cm. D. (27 in x 15 in. x 13 1/4 in) and weighs 24 kg. (53 lbs.). The sides and top are finished in oiled walnut, and a colorful sculptured foam and cloth grille accents the darker wood tones. Since the T-400 is generally intended for mounting adjacent to a wall, the rear of the cabinet is stained but not furniture finished.

Speaker connection is made to two well-marked terminals in a recessed cavity on the rear of the enclosure. Tweeter- and midrange-level switches are placed directly above the terminals. Each of these is a two-position switch, with the up position corresponding to normal equalization and the down position corresponding to a 3-dB level reduction.

A 30.5-cm (12-in.), high-compliance woofer is mounted on the bottom of the front panel and works into a sealed enclosure. A 13-cm (5-in.) midrange driver and 9-cm. (3 1/2-in.) tweeter share the central portion of the front panel, while two 5-cm. (2-in.) super tweeters are mounted at the top, angled away from the front axis for broader dispersion of the highest frequencies. A very clearly-written instruction manual accompanies each speaker.

### Measurements

Impedance as a function of frequency is shown in Fig. 1. The two extreme positions of level control are plotted since

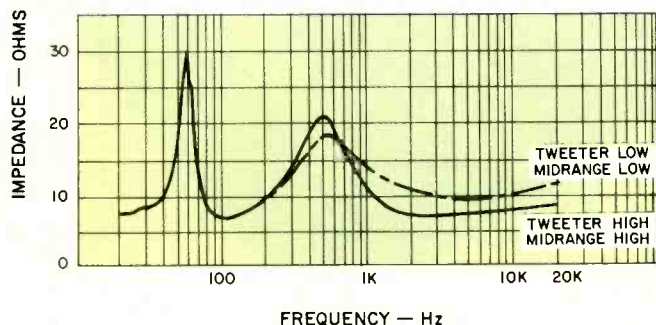

Fig. 1—Impedance versus frequency.

this represents the greatest impedance variation that will be seen by a power amplifier. The highest impedance is presented when the midrange and tweeter switches are both in the down or low position. The lowest impedance occurs for the switches placed upward. The T-400 is rated at 8 ohms, and the lowest value measured was approximately 7 ohms.

The polar impedance plot for the downward switch positions is shown in Fig. 2. In a sense, this polar measurement is a duplication of the impedance plot of Fig. 1. However, Fig. 1 is a plot of the magnitude of impedance and is a rapid overall look at the highest and lowest values of impedance and how they relate to frequency. Figure 2 goes a bit further and shows the nature of load which the speaker presents to an amplifier, including where it is capacitive reactive and where it is inductive reactive.

Two basic resonances exist, one at 58 Hz, the other at 490 Hz. Two worst-case capacitive-reactive loads for power amps occur at 65 Hz and 940 Hz. These are low enough in frequency that any well-designed amplifier should be capable of driving the T-400 without undue stress at high levels.

To check for impedance nonlinearities, a constant-voltage sine-wave signal is applied to the speaker terminals and a spectrum analysis made of the current demanded by the speaker. Impedance nonlinearities show up as distortion of this current and indicate the nature of load which constant-voltage power amplifiers must be able to control. A worst-case nonlinearity in impedance was measured at the bass resonance of 58 Hz. At a constant peak-to-peak voltage drive of 8 volts, corresponding to a drive level of one watt into the rated 8 ohms, speaker-drive current measures 3.2% second harmonic content (106 Hz) and 1% third-harmonic content (168 Hz). With the drive voltage increased to ten watts, the second harmonic rises to 5.5% while the third harmonic drops to 0.8%. While this indicates a small amount of magnetic field nonlinearity in the woofer for moderate cone excursion, the load current can be readily controlled by any well-designed amplifier, since it occurs at such a low frequency.

The free-field (anechoic) frequency response is shown in Fig. 3 for the amplitude of sound pressure at one-watt drive and a one-meter axial position, and in Fig. 4 for the phase of

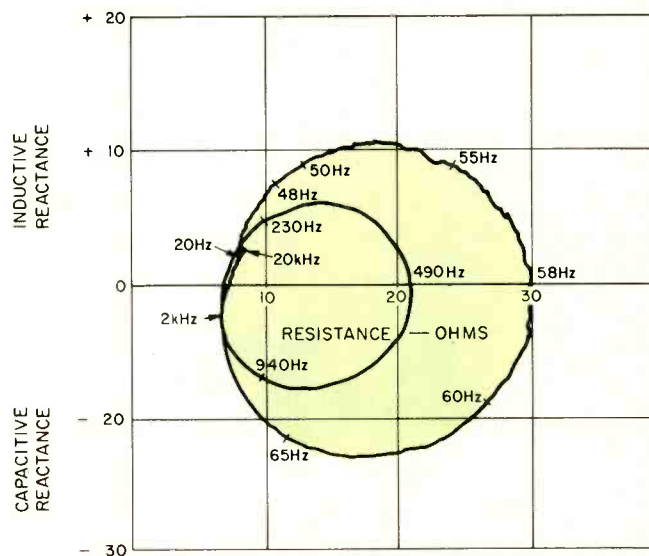

Fig. 2—Complex impedance polar plot.



# Phase Linear 8,515,200 watts later.



Back in '71 Phase Linear was Bob Carver, an audiophile with 200 square feet in the basement of an A & P store in the Pacific Northwest and one all-consuming obsession: to design and build the world's most powerful stereo amplifier.

Today Phase Linear Corporation is an acknowledged leader in high power technology, selling a complete line of amps and pre-amps throughout the world, operating out of one of the most advanced stereo component plants in the industry.

Phase Linear is now a household word among serious listeners, a word synonymous with power, quality, reliability and way-out-front technology.

And Bob Carver, Steve Johnson and A. P. VanMeter have come to be

recognized as the gurus of state-of-the-art amplifier design and development.

Phase Linear has dispensed over 8½ million watts of power to music lovers everywhere, starting with the famous super reliable, virtually distortion free Phase Linear 700, the first successful 700 watt amplifier. The popular Phase Linear 400 watt amplifier quickly followed. The incredible Phase Linear 4000 pre-amplifier was then perfected followed by a smaller version, the Phase Linear 2000. Recently the Phase Linear 1000 Noise Reduction System was added to the line . . . and there are many more advanced products in the wings.

Technological milestones along the way have included a unique Amplifier Protection Circuit (Patent #3,727,148),

the first practical Expansion System, the innovative Auto Corralator Noise Reduction System and a unique Ambience Injection System for pre-amps.

Phase Linear has come a long way from that basement lab of Bob Carver's. But products are still made one at a time, and one out of every three people in production is involved in quality control or testing.

And that's the way it'll be for the next 8,000,000 watts.

*Phase Linear*  
A POWERFUL DIFFERENCE

**Phase Linear Corporation,**  
20121 48th Avenue W.  
Lynnwood, Washington 98036

Check No. 32 on Reader Service Card



the sound pressure under the same conditions. The amplitude of sound pressure is plotted for the two extreme equalizer positions. The effect of the equalizers is approximately 3 dB, as specified by Panasonic.

Low frequency response extends down to about 55 Hz, dropping off smoothly below that frequency. Response up through the range of musical instrument fundamentals is smooth and uniform. A dip in response at around 1500 Hz is followed by strengthening of the output at around 7000 Hz. The response drops rapidly above 14 kHz for an axial one-meter microphone position.

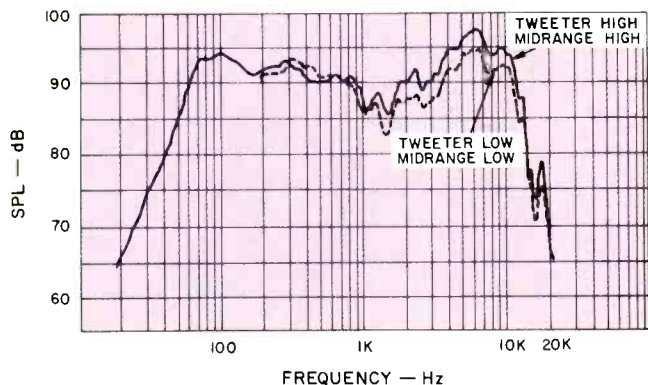

Fig. 3—One-watt, one-meter anechoic amplitude response.

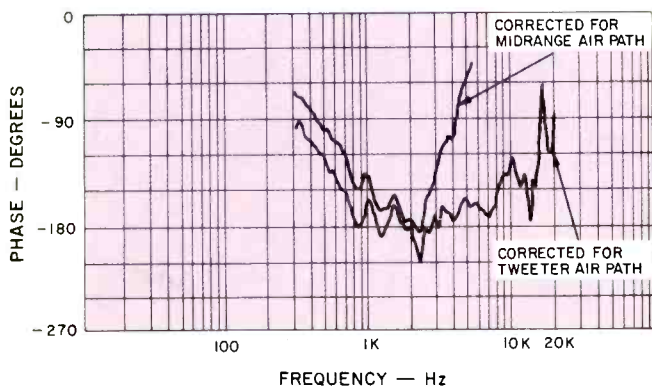

Fig. 4—One-meter anechoic phase response.

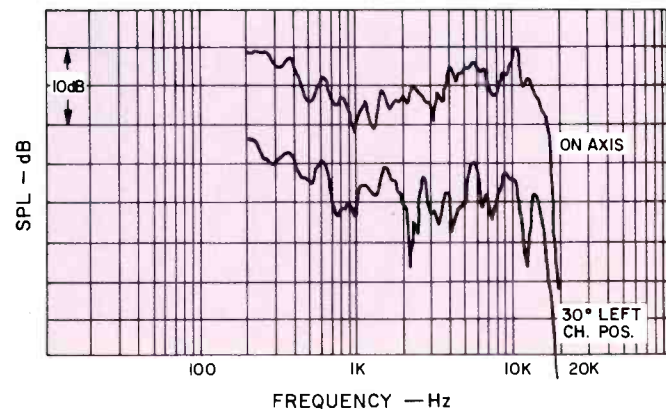

Fig. 5—Three-meter "room" response, tweeter and midrange controls in high positions.

From the phase response, it is evident that the sound from the tweeters arrives before the sound from the other speakers in this four-way system with frequencies above 8 kHz arriving first. Shortly afterward the sound from the 2.5-kHz to 8-kHz range arrives to reinforce the super-tweeter signal. One-tenth millisecond later, the 800-Hz to 2.5-kHz sound is heard, and 0.25 millisecond after this, the sound spectrum below 700 Hz is received. The phase response is shown for two time delays; the curve marked "corrected for tweeter air path" is plotted for the arrival of sound from 2.5 kHz to 8 kHz, the other curve is plotted for 800 Hz to 2.5 kHz arrival. The sound from all drivers above about 800 Hz is uniform in phase transition but is 180 degrees out of phase with frequencies below that. This will not be significant when T-400s are used throughout the sound system, but indicates that some care may be needed if this speaker is used for a quadraphonic addition to an existing stereo installation.

The phase transitions are smooth and uniform, however, the arrival time differences make the response non-minimum phase. The basic frequency response changes with off-axis angle. At 15 degrees from the direct on-axis position, the high-frequency drivers interfere with each other and create a nonminimum phase characteristic with 540 degrees of acoustic phase angle change at 6.6 kHz.

The way a speaker sounds in a room is far more important to a listener than its anechoic chamber response. Figures 5 and 6 show more nearly the way the T-400 measures in a room. The unit was placed along a wall, as recommended by Panasonic, the listening position located 3 meters away from the speakers and one meter above the floor. The frequency response corresponding to the first 13 milliseconds of sound due to an impulse is shown in these figures. Both a direct-front listening position and a 30-degree left-channel-stereo seating position were measured. The curves are displaced 10 dB on this plot to prevent confusion.

These measurements indicate that the T-400 will tend toward a lower pitch dominance in its timbre at around 200 Hz, a sound some would describe as "chesty." This may be partially corrected by pulling the T-400 away from the wall. The midrange level is down with respect to the extreme top end.

The T-400 is definitely hotter in high-frequency response when pointed toward the listening position than when a normal off-axis stereo listening position is taken. The "chesty" sound may be somewhat offset by rotating the speakers slightly so they point more nearly toward the listening position. The effect of floor and ceiling scatter is minimal in this early sound as is shown by the similarity of this response and the anechoic measurement.

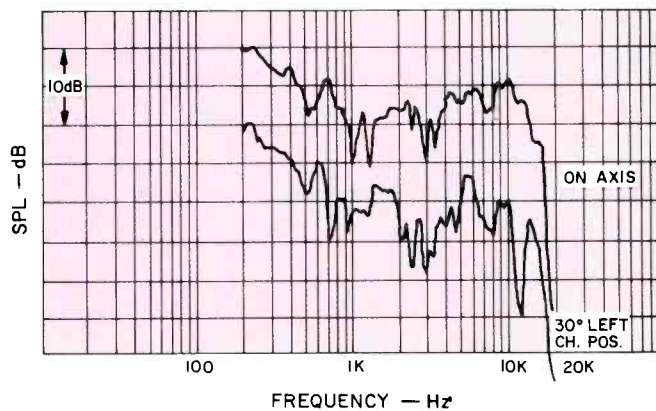
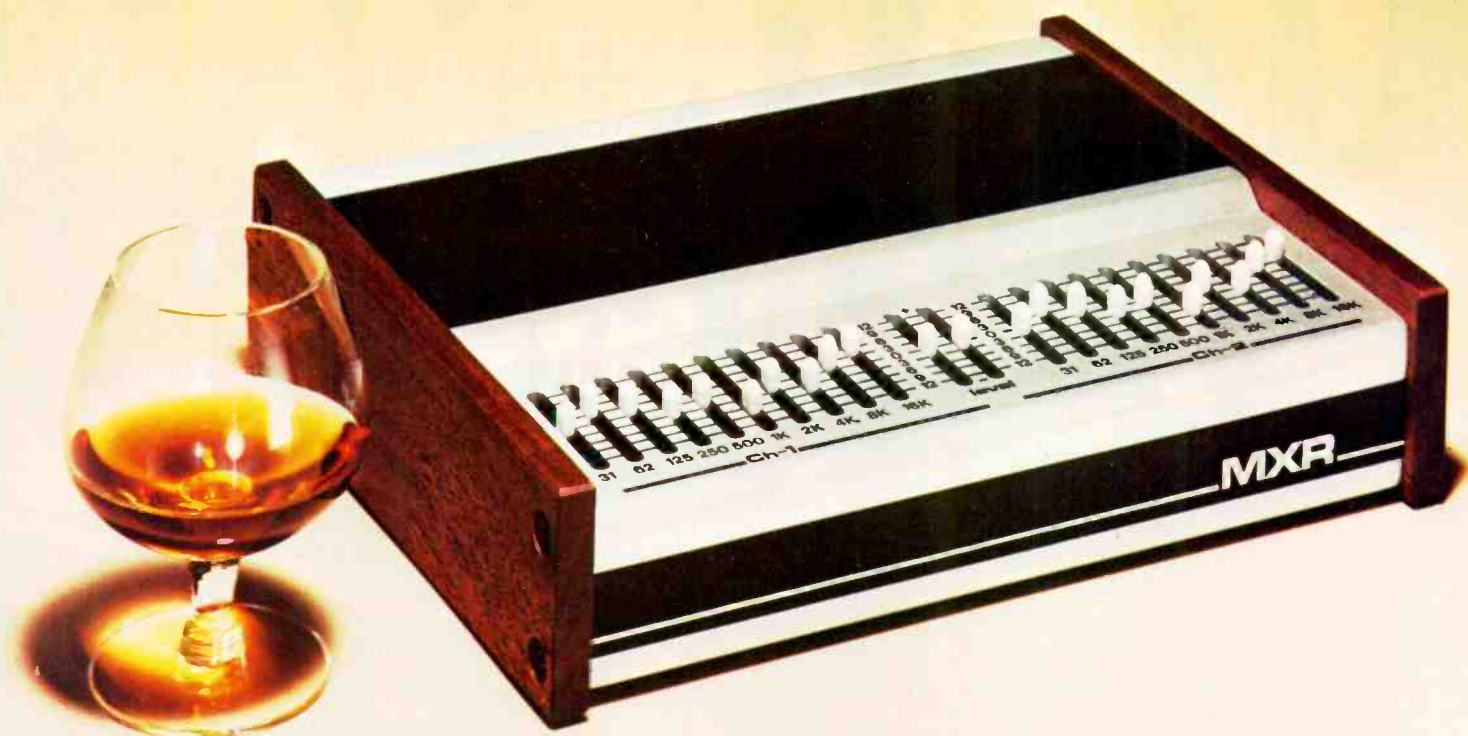

Fig. 6—Three-meter "room" response, tweeter and midrange controls in low position.



# To Your Taste

Even the most perfect of high fidelity systems cannot escape those little inconsistencies that nag the ear. Room acoustics, speaker inadequacies, or even recording quality can produce listening environments that are less than optimum.

Then, too, each person has his own tastes in frequency response that can vary from time to time, or recording to recording.

Presenting the answer to your frequency response problems: The MXR two channel ten octave-band equalizer. Ten bands divide each channel's frequency response in one octave increments.

Boost or subtract from the tonality of an octave spread in either channel. A gliding touch of a slide control tailors the frequency response of your system to your room acoustics. Add punch to a bass line. Or brighten up a flute solo. Precisely; repeatably.

Uniquely affordable and elegantly appointed, the MXR two-channel equalizer is crafted in hefty brushed aluminum, with simulated leather and solid oiled black walnut. Its design and circuitry will compliment any modern hi-fi system with gentle elegance and imperceptible distortion.

Its extreme dynamic range allows for application in many situations, and it is therefore made available in a professional version with phone jacks, and a home stereo version with pin jacks and tape monitoring capabilities.

It is instantly adaptable to your system and available at leading dealers at the incredibly reasonable price of \$199.95.

**MXR**  
Innovations

Check No. 28 on Reader Service Card



# The new Po by Sansui



**SANSUI ELECTRONICS CORP.**  
Woodside, New York 11377 • Gardena, California 90247 • SANSUI ELECTRIC CO., LTD., Tokyo, Japan  
SANSUI AUDIO EUROPE S.A., Antwerp, Belgium • In Canada: Electronic Distributors



# Powerhouse



Power, features and performance. That's what the new Sansui 9090 stereo receiver is all about.

Look what it has to offer • A whopping 110 watts of continuous RMS power per channel driven into 8 ohms over the 20 to 20,000 Hz range with no more than 0.2% total harmonic distortion • Twin power meters to monitor the output for each channel • Advanced PLL IC Multiplex Demodulator for improved channel separation, eliminating distortion and reducing detuning noise • Twin signal meters for easy, accurate tuning • 7-position tape play switch for total creative versatility in dubbing and monitoring • and many other exciting features • cabinet finished in walnut veneer.

All in all the Sansui 9090 represents what is probably the most advanced receiver available today. Watt for watt, feature for feature, dollar for dollar, an almost unbelievable value at under \$750.\*

Also available is the Sansui 8080 at under \$650\* with 80 watts of continuous RMS power under the same conditions with almost all the same features. Cabinet in simulated walnut grain.

Try, and then buy, one of the new Sansui receivers at your favorite Sansui franchised dealer today. You will be glad you did. For years to come.

\*The value shown is for informational purposes only. The actual resale price will be set by the individual Sansui dealer at his option.



Sansui 9090

Sansui 8080

Check No. 42 on Reader Service Card



The polar energy response is shown in Fig. 7 for a horizontal pattern and in Fig. 8 for the vertical pattern. This measures the angular dependence of the total sound energy from 20 Hz to 20 kHz. The T-400 has a preferred left-versus-right horizontal directivity, as shown. The sound is also directional in its vertical characteristics, with an upward launch angle that is about right for floor-mounted listening. This correlates well with the observation that the room response is similar to the anechoic response, the exception being the 200-Hz reinforcement commonly noted for wall placement with enclosures of this size. In many listening situations, it would appear that better stereo imagery could be

obtained by rotating the speakers toward the average listening location. The directional characteristics may prove to be a mixed blessing. Normal room decor will not materially affect the sound, but the stereo image will tend to "walk" with you as you move about the listening area and will also tend to constrict the area.

Harmonic distortion for the musical tones E1, A2, and A4 is shown in Fig. 9. Third harmonic distortion, which corresponds to the creation of the fifth in the octave higher, is stronger in the T-400 than the second harmonic for A2 and A4. At E1 or 41 Hz, the woofer is having some difficulty, which indicates some nonuniformity of cone motion. At 440 Hz the harmonic distortion is acceptably low, however the average position of the woofer cone moves outward from its no-signal physical location as the sound level is increased. At the maximum drive level of Fig. 9, the net displacement is 1.3 cm. at 440 Hz. This very slight breathing of average physical position with drive is very common in loudspeakers and can account for some stereo image wander under rapidly changing musical program dynamics.

Intermodulation distortion was measured by mixing the tones E1 (41.2 Hz) and A4 (440 Hz) in equal portion. These tones are chosen because of their musical significance and

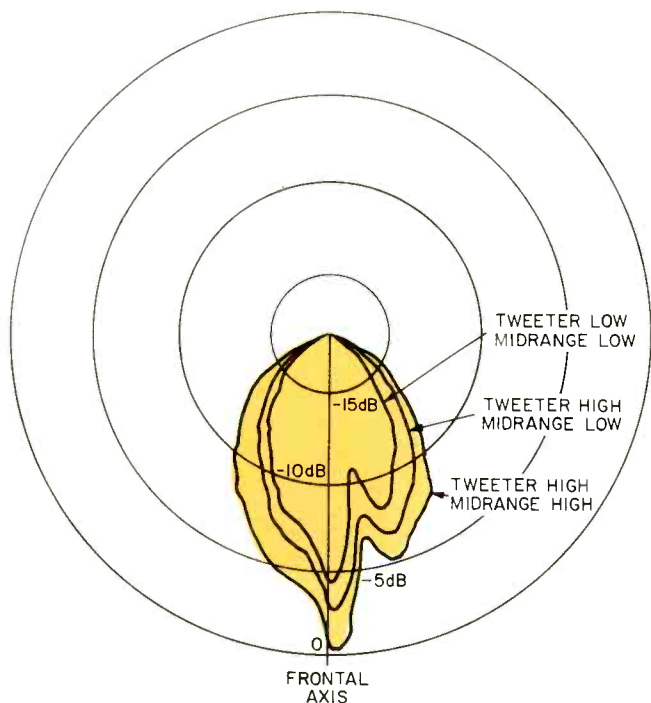

Fig. 7—Horizontal polar amplitude response.

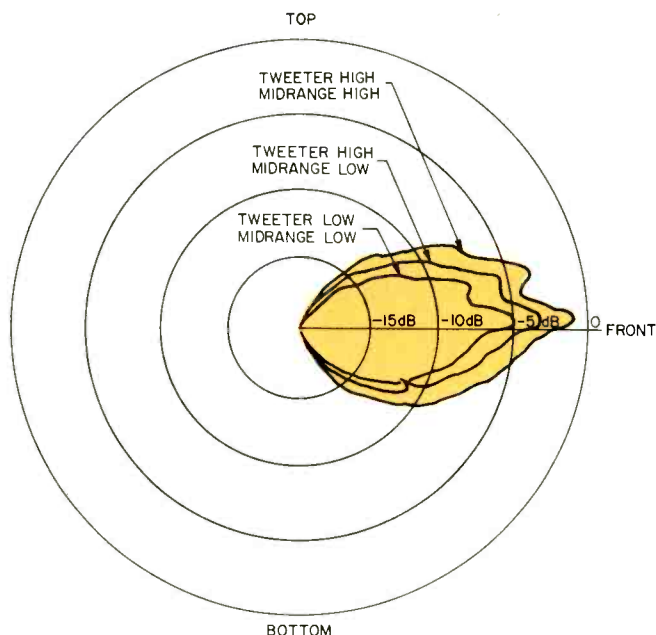

Fig. 8—Vertical polar amplitude response.

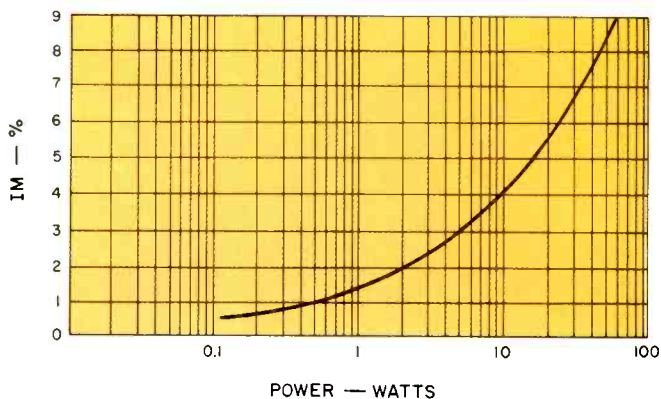

Fig. 10—Intermodulation of A4 or 440 Hz by E1 or 41 Hz, mixed one to one.

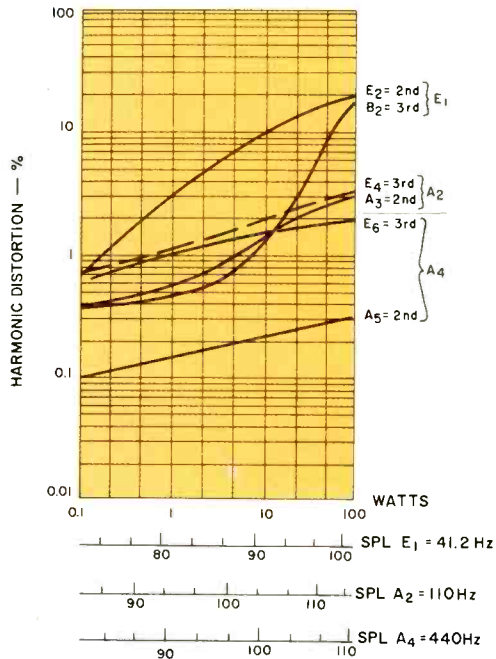

Fig. 9—Harmonic distortion for the musical tones E1 or 41 Hz, A2 or 110 Hz, and A4 or 440 Hz.

# While everyone is still trying to make V-FETS at any price, we now make them at a lower price.



When Sony introduced the first amplifiers with vertical field-effect transistors last year, the reactions were nothing short of incredible.

Consumers wrote in asking where they could hear the equipment. Audiophiles demanded to know where they could buy it. And our competitors wanted to know how they could make it.

In fact, the only problem was that more people couldn't afford the \$1300 price.

So, we at Sony decided to do something about it. And what we've come up with is our new \$400 V-FET integrated amplifier, the TA-4650. The TA-4650 is quite an advanced little piece of equipment. Because the V-FET isn't just another combination of gadgets, or a souped-up version of the same old thing. It's a completely new device that combines the good points of both bi-polar transistors and triode vacuum tubes. Without suffering the drawbacks of either. Because it's made with V-FETS, the TA-4650 gives you a new level of highly defined triode sound; along with the efficiency and stability found only in solid state devices. The TA-4650 delivers 30 watts per channel, minimum RMS at 8 ohms, 20Hz-20kHz with no more than 0.1% total harmonic distortion.

It has a direct coupled power amplifier stage. As well as direct coupled FET amplifiers in the tone control and buffer stages.

Its bass and treble controls have a turnover frequency selector that starts at 250HZ/500HZ for bass and 2.5kHz/5kHz for treble.

Its volume control is equipped with a switch for 20dB muting. And it has a level control memory device so volume can be set at any predetermined point.

But as good as our new V-FET amplifier is, we're just as proud of the components we make to go along with it.

Our ST-4950 AM/FM stereo tuner, for example, has a MOS FET front end, uni-phase solid state filters and IC's in IF stages. This allows an FM capture ratio of only 1.0dB, selectivity of 80dB and an S/N ratio of 70dB. The ST-4950 also has a phase-locked loop

(PLL) MPX section. Which means you get excellent stereo separation and low distortion.

Of course, if you're going around looking for a turntable, by all means take a look at our PS-4750 (cartridge sold separately).

It has a direct drive servo motor with a wow and flutter rating of only .03%.

Its base and platter are made from molded compound instead of metal, so resonance has been greatly reduced. It also has air-damped cushions, which compensate for warps in records (again reducing resonance). The end result is a much cleaner sound.



It's no accident that Sony makes the world's first commercially available V-FET equipment. Or that we have matching components good enough to complete your system.

You see, we've got more solid state audio experience than anyone else. We've been at it for twenty years. For proof just stop by your Sony dealer. And use your ears.

\*TA-8650: 80 watts per channel, min. RMS @ 8 ohms, 20Hz-20kHz, with no more than 0.1% total harmonic distortion.

# SONY®

©1975 Sony Corp. of America, Sony, 9 W. 57 St., N.Y., N.Y. 10019. SONY is a trademark of Sony Corp.

Check No. 13 on Reader Service Card

www.americanradiohistory.com



because they are shared by the same driver in the T-400. The measured modulation of A4 by E1 is shown in Fig. 10. The intermodulation is primarily amplitude modulation with very little phase modulation. As the power level is raised, the average position of the cone moves outward and accounts, at 60 watts, for a 15-degree static phase advance of the 440-Hz tone due to the presence of the 41-Hz tone.

The ability of the T-400 to handle broad-band peaks such as applause, is measured in the crescendo test. A representative inner musical voice, such as A4 (440 Hz) or middle C (262 Hz), is measured by itself, and then in the presence of wideband Gaussian noise with an average power (measured over a 20 kHz band) 20 dB higher than that of the musical voice. A crescendo limit is defined when the inner voice is reduced 1 dB in level by the presence of the incoherent noise. In the T-400 the crescendo limit was reached at a peak noise power of approximately 125 watts for the tone A4, and a peak power of 312 watts for tone middle C. This indicates a moderately strong power-handling capability.

The ability of a loudspeaker to provide good reproduction of transient sounds is measured with a perfect transient—the impulse. In the tests performed by *Audio*, the impulse response is computed from the frequency response, that is, the analytic signal is computed and its magnitude is plotted in dB versus time, in a form called the energy-time curve. The energy-time curve for the T-400 is shown in Fig. 11 for a one-meter axial microphone position and in Fig. 12 for a one-meter 30-degree off-axis position—the direction the listener would assume in the left-channel stereo position.

The super tweeters and the main tweeter are positioned on the front panel of the enclosure so that their sounds

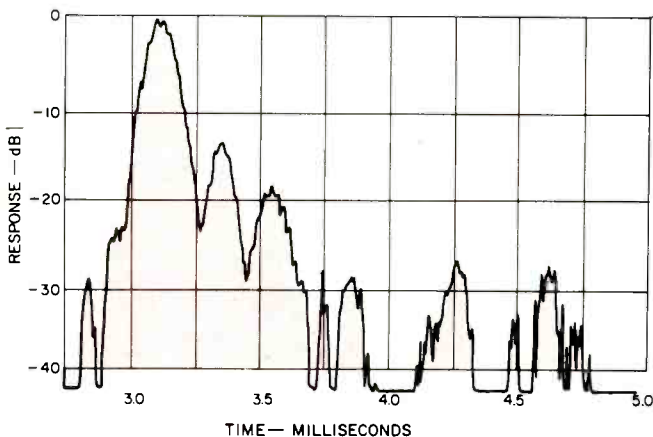

Fig. 11—One-meter energy-time response measured on axis.

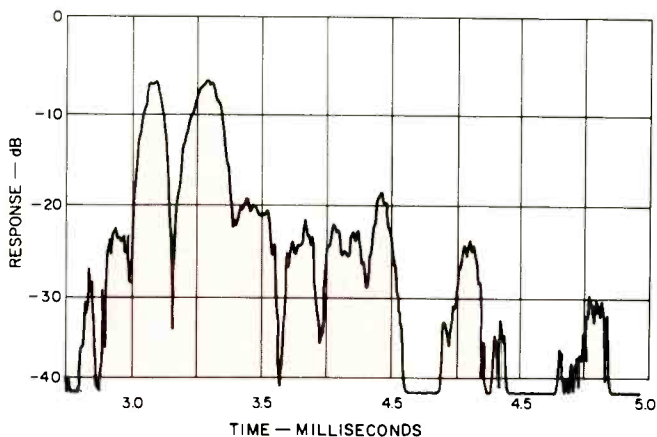

Fig. 12—One-meter energy-time response measured 30 degrees off axis.

coincide and reinforce, for a direct front listening position. This is shown in Fig. 11 by the single energy peak at 3.1 milliseconds. The subsequent peaks at 3.3, 3.6, and 3.8 milliseconds are reverberation components falling off at a rate of about 32 dB per millisecond. These will not significantly color the impulse behavior on-axis because of their rapid decay. The enclosure edge-diffraction components at 4.25 and 5.64 milliseconds are also well down, at levels of 28 dB below the first sound.

The off-axis transient response does not fare as well as the on-axis response because of the lateral spacing between the average acoustic centers of the super tweeters and the center of the midrange and tweeter speakers. This causes a spread of energy over a range of one millisecond from first arrival. The result is a loss of clarity of sharp transient sounds and a change in the timbre between off-axis and on-axis listening positions for frequency components above 1 kHz. The edge-diffraction components are slightly displaced, due to the change in geometry, but remain at a reasonably low level at 4.3 and 4.8 milliseconds. In spite of the difference in appearance between the on-axis and off-axis energy-time curves, 95 percent of the sound energy from both positions arrives within 0.45 milliseconds of the first sound arrival. These measurements lead this reviewer to recommend rotating the T-400 toward the listening position to improve its transient reproduction.

### Listening Test

The T-400 speakers were initially placed against a flat wall, as recommended by Panasonic. The listening geometry chosen for stereo material consisted of an equilateral triangle with the spacing between speakers approximately 3 meters. In this position there was a distinct midbass peak that caused an unnatural emphasis of male vocals and midbass instruments. This was partially cured by pulling the speakers away from the walls about a half meter, but the bass was still considered too hot. The T-400 is a good reproducer of organ music, but has a distinct tendency to make you aware of any rumble or hum in your system. A small bass cut with the pre-amp equalizer finally achieved what was considered the best balance. At high sound levels the bass has a tendency to become less distinct in percussive articulation.

After considerable adjusting and listening, final adjustment positions were the midrange equalizer switch in the high position and the tweeter switch in the low position. The extreme high frequencies were down in level when this was done, but a more uniform balance resulted without top-end spit or annoying levels of audible record scratch.

The T-400 delivers good kick drum sound and can handle a lot of horn and brass peak power without caving in. Solo vocals are well placed and clear in the stereo image. Choral groups seemed spatially smeared and indistinct. Despite this apparent contradiction in reproduction of the human voice, this impression was noted in several types of selections.

The listening position for good stereo imagery is a bit critical for wide range material when the speakers are placed flat against the back wall. Rotating the speakers toward the listening position definitely helped the stereo imagery at the preferred listening position, but restricted the listening area to a best-seat-in-the-house situation. If one listens alone, I recommend pulling the speakers away from the wall and rotating them inward toward your seating location; otherwise, pull them away from the wall but do not rotate them.

The T-400, though not intended as state of the art, does deliver accurate and high quality sound. It demands a good amplifier and clean program material and is well suited for listening areas that are bright in their acoustic properties.

Richard C. Heyser

Check No. 91 on Reader Service Card

**This Christmas give a sound gift**

# **GIVE AUDIO MAGAZINE**

Looking for the perfect gift for the hi-fi/stereo enthusiast? Maybe it's your son, sister, father, friend or even a business associate. Give Audio Magazine, the gift that will be remembered twelve times during the year . . . the gift that comes every month.



## **A SUBSCRIPTION TO AUDIO**

The first gift subscription is only \$7.00 and each additional gift subscription is at the money saving rate of \$4.68. Give the gift that's special . . . and save when you buy two or more subscriptions.

## **WE'LL SEND AN ENGRAVED GIFT CARD**

Each person will receive a beautifully engraved gift card telling the gift is from you. Take advantage of this special holiday offer. Mail the order form today. By the way, why not include yourself and extend your own subscription.

## **SPECIAL CHRISTMAS SUBSCRIPTION ORDER**

First Subscription \$7.00, 1 year

Name \_\_\_\_\_

Address \_\_\_\_\_

City \_\_\_\_\_ State \_\_\_\_\_ Zip \_\_\_\_\_

Additional Subscription \$4.68, 1 year

Name \_\_\_\_\_

Address \_\_\_\_\_

City \_\_\_\_\_ State \_\_\_\_\_ Zip \_\_\_\_\_

Additional Subscription \$4.68, 1 year

Name \_\_\_\_\_

Address \_\_\_\_\_

City \_\_\_\_\_ State \_\_\_\_\_ Zip \_\_\_\_\_

Engraved Gift Card should read from \_\_\_\_\_

Bill Me     Payment enclosed

Charge my credit card No. \_\_\_\_\_ Expires \_\_\_\_\_

American Express

Master Charge

(Bank No. \_\_\_\_\_)

My Name \_\_\_\_\_

Address \_\_\_\_\_

City \_\_\_\_\_ State \_\_\_\_\_ Zip \_\_\_\_\_

Signature \_\_\_\_\_

Rush this order to Audio Gift Manager,  
401 N. Broad Street, Philadelphia, Pa. 19108



## Yamaha Model CT-7000 Stereo FM Tuner

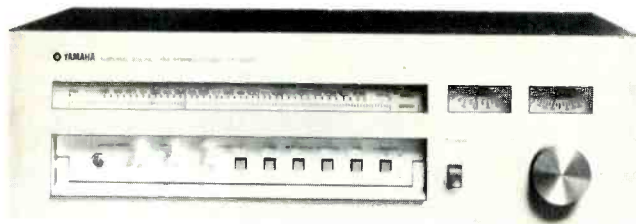

### MANUFACTURER'S SPECIFICATIONS

**IHF Sensitivity:** Normal, 2.0  $\mu$ V; Wide, 2.5  $\mu$ V. **Selectivity:** Normal, 85 dB; Wide, 18 dB. **S/N:** Mono, 78 dB; Stereo, 75 dB. **Capture Ratio:** Normal, 0.7 dB; Wide, 0.6 dB. **THD:** Mono-normal, 0.06%; Mono-wide, 0.04%; Stereo-normal, 0.06%; Stereo-wide, 0.04% at 400 Hz. **THD** (from 50 Hz to 10 kHz): Mono-normal, 0.2%; Mono-wide, 0.08%; Stereo-normal, 0.3%; Stereo-wide, 0.15%. **Image, I.F. and Spurious Rejection:** Over 120 dB. **AM Suppression:** Over 60 dB. **Separation:** 400 Hz, normal or wide, 50 dB; from 50 Hz to 10 kHz; normal, 35 dB; Wide, 40 dB. **Frequency Response:** 30 - 15000 Hz  $\pm$  0.3 dB. **Sub-carrier Suppression:** 70 dB. **Muting Override Signal Level:** From 3 to 30  $\mu$ V. **Stereo Threshold:** From 3 to 30  $\mu$ V. **Output Level:** 775 mV fixed; 2mV to 70mV variable.

### GENERAL SPECIFICATIONS

**Power Consumption:** 23 watts, 13 watts with illumination off. **Dimensions:** 17  $\frac{1}{4}$  in. W x 5  $\frac{3}{4}$  in. H x 12  $\frac{1}{2}$  in. D. **Weight:** 28.6 lbs. **Price:** \$1200.00

The first thing that must be said about this magnificent FM tuner from Yamaha is that it succeeded in giving the test equipment in our laboratory a bad inferiority complex. Frankly, we thought we had upgraded our measurement equipment so that it was a couple of orders of magnitude better than anything we would be called upon to test. Yet the Yamaha CT-7000 specs are, in the main, better than we are able to measure. And rather than repeat that statement with each reported measurement that follows, we thought we'd better get that out of the way right at the beginning. We shall report our measurements as we read them, with the understanding that readers (and the people at Yamaha) will sympathize with our limitations.

As for the operating features, circuit highlights, and appearance of this tuner, those we can describe quite accurately, and the photo of the front panel helps. Many of the goodies are hidden under that sleek hinged door which runs across most of the lower portion of the front panel. But with it closed, all one sees when looking at the brushed silver panel of the Yamaha CT-7000 is a long, linear dial scale, calibrated at every MHz and augmented by a 100 point logging scale for easy station reference. Two small "windows" at the right frame the center-of-channel tuning meter and the signal-strength meter which also doubles as a multipath indicating meter. There's a lever-toggle power on-off switch

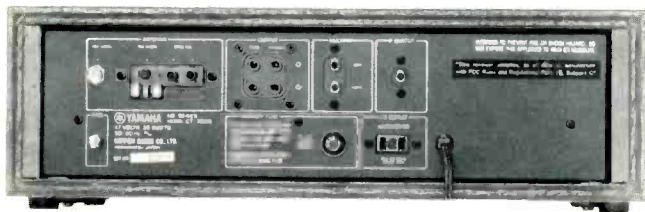

Fig. 1—Rear panel.

and a massive tuning knob coupled to just about the smoothest acting flywheel arrangement we've ever spun across the 20 MHz's of the FM band. Ah, but when you tap the door base lightly to open it (it swings downwards), what additional wonders are disclosed! There's a built-in headphone jack powered by its own amplifier and a level control for that output, as well as one for the variable-level output jacks at the rear. There's a *Muting* on-off switch placed adjacent to a control which varies muting threshold, an *I.F. Mode* switch which varies the i.f. bandwidth (about which we'll have much more to say shortly), a button which selects mode of operation of the dual purpose signal-strength meter, an *Auto-Blend* switch which, when activated, introduces two degrees of high-blend when listening to weak-signal stereo, depending upon actual signal strength. Also hidden behind the hinged door are a mono/stereo *Mode* switch and a pushbutton which turns the dial *Illumination* on and off.

The rear panel, pictured in Fig. 1, contains antenna input terminals for 300-ohm connection and two types of connection facilities for 75-ohm transmission lines—one a coaxial connector, the other a combination of cable clamp (to retain the cable by gripping the outer shielded conductor) and screw terminal for the inner conductor. There are two pairs of output jacks, one for the fixed level outputs, the other for the variable level outputs controlled from the front panel. A pair of jacks designed for connection to an external oscilloscope comes next, followed by an i.f. output jack (which might perhaps be labelled more clearly as a detector or 4-channel output jack which is what it is). A chassis ground terminal, fuseholder and unswitched convenience a.c. outlet complete the rear panel layout.

### Circuit Details

Details of the circuitry contained in the Yamaha CT-7000 would take longer to enumerate than the entire length of this report. We shall try to describe a few of the more important and innovative ones. (Refer to Fig. 2, an internal view.) Three dual-gate MOS FETs are used in the frontend, which contains two full stages of r.f. amplification and employs what Yamaha claims is the world's first seven-gang tuning capacitor. A seven-stage differential amplifier is used in the i.f. section together with ceramic and LC filter blocks. There are actually two separate i.f. stages; "normal" mode is for best selectivity in "crowded" signal areas, while "wide-band" works best where station crowding is not a problem

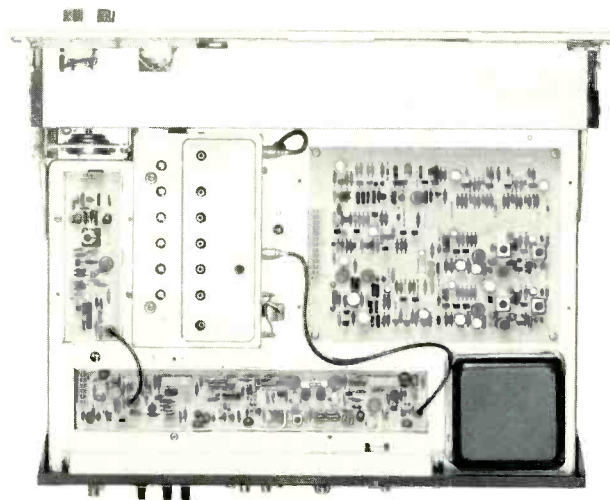

Fig. 2—Interior view.

# Reintroducing A World Standard...

## CBS Laboratories' STR Professional Test Records



For over ten years, the original series of these high-precision test records set a standard for the audio industry. Now the new series sets an even higher standard. It's been revised, recut and expanded.

The new series consists of eight records for professionals and one for non-professional audiophiles.

Each record contains a complete series of easy-to-use tests to help you rapidly and accurately evaluate components and systems. Even one of these records can eliminate the need for costly, additional equipment. Each will find productive use and save you hours in the laboratory, on the production line and in field testing.

Take a look at what this essential testing series contains:

**SEVEN STEPS TO BETTER LISTENING**—For only \$6.98, you can improve your system with CBS Laboratories' "Seven Steps to Better Listening." This high-precision test record enables you to make sure that your equipment functions properly . . . to tune your system to your ears and your room acoustics. Included is a detailed 16-page booklet by Audio's Edward Tatnall Canby explaining how to use the record to improve the performance of your system. With the record you can perform the following "ears alone" tests: left-right identification, phasing, loudspeaker balance, tone control setting, alternate phasing, buzz and rattle elimination, lateral tracking, and vertical tracking.

★ **STEREOPHONIC FREQUENCY TEST RECORD STR 100** Designed for the evaluation of pickups and systems. Provides a constant amplitude characteristic below 500 Hz and a constant velocity characteristic above 500 Hz. Tests include: Sweep Frequency—with the sweep rate synchronized for use with a graphic level recorder; Spot Frequency—with voice announcements; Channel Separation; Wavelength Loss and Stylus Wear—to pinpoint oversize or worn-out styli, and excessive pickup tracking force; Compliance; Phasing; Vertical and Lateral Tracking; Tone Arm Resonance—to check system performance at low and subaudible frequencies and thus reveal undamped resonance which may cause equipment overloading.

★ **SQUARE WAVE, TRACKING AND INTERMODULATION TEST RECORD STR 112** Enables detailed study of tracking capabilities of stereophonic phonograph pickups. The square wave modulation allows a rapid appraisal of stylus-tip mass, damping, and tracking. Low frequency compliance and tracking are determined by means of 300-Hz bands of progressively increasing amplitude. Intermodulation distortion measurements are made possible by graduated 200-Hz intermodulation test bands. The Str 112 has been cut with vertical angle approximating 15°, which is representative of current recording practice.

★ **BROADCAST TEST RECORD STR 151** Developed especially to meet the needs of broadcast engineers, audiophiles, and other professionals seeking a convenient signal source for the testing and adjustment of all audio equipment. Tests include: phonograph pickup response and separation, speed accuracy at 33 1/3 and 45 rpm, wow and flutter, rumble and hum detection, ballistic test of V.U. meters and many others.

★ **RIAA FREQUENCY RESPONSE TEST RECORD STR 130** Provides RIAA frequency characteristics for the calibration of professional recording equipment and for testing the response of professional and consumer record reproduction equipment. This record is suitable for use with a graphic level recorder to provide permanent, visible records for precise evaluation. Spot frequency bands for use without automatic equipment are included.

★ **318 MICROSECOND FREQUENCY RESPONSE TEST RECORD STR 170** Provides pickup designers and recording studios with a high-level, easily-equalized signal for frequency response and channel separation measurements. The STR 170 employs a 318 microsecond characteristic corresponding to the "test" or "flat" mode common to most disc recording equipment. Constant amplitude recording is employed in the region below 500 Hz with constant velocity recording in the region above. The transition is smooth, in contrast with the STR 100 which employs a sharp breakpoint at 500 Hz. The record is suitable for use with a graphic level recorder to provide permanent, visible records for precise evaluation.

★ **WIDE RANGE PICKUP RESPONSE TEST RECORD STR 120** Makes possible the measurement of pickup response at frequencies far beyond the audible range, where elusive distortion elements can cause audible distortion. The low-frequency range includes glide-tones at twice normal level for the detection and elimination of arm resonance, loudspeaker cone and cabinet rattles. Other tests include: silent grooves for measuring rumble and surface noise characteristics; and standard level bands at 0 dB for overall system S/N measurements. This record is suitable for use with a graphic level recorder to provide permanent, visible records for precise evaluation.

★ **QUADRAPHONIC TEST RECORD SQT 1100** Designed for calibration, verification, and adjustment of SQ™ decoding equipment. The record provides test bands for pickup measurements, for adjustment of decoder electronics and for channel identification and balance. Each band is described in terms of recorded characteristics and its intended use.

★ **RIAA PINK NOISE ACOUSTICAL TEST RECORD STR 140** Designed for acoustical testing of systems and loudspeakers and for psychoacoustic tests on reproduction equipment. With the STR 140 it becomes possible to test loudspeakers in the room in which they will be used. Spot frequency tones with voice announcements facilitate the testing procedure. Continuous glide-tones in 1/3-octave bands cover the frequency range from 30 to 15,000 Hz and are synchronized with a graphic level recorder.

The original series has been unavailable for many years. Quantities of the new and improved series are also limited. So make sure you have perfect copies on hand for years to come by ordering duplicates. Fill out and mail the coupon now for immediate action.

SQ is a Trademark of CBS Inc.

Only a limited quantity are available. Be sure to order enough for many years of use.

Send me the following test records:

- Seven Steps to Better Listening (STR 101) \$6.98 each. Quantity \_\_\_\_\_
- Stereophonic Frequency (STR 100) \$10.00 each. Quantity \_\_\_\_\_
- Square Wave, Tracking and Intermodulation (STR 112) \$15.00 each. Quantity \_\_\_\_\_
- Wide Range Pickup Response (STR 120) \$15.00 each. Quantity \_\_\_\_\_
- RIAA Frequency Response (STR 130) \$15.00 each. Quantity \_\_\_\_\_
- RIAA Pink Noise Acoustical (STR 140) \$15.00 each. Quantity \_\_\_\_\_
- Broadcast test (STR 151) \$15.00 each. Quantity \_\_\_\_\_
- 318 Microsecond Frequency Response (STR 170) \$15.00 each. Quantity \_\_\_\_\_
- Quadraphonic Test (SQT 1100) \$15.00 each. Quantity \_\_\_\_\_

SEND TO:  
AUDIO TEST RECORDS  
401 N. Broad Street  
Philadelphia, Pa. 19108

Amount Enclosed \$ \_\_\_\_\_  
(Payment must accompany order)

Name \_\_\_\_\_

Address \_\_\_\_\_

City \_\_\_\_\_

State \_\_\_\_\_ Zip \_\_\_\_\_



and you want the ultimate in phase linearity, high-frequency stereo separation, and lowest possible distortion. A linear-phase wideband discriminator circuit serves as an FM detector and is, according to the maker, individually adjusted for minimum phase distortion. A dual-stage, constant-current circuit drives the detector for increased stability. The MPX decoder section employs a phase-lock loop circuit built up from discrete components (rather than from one of the available "packaged" IC PLLs now available). Negative feedback, unique to Yamaha, is used to reduce intermodulation distortion. As for the PLL circuitry, it is of the type that requires no tuned inductance circuits. Active low-pass filters are used to provide the necessary de-emphasis characteristic, and the outputs of these filters are direct coupled in a three-stage amplifying system, which includes a buffer amplifier. A separate three-stage direct-coupled audio amplifier is used to drive the headphone jack. Each circuit board used in the construction of the Yamaha CT-7000 is individually shielded in its own stainless steel cover. While we don't normally "count transistors" in evaluating the quality of a product, it may be of some interest to readers to know that this tuner contains 108 transistors, 12 FETs, 33 diodes, nine zener diodes, and seven IC circuits!

### Laboratory Measurements

Again, with apologies for our test equipment, we measured an IHF sensitivity of 1.9  $\mu\text{V}$  in the "normal" i.f. position and 2.4  $\mu\text{V}$  in the "wide" position. Some 50 dB of quieting was attained at 2.8  $\mu\text{V}$  and 3.4  $\mu\text{V}$  for these two operating modes respectively. Figures 3 and 4 show our measured S/N results of 78 dB and 69 dB for mono and stereo in the "narrow" or "normal" position and 75 dB and 68 dB for the same measurements made in the "wide" setting. We suspect that our generator's limit in mono is therefore 78 dB in mono

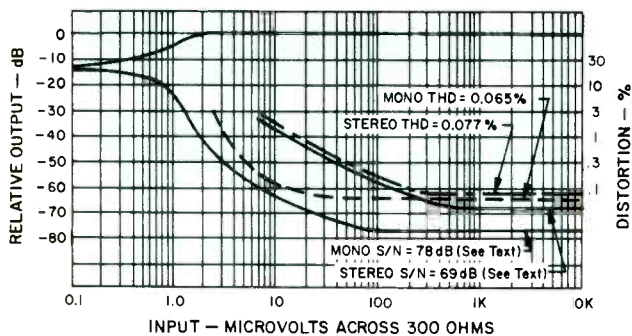

Fig. 3—FM quieting and distortion characteristics, "Normal" i.f. position.

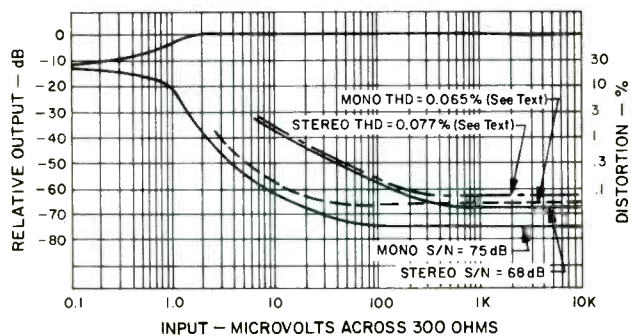

Fig. 4—FM quieting and distortion characteristics, "Wide" i.f. position.

and somewhere around 70 dB in stereo, which accounts for our inability to measure claimed specs. Note too that our THD measurements at mid-frequencies (1 kHz) for both the "normal" and "wide" settings were the same, indicating clearly that we were limited by the built-in distortion of our signal generating equipment. We are therefore in no position to dispute Yamaha's claim of 0.04% in the wide position for both mono and stereo. It's very likely true!

We had previously suspected that the stereo separation capability of our stereo FM generator was about 50 dB, since that's the most we ever measured for any tuner or receiver we ever tested. Much to our surprise, we obtained a reading of 53 dB for mid-frequency separation when operating the CT-7000 in the narrow position, as plotted in Fig. 5. Interestingly, in the "wide" operating mode, although mid-band separation was slightly less, high frequency separation was clearly better, remaining above 40 dB all the way out to 15 kHz. These two plots clearly prove the importance of wide bandwidth for good high-frequency stereo separation, as well as the need for excellent phase linearity throughout the i.f. and detection system. Yamaha obviously has a good measure of both. Even within the limitations of the generator, the distortion curves shown at the bottom of Fig. 6 clearly show that increased bandwidth leads to lower high-frequency distortion in stereo. Note that when this setting was used, THD at 10 kHz in stereo was less than 0.3%—the lowest we have ever encountered. No low-pass filters were used in making this or any other measurements. There was just no evidence of the usual "beats" with the 19-kHz carrier we find with so many other FM tuners.

As for spurious, image, and i.f. rejection, our instrumentation permits us to read up to 100 dB for these specs. That's what we read with the Yamaha under test. The manufacturer claims better than 120 dB for each. What more can we say? Measuring capture ratio below 1.0 dB is tricky at best, but we managed to confirm at least one of Yamaha's claims for this important spec: 0.7 dB in the normal setting with a 100  $\mu\text{V}$  input. Fantastic!

Muting level was found to be adjustable in our sample over the signal strength range from 4  $\mu\text{V}$ , while stereo threshold was factory set at about 7.0  $\mu\text{V}$ , a suitable point for this tuner. Transition from mono to stereo is noiseless and absolutely positive. At signals below 100  $\mu\text{V}$ , blending of high frequencies as well as upper mid-frequencies takes place automatically, reducing separation substantially above 1 kHz, but reducing noise to listenable levels. Between 100  $\mu\text{V}$  and 1 mV signal strengths, the auto-blend feature, if activated, blends highs to a lesser degree, retaining adequate separation while accomplishing noise reduction which makes medium-strength signals received from stereo broadcasters quite good, in terms of background noise.

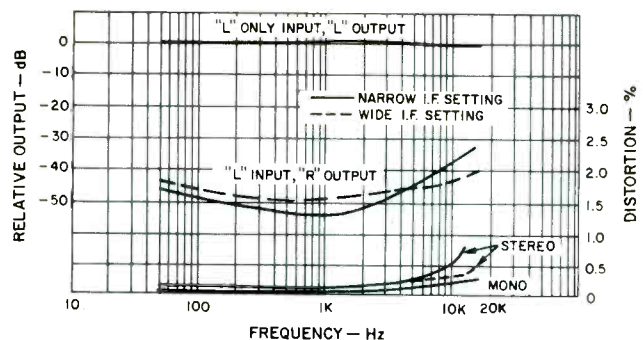
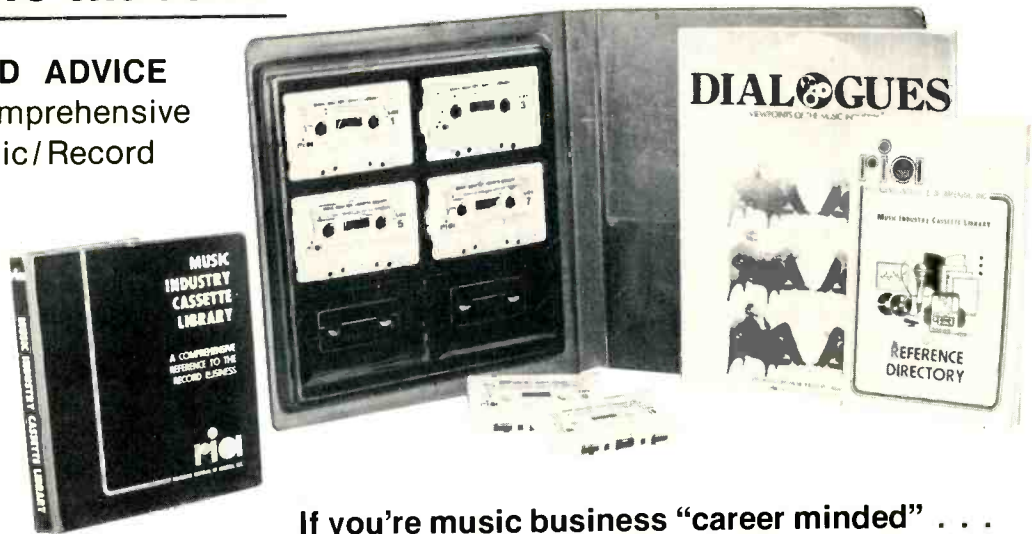

Fig. 5—Separation and distortion versus frequency.

# ***NOW...an AUDIO exclusive:***

This timely **SOUND ADVICE** suggestion: A Comprehensive Guide to the Music/Record Business . . .



If you're music business "career minded" . . .

## *Hear the facts for yourself in taped interviews straight from the "pros"*

Compiled from Recording Institute of America's interviews with key executives and "hit-makers", plus Reference Directory and Dialogue Viewpoints of industry "stars".

Listen to the industry "pros" describe the workings of the Music Business. Hear the most respected attorneys of the entertainment field define and discuss the legal terminology of Recording Contracts, Songwriter Contracts, Professional Management Contracts. Over 3½ hours of professional reference . . . could be the most important 200 minutes of your life!

Plus . . . RIA Reference Directory, including sample songwriter affiliation forms, sample artist contracts, writer contracts, etc., in addition to a Directory of Record Manufacturers, Music Publishers, Personal Managers, Producers and Booking Agents. Also **Record World's "Dialogues"** with over 50 candid interviews from **Record World** magazine, and a cross-section of "star" personality interviews.

You get all the above (regularly \$49.95) for only \$39.95 for Audio readers.

**\*Interviews include:**

Pete Bennett.....	Promotion, Apple Records
Sid Bernstein.....	Personal Manager and Promoter
Rick Blackburn.....	Dir. of Sales, Columbia Records
Terry Cashman.....	Pres., Cashwest Productions, Inc.
Bob Cato.....	V.P., Creative Services, United Artists
Kip Cohen.....	V.P., A&R, A&M Records
Al Coury.....	V.P., Production, Capitol Records
Al DeMarino.....	V.P., Music Department, CMA
Tom Draper.....	Dir., R&B, RCA Records
Kenny Gamble.....	Pres. & Producer, Phila. Int. Rec. Co.
David Glew.....	V.P., Marketing, Atlantic Records
Barbara Harris.....	Dir., Artist Relations, Atlantic Records
Emil LaViola.....	Prof. Mgt., Chappell Publishers
Michael Martineau.....	Booking Agent, Premier Talent
Mark Meyerson.....	A&R, Atlantic Records
Barry Oslander.....	West Coast Prof. Dir., Jobete Music Co.
Richard H. Roemer.....	Law Firm of Roemer & Nadler
Alvin Teller.....	V.P. Merchandising Marketing, Columbia Records
Peter Thall.....	Law Firm of Casper & Thall, P.C.
Ron Weisner.....	V.P., Artist Relations, Buddah Records

. . . and many others

**10 DAYS FREE APPROVAL—MAIL TODAY**

Book and Learning Systems Division  
NORTH AMERICAN PUBLISHING COMPANY  
401 N. Broad Street, Philadelphia, Pa. 19108

Send me the complete "MUSIC INDUSTRY CASSETTE LIBRARY." If I decide to keep this after 10 days examination I will remit the purchase price plus postage and handling, or return it for cancellation of all charges.

Name (please print) \_\_\_\_\_

Signature \_\_\_\_\_

Firm or Inst. \_\_\_\_\_

Home Address \_\_\_\_\_

City, State, Zip \_\_\_\_\_

**SAVE MONEY.** My payment is enclosed. Publisher pays all postage and handling. Same money-back return privilege.



## Listening and Use Tests

We were in for a few more surprises when we got down to our listening tests and evaluations. It was then that we first began to appreciate what Yamaha calls its "auto-touch tuning" system. The large tuning knob is actually part of a capacitance switch which is activated by the user when he touches the knob. While tuning to a station, the built-in a.f.c. circuitry is turned off to enable the user to zero in precisely on the desired station signal. While this tuning is in process, the tuning indicator lamp is extinguished. As a station signal is approached, it glows softly and, when tuning has been completed and the user lets go of the tuning knob, the a.f.c. circuit comes back on and the tuning indicator is illuminated to full brightness. Normally, we have frowned upon a.f.c. circuits in general as it was our feeling that they usually contribute to distortion and non-linearities in a tuner circuit, and that given today's heat-free solid-state stable circuitry, there is no need for a.f.c. as a drift-prevention crutch. Well, this a.f.c. circuitry contributes absolutely no added distortion to the audio output of the Yamaha CT-7000. In fact, all our measurements in the lab were made with the a.f.c. active since we obviously didn't keep our fingers on the tuning knob while making the measurements. When we became aware of the a.f.c. feature and the way it works, we decided to check some of our measurements to see if we could fine-tune the tuner (with hands on tuning knob to deactivate the a.f.c.) for lower distortion than we had previously observed. If any improvement occurred under these conditions, it was too low for us to observe, since we were already below 0.065% in our previous mono THD readings. Nor could we detect even the slightest shift or change of appearance of the output waveform as observed on our monitoring oscilloscopes as a.f.c. was activated and deactivated. The only time the a.f.c. did anything was when we deliberately detuned the signal. Under those conditions, the a.f.c. was strong enough (when reactivated automatically) to pull the tuning close enough to optimum so that distortion was once again below 0.1%. Here is an

a.f.c. circuit that doesn't "get in the way" of performance and can be of genuine assistance to the "sloppy" knob twirler who doesn't have the patience to tune as carefully as he or she should!

(Editor's Note: Yamaha says they designed the a.f.c. circuitry in their tuner sections as a final tuning compensator, to minimize distortion and increase separation.)

It goes without saying that the signals received were limited in quality entirely by the broadcast practices of the stations we received. Which, of course, brings us to the ultimate question. Should one spend \$1200.00 on what is probably the best performing tuner presently available, when most stations are becoming worse and worse insofar as the quality of their broadcast signals are concerned? That depends largely upon where you are located and whether or not you have stations in your area that are careful about the kinds of signals they transmit. Is this the "best" tuner we have ever measured? Well, the previously tested Sequerra Model One does as well (we can't say "better" since in both cases our test equipment was not as good as the product demanded), but it costs more than twice as much as the Yamaha. Of course, the Sequerra has all kinds of nice things like digital frequency readout and panoramic oscilloscope displays, use of a scope instead of meters for tuning and signal analysis, and the like. There would therefore seem to be two choices for the absolute perfectionist who seeks the best in FM tuners. If you are fascinated by digital readout, scopes and the like and seek absolutely tops in specifications and performance, take home a Sequerra Model One. If you are strictly a purist, and want a super FM tuner, that's equally first-rate in its specifications and measured performance, that's flawlessly designed, simple to operate, and offers that important wide-band mode (we were able to take advantage of it even in the crowded New York metropolitan area down at the bottom of the dial), you're not likely to find a better performer than the Yamaha CT-7000.

Leonard Feldman

Check No. 92 on Reader Service Card

## Koss HV/1A Headphone



### MANUFACTURER'S SPECIFICATIONS

**Elements:** 50-mm dia. (2 in.) Decilite™ dynamic, velocity operated. **Source Impedance:** 157 ohms at 1 kHz, designed to operate with source impedances of 3.2 to 600 ohms. **Frequency Response:** 15 to 20,000 Hz. **Sensitivity for 100 dB SPL:**

0.9 V rms, sine wave, at 1 kHz; 0.5 V rms pink noise. **THD:** Less than 0.5% at 1 kHz, 100 dB SPL. **SPL at 1% THD, 1 kHz:** 108 dB. **Power Handling Capability:** 5 V continuous. **Cord:** 3-conductor, coiled, 3 meters (10 ft.) extended. **Earcushions:** Soft acoustical sponge. **Headband:** Extendable, with self-adjusting, pivoting yokes and soft, padded vinyl cover. **Weight:** 285 grams (10 oz.) less cord. **Price:** \$49.95.

The Manufacturer's Specifications section above just about tells the entire story, since there is very little more that can be said. However, some additional details may be interesting to the reader. For example, the foam pads are doughnut-shaped, 2¾ in. outside diameter with the "hole" opening 1-5/16 in. diameter, and the depth is ¾ in. The color is dark brown, matching the brown plastic cups which have a shiny chromed trim ring. The cups are vented both in back and around the sides, which accounts for the low isolation from external sounds. The cups themselves are 3 inches in diameter and are held by a double swivel, permitting full adjustment to the wearer's ears. The extendable portion of the band has detents to ensure that it remains in the selected position. The band itself is a sturdy steel strip, vinyl covered, with the detent mechanism encased in molded plastic terminations of the band. The cord is dark brown in color, miniature in dimension, and is coiled in a very compact form, with the three leads terminating in a detachable plug, rather than a molded one which is difficult to replace if ever one wants to change to some other form of plug. The d.c. resistance of each phone was measured at 148 ohms in the maximum-volume position and 869 ohms in the minimum-volume position, indicating that the level control is a series resistance, which would be a distinct advantage if the

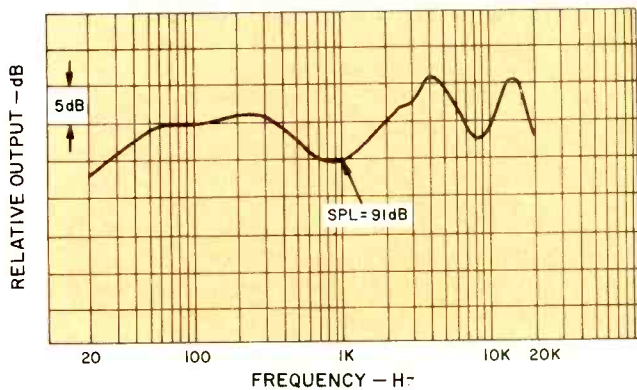

Fig. 1—Frequency response of Koss HV/1A stereophones.

phones were to be used on 600-ohm circuits. The impedance of the single phone was measured at 240 ohms. Weight is specified as 10 oz. for the phones, less cord, though the cord and plug add only another 3 oz. to the total.

### Measurement Method

Determining the performance characteristics of headphones is a fairly complicated project. The phones must be coupled to a microphone by means of an artificial ear of specific characteristics—and here there is a difference of opinion. In general, the cavity between the microphone diaphragm and the headphone diaphragm is specified as 6 cu. cm for headphones and 2.5 cu. cm for hearing-aid phones. For some years, this observer has used a shop-built artificial ear which gets modified occasionally in striving for improved performance. The "ear" consists of a maple block 5 1/2 inch in diameter and 6 1/2 inches long—about the dimensions of the average head as far as spacing goes. Through the center is a 3/4-in. hole to accommodate an AKG C-451E condenser microphone, and on the front is a B & K metal adapter. The microphone is inserted just far enough to provide the 6-cu. cm cavity. The microphone—suitably modified for single-ended use rather than for the phantom powering normally used—has its output fed into the proper receptacle on a graphic recorder, the Justi-Meter III. For a frequency run, the source is the B & K QR-2009 test record, which has a sweep from 20 to 20,000 Hz, and it's equalized in such a manner that it can be repro-

duced "flat" with networks using R and C elements, as is the case with Justi-Meter III. The record is reproduced, and the output fed to an amplifier with the signal terminated by the amplifier's normal load resistance. The signal is adjusted to 3.0 volts, and the headphone driven from this 3-volt signal through 100 ohms—about normal for receiver headphone jacks.

Frequency runs are made for both phones, and a second measurement is made by reproducing a 400-Hz square wave through a loudspeaker and with the headphones off the "ear," the output of the microphone is measured. The phones are then placed on the ear, and the output again measured. This gives the isolation, in dB, with the phones on the ear, as compared with the signal without the phones. There are many uses where a high degree of isolation is desired, as where one is recording in the presence of a live source, and airborne sound from the source should be reduced as much as possible in order to hear the actual sound that is being recorded.

### Performance

Figure 1 shows the frequency characteristic of the HV/1A phones, averaged between the two phones of the pair. While that may seem a little unscientific, it is actually almost the way we hear the phones. And besides, the two curves were never more than 3 dB apart over the entire range from 20 to 20,000 Hz—a remarkable feat. Furthermore, these phones offer the best—thus, flattest—response of any that we have measured with the exception of the Koss ESP-9.

Sound pressure level from these phones measured 91 dB with the 3-volt signal applied through 100 ohms, a value which is lower than the loudest ones tested, but still within the ball park. The HV/1A phones are still 3 dB louder than the Koss ESP-9, and to the average user, adequately loud for any normal purpose, though perhaps not loud enough for the rock buff. In any case, they were comfortable to wear for periods up to one hour, at least, and were not tested for more than that at one sitting.

Because of the openings in the cup and the softness of the foam pads, isolation from outside sounds was less than 2 dB, so the phones would not be suitable for recording in the vicinity of the live source, but for simply listening to music, they are excellent.

C. G. McProud

Check No. 93 on Reader Service Card

## Crown VFX2 Electronic Filter-Crossover



### MANUFACTURER'S SPECIFICATIONS

**Frequency Response:** 18 Hz to 38 kHz  $\pm$ 0.5 dB with 600 ohm load. **Output:** 10 V maximum, 2.5 V rated with 600 ohm load. **Gain:** 0 to 15.5 dB. **Hum and Noise:** 100 dB below rated output, 20 Hz to 20 kHz. **IM Distortion:** Less than 0.01% at

rated output. **Filters:** Separate 18-dB Butterworth high and low pass with adjustable corner frequencies. **Dimensions:** 19 in. rack mount with W.E. hole spacing, 3 1/2 in. H, 5 3/4 in. D. **Weight:** 6 lbs. **Price:** \$299.00

The Crown Model VFX2 is a dual-channel filter/crossover unit designed to provide continuously variable filters to perform either high-pass, low-pass, or bandpass functions in a professional, commercial or home high fidelity system. The unit is ruggedly constructed and fits the standard 19 in. rack mount, occupying only 3 1/2 in. of vertical rack space and 5 3/4 inches in depth.

The front panel has four sets of range/vernier knobs for the high- and low-pass frequency setting of the filters in the two audio channels. A shadow mask pushbutton switch controls the power. The rear panel controls are a screwdriver-adjustable level (attenuator) control and a mode switch for selecting either the crossover (low pass) or filter (bandpass) outputs for each audio channel. Rear-panel connectors include a variable-gain bridging input for each channel in ad-



dition to the unity-gain unbalanced input. Output connectors (both high and low pass) are provided for inverted and noninverted (normal) modes.

For greater reliability, the VFX2 uses ¼-in. phone jacks; input is by 3-conductor jacks balanced/unbalanced or 2-conductor jacks unbalanced unity gain; output is by 2-conductor jacks. To prevent the accidental moving of the range/vernier settings, the VFX2 has a smoked plastic cover that can be attached over the front of the unit.

The VFX2 filter set is quite useful for reprocessing or playing all types of records, particularly the early 78-rpm acoustics and electrics as well as the more recent monophonic 78s and LPs, the current stereo and matrix recordings. Other equally important uses include equalizing deficient program material in a manner not possible with the usual tone controls, constructing one-third octave or other narrow-band pink-noise sources for use in acoustical measurements, etc.

Of particular interest to the professional and the audiophile is the use of the VFX2 as a high-quality dual-channel crossover with 18 dB/octave slopes and continuously variable crossover frequencies. Currently, there is renewed interest in electronic crossovers for use in bi- and tri-amplified speaker systems, with great interest in achieving true high fidelity bass performance by utilizing speakers specifically designed for low bass reproduction.

The VFX2 utilizes five RC4558 dual operational amplifiers

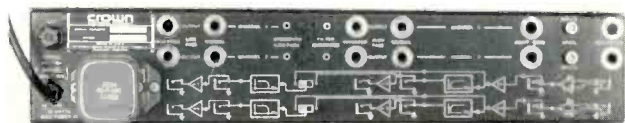

Fig. 1—Rear panel.



Fig. 2—Internal view.

in each channel, in effect, 20 op-amps equivalent to 402 transistors, 44 diodes, and 2 zeners. The circuit appears to be a variant of a non-inverting voltage-controlled voltage-source (VCVS) design, and consists of a 6 dB/octave stage cascaded with a second 12 dB/octave section. The latter is implemented with two operational amplifiers. Results of this

design approach are very high input impedances, low output impedances, and low sensitivities to drift arising from temperature changes and circuit aging.

The liberal use of operational amplifiers in the VFX2 is apparent throughout the unit. There are buffer amplifiers at the inputs to assure very high (1 megohm) input impedances which permits use of the crossover with long cables and any type of preamplifier. Use of high supply voltages for the op-amps, e.g.,  $\pm 15$  volts, assures that the crossover can handle up to 10 volts without overloading. At unity gain, this type of output is far greater than is required by any power amplifier. The liberal use of op-amps is also apparent in the availability of inverting outputs. Each of these inverting outputs requires one op-amp so that four of these op-amps are used to supply the four inverted outputs. The inverting outputs, although not essential, are a very useful addition because phasing of the loudspeakers can be made at the crossover rather than changing connections at the speaker or power amplifier. Phasing becomes particularly important when the crossover is set at very low frequencies (e.g., 100 Hz) such as when used with a high quality extended-bass system. An out-of-phase condition between the low-frequency speaker and the rest of the system would appear as an attenuation in the upper bass region and would definitely be audible. By merely changing the outputs from *Normal* to *Inverted* for one of the sections (high pass or low pass), the listener can quickly determine which jack gives the correct phasing.

The filter characteristic is a third-order Butterworth, which has a maximally flat response in the pass band of the filter to a time dependent signal such as is encountered with musical material. The phase shifts for this type of filter are, however, not linear with frequency. A linear response would be an ideal case since this would lead to a constant group delay at all frequencies and, consequently, the time dependent signal would not be distorted. However, human hearing is relatively less sensitive to distortions of this kind than it is to amplitude variations with frequency, e.g., ripple in the pass band.

Measurements of harmonic distortion products using a wave analyzer with an 80-dB range showed that second harmonic distortion was always less than 0.1% at input voltages less than 9 volts and at frequencies below 10 kHz. Third harmonic and all higher order distortion components were nearly unmeasurable, i.e., less than 0.01%. The second harmonic distortion reflected the internal residual distortion of the oscillator and not of the VFX2. The frequency response measured was the same as given in the VFX2 specifications.

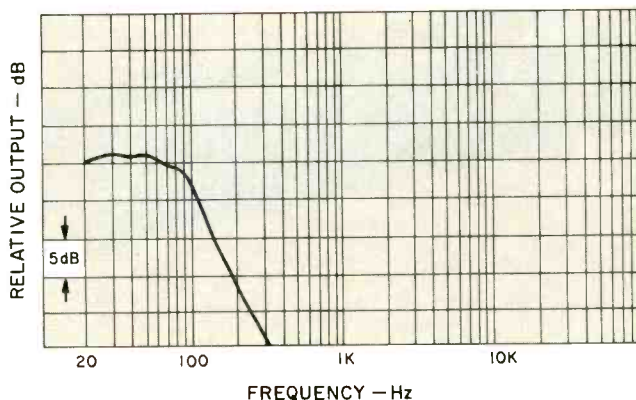

Fig. 3—Response with crossover frequency of 100 Hz.

The slopes of the filters were within 0.5 dB down to -60 dB relative to the bandpass output.

The corner frequencies as indicated on the front panel are reasonably accurate. However, for exact frequency settings, use a simple a.c. voltmeter, an audio oscillator and, if available, a frequency counter. Figure 3 shows the response curve for the VFX2 when set for a crossover frequency of exactly 100 Hz.

In using the Crown VFX2 as a crossover in our system, we noted two deficiencies. The first is a lack of level controls on

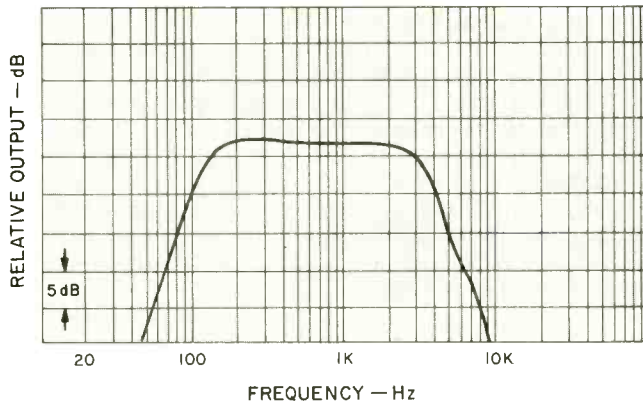

Fig. 4—Bandpass setting with cutoff frequencies of 160 and 3000 Hz, 18 dB/octave slope rate.

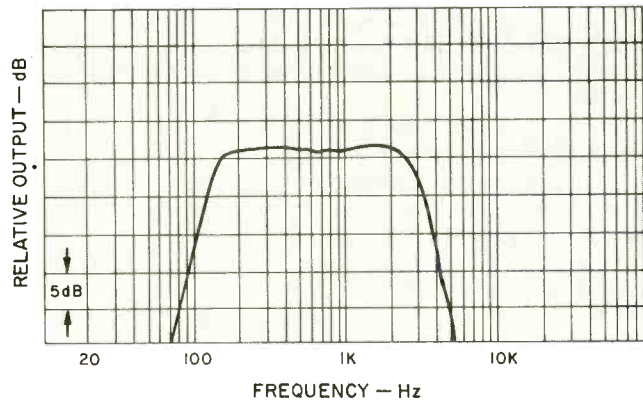

Fig. 5—Bandpass setting with cutoff frequencies of 160 and 3000 Hz, 36 dB/octave slope rate.

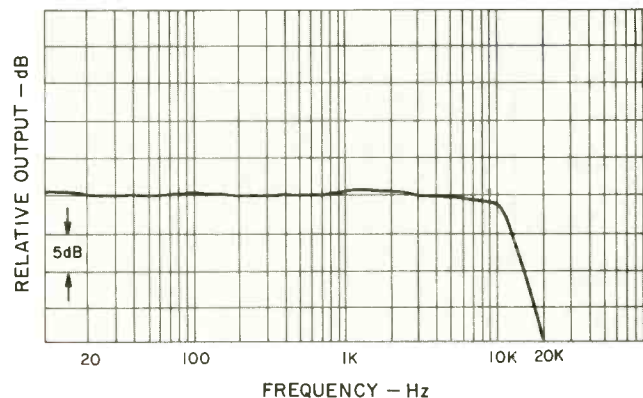

Fig. 6—Setting for noisy modern discs, high-pass filter at 20 Hz or off, low-pass at 10 kHz with 18 dB/octave slope rate.

the high- and low-pass sections, which means that power amplifiers used with the VFX2 should have a volume control to compensate for varying power amplifier sensitivities and loudspeaker efficiencies. The second deficiency is the omission of a summed left-plus-right output for the low-pass filter. Experience shows that for reproduction of low bass, a single monophonic bass speaker (woofer) is adequate in small rooms where the left- and right-channel speakers are not widely spaced, particularly since bass frequencies below about 100 Hz are not directional. A crossover such as the VFX2 cannot be used in this monophonic mode, but must be used with two subwoofers. However, a suitable op-amp mixer is very easy to add to the VFX2 because of its op-amp design, thus permitting the use of one subwoofer in the common mode.

As mentioned earlier, the VFX2 is very useful as an 18 dB/octave filter for record collectors, particularly collectors of early acoustic and electrical 78-rpm shellac records. The unit is inserted in the *Tape In* and *Out* circuits or between the preamplifier and amplifier when they are separate units. Figure 4 is a response curve for the playback of early acoustic 78-rpm records. The high-pass filter of the VFX2 is set at 160 Hz and the low pass filter at 3000 Hz. In practice, the low-pass filter (cutoff frequency) is usually adjusted for each recording as it is being played until the noise elements are removed or diminished appreciably. In Figure 4 the cutoff frequencies are at 160 and 3000 Hz with an attenuation rate of 18 dB/octave, while Figure 5 shows the same response, but at 36 dB/octave attenuation. Note that with such a steep attenuation, the cutoff point has shifted to about 2800 Hz at the high end. A shift towards a narrower bandpass has also occurred at the low end. In Figure 6 the high-pass filter is set at 20 Hz or turned off and low-pass cutoff frequency is set at 10 kHz, with an attenuation rate of 18 dB/octave. This is a useful setting when playing noisy LPs. As mentioned earlier, in practice the low-pass and high-pass filters are usually adjusted while the record is playing and the bandpass limits set for the least amount of noise.

During the past six months, the Crown VFX2, used as a crossover, has performed faultlessly in our music system. The unit is set for a low crossover frequency of exactly 100 Hz and the common mode output is fed to a 60-watt amplifier having a high damping factor. The output of the amplifier is coupled to our Janis Audio Associates W-1 subwoofer.

Use of the VFX2 crossover and the W-1 subwoofer permitted us to hear the bass frequencies below 100 Hz in an extremely clean manner and *in toto*. In the usual high quality music system, the very low bass frequencies are too often missing since very few speakers can adequately reproduce musical frequencies much below 40 Hz. This is particularly true of the low-bass pedal organ frequencies such as the 23 Hz note recorded on the Advent 5009 record (**Lemmen•Vierne•Dupre•Widor**) and the 27.5 Hz note on the ARK 10251-S (**Organ Music From Westminster**). There are many classical recordings in which the nine-foot concert bass drum, generally tuned to 31 Hz, is prominently featured, but the actual fundamental is rarely reproduced. On the Columbia MQ33172 (**Carmina Burana**), the Angel S-35430 (**Pictures at an Exhibition**), or the RCA QuadraDisc ARD1-0707 (**Citizen Kane**), to name a few, there is liberal use of this great drum, and this system reproduces it with awesome power and sonority. In the currently popular music the various bass instruments and, in particular, the ultra-low frequencies produced by synthesizers is superbly reproduced. The Crown VFX2 dual-channel filter/crossover is undoubtedly a very excellent crossover in this application.

B. V. Pisha

Check No. 94 on Reader Service Card



## Nakamichi Reference Monitor Loudspeaker System



### MANUFACTURER'S SPECIFICATIONS

**Frequency Response:** 40 Hz to 16 kHz  $\pm 5$  dB, on axis; 40 Hz to 10 kHz  $\pm 10$  dB, 60° off axis. **Power Rating:** 60 watts peak, 20 watts intermittent, 3 watts continuous. **Nominal Impedance:** 8 ohms. **Sensitivity:** 96 dB SPL for 1-watt input at one meter on axis. **Harmonic Distortion:** Less than 7 per cent at 10-watts input (106 dB SPL at one meter on axis) above 50 Hz. **Dimensions:** 25 1/2 W x 34 3/8 H x 17 1/4 D. **Weight:** 110 lbs. (50 kg). **Price:** \$2,400.00 per pair.

ers, has expanded their product line to include loudspeakers. The loudspeaker introduced under the label Nakamichi Reference Monitor is new in this country, but is a system developed and manufactured by Mitsubishi Electric Corp. and reportedly is used as a studio monitor by the Japan Broadcasting Corporation (NHK) as well as broadcasting stations and recording studios throughout Japan. (Editor's Note: Smaller version of this Nakamichi Reference Monitor

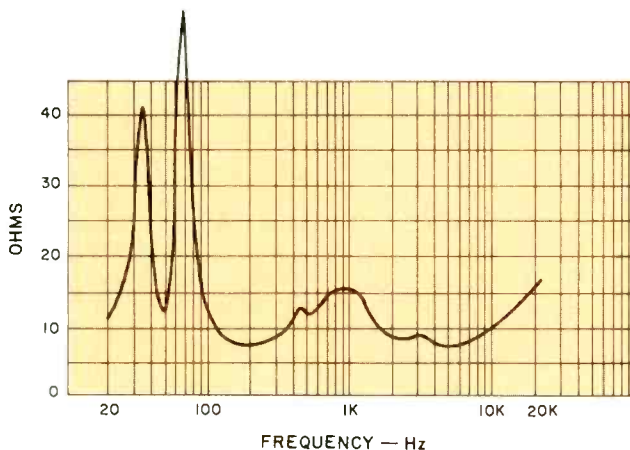

Fig. 1—Impedance.

Speaker with 8-in. woofer and 1 1/2-in. tweeter is also available at \$1,600.00 per pair.

A 12-in. woofer is used with a bass reflex enclosure of the phase inverter type and is intended to carry the spectrum up to 1500 Hz. Frequencies above that are carried by a 2-in. cone tweeter.

Except for an optically opaque grille cloth which covers most of the front surface, the front, top, and sides are finished with dark lacquer so smooth you can see your reflection in it.

Speaker connection is made through either of the two XLR type receptacles provided, one on either side of the enclosure. While this is fine for a studio monitor, it is not the thing for a normal user to wire up and connect to his home system, even though XLR plugs and complete wiring instructions are included. We would like to see this changed to a more conventional connector for domestic use.

There is no equalization control provided, and the system comes equalized for flat response. To prove that fact, Nakamichi provides an anechoic frequency response measurement and impedance measurement for each system.

When you take delivery of this loudspeaker system, invite a husky neighbor over to help you set it up. At 110 lbs. per speaker and with smooth lacquer sides, this system is quite a handful. Part of the reason for this is that Nakamichi recommends the Reference Monitor be mounted 12 to 15 in. away from a wall and 15 to 20 in. off the floor. Four standard cinder blocks are suggested for this purpose under each speaker. The cinder blocks do not come with the unit, so be prepared in the finest spirit of *noblesse oblige*.

This system is very efficient and can provide brisk sound levels with low and medium power amplifiers. No unusual requirements are imposed on the remainder of the audio system with the obvious exception that only the highest quality components should be contemplated with a loudspeaker system of this quality. Nakamichi supplies a short, but very thorough instruction brochure with the Reference Monitor.

### Technical Measurements

The magnitude of the measured impedance is shown in Fig. 1. The two resonance peaks in the bass frequency region are due to the fact that this system is a vented design. There are some interesting details in the 400 Hz to 4000 Hz region that indicate some interaction of the loudspeaker drivers with their local acoustic environment. The more complete polar impedance plot of Fig. 2 and the expanded scale plot

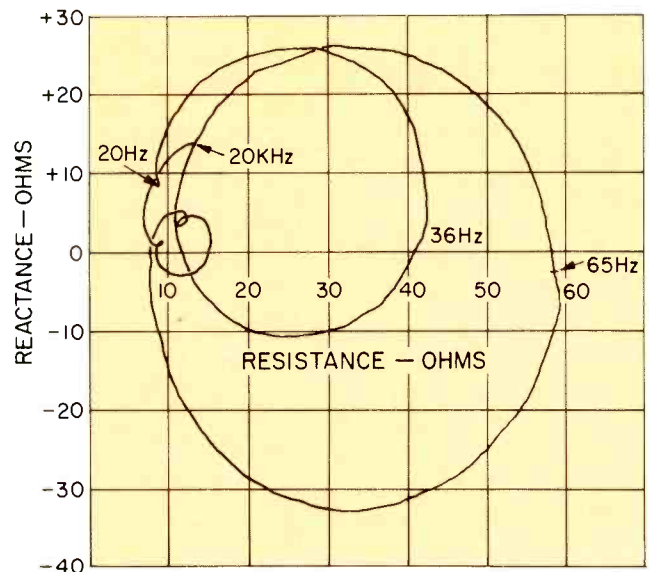

Fig. 2—Polar impedance plot.

of Fig. 3 show the details of this situation. The two bass resonances occur at 36 Hz and 65 Hz, with values of 42 and 58 ohms respectively. The size of these peaks is not significant to the acoustic response.

The expanded plot in Fig. 3 shows the type of load which this speaker imposes on a power amplifier for the frequen-

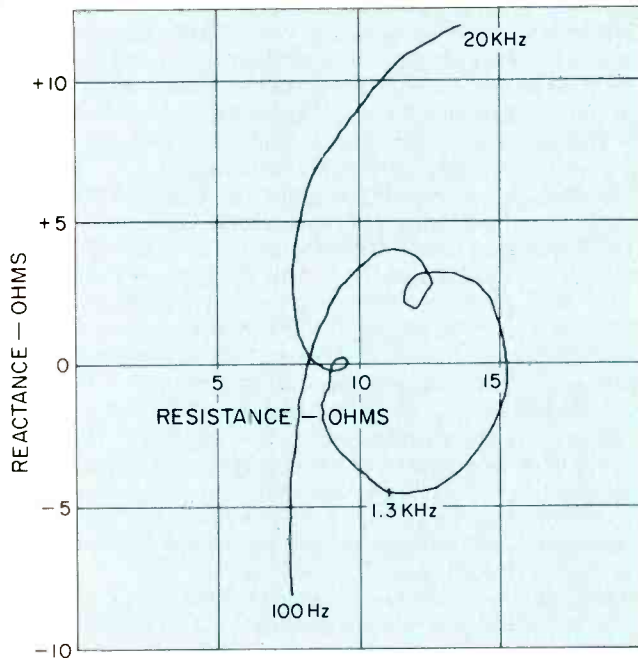

Fig. 3—Expanded-scale polar impedance plot.

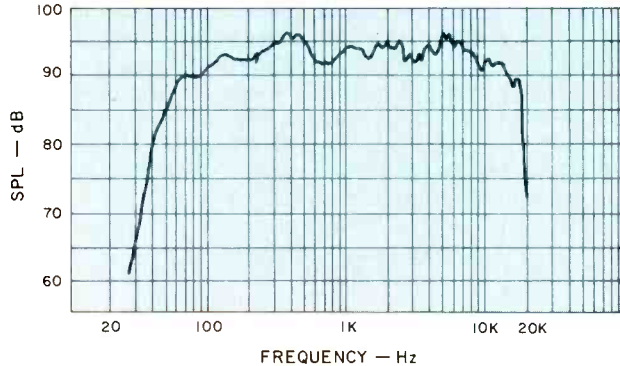

Fig. 4—One-meter anechoic amplitude response at one-watt drive.

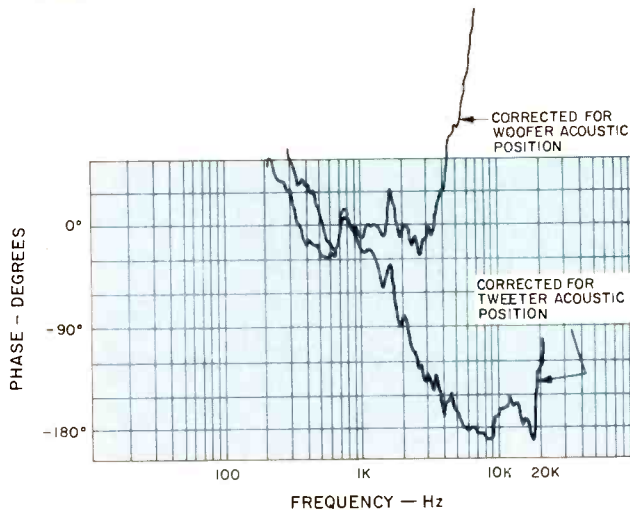

Fig. 5—One-meter phase response.

cy range of 100 Hz to 20 kHz. The nature of this plot indicates that a small amount of acoustic interaction is occurring, probably standing wave patterns within the enclosure.

The lowest high-frequency capacitive load exists at 1.3 kHz and is 12 ohms at an angle of about 30 degrees lagging, which should offer no problems for any good power amplifier. The lowest impedance measures slightly less than 8 ohms.

The one-meter anechoic frequency response is shown in Fig. 4 for its magnitude and Fig. 5 for phase. The sound pressure level in Fig. 4 for a one-watt drive level averages better than 94 dB, which indicates a moderately high efficiency for this system. The low-frequency response falls off rapidly below 50 Hz, a surprisingly high frequency for a professional monitor of this physical size. Since this is a vented system and acoustically unloads so rapidly, it's probably a good idea to use a subsonic cutoff or rumble filter in the preamplifier to prevent subsonic signals from driving the woofer outside its linear range and muddying the response by cross modulation. Such signals could arise from warped records, for example. In a professional recording studio, such program defects do not exist, so a designer need not worry about them. But the signal environment outside the professional studio is quite another story.

Interestingly enough, an anechoic response plot on this particular speaker, as it was tested in Japan, was supplied with the unit. Our measurements duplicated those of Mitsubishi perfectly with the exception of a slight difference above 10 kHz which was due to the fact that we test on the geometric center line of the speaker, rather than in front of the tweeter where Mitsubishi's measurements were taken. Moving our microphone to tweeter level verified this, but for standardization we will continue supplying the response taken on the geometric axis. What makes this result significant is not simply the honesty of Mitsubishi, but that their measurement is done in the classic anechoic chamber, while ours is by coherent signal processing, time delay spectrometry, in a quite substantially reverberant room.

The overall response is quite uniform on the average, but has localized variations. These are shown by the subsequent energy-time plot to be due to enclosure and grille diffraction. The effect should be an overall balanced sound with some coloration in timbre as one moves his listening position relative to the enclosure.

For those technically minded readers, the sound pressure, measured directly in the vent, peaks at 50 Hz, while the near-field woofer cone pressure dips at 43 Hz and has a lower peak at 39 Hz.

The phase response Fig. 5 was duplicated for the two acoustic positions of the woofer and the tweeter. The response is in-phase for the woofer and, as is common for passive crossover two-way systems, 180 degrees out of phase for the tweeter. The impulse response will be a preliminary underpressure, followed in a few tenths of a millisecond by a swing to overpressure as the listener's location, as the woofer response arrives slightly after the tweeter response. With the exception of the crossover between drivers, the overall response is principally minimum phase.

Of course, the average listener does not live in an anechoic chamber, but uses a room. The three-meter room test of the Nakamichi Reference Monitor is shown in Fig. 6. This test was made, in fact, in the exact position used by this reviewer for the listening test. The speakers were placed on a pedestal formed from four cinder blocks, exactly as recommended by Nakamichi. The speaker was away from the wall and angled toward the listening area. The microphone was placed three meters away from the front of the enclosure and at an ear height of one meter above the floor.



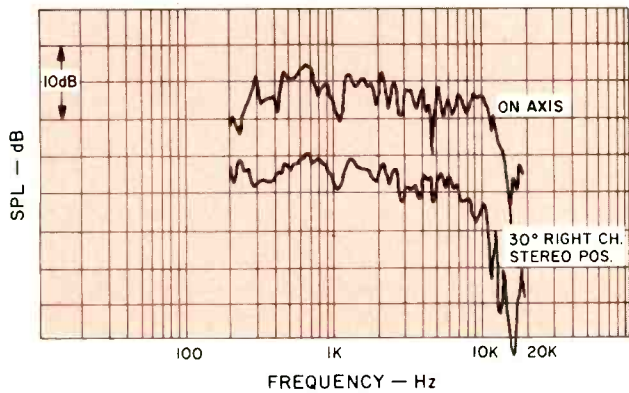

Fig. 6—Three-meter or room response.

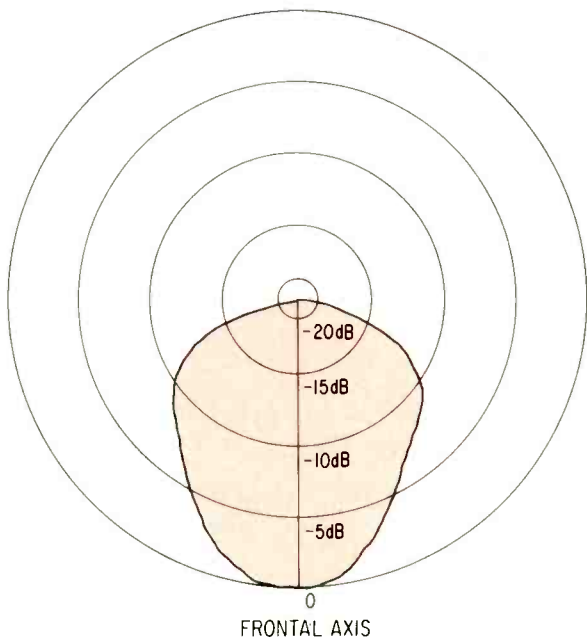

Fig. 7—Horizontal polar energy response.

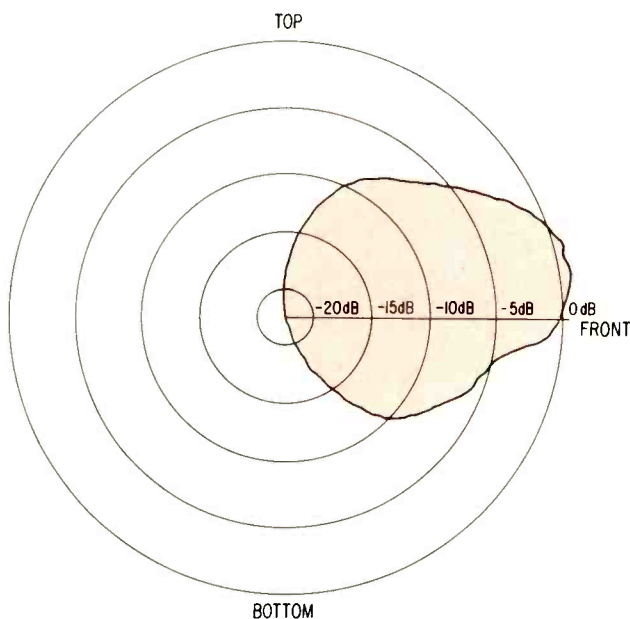

Fig. 8—Vertical polar energy response.

The frequency response that is shown is the Fourier transform of the first 13 milliseconds of sound due to a perfect impulse. Two measurements are shown, one with the speaker oriented toward the microphone and the other with the speaker angled 30 degrees away in a manner corresponding to a right-channel stereo unit that is pointing to the right of the listener. The plots are displaced 10 dB for clarity.

The room response is very good for both positions. The extreme top end dropped inexplicably compared to the anechoic response, though a number of early scatter signals were picked up, and the response is good overall. The fact that the average response is so similar for both angle positions indicates high probability of good stereo imagery. While the off-axis response is some 2 or 3 dB lower than the on-axis, the important thing here is their similarity.

The amount of fall off with horizontal off-axis is shown in the polar energy plot of Fig. 7. This is a computation of the total energy in all components from 20 Hz to 20 kHz and is plotted as a function of angle. This plot shows that the Nakamichi Monitor System should be angled toward the listening position for the most uniform energy balance. There is no apparent left-versus-right bias of energy.

The vertical energy response is shown in Fig. 8. This loudspeaker launches most of its energy upward. The plot shows that, given a choice, this speaker should be mounted closer to the floor than the ceiling. If the speaker is too close to an acoustically hard ceiling, a distinct coloration will result due to ceiling-scattered sound.

Harmonic distortion for the musical tones E1 or 41 Hz, A2 or 110 Hz, and A4 or 440 Hz is shown in Fig. 9. The woofer showed substantial waveform change in the reproduction of E1 (41 Hz) above the 12-watt average level and this is signified by the identifying marks on this plot. All other frequencies were easily handled to 100 watts average power. However, with the efficiency of this system, I could only recommend such power levels as a means of breaking leases. With the exception of E1 (41 Hz), which is really below the acoustic cutoff of this speaker, harmonic distortion is reasonably low. The break in characteristic in the 0.1- to 1-watt range will be explained later.

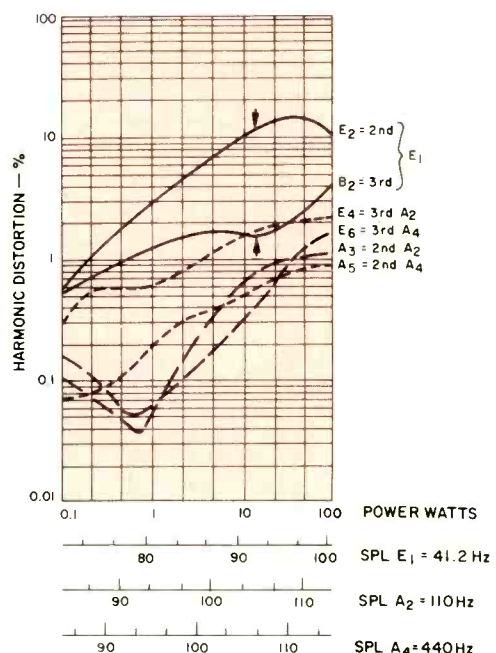

Fig. 9—Harmonic distortion for the tones E1 or 41 Hz, A2 or 110 Hz, and A4 or 440 Hz.

Fig. 10 shows the intermodulation of A4 by E1 (or 44-Hz by 41 Hz) when they are mixed in equal portion. The IM at high power levels is astonishingly low. The type of distortion on A4 at an average power of 60 watts is composed of both amplitude and phase modulation, with 3 per cent peak-to-peak amplitude modulation and 5 degrees peak-to-peak phase modulation at 41 Hz. At this drive level, the woofer shifts position toward the listening area by an amount corresponding to 0.02 milliseconds of air path delay, which is totally inconsequential as far as the sonic effect on the frequencies which the woofer is called upon to handle. The IM falls rapidly with decrease in power to a plateau of about 1.3 percent.

The Nakamichi Monitor has an acoustic transfer function that, at frequencies below 350 Hz, has a shelving type increase above 0.1 watt. This is approximately a 0.6 dB increase in gain, somewhat like a program expander. This should give a mild emphasis to sound peaks above this power level, but will also cause a small lateral spread of musical partials in the stereo stage when instrumental voices are in the one watt and above power range. This characteristic is the reason for the unusual low power harmonic distortion property.

The crescendo handling test was passed easily for three sigma noise peaks up to 350 watts. This means that inner musical voices will not become smeared for sudden momentary random signals, such as applause, that have average power in a 20 kHz band that is 20 dB higher than the average power of the musical tone it is riding over.

The energy-time response, which is the square of the true amplitude of the impulse response, is shown in Fig. 11. The main peak at 3.15 milliseconds. The subsidiary peaks are due to diffraction and scatter within the enclosure. The peak at

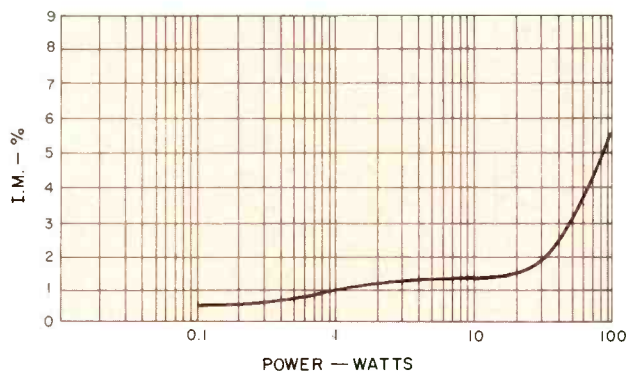

Fig. 10—IM distortion of A4 or 440 Hz by E1 or 41 Hz mixed one to one.

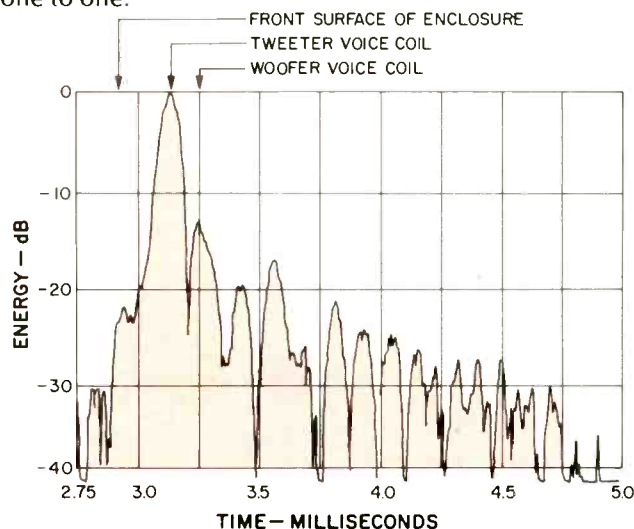

Fig. 11—Energy-time response.

3.6 milliseconds, which is the largest contributor, is due to sound from the tweeter that travels along the front grille and reradiates from the top of the enclosure. Other subsidiary peaks are due to reflections from grille and associated housing. This is not as good an impulse response as one might expect from a professional monitor speaker. The problems are associated with the physical housing and manifest themselves in two ways. First, the basic frequency response is made somewhat nonuniform for these peaks, and second, there is a distinct change of timbre with listening position for the very highest range of frequencies that gives an effect equivalent to polar response irregularities. The average energy is uniform, as has been shown, but the details of the response will be very slightly modified.

The sides of the Nakamichi Monitor System are rounded, which is a correct way to minimize diffraction from the vertical edge discontinuities. This is why there are no broad "clumps" of energy more than a half millisecond following initial sound.

The first dominant arrival at 3.15 milliseconds has the peak of its response at 8.3 kHz, which means a relatively bright sound. Ninety-five percent of the sound energy arrives within 3.3 milliseconds, and ninety-nine percent arrives within 3.7 milliseconds.

### Listening Test

Nakamichi Research provides very explicit recommendations concerning the physical placement of their Reference Monitor System, which were followed to the letter. Four "standard" cinder blocks, measuring 7 1/2 X 7 1/2 X 15 1/2 in. were placed under each speaker to bring them 15 inches off the floor. At 110 lbs. (50 kg) per speaker, the use of cinder blocks is quite logical, if incongruously undecorous. A cloth covering was placed over the cinder blocks prior to hefting the speakers into place.

Standing more than 15 in. away from the back wall, these monoliths make a formidable obstacle that should not be placed where the unwary guest might collide with them. Believe me, the speakers won't budge.

The speakers were tried in both a forward-facing configuration and rotated toward the listening area. Because of discernible polar characteristics, the angled position was chosen for the listening test.

A word of comment on speaker hookup is in order. The Nakamichi Reference Monitor clearly shows its professional heritage by the fact that connection is made to a four-pin XLR type connector. There is an XLR receptacle on each side and they are provided with a locking cap to cover the receptacle not in use. Though it appears this system was originally designed for flush wall mounting, Nakamichi wisely recommends pulling it away from the wall. One problem might arise with the Cannon XLR-4-11C plugs which Nakamichi supplies for hook up. Despite the good instructions supplied, this is not a task many non-professional users will enjoy, even if they have a soldering iron.

Nakamichi also recommends that the user employ a fast-acting 2.5-ampere fuse to protect the loudspeaker from damage. In view of the substantial investment which this system represents, this is a wise precaution.

Overall listening impression is that this system is very analytical in that there is very little coloration of timbre over most of the frequency range. It is a sound, or lack of it, that is needed in certain studio applications. But it will not blow your ears off with robust midrange peakiness, if that is the kind of "monitor" you are expecting. While there are definite polar response "fingers," these can be eliminated by rotating the speakers toward the listening area.



The low bass response was found to be somewhat thin, and in fact, a check was made to be certain that the polarity of one channel had not accidentally been reversed with respect to the other. Though this thinness was most noticeable with super low frequency organ music, percussive bass sounded clean to my ears, with no trace of a boomy hang-over. The bass spectrum, once it gets going, is so well balanced with respect to the midrange that no position of pre-amplifier tone control sounded more accurate than flat equalization in the low end.

Piano music sounded most accurate with a very slight cut in treble, corresponding to about 2 dB at 10 kHz with the Marantz preamp this reviewer uses. The overall response was a bit bright with what to be a mild upper treble peak.

There were two subjective or personal impressions that detracted from perfect performance, which might not be judged as detrimental by others. One of these was a slight sense of compression of dynamic range on program peaks. This showed up as a strained sound on orchestral and vocal peaks in what seemed to be the 3-to-5-kHz range. To those who know the sound I refer to, it was a very mild case of "cone cry." Perhaps a part of this two-way system is called upon to carry too much of a load.

The second subjective impression was that horns appeared somewhat back in the stereo stage, though the general impression I had was that the stereo stage was compressed in depth and pulled forward to lie on a surface passing through the location of the loudspeakers.

But these were the *only* problems I sensed. In general, stereo lateralization and accuracy of instrument location in angle is exceedingly good. Center-channel vocals come smack from stage center and do not broaden into "jolly green giant" voices. The sound of percussion is very good and overall transient accuracy is excellent, although not as well articulated as the very best electrostatic top ends I have heard.

One of the interesting observations of the Nakamichi Reference Monitor is that it can be listened to at low sound levels without losing balance. This is a trick of the trade with which one can quickly separate the clean loudspeaker from the impressive, but peaky responded loudspeaker. This Nakamichi is definitely clean in spectral balance. At a price of \$1,200 per speaker, the sound had better be good, and the Nakamichi's sound is good.

Richard C. Heyser

Check No. 95 on Reader Service Card

## BGW Systems Model 500D Basic Power Amplifier



### MANUFACTURER'S SPECIFICATIONS

**Power Output:** 200 watts per channel, both channels driven into 8 ohms, with less than 0.1% total harmonic distortion or intermodulation distortion, from 20 Hz to 15 kHz; 251 watts per channel, both channels driven into 4 ohms, with less than 0.25% total harmonic distortion or intermodulation distortion, from 20 Hz to 15 kHz; 501 watts mono mode with less than 0.25% total harmonic distortion or intermodulation distortion from 20 Hz to 15 kHz. **Signal-to-Noise Ratio:** 110 dB. **Damping Factor:** 500. **Dimensions:** 19 in. W x 7 in. H x 12 in. D. **Weight:** 49 lbs. **Price:** \$839.00

The BGW 500D, yet another addition to the 20 to 30 stereo power amps in the 150 to 200 watt per channel power class, appears to be quite well made, about as solid as a brick. The

basic chassis is a rectangular steel box with the top open. The power transformer is appropriately large and is mounted on the inside left (as viewed from the front). An L-shaped bracket is attached to the internal floor of the chassis and has mounted to it two 10,000  $\mu$ F/75V capacitors, a diode bridge rectifier, a silicon controlled rectifier, and a three-terminal barrier strip to terminate the incoming line cord. Two large power resistors are mounted on the bottom of the chassis; one is in series with the a.c. line to reduce in-rush current and gets relay shorted after a short time delay, and the other is in series with the SCR which is wired across the plus and minus terminals of the power supply.

On the inside rear of the enclosure is a barrier strip for primary strapping of the power transformer, the cooling fan, and a PC board containing the turn-off time delay and the SCR crowbar control circuitry.

Covering the top of the enclosure (except for about an inch in the middle) are the two heat sink/amplifier modules. These are large sinks with two rows of six TO-3 power transistors mounted on them. On the non-fin side of the sinks are the amplifier circuit boards. Connections are made to the power supply's input and output through an 11-pin connector mounted on the circuit board. Over the top of the heat sinks is the top cover of the unit, which is solid on the top and rear and open at the left and right ends. The ar-



Fig. 1—Rear panel.

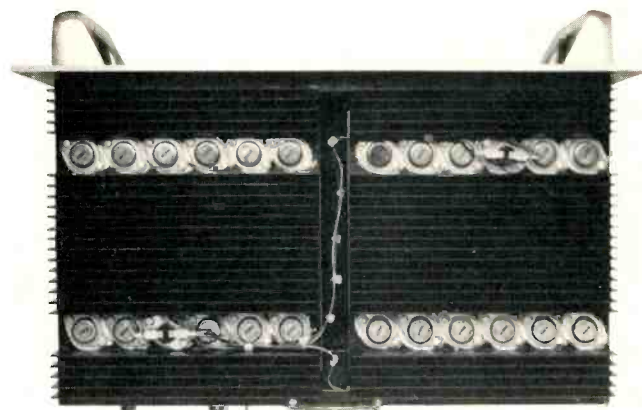

Fig. 2—Interior view.

angement is such that the air flow from the fan comes up between the heat sinks in the middle and is forced to travel horizontally through the fins to the exit ports in the top cover. All in all, a very effective cooling scheme.

The front panel, which is 3/16-in. thick, has two beefy handles, a rocker-type power switch/circuit breaker, and a LED power-on indicator. On the rear panel are two pairs of five-way binding post speaker connectors, two phone-jack input connectors, the power cord, and a protruding 1/4-in. shaft that operates the stereo/mono switch.

### Circuit Description

The first stages of the 500D are those of a LM318 operational amplifier. The output of the op amp feeds a complementary pre-driver stage, Q1 and Q2, operating at a collector current of about 25 mA. Considerable emitter degeneration is present in this stage, which raises the output impedance, giving the output stage more of a current source, improves stage linearity, and helps the stage quiescent current stability.

Connected between the collectors of Q1 and Q2 is the bias shunt regulator, Q3. The output stage is a quasi-complementary emitter-follower. Q4 and Q6 are Darlington-connected followers, driving the composite plus half-cycle output transistor, consisting of Q8, 10, 12, 14 and 16 in parallel. Q5 is the input to the compound-connected minus half-cycle side of the output stage. Q7 is an emitter-follower, driving the minus half-cycle composite-output transistor, Q 9, 11, 13, 15, 17 in parallel. Q6 and Q7 drivers are RCA multiple-emitter-site devices, and all outputs are RCA single-diffused types.

Negative feedback is taken back in two loops. One loop, via R9 and C9, is around the predriver and output stage, and the overall loop, through R5 and C3, is around the total amplifier.

Mono full-bridge operation of this unit is selected by pushing in the shaft on the rear panel. A switch on one amplifier's circuit board converts one channel to a unity gain inverting circuit with its input fed from the output of the other channel. The load is then taken between the hot terminals of each channel and effectively doubles the output voltage giving the per channel four-ohm power into a single eight-ohm load.

There is no instantaneous VI limiting in this circuit, adequate safe area being provided by the multiplicity of output devices. A circuit on the time-delay circuit board senses plus and minus d.c. levels in the output of each channel and if considered excessive, triggers the SCR crowbar device which shorts the plus and minus 75 V supply together through a two-ohm resistor. This discharge of the power supply causes the primary circuit breaker to open, thus shutting off the amplifier and protecting the load.

### Listening Tests

The 500D was listened to on the reviewer's arrays and a pair of Dahlquist DQ-10s recently loaned to *Audio* for amplifier review purposes. The bass reproduction on this amplifier is excellent, giving good control of the DQ-10 woofers. It is relatively free of upper bass boominess and has good lower bass punch. The midrange sound is similarly good, though the high end sound has a bit of brightness or edginess.

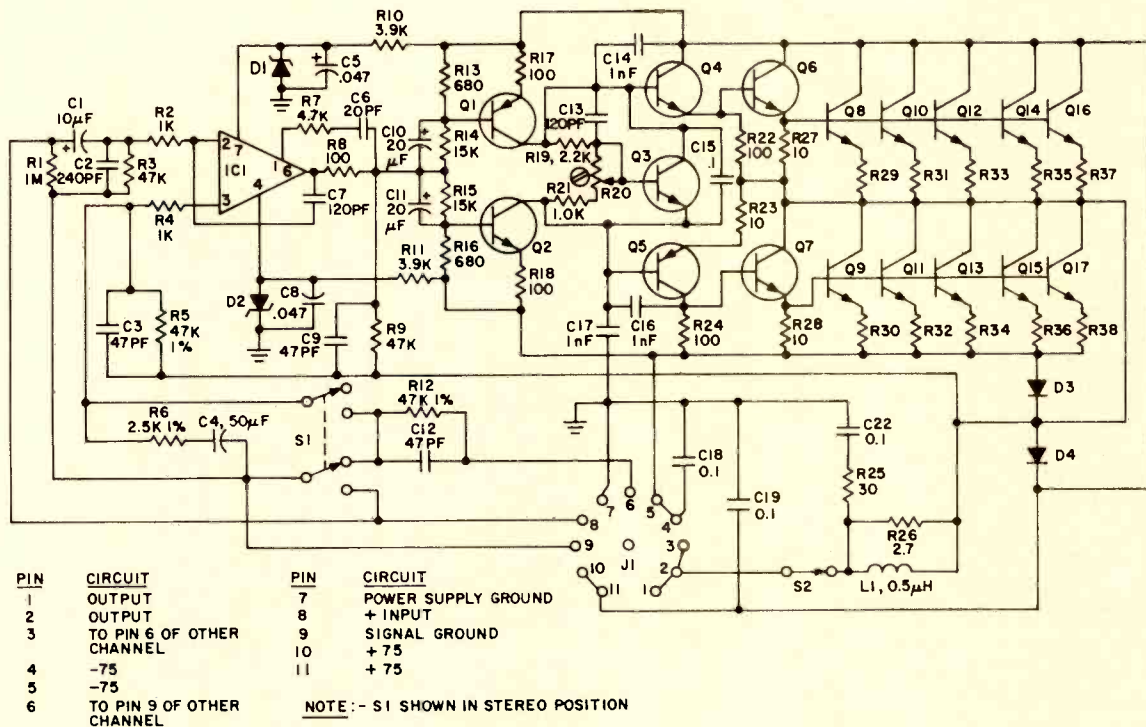

Fig. 3—Schematic of BGW 500D.



## Measurements

The 500D was first run at one third of rated power, 66.6 watts, into eight-ohm loads for one hour with a 1 kHz test frequency. Under these conditions, the fan alternately ran at low and high speed. The unit was then run for a second hour into four-ohm loads. Rated power into four ohms is 251 watts per channel and the test power was therefore 83.7 watts per channel. This time, the fan ran continuously at high speed and exhausted plenty of heat. Fan noise at high speed is fairly loud and could be objectionable to some people in a home music installation but would probably be okay in industrial and PA applications. However, if one is really pushing the amp hard and the fan does go to high speed, the resulting music level would in all probability drown out the fan noise. All things considered, this unit has excellent thermal capability and is one of the few units on the market that has adequate cooling for low impedance loads.

Voltage gain was measured and found to be 20X or 26 dB, which is normal gain for power amps. IM distortion along with 1 kHz THD is shown in Fig. 4. The measured behavior of this amp is different from any other thus far in that the IM and 1 kHz THD are virtually independent of power over a

very wide range. The predominant harmonic distortion is even order, stemming from a gain imbalance per half cycle. It wasn't determined just where in the circuit that this gain imbalance occurred, but it could be in the way the unit is internally grounded and/or in the output stage where the minus half cycle or compound side has more gain than the cascaded emitter-followers in the plus half-cycle part of the circuit. The distortion products on IM are essentially a 60-Hz square wave which indicates even-order nonlinearity, and on THD, the residue looks like a full wave rectified sine-wave, again indicative of even order nonlinearity. There are some higher order odd harmonics present also, mainly due to crossover distortion and are shown in Fig. 4. The fact that they peak at about 100 mW instead of disappearing below 1-10 watts, as has been characteristic of the better amps tested, may be partially responsible for the slightly harsher high end exhibited by this amp in the listening tests. The predominance of even-order products may be responsible for the apparent extra brightness observed.

Figure 5 illustrates the one-watt frequency response and THD vs frequency and power. The high end rolloff is at a lower frequency than usual, being 3-dB down at 80 kHz. The THD curves reveal increasing high frequency distortion with decreasing level. This is mainly caused by crossover or notch distortion where the magnitude starts to increase with frequency due to the falling compensated open-loop-gain characteristic. The magnitude of the notch starts to override the half-cycle gain unbalance, which is about 0.03% above 3 kHz. The 200-watt curve has the lowest magnitude, but starts to rise above 13 kHz or so due to early peak clipping due to common mode conduction in the single-diffused output devices dragging down the power supply. There were no observable aberrations in THD near 120 Hz due to beating of the signal test frequency with the 120-Hz power supply ripple.

Figure 6 shows a 80-V p-p, 200-watt, 50-Hz square wave into 8 ohms and a 10 V p-p, 10-kHz square wave into 0.22  $\mu$ F. The 50-Hz waveform exhibits relatively low tilt which is de-

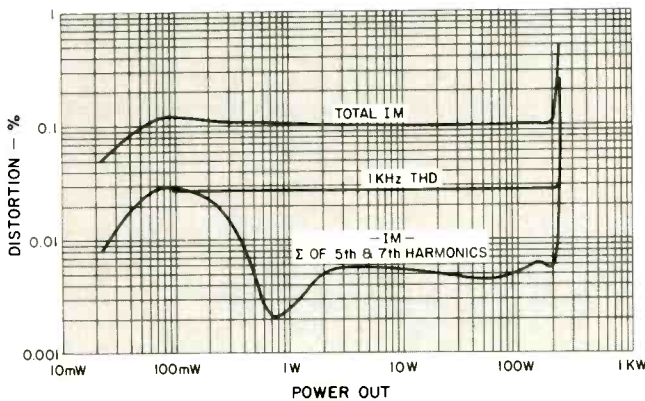

Fig. 4—Distortion versus power into 8-ohm loads.

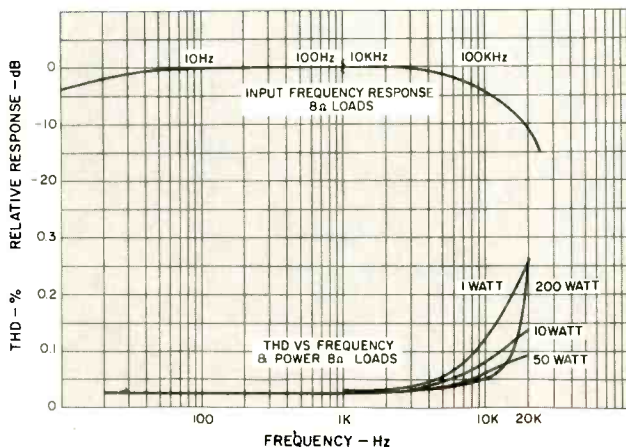

Fig. 5—Upper curve, 1-watt frequency response with 8-ohm loads (note break in scale at 100 Hz-10 kHz); lower curve, THD versus frequency and power with 8-ohm loads.

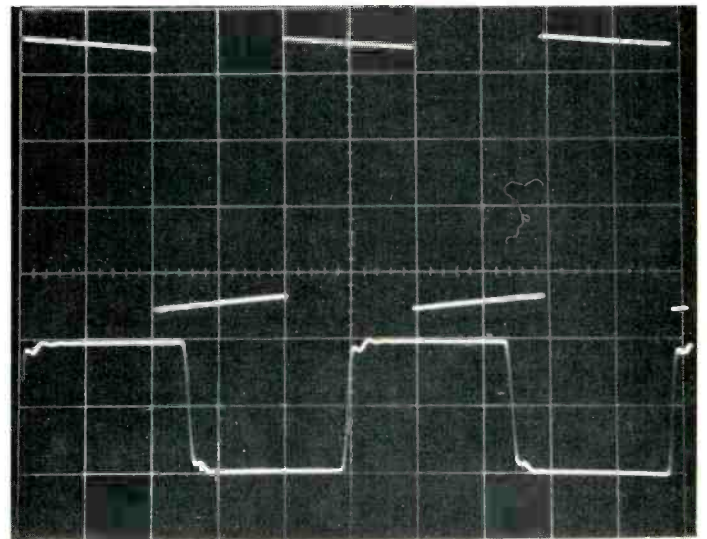
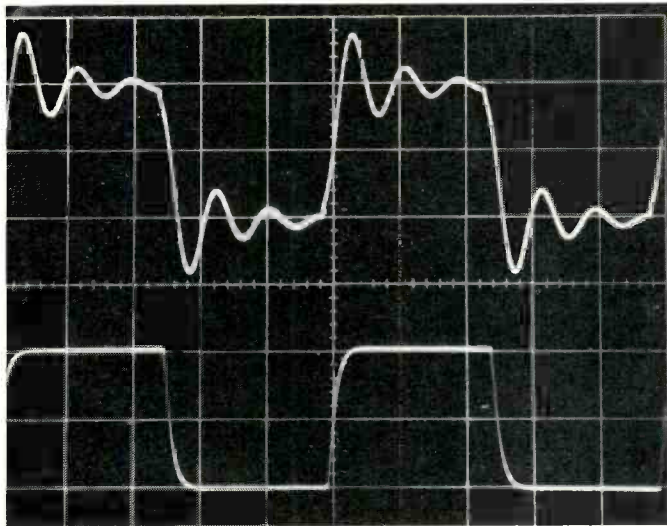
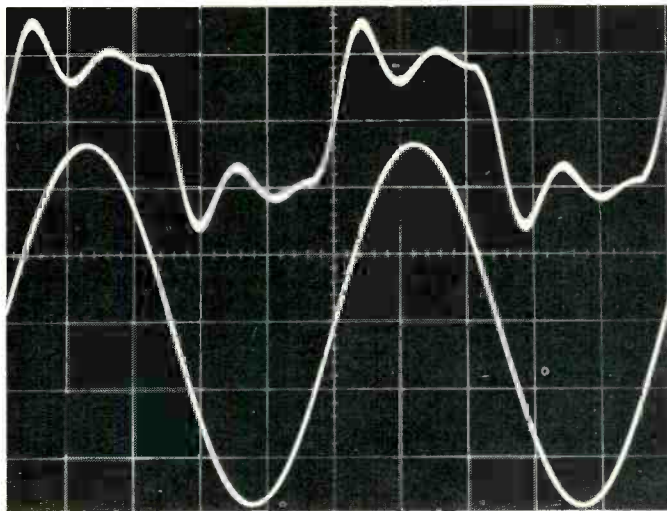

Fig. 6—Top curve, 200-watt, 50-Hz square wave with 8-ohm load (scale: 20V/cm, 5 mS/cm); lower trace, 10-V p-p, 10-kHz square wave into 0.22- $\mu$ F load (scale: 5 V/cm, 20  $\mu$ S/cm).



**Fig. 7**—10-V p-p, 10-kHz square wave into, top, 2- $\mu$ F load and, bottom, 8-ohm load. (Scale for both: 5 V/cm, 20  $\mu$ S/cm.)



**Fig. 8**—Behavior at 20 kHz into 1- $\mu$ F load. Top, square wave; bottom, sine wave. (Scale for both: 20 V/cm, 10  $\mu$ S/cm.)

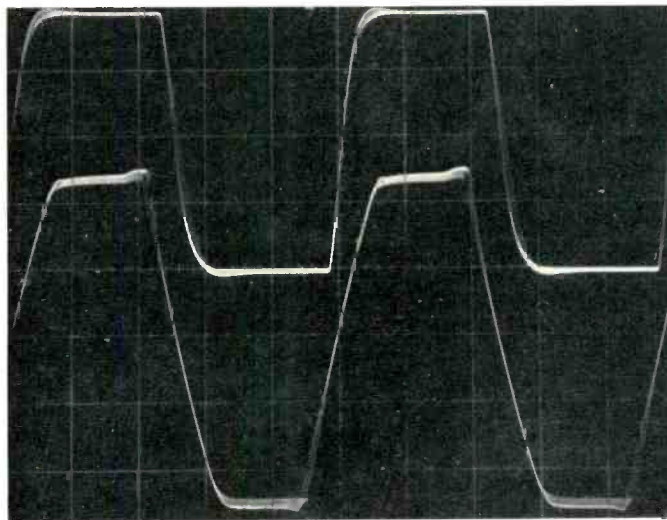

**Fig. 9**—Top curve, 20-kHz square wave into 8-ohm load; lower curve, 20-kHz sine wave into 8-ohm load with 2-dB overdrive. (Scale for both: 20 V/cm, 10  $\mu$ S/cm.)

sirable. A reader recently suggested that amplifiers be tested with capacitive loads in the range of 0.05 to 0.2  $\mu$ F to see if any real amplifier instability occurs. Accordingly, the second trace of Fig. 6 shows the 500D's behaviour with 0.22  $\mu$ F. As capacitance is raised from zero, the circuit starts to ring at about 0.05  $\mu$ F and rings more and more with decreasing resonant frequency as capacitance increases to the low microfarad range. With this amplifier, no sign of amplifier instability *per se* was observed. The ringing shown is caused by the RLC network formed by the series buffering inductor typically paralleled by a resistor in the 1-15 ohm range and the capacitance load itself.

Figure 7 is for a 10-kHz, 10-V p-p square wave into a 2- $\mu$ F load and an 8-ohm resistive load. Ringing with 2  $\mu$ F is typical of other solid-state amps. The rise time of the resistive load waveform is slower than most other solid-state amps, reflecting the designer's philosophy on required or desirable bandwidth. Of greater interest in this regard, however, is the fact that the rise time as a function of signal level is more constant than any amp so far tested, being about 4-5  $\mu$ S. Furthermore, at 80-V p-p, the shape is still exponential instead of straight sided which suggests that the amplifier isn't allowed to slew rate limit by the relatively slow overall rise time. (See top trace of Fig. 10.) Fig. 8 shows behaviour at 20 kHz into a 1- $\mu$ F reactive load. The top trace is for square-wave drive. Attempts at higher levels simply blew the primary circuit breaker. The level that was achieved (40-V p-p) is suggestive that the amplifier is behaving equally for plus and minus transitions and would probably look good at higher outputs if the breaker would permit. The sine wave level is 40 V rms or 200 volt-amps. THD under these conditions was 0.4%.

The top trace of Fig. 9 is an 80-V p-p, 20 kHz square wave into 8 ohms. Note the rise and fall portions are exponential in shape, and both transitions behave about the same. The blurring at the corners is a 120-Hz power-supply-ripple modulation effect that decreases as power is reduced. The lower trace is for a 2-dB overdrive beyond the onset of visual clipping with a 20-kHz sine wave. Not evident in this trace is the sudden reduction of peak amplitude when clipping occurs, which must be accompanied by increased common mode conduction in the output stage, thus dragging down the power supply. "Sticking" *per se* is relatively absent.

Damping factor was measured as a function of frequency and varied from 225 at low frequencies to 200 at 1 kHz, decreasing to about 25 at 20 kHz. Output noise as a function of measurement bandwidth is shown in Table I below. The higher noise level in the 20 Hz to 20 kHz band was caused by line harmonics, and the 122  $\mu$ V figure is 110 dB below 200 watts into eight ohms—quite good. Power at 1 kHz at onset of visual clipping into four-, eight-, and sixteen-ohm loads was 380, 231, and 129 watts, respectively.

In summary, the 500D is a strong, well-built amplifier that should be quite rugged in use, especially with lower impedance and capacitive loads. It would be a very excellent choice as a woofer amplifier in a multi-way system. As a wide range amplifier, the 500D will drive difficult loads with stability and safety.

Bascom H. King

Check No. 96 on Reader Service Card

**Table I**—Output noise as a function of bandwidth, in  $\mu$ V.

Bandwidth	Left	Right
20-20k	122	70
400-20k	60	63



# Directory Addenda

**Audio General**  
1631 Easton Road  
Willow Grove, Pa. 19090

**Gale Electronics**  
c/o Roth-Sindell  
Suite 102  
540 Kelton Ave.  
Los Angeles, Calif. 90024

**Sennehiser Electronics Corp.**  
10 West 37th St.  
New York, N.Y. 10018

**McIntosh Laboratory, Inc.**  
Two Chambers St.  
Binghamton, N.Y. 13903

The listing for Infinity's Servo Statik IA on page 86 of the October Directory contained several errors. System type is electrostatic, rather than ported, and has a sealed bass comode operating below 70 Hz. It does not have a Walsh tweeter.

**Amtroncraft Kits, Ltd.**  
1 West 13th St.  
New York, N.Y. 10011

**Stark Designs Co.**  
7621 Fulton Ave.  
North Hollywood, Calif. 91605

**STR**  
3000 Orange Grove Ave.  
North Highlands, Calif. 95660

**Jensen Sound Laboratories** notes that the prices listed for their speakers in October's Annual Equipment Directory are for speaker pairs.

## AMPLIFIERS

MANUFACTURER	MODEL	FTC power/chan., 8 ohms, watts	Freq. range for rated power, Hz.	Highest THD from 0.25W to rated power, %	Highest THD from 0.25W to rated power, %	S/N phono, re 10 mV input, dB	Phono sensitivity, in mV, Phono 1, phono 2	Phono overload, in mV, Phono 1, phono 2	Mike input sens., mV	High level input, V	Headphone output level, V	Headphone load impedance	Output impedance, ohms	Damping factor, 1 kHz	Dimensions, in inches	Weight, lbs. (net)	Price, \$	NOTES
AMTRONCRAFT	(B) UK-192 UK-185	25 10	5-80 20-20	1.0 0.5		80	3		0.07		4 4	12½x9x4			5	139.95(K) 99.50(K)	Requires power supply.	All models solid-state except where mod. no. preceded by (T). Basic power amps have mod. no. preceded by (B). (K) indicates kit price; (W) wired. (Q) with mod. no. indicates quad.

## PREAMPLIFIERS

MANUFACTURER	MODEL	Frequency response Hz. - 2kHz, ±1 dB	Rated output, V	THD at rated output, %	IM at rated output, %	S/N ratio, phono, dB re 10 mV input	Phono sens., mV, phono 1/phono 2	Phono overload, mV, phono 1/phono 2	Mike input sens., mV	High level sens., V	Tape mon. impedance, ohms	Tape mon. output level, V	Dimensions, in.	Weight, lbs.	Price, \$	NOTES
AMTRONCRAFT	UK-175 UK-118								0.1 1.0				9x6½x4¼ 117/ax7x4	2 1½	99.50(K) 115.50(K)	Powered by amp. As above.
AUDIO GENERAL	511	20-20 -0.1	5	0.005	0.005	80	2.3	70	0.23	38k	0.23	14x10x5¼	15	400.00	No tone controls.	

# SPEAKERS

MANUFACTURER	MODEL	Enclosure type	Woofer dia., in.	Woofer resonance (in-system)	Midrange dia., in.	Midrange type	Tweeter dia., in.	Tweeter type	Level control(s)	M=Mid, T=tweeter	Anechoic freq. response	Sens. for 1 W, 1 m, 10 Hz, ±2 dB	Power handling capability	Crossover frequencies, Hz.	Impedance, nominal	Dimensions, inches	Wood finish	Grille material, color	Weight, lbs.	Price, \$	NOTES
GALE ELECTRONICS	GS-401	Ac.sus.	(2)8		(2)4	Cone	3/4	Dome	M,T		55-20	79	40	450, 4.5k	8	23x13	*	*	385.00	*Choice.	
STARK DESIGNS	SR-1	Ac.sus.	10	43	5	Cone	1	Dome	M,T		40-20	79	40	450, 4.5k	8	24x15	Wal.	Foam 5 colors	42	165.00	(1)
	SR-2	Ac.sus.	12	38	5	Cone	1	Dome	M,T		35-20	81	50	450, 4.5k	8	24x15	Wal.	Foam 5 colors	48	195.00	(1)
	SR-3	Ac.sus.	12	38	(2)5	Cone	(2)1	Dome	M,T		35-20	81	60	450, 4.5k	8	24x16 1/2	Wal.	Foam 5 colors	57	240.00	(1) (2)
STR	Beta	Ported	8	75	-	-	3 3/4	Dome	-		55-22	93	18	1.5k	8	16x9 3/4	Vinyl	Foam, blk	18	74.50	Fused
	Gamma	Ac.sus.	10	42	3 3/4	Dome	-	PZ	-		37-21	93	30	1.5k, 10k	6	23x14 1/2	Wal.	Foam, blk	43	179.00	Fused
	Gamma II	Ac.sus.	10	42	-	-	3 3/4	Dome	-		37-21	93	30	1.5k	6	23x14 1/2	Vinyl	Foam, blk	43	108.00	Fused
	P-10	Ported	10	65	4 1/4	Dome	3 3/4	Dome	T		40-20	95	75	1.5k, 5k	6	25x13 1/2	Wal.	Cloth, blk	65	249.00	Fused
	P-12	Ported	10	65	4 1/4	Dome	(2)	Dome	M,T		30-21	91	125	300, 5k	8	31x15 1/2	Wal.	Cloth, blk	80	349.00	Fused
	Sigma II	Ported	12		4 1/4	Dome	(2)	PZ	M,T		40-21	94	200	900, 5k	8	31x15 1/2	Wal.	Cloth, blk	85	399.00	Fused
	Omega III	Dual slot	(2)12		8	Cone	(2)	PZ	W,M,T		23-18	93	200	150, 3k	8	31x15 1/2	Wal.	Cloth, blk	170	649.00	Fused, bi- and tri-ampable.
	Theta III*		(2)12				(3)	PZ	T		5k-25k	100	150	4k	20	6x6x12 1/2	Wal.	Cloth, blk	5	149.00	*Add-on tweeter; fused; for parallel operation.

REFERENCE NOTES: (1) Rotatable High Frequency Dispersion Unit. (2) Rear mounted mid and high frequency drivers.

# MICROPHONES

MANUFACTURER	MODEL	Directional pattern	Operating principle	Case material	External finish	Impedance, ohms	Freq. resp., Hz-kHz, ±2 dB	EIA sensitivity, dBm	Mic connection	Cable length, ft.	Cable plug type	Dimensions, in.	Weight, oz.	Mounting method	Price, \$	NOTES
SENNHEISER	MD-441	Super card.	Dyn.	Metal	Chrome plastic	200	30-20	-146	XLR	15	-	10.6x1.4x1.3	16	5/8 x 27	275.00	Adj. Freq. resp.
	MD-421	Card.	Dyn.	Plas.	Chrome plastic	200	30-17	-146	XLR	15	-	7x1.8x1.7	14	5/8	193.00	
	MD-416	Card.	Dyn.	Metal	Satin nickel	200	50-16	-151	XLR	15	-	7 x 2	11	5/8	180.50	
	MD-413	Card.	Dyn.	Metal	Satin nickel	200	50-15	-151	XLR	15	-	5 x .87	10	5/8	140.00	
	MD-211	Drum.	Dyn.	Metal	Satin chrome	200	30-20	-151	XLR	15	-	5 x .87	4.5	5/8	214.50	
	MD-402	Super card	Dyn.	Metal	Chrome	750	80-12.5	-151		5	Phone	5.7 x .83	6 1/2	Clamp	50.00	
	MD-412	Super card	Dyn.	Plastic	Plastic	800	50-12.5	-151		5	Phone	5 1/2 x 1 1/2	2.1	Clamp	72.50	
	MKH-815	Beam	RF cond.	Metal	Satin nickel	10	50-20	-115	XLR	-	-	22x 3/4	14	Clamp	629.00	
	MKH-415	Club	RF cond.	Metal	Satin chrome	10	40-20	-121	XLR	-	-	10x 3/4	6	Clamp	529.00	
	MKH-435	Card.	RF cond.	Metal	Satin chrome	10	40-20	-121	XLR	-	-	7 1/2 x 3/4	5	Clamp	495.00	
	MKE-201	Drum.	Elect. cond.	Metal	Satin nickel	15k	50-15	-135		5	Phone	7x 3/4	4	Clamp	126.50	
	MKE-401	Card.	Elect. cond.	Metal	Satin nickel	15k	50-15	-135		5	Phone	7x 3/4	4	Clamp	147.50	
	MKE-2002	*	Elect. cond.	Metal	Enamel	1.5k	40-20	-141		10	DIN		2		330.00	*Double mike for bi-aural stereo.

# HEADPHONES

MANUFACTURER	MODEL	Type (dynamic, electrostatic, etc.)	Freq. response, Hz-kHz, ±2 dB	Impedance, ohms	Sensitivity, dB SPL for 1 mV input	Maximum input, mV	Distortion, % at rated input, 1 kHz	Cord length, ft.	Weight, oz.	Price, \$	NOTES
SENNHEISER	HD-44	Dyn.	40-15	640	94	8k	1.5	10	1.2	29.75	Open-air design. Deluxe version of 414. Mono. for TV listening. High isolation, for monitoring.
	HD-414	Dyn.	20-20	2k	102	18k	1	10	4.8	49.75	
	HD-424	Dyn.	16-20	2k	102	18k	1	10	6.7	79.95	
	HD-4004	Dyn.	100-6	17	82	5k	1.5	25	0.6	12.00	
	HD-110	Dyn.	20-20	200	98	7k	1	5	10	111.50	



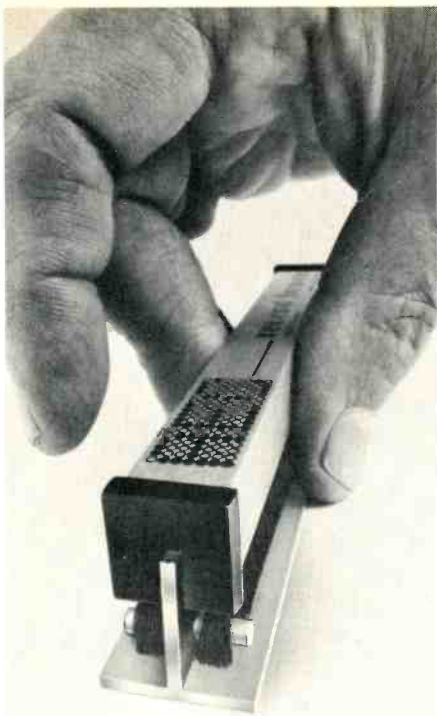

**LP surface noise? Now there's a better way to give it the brush.**

Since all modern LP's are made of vinyl, they're all subject to two kinds of surface noise—from dust in the grooves and from static electricity.

Now there's a way of eliminating both problems effectively (and prolonging the life of your records in the process). It's our new A.E.C. Megafilare (million bristle) record brush.

Designed for us By London FFRR, this easy-to-use brush features special electrically conductive bristles, which carry away the static with the dust. And they do it without the need for messy liquids—which can eventually clog the grooves.

A.E.C. Megafilare brushes (and London FFRR-designed, ultra-precise A.E.C. Posiscan cartridges) are available wherever C/M Laboratories products are sold. Or write us at 327 Connecticut Avenue, Norwalk, Conn. 06854.

**AUDIO**  
INTERNATIONAL, INC.

CHRISTMAS GIFTS...FOR YOUR RECORDS.

Check No. 8 on Reader Service Card

# The Column



**Atlantic Crossing: Rod Stewart**  
Warner Brothers BS 2875, stereo, \$6.95

Sometimes it's fairly interesting to take a wild animal and domesticate him, but such experiments aren't very interesting if extended over a period of time. This is Rod Stewart's album in which the backing musicians are dressed in business suits rather than dungarees—producer Tom Dowd (replacing regular producer Rod Stewart) has taken Rod out of the garage band bash sessions and placed him in front of seasoned session men who play with precision/taste more often than exuberance/flash. Sometimes it works (mostly on the slow side), and sometimes it doesn't—but this is an experimental album rather than your usual Rod Stewart disc. I like it quite a bit, especially compared to the majority of records out on the shelves, but it's as flaw-laden as Alice's *Welcome to my Nightmare* or Roger Daltrey's solo efforts. You can take the man out of the jungle, but you can't totally take the animal out of him—but Tom Dowd almost does from time to time.

Dowd knows more about getting a band to sound right than getting the most out of a vocalist—Stewart doesn't sing his best on the fast side, particularly on *Stone Cold Sober*. The

players seem to be hitting the right notes, and the track seems to sound good, but somehow Stewart has the kind of voice that rocks best when pitted against a chunky rhythm guitar like Ronnie Wood's than a precise rhythm section and rather restrained guitar. Good old Roddy knows how to deal with a slow tune when the backing is right, and songs like *I Don't Want To Talk About It*, the Al Greenisms of *This Old Heart of Mine*, and Sutherlands' *Sailing* come off as sterling gems with no comparable tracks in the entire Stewart catalogue. When Stewart's done a ballad in the past, it's usually been marked by the same rough edges that characterize his up-tempo numbers. Now his ballads are smooth, well-crafted pieces of plastic, but his rockers lack the raunch—I suppose how much you like this album depends largely upon (1) how important you think raw punch is to Stewart's music and (2) whether you value Rod's rockers higher than his "down" tunes.

Don't get me wrong—I enjoy listening to this album quite a lot, and Rod'll shine through any muck that you place around his voice. He's one of the most recognizable vocalists on the scene today, and this is his first al-

bum to sound like the "finished product" that I've heard Rod gripe so much about, he being a great defender of looseness and spontaneity. I just hope that in the future Rod recognizes the importance of the "ka-chunk" to his music, and with Ron "He's Good-Looking, Girls" Wood moving over to the Rolling Stones (we suspect) and The Faces dissolving, my guess is that the Stewart-Wood collaborations may re-emerge as the dominant force on Rod's solo outings, as the reason for all this gloss on *Atlantic Crossing* is just to prove that there's a difference between Faces albums and Stewart albums. Point proved, let's get back to basics.

Jon Tiven

Sound: A — Performance: B

**The Dream Weaver:** Gary Wright  
Warner Bros. BS-2868, stereo, \$6.98

Gary Wright is yet another solo artist who came out of a band that has been around for quite some time. His origin is Spooky Tooth, a band I never could really get a handle on, yet often enjoyed. Wright played keyboards with that band and it's only fitting that, apart from the vocals and the drums of Andy Newmark and Jim Keltner, all the sounds are from keyboard instruments (Ronnie Montrose's guitar is heard on one cut). Moog bass, Arp strings, Fender piano, Hammond organ, and other brand name sounds provide an exquisite framework for more relaxed vocals than you would ever expect from a Spooky Toother.

The lyrics are in keeping with our times. Rock frankly has run out of words and in general lost interest in lyrics other than as a hook to give the title some meaning. On this album, except for the poetry of *Dream Weaver*, poetry takes a minor role in the whole of any song. In this time, where Do-ahah and Da-da-diddy-dum are definitely a no-no, an artist like Gary Wright has a real difficult time of it keeping current and keeping himself inside the framework of tried and tested Rock-type tunes. The lyric is needed to preserve the identity of the music as Rock and Roll, and also to satisfy old fans from his Spooky Tooth days. Without them **The Dream Weaver** would have to face the marketplace as an instrumental disc. Even though it merits this carping about words, **The Dream Weaver** is successful no matter how you approach it. In striking a balance between his voice and his instruments Gary produces a laid-back, comfortable album that has no outstanding tune or element, other than start-to-finish competence. The whole is greater than its parts and



Realistic STA-225  
Stereo Receiver  
About \$400

# Realistic? Pioneer? Marantz?

## Who's #1 in audio equipment?

Three famous national component brands, each with fine equipment at all the traditional price points, each with fine magazine ratings and lots of customers. Naturally we at Radio Shack like to think Realistic\* is top dog. Our reasoning goes like this:

Realistic has over 4000 stores — the entire worldwide Radio Shack system — and 21 years of manufacturing experience. Realistic has exclusive Glide-Path\* and Auto-Magic\* controls. An audio consultant named Arthur Fiedler. Service like no tomorrow. And prices like yesterday. Maybe a better question is who's #2?

# Radio Shack *Great sound since 1923*

Over 4000 Stores/Dealers in USA, Canada, England, Australia, Belgium, Germany, Holland

Check No. 36 on Reader Service Card \*Registered Trademark

## Could the ultimate system be all Crown?



It depends on how you define "ultimate". But Crown may be the only top-quality, state-of-the-art manufacturer whose components could build a complete ultimate system.

For Instance: A CX-824 tape deck, world-renowned for reliable performance. Connected to an IC-150 pre-amp. With the signal amplified by a DC-300A power amp, proved in many thousands of hours of professional use. Output controlled, monitored and switched by an OC-150. Possibly a VFX-2 for personal control of crossover points. And sound faithfully reproduced by ES-212 electrostatic speakers.

All Crown. We think *that* system would be somebody's ultimate. Certainly ours. Maybe yours.

Write us today for the name of your nearest Crown dealer. He'll talk to you — ultimately.

When listening becomes an art,



**CROWN**

Box 1000, Elkhart IN 46514

Check No. 7 on Reader Service Card



should appeal to many tastes. The ease and smoothness of the performance lifts this far away from the Spooky Tooth mold, as does the superb recorded sound.

Gary Wright is maturing right along with his audience. He even avoids hollering even once. He brings home **The Dream Weaver** with taste, flair, and warmth. *Fred De Van*

Sound: A Performance: A

**Land's End:** Jimmy Webb  
Asylum 5070, stereo, \$6.98.

This record earns my first Red

Scrawl Award. I listened to it once and then scrawled *total loss* across the cover. If you are looking for great song writers performing their own material (and Webb is a great writer), try Janis Ian **Between The Lines**, Columbia PC33394, and **Stars**, Columbia 3285; Gordon Lightfoot, **Cold On The Shoulder**, Warner MS 42206; Van Morrison, **Veedon Fleece**, Warner BS 2805; Jackson Browne, **For Everyman**, Asylum 5067, or even Paul Williams, **Here Comes Inspiration**, A&M 3606.

Avoid this Jimmy Webb album. As good as he is, he just doesn't make it

with this one. Maybe I could accept someone less well-known coming up with something like this—maybe Tim Moore, or Michael D'Abo, but I heard this Jimmy Webb album first. This review comes after listening the third time and the red scrawl still applies. *Total Loss!* *Fred DeVan*

Sound: B Performance: D

**Upchurch/Tennyson:** Phil Upchurch/Tennyson Stephens  
**Kudu KU 2251**, stereo, \$6.98.

This is a delightful R&B, jazz-rock, Stevie Wonder, Kool-and-The-Gang blend, done with the sensitivity that only pure jazz musicians have. It's performed with the eloquence and assurance of a studio musician who is doing just fine being on other folk's albums (ranging from Cat Stevens, reviewed in *Audio*, Feb. 1975, to Jerry Butler and Howlin's Wolf). Phil Upchurch is now part of the cooking CTI house rhythm unit that backs George Benson and other CTI stars. CTI is Kudu's parent label, and Kudu is CTI's style and quality, aimed at non-purists (like me).

Bassist/guitarist Upchurch and his constant cohort Tennyson Stephens (vocals and keyboards) put on a sterling performance and really show us how well an idea can work. The music is tight, smooth, and professionally executed.

Tennyson's voice can not be ignored. It's a sort of blending of Lou Courtney (*I'm In the Need of Love*, Epic KE 33011) and Les McCann (on any Atlantic). His piano is that tasteful Rhodes sound that Les pioneered, but this is no copy. There is no special cut on this album that stands out above the splendid whole, but there is one I just don't like, *Ave Maria*. I can't understand why they did it. Don't judge the sum from this one of its nine parts. On the rest of the album the CTI/Kudu creative forces are joined in their normal state of deft perfection. Arranger Bob James and the incomparable Rudy Van Gelder ("master ears") together provide arrangements and recording with a sheen of strings and voices around the basic quintet.

The result of all this is a very lovely, easy-to-listen-to album that has its creative feet in many places. It's very relaxed. Its alluring prettiness will tease you to play it often. Just don't take it too seriously. Relax—Upchurch/Tennyson are relaxed (and relaxing). Their music is calm and complete. Betcha the jazz fussybudgets won't think much of it. But they

# TDK SUPER AVILYN OUTSOUNDS CHROME AND THE #1 FERRICHRROME.

## INDEPENDENT LAB TEST RESULTS

	TDK SA	A	B	C	D
Signal-to-Noise Ratio	1 <sup>st</sup>	4 <sup>th</sup>	1 <sup>st</sup>	6 <sup>th</sup>	7 <sup>th</sup>
Distortion (I.M.)	1 <sup>st</sup>	2 <sup>nd</sup>	3 <sup>rd</sup>	7 <sup>th</sup>	6 <sup>th</sup>
Low-Frequency Response Accuracy	1 <sup>st</sup>	1 <sup>st</sup>	1 <sup>st</sup>	1 <sup>st</sup>	1 <sup>st</sup>
Mid-Frequency Response Accuracy	1 <sup>st</sup>	2 <sup>nd</sup>	5 <sup>th</sup>	5 <sup>th</sup>	2 <sup>nd</sup>
High-Frequency Response Accuracy	2 <sup>nd</sup>	2 <sup>nd</sup>	6 <sup>th</sup>	5 <sup>th</sup>	1 <sup>st</sup>
Maximum Output Level (3% thd)	1 <sup>st</sup>	2 <sup>nd</sup>	4 <sup>th</sup>	6 <sup>th</sup>	5 <sup>th</sup>
Output (0 VU)	1 <sup>st</sup>	4 <sup>th</sup>	5 <sup>th</sup>	2 <sup>nd</sup>	2 <sup>nd</sup>
Surface Abrasiveness	low	high	high	high	low

TDK's SA advances today's standard of excellence in cassette high fidelity. Until it was developed, chrome and ferrichrome had the sound—they outperformed ferric oxide tapes in extended high-frequency response with lower noise. Now, SA outsounds chrome, the #1 ferrichrome, and the leading ferric oxide tapes. SA is compatible with standard CrO<sub>2</sub> bias/eq. settings, but you don't have to worry about headwear. Its unique particle soaks up more sound and plays it back with less distortion and noise.

Check those test results. There's really just no contest. Super Avilyn delivered the clearest, cleanest sound. More lifelike sound—and for you, that's the ultimate test. Fact is, Super Avilyn is now the state of the art.

TDK Electronics Corp.,  
755 Eastgate Boulevard,  
Garden City, New York 11530.  
Also available in Canada.



Wait till you hear  
what you've been missing.

Seven tapes were tested (TDK SA, TDK KR, Scotch Chrome, BASF Chromdioxid, Advent Chrome, Scotch Classic, and Maxell UD) and ranked 1st to 7th. The chart shows the results for 5 representative tapes tested. The following tape decks were selected for use in the tests: Nakamichi 500 & 1000, Advent 201, and TEAC 450.

**Now! Get 2 free cassettes when you buy 8.  
Or! Free storage box when you buy two SA C-90's.**  
Limited supplies at participating dealers.

Check No. 50 on Reader Service Card

should understand it wasn't meant for them. Fred DeVan

Sound: A+ Performance: A

**Tomorrow Belongs To Me:** Sensational Alex Harvey Band

**Vertigo VEL-2004**, stereo, \$6.98

Exactly what you get in a big suburban singles joint anywhere in the country—no better, no worse. Strictly a dollar at the door, 75 cents a drink until nine. That's the sort of music it seems to be until you get into the disc. Then it begins to sound like a minor-league version of Genesis (on **A Lamb Lies Down on Broadway**, Atlantic 401). Let's say it's an amalgam of both. Alex Harvey brings a touch of "kultchur" to trivia, a gourmet treat for London punk-band lovers. It's a step up, or a step down, depending on where you're coming from.

This record doesn't offend me, but I doubt that I'll ever listen to it again.

Fred DeVan

Sound: B+ Performance: B

**Born to Run:** Bruce Springsteen  
**Columbia PC 33795**, stereo, \$6.98

Here we have the biggest star in Asbury Park, New Jersey being pushed onto the World Stage as T.N.B.T. (The Next Big Thing) produced by a fairly famed Rock Critic (Jon Landau) and refusing to do interviews unless he gets the cover. He's been called the New Dylan since his first record was released two years ago, and certain members of the press have gone on personal crusades for the fellow. If ever there was an advance industry buzz about a record, this must be it.

But with a hype that huge, there better be something there.

Now I'm not saying that Bruce Springsteen isn't good (heaven forbid he should get a bad review), but I'm not so sure he's God's ultimate gift to rock 'n' roll. His first two albums were excusable because they were dismal representations of the artist, and a few of the songs (just a few) were appealing. This is far more of an accurate picture of Bruce, and although his talent shines, so do his influences. Bruce Springsteen = Bob Dylan + Johnny Rivers + *Exile on Main Street* + Van Morrison + Eric Anderson + The J. Geils Band + "Not Fade Away" + A Whole Lot More That I Can't Put My Finger On.

I've always been a big fan of Rock 'n' Roll Synthesis myself, but I find this whole business of Bruce Springsteen

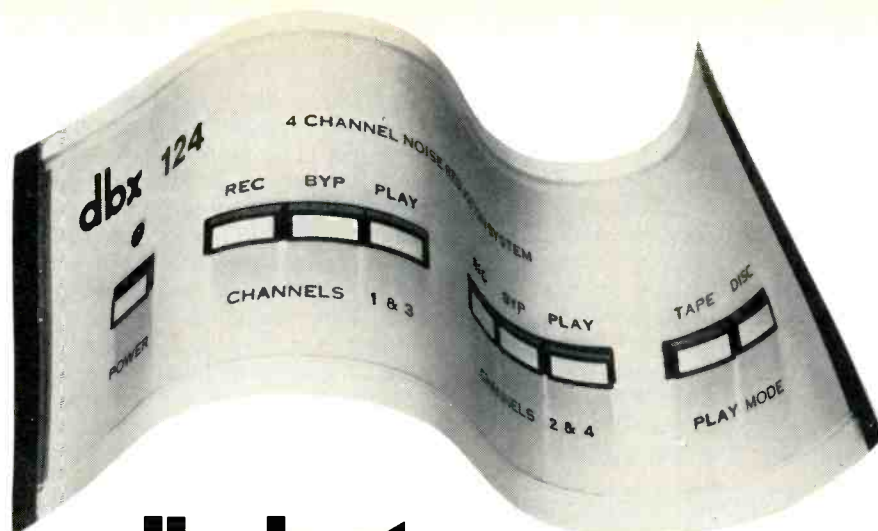

## eliminate noise in your tape recording

**F**or the first time in tape history, you can record live music on your audiophile recorder and achieve better signal-to-noise performance than professional studio recorders.

The new dbx 120 tape noise reduction system provides about 40 dB noise reduction with reel-to-reel, cartridge or cassette recorders. For live recordings, tape hiss and background noise are completely eliminated. For taping off-the-air or dubbing from records or tapes, no noise is added beyond the noise content of the material being copied. (We do not attempt to remove noise present in the original input signal, however.)

dbx 120 units also decode the newly released dbx encoded "noiseless" discs which offer over 100 dB dynamic range with no audible surface noise at any listening level.

Model 122 is a two-channel tape noise reduction system, switchable to record or play, with a dbx disc decode feature, priced at \$259.00.

Model 124 is a four-channel tape noise reduction system, switchable to record or play, which will also provide simultaneous record and play for two-channel recording, with a dbx disc decode feature, priced at \$379.00.

Words cannot adequately describe the experience of listening to recorded music with over 100 dB dynamic range. We don't expect you to believe it possible until you hear it for yourself.

For the most dramatic recorded music demonstration of your life, hear the dbx encoded "noiseless" disc at your demonstrating dbx dealer.

For complete product information and dealer list, circle reader service number or write to:



**dbx**

Incorporated, 296 Newton Street  
Waltham, Massachusetts 02154

Check No. 9 on Reader Service Card



being "The Future of Rock 'n' Roll" very unrealistic, because he's at least knee-deep in the rock 'n' roll past and can't seem to break loose except for an instant. He writes pleasant enough songs, but I can't decide whether it's solely because he knows how to plunder the best. On stage he pays his debt to Jackie DeShannon & Jack Nietzsche by doing one of their songs, and he does Stones songs, and Spec-tor songs; on record it's strictly original (ahem) material. I suppose he feels his main task is to get the songs he

writes across, but if we'd once get a chance on record to hear Bruce Springsteen as something other than a writer, those of us who consider records to be the predominantly important historical document issued by any artist could get a feel for his sense of past. And his voice is nothing to write home about—it's closer to a mumble than the primal scream.

I like the guy, I really do, even more on this record than live. I think it's time that somebody like Jon Landau (who's paid his dues to rock 'n' roll

over the years) broke loose within the record industry and got a decent royalty check. As for this album, it might sell fairly well, but it's not the type of record that's going to explode across the nation. Bruce Springsteen simply does not have the kind of voice to make it on AM radio, and if I was 15, I wouldn't idolize him, and if I was a 15-year-old girl, I wouldn't want to go out with him, so what's the point?

Jon Tiven

Performance: B+

Sound: B

# Soundcraftsmen THE PERFECT PRE-AMP



**FOR THE GREAT NEW SUPER POWER AMPS!**  
For a SUPER-SYSTEM, match the 2212 with any of these TRUE "State-of-the-Art" amps—

• PHASE LINEAR • SAE • CROWN • DYNACO • AUDIO RESEARCH • CITATION • ESS • MARANTZ • SONY • KENWOOD • BOSE • QUATRE • BGW •

**"FANTASTIC! I CAN HARDLY BELIEVE MY EARS... VERY VERSATILE & CLEAN-SOUNDING AND I REALLY LIKE THE SWITCHABLE PATCHING."**

**SPECIAL FEATURES**

- ALL PUSHBUTTONS INTERLOCKED to prevent inadvertent program destruction
- DISCRETE-OCTAVE EQUALIZATION CONTROL of ten octaves on each channel,  $\pm 12$ db each octave
- FULL-SPECTRUM LEVEL CONTROL for each channel
- AUTOMATIC CONTINUOUS MONITORING by light-emitting diodes for visual warning of overload in output circuits
- VISUAL ZERO-GAIN EQUALIZATION BALANCING on music, white noise or pink noise
- SELECTION OF TEST LITES on or off
- TAPE DUBBING BETWEEN TWO MACHINES, with optional simultaneous equalizing and monitoring
- DOUBLE-DUBBING into two recorders simultaneously
- SEPARATE SYSTEM-SELECTION enables full use of all other functions during the dubbing operation
- LINE OR TAPE equalization selector
- AUTOMATIC EQUALIZER-DEFEAT when line or tape equalizer is not in use
- FRONT PANEL TAPE input-output jacks for easy 2nd and 3rd tape recorder hookup access
- TAPE MONITORING of either tape at any time
- TWO stereo headphone jacks
- MONO SELECTOR for left, right or both channels to both outputs
- REVERSE-STEREO mode
- TWO low-level phono inputs
- FOUR independent phono preamps
- SIX A/C outlets, 4 switched, 2 unswitched
- ELECTRO-PLATED FERROUS CHASSIS—(eight sections)—provides optimum shielding to minimize magnetic field-coupling
- SINGLE-POINT system ground connector minimizes ground-loops
- TWO REGULATED power supplies

**Soundcraftsmen EQUALIZERS**

**NOW YOU CAN MAKE YOUR SYSTEM SOUND EXACTLY THE WAY YOU WANT IT TO SOUND!** In a few minutes, YOU can accurately "tune" the frequency response of YOUR stereo system and room environment to a flat  $\pm 2$  db! All you need are YOUR OWN EARS and the Soundcraftsmen Equalizer (WITH ITS STEP-BY-STEP INSTRUCTION RECORD) to transform any stereo system and room environment into an acoustically-perfect concert hall! Or to provide any special acoustical effects you desire! The Soundcraftsmen Equalizer enables YOU to instantly compensate for frequency response variations, IN SYSTEM AND ROOM.



**GUARANTEED to enhance and improve any fine system!**

Just plug 2 cables into your receiver's tape monitor jacks, and you are ready to enjoy a new experience in musical enjoyment!

**2212** Illustrated above... **\$349.50**

**20-12** Same specs as RP2212, except no I.E.D.'s, no Tape Equalizer on front... **\$299.50**

Both models include cabinet or rack mounts.

**GUARANTEED SPECIFICATIONS**

FREQ. RESPONSE — Hi-level:  $\pm 1/2$  db, 5 Hz to 100 KHz  
FREQ. RESPONSE — Phono:  $\pm 1/2$  db, 20 Hz to 20 KHz  
THD: less than .05% at 1 volt (Typ. .01% at 1 volt)  
IM: less than .05% at 1 volt (Typ. .01% at 1 volt)  
PHONO INPUT CAPABILITY: 100mw  
SIGNAL-TO-NOISE — Hi-level: 100 db below full output  
SIGNAL-TO-NOISE — Phono: 84 db below a 10mw input  
SIGNAL-TO-NOISE — Equalizer: 90 db below a 1-volt input  
GAIN — Phono: 63 db  
GAIN — Hi-level: 21 db  
OUTPUT IMPEDANCE: 600 ohms  
EQUALIZER LEVELS: Two gain controls for left and right continuously variable for unity gain compensation  
EQUALIZER RANGE: 12 db boost and 12 db cut, each octave 4:50, 60, 120, 240, 480, 960, 1920, 3840, 7680 and 15,360 Hz  
MAX. OUTPUT SIGNAL: Variable master volume control allows adjustment of optimum output to match amplifier  
GOLD SWITCHES: All contacts are gold plated for low-noise, long life, and resistance to oxidation and corrosion  
CIRCUIT BOARDS: Military grade G-10 glass epoxy  
RESISTORS: Low-noise selected carbon film  
CABINET SIZE: 7 1/4" x 20" x 11 1/4" deep  
SHIPPING WEIGHT: 28 lbs.  
MADE IN U.S.A. includes cabinet or rack mounts.

**PE2212 — \$499.50**

**FREE!**

**THE "WHYS AND HOWS OF EQUALIZATION,"** an easy to understand explanation of the relationship of acoustics to your environment. This 8 page booklet also contains many unique ideas on "How the Soundcraftsmen Equalizer can measurably enhance your listening pleasures." "How typical room problems are eliminated by Equalization," and a "10-point self-rated Equalization Evaluation Check-List."

**Soundcraftsmen**  
1721 NEWPORT CIRCLE, SANTA ANA, CA 92705

**Blues for Allah:** Grateful Dead  
Grateful Dead Records GD-LA494-G,  
stereo, \$6.98

**Bay City Rollers**  
Arista AL 4049, stereo, \$6.98

Here we have two records which are recordings of a lifestyle more than any kind of musical document. This is not to say that both of these albums lack musical worth, but that ultimately there are more important factors here than the notes played. Any impact that these records make in musical history will most likely be in terms of social rather than musical style.

The Rollers vs. The Dead is an interesting proposition for a battle of the bands, for the real test is not "Who will play their instruments with less competence?" (this competition would undoubtedly be a standoff) but "Do you like music that will help you fall into a stupor or music that will rev your heart to the Nth degree?" Personally, this writer finds being excited preferable to being laid-back, but I suppose that you listeners will have to decide that for yourselves; and when you go to the record shops you will have to ponder the crucial question—which of these two albums to bring home? Let me then present each of these musical associations in their context.

The Dead, ah, those bastions of the San Francisco sound championed by Rolling Stone magazine more often than the magazine's namesake, the original hippie band that seems to live forever. There's more hair on this band than on the Bay City Rollers, Slade, and The Rubettes combined! Musically speaking, the Dead are really past their prime, and it seems that attacking them in 1975 is no better than kicking a dead horse (or setting fire to a greaser's hair in 1965) so I shall stop. *Blues For Allah* is one of the best-recorded albums I've heard in a long time, full of crystal clear bass lines (and as Phil Lesh is the only real musician in the band, this is a plus).

But *really*, there's about as much energy here as on both sides of George Harrison's last single.

But the Rollers, *they're* another matter entirely. Many people (Clive Davis, Sid Bernstein, et al.) would have us believe that this is what's in store, or in the words of one ex-rock critic, "I have seen the future of rock 'n' roll and its name is Les McKeown." The BCR's sound more like a throw-back to early Sixties rock than the trumpets beckoning of what's to come, more or less an amalgamation of Roy Wood, The Four Seasons, and The Archies. There is no brilliant songwriter in the group, although occasionally the Faulkner/Wood team comes up with a palatable tune (mostly Beach Boys regurgitations, but I hold no grudges for plagiarism); Yea, the winningest material on their first American album stems from the pens of others. They have funny haircuts, the best of intentions, toothy smiles, amphetamine rock, and a hot record company on their side—but it's yet to be seen whether a group this limited musically (can't play their instruments for beans, can't write particularly well, sing only in fairly antiseptic voices) can take the public by storm. The Monkees did it once, but I think there was more personality there—yet both they and the Rollers were a result of a lot of people in the background (producers, managers) sweating through TV shows, photo sessions, and record dates more than any triumph of innovative powers within the music.

But in any case, it's your choice to make, The Grateful Dead or the Bay City Rollers. I'm not sure I'd put my money down for either of them, but Arista and United Artists already have done so with theirs, so I suspect you consumers are expected to follow suit.

*Jon Tiven*

Sound: A Performance:

**The Brecker Bros.:** Randy & Michael Brecker

**Arista AL 4037**, stereo, \$6.98.

This album is refreshingly different, not everybody's cup of tea, yet even those to whom it does not appeal must respect the strong musicianship it shows. Play it back as loud as your ears and speakers will permit. Study it. It's amazing how many rules of structure the Breckers successfully break with their fresh, inventive, exploratory, and highly personal style. The energy level is high, almost overpowering. Their sound assaults your ears if you're not prepared for the tight, high-speed, high-sound-level

# THE PRO/AM TAPE



## Introducing Maxell Ultra Dynamic backcoated/open reel tape.

A professional studio engineer doesn't have time for dropouts, wow, flutter, tape noise, static, poor winding, edge damage or erratic tape traction. Maxell Ultra Dynamic tape has the backcoating that eliminates these recording obstacles.

That's why the professionals use it. And why you should too.

While your Maxell UD tape is running (and the backcoating is protecting your music) you can concentrate on mike placement, sound levels and the more creative side of audio...like shushing the kids in the next room.

Maxell Corporation of America, Moonachie, New Jersey 07074. Also available in Canada.

**maxell.**

For professional recordings  
at home.





trumpet/tenor pairings or the feel of Randy's electric trumpet. Mike's tenor solos are full, heady excursions into the entrails of the tenor saxophone. The instrumental virtuosity both Breckers display is sufficient cause for celebrating the whole album.

Once the listener adjusts to the perspective of this music, its unfamiliar elements will be less uncomfortable though on your first LOUD hearing you may be nailed to your seat, transfixed, awed, dazed or confused (or shot out the door).

It seems inevitable that the Breckers

and executive producer Steve Backer would meet. When Steve was at Impulse Records he (and Bob Thiele) blazed new trails, including pioneering the first quadrasonic-only label. Steve is a perfectionist, closeting himself away from the commercial madness on his hideaway farm in Massachusetts. He always produces something different musically as well as sonically. His Impulse association probably helped change the sound on this album—it's strange, but not like the strident, weird sound which had previously come from Todd Run-

dgren's Secret studio where this disc was taped.

Randy and Michael came up to New York from Philadelphia in the sixties (even as Rundgren), and they've established themselves as the dynamic duo of the New York studio musician scene, providing trumpet and tenor on hundreds of records in every musical style. Both now in Billy Cobham's band, Randy was the original trumpet with Larry Coryell's Eleventh House (that chair now well filled by Mike Lawrence).

This music, put together by the Breckers and Backer shows a different approach, and it's leading up to something good. The Breckers, Maynard Ferguson, Cobham, Coryell, Jeremy Steig, Peter Frampton, Tom Scott, Jeff Beck, Stanley Clark, Michael Urbaniak, Brian Auger, Oregon, Anthony Braxton, Keith Jarett, Rick Wakeman, McCoy Tyner, Les McCann, and Kool and The Gang are all pointing their respective audiences in the same direction. Towards an omni-music. An omnipresent musical awareness and pragmatism that's creatively just a bit ahead of tomorrow. March on!  
Fred DeVan

## Some things hold up better than others.

The accepted concept of durability is based on several very important factors. Material. Design. Engineering. Function. And inherent value. Coincidentally, these are also the hallmarks of the Thorens TD-125 AB Mark II.

The materials are the finest available. The design and engineering incorporate the ultimate in turntable technology. Functioning flawlessly, it originates state-of-the-art that others have yet to achieve. To match the impeccable performance, this Thorens is constructed to hold up . . . not wear down. It has inbred longevity instead of built-in obsolescence.

The precision performance of the TD-125 AB Mark II serves as continuing proof of the Thorens determination to remain the classic name in turntables.

There are other models, too, starting at \$169.95.

Elpa Marketing Industries, Inc.  
East: New Hyde Park, N.Y. 11040; West: 7301 E. Evans Rd., Scottsdale, Ariz. 85260.

# THORENS®



### Procol's Ninth: Procol Harum Chrysalis CHR 1080, stereo, \$6.98

Procol hasn't changed in any major way since their inception eight or so years ago, since those who differed in opinion with group leader Gary Brooker (Matthew Fisher, Robin Trower) were promptly thrown out of the group. While the group has gone through temporary transitions, the Procol Harum of 1975 sounds almost identical to the group which produced *Whiter Shade of Pale*. Though the Booker/Reid team hasn't written a single song on a par with that, save some close misses with *The Devil Came From Kansas* and a couple of other recent classics, the group still sounds exactly the same.

On stage they're unaltered as well. Brooker delivers his vocals adequately, yet his stage presence is lacking—in fact, the only showman in the group is drummer B.J. Wilson, who is an incredible powerhouse. In concert halls, you'll rarely find a group more boring to look at. Still they persist, making one album a year and waiting for the world to catch up with them, waiting for their fan-dom to come together merely through persistence.

Their latest album is pleasant, if only because the tunes are typically Pro-

colly and the drum sound is given so much attention; this last item must be due to the efforts of producers Leiber & Stoller. One would expect that such famed and accomplished producers (The Coasters, Stealer's Wheel, et.al.) would have some great audible effect on the Harum sound, but no such luck. There are only minor differences—a cleaner wall of keyboards without the Chris Thomas drones, otherwise it's the same. I suppose they'll always stay the same—too bad I can't say the same for their writing ability.

Jon Tiven

Performance: C+ Sound: B+

**The Album of the Soundtrack of the etc.:** Monty Python's Flying Circus  
Arista AL 4050, stereo, \$6.98.

There's no doubt in my mind that the Monty Python group is not only very funny, but that they're very accessible to U.S. audiences, despite many rumours to the contrary. Just as audiences lapped up TW3, Americans are now guffawing over Python—for a multitude of reasons. Some find MPFC amusing largely for its Britishness. Obviously this is not the reason UK audiences enjoy it; there are many "in" jokes that Americans can make little sense of, except for those who read the London Times.

But people like to laugh—whether they're laughing at the British accents or at the ideas is unimportant—people are laughing at Monty Python's Flying Circus. Even stolid rock critics like me find themselves amused by their TV shows and movies. Britishers have always had a knack for striking the funnybones (and pocket-books) of Americans, regardless of whether the actual comic material can be heard over the Cockney mumbling.

The question is, can Python's attack, which is highly visual, be translated well enough onto the disc and back up into our mind's eye? Fortunately the answer is yes. They've taken the most rib-tickling bits of their movies, thrown in some conceptual jokes, running commentary, and assorted oddities (which I refrain from revealing to save them for proper presentation), and packaged them all very cleverly. Python devotees will not be disappointed with this record. Be, however, forewarned that this album, like most spoken-word recordings, does not wear well with age—it's not an album you'll get more from in repeated listening. On the other hand, unlike most comedy records, this is good the first time you hear it.

Jon Tiven

Sound: B Performance: A

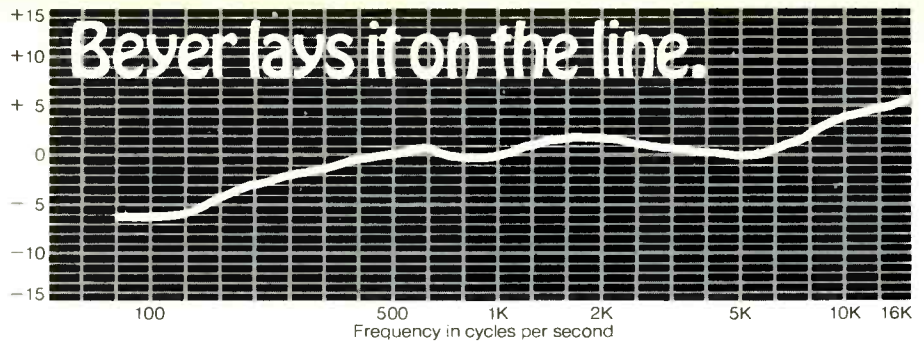

For the demanding professional, some mike manufacturers furnish a frequency print out as proof of performance.

Unfortunately, when it comes to low cost mikes for home use that practice is not only costly, but could prove embarrassing. Besides, you shouldn't expect a guarantee with an inexpensive mike.



Or should you?

You can if you buy the new Beyer 550.

At only \$42.50, the Beyer 550 provides authenticated performance at a price you can afford.

And what performance. In one elegant package you get smooth, wide frequency response, omnidirectional pickup pattern, low distortion and high signal-to-noise ratio.

Finally, you get the most generous warranty in the industry and that's another way Beyer lays it on the line.

**Another innovation from Beyer Dynamic, the microphone people.**  
Revox Corporation, 155 Michael Drive, Syosset, N.Y. 11791

Check No. 39 on Reader Service Card

## Get your new Radio Shack catalog at one of our 4000 stores today!

**Save! Our Prices Are Within 1% of Our July, 1974 Prices!**

**Hi-Fi • CB • Kits • Parts  
Phonos • Recorders • Tape  
Radios • Antennas • Tubes  
Auto Tuneup • Much More**

See what's *really* new. It's the most-wanted, most popular catalog in electronics, and loaded with our own exclusive nationally advertised brands: Realistic, Micronta, Archer, Science Fair, others — you've seen them advertised on TV. Come in for your free copy today!

**AVAILABLE BY MAIL TOO —  
JUST SEND US THIS COUPON**

**FREE! 1976 EDITION**  
**OVER 2000 PRODUCTS  
EXCLUSIVES ON EVERY PAGE  
BEAUTIFUL FULL COLOR**  
164 pages of the finest  
in home and hobby  
electronics



To: **Radio Shack** 616  
P.O. Box 1052, Ft. Worth, TX 76101  
Rush me your 1976 catalog.  
(Please Print)

Name \_\_\_\_\_ Apt. # \_\_\_\_\_  
Street \_\_\_\_\_  
City \_\_\_\_\_  
State \_\_\_\_\_ ZIP \_\_\_\_\_



# Our gimmick is no gimmicks at all.

Most speaker designers loudly proclaim accurate reproduction as their primary goal.

And so they should.

Regrettably, it doesn't always work out that way. A booming bass, a peaky midrange or some other dramatic device often suggests something quite different.

At Rectilinear, we have always avoided the dramatic...shunned gimmickry like the plague.

Witness our new Contemporary Laboratory Series.

Initial critical reaction has been very complimen-

tary and remarkably similar in expression.

Here's Norman Eisenberg commenting on the new Rectilinear 7, "The Rectilinear 7... offers totally 'ungimmicked' sound that is low in distortion, extremely transparent and devoid of any boxy resonances."

And in assessing the Rectilinear 5, Len Feldman was moved to write, "I liked the Rectilinear 5 for its freedom from 'gimmicky' sound, its sense of naturalness."

No gimmicks. Isn't that what great sound is all about?

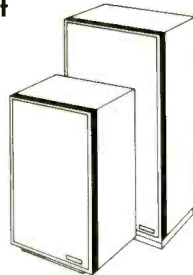

## Rectilinear®

Rectilinear Research Corporation, 107 Bruckner Boulevard, Bronx, N.Y. 10454.

Check No. 38 on Reader Service Card

# Our new cartridges will turn your good record player into a great record player.

Perhaps you've tried to track your records at the lowest advertised setting for your elliptical stylus. In the hopes of optimizing performance and reducing record wear. But every footstep threatens to bounce the stylus out of the groove. And big crescendos are simply *fuzzy*. Should you get a better player? No. Get a better stylus.

We have a sensible new approach. A stylus shape that contacts more of the groove wall, to spread tracking force over a greater vertical area. The Shibata

stylus. It safely tracks your records at up to 2 grams while maintaining response to 45,000 Hz, offering great stereo separation, and *reducing* record wear... even compared with an elliptical stylus at less than a gram.

Put an Audio-Technica Dual Magnet UNIVERSAL cartridge with genuine Shibata stylus in your good old record player today. It's a great combination for better sound today and tomorrow, and tomorrow.



AT12S

AT14Sa

AT15Sa  
AT20SLa



## audio-technica®

INNOVATION / PRECISION / INTEGRITY

© AUDIO-TECHNICA U.S., INC., Dept. 125A, 33 Shiawassee Ave., Fairlawn, Ohio 44131  
Available in Canada from Superior Electronics, Inc.

**Blackmore's Rainbow:** Ritchie Blackmore

Polydor PD 6049, stereo, \$6.98.

This is what you might call an album that became a group: Ritchie Blackmore, then lead guitarist in multi-million-dollar rock group Deep Purple, got bored with making records just as a member of Purple so in his spare time made a solo single, *Black Sheep of the Family*, with several of his friends. The results pleased both his ears and those of his peers so that Ritchie, enthused with total control for the first time in two years, decided to turn the solo single project into a solo album project. So it was off to Switzerland and Germany to cut **Rainbow**, a debut solo LP by our guitar hero backed by Elf, a group from the Deep Purple management company superstructure. Ritchie made the record and saw that it was good, so he kissed Deep Purple goodbye and turned Elf into his band, and thus was born the latest heavy metal thunder. Voila, two bands for the price of one!

The album seems to do nothing but threaten Deep Purple's stance as the Top Guitar-based Band in the World. Because even though Blackmore's replacement (ace plectrum mover Tommy Bolin) can deliver, it is yet to be seen how his semi-jazz style will jell with Purple's, and Ritchie has definitely got his act together. His guitar playing has always been brilliant, but here he plays with more care and thought than previously. I'm certain he realizes that with all the weight on him now, he'd *better* perform. That's his name on the cover, and if he puts out a terrible record he's got no shelter to hide under.

He doesn't pull any punches—from *Temple of the King* to *Still I'm Sad* there's a maximum of excitement and a minimum of filler. It could almost pass for a Deep Purple album except the rhythm section is far simpler. Ritchie Blackmore is the focal point, and since hard rock is a guitarist's medium that is important. Singer Ronnie Dio performs far better than he ever did in Elf, spurred on by Ritchie's guitarwork, no doubt. The sound is extremely clean and precise (the pressing of the record could be better, but that's not Ritchie's fault). If they can cut it live as well as they do on record (and Lord knows Purple always exceeded their studio discs onstage) this band will be monstrous in 1976.

I'm certainly glad I'm not Tommy Bolin—I'd have a tremendous cloud hanging over my head, because that boy's got a lot to live up to. *Jon Tiven*  
Sound: \_\_\_\_\_ Performance: A

**Sabotage:** Black Sabbath  
**Warner Brothers BS 2822**, stereo, \$6.98

Let's have another one just like the other one—here is the new album by perhaps the least coherent/competent singers/players of all the heavy metal groups. They're all right, I guess, always entertaining and the big difference from one album to the next is in the production and the covers and not really in the music. I sort of like them, and I sort of don't, but the real impression that this group makes upon me is that they sell extraordinarily well for a group with very little to say. I can't understand why they keep it up—maybe Ozzy is just waiting for somebody to call their bluff. If so, this is it: you aren't doing anything revolutionary, creative or particularly interesting other than taking advantage of the public. Congratulations on a job well done, but that's practically all it is. *Jon Tiven*  
 Sound: B Performance: ?

**Futurama:** Be-Bop Deluxe  
**Harvest ST-11432**, stereo, \$6.98.

Bill Nelson, lead singer/songwriter/guitarist/keyboardist in this group, is an adventurous sort who has taken nothing for granted. He disputes the proposition that only self-indulgent keyboard-based groups can play around with time signatures, he trifles with territories that musicians dared not tread previously, and he is clever with words—all within the context of the three-piece hard rock band. And this band, Be-Bop Deluxe, may well be the rock 'n roll band that the world has been waiting for. For Nelson is the fusion of the rock 'n roll musician and the rock 'n roll persona and can defend either position with equal strength and grace.

On first listening, the album is stupefying, and it's very difficult to grasp the changes (although the personality is readily identifiable). Something like *Stage Whispers* or *Sound Track* is pretty mind-boggling when it first hits you, but certain things become instantly clear: the man knows how to rock and he knows how to play guitars though these things are not necessarily paired. Keith Richard sure knows how to rock and the world loves him for it, though his technical prowess on his instrument is not especially astounding while John McLaughlin is the opposite case. But at last, in Bill Nelson we come to a being who has the discipline to practice and the steady inner backbeat to issue solos with spine-tingling freedom. Not to ignore his creative abilities—Nelson's guitar lines are perhaps

# Speaker Kits.



There's one part of your component system you never thought could be assembled as a kit. Money-saving, multi-element stereo speakers. Build them yourself to save up to half the retail cost of comparable ready-built systems. And get great sound in the bargain.

Send us your name and address and we'll mail you our free 32-page catalog of speaker kits, raw speakers, crossovers, enclosures and tips on design and construction. It's practically a manual on speaker building. Write or call:

**1-800-426-7736**  
 (toll free) for your free catalog.



Dept. AU-2—5500 35th N.E., Seattle, Wa. 98105

Check No. 55 on Reader Service Card



**SAVE!**

## AUDIO

Custom designed Library Cases will protect your magazine copies. These files are rugged and made with a rich Kivar cover. Shipped postage paid. Prices: \$7.50 each; 3 for \$20; 6 for \$37. Return the order form below with your payment.

Please send me \_\_\_\_\_ library cases. Prices: \$7.50 each; 3 for \$20; 6 for \$37. My check or money order is enclosed.

My Name \_\_\_\_\_  
 Company \_\_\_\_\_  
 Address \_\_\_\_\_  
 City \_\_\_\_\_ State \_\_\_\_\_ Zip \_\_\_\_\_

Mail to: Audio,  
 401 N. Broad Street  
 Philadelphia, Pa. 19108

Allow four weeks for delivery.

## Does Your AM Tuner Sound Like Quality FM?



### Our Dymek AM5 Does!

- Solid state—FET-IC construction throughout
- Unusually low distortion—less than 1%
- Typical AM "noise and whistles" are 90% eliminated
- Ceramic filters provide remarkable selectivity
- 4 μv sensitivity pulls in the distant stations

#### Audio quality comparable to FM

Factory direct—Money back guarantee. Lease plan and Master Charge available. Call or write for complete specs and performance details. Just \$295.00 for FM quality AM reception.

**Call toll free today**  
**Nationwide 800/854-7769**  
**California 800/472-7782**



McKay Dymek Co.  
 P.O. Box 2100 • Dept H5  
 Pomona, Calif. 91766

Check No. 54 on Reader Service Card



# controlled impedance

is an extra bonus advantage of every Scott loudspeaker system built since 1965. With **controlled impedance**, you are assured of compatibility between your speakers and your amplifier or receiver. Without **controlled impedance**, you can't be sure, for reasons we explain in our free brochure, "Controlled Impedance—Fact or Myth", which you may receive by circling reader service number or writing to us directly. Or visit your Scott dealer for a demonstration of **controlled impedance** loudspeaker systems priced from \$59.95 to \$349.95.



# SCOTT®

where innovation is a tradition

H. H. Scott, Inc., 111 Powdermill Road, Maynard, MA 01754

Check No. 58 on Reader Service Card

## ZEROSTAT: FOR THE SCIENTIFIC TREATMENT OF STATIC

Electrostatically attracted dust can cause surface noise and rapid wear of your records. Regular use of Zerostat helps ensure that your discs are kept in first class condition. And, since your record's surface static has been neutralized, no further dust will be attracted to it.

- Requires no power supply, batteries or refills.
- Lasts for at least 50,000 operations.
- The only device to neutralize by emitting both positive and negative ions.



Distributed by

**Discwasher Inc.**

909 University Ave., Columbia, Mo. 65201

the most original heard this year, right up there with Zeppelin's Page, Queen's May, Cong's Hillage, and Beck's Beck. At last a guitar hero worth his weight in Les Pauls!

But Bill Nelson is more than a one-dimensional musician, for his songs are also outstanding. He's a bit of a ham, tending to describe in voluminous detail his experiences as a guitar player ("Well, I'm waiting in the wings with all the strings and things that help me make the music...") or as a macho on the go ("Life is a love affair, all the girls declare it so... they know I am a gigolo..."). Some may find it heavy-handed, but I find it illuminating. The band keeps up with him every instant, though the album's bite comes about 90% from the mouth of Nelson. Simon Fox is the drummer and Charles Tumahai is the bass player, Roy Thomas Baker is the producer, and a good one. Bill Nelson has a strong set of pipes, and, girls, he's good-looking as well. I just can't wait for the first American tour, commencing any moment now. I haven't been this excited over a band in ages.

*Jon Tiven*

Sound: A Performance: A++

## Daryl Hall & John Oates

RCA APL1-1144, stereo, \$6.98

Hall & Oates hail from somewhere in Pennsylvania, and although I'm tempted to avoid the comparisons between their music and Todd Rundgren's, it's pretty near impossible. Their last album produced by Mr. R., was an embarrassment to all parties concerned—combining the worst of Todd and the worst of this duo's talents. This time around, they sound almost exactly like they're living in the music of Todd's most frequently hailed album, *Something Anything*. They write in that style, the arrangements and production is very Toddish, and even the vocal nuances are straight out of Toddsville.

This is not to knock the record, which I like very much (especially side two), but it's just to put things in perspective. The music is quite pleasing to the ear, the lyrics are amusing, and the whole feel of the record is a good one. Hall & Oates both sing and write well, but I find it difficult to understand how two people so obviously talented can live almost exclusively in another person's style. I suppose if it's possible for Badfinger to live within the Beatles, and the Dolls to echo the Rolling Stones, then Hall & Oates aren't exactly the first to do what they're doing. But will the critics love it?

*Jon Tiven*

Sound: B Performance: B+

# Jazz & Blues



**Ella Fitzgerald and the Chick Webb Orchestra**  
**Joker SM 3613, mono, \$4.98.**

Jazz fans who grew up in the 30s like to talk about the legendary battle of swing that took place the night of May 11, 1937 in Harlem's Savoy Ballroom between the Benny Goodman orchestra and the resident Chick Webb band. Goodman was then just arriving at the first high peak of his national fame and popularity, while the tiny, crippled drummer was the King of the 125th Street ballroom. By all accounts, Benny's band played as powerfully as ever that night, but the Webb crew blew the Goodmanites away with blazing, white-hot sets that drove the crowd wild. Aficionados tell how Webb finished off the session with a masterful drum solo that left Goodman and his drummer Gene Krupa shaking their heads, their jaws hanging in open admiration and amazement!

For years Chick Webb's band has been revered by European jazz connoisseurs, and most Webb reissues have come from abroad. **Ella Fitz-**

**gerald and the Chick Webb Orchestra** is on the Italian label *Joker* (reminiscent of the first pirated jazz issues of the 40s on *Jolly Roger*—are they trying to tell us something?). This is a splendid collection which showcases the Webb band's punchy, aggressive drive, and the recording has lively, vivid sound (considering they were transferred from shellac, 10-in., 78-rpm discs).

Such is the present day commercial potency of Ms. Fitzgerald (in her late teens then, and an immediate headliner with her hit *A-Tisket, A-Tasket*) that now, almost 40 years later she gets top billing over Webb on her cover. Though the LP is top-heavy with Ella's vocals, the tremendous drive and collective swing of the band come through on instrumentals *Clap Hands, Here Comes Charlie, Spinnin' the Web, Harlem Congo, and Strictly Jive*. The Edgar Sampson (of *Stompin' at the Savoy* fame) arrangements are clean and spacious, leaving plenty of room for fiery soloists like trumpeters Taft Jordan and Bobby Stark. Hearing their surging, exuberant playing, one can almost see again those hundreds

## NEW GRAPHIC EQUALIZER



USES LATEST IC TECHNOLOGY

**SPECTRO-ACOUSTICS** Model 210 Graphic Equalizer provides 10 bands per channel of equalization allowing  $\pm 15$ db boost or cut in each of the 10 audible octaves. An exclusive circuit utilizes "Gyrator" Synthesized Inductors which are almost totally immune to magnetic fields and current saturation. Any equalization setting can be made without exceeding the specified signal to noise ratio and distortion.

- \* Unique all IC construction allows all circuitry to be mounted on one easily removable circuit board which substantially reduces cost while increasing reliability and servicability.

For more details see your local dealer or contact Spectro Acoustics, Inc.

### SPECIFICATIONS

- THD • Less than 0.1% of 1 volt RMS output 20Hz - 20 KHz
- IMD • Less than 0.01% from ten volts to 100 millivolts composite output
- S/N • Noise and hum are over 105 db below full output

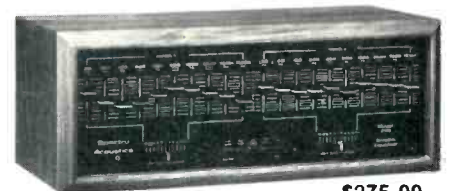

\$275.00

Spectro Acoustics Model 210

**SPECTRO ACOUSTICS, INC.**

1309 E. Spokane  
 Pasco, Washington 99301

(509) 545-1829

Check No. 48 on Reader Service Card



There's more to great sound than meets the ear.



When dust, dirt and static build up on your record, it can't possibly sound like it's supposed to sound. Groov-Kleen® is a specially designed component that removes dust and dirt, so you hear exactly what is recorded on your record — and nothing else.

An attractive chrome and steel armature, Groov-Kleen® mounts permanently on your unit. Its sable tracking brush and velvet roller lift dust and dirt out of record grooves and collect residue. All you have to do is sit and listen. And Groov-Kleen® also reduces stylus wear.

There's a Groov-Kleen® for every record player, manual or automatic. What's more, Groov-Kleen® has height and balance adjustments to insure that it can be used on any record without causing speed variation. So see your record or audio dealer and find out about Groov-Kleen®. Remember, when there's more to a record than you've been hearing, give a listen with Groov-Kleen®.

**Bib® Groov-Kleen®**  
Bib® Hi Fi Accessories 155 Michael Drive, Syosset, N.Y. 11791

Check No. 4 on Reader Service Card

**FREE** McIntosh CATALOG and FM DIRECTORY

Get all the newest and latest information on the new McIntosh Solid State equipment in the McIntosh catalog. In addition you will receive an FM station directory that covers all of North America.



**MX 113**

FM/FM STEREO - AM TUNER AND PREAMPLIFIER

**SEND TODAY!**

McIntosh Laboratory, Inc.  
East Side Station P.O. Box 96  
Binghamton, N.Y. 13904  
Dept. 1

NAME \_\_\_\_\_  
ADDRESS \_\_\_\_\_  
CITY \_\_\_\_\_ STATE \_\_\_\_\_ ZIP \_\_\_\_\_

If you are in a hurry for your catalog please send the coupon to McIntosh. For non rush service send the Reader Service Card to the magazine.

Check No. 27 on Reader Service Card

of high-stepping Savoy dancers, Lindying until the small hours every night. Home of Happy Feet, it truly was!

John Lissner

Sound: C Performance: A

**Skull Session:** Oliver Nelson

**Musicians:** Nelson, alto saxophone; Lonnie Liston Smith, electric and acoustic pianos; Mike Wofford, arp and piano; Chuck Domanico, bass; Dennis Budimire, Lee Ritenour, electric and acoustic guitars; Billy Green, Billy Perkins, Jerome Richardson, Buddy Collette, Bud Shank, reeds; Buddy Childers, Bobby Bryant, Paul Hubinon, Oscar Brashear, trumpets and flugelorns; Grover Mitchell, Richard Nash, Chancey Welsh, Maurice Spears, trombones; Vinny De Roas, Davis Alan Duke, French horns; Don Waldrop, tuba; Shelley Manne, Jimmy Gordon, drums; Willie Bobo, percussion.

**Songs:** *Skull Session, Reuben's Rondo, 125th Street and 7th Avenue, One for Duke, Dumpy Mama, Baja Bossa, In a Japanese Garden, Flight for Freedom.*

**Flying Dutchman BDL 1-0825, stereo, \$6.98.**

Big bands have always possessed the greatest potential for harmonic, melodic, and rhythmic possibilities. When the jazz-rock group with added horn sections became popular in the late sixties, the big band moved into a new era, exploring things with results the smaller groups couldn't predict. Such was the success of Maynard Ferguson's MF Horn.

Oliver Nelson has always been an advocate of the big band concept. His achievements are omnipresent in television, movies, jazz bands, etc., and in playing the sax. The premise for **Skull Session** was to see how melodic Nelson could make the electronic instruments sound. Electronics make instruments louder, and some people confused louder with better. But with Oliver Nelson the musical quality went in before the volume went up. The result is a set of strongly involving electronic and acoustic sounds, incorporating electronics with contemporary rhythm pulsations. *Skull Session* brought just this idea to reality. Mike Wofford on arp and Lonnie Liston Smith on electric piano pitted against the brass colorations produce electrifying results.

The cut *125th and 7th Avenue* is as crowded with full punchy ensembles and ear-grabbing solowork as this bustling intersection is with people. It

has been the site of much political and musical thinking, and Oliver Nelson has captured a veritable cross-section in this very funky composition. Best is the rhythm section, especially the interplay between Shelly Manne and percussionist Willie Bobo.

There are a couple of swinging cuts which demonstrate how well balanced a set of rock electronics can be made to be. *Reuben's Rondo* is an augmented arrangement of a piece Nelson wrote in 1959. Shelley Manne is one of the most versatile drummers alive. His fills are museum pieces and his choice of cymbals is as tasty as the way he tunes his drum set. He is able to play any particular type of music and make it sound like it's the only type of music he plays. Other drummers should take a lesson from this brilliantly open-minded individual.

*One for Duke* captures the sound of Duke Ellington's reed section in undercoating the melody with some bass clarinet. Then it begins to sound more like a thought from Thad Jones. Jerome Richardson leads the sax section and it takes on the sound of Jones' section during Richardson's tenure in New York. This arrangement has a much more modern sound than the post-bop *Reuben's Rondo*, as Mike Wofford comps on electric piano.

*Dumpy Mama* is more funk. Richardson does extended time on the flute. *Baja Bossa* is a beautiful Latin-esque sampler. Laurindo Almeida's acoustic guitar solo is a thoughtful introduction to *In a Japanese Garden*. It accurately reflects the serene atmosphere where ideas and feelings, as in music, are often understood more by a convincing look or quick glance than by verbal communications. Nelson's alto solo is an example of this superb articulation and phrasing.

*Skull Session* is a worthwhile treat for big band enthusiasts, and it is a logical introduction to different kinds of good music for listeners who want to broaden their scope of music appreciation.

Eric Henry

Sound: B Performance: A

**Native Dancer:** Wayne Shorter featuring Milton Nascimento

**Musicians:** Shorter, tenor, soprano saxes, piano; Nascimento, vocals, acoustic guitar; Herbie Hancock, piano; Airto Moreira, percussion; Dave McDaniel, bass; Roberto Siova, percussion; Wagner Tiso, electric piano, organ, bass; Jay Graydon, bass; David Amaro, acoustic guitar.

If you are considering an **investment** in sound reproduction,

**Don't make a move until you hear the 3 new BOZAKS**

For more than 25 years Bozak has been providing discriminating music listeners with loudspeakers which have been recognized as representing the highest standards of integrity in sound reproduction. Now Bozak has applied its same principles of

design — pushing the limits of the state of the art without compromising the laws of science — to two new electronic products and a new monitor type speaker for the home music systems of those who recognize and demand "the very best in music."

### Model 919 Audio Signal Processing Center

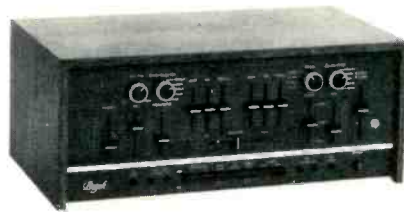

This mixer-preamplifier gives much of the flexibility found in commercial sound studios. With it you can mix and blend stereo sounds from records, tapes, tuners and microphones with differing input levels into a two-channel composite for recording or for listening.

### Model 929 Audio Power Amplifier

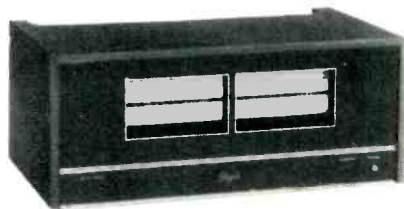

The ultimate in an amplifier for the home music system, the Model 929 has nearly identical circuitry to Bozak's commercial Model CMA-2-150 which has been selected for the most demanding applications in concert halls, theaters and auditoriums. Each of its two channels delivers 150 watts continuous minimum sine wave power into 8 ohms from 20 to 20,000 Hz at less than 0.2% total harmonic distortion. That is enough power for even the most important home music systems — those employing Bozak's Concert Grand speakers.

### Monitor C Loudspeaker System

Monitor C has been specifically designed to reproduce modern music, with its heavy emphasis on bass, with the greatest realism possible. You truly hear each note as it was played; Monitor C spells an end to "thump-thump" bass. Discotheques, as well as homes, are taking it to their hearts.

You can hear these magnificent audio system components at selected Bozak dealers. We'll gladly send you the name of one in your area.



**Bozak, Inc.**  
Box 1166, Darien, Connecticut 06820

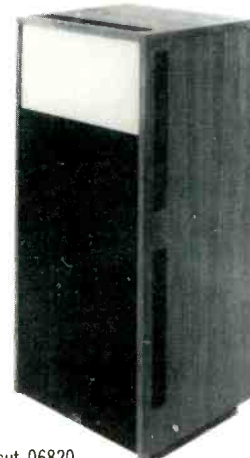



**Songs:** *Ponta De Areia, Beauty and the Beast, Tarde, Miracle of the Fishes, Diana, From the Lonely Afternoons, Ana Maria, Lilia, Joanna's Theme.*  
**Columbia PC 33418**, stereo, \$6.98.

**Native Dancer** boasts inspirational music from beginning to end. Shorter's comments accurately summarize the musical results: "... only this combination of five Americans and four Brazilians could conceive and mold such an expressive life force contained within."

Although the music is restrained and relaxed in tempo and volume, it in no way lacks vital drive and intensity. **Native Dancer** possesses the power to move mountains and cut through icebergs without having to demonstrate explosive power.

Shorter's piano playing makes a thoughtful addition to *Diana*, a composition to the daughter of Airta and Flora Purim. His playing mirrors the understatement which is the most elemental aspect of his sax work. *Lilia* is a conduit for an interesting 5/8 meter

undercurrent over which Shorter's soprano sax gently flows.

Herbie Hancock's acoustic piano on *Beauty and the Beast* hints at what his repertoire may sound like in an acoustic setting. The cut is laid back but very funky. It's a catchy instrumental which you'll find yourself singing.

Milton Nascimento is a very talented Brazilian guitarist and vocalist. Shorter said that he thought it unnecessary to say who Milton Nascimento is because he thought everybody knew. Everybody who hears his unique performance will remember.

*Ponta De Areia* is a vocal carnival with apparent falsetto overdubbings surfacing beside Nascimento's leads. Most gratifying are Nascimento's quick and accurate range transpositions. Shorter's soprano brilliantly complements the vocals.

A more mellow showcase is the magnificent ballad *Tarde*. Shorter is on tenor and Nascimento explores his own lower vocal range. Wagner Tiso builds a lilting harmonic foundation on organ. *Tarde* means suffering extendedly without asking forgiveness. The inside sleeve also explains the other titles.

*Miracle of the Fishes* has an elusive melody throughout the tune which fades behind an electric piano codetta before we can grab it. Rhythmically a 6/8 Nanigo, it has quite a euphonious array of vocals. Shorter's articulations within lightning runs up and down the entire register of the saxes are flawless and his intonation is unwavering.

**Native Dancer** is comparable to **Chick Corea-Light as a Feather** vintage. Both concepts take a light and airy approach to making music. Their music is relaxing yet stimulating, incorporating some provocative Brazilian elements. **Light as a Feather** is a musical milestone. Time will tell if **Native Dancer** stands in the same deep waters. The music has a hypnotic effect, transporting the listener to its tropic origins.

Eric Henry

Sound: A-/B+

Performance: A

**Jazz Funeral at New Orleans:** George Lewis

**Olympic 7117**, mono, \$4.98.

**Live Concert:** George Lewis & His Orchestra

**Saga 6921**, mono, \$6.95.

New Orleans jazz is never better than when it is played by men who have lived with it all their lives; when trombone, trumpet and clarinet

## When you're buying a mixer, read the small print first.

We're talking, of course, about the specs. Because they'll tell you right away just how good a mixer really is. And that's especially important when you've already got a quality recorder. Our Tapco 6200 has bass and treble controls on every channel. Complete stereo panning on every channel. Line outputs from every channel for quad recording. Line inputs on every channel for quad mixdown. 82 dB signal to noise ratio on balanced Low Z mike inputs. There's actually a lot more. Like the 6200's AutoPad automatic padding that virtually eliminates overload problems. And for complete recording studio capability at home, check the Tapco Graphic Equalizer and Reverberation System, too. The small print reads just as good.

**TAPCO**

2200 Graphic Equalizer  
289.00

4400 Reverberation System  
389.00



6200 Mixers From \$349.00

TAPCO, 405 Howell Way, Edmonds, Washington 98020 (206) 775-4411  
 Check No. 49 on Reader Service Card

weave highly-charged counterpoint, and when the solos sail out of ensembles with increasing excitement. There are many moments like this in these collections, when the emotions and artistry of the New Orleans veterans and artists communicate in an inspired manner.

Clarinetist Lewis was part of the original Bunk Johnson band. Like other Crescent City revival groups, it was a collection of aging and out-of-practice Black and Creole musicians, ex-stevadores and longshoremen, refurbished with instruments, (and, in Johnson's case, a new set of teeth) by dedicated, white, middle-class fan/entrepreneurs.

When the Johnson band hit New York in 1944 it received widespread media coverage. At its best it played with wonderful drive and spontaneity; it was jazz that got right down to the core. But at its worst, there were many embarrassing moments: grossly out-of-tune passages, botched ensembles, and defective tempos. After Johnson passed away in 1949 and George Lewis assumed leadership, things tightened up musically, and he successfully led the group until his death in the late 60s.

These recordings contain selections culled from a 1953 Lewis concert. Some of the musicians involved, including the incredible octogenarian trombonist Jim Robinson, are still with us and playing with the Preservation Hall Jazz Band. Although the two albums, the budget Olympic and the British Saga duplicate each other on three tracks (*When the Saints . . . , Panama, and Burgundy St. Blues*), they can be considered complementary and are both recommended.

*Saints* is the key track, a remarkable eight-minute joy ride with inspired, solid ensembles full of color and movement, with Robinson playing a rough, savage trombone solo with tremendous vigor. *Ice Cream*, which appears only on the Olympic, really drives, with perfect swing created by piano, trombone, and the thumping, rhythmic thud of the banjo. The strong, surging exuberance of the players will lift you right out of your chair.

*Caledonia*, which kicks off side two on the Saga disc, is another gem, a brassy, rollicking, boogie blues that starts off in a typically ragged manner, with trumpeter Avery "Kid" Howard barking the vocal, picking up strength on his horn, growling and blowing with the uninhibited energy of a much younger man. Lewis' expressive New Orleans clarinet is heard weaving in and out of ensembles with its

liquid tone providing a fluency that is the cornerstone of the band's front line. The rhythm section is tremendous here with bassist "Slow Drag" Pavageau, drummer Joe Warkins, banjoist Lawrence Marrero, and pianist Alton Purnell playing with driving fervor that builds a rocking momentum as it rolls along furiously chorus after chorus. Both albums are well recorded, offering a crisp, monaural sound. Absolutely exhilarating music.

John Lissner

Sound: B+

Performance: A



- Most effective cleaning system
- Easy . . . Thorough . . . Safe
- Cleans 'em all . . . LP's, 45's, 78's
- Removes static . . . Leaves no residue
- No electricity . . . You Spin & Clean Records
- Special concentrated Record Wash solution
- Gentle plush scrubbing pads get deep into grooves . . . remove for easy cleaning
- Only \$19.95, suggested list price.

After years of research with all types of record cleaning gadgets, gizmos and gimmicks, Fidelitone came up with a simple, direct solution . . . the Record Washer! Now you can wash your records quickly and easily with this unique Spin & Clean system. Gets out dirt deep down in the record groove . . . gives you maximum performance from your old records. Comes complete with special cloth and enough Fidelitone Record Wash Concentrate to wash up to 1,000 records!



**FIDELITONE**

207 N. Woodwork Lane Palatine, IL 60067

THE TOUCH OF MAGIC  
in Phonograph Needles, Cartridges,  
Record Care, and Audio Accessories

Check No. 14 on Reader Service Card

## THE DYNAMIC DUO!

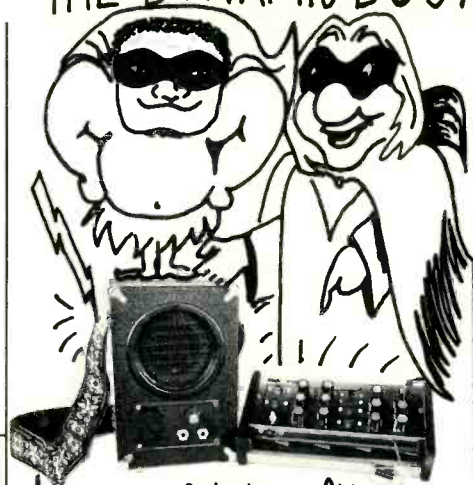

Pygmy Portable  
Amplifier  
\$39.95

GNOME  
micro-Synthesizer  
\$48.95

If you're into electronic music, PAIA's Pygmy Portable Amp and Gnome Micro-Synthesizer are a pair that's hard to beat. And now we offer them together, as a package, at a price that can't be beat — \$84.50 plus 10 lbs shipping — catalog #3741.

DEMO LINE—Use Ma Bell's low night rates to get a one minute demo of PAIA Synthesizers. Our recording equipment also takes catalog requests, charge orders, etc. (405) 843-7396.

— FREE CATALOG —

**PAIA** Dept. 11-A  
ELECTRONICS, INC. 1020 W. Wilshire Blvd.  
Oklahoma City, OK 73116

Check No. 31 on Reader Service Card

**J. E. SUGDEN & CO. LTD.**  
AUDIO EQUIPMENT  
OF BRITISH DESIGN



AMPLIFIERS AND TUNERS  
AS WELL AS LABORATORY  
MEASURING INSTRUMENTS

by the *QUALITY MINDED*  
for the *QUALITY MINDED*

WHY SETTLE  
FOR ANYTHING ELSE?

FOR INFORMATION WRITE:  
AUDIO IMPORTS  
P.O. BOX 27345  
INDIANAPOLIS, IND. 46227

Check No. 2 on Reader Service Card



# Advertising Index

ADVERTISER	PAGE	ADVERTISER	PAGE	ADVERTISER	PAGE
Ace Audio	111	Garrard (Plessey)	14, 15	Rectilinear	89
Preamplifiers		Turntables		Speakers	
Check No. 56 on Reader Service Card		Check No. 16 on Reader Service Card		Check No. 38 on Reader Service Card	
Acoustic Research	21	GTE Sylvania - Entertainment Products	41	Revox	25, 89, 94
Loudspeakers		Stereo Receivers		Hi-Fi Components	
Write Direct to Advertiser		Check No. 17 on Reader Service Card		Write Direct to Advertiser	
Astatic	37	Harman-Kardon	10, 11	Microphones	
Styli		Hi-F Components		Check No. 39 on Reader Service Card	
Check No. 1 on Reader Service Card		Check No. 18 on Reader Service Card		Record Cleaning Device	
Audio Imports	97	Infinity Systems	4, 5	Check No. 40 on Reader Service Card	
Audio Equipment		Speaker Systems			
Check No. 2 on Reader Service Card		Check No. 19 on Reader Service Card		Rhoades	110
Audio Technica	90	Institute of Audio Research	36	Teledapter	
Cartridges		Education		Write Direct to Advertiser	
		Check No. 20 on Reader Service Card		Rocelco	43
BGW Systems	12	Jennings Research	51	Loudspeakers	
Amplifiers		Loudspeakers		Check No. 10 on Reader Service Card	
Check No. 4 on Reader Service Card		Check No. 25 on Reader Service Card		SAE	6
Bose Corporation	13	Jensen Sound Labs	8	Hi-Fi Components	
Speakers		Hi-Fi Components		Check No. 41 on Reader Service Card	
Write Direct to Advertiser		Check No. 21 on Reader Service Card		Sansui	58, 59
Bozak	95	Lux Audio	27	Hi-Fi Components	
Hi-Fi Components		Hi-Fi Components		Check No. 42 on Reader Service Card	
Write Direct to Advertiser		Write Direct to Advertiser		Saxitone	109
Braun	49	Magnavox	45	Cassettes	
Speakers		Hi-Fi Components		Write Direct to Advertiser	
Write Direct to Advertiser		Check No. 23 on Reader Service Card		Schwann	107
Capitol Magnetics	105	Magnepan	26	Record & Tape Guide	
Recording tapes		Hi-Fi Components		Write Direct to Advertiser	
Check No. 5 on Reader Service Card		Check No. 22 on Reader Service Card		Scott	92
C/M Laboratories	82	Mantis Research Labs	106	Hi-Fi Components	
Hi-Fi Components		Hi-Fi Components		Check No. 58 on Reader Service Card	
Check No. 8 on Reader Service Card		Check No. 24 on Reader Service Card		Shure	31
Crown International	20, 83	Marantz	Cover III	Hi-Fi Components	
Hi-Fi Components		Speakers		Check No. 43 on Reader Service Card	
Check No. 6 on Reader Service Card		Write Direct to Advertiser		Sonic Research	39
Hi-Fi Components		Maxell	87	Cartridges	
Check No. 7 on Reader Service Card		Cassettes		Check No. 46 on Reader Service Card	
DBX	85	Mc Intosh	94	Sony Corp.	61
Hi-Fi Components		Tuners & Preamps		Hi-Fi Components	
Check No. 9 on Reader Service Card		Check No. 27 on Reader Service Card		Check No. 13 on Reader Service Card	
Discount Music Club	112	McKay-Dymek	91	Soundcraftsmen	86
Samples		AM Tuners and Antennas		Hi-Fi Components	
Write Direct to Advertiser		Check No. 54 on Reader Service Card		Check No. 47 on Reader Service Card	
Discwasher	2, 92	MXR Innovations	57	Speakerlab	24
Record Cleaning Device		Hi-Fi Components		Speaker System Kits	
Write Direct to Advertiser		Check No. 28 on Reader Service Card		Write Direct to Advertiser	
Dual (United Audio)	7	Onkyo	103	Spectro-Acoustics	93
Hi-Fi Components		Receivers, Amplifiers, & Tuners		Hi-Fi Components	
Check No. 11 on Reader Service Card		Check No. 30 on Reader Service Card		Check No. 48 on Reader Service Card	
Dynaco	33	PAlA	97	Superscope	9
Hi-Fi Components		Amplifiers & Synthesizers		Hi-Fi Components	
Write Direct to Advertiser		Check No. 31 on Reader Service Card		Write Direct to Advertiser	
Elpa Marketing	88	Phase Linear	55	Tapco	96
Hi-Fi Components		Amps & Preamps		Hi-Fi Components	
Write Direct to Advertiser		Check No. 32 on Reader Service Card		Check No. 49 on Reader Service Card	
Empire Scientific Corp.	29	Pickering	23	TDK	84
Cartridges		Cartridges		Cassettes	
Check No. 12 on Reader Service Card		Check No. 33 on Reader Service Card		Check No. 50 on Reader Service Card	
E.S.S.	3	Pioneer	Cover II	TEAC	52, 53
Hi-Fi Components		Turntables		Cassette Deck	
Check No. 13 on Reader Service Card		Check No. 34 on Reader Service Card		Check No. 51 on Reader Service Card	
Fidelitone	97	Primo Co.	106	Technics	Cover IV
Hi-Fi Components		Hi-Fi Components		Hi-Fi Components	
Check No. 14 on Reader Service Card		Check No. 35 on Reader Service Card		Check No. 52 on Reader Service Card	
Fuji	35	Radio Shack	83, 90	Tripod	108
Hi-Fi Components		Hi-Fi Components		Hi-Fi Components	
Check No. 15 on Reader Service Card		Check No. 36 on Reader Service Card		Write Direct to Advertiser	
		Hi-Fi Components		Yamaha Audio	19
		Check No. 37 on Reader Service Card		Hi-Fi Components	
				Check No. 53 on Reader Service Card	

# What's New in Audio

## Bozak Model 929 Preamplifier



This Audio Signal Processing Center includes a phono input, microphone input, and choice of tuner, AUX, or either of two tape inputs. All pre-amplifier stages are on plug-in modules. A *Mike Pan* control permits shifting the apparent position of a microphone anywhere from extreme right to extreme left. The continuously-variable *Stereo Blend* slide control goes from mono to stereo, and may even be expanded to an "extra-wide" dimension labelled *Stereo +*. The mode selector includes *Mono*, *Stereo*, *Reverse Stereo*, *Stereo Blend*, and *Reverse Blend*. Two tape monitor circuits are provided. A *Cue Output Selector* permits monitoring *Phono*, either *Tape Monitor*, *Program*, or *Main Output*. Distortion is less than 0.1% from 20 to 20,000 Hz. at 10 V into 200 ohms.

The 929 is 7-in. H, x 17-3/4 in. W, x 10-3/4 in. D. It weighs 21 pounds and is priced, w/o optional walnut cabinet, at \$797.

Check No. 72 on Reader Service Card

## Society of Audio Consultants

A new Consumer Associate member category is opening in the Society of Audio Consultants (SAC) which presently has more than 3,000 professional Certified Audio Consultant Members. For the charter membership of \$7.50 before January 15, 1976 members will receive the monthly newsletter, audio career information, free advertising privilege in SAC's Audio Flea Market, special rental privileges on home study courses and exclusive premiums from equipment manufacturers. Annual membership fee is \$10.

Check No. 74 on Reader Service Card

## Inovonics Recorder Electronics



These single-channel tape recorder electronics include play, record, and bias/erase circuitry in a rack-mount panel 3½-in. high, made to plug directly into Ampex 300, 350, and 351 transports, but can be readily adapted to other tape mechanisms. Switching is all-electronic, eliminating mechanical switching noise and permitting remote control. Reproduce circuitry is phase corrected. The regulated power supply and plug-in circuit cards are included. Record amplifier distortion measures less than 0.1% at operating level, less than 0.2% at 25 dB above operating level. The 360 circuitry is priced at \$645.00. Sync reproduce optional at \$60.00.

Check No. 70 on Reader Service Card

## Hirschmann Antenna/Booster



The Hitronic electronic car aerial has a miniature amplifier built into the base of the unit, which will amplify signals up to a level double the original. There are seven click-stop aerial lengths, one of which will be suitable for any signal field strength, and an eighth or retracted position for car washes. Operating voltage is either 6 or 12 V, and current consumption is about 7 mA. The base can be mounted at any angle from horizontal to vertical through use of the template supplied. Price: \$46.08.

Check No. 71 on Reader Service Card

When you  
hear the  
incredible  
sound . . .



when you  
touch the  
sensitive,  
responsive  
controls . . .



and when  
you see  
the beautiful  
craftsmanship . . .



you'll want  
to own one.

Onkyo offers a full line of highly rated stereo receivers, amplifiers and tuners; the world's 1st fully automatic 4-ch receiver; 2/way & 3/way speaker systems . . . all in a broad price range. See your dealer.

**ONKYO**

Onkyo U.S.A. Corporation

25-19 43rd Ave. Long Island City, N.Y. 11101  
935 Sivert Drive, Wood Dale, Ill. 60191

Check No. 30 on Reader Service Card



# Canby's Capsules

## Edward Tatnall Canby

**Judith Blegen, Frederica von Stade.** (Solos and Duets for soprano). Charles Wadsworth, piano. **Columbia M 33307**, stereo, \$6.98.

**Simple Gifts. The Metropolitan Opera Madrigal Singers.** (Met. Opera Guild.) **Advent 50102**, stereo, \$6.98. (878 Clarence Rd., Cleveland, Ohio 44121)

**Hindustani — A Panorama of North Indian Music. Vanguard Everyman SRV 73010**, stereo, \$3.89.

**Karnatic — A Panorama of South Indian Music. Vanguard Everyman SRV 73011**, stereo, \$3.89.

**Janet Baker - Mozart, Haydn,** Engl. Chamber Orch., Leppard. Philips 6500 660, stereo, \$7.98.

**Janet Baker - Handel.** Engl. Chamber Orch., Leppard. Philips 6500 523, stereo, \$7.98.

**The Artistry of Janet Baker (Holst, Finzi).** With Wilfred Brown, ten. Engl. Chamb. Orch. Imogen Holst. **Everest 3365, QS**, \$4.98.

**Elgar: Sea Pictures. Mahler: Five Songs from Ruckert.** Janet Baker; London Symph., New Philharmonia, Barbirolli. **Angel S 36796**, stereo, \$6.98.

**The Art of the Viola da Gamba, vol. 2** Marin Marais. Eva Heinitz; Malcolm Hamilton, harpsichordists. **Delos DEL 25403**, stereo, \$6.98.

**Eva Nordfelt plays Swedish Baroque Harpsichord Sonatas (Roman, Agrell).** **Orion ORS 74157**, stereo, \$6.98.

**Domenico Scarlatti Sonatas for Harpsichord, vols. 1, 2.** Kenneth Cooper. **Vanguard VSD 71201/2**, stereo, \$6.98 ea.

Two glorious all-American star voices, (despite the names) in solos and duets with piano, ranging from Scarlatti, Mozart, Schubert, through Brahms, Chausson, Saint-Saens. Only one problem: all the music is "chamber" type, close-up room music, and the recording is the same—but the ladies let loose like the Met. *TOO LOUD!!* Fine sound but very out of style. When will American pros learn to sing *softly* and well? Why so powerhouse??

Six younger Met members in an unexpected operation—madrigals, songs together, even church motets. They do remarkably well, considering, and the sopranos know how to sing softly. But the ensemble, well coached, still sounds faintly like *that* Sextet in *Lucia*. No great blend. Opera lovers will be charmed, rightly, but choral and madrigal people will be unamused.

Far-Eastern music is rapidly making its way into Western cultures and these two BBC-derived discs, deliberately designed to bring unusual instrumental and vocal Indian music to records (radio?), are beautifully performed, superbly recorded, well annotated, evidently taken down locally in India. Exotic sounds—musical glasses, unusual strings, drums, a sort of "jews harp," plus some singing. You could well start your Oriental Collection right here, and the price is decidedly right.

A great vocal musician in recent perspective—she began as a pure British-type soprano, has now turned more international and operatic, still with perfect control and accurate musicianship. The Mozart/Haydn, a brace of mostly unusual arias and songs, is top rank. Her Handel, a choice of highly florid and difficult items, is a bit heavy-voiced (and close-recorded) for Handel, but still remarkable. The Everest **Artistry** is a reissue, one side Holst, the other Britisher Finzi—Holst is massively introspective and long, for U.S. ears, Finzi is more open, straight Romantic; she shares it with tenor Brown. Best of all these (and there are others) is the Elgar/Mahler of c. 1970, when Baker still sang pure British. Lovely, un-pompous Elgar songs, plus a side of Mahler. A dedicated performance.

The grand lady of the gamba summing up her longtime art in this series. By now she sounds a trace old fashioned, playing cello-like (with some vibrato) but she's always authoritative and musical. Marin Marais, *the* gamba composer, writes somewhat didactic French Baroque suites.

This forceful Swede, not yet 30, plays in the Landowska tradition, strongly, heavily registered and dramatic. Stockholm's Baroque sounds much like other late Baroque; both Roman and Agrell are younger than Bach, edging on into early Rococco or "galant" style. Interesting.

The jaunty color cover, Cooper in an outrageously ruffled and printed mod shirt with two fingers in the air, sets the tone for these amiable and generally excellent Scarlatti renderings. Get 'em by all means!

**Satie for Two.** Peter Kraus, Mark Bird, guitars. **Orion ORS 74163**, stereo, \$6.98.

Two young classical guitarists here take on that old French music-devil, Satie, whose many small piano works slyly dug at the foundations of tottering Romanticism back in the late 19th C. Satie's satire was in the deflated titles—*Dried Embryos*, *Cold Pieces*, etc.—but also in artful musical simplicity, full of titillating "mistakes." These qualities come over well on the two guitars, though the boys are perhaps a bit too earnest. (Satie was never earnest! A total, gadfly. Outwardly, anyhow.)

**Brahms: Complete Piano Quartets.** Beaux Arts Trio (Cohen, Greenhouse, Pressler) and Walter Trampler, viola. **Philips 6747 068**, 3 discs, stereo, \$23.96.

If you are in a Brahms mood, here's a fine supplement to the big orchestral pieces—three big works for three strings and piano, gorgeously recorded and played by an American-based, super-pro foursome (two born in Europe), impeccably tuned to the European tradition. The polish and sheen is purely American, the styling good continental. The pianist, rightly, is the powerhouse here—Manahem Pressler, one of the best. The others play too blandly for my taste, but he keeps things moving.

**Ivan Rebroff. 25 Greatest Russian Melodies.** With balalaika ens. **Vanguard Twofer VSD 67/68**, 2 discs, stereo, \$6.98.

Here's that *man* again—huge, cavernous Russian basso who suddenly becomes a tenor, then a torchy contralto, *and* a soprano, more or less. Assuming it really is all him. Even some male-female duets in octaves. Overdub? Can't be sure these days! Anyhow, he gets all the label credits. Russian pop/folk style, big orch. with balalaikas, some no-voice bands for contrast. Easy listening, and now all you'll need is Yma the Sumac—you'll have heard Everything. (But he's much better.)

**Acoustic Research, Inc. Demonstration Record. Vol. 1: The Sound of Musical Instruments.** (10 American Drive, Norwood, MA 02062) \$5.00

Mostly classical excerpts, out of Spain and Discos Ensayo. This—for a demo—is musically more responsible than most. Only a few items are faded out in mid-note or mid-movement, and most are reasonably long, ranging from Bach to jazz, via Mozart, Stravinsky, Britten, Albeniz, and so on. Hi-fi annotations on each piece—how to listen and judge your equipment. Some of it mildly fatuous, some pretty good. How about: "Who would deny that the human voice is the most expressive of all instruments?" Not me!

## SECRETS FROM THE AUDIO FILE



## Tape giving you static?

### ADVICE FROM:

Jay Ranellucci, recording engineer, Capitol Records, Inc.

**PROBLEM:** Do you record electric guitars and end up with static? Do your country western tapes crackle and pop like a campfire? The problem could be dropouts caused by tape creases, dust, debris or flaking iron oxide coating.

**RECORDING TIP:** Dropouts can be more of a problem with cassette tape because of its slow playback speed. One dust clump will obscure more signal at 1 7/8 ips than at 15 ips. To eliminate the problem, use special care selecting, handling and storing your cassette tapes.

**TAPE TIP:** Record on premium tape that has a heavy duty binder to prevent oxide flaking. Use tape treated with conductive coating to prevent static from building up in low humidity. (Static attracts dust and debris.) Unlike most tapes, The Music Tape conductive coating is on the underside, so as not to diminish the amount of signal-storing oxide on the recording side. Thus dropouts are prevented without sacrificing recording quality.

When you record music, record on

**the music tape**  
cassette • cartridge • open reel  
BY CAPITOL



CAPITOL MAGNETIC PRODUCTS  
A DIVISION OF CAPITOL RECORDS, INC.  
LOS ANGELES, CALIFORNIA 90028 • A MEMBER OF THE EMI GROUP



TM OF EMI LIMITED

Check No. 5 on Reader Service Card



# Classified

## FOR SALE

**AUDIO RESEARCH MAGNEPLANARS** and Electronics. ESS, Infinity, Ohm, Dahlquist, EPI, Audionics, Radford, Crown, Citation, BGW, Transcriptor, Linn-Sondek, Keith Monks, ERA, Connoisseur, SME, Supex, Decca, Grace, Sony, Spectrum Scanning Tuner, Epicure Amplifier, Marantz 500, DBX, ADC, Nakamichi, B&O, Tandberg, Celestion, Marc Levinson, Stax, Dayton-Wright, others. **THE GRAMOPHONE LTD.**, 757 Asp St., Norman, Okla. 73069. 405-364-9477.

**ANTI-SKATING for AR TURNTABLES!!** Proven counterweight design of nickel steel & aluminum construction. Install yourself in minutes. \$7.00 postpaid. (Dealer inquiries invited.) **AUDIO INNOVATIONAL PRODUCTS**, P.O. Box 137, Ballardvale Station, Andover, Mass. 01810.

**SUPEX — ORTOFON — OTHER MOVING COIL CARTRIDGE OWNERS;** Send for free literature on our Micro-Preamp Superb performance at \$99.95. Huntington Electronics, Box 2009-A, Huntington, Conn. 06484

**ELECTRONIC CROSSOVERS—ALL TYPES.** Updated definitive booklet describes applications; how to improve speaker systems; \$7.50 postpaid, credited to first purchase. Huntington Electronics, Box 2009-A, Huntington, Conn. 06484.

**LOWEST DISCOUNT PRICES ANYWHERE** on audio equipment. All major brands discounted. Write for quotes, K&L Sound Services, 75 N. Beacon St., Watertown, Mass. 02172.

**DIAMOND NEEDLES** and Stereo Cartridges at Discount prices for Shure, Pickering, Stanton, Empire, Grado and ADC. Send for free catalog. **LYLE CARTRIDGES**, Dept. A, Box 69 Kensington Station, Brooklyn, New York 11218.

**THE MONEY SAVER!** Write **STEREO SPECTRUM**, Box 1818, Miami Beach, FL 33139.

**GRAPHIC EQUALIZER PLANS:** Novel circuit very effective/inexpensive, requires no inductors. Ten knobs (octave bands) compensate your Hi-Fi/Tape providing better listening. Complete plans rushed only \$3.49. **GREEN BANK SCIENTIFIC**, Box 100C, Green Bank, WVa. 24944.

### COMPETENCE IN AUDIO SINCE 1928!

Qualified service, custom installations  
Klipsch, Sequerra, SAE, McIntosh, Levinson,  
SME, Ortofon, Fidelity Research, Tandberg.

We buy and sell quality used gear.  
**THE MUSIC BOX, INC.** 58 Central Street,  
Wellesley, Mass. 02181. (617) 235-5100.

### SIGHT & SOUND LTD.

Catering to the audiophile who desires the absolute in sound, equipment, service and professionalism.

#### OUR LINES

Ampzilla, ADS/Braun, AKG, B&O, Beyer, Bose, Crown, Dahlquist, DBX, Linn Sondek/MAL, Magneplan, McIntosh, Micro Acoustics, Ortofon, Revox, Soundcraftsman, Tandberg, Yamaha.

#### OUR STAFF

Engineers, physicists, musicians, teachers — all devoted audiophiles dedicated to providing the epitome in experience, patience and service.

#### OUR LOCATION

Campus Hills Shopping Center, Five miles northeast of Bel Air, Maryland 21014 on Route 22. Phone 1-301-838-2100.

## FOR SALE

**DON'T LET VOLTAGE TRANSIENTS ZAP YOUR HI-FI.** Solid State Equipment Protector. Plugs into outlet. Check or money order \$6.95. Kopp Sales & Service, 1650 William St., Buffalo 14206. Free brochure—send SASE.

**RECORDING TAPE CLOSEOUT:** Dozen reels 2400', \$12.00. Dozen 1200', \$8.00. 24 reels 900', \$6.00. 24 600', \$5.00. Postpaid Guaranteed. Mitchell, Box 132A, Flushing, N.Y. 11367.

**ONE STOP** for all your professional audio requirements. Bottom line oriented. F.T.C. Brewer Company, P.O. Box 8057, Pensacola, Florida 32505.

**DON'T PAY THE HIGH MAIL ORDER PRICES. THIEVES WAREHOUSE OF SARASOTA**, 6564 GATEWAY AVENUE, SARASOTA, FLORIDA 33581.

**BUILD YOUR OWN SPEAKERS AND SAVE UP TO 50%.** You can assemble your own high quality, multi-element stereo speakers in a few hours and save up to half the cost of comparable speakers. Send for our free 32-page catalog of speaker kits, raw speakers and accessories. **SPEAKERLAB**, Dept. A2, 5500—35th N.E., Seattle, WA 98105.

**OPERA TAPES.** Historical performances of past 40 years. Unbelievable treasures and rarities. ALSO LP RECORDS. Free catalog. Ed Rosen, 66-33 Saunders St., Rego Park, N.Y. 11374.

**WESTCHESTER AND FAIRFIELD COUNTY AUDIOPHILES TAKE NOTE! THE AUDIOPHILE**, 231 BEDFORD STREET, STAMFORD, CONN. specializes in equipment for the connoisseur. Ampzilla, Koss Model One, ADC, Citation, Crown, Dahlquist, Dyna, Epicure, Infinity, Philips, SAE, SME, Stax, TEAC, Technics, Thorens and many more (203) 348-3551 (Closed Mondays).

**CONNECTICUT:** Yamaha, Celestion, IMF, Infinity, Braun, Revox, Stellavox, Thorens, ESS, Supex, BGW. Will ship prepaid. **AUDIOCOM**, 177 Sound Beach Avenue, Old Greenwich, Conn. 06870. (203) 637-3621.

**STEREO TIMER AND ELECTRONIC DIGITAL CLOCK.** P.C. Board with instructions \$9.95. Kit with box \$99.95. Assembled unit \$149.95. Wake up and fall asleep to strains of your favorite AM/FM, record, or tape. This product will be an attractive addition to your stereo equipment. Switches up to 1200 watts. **Cosmos Electronics**, Dept. A3 P.O. Box 33278, Seattle, Wash. 98133.

### VIDEO EQUIPMENT-LOW PRICES

**PANASONIC** cameras, monitors, vtrs  
**RCA** cameras (low light), monitors  
**GYRR** time lapse vrt  
Many accessories; new vidicons  
Write or call your dealer.

#### ELECTRONIC EYE

9044 Eldora Drive  
Cincinnati, Ohio, 45236  
(513) 891-9044

### SAVE TIME AND MONEY!

We have 15 years experience selling over 60 major brands. Save up to 50% off. We get the best deals from the manufacturers you get the best deals from us! Call now (212) 338-8555 or write, S.C.A. Dept. AM, 2122 Utica Ave. Brooklyn New York 11234.

## FOR SALE

# massachusetts

tripod audio offers you advice on & demonstrations of the finest equipment available. our emphasis is on giving you the best sound/dollar value we can.

our suppliers include... dahlquist • ampzilla • thaedra • b & o • allison • yamaha • citation • sonus • nakamichi • advent • ads • technics • tandberg • phase linear • stax • denon

**tripod audio**  
219 main street northampton (413) 584-6498

**DYNACO-A-R.** transistors, repairs-boards-& units, speaker service. Send for prices & details: **BEAR ELECTRONICS**, 177-R Hillcrest Road, Mt. Vernon, N.Y. 10552.

**NO GIMMICK!** JBL, Marantz, Pioneer discounted 60%! Amazing details FREE. John Peterson, Box 8014A, Canton, Ohio 44711

### AUDIO BREAKTHROUGHS

"We're closing the gap on perfection"

Long Island's finest audio dealer. The incredible Lux M-6000 now you can hear what a \$3,000 amplifier sounds like! See the original Transcriptors turntable with new fluid damped arm; complete selection of ultra-fidelity records; Sheffield, Levinson, Fulton, Jonas Miller and more! Just arrived; the new elliptical Decca Mk V, Audiocraft and Grace damped tonearms. Satin "ultimate" cartridge, plus Paoli tube amplifier, Magneplanar, Linn Sondek, Lux turntable, B&W, KEF speakers and drivers, Yamaha (CT-7000, B-1 and NS-1000M!), Supex, M&K super woofer, IAD ultra-low distortion dynamic range expander! Levinson, new Polk, IMF and the list goes on... **AUDIO BREAKTHROUGHS**, 1681 Northern Blvd., Manhasset, N.Y. 11030. (516) 627-7333.

**DON'T PAY THE HIGH MAIL ORDER PRICES. THIEVES WAREHOUSE OF FT. WALTON BEACH**, 652-D BEAL PARKWAY, N.W., FT. WALTON BEACH, FLORIDA 32548

**CROSSOVERS** - Custom designed, fully tested; guaranteed quality. Free brochure. Write: Networks; Box 458; Placentia, Calif. 92670.

**SCOTCH—TOK—MAXELL—MEMOREX—CAPITOL—AMPEX.** Blank tape. Lowest Prices S & P Enterprises, Box 101, Elk Grove Village, Ill. 60007.

Rates: 35¢ per word per insertion for noncommercial advertisements; 60¢ per word for commercial advertisements. Frequency discounts as follows: 3 times, less 10%; 6 times, less 15%; 12 times, less 20%. Closing date is the FIRST of the second month preceding the date of issue. Payment must accompany all orders. Use the handy self-addressed, postage paid card at the back of this issue. When replying to Audio box number ads, send letters c/o Audio, 134 North 13th Street, Philadelphia, Pa. 19107. For more information about classified advertising, circle Reader Service Card #135.

## FOR SALE

### CASSETTES

Plain white cassette labels. Norelco cassette cleaners, famous brand cassettes. Send for open reel and cassette discount catalog.

	1-9	10-99	100	1000	10M
Cassette Labels		.02	.015	.01	.006
Norelco Cassette Cleaner	.65	.60	.55	.50	.45
10" Metal, NAB, Used Reel	1.00	1.00	.90	.80	.75
10" Fiberglass used 3/4" Hole	.50	.50	.40	.35	.30
Scotch Cassette SC90HE	2.72	2.55	2.44		

\*Buy 2, SC90HE, get 1 free.  
Plus Postage by Weight and Zone. Minimum Order \$5.00

#### OPEN REEL STEREO TAPE BUYERS!

At last! An open reel catalog, including titles, songs, etc. of 95 long play, 2-3 hour albums by American Airlines or Ampex 4 track stereo tapes. Send \$1.00—and we will also mail you a 140-page Harrison stereo tape guide—so you'll get both for \$1.00—and this \$1.00 is refundable on your first \$10.00 purchase of open reel stereo tapes at our 30% discount.

We've Got the "Spirit" The Prices And The Address To Prove It  
**Saxitone's Bicentennial Tape Shoppe**  
1776 Columbia Rd., N.W., Wash. D.C. 20009



**AMPEX TAPE—NEW 1800'** on 7" reel 12 for \$18 POST-PAID; 1200' 12 for \$13 POSTPAID—free list—WIDE RESPONSE, 6114A SANTA MONICA BLVD., HOLLYWOOD, CA. 90038.

**ELECTROENCEPHALOPHONE:** brainwave monitor. Professional biofeedback instruments. J&J 8102-A, Bainbridge, WA. 98110.

**10 1/2" RECORDER SPECIALISTS:** Fresh new Scotch L/N 3600 ft. on new 1/4" NAB metal reels five for \$35.00. New Ampex GRANDMASTER tape on 10 1/2" metal reel, six for \$73.00. New 4 channel 8-track blank cartridge loaded with 40 minutes Scotch L/N tape. \$23.00 per dozen. Reconditioned NAB metal 10 1/2" reels, \$24.00 per dozen. 10% on above for postage. Sound Investment, P.O.B. 88338, Dunwoody, Ga. 30338.

**CENTRAL NEW YORK HI-FI ENTHUSIASTS**—Britain's finest loudspeakers on demonstration—THE IMF STUDIO AND ALS40—as well as Marantz, Pioneer, Revox, Beyer, Epicure (3 lines), Thorens, Ortofon, XLM, Discwasher... THE SOUND SHOP, 96 Seneca Street, Geneva, N.Y. 14456 (315) 781-0215.

**CALIFORNIA'S UNIQUE AUDIO SHOP** proudly presents: ADC, Allison Acoustics, BGW, Burwen, Decca, Dynaco, ESR, Harmon Kardon, Linn Sondek, Quad, Soundcraftsmen, Transcriptors, etc. AUDIO TECHNIQUES, 351 South Baywood, San Jose, California, 95128. Phone 408-984-6655 weekdays 11-8, weekends 12-6.

**THE FIRST (1962)** and most durable of the "underground" subscriber-supported audio publications. STEREOPHILE has proven itself the most reliable source of information available to the perfectionist who can hear differences between the top amplifiers, pickups, etc.

There are good reasons why the latecomers have modeled themselves after STEREOPHILE. To learn some of them, write for our free blurb sheet or send \$7 for 4 issues of the real thing. Address to STEREOPHILE, Box 49, Elwyn, Pa. 19063

**CYBERACOUSTIC LABS** presents the new RTR DR-1 DIRECT DRIVE ELECTROSTATIC TRANSDUCER SYSTEM! DRIVEN by its own internal servo-feedback amplifier!

MORE musical than any tube or fet system ever devised! ITS uncanny realism is totally unequalled by any other electrostatic system, including headphones!

THE first true non-directional (360°) electrostatic system! GATHER your most revealing records or master tapes and call for an appointment today!

Cyberacoustics by Barclay-Philadelphia's Exclusive RTR Distributor  
503 Haverford Ave., Narberth, Pa. 19072  
1-215-667-3048

**DYNACO RACK MOUNTS** for pre-amps, tuners, integrated amps. \$24.95 postpaid, \$22.50, three or more. AUDIO BY ZIMET, 1038 Northern Blvd., Roslyn, N.Y. 11576 (516) 621-0138

## FOR SALE

ATTENTION: LATIN AMERICAN AUDIOPHILES

ATTENTION: VACATIONERS VISITING THE MIAMI AREA

ATTENTION: RESIDENTS OF SOUTH FLORIDA

**SOUND COMPONENTS, INC.** is THE place for state of the art stereo. Some of our products include:

**LOUDSPEAKERS** — SPENDOR BCII and BCIII, Audio Research Corporation Magnaplanars, Quads, Magnepan, Allison I and II, Bowers & Wilkins, FMI including the J System, Gale, M&K Sub-Woofers, Dayton Wright XG-8 Mark III, IMF Small Monitor, IMF Studio IIB, IMF Super Compact

**TURNABLES** — Linn-Sondek, The Michell Engineering Co. Transcriptors, B&O 3000-2 and 4000-2, and Yamaha

**PICKUPS AND TONEARMS** — Ultimo DV38/20A, Denon 103-S, Satin M15 Conic, Supex 900 and 901, Ortofon SL-15E Moving Coil Pickups, SME, Audiocraft, KMAL, Grace 707 Tonearms, Dayton Wright 535 Infranoise Cartridge Pre-amp, Denon Transformers, Ortofon Transformers, and Hoffman Transformers

**ELECTRONICS**—Audio Research, Lecson, Quad, BGW Ampzilla, Dayton Wright, Paoli, Yamaha, B&O Citation, Stax, Radford

**RECORDINGS** — A range of selected British, French, and German pressings. Also, the Fulton and Sheffield discs.

All of the above products are in stock and on demonstration in our 1100 sq. ft. showroom.

Hours: 10 - 6 Monday through Saturday.  
We accept Master Charge and BankAmericard  
We ship mail order in continental U.S., prepaid.

**SOUND COMPONENTS, INC.**  
2710 POUNCE DE LEON BLVD.  
CORAL GABLES, FLORIDA 33134

Telephone: 305-446-1659 TWX: 810-848-7627  
Superb Products For The Discriminating Audiophile and Music Lover.

**CANADIANS** — DYNACO COMPONENTS AT TREMENDOUS DISCOUNTS. Write En-Jav Sales, Hornepayne, Ontario.

**TUNED ROCK P.A.'s.** Customized high intensity touring/permanent installation sound systems, including narrow band (5 Hz!) feedback suppression, detailed regenerative response. Acoustic-Voicing/environmental equalization ( $\pm 1$ dB at your ears), room design/measurement/treatment, <15% articulation loss of consonants, 1000's of customized professional products including... fiberglass horns, consoles, comp/rms/peak limiters, 18db continuously variable electronic crossovers, digital/acoustic delays, omniprocessors, phasers, reverb, echo, doubling/tripling effects. P.A. noise reduction, piezo transducers, frequency shifters from... J.B.L./Altec Pro, Tascam, U.R.E.I., Eventide, Gately, Studer, Beyer, Crown, Community Light/Sound, Mom's Audio, McIntosh, Bozak, Allen Health, Gauss, Cetec, Scully, Multi-track, etc. All shipped prepaid/Insured. Music & Sound Ltd. 11 1/2 Old York Rd., Willow Grove, Pa 19090 (215) 659-9251.

#### DEALERS!! CONSUMERS!!

Write for quotes on all medium and many High End lines. We need campus reps and people seriously interested in hi-fi to properly demonstrate a fantastic loudspeaker line. Liberal compensation for qualified individuals. Write: Audio P.O. Box 36 Solsberry, Indiana 47459, or call (812) 825-9750 or (812) 332-4252.

#### UTAH'S OLDEST, FINEST AUDIO SPECIALISTS

McIntosh	Levinson
Infinity	Bozak
Servo Statik IA	JBL
DSP Amp	Pioneer
B&O	Supex
Yamaha	Stanton
Tandberg	AKG
Nakamichi	DBX

#### WINTERTON'S AUDIO

Salt Lake — 2164 Highland Drive  
Provo — 83 North University  
Price — 20 North Carbon

## FOR SALE

ATTENTION...

LUCKY OWNERS OF:

DYNA STEREO 70  
RABCO SL8(E)  
DYNA PAS-3(X)  
INFINITY 2000A  
DECCA MKV AND "EXPORT"  
DYNA MARK III  
SHURE SME and  
other tubular tonearms

THE DKL LABORATORY, INCORPORATED HAS DEVELOPED UNIQUE MODIFICATIONS ENGINEERED SPECIFICALLY FOR THESE COMPONENTS. NOW YOU CAN GREATLY IMPROVE THE SOUND QUALITY TO

"ULTRA DEFINITION"

PRICED FROM \$25.00 TO \$170.00, OUR MODIFICATIONS OFFER VAST AUDIBLE IMPROVEMENTS AT REASONABLE COST.

FOR MORE INFORMATION CONTACT:

DKL LABORATORY, INCORPORATED  
BOX 683  
SEVERNA PARK, MARYLAND 21146  
OR CALL: (301) 588-6257  
MONDAY, WEDNESDAY, THURSDAY,  
SATURDAY 2-8 PM

WE SPECIALIZE IN ONLY THE FINEST SOUND COMPONENTS—ALLOW OUR STAFF OF AUDIO EXPERTS TO HELP YOU CREATE YOUR "ULTRA DEFINITION" SOUND SYSTEM. CHOOSE FROM THE WORLD'S FINEST COMPONENTS LIKE:

AUDIO RESEARCH—electronics and speakers  
BGW—power amplifiers  
DBX—noise reduction systems, dynamic range enhancers  
"HAND-TUNED" DECCA MKV—cartridges  
DYNACO—tube electronics  
FULTON—regular and MODULAR speakers  
HK CITATION—amps, tuners  
IMF—"MONITOR-ORIENTED" speakers, kits, sub-woofers  
LINN—SONDEK—turntables  
MAGNEPAN—speakers  
M & K—sub-woofers, matrix systems  
PAOLI—tube amplifiers  
RABCO—turntables  
RTR—electrostatic speakers  
SOUNDCRAFTSMEN—pre-amps, equalizers  
STAX—electrostatic headphones  
"SUPER SHURE" SME—tonearms  
TANNOY—turntables, speakers

AND SCORES MORE.

WASHINGTON D.C., MARYLAND, VIRGINIA  
AREA RESIDENTS TAKE NOTE—

YOUR "STATE-OF-THE-ART" DEALER IS:

DKL SOUND LAB  
943 BONIFANT  
SILVER SPRING, MARYLAND 20910  
Hours: MONDAY, WEDNESDAY, THURSDAY,  
SATURDAY 2-8PM FRIDAY BY  
APPOINTMENT ONLY, CLOSED TUESDAY  
(301) 588-6257

**STATE-OF-THE-ART** comes to NORTH-CENTRAL FLORIDA, serving you with: AUDIO RESEARCH, Citation, Crown, Dahlquist, Denon, Dynaco, Fidelity Research, DBX, G.A.S. Co., Hartley, Infinity, Magneplanar, Mark Levinson, Ortofon, Rabco, Revox A-700, SME, Supex, Thorens, Transcriptors, and \$10,000 worth of test equipment for in-store audio analysis. We maintain a mobile recording van and sell professional recording equipment. **AUDIO, ETC., INC.**, 1999 N.W. 43rd Street, Gainesville, Florida, 32605. 1-904-377-4107.

**TEAC 1/2 TRACK** tape deck model 7030 GSL, mint. \$700 firm. You pick up in R.I. (401) 766-6019.

**LOW NOISE RESISTORS**—1/4W, 5% carbon film from 10-3.3 Megohm for 3/2 each. Fifty per value is \$1.25. 1N4004, 1N4148 diodes. Postage 75c. **COMPONENTS CENTER**, Box 134A, New York, N.Y. 10038.



## FOR SALE

### AN IMPORTANT ANNOUNCEMENT

**Parnassus Audio** is now producing a full Class A (not AB) stereo power amplifier capable of relatively high output power.

The amplifier additionally satisfies the theoretical criteria for completely eliminating transient intermodulation distortion.

The difference in sound quality between this amplifier and conventional amplifiers is easily audible, even to the inexperienced.

We welcome requests for a descriptive brochure.

Dealerships will be limited.

Address all inquiries to: **PARNASSUS AUDIO, INC., 2918 Harper Street, Berkeley, California.**

**MINNEAPOLIS** — High Quality Audio Has Finally Arrived! Audio Research, Bang & Olufsen, Klipsch, Audionics, Radford, Revox, Bozak, Crown, DBX, Sequerra and others... **THE SOUND ENVIRONMENT**, Butler Square, Suite 114, 100 North Sixth Street, Minneapolis, Minn. 55403, (612) 339-4641.

**DON'T PAY THE HIGH MAIL ORDER PRICES. THIEVES WAREHOUSE OF BETHESDA**, P.O. BOX 34251, WEST BETHESDA, MD. 20034.

**PROFESSIONALLY SPEAKING**... Klipsch, Nakamichi, Crown, Yamaha, SAE, Bose, Burwen, DBX, Soundcraftsmen, Transcripator, Microacoustic, Teac, Sonab, Dokorder, Supex, Grace, JBL. For that extra personalized service visit — **HAL'S STEREO SOUND CENTER, INC.**, RT. 1 & Texas Ave., Trenton, N.J. 08638, 609-883-6338.

**ABSOLUTELY THE LOWEST PRICES** on name brand stereo components. Send for our free catalog to **BOSTON STEREO INC.**, 1589 Commonwealth Avenue, Brighton, Massachusetts 02135.

**MARANTZ 10-B**. Complete set of spare tubes \$750. Glenn English, (512) 478-2054.

**BURGLAR** alarm dialing unit automatically calls police. \$29.95. Free literature. **S&S SYSTEMS**, Box 12375H, North Kansas City, MO 64116.

### AMPZILLA — THAEDRA

Sound Advice, 536 State Road, Emmaus, Pa. 18049. Hours: Daily 6-9:30, Sat. 10-6.

**RUMBLESEAT RECORDS** - new label — Big Band Era. Send for free catalogue. Rumbleseat Records, P.O. Box 233, Irvington, N.Y. 10533.

### ATTENTION WESTERN NEW YORK AUDIOPHILES

The word is getting around!! Our personalized, honest service and quality equipment make a winning combination. In addition to the incomparable **AUDIO RESEARCH** line, (T-1B's black/natural in stock), we carry **AMPZILLA**, **SAE**, **Phase Linear**, **Yamaha**, **Quintessence**, **LEVINSON**, **B&O**, **IMF**, **MAGNEPAN**, **M&K Subwoofers**, **Hegeman**, **Infinity**, **RTR**, **ESS**, **DAHLQUIST**, **Fulton Music**, **QUATRE**, **Onkyo**, **Connoisseur**, **Technics**, **Thorens**, **Dynaco**, **Transcripators**, **Cerwin Vega**, **Soundcraftsmen**, **Supex**, **Ortofon**, **AOC**, **Micro-Acoustics**, **Damped SME**, **Linn Sondek**, **KMAL**, **Naim Audio**, etc. The Stereo Emporium, 3407 Delaware Ave., Buffalo, N.Y. 14217. (716) 874-3372.

**AUDIOPHILES WANTED!!** Put your knowledge to use, earn an excellent spare time income. We need campus representatives to sell name brand stereo equipment at substantial discounts in your area. No investment necessary. For information and application please write: **ABCO**, Dept. CR, 915 Grand Avenue, New Haven, Conn. 06511.

**CAROLINA'S ONLY AUDIOPHILE CENTER** — Infinity Servo-Statiks, Switching amp, Ampzilla, Dahlquist, Magnepan, FMI, Ortofon, Crown, Accuphase, SME, Decca, Hegeman, Klipschorn, Technics, Teac, Marantz, Harmon Kardon on demonstration.

Vickers Audio  
210 West Franklin St.  
Chapel Hill, No. Carolina 27514  
(919) 929-4554

## FOR SALE

**ENGINEERED ENCLOSURE & CROSSOVER DESIGNS** — free w/purchase of our J.B.L., Gauss, Altec, and Community raw drivers and horns. Music & Sound Ltd., 11-1/2 Old York Road, Willow Grove, PA 19090 (215) 659-9251.

### Loudspeaker Reconciling Labs

**PROPRIETARY CUSTOMIZED MOODS** reduce tone arm friction, damp spurious resonances, minimize torsional forces, improve tracking, and reduce hum and record wear. For **S.M.E.'s—\$30.00\*** For **Rabco SL-8(E)—\$100.00**. For **Transcripators—free\*** (\*with purchase).

### NOW

**LISTEN** to our calibrated **Satin/Denon/F-R/Ortofon/Supex** moving coils. **B&O/Grace/Micro-Acoustics**. From the laboratories of **Music & Sound Ltd.**, 11-1/2 Old York Rd., Willow Grove, Pa. 19090 (215) 659-9251.

### Levinson & Stax Cartridge Preamps

**NORTHERN N.J.'S FINEST AUDIO STORE**, 20 minutes from N.Y.C. **Ampzilla**, **Avid**, **Bozak**, **B&O**, **Crown**, **Dahlquist**, **DBX**, **Dual**, **IMF**, **Kenwood**, **Magneplanar**, **Micro-Acoustics**, **Ortofon**, **Phase Linear**, **Pioneer**, **Quintessence**, **Thorens**. Write or call **University Stereo**, 57 E. Ridgewood Ave., Ridgewood, N.J. (201) 447-5700.

**CROWN SX-724**, **IC-150**, **D-150**, **Burwen**, **RTR HPR-12** **Magnums**, **Nakamichi 700**. (215) 942-2161.

**N. CALIFORNIA'S CUSTOM IMF DEALER** is now offering: **IMF SMALLER MONITOR** — Smaller version of the world-acclaimed **MONITOR!**

**IMF MODEL R!!** Flat to 20 Hz. Stunning transient attack! Uses new version of **KEF** flat woofer. At \$330 — extraordinary!

**IMF SUB-WOOFER KIT** — Dual transmission line system flat to 6 Hz — \$250!!

**STUDIO IIB** and **MONITOR MK IV** — Both newly "impulse" revised!

Custom demonstrations in The IMF Listening Room. For information and/or listening appointment, write or call **Russ Goddard, CUSTOM IMF DEALER**, 1171 W. Latimer, Campbell, California 95008. (408) 374-4697.

**Mail order customers:** For your convenience, all orders are shipped **prepaid and insured, by air!**

**BUY DIRECT FROM ENGLAND'S HI-FI MAIL ORDER SPECIALISTS!** Save on **B&O**, **Celestion**, **Decca**, **Tandberg**, **Revox**, **Transcripator**, **Jordan-Watts**, **Lovther**, **KEF**, **Rogers**, **SME**, **Ariston**, **HPD**, **Sugden**, **Radford**, **Neal**, **Ferrograph**, etc. Shipping lists free or send \$3.00 bills to include literature. **Goodwin Ltd.**, 7 Broadway, Woodgreen, London N.22. Phone 01-888-0077. Visitors welcome.

**SURPRISE! SURPRISE!** Digital Piano Tuning Device tunes musical instruments Accurately! Perfectly! Inexpensively! Construction-Instruction Plans Complete \$12.95 Airmailed Postpaid! Moonlighting quickly repays \$40 electronics investment! **GREEN BANK SCIENTIFIC**, Box 100E, Green Bank, W.Va. 24944.

**WESTCHESTER AND FAIRFIELD COUNTY AUDIOPHILES TAKE NOTE! THE AUDIOPHILE, 231 BEDFORD STREET, STAMFORD, CONN.** specializes in equipment for the connoisseur. **Ampzilla**, **Koss Model One**, **ADC**, **Citation**, **Crown**, **Dahlquist**, **Dyna**, **Epicure**, **Infinity**, **Philips**, **SAE**, **SME**, **Stax**, **TEAC**, **Technics**, **Thorens** and many more (203) 348-3551 (Closed Mondays).

**MAKING HIS MOVE** — Mel Schilling, formerly of Willow Grove, Pa., has taken his knowledge of music and sound to California, where he will continue to serve a select nationwide clientele devoted to ultra state-of-the-art stereo. All shipments prepaid and insured. Write or call — 20929 Ventura Blvd., Woodland Hills Village, Woodland Hills, Calif. 91364. (213) 348-4600.

**CASSETTE LABELS:** 1,000 labels sheeted 6 up or type-writer roll, \$9.95. Shipping 10%. **TARZAC**, 638 Muskogee Avenue, Norfolk, Virginia 23509.

**YELLOW PAGES OF AUDIO**—Comprehensive reference to professional as well as consumer audio products and manufacturers. **FREE** classified advertising information and copy form available with each issue. \$1.50 Box 94, Colmar, Pa. 18915.

## FOR SALE

### Listen to TELEVISION IN STEREO



The **TE-200 TELEDAPTER** EASILY CONNECTS TO ANY TV & STEREO SYSTEM. Using our coupling and matrix circuit, teledapter takes a low impedance output from the television and delivers two HIGH IMPEDANCE CHANNELS OF SIMULATED STEREO, to drive any amplifier. Frequency response is maintained so you can hear the tinkle of bells or booming bass sounds as it happens on TV. With service warranty and hookup instructions \$16.95 ppd. Guaranteed to make your TV 100% more enjoyable.

OUR NEW **TE-300 VHF-UHF HI-FI TUNER** IS NOW AVAILABLE. A complete and self contained 110 volt tuner. VHF-UHF antenna connections - Recording and amp output jacks. Five year service warranty \$149.95 ppd. From our factory.

SEND:  CHECK  MASTER CHARGE NO. for  TE-200  TE-300 or  \$5.00 for C.O.D. TO: RHOADES NATIONAL CO. DEPT AD P.O. BOX 817 HENDERSONVILLE, TENNESSEE 37075

NAME \_\_\_\_\_

ADDRESS \_\_\_\_\_

CITY \_\_\_\_\_

STATE \_\_\_\_\_

ZIP \_\_\_\_\_

SEND COMPLETE CATALOG

**ST. LOUIS' LEADING QUALITY AUDIO DEALER**—Featuring the following equipment:

### AUDIO RESEARCH

ACCUPHASE	PHILIPS
AKG	QUAD
ALTEC PRO	QUINTESSENCE
B & D	REVOX 700
BOZAK	RTR
CITATION	SCULLY
DECCA	STANTON
EPICURE	STAX
KMAL	TANDBERG
LINN SONDEK	TECHNICS
NAKAMICHI	UHER
PHASE LINEAR	YAMAHA

and others

Equipment tested before being shipped prepaid.

J.C. Gordon Company  
2831 Hampton Avenue  
St. Louis, Missouri 63139  
(314) 647-8866  
Since 1927

**NEW GENERATION** Crown Amplifiers, Cleanest, Smoothest sound ever produced - Crown D1200/HP1200, on demo only at **Barclay Recording**, 503 Haverford Ave., Narberth, Pa. 19072. (215) 667-3048.

**FLORIDA AUDIOPHILES!** Phase Linear, I.M.F., B&O, H/K, Marantz, Quatre, Thorens, Sony, Klipsch, Revox, Barzilay cabinets. Sales and expert repairs. **INTERDERS PLUS SOUND**, 3038 N. Federal Highway, Ft. Lauderdale, Florida 33306. (305) 566-3511.

**NORTHWEST'S FINEST** — Audio Research, Audionics, Braun, Burwen, Crown, Dahlquist, Dayton Wright, Decca, Denon, Dunlop Clark, Fidelity Research, FMI, Gale, GAS, Grace, Hartley, IMF, Linn Sondek, Magnepan, Mark Levinson, Nakamichi, Otari, Quad, Quatre, Quintessence, Radford, Sequerra, Stax, Supex, Tandberg, Technics, Yamaha, also Custom Designed Superwoofers, and many more, **HARTLEY ELECTRONICS**, 1502 Butternut, Richland, WA 99352. (509) 946-4459 until 6:00 PM, Then 946-1529 evenings.

**NAME BRAND RECORDING TAPE**, custom loaded. Available in cassettes, reels, and cartridges. Huge savings direct from manufacturer. **MJS**, 516 Brooks, San Jose, Calif. 95125.

Audio Research	M & K	Fidelity Research
Quintessence	Gale	Mark Levinson
Techniques	KMAL	Connoisseur
Dahlquist	Supex	Magnepan
Hartley	Yamaha	Sequerra
Quatre	Win Labs	Fulton
Braun	Audionics	Grace
SME	Nakamichi	Stax
SAE	Linn Sondek	DBX

**GARLAND AUDIO, INC.**  
2960 Stevens Crk. Blvd.  
San Jose, California 95128  
(408) 244-6724

## FOR SALE

audio co.  
C  
E

25 Aberdeen Drive  
Huntington, New York 11743  
new • **AUDIO EQUALIZER**  
• **BASIC STEREO PREAMP**  
• **ZERO-DISTORTION PREAMP**

free catalog with test reports

Check No. 56 on Reader Service Card

BERKELEY, CALIFORNIA

<b>speakers &amp; headphones</b>	ADS FMI M&K Gale Polk Stax Braun Beyer Fulton Quatre Magnepan Quad ESL Audionics Cambridge Dahlquist Sennheiser Beveridge ESL	<b>electronics</b>	ADS GAS Quad Herc Quatre Radford Ampzilla C/M Labs Audionics Cambridge Parnassus Quintessence Mark Levinson
<b>tape-recorders, processors, &amp; accessories</b>	ARK Dbx Lamb Beyer Braun Revox Sheffield Vac-o-rec Nakamichi Quintessence	<b>record-playing equipment</b>	SME BSR KMAL Dual Grace Supex Win Labs Connoisseur Keith Monks Linn-Sondek Mark Levinson Fidelity Research

**STEREO WORKSHOP**  
2985 College Avenue  
Berkeley, California 94705  
(415) 843-5836

**new hours**  
Tues-Sat  
12-5 PM  
6-10PM

Sun-Mon  
closed

open for browsing  
private appointments for auditions & consultation

**DYNA STEREO 70 MOD KIT.** Tighter bass, improved transient response, higher definition. Complete instructions, schematics, parts list, \$5.00. With parts kit, including all new tubes, \$58.00. Or we will modify \$105.00 all postpaid. Audio Designers, Box 122, Ledyard, Conn. 06339.

**LOOKING FOR HIGH QUALITY "PREVIOUSLY OWNED" MERCHANDISE?** Referral/resale service for industrial and professional audio equipment. All merchandise guaranteed to meet manufacturer's specification for 12 months (parts, labor, and round trip shipping included). Call or write OH-RWERKE, 40 High Street, Guilford, Conn. 06437, (203) 453-5285.

**SAE MARK 1M** preamp with cabinet, mint. \$410. Call (518) 783-6890, evenings.

**CROWN CX-822**, mint. \$1700; DC-300A, case, \$600; Shure M-67 mixer, \$100. Robert Busk, 1203 N.W. 4th Ave., Gainesville, Fla. 32601. (904) 373-3043.

**CERWIN-VEGA PRODUCTS**  
(312) 581-7436

**STEREO COMPONENTS:** Over 50 brands & accs. List 50¢ refundable Custom Audio c/o Dick Walen 4226 Robert St. Red Wing, Minn. 55066

## FOR SALE

**FLORIDA'S LARGEST AUDIO RESEARCH DEALER.** Full Audio Research Systems on display SP3-A-1 Dual 76A/Dual 150/Dual 52/Magneplanar Tympani 1 C/Tympani IV. Plus AR, B&O, Crown, Denon, Fulton, IMF, Magnepan, Marantz, Mark Levinson, Nakamichi, Paoli, Phase Linear, Revox, Russound, SAE, Satin, Sequerra, Sherwood, Shure, Stax, STR, Supex, Tandberg, Technics, Transcriptors, Uher, Yamaha. SOUND AND SIGHT, INC. 20 N. Federal Highway, Boca Raton, Florida 33432, (305) 391-1843.

**DON'T PAY THE HIGH MAIL ORDER PRICES. THIEVES WAREHOUSE OF MOBILE.** 1770 BELTLINE HIGHWAY, MOBILE, ALABAMA 36609.

**TUBE EQUIPMENT:** McIntosh, Marantz and Dynaco. Klipsch speaker wanted. 4430 Wheeler, Houston, Texas. (713) 747-4682.

**MAGNEPLANAR TYMPANI 3-A's**, mint, neutral fabric, with bass screens. Call (919) 449-4132.

**AKG, ALTEC, AUDIO RESEARCH, Beyer, CROWN, DAHLQUIST, DBX, DECCA, INFINITY, KLH 9s, Koss, Nakamichi, Ortofon, PHASE LINEAR, PML, REVOX, SAE, Sennheiser, Sequerra, Sony, Stanton, Stax, Supex, Tandberg, TASCAM, Technics, Thorens, etc.**

### HI-FI HAVEN

28 Easton Ave.  
New Brunswick, N.J. 08901  
201-249-5130

### LOW NOISE STEREO PREAMPLIFIER.

Model SP5200. New! In limited production. Ask your dealer or contact Burwen Laboratories, Dept 11, 209 Middlesex Turnpike, Burlington, Massachusetts, 01803 Tel. 617-273-1488

**INFRA WOOFER™** world's largest, deepest, most powerful sub-woofer system can be had only at Music and Sound, Ltd. 50 dB per octave crossover, bandpass 16 Hz...\$1495.

**DAHLQUIST, F.M.I., I.M.F., HARTLEY SUB-WOOFERS**, for the closest approximation to dipole definition \$132 up! Shipped prepaid/insured. Music and Sound, Ltd., 11 1/2 Old York Road, Willow Grove, Pa. 19090 (215) 659-9251.  
+ Free PassiveX-over Design w/Purchase +

**DEALERS:** We will buy your excess stock. ALL lines, no quantity too large or small. Cash paid immediately. Call M. Gasman 617-924-0561.

**SAL-A-THON** - Bring cash today and take it away. Low prices on used test equipment. Subject to prior sale FOB, Brockton: Simpson Handiscope 100 Khz, \$55.00; HP 120AR w/PII 200 Khz mod., \$95.00; HP 202A F.G. 008-1200 Hz, \$95.00; HP 400D AC VTVM 10Hz-4Mhz, 1mv-300v, \$75.00; Tek 105 sq. wave gen. 25Hz-1Mhz, \$75.00; Tek 181 time mark gen., \$95.00; GR 1330A bridge osc. 5k-50Mhz, \$375.00; GR 1021A 40-250 or 250-900 Mhz, \$275.00; HP 523D counter 1.2Mhz, per TIM, \$120.00; Oecade .1 ohm-111 megohm 9 decades, \$49.00. WALLEN ELECTRONICS CO., INC., 46 No. Manchester Street, Brockton, Mass. 02402. (617) 588-6440, (617) 472-0244

**DON'T PAY THE HIGH MAIL ORDER PRICES THIEVES WAREHOUSE OF TAMPA.** 1531 SOUTH DALE MABRY, TAMPA, FLORIDA 33609.

**TORONTO AREA FM FANS:** Get the full story on local programming, new products, dealers, record reviews. The FM Guide, 122 Davenport Road, Toronto M5R 1H9. One year, \$7.00.

**ORIGINAL TRANSCRIPTOR HYDRAULIC REFERENCE TURNTABLE** (do not confuse with smaller "Skeletal" table/Vestigial arm package from Ireland) now available direct from U.S. importer. Magnificent turntable complete with silicone-damped Unipivot arm, \$498.00 freight prepaid. Without arm, including blank arm-mounting board or one cut for SME, \$398.00. Send \$100.00 down for COD shipment. Audiophile Imports, 10 East Erie, Chicago, 60611. (312) 787-0754.

**West Michigan Audiophiles**—Paoli, Ampzilla, Transcriptors, Magnepan, Fulton. Available at Music Center/Equinox, (616) 457-2117, or Box 333, Grandville, Michigan 49418.

## FOR SALE

**SHOP AROUND** — Listen to every speaker available — then come to Cyberacoustic Laboratory and hear RTR's New Direct Drive Electrostatic DR-1 speaker system at Philadelphia's exclusive distributor — by appointment — 503 Haverford Ave., Narberth, Pa. 19072. (215) 667-3048.

**CAR STEREO** — all major brands. Lowest prices. Audio, Suite 47, 947A Dyer Avenue, Cranston, R.I. 02920.

### FREQUENCY EXTENDER-EQUALIZER

Model EQ3200. New! In limited production. Ask your dealer or contact Burwen Laboratories, Dept 11, 209 Middlesex Turnpike, Burlington, Massachusetts, 01803 Tel. 617-273-1488

**SOUNDAMERICA** — Northern Minnesota's finest Audio dealer. Crown, SAE, Infinity, Yamaha, Ortofon, Shure, Thorens, Pioneer, Sony, Kenwood, E-V, Teac. Finest selection — will ship prepaid. SOUNDAMERICA 2116 Maple Grove Rd., Duluth, Minn 55811

**CYBERACOUSTIC LABORATORY** is a research and development center combined with the most scientifically advanced audio/acoustics lab; featuring Crown, IMF, Mark Levinson, Nakamichi, Burwen, UREI, RTR, DBX, Ortofon, Decca, HK-Rabco, AKG, and more. Crown tape recorder specialists. Send for free catalog! 503 Haverford Avenue, Narberth Pa. 19072. (215) 667-3048.

**LET STEREO ONE** bring a new excitement to your listening pleasure. Stereo One is at 1229 Post Rd., Fairfield, Conn. 06430. For the discriminating listener we offer: McIntosh, Mark Levinson, Braun ADS, Quatre, Nakamichi, Revox, Thorens, Supex, Dahlquist, Ortofon, B&O, Denon, F-R, JBL, Yamaha, Phase Linear, Jecklin Float, & Bi-Amplified Bozak Speakers. We ship pre-paid. For competent, professionally objective advice call:

STEREO ONE  
1229 Post Road  
Fairfield, Conn. 06430  
Phone 203-255-5939

### THE AUDIOPHILE

At last! An audio dealer in the Washington, DC, Metropolitan area serving the sound purist. Audition the new DB Systems preamp — absolutely the finest sound available today, tube or transistor. Listen to your favorite records through the Stax SRX Mk II electrostatic headphones or Quad ESL's with M&K sub-woofer. The sound may surprise you. 582 N. Frederick Ave., Gaithersburg, Md. 20760. (301) 948-2999. Where quality is foremost.

**GATELY PROKIT SM-6** mixer, EQ-6 equalizer, EK-6 reverb. Excellent! \$550. Nelson Wright, 617-767-0493 evenings.

**PHILA'S IMF ROOM** — Separate facilities to hear the exquisite sound of IMF loudspeakers. (215) 667-3048.

**JBL 061 S7R's** (2), \$400 each; AR32's (2), \$150 each; Advent Frequency Balance Control, \$100; Dual 1229 with Shure V-15II, base & dust cover, \$125.00; AR-XA with Empire 999, \$60; Kenwood KA5002, \$110; Koss E9 headphones, \$125; Kenwood KT-6005, \$200. (606) 272-6896.

### YOUR ROOM IS THE MISSING LINK

A state of the art system is usually junk in the typical poor listening environment, and therefore a rip-off. Our acoustical consulting division will have a calibrated "reverberation curve vs. frequency" measurement performed in your room, and our engineering dept.'s plan of correction, loudspeaker placement, and room equalization, all at no cost with your purchase or upgrade. Music & Sound Ltd., 11 1/2 Old York Rd., Willow Grove, Pa. 19090. (215) 659-9251.

**CANADIANS:** Best Hi-Fi discounts on over 96 leading Hi-Fi brands. Many exclusive factory closeout and special deals. Quotations via return mail. Nationwide mailorder service. FREE catalogs jam pack with bargains in: Hi-Fi equipment, tape and recording accessories, calculators, telephones and accessories, kits, parts, etc. Hundreds of factory and government surplus specials too! American inquiries welcome. Rush free catalog request to: ETCO, Dept. AUA, Box 741, Montreal H3C 2V2.



## FOR SALE

### CONSIDER YOUR SOURCE FOR SOUND

#### I. Credentials

College instructors in audio /acoustics, Inventors/graduate electrical engineers, Recording & disc mastering engineers; MEMBERS: United Inventors & Engineers Acoustical Society of America  
Institute of Electronic Engineers

#### II. Facilities

Anechoic Chamber: >.9a working floor  
\$50,000 research laboratory  
Factory authorized "A" warranty stations  
Loudspeaker Reconditioning Lab

#### III. Our Distinguished Suppliers

Audio Research, Sequerra, Satin/Denon/F-R, Transcriptors, F.M.I./R.T.R., Linn Sondek, Nakamichi, Dayton Wright, Dahlquist, Crown, Infinity, I.M.F., London Decca, Quad, Rogers, Spondor, Stax, B&O, Grace, Supex, Micro Acoustics, Custom Rabco, Braun, Revox A-700, Drtofon, Damped S.M.E., Scully, Mark Levinson, Koss-ELS, Yamaha.

+

1000's of PROFESSIONAL products (see Tuned Rock P.A. ad).

Music & Sound Ltd., 11 1/2 Old York Rd., Willow Grove, Pa. 19090. (215) 659-9251.

#### Whom Would You Trust?

THOUSANDS OF LIKE NEW LP's and prerecorded tapes. Catalogue \$1.50. House of Records, Hillburn, New York 10931.

AUDIO RESEARCH, AUDIONICS, BANG & OLUFSEN, BOZAK, CROWN, DBX, KLIPSCH, KMAL, LINN SONDEK, NAKAMICHI, PHASE LINEAR, RADFORD, REVOX, SEQUERRA, STAX, TANDBERG, BEYER, SENNHEISER, and other fine instruments for the reproduction of music. Send for list of used equipment AUDIO SYSTEMS AND DESIGN, 5421 South 84th St., Lincoln, Nebraska 68516 (402) 489-9888 . . . and 4408 Capital Ave., Omaha, Nebraska 68131. (402) 556-7559.

PROTECT YOUR LPs. Poly sleeves for jackets 8c round bottom inner sleeves 6c Poly lined paper sleeves 15c White jackets 35c Postage \$1.25. House of Records, Hillburn, New York 10931.

#### NEW YORKERS—WE ARE COMMITTED!

Consult with us about your audio needs. We have what you want, we offer FULL service.

IMF, BGW, SAE, OHM, INFINITY, KLIPSCH, ORTOFON, THORENS, SME, LEVINSON JC-1, STAX, ADS-BRAUN, TECHNICS, PIONEER, KENWOOD, CROWN, MARANTZ, TANNDY, KEF, IAS, OBX, REVOX and Many Others.

INNOVATIVE AUDIO  
129 DeGraw Street  
Brooklyn, NY 11231  
(212) 596-0888  
Call For Appointment

THE JANIS WOOFER IS ABSOLUTELY FLAT TO 30 Hz.! The specifications can only hint at the effortless, ultra-clear and detailed bass reproduction to the limits of hearing. Typical response 30 - 100 Hz. + 1/2dB, distortion about 1% max. About 60 W is enough to drive this speaker. Elegant in size (22"x22"x18" high) and appearance. Full details: Janis Audio Associates, Inc.; Box 88 Throgs Neck Station; New York, N.Y. 10465.

HONG KONG, TAIWAN, JAPAN, Asia Directory. World products information. Mail-orders, bulk-orders. Listings. Directory and Information \$1.00 today. World Trade Inquiries. Box 6224, Spokane, Wash. 99207.

#### ALAN AUDIO OF INDIANA

ADVENT, ADS/BRAUN, AVID, CITATION, CROWN, FULTON, GALE, LINN-SONDEK, NAKAMICHI, OHM, ORTOFON, REVOX, SHURE, SME, SUPEX, TANNOY/MICRO, YAMAHA, Amplifier & tuner testing; cartridge comparisons; fully instrumented factory authorized service

Alan Audio, 310 S. Washington, Bloomington, Indiana 47401; 812-332-2192  
Open Sunday, Closed Saturday.

MIDWESTERNERS - Write for COMPONENT AND RECORDING TAPE DISCOUNT PRICE LIST. AUDID, Box 477, Notre Dame, Indiana 46556.

## FOR SALE

STEREO NEEDLES AND CARTRIDGES—ADC, B&O, GRADO EMPIRE, MICRO-ACOUSTIC, PICKERING, ORTOFON, SHURE, STANTON, SUPEX, SONY, PANASONIC, RCA, BSR, and others. Write for FREE CATALOG. NEEDLE IN A HAYSTACK, INC., P.O. Box 17436, Washington, D.C. 20041.

NOW IN PRODUCTION: World's heaviest 12" woofer. 17Hz resonance. Over 200 watts RMS. Sand cast frame, \$59.00 delivered U.S.A. Rockwell Systems, Inc., 100 Liberty St., Rockwell, N.C. 28138. NOW THE BIG MID-RANGE: 3" dome, 3" voice coil, 96 watts RMS sine wave power at 1000Hz. Over 120 degrees dispersion 500 to 5000 Hz. Weight 12 1/2 pounds. \$99.50 postpaid USA.

AR-3A - like new, walnut stands plus glass tops. \$250. (804) 282-5918.

WESTCHESTER HEADQUARTERS for the great sounds in the world. Quad, Cambridge, Dahlquist, Bose ESS, Braun, SAE, EPI, Crown, Phase Linear, Tandberg, Thorens, Yamaha, Nakamichi, Technic, BGW, Dual, Revox, Leak, B&O, DBX, Burwen. We stock Ampzilla. The listening Room, Inc. 590 Central Ave. Scarsdale, N.Y. 10583 (914) 472-4558.

IMF MONITOR Mk III's, perfect condition. (814) 238-5016; evenings call (814) 238-7883.

#### AUDIO'S HI-FI HANDBOOK

Complete reference guide to over 1,000 components, including prices and specs. All arranged in tabular form for easy comparison. Plus over 30 outstanding articles on audio topics, trends and advances. State-of-the-art reading for audiophiles. Only a limited quantity available. Over 200 pages. Send \$3.95 (includes shipping and handling) to: Jean Davis, Audio Hi-Fi Handbook, 134 N. 13th St., Phila., Pa. 19107.

MILWAUKEE & WISCONSIN'S only audiophile dealer. Specialists in components by Crown, Dahlquist, Transcriptors, Integral Systems, Epicure, Nakamichi, Bozak, Citation, Ohm, SME, Ampzilla, DBX, Infinity, SAE, RTR, ESS, Revox, Phase Linear and 50 others. Wisconsin's only Audio Research dealer with the entire product line on demonstration. WACK ELECTRONICS INC., 5722 W. North Ave., Milwaukee 53208. 414-442-3441.

#### —SPEAKER CATALOG—

Up to date. Top quality drivers. Hop-up the speakers you have or build new ones. Transmission-line speaker plans \$5.00—Foam damping material. E&E Audio, 2816 Church Ave., Brooklyn, New York 11226. .212 462-0984

SOUND ADVICE MAGAZINE — the second issue includes comparative reviews of amplifiers: Audio Research Dual 76A; C/M Labs 912; Electro Research Class A; Luxman 4000; Naim NAP160; SAE 2500; Stax High Powered FET Class A; and Technics SE9600. Preamps include Audio Research SP3a-1; Crown IC-150; Dayton Wright Sps; Dynaco PAT-5; ESS preamp; Harman Kardon Citation 11a; Levinson JC-2; Luxman C-1000; McIntosh C-28; Naim NAC12; Phase Linear 2000; Radford; Soundcraftsman 2217; Stax FET; and Technics SU9600. Cartridges reviewed: Audio Technica AT20SLA; Decca V Elliptical; Empire 4000/III; Shure V15 Type III; and Stanton 681EEE. Some extra goodies: Keith Monks Tomarm; Linn-Sondek turntable; IAO Dynamic Range Expander; Dayton Wright and Levinson Jc-1-AC moving coil preamps. Much more. Four issues — \$9 (\$11 first class; \$12.50 foreign — sent airmail), Sound Advice, 225 Kearny, No. 200M, San Francisco, Calif. 94108.

THE BOTTOM END, as reviewed in the April *Stereophile*. A new compact super bass speaker that retails for around \$200.00. A no-compromise performer with smooth response below 20 Hz. Ideal for use with Magnaplanars, Quads, Dahlquist, ESS, or any system deficient in low bass, because of room placement. BOTTOM END CROSSOVERS permit the use of one woofer, no bi-amping, one amplifier does it all. Model X1 for all Magnaplanars, Model X2 for all others. Literature and information available upon request, dealer inquiries invited. Consumers write for the name of your nearest dealer. M & K Sound Inc., 8719 Wilshire Blvd., Beverly Hills, Calif. 90211.

## FOR SALE

### FREE details... A DIFFERENT KIND OF RECORD CLUB

Discounts up to 73%, no "agree-to-purchase" obligations. All labels, Schwann catalog of thousands of titles; classical, pop, jazz, country, etc. Discount dividend certificates. Newsletter; accessories; quick service. 100% iron-clad guarantees. Write for free details.

DISCOUNT MUSIC CLUB, INC. DEPT. 14-125  
650 Main Street, New Rochelle, N.Y. 10801

#### CURRENT AND RECOMMENDED:

SONEX speaker. Originally developed as a mix down monitor, a piezoelectric has been added for dispersion. The result is a very efficient, accurate reproducer with very good power handling \$185 each.

DREADNAUGHT power amps by Dunlap Clarke. Absolutely stable, superior protection. Despite other claims this is the first solid state amp we have heard which is as good or better than the best tube equipment we have heard. We used to have to specialize depending on what the amplifier was to be used for. This is the amp for super-woofers or any part of a bi or tri-amped system, or for PA or band use. Models 500 and 1000, \$800 and \$1200. These amps will also be available under the Sequerra name with different cosmetics.

SUPEX SMM5 moving magnet cartridge. Not the best but exceptionally smooth. Nothing can touch it for \$50.

GRACE 940 oil damped, uni-pivot tone arm. \$149.

FIDELITY RESEARCH cartridge and transformer. The best moving coil yet. Highly regarded even by resident Decca freak. Great depth of image and detail. Also variety of preamps. Cart. \$130. Toroidal transformer \$150.

CAMBRIDGE AUDIO P50 and P140 integrated amplifiers with toroidal power supply and state of the art preamp. \$350 and \$550. Also TL 200 transmission line speakers, DECCA BRUSH. Over a million conductive bristles eliminate need for liquids and reduce static. \$15.

OECCA CLEAN-UP. The ultimate dust bug. Same bristles as brush, conductive shaft and ground wire. \$15

also: GAS Ampzilla, Dayton Wright, C/M Labs, Sony, Lux, BGW, Audionics, Lexson, Revox, Otari, Nakamichi, Neal, FMI, Celestion, IMF, Linn Sondek, ERA, Micro 700, Dual, Decca, Drtofon, Supex, Sennheiser, Beyer, Sequerra. Shipped free anywhere in U.S. and Canada.

GREENWOOD SOUND, INC.  
P.O. Box 2069  
Portland, Ore 97202  
503 235-1776

CUSTOM BUILT SPEAKER SYSTEMS, enclosures, kits foam grills, crossovers & parts. Raw speakers, veneers, vinyls. CSS, 8460 Marsh, Algonac, Mich. 48001.

HI-FI ENTHUSIASTS WANTED!! Earn more than just spare money in your spare time. We need campus representatives to sell name brand stereo components at discount prices in your area. High commission, no investment required. Serious inquiries only, please. Contact: Alan Weisberg, K&L Sound Services Co. 75 N. Beacon St., Watertown, Mass. 02172.

#### DON'T PAY THE HIGH MAIL ORDER PRICES

THIEVES WAREHOUSE OF PENSACOLA  
3731 NAVY BOULEVARD, PENSACOLA, FLORIDA 32507

MINT SONY PREAMP 2000, \$185; Sony SQ Decoder SQD2020, \$135; Kenwood Audio-Denoiser KF8011, \$140; Pioneer SA900 amp, 120 watts rms, \$175. (919) 578-0655, A Blanchard, P.O. Box 2034, Burlington, N.C. 27215.

DEMO EQUIPMENT . . . BOSE 1801 Stereo Power Amps. \$779.00. Braun LV102DA Tri-amped. Speaker System \$585.00 each. TELEX 235 series Cassette Duplicator System. 1/2 tr. 2ch. system includes open reel master, cassette master and 3 cassette slaves. System includes consoles and cables. Used only as demo. A value at \$2000.00. AUDID CRAFT CO., INC., 3915 CARNEGIE AVE., CLEVELAND, OHIO 44115, 216-241-5560.

REVOX OWNERS — Factory authorized service, parts & accessories for the Western states. Beverly Stereo Audio Clinic, 8413 Beverly Blvd., L.A., Calif. 90048. (213) 651-3652.

DBX: 119 Compressor/Expander, \$125; 1242/4 Channel Noise Reducer, \$225. John, 414-782-7398.

## FOR SALE

**TRANSCRIPTOR SKELETON TURNTABLES**, for the discriminating audio enthusiast, are now available at Port Of Sound. The glass enclosed turntable in combination with the Vestigal arm offers performance rated among the very best. Port Of Sound, 8665 N. Port Washington Rd., Milwaukee, WI. 53217.

**STATE-OF-THE-ART PERFORMANCE FROM THE** Transcrip-tor Vestigal tone-arm on display with the Transcrip-tor Skeleton turntable at Opus 2, 404 S. Perkins Ext., (901) 683-0117 and Germantown, (901) 754-8431, Memphis, Tn. 38122.

**Used 1" x 3600' video tape**, 10" reels, Scotch 551-1-3600-R41, \$30 each + postage. Audio Box number A512-1.

**KENWOOD KF-8011** denoiser, \$175; Koss ESP-9 head-phones, \$150. Hobish, 7306 Park Heights Ave., Baltimore, Md. 21208.

**PIONEER TX-9100** tuner. Very good condition with little use. Shipped prepaid insured for \$175! Chris Hood, 11 E. Prospect Ave., Pittsburgh, Pa. 15205.

**MARANTZ MODEL 500**. Immaculate condition. Will sell for \$1000. (919) 929-6824.

**CROWN ES212** electrostatic speakers, \$900/pair. (219) 533-9859.

**JBL PARAGON**, walnut, \$1800. Mark Conrad, 1004 Have-lock Dr., Taylors, S.C. 29687. (803) 268-6840.

**STEREO CARTRIDGES and STYLUS REPLACEMENT** For ADC. Audio Technica, B&O, Grado, Empire, Micro Acoustics, Pickering, Ortofon, Shure, Stanton, Supex. Write for free cat-alog: Needle In A Haystack, Dept. A, P.O. Box 17435, Wash-ington, D.C. 20041.

**SCOTCH-AMPEX TAPE** — Lowest prices! Ampex Grand-master, 10 1/2", our metal flanges, boxed—\$13.50 postpaid. Cheaper in quantity. Free price lists. Omega Audio, 25520 Graham Road, Detroit, Mich. 48239.

### GOODY DEPARTMENT

DECCA Megafilm Brush \$15.00

SUPEX SL4 6 gram universal head shell \$7.00

SUPEX AL2 cueing device, camped for AR/Thorens/  
KMAL/Rekokut \$19.00

SUPEX AC11 stylus cleaner \$4.00

CM LABS electronic crossover, 6 db, 100 hz steps \$158.00

PAC Piezoelectric add on tweeter, two per burl finish en-closure, 6 db/octave crossover \$100.00 pr.

ALL shipped postpaid/satisfaction guaranteed

Perfectionist Audio Components

172 Ocean Ave., Lynbrook, N.Y. 11563

**ESS AMT-1** Towers, ESS preamp, very negotiable. (301) 341-1148.

**REVOX A-77 TAPE DECK**, \$375. Robert Sadowsky, 3235 Emmons Ave., Brooklyn, New York 11235. (212) 934-9425.

**MC INTOSH MA-6100**, \$550. Fisher DR-14 CD-4 demod-ulator, \$60. Integral Systems 200 amplifier with cabinet, \$250. Marantz 4000 Quad adapter with cabinet \$150, SQA-2 SQ logic \$50, RC-4 remote \$25. Advent 201 \$225. Philips GA212 turntable with Shure V-15 type two, \$150. Bozak B-305's, \$500. Infinity Monitors \$700. Call Chuch 313-653-7192.

### SAN DIEGO, CALIFORNIA

ADC \* Advent \* AKG \* AR \* Audio Research \* Be-  
yer \* BIC \* Burwen \* Crown \* Dahlquist \* DBX \*  
Dual \* Dynaco \* Garrard \* Grado \* Harman-Kardon  
\* Janszen (electrostatic) \* KMAL \* Koss \* Linn-Son-  
dek \* Magneplanar \* Maxell \* Micro-Acoustics \*  
Nakamichi \* Ohm \* Philips \* Rabco \* Revox \* RTR  
\* Sennheiser \* Sherwood \* Shure \* SME \* Sonab  
\* Sony \* Supex \* Tandberg \* Tapco \* TDK \*  
Yamaha

Sound Company

4701 College Ave. (714) 582-4148

3675 Sports Arena Blvd. (714) 224-2844

**SOUNDTRACKS** — MOVIES, TV, BROADWAY, RELATED,  
RARE \$1.00 FOR CATALOG, REFUNDABLE "MR. SOUND-  
TRACKS," 59-359 PUPUKEA RD., HALEIWA, HAWAII 96712.

## FOR SALE

**IMF LOUDSPEAKERS**, Monitors featured, Levinson, Burwen, CM Labs, Futterman tubed electronics. Jecklin Float Elec-trostatic Headphones. Leak Stereo-20 tubed amplifier, new \$200. Beam-Echo rare (English) tubed mono amplifier new \$195. RTR 400E electrostatic speakers nearly new \$235 each. Sheffield recordings. Bohn Omnitrex SR1 portable cal-culators, regularly \$130, now \$75. Trades accepted. **WANT-ED**: Futterman, Marantz, McIntosh tubed equipment. GOLDEN EAR, registered name (formerly Audiocraft), South Rock-wood, Michigan 48179. (313) 379-9945.

**NO CHARGE TO INSERT ADS!** NO COMMISSION WHEN ITEMS ARE BOUGHT OR SOLD! BUY, SELL OR TRADE YOUR HIGH END HI-FI THROUGH AUDIOMART, THE AUDIOPHILE'S CLASSIFIED NEWSLETTER. SUBSCRIBE: \$4/12. BDX 821, STRATFORD, CONNECTICUT 06497.

**SERVICE MANUALS** for all audio equipment. Includes schem-atic, parts list and servicing. Send make, model and \$5.00 to Daugherty Audio Service, 7313 Inzer, Springfield, VA 22151.

**DYNAMIC SPECIALITIES IS A WEST COAST STORE DEALING PRIMARILY IN USED AUDIO EQUIPMENT.**

1. We sell & offer service for vintage tube equipment, e.g., Marantz, McIntosh, Citation, Quad, Scott, Fisher, Revox, Ampex, etc.

2. We carry a wide range of used components, vintage & current.

3. We also demonstrate & sell certain new equipment: Ful-ton, Grace, Supex, Fr, Dahlquist, M&K, Connoisseur.

4. Sample of stock at time of writing - Marantz 8 (2), 7c, SAE IVCN, MAC 2505, MC60 (2), ARC D75A, D50FIB, SP3A-1, Quad 303, Crown IC150, Leak TL/12 Plus, Cita-tion I, II, III, Revox G36, A77, TEAC 7030SL, Dahl-quist DQ10, Sony 777, 2251, Dyna 70 (2), Mk III (2), ST35 (2), 120, Thorens TD125II/SME, & more.

Also, Telefunken tubes, photographic & musical instru-ments.

### WE BUY, SELL, TRADE DYNAMIC SPECIALITIES

2261 Spring St.

Redwood City, California 94063

415-364-6634

**DON'T PAY THE HIGH MAIL ORDER PRICES.** THIEVES WAREHOUSE OF ATLANTA, 4166 BUFORD HIGHWAY, N.E., ATLANTA, GEORGIA 30345.

**DON'T PAY THE HIGH MAIL ORDER PRICES.** THIEVES WAREHOUSE OF ATLANTA, 1030-3 CHEROKEE ROAD, SMYRNA, GEDRGIA 30080.

**DON'T PAY THE HIGH MAIL ORDER PRICES.** THIEVES WAREHOUSE OF MONTGOMERY, 3386 NORMAN BRIDGE ROAD, MONTGOMERY, ALABAMA 36105.

**DON'T PAY THE HIGH MAIL ORDER PRICES.** THIEVES WAREHOUSE OF ATLANTA, NORTH LAKE MALL, 4800 BRIAR CLIFF ROAD, ATLANTA, GEORGIA 30345.

**DON'T PAY THE HIGH MAIL ORDER PRICES.** THIEVES WAREHOUSE OF ATLANTA, 3164 PEACHTREE ROAD, N.E., ATLANTA, GEORGIA 30303.

**AUDIO RESEARCH D75A** amplifier \$550. Magneplanar Tympani 18's \$725. (213) 240-1706.

**THE TRANSCRIPTOR SKELETON TURNTABLES AND VESTIGAL** tone-arms are far ahead of their time. Don't waste time. Come and see them now at: Audio Specialties, 2661 Campbellton Rd. S.W., Atlanta, Georgia 30311.

**TRANSCRIPTOR TURNTABLES, VESTIGAL TONE-ARMS** and the world's most accurate stylus scales. Transcriptor turntables are acoustically/sonically silent, aesthetically beau-tiful. Get yours now! Golden Ear (formerly Audiocraft), South Rockwood, Mi. 48179.

**TRANSCRIPTOR SKELETON TURNTABLES** and VESTIG-AL tone-arms. Specializing in precision mounting of the Vest-igal tone-arms on your turntable. Call (412) 441-3770 for appointment. Kevin's Audio Specialties, Pittsburgh, PA.

**DON'T PAY THE HIGH MAIL ORDER PRICES.** THIEVES WAREHOUSE OF ATLANTA, 2769 LAKEWOOD AVENUE, S.W., ATLANTA, GEORGIA 30315

## FOR SALE

**USED EQUIPMENT:** AUDIO RESEARCH TYMPANI IA, \$650; BGW 500R, \$495; GALE SPEAKERS, \$575; QUINTESSENCE PREAMP, \$360; EQUALIZER, \$360; CROWN D60, \$220. HARTLEY ELECTRONICS, 1502 BROWNUT, Richland, WA. 99352. 946-4459 or 946-1529 evenings.

**C22. DOCUMENTED PERFEL**, \$350/offer. Wm. Henne-berg, 908 Lomita, Segundo, Calif. 90245.

**STEREO REPRESENTATIVES NEEDED!!** Lowest Price List Buying!! Over 80 Brands!! Krasco Stereo, 623 Campbell Ave., West Haven, Conn. 06516.

### FORMULA 4 PROFESSIONAL LABORATORY TONE ARM

Only viscous damping with low effective mass can ensure natural sound without 'listening fatigue' enabling all cart-ridges to reach their region of best performance, the so-called 'Linear Region' essential for perfect CD-4, UD-4 matrix quadraphony and stereo due to the suppression of in-stantaneous tracking force extremes reducing record wear and H.F. playback distortion. Viscous damping means better tracking of warped records, the sound having rich full bass plus a tape-like consistency with steady stereo image and near pinpoint localization. Jewelled Unipivot friction below 0.005 gm. Effective Mass 4.50 gm VTF 0-3 gm stylus pivot 224mm. Optimum performance with ultra high or low com-pliance cartridges weighing 3-10 gms. Leaflet \$1 deductible from purchase. Price \$89 including airmail. Formula 4, 15 Heather Walk, Edgware, Middlesex HA8 9TS, England.

**TRANSCRIPTOR SKELETON TURNTABLES**, FOR THE dis-criminating audio enthusiast, are now available from Audio House, LTD. The all glass enclosed turntable in combination with the Vestigal tone-arm offer performance among the very best. Audio House Ltd., 510 First Street, Lake Oswego, Or. 97034.

**TRANSCRIPTOR SKELETON TURNTABLES**, FOR THE dis-criminating audio enthusiast, are now available from Sound-smith. The glass enclosed turntable in combination with the Vestigal tone-arm offer performance rated among the very best. The Vestigal tone-arm is also available separately for custom mounting on your turntable. Soundsmith, 242 State St., Portsmouth, N.H. 03801.

**TRANSCRIPTOR SKELETON TURNTABLES**, FOR THE dis-criminating audio enthusiast, are now available from Sounds & Settings. The glass enclosed turntable in combination with the Vestigal tone-arm offer performance rated among the very best. The Vestigal tone-arm is also available separately for custom mounting on your turntable. Sounds & Settings, 622 E. Liberty, Ann Arbor, Mi. 48108.

**TRANSCRIPTOR SKELETON TURNTABLES**, FOR THE dis-criminating audio enthusiast, are now available from KSS Sound. The glass enclosed turntable in combination with the Vestigal tone-arm offers performance rated among the very best. KSS Sound, 9 Music Square West, Nashville, Tn. 37203.

**TRANSCRIPTOR SKELETON TURNTABLES**, FOR THE dis-criminating audio enthusiast, are now available from Sound Of Music. The glass enclosed turntable in combination with the Vestigal tone-arm offers performance rated among the very best. Sound Of Music, Mpls-St. Paul, and Mankato Mn. and Eau Claire, Wi.

**TRANSCRIPTOR SKELETON TURNTABLES**, FOR THE dis-criminating audio enthusiast, are now available from Wack Electronics. The glass enclosed turntable in combination with the Vestigal tone-arm offers performance rated among the very best. The Vestigal arm is also available separately for custom installation on your turntable. Wack Electronics, Inc., 5722 W. North Ave., Milwaukee, Wi. 53208.

**DON'T PAY THE HIGH MAIL ORDER PRICES.** THIEVES WAREHOUSE OF NORTH TAMPA, 1441 EAST FLETCHER AV-ENUE, TAMPA, FLORIDA 33612

### BRAND NEW — FACTORY FRESH

Sherwood S-8900A Prima receiver, \$299. TEAC 360S cas-sette recorder, \$305. BASF C-90 chrome cassettes, 10 for \$25. Shipped freight collect. Full manufacturers warranty. Buy from the Big One on the West Coast — Stereo Ware-house, 813 Pacific Ave., Santa Cruz, California 95060. (Calif. Res. add 6% sales tax.) All orders shipped same day received.



## FOR SALE

TYPE YOUR SLIDE! Sizes 3 1/4x4 - \$2.25 per 50 and 2x2 - \$2.75 per 100. Radio Mat Slide Company, 444 N. Peninsula Drive, Daytona Beach, Fla. 32018.

**THE ABSOLUTE SOUND**, in its seventh issue, will assess the state-of-the-art in audio components. It will review a new generation of components (in depth) that purport to advance the audio art: the Infinity Servo-Statik Ia; Mark Levinson's new preamp, the J(ohn) C(urly)-2; Yamaha's low-feedback preamp and its V-FET amplifier; Audio Research's Dual 76A and SP3A-2; the Dayton-Wright MKIII Electrostatic; Luxman's new amplifiers (at 300 and 180 watts per channel respectively); the Denon Spherical and Shibata moving coil cartridges; Rabco's SP-7 straight line tracking turntable. Nor is this the end of it. We shall also be taking a look at the Quad Electrostatic; the Yamaha Super Speaker; the Fidelity Research cartridge; Ohm-F; KEF 104; the Hegeman speakers; Epicure's electronics (amps and preamps) and more. We'll also be updating our recommended recordings, with additional emphasis on record reviews. Subscriptions (four issues): \$10 US, \$11 Canada. Add \$2 for first class mailing if desired. \$13 foreign (airmail). Back issues 1 through 6, \$3 each. The Absolute Sound, P.O. Box 5, Northport, N.Y. 11768.

**MARANTZ 500**, excellent factory tweaked unit. \$800. (919) 467-9198.

**DECCA INTERNATIONALSUPEX** lift, \$130. Wharfedale tweeter, 8-inch woofer, \$45. Xover coils: (4) .01 mh; (2) .9 mh, \$12. Want high grade tube power amp. Friedman, 606 S. Coler Ave., Urbana, Ill. 61801.

**SAE - Mk 1M preamp**, Mk 27 double band octave equalizer, cabinets, both mint - \$765.00. TEAC 5300 with dust cover and remote control - \$575.00. DBX 124 compressor-expander - \$265.00. (518) 783-6890.

### 6-14 NOISE REDUCTION

Burwen DNF1201 works on any program source without pre-coding. Eliminates hiss without changing tonal quality of program material. Request information and dealer directory. Burwen Laboratories, Dept. 10, 209 Middlesex Turnpike, Burlington, Massachusetts, 01803 Tel 617-273-1488.

**PIONEER AMFM STEREO TUNER** with Quad synthesizer and Koss Phase 2 headphones. Like new, bought this year. Will sell for best offer. Also includes 4 Allegro speakers, also like new. Must sell immediately. Patnaude, RFD 2, Boxford, Mass. 01921.

**SAE Mark IVCM power amp**, SAE Mark IX preamp, 2 RTR-400E speakers, Toshiba SR-50 turntable. Best offer for system, or will sell components individually. (516) 799-0611.

**SOUND ADVICE SUBSCRIBERS**: the entire technical staff of the magazine remains together and continues to create the quality work you expect from us. We are changing publishers. If you wish to receive our magazine, send a xerox of your cancelled check with your name and address to me personally: Peter Moncrieff, 2449 Dwight Way, Berkeley, California 94704.

**NAKAMICHI 700**, mint. 50 Cr02 C-90 tapes. Make offer. McIntosh MPI-4 scope \$475. Box A512-4, co Audio.

**ESS AMT-1 OWNERS**: Dissatisfied with bass? Our modification greatly improves performance, leaves warranty intact. Only \$69.95 plus tax and shipping. Free brochure. TRANS-BASS SYSTEMS, 2323 S. Dtis, Santa Ana, Calif. 92704.

**TRANSCRIPTOR SKELETON TURNTABLES** and VESTIGAL tone-arms are alive and doing well. Transcripator, just one of the comprehensive state-of-the-art components available from: The Stereo Emporium, 3407 Delaware Ave., Buffalo, N.Y. 14217.

**AUDIO RESEARCH SP-3A-1** preamp offers more sonic improvement for upgrading an already good audio system than any other component. \$695. We trade. We carry the same lines as other audiophile dealer listings. See our Absolute Sound Room. The Stereo Shop, 107 Third Ave. SE, Cedar Rapids, Iowa 52401, and Village Shopping Center, Davenport, Iowa 52806.

**D-75A Sony 2251 w/SME 3009 & Supex SD900E**, Sony TA-2000F preamp. New warranties. Trades considered. 509-943-1044.

## FOR SALE

**TRADE IN YOUR KLH 9's, QUADS, AND MAGNEPLA-NARS.** The incomparable Fulton J speakers are available. Place your order now. We recommend: Paoli tube amplifiers, Paoli SP3A-1 modifications, Denon moving coil cartridges, Decca's new record care system, KEF B104 speakers, Linn-Sondek, Transcriptors Skeleton turntable with vestigial arm, and the new, more comfortable Stax earspeakers. Quality equipment in all price ranges. Trade-ins accepted. Contact us for fine used equipment: Pair of Marantz 8b's, MacIntosh 240, several Dynaco 400's, Fairchild Compander, KLH 5's, EPI 202's, Quads. **DO NOT BUY ANOTHER SPEAKER** until you have heard the natural sounding, low distortion Fultons at NATURAL SOUND, 1021 Claremont Street, Lincoln, Nebraska 68508, (402) 475-3325 and E-7 Institute and Einhorn, Worcester, Mass. 01609. (617) 755-1461.

**DISCOUNT PRICES** on stereo components. All major brands. Write for quote. Seashore Stereo Sales, 204 Woodcrest Ave., Absecon, N.J. 08201.

**NO MATTER HOW GOOD YOUR COMPONENTS, YOUR ROOM IS YOUR WEAKEST LINK!** I am selling a 3900 cubic foot SOUNDPRODFED music room with non-parallel ceiling, 14,000 watts AC, super antenna system, etc. With it goes a historic restored 3 bed 2 1/2 bath detached townhouse in Alexandria, Va., a short, pleasant (!) commute from Wash DC. Extras like Thermopane windows, gas CAC, etc. too numerous to list. \$97,000. Call (703) 549-3054.

**DAHLQUIST - 10A's**, 4 months old, original cartons, warranty cards, as new - \$630. (212) 376-4842.

**ESS AMT-3's**, Heil monitor speakers. 1 year old, mint \$625. (212) 376-4842.

### SAN FRANCISCO

At last a source for truly superior audiophile products. Accurate advice, unsurpassed service, and incomparable components from: **THE SOURCE**, Box A512-2, c/o Audio, 401 N. Broad St., Philadelphia, Pa. 19108.

**STEREOPIUS** - the new equipment review quarterly. Brings you in-depth, realistic reviews on the latest in the world of components. If you are considering any component purchases in the future don't be without it. \$9.00/year (\$11.00 first class) \$12.00 foreign. \$11.00 Canadian. P.O. Box 269, Fort Walton Beach, Florida 32548.

**2 Marantz 9 amplifiers** rack mount. Excellent condition, Kenwood KF-8011 multi-band dynamic noise filter. (647) 358-2254.

**MICHIGAN AUDIOPHILES**, visit our new location featuring the area's widest selection of state-of-the-art components. See our transcriptors display with the all glass enclosed SKELETON turntable. Hear the difference in the VESTIGAL tone-arm when A-Bed with the others. Audio One, 167 N. Woodward Ave., Birmingham, Mi. 48011, (313) 646-6666.

**TRANSCRIPTOR SKELETON TURNTABLES**, FOR THE discriminating audio enthusiast are now available from A.C. Recording & Electronics. The glass enclosed turntable in combination with the Vestigal tone-arm offers performance among the very best. A.C. Recording & Electronics, 7 U.S. Highway 206, Raritan, N.J. 08869.

### DECOURSEY ELECTRONIC CROSSOVERS

Complete with plug-in Butterworth filters of your specified frequencies and with 6, 12, or 18 db/octave attenuation. Regulated power supply. Bi-amp or triamp for monaural, stereo, or quadraphonic systems. Other options: Electronic summer for single woofer stereo; VLF noise filters. For OEM and home builders; Series 500 and 600 Hi-pass and Low-pass filter pairs. Also regulated power supplies. Write for brochure. DeCoursey Engineering Laboratory, 11828 Jefferson Blvd., Culver City, CA 90230

### ARP SYNTHESIZERS!

New Rock Bottom Prices

Explorer, AXXE \$730; Pro-Soloist \$875; Odyssey \$1165; String Ensemble \$1315; Model No. 2600 \$2260. Dickstein Distributing, 1120 Quincy Avenue, Scranton, Pennsylvania 18510.

**AR AMPLIFIER** with walnut cover. Excellent condition, 3 years old. Best offer over \$130. Drasin, 107 Buckley St., Liberty, N.Y. 12754.

## FOR SALE

**CROWN SX822 Deck**, 7 1/2 - 15 ips, \$1200; D150 Amplifier, \$300; both units 6 months old with WARRANTY & CAR-TONS; Gary Davison, 128 West End Ave., Binghamton, N.Y. 13905; (607) 729-2064

**IN PURSUIT OF EXCELLENCE WE OFFER:** Infinity, Crown, Revox, Fulton, Sennheiser, Philips, Ortofon, ESS, SAE, Beyer, DBX, Altec, Technics direct drives, RTR, McIntosh, JBL, Transcriptors, Klipsch, Citation, Decca, SME, Sequerra, Micro/Acoustics, Lamb, Dahlquist, Tannoy, Yamaha, Soundcraftsmen, Marantz, and more . . . Also custom room equalization, individually damped Altec & JBL Monitors and an ongoing equipment evaluation program. The House of Sound, 821 Kent Ave., Baltimore, Md. 21228.

### NOW AVAILABLE

**FAMOUS REFLECTING SYSTEM'S 4 1/2" REPLACEMENT DRIVERS**. \$7.98 POSTPAID. QUANTITY DISCOUNTS. FREE SPECIFICATIONS. AURATONE, BOX 580-26A, DELMAR, CALIFORNIA 92014.

**THE AUDIO RESEARCH ROOM**. The complete line of Audio Research equipment on display under ideal listening conditions. AUDIO SYSTEMS & DESIGN, 5421 South 84th St., Lincoln, Nebraska 68516 (402) 489-9888.

## RADIO PROGRAMS

**1930-1962 RADIO PROGRAMS**, Reels, \$1.00 hour! Cassettes, \$1.00 show! Mammoth catalog \$1.25. AM TREASURES, Box 192 AU, Babylon, New York 11702

**RENT RADIO SHOWS** - Make your own copies or just listen. Great way to build your collection reasonably. Catalog \$1 refundable. OTR Rental, Box 465, Livermore, Ca. 94550

**YESTERDAY'S RADIO PROGRAMS ON TAPE**. Reels, cassettes - fast reliable service. Catalog \$1.00 refundable with first order. ADVENTURES, 1301-A North Park Avenue, Inglewood, California 90302.

**RENT OLD RADIO PROGRAMS** as low as 50c per reel week.

GOOD OLD RADIO  
P.O. Radio  
Lone Pine, Calif. 93545

**OLD RADIO PROGRAMS ON TAPE**. Thousands available. Low prices, finest quality, immediate service. Catalogue 25c. Nostalgic Radio, Box 29K, Peoria, Ill. 61601.

**RADIO AS IT WAS** - Rag time, Honky-Tonk, etc. others. Reel, Cassette, Cartridge, Custom discs. Our package or recorded to your order from our library. Sample cassette and list \$1.25. Refundable. Nostalgic Enterprises, P.O. Box 3786, St. Louis, Mo. 63122.

**OLD TIME RADIO PROGRAMS** on cassette. Catalog \$1.00. MB/JB Enterprises, Box 724, Spencer, Iowa 51301.

**GOLDEN AGE RADIO** - your best source for radio tapes. Box 25215-D, Portland, Oregon 97225.

**OLD RADIO LIVES AGAIN!** Catalog with big selection available for \$1.00. R.R. Schurch, 9370 Urban Dr., La Mesa, Calif. 92041.

## SPEAKERS

**SAVE 50%**. Construct speakers and save money. Send for free catalog and instructions. Speaker Kit, Box 12A, Monomomie, WI 54751.

### MUSICAL SPEAKERS REPAIRED

ALTEC WARRANTY STATION  
Hughes Electronics Service  
45 Dunn St., Asheville, N.C. 28806

## AUTHORS, BOOKS

**PUBLISH your book!** Join our successful authors: All subjects invited. Send for free appraisal and detailed booklet. Carlton Press (Dept. VRX) 84 Fifth Avenue, New York 10011.

## RECORDS

**SOUNDTRACKS/DC, JAZZ/PERSONALITY** — FREE NEWSLETTER! RTSA, 3700 S. Plaza Drive, Bldg F/211, Santa Ana, California 92704.

**QUADRAPHONIC RECORDS AND TAPES** - World's largest selection - all labels, over 1000 titles - at discount prices! For your free illustrated quad catalog, write: SOUND CONCEPTS, 2713 West Radan, Dept. C12 Peoria, Illinois 61604.

**SHOW ALBUMS**—Rare. Out of Print LP's. 52 page list 50c Broadway/Hollywood Recordings Georgetown, Conn. 06829. Phone (203) 544-8288.

**5,000,000 SURPLUS** Records, Tapes—100 new LP's major labels \$65.00; 60 8-track prerecorded, all major labels \$90.00; 40 prerecorded cassettes, major labels, new \$50.00; 25 open reel prerecorded, all major labels, new \$49.50. Catalogue available \$1.00 refundable with first order. Surplus Records & Tapes, Box 496, Lone Pine, Calif. 93545.

**PERFECTLY CLEAR™** ultra hi-fi record Burwen Laboratories BL-2. The East Bay City Jazz Band — Big Bear Stomp. Oriental Strut. Louis-i-an-i-a Blues My Naughty Sweeties Gives to Me. Dans Le rue d'Antibes, etc. \$10.50 each postpaid \$70.00 postpaid in lots of 10. Send check or money order Massachusetts residents add 3 sales tax Dealers wanted. Burwen Laboratories Inc. 209 Middlesex Turnpike, Burlington, Massachusetts 01803 617-273-1488.

**SOLD @ AUCTION: COLLECTORS RECORDS, LP's:** Jazz, Soundtracks, Personalities, Original Casts, Country/Western, Blues, Indicate which list from: Ray Macknic, (or) Theo's, P.D. Box 7511, Van Nuys, Calif. 91406.

**FREE 200-PAGE CATALOG.** 1,400 New Stereo Recordings. Renaissance, Baroque, Classical, Romantic, Modern Music. Not sold in stores. Not listed in Schwann's. Highest quality! Budget label prices! Available only by mail. MUSICAL HERITAGE SOCIETY, Box 932 AU, New York, N.Y. 10023.

**RECORD COLLECTORS' CONTACT GUIDE.** Dealers, magazines, societies, Handbooks and directories listed. \$3.00. Jackson, 1506 W. Barker, Peoria, Ill. 61606.

**OLDIES** — 45 RPM Original hits. Catalog 50c C&S Record Sales. Box 197, Wampsville, N.Y. 13163.

**WHILE YOU WERE LOOKING** for out-of-print records, you should've been looking for us. Discontinued, 216 N. Rose, Burbank, California 91505.

**FILM-STAGE SOUNDTRACKS.** Large free list. A. Lutsky, P.O. Box 557342, Miami, Fla. 33155.

**CATALOGS.** Broadcasts, soundtracks, Personalities of Thirties, Forties. Box 225, New York, N.Y. 10028

**COLLECTORS 45's** originals, good to mint. Send want list and SASE. Buffalo Records, P.O. Box 398, Kirkland, Ill. 60146.

**WANTED: Albums, EP's, 45's,** radio shows, transcription discs by Percy Faith; albums by Warren Barker, Clare Fischer, George Shearing, AUDIO magazines from 50's and early 60's. Bill Halvorsen, 646 Azalea Drive, Rockville, MD 20850

**Rare 78's.** State Category. Record lists, 3238 Stoddard, San Bernardino, CA 92405.

**CLASSICAL LPs** bought—sold. Junker, 705 - 5th Ave., San Francisco, Ca. 94118.

### NEW HI FI RECORD FLOATING DOWN TO COTTON TOWN

Babson College Dixieland Band - Babson Label. Recorded at Burwen Studios—Sugar Foot Stomp, Darktown Strutters Ball, Floatin Down to Cotton Town, Your Feet is Too Big, Wolverine Blues, etc.

Still Available: PERFECTLY CLEAR BL-2, THE EAST BAY CITY JAZZ BAND — Big Bear Stomp, Blues My Naughty Sweetie Gives to Me, Dan Le rue d'Antibes, etc. \$10.50 each, \$70.00 package of 10, postpaid. Massachusetts residents add 3% sales tax. BURWEN LABORATORIES, 209 Middlesex Turnpike, Burlington, Mass. 01803.

## TAPE RECORDINGS

**RENT** Open Reel or Cassette Prerecorded tape. All labels. Catalog \$1.00. Tape & Time, P.O. Box 740, Hopkins, Minn. 55343.

**EVERYTHING ON OPEN REEL!** Prerecorded classical/popular tapes. Latest releases. Dolby Quad, 96-page catalogue \$1. Barclay-Crocker, Room 857A, 11 Broadway, NYC 10004.

**AMBIPHON'S RECORDS AND TAPES** — Quad and stereo. Highest quality available anywhere! Send stamped, addressed envelope to: Amphiphon Records, Dept. A, P.O. Box 341, Kingsbridge Station, Bronx, New York 10463.

### SOMETHING NEW!

A sure cure for nostalgia.

Just out! Cassette Tapes played by "The Versatile Strings"

1. "Souvenirs of Your Old Favorites"

With unequalled acoustically pure instrumentation. A Gibson Mandola and Lyon & Healy Guitar. A beautiful sound. Twenty four (24) selections, many with a romantic Latin lilt — one hour.

2. "The Good Old Happy Sounds"

Banjo and Guitar. A moving and joyous sound. Twenty two (22) selections — one hour.

Two hours of good listening pleasure. Price: \$4.95 per Cassette ea. or \$8.95 for both. Postage paid. Send check or money order to:

Reilly Records

P.O. Box 890

Baldwin Park, CA 91706

California residents add 6% sales tax.

## SHORTWAVE

**HEAR POLICE FIRE Dispatchers.** Catalogs show receivers; exclusive directories of "confidential" channels. Send 10c stamp. Communications, Box 56AU, Commack, New York 11725.

## SITUATION WANTED

**FORMER DJ** would like to return to radio in a similar position or as a Program Director. I have a third class broadcast endorsed license, 2 years college, 2 years experience. Contact: Doug Galliher, 3907 Angol Place, Jacksonville, Florida 32210. (904) 771-7386.

## MUSICAL INSTRUMENTS

**UP TO 60% DISCOUNT.** Name brand instruments. Catalog. Freeport Music, 455R Route 110, Melville, N.Y. 11746.

**40% DISCOUNTS.** Huge Stock of Name Brand Instruments. Free Catalog. Gracin's 110 Dept. A, 606 Route 110, Huntington, N.Y. 11746.

**WHOLESALE** Musical Instruments, accessories. Allied, 573, Route 17, Paramus, N.J. 07652.

**\$300-\$1200 off** on new pianos & organs. Catalogue, Liberty Music, Box 88, E. Weymouth, Mass. 02189.

**EM synthesizer** concept-features universal compatibility, modular construction. For complete information send SASE or 25c to: **CFR ASSOCIATES**, POB F, Newton, NH 03858.

## PHOTOGRAPHY

**16mm SOUND Features, Shorts, New, Used for Sale.** Free Catalog. National Cinema, 333 W. 57th St., N.Y., N.Y. 10019.

**CASH FOR PHOTOS.** Report tells how and where. Send only \$1 for booklet 'P54' to Dayspring, 560 Lake Dr., Box 292, Owosso, MI 48867.

## TELEPHONE ANSWERING EQUIPMENT

**DICTAPHONE-ANSAFONE** — below wholesale. All brand new in original cartons. Model 520, \$200; Model 610, \$145; Model 640, \$275; Model 1700, \$825. E.B.L., (212) 377-8424 (24 Hrs.)

## SERVICES

**CONSUMERS** - We recommend components and systems and mate your needs and budget to the best performance available. Satisfaction guaranteed. Send \$3.00 to: FSC 219 E. 17th St. Bloomington, Indiana 47401.

**CUSTOM RECORDING SERVICE.** Tapes, discs, and cassettes. Stereo and mono. Live and copies. Editing. Masters and pressings. High quality at reasonable rates. Joseph Gliovanelli, Audio-Tech Laboratories, 2819 Newkirk Ave., Brooklyn, N.Y. IN9-7134.

**MASS PRODUCTION-CUSTOM REPRODUCTION** — 8-Track, cassette & Reel to Reel. We specialize in corporate meetings. Call or write T.S. Recording/c/o T.C. Shearer, 385 Ocean Blvd., Suite 5C, Long Branch, N.J. 07740, (201) 870-2952.

**COMPLETE CUSTOM RECORDING SERVICE** — Record pressing, cassette duplication — editing — location recording. Omega Audio, 25520 Graham, Detroit, Mich. 48239.

**ULTIMATE DUPLICATION** (10 up) from your program source to Maxell UD tapes & cassettes at amazingly low prices. DBX, Dolby available. Box 3065, Seattle, Washington 98114.

**THE NEW YORK AUDIO SOCIETY INC.** is a unique, non-profit, member supported hi-fi club featuring interesting monthly meetings about sound and the latest audio techniques. We invite all N.Y. area audiophiles to attend one of these sessions as our guest. Details about meetings and membership available. Write Box 5889 Grand Central P.O., N.Y.C. 10017. Call 212-722-2781.

**STEREO MASTERS, RECORDS AND ALBUMS.** Check our prices. Newest type high level cutting equipment featuring: Neumann VMS 70 Computer control lathe, Parametric Equalization, Dolby, DBX, and the new SX74 Cutting System by Neumann. Special package prices on pure vinyl album and single record production. 1000 45 RPM stereo singles \$273.00 including mastering. 100 LP albums \$436.00 including printed jackets. Write or call for brochure. A & R Record Manufacturing Corp., 902 N. Industrial Blvd., Dallas, Texas 75207. (214) 741-2027.

### SONGWRITERS

Present your songs to publishers like professionals. By mail or in person, find out the correct way. Also find out where to get the right business contacts. Write for this valuable and informative booklet. Send \$3.00 to:

#### SUNSOUND

256 S. Robertson, Dept. 1558  
Beverly Hills, Ca. 90211

**TAPE RECORDER HEADS** brought back to spec. Wear removed. Brilliant finish. \$10.00 each. One day service. E. Maher, 5 Evans Place, Orinda, Calif. 94563.

**DON'T PAY** the high mail order prices. Thieves Warehouse is coming to your area. Franchises available. Thieves Warehouse, P.O. Box 8057, Pensacola, Florida 32505.

### HIGH FIDELITY SPEAKERS REPAIRED

#### AMPRITE SPEAKERS SERVICE

655 Sixth Avenue, New York, N.Y. 10010  
212-CH3-4812

**NASHVILLE RECORD PRODUCTIONS** WILL PRESS HIGH QUALITY PURE VINYL RECORDS FROM YOUR TAPES. SEND FOR SAMPLE RECORD AND PRICE LIST. ALSO FINEST DISC MASTERING. 469 Chestnut St., NASHVILLE TENNESSEE 37210.

**CANVAS PHOTO TOTE BAG.** Your favorite color or BW picture. We'll blow it up in full color on our 12x14 canvas tote bag. Send \$2.50 for catalog and price list. Refundable with your first order. Write to: Giensova Marketing Assn., P.O. Box 4991, Washington, D.C. 20008.

**DYNACO COMPONENTS** assembled. Lowest possible prices. Guaranteed fully. Box A512-3, c Audio.

## REAL ESTATE

**ONE VACANT GARAGE** for rent—Daily rates also. W. E. Anderson, 401 - 76 Street, Brooklyn, N.Y. 11209.



## AUTO ACCESSORIES

**SANDBLASTERS** - \$39.50-\$839.50. Free Catalog, Truman, 1330A Market, Youngstown, Ohio 44507.

**CORVAIR** Parts — 1,000 Different parts. Catalog \$1.00. Clark's Corvair Parts, Shelburne Falls, MA 01370

## INSTRUCTION & EDUCATION

**DIGITAL ELECTRONICS!** Design and understand Digital Circuits. Increase technical competence. Complete and guaranteed course is highly effective. \$10.00. Free literature. DYNASIGN, Box 60AM, Wayland, Mass. 01778.

**PROFESSIONAL HI-FI COURSE**—Instructors include Len Feldman, Julian Hirsch, Larry Klein, and Larry Zide. Home study course also available. Send \$1.00 for audio primer and full information or visit HI-FI EXPO, 393 5th Ave., New York City 10016.

**FREE EDUCATIONAL ELECTRONICS CATALOG.** Edukits Workshop, Department 503FK, Hewlett, New York 11557.

## EQUIPMENT WANTED

**CASH FOR** Mint Ips & prerecorded reel tapes. Records, Box 323, Hillburn, New York 10931.

**MCINTOSH 275.** Call collect (313) 331-0453.

**NEED ACRO 300** Ultra Linear Output transformer new or good condition. Will pay fair price. Maathuis, 510 16th St., Ogden, Utah 84404.

### WE MUST HAVE YOUR USED COMPONENTS

Premium Trade or Cash for: McIntosh C22/24, MC75/225/240/275. Marantz 7C/T, 8B, 9B, 10B, J.B.L. SA-600/660, Metregon, Minigon, Hartsfield, L-101, Music & Sound Ltd., 11 1/2 Old York Rd., Willow Grove, Pa. 19090. (215) 659-9251.

**WANT TO BUY** Revox-A77 Deck, used but good condition. Will pay up to \$500. Tom Stone, 130 East 18th Street, Apt. 2-U, New York, N.Y. 10003. (212) 777-2029

**WANTED:** Reel to Reel Tape Deck, Cassette tape deck with speakers and headphones by Soundesign. Write: Hubert Woods, 162 Curry Court, Talladega, AL 35160.

**WANT SOMETHING?** Place a FREE WANT AD in AUDIOMART today! SUBSCRIBE! \$4/12 Box 821, Stratford, Connecticut 06497

**NEED ACRO TO-330** output transformer. State condition and price. Chris Hood, 11 E. Prospect Ave., Pittsburgh, Pa. 15205.

**PANASONIC CALCUTTA** Portable Stereo Phonograph with FM/AM Radio. Stereo eye and stereo muting. Model No. SG-650. 6 1/2" PM speakers. L. Oakes, Beaven Kelly Home, Holyoke, Mass. 01040.

### CANADIANS!

Looking for Quad ES speakers (2), also McIntosh MPI-3. Reply, stating price, condition and serial numbers to Phillips, 1 Welland St. N., Thorold, Ontario, Canada L2V 2B8.

**RECORDS WANTED** — LP's—"Odessa" & "Cucumber Castle" by the Bee Gees. Near new condition. Wm. J. Riese, 3429 S. Nucla Way, Aurora, Colo. 80013.

**SOUNDCRAFTSMEN** preamp or SAE preamp and/or Soundcraftsmen equalizer. 7302 Forest Rd., No. 304, Landover, Md. 20785.

**WANTED: MCINTOSH 75** mono amplifier. Melvin Robinson, 214 W. 15th St., Cincinnati, Ohio 45210.

**WANTED: HARMON KARDON** Citation A preamp. Also need volume control for Citation A. J. P. Sammut, 432 Chestnut Ave., San Bruno, Calif. 94066.

**Wanted: Surplus merchandise** and components. Sheldon Richman, buyer, Richman Sales Co., 3321 Columbia, Lincolnwood, Ill. 60645 (312) 679-4851.

## EQUIPMENT WANTED

**TOP PRICES PAID** for all Lionel trains, any condition. Call today. (212) 833-8920.

**WANTED—"LUX" OR "LUXMAN"** tube stereo power amplifier and tube stereo preamplifier. Any reasonable price or condition. Please contact immediately Box 1159, New Rochelle, N.Y. 10805.

## TAPE & TAPE RECORDERS

**SCOTCH RECORDING TAPE,** lowest prices TAPE CENTER Box 4305B, Washington, O.C. 20012.

**SCOTCH, CAPITOL.** Blank cassettes, cartridges, reels. Discount prices. Lawson's, Box 510, Livermore, CA 94550

**SCOTCH AND MAXELL TAPE DISCOUNTED.** Write and Save. N.A.B. Audio, Box 7, Ottawa, IL 61350

**RECORDING TAPE:** Custom Loaded, 8 track, reel, cassette. Prices on request. DICK WALLEN, 4226 Robert St., Red Wing, Minn. 55066

**TDK, BASF, Memorex, Maxell,** cassettes, reels, 8-tracks. Lowest Prices. Guaranteed, New. S&S Audio P.O. Box 56039 Harwood Heights, IL 60656

## HIGH FIDELITY

**DYNAKITS, IAD,** lowest prices, Underground HI-FI Sales, 324 Broadwater Road, Arnold, Md. 21012. (301) 647-0919.

### NOW AVAILABLE

**FAMOUS REFLECTING SYSTEM'S 4 1/2" REPLACEMENT DRIVERS, \$7.98 POSTPAID. BIG QUANTITY DISCOUNTS, FREE SPECIFICATIONS, AURATONE, BOX 580-26, DEL MAR, CALIFORNIA 92014.**

## BUSINESS OPPORTUNITIES

**BUSINESS INVESTIGATOR DISCLOSES** jealously guarded mail order trade secrets. Helps beginners make \$600.00 weekly. Giant free report! Futurionics, 1311 Berkshire, Austin, Texas 78723.

**\$500/1000** stuffing envelopes. Nothing to buy or sell. Circulars supplied free! Rush stamped addressed envelope to: K. Heinrich, Box 123-SAJ, Hayes Center, NB. 69032.

**\$100 WEEKLY POSSIBLE** — Stuffing, mailing circulars for advertisers. Home - spare time. Information — Send stamped envelope. Opportunities, Box 721 - AD, Lynbrook, N.Y. 11563.

**DO SIMPLE ADDRESSING** — Mailing. Keep \$8.00 profit. Receive \$12.95 orders. Details — Rush stamped envelope. Distributors, Box 9 — AD, East Rockaway, N.Y. 11518

**EARN \$100.00 NIGHTLY** PLAYING RECORDS. DISCOTHEQUES ARE IN. COMPLETE DETAILS. DOS, DONT'S, PHOTOS, DESCRIPTIONS, ETC. SEND \$5.00 TO "DYNAMIC UNO," P.O. Box 8116, CORPUS CHRISTI, TEXAS 78412.

**UNIQUE COLLECTION TECHNIQUE** for business with past-due accounts. Rush \$1 for free guide. Raymond Fry, 1702 S. Palm, Ontario, CA. 91761.

**Business loans;** 20 sources \$2.00. N&N, Box 3483-A Temple, Texas 76501.

**\$25.00 DAILY POSSIBLE:** Addressing—stuffing envelopes. Typing/longhand. Details—Rush stamped envelope. Elite, Box 715—AD, Lynbrook, N.Y. 11563.

**CANADIAN DEALER** looking for American or British trade connections willing to work on cost plus basis (for cash quantity purchase) on closeouts and regular stock. Interested JBL, Thorens, Shure, BASF, TDK, Scotch, Watts, Marantz, etc. Replies held confidential. Electronic Shoppers World, 278 Havelock, Toronto, M6H 3B9.

## GOVT. SURPLUS

**MANUALS for Gov't. Surplus** Radios, Test Sets, Scopes. List 50c Books, 7218 Roanne Drive, Washington, D.C. 20021.

## HELP WANTED

**AUDIO IS EXPANDING** its editorial staff and is seeking knowledgeable audiophile with editing and writing experience. Must be good writer and have magazine production experience. Position is in head office in Philadelphia. Send resume with salary requirements, in confidence, to Frank Nemeyer, North American Publishing, 401 No. Broad St., Philadelphia, Pa. 19107.

**MALE/FEMALE** experienced—stock boy/delivery clerk. Apply in person or call 212-SH. 8-8920.

**AUDIO ENGINEER** — BS or equivalent. Experienced in design of solid state professional broadcast and recording systems. Ability to work with customers. Opportunity for advancement in growing company. Send resume, including salary requirements to Robins/Fairchild, 75 Austin Blvd., Com-mack, N.Y. 11725.

## COMMUNICATION EQUIPMENT

**CB — MARINE — SCANNERS — HAM** Buy Below Wholesale. Save up to 50%. Buy Direct From Factory Warehouse. Guaranteed Lowest Prices Anywhere. Catalog \$1.00: WHITLOCK INTERNATIONAL, P.O. Box 131, Wayne, Michigan 48184

## PLANS & KITS

**CONSTRUCT YOUR OWN** speaker enclosure. Send \$2.00 for drawing to: Creightney Sounds, 140-25 169th Street, Jamaica, N.Y. 11434.

### TOUCHING MACHINE

Listen to music through your skin with the amazing patented Sonic Stimulator. Feel a concert of pleasure anywhere it touches you. Send for free literature.

#### AUDITAC

1940 Washington  
San Francisco 94109  
(415) 775-7061

# HELP!

Anytime you have a question about your Audio subscription, please include a mailing label to insure prompt service on your inquiry.

## CHANGE OF ADDRESS

If you're about to move, please let us know approximately four weeks before the move comes about. Or, if there is anything wrong with your current mailing label, please let us know on this form also. Simply affix your present label here, and carefully print the updated information below.

AFFIX LABEL HERE

## PLEASE HELP US TO SERVE YOU BETTER

AUDIO MAGAZINE  
401 N. Broad Street • Phila., Pa. 19108

Name \_\_\_\_\_ (Please Print)  
Company \_\_\_\_\_  
Address \_\_\_\_\_  
City \_\_\_\_\_ State \_\_\_\_\_ Zip \_\_\_\_\_

Continued from page 107

out of the violas and celli in the Walker piece.

The second album is unabashedly contemporary in sound and method. Olly Wilson's *Akwan* (1974) uses a Fender-Rhodes electric piano and amplified strings, though it is not technically an electronic composition. Nevertheless, the interplay among the trombones near the beginning, the manner in which percussion and the Fender-Rhodes are employed, and the overall abstraction of the piece give it a distinct electronic-music flavor (particularly of the tape-with-orchestra variety). Wilson uses novel voicings (especially in the brass), displays a highly developed consciousness of rhythm/arhythm, and has a masterful sense of timing which allows him to extend an idea until just before the moment monotony would set it. *Akwan* is, to my ears, a major work, one which will be heard and discussed often in the future.

T. J. Anderson's *Squares* (1965) involves such things as symmetries of fragmented phrases, overlapping tone-color "platforms," and the like. What would seem on paper a disjointed collection of disparate ideas, sounds quite unified, thanks to the ingenuity of Anderson's systems of grouping. Though it is an atonal, essentially themeless work, it is no doubt the kind of indisputably contemporary composition that will nonetheless appeal to musical conservatives, if only because the pieces fit together into such a neat, accessible bundle.

Talib Rasul Hakim may be an unfamiliar name because the composer first attracted attention as Stephen Chambers. *Visions of Ishwara* (1970) is an esoteric and stately work, which begins and ends with an exotic alto flute line over a ceremonial-procesional bass drum pulse. The trombone, tuba, and percussion parts are seemingly derived from Tibetan ritual music, with the rest of the orchestra arranged so that each group of instruments seems to seek its own level at random. The effect is not unlike a Sun Ra improvised ensemble, translated into orchestral-block terms. *Visions* is a very impressive composition, which should help the composer retain his reputation under his new name.

It's always difficult to judge the performance of a new and complex composition without access to the score (and sometimes even with the score), but all three works seem to have received tour-de-force realizations by Freeman and Richard Bunker, soloist on *Akwan*.  
Tom Bingham  
Sound: A Performance: A

# Annual Index

## Subject Index

### AM Radio

*Quality AM Radio*, George McKay, Jan., 28.

### Amplifiers

*Bi-Amplification*, John M. Lovda and Stephen Muchow, Sept., 20.

*Power FETs*, Bascom H. King, Feb., 42.

*Transient IM Distortion*, W. Marshall Leach, Feb., 34.

*Cassette Decks: How Well Do They Stack Up*, George W. Tillett, Sept., 38.

*Christmas Buying Guide*, Nov., 54.

### Construction Articles

*Build an Audio Generator*, M. J. Salvati, Oct., 22.

*Build A Dynamic Noise Suppressor*, Maxwell S. Strange, June, 34.

*Crossword Puzzle*, Aug., 38.

*dBs Made Simple*, Herman Burstein, Jan., 36

### Directories

*Annual Product Directory*, October.

*Addenda*, December, 77.

*Directory of Manufacturers*, Oct., 30

Amplifiers, 36; Cassette and Cartridge Tape Decks, 72; Equalizers, 105; Headphones, 102; Loudspeaker Systems, 76; Microphones, 106; Multi-Play Turntables, 58; Open-Reel Tape Decks, 68; Phono Cartridges, 64; Preamplifiers, 44; Receivers, 52; Single-Play Turntables and Tonearms, 60; Tuners, 48.

*Car Speakers Directory*, July, 18.

*Car Stereo Radio/Tape Player Directory*, July, 13.

*Car Stereo Radio/Tape Player Manufacturers*, July, 12.

### Equipment Profiles

Ace Audio ZDP Preamplifier, April, 60.

ADS 2001 Car Speaker System, July, 36.

AKAI GX-400D-SS Open-Reel Tape Deck, Feb., 56.

Avid 102 Speaker System, Sept., 62.

Becker Mexico Car Radio, July, 25.

B&O BE-2200 Cassette Deck, Aug., 67.

BGW 500D Basic Amplifier, Dec., 76.

C/M Laboratories, RR-805 Receiver, June, 54.

Craig 3139 Car Radio, July, 25; addenda, Oct., 20.

Crown VFX/2 Crossover/Filter, Dec., 69.

Dynaco 400 Basic Amplifier, May, 46.

ELAC 760 Automatic Turntable, Aug., 62.

Elekt-O-Fonie FU-100 Receiver, Apr., 54.

EPI One Basic Amplifier, Nov., 66.

Ferrograph Super Seven Open-Reel Tape Deck, Mar., 42.

Fisher ST-425 Speaker System, Jan., 48.

GAS Ampzilla Basic Amplifier, Sept., 57.

Heath AR-2020 Receiver, June, 48.

Hitachi HS-300 Speaker System, Mar., 46.

J.I.L. 605 Car Radio, July, 26.

JVC 4VR-5426X Receiver, Aug., 47.

Kenonic C-200 Control Amplifier, P-300 Basic Amplifier, Mar., 49.

Kenwood KP-5022 Turntable, Sept., 65.

Kenwood KX-710 Cassette Deck, Apr., 65.

Koss HV/1A Headphones, Dec., 68.

Marantz 125 Tuner, Feb., 54.

Nakamichi 500 Cassette Deck, Nov., 62.

Nakamichi Large Reference Monitor Speaker System, Dec., 72.

Panasonic CQ-999 Car Radio, July, 28.

Phase Linear 4000 Preamplifier, Nov., 58.

Philips RH-532 Speaker System, Apr., 67.

Pickering XUV/4500Q Phono Cartridge, Nov., 71.

Pioneer KP-301 Car Radio, July, 30.

Pioneer CT-F7171 Cassette Deck, Nov., 72.

Polk Nine Speaker System, May, 36.

Radio Shack STA-225 Receiver, Dec., 46.

SAE Mk IIICM Basic Amplifier, Jan., 61; Addendum, Aug., 69.

Sansui 881 Receiver, Apr., 55.

Scott R77S Receiver, May, 32.

Sharp RT-480U Cassette Recorder Addendum, Jan., 65.

Sherwood 7210 Receiver, July, 34.

Shure M-64 Preamplifier, Feb., 61.

Sony TC-755 Open-Reel Tape Deck, Sept., 67.

Soundcraftsmen PE-2217 Equalizer, Mar., 36.

Supex SD-900/E Phono Cartridge, Sept., 60.



Sylvania AS-210A Speaker System, Aug., 63.  
 Technics by Panasonic RS-676 Cassette Deck, May, 72.  
 Technics by Panasonic T-400 Speaker System, Dec., 54.  
 Technics by Panasonic SA-8500X Receiver, Mar., 31.  
 Wollensak 8080 8-track Cartridge Deck, Aug., 52.  
 Yamaha B-1 Basic Amplifier, Aug., 56.  
 Yamaha CR-1000 Receiver, Jan., 54.  
 Yamaha CT-7000 Tuner, Dec., 64.  
 Yamaha YP-701 Automatic Turntable, June, 52.

### FTC Ruling On Amplifiers

*FTC Wattage Ratings: An Optimistic View*, Brian Wachner, Feb., 22.  
*FTC Wattage Ratings: An Alternative View*, Robert Tucker, Feb., 30.  
*How Valid is the FTC Preconditioning Rule?*, Joseph DeMarinis, Sept., 30.

### Headphones

*Dual Impedance Headphone Circuit*, D. A. Kerr, May, 24.  
*Piezoelectric Principle in Headphones*, Martin Clifford, May, 28.

*Language of High Fidelity, Part XIII*, Martin Clifford, Dec., 38.

*Miking With The Three-Point System*, Dec., 28.

### Quadraphony

*What Do You Really Hear in Quadraphony?*, Daniel Shanefield, Nov., 44.  
*Up-Date: Musings on the Four-Channel Scene*, George W. Tillett, Nov., 36.

*Record Cleaners—Do They Really Work?* B. V. Pisha, Mar., 20.

### Loudspeaker Systems

*Earthquake Sound System*, C. J. Czerwinski and G. R. Lewis, Apr., 46.  
*Motional Feedback in Loudspeaker Systems*, George W. Tillett, Aug., 40.  
*Speaker Tests*, Richard C. Heyser; *Polar Response*, May, 30; *Room Test*, Jan., 66.  
*A. N. Thiele—Sage of Vented Speakers*, Ray J. Newman, Aug., 30.

*Recording at Home Through the Years*, George Blacker, Apr., 28.

*Sun Ra, The Many Worlds of*, Tom Bingham, Mar., 56.

*Syn-Aud-Con—Audio Toolmaker*, Carolyn P. Davis, Sept., 54.

*Making Tape*, Joseph Kempler, Apr., 38.

*Basics of Turntables*, David L. Josephson, June, 26.

*Adoption of the Westrex 45/45 System*, Ralph W. Wight, Mar., 24.

## Author Index

**Bingham, Tom**, *The Many Worlds of Sun Ra*, March, 56.  
**Blacker, George**, *Home Recording Through the Years*, April, 28.  
**Burstein, Herman**, *dBs Made Simple*, Jan., 36.  
**Clifford, Martin**, *Language of High Fidelity*, Dec., 38; *Piezoelectric Principle in Headphones*, May, 28.  
**Czerwinski, C. J. and G. R. Lewis**, *Earthquake Sound System*, April, 46.  
**Davis, Carolyn P.**, *Syn-Aud-Con: Audio Toolmaker*, Sept., 54.  
**DeMarinis, Joseph**, *How Valid is the FTC Preconditioning Rule?*, Sept., 30.  
**Feldman, Leonard**, *Five Car Radios Tested*, July, 24.  
**Heyser, Richard C.**, *Speaker Tests—Polar Response*, May, 30; *Room Tests*, Jan., 66.  
**Josephson, David L.**, *Basics of Turntables*, June, 26.  
**Kempler, Joseph**, *Making Tape*, April, 38.  
**Kerr, D. A.**, *Dual Impedance Headphone Circuit*, May, 24.  
**King, Bascom H.**, *Power FETs*, Feb., 34.  
**Leach, W. Marshall**, *Transient IM Distortion*, Feb., 34.  
**Lewis, G. R., and C. J. Czerwinski**, *Earthquake Sound System*, April, 46.  
**Lovda, John M. and Stephen Muchow**, *Bi-Amplification*, Sept., 20.  
**McKay, George**, *Quality AM Radio*, Jan., 28.  
**Muchow, Stephen, and John M. Lovda**, *Bi-Amplification*, Sept., 20.  
**Newman, Ray J., A. N. Thiele—Sage of Vented Speakers**, Aug., 30.  
**Pisha, B. V.**, *Record Cleaners—Do They Really Work?*, March, 20.  
**Salvati, M. J.**, *Build an Audio Generator*, Oct., 22.  
**Strange, Maxwell G.**, *Build a Dynamic Noise Suppressor*, June, 34.  
**Tillet, George W.**, *Cassette Decks, How Well Do They Stack Up?*, Sept., 38; *Motional Feedback in Loudspeakers*, Aug., 40; *Up-Date: Musings on the Four Channel Scene*, Nov., 36.  
**Tucker, Robert**, *FTC Wattage Ratings: An Alternative View*, Feb., 30.  
**Wachner, Brian**, *FTC Wattage Ratings: An Optimistic View*, Feb., 22.  
**Wight, Ralph W.**, *Adoption of the Westrex 45/45 System*, March, 24.

STATEMENT OF OWNERSHIP, MANAGEMENT AND CIRCULATION, Act of August 12, 1970; Section 3685, Title 39, United States Code.

1. Date of Filing, September 15, 1975. 2. Title of Publication, AUDIO; 3. Frequency of Issue, Monthly; 4. Location of Known Office of Publication, 134 N. 13th Street, Philadelphia, Penna. 19107; 5. Location of the Headquarters or General Business Offices of The Publishers, 134 N. 13th Street, Philadelphia, Penna. 19107.

6. Names and Addresses of Publisher, Editor, and Managing Editor: Publisher, Jay L. Butler, 134 N. 13th Street, Philadelphia, Penna. 19107; Editor, Eugene Pitts III, 134 N. 13th Street, Philadelphia, Penna. 19107; Managing Editor, none.

7. Owner, North American Publishing Company, 134 N. 13th Street, Philadelphia, Penna. 19107. I. J. Borowsky, 134 N. 13th Street, Philadelphia, Penna. 19107.

8. Known Bondholders, Mortgagees, and Other Security Holders Owning or Holding 1 Percent or More of Total Amount of Bonds, Mortgages or Other Securities: None.

9. Paragraphs 7 and 8 include, in cases where the stockholder or security holder appears upon the books of the company as trustee or in any other fiduciary relation, the name of the person or corporation for whom such trustee is acting, also the statements in the two paragraphs show the affiant's full knowledge and belief as to the circumstances and conditions under which stockholders and security holders who do not appear upon the books of the company as trustees, hold stock and securities in a capacity other than that of a bona-fide owner. Names and addresses of individuals who are stockholders of a corporation which itself is a stockholder or holder of bonds, mortgages, or other securities of the publishing corporation have been included in paragraphs 7 and 8 when the interests of such individuals are equivalent to 1 percent or more of the total amount of the stock or securities of the publishing corporation.

10. This item must be completed for all publications except those which do not carry advertising other than the publisher's own and which are named in Sections 132,231, 132,232 and 132,233. Postal Manual (Sections 4355a, 4355b, and 4356 of Title 39, United States Code).

	Average no. copies each issue during preceding 12 months	Single issue nearest to filing date
A. Total no. copies printed (Net Press Run)	123,570	125,025
B. Paid circulation		
1. Sales through dealers and carriers, street vendors and counter sales	24,444	23,539
2. Mail Subscriptions	77,521	79,418
C. Total paid circulation	101,965	102,957
D. Free Distribution by Mail, Carrier or other means		
1. Samples, complimentary, and other free copies	4,828	5,597
E. Total distribution (Sum of C and D)	106,793	108,554
F. 1. Office use, left-over unaccounted, spoiled after printing	1,009	1,071
2. Copies distributed to news after printing	15,768	15,400
G. Total (Sum of E and F—should equal net press run shown in A)	123,570	125,025

I certify that the statements made by me above are correct and complete.

JAY L. BUTLER, Publisher

# "The Marantz 1070 integrated amp is close to optimum in performance and the low price makes it an even better value."



## The 1070 Stereo Amp

"As far as good basic features are concerned, it's comparable to units costing twice as much."

"It maintains all the features of the Marantz 1060, plus it adds a number of features of its own. For instance, it now has graphic slide-type tone controls, two tape monitors and a versatile mode selector switch"

"With the 1070 you have a full range of tone controls like bass, mid range and treble slide controls plus preamp out and main in jacks"

"I feel strongly about the preamp out jacks. You can re-equalize tape recordings, insert equalizers or even add electronic cross-overs into the chain"

"One major feature that I like in the 1070 is its ambience circuitry. Essentially it's a speaker matrix or pseudo 4-channel. This means you can get into simulated 4-channel sound by just adding a second pair of speakers"

"In addition to the step up in power to 35 watts minimum continuous power per channel with no more than 0.3% total harmonic distortion, 20 Hz to 20 kHz both channels driven into an 8 ohm load, the circuitry is direct coupled"

In December, 1974, sound engineers and audiophiles were invited to examine and discuss the new Marantz Stereo Console Amplifiers featuring models 1040 and 1070 and the new Marantz 112 AM/FM Stereo Tuner. The following comments were taken from that taped discussion.

"The circuitry is now full-complementary direct coupled to the speaker terminals. As a result, the damping factor is much improved at low frequencies where it counts"

"The output circuitry now includes a speaker protection relay circuit and turn on delay"

"There's improved thermal stability. This buys long term reliability as well as improved performance"

## The 1040 Stereo Amp

"The new 1040 integrated amp is rated at 20 watts minimum continuous power per channel with no more than 0.3% total harmonic distortion, 20 Hz to 20 kHz, both channels driven into an 8 ohm load"

"It also has the ambience circuitry for simulated 4-channel. Most all of the features of the 1070 are on the 1040"

"It's an excellent performance component for a modest price"

## The 112 Tuner

"It's got phase lock loop, a Dolby<sup>®</sup>\* de-emphasis switch and a number of other high-performance features. There're no gimmicks in it. Every feature is practical"

"A complete system including the 112 tuner plus either the 1070 integrated amp or the 1040 integrated amp gives performance you couldn't get in most receivers and still costs less than \$500"

The Marantz 1070 Amp, 1040 Amp and 112 Tuner are just part of the exciting new Marantz component line starting as low as \$199.95. Each of them reflects the kind of technical expertise and engineering excellence that has made Marantz the choice of professionals world-wide. Stop by your local dealer and see the entire Marantz line. Or send for a free catalog.

Marantz. Ask an expert.



\*Dolby System under license from Dolby Laboratories, Inc. ©1975 Marantz Co., Inc., a subsidiary of Superscope, Inc., 8150 Vineland Ave., Sun Valley, CA 91352. In Europe: Superscope Europe, S.A., Brussels, Belgium. In Canada: Superscope Canada, Ltd., Ontario. In the Far East: Marantz Far East, Tokyo, Japan. Prices and models subject to change without notice. Consult the Yellow Pages for your nearest Marantz dealer.



# Only Technics gives you the world's most precise drive system, any way you want it.

Direct-drive precision. Now you can have it any way you want it. Because Technics uses direct drive in more kinds of turntables than anyone else. You can get it for under \$200 in the SL-1500. One of four manuals. Or for about \$500 you can have our professional turntable, the SP-10. There's a fully automatic single play model, the SL-1300. And the world's first direct-drive changer, the SL-1350.

And all these turntables share the Technics direct-drive system. A system so superior that FM stations have been using our direct-drive turntables for years. Here's why. In our direct-drive system, the platter is an extension of the motor shaft. There are no belts or idlers to produce variations in speed. So all our turntables have less than 0.03% wow and flutter (WRMS) (0.04% for the SL-1350).



**Direct Drive System**

You won't hear any rumble either. Because we use an electronically controlled DC motor that spins at exactly 33 or 45 rpm. And, unlike rumble-producing high-speed motors, our motor introduces so little vibration into the system that any rumble remains inaudible (-70dB DIN B).

And every Technics direct-drive turntable has variable pitch controls. A built-in stroboscope. And CD-4 phono cables. And for those that include a tone arm you also get viscous damped cueing. Anti-skating. Feedback insulated legs. Even a dust cover and an integral base.

But we don't have to tell you how good these turntables are. Read some of the reviews\*. And see for yourself.

The concept is simple. The execution is precise. The performance is outstanding. The name is Technics.

\*SP-10 - Audio, 8/71; Stereo Review, 9/71; Audio, 10/73. 3/74.  
SL-1100A - Stereo Review, 7/73; High Fidelity, 9/73.  
SL-1200 - Radio Electronics, 7/74; Audio, 7/74; Stereo, Fall '74.  
SL-1300 - FM Guide, 9/74; Stereo Review, 2/75.

FOR YOUR TECHNICS DEALER, CALL TOLL FREE 800 447-4700  
IN ILLINOIS, 800 322-4400.

## Technics

by Panasonic



Check No. 52 on Reader Service Card