

Scenes:
AES Convention

Audio

THE AUTHORITATIVE MAGAZINE ABOUT HIGH FIDELITY • AUGUST 1975

75¢

47425



U0803760 0476 30725005P0101212
DON L HUNTER
2608 CENTRAL BLVD.
EUGENE OR 97403

Thiele-
Vented Speakers

Motional Feedback in Speakers



Best of each

4-track units. With three motors and three heads, it has virtually every professional feature you'd want. Yet it's extremely simple to use. In addition to stereo record/playback, it also highlights 4-channel playback. The RT-1020H (15, 7½ ips) is the high speed counterpart of the RT-1020L. While the RT-1011L shares most of the features of the RT-1020 series, it does not include 4-channel playback. The complete extent of their capabilities becomes apparent only after you've worked with them. Then you'll recognize the magnitude of Pioneer's accomplishment.

The RT-1050 is a 2-track, 2-speed (15, 7½ ips) 3-head deck which, like all all Pioneer models, can handle professional 10½-inch tape reels. Its unique combination of bias and equalization switching controls give 12 different settings to optimize the performance of any tape on the market.

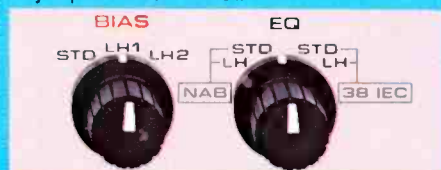

12 Bias & Equalization settings optimize performance.

The RT-1050's 3-motor transport system is activated electronically by full logic, solid state circuitry, triggered by feather touch pushbutton controls. Its transport is completely jam- and spill-proof, permitting you to switch from Fast Forward to Fast Rewind, bypassing the Stop button.

The RT-1050 was specifically designed for easy operation with a wide combination of professional features like extended linearity VU meters with adjustable sensitivity, mic/line mixing, pushbutton speed selection and reel tension adjustment buttons. There's also an exclusively designed pause control, and independent control of left and right recording tracks.

The same 2-track recording system studios use for better signal-to-noise ratios and higher dynamic range is incorporated into the RT-1050. Yet it can be easily converted to 4-track use with an optional plug-in head assembly. Everything considered, it's the most versatile open-reel deck you can buy. Professionals prefer it for its studio-quality performance. Everyone appreciates its completely simple operation.

Pioneer open-reel and cassette decks are built with the same outstanding quality, precision and performance of all Pioneer high fidelity components. That's why, whichever you choose, you know it's completely professional and indisputably the finest value ever in a studio-quality tape deck.

U.S. Pioneer Electronics Corp.,
75 Oxford Drive, Moonachie,
New Jersey 07074.

West: 13300 S. Estrella, Los Angeles
90248 / Midwest: 1500 Greenleaf, Elk
Grove Village, Ill. 60007/ Canada:
S. H. Parker Co.

PIONEER
when you want something better

Pick The Cassette Features You Need

Model	Dolby	Memory Rewind	Frequency Response (Chrome tape)	Peak Indicator	Level Limiter	S/N (with Dolby)	Wow & Flutter (%-WRMS)	Price ‡
CT-9191*	Yes	Yes**	20-17kHz	Yes	Yes	62dB	0.07	\$449.95
CT-7171*	Yes	Yes	30-16kHz	Yes	Yes	58dB	0.10	\$369.95
CT-6161*†	Yes	Yes	30-16kHz	No	No	58dB	0.12	\$299.95
CT-5151	Yes	Yes	30-16kHz	Yes	Yes	58dB	0.12	\$269.95
CT-4141A	Yes	No	30-15kHz	No	No	58dB	0.13	\$239.95
CT-2121*	Yes	No	30-16kHz	No	No	58dB	0.12	\$199.95††

* Front loading

†† Less cabinet

** Plus Rec/Play auto start

† Not shown

Pick The Open-Reel Features You Need

Model	Speeds (ips)	Frequency Response (± 3dB)	Tape Bias/Equalization Positions	Wow & Flutter (% at highest speed)	S/N	Mic/Line Mixing	4-Ch. Play	Price ‡
RT-1050	15, 7½	30-22kHz	3/4	0.06	57dB	Yes	No	\$699.95
RT-1020H†	15, 7½	30-22kHz	3/2	0.06	55dB	Yes	Yes	\$649.95
RT-1020L	7½, 3¾	40-20kHz	3/2	0.10	55dB	Yes	Yes	\$649.95
RT-1011L	7½, 3¾	40-20kHz	2/2	0.10	55dB	Yes	No	\$599.95

† Not shown

‡ Dolby is a trademark of Dolby Labs., Inc.

‡ Prices listed above are manufacturer's suggested resale prices only. Actual resale prices will be set by the individual Pioneer dealer at his own option.



RT-1050



CT-7171



Bringing you the best is up to us.

High fidelity is important to us at Pioneer. It's all we do and it's all we care about. We are excited that cassette tape decks have reached a level of performance that meet the highest standards. We are excited because we know that it means more enjoyment for you from your high fidelity system. We also know that you can now get more versatility and value out of your high fidelity system than ever before.

The great advances in cassette technology have had impact on the reel-to-reel tape deck concept as well. We believe that the era of the small, inexpensive 7-inch reel tape deck is past. Neither its convenience nor its performance make it a good value compared to the new cassette technology. And it is now possible for Pioneer to offer you a professional, studio-quality 10½-inch reel deck at prices that compare favorably with what you might expect from old fashioned 7-inch reel units. In our judgment the old ideas must move aside for the new ideas. And Pioneer has some very intelligent new ideas in tape for you.

The convenience of cassette.

The performance of open-reel.

The new CT-9191, with built-in Dolby[®] establishes a new and incomparable level for cassette deck performance and features. Designed with up-front controls and cassette loading, you can stack other components above it or under it.

Performance features stack up, too.

Bias and equalization switches insure optimum recording and playback for every type of cassette tape made. There's even automatic bias/equalization switching when the new type CrO₂ cassette, equipped with the special identifying notch, is inserted. A front panel indicator light signals this automatic operation.



Simple vertical cassette insertion visible at all times.

Distortion- and interference-free recordings are consistently produced, thanks to a combination of wide-scale range VU level meters (-40dB to +5dB), an LED peak level indicator light, a selectable level limiter circuit, and an FM multiplex filter switch.

Locating a desired program point in a cassette is simple with the new CT-9191. A specially designed memory rewind switch (including record/play automatic re-start) and 3-digit tape counter, make precision cueing a breeze.

Operation is further simplified with automatic tape-end stop, dual concentric rotary mic and line input controls — for mic and line mixing — and separate rotary output level controls, all with adjustable

memory index markers. In addition, there are soft-touch solenoid operated transport controls. This combination makes the 9191 the recording studio that fits on a shelf.

Two independent drive motors, plus solid ferrite record/playback heads combine to provide a new low in wow and flutter (0.07% WRMS) and a new high in

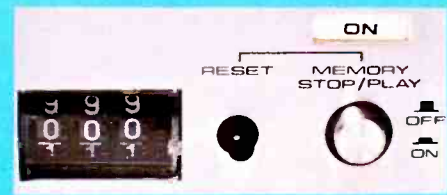

Memory rewind with record/play automatic re-start.

frequency response (20 to 17,000 Hz; CrO₂ tape).

Whether you choose the ultra sophistication of the CT-9191 or Pioneer's other front loaders — CT-7171, CT-6161, CT-2121, or the top loading CT-5151 and CT-4141A, which snare many of its features, you're assured optimum performance and maximum value in their respective price ranges. One tradition that never changes at Pioneer.

Open-reel. A professional recording studio in your home.

Professionalism comes with all four studio-quality open-reel models. The RT-1020L (7½, 3¾ ips) is unequalled in



CT-9191



**Whether you
use a
cassette or
open reel deck
is up to you.**





RT-1020L



RT-1011L



CT-2121



CT-5151



CT-4141A

RESIDUE PROOF

Every record cleaner claims to remove dirt. But you never read about what stays behind. This omission may be more than just oversight. See for yourself.

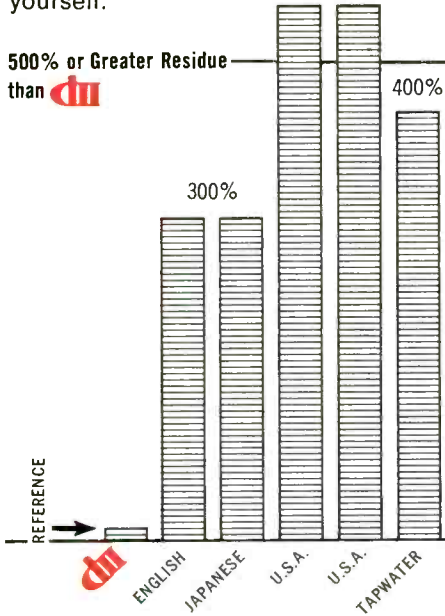

Actual dry weight measurements of best selling record cleaners.

But this is just half our story. Only discwasher's directional pile brush (Pat. Pending) lifts fluid and residue off the record by capillary action.

So things aren't left to air dry.

Discwasher—the superior record cleaner is at Audio Specialists world wide.



Discwasher Inc.

909 University, Columbia, Mo. 65201

Audio

August, 1975

"Successor to **RADIO** Est. 1917"

Vol. 60, No. 7

Feature Articles

- 30 A.N. Thiele: Sage of Vented Speakers/Ray J. Newman
- 38 Audio Crossword
- 40 Motional Feedback in Loudspeakers/George W. Tillet

Equipment Profiles

- 47 JVC 4VR-542X Receiver
- 52 Wollensak 8080 Cassette Deck
- 56 Yamaha B-1 Power Amplifier, UC-1 Control Unit
- 62 ELAC 760 Automatic Turntable
- 63 Sylvania AS-210A Speaker System
- 67 Bang & Olufsen BE-220 Cassette Deck
- 69 Addendum: SAE MK-IIICM Amplifier

Record & Tape Reviews

- 70 The Column/Fred DeVan
- 80 Canby's Capsules/Edward Tatnall Canby
- 82 Classical Reviews/Edward Tatnall Canby
- 87 Jazz & Blues
- 93 Tape & Turntable/Bert Whyte
- 94 Theater Music/Donald M. Spoto

Audio in General

- 6 Audioclinic/Joseph Giovanelli
- 10 Tape Guide/Herman Burstein
- 14 Audio ETC/Edward Tatnall Canby
- 16 Behind the Scenes/Bert Whyte
- 20 What's New in Audio
- 22 Dear Editor:
- 74 Advertising Index
- 95 Classified Advertising

EDITOR Eugene Pitts III
ASSOCIATE EDITOR Edward Tatnall Canby
ASSOCIATE EDITOR Bert Whyte
ASSISTANT EDITOR Charles Graham

PUBLISHER Jay L. Butler
MARKETING DIRECTOR Sanford L. Cahn
DESIGN Janet Lee
CIRCULATION MANAGER Jean Davis

ADVERTISING PRODUCTION Evelena Brown

Contributing Editors: Herman Burstein, Martin Clifford, Fred De Van, Leonard Feldman, Martha Sanders Gilmore, Joseph Giovanelli, Richard C. Heyser, Bascom H. King, C.G. McProud, B.V. Pisha, Donald M. Spoto, George W. Tillet.

AUDIO (title registered U.S. Pat. Off.) is published monthly by North American Publishing Co., Irvin J. Borowsky, President; Frank Nemeyer, and Jay L. Butler, Vice Presidents; R. Kenneth Baxter, Vice President/Production: Nate Rosenblatt, Promotion Director; Mary Claffey, Circulation Director.

RATES—United States only: 1 year for \$7.00, 2 years for \$12.00, 3 years for \$17.00; outside the U.S.: 1 year for \$9.00, 2 years for \$16.00, and 3 years for \$23.00. Printed in U.S.A. at Columbus, Ohio. All rights reserved. Entire contents copyrighted 1975 by North American Publishing Co. Second class postage paid at Philadelphia, Pa. and additional mailing office. Back issues, \$2.00 each. World Library Congress number: ISSN 0004-752X. Dewey Decimal number: 621.381 or 778.5.

REGIONAL SALES OFFICES: Jay L. Butler, Publisher and Sanford L. Cahn, Marketing Director, 41 East 42nd St., New York, N.Y. 10017, telephone (212) 687-8924.

Jay Martin, 2525 West 8th St., Los Angeles, California, 90057, telephone (213) 385-2917.

REPRESENTATIVES: Continental Europe: John Ashcraft, 12 Bear St., Leicester-Square, London W.C.2, telephone 930-0525.

For Benelux and Germany: W.J.M. Saunders, Mgr., Herengracht 365, Amsterdam, Holland, telephone 24.09.08.

Japan: Japan Printing News Co., Ltd., No. 13-2 Chome Ginza Higasi, Chuo-ku, Tokyo, telephone 541-5795.

AUDIO Editorial and Publishing Offices, 134 N. 13th St., Philadelphia, Penna. 19107
Postmaster: Send Form 3579 to the above address



These four major developments make the B·I·C VENTURI™ speakers totally unlike all others...and better.

B·I·C VENTURI Principle Bass Section (pat. pend.) transforms the magnitude of air mass and energy in a way never before applied to acoustics. (Fig. A) The result is bass response hundreds percent more efficient and substantially purer in quality than is possible from any other speaker of comparable size.

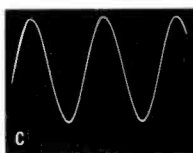
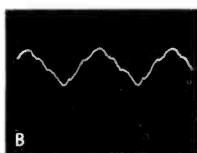
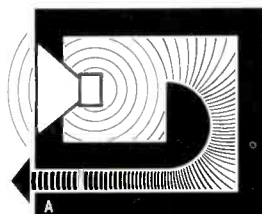

B — Shows output of low frequency driver when driven at a freq. of 22 Hz. Sound pressure reading, 90 dB. Note poor waveform.

C — Output of B·I·C VENTURI coupled duct, (under the same conditions as Fig. B) Sound pressure reading 111.5 dB (140 times more output than Fig. B) Note non-distorted appearance.

Biconex™ Pyramidal Dispersion Horn (pat. pend.) was developed to match the demanding capabilities of the B·I·C VENTURI bass section. It is far more efficient, can handle more power and covers a wider, uninterrupted frequency range than cones and domes. And, unlike other horn designs, it can't add metallic sound coloration and has truly wide angle dispersion in both the horizontal and vertical planes, for unrestricted system positioning.



Biconex horn

Dynamic Tonal Balance Compensation (pat. pend.) adjusts speaker performance automatically (when desired) to provide aurally "flat" response at all listening levels in accordance with the Fletcher-Munson hearing characteristics. This is accomplished in a manner which cannot be achieved by amplifier loudness or contour controls.

Extended Musical Dynamic Range results from the unique combination of high efficiency and high-power handling capability. Even our smallest model, the new Formula 1 can be used with amplifiers rated up to 50 watts RMS per channel. The Formula 2 will handle 75 watts; the Formula 4, 100 watts; the Formula 6 can take 125 watts. Yet any of these can make Titans of low-powered amplifiers.

A 4-page color brochure is needed, at the very least, to properly describe what makes these B·I·C VENTURI speaker systems so different, and we think you'll agree, better. So this is what we will send you, upon request. Or better still, visit your B·I·C VENTURI dealer, and hear for yourself.



B·I·C VENTURI™

BRITISH INDUSTRIES Co., Inc.
Westbury, New York 11590
Div. of Avnet, Inc., In Canada:
C. W. Pointon, Ltd.

B·I·C VENTURI is a trademark of British Industries Co.

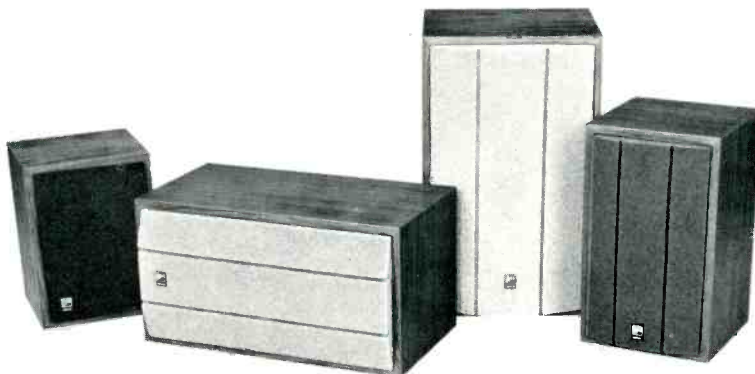

Check No. 9 on Reader Service Card

Our new series is so advanced, we expect our first customers to be Audio Research & Crown.

They'll haul it back to their labs. And play it. And play with it. And in general, examine it to pieces to find out How We Did It.

Sony's Vertical Field Effect Transistors: What our competitors are eating their hearts out about.

It's a shame the term "state of the art" has been worn ragged in dozens of "This is It, this is finally and really It" stereo ads. Because anyone in the business will tell you that V-FET's are the biggest thing since the invention of the vacuum tube. V-FET's combine all of the advantages of both triode vacuum tubes and conventional transistors. With none of their disadvantages.

But nobody else can take advantage of these advantages yet. Ask anybody else how their V-FET's are coming. The responses will range from a forthright and candid "we're working on it," to an equally forthright and candid "buzz off." Sony is the first company in the world making commercially available equipment with V-FET's. A power-amp and integrated amp.

Herewith a partial, and oversimplified explanation of just what in the world we're talking about.

Triode vacuum tubes: Pros and cons.

To belabor the obvious for a moment, in amplifiers, the name of the game is distortion. And until now triode vacuum tubes have yielded the lowest levels around. That's because of their non-saturating voltage versus current characteristics. Also, they do not suffer from carrier storage effect (which is standard equipment with regular transistors, and causes notch distortion and deterioration in transient response).

So much for the good points of tubes. They also tend to be inefficient, begin to deteriorate as soon as you use them, and wear out. Their high impedance characteristics generally require an output transformer to drive the speakers. And there's no way you can set up a true complementary circuit with vacuum tubes, so there's no way you can get true wave form symmetry.

marked tendency toward thermal runaway (which is a fancy way of saying they try to self-destruct).

V-FET's: All pros. And that's no con.

First off, V-FET's are very reliable, very efficient and last almost forever. They also match the highly defined tonal quality previously provided only by vacuum tubes. V-FET's don't become saturated with current. But at the same time, they protect themselves as temperatures build up. So there's no possibility of thermal runaway. Their low impedance characteristics mean no output transformer (the less gizmos in the circuit, the better the sound). The use of V-FET's allows for better control of negative feedback, making the amp more stable. V-FET's don't have carrier storage effect to cause switching lag. And you can use V-FET's to build a true complementary circuit, thus obtaining true wave form symmetry. And isn't that what it's really all about?

One more thing. We'd be less than forthright and candid if we didn't admit that our new amplifiers are a bit pricey. As much as \$1300 a piece.

At Sony, we've always maintained that, in the end, the best way to buy equipment is to hear it for yourself. So we're making what's probably the best offer you've ever heard. Have your dealer hook up our new V-FET equipment against *anything* made by *anybody*. If we sound sure of ourselves, we are.

And we're sure your own ears will tell you we've got the best sound you've ever heard.

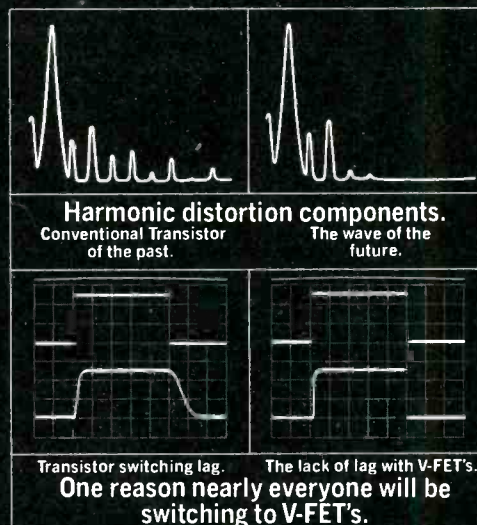

Conventional Bi-polar transistors: Pros and cons.

The advantages of bi-polar transistors can be dealt with in a sentence. They're very reliable, very efficient and last almost forever. But there are a number of bugs in the ointment.

Bi-polar transistors can become saturated with current. And they all cause switching lag distortion. To obtain acceptably low levels of distortion, plus wide frequency response, you need to pump in a lot of negative feedback. Which can make the amp unstable.

Plus (at no extra charge), as they heat up, bi-polar transistors have a

SONY®

Check No. 34 on Reader Service Card

Audioclinic

Joseph Giovanelli

"Stuck" Stylus

Q. After balancing the tonearm, setting the tracking force for 2 grams (required by my cartridge), and setting the anti-skating force for that same 2 grams, and making sure that the cartridge is adjusted properly for overhang, I put on a record. All went well until the arm was about an inch and a quarter into the record, the stylus then gets "stuck." This happens on ALL of my records, new and old. I found that I could move the arm slightly inward, and once again, all goes well for a time. When the arm reaches four and a half inches in, it once again "sticks." I have tried mounting and remounting my cartridge. I've changed the tracking force to 1.5 grams, using both antiskating settings for conical and elliptical. My tonearm still "gets stuck." I know that this is not a problem related to worn or dirty records because it occurs with all of my records.

I hope the problem is that I am doing something wrong and not my turntable. Your advice will surely be of help.—R. Padilla, New York, N.Y.

A. I suggest that you obtain a force gauge. Use it to check the accuracy of your tracking adjustments. Sometimes the calibrations for tracking force are incorrect, and this can only be determined by the use of an independent tracking force gauge. Like the tracking force adjustments, the antiskating force calibrations could be incorrect, so that you are using too much antiskating force. To obtain a reasonably good setting, consider obtaining a blank disc (one having no grooves at all) from a recording studio. Set the antiskating force so that the arm moves neither inward nor outward. Move it to various points on the surface of the disc. You may have to compromise on this adjustment. In some parts of the disc the arm will tend to pull inward slightly; in other parts, it may pull outward by an equal amount.

Your problem also could be the result of defective bearings. They may have so much friction that the arm is

not free to be pulled along by the stylus. In that case, the turntable should be returned to your dealer for repair or replacement.

Paralleling Speakers

Q. My receiver puts out 70 watts at 8 ohms and 90 watts at 4 ohms. There is provision for two sets of speakers on this receiver. Does this mean that my resistance is 4 or 8 ohms? I am using four 8-ohm speakers.—Mark Smith, East Hanover, N.J.

A. First you should understand that speakers are rated as to impedance, not resistance. It's easy to confuse these two related, but different things. The term impedance takes into account both resistance (which is the same regardless of frequency) and inductance (which changes with frequency).

The switch on the front panel of your amplifier selects *Main*, *Remote*, or *both Main and Remote* (together). It is not intended to select the impedance presented to the amplifier. When both the *Main* and *Remote* speakers are operated at the same time, the speakers are wired in parallel. Thus, in your case, you would have two 8-ohm speakers in parallel on each channel, resulting in an impedance of 4 ohms. Do not add more speakers in parallel. To do so might well result in such low combined impedance (two ohms or less) that your amplifier would be damaged.

More Power From an Amplifier?

Q. I have a Lafayette 8-track recorder. I have found that I can run the FM portion of my receiver through the deck. With the tape switch on, I notice a tremendous increase in bass and I also notice a considerable increase in volume. What I think is happening is that the tape deck is used as an amplifier. Please give me an estimate of the increase in power that I can expect from this arrangement.—Mark Smith, East Hanover, N.J.

A. Your tape machine, when used to alter the sound from your receiver,

is acting as an amplifier, just as you have said. Probably there is a playback correction network in that amplifier, which accounts for the added bass.

Your receiver does not produce more power when the tape deck amplifier drives it. The power amplifier can deliver only so much power. A preamplifier can only boost the input voltage feeding the power amplifier. When the voltage reaches the point at which the amplifier is delivering its rated power, no additional increase can take place. Increasing the signal input voltage further can only produce distortion and possible damage to the amplifier's output stage.

There are also preamplifiers which are incorrectly called "power boosters." These preamplifiers amplify the output of musical instruments such as electrical guitars. They do not add power. They boost the signal to the point where it can drive the power amplifier to obtain its maximum rated power.

Wiring a Cartridge for Mono

Q. In some phono cartridge installation instructions, the user is directed to join the left and right channel leads, either at the cartridge or at the preamplifier for monophonic service.

Might this practice not upset the cartridge loading characteristics or spoil the response in some other way?—(Name Withheld), Los Angeles, Cal.

A. Wiring a cartridge for monophonic service in the manner described in the instruction manual will change the recommended optimum load. The actual, audible effect of such a change will ordinarily be of so little consequence that it is ignored.

If you have a problem or question on audio, write to Mr. Joseph Giovanelli, at AUDIO, 134 North Thirteenth Street, Philadelphia, Pa. 19107. All letters are answered. Please enclose a stamped, self-addressed envelope.



THE INNOVATORS. BY BOSE.

The only Direct/Reflecting® loudspeaker systems.

The Bose 901, 501 and Model 301. The only speaker systems that meet the two basic requirements for preserving the qualities of live music in reproduced sound: the proper balance of reflected and direct sound for spaciousness and clarity; and flat power radiation to assure correct frequency balance and accurate reproduction of instrumental timbre in an actual listening environment.

The internationally acclaimed 901® system utilizing nine full range drivers with an active equalizer to provide the ideal balance of reflected to direct sound at all frequencies, setting the standard for lifelike music reproduction in the home.

The unconventional 501 incorporating an exceptionally linear 10" woofer and two rearward facing tweeters to furnish many of the performance advantages of the 901 system, but at substantially lower cost.

The new Model 301 offering a unique combination of features: Asymmetrical Design, a Direct Energy Control and a Dual Frequency Crossover™ network. This achieves reflected and direct sound with flat power radiation in a bookshelf enclosure, producing a sound quality that is extraordinary from so compact a speaker at so low a price.

The innovative speakers. From Bose. Each unique in concept and design to provide the maximum musical enjoyment for your home. One of them will ideally meet your requirements.

Shown above, left to right, 501, 901, and Model 301. For information, write to us at room AS.

Model 301 Patents Issued and Pending

BOSE®

The Mountain, Framingham, MA 01701

Frequency response and distortion are substantially unchanged. Distortion is probably a bit less because of the cancellation of the vertical component caused by the "pinch effect."

Turntable Cueing Revisited

In the December, 1974 issue of *Audio* you described one way to cue up turntables. I can suggest another, simpler method which I've used for several years to produce top-quality tapes, using only a reel-to-reel tape deck, two turntables, two Shure pre-

amps, and a Crown IC-150 preamplifier/control unit. Here's how it works:

1. Plug outputs from arm into Shure stereo preamps.

2. Plug output from preamplifiers into the two tape inputs on the pre-amplifier.

3. To play each table: turn the IC-150 function selector to Tape 1 or Tape 2.

4. To cue each table: push Tape Monitor 1 or Tape Monitor 2.

As you can appreciate, when the monitor is depressed, there is no effect on the Line outputs feeding any

connected tape machines. However, the main outputs feeding the power amps now carry the cue information. Further, any adjustment in cue volume has no effect on the line outputs. When the monitor function is released, the straight program material is still available.

The separation between the line and monitor functions in the IC-150 is around 75 dB, more than enough for this scheme to work well. This scheme will work with any preamplifier or integrated amplifier having two tape inputs and two tape monitors.

True, with this system, no segue is possible. In such a situation, I use another approach. At my studio, we have a Sony MX-16 mixer. It is set up so that, at the bottom of each slide-pot fader, a micro-switch switches the output of the phono preamplifier from the mixer input to a pair of (added) stereo output jacks, which are then connected to a cue amp. Each slide-pot on this mixer has been equipped with its own micro-switch so that all signal sources can be cued. Multi-source montages are easy to accomplish. This micro-switch idea could be used just as easily with any small, straight-line mixer, such as a Sony MX-12, Telefunken, etc.

By adding a switch to the pots on mixers equipped with rotary pots (Shure, etc.); these mixers can be used for cueing. In other words, when any pot is turned off, it is placed automatically into cue! Works well, too!
—Stephen H. Lampen, San Francisco, CA.

Note. I hope that you find this sort of material interesting and helpful. Those readers who are kind enough to take the time to write up this sort of information are specialists in their fields, and, as such, are privy to knowledge not normally available to most of us.

So for myself and the rest of my readers, thanks to all of those who have written, and to those who will do so in the future.

I will be especially glad to hear from any one out there who has had success dealing with line transients. I refer to those instances where a refrigerator, fish tank, oil burner, etc., puts a pulse on the power line, which, in turn, finds its way into a music system and produces audible pops or other noise from the loudspeakers. Some equipment is more sensitive to this than others. While this sort of interference can often be eliminated by placing a constant voltage transformer between the power line and the music system, this is an expensive cure.

Accuphase

The critical acclaim
has been as impressive
as the product
itself.

These independent
test laboratory reviews
and these superb
stereo components are
now readily available.

RSVP

TEAC Corporation of America
7733 Telegraph Road, Montebello, California 90640

The tuner that restates the state of the art.

Imagine a stereo FM tuner that performs as cleanly and vividly as your favorite records. That has distortion so low it defies laboratory measurement. That automatically rejects all unwanted noise and interference.

You're looking at it. The YAMAHA CT-7000... the new state of the art tuner. Its cost? \$1,200. So listen at your own risk, because you may never be satisfied with any other tuner again.

It's the first tuner with Negative Feedback.

Long used in amplifiers to lower distortion, the application of Negative Feedback to the CT-7000 has all but eliminated MPX distortion. (At 400 Hz, for example, it's an unheard of 0.02%—and that includes distortion caused by the measuring instrument itself.) Also, Negative Feedback eliminates the need for distortion-causing Side Carrier Filters.

For superior separation of the left and right channels, Yamaha designed a unique *Phase Lock Loop MPX Decoder*. Instead of being a single IC chip as in other tuners, our Phase Lock Loop consists of discrete components mounted on their own circuit board, thus allowing precise control in production and hand-tuning adjustment to meet exact specifications.

A 7-Gang Tuning Capacitor? Most tuners get by with 4 or 5 stages. We refused to. By designing the Front End with our unique 7-Gang Tuning Capacitor and utilizing Dual Gate MOS FETs, the CT-7000 can receive the weakest stations and, at the same time, accept an extremely high input (up to 1 volt input signal) without overloading.

Advanced IF Amp Stages. Inside the IF amp stage is the world's finest combination of ceramic and L/C filters. This has resulted in an advanced degree of selectivity (the ability to pick out a desired signal while rejecting neighboring frequencies). And maintains proper phase linearity and minimum distortion (less than 0.08%).

A selectable IF Mode lets you choose the width of the tuner's selectivity... narrow setting for crowded band areas; wide setting for uncrowded areas. The tuner's reception can be optimized for virtually every listening situation.

Some other important differences. An *Auto Blend Logic Circuit* automatically operates in three stages to blend high and middle-high frequencies for maximum stereo separation with minimum noise and distortion on even the weakest stations. And you don't need to get up and switch in the MPX filter when a station turns noisy. The CT-7000 does it for you—silently, automatically.

There's Auto-Touch Tuning that automatically disengages AFC while you tune, for maximum station selection. When you release the tuning knob, AFC reengages and locks onto the station.



electronically fine-tuning it to the one point of maximum stereo separation and minimum distortion.

A unique Variable Muting Control makes it possible to receive music where there used to be just noise. This control lets you select the muting cut-off level to an unbelievably low 10 dB (3 m μ), yet it can be adjusted to accommodate stations up to 30 dB (30 m μ) in level.

Variable Output Level permits adjustment of the tuner's output to match the other input levels. So, when switching from tape, to records, to the CT-7000, you don't have to readjust your volume control.

The end of Multipath Distortion. Reflection of FM signals off their surroundings causes multipath distortion. And that causes muddled, distorted sound. Until now, you could rely on inaccurate signal strength meters to orient the antenna—or you could invest about 800 dollars in an external oscilloscope.

The CT-7000 neatly solved that problem with a unique signal minus multipath circuit which when activated by the S-M front panel relay, allows the signal strength meter to accurately display the multipath content of the incoming signal. Without guesswork, you now can zero-in the antenna incoming signal to reduce to a minimum multipath interference and distortion. In

fact, tests show the S-M meter of the CT-7000 to be three times more accurate for this purpose than an oscilloscope.

Some things we didn't have to do. We could have settled for just having the best performing tuner in the world. But we also wanted it to be the most reliable and durable.

That's why all the push buttons are silky-smooth, precision reed relays instead of switches. Why the flywheel is solid brass. And why, beneath the walnut wood case, each circuit board is protected by a stainless steel cover to guard against stray noises and interference.

Or as Stereo Review summed it up in its January 1975 issue: "Judged by its overall measured performance, the Yamaha CT-7000 is clearly one of the finest FM Tuners ever made. In no respect was it less than superb, and in a few areas—notably distortion, image rejection, AM rejection, and pilot-carrier suppression—it was either far better than anything we had previously measured or simply beyond the measurement abilities of the best laboratory instruments."

Your Yamaha Audio Dealer will be pleased to demonstrate the incomparable CT-7000. Plus other state of the art Yamaha components that make up the system—designed to make you unhappy with what you're listening to now. Because, like life, the best is always yet to come.



INTERNATIONAL CORPORATION, P.O. BOX 6600, BUENA PARK, CA 90620

Check No. 39 on Reader Service Card

Tape Guide

Herman Burstein

Tape Head Care

Q. I am writing to you in the hope that you will be able to answer questions that my dealer can't. I am the proud owner of a Revox A-77 deck. The manual supplied with the machine is very comprehensive, but it makes no mention of routine head and guide demagnetization. Is such maintenance required for the A-77? Also, my machine is set up for Scotch 203 tape. Will the use of a thicker base tape (1½ mil Scotch 202) cause any significant increase in head wear?—Peter A. Thrift, Bellevue, Nebraska

A. Manufacturers often recommend that heads and guides be demagnetized after about every eight hours of use. On the other hand, at least one manufacturer recommends much less frequent demagnetization. If you want to be on the safe side, I suggest that you write to Revox.

I doubt that there will be significant difference in head wear according to the thickness of the tape. More important is the quality of the tape you use. One that is optimally lubricated and that doesn't shed excessively is best. Tape tension and pressure exerted by pressure pads (is used) also affect in head wear.

Which Tape Deck to Buy?

Q. I am trying to decide which tape deck to buy. I want no compromises. I want it to have 10½-in. reels, three motors, solenoid operation, automatic stop at predetermined places, auto-reverse, smooth handling, 15, 7½, and 3¾ ips speeds. I have read that the only difference between a quarter-track and a half-track recording is about 3-dB better signal-to-noise ratio. Is this true, and how much difference does 3 dB make?

I have read a lot about the Dolby system and wonder if it would provide much improvement on a top-quality recorder? I am listing the ma-

chines I am considering. Please tell me which are the best, and also what tapes are the best.—John Nuss, Old Bethpage, N.Y.

A. I cannot make recommendations as to the best machine for your needs. As I have stated here previously, Audio's policy prevents me from doing so. Considering the high standards you are setting for yourself and the considerable amount of money you will be spending, I believe you should take the time to get out to the audio stores to check with your eyes and ears the performance of the machines which interest you.

A 3 dB difference in signal-to-noise ratio is significant, but barely so. In other words, it would be slightly audible. With fine tape machines such as those you list I doubt that Dolby would make much difference audibly, unless you go down to the slowest speeds. Dolby makes the most improvement with machines which have poor S/N ratio to begin with.

Correcting Wandering Tape Speed

Q. When I listen to a tape from my mother made in 1964 on a small, cheap reel-type "voice letter" machine, the speed varies throughout the tape, and her voice runs from a squeaky high to a low bass. I have dozens of tapes kept over the years, some with voices that no longer exist, and others which can never be duplicated. All contain some speed variations. Is any equipment available that I can use to correct the speed of these tapes while I make new, even-speed copes of them?—J.R. Kendrick, Honolulu, Hawaii

A. The only solution is to vary the frequency of the a.c. power to which you connect your tape machine. You can build such a power supply from construction articles which have appeared from time to time in electron-

ics magazines. Or you can use an audio oscillator connected to a power amplifier and vary the sine wave output of the power amplifier, using it to supply the a.c. power for your playback tape machine. Of course, the machine you make the new recordings on will use regular a.c. power.

Recording Whistle

Q. For years I have been recording off the air with an Eico RP100 recorder and a Scott 350B tuner with satisfactory results. I recently acquired a new tuner, Kenwood KT6000, and with the same recorder I now get a continuous high frequency whistle along with the program material. I am told this is due to interaction of the bias oscillator of the recorder (50-100 kHz) with the pilot tone (38 kHz) that is part of all stereo broadcast signals. How can this be corrected?—Stephen Gaydica, Hewlett, N.Y.

A. The reason you have been given is probably correct. The solution is to introduce a tunable filter between the tuner and the tape recorder. I suggest that you consult your local audio store, a mail order audio house or the makers of your equipment.

Recording Level Problems

Q. I am recording with a TEAC A-1500U tape deck. I set the monitor switch to Source and adjust the level so that the VU meter reads 0 on the loudest passages. When the tape is played back, the level is too low (his is audible), and peak passages register only -4 or -5 on the VU meter. I

If you have a problem or question on tape recording, write to Mr. Herman Burstein at AUDIO, 134 North Thirteenth Street, Philadelphia, Pa. 19107. All letters are answered. Please enclose a stamped, self-addressed envelope.

We don't have to overpower you!



The exceptional sound quality and high power of Dynaco's Stereo 400 places it in a class by itself. Now we have designed the Dynaco Stereo 150, for those who want the sonics of the 400 with more modest power. Within its power rating, the difference is almost undetectable.

Like the 400, the Stereo 150 offers a massive power supply, full complementary symmetry output, and thermal tracking bias to eliminate "notch" distortion. Pre-tested audio circuitry and wide open layout make it a typically easy Dynakit to build.

Combine it with our new PAT-5—already famous for the very finest solid state sound. Even on a cost-no-object basis, you still may not believe your ears.



PAT-5 Kit **\$199**; Assembled \$325
Stereo 150 Kit **\$225**; Assembled \$325
Stereo 400 Kit **\$499**; Assembled \$669

MINIMUM POWER OUTPUT SPECIFICATIONS
Maximum total harmonic distortion less than 0.25% from 20 Hz to 20 kHz into an 8 ohm load, both channels driven, with FTC preconditioning: Stereo 400—200 watts per channel
Stereo 150—75 watts per channel

DYNACO Box 88,
Blackwood, N. J. 08012
Also available in Canada from Dynaco of Canada Ltd.

If you are considering
an **investment** in sound
reproduction,

Don't make a move until you hear the 3 new BOZAKS

For more than 25 years Bozak has been providing discriminating music listeners with loudspeakers which have been recognized as representing the highest standards of integrity in sound reproduction.

Now Bozak has applied its same principles of

design — pushing the limits of the state of the art without compromising the laws of science — to two new electronic products and a new monitor type speaker for the home music systems of those who recognize and demand "the very best in music."

Model 919 Audio Signal Processing Center

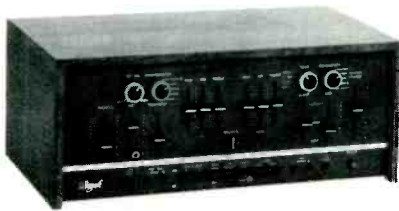

This mixer-preamplifier gives much of the flexibility found in commercial sound studios. With it you can mix and blend stereo sounds from records, tapes, tuners and microphones with differing input levels into a two-channel composite for recording or for listening.

Model 929 Audio Power Amplifier

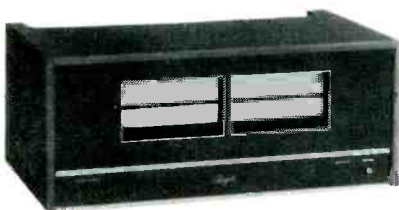

The ultimate in an amplifier for the home music system, the Model 929 has nearly identical circuitry to Bozak's commercial Model CMA-2-150 which has been selected for the most demanding applications in concert halls, theaters and auditoriums. Each of its two channels delivers 150 watts continuous minimum sine wave power into 8 ohms from 20 to 20,000 Hz at less than 0.2% total harmonic distortion. That is enough power for even the most important home music systems — those employing Bozak's Concert Grand speakers.

Monitor C Loudspeaker System

Monitor C has been specifically designed to reproduce modern music, with its heavy emphasis on bass, with the greatest realism possible. You truly hear each note as it was played; Monitor C spells an end to "thump-thump" bass. Discotheques, as well as homes, are taking it to their hearts.

You can hear these magnificent audio system components at selected Bozak dealers. We'll gladly send you the name of one in your area.



Bozak, Inc.
Box 1166, Darien, Connecticut 06820

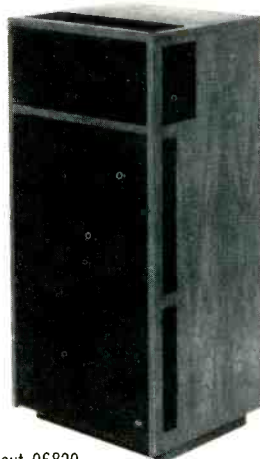

have played my tapes on another deck (Sony 255) and get the same low playback level. But a tape recorded on the Sony back properly on the TEAC. I am using Scotch 290 (1/2 mil) tape.—John L. Bagwell, Lanham, Maryland.

A. It appears that your problem is miscalibration of the VU meter. Whether this is true for tape in general, or only when you use 1/2 mil tape, can easily be checked by investing in a small reel of 1 1/2 or 1 mil tape and noting whether you still get underrecording. It is also possible that your machine is underbiased. Up to a point more bias current increases the amount of signal that gets recorded on the tape. If treble response is exaggerated, which can happen when there is too little bias, then underbiasing is indicated. Have an authorized technician check the bias and record/play response.

Concert Hall Recording

Q. I have the fantastic opportunity of recording live in the Teatro Colon, in Buenos Aires, one of the best concert halls in the world. The Teatro Colon, however, does not encourage recording engineers, and its equipment is painfully obsolete. I must get acquainted with modern equipment and techniques for recording live, but none of the magazines to which I am a regular subscriber offers much information on recording techniques and equipment. Would you know of any publication (books, manuals, magazines, catalogues, anything!) that could give me not-too-technical reports on available recording equipment and general information about recording techniques?—Oscar J. Romero, Buenos Aires, Argentina

A. You might write directly to manufacturers of recording equipment. You can get their names and addresses from *Audio* and other periodicals in which they advertise. *Audio* published a series of three articles by David Josephson on Microphones in December, 1973, July and Aug. 1974. You will find a chapter on microphones in *Hi-Fi Made Easy* by Norman Crowhurst (Gernsback Library, 154 W. 14th St., New York, N.Y.). A chapter on microphones is in my book, *Getting the Most Out Of Your Tape Recorder* (John F. Rider, Inc., 114 W. 14th St., New York, N.Y.) A chapter on using a tape recorder and microphones ("Increase Your Enjoyment of Music") is in *How To Select and Use Your Tape Recorder* by David Mark (Rider). And a chapter on stereo microphone technique is in my book *Stereo, How It Works* (Gernsback).

The final touch of excellence to a superb sound system

KENWOOD introduces with pride the incomparable Model 7 and the new LS-Series Speaker Systems. Not since the invention of the loudspeaker itself has there been such an exciting breakthrough in high-fidelity sound reproduction!

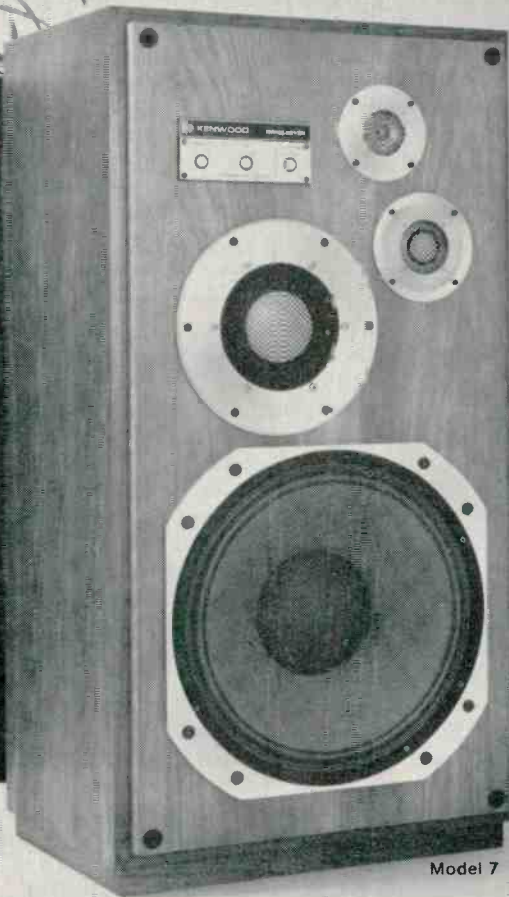

Model 7

The Model 7 . . . uncompromising performance that recreates an exact replica of original sound. Uniquely fabricated diaphragms ■ Powerful new magnetic assemblies ■ Special lumber-core baffle board ■ 4-way system with unique dividing network.



LS-405

LS-406

LS-405

The LS-Series . . . three exceptional, high-efficiency speaker systems that put advanced speaker design and performance within range of a moderate budget.

For complete information, write . . .

KENWOOD

15777 S. Broadway, Gardena, CA 90248
72 02 Fifty-first Ave., Woodside, N.Y. 11377
In Canada: Magnasonic Canada, Ltd.

Check No. 18 on Reader Service Card

Audio ETC

Edward Tatnall Canby

ON THE THEORY that one diagram is worth a column of words, I spent a lot of time recently on my hands and knees in my New York apartment, taking measurements—see diagram. There you will find my own solution to a major problem these days, how to cram four channels of sound into a crowded, ill-shaped urban apartment. Most people still think it is impracticable.

Far from it. In fact, it took me less time to find the right place for four small speakers in my zany and unsymmetrical apartment than it did to make the diagram, unaccustomed as I am to public drawing. It is a sure thing, I say, that if we don't get four channels into thousands of urban apartments like this, we might as well give up, because urban America is America, at least indoors.

For a long time, I've had a hunch that this problem wasn't as bad as most people think. When Electro-Voice recently turned up with a new small-space, big-bass speaker designed expressly for this type of situation, I acted fast. I borrowed four of the Interface: A units, which come in pairs, and hauled a quadraphonic receiver down from the country to plug them into. My four-way solution, as per picture, came after a series of trials in various temporary positions—and I hasten to add that you *must* do this first, before you get into arguments about furniture and decor. Nine times out of ten, there will be no need to do heavyweight moving. Rather, it's likely to be a change of tables, pictures, lamps, and chairs, no more. But the right place, you must understand, is going to be vastly better than the wrong and

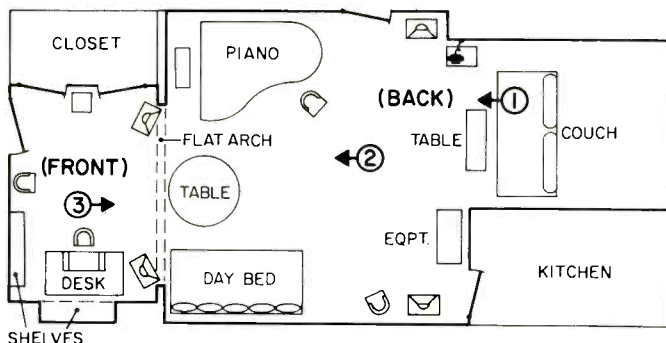

thus worth the effort.

I put the front speakers where, years ago, I had found the only workable location for stereo in that same addle-shaped room. I tried them all. You will note that the back speakers, like the front, occupy positions of *approximate* room symmetry, in a highly lopsided area. It is a first principle that one never places pairs of speakers in grossly unsymmetrical locations—say, one with a wall or corner behind it and the other with a big space behind. It will not work. Don't even try. On the other hand, even a barely approximate symmetry, as between that small corner niche, where my right back speaker is (former telephone table location!), and the corner next to the kitchen, opposite, where the left speaker is, can work out astonishingly well. The little niche made all the difference, as I specifically found out.

For three positions, as marked, I achieved a spacious and listenable quadraphonic sound, though you might not be-

lieve it. From the recessed couch (1), actually a bit behind the back speakers, the effect is splendid though the left channel is partially in acoustic shadow and the right is rather close. Fortunately, the Interface: A speakers have excellent sound dispersion, so that you must walk right up to one of them before the sound is heard separately. Mark of a good quadraphonic reproducer. From the center of the space (2), I can do my favorite walk-about listening, on foot. There's just room to move in time to the music without bumping into a channel. As for the day bed, it is sonically out of bounds. I don't listen in bed.

From my work desk in the semi-alcove near the entrance door, I hear a reversed image via reflection. By no stretch could this be called discrete quadraphonic—but I find it pleasant even so, and better than it ever was in stereo from the same place. More info, even if scrambled.

I had long previously found that the placement of the front (stereo) speakers at the edges of the flat overhead arch, *with space behind them*, greatly enhanced the forward sense of distance and fullness of sound as one listens from the main part of the room. Now, that big space is drawn in and around the back speakers to include the whole listening area. I could ask for no more.

As for the E-V Interface: A speakers, they did indeed fit right into this arrangement. They are of a new, little shape, only 14 by 22 inches and so shallow, only eight inches deep, that you can back them inconspicuously near a wall at the back of a table or other support where, with their neat black grille covers, they blend right into the background, out of the way. No need to make separate furniture lumps out of them. The units were designed as an updated, computer-calculated, optimum juggling of a number of ingeniously combined principles for maximum bass in minimum space—an honorable and ancient idea. Inside there is a tuned system for efficiency (I noticed this immediately) and a passive-front radiator which, in effect, replaces a body of air larger than the box could hold, for correspondingly-increased bass range. Also, there is an equalizer unit, one (stereo) for each pair of speakers. It adds 3 dB of bass boost, with a bottom cut-off to avoid rumble and shake.

Now, I, along with plenty of other hi-fi people, have always distrusted electronic boosting of this sort. It is not the ideal way to get bass, which might be said to be the Klipschorn way, for one. But corner Klipschorns do not into an apartment fit, especially one with 10 mini-corners like mine. I found that E-V's very modest 3 dB boost was gentle in action and introduced no audible musical problems for my ears. Moderation is a good principle.

One problem, though not E-V's fault. The equalizer units, two for quadraphonic, must be inserted before the main amps and thus use the familiar record-out and monitor-in system, through pairs of connecting cables. (There are extra ins and outs to take your other equipment.) So for just plain phono, I hooked in 10 signal cables and four power cords in an unsightly mess of wire dangling behind my equipment table. Suppose I were to add tape, plus Dolby, Burwen or dbx, plus an outboard demod or decode unit? All use in/out monitor jacks, and the wire tangle would be monstrous, even dangerous. Aaargh!!!

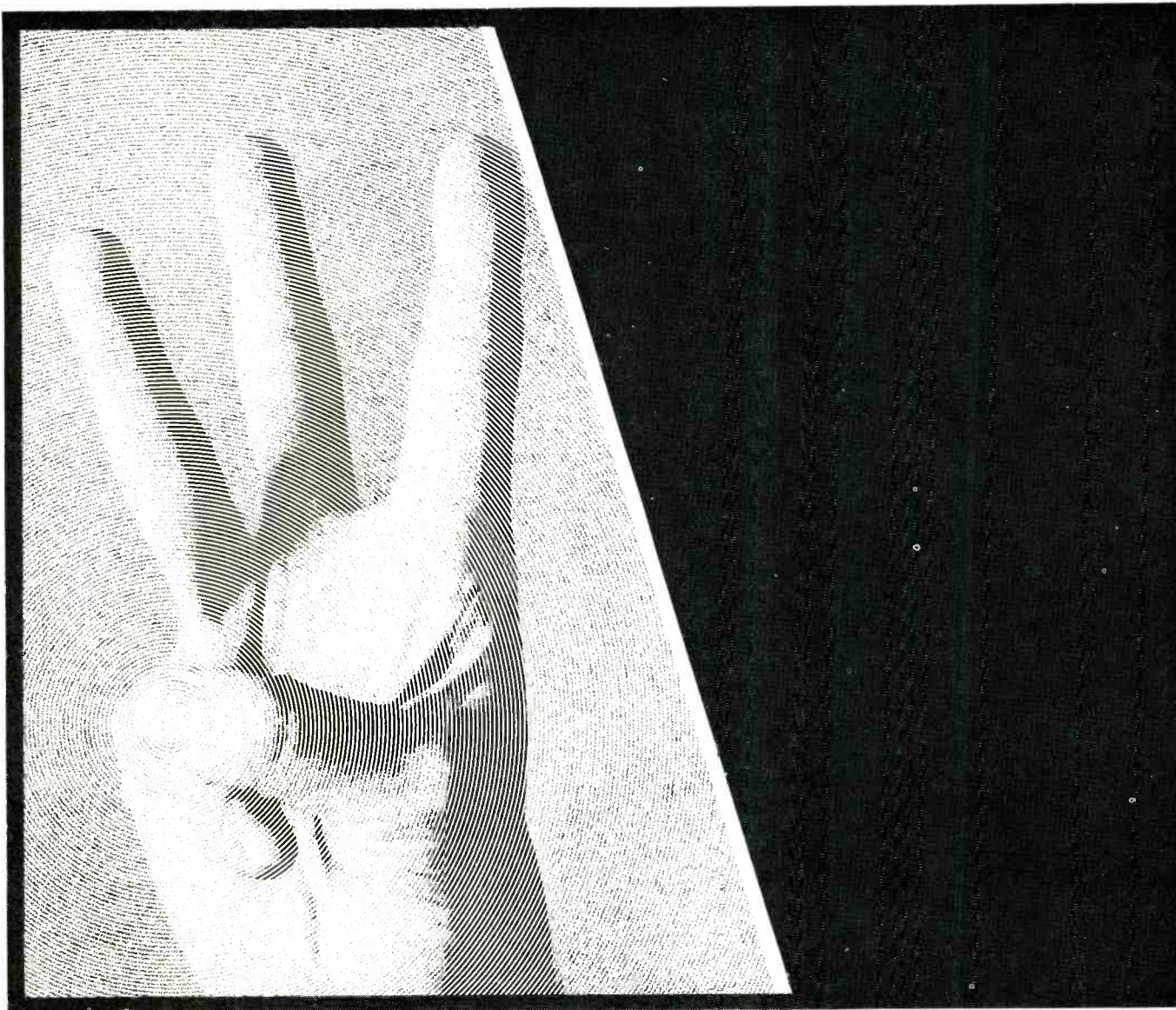

Best. best. best buys.

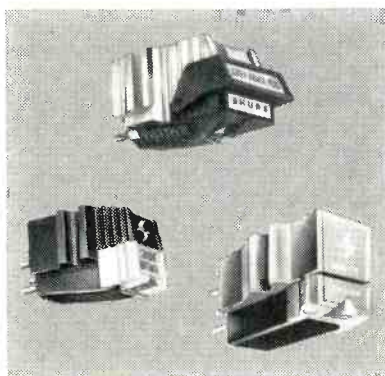

Fact: the lowest cost way to improve your whole high fidelity system is simply to upgrade the source of sound—the cartridge! If you're on a temporary austerity program, the Shure M44E can make a significant difference in sound over the cartridges supplied with many budget component systems. If your budget is a trifle more flexible, an M91ED can bring you into the area of high trackability (with performance second only to the V-15 Type III). And for those who can be satisfied with nothing less than state-of-the-art playback perfection, Shure offers the widely acclaimed V-15 Type III, the recognized number one cartridge in the industry, which, in truth, costs less than a single middle-of-the-road loudspeaker. To read about what a Shure cartridge could do for your system, write:

Shure Brothers Inc.
222 Hartrey Ave., Evanston, IL 60204
In Canada: A. C. Simmonds & Sons Limited



Manufacturers of high fidelity components, microphones, sound systems and related circuitry.

Check No. 33 on Reader Service Card

Behind The Scenes

Bert Whyte

EVEN AS THE SWALLOWS come back to Capistrano each year, a bit further South in California, the audio fraternity flocks to the annual Los Angeles convention of the Audio Engineering Society. This 51st convention of the AES was held May 13th through 16th in its usual place at the Los Angeles Hilton.

While the country in general and certain sectors of the hi-fi industry are still in the thrall of the recession, this seems not to be the case with the world of professional audio. The 51st convention was decidedly upbeat, with first day attendance breaking all previous AES records, overall attendance setting a new record, and the greatest number of manufacturers exhibiting products to date. While there was some cautionary hedging about business conditions from a few people, in general, the atmosphere was buoyant, confident, and optimistic.

However, it must be noted that while there was plenty of new equipment on display, there was nothing particularly outstanding or revolutionary. A good number of things could be classified as evolutionary updates. In other words, this convention gave us nothing on the order of the BASF *Unisette*, or high polymer piezoelectric films that were the highlights of recent conventions. Speaking of the *Unisette*, it appears that its production timetable has gone awry once again. The anticipated playback deck from Studer has yet to be seen, and similar decks from purportedly interested Japanese manufacturers have not appeared either. Insiders say cost is the problem, and with the inflation-bloated prices of parts and supplies, this is easy to understand. I hope this can be overcome, and soon, for in this reporter's opinion, the *Unisette* has great potential and a definite place in the world of audio.

At this convention, as usual, when one walks into the main exhibit area, the eyes are assaulted by a vast panoply of professional products (how's

that for alliteration!). Considering that there are 15 other rooms or areas, plus demo rooms on another floor, all stuffed with audio equipment, one hardly knows where to begin. It is impractical to cover everything...for one thing you're constantly bumping into people you know, and in no time at all, five or six people are holding a mini-seminar on some aspect of audio, meanwhile doing a damn good job of blocking the aisles. Then you meet those who suggest a brief hiatus from the show to partake of a refreshment. Lastly, it must be admitted that I bypass some products which are of little interest in my audio milieu. Thus, with apologies to those who may feel slighted, some random observations on audio products that caught my eye in my ramblings through the exhibit halls.

You can always count on Steve Temmer, of Gotham Audio, to come up with an exotic product. This time it was the Europa Film high-speed electroplating system for producing record mothers and stampers. The master lacquers are plated in two kettle-shaped containers, and people were kidding Steve that he had a fast food franchise for "broasted" chicken! With racks of ancillary equipment and interconnecting fancy plumbing, the system fairly reeks of precision and high technology. The unit uses 40 volt/400 ampere rectifiers (with a fuse nearly as thick as my wrist!), and deposit time for a 10-mil plating thickness is less than 30 minutes.

There is always a bewildering profusion of mixing consoles at any AES convention, and each year they grow more elaborate. There seems to be a growing trend towards automatic programmed mixdown, wherein once set, a particular mixdown can be repeated whenever desired. Consoles from Automated Processes and Quad Eight featured such facilities. As for so-called portable mixers (transportable would probably be more accurate), there were legions of them, in all sorts of configurations. The baby

Neve unit, called Kelso, is particularly attractive and uses those super smooth conductive-plastic faders.

The Dolby stand featured the new CP100 Cinema Processor for the production of Dolby-encoded magnetic and optical sound tracks and—the new sensation—stereo optical tracks. Dolby was hosting a demonstration film, incorporating encoded-stereo optical tracks, at the Doheny Plaza Theater, but unfortunately the theater was located in Beverly Hills, quite a haul from the Hilton in downtown L.A., so I did not get to the demo. Dolby has also gone into the noise production business, and Ray and Dagmar Dolby were proudly showing their first model, five-month-old Master Thomas Dolby.

Attracted by a blinding light at one booth, I found it was Crown International lighting up 600-watt bulbs with their M600, a mono power amplifier. If you have a speaker with a 4-ohm impedance, connect it to this unit which will pump out a mere kilowatt! Amplifiers were much in evidence at the convention as witness a new 400-watt/channel unit from Altec, and 300-watt/channel units from JBL and SAE. BGW was on hand with its "Sensurround" Earthquake amplifier, as well as lesser power units. Up on the fourth floor, Yamaha was getting plenty of attention demonstrating its new \$1600 vertical FET amplifier, the B-1. Its companion accessory module, for comparing up to five pairs of speakers, should find favor with the high-end hi-fi shops.

At the Philips' booth and on demo on the fourth floor, the new AKG BX10 reverb unit was creating quite a stir. About one quarter the size of the BX20 unit I am currently using, it features the same boooiinggg-free reverb of the big unit and at less than half the price (approx. \$1300.00).

Magnificent professional tape machines were being displayed by such as Ampex, Scully, 3M, MCI, and Studer, in various formats up to 24 channels on 2-inch tape. There were no

All cartridges are not created equal. Here's proof.

“...Tracking ability at low and middle frequencies was exceptional...the high level required half the tracking force of most other cartridges...One of the best 2-channel stereo cartridges and better than most CD-4 types.”

HI-FI NEWS AND RECORD REVIEW

Our new Super XLM MK II (\$125.) is the finest cartridge available. It was engineered solely for the true audiophile and the serious music listener who own the very finest components.

It embodies principles found in no other cartridges, as evidenced by our U.S. Patent. It features a unique "induced magnet" whereby the magnet is fixed and the magnetism is induced into a tiny hollow soft-iron collar. This collar in turn moves between the pole pieces thereby allowing for a major reduction in the mass of the moving system. This LOW MASS permits the Shibata type stylus to trace the most intricate modulations of stereo and CD-4 record grooves with a feather-light tracking force—as low as $\frac{3}{4}$ of a gram.

This results in super-linear pick up especially at the higher frequencies of the audible spectrum, which other cartridges either distort or fail to pick up at all. This low tracking force also assures minimal erosion and a longer playing life for the records.

This family of LOW MASS Cartridges is also offered with elliptical diamond stylus for stereo play exclusively—the XLM MK II (\$100) and VLM MK II (\$75).

For detailed specifications, write ADC.



U.S. PAT. NO. 3294405

ADC Super XLM_{MK II}

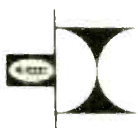

**AUDIO
DYNAMICS
CORPORATION**

A BSR Company • New Milford, Conn. 06776

The CROWN VFX-2

electronic crossover

Commercial sound contractors across America have been asking for an electronic crossover for use on sophisticated sound installations. There's no more waiting. And the Crown VFX-2 embodies all you expect in high quality and performance capabilities from the people at Crown.

Only the Crown VFX-2 electronic crossover will give every installation **maximum** versatility. Such **flexibility** for so little cost. And never before has an electronic crossover been offered that can be easily and readily adjusted with front panel controls.

Tunable from 20- to 20,000 Hz, this solid state component is compatible with 600 ohms loads and up, and features both balanced and unbalanced inputs and outputs.

Overall noise and distortion are extremely low. IM distortion is less than 0.01% at rated output, and noise is more than 97dB below rated output with open inputs.

Providing either crossover or bandpass functions, the VFX-2 utilizes two continuously variable filters per channel, and filter roll-off is at a fixed 18 dB/octave.

Applications include stereo bi-amping, mono tri-amping, and combining the bandpass filter with the normal two-way crossover on a mono signal. And all connections are quarter-inch phone jacks for positive electrical contact.

The VFX-2 is designed for standard 19" rack mounting and measures in at 3½" high by 5¾" deep and includes a clear plastic cover for protecting control settings.



Write for complete specifications.

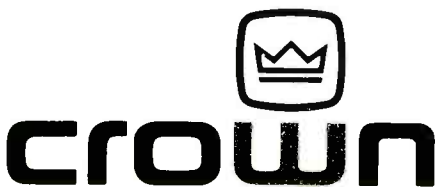

CROWN

BOX 1000 - ELKHART, IN. 46514 - 219/294-5571

Check No. 13 on Reader Service Card

new models as far as I could see, but there were updatings and some new accessories. At Ampex, they were showing a new model of Frank Rush, the dean of field reps. Devoid of some 20 odd pounds and shorn of his Confederate cavalry officer's moustache, I hardly recognized the man. Frank showed me what is called a "Search to Cue" device for the Ampex MM-1100. For use as an aid in mixdown and overdubbing, the unit can place a zero reset or cue point anywhere on a tape, in either the *Stop*, *Fast Forward*, or *Rewind* position. An hours, minutes, and seconds counter with an LED digital readout gives the position of the tape. Punch in the Cue button and the machine will search forward or backward until it reaches the preset cue position. Press the Play button simultaneously with the Cue button and it will find the cue spot, stop the transport, and go immediately into Play mode. The system is accurate to within plus or minus one half second. I wish they would make such a gizmo for the Ampex 440, if only for the super-accurate counter function. Ah, well!

Eventide Clock Works and Lexicon were showing the latest models of their digital delay systems. There have been various updates, not the least of which is an expansion of dynamic range beyond 90 dB. Cost has come down, but there is a way to go before these units are affordable for far-out experimenters in quadraphonic synthesis.

In the dbx room, they were demonstrating the latest direct-to-disc Sheffield record, #4, which had been encoded with the dbx system. With the master lacquer having a S/N ratio of over 80 dB, this might seem like overkill, but you'll have to judge for yourself. All I can say is that the record was totally noiseless and sounded sensational.

Now to the business of quadraphonic sound. Columbia was on hand in the Patio Room with the most advanced of their SQ decoders. They had gone to the trouble of bringing in sound-absorbing panels from a studio, and with the room acoustics fairly well tamed through this expedient, the sound of the Ben Bauer-designed Leslie DVX speakers was excellent. In a variety of pop and classical items, we heard fine quadraphonic imaging and sound localization, and this was unquestionably the best SQ demonstration heard at any of the hi-fi shows. Sansui held sway on the fourth floor and, with four JBL monitor speakers, gave a good representation of the ca-

pabilities of QS. Most impressive was the performance of their latest quadraphonic synthesizer, which can do wondrous things with stereo records. Nippon Columbia was demonstrating their latest UD4 hardware with a variety of recordings using this system. The sound was clean and firmly localized and received some quite favorable comments.

Now to CD-4. JVC was showing their new Mark Three CD-4 system built around a phase-locked-loop modulator, which is said to give significant improvements in sum and difference frequency response, S/N ratio, dynamic range, and distortion. In a joint effort between JVC and RCA, a similar type of PLL CD-4 modulation system was introduced by RCA which they call the "Quadulator." John Eargle, President of the AES, presented a paper on the new JVC system, in their behalf, as did Greg Bogantz of RCA for their new Quadulator. There is no doubt that these new systems for CD-4 have made an audibly superior product. I have several experimental discs at home, and there is no question of the increase in quality over the same recordings made with previous systems. There is a great deal more to this development. I had the privilege of visiting the JVC Cutting Center in Los Angeles as the guest of John Eargle and will be giving you full details of my visit and what I learned about the new modulation system in an upcoming issue.

Finally, before I leave the subject of the 51st AES convention, I would be most remiss if I did not mention the absolutely sensational entertainment presented to us at the conclusion of the awards banquet. Two virtuoso performers on the ARP electronic music synthesizers, Tom Piggott and Mike Brigida, along with a very accomplished rock drummer, gave us a quad concert which was stunning. The sound system was a giant Altec theater system in each corner driven by their new 400-watt amplifiers, augmented by no less than Gene Czerwinski's Cerwin Vega corner plugs as used in the movie *Earthquake*, driven by a mere 6000 watts. Crossover was at 30 Hertz through the new Crown VFX crossovers! The boys gave us a number of great tunes but the absolute end was *MacArthur Park*, which was the most sonically dynamic and exciting sound I have ever heard...at least as a sheer sound experience. The sight of the AES engineers and their wives roaring their approval and stomping and whistling for encores was something I won't soon forget. ☞

JBL Loudspeaker Components



Twelve brand new pages. Forty-seven JBL components—dividing networks, lenses, horns, transducers, everything.

Lots of these goodies have never been available as individual components before. (They've been performing inside JBL's newest professional studio monitors.)

Write us. We'll send you the catalogue, free, along with the name and location of your nearest

authorized JBL Loudspeaker Components Dealer.

He's important. Besides all those components he's got a fresh supply of the new JBL Enclosure Construction Kits that tell you everything you need to know about building your own JBL enclosure.

Fill out this coupon and send it along to JBL, the people who wrote the book on sound.

Check No. 19 on Reader Service Card



3249 Casitas Avenue
Los Angeles 90039

Gentlemen:
I can't beat the price. Send
me the book.

Name _____

Address _____

City _____ State _____ Zip _____

James B. Lansing Sound, Inc.
High fidelity loudspeakers
from \$99 to \$3210.

A.

Dear Editor:

Transient IM

Dear Editor:

Thank you for publishing the Leach article on "Transient IM Distortion in Power Amplifiers" (*Audio*, Feb., 1975). This is the type of analysis that is very much needed in the design of audio equipment, to take it out of the "arts and crafts" category and give it a firm scientific basis.

From 1948 until about 1968 (when I bought my first transistor amplifier, a Dynaco Stereo 120), my standard of comparison was a vacuum tube amplifier that I designed and built and wrote up for *Audio (Engineering)* in 1948. All stages were push-pull. The output, from a pair of Western Electric 300-Bs, was 30 watts, at about 2% IM distortion, and the power curve was within 1 dB from 20 Hz to 22 kHz. *There was no feedback of any kind.* My friends used to bring in other amplifiers for A-B tests, especially some of the early transistor jobs, and this old 300-B amplifier always won without any argument, until about 1968.

The best praise I have for Leach's article is to say that I wish I had written it!

Curtiss R. Schafer
Sandy Hook, Ct.

More on TIM

Dear Sir:

In his otherwise excellent article on transient IM distortion (TIM) in the February *Audio*, Prof. Leach states that operational amplifiers like the 741 are prone to TIM because of their low 2 to 5 Hertz open loop bandwidth. In audio design, as in servo and other control systems, the term "open-loop" gain means gain around the entire forward and feedback paths. But in op amp terminology, "open-loop" response means the response of the device *without* external feedback. The compensation controlling the bandwidth is usually lead type, rather than lag which (as he notes) reduces TIM instead of increasing it.

The slew rate of the 741 is about 0.5 volt per microsecond—roughly 5000 times faster than it would be if lag compensation were used. This fast slew rate insures that any "holes" resulting from transients will be so brief as to be inaudible. I have critically

compared 741s with high grade tube circuits and could hear no difference (closed-loop gain was limited to 20 dB max.). There may be ways of using op amps that could lead to problems, but local feedback around each op amp will prevent this.

Donald E. Phillips
Cedar Rapids, Iowa

The Author Replies

The 741 op amp is internally lag compensated by a 30 pF capacitor. This is necessary to prevent oscillation when external feedback is added. Normally, when the op amp is used with external negative feedback, the bandwidth of the closed-loop amplifier is reduced by placing a capacitor in parallel with the feedback resistor from the output terminal to the inverting input terminal. This capacitor increases the feedback at higher frequencies, thus reducing the bandwidth of the closed-loop amplifier. If the feedback loop is broken, the capacitor has in effect increased the bandwidth around the complete forward and feedback paths, and this is, technically, lead compensation. However, in the case of the 741, lead compensation in the feedback loop is not necessary for stability since the op amp is already internally lag compensated for this purpose.

Although lead compensation in the feedback loop of an op amp will reduce its tendency to produce TIM when used as a voltage amplifier on its own, we must examine what would occur when this op amp is included in the forward path of a power amplifier with negative feedback of its own. Since the bandwidth of the op amp has been reduced by "local" lead compensation in its feedback loop, the open-loop bandwidth of the power amplifier as a whole has been reduced. This can lead to TIM in other stages of the amplifier, although this depends heavily on the particular design.

Nearly all state-of-the-art power amplifiers today employ an op amp input stage, whether discrete components or an IC. I prefer the discrete designs until some IC maker markets a unit in which the amplifier designer can adjust the internal frequency

compensation (these exist, but are not in production), and more importantly, the local negative feedback in each internal stage. This way the op amp will be capable of being tailored to meet the specific objectives of the amplifier designer. Otherwise, I think most IC op amps are better suited for d.c. and low-frequency instrumentation amplifiers. However, some of the IC amplifiers designed for r.f. applications may be ideally suited for audio purposes. I have not investigated this in any detail.

Whether IC op amps are suited for mixer and low-level applications where they will not be inside the feedback loop of another amplifier is something I have not investigated. I would refer those interested in this application to Hoge, W.J.J., "Tubes Versus Transistors: A Further Comment," *J.A.E.S.*, June 1974, p. 338. Mr. Hoge gives the results of an actual listening test performed on commercially available mixer amplifiers. His conclusion was that mixer amplifiers which have open-loop bandwidths smaller than the audible frequency spectrum sound inferior.

In my article on TIM, I concentrated on describing its worse possible manifestation in power amplifiers. There are more subtle effects which I did not describe relating to how the THD of an amplifier varies with frequency at a constant power level. If the amplifier's THD increases rapidly with increasing frequency, a subtle form of TIM can be triggered by wideband audio signals with excessive high frequency levels, even though the input stages do not clip. I believe this form of TIM is the one most likely to be produced by a commercially available amplifier.

W. Marshall Leach
School of Elec. Eng.
Geo. Ins. of Tech.

FTC Violators

Dear Sir:

Although the FTC has passed the "honest power in advertising" rule, it has had no effect whatever in our area. Ads still flood the newspapers here claiming 200-watts for 8-track

You never had it so good.



(Akai's new GXC-39D stereo cassette deck.)

You may be asking yourself how we could possibly know what you've ever had — and how good it was. Well, we couldn't. Except when it comes to Akai's new GXC-39D.

Then we say — with what it has and for what it costs — you never had it so good. This cassette deck is so good you can push a button at a certain spot in the tape and it'll remember. And go back to it anytime you want.

Flick on the Dolby* switch and it'll filter out any bad sounds going to your speakers. Flick another switch and it's set for low noise tape.

Push another button and it'll pause in the middle of a recording. Push it again and it'll start again, smoothly.

Just turn on the GXC-39D and your tape will be running across Akai's own glass and crystal heads. We developed them.

Lights pop on to remind you the tape is running.

More lights pop on if the recording level is too high.

It has direct function controls so you can go from play to forward to rewind and back to play — non-stop.

And it comes in Akai's professionally styled brushed aluminum finish.

The Akai GXC-39D stereo cassette deck. We never had it so good, either.

Akai America Ltd., 2139 E. Del Amo Blvd., Compton, Calif. 90220
*Trademark of Dolby Laboratories, Inc.

If you're going to get big, you gotta be good.
We're good.

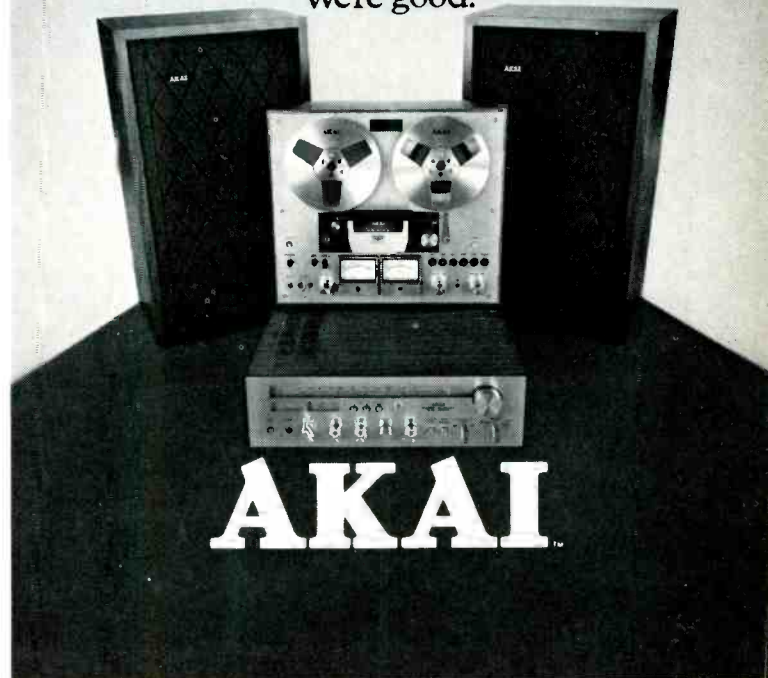

AKAI

THE SOUND VAULT



Every UD cassette gives you stainless steel guidepins to keep your recordings secure.

Tough steel pins form part of the internal security system inside every UD cassette.

They make sure your UD tape runs smooth and winds even. (Ordinary cassettes have plastic posts that can wear out and cause wow and flutter.)

These steel pins are another reason

your Ultra Dynamic cassette captures the very best sounds (both high and low) your equipment can produce.

Use Maxell Ultra Dynamic cassettes and you'll always play it safe.

Maxell Corporation of America, Moonachie, New Jersey 07074. Also available in Canada.

maxell
For professional recordings
at home.



Check No. 21 on Reader Service Card

tape players. I phoned several of these advertisers and none of them was aware of the rule; most of them refused to believe me. And one man said, "Even if there is such a ruling, they'll never bother with us—we're too small."

I'm sure this problem exists all over the country in smaller cities. To what department of the FTC should one send clippings of offending ads, along with a letter asking the FTC to inform the violators that they are wrong?

Bruce Cullom
Sound Town, Inc.
Texarkana, Tx.

The rule most certainly applies to 8-track players as well as receivers and amplifiers. Inquiries about the rule should be sent to:

Carthon E. Aldhizer
Div. of Special Statutes
Federal Trade Commission
Washington, D.C. 20580
Tel: (202) 963-7124

In addition, the EIA has published a batch of data on the ruling, and should be glad to send materials to stores in your area. Address Jack Wayman, Electronic Industries Assn., 2001 Eye St. N.W., Washington, D.C. 20006. Telephone (202) 296-5550.

Electo-O-Phonie Enthusiast

Dear Sir:

Since I am an owner of the Elekt-O-Phonie FU-100's immediate predecessor, the F/Mc2, I read Professor Lirpa's review in *Audio* (April, page 54) with great interest. Almost before I finished reading I ran to the nearest Five and Ten Cent store where I bought an FU-100 for my car. It works fine on 12 volts d.c. My only problem came when I fitted the Klipschorns (I refuse to listen to any other speakers) into my Volkswagen. It was worth the trouble, though. Can you imagine my satisfaction as I cruise down the Boston Post Road on my way to work every morning at 140 mph, listening to all eight channels simultaneously?

Alan M. August
N. Providence, R.I.

Dear Sir:

My hat is off to Professor I. Lirpa for his enlightening equipment profile of the Elekt-O-Phonie Model FU-100 Octaphonic Receiver. One question plagues me about this obviously sophisticated piece of gear. What does the "FU" stand for? *Frequencies Unthinkable*, maybe?

Jack Stevens
WXCL Radio
Peoria, Ill.

READER INQUIRY CARD

August, 1975 This card expires October 31, 1975

CHECK BOX A or B beside each coupon number

- A to help me make an immediate decision to purchase
 B to explore a new method or to keep my files on the subject to date.

	A	B		A	B		A	B		A	B		A	B		A	B		A	B				
1			16			31			46			61			76			91			106			121
2			17			32			47			62			77			92			107			122
3			18			33			48			63			78			93			108			123
4			19			34			49			64			79			94			109			124
5			20			35			50			65			80			95			110			125
6			21			36			51			66			81			96			111			126
7			22			37			52			67			82			97			112			127
8			23			38			53			68			83			98			113			128
9			24			39			54			69			84			99			114			129
10			25			40			55			70			85			100			115			130
11			26			41			56			71			86			101			116			131
12			27			42			57			72			87			102			117			132
13			28			43			58			73			88			103			118			133
14			29			44			59			74			89			104			119			134
15			30			45			60			75			90			105			120			135

Name _____

Address _____

City _____ State _____ Zip _____

Phone number (_____) _____

Are you a subscriber to AUDIO Magazine? Yes No

READER INTEREST INFORMATION:

- | | |
|---|---|
| 1 <input type="checkbox"/> High Fidelity Enthusiast | 4 <input type="checkbox"/> Broadcast Engineer / Manager |
| 2 <input type="checkbox"/> Home Recordist | 5 <input type="checkbox"/> Audio Service Technician |
| 3 <input type="checkbox"/> Professional Recordist | 6 <input type="checkbox"/> Audio Manufacturer or Dealer |
| 7 <input type="checkbox"/> Other _____ | |

I would like to see more Technical articles Articles for beginners
 Construction projects Articles on music
 Music reviews Classical Jazz Rock
 Other _____

I buy an average of _____ records a year Age _____

I have purchased the following equipment after seeing it advertised in AUDIO Magazine: _____

I am planning to purchase the following equipment in the next year _____

Comments _____

SUBSCRIBE

Don't wait until your subscription runs out. Renew now and insure uninterrupted service. The remaining issues on your current subscription will be added. Postage will be paid.

Gentlemen: Please enter my subscription to AUDIO.

Name _____

Address _____

City _____ State _____ Zip _____

- | | | |
|---|---|--|
| <input type="checkbox"/> New Subscription | <input type="checkbox"/> Payment Enclosed | |
| <input type="checkbox"/> Renewal | <input type="checkbox"/> Bill me | |
| <input type="checkbox"/> 3 Years—\$17 | <input type="checkbox"/> 2 Years—\$12 | <input type="checkbox"/> 1 Year—\$7 |
| <input type="checkbox"/> (Foreign—\$23) | <input type="checkbox"/> (Foreign—\$16) | <input type="checkbox"/> (Foreign—\$9) |

You may pay for your subscription on your credit card.

Credit Card No. _____ American Express
 Diners Club
 Master Charge

Card expires _____ Bank No. _____

Signature _____

For office use

FIRST CLASS
Permit No. 22,489
Philadelphia, Pa.

BUSINESS REPLY MAIL

No Postage Necessary if Mailed in the United States

POSTAGE WILL BE PAID BY:

AUDIO

134 North Thirteenth St.
Philadelphia, Pa. 19107

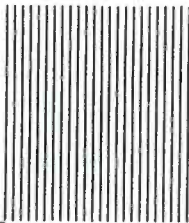

FIRST CLASS
Permit No. 22,489
Philadelphia, Pa.

BUSINESS REPLY MAIL—No Postage Necessary if Mailed in the United States

Postage will be paid by

Audio Magazine
P.O. Box 13892
Philadelphia, Pa. 19101



READER INQUIRY CARD

Fill in other side to get more information on advertised products

SUBSCRIPTION ORDER CARD Fill in other side to order a new subscription

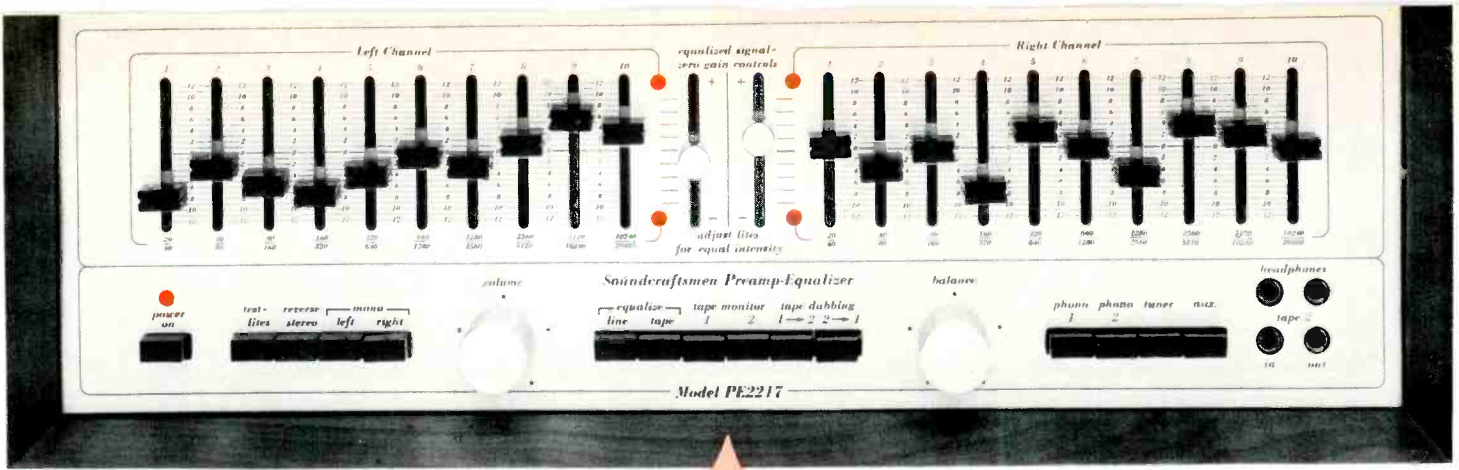

Soundcraftsmen

THE PERFECT PRE-AMP

FOR THE GREAT NEW

SUPER-POWER

AMPS!

For a SUPER-SYSTEM, match the 2217 with any of these TRUE "State-of-the-Art" amps —



- PHASE LINEAR • SAE • CROWN • DYNACO • AUDIO RESEARCH • CITATION •
- ESS • MARANTZ • SONY • KENWOOD • BOSE • INTEGRAL SYSTEMS • BGW •

Audio engineers agree that the ultimate Preamp must have all the CONTROL flexibility of a patch panel... our new PE2217 has pushbutton-patching, plus 22 more MUST features...

SPECIAL FEATURES

- ALL PUSHBUTTONS INTERLOCKED to prevent inadvertent program destruction
- DISCRETE-OCTAVE EQUALIZATION CONTROL of ten octaves on each channel, ± 12 db each octave
- FULL-SPECTRUM LEVEL CONTROL for each channel
- AUTOMATIC CONTINUOUS MONITORING by light-emitting diodes for visual warning of overload in output circuits
- VISUAL ZERO-GAIN EQUALIZATION BALANCING on music, white noise or pink noise
- SELECTION OF TEST LITES on or off
- TAPE DUBBING BETWEEN TWO MACHINES, with optional simultaneous equalizing and monitoring
- DOUBLE-DUBBING into two recorders simultaneously
- SEPARATE SYSTEM-SELECTION enables full use of all other functions during the tape dubbing operation
- LINE OR TAPE equalization selector
- AUTOMATIC EQUALIZER-DEFEAT when line or tape equalizer is not in use
- FRONT PANEL TAPE input-output jacks for easy 2nd and 3rd tape recorder hookup access
- TAPE MONITORING of either tape at any time
- TWO stereo headphone jacks
- MONO SELECTOR for left, right or both channels to both outputs
- REVERSE-STEREO mode
- TWO low-level phono inputs
- FOUR independent phono preamps
- SIX A/C outlets, 4 switched, 2 unswitched
- ELECTRO-PLATED FERROUS CHASSIS — (eight sections) — provides optimum shielding to minimize magnetic field-coupling
- SINGLE-POINT system ground connector minimizes ground-loops
- TWO REGULATED power supplies

Soundcraftsmen **EQUALIZERS**

NOW YOU CAN MAKE YOUR SYSTEM SOUND EXACTLY THE WAY YOU WANT IT TO SOUND!

In a few minutes, you can accurately "tune" the frequency response of your stereo system and room environment to a flat ± 2 db! All you need are your own ears and the Soundcraftsmen Equalizer (with its step-by-step instruction record) to transform any stereo system and room environment into an acoustically-perfect concert hall! Or, to provide any special acoustical effects you desire! The Soundcraftsmen Equalizer enables you to instantly compensate for frequency response variations, in system and room.

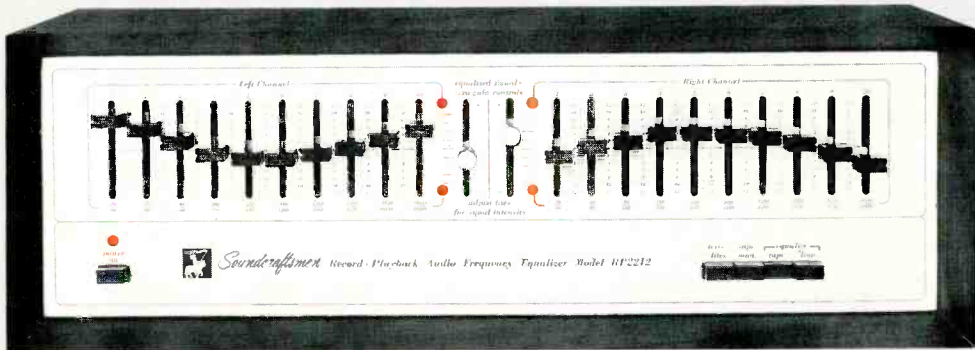

GUARANTEED to enhance and improve any fine system!

Just plug 2 cables into your receiver's tape monitor jacks, and you are ready to enjoy a new experience in musical enjoyment!

2212 Illustrated above . . . **\$349.50**

20-12 Same specs as RP2212, except no L.E.D.'s, no Tape Equalize on front **\$299.50**

Both models include walnut-grained cabinet or rack mounts.

SPECIFICATIONS

- FREQ. RESPONSE — Hi-level: $\pm 1/4$ db, 5 Hz to 100 KHz
- FREQ. RESPONSE — Phono: $\pm 1/2$ db, 20 Hz to 20 KHz
- THD: less than .05% at 1 volt (Typ. .01% at 1 volt)
- IM: less than .05% at 1 volt (Typ. .01% at 1 volt)
- SIGNAL-TO-NOISE — Hi-level: 100 db below full output
- SIGNAL-TO-NOISE — Phono: 84 db below a 10mv input
- SIGNAL-TO-NOISE — Equalizer: 90 db below a 1 volt input
- OUTPUT IMPEDANCE: 600 ohms
- MAXIMUM OUTPUT: 5 volts into hi impedance, 2.5 volts into 600 ohms
- EQUALIZER LEVEL: Zero-gain controls for left and right continuously variable, for unity gain compensation
- EQUALIZER RANGE: 12 db boost and 12 db cut, each octave at 30, 60, 120, 240, 480, 960, 1920, 3940, 7680 and 15,360 Hz.
- MAX. OUTPUT SIGNAL: Variable master volume control allows adjustment of optimum output to match amplifier
- CIRCUIT BOARDS: Military grade G-10 glass epoxy
- RESISTORS: Low-noise selected carbon-film
- POWER SUPPLY: Separate supply for phono and equalizer
- DIMENSIONS: Walnut-grained case $7 1/4" \times 20" \times 11 1/4"$ deep
- WARRANTY: 2 years parts and labor
- SHIPPING WEIGHT: 28 lbs.

MADE IN U.S.A.

PE 2217 \$499.50

includes walnut-grained cabinet or rack mounts.

FREE!



The "Why's and How's of Equalization," an easy to understand explanation of the relationship of acoustics to your environment. This 8 page booklet also contains many unique ideas on "How the Soundcraftsmen Equalizer can measurably enhance your listening pleasure," "How typical room problems are eliminated by Equalization," and a "10-point self-rated Equalization Evaluation Check-List."



Soundcraftsmen

1721 NEWPORT CIRCLE, SANTA ANA, CA 92705

Check No. 35 on Reader Service Card

Editor's Review

HALF A DOZEN of the world's foremost loudspeaker authorities, including A.N. Thiele, Richard Small, J. Robert Ashley, J.E. Benson, Murray, and very probably Paul Klipsch, will be leading a series of tutorial seminars to be held in conjunction with the Australian Institution of Radio and Electronics (IRE) Electro-Acoustic Conference in Sydney, Australia late in August. A special tour has been arranged, the cost of which covers all transportation (including that in Australia), hotel bills, landing fees, tips, but no meals. Estimated price of the two-week tour is \$1400.00 per person from Los Angeles, and this represents a considerable savings for a remarkable opportunity.

The group leaves Aug. 16 from Los Angeles, and there will be a two-day stopover in Fiji for jet-lag recovery. The tutorial lectures will be held on the 20th, 21st, and 22nd at the Univ. of Sydney, with the 25th through the 29th spent at the IRE Conference. There will also be some outside touring arranged, and preliminary plans include a concert at the Sydney Opera House.

If you would like to go on this tour, you must act quickly, since a deposit of \$250.00 must be in by July 20th and the balance by August 1st. Deposits should go to Bud Edmonds, Research Associates, 66 Minnehaha St., Manitou Springs, Colorado 80829 (303) 685-5776. Further information can be obtained from Edmonds. A remarkable opportunity!!!

Covers

The Edison Triumph shown on this month's cover represents an unusual transitional unit between the Model A and the Model B. Its serial number is 25609, and it was built about 1898. It plays either brown or black cylinders, but only the two-minute variety, and is capable of playing up to 14 cylinders with a single winding of its triple-spring motor. The unit apparently was a top-of-the-line model and sold for about \$50.00 with the black and brass horn shown. There was a black, floor-standing horn sold as an accessory.

The Model C reproducer, which goes with this unit, has a spherical sapphire stylus for vertical-cut cylinders and a stretched-copper diaphragm. The unit also has a record shaver and a recorder.

The mechanical refinement of the unit is fairly advanced for the time. The drive belt can be accurately tensioned by means of a screw which lowers the entire motor against the belt, and the nickel-plated chassis features replaceable bearings. A screw-set governor regulates speed.

The unit is owned by an ardent, young collector, Evan Blum, whose specialty is doing restorations of reasonably complete machines. Blum also has about a dozen machines for sale, including a Fireside B which was made for only about two months. The Fireside B played the four-minute wax cylinders but was dropped soon after its introduction because the much superior Amerol cylinders came on the market.

Blum is currently working on an article about sources of supply and services for this field, which we hope to publish in the not-too-distant future. We will be happy to forward any correspondence to Blum, either about his collection or about the article.

Back in June, the credit for the cover was inadvertently dropped, and we apologise to Philadelphia Wireless Institute from whose collection the Radiola Model 27 in the photo came.

Philadelphia Wireless, not incidentally, is one of the nation's oldest and best schools for technical training in the disciplines related to electricity, radio, and broadcasting. The faculty believes in classroom education as it appears to offer better opportunity for back-and-forth interchange between teacher and student. The school also features a variety of radios, TVs, test instruments, and breadboard circuit set-ups for hands-on training. They are located at 1533 Pine St., Philadelphia, Penna. 19102.

Stereo AM

RCA Broadcast Systems demonstrated a proposed stereo AM system at the recent National Association of Broadcasters meeting in Las Vegas. The proposed system multiplexes the two discrete left and right signals on the broadcast carrier for later decoding by the stereo AM receiver. Mono receivers would be able to receive a single composite signal with no degradation in performance.

Hermon H. Scott

Hermon Hosmer Scott, one of the handful of inventive pioneers who helped launch the high fidelity industry when he founded H.H. Scott, Inc. in the mid-Forties, died in April after a protracted illness. He was 66 years old.

Scott graduated from the Massachusetts Institute of Technology, receiving his Master's degree in Electrical Engineering from MIT in 1931. He was subsequently employed by the General Radio Co. as a development engineer, and while there developed the first sound level meter. In 1939 he designed and patented the R/C oscillator, on which most signal generators have been based for many years.

Another significant development was his dynamic noise suppressor, a device which materially lowered the level of scratch on records while preserving most of the musical content. Originally for radio stations, simplified versions were later sold for high fidelity. He held more than 100 patents.

During 1947 in Maynard, Mass. Scott founded the company which bears his name. The firm became one of the two best-known makers of high fidelity components (along with Fisher Radio), and was sold in 1972 to Eastern Air Devices, at which time he retired.

Scott's lifelong interest in music led to his becoming a Trustee of the Boston Opera. He was a Fellow of the Institute of Electrical and Electronic Engineers. He received the John Potts Award of the Audio Engineering Society in 1951, becoming a Fellow of the AES in 1952. In 1961 he was elected Executive Vice-President of the AES, becoming President in 1962, and joining its Board of Governors in 1963. In 1974 he was elected Executive Vice-President of the AES, becoming President in 1962, and joining its Board of Governors in 1963. In 1974 he was made an AES Life Member. E.P.



The source of perfection
in sound...tracks at
one gram (or less) in stereo
and discrete.

Frankly, perfection doesn't come easily. Pickering's engineers pursued the idea of a totally new departure in cartridge design with all the zeal of true crusaders.

They had a reason . . . there was a demand for a pickup to play both stereo and discrete (as well as SQ and QS) with total and absolute precision at one gram.

That they succeeded is a remarkable achievement because this cartridge successfully tracks all types of records at forces even lighter than one gram. It is a real first to do it this accurately.

The Pickering XUV/4500Q possesses excellent performance characteristics that provide outstanding frequency response and separation beyond 50 kHz. These improvements make possible the most faithful reproduction of the 30 kHz FM-modulated material on discrete records. It is noteworthy that Pickering's exclusive, new design development, which provides superior 4-channel discrete performance, also greatly enhances the reproduction of stereo records.

The XUV/4500Q features Pickering's patented Quadrahedral® stylus assembly. The Quadrahedral stylus assembly incorporates those features that produce extended traceAbility™ for 4-channel as well as stereo. This means that it possesses not only superior performance in low frequency tracking, but also in high frequency tracing ability. When combined with the exclusive Quadrahedron™ stylus tip, a brand new shape, it can truly be called: "the Source of perfection in Sound", whether the playback requirement is stereo, SQ, QS or discrete 4-channel.

The specifications are so exciting that we hope you will write to Pickering and Company, Inc., Dept. A 101 Sunnyside Blvd., Plainview, New York 11803 for further information.



"for those who can hear the difference"

Check No. 27 on Reader Service Card

A.N. Thiele~ Sage of Vented Speakers

Ray J. Newman*

RECENTLY A SIGNIFICANT and elegantly-written article describing the nature of vented speaker boxes was republished in this country (1,2) 10 years after its original publication in Australia (3), A.N. Thiele's "Loudspeakers In Vented Boxes." I strongly believe this article is an important milestone in the literature on high-quality sound reproduction, and that it deserves to be shared with a wide spectrum of readers. It has already stirred active interest as shown by several notes and letters in the AES Journal (4,5,6,7) and in recent AES convention papers (8,9).

In his article Thiele investigates the behavior of vented-box speaker systems by analyzing their equivalent circuits as high-pass filters. Using techniques of electrical network analysis, he arrives at a remarkable tabulation involving not one, but 28 ordered ways of creating a vented-box speaker system! The discussion ranges to such matters as the specifics of designing the speaker box, measurement of required loudspeaker characteristics for proper design, and some especially significant discussion regarding loudspeaker efficiency and cone excursion as they relate to different system types. The details of some of these matters together with their implications will be pursued in this article. It should be understood from the outset that only the mid- to low-frequency part of the system, roughly below the frequency at which the cone's circumference equals one wavelength is being dealt with. This in no way detracts from the importance of Thiele's article, as this region is a most demanding one indeed and generally dictates the size and performance format of the complete system.

The following important implications of the generalized vented-box information presented by Thiele are listed here as an early broad summary:

1. Considering the four interrelated matters of *low-frequency limit* (the 3 dB-down point), *usable cone diameter*, *maximum cone excursion* above the low frequency limit, and *acoustic power output*, the nature of many types of vented systems as compared to sealed systems can be summarized as shown in Table I.

2. A simple but elegant relationship between *system efficiency*, *low frequency limit*, *box volume*, and one parameter pertaining to the *speaker mechanism* alone is also described by Thiele. This relationship is valid for both vented and closed systems, and although Thiele's table of 28 alignments indicates that many comparisons are possible (depending on the type of vented system), one of the more useful alignment types (Thiele's fourth-order Butterworth alignment) yields the comparisons shown in Table II between a vented- and a closed-box system possessing flat response. Again this implication, stated in three different ways, is a powerful and useful concept.

3. Thiele's tabulation (Table IV) of 28 ways of creating a

vented system is the most interesting and useful information of all. Presented in concise format are a large palate of possibilities for creating correctly-tailored speaker-box systems. Each of these possibilities or, as Thiele refers to them, *alignments* has its own set of interesting characteristics. As examples:

(a) Some alignments describe how to make systems with the low-frequency limit *higher* than box tuning and the speaker's free-air resonance frequency.

(b) Other alignments describe systems with the low-frequency limit *lower* than box tuning and the speaker's free-air resonance frequency.

(c) Still other alignments are realized by using auxiliary electrical filters or equalizers. These illustrate ways of trading off box volume for system efficiency in the lower part of the system's operating range.

The possibilities of the alignment table are fascinating from the standpoint of system design, because they permit a logical and systematized approach in creating a vented speaker system. Further, they permit the system to take many different forms in terms of performance characteristics, box size, and speaker parameters to suit particular design goals. The Alignment Table (Table IV) changes vented-box design from something akin to splashing around in the Dismal Swamp, to having at least a canoe and a compass.

The Alignment Table

The high point of Thiele's presentation is the table of alignments—methods of properly coordinating the box and speaker for a specific type of system response (12). Table IV, presented here, is somewhat simplified from Thiele's table. The *Alignment Details* column includes the name of the fil-

Table I—Relationships of Parameters of Sealed and Vented Systems.

LF Limit	Cone Dia.	Max. Cone Excursion *	Power Output
Same	Same	Same	8 times sealed
Same	Same	About 1/3 of sealed	Same
Same	$\sqrt{1/3}$ or about .6 of sealed	Same	Same
$\sqrt{1/3}$ or about .6 of sealed	Same	Same	Same

* Considering only the range above low frequency limit, maximum excursion occurs at this limit for a sealed system and at 1.45 times this limit for Butterworth-type (see text explanation) vented systems.

*Senior Systems Engineer, Electro-Voice, Inc. Buchanan, Michigan

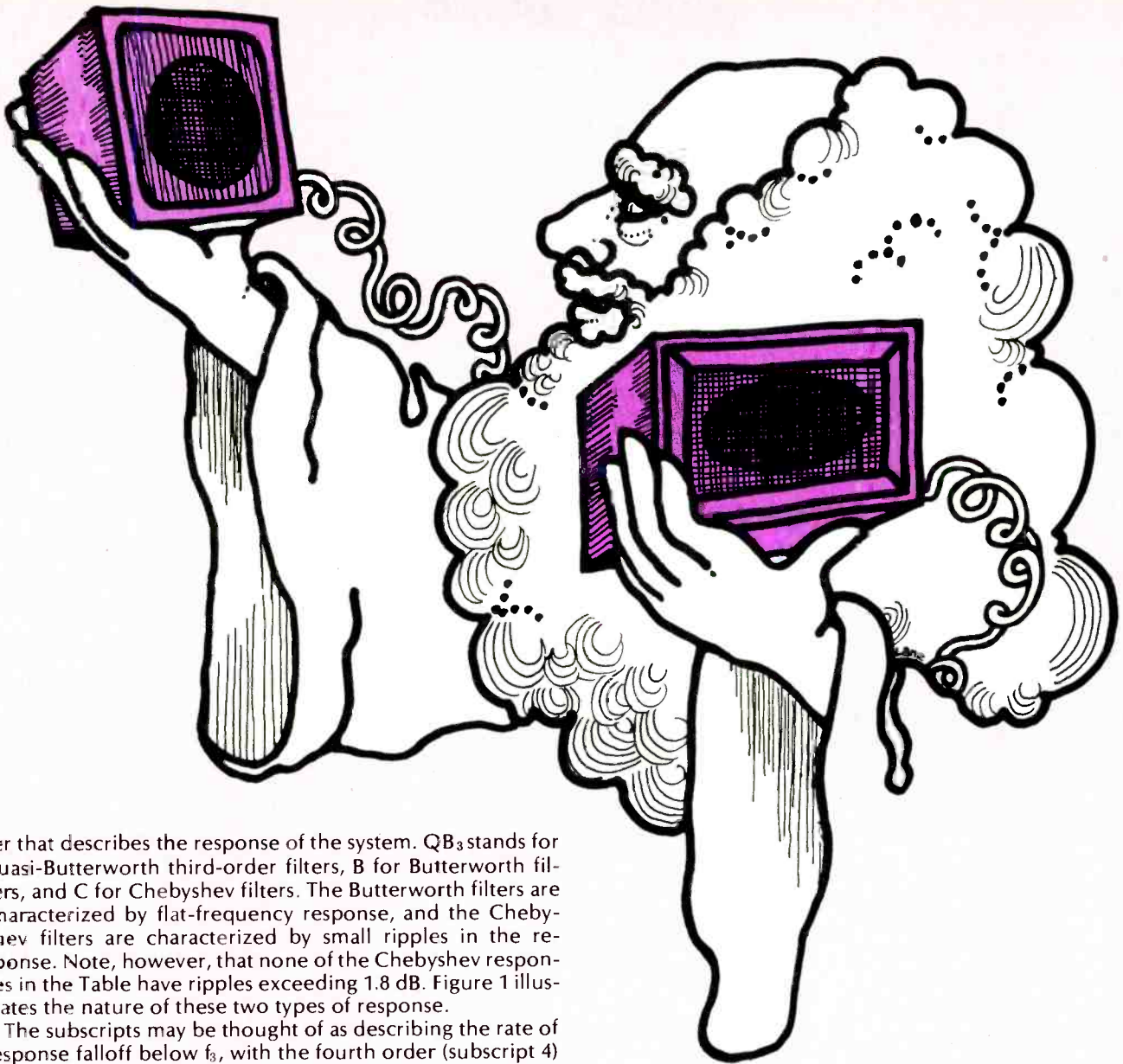

ter that describes the response of the system. QB_3 stands for quasi-Butterworth third-order filters, B for Butterworth filters, and C for Chebyshev filters. The Butterworth filters are characterized by flat-frequency response, and the Chebyshev filters are characterized by small ripples in the response. Note, however, that none of the Chebyshev responses in the Table have ripples exceeding 1.8 dB. Figure 1 illustrates the nature of these two types of response.

The subscripts may be thought of as describing the rate of response falloff below f_3 , with the fourth order (subscript 4) falling off at 24 dB/octave with decreasing frequency, the fifth order at 30 dB/octave, and the sixth order at 36 dB/octave. Note that all the alignments have basic 24 dB/octave falloff rates due to the mechano-acoustic nature of the beast, and that the more rapid falloffs are a by-product of the electrical filters or auxiliary circuits required (i.e., additional electrical rolloffs of 6 dB/octave and 12 dB/octave for fifth- and sixth-order responses, respectively). Additional table notations are as follows:

- f_3 = the 3-dB-down point on the response curve;
- f_s = the speaker's free-air resonance frequency;
- f_b = the frequency at which the box is tuned (a function of box volume, vent area, and length, not of the speaker mechanism);
- C_{as} = the acoustic compliance of the cone suspension system (crudely, how "loose" the suspension is);
- C_{ab} = the acoustic compliance of the volume of air in the box ($C_{cb} = NV_b$, where N is a constant dependent on the measurement system used, and V_b is box volume), and
- Q_t = the speaker's "Q" when connected to the driving amplifier. (This may be thought of as how far down the speaker's response is at free-air resonance relative to its mid-band response in a very large baffle — i.e. $Q_t = 0.5$ means that the response is down 6 dB at resonance.)

With the above definitions in mind, several observations may be made. Note that only three pieces of information (f_s , C_{as} , and Q_t) are needed to completely describe the nature of the speaker mechanism alone (assuming amplifiers with high damping factors) to create a system, and that the complete system calls for three ratios, involving box charac-

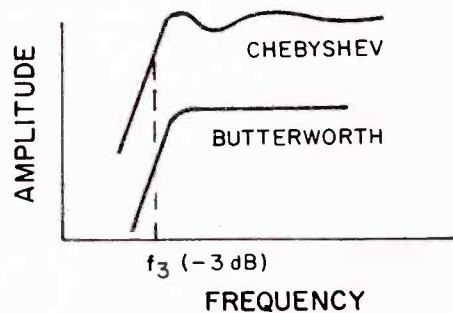

Fig. 1—Nature of Butterworth and Chebyshev filter responses compared.

teristics, low frequency response limit, and speaker characteristics plus the speaker's Q_t to be at specified values for a specific alignment. For a speaker designer, this requires the selection of a specific alignment (because of some desired characteristics it possesses), usually coupled with a selection of low frequency limit (f_3), box size, and speaker diameter, and then careful manipulation of the three speaker characteristics (f_s , C_{as} and Q_t) to satisfy the requirements of the table. In practice, this is a rather complicated matter as the initial selection of alignment type, f_3 , box size, and speaker diameter involve dragging in many external considerations regarding the amount of power the system must radiate, distortion levels, where the system will be used, etc., which are beyond the scope of this article.

As the table of alignments appeared not to be generally known in the U.S. until recently, many, if not most, available unmounted speakers intended for vented boxes have somewhat random characteristics not necessarily tied to specific table alignments. For such random characteristic speakers the moderately large number of table alignments provides the designer a better chance of finding a reasonable (and hopefully usable) alignment for his speaker. Let us instead, however, consider the table from the viewpoint of a thoughtful designer of speakers who has knowledge of the table's existence prior to creating his speakers.

The first item to note in classifying the alignments in the table is that the first nine alignments do not require auxiliary electrical circuitry or equalization, unlike the remaining 19. Of these first 9, numbers 1 thru 4 are characterized by having the system's low frequency limit (f_3) higher than both the speaker's free air resonance frequency (f_s) and the box tuning frequency (f_b). (This appears in the table as entries showing f_3/f_s greater than 1, and f_3/f_b greater than 1, respectively.) In the case of the first four alignments, the table

also implies a speaker considerably more compliant than the air volume in the box (C_{as}/C_{ab} considerably greater than 1) and small Q_t 's if you please (Q_t 's less than .303), which usually implies large magnets. The remaining unequalized alignments (5 thru 9) indicate low-frequency limits at or below the unmounted speaker's free space resonance (f_3/f_s is 1 or less). Also implied here are box tunings at or above the low-frequency limit (f_3/f_b is 1 or less), stiffer speakers relative to the box air volume stiffness (C_{as}/C_{ab} of 1.4 to .485), and more generous Q_t 's (.383 to .557). In alignments 5 through 9, the greatest novelty is their ability to maintain output below the speaker's resonance frequency, although often fairly large boxes are required to do this and rapidly rising cone excursion in the region of f_3 to f_b is a by-product. Some interesting possibilities are presented by these 9 unequalized alignments although I suspect that, like as not, most designers of systems would settle on alignment 5 or one near it.

The remaining alignments (10 thru 28) all require an auxiliary filter. Alignments 10 through 14 can be realized with passive electrical networks, as the networks here have the function of removing a natural low-frequency rise from the response; in other words they "de-hump" the extreme low end of the system's response. Figure 2 illustrates the nature of these responses.

Alignments 15 through 19 can best be realized with active electrical networks. The networks here are required to lift up the extreme low end, as shown in Fig. 3. These alignments have the interesting tradeoff of box volume for some efficiency loss (with flat response restored by the equalizer) at the extreme low end of the system's range. These alignments can permit smallish boxes to have rather low cutoffs (note the moderately large values of C_{as}/C_{ab}). This may be seen by noting the similarities between alignments 4 (an unequalized alignment) and 15 (requiring a lift equalizer).

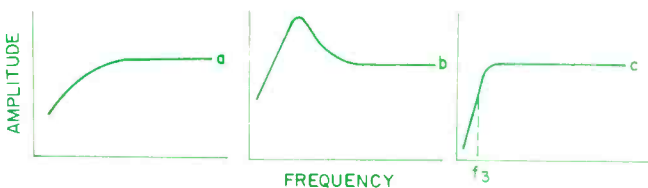

Fig. 2—Nature of response of alignments 10 through 14 before and after addition of the required auxiliary filters.

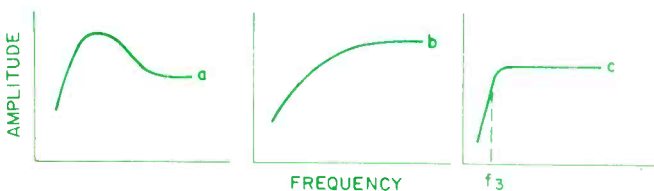

Fig. 3—Nature of response of alignments 15 through 19 before and after addition of the required auxiliary filters.

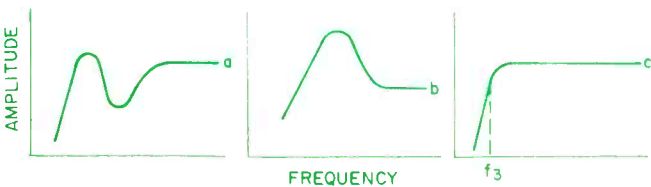

Fig. 4—Nature of the response of alignments 20 through 25 before and after addition of the required auxiliary filters.

Table II— Relationships of low-frequency limit, box size, and efficiency between sealed and vented systems.

LF Limit	Box Volume	Efficiency
Same	Same	4.5 dB greater (or 2.8 times sealed)
Same	About 1/3 of sealed	Same
About 0.7 (1/2 octave) of sealed	Same	Same

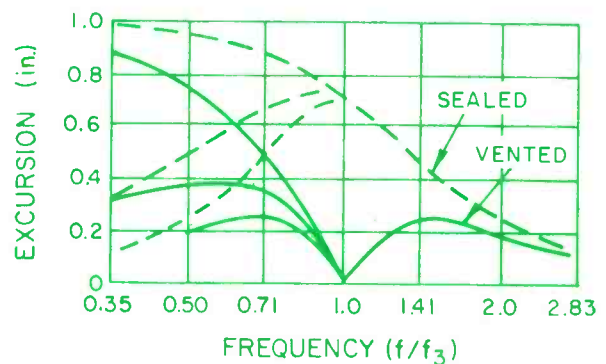

Fig. 5—Cone excursion as a function of frequency for Butterworth-aligned vented systems and for sealed systems, with and without filters (after Thiele).

Tomorrow's Sound Today



the new **UL range** by



Studio quality High Fidelity Loudspeakers

Totally designed and built by England's most experienced loudspeaker manufacturer, the high power handling CELESTION UL range offers audiophile and professional users flatter frequency response and lower distortion than speakers currently labelled "laboratory standard." The new UL range complements the Celestion Ditton Series, world renowned for ultra-wide frequency response, high efficiency, low distortion, and now featuring the new Ditton 33. Celestion UL and Ditton Series provide eight models to surpass the fastidious audiophile's exacting requirements. They are available from a select group of knowledgeable dealers. Write or check reader inquiry card No. 10 for complete specifications and the name of your nearest Celestion dealer.

Sole North American Distributors: **ROCELCO INC.**
160 Ronald Dr.
Montreal, Canada H4X 1M8
Phone (514) 489-6842

Note here that the speaker Q_t values are about the same (around 0.3) and the C_{as}/C_{ab} values are about the same (around 3.0). This would permit taking the same speaker in the same box and altering the vent or box tuning to obtain $f_3/f_s = 1.45$ for alignment 4, or to 1.0 for alignment 15 (with the 6-dB equalization lift for alignment 15). Thus, by using the equalized system, it is possible to decrease the low-frequency limit by a factor of 1.0/1.45, at the expense of a moderate amount of efficiency loss in the extreme bass—fascinating! The odds against coming up with a correct number 15 alignment by splashing around in the swamp of empirical cut and try without Thiele as a guide are vast.

Yet another group of alignments, which can probably be best realized thru the aid of active filters, are numbers 20 thru 25. In these cases, the filters are required to restore an unequalized system-response characteristic that progressively begins to resemble a dip between the low-frequency limit of the system and its mid-frequency response as alignment number 25 is approached. A rough idea as to what is being done is illustrated in Fig. 4.

In general, alignments 20 through 25 progressively tend toward boxes with large air compliance compared to speaker suspension compliance (C_{as}/C_{ab} is 1 or less), which often implies large boxes with the reward being a low frequency limit usually substantially below the speaker's free air resonance, (Alignment 25 has its -3 dB point at about 0.4 f_s —with a moderate filter boost of only 6 dB. Note that the electrical filters employed with these alignments (as well as those employed with the other equalized alignments discussed) progressively cut off electrical input to the speaker system below its low-frequency limit (f_3), which is an aid in reducing low-frequency cone excursion in the region where such excursion gives little fundamental acoustic output (but often appreciable distortion). The conservation of amplifier power below f_3 also tends to make up for the increased amp output required for the boost filters used by most of the alignments 15 to 25 in the range above f_3 .

It is difficult to completely sum up this table of alignments as it contains so many unusual possibilities for vented systems with the most interesting physical realizations of these possibilities often lurking within the f_s 's, f_b 's, and C 's of the tabulation in tantalizing, mind-twisting ways. Some of the gross characteristics of groups of these alignments have been discussed here to illustrate a few of the meanings of the table and pass on the realization of the many possible, often highly sophisticated, ways of dealing with the seemingly simple task of putting a hole in a speaker box.

System Efficiency Relations

A highly significant matter which deals with relationships between several system parameters and efficiency is developed by Thiele. As Small points out in his project note on efficiency (13), several writers have realized the significance of

this (14) (15) (16), but Thiele appears to have been the first to record it in the literature. Knowledge of the way system parameters affect efficiency is quite important since amplifier power, even now, is not unlimited, and a designer has to contend also with the problem of speaker destruction, especially in trying to reach live performance sound pressure levels. Efficiency describes how much electrical power input is needed for a particular acoustic power output. This power output, coupled with the size and characteristics of the listening environment, are what determines pressure levels in the environment. Currently, when home speaker designers are reaching for ever-smaller boxes and also trying to maintain an adequate low frequency limit, a knowledge of when the absurd is being approached or of ways of obtaining the best return from moderate-size boxes would seem important. Thiele shows how to grasp this situation in a usable manner for both vented and sealed enclosures. The relatively simple expression that helps to do this is (17) which can be restated as:

$$E = 16 \times 10^{-12} f_3^3 V_b K,$$

Where E is the conversion efficiency presuming radiation is confined by a large flat surface (or radiation into a half space);

f_3 is the frequency at which the system's output is 3 dB down;

V_b is the internal volume of the box (cubic in.). In the case of sealed systems, this presumes that the stiffness of the air in the box is much greater than the stiffness of the loud-speaker mechanism, and

K is a factor dependent on specific system type—usually 1 to 2 for sealed-box systems, and 3 to 4 for vented, unequalized systems.

This expression is indicative of the efficiency of a system at low frequencies (wavelength greater than speaker circumference), but if good total system design is followed, the efficiency over most of the audible range probably should be less than 3 to 6 dB below this level.

Of interest on first inspection is the powerful effect of f_3 , which is raised to the third power. Thus, cutting f_3 in half means reducing efficiency by 8 times, or 9 dB. Of lesser influence is the effect of V_b , with the implication that every time box size is halved, so is efficiency (i.e., 3 dB). As noted in the definition, the K factor is between 1 and 2 for most sealed-box systems, and between 3 and 4 for most simple vented systems, although values of 9 to 18 are possible for some vented systems requiring auxiliary filters.

Small (18) points out that comparison of a common non-equalized number 5 alignment with a sealed box can yield the conclusions presented in tabular form at the beginning of this article. Having 4.5 dB of additional efficiency available for the same low-frequency limit and box size can be useful when a designer is working near the limits imposed by very low efficiencies—chiefly very large amplifier requirements and danger of electrical burnout. As home systems often tend to maintain excellent low-frequency performance with the smallest reasonable box size (of even greater interest now, with 4-channel systems), the information in the efficiency equation can be put to good use by employing vented systems to decrease f_3 or decrease box size, while maintaining the same efficiency as a closed-box system.

Cone Excursion Considerations

Figure 5 is reproduced from Fig. 10 of Thiele's article (19). Relative cone excursions are illustrated for three cases of sealed-box and three cases of a vented-box of the Butterworth-type alignments. Note the minimum excursion at $f/f_3 = 1$ inherent in the vented system. Cone excursion in real-

Table III—Comparison of output, Cone Diameters, and Cone Excursions of Vented Box and Sealed Box Systems under certain conditions.

f/f_3	Excursion (closed) Excursion (vented)	Increase in output of vented system for same excursion	Increase in dia. of sealed box piston to match output of vented box at same excursion
1.00	Large	Large	Large
1.25	2.80	7.80	1.67
1.41	2.00	4.00	1.41
2.00	1.33	1.77	1.15
3.00	1.12	1.25	1.06

INVISIBLE SOUND, COMPACT AND POWERFUL.

The ADS L710 and L810 are four driver, three way speakers for audiophiles who demand studio performance from a system that is still compact enough for bookshelf placement. These systems share exceptionally wide-range frequency and power response that places them in the small select group of reference quality speakers without demanding the usual penalty of size and price.

We invite you to test them against any high quality speakers regardless of cost. Listen how accurately the virtually massless 1" soft-dome tweeter follows every detail of a solo violin. Notice how uniformly the unique mid-range driver reproduces the subtleties of a familiar voice—no brassy sound ever, instead, unmuffled openness. The 2" soft-dome smoothly radiates nine times as much power into a hemisphere

as a conventional speaker of the same area. Then train your ears on the woofers. They are small in diameter for optimum transient and power response, this extends clarity and detail down into bass. It is elegantly accomplished by two active, perfectly phased drivers with unprecedented lateral excursion. You never before heard a bass drum come so much alive.

Flowless consistency in all these qualities is our uncompromising standard of excellence, and it is built into every model from ADS and BRAUN.

Your local ADS dealer will proudly demonstrate the L710 and L810 in his sound studio. Take the time and test them critically. Take the step beyond transparency. Experience "Invisible Sound." It then will be impossible for you to accept anything less.

ANALOG & DIGITAL SYSTEMS, 377 Putnam Avenue, Cambridge, Massachusetts 02139.

ADS L710



ADS L810

izable systems can be a very small value compared to the higher-frequency excursions at the same output power. It is fascinating to watch the cone become essentially motionless at f_3 while high sound levels are produced by the system. Peak excursion for the vented system is reached at 1.45 times the low-frequency limit, and decreases as f/f_3 continues to increase. In contrast to this, closed-box systems reach their near-maximum excursion values at in-box resonance and show a constant drop with increasing frequency at a given output level.

The differences in the plots below $f/f_3 = 1$ are due to the effects of auxiliary filters being applied in four of the six examples. The particular examples portrayed involve specific, carefully-coordinated, filter-loudspeaker-system combinations chosen for complementary characteristics. The highest excursion curve of a given box type is associated with an unfiltered system, the middle curve requiring use of a first-order filter (6 dB/octave decrease of the electrical input to the system with decreasing frequency below $f/f_3 = 1$) and the lowest curve requiring a second-order filter (12 dB/octave decrease in system input below $f/f_3 = 1$).

Note that low-frequency-cut filters can be applied to any kind of system, but in alignments 10 through 27, the low-cut feature is automatically a part of the required auxiliary filter. (Alignments 10 to 14 specify first-order filters, while 15 through 27 specify second-order filters.) Thiele believes the input-extinguishing action of the filters below the low-frequency limit of the system is desirable, and reasonably so, since the filter action:

A. Conserves available amplifier power by more nearly restricting its use to the part of the low-frequency spectrum that the speaker system is capable of reproducing well, and

B. Reduces distortion caused by the speaker being driven to what would be (without a filter) its largest excursion in a frequency region where acoustic output is becoming rapidly diminished.

Considering the frequencies above $f/f_3 = 1$, a tabulation is shown in Table III for the ratio of cone excursion of a closed-box system to that of a vented-box system, assuming the same output power is available from each. In one column difference in excursion is tabulated, presuming the same available piston size for both systems. A second column translates this excursion to the increase in power output required to bring the excursion of the vented system up to that of the sealed unit. The third column shows the increase in piston diameter of the sealed-box system necessary to match the output of the vented system if the excursion must stay the same. The last column is especially interesting because it illustrates that as the frequency of a Butterworth-aligned vented box approaches three times the low-frequency limit, the vent ceases to function. At low frequencies, the vented system operates as if it were a sealed system with an ever-growing piston size, until at $f/f_3 = 1$ the equivalent piston has grown to immense size. This explanation is appreciably better than the naive concept that, if both sides of the cone were used through venting, the effective substitute speaker would have twice the area (or 1.41 times the diameter). Actually this equivalent substitute speaker would be this size one-half octave above the low-frequency limit, and it would grow rapidly as the limit is approached.

There is a most interesting connection between the substitute speaker matter and the matter of the efficiency increases available through venting. Together these matters imply that f_3 can be pushed lower through venting, or box size further reduced without running out of excursion and/or pushing efficiency into a problem area, if one is satisfied to deal with the excursions presented by current sealed-box systems. Venting also has something to offer if one is concerned about reducing excursion at a given level of size and frequency bandwidth in order to further reduce forms of excursion-related distortion.

Closing Remarks

I have tried to deal with some selected topics from a most elegant and pertinent article in the literature on sound reproduction apparatus. The highlight of Thiele's presentation is the tabulation of 28 ways of designing a vented-box system and doing it properly every time. Topics dealing with efficiency and excursion were singled out as having special importance in discussing what in vented systems is different and significant from the more normal sealed-box type of direct radiator system. Cone excursion is important, as only so much is available and many forms of distortion are associated with it, but it is the connection between required acoustic output levels and the movement of the speaker cone. Efficiency is also significant as it is the connection between required acoustic output levels and the movement of the speaker cone. Efficiency is also significant as it is the connection between acoustic output and electrical input requirements and intimately involves the effects of box size, low frequency system limits, and system type.

The vented system is certainly not new, but it is a format often handled at less than full potential when chosen. To some extent, this may be a reflection of its relative com-

Table IV—Summary of Vented-Box Alignments, after Thiele.

Alignment Details		Box Design				Aux. Ckts. Required
No.	Type	f_3/f_5	f_3/f_b	C_{as}/C_{ab}	Q_t	
1	QB ₃	2.68	1.34	10.48	.180	no
2	QB ₃	2.28	1.32	7.48	.209	no
3	QB ₃	1.77	1.25	4.46	.259	no
4	QB ₃	1.45	1.18	2.95	.303	no
5	B ₄	1.000	1.000	1.414	.383	no
6	C ₄	.867	.935	1.055	.415	no
7	C ₄	.729	.879	.729	.466	no
8	C ₄	.641	.847	.559	.518	no
9	C ₄	.600	.838	.485	.557	no
10	B ₅	1.000	1.000	1.000	.447	yes
11	C ₅	.852	.934	.583	.545	yes
12	C ₅	.724	.889	.273	.810	yes
13	C ₅	.704	.882	.227	.924	yes
14	C ₅	.685	.877	.191	1.102	yes
15	B ₆	1.000	1.000	2.73	.299	yes
16	C ₆	.850	.868	2.33	.317	yes
17	C ₆	.698	.750	1.81	.348	yes
18	C ₆	.620	.698	1.51	.371	yes
19	C ₆	.554	.659	1.25	.399	yes
20	B ₆	1.000	1.000	1.000	.408	yes
21	C ₆	.844	.954	.722	.431	yes
22	C ₆	.677	.917	.500	.461	yes
23	C ₆	.592	.902	.414	.484	yes
24	C ₆	.520	.890	.353	.513	yes
25	C ₆	.404	.876	.276	.616	yes
26	B ₆	1.000	1.000	.732	.518	yes
27	C ₆	.778	.911	.110	1.503	yes
28	QB ₃	.952	.980	1.89	.328	yes

Today, the sky's the limit on what you can spend. So Philips' down to earth advice could help you make the right choice.

Suppose you're a true audio aficionado. Philips presents the most automated and technologically advanced turntable ever made. The GA 209.

The electronic 209 is the only turntable with three DC motors. One cues the tone arm. The second transports it. The third, a DC servo motor/tacho generator spins the platter.

The 209 makes listening to great music easy. Just place a record on the platter and walk away. The 209 takes over. It even measures the record size for accurate cueing and automatically selects the correct speed.

While the record is spinning, the tacho generator instantly corrects for power fluctuations, record mass,

styles mass and dust bugs so that wow, flutter, and drift virtually do not exist.

The precision ground drive belt gives you the added advantage of filtering out motor rumble.

Then, after the record is over, the 209 returns the tone arm and shuts itself off.

If you enjoy cueing a record yourself and getting performance that surpasses many broadcast tables, the Philips GA 212 will fit your system. It has the one feature that all better turntable manufacturers agree on. A DC servo motor/tacho generator drive system. Yet, the 212 is the least expensive turntable with this important performance factor. It virtually guarantees accurate turntable speed, so audio problems like wow and flutter are almost non-measurable.

Inside, the 212 is completely solid-state. There's nothing moving. That means there's nothing to make noise—either mechanical or electronic. Plus the 212 has professional feather touch, lighted controls.

If you're more interested in a turntable that gives a maximum of performance matched with a minimum of operating involvement, choose the Philips GA 427.

Move the tone arm over the lead-in groove, the platter starts spinning. Cue down with the hydraulic control, the 427 takes over. Its low speed 24 pole synchronous motor and precision drive belt means wow, flutter, and rumble are insignificant.

When the record is over or when you change your mind (there's a play interrupt feature) the 427 will return the tone arm and turn itself off. All Philips turntables include base and removable dust covers.

Philips turntables give you a meaningful difference between models. Visit your better audio shop. Then consider the Alternatives.

PHILIPS AUDIO VIDEO SYSTEMS CORP.
AUDIO DIVISION
91 McKee Drive, Mahwah, N.J. 07430

Check No. 26 on Reader Service Card

Alternative tables.

Philips gives you three ways to turn. Automatic, Electronic, Automated-Electronic.



PHILIPS[®]
TM NV Philips Holland

plexity of design and operation and also a need for more information on what it can do and how to make it "do" properly. Thiele's article is certainly a most definitive statement in these respects.

Thiele's work has provided the theoretical groundwork for at least two commercially-available loudspeaker systems in recent years: *Interface: A* and *Sentry III*, both manufactured by Electro-Voice, Inc. Thiele's paper also was the basis, by way of Small, for a construction project by Messrs. Lampton, Chase, and De Vries in the December, 1973, and August, 1974, issues of this magazine.

References

- (1) Thiele, A.N.; "Loudspeakers in Vented Boxes: Part I," *Journal of the Audio Engineering Society*, Vol. 19, No. 5, May, 1971, pp. 382-392.
- (2) Thiele, A.N.; "Loudspeakers in Vented Boxes: Part II," *J.A.E.S.*, Vol. 19, No. 6, June 1971, pp. 471-483.
- (3) Thiele, A.N.; "Loudspeakers in Vented Boxes," *Proceedings of the IRE Australia*, Vol. 22, Aug. 1961, pp. 487-508.
- (4) Ashley, J.R.; Postscript to "Loudspeakers in Vented Boxes," *J.A.E.S.*, Vol. 19, No. 6, June 1971, p. 516.
- (5) Small, R.H.; "Efficiency of Direct-Radiator Loudspeaker Systems," *J.A.E.S.*, Vol. 19, No. 10, Nov. 1971, pp. 862-863.
- (6) Ashley, J.R.; "Efficiency Does Not Depend on Cone Area," *J.A.E.S.*, Vol. 19, No. 10, Nov. 1971, pp. 863-865.
- (7) Small, R.H.; "Simplified Loudspeaker Measurements at Low Frequencies," *J.A.E.S.*, Vol. 20, No. 1, Jan./Feb. 1972, pp. 28-33.
- (8) Keele, D.B.; Jr., "The Vented Loudspeaker: A Restatement," *J.A.E.S.*, Vol. 21, No. 4, May, 1973, pp. 246-255.
- (9) Newman, R. J., "A Loudspeaker System Design Utilizing a Sixth-Order Butterworth Response Characteristic," *J.A.E.S.*, Vol. 21, No. 6, July/August, 1973, pp. 450-456.
- (10) Thiele, A.N.; "Loudspeakers in Vented Boxes: Part II," *J.A.E.S.*, See equation #77, p. 472.
- (11) Small, R.H.; Op. cit. 5, above.
- (12) Thiele, A.N.; "Loudspeakers in Vented Boxes: Part I," *J.A.E.S.*, See Table I, p. 388.
- (13) Small, R.H.; Op. cit. 5, above.
- (14) Jordan, E.J.; "Loudspeaker Enclosures," *Wireless World*, Vol. 76, No. 1423, Jan. 1971, pp. 2-6.
- (15) Kloss, H.; "Loudspeaker Design," *Audio*, Vol. 55, No. 3, March 1971, pp. 30-32, 56.
- (16) Finegan, J.D.; "The Inter-Relationship of Cabinet Volume, Low Frequency Resonance, and Efficiency for Acoustic Suspension Systems," presented May 5, 1970, 38th Convention of the AES, Los Angeles.
- (17) Thiele, A.N.; Op. cit. 10, above.
- (18) Small, R.H.; Op. cit. 5, above.
- (19) Thiele, A.N.; "Loudspeakers in Vented Boxes: Part I," *J.A.E.S.*, (See Fig. 10 and equations (81) and (84), pp. 472 and 473).

AUDIO CROSSWORD

So you know your audio terminology! You say you like crossword puzzles? Herewith *Audio* presents its first *Audio Crossword*. Next time we'll give you a really tough set of terms to fill in. Answers to this one are on page 79. Good luck!

Across

1. Connecting wires; _____ cords.
4. Column in this magazine; Audio _____.
5. The Authoritative Magazine About High Fidelity.
7. Two separate signals from two speakers.
9. Jacks from which signals leave (plural).
12. A function switch _____ selector.
14. Name for 10½-in. tape reels.

Down

1. Common name for RCA (audio) plugs and jacks.
2. Individual part of tape, which carries one sound signal.
3. Erase, Record, and Playback parts of tape machine.
4. Tape in an 8-track cartridge is _____.
6. Man who invented a noise reduction system.
8. Volume Units.
9. Units of resistance.
10. Total Harmonic Distortion.
11. Whole _____, or semi _____; pitch.
13. Initials of editor of 5 across.

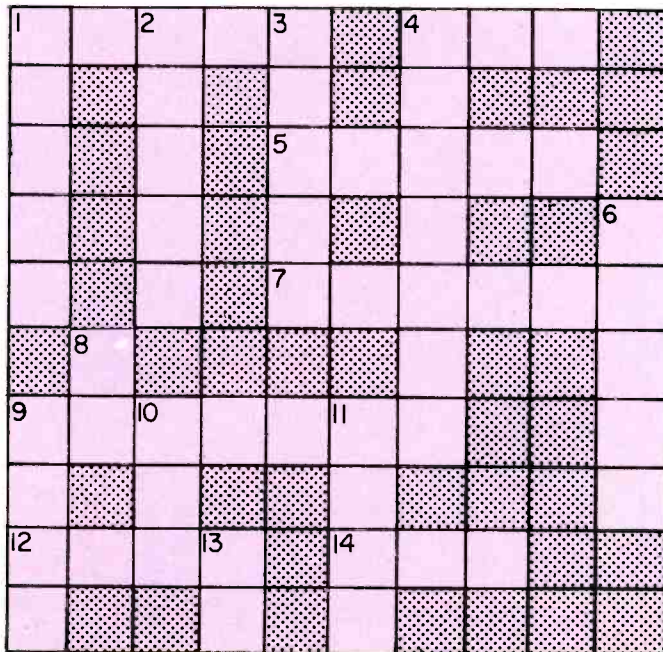



Your experience has taught you
the things that make a FINE microphone.
Now treat yourself to a
test experience with the FINEST.

ASTATIC 800 SERIES
CARDIOID AND OMNIDIRECTIONAL
MICROPHONES

Ask your nearest Astatic Distributor or
write direct for a trial installation.

THE BIGGEST NAME IN
PHONO CARTRIDGES, NEEDLES, MICROPHONES



THE ASTATIC CORPORATION / Conneaut, Ohio 44030 U.S.A.
In Canada: Canadian Astatic Ltd., Scarborough, Metro Toronto, Ontario
Export Sales: Morhan Exporting Corp., 270 Newton Road, Plainview, New York 11803, U.S.A.
Check No. 3 on Reader Service Card

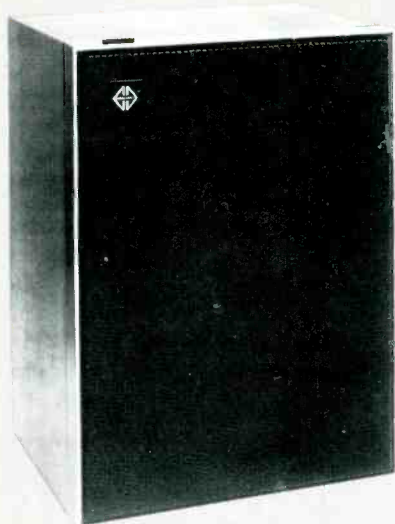

Philips RM532



LWE 15



Andante 3A

Motional Feedback in Loudspeakers

George W. Tillett

A BIG PROBLEM loudspeaker designers face today is the difficulty of producing good bass response from a small system. As the enclosure size decreases, the air inside becomes stiffer, which tends to restrict cone motion and force the system resonance higher. For example, an 8-in. speaker with a free-air resonance of 25 Hz might have a resonance as high as 130 Hz in a one cubic foot closed box. This generally means that the low frequencies will be distorted, and what bass is produced will be colored. System resonance is determined by the cone diameter, magnetic field, moving mass, suspension, and the stiffness of the air spring. Thus, the designer can either trade efficiency for bass by using some kind of mass loading, he can use a smaller cone, which might increase the intermodulation distortion (and probably cost more due to the increased magnet size), or he can opt for a vent. This vent can take the form of a tube or duct, but it too must be very carefully designed or it can make matters worse! Alternatively the designer could put the loudspeaker inside the amplifier feedback loop where the distortion could be reduced and the resonances controlled. This concept is called Motional Feed Back, or MFB.

Most engineers believe that when negative feedback was

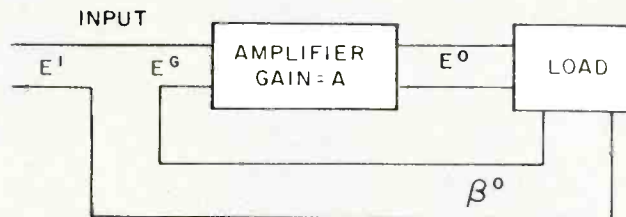

Fig. 1—Block diagram of a system with negative feedback.

found to improve the performance of amplifiers, loudspeaker designers then began to wonder how the same principle could be applied to reduce the distortion produced by loudspeakers. One might think so, since amplifier feedback was invented a long time ago, but as Josh Billings would say, it just ain't so. Although Black and Blumlein were working on amplifier feedback in 1934 (1), Hanna had filed a patent for a system of servo (motional feedback) to control the response of a balanced armature speaker some 10 years earlier (2). During the next 20 years, many articles on motional feedback were published, and the problems were well summarized by Olson (3) in 1940.

In simple terms, negative feedback means that a portion of the output of an amplifier is fed back in opposite phase, thus reducing the overall gain as well as canceling some of the non-linearity (distortion). Figure 1 shows a block diagram of an amplifier with a feedback loop. The gain of the amplifier is A, thus:

$$A = \frac{E^0}{EG}$$

If the feedback is applied and the input voltage increased to E^1 —making up for the loss in gain, then it follows that:

$$A_{fb} = \frac{E^0}{E^1} = \frac{E^0}{EG - \beta E^0}$$

The gain reduction due to feedback is therefore:

$$\frac{A}{A_{fb}} = \frac{E^0/EG}{E^0/(EG - \beta E^0)} = 1 - \frac{\beta E^0}{EG} = 1 - \beta A$$

The quantity $1 - \beta A$ is called the feedback factor and is usually expressed in dB. Thus, to say an amplifier has 20 dB of feedback means that the feedback loop has reduced the

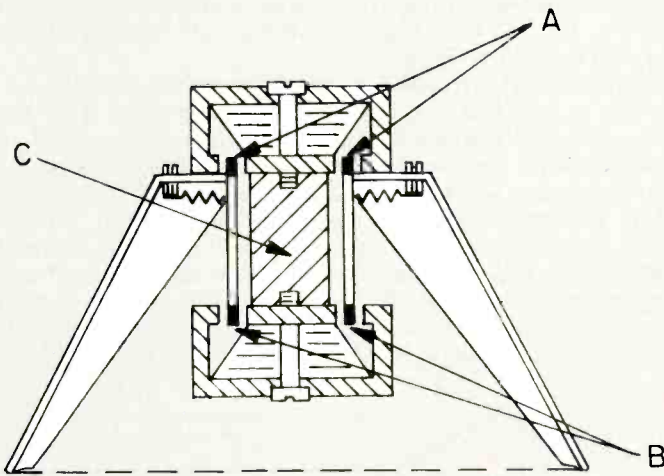

Fig. 2—The Gogny twin voice coil loudspeaker. A is the driven coil and B is the pickup coil. C is made of non-magnetic material and serves only as a mounting piece.

gain by 20 dB or a factor of 10. If the amplifier has been well designed, then the distortion will have been reduced by a similar amount.

The question is, how to put the loudspeaker inside the feedback loop? Well, there are three methods commonly used. The first uses a separate voice coil to produce the feedback voltage (or current); the second uses a transducer to pick up the output signal, and the last takes a feedback "error" signal from a bridge or other network connected to the loudspeaker.

Applications of MFB

Figure 2 shows a loudspeaker with twin voice coils developed by Gogny in France, patented in 1954. As might be expected, there are a number of problems associated with this kind of construction. The pickup assembly must be kept small to avoid irregularities in the cone radiation, and the electrical coupling between the coils must be kept at minimum. The Gogny speaker had a very short voice coil, measuring only 8 mm (5/16 in.) with a diameter of 1½ in. The cone size was 12 in. and the servo control could only function up to the frequencies at which cone breakup occurred. In this case, the crossover point was 800 Hz, and the cone acted

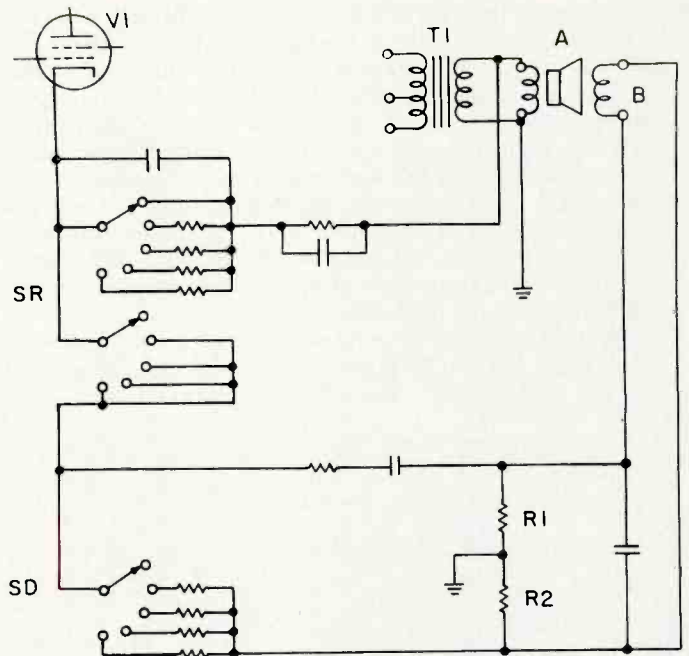

Fig. 3—MFB circuit used in the Matsushita amplifier. A is the driven coil, B is the pickup coil which provides the feedback signal. T1 is the amplifier output transformer.

more or less like a piston below that frequency. I heard this hybrid servo system several times at the Gogny plant in Paris and was most impressed with the clean bass and overall clarity.

About the time Gogny was carrying out his experiments, or possibly even earlier, Naraji Sakamoto, of the giant Matsushita company in Japan, also evolved a practical double voice coil loudspeaker. The driven coil was about 1½ inches in diameter and the pickup coil was one inch in diameter. Cone size was 8-in. and, as in the Gogny system, feedback was used only up to 800 Hz. Conventional crossovers were employed with a 3-in. midrange unit plus a 2-in. horn tweeter. The enclosure size was 0.83 cubic ft., and Fig. 3 shows the basic circuit used in the companion amplifier. T1 is the amplifier output transformer, and signals from pickup coil B are taken via two paths to switch SD, with another loop taken from driven coil A. Note the two resistors, R1 and R2, giving a combination of negative and positive feedback, an arrangement often used in amplifiers to obtain zero output

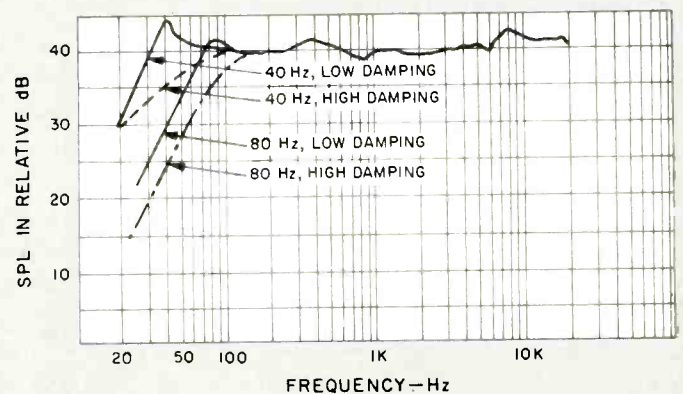

Fig. 4—System resonance and damping in the Matsushita amplifier. Two resonant frequencies, 80 Hz and 40 Hz are shown, each with high and low damping.

impedance in the days when this was thought desirable. The feedback loops are taken to the cathode of a pre-driver tube and control SD will affect the damping, while twin control SB changes the speaker system resonance as shown in Fig. 4. Two extremes are shown, 40 and 80 Hz system resonances, each with high, and with low damping. Although Sakamoto seems to emphasize the importance of resonance control and critical damping to get good bass from a small enclosure, the MFB arrangement also reduces distortion, as can be seen in Fig. 5. Here an 8-in. speaker with MFB is compared to a similar unit without feedback, in terms of second and third harmonic distortion.

The same loudspeaker was used with several other amplifier systems, but the MFB circuitry was simpler, although at least two had bass-lift controls in the feedback loop.

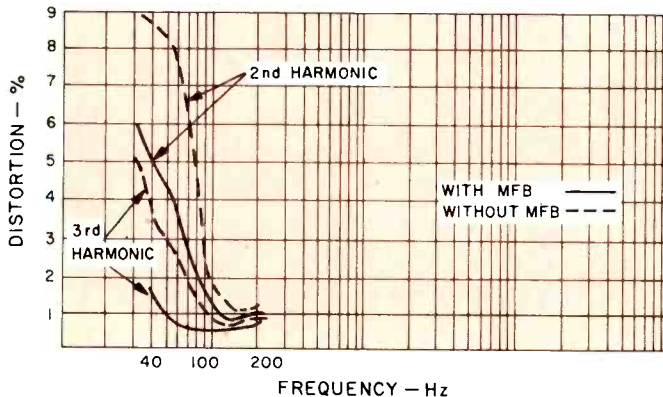

Fig. 5—Second and third harmonic distortion of Matsushita speaker, with and without MFB.

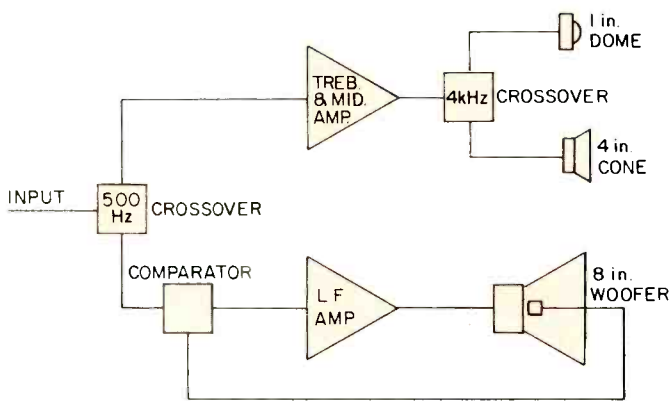

Fig. 6—Block diagram of the Philips RH-532.

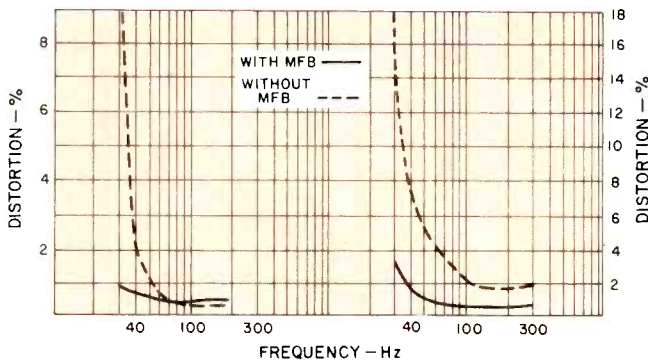

Fig. 7—Distortion of the Philips 8-in. cone (left) and distortion of the 3A speaker (right), each shown with and without MFB.

Feedback Via Piezo Material

Now for a look at the transducer method (4) of MFB—the most successful being the Philips system developed by Klaassen and de Koning (5) about 7 years ago in Holland. The present system (reviewed in our April, 1975 issue) consists of three loudspeakers all housed in a small enclosure measuring only 15 in. H. × 11 in. W. × 8 in. D. The bass speaker has an 8-in. cone, and it crosses over to a 5-in. midrange unit at 500 Hz, with a 1-in. dome taking over at 4 kHz. These speakers occupy only 550 cubic inches, while the rest of the space is taken up by a 40-watt low-frequency amplifier plus a 20-watt unit for the treble and midrange. Truly a case of *multum in parvo!* The transducer used for feedback is really an accelerometer—a disc of piezo-electric material mounted on the loudspeaker voice coil together with a tiny pre-amplifier. The voltage generated is proportional to the mechanical movements of the cone, which are compared to the input signal by the comparator as shown in Fig. 6. The two signals are 180 degrees out of phase and distortion is reduced considerably, as shown in Fig. 7. This acceleration feedback effectively increases the apparent mass of the moving system so the resonance is brought down. The system resonance is lowered by the use of MFB in this case to 35 Hz. This is a dramatic improvement, for without MFB it would increase to 75 Hz!

The third system of MFB is sometimes called velocity feedback, as it makes use of the back emf generated by the speaker voice coil due to its motion in the magnetic field. In other words, the speaker acts as a microphone, and at resonant frequencies, where the cone movement is larger than the applied signal, an error signal is generated. This has to be separated from the applied signal and there are several ways to do this. A bridge circuit is often used (6) and Fig. 8 shows an example. Connected in series with the loudspeaker is network Z_e whose phase angle is equal to the impedance of the loudspeaker in the blocked state. The difference

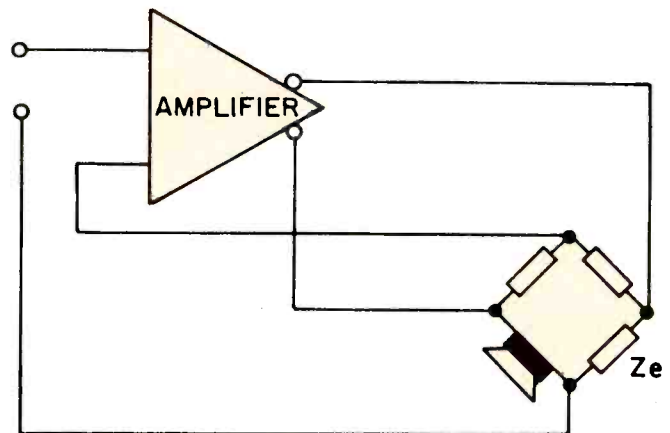

Fig. 8—Typical bridge MFB circuit. Z_e is equivalent to the impedance of the speaker in blocked state.

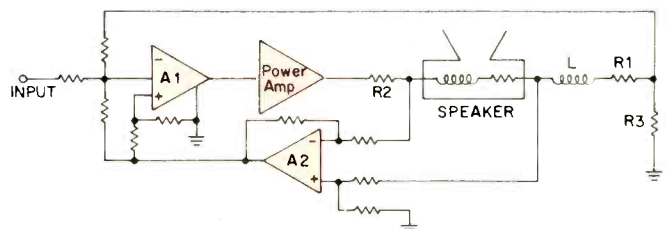

Fig. 9—MFB circuit developed by NASA. L1, R1, and R3 form the sensing network.



sound as clear as light

Experience a clarity of sound beyond anything you've heard from loudspeakers rooted in past technology — the sound as clear as light of ESS Heil air-motion transformer speaker systems

ONLY the ESS Heil air-motion transformer diaphragm can, alone, accelerate air to a speed more rapid than its own moving surfaces. Instantly. Accurately. Cleanly.

ONLY the ESS Heil air-motion transformer has been acclaimed around the world as the first really new air-moving principle in five decades.

ONLY the ESS Heil air-motion transformer is the loudspeaker of the future, free from bondage to cones, domes, voice coils, mass and inertia.

When a revolutionary new principle recreates the excitement and grandeur of an original performance with a clarity and dynamic power never experienced before, technical arguments aren't necessary. Hear the new ESS standard of excellence yourself. Visit a franchised ESS dealer, one of a handful with the courage to premier the most advanced state-of-the-art designs in high fidelity — the ESS Heil air-motion transformer. Listen to ESS, you'll hear sound as clear as light.

Illustrated left to right are the ESS amt 1 Tower, amt 1, amt 3 and amt 5 — four of six ESS Heil air-motion transformer loudspeaker systems. Sound as clear as light for every requirement.



ESS, inc.

9613 oates drive • sacramento, ca. 95827

ESS products are available in CANADA through ESS CANADA

Announcing
The speaker that
INFINITY'S



wasn't made to sell.

SERVO STATIK 1A

Not very long ago, before Infinity Systems was Infinity Systems, it was a small group of extremely dissatisfied, conceptually exotic, pighead-stubborn aerospace-physicist/music freaks in a garage.

Our dissatisfaction was with the sound and inherent distortion in *all* existing speakers.

Our exotic concepts promised an entire new technology of audio electronics.

And our obstinate nature made us push those Lorelei theories into a unique realization: the Servo Statik 1.

We developed the Servo Statik for one reason—to create the world's finest medium of audio reproduction, regardless of cost. For ourselves, really.

We figured we could then use this new proprietary technology primarily as a reference standard—a benchmark technology, enabling us then to create a popular-priced line of vastly superior-sounding speakers. We didn't figure people would actually line up to buy the appallingly expensive Servo Statik 1.

We were wrong.

The mystique grew. And so did Infinity.

Now we are announcing the Servo Statik 1A. Without fear

of contradiction we

can state that no speaker

ever made is as

distortion-free, as accurate, as capable of as wide a dynamic range and as great a frequency response as the Servo Statik 1A.

The system consists of two electrostatic screens which produce tones from 70 Hz to 40 kHz, a separate bass cube producing tones from 15 to 70 Hz and a servo bass amplifier/electronic crossover.

Its 15 Hz to 40,000 Hz power bandwidth means it produces the full sonorities of the 64 foot diapason (the largest pipe of a cathedral organ) as well as the inaudible but vitally important orchestral overtones.

Its 114 dB peak sound pressure levels means it can fully reproduce the transient peak of every section in the symphony orchestra, the full volume of a concert grand piano in the same room, or the raging, raunchy thrust of the most punching rock sound.

Its midrange and high frequency electrostatic modules are angled to provide horizontal and vertical dispersion—creating a life-breathing concert-hall ambience that is unrivalled.

Its separate Brazilian rosewood veneer bass cube houses an 18" woofer with a 35 lb. magnetic circuit and a motion sensor as the heart of its servo mechanism system. The servo woofer, driven by its own 150 watt RMS DC servo amplifier, generates unparalleled distortion-free bass reproduction; articulate, tight and accurate.

Its electronic crossovers with high voltage FETS, and crossing over at 70 Hz and 2,000 Hz, provide perfect phase linearity over the entire musical spectrum.

In its unprecedented homogeneity and musicality, the Servo Statik 1A is a staggering achievement.

It costs \$3,200.

Yet you don't have to spend \$3,200 to get typical Infinity clarity, transparency and depth of sound.

As we said, one of our objectives in conceiving the Servo Statik 1A was to develop a benchmark technology for a more "realistically" priced line of speakers.

The result? Every Infinity speaker, from the POS II at around \$100 to the Monitor II at about \$450, has achieved superlative reviews from leading testing labs and audio reviewers.

Very soon Infinity will top these technological achievements by introducing the DSP Switching Amplifier™—not just a new amplifier, but a new *concept* of amplification; an esoteric technology that will have far-reaching effect in the audio and music industries.

We've restricted sales of the Servo Statik 1A to a select family of dealers. Drop us a note and we'll be happy to tell you the Infinity dealer nearest you.

We hope you'll treat yourself to the experience of listening to the Servo Statik 1A. Or any Infinity speaker.

You'll discover a totally new phenomenon: live music without the musicians.

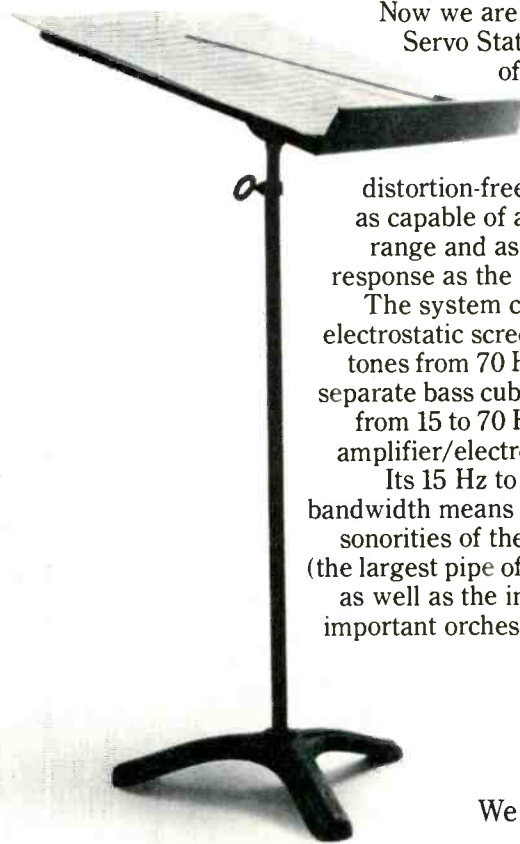

 Infinity

We get you back to what it's all about. Music.

voltage is then applied as feedback (7,8). In a more elaborate version developed by the Ames Research Center of NASA (Fig. 9), a sensing network is formed by L, R1, and R3; the speaker voice coil is shown as a lumped inductance with internal resistance.

Velocity MFB systems are also used by LWE, the French company 3A, and the Belgian firm Servo-Sound. The last-named company also uses a non-linear-feedback arrangement to boost the bass at low listening levels. The French firm calls their system Acoustic Pressure Feedback. It has a 10-in. bass unit with a 4-in. midrange and a 2-in. horn tweeter. The built-in amplifier has an output of 125 watts and is housed in the speaker enclosure. The system measures a mere 18-in. H. \times 12-in. W. \times 7½-in. D. A bridge circuit is used to derive the feedback voltage. At 30 Hz, the bass cone moves nearly one-half inch with input of only five watts sine-wave power. The distortion characteristics are given in Fig. 7. The bass unit crosses over to the 4-in. unit at 400 Hz, and the crossovers are built-in. Provision is made for a separate 20-watt amplifier for the treble and midrange. These 3A systems are now available in Canada and will be sold here in the near future.

The LWE loudspeaker systems were designed by L.W. Erath and are now marketed by CM Laboratories, Inc. Unlike the 3A system, the LWE servo-control extends over the entire audio spectrum, with one element in the sensing network variable to permit some modification of the bass response. This variable element is called "Room Gain Control," and it has five switched positions. The largest system in the LWE line uses a 15-in. bass speaker, a 6-in. midrange, and two tweeters, while the smallest, Model 10, is a book-shelf system with a 10-in. woofer and a 2-in. tweeter. All these systems are available separately but if they are not

used with a CM amplifier the connections inside the amplifier would have to be made by a technician.

Summary

With the growing popularity of quadraphonic sound and the consequent emphasis on small loudspeaker systems, MFB would seem to provide some of the answers to the inherent space problems. I am sure we will see more high quality compact systems with built-in amplifiers with MFB in the not too distant future. If only an MFB system could be devised that would provide complete room correction too...!

References

1. H.S. Black, "Stabilised Feedback Amplifiers," *Electronic Engineering Handbook*, 1934.
2. C.R. Hanna (Westinghouse), U.S. Pat. 1,645,282 (filed 1924), granted 11 Oct. 1927.
3. H.F. Olson, *Acoustical Engineering*, D. Van Nostrand, Princeton, N.J., 1940.
4. H.W. Holdaway, "Design of Velocity Feedback Transducers," *Transactions IRE*, Sept. 1963.
5. J.A. Klaasen and S.H. de Koning, "Motional Feedback with Loudspeakers," *Philips Technical Review*, 1968, No. 5. Also E.R. Hanson, "A Motional Feedback Speaker System," AES Preprint No. 924.
6. D.T.N. Williamson, "More Views on Loudspeaker Damping," *Wireless World*, Dec. 1947.
7. H.H. Lowell, "Motional Feedback," *Electronics*, Dec. 1951.
8. E. de Boer, "Theory of Motional Feedback," *Transactions IRE*, Jan. 1961.

Magneplanar[®] Tympani

**THEORETICALLY SOUND
MUSICALLY ACCURATE**

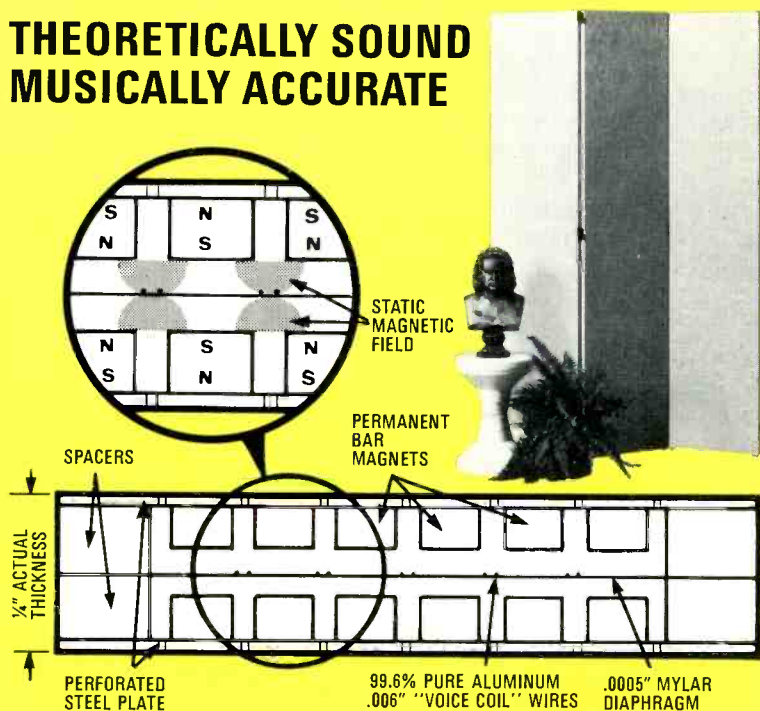

Cross-section Tympani IIIA and Tympani IB Tweeter

The MAGNEPLANAR Tympani, based upon proven concepts, is an important advancement toward the theoretically perfect speaker.

Low-mass Mylar diaphragm with controlled tension provides critical damping.

Low diaphragm breakup.

No speaker cabinet to cause resonance, loading problems, or transient degradation.

Linear power response—no compression of dynamic range.

8 ohm power amplifier load throughout the audio range with essentially no inductive or capacitive reactance.

High power handling.

No high voltage or arcing problems.

Not sensitive to humidity, temperature or dust.

Efficiency: 10W RMS, 500 Hz, 97 dB at 6 feet (Tympani III A).

Sound theory... unsurpassed musical accuracy. Visit your Audio Research dealer today.

**audio research
corporation**

Box 6003B Minneapolis, Minnesota 55406

Tel: (612) 721-2961

© Magneplan, Inc.

Equipment Profiles

JVC 4VR-5426X 4/2-channel FM/AM Receiver



MANUFACTURER'S SPECIFICATIONS

FM Tuner Section

IHF Sensitivity: 2.2 μ V. **50 dB Quieting:** 3.0 μ V. **S/N Ratio:** 68 dB. **Selectivity:** 60 dB. **Capture Ratio:** 2.0 dB. **AM Suppression:** 50 dB. **Image Rejection:** 55 dB. **I.f. and Spurious Rejection:** 80 dB. **THD:** Mono, 0.5%; stereo, 0.8%. **Muting & Stereo Threshold Level:** 2.2 μ V. **Frequency Response:** 20 Hz to 15 kHz \pm 1 dB.

AM Tuner Section

IHF Sensitivity: 30 μ V, internal antenna; 200 μ V/m, external.

S/N Ratio: 55 dB. **Selectivity:** 30 dB. **Image Rejection:** 45 dB. **I.f. Rejection:** 50 dB.

Amplifier Section

Power Output: 13 watts/channel continuous power from 20 Hz to 20 kHz at 4 or 8 ohms, 4-channel operation (15 watts from 40 Hz to 20 kHz); 30 watts per channel, 8 ohms, 2-channel operation, from 20 Hz to 20 kHz (32 watts from 40 Hz to 20 kHz). **THD:** 1.0% at rated output; 0.1% at half rated output. **IM:** 1.0% at rated output; 0.2% at half power. **Damping Factor:** 30 at 8 ohms. **Input Sensitivity:** *Phono*, 1.5 mV; *AUX and Tape*, 200 mV. **S/N Ratio:** *Phono*, 65 dB; *AUX and Tape*, 75 dB. **Tone Control Range:** Bass, \pm 10 dB at 100 Hz; treble, \pm 10 dB at 10 kHz. **Loudness Control:** +12 dB @ 50 Hz; +6 dB @ 10 kHz.

General Specifications

Dimensions: 18-3/4 in. W. x 6-3/8 in. H. x 15-3/8 in. D. **Price:** \$399.95.

Japan Victor Company is, as most everyone knows, responsible for the introduction of the CD-4 discrete record in Japan and, in partnership with RCA in this country, has been actively promoting that 4-channel disc format. It is no surprise, therefore, that the company's line of high fidelity receivers (from highest-priced models to this relatively low-cost unit) should include full demodulating facilities for CD-4 record playback. Bowing to demands for universality, the 4VR-5426X also includes matrix decoding for SQ-encoded records and other matrix-encoded discs such as RM and QS, though these facilities are by no means as sophisticated as those found on more expensive units which employ various forms of logic separation-enhancement circuitry.

The front panel of the receiver is designed along fairly conventional lines. The upper section includes a blacked-out dial panel, which becomes illuminated when power is applied. Restricted to one tuning meter for reasons of economy, JVC wisely chose to have that meter (at the left of the dial scale) act as a signal-strength meter in AM, but as a center-of-channel tuning meter in FM. The FM dial scale is linear, and there is a logging scale between the AM and FM numerals to permit easy referencing of favorite stations. To the right of the dial scale are the usual stereo indicator light and the increasingly popular (on 4-channel equipment) "radar" light, which glows when CD-4 records are played. A good-sized tuning knob is located at the right of the dial area.

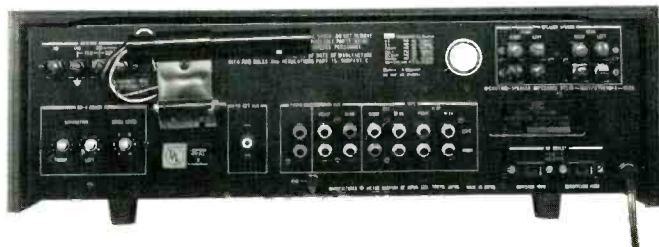

Fig. 1—Back panel of the 4VR-5426X.

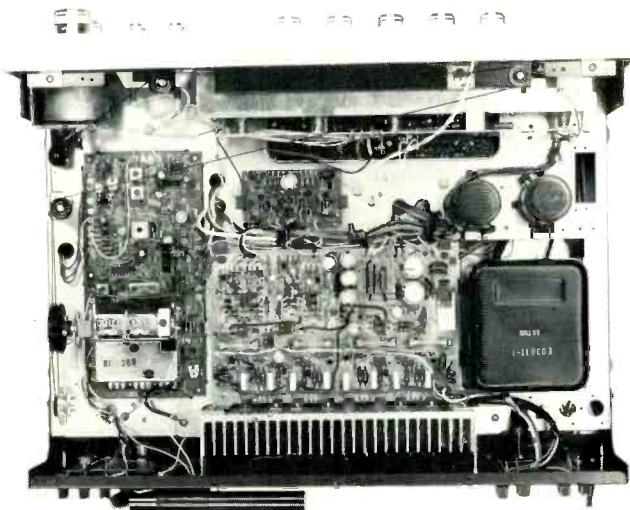

Fig. 2—Internal view.

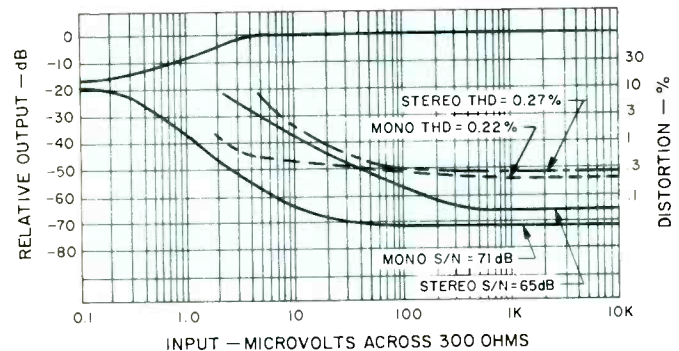

Fig. 3—FM quieting and distortion characteristics.

Controls located along the lower, gold-colored section of the front panel include a lever-style power on/off switch, a speaker switch (which determines whether the receiver is to be operated in its "bridged" 2-channel mode or in 4-channel, since only one quartet of speakers can be connected to the unit), bass and treble controls, a mode switch (with positions for 2-channel, 4-channel discrete or matrix playback), a program source selector switch, four small, individual-channel level controls, and a master volume control. A pair of phone jacks, for front and rear plugs of quadraphonic phones, are located adjacent to the power on/off switch. There are also a pair of push buttons for tape monitoring and loudness control activation.

The rear panel of the receiver, pictured in Fig. 1, includes thumb-screw speaker-connection terminals for the four speakers, *Tape Rec* and *Play* jacks with full 4-channel capability, *Phono* and *AUX* input jacks and *Antenna* terminals for either 75-ohm or 300-ohm external FM antennas and an external AM antenna. A short, pivotable, AM ferrite-bar antenna is also located on the rear panel. There are three adjustment controls needed for setting up your CD-4 cartridge for optimum separation and lowest distortion, as well as a pair of a.c. convenience receptacles and an FM detector output jack for connection of future 4-channel FM decoders. While a short wire is connected to one of the FM antenna terminals at the factory (it is capacitively coupled to the line cord to serve as a minimal indoor FM antenna), we do not recommend its use as a substitute for a true antenna (indoor or outdoor) if serious FM listening is planned.

Receiver Circuitry

Despite its relatively low cost, the JVC 4VR-5426X has some interesting and sophisticated circuitry built into its compact chassis, a view of which is shown in Fig. 2. The front-end uses an FET r.f. amplifier and a three-gang tuning capacitor for FM. The i.f. section includes a bi-polar transistor as well as a multi-purpose IC for amplification, limiting and detecting. A multi-element, ceramic, tuned filter precedes this IC. A single IC, which incorporates a phase-lock-loop circuit, is used for multiplex decoding, and all AM circuitry is contained in another multi-function integrated circuit. The entire tuner section is built onto a single p.c. module, and there are separate modules for the preamp section, the CD-4 demodulator circuits, voltage amplifier stages, tone control amplifiers, loudness compensation circuits, and the main power amplifier sections. The power amps use a differential amplifier stage and feature direct speaker coupling via protective fuses in each channel. These fuses are replaceable only after removing the unit from its wood cabinet. While a full schematic diagram is supplied with the owner's manual, the CD-4 decoder section is shown as a blank block with no circuit details spelled out.

FM Performance Measurements

IHF sensitivity for our sample measured exactly 2.2 μV , exactly as claimed and, more important, 50 dB of quieting was obtained with only 2.8 μV of signal applied in mono mode. Best overall S/N ratio obtained for high-level input signals was 71 dB, equal to performance obtained with receivers costing considerably more than this one. Capture ratio measured 2.2 dB, while AM suppression exceeded published specifications, measuring 53 dB. Stereo sensitivity was 7.0 microvolts, although automatic switching to the stereo mode took place at signal strengths of just over 2.0 μV —the same signal level required to overcome muting when that circuit was actuated. Harmonic distortion at mid-frequencies was considerably better than claimed, with readings of 0.22% in mono and 0.27% in stereo. Quieting and distortion characteristics in mono and stereo are plotted in

the graphs of Fig. 3. Aside from the stereo quieting characteristics (it took 45 μV of signal input to reach the 50 dB quieting point in this mode), the measured performance characteristics of the FM section of this receiver are quite surprising when one examines the relatively simple circuitry used in this section. JVC has managed to extract really excellent performance with a minimum of circuit complexity here. Considering the fact that the MPX section is a modern, phase-lock-loop IC with no tuned circuits to align, we would have expected a bit better overall separation figures than we measured in stereo FM, particularly at the high frequency end where separation decreased to 28 dB at 10 kHz, but this is more of an engineering point than one which would truly adversely affect audible results, since mid-band separation is over 40 dB and, more important, distortion over the entire audio spectrum is quite low (under 0.3% at 10 kHz in mono, 1.0% at the same frequency in stereo) as shown in Fig. 4.

Amplifier Measurements

JVC elected to give two complete power ratings for the amplifier section of this receiver, both in strict conformance with the new FTC audio power rule. The 13-watt-per-channel figure applies to the full audio spectrum, whereas the 15-watt-per-channel rating applies if you are willing to settle for a power band of from 40 Hz to 20 kHz. Equivalent ratings

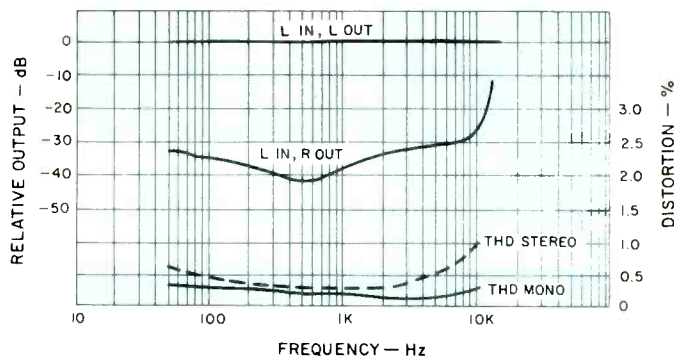

Fig. 4—Separation and distortion versus frequency.

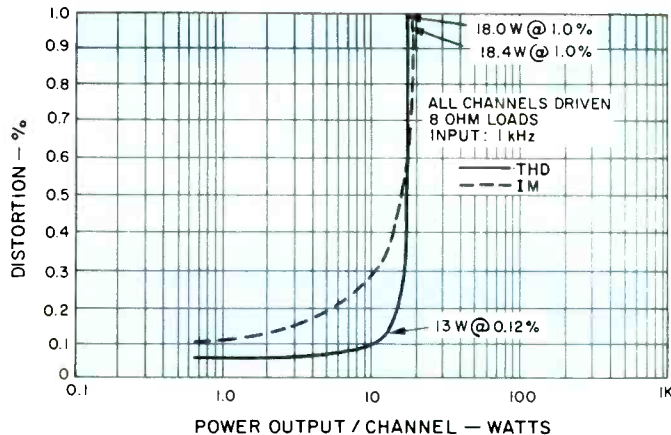

Fig. 5—Harmonic and IM distortion characteristics.

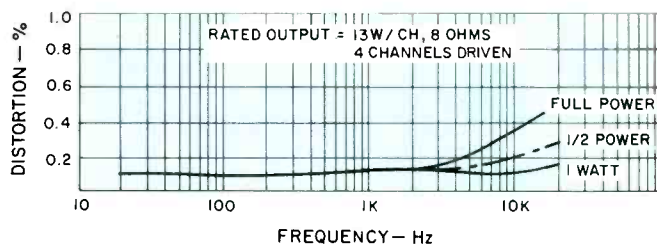
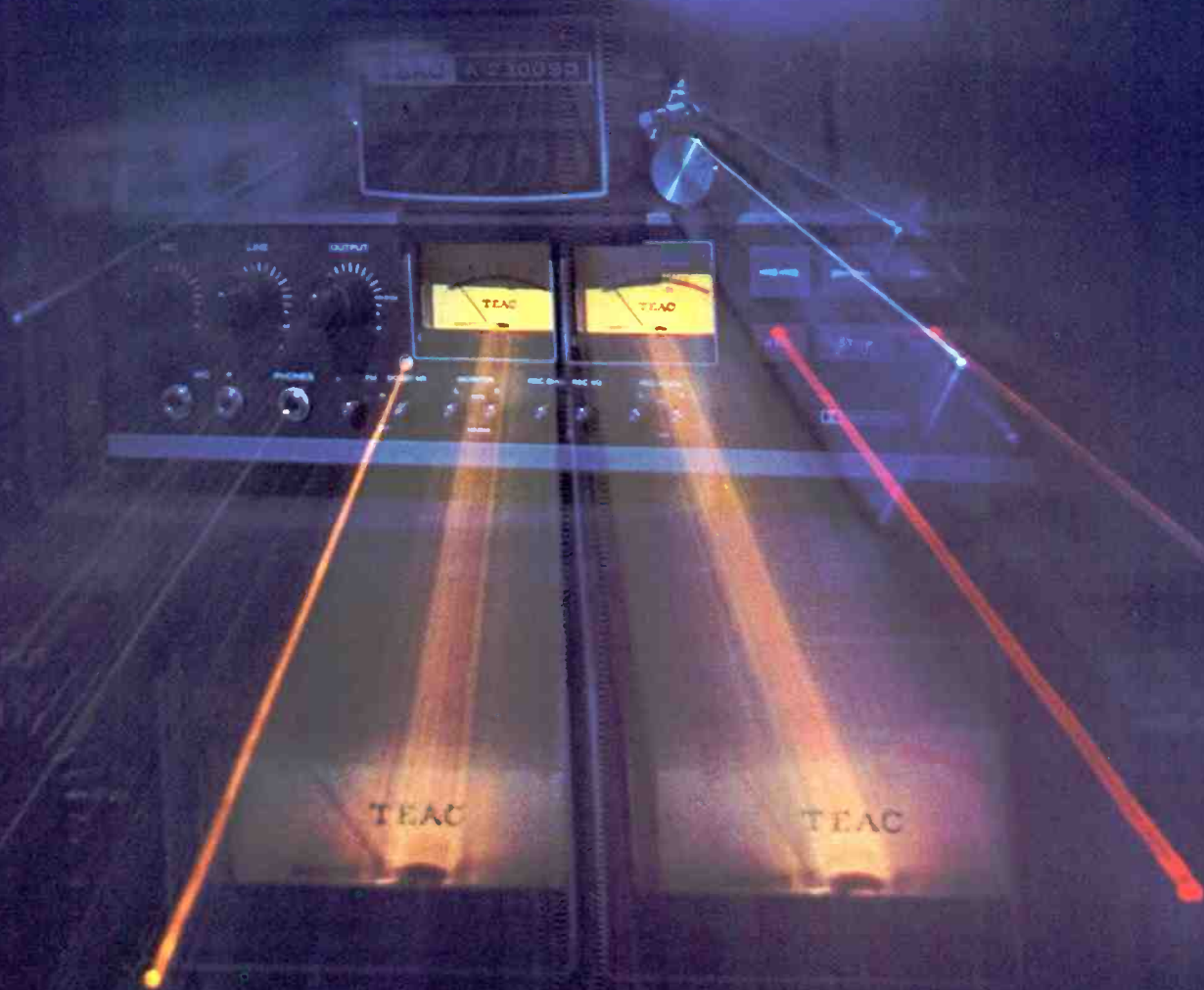

Fig. 6—Distortion versus frequency.

TEAC A-2300SD

74dB

signal to noise ratio



Noise vs signal

Noise is usually defined as an unwanted disturbance of some sort. In a tape recorder, noise does not occur at the same volume level across the entire frequency spectrum. Low frequency hum is generally louder than high frequency hiss, but the human ear does not perceive noise in that relationship.

The sensitivity of the ear is not uniform with frequency, a situation expressed graphically in the well known Fletcher-Munson curves. Since the ear is most sensitive to sounds in the range from 1 kHz to 4 kHz, low frequencies (hum) must be substantially louder than high frequencies (hiss) for the same *apparent* loudness.

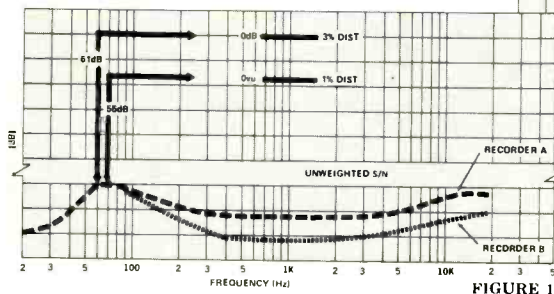

FIGURE 1

You can see from Fig. 1 that recorder A has more hiss than B, yet the unweighted signal-to-noise ratio would be the same for both machines (61 dB). Obviously this method of specifying noise characteristics is inadequate and misleading. It gives no indication at all as to the *kind* of noise measured. Hiss is more annoying than hum because it is more apparent at the same relative level.

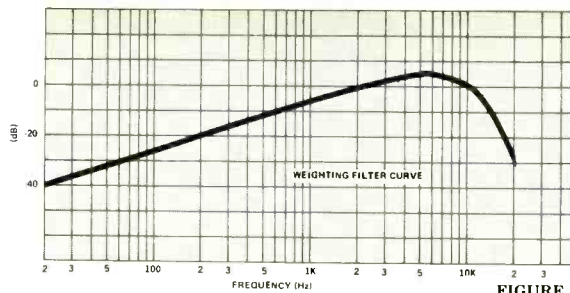

FIGURE 2

What is weighted noise?

Weighting curves simulate the non-linearity of human hearing (Fig. 2). When they are used as filters in signal-to-noise measurements, they make the resultant specifications more credible and meaningful. Comparisons based on weighted noise figures are therefore more valid.

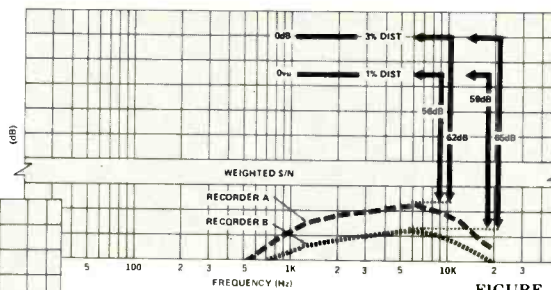

FIGURE 3

Using the previous example of recorders A and B, we now send the overall noise through the weighting filter and then measure the remaining noise. You can see from Fig. 3 that recorder A measures 62 dB, while recorder B measures 65 dB referenced to 3% distortion. Now this comparison more accurately corresponds to what the listener actually hears and the subjective annoyance of the noise.

Why add Dolby?

Because you can gain an additional 9-10 dB reduction in noise with the B-type Dolby system. And that works out to be 74 dB on the

A-2300 SD. We took something already quite good, and made it better.

The advantages of integral Dolby.

With an external Dolby unit, irregularities in a tape recorder's frequency response characteristics will be magnified during the signal processing, generally by a factor of two. When the Dolby circuits are an integral part of the recorder, however, the record and playback electronics can be optimized for the encode/decode

processing. In addition, with integral Dolby you don't have to pay for an extra power supply, cabinetry and the like.

Some popular misconceptions.



There's no doubt that Dolby is an effective means of reducing noise, however the system will not eliminate any noise present on the original signal source. That noise would go through the encode/decode processing along with the signal.

Then there's the feeling that Dolby reduces high end response in the process of reducing hiss. Highs are reduced during decoding, but in exact proportion to the extent they were boosted during encoding – back to the level they were on the original music. Finally, since the Dolby system is level sensitive – low level signals are affected more severely than high level signals – it should be emphasized that very high level signals are virtually unaffected by Dolby.

Complete Dolby flexibility.

The Dolby/FM switch activates the new 25 micro-second de-emphasis curve for decoding Dolbyized broadcast material. In addition, there's an FM copy switch on the back of the unit so you can record the broadcast encoded while monitoring the program decoded for a more accurate listening reference. With the A-2300 SD you can decode any external Dolby source. And the external calibration controls, including a built-in tone generator, help you derive optimum benefits of the Dolby system through accurate level settings.

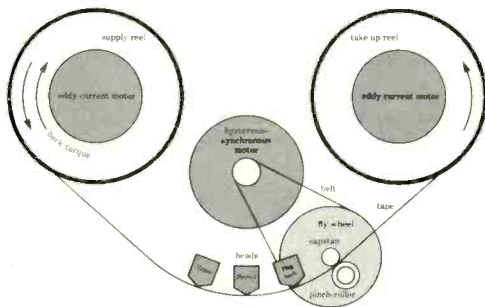

Tape it.

There's a unique satisfaction to be had in personally selecting and sequencing your own source material. Enjoy tapes that exactly satisfy your particular musical tastes, your changing moods. The tapes you make will bear the imprint of your individuality. They will become the expression of your personal artistic perceptions. And if you truly enjoy listening to music, the qualitative difference that the A-2300 SD makes can offer you years of rewarding and enjoyable musical experiences.

We've been making 3-motor, 3-head tape recorders for over 20 years. Continually refining and perfecting the fundamentals. Consistently providing the features and functions that best fit your recording needs. There's a certain pride here. A reputation for quality and reliability can not be proclaimed. It must be earned.

THE WHITE PAPER

A lot of the information in this ad was excerpted from The White Paper. If you're interested in tape recording in general, and TEAC products in particular, be sure to get your free copy. You can do that by writing us. To audition the A-2300 SD and hear the audible improvement it makes, just call (800) 477-4700* to find the name of your nearest TEAC retailer. We'll pay for the call.

*In Illinois, call (800) 322-4400

A-2300SD



TEAC®

The leader. Always has been.

TEAC CORPORATION OF AMERICA
7733 Telegraph Road, Montebello, Calif. 90640

Dolby is a trademark of Dolby Laboratory Inc. © TEAC 1975

for bridged two-channel operation, as stated by the maker, are 30 and 32 watts per channel, respectively, all at 8 ohms. Note, that in the bridged mode, the use of 4-ohm speakers is *not* recommended, nor specified by the manufacturer. Based on our measurements, all the stated ratings are a bit on the conservative side. We measured 18.0 watts for 1.0% THD at mid frequencies in 4-channel operation, as shown in Fig. 5. IM distortion, also plotted in this graph, reached its rated value of 1.0% at an output of 18.4 watts per channel. Surprisingly, power ratings were limited at the high-frequency end rather than at 20 Hz, where one normally runs into the higher distortion as one approaches maximum power output. In the case of the 4VR-5426, distortion remained low (0.1%) for 13 watts per channel output at 20 Hz, but tended to rise at the high end for the same output, as shown in the graphs of Fig. 6. Nevertheless, for a 1.0% THD rating, we would have rated the receiver at a full 15-watts per channel, rather than 13 watts. In the case of bridged 2-channel operation, we measured 35-watts per channel at mid-frequencies, since it has been our experience that curves would have been similar to those obtained in 4-channel operation (but at proportionately higher output power). Damping factor, measured in the 4-channel mode, was 32 for 8 ohm loads, while residual amplifier noise (basic amplifier only) measured 87 dB below full output.

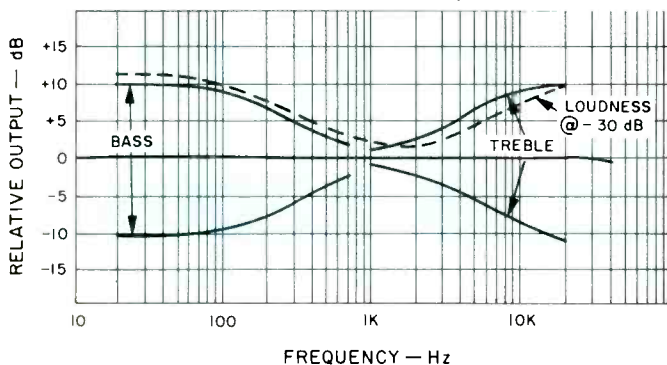

Fig. 7—Tone control range and loudness characteristics.

Preamplifier Measurements

Phono input sensitivity exceeded claims, with a bit over 1.0 mV of signal required at 1 kHz to drive the system to rated output. However, overload capability was rather low, with only 31 mV of input signal (again, 1 kHz) required to create distortion in the preamp stage. Users of this receiver are cautioned not to use high-output phono cartridges with it, since such use may limit dynamic range. Since most people who purchase this receiver will undoubtedly be buying a CD-4 cartridge, this problem is not particularly serious, as these cartridges tend to produce somewhat lower output than equivalent stereo cartridges.

Hum and noise in phono (unweighted) was -60 dB as opposed to the -65 dB claimed by the manufacturer, but this proved to be quite low enough in our subsequent listening tests. While there are no high-cut or low-cut filters in this receiver, the tone controls operated much as expected, and the tone control ranges are graphed in Fig. 7. Also shown in this graph is the action of the loudness control when set at -30 dB below full volume. JVC chose to emphasize highs as well as lows in their loudness circuit, and in our opinion, too much emphasis was added at the high end. Many experts contend that *no* treble boost should be introduced by a loudness circuit or that, at most, it should be just a few dB at 10 kHz. Hum and noise in the high-level positions of the selector switch measured 78 dB below full output.

Listening and Use Tests

Comparing CD-4 reproduction with either SQ or QS disc playback on this receiver is really a bit unfair, since the CD-4 discs offer noticeably greater 4-channel effects than can be had with these basic matrix circuits. With the limited separation afforded by the two matrix decode positions, listener positioning becomes fairly important and you should try to set up your speakers so that you are located fairly centrally between them. This receiver definitely favors the CD-4 records, however.

As expected, FM reception was amazingly good, considering price and circuitry. There is, unfortunately, no way to switch to mono FM when noisy stereo signals are received and, in view of the fact that automatic switching occurs at very low signal strength, we had to pass up certain stereo stations that were just too noisy in stereo though they might have been acceptable in mono.

In the 4-channel listening mode (the only one we used in our listening tests), it's important to use speakers of relatively high efficiency with this receiver, since 13 watts per channel (or 15 watts, if you accept our modified rating) is not really enough power to drive acoustic-suspension or other fairly low-efficiency speaker types. With the ported, high-efficiency systems we used in our listening tests, the 4VR-5426X delivered enough clean power to satisfy most listening needs in average-to-small sized listening rooms. When you consider its overall performance, its 2-channel "starter" capability, at more than double the per-channel power and its measured and audible performance, this receiver is certainly the answer for those who want four-channel sound but can't yet afford the price of those ultra-sophisticated, super-matrix with logic plus CD-4, higher-powered units which can cost more than an entire system (including speakers, turntable and cartridge) incorporating the 4VR-5426X. If, later on, you want the ultimate of matrix-decoding circuits, you can always add a more elegant, separate, matrix decoder and still come up with a good working 4-channel system at unusually low cost.

Leonard Feldman

Check No. 70 on Reader Service Card

Wollensak 8080 8-Track Cartridge Recorder

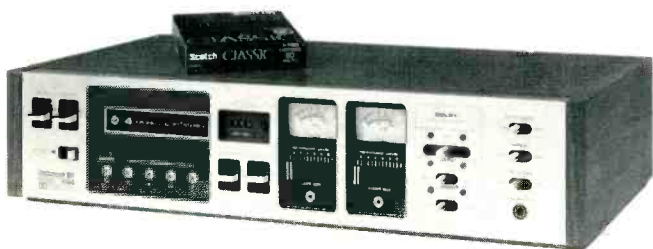

MANUFACTURER'S SPECIFICATIONS

Speed: $3\frac{3}{4}$ ips. **Wow and Flutter:** 0.1% wtd. rms. **Tape Shut-off:** Manual or automatic. **Input Sensitivity:** AUX, 80 mV; Mike, 0.25 mV. **Output:** 1 V at 0 VU. **Distortion:** Less than 1% at 0 VU. **Frequency Response:** 30 Hz to 15 kHz with Scotch Classic; 30 Hz to 12 kHz with standard tape. **Signal-to-Noise Ratio:** Better than 50 dB without Dolby; better than 60 dB with Dolby. **Dimensions:** 19 in. W. x $10\frac{1}{4}$ in. D. x 5 in. H. **Weight:** 17 lbs. **Price:** \$344.95.

Tape recording enthusiasts who associate 8-track machines with automobiles and \$99 compacts should take a close look at the new generation of 8-track units designed for top-quality performance. As they did with cassette machines,



The Dual 701.

Some extraordinary test reports about an extraordinary turntable.

Test reports of the Dual 701, in magazines like this one, have been totally unlike those of any other component. Not just because the reports are favorable; none of these magazines wastes anyone's

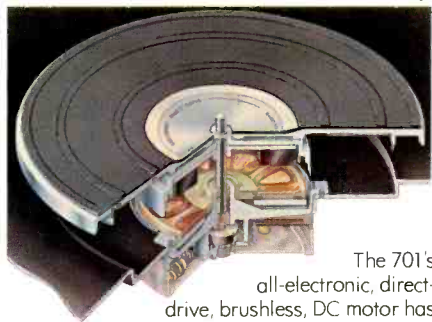

The 701's all-electronic, direct-drive, brushless, DC motor has Hall-effect feedback control and is energized by a regulated power supply.

time reviewing run-of-the-mill products; there are too many good ones available. The reports are different because of two themes that run through them.

One theme acknowledges that the 701's

performance is actually superior to the measuring capability of available test instruments. For example, Hirsch-Houck Labs in Stereo Review found the wow level of the 701 "essentially at the residual level of our test record—about 0.03 per cent." So did Popular Electronics.

The Feldman Lab Report in FM Guide stated: "We could detect no flutter whatsoever, and the low readings that we did get for wow were no doubt the result of using a record which was not absolutely concentric."

Stereo & HiFi Times found "arm friction was lower than my capability to measure reliably."

The second theme throughout the reports is the unequivocal ranking of the 701 at the pinnacle of perfection in record playback. In the following quotes, note the absence of such familiar qualifiers as "one of the" or "among the."

Stereo Review: "... technical performance characteristics surpass to a greater or lesser degree those of any other integrated record player we have tested."

FM Guide: "The Dual 701 is probably the smoothest acting, most rumble-free system we have ever tested."

Popular Electronics: "In almost every respect, the Dual 701 surpassed just about every other record player— manual or automatic—that we have tested."

High Fidelity: "... the Dual 701 has placed itself in the select group of products against which we must measure the performance of others."

And, the highly conservative English publication, HiFi News & Record Review, with typical British understatement commented: "The experience of listening to records of the highest quality on this turntable is not likely to be forgotten... you will never again be satisfied with anything less perfect."

If you wish to experience the same caliber of performance as these highly experienced and most critical of all audio experts, you need only visit your nearest United Audio dealer and ask for the quietest turntable ever made. You are in for an extraordinary experience—with this fully automatic, single-play, electronic, direct-drive turntable. \$400, including base and dust cover.

The 701's unique counterbalance houses two separate anti-resonance filters which absorb resonant energy in the frequency ranges of the tonearm/cartridge system and the chassis.



Dual[®]

United Audio Products, 120 So. Columbus Ave., Mt. Vernon, N.Y. 10553

Exclusive U.S. Distribution Agency for Dual

Check No. 38 on Reader Service Card

Wollensak is showing the way with innovations and improvements in these machines. Introduced last year, the Model 8080 has a frequency response which extends to over 16 kHz and exhibits an excellent signal-to-noise ratio and low distortion. This new standard of performance can partially be explained by the fact that the machine was designed for use with the new Scotch Classic cartridge tape, which has better high frequency response than earlier formulations. However, there are real improvements in the machine itself, as we shall see from the results obtained with Scotch HO/LN tape.

Styling is neat and workmanlike, with a black and satin finish on the front panel. The cartridge compartment is on the left, and under this door are five indicator lights, one for Record and one for each of the four tracks. The track Select switch is on the extreme left, along with two other lever switches for Fast Wind and Eject. Next in line come the two VU meters, located in recessed panels, slide controls for recording levels, and two miniature microphone sockets. Then come two groups of three lever switches for the following functions, 2-chan./4-chan. select, Regular/Special Tape select, Dolby select, Auto Eject On/Off, Repeat Program All/One select, and FM Listen On/Off. Just beneath the last three is a headphone socket which takes a standard stereo plug. Input and output sockets, shown in Fig. 1, are at the rear, together with the Dolby calibration controls, and a

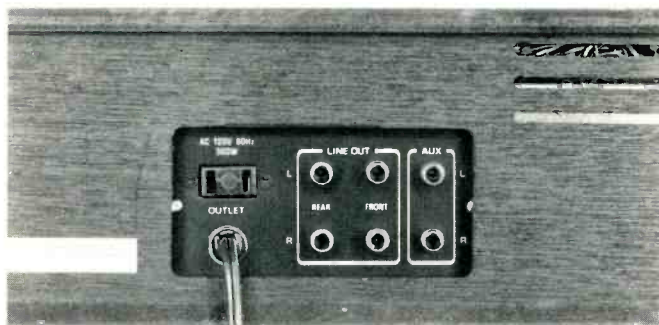

Fig. 1—View of back panel.

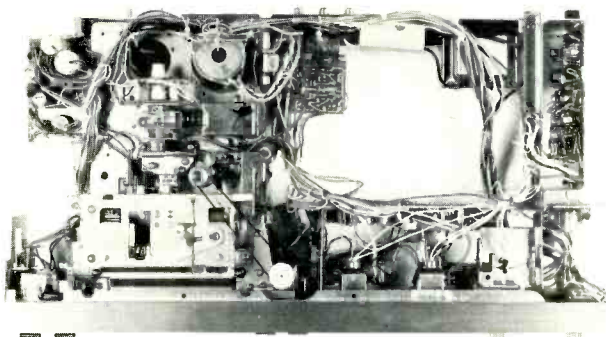

Fig. 2—Interior view.

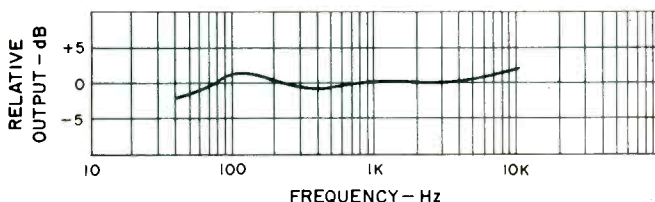

Fig. 3—Playback response from a standard test tape.

spare a.c. outlet. The FM Listen switch enables the Dolby decoder section to be used independently of the rest of the unit so that you can decode a Dolby FM broadcast and feed the signal to the rest of your sound system. Flipping the FM listen switch turns the unit on without having to insert a cartridge. The Dolby switch has three positions, FM Decode, Record/Play, and Off. In the first position, the decoder is in circuit for listening to or recording Dolby broadcasts. In the Record/Play position, Dolby encoding is in circuit for recording and decoding for playback. The Off position switches the Dolby section out completely.

The tape select switch has two positions, one for regular tapes such as Scotch HO/LN, and a Special position for Scotch Classic tape. This second position changes the equalization of the 8080 so that the characteristics of the Classic tape are more closely matched. It operates only in Record mode and doesn't affect playback.

The Auto Eject switch works in conjunction with the Repeat switch. In the record mode with the Auto Eject switch on and the Repeat at One, the cartridge will record the selected track and then eject. With the Repeat switch in the All position, tracks 1 through 4 will be recorded on the cartridge, which will then be ejected. With the exception of the Pause control which also functions as a Stop switch, the other controls call for no particular comment.

Measurements

Figure 3 shows the playback response from a standard test tape, which is now obviously outdated because of the new standards of performance achieved by Wollensak. This high level of performance is underlined by the results obtained

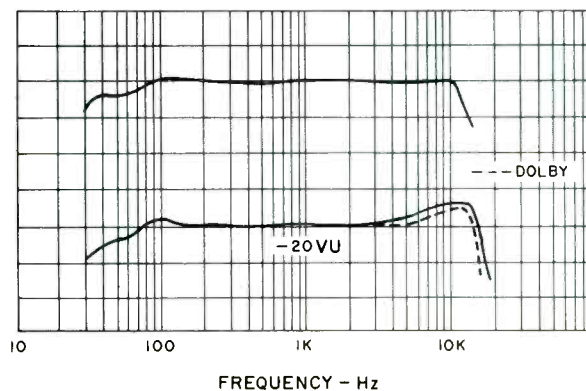

Fig. 4—Record-play response with Scotch Classic.

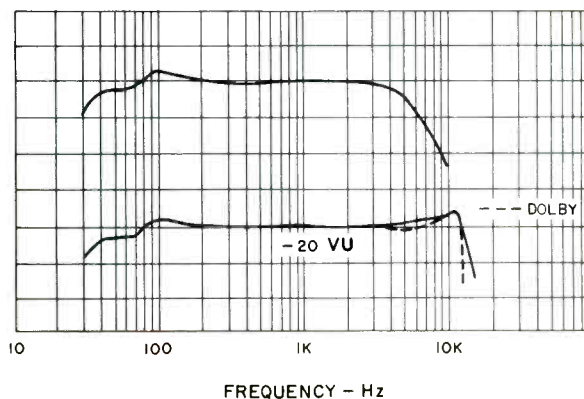

Fig. 5—Record-play response with Scotch High Output, Low Noise tape.

The new Sansui LM Loudspeakers that set the AES Convention on its ears.



LM 330
CUT-A-WAY

At the Convention of the Audio Engineering Society in Los Angeles last May, Sansui demonstrated a new concept in loudspeaker design.

The reception from these experts—chief engineers of radio and TV stations, record producers, recording engineers and sales executives of audio companies—was even more sensational than we ourselves expected.

And these are the reasons:

Unlike conventional speakers, the LM design incorporates a multi-radiational tweeter device. High frequencies instead of being lost through encapsulation, are diverted through three special exponential horns and recovered into sound energy that

adds a breathtaking sense of ambience, and realism. The LM speakers also display extremely stable and well-defined stereo images. At the same

time, both the transient response and efficiency of the system are greatly increased. An extra large woofer assembly gives exceptionally strong bass response ordinarily available only in much larger and more expensive speakers.

Hear any of the 3 models available at your nearest Sansui franchised dealer. You never heard music so alive before.

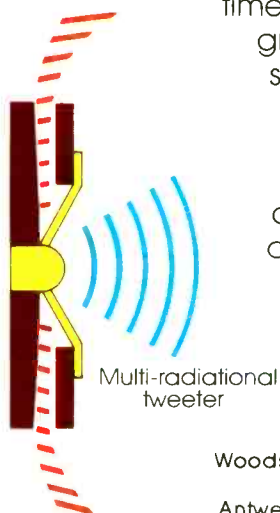

Multi-radiational
tweeter



SANSUI ELECTRONICS CORP.

Woodside, New York 11377 • Gardena, California 90247

SANSUI ELECTRIC CO., LTD., Tokyo, Japan • SANSUI AUDIO EUROPE S.A.,
Antwerp, Belgium • ELECTRONIC DISTRIBUTORS (Canada) Vancouver 9, B.C.



Check No. 32 on Reader Service Card

with Scotch Classic tape, which is shown in Fig. 4. The 3 dB point for Classic was 16.5 kHz, with response rising from the 3 kHz point. With the machine switched to *Regular* tape and using a Scotch High Output/Low Noise cartridge, the results shown in Fig. 5 were obtained. The -3 dB point here was 14.3 kHz—not all that far under the Classic, though headroom was somewhat less. Response of the Dolby system was well within the 2 dB tolerance for both cartridges.

Distortion at 1 kHz is shown in Fig. 6 and distortion versus frequency is plotted in Fig. 7. Signal-to-noise ratio, using a standard A weighting, was 50 dB for the Scotch HO/LN tape and 52 dB for the Classic, increasing to 60 and 62 dB, respectively, with the Dolby system switched in. Input sensitivity to read 0 VU was 84 mV for line inputs and 0.24 mV for microphone inputs. Output at 0 VU was 850 mV. Erasure was better than 66 dB, and crosstalk (measured at 400 Hz) was 67 dB between adjacent tracks and 45 dB between stereo channels. Wow and flutter, that old bugbear of cartridge machines, was measured at 0.18 percent, DIN record-play. The maker's specifications give a wow and flutter figure of 0.1 percent weighted, but no details are given as to the standard so that it is possible that refers to playback only. Fast forward speed is about 3.5 times the normal record-play speed of 3¼ ips, and a 90-minute cartridge was timed at 6.75 minutes. Tape speed was found to be less than 0.25 percent slow.

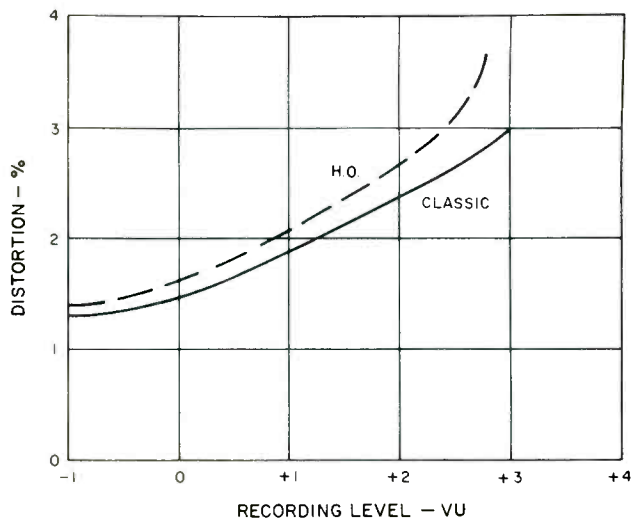

Fig. 6—Distortion at 1 kHz.

Listening Test

The first question most readers will ask is how does the 8080 compare with a similarly priced cassette machine? In terms of the basic performance parameters, such as frequency response, distortion, and so on, there isn't much to choose between the two formats at this price level. There's

no getting around the inherent design limitation of the 8-track's inability to rewind for "instant" replay, but how much of a disadvantage this will actually be will have to be decided by the individual user. However, the argument for compatibility in both auto and home tape formats should not be overlooked, and, of course, one wants the best possible unit for home use.

The 8080 will play quadrasonic cartridges and can make two-channel recordings as well. There are only two recording amplifiers, so you cannot record in four channels.

For the first use test, I hooked up the Model 8080 up to my sound system and played some Columbia quadrasonic tapes, including *Man of La Mancha* and Bartok's *The Miraculous Mandarin*. Overall sound was clean and spacious with a clarity and crisp definition of transients which I have never heard before from an 8-track machine. I missed

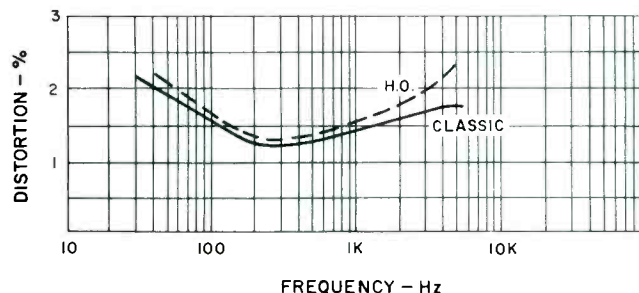

Fig. 7—Distortion versus frequency.

the convenience of four VU meters but balancing the channels was not *that* difficult. No trouble was experienced in making excellent stereo recordings from discs or off the air, although I did find it rather tedious to wait while the tape wound itself before I could listen. But then, I usually make a number of short recordings for test purposes, rather than immediately beginning with the transfer of a complete symphony, for example. As more and more FM stations adopt the Dolby system (there are over 90 presently), the chances are that Wollensak's method of Dolby inclusion will save you money at some time in the future.

Particular attention was paid to the construction of the 8080, particularly to the mechanics involved in head motion to select the various tracks. Tolerances are very small here, and any wear or mechanical distortion could cause problems. No evidence of skimping or bad design was found, and the machine should stand up for years of hard use. Of course, the heads must be kept clean, as with every tape machine, and only good quality cartridges should be used. Wow and flutter figures are greatly influenced by the cartridge itself, and I was not really surprised to find one cartridge, the brand of which shall not be named, virtually unplayable! The moral is obvious.

George W. Tillett

Check No. 71 on Reader Service Card

Yamaha Model B1 Power Amplifier

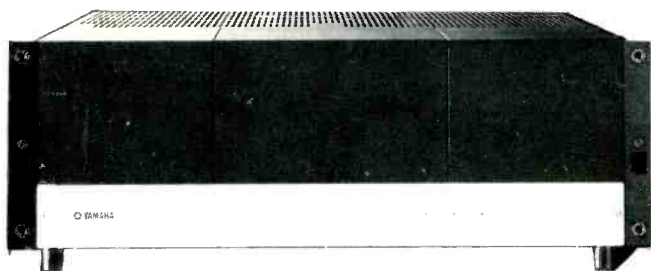

MANUFACTURER'S SPECIFICATIONS

Continuous RMS Power Output: 150 watts per channel, with 8 or 4 ohm loads, both channels driven from 20Hz to 20 kHz, with 0.1% or less total harmonic distortion. **IM Distortion:** 0.1% at rated power, SMPTE. **One-Watt Frequency Response:** 5 Hz to 50 kHz, +0, -1 dB. **Power Bandwidth:** 5 Hz to 50 kHz, 0.5% distortion. **Hum and Noise:** 110 dB. **Damping Factor:** 100 at 1 kHz, 8 ohms. **Input Sensitivity and Impedance:** 0.775 V, 50k ohms. **Weight:** 95 lbs. **Price:** \$1600.00; UC-1 control unit, \$250.00 (optional).

The Yamaha B-1 is one of a new breed of amplifiers from Japan using vertical field-effect transistor (V-FET) output devices. The unit is beautifully made, solidly constructed, and

A tribute to appreciation.

Music appreciation. Art appreciation. Appreciation for excellence in performance. A fulfillment that comes from the experience, not from the parameters by which it was created.

The Contrara Group of loudspeakers is a tribute to that appreciation. We should not deliberate how Amilio Contrara has sculpted the walnut, blended it with cloth and merged it with technology to bring visual satisfaction. Nor, how he has balanced the electronics with physics to provide audible gratification.

Ours is only to enjoy. To appreciate. To savor. Something only our ears and eyes can savor for themselves.

If you enjoy your music and quality craftsmanship, you'll appreciate the Contrara Group; it's a tribute to your sensitivity. Write us for additional information. We'll send you a booklet on appreciation and a list of locations where you can enjoy Contrara.

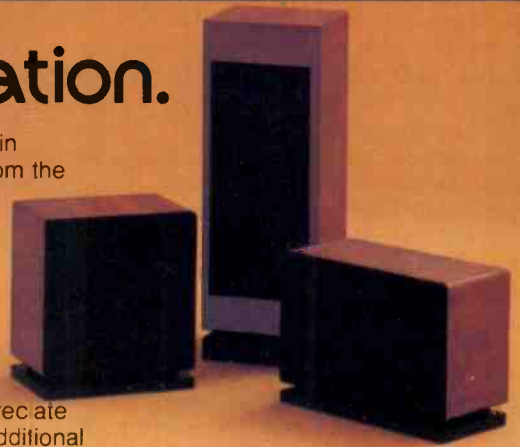

CONTRARA GROUP

JENNINGS RESEARCH INC.

64 N. Fair Oaks Ave., Pasadena, Calif. 91103

Canadian Distributors - THE AUDIO GROUP INC., 105 Denison St., Markham, Ontario

CIRCLE 25 ON READER-SERVICE CARD

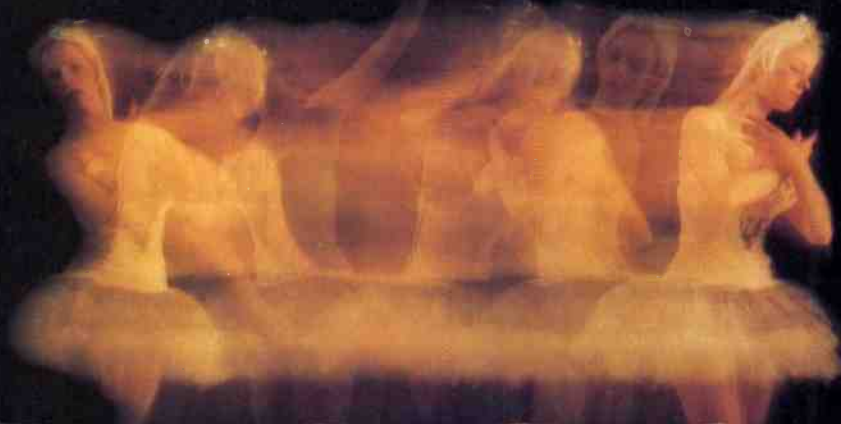

very heavy, weighing about 95 lbs. The UC-1, a companion control unit with peak-reading power meters and speaker switches, adds another 14 lbs. After moving this amp about several times, this writer would recommend a small crane or fork lift for prospective owners.

The chassis has two heavy side pieces with a sub-floor between for most of the front-back distance. Power transformers and filter capacitors are bolted to this sub-floor, along with PC and other connectors for all the sub-assemblies including two output-device heat sinks and one power amp drive board per channel, two regulator boards, a protection board, another large heat sink with 6 regulator transistors and several power resistors, the front panel chosen, and finally the input amplifier and filter board. The output device heat sinks are rather large and the output devices themselves are in a large case—about 50% larger than the usual diamond-shaped TO-3 output device. The wiring is neat, and workmanship excellent. The standard front panel insert takes about 30% of the height, starting at the bottom of the front edge, and is horizontally grained, clear anodized aluminum, contrasting with the black remainder of the amp.

Controls with the standard insert are a pushbutton main power switch and two output level controls. Three light-emitting diodes (LEDs) indicate *Power On*, and either *Thermal* or *Overload Protection* circuitry activation.

The UC-1 can either be snapped onto the B-1's front, adding about 2-1/2 in. to the depth, or used in a remote location with its long, heavy interconnecting cable. Controls are a lever *Power* switch, lever *Rumble-Filter* switch, master speaker *On/Off* switch, five pushbutton switches for selection of five speaker pairs, and 10 speaker level controls. These last are driven from the input buffer and amplifier, and the wipers drive the power amp inputs. This control unit

thus allows five pairs of speakers to be compared at equal volume levels without the insertion of high-level speaker line pads which could degrade power and damping characteristics. Yamaha must have believed that the B-1 was so good (with good reason) that it would be used as a reference amp in a demo room set-up for comparisons of high-end speakers.



UC-1 Control Unit

The remaining feature of the UC-1 is a pair of wide dynamic range, peak-reading power meters. These meters cover a dB range from -50 to +5 and a resulting power range, as calibrated, of 1 mW to 300+ watts into 8-ohm loads. These meters are absolutely first-rate. Peak power is really what counts in regard to amplifier clipping and available headroom. Reading power over such a wide range without changing meter ranges is very useful and informative, and this system is by far the most accurate and meaningful of any meter set-up seen thus far. The equivalent ballistics are such that the meters accurately capture short duration peaks of long duty cycle, then quickly move up to indicate the captured peak, and finally decay relatively slowly. The only system which might be superior would be a peak-reading power meter which measured actual power delivered into the load by sensing the voltage and current delivered, though no such meter is commercially available presently.

On the back of the B-1 are 10 speaker output connectors, two primary power fuses, one unswitched a.c. outlet, a connector for remote turn-on of power, and two pairs of signal input RCA jacks. One pair of these input jacks is a direct input to the power amp, and the other, labelled *Normal*, goes to the input buffer amp. A small slide switch selects either *Normal* or *Direct* input, and a second such switch can activate a 10-Hz rumble filter, with a ground binding post completing the rear panel. Considering its construction and features, this amp is outstanding, as it well should be for its price.

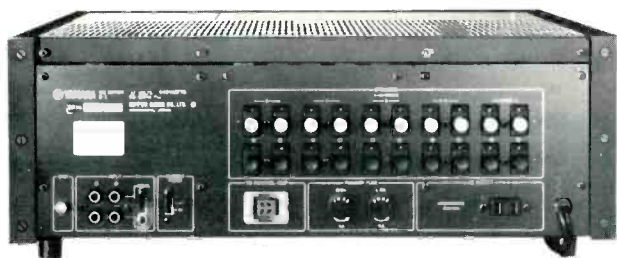

Fig. 1—Rear of the Yamaha B-1 amplifier.

Circuit Description

A good deal of basic information about V-FET technology was published in the February, 1975 issue of *Audio*. We will refer back to some of this description later on.

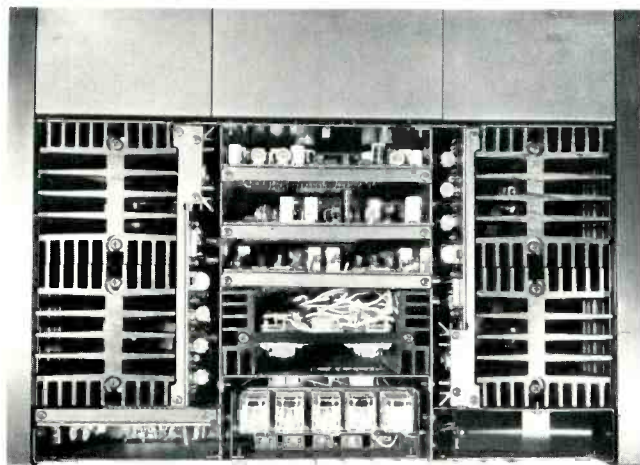

Fig. 2—Interior of the B-1 amp.

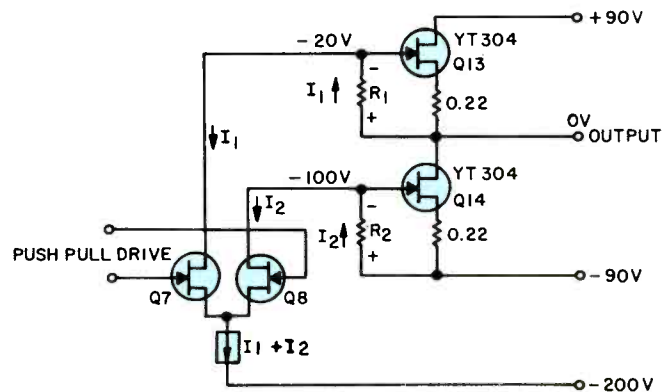

Fig. 3—Simplified drive circuit.

The AR-11

A new standard of accuracy from Acoustic Research

Musical accuracy

The AR-11 is the most accurate speaker system ever made by Acoustic Research. Its performance, drivers, and crossover are identical to those of the recently introduced AR-10 π , except that the AR-11 does not incorporate a Woofer Environmental Control and the associated crossover components.

The AR-11 is designed for optimum performance when placed against a wall, as on a bookshelf, or slightly away from two room surfaces, as illustrated.

New drivers

The AR-11 uses a substantially improved version of the 12 inch woofer with which Acoustic Research introduced the acoustic suspension principle to home listeners, as well as the dome midrange driver of the AR-3a. It also uses a newly designed 3/4 inch highrange based on the original high-frequency dome radiator introduced by Acoustic Research in 1959. This highrange incorporates new diaphragm materials, voice coil, and construction



techniques that have produced significant improvements over earlier versions.

These drivers, in combination with a new crossover network, have resulted in a speaker system with uniformly dispersed flat energy output to the highest audible frequencies. The AR-11 is able to transmit the information from a program source to listeners in most positions in a listening room with an unprecedented degree of accuracy.

Complete specifications of the AR-11 are available on request from Acoustic Research.

As with all AR speakers, the workmanship and performance of the AR-11 are guaranteed for five years.

Acoustic Research
10 American Drive
Norwood
Massachusetts 02062
Telephone 617 769 4200



- Please send specifications of the AR-11
 Please send a copy of the AR demonstration record 'The Sound of Musical Instruments' (check for \$5 enclosed)

Name _____

Address _____

AU8

The schematic diagram of the B-1 is rather large and complicated, with the circuitry for the power amp proper taking up about 20% of the total space but not including the power supply for both channels. Starting with the power supply section, a small power transformer is connected to the incoming a.c. line without going through the power switch. This powers a simple one-transistor, relay-driver circuit. Turning on the power switch grounds one end of the transistor base turn-on resistor and pulls in the relay, which then feeds a.c. to the two main power transformers. It is then easy to turn the amp on from a remote location, a simple contact closure being all that's required.

The main winding on each transformer feeds plus and minus, full-wave rectifiers and two 15,000 μ F capacitors for the output stages of each channel. The developed voltage is about ± 90 V d.c. The remainder of the windings are used, one phase per transformer, to develop full-wave rectified d.c. for five voltage regulators which produce +12, ± 25 , +40, and -200 V d.c. These are all full electronic regulators with error-sensing amplifiers which control series-pass transistors.

The +12 is used for the output stage protection circuitry, the speaker switching relays, and the relay mounted on the input buffer amplifier that switches in the capacitors for the low-cut rumble filter. The ± 25 is used to power the input buffer amp and the meter electronics of the UC-1. The +40 and -200 are used by the main power amps only.

Each ± 90 V supply for an output stage is routed through a series-pass power transistor, an NPN for the plus and a PNP for the minus, before arriving at the output stages. The series-pass transistors are normally fully saturated or fully on. The drive circuitry for these will be cut off, thus shutting off the supply to the output stages if the load current is excessive or if the V-FETs get too hot due to restricted ventilation (thermal overload). Further, if the bias supply for the power amps (-200 V) or the +40 V fails, the supply to the V-FETs is cut off. Recovery from any of the above conditions is rapid and automatic as soon as the fault condition is corrected.

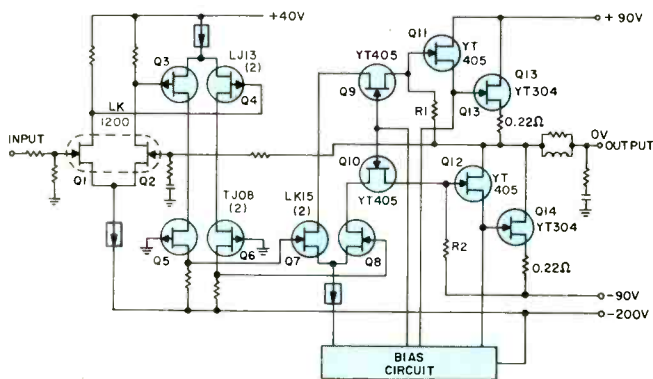

Fig. 4—More complete schematic.

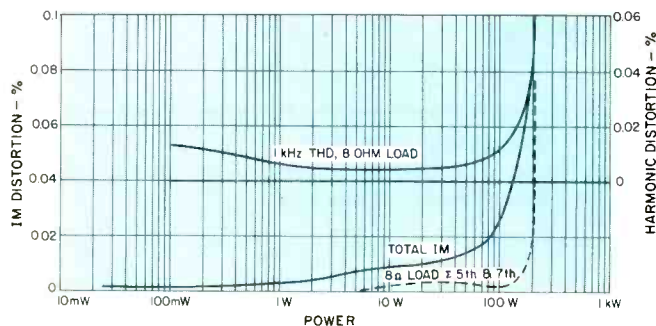

Fig. 5—THD and IM versus power.

There is one more protection circuit, mainly concerned with protecting the load, which senses the d.c. potential of both output lines and opens the speaker relay if either output line exceeds ± 2 V d.c. This circuit also functions as a time-delay mute during power turn-on, keeping the speaker relay open for several seconds.

A complete schematic for the UC-1 wasn't available, though there is a block diagram, but its operation is fairly straightforward. The output of the power amp, suitably attenuated, goes first through an a.c. logarithmic amplifier and then into a linear detector. The d.c. voltage thus produced then goes through a d.c. log amp and into a peak-hold circuit. The final result is a d.c. voltage proportional to the peak value of the log of the power amplifier output voltage. This d.c. is used to drive the meter and gives equal deflection for each decade of power shown on the meter.

The input buffer amplifier serves to present a high input impedance (100K) to the signal source on normal input, provides a low impedance drive for the level controls which are 1 K, and is an active circuit for the 12-dB-per-octave rumble filter. The overall gain is 1X for input to the level control. The circuit itself has an N-channel horizontal (or normal) FET input differential pair in which both output phases are differentially combined to drive a following inverting P-channel H-FET. This stage is operated common source, like a common resistor with a bipolar, with a source degeneration resistor of 150 ohms. The second stage drives a small power N-channel V-FET source-follower operating with a drain current of about 25 mA. Overall negative feedback is taken back to the inverting input to set the closed-loop gain at about 1.3X for proper operation of the active low-cut filter when in operation. This slight gain is taken out by a series resistor that feeds the level controls.

The power amplifier circuitry can best be approached by looking at the output stage, and a simplified schematic of it is shown in Fig. 3. A more complete, though still-simplified diagram is shown in Fig. 4. The output stage should be called single-ended push-pull, rather than quasi-complementary. This distinction was discussed on pages 48 and 50 of the February, 1975 *Audio*. Of interest is the fact that only FETs are used from input through output, no bipolar devices are incorporated, and there are only two output devices.

One thing common not only to this circuit but all V-FET amps seen thus far is that the saturation voltage drop of V-FETs is considerably higher than bipolar devices, and therefore the ultimate power for a given supply voltage is lower than with bipolar designs. A typical bipolar amp deliv-

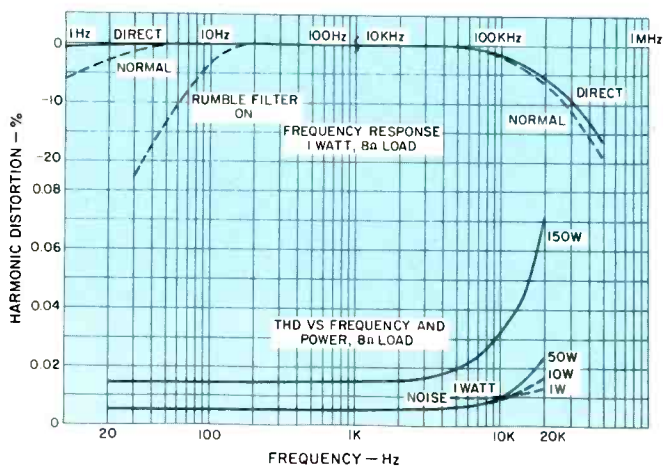

Fig. 6—One-watt frequency response into 8 ohms with THD versus frequency and power. Note break at 100 Hz/10 kHz in response curve.

ers about 230 to 250 watts into 8-ohm loads with a ± 75 V supply, whereas the B-1 puts out about 220 watts with a ± 90 V supply. This simply means that the ultimate power conversion efficiency of V-FETs isn't as high as that of bipolar devices.

Listening and Use Tests

Considerable time was spent a few months ago listening to the B-1, mostly with a rather efficient, equalized speaker array which concentrated attention on the lower portion of the amp's power range. In this use, the Yamaha B-1 was judged to be outstanding, definitely one of the best amps heard up to that time. Some additional listening was done then with Magnepan NG-2167F speakers, which are quite inefficient and thus used a different portion of the Yamaha's power range. It was this writer's opinion that the B-1 was as good as, if not slightly better than any bipolar amp heard until that time. It sounded a bit smoother and more like a very good tube amp than the hottest bipolar contender. When it was driven into clipping, however, it didn't sound as clean as the best bipolar amps.

A second B-1, this time with the optimal UC-1 control unit, was obtained recently for this review and the amp sounds as good as remembered. This reviewer has been doing a great deal of listening evaluation recently with the

Stax SRX Mk-II electrostatic headphones, and the first thing that was done with the second B-1 was to listen to it with the Stax phones. The sound is extremely good, and the only amps which have been judged superior with 'phones listening (and then not by a great margin) are a pair of modified Marantz Model 9 tube units and a specially developed Class-A transistor amp, neither of which are commercially available.

The peak-responding meters are an absolute pleasure to watch and use. It was noted that for equal outputs from a common signal source, the B-1 would frequently read peak powers from 5 to 10 times what was indicated by conventional meters on another solid-state amp, meters which were otherwise correctly calibrated for RMS watts on a steady-state sine-wave basis.

Measurements

The B-1 was first operated for one hour at one-third rated power, 50 watts, into 8-ohm loads, as per the FTC power output regulation. The amp operated without thermal shutdown for the full hour required by the rule but did become extremely hot, as was expected. Temperatures didn't exceed 100°C , however, since the thermal cutouts on the heat sinks are set at that temperature.

Voltage gain into 8-ohm loads was found to be 43.5X or 32.8 dB on direct input and varied from 5.5X to 43.0X, 14.8 to 32.7 dB, through the normal input with minimum to maximum settings of the front gain control. (Note that all measurements were made through the direct input unless otherwise noted.)

IM and 1 kHz THD versus power are shown in Fig. 5. THD versus frequency and power are shown in Fig. 6, along with one-watt frequency responses for direct, normal, and rumble filter-in settings. One interesting observation was that the high frequency response on normal inputs didn't change much with the gain control settings due to their low 1K ohm value, in contrast to other units with higher impedance input volume controls.

Distortion for this unit is satisfactorily low and is not very different from many current bipolar designs. In Fig. 6, the 10-watt distortion is so close to the 50-watt values that one curve is shown for both. The 1-watt distortion is buried in noise at about 0.01% and climbs just above this value between 10 and 20 kHz. It was noticed that the amount of higher order odd-harmonic distortion was rather depen-

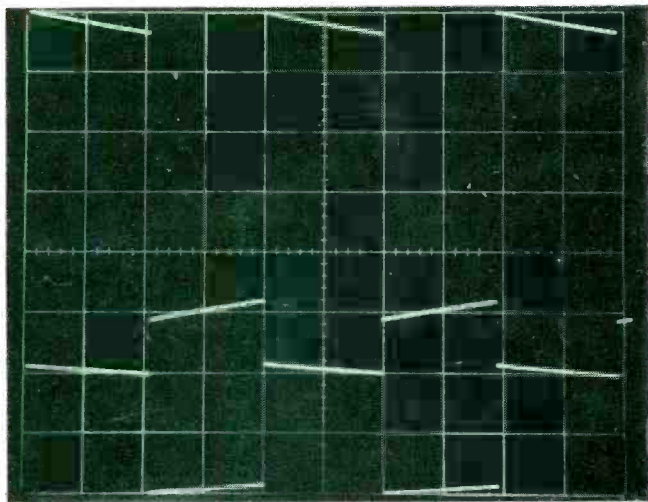

Fig. 7—50 Hz square waves, 8-ohm loads, 5 mS/cm. Top, 290 watts, 20 V/cm; bottom, 3.13 watts, 5 V/cm.

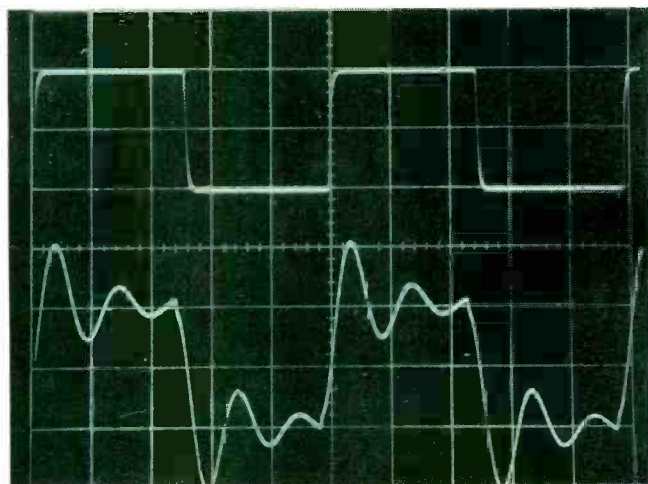

Fig. 8—10 kHz square waves, 5 V/cm, 20 $\mu\text{S}/\text{cm}$. Top, 3.16 watts with 8-ohm load; bottom, about 3 VA, 2 μF load.

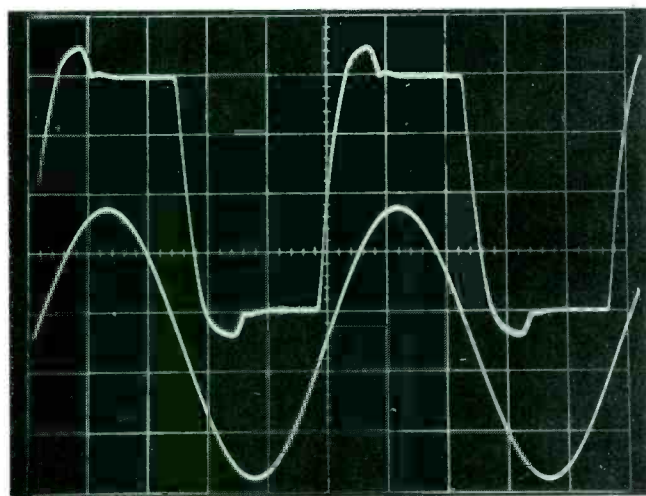

Fig. 9—Top 20 kHz square wave 20 V/cm, 10 $\mu\text{S}/\text{cm}$ about 200 watts with 8-ohm load; bottom, 200 VA, 40 V rms, 0.15% THD.

dent on output-stage idling current, and at least 400 mA, Yamaha's design value, is required to keep these distortion components negligibly low. Distortion measurements through the input buffer amp on normal input were virtually the same as when bypassing this amp through the direct inputs. 'Scope photos of amplifier responses are shown in Figs. 7, 8 and 9 for various levels, waveforms, frequencies, and loadings. Fig. 7 shows the response to low and high-level 50-Hz square waves into an 8-ohm resistive load, while Fig. 9 indicates the response to a 10-kHz, relatively low-level square wave with resistive and reactive loads. The ringing with the 2 μ F load is typical of solid-state power amps and is aused by an output RL buffering network that is used in the B-1 as well as most other solid-state amps. Attempts at 'scope photos with much higher levels than 10 to 15 V p-p, 1 to 2 μ F loads, and fast square waves caused the protection circuitry to activate. Some 20 kHz high-power square waves are shown in Fig. 9. The overshoot for the square wave with a resistive load starts at 15 to 20 V p-p and gets larger as the level increases to the 80 V p-p shown. This amplifier, like many others, is in a slewing condition when it changes state from one level to another where the level changes represent a large fraction of the available output swing for a fast step input. Large error signals are operating inside the amp to cause it to go to the required new level as fast as it can. The speed and manner that the output reaches the new level is determined by how the amp is compensated for stability and how fast these RC networks can be charged by the available current in the stages where they are located. The overshoot in the B-1 is its particular way of recovery from a heavy slewing condition. Note, however, that the amp behaves essentially the same for a plus-to-minus as for a minus-to-plus transition, which is a tribute to the symmetry of the circuit. Several of the recently reviewed power amps recover or reach their new levels with less or no overshoot.

However, it is not clear at this time whether this phenomenon has any particular sonic significance.

Table I—Output Noise.

Bandwidth, Hz	Right, μ V	Left, μ V
Direct		
20 to 20k	85	54
400 to 20k	67	48
Normal, Rumble Filter Out		
20 to 20k	105	90
400 to 20k	93	82
Normal, Rumble Filter in		
20 to 20k	110	95
400 to 20k	97	86

Output noise with shorted inputs is shown in Table I as a function of measurement bandwidth, direct or normal input, and rumble filter in or out. It can be seen that the input amplifier used for normal inputs does add some noise, but even the highest noise level of 110 μ V is still some 110 dB below rated output of 150 watts into 8 ohms. These are truly excellent output noise figures, indeed.

Power output at visual onset of clipping for 4-, 8-, and 16-ohm loads was 213, 220, and 144 watts, respectively.

Conclusions

The Yamaha B-1 amplifier is a fine piece of equipment and has some very useful and interesting features. It is an excellent first implementation of a new technology, though it is hoped that with time the price and complexity of V-FET amps will decrease. This amplifier can be recommended as a state-of-the-art device for those with the wherewithall to afford it.

Bascom H. King

Check No. 72 on Reader Service Card

ELAC/Miracord 760 Automatic Turntable



MANUFACTURER'S SPECIFICATIONS

Speeds: 33 $\frac{1}{3}$, 45, and 78 rpm. **Wow and Flutter:** 0.06%, and 0.07%, respectively. **Rumble:** -44 dB. **Variable Speed:** \pm 3% of nominal. **Dimensions:** 14 $\frac{1}{2}$ in. W. x 12 $\frac{1}{2}$ in. D.; base, 18 $\frac{1}{2}$ in. W. x 14 $\frac{1}{2}$ in. D. **Price:** \$199.95.

The Miracord 760 is an updated but less expensive version of the Model 50HII which we reviewed in May, 1972. It costs \$199.95, as compared to \$249.95 for the 50HII. Surprisingly, there are few differences, and those are minor. There are strobe rings on the turntable instead of a neon-lit window, no stylus brush is included, and the turntable platter does not have the beveled edge of the 50HII — and that's about all. Everything else, motor, changing mechanism, and arm,

are the same or nearly so, and the two models even look alike:

On the right are three black pushbuttons for 7-, 10-, and 12 in. records, and a fourth button, a red one, activates the Stop switch. At the left front is a three-position speed-change switch, and the variable speed control is behind that at the rear corner. An anti-skating control, calibrated for 1 to 6 grams, is at the right rear near the tone arm pivot.

The arm is counterbalanced, and its weight has a milled plastic strip that meshes with the extension of a small control knob (see Fig. 2). Adjustment is simplicity itself. All you do is turn the knob until the arm (with cartridge attached) is balanced, then turn the control on the pressure dial (to the left of the pivot) to read 2 grams or whatever figure is recommended by the cartridge maker. The anti-skating knob is then set to the same figure. The plug-in head will take most cartridges, and the metal mounting insert is adjustable for



Fig. 1—View of Arm mount.

quick, easy alignment. In front of the arm pivot is a long cuing lever whose lifting height and lowering time are adjustable. A silicone-filled dashpot provides nice, slow lowering of the arm. The platter is quite heavy, weighing a bit more than 6 ¼ lbs. There are two strobe scales, one for 60 Hz and the other for 50 Hz.

As with the 50HII and other Miracords, the 760 has two spindles: a short one for single play and a "Magic Wand" for automatic play of up to 10 records. If the short spindle is inserted upside down the record will play continuously, a di-

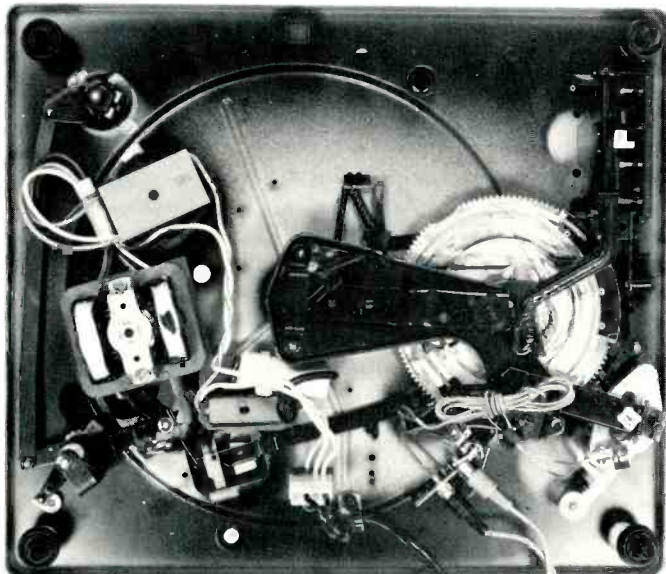

Fig. 2—View underneath the turntable.

version that will probably have limited appeal, though it's certainly useful for test engineers! The long spindle holds the record on three small supports which drop each record very gently. The silicone-damped mechanism of the arm in-

sure that the fragile (and expensive) phono stylus is not damaged as it lands on the record. The motor is a 4-pole asynchronous type which keeps the speed constant. Drive is applied to the inside of the turntable rim by a rubber idler wheel.

Two phono cartridges were used for the tests: a Shure V15-III, and an Audio-technica AT20, a top-of-the-line CD-4 pickup. The first measurements were for wow and flutter, and the figures came out 0.05% and 0.06% respectively, slightly better than the specified 0.06% and 0.07%. The rumble measurement was -54 dB (ARRL), also excellent for a machine in this price range and notably better than the maker's claim. Tone arm resonance measured with the Shure cartridge was approximately 7 Hz, well below the critical region. As expected, the speed remained stable over the range from 90 to 130 volts. The variable speed control gave its specified variation of plus and minus 3%.

The stylus pressure scale is calibrated in grams from 0 to 6, and it was found accurate within 5% above one gram. Arm tracking error was about 0.5 degrees at the worst position. The force needed to trigger the changing mechanism was less than 0.5 grams, a far cry from the cumbersome old built-like-a-battleship models of 20 years ago that used to need ounces to start the cycling sequence. The arm's friction was quite difficult to measure, being below 25 milligrams.

Cycling time was 16 seconds, a little slower than some other changers but not judged a disadvantage because the records and pickup are handled so gently. The cuing control worked smoothly and with precision, a pleasure to use. Special low-capacity cables are recommended for use with CD-4 cartridges; those supplied plug into sockets underneath so changing them is an easy matter. In order to see the strobe markings clearly the unit has to be placed near a fluorescent light; no doubt some ingenious souls will mount a small neon lamp nearby.

Summing up, the Model 50HII is still an excellent record changer at \$249.95, but at a saving of \$50, the 760 is a real bargain.

George W. Tillet

Check No. 73 on Reader Service Card

GTE-Sylvania Model AS210A Speaker System



MANUFACTURER'S SPECIFICATIONS

System Type: Two-way acoustic suspension. **Drivers:** One 10-in. (25.4 cm) woofer, one 1 ½-in. (3.8 cm) dome tweeter. **System Resonance:** 42 Hz. **Crossover Frequency:** 1.5 kHz. **Impedance:** 8 ohms nominal. **Power Requirements:** 10 watts average. **Size:** 15 5/8 in. W. x 11 3/4 in. D. x 24 in. H. (39.7 x 29.8 x 61 cm). **Weight:** 51 lbs. (23.1 kg). **Price:** \$99.95.

The Model AS201A speaker system, from GTE-Sylvania, is a two-loudspeaker design. The bass frequencies are handled

by an acoustic suspension enclosure housing a 10-in., high-compliance woofer, while the upper frequencies are carried by a 1 ½-in. dome tweeter. The cabinet is of moderate size and is finished in walnut vinyl. The grille is sculptured brown foam, held in place by grip fasteners on the front panel board. The units are designed for either floor or shelf mounting.

A recessed cavity on the rear of the enclosure contains the speaker terminals and two toggle switches. The terminals are of the 5-way three-quarter inch spacing variety which allows ready hookup by spade lugs, twisted wire, or banana plugs. The plastic insulated caps on these terminals are colored for polarity identification—red for positive and black for negative. Printed next to the respective terminals are the legends *Pos* and *Neg*, so the user should have no trouble making proper connection.

Two toggle switches are mounted above the speaker terminals. One, a three-position switch, is labelled *Mid Freq.* and has the marking *Normal*, *Lo*, and *Hi* in vertical-ascending order. This may be a good technical solution for a single switch which changes the mid-frequency response in a two-way system, but it is less than perfect human engineering since the lowest acoustic position is the center switch position. The other toggle switch is better. It is a two-position *High Freq.* control marked *Hi* and *Lo*. Fortunately, the acoustic effect of both controls is modest, so the user cannot go far wrong.

The foam grille is massive-looking, but almost perfectly transparent acoustically. It is held to the front panel with Velcro fasteners, which allow it to be removed readily for cleaning. A Sylvania logo is fastened to the foam front in one special place with a Velcro fastener. As received, the logo was mounted for vertical speaker placement with the woofer at the bottom of the panel and the rear panel control labels upright. If horizontal shelf mounting is desired, the logo can be rotated ninety degrees, and refastened to stay upright. If you do this, be certain to make the logo appear in the upper right corner so that the tweeter will be farthest

away from the shelf. This is to prevent shelf reflection from the tweeter. The panel side of the grille is hollowed to fit the slightly protruding speakers so there is only one way the grille will attach properly. Because of the weight of the AS210A only a very sturdy shelf should be used.

The AS-210-A is covered by a five-year warranty for any part which fails in normal use during this period. The warranty also covers replacement labor or service charge for the first two years.

Technical Measurements

The magnitude of load impedance which the AS210A presents to an amplifier is shown in Fig. 1 for two positions of the equalization controls. While there are six possible equalization combinations, the two shown in Fig. 1 represent the extremes, so far as the load impedance is concerned.

When it comes to impedance there is one thing you can depend upon—loudspeakers are never pure resistors. That is no fault, they do not have to look like resistors. Yet, the recent fuming and fussing about the method of testing power amplifiers for power has all but ignored the true load which the amplifier must drive—the speaker. As this reviewer has pointed out before, one can calculate a loudspeaker's complete impedance, magnitude, and phase angle, from measurement of impedance alone. That is why we show that measurement. But perhaps a better service can be provided if we also evaluate the loudspeaker as it might cause problems when used as a load for a power amplifier. Amplifiers designed to drive pure resistances may experience stomach aches when asked to drive actual loudspeakers at high level. This is not the fault of the loudspeaker, but is certainly caused by its presence.

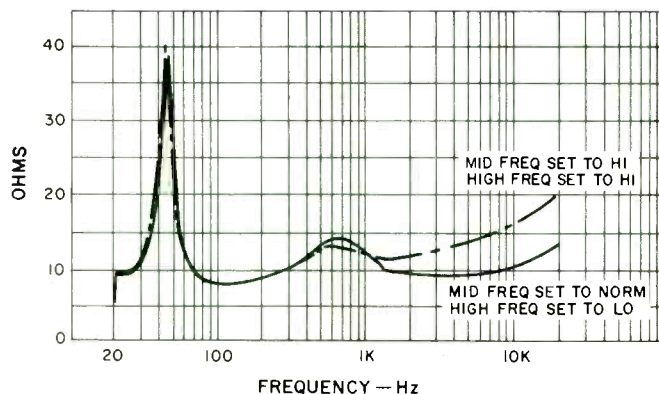

Fig. 1—Impedance.

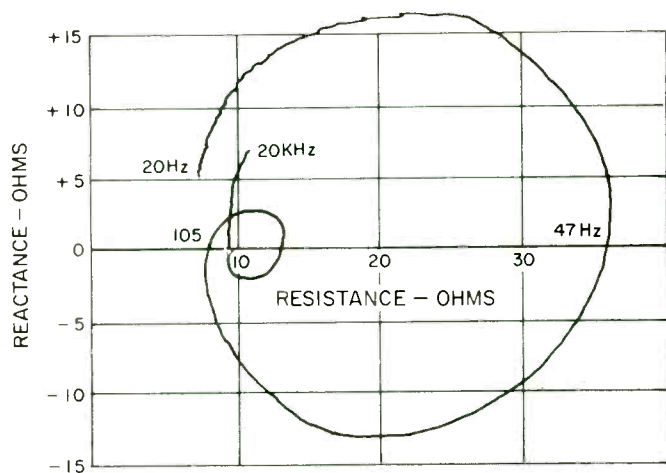

Fig. 2—Complex impedance plot.

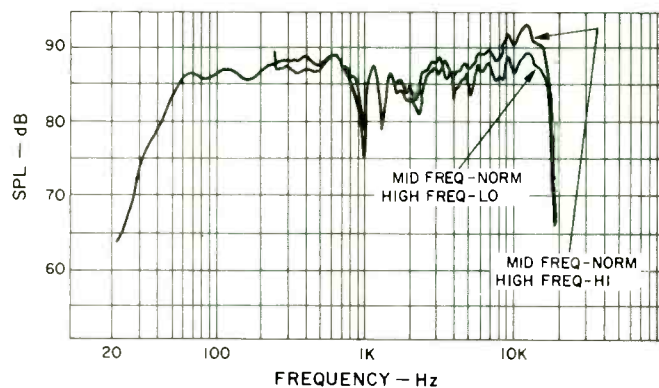

Fig. 3—One-meter, on-axis anechoic amplitude response, one-watt input.

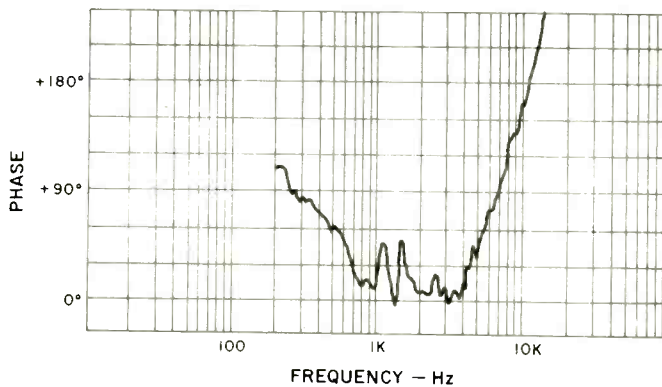

Fig. 4—One-meter, on axis phase response, corrected for acoustic position of midrange driver.

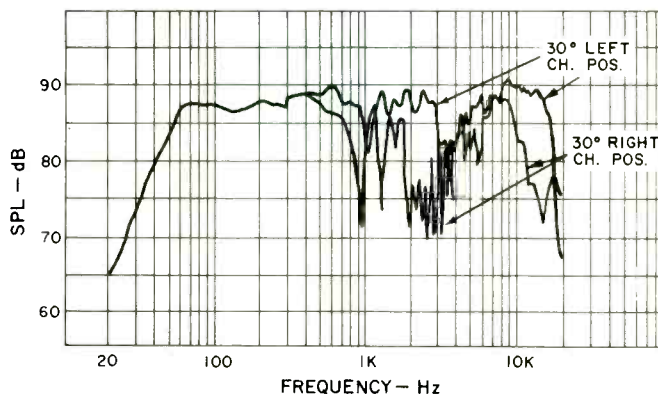

Fig. 5—One-meter anechoic amplitude response for 30° off-center listening positions.

Figure 2 is the measurement of the complex impedance of the AS210A for the *Mid Freq = Norm, High Freq = High* positions of equalization. The frequency range covered is from 20 Hz to 20 kHz. Only a few frequency values are marked on this plot since Fig. 1 shows the frequency characteristic for the same data measured as magnitude.

The lowest value of impedance presented by the AS210A is slightly below 8 ohms, and is resistive. Two main resonances are shown, one of them is the characteristic resonance of a sealed enclosure (the large circular arc in Fig. 2) which peaks here around 43 Hz. The other is a midrange peak at 600 Hz. This speaker is resistive at four frequencies between 20 Hz and 20 kHz. The worst reactance load at high frequencies, where many inexpensive amplifiers experience difficulty, is a capacitive reactance of only 11 degrees phase angle near 1100 Hz. The worst reactive volt-ampere drive near bass resonance should offer no problems to any reasonably well-designed amplifier. These plots show that the AS210A offers no load problem.

One-meter on-axis anechoic frequency response is shown in Fig. 3 for amplitude (SPL) and in Fig. 4 for phase. The axial SPL is quite smooth. The low frequency response is a textbook 12 dB-per-octave rolloff below 55 Hz. Some crossover notching occurs at around 1100 Hz but the trend is smooth up to an upper limit around 18 kHz.

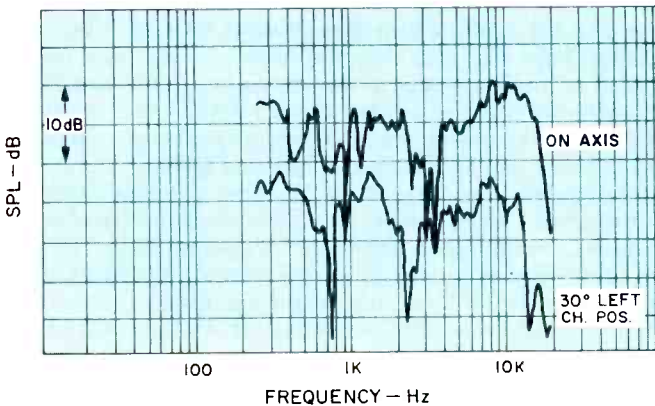

Fig. 6—Three-meter room response—speaker on floor.

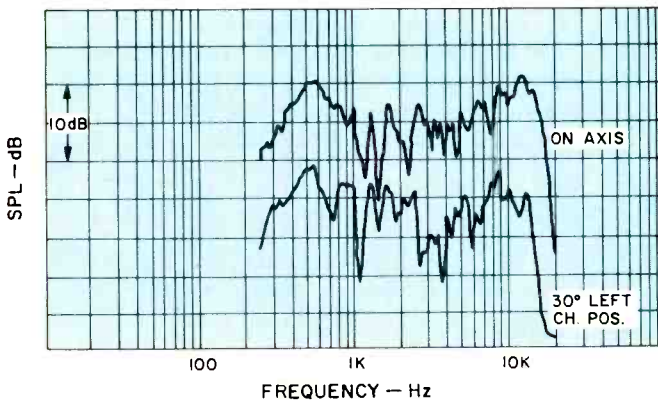

Fig. 7—Three-meter room response—speaker 24 in. above floor.

The axial phase response reveals that the woofer and tweeter are in phase at crossover with no sudden phase shift to mar performance. The axial response is principally minimum-phase throughout the frequency range. Above 3 kHz the tweeter has a 90 degree phase lag for this measurement. Only one phase measurement is shown, and this is corrected for the average acoustic position in the range from 600 Hz to 3 kHz. The acoustic position from 3 kHz to 12 kHz is such that the sound reaches the ear 0.1 millisecond earlier than sound in the 600 to 3 kHz range. The sonic effect of this arrival difference usually is to emphasize speech sibilants

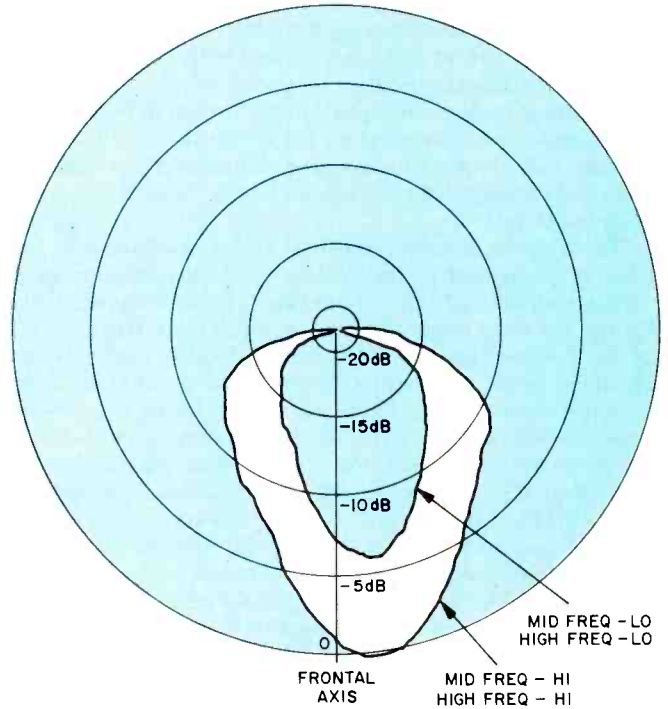

Fig. 8—Horizontal polar energy response.

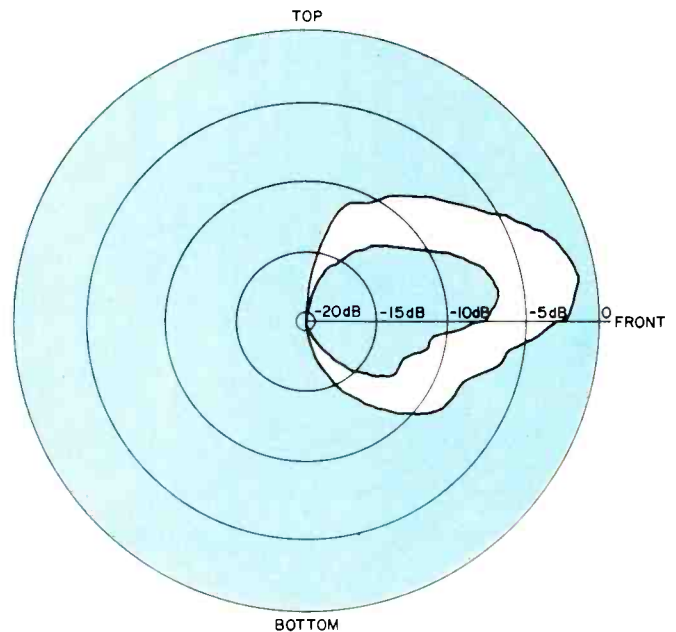

Fig. 9—Vertical polar energy response.

and crisper short-duration sounds. However the magnitude of delay in this speaker on axis is so small as to be negligible.

There is a distinct off-axis effect that deserves some notice. The best frequency response occurs directly in front of the AS210A. When the speakers are placed in a right channel and left channel stereo position, however, the anechoic response is not as smooth, as can be seen in Fig. 5. With the speaker rotated so that its axis falls to the right of the listener (right channel stereo position), the unit is distinctly non-minimum phase. In the frequency range from 1100 Hz to 2100 Hz the 30-degree right channel position has a non-minimum phase transition of 1440 acoustical degrees lag. Even a 10-degree angle offset from the on-axis position provides a 720-degree acoustic phase transition. This indicates that the best sound will be obtained with the speakers angled directly toward the listening position.

The three-meter room response is shown in Figs. 6 and 7. These measurements are the Fourier transform of the first 13 milliseconds of the loudspeaker's impulse response. They show the characteristic timbre for "early" sound in a normal listening situation.

The listening test revealed that an off-floor speaker position, as suggested in the instructions, provided more accurate sound than floor mounting. Figure 6 shows the response for floor mounting flat against a back wall. The data of Fig. 7 shows the response with the AS210A raised 24 inches off the floor, placing the center of the speaker at ear level, approximately one meter above the floor. The off-floor response may be seen to be distinctly superior. And as in the anechoic measurements, the on-axis response is better than that off-axis. I definitely recommend rotating these speakers in toward the listening area. The equalization used for all of these measurements was *Normal* for mid-frequency and *High* for high-frequency switch positions.

The polar energy response is given in Fig. 8 for the horizontal direction and in Fig. 9 for the vertical direction. Two extreme equalizations were used for the polar tests. In one case both mid-frequency and high-frequency switches were set to *Low*, and in the other both were set to *High*. It is obvious from Fig. 8 that there is a distinct left-channel sound superiority that verifies the anechoic and room test measurements. This measurement shows that a substantial amount of sound will be reflected off the back wall if the

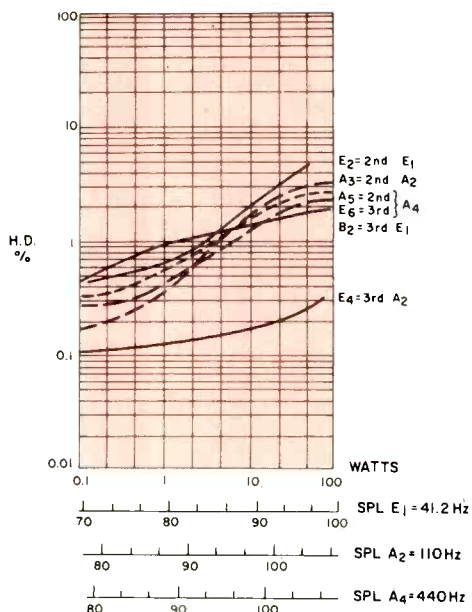

Fig. 10—Harmonic distortion for musical tones E1 (41 Hz), A2 (110 Hz), and A4 (440 Hz).

speakers are rotated toward the listening area while placed against that back wall. In some listening rooms this might give a stage-filling spread of sound pleasing to some ears, but not so realistic to others. To minimize this effect it may be necessary to experiment with the speakers pulled away from the wall. The broad horizontal dispersion of frequencies indicates that large reflecting objects, such as book cases, should not be placed next to the AS210A if they extend past the front of the enclosure.

Harmonic distortion for the musical tones of E1 (41.2 Hz), A2 (110 Hz), and A4 (440 Hz) is shown in Fig. 10. This distortion, though not spectacularly low, stays at quite acceptably low levels, generally below 1% through the usual listening range.

Intermodulation of 440 Hz by 41 Hz is shown in Fig. 11 as a function of drive level. There are about equal amounts of phase and amplitude modulation on A4 caused by E1. At 10 watts the amplitude modulation is 4% peak-to-peak and the phase modulation is 6 degrees peak-to-peak. At 40 watts there is 8% amplitude modulation and 10 degrees phase modulation. These are both principally 41 Hz modulations.

In the crescendo-handling test, incoherent noise of 80 volts peak-to-peak magnitude caused a one-half dB drop on a very low level A4 inner musical voice while barely suppressing a middle C voice. It can be concluded that applause and hand claps will not cause significant modulation of low level musical passages when the AS210A is driven within its power rating. Both A2 (110 Hz) and middle C (262 Hz) are one-half dB softer at 20 watt drive level than they should be based on the acoustic gain of each at the 0.1 watt drive level. Sudden loud passages may therefore cause a tiny lateral spread of musical voices in the stereo image for those left-of-center or right-of-center sounds which have more of their energy in one channel. This effect is virtually nonexistent below 1 watt and at normal listening levels.

The energy-time curve of Fig. 12 is very good for a speaker in this price range. This is the envelope of the impulse response computed for a one-meter on-axis position. The major sound energy arrives at 3.0 milliseconds, with very small reverberant and diffractive scattering arriving after that time. Integration of this data reveals that 95 percent of the sound energy arrives within 3.1 milliseconds and 99 percent arrives within 3.4 milliseconds. The only late straggler (arriving at 4.6 milliseconds) is due to enclosure-boundary diffraction, and that is almost 30 dB down. The dominant frequency for the first sound arrival is in the 10 kHz range. Therefore record ticks and scratch might be accentuated to a small extent.

Listening Test

Two listening positions were chosen for auditioning the AS210A. In one position the speakers were placed flat against a wall and raised off the floor so as to be nearly ear

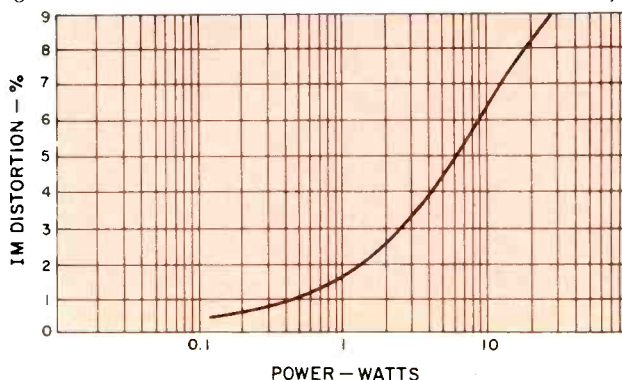

Fig. 11—Distortion of A4 (440 Hz) by E1 (41 Hz), mixed 1:1.

height for a listener who is seated. In the other listening position the units were placed on the floor, slightly away from the back wall. The stereo listening angle was about 60 degrees for both positions.

From the standpoint of overall sonic balance of the midrange and upper frequencies the better of the two positions is the raised, wall-mounted location. However the bass frequencies appeared to my ears to be too strong when the

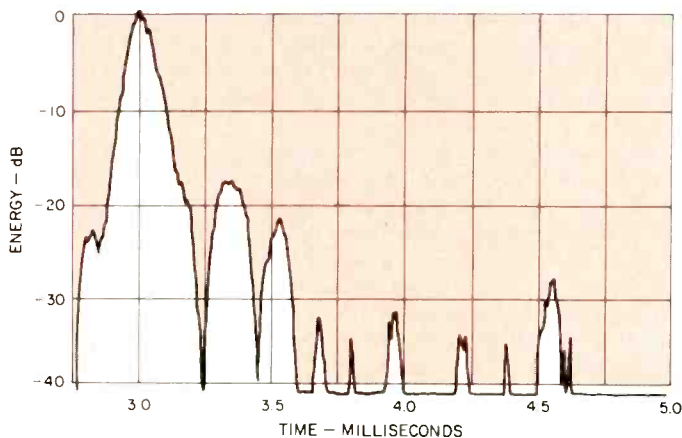
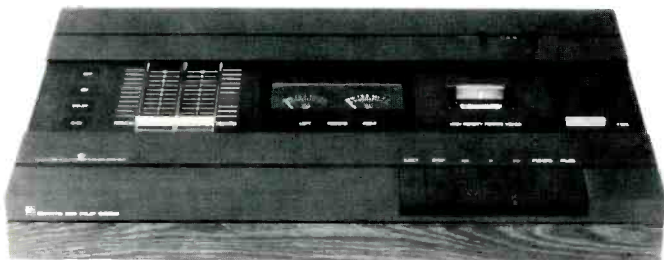

Fig. 12—Energy-time response.

speakers were against the wall. The floor position reduced this bass dominance but did so at the expense of midrange clarity. The AS210A, in my opinion, needs all the midrange level you can get from conventional tone control equalization. This is because of the strong bass (200 Hz and below)

Check No. 74 on Reader Service Card

Bang & Olufsen Model 2200 Cassette Deck



MANUFACTURER'S SPECIFICATIONS

Frequency Response: 30 Hz to 14.5 kHz. **Signal/Noise Ratio:** At least 52 dB with CrO₂ tape; at least 61 dB with Dolby. **Input Sensitivity:** Line, 0.2 V at 2.2M ohms; mike, 0.1 mV at 1000 ohms. **Wow and Flutter:** Less than 0.2%. **Erase:** At least 70 dB. **Output Level:** Line, 660 mV. **Speed Deviation:** Within 1.5%. **Fast Forward or Rewind Time:** 70 sec., C-60. **Dimensions:** 19.7 in. W. x 2.9 in. H. x 9.1 in D. **Weight:** 12.6 lbs. **Price:** \$460.00.

The Bang & Olufsen 2200 cassette recorder has a clean and uncluttered appearance, with a flat top panel in black finish with real wood skirting on the sides and front. The



Fig. 1—Rear view of the B&O BE-2200.

which tends to overwhelm the midrange frequencies even with the *mid frequency* equalization in the *Hi* position. The very highest frequencies, carried by the tweeter, can be brought up to the level of the bass frequencies with the tweeter control in *Hi*. Even with a *Lo* tweeter control setting on the AS210A and conventional tone control boost, the midrange appears to lack punch.

The bass heaviness of this system, coupled with the robust high frequency response, may constitute sound that is pleasing to a great many listeners. I am not one of them. I must admit that classic pipe organ sounds very good on this system and creates a good, space-filling illusion. Vocals and percussion bass instruments did not appear as accurate to my ear.

Stereo localization is moderately good with this system, with a slight tendency for lateral spreading of some stereo instruments. For those instruments which contain most or all of their energy in the frequency range of the tweeter, the sound is darn good. The tweeter is, in fact, the star performer in this loudspeaker system. The articulation and transient performance of the tweeter is excellent.

The AS210A is not a speaker system that I can recommend as a primary stereo system for a very large room. There are, however, several applications where the sound qualities of this speaker can be put to good use. One is as the important rear speakers of a quadraphonic installation. The distribution of sound energy may complement that of some of the higher quality systems one might use for the front. A second application is that of low-cost stereo speakers for a very small room, as in many college dormitories, where the bass response of many systems often sound anemic. The AS210A should shine in that environment.

Richard C. Heyser

flush-mounted *Off, On, Dolby,* and *CrO₂* push-button switches and status lights are located at the left end. Immediately to the right are the slide-type record-level controls. Adjusting the control's narrow-bar knob moves a sheet of transparent plastic with a horizontal green line which indicates level on the scale printed white on a black background under the sliding plastic.

The level meters are located in the middle of the deck, with a record indicator just in front. The meter needles and the normal-level scales are white, with high levels in red, all against a black background. Illumination from the back of the meters provides additional contrast, and the tapered shape of the needles aids in reading varying levels. To the right of the meters is the cassette well, which has a note on

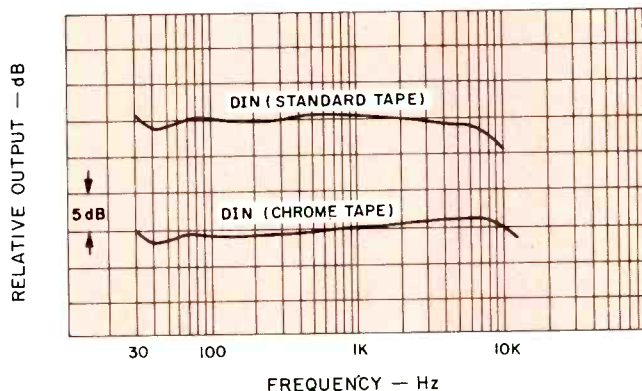

Fig. 2—Playback from DIN test tapes; top, standard, and bottom, chrome.

its cover that the machine is equipped with high-density ferrite heads. Tape is inserted into the tray attached to the cover and positioned by pushing down on the cover. In front of the well are the *Eject, Stop, Rewind, Play, Fast Forward, Record, and Pause* piano-style keys.

Next to the cassette well and at the right end of the deck are the stereo phone jack and a DIN microphone jack. These are recessed below the top of the panel and can be covered by a small sliding panel with a bar knob. An added convenience is the inclusion of a *Stereo/Mono* switch for the microphone, facilitating feeding both channels with just one mike. Behind the well are the counter with its *Reset* button and the memory *On/Off* switch.

Line input and output connections are made at the back with a 5-pin DIN socket. B & O provides an adapter cable with four phono jacks to facilitate connections to the typical American system. There is also a DIN socket with input/output levels to match European radio standards. Plugging into the microphone jack disconnects the line inputs.

Performance

The 2200 deck performed very smoothly in all of its tests, meeting all of its specifications. Playback response with a standard DIN tape was within 2 dB from 31.5 Hz to 6.3 kHz, but with a droop of almost 5 dB at 10 kHz. Playback response with the CrO₂ DIN tape was better at the high end, with a droop of just 2.4 dB at 12.5 kHz. (See Fig. 2.) The record/playback response curves of this unit were particu-

larly noteworthy because of their flatness. Using Capitol Music tape with Dolby out, shown in Fig. 3, the response curve was flat within a fraction of a dB from 50 Hz to almost 10 kHz at -20 VU. At this level, the 3-dB-down points were at 26 Hz and 16.0 kHz, superior to the 30 Hz to 14.5 kHz specification. Similar flat responses were obtained with BASF LH and Memorex MRX₂. The headroom at 0 VU was limited to 6.1 to 7.1 kHz with these tapes, with low frequency droop also in evidence. With the fast-response meters provided, this limitation (shown when using constant-level test signals) is more apparent than would be the case in actual practice. One of the benefits associated with the flat response of these low-noise tapes was that any mistracking in the Dolby circuits was minimized.

Performance with two ferrichrome tapes, Scotch Classic and Meriton, was less satisfactory overall. Although the headroom at 0 VU was better than the low-noise tapes, there was rising high-frequency response at -20 VU in Dolby mode.

The Dolby-out record/play responses with TDK KR chrome tape showed good headroom at 0 VU, within 3 dB out to 15.0 kHz at -20 VU and generally flat at both levels. With Dolby in, the response was quite acceptable at -20 VU with elevations of 2 dB at 100 Hz and 6 kHz.

The harmonic distortion of the 2200 over a range of input levels (1 kHz) was determined using a spectrum analyzer. In this way distortion products were measured at low input levels where noise would normally cause higher, erroneous readings with commonly-used distortion meters. BASF LH, Capitol Music, and Memorex MRX₂ showed the lowest total distortion over the test range, reaching 3 percent distortion at about +3.5 VU. The ferrichrome and CrO₂ tapes reached the same distortion level at +1 VU. The levels of the harmonics generated with a 0 VU input signal over a frequency span of 30 Hz to 10 kHz were also measured. The analyzer showed that the dropping figures for distortion from 2 kHz to 5 kHz were the result of harmonics being eliminated by tape saturation effects. Also revealed was the fact that the distortion products at 10 kHz were actually forms of subharmonics, perhaps beat notes with the bias oscillator. The average A-weighted signal-to-noise ratio for three low-noise tapes was almost 54 dB relative to 0 VU, about 57 dB relative to a 3 percent distortion reference.

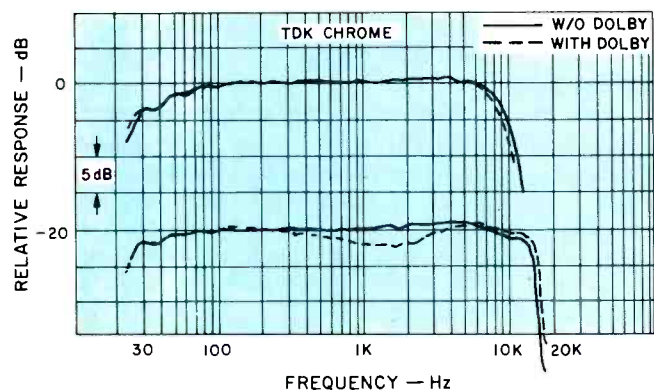

Fig. 3 — Record/Playback response, Capitol Music tape, with and without Dolby, recorded at Zero VU, and at -20 VU.

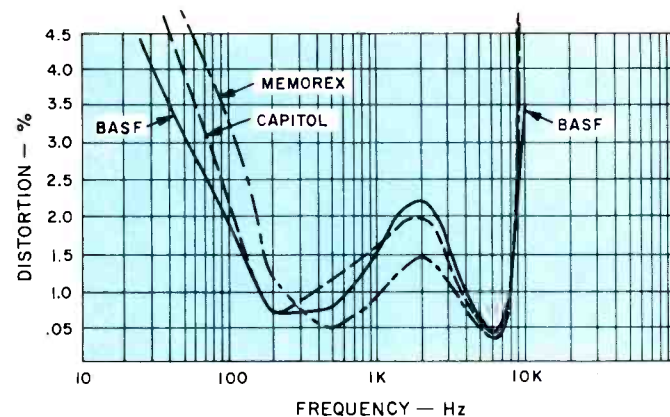

Fig. 4 — Harmonic distortion at 1 kHz, three tapes, with Dolby. Variations were so small (less than 1% generally), that curves could not be shown separately.

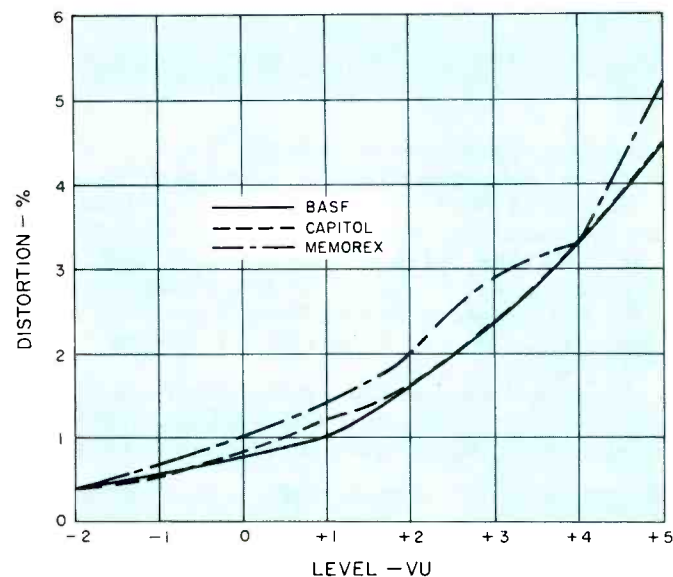

Fig. 5 — Distortion versus frequency for three tapes.

With Dolby in, the average signal/noise ratio reached 61 dB and 64.6 dB. Results with ferrichrome and chromium dioxide tapes were not as good, though the TDK KR did meet the B & O specification of over 52 dB without Dolby and over 61 dB with Dolby. The 3 percent distortion reference is quite appropriate for this deck, with its fast-response metering. These meters are frequency dependent, with greater deflection at the frequency extremes, about +5 dB at 40 Hz and 10 kHz, a good idea in most respects.

The spectrum analyzer was needed to verify that the unit did indeed surpass its 70-dB erase specification, actually doing at least 1 dB better without Dolby, and at least 6 dB better in Dolby mode. Crosstalk between stereo channels was -28 dB, acceptable although a bit high, and more than 60 dB down between adjacent channels of opposite-play direction. The best flutter figure obtained was 0.08%, and 0.19% was the average for DIN weighting, within the specified 0.20%. Average rewind time was 65 seconds, well within the 70-second specification. Tape speed was 0.6% fast with 120 V a.c. power.

The drive signal input to the headphone jack was 775 mV across 8 ohms, giving good listening volume with phones of various sensitivities and impedances, a desirable feature. Microphone input sensitivity of 0.094 mV was slightly better than the specified 0.1 mV. Line sensitivity was 107 mV, noticeably better than the specified 200 mV.

The output for 0 VU indication in playback was 700 mV

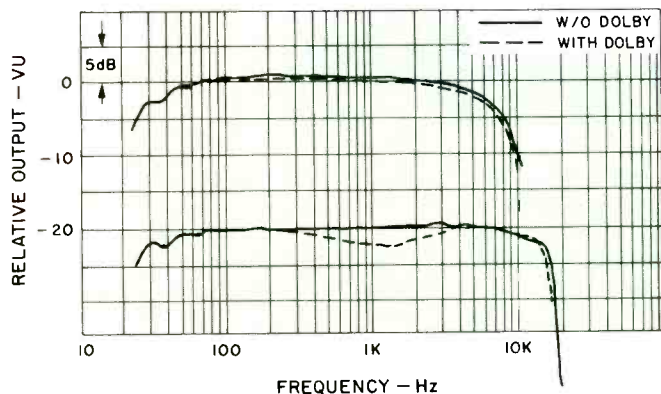

Fig. 6 — Record/Playback response, TDK KR (chrome) tape, with and without Dolby.

compared to the specified 660 mV. With no output controls, the level played back was dependent upon the record sensitivity of the tape used. There is no output from the recorder line output when in Record mode, although the headphone jack is driven. The dynamic action of the meters was checked by feeding in a single-cycle tone burst of the same amplitude as would provide a 0 VU indication if it were continuous. The meters reached -3 dB with a 705 Hz burst and -1 dB with a 345 Hz burst which have 1.4 and 3 millisecond periods, respectively.

In-Use Tests

The meters of the B & O 2200 are superior to many others classified as peak responding. The attack time is visually well correlated to the audible character of the music. The decay time is well chosen so there is no sense of a lagging indication of level. The record-level controls slide smoothly with no binding.

The tape motion controls responded to a light touch, continually conveying the impression of quality construction. A minor criticism is that the solid black of the memory On-Off switch against the black background of the top panel made it difficult to be certain of the status of this function. A light-colored band around the button would be an aid.

The instruction book is not lengthy or detailed, but adequate. A schematic is supplied, of excellent quality with component values and functions clearly identified. On the back of the schematic, two board layouts pinpoint the location and function of all the adjustment pots. This information will be of great value to owner or serviceman in peaking the performance to match a particular tape. Access to most of the circuitry is gained by removing four bottom screws. High quality workmanship and components are evident throughout the machine.

Listening tests were performed by making copies, both with and without Dolby, of the *October Excursion* and *Epiphany* movements of Respighi's *Feste Romana*. Perhaps the best indication of the quality of the playback with various tapes is that no change could be heard between the dubs and the original. On the other hand, the ferrichrome tapes gave the plucked mandolin a slightly wiry sound, and their poorer noise performance was apparent. The chromium dioxide tapes failed to give improved performance over the low-noise varieties, which proved to be very well matched to this cassette deck.

Howard A. Roberson

Check No. 75 on Reader Service Card

Addendum

SAE MK-IIIICM Amplifier

It was discovered recently that two inaccurate 'scope photos appeared in the January, 1975 review of the SAE Mk-IIIICM power amplifier. Specifically the upper trace of Fig. 7 on page 63, showing low frequency tilt at high power, and the upper trace of Fig. 10 on page 64, showing an exponential leading edge on a high power 20-kHz square wave, are in error.

The square-wave and pulse generators used for these photos both have a d.c. component in their output equal to one half of the peak-to-peak signal output. In the Mk-IIIICM design, there are two back-to-back diodes from the signal input to the overall shunt loop-feed-back resistor. The purpose of these diodes is to reduce the amount of internal overdrive signal when the amplifier is driven heavily into clipping. With a d.c. component on the input square wave, one of these diodes

conducts and, by rectification, upsets or influences the fed-back output signal, thus causing low-frequency tilt at higher output powers (greater input voltages) and an exponential shape on the rise time of a large, fast step-input change.

With the d.c. component removed with a suitable external series capacitor and shunt resistor with a very long time constant, which is representative of normal use with preamp outputs, the high-level 50-Hz square wave would have virtually no tilt, and the large fast step-input response would be more linear or straight sided, and have a full-power rise time closer to 3 or 4 μ S than the 6 to 7 μ S indicated in the review.

The use of these signal generators having the d.c. component generally does not affect other input a.c. coupled amps which don't have input limiting diodes used in this manner, and the 'scope photos shown with those reviews are correct.

The Column

Fred DeVan



Dixie Rock: Wet Willie
Capricorn CP-0149, stereo, \$6.98
Keep On Smilin': Wet Willie
Capricorn CP-0128, stereo, \$6.98

Wet Willie, Capricorn's brash, spunky, "best of the bar bands," has made the most perfunctory disc possible on **Dixie Rock**. It's dry, plodding, and pedantic, by Wet Willie standards. This band has put out such exciting, driving, gutsy performances in the past that this record is disappointing. It's as if old age or road fever had struck them comatose. All the thrill I got from picking up the album was dashed by the merely better-than-standard boogie music it contained. Better than standard, but not the Wet Willie they showed on their earlier album, **Keep On Smilin'**. That one was so good that nothing could surpass it. **Dixie Rock** sounds like an uninspired quickie that no one cared about. Even though the band has so much talent, they succeed in making the inevitable so-so album that plagues every good group occasionally. Wet Willie is not a mediocre band, so let's keep on smilin' and talk about **Keep On Smilin'**.

That one was dynamite—presented by the best sock-em "bar" band in the South. Uninhibited, vital, colorful, skillful, contemporary rock. Boy, what

a band that was—and still is. I'm sure a little rest and reflection will help them vindicate themselves for the lower quality of **Dixie Rock**. The stompin', spunky, ultimate boogie style that's their trademark really came together on **Keep On Smilin'**. The strong vocals that always fit, and funky horns that fly, really set them apart from other groups. These qualities exist on all their albums, but **Keep On Smilin'** is their best recorded performance.

Country Side of Life, *Keep On Smilin'*, and *Soul Sister* are among the finest tracks to come out of the Macon, Ga. home base of Capricorn Records, and location of their fantastic studio. It's such a good studio that it's probably easy to be lazy and laid back when working there. *Alabama* is a lovely, wistful love-anticipation ballad that is far superior to the usual change-of-pace, slow tune most bands throw into their act. The basic pace of their rhythm section is a laid-back, rolling and bopping masterpiece. And very Southern. However, they are never sloppy. Even with boogie lyrics, the "Willietts" tighten everything up by raising the excitement level with amazing vocal interplay and strength. The whole band wails, but unlike the Boston style (J. Giles), the vocals are

allowed to come up front.

A lot of this is accredited to Tom Dowd, the band's producer. All the good things about sound and performance excitement that Dowd forgot when he did Eric Clapton's **461**, are deftly applied to **Keep On Smilin'**. When Tom Dowd produces a good record, he delivers a great one. The sound is as gutsy as the band and the material. Clean and open.

The delineation between instruments and voices is faultlessly clear, but the pressing I have is one from the height of the vinyl shortage madness and is junk. Somehow through the slush and gravel, the wizard of Warner manages a nearly-acceptable record. I don't think a current pressing of the album would be so bad. If you do get one that's excessively noisy, drop a note to the nice understanding folks in Burbank. That's the only way they will be able to find those evil old oil-crisis-caused discs. **Keep on Smilin'**.

Dixie Rock

Sound: B+ Performance: C

Keep On Smilin'

Sound: A? Performance: A+

Reality: Monk Montgomery
Philadelphia Int'l. KZ33153 Stereo,
\$4.95.

What a refreshing treat this record is! After all the thundering bass players with their 16-foot high amplifier-speakers going thump, whump, along comes Monk Montgomery with the electric (Fender) bass as a *lead voice!* A bass player up front—playing melodies, chromatic structures, and obli-gattoes—not just guitar chords. And playing warm and light! A Fender bass behaving like a tenor sax, a trombone, a cello, a scating male voice. Low and sensual, rich and sensitive. Monk's brother Wes was a gifted guitarist who died at an early age several years ago. Monk is one of the few musicians who didn't scoff at the Fender bass in the early Fifties when it was first produced. At that time he was with the Lionel Hampton big band, and he was one of the very first acoustic bass players to adopt the electric. He not only used it, but almost alone lifted it out of its toy novelty class to make it the most used of all electrical musical instruments. We have all had our musical orientation changed by the existence of this instrument. Without it much of the music we hear today would be impossible.

In addition to my formal training on the acoustic (double) bass, and experience playing trombone, euponium and tuba, I own and play an electric (Fender Precision) bass. Thus, I have some understanding of how unusual are the things Monk Montgomery does with his instrument. He is a master!

Specifically, on *I Love You, Camille* (written by Bill Cosby) he glides through the theme in two-part harmony with Ron Feuer on Hammond organ to create sound so haunting and lovely that it just stopped me in my tracks. He moves over the full range of "his" instrument with astonishing ease and aplomb. One would never guess that these sounds are coming from the same instrument that growls and roars behind the likes of Brownsville Station, or any other of the hundreds of practitioners of bad taste who pollute the air with bad rock and roll.

Monk Montgomery doesn't play rock. He doesn't play jazz. He doesn't play anything that we have a name for, but he does play taste. He is a real musician—a true virtuoso. Perhaps I can't be objective because I understand the technical problems presented by what he's doing. Yet as I write this I realize I'm listening to nothing less than perfect musical expression and performance. If you've ever played any instrument, even a kazoo,

you will know the first time you hear him that something extraordinary is going on.

What it is or how it is done is less important than being aware that this performance is a masterpiece. If rearranged and restructured it could be called *Concerto for Electric Bass and the Philly Sound*. If hyped up and roughened, it would have a dozen descriptions from as many press agents. But leave it as it is: just call it wonderful, pleasant, contemporary music at its finest.

Since the label is Philadelphia International we expect quality and class. Perfect recording is therefore taken for granted. The sound of Philly is one of the most sought-after in popular music today. It is universal and in one way or another appeals to almost everybody. But this disc is above even that elevated standard.

I've listened to every record thus far released by PIR, Inc., and I've yet to find a bad one. They issue many different kinds of music, but the Philly quality is always there. If America has an equivalent to ECM (of Germany) it is the Sound of Philadelphia (i.e. PIR). **Reality** is a departure only in the material presented, and it's one of the best efforts of the energetic young musicians who run the company. They've promised 17 discs in the next two or three months, so I plan to take a long look at PIR soon.

Right now, I'm going to put on Monk Montgomery's **Reality** one more time, grab my Fender bass, sit in the center of my listening room and get totally carried away. I love this record!

Philadelphia International Records Discography

Listed here are some of the best records issued by PIR:

War of the Gods, Billy Paul, KZ32409; **Half and Half**, Cleveland Eaton, KZ32077; **Yellow Sunshine**, Yellow Sunshine, KZ32405; **Spiritual Concept**, Spiritual Concept, KZ32404; and three by the O'Jays: **Live in London**, KZ32953, **Back Stabbers**, KZ31712, **Ship Ahoy**, KZ32408.

Sound: A

Performance: A

Light of Worlds: Kool & the Gang
De-Lite 2014, stereo, \$6.98.

For quite some years Kool & the Gang tried to get a break playing a jazz-affected kind of barroom blues. Struggling for all they were worth, they spiked their product with a heavy dose of tight 4/4 dance rhythms, and played jazz around the big beat. At first they had to play funky in order to

Some of your music is missing.



... Unless you have adequate amplifier power. Some of the most dramatic music in your record or tape collection is being clipped away if your amplifier doesn't have the power to handle difficult passages at realistic listening levels.

That's the *raison d'etre* of the Phase Linear 700B Amplifier. It has the highest power, widest frequency response, lowest distortion of any stereo amplifier in the world. It may be what you need to restore your missing music. Ask your dealer for a demonstration.



Phase Linear 700-B

THE POWERFUL DIFFERENCE

PHASE LINEAR CORPORATION,
P. O. BOX 1335,
LYNNWOOD, WASHINGTON 98036

Check No. 24 on Reader Service Card

eat, and they played their jazz around bars in the Jersey City area in the mid-Sixties where no one was listening.

As time went by, the seven-man band got more and more affected by the funky stuff while attempting to deny their jazz roots. Out of the necessity to eat and a healthy dose of frustration, a blending of the two seemingly conflicting forms became the musical direction of the band. They changed their name from The Jazziacs and made their first album in

1969, but after seven albums and five more years, they were still little known.

After their seventh album, *Kool Jazz*, (De-Lite DEP 4001) they decided to do a commercial, repetitious little thing called *Jungle Boogie*, which hit #1 on the R&B charts. It sold scads of 45 doughnuts and my daughter Yvette (then 11) drove me nearly nuts playing it. I hated that record, but I heard something that made me curious. She conned me into watch.ng them on

television and what I saw looked to me like a jazz band that had sold out. We discovered the group's previous, more rewarding albums, and suddenly *Jungle Boogie* fit into a much bigger scenario. Now she and I both listen to all the Kool & Gang we can find.

Today the group is an unqualified success with three gold records in six months, all out of album number 8, *Wild And Peaceful* (Delight DEP 2013). Now we have number 9, *Light Of Worlds* exhibiting a further catharsis of the band. Here they show the development of their years of hard work.

This album is not a departure from the format that made them happen. A little James Brown thumping, a bit of Herbie Hancock keyboards, a little Stanley Turrentine sax blowing, and a lot of Kool & The Gang. This music is jazz stepping into rhythm & blues, not adapted R&B. The music stretches from easy listening to hard thumping on one disc. This mix probably limits their audience acceptance, since if you go to hear them for one style you get the other styles whether you like them or not. This *Light of Worlds* appears spotty because of the wide range of subject matter it covers.

The whole record is quite enjoyable and easy to listen to often. Frankly, I hope they continue to confuse their fans, cause it's seldom you get musicians who steadfastly follow their own instincts and are not swayed by success into starving the audience. Why should everything that they do after a hit be reminiscent of that hit?

The sound is good, at times exceptional. Mastering and pressing are excellent, with no noise, pops, or crackles, even in the very light keyboard passages which supply a delicate dimension. The engineering is rich and detailed. The synthesized quad sound is superb with excellent instrument location in either SQ or QS mode. With all their texture a true quad album would indeed be a delight, but there is little wrong with this stereo disc.

Kool & The Gang are a pleasure to explore. It is obvious that there is a lot to be heard from them in the future. Fortunately, while we await their next offering, we have nine already to nicely fill the time.

Sound: A Performance: A+

Nightbirds: LaBelle
Epic KE-33075, stereo, \$5.98

Patti LaBelle is an almost-middle-aged singer who has been around for

Which speaker looks like it sounds the best.

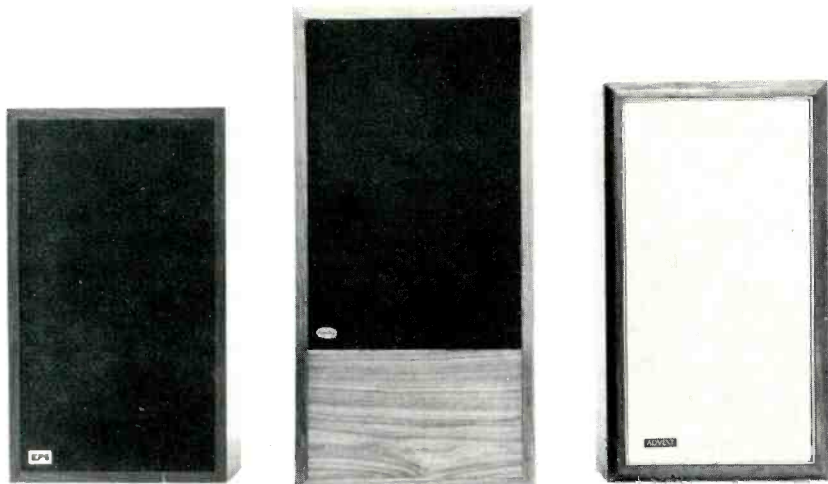

EPI 110

HARTLEY ZODIAC '75

ADVENT "LARGER"

Most audio experts agree: the bigger the box, the bigger the sound. A bigger cabinet means better bass response.

So when we designed the Hartley Zodiac '75 to compete with other popular bookshelf speakers, we made it bigger. By using only a few more inches of your shelf or floor, we give you Twenty-five to Sixty percent more cabinet than our competition. And more cabinet means bigger sound.

Our cabinet is only part of a two-way speaker system that gives clear, sharp response from 30 to 25,000 cycles. We build our Zodiac speakers in asymmetrically matched pairs for better sound dispersion. We use only top grade walnut veneers and a unique acoustic foam grille. And we back them with a Five-year warranty. Five years, not Two or Three.

We do all of this for about the same price as our competition. You see, we believe when you spend your hard earned dollars for speakers, you deserve the biggest sound your money can buy.

Hartley Products Corporation

56 North Summit Street, Tenafly, New Jersey 07670
(201) 871-3442

Hartley Canada Ltd., St. Hyacinthe, Quebec • Coral Audio Corp., Tokyo-Osaka, Japan • Royal Asia Ltd., Taipei, Taiwan • Interdyn, Melbourne, Australia.

as long as I care to remember. She is a chameleon who changes her style abruptly, yet successfully. This is a whole new thing for her, and it's her best yet. Compared to what she has done before it's almost non-commercial, yet it will probably be her biggest success ever. It has broad appeal that makes it work, but it's not the instant Top-40 thing she used to do. In fact, the most interesting aspect is that it is a very unusual effort, unique in many ways, both musically and conceptually.

Its stellar tune is *Lady Marmalade*, a wild, sexy song, with a feminist slant on it all (but you have to be bi-lingual to get the whole message) sung in English and French, by three strong Black females.

On *Don't Bring Me Down*, *Nightbirds*, *What Can I Do For You*, and *All Girl Band*, LaBelle, Sarah Dash, and Nona Hendry romp and roll through their material like the unisex Valkyries from 1975 that their fans think they are. Maybe they are. I don't think Allen Toussaint has a Richard Wagner fixation, or any other personality problem, but he has produced one hell of a record with this band and these three supercharged raunch-and-roll superwomen. Seen up close they look completely out of character until they start to sing.

LaBelle is not everybody's trip, but it's definitely an interesting one. **Nightbirds** has amazing lyrics which could only come from someone with a mature point of view. LaBelle are not kids (nor are they like Stella Dallas) but they are having fun, as always.

Their band is splendid. Maybe the horns stumble around a bit, and the sound could be better. I am not sure what it is, but it's not Allen Toussaint's usual crystal-clear sound. There are also a few spots where I thought I could hear some distortion. Nothing vital, however. Curious, successful, refreshing.

Sound: B Performance: A

New Skin For The Old Ceremony:
Leonard Cohen

Columbia KC-33167, stereo, \$5.98

Canadian poet-singer Leonard Cohen has a new record out. For Leonard Cohen fans, it probably is as good as, or better than, his previous one. But I am not at all a Leonard Cohen fan. I spent a lot of time trying to accept his own particular presentation of words. Possibly my bias comes from the anti-music quality of his performance. Like Rod McKuen, the words are all that's really of any importance to him. His standard lethargy pervades

this disc. For all his possible virtues, he bores me so much that I didn't hear the whole album. Maybe someday I will.

To all Leonard Cohen's special friends, I am sure **New Skin For The Old Ceremony** will be welcome. It's probably better than I realize.

Sound: B Performance: B

The Baker-Gurvitz Army
Janus JXS 7015, stereo, \$6.98.

A must for Ginger Baker followers,

like me. It's spotty, sometimes good, sometimes spectacular, sometimes frustrating. The sound also varies, and is a bit sloppy. The production is casual, at best. As usual, a few spots of fine Ginger Baker flash. **Cream**, **Blind Faith**, and **The Ginger Baker Air Force** still remain the best of Ginger Baker! Try this one—you may not love it, but it's worth trying.

Sound: A Performance: B

(Continued on page 79)

WHEN IT COMES TO SOUND, TDK IS IT. AT TDK, AUDUA IS IT.

Audua open reel. Unexcelled high-end frequency response and freedom from distortion.

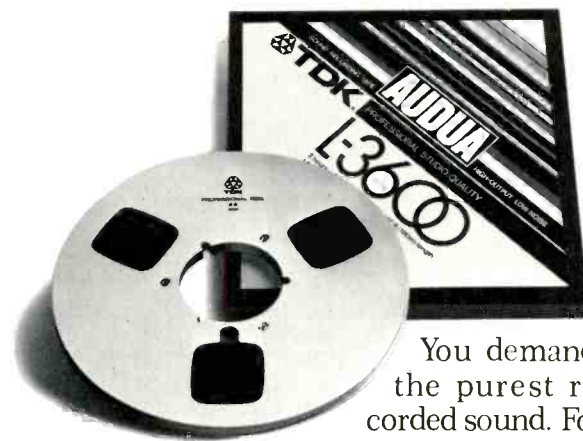

You demand the purest recorded sound. For you there's TDK Audua-L open-reel tape. In independent lab tests against six other premium quality tapes, Audua's high-end frequency response was unsurpassed, exceeding 20,000 Hz. And no other tape obtained a lower level of distortion (THD). Which makes for perhaps the most brilliant, purest sound you've ever enjoyed. Audua's performance is so good, you can make superb recordings even at 3¾ ips! Audua the pure, for you the purist.



Wait till you hear what you've been missing.

TDK Electronics Corp., 755 Eastgate Blvd., Garden City, N.Y. 11530. Also available in Canada.

Check No. 36 on Reader Service Card

Advertising Index

Advertiser	Page	Advertiser	Page	Advertiser	Page
Acoustical Research	59	DBX, Inc.	86	Polk Audio	90
AR-11 Speaker		Model 117		Hi-Fi Components	
Check No. 1 on Reader Service Card		Check No. 14 on Reader Service Card		Check No. 30 on Reader Service Card	
AKAI	23	Discwasher	2	Recording Institute of America	81
GXC-39D Tape Deck		Record Cleaning Devices		Music Industry Cassette	
Write Direct to Advertiser		Write Direct to Advertiser		Write Direct to Advertiser	
Aries	90	Dynaco	11	Revox	86
Synthesizer Kit		Hi-Fi Components		Tape Decks	
Check No. 2 on Reader Service Card		Write Direct to Advertiser		Write Director to Advertiser	
Astatic	39	ESS, Inc.	43	Rhoades	97
Hi-Fi Components		Ess Heil Amt Loudspeaker Systems		Teledaptor	
Check No. 3 on Reader Service Card		Write Direct to Advertiser		Write Direct to Advertiser	
Audio Amateur	93	Frazier, Inc.	83	Rocelco, Inc.	33
Constructors Publication		Speakers		Loudspeakers	
Check No. 4 on Reader Service Card		Check No. 15 on Reader Service Card		Check No. 10 on Reader Service Card	
Audioanalyst	79	Great American Sound	79	SAE, Inc.	91
Loudspeakers		Servo-Loop Preamplifier		Hi-Fi Components	
Check No. 5 on Reader Service Card		Check No. 16 on Reader Service Card		Check No. 31 on Reader Service Card	
Audio Dynamics Corp.	17	Hartley	72	Sansui	55
Hi-Fi Components		Speakers		Hi-Fi Components	
Write Direct to Advertiser		Write Direct to Advertiser		Check No. 32 on Reader Service Card	
Audio Research Corp.	46	Infinity	44, 45	Saxitone	95
Magneplanar Tympani		Hi-Fi Components		Magnetic Tapes	
Write Direct to Advertiser		Check No. 17 on Reader Service Card		Write Direct to Advertiser	
Audio-Technica	89	Jennings Research	57	Schwann Record & Tape Guide	85
Cartridges		Loudspeakers		Sample Issue	
Write Direct to Advertiser		Check No. 25 on Reader Service Card		Write Direct to Advertiser	
Avid Corp.	87	Kenwood Electronics	13	Shure Bros.	15
Speaker Systems		Loudspeakers		Hi-Fi Components	
Check No. 6 on Reader Service Card		Check No. 18 on Reader Service Card		Check No. 33 on Reader Service Card	
BGW	92	James B. Lansing, Inc.	19	Sony	4, 5
Hi-Fi Components		Hi-Fi Components		Amplifiers	
Check No. 7 on Reader Service Card		Check No. 19 on Reader Service Card		Check No. 34 on Reader Service Card	
BML Electronics, Inc.	84	Magnepan, Inc.	88	Soundcraftsmen	27
Tracer II		Magneplanar Speakers		Hi-Fi Components	
Check No. 8 on Reader Service Card		Check No. 20 on Reader Service Card		Check No. 35 on Reader Service Card	
Bose Corp.	7	Maxell	24	Superscope, Inc.	102, Cover III
Loudspeakers		Hi-Fi Components		Sony Tape Recorders	
Write Direct to Advertiser		Check No. 21 on Reader Service Card		Write Direct to Advertiser	
Bozak	12	McIntosh Lab.	89	Tandberg of America	91
Hi-Fi Components		Free Catalog		Hi-Fi Components	
Write Direct to Advertiser		Check No. 22 on Reader Service Card		Write Direct to Advertiser	
Braun	35	PAIA	88	TDK	73
Loudspeakers		PAIA Kits		Audua-L	
Write Direct to Advertiser		Check No. 23 on Reader Service Card		Check No. 36 on Reader Service Card	
British Industries Co.	3	Phase Linear	71	TEAC	8, 49, 50, 51
Hi-Fi Components		Hi-Fi Components		A-2300SD	
Check No. 9 on Reader Service Card		Check No. 24 on Reader Service Card		Write Direct to Advertiser	
Cerwin-Vega	21	Philips Audio Video System Corp.	37	Technics by Panasonic	Cover IV
Hi-Fi Components		Turntables		Hi-Fi Components	
Check No. 11 on Reader Service Card		Check No. 26 on Reader Service Card		Check No. 37 on Reader Service Card	
C/M	82	Pickering	29	United Audio	53
Hi-Fi Components		Hi-Fi Components		Dual 701	
Check No. 12 on Reader Service Card		Check No. 27 on Reader Service Card		Check No. 38 on Reader Service Card	
Crown International	18	Pioneer	Cover 2, 1	Yamaha	9
Hi-Fi Components		Hi-Fi Components		FM Tuner	
Check No. 13 on Reader Service Card		Check No. 28 on Reader Service Card		Check No. 39 on Reader Service Card	

(Continued from page 73)

Physical Graffiti—A Pre-view: Led Zeppelin

Swan Song 200, stereo, 2 discs, \$13.98

No matter that I have heard only two cuts from this record, and those only under surreptitious circumstances. Led Zeppelin's new album continues their incredible money making. Why shouldn't they make money? They have never made a record that wasn't worth three of most other groups.

House of the Holy was phenomenal. Anything that sustains Robert Plant's vocal and visceral exercises has to be phenomenal. Jimmy Page's guitar is a phenomenon (one of the tracks I heard had one of his acoustic solos). John Bonham has more strength and stamina than a whole orchestra, the most unpredictable drummer in the world. John Paul is like a musical genius in an instrument store. They are Led Zep, and Led Zep is Rock and Roll perfection. Only they are palatable when you want to hear Led Zeppelin music. No one else can do or does what they do. I have never heard of a Led Zeppelin copy group, nor anyone else grifting from their most individual, distinctive brand of music. No one else even comes close. You don't have to understand or like them to be blown away by the likes of *Stairway to Heaven*, or *Ramble On*.

I've seen hard-headed mid-fifties Jazz freaks driven into delirium by the fact that something done by Zeppelin fascinates them. But that's normal. Led Zeppelin does something fascinating to someone all the time.

Sound: ? Performance: A

Crossword

Answers to puzzle on page 38

1	P	A	2	T	C	3	H		4	E	T	C		
	H			R			E			N				
	O			A		5	A	U	D	I	O			
	N			C			D			L			6	D
	O			K		7	S	T	E	R	E	O		
			8	V						S				L
9	O	U	10	T	P	U	11	T	S					B
	H			H						O				Y
12	M	O	D	13	E		14	N	A	B				
	S				P			E						

Thaedra
is here!

SERVO-LOOP PREAMPLIFIER

THE ULTIMATE
HAPPENS ONLY ONCE!!

BUILT IN SERVO CONTROLLED HEAD AMP FOR MOVING COIL CARTRIDGES PLUS REGULAR PHONO WITH NO GRAIN. TAPE MON. AND COPY FOR 3 MACHINES. 5 POSITION LOW FREQUENCY FILTER. ALL CONTROLS AND SWITCHES ENVIRONMENTALLY PROOFED. DEPOSITED THICK-FILM LEVEL AND TONE CONTROLS.

MORE, MORE, AND MORE!!

HEAR THAEDRA AT YOUR DEALER SOON!

\$799.00 DENVER & WEST COAST
\$809.00 EAST OF DENVER



THE GREAT AMERICAN SOUND COMPANY, INC.
8780 SHOREHAM DRIVE • WEST HOLLYWOOD, CA 90069
TELEPHONE: (213) 659-2486

Check No. 16 on Reader Service Card



**Walt Ostrander, Audioanalyst,
As Seen Through The Eyes
Of His A-100X Speaker**



Stereo Review calls his product "Superb."

Walt Ostrander, Nice Guy



Our works get "the works" before they go into the case. This means each and every assembly. For that reason, Modern Hi-Fi & Stereo Guide can call our sound "deeply satisfying," and we can offer a Six Year Warranty on the entire line.

All the best speakers use quality components. It's the configuration in which they're used that makes the difference. Is our difference worth our overtime? To all concerned, it is. Listen to us. Write and we'll arrange a test. We invite you to show our speaker everything you've got. Except mercy.



Audioanalyst

P.O. Box 262, Brookfield, Conn. 06804
Monstrous About Perfection
European and Mideastern Distributor:
Argo Hellas International
Hollstein Hotel in Taunus
6382 Friedrichsdorf/Bad Homburg
West Germany
Distributed in Canada by:
Superior Electronics, Inc.



Check No. 5 on Reader Service Card

Canby's Capsules

Edward Tatnall Canby

Chopin: Vars. on Mozart's "Lá ci darem la mano" (Don Giovanni), Op. 2; Fantasy on Polish Airs, Op. 13; Andante Spianato and Gnde. Polonaise brillante, Op. 22. Claudio Arrau; London Philharmonic, Inbal. **Philips 6500 422**, stereo, \$7.95.

Bach: Mass in B Minor. Palmer, Watts, Tear, Rippon; Amor Artis Chorale, Engl. Chamber Orch., Somary. **Vanguard VSD 71190/91/92** (3 discs), stereo, \$20.94.

The Four Antiphonal Organs of the Cathedral at Freiburg. Bach: Four Great Toccatas and Fugues. E. Power Biggs. **Columbia MQ 32933**, SQ quadraphonic, \$6.98.

Highlights from Handel's Judas Macabaeus. Harper, Watts, Young, Shirley-Quirk, Amor Artis Chorale, Wandsworth Sch. Boys Choir, Engl. Chamber Orch., Somary. **Vanguard VSQ 30029**, SQ quadraphonic, \$7.98.

Stravinsky: Les noces (two early versions); **Le Chant du Rossignol: Symphonies for Wind Instruments.** Orpheus Ch. Ens., Gregg Smith Singers, Col. Symph., Craft. **Columbia M 33201**, stereo, \$6.98.

A Tribute to David Oistrakh, 1908-1974. **Columbia MH 33328**, 2 discs, mono, \$13.96.

Ravel: Bolero; La Valse; Rapsodie espagnole. Boston Symphony, Ozawa. **Deutsche Grammophon 2530 475**, stereo, \$7.98.

Piano Music of Ravel, Vol. 1. Pascal de Rogé. **London CS 6873** stereo \$6.98. (*Valses nobles et sentimentales, Tombeau de Couperin, Sonatine.*)

A roundup of the few Chopin works for piano with orch. aside from the two familiar early concertos. Arrau does them solidly, effortlessly; but the two side 1 items are pretty heavy stuff, on the edge of being overblown—though Schumann didn't think so at the time and hailed Chopin as a genius. True! And so was S. The "Spianato" on side 2 is more familiar as well as more easily digestible. The usual superb Philips recording.

The Mass is more profound, more contemplative, more dramatic, than this professional-type big-time performance with its loud pro-style chorus, unblended, a too-prominent vocal quartet, a restless, bouncy quality to the faster movements and not enough thought in the slow ones. The low soloists are best—Helen Watts and Michael Rippon. It's all very brassy and somehow harsh in sound, unperceiving. Somary is a lot better in Handel.

Biggs' effervexcent organ escapades are always fun—but why does Columbia pick such unlikely acoustics for proving SQ "discreteness," complete with diagrams? Four organs from one (electric) keyboard, panpotted into a square, but the huge reverb allows only a vague directionality though the sound is magnificently "surround"—and how. Sturdy Biggs Bach, quite intelligible in spite of the big mix.

Johannes Somary's numerous Handel recordings—both complete and in excerpt format as here—are fast, efficient, modern, and very pro, adequately "authentic" too; but musically I find them on the hard, dogmatic side, minus much feeling for rhythmic and dramatic balance. Top-rank solos—his women are best (Harper, Watts); basso Shirley-Quirk rumbles like an earthquake. A very pro. chorus, loud, accurate, energetic, wobbly, and unblended. Yes—the old sanctimoniously sincere Handel of the mammoth performance is gone. I sometimes miss it.

Curious! Definitely for female voices and four pianos, a la "Sacre," **Les noces** went through two discarded versions, 1917 with orch.; 1919, incomplete, with percussion, two cimbaloms, harmonium, and player piano! Here are both. Robert Craft's didactic touch doesn't give much life, though everybody works hard and well. And did they get the player piano working? He doesn't say. I'd like to know. Wouldn't you? Unimaginative.

If you are an Oistrakh fan, here are his U.S. recordings 1955-56, in excellent mono fi, boiled down to two LPs from the original 3 discs. Mendelssohn, Mozart, Vivaldi, Shostakovich; at Phila. and New York.

The Ravel Centenary—and already he is so far away. Younger performers miss the point, that steely, taut elegance of the earliest neo-classic. Ozawa, in Boston, at least gets all of the drive and tension though tempi are hurried and details not sharp. The big Boston liveness is superb for huge brass and drums in this hair-raising *Bolero*; *La Valse* is fast and rightly maniac—the waltz gone controlled-insane. *Rapsodie espagnole* (D-G misspells it on the cover!) is split between sides, which spoils its mood.

Rogé is very much the younger neo-Romantic, even to long hair. His Ravel is heartfelt, expert, but cast in a dreamy, untaut style that will astonish those who thought they knew Ravel pretty well. Very slow, full of great pauses, meditations, relieved only in the furiously fast movements—which Rogé does with easy ability. Fine if you have no preconceptions—but try Gieseking's Ravel (Angel mono) for another generation's thinking.

NOW...an AUDIO exclusive:

This timely **SOUND ADVICE** suggestion: A Comprehensive Guide to the Music/Record Business . . .

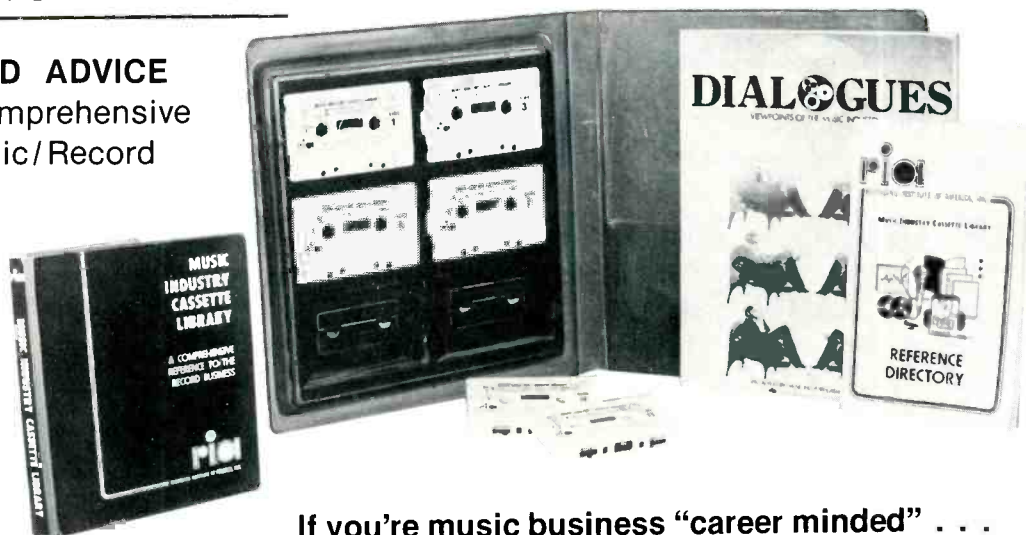

If you're music business "career minded" . . .

Hear the facts for yourself in taped interviews straight from the "pros"

Compiled from Recording Institute of America's interviews with key executives and "hit-makers", plus Reference Directory and Dialogue Viewpoints of industry "stars".

Listen to the industry "pros" describe the workings of the Music Business. Hear the most respected attorneys of the entertainment field define and discuss the legal terminology of Recording Contracts, Songwriter Contracts, Professional Management Contracts. Over 3½ hours of professional reference . . . could be the most important 200 minutes of your life!

Plus . . . RIA Reference Directory, including sample songwriter affiliation forms, sample artist contracts, writer contracts, etc., in addition to a Directory of Record Manufacturers, Music Publishers, Personal Managers, Producers and Booking Agents. Also **Record World's "Dialogues"** with over 50 candid interviews from **Record World** magazine, and a cross-section of "star" personality interviews.

You get all the above (regularly \$49.95) for only \$39.95 for Audio readers.

*Interviews include:

Pete Bennett..... Promotion, Apple Records
 Sid Bernstein..... Personal Manager and Promoter
 Rick Blackburn..... Dir. of Sales, Columbia Records
 Terry Cashman..... Pres., Cashwest Productions, Inc.
 Bob Cato..... V.P., Creative Services, United Artists
 Kip Cohen..... V.P., A&R, A&M Records
 Al Coury..... V.P., Production, Capitol Records
 Al DeMarino..... V.P., Music Department, CMA
 Tom Draper..... Dir., R&B, RCA Records
 Kenny Gamble..... Pres. & Producer, Phila. Int. Rec. Co.
 David Glew..... V.P., Marketing, Atlantic Records
 Barbara Harris..... Dir., Artist Relations, Atlantic Records
 Emil LaViola..... Prof. Mgt., Chappell Publishers
 Michael Martineau..... Booking Agent, Premier Talent
 Mark Meyerson..... A&R, Atlantic Records
 Barry Oslander..... West Coast Prof. Dir., Jobete Music Co.
 Richard H. Roemer..... Law Firm of Roemer & Nadler
 Alvin Teller..... V.P. Merchandising Marketing,
 Columbia Records
 Peter Thall..... Law Firm of Casper & Thall, P.C.
 Ron Weisner..... V.P., Artist Relations, Buddah Records

. . . and many others

10 DAYS FREE APPROVAL—MAIL TODAY

Book and Learning Systems Division
 NORTH AMERICAN PUBLISHING COMPANY
 134 North 13th Street, Philadelphia, Pa. 19107

Send me the complete "MUSIC INDUSTRY CASSETTE LIBRARY." If I decide to keep this after 10 days examination I will remit the purchase price plus postage and handling, or return it for cancellation of all charges.

Name (please print) _____

Signature _____

Firm or Inst. _____

Home Address _____

City, State, Zip _____

SAVE MONEY. My payment is enclosed. Publisher pays all postage and handling. Same money-back return privilege.

big fat trout lure for the taking, and every so often somebody in the West makes a grab and licenses the Czech material. I can think of three or four labels, including one of the major "low price" lines, created especially for Supraphon. Somehow, none of them seem to have survived long. Somehow, the sonic quality has always been a wee bit doubtful, and who was to say whether the fault was Supraphon's or the importers?

To change my analogy, I think maybe Vanguard has now cracked this particular nut. Vanguard's quality control (their phrase) has always been

excellent and accounts for the superior sound on this company's reissues over recent years. The sound was there from the beginning. Maybe Supraphon has updated? In any case, these are flawless recordings, up to anybody's high standards and up to Vanguard's own. You won't find any better surfaces, not even from Philips, either. A happy beginning, I'd say.

The Czechs understandably go in for Czech/Bohemian music and, for rather clear reasons, a bit of Russian too. It is their strong point, this repertoire, and nothing to be ashamed of, politics or no. In listening here, my

only reservation, not a strong one, is to note that (predictably) there is a lower tension in this playing that we in the West, especially in America, somehow expect in our own performances. The Violin Concerto benefits—you can push Dvořák just so much and no more, anyhow. Shostakovitch in particular benefits a great deal. The Fifth is traditionally played over here with a certain beetle-browed fervor and sardonic intensity, which to my mind merely brings out its fatuous side. Shostakovitch is that way—too fulsomely serious-minded, which too easily turns into, so to speak, serious-windedness. I found the relaxed Czech performance very attractive. It takes the wind out of Mr. S. but leaves the substance. Of which there is, really, quite a lot!

George Flynn: Wound. John Cage: Winter Music (version for 4 pianos). George Flynn, pf. **Finnadar QD 9006** (Atlantic), CD-4 quadrasonic, \$6.98.

Well, here we go, and in quadrasonic too. Whammo! The various schools of contemporary music, you see, are just as rigidly stylized as "classical" music has ever been, and as pop music is too; this is the crash-bang school of piano, if I may wax descriptive. I don't mean it is unimportant. I'm just saying that it is definitely, unswervingly crash-bang.

Also somewhat aleatoric, which means, by chance, on purpose. The Cage piece was a pioneer effort of this sort back in 1960. George Flynn's own work stems from Vietnam horrors as of c.1968 and that is just the way it sounds, all raw and bloody. I can practically hear the bullets tearing flesh and the bombs and the shrieks of the dying. Brrrr—stay away: war.

It seems anticlimactic to speak of CD-4 in such a context, but in an ambient sort of fashion it does add to the impact of *Wound* though the sound is as of a single piano. In *Winter Music* the CD-4 is more pointed. This curious collection of pianistic options on paper—you take your choice, within specified limits, as you play—is done four times (all on the same piano, I suppose) and each of these appears in one channel, all at once. To be consistently aleatoric, Mr. Flynn did not listen to the other channels via phones as he laid down each performance. The conjunctions of the four, then, are completely chance, or almost anyhow. Needless to say, they are all different. Different choices.

So far so good. But this concept is a lot easier to understand than to listen to. No beat, no perceptible rhythm, just very slow, casual dissonant chords, produced every once in a

TRACER...

"It just might be perfection!"

What are the characteristics of the perfect loudspeaker system? 1. Linear and efficient response. 2. Absolute absence of coloration and distortion. 3. Unexcelled power handling capabilities. 4. Perfect transient response. 5. Ultra wide dispersion.

Finding a speaker system with all of these characteristics has been impossible. Impossible, that is, until BML introduced Tracer - the line of loudspeakers that has fulfilled this impossible dream.

Tracers utilize the most advanced techniques in speaker design . . . dual phase coupling, (our amplitude modulating transmission line) . . . solid state tweeters that do not have the harsh, peaky effect found in other systems . . . crossover elimination, not even a capacitor, and no tweeter level control . . . no insertion loss and no phase distortion.

Treat your ear to Tracer's auditory excellence! Perfection? They just might be!

BML Electronics, Inc.
Acoustics Division

P.O. Box 711
Wheeling IL 60090

(AC 312) 271-7755

**Dealer
inquiries
invited**



Tracer I - \$99.95



Tracer II - \$149.95

Check No. 8 on Reader Service Card

while on impulse, with great stretches of time in between. A rigorously restricted format, even if important in its implications. But who listens to implications?

Variationen über einen Walzer von Diabelli (Variations on a Waltz by Diabelli). Jörg Demus, hammerflügel. Archive 2708 025, 2 discs, stereo, \$15.96.

So it won't sell (and at such a price!). So what! I can only tell you that this is one of the most exciting and dramatic piano recordings in the history of the art and it really flipped me. Not only the music, most of which for a quarter century I have wondered about in vain. But the instruments, the "hammer grands"—no less than three early 19th-century grand pianos, with "wings," that is, the raised-up tops, beautifully restored to like-new usefulness. And on top of this, performance by Jörg Demus that is no less than stunning. Demus (remember him 'way back as half of the two-piano Demus/Badura-Skoda team?) is one of the top keyboard exponents of the Viennese school and, uniquely, a fine artist who has given himself to performing the older Viennese music on the instruments for which it was written. An unbeatable combination.

In 1821 Diabelli, a music publisher and sometime musician himself, launched a sort of piano competition by inviting some 50 prominent Austrian composers, including many from what are now Czechoslovakia and Hungary, to each write a variation on a little waltz of Diabelli's own, the whole to be published in a grand collection. Beethoven, in his late curmudgeon period, at first refused, then testily came up with a gigantic work, no less than 33 variations in late-Beethoven monumental style, his last big piano piece. It had to be published separately, of course. In recent times most important pianists have tackled the Diabelli Variations, and eight recordings are now listed in Schwann.

But what of the dozens by other composers, including a variation from such as Schubert, the boy Franz Liszt, Czerny, Hummel, W.A. Mozart II (Mozart's youngest son), and a host of unknowns as of today? Not an audible peep. The usual 19th-century leader-worship has prevailed; (a) Diabelli's Waltz is a nothing-Waltz (ah, but how cleverly shaped for variations, as Beethoven saw!) and (b) the other composers were nothing-composers.

Well, here is the Beethoven, on one disc, two sides complete. And here

The Schwann Record Catalog

Did You Know That???

Did you know Mozart's Serenade No. 12, K. 388 is the same as his String Quintet, K. 406? That Mozart's Concerto No. 2 in D for Flute is the same as his Concerto in C for Oboe? That Bach's Concerto No. 3 in c minor for 2 harpsichords, S. 1062 is an alternate version by him of the famous Concerto in d minor for 2 Violins? Bach's Concerto No. 1 in a minor for Violin, S. 1041 is the same as his Concerto No. 7 in g minor for Harpsichord, S. 1058? That his *Missa 1773* is the Kyrie and Gloria from the b minor Mass?

Did you know that both Rossini and Paisiello wrote an opera "Barber of Seville?" Both Leoncavallo and Puccini wrote a "Bohème?" Both Gluck and Monteverdi wrote an "Orpheo?" Music to "Romeo & Juliet" was written by Berlioz, Gounod, Prokofiev, Tchaikovsky? Music to "Pelleas et Melisande" was written by Debussy, Faure, Schoenberg and Sibelius? That some of the most famous 'Spanish' pieces were written by a Russian composer (Capriccio espagnole) and a French composer (Rhapsodie espagnole, Bolero, Iberia)? That Ravel wrote "Sheherazade" and Rimsky-Korsakov "Sheherazade?"

Did you know that there are records by 6 members of the Bach family? That 111 of Bach's 215 surviving cantatas are recorded? That there are records by both Mozart and his father? There are two composers named Brown, 3 Jones, 6 Smiths? That "Haydn's Toy Symphony" actually is movements 3, 4, 7 of Leopold Mozart's "Cassatio?" That there are records of music by King Frederick II of Prussia; Wilhelmina, Margräfin von Bayreuth, Louis XIII, Benjamin Franklin? That composer/musician Pablo Casals lived to be 97, Julius Reubke died at 24?

What else can you find? Be sure to get a Schwann Record Catalog each month — an indispensable reference work which should be in every home. Available at record dealers everywhere.



For a sample copy, sent postpaid directly to your home (but **please** try our record shop first) send \$1.60 check.

Schwann Record & Tape Guide

137 Newbury Street, Boston, Mass. 02116

are you missing the surprise in Haydn's Surprise Symphony?

It was probably intentionally sacrificed by the record or tape manufacturer (for reasons we explain in our literature).

The dbx 117 Dynamic Range Enhancer Noise Reduction Unit restores up to 20 db of the dynamics missing from records, tapes, and FM broadcasts and puts life back into the music. The Model 117 also lets you make professionally noise-free, full dynamic range recordings on even a modestly priced tape recorder.

The stereo dbx 117 is available from better audio dealers at \$175. dbx, Incorporated, 296 Newton Street, Waltham, Massachusetts 02154



dbx inc.

Check No. 14 on Reader Service Card

The best by far... because Revox delivers what all the rest only promise.



Revox Corp.
155 Michael Drive
Syosset, N.Y. 11791

Please tell me where I can see and buy Revox A77
Revox Good used machines*
Name _____ Address _____
*As and when available from our dealers. SBF

are most of the others, more than 30 of them, on the second disc! Beethoven, of course, towers high and waxes difficult as we already know from standard-piano versions. But let me tell you, all things considered, the other composers including unknowns from Assmeyer(!) to Worzischek are extraordinarily good. There is not one of the short pieces which is in any way stupid, banal or trite; many are really beautifully contrived. If any similar group of our own contemporaries could turn out such a high-level and well-styled collection as this, we could be said to have a developed culture. Beethoven, we are now given to understand, stood high on the shoulders of other men. Without them, he would have been, let's say, a minor lves.

Play straight through these consecutive little pieces—the Diabelli Waltz holds them together admirably for the ear, and Carl Czerny's brilliant coda carries the whole to a cheering, scintillating finish, and you don't need to know which is Schubert or Liszt, which Assmeyer. It all flows.

By far the most notable of the three pianos, as recorded, is the Gröber, 1815-25, out of Innsbruck, built in an earlier type of configuration. It is used for most of the non-Beethoven variations, alternating easily with the similar British Broadwood of 1802. On disc, this Gröber is extraordinary—such brilliance of color and timbre, not cool stainless steel as our modern grand but all brass and bronze, wiry like a thunderous Hungarian zither with keyboard attached. It sounds out as the loudest of the three, but this is undoubtedly a recording phenomenon. The Broadwood is a milder version of the same. Beethoven's music is played on a tougher, later, harder, Conrad Graf piano of 1839, like the last piano Beethoven owned. It seems less loud—but again this is surely because of its much heavier percussive sounds—violent transients difficult to record.

Did Beethoven himself pound out these hard-edged metallic forte jabs? Without a doubt! He was well known for breaking strings.

Correction
May's *Classical Reviews* of Michael Murray's Bach and Widor recordings listed an operative address. Organ recording enthusiasts can now order these discs from:
Century Advent Recording
878 Clarence Road
Cleveland, Ohio 44121

Jazz & Blues

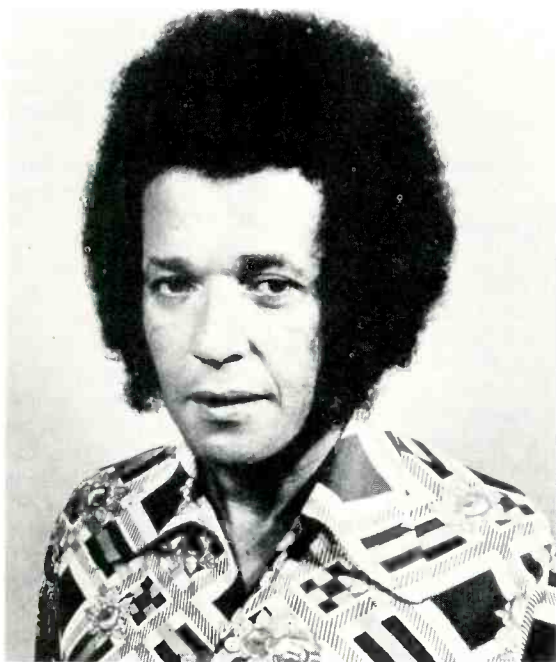

Hampton Hawes at Montreux, 1973

Three LP Records

Playin' in the Yard: Hampton Hawes

Musicians: Hawes, electric and acoustic pianos; Bob Cranshaw, electric bass; Kenny Clarke, drums.

Songs: *Playin' in the Yard*, *Double Trouble*, *Pink Peaches*, *De De*, *Stella by Starlight*.

Prestige P-10077, stereo, \$6.95.

Hampton Hawes, master contemporary keyboard artist, makes up for lost recording time in this series of three Montreux Jazz Festival releases from Prestige Records. Hawes slipped from view in this country in the mid-Sixties, leaving recordings and memories of his vibrant bop style. Recently he returned on *Blues For Walls*, his first Prestige release. At that time he showed broadened capability at the keyboard and as a composer.

On these live recordings Prestige has captured the added dimension of this marvelous musician in company with his peers. Listeners will find time flying as they enjoy Hawes' excursions on acoustic as well as electric piano.

His tasteful and sprightly use of the electric piano is gratification a-plenty for this keyboard-o-phile. He dances

fancifully over the keys on the medium-tempo blues *Double Trouble*, then Cranshaw continues, frolicking on his Fender bass before the trio goes into the rock section of the number. This lasts for several choruses before Hawes switches to acoustic piano. Bass and drums drop out, and he revs up his motors for an extended solo flight. He's like a lark as he zips in and out of tempi with never the slightest hint of uncertainty. He highlights part of this cadenza painting a blues rainbow with his right hand while underlining it with a groovy walking-bass line in the left.

Bob Cranshaw deserves credit for his keen ear and excellent time. His notes throb with that extra duration exercised only by top bassists. He does a fine job of holding things together in *Pink Peaches*. The tune begs for a funky-street beat, which Clarke is unable to supply, apparently because he's unfamiliar with jazz-rock and tends to play a rather cluttered style here. And, though he makes a noble effort, his time wavers. But with Cranshaw present, Clarke finds the right way back to the time.

Playin' in the Yard, the title tune and longest cut on the date, is done almost as two-beat swing. I say *almost*, because Clarke vacillates be-

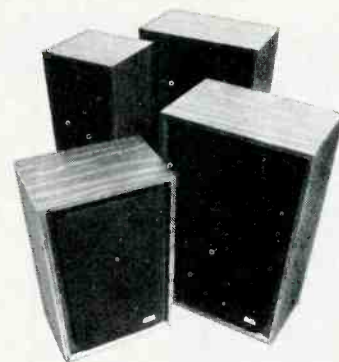

Before we started making speakers, we made something else.

A commitment.

The most acclaimed new line of speaker systems on the market today didn't get there by accident.

At Avid, we're totally dedicated to just one thing and one thing only: the design and construction of the cleanest-sounding, most accurate speakers in their price range.

Each and every one.

And that's not just so much advertisingese. It's for real. And we're not the only ones who think so.

"A best in its class..."
High Fidelity—August, 1974/
Avid 100.

"Extremely smooth and neutral..." Len Feldman, FM Guide—December, 1974/
Avid 102.

"Utter smoothness and freedom from undue emphasis or coloration..." Julian Hirsch, Stereo Review—April, 1974/
Avid 103.

"One of the more sensational high-fidelity buys of our time..." Modern Hi-Fi & Stereo Guide—November, 1974/
Avid 60.

But it's not what we think, or even what the critics think, that's important. It's what you think. See for yourself at your nearest Avid dealer. Avid. The word is getting around.

AVID
CORPORATION

10 Tripps Lane/East Providence, R.I. 02914

Check No. 6 on Reader Service Card

MAGNEPLANAR®

They don't look like speakers.
They don't sound like speakers.
They sound like you're there . . .

The company that developed the state of the art Tymani Magneplanar speakers has now developed a less expensive model, the MG-11, which is sold exclusively through Magneplan dealers.

With 85 square inches of tweeter and 500 square inches of total diaphragm area, this speaker produces a huge true to life sound so real it must be heard to be believed.

\$625.00 per matched pair, formerly MG 2167-F

MAGNEPLANAR
MAGNEPLANAR PRODUCTS
P. O. BOX 3642 WHITE BEAR LAKE, MINNESOTA 55110

Check No. 20 on Reader Service Card

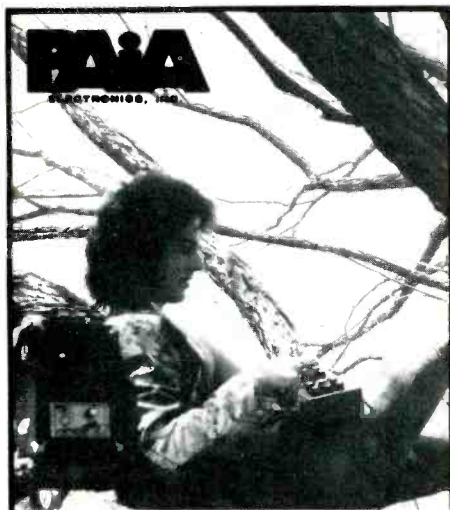

LOOKING FOR INNOVATION? LOOK TO PAIA KITS.

Some recent examples . . .

The GNOME, The only Electronic Music Micro-Synthesizer available in a hand held, battery powered package.

\$48.95 shipping wt. 4 lbs.

The PYGMY, battery powered practice/headphone/stage amp. 8 watts peak power driving super-efficient 5" acoustic suspension speaker.

\$39.95 shipping wt. 6 lbs.

NEW 24 HOUR DEMO-LINE for a one-minute recorded demo of PAIA Synthesizers (405) 843-7396. Catalog requests or charge orders also acceptable.

FREE CATALOG

PAIA Electronics, Dept. A 1020 W. Wilshire Blvd., Oklahoma City, OK 73116

Check No. 23 on Reader Service Card

tween the two-beat and the more funky rock beat which Jack De Johnette played behind the tune on Rollins' **Next Album**. Nevertheless, the tune comes off very well. Cranshaw cops some solo time ably backed by Hawes' clever and effective understatements. This is an excellent tribute to tenor giant-composer Sonny Rollins.

My favorite cut is *De De*. It is an easy mellow ballad, a la bossa nova, with tranquilizing effects. *Stella* by *Starlight* is . . . well . . . *Stella* by *Starlight*.

Sound: B Performance: B

Blues a la Suisse: Dexter Gordon **Musicians:** Gordon, tenor saxophone, Hampton Hawes, electric and acoustic pianos; Bob Cranshaw, electric bass, Kenny Clarke, drums. **Songs:** *Gingerbread Boy*, *Some Other Spring*, *Secret Love*, *Blues a la Suisse*. **Prestige P-10079**, stereo, \$6.95.

Dexter Gordon's last release, **Generation**, is a tough act to follow, especially when you know hands down that it was his best album to date, featuring an explosive rhythm section and more than noteworthy solos by Freddie Hubbard and Dexter. It would be even tougher to follow if anyone else had to do it. But since Dexter plays better all the time, if better than great is possible, and since live recordings are more natural than studio dates, **Blues a la Suisse** is way up there near **Generation**.

This is a quartet date featuring Gordon on tunes he has not previously recorded. *Gingerbread Boy*, by another tenor giant, Jimmy Heath, gets a thorough going-over by Dexter. Played somewhat slower than Miles Davis played it on his record the tune loses none of its punch.

As with the rest of the album Dexter monopolizes the solo space on *Secret Love*, giving what's left to Hampton Hawes. I confess, I've been spoiled by the way James Moody did *Secret Love* on his **Never Again** album. The head on Moody's version sounds tighter because the rhythm section is tighter, and Mickey Tucker vamps the opening rhythmically in a most compelling fashion. Nevertheless, Dexter compensates with a superb solo flight of his own.

Sound: B Performance: BT

Ammons and Friends at Montreux: Gene Ammons **Musicians:** Ammons and Dexter Gordon, tenor saxophone; Cannonball Adderly, alto saxophone; Nat Adder-

ley, cornet; Kenny Clarke, drums; Hampton Hawes, electric piano; Bob Cranshaw, electric bass; Kenneth Nash, congas.

Songs: *Yardbird Suite*, *Since I Fell For You*, *New Sonny's Blues*, *Sophisticated Lady*, *Treu Bleu*

Prestige. P-10078, stereo, \$6.95.

Surprise! Well, to me, anyhow. The late Gene "Jug" Ammons shows that on this recording he had turned away from the commercial "soul" routine he'd been into for several years. Actually I had an inkling he might be coming back to the mainstream when I heard some of his buddy Sonny Stitt's work (**Tune Up**, and **Constellation**, on Cobblestone). Then I ran across an album of Gene's called **Big Band Jug**. Need I say more? And then when I looked down the list of tunes and personnel on this record I guessed he was into some heavy blowing.

Sure enough, I was right. The quartet opens with *Yardbird Suite*. After mystically working through the head, in a *Night in Tunisia* vein, Ammons takes off for a whole bunch of swinging choruses. *New Sonny's Blues* by Sonny Stitt gives us the delightful opportunity to catch the rhythm section doing the blues—featuring a Hawes solo after one by Jug.

Ellington's beautiful *Sophisticated Lady* brings out the soft side of Ammons. His solo is sweet and relaxed, and Hawes' cute and subtle runs make ideal backing.

Dexter Gordon and the Adderly brothers arrive in time for the merriment of the finale on *Treu Bleu*, an Ammons up-tempo swinging original. Nat Adderly's creative use of staccato notes in a syncopated array is the most effective solo of the lot. Toward the end of the tune the four horns play leap frog, swapping four-bar phrases all around. After an effervescent statement by the four in unison, it's back to the head. The ensemble work is slightly sloppy, but who cares after the walloping these titans give the tune?

It's anti-climatic to say there is something that mars this otherwise-excellent performance. It's Kenny Clarke's drum work. He tries too often to do too much. And his kicks, instead of propelling the group, get in the way. If you let that one deficiency keep you from buying this record you will just miss one of Gene Ammons' best performances on record.

Sound: B Performance: B

As to the technical quality of these three recordings, you can get a fair sample by listening to Hawes playing

the head of *Playin' in the Yard*. Behind him you can hear the snares vibrating clearly, and throughout the rest of the tune the cymbals come through cleanly, showing treble sound comparable to most studio recordings. Cranshaw's bass is also vibrant and undistorted, highlighting the good, firm bass reproduction.

These three Montreux albums contain hours of pleasurable listening. If your ears can stand a bit of drum noise, or if you can do a little on-the-spot drum editing, you'll find the music here is top notch. To those responsible for choosing the musicians for the Festival, I say a more appropriate drummer could have been found.

If you must choose between these discs, choose **Blues a la Suisse**.
Eric Henry

Preclusion: Patrice Rushen

Musicians: Rushen, electric and acoustic pianos, clavinet, ARP synthesizer; George Bohannon, trombone; Oscar Brashear, trumpet, flugelhorn; Hadley Caliman, flute, alto flute, soprano sax; Joe Henderson, tenor sax; Ndugu, drums; Tony Dumas, electric bass, "blitz" bass; Kenneth Nash, percussion.

Songs: *Shortie's Portion*, 7/73. *Haw-Right Now*, *Traverse*, *Puttered Bop-corn*.

Prestige 10089, stereo, \$6.95.

Patrice Rushen is all of 20 years old. Wow! Can you believe it? An album chock full of her own compositions and arrangements on which she shows off her keyboard talents. You might think that for someone to arrange her own recording session at such a young age she must be the child of movie stars or record producers or some such. Not here! No way! There's no nepotism or anything else involved here, save the merits of a young talent hard at work. Patrice is excited about her first record, and rightfully so. It represents her—the dues she's paid, the culmination of her previous musical experiences with trombonist Melba Liston, singer Abbey Lincoln, various soul groups and studio work and, of course, her producer and teacher Reggie Andrews.

Shortie's Portion makes a swinging helping for any avid pair of ears. Miss Rushen is on acoustic piano here for two solo outings, separated by a couple of horn solos. Her solos show the influence of McCoy Tyner, among others. More than that, they herald the arrival of a developing keyboard giant sprouting much more than musical cliches and memorized riffs and licks.

Why any cartridge (even ours) with an elliptical stylus must be considered just a bit old-fashioned.

As a premium stylus, elliptical designs have only one real advantage over a Shibata stylus: lower cost. Which is why we still offer them.

But when it comes to performance, a Shibata stylus is far, far better. It provides the small scanning radius needed to track highs (up to 45 Hz for CD-4), but without the penalty of requiring extremely low stylus force settings.

In fact, even tracking at up to 2

grams, a Shibata stylus is easier on your records than an elliptical stylus trying to track at 1/2-gram! New records last longer, old records sound better, and you can play every kind of two or four-channel record made.

All Audio-Technica top-of-the-line cartridges have genuine Shibata styli. Anything less would be false economy for you... and out-dated technology for us. Prove it to yourself today.



audio-technica

AUDIO-TECHNICA U.S., INC., Dept. 85A, 33 Shiawassee Ave., Fairlawn, Ohio 44313
Available in Canada from Superior Electronics, Inc.

FREE McIntosh CATALOG and FM DIRECTORY

Get all the newest and latest information on the new McIntosh Solid State equipment in the McIntosh catalog. In addition you will receive an FM station directory that covers all of North America.



MX 113

FM/FM STEREO - AM TUNER AND PREAMPLIFIER

**SEND
TODAY!**

McIntosh Laboratory, Inc.
East Side Station P.O. Box 96
Binghamton, N.Y. 13904
Dept. 1

NAME _____
ADDRESS _____
CITY _____ STATE _____ ZIP _____

If you are in a hurry for your catalog please send the coupon to McIntosh.
For non rush service send the *Reader Service Card* to the magazine.

Check No. 22 on Reader Service Card

The two horn solos are by trumpeter Oscar Brashear and tenor saxophonist Joe Henderson, who sounds magnificent here which is not unusual when he and his irreplaceable, unrelacquered, mellow old tenor sax get together. It is unfortunate that Henderson's own recent releases, *The Elements* (Milestone MSP-9040) and *Black is the Color* (Milestone M-90530) are not commensurate with the talent that the man has to offer. This is simply due to the musical variety being constricted to no more than a hair's breadth, hence posing overbearing limitations

on the already overly-exploited ear. Henderson is heard to great advantage on albums by other artists including Flora Purim's *Butterfly Dreams* (Milestone M 9052) and Ron Carter's *All Blues* (CTI 6037). When Henderson gets together to play good music, what comes out is one of the most identifiable and influential reed voices in music today. This is certainly the case here.

Miss Rushen's compositions are interestingly constructed. There aren't any hodge-podge, hackneyed themes or lines to be trampled over just once more. 7/73 is a beautiful bossa-like

ballad which Patrice sprinkles with spice and everything nice on electric piano. If there are any influences on her compositions (what am I saying? of course there are; everyone has some), I detect some Thad Jones in the phrasing and rhythmic structure. The tune hints at Thad's *It Only Happens Every Time* from Thad Jones and Mel Lewis' *Consummation* LP (Blue Note BST 84346).

Traverse really is an appropriate title for this tune. Much musical ground is covered. The beginning brings to mind the sounds of a summer evening with little more than the breeze of a soft wind and a Jiminy Cricket scampering lightly over the keys of the acoustic piano. Then, Patrice swings lightly with bass and drums (no horns). And, suddenly, magically, we are whisked away to a super-samba wonderland.

Today, as music expands in all directions, there is a growing expectation of and necessity for the new keyboard artists to be familiar with the whole array of keyboards. On *Puttered Bopcorn*, a super funky tone and not a redone bopper, as the play on words suggests, Miss Rushen performs on Arp Synthesizer. Bassist Tony Dumas helps groove this tune. By the way, what is a "blitz" bass?

In order for some folks to be swayed to purchase an album, the music has to fit some label or category. Is it all swing? Or Latin? Rock, Bop, or what? *Preclusion* is all of these and more. It's not hung up in any one bag; it's all good music. And, if you have to have a label for it, it's all Patrice Rushen! Here's where the one-time diamond-in-the-rough has made the transformation into a still-being-polished, but glowing gem. Nothing adds more to an album of good sounds than *sound* reproduction. Justice has been done in mixing and pressing this LP, as much as can ordinarily be expected by American standards. I highly recommend *Preclusion*. Eric Henry

Sound: B+

Performance: A-

The Greatest Jazz Band: Jimmie Lunceford and his Orchestra. *Olympic Gold Medal* 7123, mono, \$4.98.

The title of this album stakes out a brash and extravagant claim certain to be challenged by admirers of Basie, Ellington, Goodman, and Fletcher Henderson, at the very least. While certainly not *the greatest* of all jazz groups, Lunceford's crew was in the front rank, dominating, along with the four mentioned above, the big band scene in the Thirties.

ARIES - KITS!

ARIES INCORPORATED
119 FOSTER STREET
PEABODY MASS
01960
(617-532-0450)

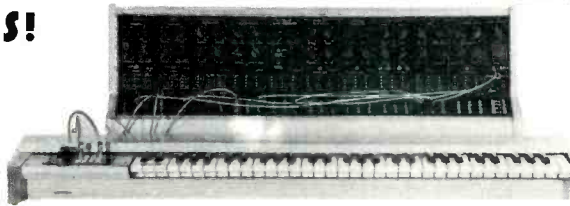

A NEW ELECTRONIC MUSIC SYNTHESIZER KIT
*Standard 1 Volt/Octave, 10 Volt range scale factor
*Fully compatible with the products of other manufacturers
*Five octave, two voice high quality keyboard
*Fully modular, professional construction
*Priced at a fraction of other units
*Available in kit or wired form
*WRITE, OR CHECK READER REPLY FORM FOR INFORMATION ON THIS, AND OTHER ARIES ELECTRONIC KITS

Check No. 2 on Reader Service Card

Polk Audio
proudly introduces
the Model 7 Bookshelf Monitor System;
a moderately-priced full-size system
capable of revealing the subtle qualities
of state-of-the-art equipment.



At \$119 each, we can hardly believe it ourselves

polkaudio

4900 Wetheredsville Road, Baltimore, Maryland 21207

Canada: Keldon Electronics, Ltd.

Check No. 30 on Reader Service Card

In a way, Lunceford's and Basie's bands were complementary, each making its forceful impact by different means. Where Basie's men drove into blues and stomps with roaring enthusiasm, their simple riff style propelling the mounting orchestral tension, Lunceford relied on the opulence and detail of studied orchestrations and more precise execution, approaching, closer than any other band, the standard set by Benny Goodman which brought this kind of ensemble playing closest to perfection.

The Lunceford band was one of the slickest show bands of all time. Its trumpet men dazzled audiences with gimmicks such as throwing their horns in the air and catching them with the accuracy and timing of professional drum majors. The trombone section would swivel right and left while playing swinging tunes—a trick that Glenn Miller copied and which contributed to his band's popularity.

But what the stiffer and more mechanical Miller band could not copy was the innate ensemble quality that made Lunceford's the most relaxed of orchestras. The lazy, caressing beat of *Morning After* is as fine a tribute to the Lunceford discipline as the precision and swing on the up-tempo *Battleaxe*. *Moonlight and Music* and the Sy Oliver arrangement of *I'm Walking Through Heaven With You*, though it has a Dan Grissom vocal, really showcase the opulent sound of the Lunceford sax section. Led by altoist Willie Smith, the cohesion and instinctive understanding of the five-man reed team is readily apparent. Their phrasing and blending are so complete that the listener is all but convinced he's hearing a single instrument. The Lunceford sax section achieved the most delicate pianissimo effects, yet it could swing the whole band with tones as forceful as the band's vigorous brass. *Annie Laurie*, a Lunceford standard, is a fine swinger which spotlights the brass section in a vivid, sharply-disciplined performance. Trummy Young's bold, open trombone work is a consistent joy, along with Paul Webster's piercing, high-register trumpet solos.

The gifted arranger-trumpeter Sy Oliver, who was the most important shaper of the band's sound, had gone over to Tommy Dorsey by the time these recordings were made. With TD he was to achieve greater fame and make more money, but the Oliver influence remains in each of these selections. All are played in the relaxed, crisply-phrased Oliver manner. Even the highly commercial ar-

Incomparable. Tandberg TR-2075



The best was not good enough. So we re-invented the stereo receiver. TR-2075 combines a sensitive tuner and pre-amp with an extremely powerful amplifier—all on one chassis. Result: fantastic performance that even more expensive, separate chassis components cannot beat!

We're our only competitor

TANDBERG OF
AMERICA INC.

A820

A1020

Tandberg of America, Inc.
Labriola Court
Armonk, New York 10504

I want to hear more!
Please send free booklet on TR-2075 to

Name _____

Address _____

City _____

State _____ Zip _____

Who Says Audiophile Components have to be Expensive?

No one really says so, but most people think so. The SAE Mark XXX Stereo Preamplifier and Mark XXXIB Stereo Power Amplifier offer the highest engineering excellence and quality parts available at a moderate price.

To find out what makes these the most sought after components, fill out the coupon and mail today.



SAE
*Components
for the
Connoisseur*

SAE, Inc., Electronics Division
P.O. Box 60271, Terminal Annex, Dept. A 875
Los Angeles, California 90060

Gentlemen:

Please rush free information on the Mark XXX and Mark XXXIB by return mail.

Name _____

Address _____

City _____ State _____ Zip _____

rangements that back singer Grissom reflect the brilliance and subtlety of Oliver's scoring. Needless to say, this Lunceford collection is highly recommended.

All of the tracks on this Olympic LP were taken from the Long-Worth Co. radio station library. They were recorded in 1942-43. The pressings of those transcriptions (16 rpm) had respectable sonic quality for the day.

John Lissner

Sound: B+

Performance: A+

The Colours of Chloe: Eberhard Weber

Musicians: Weber, bass, cello, ocarina; Rainer Bruninghaus, piano, synthesizer; Peter Giger, percussion; Ralf Hubner, drums; Ack van Rooyen, flugelhorn.

Songs: *More Colours, The Colours of Chloe, An Evening With Vincent Van Ritz, No Motion Picture.*

ECM 1042 ST, stereo, \$6.98.

Nothing less than great music from beginning to end! This music far surpasses what words can say about it.

Weber has created an album full of

tillating sounds, employing both classical and jazz idioms. It's not fusion in the sense of the familiar jazz-rock fusions we know so well. Instead each selection maintains its own musical identity. There's no watered down jazz or classical music herein, or any other bastardizations thereof. Each is its own thing, yet somehow they complement each other perfectly. Weber's orchestrations for the cello section of the Sudfunk Symphony Orchestra lay an elastic foundation which maintains the discipline of classical music even while allowing the jazz section to function freely.

Close your eyes and savor the delectable piano solo on *Colors of Chloe*. Bruninghaus brings us out of a forest of strings into a cool summer waterfall. Sparkling and refreshing notes form a melodic continuum over the ridges of the rhythm section. You like flugelhorns? Well, Ack Van Rooyen plays the plating right off his horn on the free 'n up *Evening with Vincent Van Ritz*.

What else the album has going for it would take up more space to describe than is available. There's good music here and there's lots of it. Everyone's ideas gel together splendidly without being hindered by the muck of technique that often results when young masters get together. Weber plays a five-stringed bass. If we couldn't figure that out from his octave jumps on *Chloe*, the picture on the back cover would tell us.

Colours of Chloe is on ECM—the Rolls Royce of jazz labels. Only superior music is allowed to grace these letters of distinction, so conventional sugary strings and geared-up synthesizers are absent. Rather, Weber draws uncanny voicelike textures from these usually over-exploited instruments. What we've been conditioned to expect from synthesizers and strings, and what he's produced are at opposite ends of the spectrum.

The sound of **Colours of Chloe** is not the sound of Europeans imitating jazz from America, as happened after bop, in the Fifties and Sixties in Europe. Weber is representative of many younger European musicians, developing music that is new, modern, and distinctly their own. Eberhard Weber isn't Chick Corea, but his music is just as valid. His reputation will grow among *afficionados* of good music, and then... well...

This is one of the year's better jazz releases, whether it sells or not.

Eric Henry

Sound: A

Performance: A

GOOD CAN BE EVEN BETTER



CROWN DC300A
(the old standard)

SOUND: Good overall performance limited by current limiting circuits.

MUSCLE: 16 rugged 150 watt output transistors.

COOLING: Integral heat sink chassis construction with additional fins.

POWER: 155W/ch 1 Hz—20 KHz @ .05% into 8 ohm loads.

No 4 ohm rating possible as unit will not precondition per FTC ruling.

SPEAKER PROTECTION: Relies solely on single fuse in primary of power supply.

PRICE: \$799.00..... \$799.00 (more for your money).

The BGW 500D will drive more speakers in parallel or any kind of load with absolutely no difficulty, unlike amplifiers designed with current limiters.



BGW 500D
(the new standard)

Highest accuracy over the complete audio band. Elimination of current limiters yields unbelievable improvement, especially noticeable into lower impedances at high power levels. No chirps, buzzes, etc. Sounds clean!

20 rugged 150 watt output transistors.

Low noise dual speed fan cooling huge extruded aluminum heat sinks means uninterrupted performance under even the most grueling operation.

150W/ch 10 Hz — 20 KHz or 200W/ch 25 Hz—15 KHz @ .2% into 8 ohm loads.

251W/ch 20 Hz — 15 KHz @ .25% into 4 ohm loads.

Electronic SCR crowbar with magnetic circuit breaker. Saves your precious speakers in the event of output transistor failure.



BGW Systems in Canada . . . Recrion, Limited
P.O. Box 3742 105 Denison Street
Beverly Hills Markham, Ontario
CA 90212 (416) 495-0880
(213) 391-032

Check No. 7 on Reader Service Card

Tape & Turntable

Bert Whyte

Appalachian Spring. Aaron Copland, composer, conducting the Columbia Chamber Orchestra. **Columbia MQ 32736**, SQ disc, \$6.98.

If you are familiar with the music of the ballet suite, scored for full orchestra, you will be fascinated with this (the original) chamber orchestra version which utilizes only 13 instruments. Aaron Copland tells us that the scoring and the size of the orchestra were dictated by the size of the small concert hall in the Library of Congress, where Martha Graham was to dance the premiere performance.

Needless to say, this is a much more intimate sounding version than the full orchestral suite. When you're listening to it, inevitably your mind supplies the missing brass and percussion and the other parts with which most listeners will be familiar. This is very clean, open sound, with beautiful strings and woodwinds in a quadrasonic recording that furnishes lovely warm ambience, and proves that four-channel sound can be successfully used in small-scaled productions. **Appalachian Spring** is, of course, a masterpiece and always a delight to hear, whatever the format.

Peter and the Wolf: Prokofiev. **Young Person's Guide to the Orchestra:** Britten. Will Geer, narrator. J. Somary w. English Chamber Orch. **Vanguard VSQ 30033**, SQ quadrasonic disc, \$7.98.

A glance at the latest Schwann catalog reveals that there are 15 recordings of **Peter and the Wolf**, and 12 versions of the **Young Person's Guide**, with narrators as diverse as Capt. Kangaroo, Peter Ustinov, Boris Karloff, and Mia Farrow, to name just a few.

Obviously, this new Vanguard recording is up against some stiff competition, but it has some very potent factors in its favor. For one thing, it is the only quadrasonic version currently available. This in itself might not influence some people, but believe me, this is quadrasonic sound of rare excellence, and a most persuasive reason for using this medium.

Play this recording in stereo, and then play it through a reasonably sophisticated SQ decoder. The enhancement of the acoustic perspective is dramatic, and the sense of involvement in the recording environment is so real, that the stereo sound seems confined and almost one-dimensional by comparison. There is little quadrasonic "trickery" employed here ... no wildly-swinging pan-pots or channel switching. The object here was to achieve very natural sound, exemplified by a feeling of air around the instruments; a smooth, spacious projection of all the orchestral elements, without "spotlighting" for exaggerated effect, nor the stridency which mars far too many recordings these days.

The sound is ultra-clean, with extended high frequency response in the silky sheen of upper register strings. The very exposed and open scoring of **Peter and the Wolf** calls for precise internal balances, and in this recording they are splendidly realized. I never heard any instrument or group of instruments cover or "swamp" one another.

In this type of recording the narration is usually recorded separately from the music, and then spliced in at the appropriate places in the score. This was done here nigh to perfection, with most discreet and judicious use of plate-type reverb for continuity between voice and orchestra.

Will Geer, who does the narration, is a fine character actor currently appearing as the gruff old grandpa in **The Waltons** television show. Rather amusingly, in the **Young Person's Guide**, he does the narration in a pleasant well-modulated voice, with beautiful diction, but in **Peter and the Wolf** slips into his "mountain twang" and at times the "cornpone" gets a little thick. No doubt devotees of **The Waltons** will feel very comfortable with his performance.

All in all, this is a superb recording with some really rich sonorities. Listen to the *Procession* in the finale of **Peter and the Wolf** for some great blaring brass sounds and the clean, solid impact of low frequency percussion.



the audio amateur ?

The brain boggles at what old Johann could have done with his own console, preamp, 8-in-2 out mixer, octave equalizer, electrostatic speakers, or 24 inch woofer.

Come boggle with us.

the Audio Amateur

Box 30 A
Swarthmore, Pa.
19081

Craig Stark of STEREO REVIEW says:
"Top quality, only U.S. publication devoted to the serious audiophile constructor."

Name
Street
City State
Zip

Check No. 4 on Reader Service Card

HELP!

Anytime you have a question about your Audio subscription, please include a mailing label to insure prompt service on your inquiry.

AFFIX LABEL HERE

CHANGE OF ADDRESS

If you're about to move, please let us know approximately four weeks before the move comes about. Or, if there is anything wrong with your current mailing label, please let us know on this form also. Simply affix your present label here, and carefully print the updated information below.

PLEASE HELP US TO SERVE YOU BETTER

AUDIO MAGAZINE

134 N. 13th Street • Phila., Pa. 19107

Name
(Please Print)
Company
Address
City State Zip

Theater Music

Donald M. Spoto

Sunset Boulevard: The Classic Film Scores of Franz Waxman. National Philharmonic Orch. Chas. Gerhardt. RCA ARD1 0708, CD-4 Quadradisc, \$6.98.

By the 1930s, Hollywood had come a long way since the days of the mighty Wurlitzer, the large pit orchestra and the matinee music which accompanied films. This early music was performed more for pragmatic than esthetic reasons: the whirr of projectors, the banging of movable chairs, and the noise of undisciplined patrons had to be masked.

With the advent of sound film, major studios realized the importance of a good musical score. Dramatic value (or more accurately, melodramatic value) was added, and serious composers were commissioned for major films: Arthur Honegger, Dmitri Shostakovich, Sergei Prokofiev, Virgil Thomson. Some composers, however, became famous for their film scores alone, and among RCA's numerous new releases, none is more significant than this one of Franz Waxman's work.

Two-time Oscar winner (*Sunset Boulevard* and *A Place in the Sun*, both included in this recording), Waxman may well be, with Bernard Herrmann, the greatest of film composers. The moment of creation in *The Bride of Frankenstein* (1935) owes much of its emotional complexity to Waxman's beautifully terrifying score with its glorious bells and eerie understanding of the thin line of demarcation between the grotesque and the gorgeous. Hitchcock's first American film, *Rebecca* (1940), was enhanced by his sensitive neo-Gothic music, and

The Philadelphia Story had Waxman's genius adding delicious counterpoint and bittersweet harmony.

His scores for *Prince Valiant* (1954), *Sunset Boulevard* (1950), and *Taras Bulba* (1962) are surely interesting, and far better than the kind of monotonous lushness to which Max Steiner and Alfred Newman too frequently descended. But Waxman's greatest scores are not represented in this album. They are *Sayonara* (1957) and *The Nun's Story* (1959), the latter very likely the finest film score ever composed. It is long out of print in its original Warner Brothers soundtrack version, with that lovely photo of Audrey Hepburn in white veil and wimple on the album cover. My own much-played copy may be one of the few copies around.

Franz Waxman has the kind of imagination, sensitivity, understatement, and depth of feeling that make him one of the great composers of our time in a very special kind of genre. He deserves better than this disc, on which Charles Gerhardt and the National Philharmonic (whomever they may be) perform loudly but without great feeling. And the cloying rumbles in the bass may lead you to think you've amp trouble. Not so; it's just a badly cut quadradisc.

Performance: C Sound: C

Judas Maccabeus (Highlights): Handel. English Chamber Orch., cond. by J. Somary.

Singers: Harper, Young, Watts, Shirley-Quirk.

Vanguard VSD 71200, stereo, \$6.98.

The musical genre oratorio originated in Rome about 1600, with per-

formances of religious cantatas at the oratory of St. Philip Neri, whence the name. The history of the English biblical oratorio can be dated to 1732, the premier date of Handel's *Esther*. Among that composer's other oratorios, few are as popular as *Judas Maccabeus*, and this Vanguard recording of highlights is a splendid version indeed.

Conductor Johannes Somary, whose precision and style we have enjoyed for many years in New York, where he is music director at the Church of Our Savior, leads an enthusiastic cast and the English Chamber Orchestra. Somary rightly emphasizes Handel's airy touches in this 1747 work. He keeps the Amor Artis Chorale and the Wandsworth School Boys' Choir stoutly in front of baritone John Shirley-Quirk in the finale *Rejoice, Oh Judah!* but modulates them for the soprano-alto duet with chorus, *Hail, Hail Judea, Happy Land!* And who could repress a smile at *Sound an alarm!* The trumpets fairly open up the celestial gates at music like this!

Heather Harper's soprano has a lilting, sustained quality in this recording that has not always been evident. *Wise Men, Flattering* is delivered with elegance and control—not easy, given the phrasing Handel and his librettist Thomas Morell indicated. Vanguard and Somary demonstrate good taste and a high degree of professional musical ethic in this and related discs. And the cutting has been done without warble, whoosh or scratch. The 18th century couldn't have had music reproduction, but if it had, how pleased Handel would have been with this!

Performance: A Sound: A

Classified

FOR SALE

AUDIO RESEARCH MAGNEPLANARS and Electronics, ESS, Infinity, Ohm, Dahlquist, EPI, Audionics, Radford, Crown, Citation, BGW, Transcriber, Linn-Sondek, Keith Monks, ERA, Connoisseur, SME, Supex, Decca, Grace, Sony, Spectrum Scanning Tuner, Epicure Amplifier, Marantz 500, DBX, ADC, Nakamichi, B&O, Tandberg, Celestion, Marc Levinson, Stax, Dayton-Wright, others. **THE GRAMOPHONE LTD.**, 757 Asp St., Norman, Okla. 73069. 405-364-9477.

FIREWORKS NEWS MAGAZINE—Covering Commercial—Display Fireworks, Sources, Construction, Black Powder, Fuse, Literature. Firecrackers To Bombshells! Interesting Catalog—25c With Sample—\$1.00 Pyro Press, Box 12010-P, Lexington, Kentucky 40511.

ORTOFON — SUPEX CARTRIDGE OWNERS; our Micro-Preamp outperforms any transformer. Free literature. Huntington Electronics, Box 2009-A, Huntington, Conn. 06484.

ELECTRONIC CROSSOVERS—ALL TYPES. Definitive booklet describes applications; how to improve speaker systems; \$5.00, credited to first purchase. Huntington Electronics, Box 2009, Huntington, Conn. 06484.

FLASH—WORLD'S FIRST HIGH OUTPUT MOVING-COIL CARTRIDGE WITH REPLACEABLE STYLUS is now in stock! The revolutionary new **SATIN M-15L** series easily surpasses ALL other cartridges in clarity, separation, and ultra-low distortion. Has rock-solid bass definition, and the realism heard from solo or massed violins is incredible. \$265., with choice of conical, elliptical, or Shibata-type stylus; cartridge with all three (interchangeable) styli purchased together, \$450. Sister models with similar qualities, \$145. and \$215. At better dealers, or direct from exclusive U.S. distributor, **AUDIOPHILE IMPORTS**, 10 East Erie, Chicago, IL 60611.

LOWEST DISCOUNT PRICES ANYWHERE on audio equipment. All major brands discounted. Write for quotes, K&L Sound Services, 75 N. Beacon St., Watertown, Mass. 02172.

DIAMOND NEEDLES and Stereo Cartridges at Discount prices for Shure, Pickering, Stanton, Empire, Grado and ADC. Send for free catalog. **LYLE CARTRIDGES**, Dept. A, P.O. Box 69 Kensington Station, Brooklyn, New York 11218.

ESS Preamp, \$275. John Igarashi, 144 Redfield, Syracuse, N.Y. 13210.

THE MONEY SAVER! Write **STEREO SPECTRUM**, Box 1818, Miami Beach, FL 33139.

ARP SYNTHESIZERS!

Pro-Soloist \$920. Odyssey \$1230. String Ensemble \$1385. #2600 \$2385. Dickstein Distributing, 1120 Quincy Avenue, Scranton, Pennsylvania 18510.

DON'T LET VOLTAGE TRANSIENTS ZAP YOUR HI-FI. Solid State Equipment Protector. Plugs into outlet. Check or money order \$6.95. Kopp Sales & Service, 1650 William St., Buffalo 14206. Free brochure—send SASE.

QUOTES ON 60 POPULAR BRANDS. Specializing in "high end" and hard to find equipment—Ace Audio, Cizek, Fulton, Phase Linear, Phillips—much, much more. Sound Center, 219 E. 17th, Bloomington, Indiana. (812) 332-4252.

MACINTOSH just completely overhauled by factory! Pair MC-60 power amps, C-20 stereo pre-amp, MR-55 AM-FM Multiplex tuner. \$500 + shipping. (614) 592-1789.

FOR SALE

RECORDING TAPE CLOSEOUT: Dozen reels 2400', \$12.00. Dozen 1200', \$8.00. 24 reels 900', \$6.00. 24 600', \$5.00. Postpaid Guaranteed. Mitchell, Box 132A, Flushing, N.Y. 11367.

CROWN D1200 & M2000 on demo in our showroom. The cleanest amp ever made, driving RTR STUDIO MASTERS. Cyberacoustic Laboratory, 503 Haverford Ave., Narberth, Pa. 19022. 215-667-3048.

BUSINESS PROPOSITION extended to you Rock Barons with surplus dough begging for work. Did you know that you can increase your earnings by just making your music installation more acceptable and far less punishing. Then just pool your moneys and come up to my OTW studio located in Highbridge, Bronx and listen to my **PATENTED ACOUSTIC TONE EQUALIZING MUSIC SYSTEM** — a slot coupled-to-air-mass featuring the equivalent, down to fundamentals, of a thirty-two foot bass note. We custom build for people who want a system of twice the conventional efficiency of the infinite baffle and bass reflex and a hundred times less emotionally fatiguing. No standing waves. No room feedback. We'll build you a knockdown model, hand you over the patent drawings for a 'song'. Call for appointment: MERCKO, WYandotte 2-1674.

OPERA TAPES. Historical performances of past 40 years. Unbelievable treasures and rarities. ALSO LP RECORDS. Free catalog. Ed Rosen, 66-33 Saunders St., Rego Park, N.Y. 11374.

LOW NOISE RESISTORS - 1/4W, 5% carbon film from 10 - 3.3 Megohm for 3 1/2c each. Fifty of one value for \$1.25. 1N4148 diodes for 6c. Ceramic capacitors. Free samples/specifications. **COMPONENTS CENTER -A**, Box 134, New York, N.Y. 10038.

CONNECTICUT: Yamaha, Celestion, IMF, Infinity, Braun, Revox, Stellavox, Thorens, ESS, Mark Levinson, Supex, BGW. Will ship prepaid. **AUDIOPHILE**, 177 Sound Beach Avenue, Old Greenwich, Conn. 06870. (203) 637-3621.

WANT TO GO BI-AMP?

DeCoursey Electronic Dividing Networks are available from \$89.10 (Monaural bi-amp) to \$205 (Stereo tri-amp). Price includes plug-in Butterworth filters; 6, 12, or 18 db. per octave at any desired cutoff frequency. Write for brochure. DeCoursey Engineering Laboratory, 11828 Jefferson Blvd., Culver City, California 90230.

TUNED ROCK P.A.'s. Customized high intensity touring/permanent installation sound systems, including narrow band (5 Hz!) feedback suppression, detailed regenerative response. Acousta-Voicing/environmental equalization (+1dB at your ears), room design/measurement/treatment, >15% articulation loss of consonants. **1000's** of customized professional products including ... fiberglass horns, consoles, comp/rms/peak limiters, 18db continuously variable electronic crossovers, digital/acoustic delays, omnipressors, phasers, reverb, echo, doubling/tripling effects. P.A. noise reduction, **piezo transducers**, frequency shifters from ... J.B.L./Altec Pro., Tascam, U.R.E.I., Eventide, Gately, Schoeps, Beyer, Crown, Community Light/Sound, Mom's Audio, McIntosh, Bozak, Allen Heath, Gauss, Cetec, Langevin, Electrodyne, etc., etc. All shipped prepaid/Insured. Music & Sound Ltd. 11 1/2 Old York Rd., Willow Grove, Pa. 19090 (215) 659-9251.

FOR SALE

CASSETTE LABELS

Plain white cassette labels, Norelco cleaners, paper mailer boxes hold Norelco type plastic box, famous brand cassettes. Send for open reel and cassette discount catalog.

	1-9	10-99	100	1000	10M
Cassett Labels (Multiples of 10)		.02	.015	.01	.006
Norelco Cassette Cleaner	.65	.60	.55	.50	.45
*Scotch Cassette SC90HE	2.72	2.55	2.44		

*Buy 10, SC90HE, get 5 free

Plus Postage by Weight and Zone

Minimum Order, \$5.00

OPEN REEL STEREO TAPE BUYERS!

At last! An open reel catalog, including titles, songs, etc. of 95 long play, 2-3 hour albums, by American Airlines or Ampex 4 track stereo tapes. Send \$1.00—and we will also mail you a 140-page Harrison stereo tape guide—so you'll get both for \$1.00—and this \$1.00 is refundable on your first \$10.00 purchase of open reel stereo tapes at our 30% discount.



SAXITONE BICENTENNIAL TAPE SHOPPE

1776 Columbia Rd., N.W., Wash., D.C. 20009

STEREO CO-OP. Now purchase stereo components directly from a manufacturer co-op, and realize substantial savings. Members include Advent, Bose, EPI, Pioneer, Sansui, Dual, Garrard, and others. Write for specific price quotations. Stereo Co-op, 1629 K St. N.W., Suite 5088-Dept. A, Washington, D.C. 20006.

KLIPSCORN-KLIPSCORN-KLIPSCORN Only the finest in Audio. Superior Sound Stereo Center, 2780 Erie Blvd. E., Syracuse, N.Y. 13224.

ONE STOP for all your professional audio requirements. Bottom line oriented. F.T.C. Brewer Company, P.O. Box 8057, Pensacola, Florida 32505.

DON'T PAY THE HIGH MAIL ORDER PRICES. THIEVES WAREHOUSE OF SARASOTA. 6564 GATEWAY AVENUE, SARASOTA, FLORIDA 33581.

BUILD YOUR OWN SPEAKERS AND SAVE UP TO 50%. You can assemble your own high quality, multi-element stereo speakers in a few hours and save up to half the cost of comparable speakers. Send for our free 32-page catalog of speaker kits, raw speakers and accessories. **SPEAKERLAB**, Dept. A2, 5500—35th N.E., Seattle, WA 98105.

CANADIANS — DYNACO COMPONENTS AT TREMENDOUS DISCOUNTS. Write En-Jay Sales, Hornepayne, Ontario.

CYBERACOUSTIC LABORATORY: only one of its kind! Featuring Crown, IMF, AKG, UREI, RTR, DBX, Infinity, Rabco, Decca, Mark Levinson, more. Crown warranty service. Featuring Crown tape recorders: Audiomodronics by our engineers. Barclay—503 Haverford Ave., Narberth, Pa. 19072; 215-667-3048.

MAXELL TAPES. AKG microphones, Stax headphones at DISCOUNT prices. Box 3065, Seattle, Washington 98114.

WESTCHESTER AND FAIRFIELD COUNTY AUDIOPHILES TAKE NOTE! THE AUDIOPHILE. 231 BEDFORD STREET, STAMFORD, CONN. specializes in equipment for the connoisseur. Ampzilla, Audio Research, ADC, Citation, Crown, Dahlquist, Dyna, Epicure, Infinity, Philips, SAE, SME, Stax, TEAC, Technics, Thorens and many more. (203) 348-3551 (Closed Mondays).

Rates: 35¢ per word per insertion for noncommercial advertisements; 60¢ per word for commercial advertisements. Frequency discounts as follows: 3 times, less 10%; 6 times, less 15%; 12 times, less 20%. Closing date is the FIRST of the second month preceding the date of issue. Payment must accompany all orders. Use the handy self-addressed, postage paid card at the back of this issue. When replying to Audio box number ads, send letters c/o Audio, 134 North 13th Street, Philadelphia, Pa. 19107. For more information about classified advertising, circle Reader Service Card #135.

FOR SALE

GRAPHIC EQUALIZER PLANS: Novel circuit very effective/inexpensive, requires no inductors. Ten knobs (octave bands) compensate your Hi-Fi/Tape providing better listening. Complete plans rushed only \$3.49. GREEN BANK SCIENTIFIC, Box 100C, Green Bank, WVa. 24944.

COMPETENCE IN AUDIO SINCE 1928!

Qualified service, custom installations
Klipsch, Sequerra, SAE, McIntosh, Levinson,
SME, Ortofon, Fidelity Research, Ampex
Professional, Tandberg.

We buy and sell quality used gear.
THE MUSIC BOX, INC., 58 Central Street,
Wellesley, Mass. 02181. (617) 235-5100.

NOW AVAILABLE... FAMOUS REFLECTING SYSTEM'S 4 1/2" REPLACEMENT DRIVERS. \$7.98 POST-PAID. BIG QUANTITY DISCOUNTS. FREE SPECIFICATIONS. AURATONE, BOX 580-22A, DELMAR, CALIFORNIA 92014.

THE AUDIO RESEARCH ROOM. The complete line of Audio Research equipment on display under ideal listening conditions. AUDIO SYSTEMS & DESIGN, 5421 South 84th St., Lincoln, Nebraska 68516 (402) 489-9888.

AMPEX TAPE—NEW 1800" on 7" reel 12 for \$18 POST-PAID; 1200" 12 for \$13 POSTPAID—free list—WIDE RESPONSE. 6114A SANTA MONICA BLVD., HOLLYWOOD, CA. 90038.

ELECTROENCEPHALOPHONE: brainwave monitor, Professional biofeedback instruments. J&J 8102-A, Bainbridge, WA. 98110.

AUDIOPHILES! Quality Sounds of Maryland has come to your rescue. Write to me for system quotes you won't believe! Send requests for equipment prices to Quality Sounds of Maryland, Gerard White, Sales Manager, P.O. Box 63, College Park, Maryland 20742.

OREGONIANS WITH UNCOMMON EARS: Hear Magneplaner, Dayton-Wright, B&W, Audionics, Infinity Servos, Braun, Quad, Ohm, Crown, BGW, Radford, Quintessence, Yamaha, Mark Levinson, Linn-Sondek, Transcriptors, Vestigal, SME, Thorens, Philips, Ferrograph, Stax, Decca, Supex, Ortofon, KMAL, Passive Crossovers, Transmission-Line Speaker Kits, Basic Drivers. Shipped Pre-paid in most cases. AUDIO-UNCOMMON, Inc. 8600 N.E. Sandy Blvd. Portland, Oregon 97220. (503) 254-6202.

JAPANESE TRANSISTORS, Kit \$23.44 contains 24 most widely used transistors, including 14 power transistors. Over 500 types available. Free catalog WEST PACIFIC ELECTRONICS, Box 25837, W. Los Angeles, Calif. 90025.

BAY AREA AUDIOPHILES: AUDIO RESEARCH, AUDIONICS, BRAUN, CONNOISSEUR, CROWN, DAHLQUIST, DECCA, DY-NACO, FERROGRAPH, F.M.I., GRACE, KMAL, LINN SONDEK, MAGNEPAN, MARK LEVINSON, NAKAMICHI, PANASONIC (SP-10), QUINTESSENCE, RADFORD, R.T.R., SEQUERRA, SHURE, SUPLEX, TANDBERG, WIN LABS, MCINTOSH (USED). Compare any of our products through our switching device using 1/1 Mark Levinson master tapes at GARLAND AUDIO, 2960 Stevens Creek Blvd., Suite D. San Jose, Calif. 95128 (408) 244-6724.

DYNACO KITS, big discounts, All Kits, Box 864, Destin, Florida 32541.

PAIR JBL HARTSFIELDS \$550.00 each. JBL SE40QS amp \$225.00. JBL SE401 energizer \$195.00 Frazier S.E.E. 24 equalizer \$350.00. Ortofon SL15 cartridge/Martin pre-amp combination \$95.00. Peter Miccolis, 1701 E. Tulip St., Phila., Pa. 19125. (215) 426-4000.

10 1/2" RECORDER SPECIALISTS: Fresh new Scotch L/N 3600 ft. on new 1/4" NAB metal reels five for \$35.00. New Ampex GRANDMASTER tape on 10 1/2" metal reel, six for \$73.00. New 4 channel 8-track blank cartridge loaded with 40 minutes Scotch L/N tape, \$23.00 per dozen. Reconditioned NAB metal 10 1/2" reels, \$24.00 per dozen. 10% on above for postage. Sound Investment, POB 88338, Dunwoody, Ga. 30338.

CENTRAL NEW YORK HI-FI ENTHUSIASTS—Britain's finest loudspeakers on demonstration—THE IMF STUDIO AND ALS40—as well as Marantz, Pioneer, Revox, Beyer, Epicure (3 lines), Thorens, Ortofon, XLM, Discwasher... THE SOUND SHOP, 96 Seneca Street, Geneva, N.Y. 14456 (315) 781-0215.

FOR SALE

HEAVY DUTY GREEN RECORD SLEEVES—45, 78 rpm—Send for free samples & price list. GREENSLEEVES, 423 Greenway Ave., Trenton, N.J. 08618.

YOUR ROOM IS THE MISSING LINK

A state of the art system is usually junk in the typical poor listening environment, and therefore a rip-off. Our acoustical consulting division will have a calibrated "reverberation curve vs. frequency" measurement performed in your room, and our engineering dept.'s plan of correction, loudspeaker placement, and room equalization, all at no cost with your purchase or upgrade. Music & Sound Ltd., 11 1/2 Old York Rd., Willow Grove, Pa. 19090. (215) 659-9251.

CONSIDER YOUR SOURCE FOR SOUND

I. Credentials

College instructors in audio /acoustics, Inventors/graduate electrical engineers, Recording & disc mastering engineers; Members: United Inventors & Engineers Acoustical Society of America
Institute of Electronic Engineers

II. Facilities

Anechoic Chamber: > 95 working floor
\$50,000 research laboratory
Factory authorized "A" warranty stations

III. Our Distinguished Suppliers

Audio Research, Sequerra, Satin, Transcriptors, F.M.I./R.T.R., Linn Sondek, Nakamichi, Dayton Wright, Dahlquist, Crown, Infinity, I.M.F., London Decca, Quad, Rogers, Spondor, Stax, B&O, Grace, Supex, Micro Acoustics, Custom Rabco, Braun, Revox A-700, Ortofon, Damped S.M.E., Scully, dbx, Mark Levinson.

+

1000's of PROFESSIONAL products (see Tuned Rock P.A. ad).

Music & Sound Ltd., 11 1/2 Old York Rd., Willow Grove, Pa. 19090. (215) 659-9251.

Whom Would You Trust?

THOUSANDS OF LIKE NEW LP's and prerecorded tapes. Catalogue \$1.50. House of Records, Hillburn, New York 10931.

RTR EXCLUSIVE PHILA. SHOWROOM All RTR Speakers on demo including the new 1600E, 280DR/ESR15's. Two and three way electronic cross overs. Don't buy any speaker until you've heard RTR. Appointment 215-667-3048; 503 Haverford Ave., Narberth, Pa. 19072.

AUDIO RESEARCH, AUDIONICS, BANG & OLUFSEN, BOZAK, CROWN, DBX, KLIPSCH, KMAL, LINN SONDEK, NAKAMICHI, PHASE LINEAR, RADFORD, REVOX, SEQUERRA, STAX, TANDBERG, BEYER, SENNHEISER, and other fine instruments for the reproduction of music. Send for list of top-grade used equipment AUDIO SYSTEMS AND DESIGN, 5421 South 84th St., Lincoln, Nebraska 68516 (402) 489-9888... and 4408 Capital Ave., Omaha, Nebraska 68131. (402) 556-7559.

CONN. AND WESTERN MASS—FRED LOCKE STEREO offers Accuphase, Epicure, Crown, Quatre, Audio Research, Phase Linear, SAE, Citation, Mark Levinson, Soundcraftsman, ESS (including bi-amped Towers), Magneplanar, Thorens, Technics, SME, Ortofon, Supex, Fidelity Research, Revox, Tandberg, TMC, Transcriptors, DBX, Beyer, Stax, AKG, Nakamichi, Sequerra, Burwen, Hartley woofers, and others Avon 203-678-1797; East Hartford 203-528-9479; New Haven 203-787-0183; Waterbury 203-757-9296; Fairfield 203-366-5246; Springfield, Mass. 413-782-7111.

REVOX A-700, \$1350—excellent condition, one year old 1-313-689-5300.

MARANTZ 7 preamp, model 9 amplifier, 10B tuner with Marantz cabinet. All absolutely brand new, never used, in original cartons with all material. Please submit offer. H. Meyer, 116 Gramatan Ave., Mt. Vernon, N.Y. 10550.

MIDDLE & NORTH JERSEY AUDIOPHILES - Stereo Sound of East Hanover offers personal, friendly service and "state-of-the-art" equipment: Quintessence, RTR, SAE, Ortofon, Transcriptors, Stax, Bang & Olufsen, Phillips, Crown, McIntosh, IMF, JBL and more. Full demo & service facilities for our customers!!!

Stereo Sound
320 Route 10
East Hanover, N.J. 07936
201-386-0050

FOR SALE

IN PURSUIT OF EXCELLENCE WE OFFER: Infinity, Crown, Revox, Fulton, Sennheiser, Philips, Ortofon, ESS, SAE, Beyer, DBX, Altec, Technics direct drives, RTR, McIntosh, JBL, Transcriptors, Klipsch, Citation, Decca, SME, Sequerra, Micro/Acoustics, Lamb, Dahlquist, Tannoy, Yamaha, Soundcraftsman, Marantz, and more... Also custom room equalization, individually damped Altec & JBL Monitors and an on-going equipment evaluation program. The House of Sound, 821 Kent Ave., Baltimore, Md. 21228.

COMPONENTS FOR THE CONNOISSEUR

LOUDSPEAKERS: Audio Research T-3A, 1B, Braun LV 1020, Dahlquist 0010, Dayton-Wright XG-8 MK11B, ESS, Fulton J Modular System, Hartley Concert Master, Hegeman 1A, & 2, Magneplanar MG2167-F, RTR 280 DR, ESR 6, 15. **COMPONENTS:** Audio Research, BGW, Burwen, Connoisseur, Dayton-Wright, Hervic, Linn-Sondek, M&K super woofers and crossovers for T-3ATM, 1B, etc., Mark Levinson Products, Ortofon, Panasonic SP 10, Quad, Quintessence, Radford, SAE, Shure, SME, Supex, Thorens Transcriptor and SEQUERRA. Brochures available.

PAUL HEATH AUDIO
354 STATE STREET
ROCHESTER, N.Y. 14608
(716) 232-2828

HONG KONG, TAIWAN, JAPAN, Asia Directory. World products information. Mail-orders, bulk-orders. Listings. Directory and Information \$1.00 today. World Trade Inquiries. Box 6224, Spokane, Wash. 99207.

HIGH PERFORMANCE HIGH FIDELITY WITHOUT THE "HYPE". Suffolk Audio takes a rational, no nonsense viewpoint on high performance audio equipment. Our advice and opinions are based in objective fact, not mythology and folklore. All equipment is pre-tested for maximum performance. Our distinguished suppliers include: Allison Acoustics, Bowers and Wilkins, Quad, Linn Sondek, Decca, Mark Levinson, Revox (incl. A-700 series), KMAL, Ortofon, BGW Systems, Radford, Beyer, Connoisseur, and much, much more. Call or write for information.

SUFFOLK AUDIO, INC.
1105 Mass. Avenue
Chambridge, Mass. 02138
Ph. (617) 868-1080

PROTECT YOUR LPs. Poly sleeves for jackets 8c round bottom inner sleeves 6c Poly lined paper sleeves 15c White jackets 30c Postage \$1.00. House of Records, Hillburn, New York 10931.

NEW YORKERS—WE ARE COMMITTED!

Consult with us about your audio needs. We have what you want, we offer FULL service.

IMF, BGW, SAE, OHM, INFINITY, KLIPSCH, ORTOFON, THORENS, SME, LEVINSON JC-1, STAX, ADS-BRAUN, TECHNICS, PIONEER, KENWOOD, SOUND CRAFTSMEN, DBX, REVOX and Many Others.

INNOVATIVE AUDIO
129 DeGraw Street
Brooklyn, NY 11231
(212) 596-0888
Call For Appointment

ARIZONA AUDIOPHILES

Crown * E.S.S. * Accuphase * S.A.E. * Revox * S.M.E. * Grace * Stax * Tandberg * Magnepan * Burwen * Rabco * Sequerra * Bose * Thorens * Stanton * Uher * Klipsch * Phase Linear * Sennheiser * J.B.L. * Sony V-F.E.T. * Beyer * Jennings Research * Nakamichi * Yamaha *

JERRY'S AUDIO EXCHANGE

Phoenix-334 E. Camelback Rd. 85012 602-263-9410
Tempe-130 E. University Dr. 85281 602-968-3491
Tucson-1037 N. Park Ave. 85719 602-622-7407

ARC SP-3G, case, \$525. BOSE 901's, deluxe, \$400. SAN-SUI OS-1, \$65. E-V T-3500 Inovac, \$100. All mint, FOB. Want ALTEC Acousta-Voicette. 703-243-0515 after 7:30 PM.

HIGH DEFINITION SUPERWOOFERS - The world's finest woofer systems-The Hartley 24 inch and 18 inch high power woofers in an optimized transmission line. Available only through Hartley Electronics, 1502 Butternut, Richland, WA 99352. Phone: (509) 946-4459 and 947-5026 after 5:00 PM.

FOR SALE

INFRA WOOFER TM world's largest, deepest, most powerful sub-woofer system can be had only at Music and Sound, Ltd. 50 dB per octave crossover, bandpass 16 Hz... \$1295.

F.M.I. & I.M.F. SUB-WOOFERS, for the closest approximation to dipole definition—\$180-\$350! Also, the rave five-way Fulton/R.T.R. super speakers. Shipped prepaid/insured. Music and Sound, Ltd., 11 1/2 Old York Road, Willow Grove, Pa. 19090 (215) 659-9251.

AKG, ALTEC, AUDIO RESEARCH, Beyer, Crown, Dahlquist, DBX, Decca, Infinity, KLH 9s, Koss, Mark Levinson, Nakamichi, Ortofon, Phase Linear, PML, Revox, SAE, Sennheiser, Sequerra, Sony, Stanton, Stax, Supex, Tandberg, TASCAM, Technics, Thorens, etc.

HI-FI HAVEN

28 Easton Ave.
New Brunswick, N.J. 08901
201-249-5130

BIG DISCOUNTS ON L.P.'s, cartridges, cassettes, "singles." Stereo and Quad, all labels all artists. No fees, no gimmicks. Same-day service, postpaid. Send stamp for free details and Schwann Basic Record Library pamphlet listing 1000 pieces of classical music arranged by musical period and composer. Or, send \$1.00 each (refundable) for Schwann Record and Tape Guide; Harrison Tape Catalogue; or "Golden Oldie" singles catalogue (listing over 5000 45 RPM's). DISCO-TAPE UNLIMITED, Mail Order Dept. AO, Box 817, LaPlace, La. 70068.

PIEZO SUPER HORN TWEETERS \$7.95 P.P. Cont. U.S.A. Daily Mfg. Co. (Mfr. of quality loudspeaker systems since 1951), 100 Liberty St., Rockwell, N.C. 28138.

CANADIANS: Shure M91ED \$24.88; Dynaco A25 \$68.00; Pioneer SX424 \$179.95; Dual 1216 \$119.00; Leak Delta 75 \$289.00; Garrard Mini changer \$13.99. Free Hi-Fi discount catalog. Etco (Au), Box 741, Montreal H3C 2V2.

NAME BRAND RECORDING TAPE, custom loaded. Available in cassettes, reels, and cartridges. Huge savings direct from manufacturer. MJS, 516 Brooks, San Jose, Calif. 95125.

DISCOTHEQUE MIXERS from \$325, equalized speakers with built-in power amplifiers, bi-amped systems, and complete portable discotheque systems. Write us for literature. Dealer inquiries invited. GLI, P.O. Box 2076, Dept. A, Brooklyn, New York 11202.

DEALERS: We will buy your excess stock. ALL lines, no quantity too large or small. Cash paid immediately. Call M. Gasman 617-924-0561.

AR TURNTABLE OWNERS. Add cueing. Precision machined. Silicon damped. American made. \$16.00, postpaid. Lyrelift, 582 Franklin Street, Cambridge, Mass. 02139

CELESTION DITTON 66 Studio Monitors, \$650. ERA Mk6/Vestigal, \$185. Radford SPA60, \$275. T. Martin, 5131 Starlight, Racine, Wisc. 53402.

FAMOUS MAKE PIANOS AND ORGANS shipped prepaid anywhere at tremendous saving. State make and model wanted for our quotation. File this advertisement for future reference. Greenwich Music Center, Greenwich, N.J.

ONE MONTH NEW! Phase Linear "Brute" System — 4000 and 700B with walnut cabinets. Sacrifice for \$1250. Please call (602) 968-6644 after 7 P.M.

DYNACO STEREO 400, PAT-4, PAT-5, FM-5. One each. Factory aligned after assembly. Brand new, never used, original cartons, warranties. Kit price, plus shipping. Delivered Northeast, or 25% down, balance COD. Box A57-2, Audio.

ORIGINAL TRANSCRIPTOR HYDRAULIC REFERENCE TURNTABLE (do not confuse with smaller "Skeletal" table/Vestigal arm package from Ireland) now available direct from U.S. importer. Magnificent turntable complete with silicone-damped Unipivot arm, \$498.00 freight prepaid. Without arm, including blank arm-mounting board or one cut for SME, \$398.00. Send \$100.00 down for COD shipment. Audiophile Imports, 10 East Erie, Chicago, 60611. (312) 787-0754.

DON'T PAY THE HIGH MAIL ORDER PRICES. THIEVES WAREHOUSE OF BETHESDA. P.O. BOX 34251, WEST BETHESDA, MD. 20034.

FOR SALE

STEREO NEEDLES AND CARTRIDGES—ADC, B&O, Grado Empire, Micro-Acoustic, Pickering, Ortofon, Shure, Stanton, Supex, Sony, Panasonic, RCA, BSR, and others. NEEDLE IN A HAYSTACK, INC., P.O. Box 17436, Washington, D.C. 20041.

NOW IN PRODUCTION: World's heaviest 12" woofer. 17Hz resonance. Over 200 watts RMS. Sand cast frame, \$59.00 delivered U.S.A. Rockwell Systems, Inc., 100 Liberty St., Rockwell, N.C. 28138.

RABCO SL8E OWNERS — Completely rebuild and modify your SL8E to be the finest tone arm available today. Space age precision and machining, new light-weight tone arm. Unbelievable tracking and reproduction. \$250.00. Jonas Miller Sound, State of the Art Components for the Experienced Listener. 8719 Wilshire, Beverly Hills, California 90211.

WESTCHESTER HEADQUARTERS for the great sounds in the world. Quad, Ohm, Cambridge, Dahlquist, Bose ESS, Braun, SAE, EPI, Crown, Phase Linear, Tandberg, Thorens, Yamaha, Nakamichi, Technic, BGW, Dual, Revox, Kenwood, Pioneer, The Listening Room, Inc. 590 Central Ave., Scarsdale, N.Y. 10583 (914) 472-4558.

QUOTATIONS on all major components and musical instruments. No fair trade in Nevada, Lowest Prices. Southern Nevada Music Co., 2295 E. Sahara Ave., Las Vegas, Nevada 89104. (702) 457-4558.

AT LAST! The high-output version of the highly regarded SUPEX SD-900 is now available in the U.S. The SD-901 will work directly into any pre-amp. \$145.00. For name of Dealer nearest you write to Sumiko, Box 5046, Berkeley, Ca. 94705.

LOOKING FOR THE BEST in High Fidelity? Try The Id. We feature lines such as Accuphase, Crown, Yamaha, Sansui, Thorens, Dual, P.E. ESS, Bozak, Altec, Ortofon, Stanton & Stax headsets. For more information call or write:

The Id
2219 Frederka St.
Owensboro, Ky. 42301
Phone (502) 926-2765

AUDIO'S HI-FI HANDBOOK

Complete reference guide to over 1,000 components, including prices and specs. All arranged in tabular form for easy comparison. Plus over 30 outstanding articles on audio topics, trends and advances. State-of-the-art reading for audiophiles. Only a limited quantity available. Over 200 pages. Send \$3.95 (includes shipping and handling) to: Jean Davis, Audio Hi-Fi Handbook, 134 N. 13th St., Phila., Pa. 19107.

MILWAUKEE & WISCONSIN'S only audiophile dealer. Specialists in components by Crown, Dahlquist, Transcriptors, Integral Systems, Epicure, Nakamichi, Bozak, Citation, Ohm, SME, Ampzilla, DBX, Infinity, SAE, RTR, ESS, Revox, Phase Linear and 50 others. Wisconsin's only Audio Research dealer with the entire product line on demonstration. WACK ELECTRONICS INC., 5722 W. North Ave., Milwaukee 53208. 414-442-3441.

—SPEAKER CATALOG—

Up to date. Top quality drivers. Hop-up the speakers you have or build new ones. Transmission-line speaker plans \$5.00 — Foam damping material... 212 462-0984

TEXAS AUDIOPHILES! On demonstration: Dahlquist, Nakamichi, Transcriptors, Linn-Sondek, Infinity, Braun, Advent, Crown, Phase Linear, Ortofon, Levinson, Supex, Quad, Klipsch, IMF, Keith-Monks, ESS, Decca, B&O, Radford, Stax, Audionics, Philips, Revox, Citation and many others. Audio Concepts, 2021 Guadalupe, Austin, Texas. Phone 512-478-7421.

HI-FI ENTHUSIASTS WANTED!! Earn more than just spare money in your spare time. We need campus representatives to sell name brand stereo components at discount prices in your area. High commission, no investment required. Serious inquiries only, please. Contact: Alan Weisberg, K&L Sound Services Co., 75 N. Beacon St., Watertown, Mass. 02172.

CAN YOU IMAGINE a magazine that recommends components in four categories from no-holds-barred to best-for-the-money? The Stereophile does it. For info write Box 49A, Elwyn, Pa. 19063.

FOR SALE

Listen to TELEVISION IN STEREO



The TE 200 TELEDAPTER EASILY CONNECTS TO ANY TV & STEREO SYSTEM. Using our coupling and matrix circuit, teledapter takes a low impedance output from the television and delivers two HIGH IMPEDANCE CHANNELS OF SIMULATED STEREO, to drive any amplifier. Frequency response is maintained so you can hear the tinkle of bells or booming bass sounds as it happens on TV. With service warranty and hookup instructions \$16.95 ppd. Guaranteed to make your TV 100% more enjoyable.

OUR NEW TE 300 VHF-UHF HI-FI TUNER IS NOW AVAILABLE. A complete and self contained 110 volt tuner. VHF-UHF antenna connections. Recording and amp output jacks. Five year service warranty \$149.95 ppd. From our factory.

SEND CHECK MASTER CHARGE NO. for TE-200 TE-300 or \$5.00 for C.O.D. TO: RHOADES NATIONAL CO. DEPT AD P.O. BOX 817 HENDERSONVILLE, TENNESSEE 37075

NAME _____
ADDRESS _____
CITY _____ STATE _____ ZIP _____
SEND COMPLETE CATALOG

CUSTOM PREAMPLIFIERS, ELECTRONIC X-OVERS, MIXERS, etc. Engineered to meet most stringent performance parameters. Call or write for additional information: OHRWERKE, 40 High Street, Guilford, Conn. 06437, (203) 399-7367.

NEW PRODUCTS: Allison Acoustics; Koss Full Range Electrostatic loudspeakers; G.A.S. (Ampzilla) amps, preamps; Quatre; Rabco's ST-7 turntable; Muntz Home Theatre Color Television (30"x40") screen. **USED MINT:** ARC-D75A, 50F1B; Burwen 1201; Citation 12; Crown IC150, D-60, 300; C-M Labs; Heric receivers; Hewlett Packard amp; ESS amp; Paoli 60M's; SAE Mark 1M, IIC; BGW 500R; Radford SC242, SPA60; IMF Monitors, IIIA's; Hartley Concertmasters; ESS AMT-1; RTR 400E, RTR ESR-6, 15; FMI 80, 120; Teac 7030 GSL. Paul Heath Audio, 354 State Street, Rochester, N.Y. 14608. (716) 232-2828.

ATTENTION

WESTERN NEW YORK AUDIOPHILES

The word is getting around!! Our personalized, honest service and quality equipment make a winning combination. In addition to the incomparable AUDIO RESEARCH line, (T-1B's black/natural in stock), we carry AMPZILLA, SAE, Phase Linear, Yamaha, Quintessence, LEVINSON, B&O, IMF, MAGNEPAN, M&K Subwoofers, Hegeman, Infinity, RTR, ESS, DAHLQUIST, Fulton Music, QUATRE, Onkyo, Connoisseur, Technics, Thorens, Dynaco, Transcriptors, Cerwin Vega, Soundcraftsman, Supex, Ortofon, ADC, Micro-Acoustics, Damped SME, Linn Sondek, KMAL, Naim Audio, etc. The Stereo Emporium, 3407 Delaware Ave., Buffalo, N.Y. 14217. (716) 874-3372.

TRANSIENT OUTPUT MONITOR for audio amplifiers. L.E.D. readout indicates 1/4 to 1000 watts average and transient power output. Hand assembled, calibrated, tested. \$100. Free literature. Analogic Design, P.O. Box 7753, Phila., Pa. 19101.

ROGERS B.B.C. MONITOR, B&W Ltd., Celestion, Radford, Decca, ERA, Connoisseur, Audionics TL-90, Goldring, Revox, Beyer, Lamb and more. Custom design and modifications. SUFFOLK AUDIO, INC. 1105 Mass Ave., Cambridge, Mass. 02138 (617) 868-1080.

SAN DIEGO, CALIFORNIA

ADC, Advent, AKG, AR-LST, Audio-Research, BGW, Citation, Crown, Dahlquist, DBX, Dynaco, FMI, Janszen, Linn Sondek, Magneplanar, Marantz, Micro-Acoustics, Ohm, Phase Linear, Philips, Quintessence, Rabco Revox, RTR, Sennheiser, SME, Stax, Supex, Tandberg, Yamaha.
Sound Company
4701 College Ave., (714) 582-4148
3675 Sports Arena Blvd., (714) 224-2844

THE FIRST (1962) UNDERGROUND audio publication of them all, the Stereophile is the subscriber-supported perfectionist's magazine the others are trying to imitate. Free dope sheet explains why. Box 49A, Elwyn, Pa. 19063.

WESTCHESTER AND FAIRFIELD COUNTY AUDIOPHILES TAKE NOTE! THE AUDIOPHILE, 231 BEDFORD STREET, STAMFORD, CONN. specializes in equipment for the connoisseur. Ampzilla, Audio Research, ADC, Citation, Crown, Dahlquist, Dyna, Epicure, Infinity, Philips, SAE, SME, Stax, TEAC, Technics, Thorens and many more (203) 348-3551 (Closed Mondays).

FOR SALE

TARZAC CASSETTES: C-1 thru C-90. CUSTOM CASSETTE LABELS. Free samples. 638 Muskogee Avenue, Norfolk, Virginia 23509.

IF YOU BUY AUDIO EQUIPMENT you can't afford not to read the *Stereophile*. Write Box 49A, Elwyn, Pa. 19063 for free blurb sheet.

ALLISON ACOUSTICS LOUDSPEAKERS have stabilized Radiation Loading. Years of intensive research by Roy Allison (formerly of Acoustic Research, Inc.) on the interaction between loudspeakers and room boundaries has yielded a new high standard of uniform bass performance. New Convex Diaphragm Mid-Range and High Frequency drivers achieve phenomenal wide dispersion (—3db 90 degrees off axis at 20kHz!) Literature and price information available upon request.

SUFFOLK AUDIO, INC.
1105 Mass. Avenue
Cambridge, Mass. 02138
Ph. (617) 868-1080

BALTIMORE-WASHINGTON AREA AUDIOPHILES REJOICE! At last a store for you. Come to Myriad Sound and hear the finest in state of the art audio equipment. Featuring the complete Audio Research line, Polk Audio Model Nines, ESS Heils, Janszen, S.A.E., Alteq, Citation, R.T.R. B&O, Thorens, S.M.E. etc. all accompanied by Fred Huggins himself. Main store at 9619 Reisterstown Rd., Garrison, Md. 21055 (2 miles North of Balt. Beltway exit 20) (301) 363-1733.

DAHLQUIST DQ-10, RTR, INFINITY, BOSE, ESS, KLIPSCH, SAE, CROWN, PHASE LINEAR, HERVIC, CITATION, YAMAHA, QUINTESSENCE, BURWEN, BEGRAM 4002, THORENS, LINN SONDEK, TECHNICS, TRANSCRIPTORS, PHILLIPS, CONNOISSEUR, A&D, SME, REVOX, SONY, ADC, ORTOFON, SHURE, MUCH MORE.

STEREO CENTER
2539 VESTAL PKWY. EAST
VESTAL, NEW YORK 13850
(607) 729-6191

PROPRIETARY CUSTOMIZED MODS reduce tone arm friction, damp spurious resonances, minimize torsional forces, improve tracking, and reduce record wear. For S.M.E.'s—\$30.00 For Rabco SL-8(E)—\$100.00. For Transcriptors—free* (*with purchase).

NOW

LISTEN to our calibrated Satin Ortofon/Supex moving coils, B&D/Grace/Micro-Acoustics. From the laboratories of Music & Sound Ltd., 11 1/2 Old York Rd., Willow Grove, Pa. 19090 (215) 659-9251.

+Levinson Cartridge Preamp+

NORTHERN N.J.'S FINEST AUDIO STORE, 20 minutes from NYC. Ampzilla, Bozak, B&O, Magneplanar, Phase Linear, DBX, IMF, Dahlquist, Ortofon, Quintessence, Thorens, Pioneer, Kenwood, Dual. Write or call - University Stereo, 57 E. Ridgewood Ave., Ridgewood, N.J. (201) 447-5700.

BERKELEY, CALIFORNIA

Mark Levinson
Quintessence
Nakamichi
Cambridge
C/M Labs
Radford
Quatre
Hervic
Revox
Grace
Supex
Dbx

ADS
M&K
KMAL
Quad
Braun
Fulton
Klipsch
Dahlquist
Audionics
Magneplanar
Connoisseur
Linn-Sondek

STEREO WORKSHOP

2985 College Avenue
Berkeley, California 94705

(415) 843-5836 open 2-8 TWThF; 12-6 Sat

MIXER MODULES—Modules designed to provide an economical route to studio-type mixing consoles. Modules have plastic element slide faders and a module for EQ. At last there is a bridge between the high-cost pro gear and components for the audio enthusiast. Send for free info to Wall of Sound, Box 239, Glen Burnie, Maryland 21061.

DON'T PAY THE HIGH MAIL ORDER PRICES THIEVES WAREHOUSE OF TAMPA, 1531 SOUTH DALE MABRY, TAMPA, FLORIDA 33609.

FOR SALE

ATTENTION... LUCKY OWNERS OF:
DYNA STEREO 70
RABCO SL8(E)
DYNA PAS-3(X)
INFINITY 2000A
DECCA MKV AND "EXPORT"
DYNA MARK III
SHURE SME and
other tubular tonearms

THE DKL LABORATORY, INCORPORATED HAS DEVELOPED UNIQUE MODIFICATIONS ENGINEERED SPECIFICALLY FOR THESE COMPONENTS. NOW YOU CAN GREATLY IMPROVE THE SOUND QUALITY TO "ULTRA DEFINITION".

PRICED FROM \$25.00 TO \$170.00, OUR MODIFICATIONS OFFER VAST AUDIBLE IMPROVEMENTS AT REASONABLE COST.

FOR MORE INFORMATION CONTACT:

DKL LABORATORY, INCORPORATED
BOX 683
SEVERNA PARK, MARYLAND 21146

OR CALL: (301) 588-6257
MONDAY, WEDNESDAY, THURSDAY,
SATURDAY 2-8 PM

WE SPECIALIZE IN ONLY THE FINEST SOUND COMPONENTS—ALLOW OUR STAFF OF AUDIO EXPERTS TO HELP YOU CREATE YOUR "ULTRA DEFINITION" SOUND SYSTEM. CHOOSE FROM THE WORLD'S FINEST COMPONENTS LIKE:

AUDIO RESEARCH—electronics and speakers
BGW—power amplifiers
DBX—noise reduction systems, dynamic range enhancers
"HAND-TUNED" DECCA MKV—cartridges
DYNACO—tube electronics
FULTON—regular and MODULAR speakers
HK CITATION—amps, tuners
IMF—"MONITOR-ORIENTED" speakers, kits, sub-woofers
LINN-SONDEK—turntables
MAGNEPAN—speakers
M & K—sub-woofers, matrix systems
PAOLI—tube amplifiers
RABCO—turntables
RTR—electrostatic speakers
SOUNDCRAFTSMEN—pre-amps, equalizers
STAX—electrostatic headphones
"SUPER SHURE"—SME-tonearms
TANNDY—turntables, speakers

AND SCORES MORE.

WASHINGTON D.C., MARYLAND, VIRGINIA
AREA RESIDENTS TAKE NOTE—

YOUR "STATE-OF-THE-ART" DEALER IS:

DKL SOUND LAB
943 BONIFANT

SILVER SPRING, MARYLAND 20910

Hours: **MONDAY, WEDNESDAY, THURSDAY,**

SATURDAY 2-8PM FRIDAY BY

APPOINTMENT ONLY, CLOSED TUESDAY

(301) 588-6257

STATE-OF-THE-ART comes to NORTH-CENTRAL FLORIDA, serving you with: **AUDIO RESEARCH, BGW, Citation, Dahlquist, Dynaco, Hartley, Infinity, Magneplanar, Mark Levinson, Ortofon, Rabco, Revox A-700, SME, Supex, Thorens, Transcriptors, and \$10,000 worth of test equipment for in-store audio analysis.** We maintain a mobile recording van and sell professional recording equipment. **AUDIO, ETC., INC.,** 1999 N.W. 43rd Street, Gainesville, Florida, 32605. 1-904-377-4107.

BUY! SWAP! SELL! Your personal ad placed FREE in *Audiomart*, the audiophile's classified newsletter. Subscribe! \$4/yearly. **AUDIOMART, Box 821, Stratford, Conn. 06497.**

A FEW competitively priced used Revox A77 decks available. Completely reconditioned by Revox, virtually indistinguishable from new and have the standard Revox 90 day warranty for rebuilt machines. Satisfaction guaranteed. Example A77 with Dolby for \$675 plus shipping. Write with requirements to ESS1, Box 854, Hicksville, N.Y. 11802 (516) 921-2620

FOR SALE

CROSSOVERS - Custom designed; fully tested; guaranteed quality. Free brochure Write: Networks; Box 458; Placentia, Calif. 92670

LOOKING FOR HIGH QUALITY "PREVIOUSLY OWNED" MERCHANDISE? Referral/resale service for industrial and professional audio equipment. All merchandise guaranteed to meet manufacturer's specification for 12 months (parts, labor, and round trip shipping included). Call or write **OHRWERKE, 40 High Street, Guilford, Conn. 06437, (203) 399-7367.**

MOVING COIL CARTRIDGE OWNERS: Your alternative is here! Our MCP-1 Moving Coil Cartridge Preamp, featuring audible superiority at a reasonable price, is now available. For information write **R B AUDIO, P.O. Box 574, Eatontown, NJ 07724.**

MINNEAPOLIS — High Quality Audio Has Finally Arrived! Audio Research, Bang & Olufsen, Klipsch, Audionics, Ampzilla, Radford, Revox, Bozak, Crown, DBX, Sequerra and others... opening June 1st... **THE SOUND ENVIRONMENT, Butler Square, Suite 114, 100 North Sixth Street, Minneapolis, Minn. 55403, (612) 339-4641.**

DYNACO RACK MOUNTS for pre-amps, tuners, integrated amps. \$24.95 postpaid, \$22.50, three or more. **AUDIO BY ZIMET, 1038 Northern Blvd., Roslyn, N.Y. 11576 (516) 621-0138**

PAOLI LINN SONDEK, Quatre, Revox, Ortofon, Dyna, SME, Mark Levinson, Supex, Decca, Stax, Thorens, Hartley, Koss Electrostatics, Epicure, KMAL, B&W, B&O, Dahlquist, Braun, Tandberg, Transcriptors, Nakamichi, Micro-Acoustics, IMF, Cambridge, Sony, Grace, others. Testing of equipment and home consultation done by appointment. Audio Workshop, Inc., Latham, New York (518) 783-9810.

MCINTOSH 2105 amp \$500; McIntosh C-28 preamp \$425; Phase Linear 700 \$550; JBL Lancer 55's \$380. All like new. Joe Cangelosi. (215) 258-2511.

AMPZILLA, built from kit, no problems. \$425.00. Dahlquists, 6 months old, \$625 pair. Call 1-301-838-7398.

LOW NOISE RESISTORS—1/4W, 5% carbon film from 10-3.3 Megohm for 31/2c each. Fifty per value is \$1.25. 1N4004, 1N4148 diodes. Postage 75c. **COMPONENTS CENTER, Box 134A, New York, N.Y. 10038.**

JBL SE401 Amplifier, equalized flat or for 001 system, \$110 (614) 888-5316 after 9:30 P.M.

JBL LX10, 1217-1290; Dynaco ST120, PAT. 4, AF-6; Soundcraftsmen PE2217, Stanley Cudnik, 720 Pennsylvania Ave., Trenton, New Jersey 08638.

LISTEN, distortion down to .01%, power up to 250 Watts RMS. Amps and preamps, sound modifiers, synthesizers, digital stuff and much more, for less. Free Catalog. Digitronics Co., dept C2, 667 East 1700 South, Drem, Utah 84057

DAYTON WRIGHT XG8, Mk III speakers, new cost \$2500 — sell \$1700. (919) 467-9198

AUDIO RESEARCH SP-3 pre-amp. Excellent condition. Transferable warranty, \$475. Alan Heuss, 30 E Kings Highway, Mt. Ephraim, New Jersey 08059.

SOUTH FLORIDA'S FIRST AUDIO RESEARCH DEALER. Full Audio Research Systems on display: SP3-A/Dual 76/Dual 51/Magneplanar Tympani I-B/Tympani IIIA+ Plus Advent, B&O, McIntosh, Marantz, Phase Linear, Sherwood, Supex, Stax, SME, Sennheiser, Tandberg, Thorens, Technics, Nakamichi, Mark Levinson, Sequerra, Fulton, Satin, Ampzilla, Magneplanar, Crown, Revox, AR. Complete audio counselling and custom installations. Sound and Sight, 20 N. Federal Highway, Boca Raton, 33432, (305) 391-1843; 141 Lakeview Avenue, West Palm Beach, 33401. (305) 655-2236.

STEREOPUS — A new quarterly audiophile publication tells it like it is. Reviews equipment with an ear to what it sounds like, good and bad points, and type of room and associated equipment for which it is most suitable. If you are into audio, get into Stereopus. We won't let you down or leave you to read between the lines. First issue available now, second upcoming soon. \$9.00 (four issues); \$11.00 (first class); \$12.00 foreign. Stereopus, P.O. Box 269, Fort Walton Beach, Florida 32548.

FOR SALE

Technics SL-1300 turntable/Stanton 681EEE \$285.00. Magnum Opus acoustic suspension-piezoelectric loudspeakers \$335.00 pr. J.V.C. VR5551 Receiver 130 watts rms, equalizer, more \$365.00. All equipment 1 month old, factory cartons, warranties. Danny, (516) LY3-7048, 199 Union Ave., Lynbrook, N.Y. 11563.

RTR Electrostatic Tweeters — 18 3" x 6" panels, two power supplies. Best offer over \$200. George Pro, 1618 Park Towne Lane N.E. No. 5 Cedar Rapids, Iowa 52402.

AMPZILLA, TRANSCRIPTORS, Magnepan. Now available in West Michigan. The Music Center, Hastings. (616) 457-2117.

BUY DIRECT FROM ENGLAND'S HI-FI MAIL ORDER SPECIALISTS! Save on B&O, Celestion, Decca, Tandberg, Revox, Transcripitor, Jordan-Watts, Lowther, KEF, Rogers, SME, Ariston, HPD, Sugden, Radford, Neal, Ferragraph, etc. Shipping lists free or send \$3.00 bills to include literature. Goodwin Ltd., 7 Broadway, Woodgreen, London N.22. Phone 01-888-0077. Visitors welcome.

SURPRISE! SURPRISE! Digital Piano Tuning Device tunes musical instruments Accurately! Perfectly! Inexpensively! Construction-Instruction Plans Complete \$12.95 Airmailed Postpaid! Moonlighting quickly repays \$40 electronics investment! GREEN BANK SCIENTIFIC, Box 100E, Green Bank, WV. 24944

MARANTZ 250 power amplifier \$299. Marantz 1030 w/cabinet \$110. Marantz Imperial 7 speakers \$240 pr. Dual 1218 with base \$100. Sold separately or together. Total system price \$700. System one year old. S. Burton, 1607 Oak #115, Denton, Texas 76201.

ST. LOUIS' LEADING QUALITY AUDIO DEALER—Featuring the following equipment:

AUDIO RESEARCH

ACCPHASE	PHILIPS
AKG	QUAD
ALTEC PRO	QUINTESSENCE
B & O	REVOX 700
BOZAK	RTR
CITATION	SCULLY
DECCA	STANTON
EPICURE	STAX
KMAL	TANDBERG
LINN SONDEK	TECHNICS
NAKAMICHI	UHER
PHASE LINEAR	YAMAHA

and others

Equipment tested before being shipped prepaid.

J.C. Gordon Company
2831 Hampton Avenue
St. Louis, Missouri 63139
(314) 647-8866
Since 1927

AUDIO RESEARCH D75G power amp (transferable warranty good for 3 more years) \$600; Marantz 7C preamp with case \$200; Harmon Kardon Citation 12 power amp (with warranty card) \$200. Tom Jansen, 602-838-6651.

TWO NEW 15" ALTEC 604-E Super Duplex speakers with dividing networks, 16 ohms. Price: \$140.00 each. Michael J. Kelly, 845 North First Ave., Kent, Washington 98031. Tel: 206-852-8944.

NEW! SUPER-HANDY EASY TO MAKE ADJUSTABLE STEREO MICROPHONE HOLDER! FOR COMPLETE PLANS, DESCRIPTION. SEND \$2 TO: KAP, BOX 185, SOUTHAMPTON, MASS. 01073.

NORTHWEST'S FINEST — Audio Research, Audionics, Braun, BGW, Burwen, Crown, Dahlquist, Dayton Wright, Decca, Fidelity Research, FMI, GAS, Hartley, IMF, Infinity, Linn Sondek, Mark Levinson, Nakamichi, Quad, Quatre, Quintessence, Radford, Sequerra, Supex, Tandberg, Transcripitor, Yamaha, also Custom Designed Superwoofers, and many more. HARTLEY ELECTRONICS, 1502 Butternut, Richland, WA 99352. (509) 946-4459 until 6:00 PM, then 947-5026 evenings.

FOR SALE

A RARE FIND: Electro-Voice 2A receivers. 27/27 watts rms. Fine tuner, 0.1% I.M. and T.H.D. distortion. You will never find a receiver of such quality at this price. \$120.00 All shipped prepaid/insured. Lesmeister Co., 3619 Wheeler, #230, Dallas, Texas 75209.

DISCOUNT — cartridges, receivers, speakers, amplifiers, car radios. Free catalog. Stereo Habitat. 481 - 3 Ave., NYC 10016.

MAGNEPLANAR TYMPANI IIIA's, Audio Research EC3-A electronic x-over, Ampzilla, two (2) each Audio Research Dual 76's. Call (704) 364-4455.

IAD DYNAMIC EXPANDER Compression is distortion, eliminate it! The Dynamic Expander has unmeasurable distortion, S/N 103dB down, LED expansion indicators, smooth expansion and decay adds up to +20dB in program material without embarrassing pumping, breathing and veiling for all who listen. Advanced engineering and esthetic design for the most beneficial addition to any system. \$265.00 Dealer inquiries invited. IAD, 10 East Erie Street, Chicago, Ill. 60611

SAE Mark 1B and Mark IIICM. New. Guaranteed Perfect. \$1,368.75. Reply Box A58-1

DYNA STEREO 70 MOD KIT. Tighter bass, improved transient response, higher definition. Complete instructions, schematics, parts list, \$5.00. With parts kit, including all new tubes, \$46.00. Or we will modify \$105.00 all postpaid. Audio Designers, Box 122, Ledyard, Conn. 06339.

DYNACO STEREO 400, PAT 4, B.I.C. 980, (617) 888-4846

TWO MCINTOSH 75 watt amps, excellent condition, \$80 each, \$150 pair. Crown 822 recorder \$400. Eight assorted P.A. mics \$50. Bogen MXM-A mixer \$75. R. Garecht, 146 Luzon Dr., Ft. Bragg, N.C.

Audio Research	M & K	Fidelity Research
Quintessence	Gale	Mark Levinson
Techniques	KMAL	Connoisseur
Dahlquist	Supex	Magnepan
Ampzilla	Yamaha	Sequerra
Quatre	Win Labs	Fulton
Braun	Audionics	Grace
SME	Nakamichi	Stax
SAE	Linn Sondek	DBX

GARLAND AUDIO, INC.

2960 Stevens Crk. Blvd.
San Jose, California 95128
(408) 244-6724

QUAD ESL, mint, pair \$600.00; also Revox A-77 \$395.00 plus shipping. (919) 449-4132.

AUDIO RESEARCH SP3A-1, \$500; Tympani 3-A speakers with bass screens \$1200; Dual 76 \$700; Ampzilla with meters, factory wired, \$600; EC-3A crossover \$450. (919) 449-4132.

THE BOTTOM END, as reviewed in the April *Stereophile*. A new compact super bass speaker that retails for around \$200.00. A no-compromise performer with smooth response below 20 Hz. Ideal for use with Magnaplanars, Quads, Dahlquist, ESS, or any system deficient in low bass, because of room placement. **BOTTOM END CROSSOVERS** permit the use of one woofer, no bi-amping, one amplifier does it all. Model X1 for all Magnaplanars, Model X2 for all others. Literature and information available upon request, dealer inquiries invited. Consumers write for the name of your nearest dealer. M&K Sound Inc., 8719 Wilshire Blvd., Beverly Hills, Calif. 90211.

PEAK POWER METERS—1/4w to 1000w Kit or assembled. **PEAK LEVEL METERS**—for taping—eliminates overdrive. **VU METERS**—professional Quality at low prices—connects directly to tape recorder, with illumination. Send \$1.00 for catalog. **RECORDING SYSTEM DESIGN CO.**, P.O. Box 297, Levittown, N.Y. 11756

SAE MK III CM POWER AMP, \$710. SAE Mk 1B preamp \$625. owned one month. Rich Rinehart, 106 W. Norwich, Columbus, Ohio 43201. (614) 297-1753.

SCOTCH—**TDK**—**MEMOREX**—**MAXELL** Blank tape. Low prices. Free catalog. S&P Enterprises, Box 117, Itasca, Ill. 60143.

FOR SALE

TDK, BASF, Memorex, Maxell, cassettes, reels, 8-tracks. Lowest Prices, Guaranteed, New. S&S Audio P.O. Box 56039 Harwood Heights, Il. 60656

PRODUCTS FOR THE DISCRIMINATING AUDIOPHILE:

Radford Electronics, Hartley Loudspeakers (full line on demonstration and 24 inch woofers in stock), G.A.S. Co. (Ampzilla), Quad, Audionics, Supex Moving Coil Cartridges (new high output models available), Thorens, Shure Tonearms, etc.; Large selection of esoteric used equipment. **SOUND ADVICE**, 536 St. Le Road, Emmaus, Pa. 18049. Hours: Mon., Thurs., Fri., 6-9:30; Sat. 10-6.

IMPROVE SIGNAL TO NOISE RATIO on tape equipment by actually measuring any damaging magnetic residuals, then really demagnetizing with the powerful, sine wave Hand-Mag. Professional Hand-D-Kit \$58.50 delivered USA on prepaid orders. Literature and Article reprint available. **ANNISCO**, 1103 N. Delaware, Indianapolis, Ind. 46202. Phone (317) 637-9282.

AUDIO BREAKTHROUGHS—Long Island's newest and finest state-of-the-art dealer, featuring these outstanding lines: Yamaha (the V-FET Amp, CT-7000 Tuner, and NS1000M Beryllium Speakers), Magneplanar, IMF, Paoli, KEF speakers and drivers. Soundcraftsman, Linn Sondek, Decca, Supex, B&W, Harmon-Kardon Citation, Dahlquist, Marantz Professional, FMI, Technics, Dynaco, and more. Custom modifications and relaxed listening facilities await you, 1681 Northern Blvd., Manhasset, New York 11030. (516) 627-7333.

IN STORE DEMONSTRATION and private appointment showroom featuring natural high definition sound from Audio Research, Magnepan, Fulton, Audionics, Radford, ESS, RTR, Quatre, Braun, Sony Corp., V-FET's, SME, Thorens, Stax, Supex, Grace, Soundcraftsman, Burwen, Marantz, Transcripitors, and more... also custom sub-systems and electronics modifications from our highly qualified service department. **Audio-Tronics, Ltd.**, E. 120 Wellesley, Spokane, Wash. 99207. (509-484-1300).

THREE BOZAK CONCERT GRAND Speakers, Marantz 10B tuner. New condition. Best offer takes all or part. V. Dufford, 922 Morton St., New Castle, Pa. 16101.

13 IN. WOOFER—15hz. Res, excellent construction, butal suspension—excellent in acoustic suspension/transmission line cabinets. Foam Grills custom cut to size. Special midrange domes. 212-462-0984

IMF STUDIO 3B speakers. Excellent condition. 6 months old — \$700. Tony Pariso, 273 S. Roycroft, Cheektowaga, New York 14225.

CURRENT AND RECOMMENDED:

SUPEX SMM5 moving magnet cartridge. Not the best but exceptionally smooth. Nothing can touch it for \$50.

GRACE 940 oil damped, uni-pivot tone arm. \$149.

LUX 1500 stereo receiver. 75 per channel @ 8 ohms, less than .05 THD 20-20000, capture ratio 1.3. We bother to import it because we think it is the best. \$800.

FIDELITY RESEARCH cartridge and transformer. The best moving coil yet. Highly regarded even by resident Decca freak. Great depth of image and detail. Also variety of preamps. Cart. \$130, Torodial transformer \$150.

GALE speaker. Very accurate British bookshelf. \$385. each.

CAMBRIDGE AUDIO P70 and **P140** integrated amplifiers with toroidal power supply and state of art preamp. \$350 and \$550. Also TL100 and TL200 transmission line speakers. \$400 and \$500 each.

DECCA BRUSH. Over a million conductive bristles eliminate need for liquids and reduce static. \$15.

DECCA CLEAN-UP. The ultimate dust bug. Same bristles as brush, conductive shaft and grand wire. \$15.

also: **GAS Ampzilla**, Dayton Wright, C/M Labs, Lux, Radford, Yamaha, Sony, BGW, Audionics, Revox, FMI 80, Celestion, ADS, IMF, Transcripitors, Technics, Fons, Connoisseur, Dual 601, 901, Decca Export, Ortofon, ADC, Sennheiser, Beyer.

Shipped free anywhere in U.S. and Canada.

GREENWOOD SOUND, INC.

5331 S.W. Macadam

Portland, Ore. 97201

503-224-1776

the Water Tower at John's Landing

FOR SALE

RTR 400E electrostatic speaker system. Brand new in factory sealed cartons! \$210 each. SAE Mark IVCM power amp. 100 watts/channel with output meters. \$395. (516) 799-0611.

CASSETTE LABELS: Custom-Blank. CASSETTE BOXES. TARZAC, 638 Muskogee Avenue, Norfolk, Virginia 23509.

DDN'T PAY THE HIGH MAIL ORDER PRICES. THIEVES WAREHOUSE OF BETHESDA, P.O. BOX 34251, WEST BETHESDA, MD. 20034.

DON'T PAY THE HIGH MAIL ORDER PRICES. THIEVES WAREHOUSE OF MOBILE, 1770 BELTLINE HIGHWAY, MOBILE, ALABAMA 36609.

TANBERG 9200XD Dolbyized, 3-speeds. Brand new, original carton and warranty. Lists for \$1000. Equipment reviewer used only for testing. Sell for \$600. Box A58-2, Audio.

SOUND ADVICE MAGAZINE — Our referenced amplifier is better than yours! We compare every amplifier tested against a piece of straight wire, and analyze in detail how it sounds different. We also A-B amplifiers with blind listening panels, using original master tapes. Square waves are photographed, clipping checked and bass described. Our first issue compared amplifiers from Accuphase, Ampzilla, Audio Research, Bozak, Crown, Dynaco, Epicure, ESS, Harmon Kardon (12 and 16) Infinity (Class D), McIntosh (2300), Paoli, Phase Linear, Quatre, Quintessence, Sony (V-FET), and Yamaha (FET). 17 Cartridges were also reviewed: ADC(XLM-II and Super XLM-II), B&O, Decca (V and export), Denon (DL103 and DL107), Fidelity Research, Grace, Micro-Acoustics, Ortofon, Satin, Stax, Supex (900, 901 and 900 prototype) and Win Lab. In addition to frequency and square wave response, we described how each sounded in six crucial characteristics. There's much more — 4 issues for \$9.00 (\$12.50 foreign). SOUND ADVICE, 225 Kearny, No. 202C, San Francisco, California 94108.

SHOT-GLASS GLASCONE LOUDSPEAKERS. Transcriptors turntables. Mark Levinson electronics. Leak English tubed FM-Tuners. C/M Laboratories electronics/speakers. Burwen noise reducers. Jensen Fives speakers, mint, \$290 pair. Beam-Echo mono tubed English amplifier, new \$195. Wharfdale WS-2 speakers, VG, \$83 pair. Sony TC-350 tapedeck, mint, \$155. Sheffield recordings. Pair Hartley 210 MSG speakers, pristine, \$235. SAE MK-IVB demo amplifier, \$250. Trades accepted. **WANTED:** Marantz, McIntosh, Futterman tubed equipment. Audiocraft, South Rockwood, Michigan 48179. (313) 379-9945.

AN IMPORTANT ANNOUNCEMENT

Parnassus Audio is now producing a **full Class A** (not AB) stereo power amplifier capable of relatively high output power.

The amplifier additionally satisfies the theoretical criteria for completely eliminating transient intermodulation distortion.

The difference in sound quality between this amplifier and conventional amplifiers is easily audible, even to the inexperienced.

We welcome requests for a descriptive brochure.

Dealerships will be limited.

Address all inquiries to: **PARNASSUS AUDIO, 2918 Harper Street, Berkeley, California.**

SERVICES

HIGH FIDELITY SPEAKERS REPAIRED
AMPRITE SPEAKERS SERVICE
655 Sixth Avenue, New York, N.Y. 10010
212-CH3-4812

TAPE RECORDER HEADS brought back to spec. Wear removed. Brilliant finish. \$10.00 each. One day service. E. Maher, 5 Evans Place, Orinda, Calif. 94563.

DON'T PAY the high mail order prices. Thieves Warehouse is coming to your area. Franchises available. Thieves Warehouse, P.O. Box 8057, Pensacola, Florida 32505.

NASHVILLE RECORD PRODUCTIONS WILL PRESS HIGH QUALITY PURE VINYL RECORDS FROM YOUR TAPES. SEND FOR SAMPLE RECORD AND PRICE LIST. ALSO FINEST DISC MASTERING. 469 Chestnut St., NASHVILLE TENNESSEE 37210.

SERVICES

CUSTOM RECORDING SERVICE. Tape and disc. Stereo and mono. Live and copies. Editing, Masters and pressings. High quality at reasonable rates. Joseph Giovannelli, Audio-Tech Laboratories, 2819 Newkirk Ave., Brooklyn, N.Y. IN 9-7134.

CUSTOM TAPE DUPLICATION 8 track and cassette. We specialize in small runs. CUSTOM AUDIO c/o Dick Walen, 4226 Robert St., Red Wing, Minn. 55066.

AUDIOPHILES! Your technical questions answered — reasonable rates. Sound Advisory Service, P.O. Box 34045, West Bethesda, Maryland 20034.

SERVICE FOR YOUR COMPONENTS. Having trouble getting satisfactory service on your equipment? Write for details on our guaranteed service. The Audiophile, 582 N. Frederick Ave., Gaithersburg, Md. 20760.

ULTIMATE DUPLICATION (10 up) from your program source to Maxell UD tapes & cassettes at amazingly low prices. DBX, Dolby available. Box 3065, Seattle, Washington 98114.

THE NEW YORK AUDIO SOCIETY INC. is a unique, non-profit, member supported hi-fi club featuring interesting monthly meetings about sound and the latest audio techniques. We invite all N.Y. area audiophiles to attend one of these sessions as our guest. Details about meetings and membership available. Write Box 5889 Grand Central P.O.; N.Y.C. 10017. Call 212-722-2781.

STEREO MASTERS, RECORDS AND ALBUMS. Check our prices. Newest type high level cutting equipment featuring: Neumann VMS 70 Computer control lathe, Parametric Equalization, Dolby, OBX, and the new SX74 Cutting System by Neumann. Special package prices on pure vinyl album and single record production. 1000 45 RPM stereo singles \$273.00 including mastering. 100 LP albums \$436.00 including printed jackets. Write or call for brochure. A & R Record Manufacturing Corp., 902 N. Industrial Blvd., Dallas, Texas 75207. (214) 741-2027.

Guaranteed repair of damaged or inoperative cassette tapes \$3.00. Kasette Clinic, Box 214844, Sacramento, Ca. 95821.

SONGWRITERS

Present your songs to publishers like professionals. By mail or in person, find out the correct way. Also find out where to get the right business contacts. Write for this valuable and informative booklet. Send \$3.00 to:

SUN SOUND

256 S. Robertson, Dept. 1558
Beverly Hills, Ca. 90211

SPEAKERS

MUSICAL SPEAKERS REPAIRED
ALTEC WARRANTY STATION
Hughes Electronics Service
45 Dunn St., Asheville, N.C. 28806

RECORDS

SHOW ALBUMS — Rare. Out of Print LP's. 52 page list 50c Broadway/Hollywood Recordings Georgetown, Conn. 06829.

OLDIES — 45 RPM Original hits. Catalog 50c C&S Record Sales. Box 197, Wampsville, N.Y. 13163

WHILE YOU WERE LOOKING for out-of-print records, you should've been looking for us. Discontinued, 216 N. Rose, Burbank, California 91505.

FILM-STAGE SOUNDTRACKS. Large free list. A. Lutsky, P.O. Box 835, Sequel, Calif. 95073.

CATALOGS. Broadcasts, soundtracks. Personalities of Thirties, Forties. Box 225, New York, N.Y. 10028

SOUNDTRACKS — JAZZ — POP. Vincent, Box 5202, Long Island City, N.Y. 11105.

FREE 200-PAGE CATALOG. 1,400 New Stereo Recordings. Renaissance, Baroque, Classical, Romantic, Modern Music. Not sold in stores. Not listed in Schwann's. Highest quality! Budget label prices! Available only by mail. MUSICAL HERITAGE SOCIETY, Box 932 AU, New York, N.Y. 10023.

RECORDS

SOUNDTRACKS/OC, JAZZ/PERSONALITY — FREE NEWSLETTER! RTSA, 3700 S. Plaza Drive, Bldg F/211, Santa Ana, California 92704.

QUADRAPHONIC RECORDS AND TAPES - World's largest selection - all labels, over 1000 titles - at discount prices! For your free illustrated quad catalog, write: SOUND CONCEPTS, 2713 West Radan, Dept. C8, Peoria, Illinois 61604.

CLASSICAL LPs bought — sold. Junker, 705 - 5th Ave., San Francisco, Ca. 94118.

100 STEREO LP'S Factory Fresh, all Major Labels, all Brand New, \$65.00 per 100.

SURPLUS RECORD & TAPES
P.O. BOX 496
LONE PINE, CALIF. 93545

PERFECTLY CLEAR™ ultra hi-fi record Burwen Laboratories BL-2. The East Bay City Jazz Band — Big Bear Stamp. Oriental Strut. Louis-i-an-i-a Blues My Naughty Sweeties Gives to Me. Dans Le rue d'Antibes, etc. \$10.50 each postpaid \$70.00 postpaid in lots of 10. Send check or money order Massachusetts residents add 3 sales tax Dealers wanted. Burwen Laboratories Inc. 209 Middlesex Turnpike, Burlington, Massachusetts 01803 617-273-1488.

JAZZ RECORDS Current, Rare, Out of Print. Free lists. DEPT. AU1, P.O. BOX 125, JAMAICA, N.Y. 11415.

SOLD @ AUCTION: COLLECTORS RECORDS, LP's, Jazz, Soundtracks, Personalities, O.C., Country/Western, Blues, Indicate list from: Ray Macknic, P.O. Box 7511, Van Nuys, Calif. 91406, U.S.A.

FREE — Giant 64 page auction Record Catalog. Songs & Records International, Box 863A, Burbank, CA 91503.

DUR UNIQUE SERVICE OFFERS YOU THE WIDEST AND MOST UNUSUAL SELECTION OF CLASSICAL RECORDINGS FROM THE FOUR CORNERS OF THE WORLD. SEND \$1.00 FOR SAMPLE MAILER. AUGUST ROJAS — CLASSICAL IMPORTS, 353-1/2 NORTH LA BREA AVENUE, LOS ANGELES, CALIFORNIA 90036.

EQUIPMENT WANTED

CASH FOR Mint Ips & prerecorded reel tapes. Records, Box 323, Hillburn, New York 10931.

MARANTZ 7C, 9: McIntosh C22. John Fong, 1238 Green St., San Francisco, Calif. 94109.

USED QUAD ELECTROSTATIC SPEAKERS wanted. Any condition. Describe units and state bottom price. Apt. 2202, 1360 Lake Shore Drive, Chicago, IL 60610.

WANTED — Jackson Audio Generator model 655. Robert Bezak, 303 Mapeat Lane, New Castle, Pa. 16101.

INFINITY 2000A — Best offer under \$350 pr. Boschen, 7 Ravine, Tenafly, N.J. 07670. (201) 567-2684, evenings.

JBL SE460 power amplifier. Mint only. C. Brello, Box 24354, Oakland, Calif. 94623.

WE MUST HAVE YOUR USED COMPONENTS

Premium Trade or Cash for:

McIntosh tube (pre) amps & tuners. Marantz tube (pre) amps 7 tuners. Marantz 7(T), 15, 16 (B), Futterman H-3, J.B.L. 400, 500, 600 series electronics, J.B.L. Hartsfield, L-101, Metrogon, Minigon, Music & Sound Ltd., 11 1/2 Old York Rd., Willow Grove, Pa. 19090. (215) 659-9251.

WANTED: NEW OR USED ALTEC Barcelona, JBL L101, Olympus, McIntosh C22, C28, Mr. Kazuhiko Murota, 1-67-203, Tsurumaihigashi, Nara City, Japan.

I WANT TO BUY any used CB equipment. Will pay up to 75% of original price. Call (213) 429-0746 collect, if necessary. Roberta Hanra, 2862 Heather, Long Beach, Calif. 90815. Or write to Audio Box A56-3.

WANTED - Pioneer SX-1010 & SA-9100; ESS-AMT series; Garrard Zero 100 SB or 100C; Sony & Tascam tape equipment; cartridges new or top condition only. Send specs, lists & prices to: Louis Sonier, 139 Dawes Road, Toronto, Ont. M4L 501.

EQUIPMENT WANTED

WANTED: RECORDING HEAD for KLH-41 Dolby open reel deck. New or near new perfect. KLH ignoring year old order. J.R. Cavanaugh, 4600 Lamont, San Diego. (714) 274-5074 (eve.).

ELECTRO-VOICE PATRICIAN IV complete 4-way speaker systems. State condition, price. Don Cohen, Box 6281, Omaha, Neb. 68106.

WANTED: STAX CAPACITOR Pickup model CPX. J.P. Sammut, 432 Chestnut Ave., San Bruno, Calif. 94066.

WANTED: JBL SG-520, SE-400S, SE-460. Mr. Kazuo Takishima, 33-7-1421, Takashima-Daira 2-chome, Itabashi-ku, Tokyo, 175 Japan

WANTED: Marantz 7C (tube), 9S (pair), model 500. K. Takishima, 33-7-1421, Takashima-Daira 2-chome, Itabashi-ku, Tokyo 175, Japan.

NAKAMICHI 700, used and in good condition, with 20dB makers. (312) 748-7837 after 6 P.M.

HERESY, CORNWALL JBL Klipschorn, Bose 901. Bruce Faulkner, 24 School Street, Keene, N.H.

TAPE RECORDINGS

RENT Open Reel or Cassette Pre-recorded tape. All labels. Catalog \$1.00. Tape & Time, P.O. Box 740, Hopkins, Minn. 55343.

EVERYTHING ON OPEN REEL! Pre-recorded classical/popular tapes. Latest releases. Dolby Quad, 96-page catalogue \$1. Barclay-Crocker, Room 857A, 11 Broadway, NYC 10004.

HAWAIIAN MUSIC on reel, cartridge, or cassette. Great for entertainment, or music collection. Send 25c for catalogue; refunded on order. Free gift included. Kamele O Hawaii, P.O. Box 1312, Kaneohe, Hawaii 96744.

AMBIPHON'S RECORDS AND TAPES — Quad and stereo. Highest quality available anywhere! Send stamped, addressed envelope to: Amphiphon Records, Dept. A, P.O. Box 341, Kingsbridge Station, Bronx, New York 10463.

SHORTWAVE

HEAR POLICE FIRE Dispatchers. Catalogs show receivers; exclusive directories of "confidential" channels. Send 10c stamp. Communications, Box 56AU, Commack, New York 11725.

HIGH FIDELITY

DYNAKITS, IAD, lowest prices, Underground HI-FI Sales, 324 Broadwater Road, Arnold, Md. 21012. (301) 647-0919.

NOW AVAILABLE... FAMOUS REFLECTING SYSTEM'S 4 1/2" REPLACEMENT DRIVERS, \$7.98 POSTPAID. BIG QUANTITY DISCOUNTS, FREE SPECIFICATIONS, AURATONE, BOX 580-22, DEL MAR, CALIFORNIA 92014.

TAPE & TAPE RECORDERS

SCOTCH RECORDING TAPE, lowest prices **TAPE CENTER** Box 4305B, Washington, D.C. 20012.

SCOTCH, CAPITOL. Blank cassettes, cartridges, reels. Discount prices. Lawson's, Box 510, Livermore, CA 94550

60 8 TRACK STEREO TAPES Factory Fresh, all Major Labels, All Brand New, \$100.00 per 60. 40 Cassettes Factory Fresh, all Major Labels, all Brand New, \$68.00 per 40.

SURPLUS RECORD & TAPES
P.O. BOX 496
LONG PINE, CALIF. 93545

SCOTCH AND MAXELL TAPE discounted. Write and save. N.A.B. Audio, Box 7, Ottawa, Ill. 61350.

COMPLETE Stock of 8 track tapes, pre-recorded and blank. New collection of classical recordings on 8 track tapes. Stereo equipment and accessories. Discount prices on all merchandise. Free Catalog. Victory Tape Sales, 2646 N.E. 189th Terrace, Miami, Fla. 33160.

AUTO ACCESSORIES

SANDBLASTERS - \$39.50-\$839.50. Free Catalog. Truman, 1330A Market, Youngstown, Ohio 44507.

RADIO PROGRAMS

1930-1962 RADIO PROGRAMS, Reels, \$1.00 hour! Cassettes, \$2.00 hour! Mammoth catalog \$1.25. AM TREASURES, Box 192M, Babylon, New York 11702.

RENT RADIO SHOWS - Make your own copies or just listen. Great way to build your collection reasonably. Catalog \$1 refundable. OTR Rental, Box 465, Livermore, Ca. 94550

YESTERDAY'S RADIO PROGRAMS ON TAPE. Reels, cassettes - fast reliable service. Catalog \$1.00 refundable with first order. ADVENTURES, 1301-A North Park Avenue, Inglewood, California 90302.

RENT OLD RADIO PROGRAMS as low as 50c per reel week.

YESTERYEAR RADIO
P.O. Radio
Lone Pine, Calif. 93545

OLD TIME RADIO PROGRAMS on cassette. Catalog \$1.00. MB/JB Enterprises, Box 724, Spencer, Iowa 51301.

OLD RADIO PROGRAMS on tape and cassette. Catalogues 50c. 30 minute sample tape with catalogue \$1.25. Satellite Broadcasting, Box 512, Miami, Florida 33165.

GOLDEN AGE RADIO—your best source for radio tapes. Box 25215-D, Portland, Oregon 97225.

OLD RADIO PROGRAMS ON TAPE. Thousands available. Low prices, finest quality, immediate service. Catalogue 25c. Nostalgic Radio, Box 29K, Peoria, Ill. 61601.

HELP WANTED

EMPLOYMENT INFORMATION — Electronic Technicians How to earn \$17,000-\$22,000 yearly, \$350-550 weekly. Not field service. Not overseas. No degree necessary. Work in U.S.A. Details \$3.00. WENDEL L. DANIELS, CONTRACT ENGINEERING, 8450 Anthony Wayne Ave., Cincinnati, Ohio 45216.

AGENT FOR U.S.A. wanted for our products: 3-way low coloration horn systems (also 2 & 4-way systems); world's only power amp with perfect square-wave response into capacitive load; battery powered pre-amp with world's lowest noise figures; and lots of other equipment with optimum transient response. Special Audio International, S-58221 Linkoping, Sweden. Tel. 013/113873.

INSTRUCTION & EDUCATION

DIGITAL ELECTRONICS! Design and understand Digital Circuits. Increase technical competence. Complete and guaranteed course is highly effective. \$10.00. Free literature. DYNASIGN, Box 60AM, Wayland, Mass. 01778.

EARN B.A. Theology. 1425 N. Rockwell, Oklahoma City, OK 73127.

UNIVERSITY DEGREES BY MAIL. Bachelors, Masters, Ph.D. Free Revealing details: Counseling, Box 1425-AM, Tustin, California 92680.

PROFESSIONAL HI-FI COURSE—Instructors include Len Feldman, Julian Hirsch, Larry Klein, and Larry Zide. Home study course also available. Send \$1.00 for audio primer and full information or visit HI-FI EXPD, 393 5th Ave., New York City 10016.

THE AUDIO WORKSHOP
Comprehensive practical training in SOUND RECORDING, PRODUCTION, and REINFORCEMENT. 16-track facilities for student projects. No prerequisites. Accommodations available. 50 Union Park, Boston, MA 02118 (617) 266-7561.

OHM'S LAW slide rule \$1. Norvex Co., 3920 Larkin, Norfolk, VA 23513.

AUTHORS, BOOKS

PUBLISH your book! Join our successful authors: All subjects invited. Send for free appraisal and detailed booklet. Carlton Press (Dept. VRT) 84 Fifth Avenue, New York 10011

PHOTOGRAPHY

PHOTO BUTTNS made from your photograph or any slogan, advertising, picture, etc. Only \$1.25 postpaid. Arcan Products, Rt. 1, Box 278, Waldorf, Md. 20601.

PROFESSIONAL TITLES — 16MM — Super-8 — 8MM — Slides, Catalog & Sample 35 cents — Art & Film Graphics, Box 17598, San Diego, Calif. 92117.

PLANS & KITS

TELEPHONE BUGGEO? Don't be Watergated! Counter-measures brochure \$1.00. **NEG-EYE LABORATORIES**, Box 547-AM, Pennsboro, WV 26415.

EM synthesizer concept-features universal compatibility, modular construction. For complete information send SASE or 25c to: **CFR ASSOCIATES**, POB F, Newton, NH 03858

MUSICAL INSTRUMENTS

UP TO 60% DISCOUNT. Name brand instruments. Catalog. Freeport Music, 455R Route 110, Melville, N.Y. 11746.

40% DISCOUNTS. Huge Stock of Name Brand Instruments. Free Catalog. Gracin's 110 Dept. A, 606 Route 110, Huntington, N.Y. 11746.

BUSINESS OPPORTUNITIES

500/THOUSAND, stuffing envelopes. Free supplies. Plus a list of 50 firms wanting homeworkers, addressers and mailers. Send self-addressed envelope to: Kevin Heinrich, P.O. Box 122, Hayes Center, Neb. 69032.

BOOKS

FREE LIST OF LOW COST POPULAR BOOKS. SUCCESS, HAPPINESS, PERSONALITY, wealth, personal problems. Capital Products, Box 1119, Dept. F, Langley Park, MD. 20787.

BOOKS...FREE CATALOG...Books that are exciting, unique, and very unusual, such as self-improvement, sex, moneymaking, sports, witchcraft, astrology, numerology, hypnosis, and many, many more. Write Plaquemines Distributors, Dept. 5-AA, Rt. 2, Box 304, Port Sulphur, La. 70083.

AUDIO DEALER PRODUCTS

AT LAST! DEPENDABLE, LOW COST Component Switching Devices for A-B comparison of speakers, amplifiers, and tape decks. Write for information and prices to — B.A. Kunz Electronic Equipment, 12111 La Padera, St. Louis, Mo. 63033.

SITUATION WANTED

YOUNG MAN — high school and Recording Institute of America graduate, seeking job training in the Audio and Recording field. Mike Dooley, 14338 Lyons, Livonia, Michigan 48154. (313) 427-7835.

FORMER DJ would like to return to radio in a similar position or as a Program Director. I have a third class broadcast endorsed license, 2 years college, 2 years experience. Contact: Doug Gallier, 3907 Angol Place, Jacksonville, Florida 32210. (904) 771-7386.

EXPERIENCED AUDIOPHILE AVAILABLE! Young, hard-working individual seeks employment with Audio firm. Degrees, electrical engineering technology. Much experience retail and merchandising. Reply Box A58-3 c/o Audio.

"The Sony TC-756 set new records



TC-756-2 Stereo Deck also features 15 and 7½ ips tape speeds; Ferrite & Ferrite 2-track/2-channel stereo three-head configuration; symphase recording that allows you to record FM matrix or SQ[™] 4-channel sources for playback through a decoder-equipped 4-channel amplifier with virtually non-existent phase differences between channels. Also available, **TC-756** with quarter-track/2-channel stereo head configuration.

for performance of home tape decks!"

(Stereo Review, February, 1975)

Hirsch-Houck Laboratories further noted, "The dynamic range, distortion, flutter and frequency-response performance are so far beyond the limitations of conventional program material that its virtues can hardly be appreciated."

The frequency response of the TC-756-2 is rated at 30 to 30K \pm 3 dB at 15 ips. Hirsch-Houck Laboratories said, "Although no claims are made for the TC-756-2 in this regard, it is the first machine we have seen whose frequency response should allow it to copy CD-4 discs in their encoded form."

The Sony TC-756-2 is representative of the prestigious Sony 700 Series — the five best three-motor 10½-inch reel home tape decks that Sony has ever engineered.

Like the TC-756-2, all feature a **closed loop dual capstan tape drive system** that reduces wow and flutter to a minimum of 0.03%; **logic controlled transport functions** that permit the feather-touch control buttons to be operated in any sequence, at any time without spill-

ing or damaging tape; an **AC servo control capstan motor** and an eight-pole induction motor for each of the two reels; a record equalization selector switch for maximum record and playback characteristics with either normal or special tapes; mic attenuators that eliminate distortion caused by overdriving the microphone pre-amplifier stage when using sensitive condenser mics; tape/source monitoring switches that allow instantaneous comparison of program source to the actual recording; a mechanical memory capability that allows the machine to turn itself on and off automatically for unattended recording; and a full two-year guarantee*.

In addition, each deck has its own versatile combination of built-in professional functions.

Sony engineers know that it's not one feature — but a combination of high performance features that makes a good unit great. Sony knows. Stereo Review knows. If you're a serious recordist, you'll want to know more about the Sony 700 Series.

SONY®

Brought to you by **SUPERSCOPE**



TC-755 Stereo Deck also offers the lowest price in the Sony 700 Series at \$699.95; Ferrite & Ferrite heads; symphase recording; 7½ and 3¾ ips tape speeds; tape path adjuster for even tape winding.



TC-758 Automatic Reverse Stereo Deck adds features like programmable auto reverse and bi-directional recording that allow up to 6 hours continuous record and playback time — longer than any Sony unit; roto-bilateral Ferrite & Ferrite heads that offer wider frequency response, better tape-to-head contact and less distortion than other magnetic heads; symphase recording; and 7½ and 3¾ ips tape speeds.



TC-788-4 Quadradial Deck features 4-channel record and playback; built-in PAN POTS that function as a built-in mixer; synchro-trak that allows record heads to double as playback heads for perfectly synchronized multi-track (sound-with-sound) recording; mode selector switches that make it virtually impossible to erase master track while recording additional tracks; and 15 and 7½ ips tape speeds.

*Superscope, Inc. guarantees to the original registered owner that all parts will be free from operating defects for two years from purchase date. Product will be repaired or replaced free of charge in the sole discretion of Superscope, Inc., provided it was purchased in the U.S.A. from an authorized dealer. The serial number cannot be altered or removed. Product must be serviced by authorized Superscope repair technicians only. **CBS, Inc. © 1975 Superscope, Inc., 8150 Vineland Ave., Sun Valley, CA 91352. Prices and models subject to change without notice. Consult the Yellow Pages for your nearest Superscope dealer. Send for free catalog.

If you listen to the experts, you'll listen to our speakers.

Ask any audio expert what makes a speaker good. If he's *Stereo Review's* Technical Editor, Larry Klein, he'll tell you, "A speaker should have no character or sound quality of its own . . . a speaker should be neutral." Or ask Julian Hirsch: ". . . uncolored sound is the only kind of speaker response that gives the listener a good chance of hearing a balanced sound."

If you listen to the experts, you'll look for neutrality in speakers. That's why you should listen to the T-200, Technics' 2-way speaker system. Hirsch-Houck Labs did: ". . . highs were virtually perfect . . . response of the woofer was notably smooth . . . difficult to believe that the sound is coming from an inexpensive compact system." *Popular Science* rated the T-200 "excellent . . . good tonal balance . . . very clean, accurate sound."

The experts are even more impressed with the T-400, Technics' 4-way speaker system. *High Fidelity*: ". . . the sound produced is well

balanced . . . neutral and uncolored with very good internal separation on complex instrumental textures . . . easily one of the better non-compact speaker systems." Martin Clifford of *FM Guide*: "Having a pair of super-tweeters angled to disperse sound . . . means not worrying about the directionality of the highs . . . bass response was good and clean."

For the complete reviews and other technical information, write: Mr. Jack Bloom, Panasonic, 1 Panasonic Way, Secaucus, N.J. 07094.

Technics also offers you the T-300 and T-500. The reviews aren't in yet, but since they share the neutrality and other important characteristics of the T-200 and T-400, we expect the experts to be equally enthusiastic.

The concept is simple. The execution is precise. The performance is outstanding. The name is Technics.

FOR YOUR TECHNICS DEALER, CALL FREE 800 447-4700.
IN ILLINOIS, 800 322-4400.

Technics

by Panasonic

Check No. 37 on Reader Service Card

