

Heyser On
Polar Response

Audio

THE AUTHORITATIVE MAGAZINE ABOUT HIGH FIDELITY • MAY 1975

75c

47425

Special
Headphone
Issue



U0803760 0476 30725005P0101212
DON L HUNTER
2608 CENTRAL BLVD
EUGENE OR 97403

Beatrix

st of each is up to us.

professional 10½-inch tape reels. Its unique combination of bias and equalization switching controls give 12 different settings to optimize the performance of any tape on the market.

The RT-1050's 3-motor transport system is activated electronically by full logic, solid state circuitry, triggered by feather touch pushbutton controls. Its transport is completely jam- and spill-proof, permitting you to switch from Fast Forward to Fast Rewind, bypassing the Stop button.

The RT-1050 was specifically

designed for easy operation with a wide combination of professional features like extended linearity VU meters with adjustable sensitivity, mic/line mixing, pushbutton speed selection and reel tension adjustment buttons. There's also an exclusively designed pause control and independent control of left and right recording tracks.

The same 2-track recording system studios use for better signal-to-noise ratios and higher dynamic range is incorporated into the RT-1050. Yet it can be easily converted to 4-track use with an

optional plug-in head assembly. Everything considered it's the most versatile open-reel deck you can buy. Professionals prefer it for its studio-quality performance. Everyone appreciates its completely simple operation.

Pioneer open-reel and cassette decks are built with the same outstanding quality, precision and performance of all Pioneer stereo components. That's why, whichever you choose, you know it's completely professional and indisputably the finest value ever in a studio-quality tape deck.



PIONEER®

when you want something better

U.S. Pioneer Electronics Corp., 75 Oxford Drive, Moonachie, New Jersey 07074
West: 13300 S. Estrella, Los Angeles 90248/Midwest: 1500 Greenleaf, Elk Grove Village, Ill. 60007/Canada: S.H. Parker Co.

Giving you the best

High fidelity is important to us at Pioneer. It's all we do and it's all we care about. We are excited that cassette tape decks have reached a level of performance that meet the highest standards. We are excited because we know that it means more enjoyment for you from your high fidelity system. We also know that you can now get more versatility and more value out of your high fidelity system than ever before.

The great advances in cassette technology have had impact on the reel-to-reel tape deck concept as well. We believe that the era of the small, inexpensive 7-inch reel tape deck is past. Neither its convenience nor its performance make it a good value compared to the new cassette technology. And it is now possible for Pioneer to offer you a professional studio-quality 10½-inch reel deck at prices that compare favorably with what you might expect from old fashioned 7-inch reel units. In our judgment the old ideas must move aside for the new ideas. And Pioneer has some very intelligent new ideas in tape for you.

The convenience of cassette. The performance of open-reel.

The stereo cassette deck has become a "must" in complete high fidelity systems. Because of its convenience, price and performance, it has virtually replaced the once popular 7-inch open-reel deck. As Julian D. Hirsch, prominent audio reviewer put it, "The best cassette machines compare favorably with a good open-reel recorder in listening quality." Pioneer proves it with four top-performing models.



Stacks compatibly with other components.

Our new CT-7171, with built-in Dolby, is a deck with a difference. It's designed with all controls up front so you can stack other components on or under it. Even the illuminated cassette compartment is front loading, for easy access and visibility.

Performance features stack up, too. Bias and equalization switches provide optimum recording and playback for every type of cassette tape made. You'll produce distortion-free recordings consistently with two oversized, illuminated VU meters plus an instant-acting peak level indicator light. And for those unpredictable program source peaks, there's a selectable Level Limiter circuit. It's similar to the type used in professional recording studios to prevent "clipping" distortion.

Finding a desired program point in a recorded cassette is simple with our new CT-7171. A memory rewind switch,

working together with the 3-digit tape counter, plus an exclusive Skip button, lets you monitor audibly at accelerated speed to make precision cueing a breeze.

Automatic tape-end stop, dual concentric level controls, separate mic/line inputs, pause control, in addition to many other features, make the CT-7171 the recording studio that fits on a shelf.

Whether you choose the sophistication of the CT-7171 or Pioneer's CT-5151, CT-4141A or CT-3131A, which share many of its features, you're assured optimum performance and maximum value. One tradition that never changes at Pioneer.

Open-reel. A professional recording studio in your home.

Professionalism comes with all three studio-quality open-reel models. The RT-1020L (7½, 3¾ ips) is unequalled in 4-track units. With three motors and three heads, it has virtually every professional feature you'd want. Yet it's extremely simple to use. In addition to stereo record/playback, it also highlights 4-channel playback. The complete extent of its capabilities becomes apparent only after you've worked with it. Then you'll recognize the magnitude of Pioneer's accomplishment.

Our RT-1050 is a 2-track, 2-speed (15, 7½ ips) 3-head deck which, like all our open-reel models, can handle



12 Bias & Equalization settings optimize performance.



**Whether you use
a cassette or
open reel deck
is up to you.**



Pick The Open-Reel Deck Features You Need

| Model | RT-1050 | RT-1020H | RT-1020L |
|-------------------------------|----------------|-------------|-------------|
| Maximum Reel Size | 10½" | 10½" | 10½" |
| Speeds | 15 & 7½ ips | 15 & 7½ ips | 7½ & 3¾ ips |
| Number of Tracks | 2 (4 optional) | 4 | 4 |
| Wow & Flutter (at high speed) | 0.06% | 0.06% | 0.10% |
| Frequency Response (±3dB) | 30Hz-22kHz | 30Hz-22kHz | 40Hz-20kHz |
| Tape Bias Selection | 3 position | 3 position | 3 position |
| S/N Ratio | 57dB | 55dB | 55dB |
| Equalizer Selection | 4-Position | 2-Position | 2-Position |
| Mic/Line Mixing | yes | yes | yes |
| LED Peak Indicator | yes | no | no |
| Memory Recording | yes | yes | yes |
| VU Meter Scale Selection | yes | no | no |
| 4-Channel Playback | no | yes | yes |
| Motors | 3 | 3 | 3 |
| Price | \$699.95 | \$649.95 | \$649.95 |

Pick the Cassette Features You Need

| Model | CT-7171 | CT-5151 | CT-4141A | CT-3131A* |
|------------------------------|---------------|---------------|---------------|-----------------------------|
| Dolby Noise Reduction | yes | yes | yes | no |
| Tape Selection Bias & Equal. | Bias & Equal. | Bias & Equal. | Bias & Equal. | Equalization |
| Auto. Tape Stop | yes | yes | yes | yes |
| Memory Rewind | yes | yes | no | no |
| Pause Control | yes | yes | yes | yes |
| Freq. Response* | 30-16,000 Hz | 30-16,000 Hz | 30-15,000 Hz | 30-15,000 Hz (*Chrome Tape) |
| Peak Indicator | yes | yes | no | no |
| Level limiter | yes | yes | no | no |
| Skip cueing | yes | yes | yes | no |
| Signal/Noise (Dolby) | 58 dB | 58 dB | 58 dB | — |
| S/N (Less Dolby) | 48 dB | 48 dB | 48 dB | 47 dB |
| Tape Heads | Ferrite | Ferrite | Permalloy | Permalloy |
| Motor Type | DC Servo | DC Servo | DC Servo | DC Servo |
| Wow & Flutter (WRMS) | 0.10% | 0.12% | 0.13% | 0.13% |
| Price | \$369.95 | \$269.95 | \$239.95 | \$179.95 |

*not shown



Check No. 18 on Reader Service Card

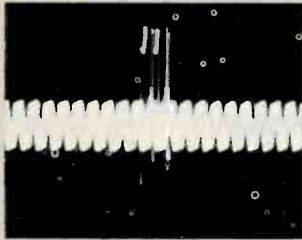

Actual, unretouched photo of an oscillograph test.

The oscillograph you see is an actual photo of a high-quality audio system "playing" a fingerprint.

You're hearing fingerprints now through your speaker system. Instead of the sound your precious discs are capable of. And no vacuum record cleaner, brush-arm or treated cloth will remove them. None.

The sound of your fingerprint

But Discwasher™—with new **du** fluid—removes fingerprints completely. Along with dust. And manufacturing lubricants (added to make pressing faster) that can act like groove-blocking fingerprints. All this cleaning without pulling polymer stabilizers from your vinyl discs.

Discwasher™. The only safe, effective way to silence the printed finger. At Audio specialists world wide.



Discwasher, Inc.
909 University,
Columbia, Mo. 65201

Audio

May, 1975

"Successor to **RADIO** Est. 1917"

Vol. 59, No. 5

Feature Articles

- 24 Dual Impedance Headphone Circuit/D.A. Kerr
- 28 Piezoelectric Principle in Headphones/Martin Clifford
- 30 Speaker Tests—Polar Response/Richard C. Heyser

Equipment Profiles

- 32 Scott R77S Receiver
- 36 Polk Model 9 Speaker System
- 42 Technics by Panasonic RS-676 Cassette Deck
- 46 Dynaco Stereo 400 Amplifier

Record Reviews

- 51 Canby's Capsules/Edward Tatnall Canby
- 57 Classical Reviews/Edward Tatnall Canby
- 59 Jazz & Blues
- 62 The Column/Fred DeVan

Audio in General

- 4 Audioclinic/Joseph Giovanelli
- 6 Tape Guide/Herman Burstein
- 12 Behind The Scenes/Bert Whyte
- 18 Dear Editor:
- 22 Editor's Review
- 52 Advertising Index
- 66 Classified Advertising

EDITOR Eugene Pitts III
ASSOCIATE EDITOR Edward Tatnall Canby
ASSOCIATE EDITOR Bert Whyte
ASSISTANT EDITOR Charles Graham

PUBLISHER Jay L. Butler
MARKETING DIRECTOR Sanford L. Cahn
DESIGN Janet Lee
CIRCULATION MANAGER Jean Davis

ADVERTISING PRODUCTION Peggy Bicknell

Contributing Editors: Herman Burstein, Martin Clifford, Fred De Van, Leonard Feldman, Martha Sanders Gilmore, Joseph Giovanelli, Richard C. Heyser, Bascom H. King, C.G. McProud, B.V. Pisha, Alexander Rosner, Donald M. Spoto, George W. Tillet.

AUDIO (title registered U.S. Pat. Off.) is published monthly by North American Publishing Co., Irvin J. Borowsky, President; Frank Nemeyer, and Jay L. Butler, Vice Presidents; R. Kenneth Baxter, Vice President/Production; Nate Rosenblatt, Promotion Director; Mary Claffey, Circulation Director.

RATES—United States only: 1 year for \$7.00, 2 years for \$12.00, 3 years for \$17.00; outside the U.S.: 1 year for \$9.00, 2 years for \$16.00, and 3 years for \$23.00. Printed in U.S.A. at Columbus, Ohio. All rights reserved. Entire contents copyrighted 1975 by North American Publishing Co. Second class postage paid at Philadelphia, Pa. and additional mailing office. Back issues, \$2.00 each. World Library Congress number: ISSN 0004-752X. Dewey Decimal number: 798.9.

REGIONAL SALES OFFICES: Jay L. Butler, Publisher and Sanford L. Cahn, Marketing Director, 41 East 42nd St., New York, N.Y. 10017, telephone (212) 687-8924.

Jay Martin, 2525 West 8th St., Los Angeles, California, 90057, telephone (213) 385-2917.

REPRESENTATIVES: Continental Europe: John Ashcraft, 12 Bear St., Leicester-Square, London W.C.2, telephone 930-0525. For Benelux and Germany: W.J.M. Saunders, Mgr., Herengracht 365. Amsterdam, Holland, telephone 24.09.08.

Japan: Japan Printing News Co., Ltd., No. 13.2 Chome Ginza Higasi, Chuo-ku, Tokyo, telephone 541-5795.

AUDIO Editorial and Publishing Offices, 134 N. 13th St., Philadelphia, Penna. 19107
Postmaster: Send Form 3579 to the above address



**BELT DRIVE ISN'T NEW.
 MULTIPLE PLAY ISN'T NEW.
 A TURNTABLE THAT COMBINES BOTH IS NEW.
 READ ALL ABOUT IT.**



Copyright 1974 B-I-C is a trademark of British Industries Co., Westbury, New York 11590. A division of Avnet Inc.

Back in monophonic times, turntable motors drove platters through a series of wheels called "idlers".

Many automatics and changers still use this system. In those days, records and playback systems were still relatively unsophisticated, so the distortions an idler drive system created didn't matter much.

Today, however, distortion is a critical problem. With recordings of increased dynamic range, wow, flutter and rumble must be reduced to inconsequential levels.

A belt-drive system is light years ahead of idler drive in that department.

And here the belt is driven by a unique motor found only in B-I-C turntables. It is a 300 RPM, 24-pole motor and it is inherently freer from noise and vibration than the 1800 RPM units with from 2 to 16 poles, which are standard in even the best of the conventional automatics.

The advantage of Programmed Multiple Play

The 980 and 960 are not record changers.

They are belt-drive Programmed Turntables which are engineered to play as many as 6 records at a time.

They have a 2-point record support system which is far less complicated and far more reliable than any umbrella spindle we've ever seen.

But an even more important advantage is this.

An automatic record handling system like the one on a B-I-C turntable can handle a single record, or 6 at a time, perfectly. No false drops. No bouncing and skating a diamond stylus across the grooves. It eliminates human error, and human error is what damages the sidewalls of your record grooves forever.

The simplicity factor

The 980 and 960 have the visibly lower profile of single-play manual instruments. They've been engineered to be simple machines, so they have fewer parts and fewer potential problems.

They abound in innovations. In the tone arm, the cartridge shell, the program panel, the entire system.

We can send you more detailed information if you write to Dept. 5A, British Industries Co., Westbury, L.I. 11590; or better yet, see them at your local audio specialist.



This is the 980 with solid state speed control and strobe. About \$200.* The 960 is identical except for these two features. About \$150.*

* Less base and cartridge.

Check No. 3 on Reader Service Card

**On
professional
performance.**



All too often, the use of the word professional is a self-serving device for conferring "excellence" on a mediocre product. And in the case of headphones, a half dozen examples come to mind.

But there is one headphone which, in the opinion of experts, is professional in every respect, the Beyer DT-48.

By whatever criteria headphones are measured...linearity, wide frequency response, low distortion, sensitivity, dynamic range...the DT-48 is clearly superior to all the rest.

As a matter of fact, the DT-48 has been designated by the German Bureau of Standards (PTB) as the preferred audiometric standard.

Oddly enough, we've never described the DT-48 as professional; we leave that to the experts.

Beyer DT-48 \$130

Beyer DT-48K with plug-in coiled cable \$140

**Another innovation
from Beyer Dynamic,
the microphone
people**

**Revox Corporation
155 Michael Drive
Syosset, N.Y. 11791**

Check No. 48 on Reader Service Card

Audioclinic

Joseph Giovanelli

More About Lightning

As a former distribution engineer for a power company in New England, I thought you'd like to hear about our experiences with the grounding of electric pole lightning arrestors.

If a ground rod is not driven into a really good ground, it is of little value. In fact, it can represent a real hazard. I have seen the results of a lightning stroke where the lightning hit the high-voltage line, followed the line to a lightning arrestor and then to the arrestor ground. This arrestor ground was a six-foot copper rod, about one and a quarter inches in diameter, driven into the ground at the foot of the utility pole, with a No. 4 weather wire connected from the arrestor to the ground rod with a ground clamp. When the ground rod was driven into a good ground, no trouble resulted from the stroke. When the ground was not a good ground, anything could happen. The pole could be damaged, the transformer could be burned out, or it could be blown right off the pole. Because of a poor ground, I have seen where lightning struck a pole, splintered it, and opened up the earth for as much as 100 feet, trying to find a good ground in which to dissipate.

Every spring we sent a team to check the lightning arrestors for leakage and to see how effective our driven ground rods were, especially in areas most susceptible to lightning strokes, such as high elevation, hilly, rocky, or open areas. We used a megohmmeter with a long wire to ground the meter to a known good ground and a quantity of rock salt.

We would disconnect the arrestor from the high-voltage line and check the resistance of the arrestor with the megohmmeter. It was supposed to test infinity. If not, we replaced it. The resistance of the arrestor ground would then be measured—from it to a good ground; either a water faucet tap of the lead sheath of a telephone cable.

Too many times we found the ground resistance also read infinity! When this occurred we dug a hole around the ground rod to a depth of

about three feet. Half a bucket of rock salt and a bucket of water was poured into the hole. Then we filled up the hole with dirt. After waiting a few minutes, a second resistance reading was taken, which in most cases turned out to be between 100 and 1,500 ohms.

Most of these grounds required this kind of treatment every Spring, and in southern states which are subjected to lightning storms most of the year, more frequent checks were required. Rock salt doesn't dissolve away quickly because it needs a fairly constant flow of water to eliminate it, and if plenty of water were present already, then we'd also have a good ground anyways.

Once we were testing an arrestor on a pole in an abandoned rock quarry. We found that the arrestor resistance had broken down. It should have read 2,300 volts relative to ground, and we read 550 volts between the two metal conduits driven into the ground at the foot of the pole (poor ground, and how!). A man who was watching us told us that after it had rained, any cat or dog walking up to the pole would pick its feet up very gingerly until it got too close to the pole, and then would leave the scene, immediately. Obviously it was feeling the voltage differential between its front and back feet increasingly as it neared the pole, first a tiny tingling, and later, a nice big voltage difference!

This man told us about one dog who had been visiting the pole pretty often for many months, but had never previously been there just after a rain-storm. He went quickly up to the pole, cocked up his leg, and then suddenly dashed off frantically, "kicking," over the hill into the distance. That dog was never seen anywhere around there, ever again!

We replaced the faulty lightning arrestor.—Guy Crooker, Portland, Maine.

If you have a problem or question on audio, write to Mr. Joseph Giovanelli, at AUDIO, 134 North Thirteenth Street, Philadelphia, Pa. 19107. All letters are answered. Please enclose a stamped, self-addressed envelope.

The impossible dream.

Since 1871 electrostatic speakers have been but a promise; today the Koss Model One has made them a reality.

Unlike most ads, this ad wasn't written for everybody. In truth, it was meant for a very small number of discerning audio enthusiasts who have dreamed an impossible dream about electrostatic speakers. And who have continually been disappointed.

For those who have dreamed the impossible, Koss has developed a full-range electrostatic speaker that reproduces the lowest to the highest octaves of music with an authority never achieved in previous electrostatic speakers. Once you've heard it, we think you'll agree. Until you do, let us tell you why.

First, the Koss Model One isn't another hybrid. The bandpass of 30 Hz to 250 Hz is reproduced by an electrostatic woofer that features over 19 sq. ft. of diaphragm surface area. No other speaker, electrostatic or dynamic, has ever reproduced the clarity and power of the lowest audible octaves like the Koss Model One. Impossible? Just listen to it.

Second, the Model One represents, to our knowledge, the first 4-way design ever offered in electrostatic speakers. This design approach has allowed Koss to offer the world's first electrostatic woofer capable of playing at concert hall levels. In addition, a unique midrange panel was designed specifically to avoid the bigger-than-life spacial distortion plaguing other large-panel speakers. In other words, a violin sounds like it is normal-size rather than as big as a



cello. The treble and tweeter panel designs were also critically matched to the wavelength requirements of their respective bandpasses. The resulting smoothness of response and uniform dispersion of energy from top to bottom establishes a new precedent in naturalness and clarity of reproduced sound.

Third, a major design breakthrough has been achieved in the Model One crossover system. And we think it's a uniquely patentable system. Instead of the expected plurality of additional coils, capacitors and resistors normally needed to achieve a 4-way crossover, the Model

One uses no other components than those needed to drive the separate acoustic panels. In other words, step-up transformers which provide the drive voltage to each of the four bandpasses also function as the crossovers. This unique transformer design eliminates the need for additional bulky, expensive, distortion-producing components that, until now, made a reasonably-priced but high performance full-range electrostatic system impossible.

Fourth, another innovative design feature of the Model One is the use of a frequency-sensitive attenuator that protects the speaker from unwanted sub-sonic signals below the 30 Hz level as well as potentially dangerous DC voltages from the amplifier.

And fifth, there's a patented Auto-Charge Bias Supply that eliminates the need for an AC cord. Imagine an electrostatic speaker system without the old "AC umbilical cord"! Or for that matter, without the obvious electrical dangers. If that isn't worth hearing, what is?

Your Audio Specialist will be happy to show you the fulfillment of the electrostatic promise. We don't think you'll be disappointed in what you hear. Nor in what you buy. But then, the Koss Model One isn't for everybody.

©Koss Corporation



the fulfillment of the electrostatic promise

KOSS® Model One electrostatic speaker

KOSS CORPORATION, 4129 N. Port Washington Ave., Milwaukee, Wisconsin 53212 • Koss International/London, Milan, Dublin, Paris, Frankfurt • Koss Limited/Ontario

Check No. 8 on Reader Service Card

www.americanradiohistory.com

Tape Guide

Herman Burstein

PLEASE GIMME MORE Open Letter To a Tape Deck Manufacturer

Dear Sir:

I have been a happy user of one of your top-flight tape decks (open-reel) for nearly a year. While it has most of the features I could wish for, some important ones are lacking. Since the price of your deck is in the high hundreds of dollars, it doesn't seem unreasonable to ask you to please fill the lack. Besides, I'm sure we are both interested in progress.

First, I must thank you for what you have already given me. Your deck is a triumph of mechanical, electronic, electro-magnetic, and human engineering. Frequency response at $7\frac{1}{2}$ and $3\frac{3}{4}$ ips provides a virtually perfect replica of the original sound, and frequency response is very serviceable for many needs at $1\frac{1}{8}$ ips. With a signal-to-noise ratio in the vicinity of 70 dB, the silence is indeed golden. Wow and flutter are imperceptible at any speed, and so is distortion at normal recording level. Tape handling is fast, accurate, and gentle. The deck is replete with features such as sound-on-sound, echo, mono, pause control, solenoid operation, record warning light, optional tape lifters, self-locking reel hubs, etc. At the same time the deck is simple to operate and foolproof.

What more, then, could I ask?

I ask that you enable me to cope with various brands and types of tapes, some old, some new, and some yet to appear. The variations in tape oxide formulations call for changes in bias, in treble boost during recording, and in the amount of audio current fed to the record head. Therefore, I ask you to include front panel controls which allow me to adjust

(Although this letter is addressed by one user to one manufacturer, it should be taken in a general spirit, speaking for many users and intended for all who make high-quality tape decks for home use.)

bias, treble boost in recording, and audio drive current.

You may legitimately object that these are not properly user controls; that there is too much danger the user will upset the delicately balanced operation of a high quality deck, which skillfully achieves an optimum compromise between the conflicting requirements for extended treble response, low distortion, and low noise; that a deck can give best performance with controls precisely set for a specific tape and accessible only to the competent person having the necessary knowledge, experience, and instruments.

Anticipating these objections, I would like to make the following specific requests.

1. Please give me a front-panel bias control, coupled with a switch that enables bias level to be read on the VU meter. Please designate a specific point on the VU meter, such as 50 on the lower scale, that corresponds to your recommended setting for the tape you recommend. This will let me vary the bias, yet return it accurately to its original level.
2. Please give me a front-panel control that lets me vary treble boost in recording, yet accurately return the boost to its original setting. I can think of at least two possibilities. The simpler would be a step control, which varies high frequency boost at, say, 15 kHz in steps of about 2 dB over an appropriate range. A more sophisticated approach would be as follows: provide a control that affords continuously variable treble boost; incorporate a high-frequency oscillator (say 10 to 15 kHz) and couple it with a switch so that the level of this test tone after treble boost can be read on the lower scale of the VU meter. Designate a specific point on the meter, such as 50 on the lower scale, which corresponds to your recommended setting for treble boost in recording.
3. Please give me a front-panel control that enables me to vary the amount of audio-drive current to the record head, yet accurately return it to the original setting. Again there are

at least two possibilities. One is a step control that, for a given VU meter reading, varies the audio-drive current in steps of about 2 dB over an appropriate range. A more sophisticated approach, similar to that suggested for the treble-boost control, would be as follows: provide a control that varies the drive signal continuously without affecting the VU-meter indication *during normal operation*; incorporate a mid-frequency oscillator (say 500 or 1,000 Hz) and couple this with a switch so that the level of the test tone can be read on the lower scale of the VU meter. Designate a specific point, such as 50 on the lower scale, which corresponds to your recommended setting of drive current. To illustrate, assume that the original setting of the audio-drive control causes the test tone to produce a reading of 50 on the lower scale of the VU meter. Now assume that I adjust the control to produce a reading of 60, which is about 2 dB higher. Thereafter, when recording, there would be 2 dB more drive signal supplied to the record head for a given reading of the VU meter.

To avert accidental disturbance of these three new controls and to discourage the consumer from fooling around with them, you might want to conceal them behind a hinged panel or recess them or make them operable only by screwdriver.

My earnest hope is that in the near future you will satisfy my requests for these front panel controls, though not necessarily in the exact manner I have suggested. Compared with the electro-mechanical marvels you have already accomplished, they should present no great technical problems. And, considering high quality tape decks as they already are, they would add little in the way of circuit complexity. When the day comes that my requests are met, not only will I be very thankful but, as should be no surprise to you, I will have a new list of requests. Such is progress.

Sincerely,

Herman Burstein

Introducing the 601. Dual's first medium-priced single-play turntable (fully automatic, of course.)

With the 601, Dual introduces its second fully automatic single-play turntable. Like the first, the electronic direct-drive 701, it shares several features with Dual's familiar multiple-play turntables, and offers a number of innovations as well.

The 601 drive system consists of an 8-pole synchronous motor, developed especially for this new model, and a precision-ground belt running directly from the drive shaft to a flywheel beneath the 12-inch dynamically-balanced platter. The motor's absolute speed constancy, its exceptional smoothness, and the isolation of the platter from the motor combine to reduce wow, flutter and rumble to an insignificant level.

The 601's 8 $\frac{3}{4}$ " tonearm is suspended in the same low-friction double gimbal as the more costly 701. Operation of the tonearm is optionally fully-automatic, manual, or continuous repeat.

Variable pitch-control is provided for both speeds, and an illuminated strobe is built into the chassis. The anti-skating system has separate calibrations for conical, elliptical and CD-4 styli.

The high level of performance and quality for which Dual turntables have been known for years is incorporated in the 601. Thus, music lovers who desire a single-play turntable in the medium-price range, with Dual precision and performance, now have it.



Dual

United Audio Products, 120 So. Columbus Ave., Mt. Vernon, N.Y. 10553
Exclusive U.S. Distribution Agency for Dual

Check No. 30 on Reader Service Card

www.americanradiohistory.com

Get inside digital electronics!

Bell & Howell Schools now offers you two fascinating learn-at-home programs that can equip you with professional know-how in the expanding field of digital technology!

The world of electronics is an astounding place—a world that, in the short span of 70 years, has taken us from a simple mechanical age into an age where electronic sophistication has actually helped man set foot on the lunar surface.

One area of this space-age technology that has been successfully harnessed for consumer and industrial use is digital electronics. It is this breakthrough that has given us such remarkable new products as tiny pocket calculators and digital-display wristwatches. And now, you can learn about some of the many extraordinary applications of digital electronics in two special learn-at-home programs from Bell & Howell Schools.

Start your exploration of electronics at home!

With these exciting home learning adventures from Bell & Howell Schools you'll experience the true thrill of discovery as did such electronic pioneers as Thomas Edison and Dr. Lee DeForest. And think about this... they didn't discover electronics in a classroom, and you don't have to either!

Whichever program you choose, test new electronic theories as you build and experiment with the exclusive Electro-Lab® electronics training system!

With your very first lesson you'll receive a special Lab Starter Kit, so you'll be able to see how basic electronic principles actually work in practice. Then, step by step, as your understanding of electronics increases, you'll actually be able to perform your own experiments and work on fascinating projects from "scratch"—like building the exclusive Electro-Lab® electronics training system. This important project helps you learn electronic skills through "hands on" experience with professional testing equipment. The Electro-Lab® system consists of a design console to help you learn how to hookup circuits—a digital multimeter for measuring electrical voltage, current and resistance. And a solid-state "triggered sweep" oscilloscope that, among other things, you'll use to analyze the operation of tiny integrated circuits. The "triggered sweep" feature locks in signals for easier reading.

I. HOME ENTERTAINMENT ELECTRONICS Learn how digital technology is being applied to home entertainment products—build and experiment with the new generation 25" diagonal color TV with digital features!

To learn the most advanced electronics technology you must work with up-to-date training tools. That's why



you'll build Bell & Howell Schools' 25" diagonal color TV with digital features as part of your training. Step by step you'll learn about the many exciting applications of the most up-to-the-minute electronics technology. And you'll have the confidence in knowing that the advanced skills you're learning will be valuable for years to come.

"Hands on" training will help you understand advanced applications of digital technology!

Your "hands on" training will give you a professional's understanding of how this advanced technology works. How features such as on-screen, digital display channel numbers and a digital time readout in hours, minutes and seconds are possible. You'll learn to program an automatic channel selector so that it skips over dead channels and "homes-in" on the channels of your choice.

And, how "state-of-the-art" integrated circuitry and the 100% solid-state chassis add immensely to your understanding of circuit theory and TV servicing techniques. You'll also become thoroughly familiar with the technology behind features such as digitally-automated tuning, and the outstanding color clarity of the Black Matrix picture tube.

By actually building and experimenting with this exceptional equipment, you'll gain the occupational skills, specialized knowledge—and the self-confidence that could open up exciting new directions for you!

II. DIGITAL INDUSTRIAL ELECTRONICS

Our exclusive digital trainer will help you discover today's exciting applications of digital electronics in industry.

Industry is constantly finding new applications for digital technology. Today, this technology is helping to set new standards of accuracy and providing a more precise method of control in refining, food processing, transportation and in manufacturing plants.

Now Bell & Howell Schools has a learn-at-home program that could get you involved in the industrial uses of this challenging technology. The program provides a solid background in basic electronic principles and the opportunity for you to experiment and learn with the Bell & Howell digital trainer. This remarkable piece of equipment lets you set up and examine a range of complex digital circuits like those in use in industry today. You will work with circuitry which has many of the numerical

and process control applications used in a number of today's most sophisticated manufacturing operations.

Bell & Howell Schools is with you every step of the way!

You'll be pleased to know that, throughout all of these dynamic Bell & Howell Schools' programs, you're just a toll-free phone call away from expert assistance should you need it.

For even more personal attention... Bell & Howell Schools has a truly unique idea—

You can attend in-person help sessions scheduled in over 50 major cities at various times throughout the year, where you can meet and talk with fellow students and receive additional assistance from an instructor.

Once you've completed this program, your skills in electronic troubleshooting could lead you in exciting new directions. While we cannot offer assurance of income opportunities you can use your training: to seek out a job in the electronics industry, to upgrade

your current job, or as a foundation for advanced programs in electronics.

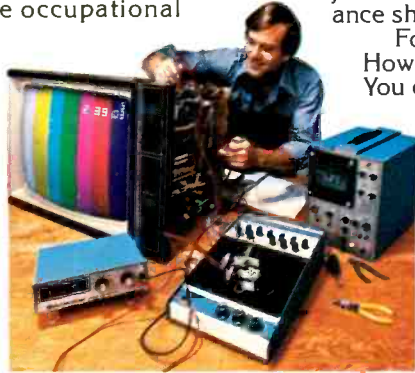

Now... audio/quadrasonics... first home program of its kind!

It's another first from a leader in home learning. Bell & Howell Schools proudly introduces America's first learn-at-home program in audio electronics featuring the exploration of quadrasonics. It's the 4-channel "wrap-around" sound system that has opened a new era in audio technology! You'll actually build Bell & Howell's 4-channel audio center including amplifier and FM-FM Stereo receiver as a part of the development of professional know-how in this exciting and promising new field. Get more details now... check the appropriate box on card and mail today!†

Why not aim yourself in an exciting new direction today—just check the Bell & Howell Schools' program you're interested in and...

Mail the postage-free card right away!

We'll see that you get more details! Taken for vocational purposes, these programs are approved by the state approval agency for Veterans' Benefits.

†Cabinet and speakers available at extra cost.

Simulated TV picture/test pattern.

"Electro-Lab®" is a registered trademark of the Bell & Howell Company.



If card has been removed, write:

An Electronics Home Study School
DEVRY INSTITUTE OF TECHNOLOGY



ONE OF THE
BELL & HOWELL SCHOOLS
4141 Belmont, Chicago, Illinois 60641

746R1

Behind The Scenes

Bert Whyte

AS ANYONE who reads this magazine is well aware, audiophilia is an insidious disease. Everything starts off quite innocently ... a fellow loves good music and is blissfully happy with his appliance store, Queen Anne radio/phono console. He happens to visit a friend who has acquired a thing called a hi-fi component system. The friend plays his favorite symphony, and our music lover is literally stunned by the high quality of the reproduction. Of course, he must forthwith obtain one of these miraculous hi-fi rigs; he thus condemns himself to a lifetime quest for sonic perfection. As the disease progresses and his audio equipment becomes increasingly sophisticated, his critical faculties are honed to razor sharpness. Finally, this hapless creature comes to realize that his hi-fi system has reached such a degree of perfection, that now he has become the slave of the software. Thus, like so many others before him, with fanatic zeal he embarks on the never-ending search for good program material.

Well, we are all in the same boat, and from the stories I have been hearing about poor record quality, and a worsening trend in this direction, we're in heavy seas, mate, and maybe shipping a little water! In the past several years the hi-fi press has been flooded with letters from irate music lovers condemning the poor quality of phonograph records they have purchased. Their protests cover the whole catalog of miseries which can afflict phono discs. They are incensed by the pops, clicks, swishes, frying and crackling, buzzes, hums, and intrusive low frequency noises which are not part of the program. They are frustrated by records unplayable because of saddle, pinch, or dish warpage. They are bugged by eccentric spindle holes, such records being known in the trade as "swingers." In addition to these gross and obvious defects, there are the more subtle problems of tracking and attendant electronic distortions, which we will

go into a little later on.

Needless to say, the letters from the victims of these discs are full of harrowing details of the travail they've been through trying to get playable copies of a particular recording, or to get some satisfaction from dealer or manufacturer. On a rough statistical basis, it would appear that these imperfect records are about evenly divided between pop and classical, and there is no particular bias between stereo records and the various quadraphonic formats. Nonetheless, because of the dynamics of classical recording, wherein pianissimo passages are common, thus more readily exposing noise problems, I would think the classical music fan is more frequently outraged, and more vocal about his record problems.

Almost invariably these letters of complaint castigate the products of practically every record company in the business. A growing trend seems to be that those who want the products of such companies as Deutsche Grammophon, Angel, and London/Decca are willing to pay up to several dollars premium per disc to get those which have been pressed in the country of origin. Some East and West coast dealers are specializing in this type of import. The rationale behind all this is the belief that the imported discs are heavier and thicker, therefore less prone to warpage, and that their surfaces are superior to records of these companies pressed in the United States. Whether these advantages of the imported discs really do exist is a moot point. London Records insists that their British and American pressings are identical. It is interesting to note that if you look in the pages of the British journals, *The Gramophone* and *Hi-Fi News and Record Review*, you will find the same irate letters from people condemning recordings purchased in London, manufactured by the very same DGG, EMI (Angel), Decca (London), HMV, etc.!

I have listened to domestic and for-

ign pressings of the same recording, and I have found them quite variable. Sometimes the foreign product was quieter, other times the US product was equally good. Still other times, both pressings were abominable. I must say, however, that on a statistical basis, the foreign pressings were consistently quieter and significantly better in the matter of warpage. I should mention that the records pressed by Philips of Holland were singled out for praise in the US and in England, and I certainly concur in this respect. I should also note that the AR speaker people recently issued a demonstration record which was pressed for AR, Inc. by the obscure Spanish company "Discos Ensayo." This has to be one of the most beautifully processed records I've ever encountered. I listened to an entire side without hearing a single pop or tick! Absolutely quiet, flawless surfaces. There was some very low level noise in several of the cuts, but it was obvious the noise was in the tape master, not the result of processing. This pressing along with those from Phillips, show that superb record quality can be achieved.

I must say a word in defense of our American companies, who under the stress of an entirely different economic situation, nevertheless produce some very quiet pressings. The premier product from Columbia, the discs from the WEA group, and the new CD-4 compound of RCA are generally quite good. Warpage is one of the major problems of American discs, with the new thinner discs really becoming contorted!

Okay, you say, we've heard all the horror stories. What is the problem? What is responsible for all these poor pressings? Don't the record companies care?

In a large sense, it's the story of the old American hustle and bustle, our huge mass market for recordings, and our mania for mass-production efficiency. I hardly need dwell on the many other products in America



We're not afraid to turn our back on you.

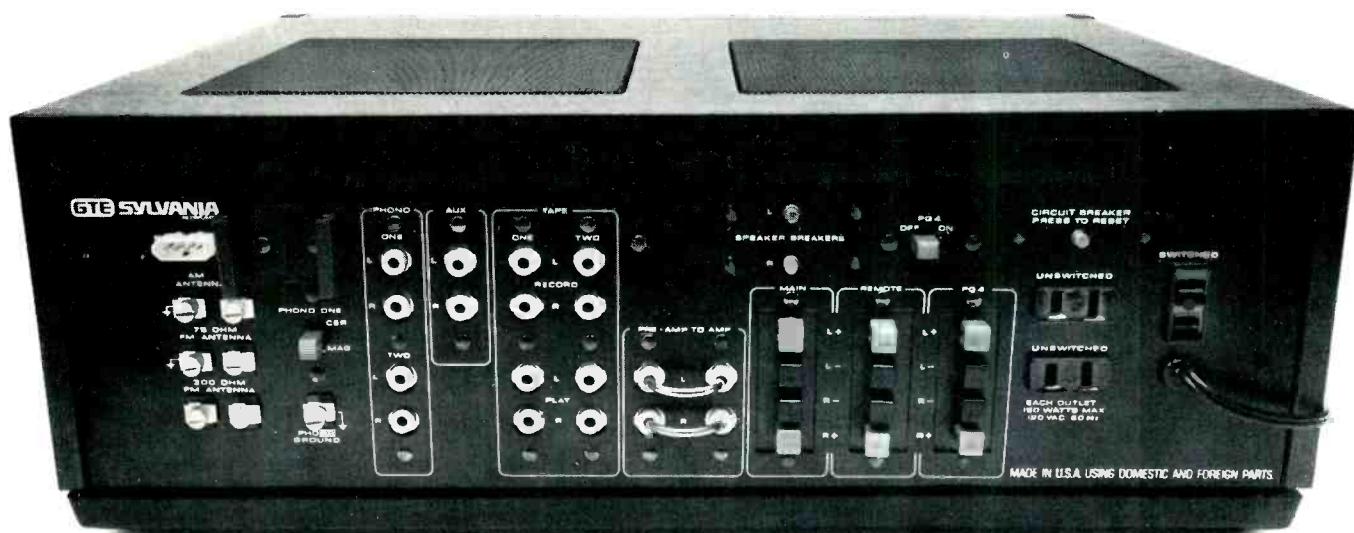

Introducing the RS 4744

We can afford to be very forward about our back.

Because the back of our RS 4744 stereo receiver is one of the most versatile you'll ever see. We've got phono inputs for two different turntables. And two sets of tape monitor input and output jacks. And terminals for main speakers, remote speakers, and PQ4 speakers. And three AC power outlets, one switched and two unswitched. The rest you can see for yourself in the picture above.

But what's behind our back is just as impressive as the back itself.

As *Popular Electronics** put it, the RS 4744 "met or surpassed all the published specifications we were able to test" and was



"...well above average in the important performance aspects."

Take power, for example. *Popular Electronics* found the RS 4744 "conservatively rated" at 60 watts per channel, min. RMS at 4 to 8 ohms from 20Hz to 20kHz with no more than .25% Total Harmonic Distortion. Which made it "outstanding for a receiver in the RS 4744's price range." FM 50 dB quieting sensitivity was equally impressive—"a very good $3\mu\text{v}$ in mono and $35\mu\text{v}$ in stereo."

But don't take our word for it. Or their word for it. Go see the RS 4744 for yourself.

Back or front, any way you look at it, the RS 4744 is one fine stereo receiver.

**Popular Electronics*, December 1974 Issue.

GTE SYLVANIA

Check No. 27 on Reader Service Card

The Quadriophile's

Features and specs, like money, aren't everything, but they can help a lot. Take a look at the comparison chart on the opposite page. You will find there many reasons why Sansui 4-channel technology is superior and why every Sansui 4-channel receiver is the best buy in its category. Of course, only a demonstration can really show you Sansui's ingenuity and what the famous Sansui sense of sound can do for you and your musical enjoyment. Only a Sansui 4-channel receiver with vario-matrix* can give you outstanding 4-channel separation, a clear sense of location and full musicality.

A Sansui 4-channel receiver can synthesize any of your favorite stereo records or tapes into fascinating quadraphonic sound. And they also contain the Sansui universal decoding system which permits decoding from any 4-channel source, including SQ and CD-4. Of course, the best way is to listen to 4-channel from 4-channel records or QS broadcasts.

Look carefully at the chart on the opposite page and then go to your nearest Sansui franchised dealer and listen to a demonstration. Prove to yourself what Sansui can do for you. Or write today for the brochure "What you should know about 4-Channel Sound."

* vario-matrix is the only 4-channel technology which offers highest interchannel separation, full frequency response, wide dynamic range, low distortion.

The Sansui QRX-3000



The Sansui QRX-3500



The Sansui QRX-6000



The Sansui QRX-7000



Sansui

SANSUI ELECTRONICS CORP.

Woodside, New York 11377

Gardena, California 90247

SANSUI ELECTRIC CO. LTD. Tokyo, Japan

SANSUI AUDIO EUROPE S.A. Antwerp, Belgium

ELECTRONIC DISTRIBUTORS (Canada) B.C.

Check No. 23 on Reader Service Card

Comparison Chart

Power Range: 9-15 Watts

| | | | | | | |
|----------------------------|-----------------------|------------|-----------------|----------------|---------------|-------------------|
| MANUFACTURER MODEL | SANSUI QRX-3000 | Fisher 334 | Kenwood KR-6340 | Pioneer QX-646 | Sony SQR-4750 | Technics SA-8000X |
| QS DECODING | Built-in VARIO-MATRIX | — | Simple RM | Simple RM | — | Adjustable RM |
| SQ DECODING | Built-in VARIO-MATRIX | Simple SQ | Simple SQ | Simple SQ | Full logic SQ | — |
| SYNTHESIZING SURROUND | Built-in VARIO-MATRIX | — | — | — | — | — |
| SYNTHESIZING HALL-AMBIENCE | Built-in VARIO-MATRIX | — | — | — | Simple Matrix | — |
| CD-4 DEMODULATING | Adaptor | Built-in | Adaptor | Built-in | Adaptor | Built-in |

Power Range: 16-24 Watts

| | | | | | | |
|----------------------------|-----------------------|---------------|--------------------|---------------|----------------|---------------|
| MANUFACTURER MODEL | SANSUI QRX-3500 | Fisher 534 | Harman Kardon 800+ | Marantz 4240 | Pioneer QX-747 | Sony SQR-6750 |
| QS DECODING | Built-in VARIO-MATRIX | — | Simple RM | Adjustable RM | Simple RM | — |
| SQ DECODING | Built-in VARIO-MATRIX | Full Logic SQ | Simple SQ | — | Simple SQ | Full Logic SQ |
| SYNTHESIZING SURROUND | Built-in VARIO-MATRIX | — | — | — | — | — |
| SYNTHESIZING HALL-AMBIENCE | Built-in VARIO-MATRIX | Matrix | — | — | — | Simple Matrix |
| CD-4 DEMODULATING | Adaptor | Built-in | Built-in | Adaptor | Built-in | Adaptor |

Power Range: 25-34 Watts

| | | | | | | |
|----------------------------|-----------------------|--------------------|-----------------|---------------|---------------|---------------|
| MANUFACTURER MODEL | SANSUI QRX-6001 | Harman Kardon 900+ | Kenwood KR-8340 | Marantz 4270 | Sony SQR-8750 | Technics E500 |
| QS DECODING | Built-in VARIO-MATRIX | Simple RM | Simple RM | Adjustable RM | — | Simple RM |
| SQ DECODING | Built-in VARIO-MATRIX | Simple SQ | Simple SQ | — | Full Logic SQ | — |
| SYNTHESIZING SURROUND | Built-in VARIO-MATRIX | — | — | — | — | — |
| SYNTHESIZING HALL-AMBIENCE | Built-in VARIO-MATRIX | — | — | — | Simple Matrix | Simple Matrix |
| CD-4 DEMODULATING | Built-in | Built-in | Adaptor | Adaptor | Adaptor | Built-in |

Power Range: 35-45 Watts

| | | | | | | |
|----------------------------|-----------------------|---------------|-----------------|---------------|---------------|------------------|
| MANUFACTURER MODEL | SANSUI QRX-7001 | Fisher E34 | Kenwood KR-8840 | Marantz 4300 | Pioneer QX949 | Sylvania RQ-3747 |
| QS DECODING | Built-in VARIO-MATRIX | — | Simple RM | Adjustable RM | Simple RM | — |
| SQ DECODING | Built-in VARIO-MATRIX | Full Logic SQ | Full Logic SQ | — | Simple SQ | Simple SQ |
| SYNTHESIZING SURROUND | Built-in VARIO-MATRIX | — | — | — | — | — |
| SYNTHESIZING HALL-AMBIENCE | Built-in VARIO-MATRIX | Simple Matrix | — | — | — | — |
| CD-4 DEMODULATING | Built-in | Built-in | Built-in | Adaptor | Built-in | Adaptor |

tm
SQ — CBS Inc.

tm
CD-4 — JVC Inc.

tm
QS — Sansui Electric Co., Ltd.

which have undergone a gradual deterioration in quality, a sacrifice to higher output and more profits. The plain fact is that on the whole we process our pressings too rapidly. In our transfers from tape to the lacquer master, we have the precision lathes and the know-how, and we don't have to take our hats off to anybody. In this respect we are as well off or better than those in similar situations in other countries. However, the precious master lacquer is electroplated

too quickly at elevated voltages and temperatures, and the intervening steps and the subsequent metal are molded in the same fashion, too rapidly. This causes an excessive and quite rough build-up of metal crystals on the unmodulated back of the record, and by the time we get to the nickel stamper, it is necessary to grind off these deposits so the stamper can fit intimately with the die in the press. This causes tiny protuberances on the modulated surface, giving a sort of

"orange peel" appearance. This is known as mold grain, and if your speaker has good enough low frequency response, it will be heard as an annoying rumble-like sound. In the heating/cooling cycle of the pressing, here again the culprit that gives rise to many of the noises is the "hurry up" syndrome. In general, if a pressing is cycled in, for example, 40 seconds, rather than 50 or 60 seconds, the disc is usually noisier. Quite obviously the reasoning here is that with the slower cycle there is less production per day. Pinch or "edge" warp is the most common warpage defect in records, and it is caused by the operators of non-automated presses removing the disc from the press while it is still too warm, and placing it on the stacking spindle with their fingers.

Finally we come to the matter of the compound used for the pressing. Basically, of course, it is vinyl with the addition of plasticizers, lubricants like lead stearate, and anti-static chemicals such as Catenac. The formulas vary but slightly from company to company. The use of a somewhat gritty filler was once fairly common, especially among the smaller companies, but this is rare now. There occurred until recently a shortage of vinyl because of the oil crisis, and this resulted in the use of some recycled vinyl. It is said that as much as 30 or 40 percent was used in some pressings. Since recycled vinyl is chopped up old records, paper labels and all, even with careful filtration some particulate matter was bound to pass through and, needless to say, caused noise.

What can be done about poor pressing quality? Isn't the consumer entitled to a high quality record at today's high prices. Sure enough, but with the attitudes prevailing in this country, and our entrenched industries, change for the better is probably wishful thinking. Which is not to say that under certain circumstances, the record industry wouldn't be responsive to pleas for upgrading of pressing quality. The circumstances? Simple, friend. As with the imported discs, offer to pay the record companies a premium for a special high quality pressing. There is even a precedent for this, when many years ago Westminster Records issued their special "Lab Series" recordings for a dollar more than the standard product. Call me a fink, and cast aspersions upon my head, but I honestly don't see any improvements happening in any other way. You've spent a lot of money on super-sensitive, high quality audio equipment. If you don't feed in the best source, it won't give you back in kind!

THE SECRET OF STR's SOUND SUCCESS FOR THOSE WHO ARE ABLE TO UNDERSTAND IT

STR uses three distinctly different approaches to produce the accurate sound of the Omega II. We take full advantage of our pioneering efforts with piezoelectric tweeters to make our totally accurate and phenomenally transparent high end. We do this by using a piezoelectric tweeter in conjunction with a one inch dome tweeter, the Omega II produces widely dispersed, high frequency response extending to well beyond 20 KHz. Our midrange is sealed in an acoustic suspension enclosure for vibrant forthright response. Our 8" midrange is both efficient and accurate and can handle as much power as one would care to put in. Two 12" woofers are mounted in the Omega II's dual slot radiator bass enclosure to provide bass response to below 30 Hz accurately for those heart-stopping passages you only thought you couldn't hear. So when you want to spend \$1,000.00 on a pair of speakers why not get three speaker systems of incomparable quality for the price of one speaker of conventional sound.

STR sound quality is available from only the most discriminating audio dealers.

For further information please contact:

S.T.R. INC.
3000 Orange Grove Avenue
North Highlands, CA 95660
(916) 488-6801

In Canada contact:

UNIVERSAL RESEARCH CORP.
13336 134th Street
Edmonton Alberta, Canada
(403) 454-1003



IS THE OMEGA II REALLY 3 DIFFERENT SPEAKER SYSTEMS?

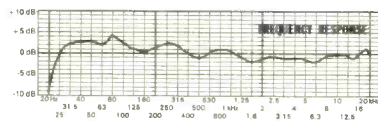

- DRIVERS:** Two 12 inch woofers with control
One 8 inch midrange with control
One 3/4 inch dome tweeter with control
One Piezoelectric tweeter with control
- SIZE:** Height 31 3/4 inches
Depth 15 3/4 inches
Width 31 3/4 inches
- FINISH:** Hand finished satin walnut with black grille cloth.
- WEIGHT:** 150 pounds
- EFFICIENCY:** Output level is 93 dB at 1 meter on axis with 1 watt RMS driving power at 100 Hz.
- CROSSOVER FREQUENCIES:**
100 Hz and 3,000 Hz.
- RECOMMENDED AMPLIFIER POWER LIMITS:**
Minimum 20 Watts RMS/ch
Maximum 250 Watts RMS/ch
- PROTECTION:**
2 fast blow fuse, 5 amp woofer, 1.5 amp midrange.
- BASIC DESIGN:**
Two side by side but separate infinite baffle enclosures with bottom facing woofers firing simultaneously into a common cavity.
- CONNECTORS:**
5-way binding posts for Bi-Amp or Tri-Amp inputs. Quick connect push terminal for normal input.
- WARRANTY:** Lifetime to original owner to specification.

Check No. 26 on Reader Service Card

ADC LOW MASS CARTRIDGES

With the patented feather-light stylus that traces record grooves with a higher degree of accuracy.



The patented low-mass design assures lower distortion and greater tracing accuracy.

The cartridge is the least expensive but one of the most critical components in a hi-fi system. Its stylus is the only contact with the complicated modulation of the record groove. To extract every note without distortion, especially at the high frequencies of the audible spectrum, is the problem.



ADC—Super XLM CD-4 Cartridge

Sensitivity:
2.0 mv./5.5 cms./sec.
Tracking Force:
¾ to 1½ grams
Frequency Response:
10 Hz to 50 KHz ± 5 dB
10 Hz to 20 KHz ± 2 dB
Channel Separation:
28 dB
Stylus Tip:
Shibata Type
.0002" x .002"

ADC—XLM Stereo Cartridge

Sensitivity:
3.5 mv./5.5 cms./sec.
Tracking Force:
¾ to 1½ grams
Frequency Response:
10 Hz to 24 KHz ± 2 dB
Channel Separation:
28 dB
Stylus Tip:
.0003" x .0007" Elliptical

ADC—VLM Stereo Cartridge

Sensitivity:
3.5 mv./5.5 cms./sec.
Tracking Force:
¾ to 1½ grams
Frequency Response:
10 Hz to 20 KHz ± 2 dB
Channel Separation:
24 dB
Stylus Tip:
.0003" x .0007" Elliptical

Lower mass = higher accuracy.

Since the magnet itself in a moving magnet cartridge contributes significantly to its mass, ADC created and patented an "induced magnet" cartridge that reduces the mass in the moving system. This allows the stylus to track with a lower force resulting in superior tracing accuracy and low distortion.

You can actually hear the difference.

Ask your hi-fi dealer to demonstrate the comparison between an ADC cartridge and any other brand. There is an audible difference that can easily be distinguished.

A modestly priced ADC cartridge may be all you need to upgrade the sound of your entire hi-fi system—and there's a model compatible with every brand of manual turntable or record changer.

Send for a free detailed brochure of the complete line of ADC cartridges.

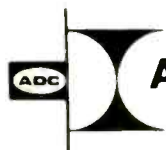

AUDIO DYNAMICS CORPORATION

A BSR Company • New Milford, Conn. 06776



In a class by itself.

The Phase Linear 400 Power Amplifier has only one serious competitor when it comes to advanced design, superior performance, made-one-at-a-time craftsmanship, proven reliability, elegant appearance . . . and incomparable value. And that's the Phase Linear 700B. Hear them both at your dealer soon.

Phase Linear 400

THE POWERFUL DIFFERENCE

201 watts per channel, min. RMS at 8 ohms from 20 Hz-20 kHz with no more than .25% total harmonic distortion.

PHASE LINEAR CORPORATION
20121 - 48th Avenue S.W.
Lynnwood, Washington 98036
Check No. 15 on Reader Service Card

Dear Editor:

ABOUT THAT V-FET AD . . .

To the Sony Corp.:

Congratulations to Sony on the development of your new V-FET output devices. This is the first time since the introduction of the bipolar transistor that a large company with your degree of influence has advocated a return to purist design philosophies. We feel that the whole industry will benefit from your new position.

Ever since the introduction of the bipolar transistor, we have been advocating purist design concepts, such as push-pulling, cross coupling and fully complementary stages, the use of amplification devices within their linear range, moderate amounts of negative feedback, etc.

While it can be claimed that FETs perform like vacuum tubes (everything else being equal), our research (dating back to 1955) indicates that although FETs are similar to vacuum tubes, each has certain desirable characteristics not duplicated by the other.

In fairness to the consumer, we should try to prevent gross oversimplifications such as "tube amps sound better" or "FET amps sound better." Just as with any complex system, an amplifier is more than the type of devices which are used. Even the bipolar transistor will approach linear operation under certain conditions. (However, designing a truly musical amplifier with bipolars is another matter.)

Perhaps now, with your influence, the concept that an amplifier can measure well under static conditions and yet sound unmusical can be successfully conveyed to the industry.

William Johnson
Audio Research Corp.
Minneapolis, Minn.

SONY REPLIES

Dear Sir:

With regard to William Johnson's letter to Sony, we say again, "Thanks Audio Research! We couldn't agree with you more." And, as the headline in our March ad in *Audio* stated, we expected someone of Mr. Johnson's

stature to be most interested and appreciative of our new V-FET technology. Audio Research's congratulations are most welcome and appreciated.

We do take small issue with Mr. Johnson where he seems to be cautioning Sony not to oversimplify the issue of V-Fets. Although he does not directly refer to our March ad in *Audio*, it is the only one he could question as it served to first introduce Sony's new series on V-FET amplifiers. Within the space limitations of the ad, we feel that we have properly described the performance characteristics of three different output devices: triode vacuum tube, bipolar transistor and vertical field effect transistor. And we have also presented what are, in Sony's opinion, the advantages and disadvantages of each. We encourage you to review our ad and decide for yourself whether we have oversimplified our message.

The great, better, best approach to advertising has always been unacceptable to Sony. We do, however, feel that our V-FET sound will become a new standard in sound reproduction. In fact, the following excerpt from our ad challenges you to go and hear what we've been hearing.

"At Sony, we've always maintained that, in the end, the best way to buy equipment is to hear it for yourself. So we're making what's probably the best offer you've ever heard. Have your dealer hook up our new V-FET equipment against *anything* made by *anybody*. If we sound sure of ourselves, we are.

And we're sure your own ears will tell you we've got the best sound you've ever heard."

Our conviction at Sony is that, in the final analysis, listening is the most valuable form of analysis. Your own ears will tell you what sound is musical or unmusical. If we sound confident in our new V-FET sound, we are. We believe in our products and we know to what standards they're made. We

(Continued on page 65)

READER INQUIRY CARD

May, 1975 This card expires July 31, 1975

CHECK BOX A or B beside each coupon number

- A to help me make an immediate decision to purchase
 B to explore a new method or to keep my files on the subject to date

1

| A | B | A | B | A | B | A | B | A | B | A | B | A | B | A | B | |
|----|---|----|---|----|---|----|---|----|---|----|---|-----|---|-----|---|-----|
| 1 | | 16 | | 31 | | 46 | | 61 | | 76 | | 91 | | 106 | | 121 |
| 2 | | 17 | | 32 | | 47 | | 62 | | 77 | | 92 | | 107 | | 122 |
| 3 | | 18 | | 33 | | 48 | | 63 | | 78 | | 93 | | 108 | | 123 |
| 4 | | 19 | | 34 | | 49 | | 64 | | 79 | | 94 | | 109 | | 124 |
| 5 | | 20 | | 35 | | 50 | | 65 | | 80 | | 95 | | 110 | | 125 |
| 6 | | 21 | | 36 | | 51 | | 66 | | 81 | | 96 | | 111 | | 126 |
| 7 | | 22 | | 37 | | 52 | | 67 | | 82 | | 97 | | 112 | | 127 |
| 8 | | 23 | | 38 | | 53 | | 68 | | 83 | | 98 | | 113 | | 128 |
| 9 | | 24 | | 39 | | 54 | | 69 | | 84 | | 99 | | 114 | | 129 |
| 10 | | 25 | | 40 | | 55 | | 70 | | 85 | | 100 | | 115 | | 130 |
| 11 | | 26 | | 41 | | 56 | | 71 | | 86 | | 101 | | 116 | | 131 |
| 12 | | 27 | | 42 | | 57 | | 72 | | 87 | | 102 | | 117 | | 132 |
| 13 | | 28 | | 43 | | 58 | | 73 | | 88 | | 103 | | 118 | | 133 |
| 14 | | 29 | | 44 | | 59 | | 74 | | 89 | | 104 | | 119 | | 134 |
| 15 | | 30 | | 45 | | 60 | | 75 | | 90 | | 105 | | 120 | | 135 |

Name _____

Address _____

City _____ State _____ Zip _____

Phone number (_____) _____

Are you a subscriber to AUDIO Magazine? Yes No

READER INTEREST INFORMATION:

- 1 High Fidelity Enthusiast
 2 Home Recordist
 3 Professional Recordist
 7 Other _____
- 4 Broadcast Engineer / Manager
 5 Audio Service Technician
 6 Audio Manufacturer or Dealer

I would like to see more Technical articles Articles for beginners
 Construction projects Articles on music
 Music reviews Classical Jazz Rock
 Other _____

I buy an average of _____ records a year Age _____

I have purchased the following equipment after seeing it advertised in AUDIO Magazine _____

I am planning to purchase the following equipment in the next year _____

Comments _____

SUBSCRIBE

Don't wait until your subscription runs out. Renew now and insure uninterrupted service. The remaining issues on your current subscription will be added. Postage will be paid.

Gentlemen: Please enter my subscription to **AUDIO**.

Name _____

Address _____

City _____ State _____ Zip _____

- New Subscription Payment Enclosed
 Renewal Bill me
 3 Years—\$17 2 Years—\$12 1 Year—\$7
 (Foreign—\$23) (Foreign—\$16) (Foreign—\$9)

You may pay for your subscription on your credit card.

Credit Card No. _____ American Express
 Diners Club

Card expires _____ Master Charge
 Bank No. _____

Signature _____

For office use

1

FIRST CLASS
Permit No. 22,489
Philadelphia, Pa.

BUSINESS REPLY MAIL

No Postage Necessary if Mailed in the United States

POSTAGE WILL BE PAID BY:

AUDIO

134 North Thirteenth St.
Philadelphia, Pa. 19107

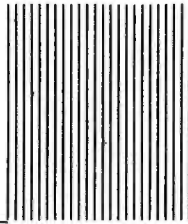

FIRST CLASS
Permit No. 22,489
Philadelphia, Pa.

BUSINESS REPLY MAIL—No Postage Necessary if Mailed in the United States

Postage will be paid by

Audio Magazine
P.O. Box 13892
Philadelphia, Pa. 19101

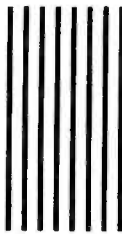

READER INQUIRY CARD

Fill in other side to get more information on advertised products

SUBSCRIPTION ORDER CARD Fill in other side to order a new subscription

AFTER YOU LOOK AT TEAC, LISTEN TO DOKORDER.



We're one of two major companies seriously and exclusively into the manufacture of high performance tape recorders. The smaller one.

When you work with a tape recorder the only thing that counts is how well it works with you, not the size of the company that made it.

For sure they sell more tape recorders than we do. But you're only interested in the one you buy. They spend more on advertising,

too. But you're buying a tape recorder, not an ad.

They have a sophisticated assembly line and so do we. Theirs is just longer. They have a big quality control department and ours is smaller. But only one man can check one machine at a time and it's the commitment to quality that matters.

They're continually working on new products...we are, too. And good ideas have nothing to do with size.

So if you compare specs, features and functions you'll find yourself comparing two excellent tape recorders. One of them, however, takes significantly fewer dollars to buy. Ours. And that's the difference.

You won't always find TEAC and DOKORDER at the same store; we're too much alike. Naturally they have more dealers, so you may have to look around a little.

But that's the only price you'll have to pay for paying a lower price.

TEAC 2340

| | |
|---------------------------------------|---------------------|
| Motors | 3 |
| Heads | 3 |
| 4-Channel Record and Playback | Yes |
| Built-in S-O-S/Echo | No |
| Overdub | Yes |
| Frequency Response at 7½ ips | ±3 dB, 40-18,000 Hz |
| S/N | 55 dB |
| Wow and Flutter at 7½ ips | 0.08% |
| Manufacturer's suggested retail price | \$739.50 |

DOKORDER 7140

| | |
|---------------------------------------|---------------------|
| Motors | 3 |
| Heads | 3 |
| 4-Channel Record and Playback | Yes |
| Built-in S-O-S/Echo | Yes |
| Overdub | Yes |
| Frequency Response at 7½ ips | ±3 dB, 30-23,000 Hz |
| S/N | 58 dB |
| Wow and Flutter at 7½ ips | 0.08% |
| Manufacturer's suggested retail price | \$629.95 |

Features and specifications as published by respective manufacturers in currently available literature.

DOKORDER

5430 Rosecrans Avenue, Lawndale, California 90260

7140



Check No. 6 on Reader Service Card

Editor's Review

WHO ARE the top ten high fidelity manufacturers in the United States? Take a minute and guess—before reading the rest of this editorial.

In a feature story in the January 29th edition of *Home Furnishings Daily*, H.W. Hutchinson says that half of the hi-fi industry's estimated \$750 million in sales during 1974 was accounted for by the ten leading organizations. And this is a down economy, with figures like those? Pretty startling, aren't they?

Okay, so who's on top? Most likely U.S. Pioneer, according to Hutchinson, since they had a reported volume of about \$80 million last year, a figure which the firm says is accurate. (All these figures are factory values.)

Marantz, says Hutchinson, is second with \$50 million, a total which doesn't include the firm's substantial export business or contributions from Sony tape equipment or Superscope brand products.

Fisher Radio is listed as third, with an estimated \$30 million in U.S. sales. Fisher, of course, does a large amount of OEM and private-label business in speakers; these figures are included in their total, though sales from the firm's modular stereo business are not.

TEAC was fourth, with an estimated \$29 million, a total which again did not include the firm's export business, the TASCAM pro line, or the recently introduced Kenonic Accuphase electronics. Significantly, as Hutchinson points out, TEAC's position was achieved without the wide product lines of the other leaders, as the firm concentrated almost exclusively on tape recorders until the introduction of the Kenonic line.

Kenwood was placed fifth, with \$26 million, while Sansui, at \$22 million, was sixth. These two are full-line firms.

At seventh, JBL was the second specialist firm (speakers) on the list, with estimated sales of \$21 million in the U.S. Hutchinson notes that JBL exports about 40 percent of its total production each year.

United Audio, specializing in Dual turntables (though it introduced a high-end cassette deck last year), was next with an estimated \$20 million. This figure was also the reported achievement of Shure Bros., which makes phono cartridges (principally). Some \$18 million was the reported total for JVC in the U.S., which excluded their TV, modular hi-fi, and portable radio business.

Well, there they are, the top ten of audio. I think those figures are pretty impressive, both individually and collectively. Congratulations, industry, on staying so strong in these tough times.

FTC Regulation . . . Next?

If you read what Brian Wachner and Bob Tucker had to say about the FTC power-output regulation (February) you probably were interested in what else they had to say on the subject last month (*Dear Editor*, April).

Perhaps too you'll be interested in a few of my thoughts on FTC regulation, such as they are. First of all, there are some practical aspects of the rule with which we editors and publishers have to deal. These are partially covered in my comment in the letters column, but it may be surprising to learn that this editor doesn't see most of the ads for a particular issue until it is in its final proof stage. Our publisher ordinarily will not see an ad until the magazine has been published.

While the basic intent of the power-output rule is laudable, it seems from this vantage point that the whole business opens the door for further action by government agencies. And if you thought there were strong discussions of the power-output rule in this and other magazines devoted to the "sport" of audio, think for a moment about what would happen if the FTC got into speakers. (Frankly, I almost hesitate to suggest such a thing in print for fear that the FTC will open that Pandora's box, but, no, I know of no plans by the FTC to do so.) I therefore suggest that the IHF, EIA, IEEE, AES, or somebody form a committee—of engineering folks, I hope—to draw up some reasonable standards for speaker measurement. While such standards ought, most properly, come from an industry organization, I am willing to act as a clearing house for suggestions and comments until an appropriate committee is set up. But we ought to get off the dime, to get active, instead of being put into a defensive, reactive position at some time in the future. We just might learn something about speakers in the process.

Ultima One

Okay, you win! I'll admit it; we pulled your leg four months early this year. The Ultima One, from Ultima Electronics, which graced the cover of our January issue, is not a real receiver. The "engineer," Karl Kofoed, really isn't an engineer at all but an artist-friend of *Audio*, and obviously his work is good since a lot of you thought that the Ultima One was a real receiver. So, yes, it was a hoax, but we had fun with it and something fun isn't bad in these all-too-serious times. We hope that you aren't mad at us for peering into the future to come up with the Ultima, and to those who are still mad at us, we apologize, quite sincerely. *E.P.*



Discover The Fourth Component!

**You have a receiver. You have a turntable.
You have your speakers. You think you have it made.**

Well, think again. Think about the cartridge, because your pick-up can make or break the performance of your audio system. It's the part too many stereo beginners forget. That important fourth part where the music begins.

You may not realize it, but your cartridge and its stylus has first contact with the music in the grooves of your records. But it doesn't just plod along round and round producing all that sound. It's actually vibrating along the sides of the grooves in an incredibly complex dance that represents all the music on the record. And all too quickly for your eye to see, but not for your ear to hear. Because if your cartridge is faulty, no amount of expensive equipment . . . speakers, turntable or receiver . . . will make up for the distortion it can produce.

That's why you need a cartridge you can depend on. One that's the best your money can buy. Specifically, a Pickering:

Because a Pickering cartridge has the superior ability to "move in the groove" . . . from side to side and up and down without shattering the sound of your music . . . on your records.

Because a Pickering cartridge possesses low frequency tracking ability and high frequency tracing ability (which Pickering calls *traceAbility™*). It picks up the highest highs and the lowest lows of musical tones to reveal the distinctive quality of each instrument.

Because only a Pickering cartridge can be individually and easily suited to your music system. Each is rated with a Dynamic Coupling Factor which tells the dealer immediately what kind of turntable or separate arm the pick-up needs whether your system is stereo or discrete quad.

Your stereo cartridge. It's the fourth part of your music system that's too important to forget. And so is a Pickering.

For further information see reader service card or write to Pickering & Co. Inc. Dept. A
101 Sunnyside Blvd., Plainview, N.Y. 11803

 **PICKERING**

"for those who can hear the difference"

Check No. 17 on Reader Service Card

DUAL IMPEDANCE HEADPHONE CIRCUIT

D. A. Kerr

MOST HEADSETS for use with modern music systems have a nominal impedance of 8 ohms, and most modern stereophonic amplifiers include circuitry to drive such headsets. But many high-quality headsets, such as those intended for professional use, have much higher nominal impedance, typically 600 ohms. The same is true of many representative high quality headsets, including the AKG (Philips) K-180 and Beyer (Revox) DT302 at 600 ohms, Telefunken TH-28 at 400 ohms, Koss Pro/4AA at 250 ohms, Lafayette F-600

and Ercona D-42 at 200 ohms, and Sennheiser HD414 at 2000 ohms.

The audiophile who has two or more headsets of different rated impedances may be at a loss to know how to accommodate them to his amplifier. Fortunately, a simple circuit modification may be easily made to most amplifiers to allow headsets of different impedances to be used interchangeably with comparable performance. No impedance selector switch is required, and the circuit delivers equal audio power to either headset assuming of course, that they are of comparable efficiencies.

Such an arrangement may at first seem paradoxical: if the circuit matches the impedance of one type of headset, it certainly cannot match the other. But impedance matching, in the conventional sense, is not used in the normal headset-driving circuit. The tiny amount of power required to drive a headset, typically less than one milliwatt, is many thousand times less than a power amplifier would deliver into a truly matched load.

This is because in modern audio power amplifiers the load (loudspeaker) is not matched to the internal impedance of the output stage. Typically the source impedance of the output stage is many times less than the rated load impedance. This produces presently accepted values of damping factor and, for modern amplifier circuits, is consistent with low-distortion operation.

Figure 1A shows a typical headset circuit, and Fig. 1B shows its essential technical features. Resistor R_0 in series with each headphone channel is chosen to provide an appropriately small amount of power to the headphone. It can even be thought of as providing an intentional mismatch

between amplifier and headphone. The impedance of the source feeding the headphone is essentially equal to R_0 , typically much greater than the impedance of the headphone load, Z_L .

Now consider our objective of delivering comparable amounts of power into two significantly different impedances. We will call the lower of these Z_L (perhaps 8 ohms) and the higher one Z_H (let us say 600 ohms). Imagine that the internal, or source, impedance (R_s) of the new headphone-driving circuit were a value between Z_L and Z_H . When the load is Z_L , there is a mismatch between the source and the load due to the fact that R_s is higher than Z_L . When the load is Z_H , there is a mismatch due to the fact that R_s is lower than Z_H . By properly choosing the value of R_s , these two mismatches may be made equal in magnitude, and thus the same power will be delivered to each headset.

This value of R_s is $\sqrt{Z_L Z_H}$, and is given in Table 1 for the most common combinations of Z_L and Z_H .

However, in most cases we cannot simply replace the R_0 resistors in the present headphone circuit with resistors of value R_s . This is because R_s is usually significantly smaller than the source impedance, R_0 . Hence the resulting power to either headset would be much greater than with the original circuit, requiring the amplifier to be operated at an unnaturally low volume level when headphones were in use.

In Fig. 2 we see a hypothetical circuit which solves this problem. The source impedance has indeed been made R_s , but step-down transformer T1 has been added to reduce the voltage supplied to the circuit to a value producing the same power into the headsets that would have been deli-

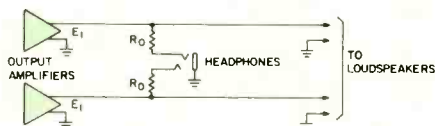

Fig. 1A—Typical circuit for driving stereo headphones.

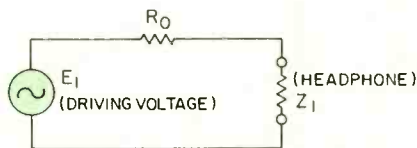

Fig. 1B—Equivalent circuit (one side only).

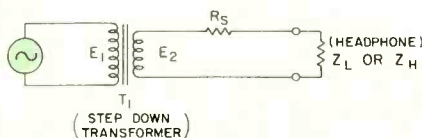

Fig. 2—Basic dual-impedance headphone circuit.

vered by the original (R_O) circuit into the headset impedance for which it was intended.

Fortunately, in most cases the transformer can be eliminated by the circuit of Fig. 3A. So far as the behavior of this circuit at the output terminals is concerned, it can be considered identical to the circuit of Fig. 3B. The equivalent source voltage of this second circuit, E_E , is the true driving voltage, E_1 , reduced by the voltage dividing action of R_1 and R_2 . The equivalent source impedance, R_E , is the value which would be obtained by connecting R_1 and R_2 in parallel.

Thus, by properly choosing the values of R_1 and R_2 , we can create a circuit which acts like the circuit of Fig. 2, the voltage-divider action exactly replacing the voltage step-down provided by the transformer, T1, and the equivalent source impedance (R_E) having the value desired, R_S . If R_S were larger than R_O transformer T1 would have been a step-up transformer, and no choice of R_1 and R_2 could be made which would allow the circuit of Fig. 3A to replace the circuit of Fig. 2. This situation rarely arises with conventional audio power amplifiers.

The equations for determining the values of R_1 and R_2 are given in the box.

Fortunately, for the impedance values, and values of R_O encountered in most applications of this circuit, we can use a compromise circuit which avoids replacing the original series resistor, R_O , with a new resistor, R_1 . We merely leave the present R_O resistor(s) in the circuit and add, in parallel with each, a resistance which we shall call R_P . By proper choice of R_P , the source impedance becomes Z_S , as originally desired, and equal power will be delivered to headsets of either impedance. Although this power level may be slightly different from that delivered by the original (unmodified) circuit, in most situations the difference will be far less than the differences in headset power level provided by different amplifiers, for example. And this circuit is easy to install, involving only addition of the two resistors R_P in parallel with the headphone connections.

Table 2 gives appropriate value of R_P for combinations of an 8 ohm headphone impedance and various higher impedances, as well as for various values of R_O originally present in the amplifier. For all combinations, the difference between the power level supplied by the new circuit and that supplied by the original circuit is less than 3 dB.

The values in Table 2 have been

rounded to the nearest Radio TV Manufacturers' Association value for 20% resistors. If the value of R_O desired is not in the table, use the nearest listed value. The power dissipated in the R_P resistors is very small, and 1/4 watt carbon resistors may be used. If space permits and since they are more easily available, 1/2 watt or larger resistors may be used.

In most modern amplifiers, the most convenient location for the added resistors is right at the jack. The common (ground) end of each resistor can be connected to the common (sleeve) terminal of the jack, with the other end of the two resistors going to the tip and ring terminals. Figure 4 shows the final circuit.

For those interested in applying

these circuits to situations not covered by the tables, the box gives the equations needed to calculate the various values.

It would often be desirable to provide dual-impedance headset operation for the monitor circuit of a tape recorder. However, if the present monitor circuit feeds directly from the line output of the recorder, or from a low-power headphone amplifier, then the circuit described by this article probably cannot be used. This is because such lower-power sources usually have low values R_O , and as previously mentioned the dual impedance circuit cannot handle the case where R_S is to be greater than R_O . Another way to characterize this limitation is that a low-power source can-

TABLE 1
 R_S values for equal power into various values of Z_L and Z_H (ohms)

| Z_L | Z_H | | | | R_S |
|-------|-------|-----|------|--------|-------|
| | 50 | 600 | 2000 | 10,000 | |
| 8 | 20 | 69 | 126 | 283 | } |
| 50 | — | 173 | 316 | 707 | |
| 600 | — | — | 1100 | 2,450 | |
| 2000 | — | — | — | 4,470 | |

TABLE 2—Load impedance, 8 and:

To determine values of R_P , which in parallel with present resistor R_O will produce equal power into various load combinations. (All values ohms)

| R_O | 50 | 600 | 2,000 | 10,000 |
|-------|----|-----|-------|--------|
| 150 | 22 | 120 | 820 | * |
| 180 | 22 | 120 | 390 | * |
| 220 | 22 | 100 | 330 | * |
| 270 | 22 | 100 | 220 | ** |
| 330 | 22 | 82 | 220 | 1,800 |
| 390 | 22 | 82 | 180 | 1,000 |
| 470 | 22 | 82 | 180 | 680 |
| 560 | 22 | 82 | 150 | 560 |
| 680 | 22 | 82 | 150 | 470 |
| 820 | 22 | 68 | 150 | 470 |

*Indicates unworkable combination.

**No added resistance required; use circuit as is.

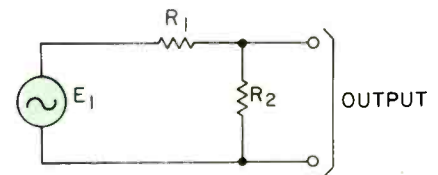
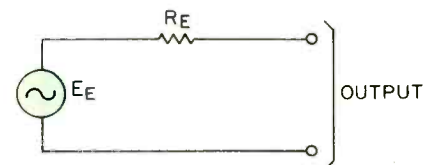

Fig. 3A—Voltage divider circuit.



$$E_E = E_1 \frac{R_2}{R_1 + R_2}$$

$$R_E = \frac{R_1 R_2}{R_1 + R_2}$$

(SAME AS R_1 AND R_2 IN PARALLEL)

Fig. 3B—Equivalent voltage divider circuit.

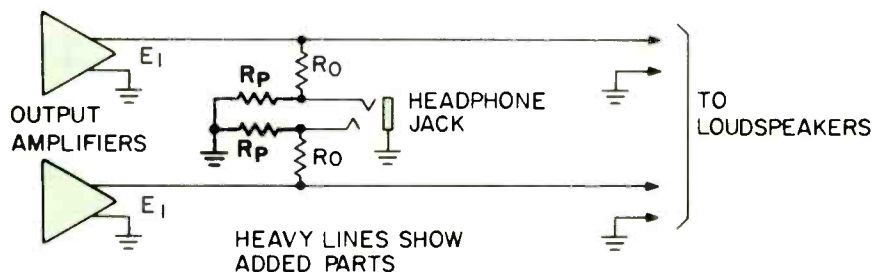

Fig. 4—Final dual-impedance headphone circuit.

THE PRO/AM TAPE



Introducing Maxell Ultra Dynamic backcoated/open reel tape.

A professional studio engineer doesn't have time for dropouts, wow, flutter, tape noise, static, poor winding, edge damage or erratic tape traction. Maxell Ultra Dynamic tape has the backcoating that eliminates these recording obstacles.

That's why the professionals use it. And why you should too.

While your Maxell UD tape is running (and the backcoating is protecting your music) you can concentrate on mike placement, sound levels and the more creative side of audio...like shushing the kids in the next room.

Maxell Corporation of America, Moonachie, New Jersey 07074. Also available in Canada.

maxell.

For professional recordings
at home.

Check No. 11 on Reader Service Card



not deliver adequate power to a headphone through the impedance mismatch upon which operation of the "dual impedance" circuit depends. If the headphone monitor circuit is driven from an internal loudspeaker amplifier, with series resistors, as in Fig. 1, then this dual-impedance circuit can be applied. 

Equations

To determine impedance, R_s needed to provide equal power into loads Z_L and Z_H (Ref. Fig. 2):

$$(1) \quad R_s = \sqrt{Z_L \cdot Z_H}$$

Series resistance, R_1 , and shunt resistance, R_2 , to give source impedance R_s and to deliver the same power to loads Z_L or Z_H as the original circuit (Fig. 1) would have delivered to load of impedance Z_L : (Ref. Fig. 3A)

$$(2A) \quad \text{Let } C = \frac{R_s + Z_L}{R_o + Z_L} \cdot \frac{Z_L}{Z_L}$$

$$(2B) \quad \text{Then } R_1 = \frac{R_s}{C}$$

$$(2C) \quad \text{And } R_2 = \frac{R_s}{1-C}$$

$$(3) \quad R_p = \frac{R_o R_s}{R_o - R_s}$$

Shunt resistance, R_p , to produce the desired source impedance R_s while keeping the series resistance at its initial value, R_o (Ref. Fig. 4).

The use of this approach produces equal power in loads Z_L and Z_H , but this power level is most generally different from that which would have been delivered by the original circuit to a load of Z_L . The shift in level from that of the original circuit is given by the equation:

$$(4) \quad \text{Level shift (in dB)} =$$

$$20 \log_{10} \left(\frac{R_s}{R_o} \cdot \frac{R_o + Z_L}{R_s + Z_L} \cdot \frac{Z_L}{Z_L} \right)$$

Negative values (i.e., quantity in parentheses less than 1) represent less power delivered by the new circuit than by the original. For ease in interpretation, the following table gives the values of the quantity in parentheses for various level shifts:

| Level shift (dB) | Quantity in parentheses |
|------------------|-------------------------|
| +3.0 | 1.41 |
| +2.0 | 1.26 |
| +1.0 | 1.12 |
| 0 | 1.00 |
| -1.0 | 0.89 |
| -2.0 | 0.79 |
| -3.0 | 0.71 |

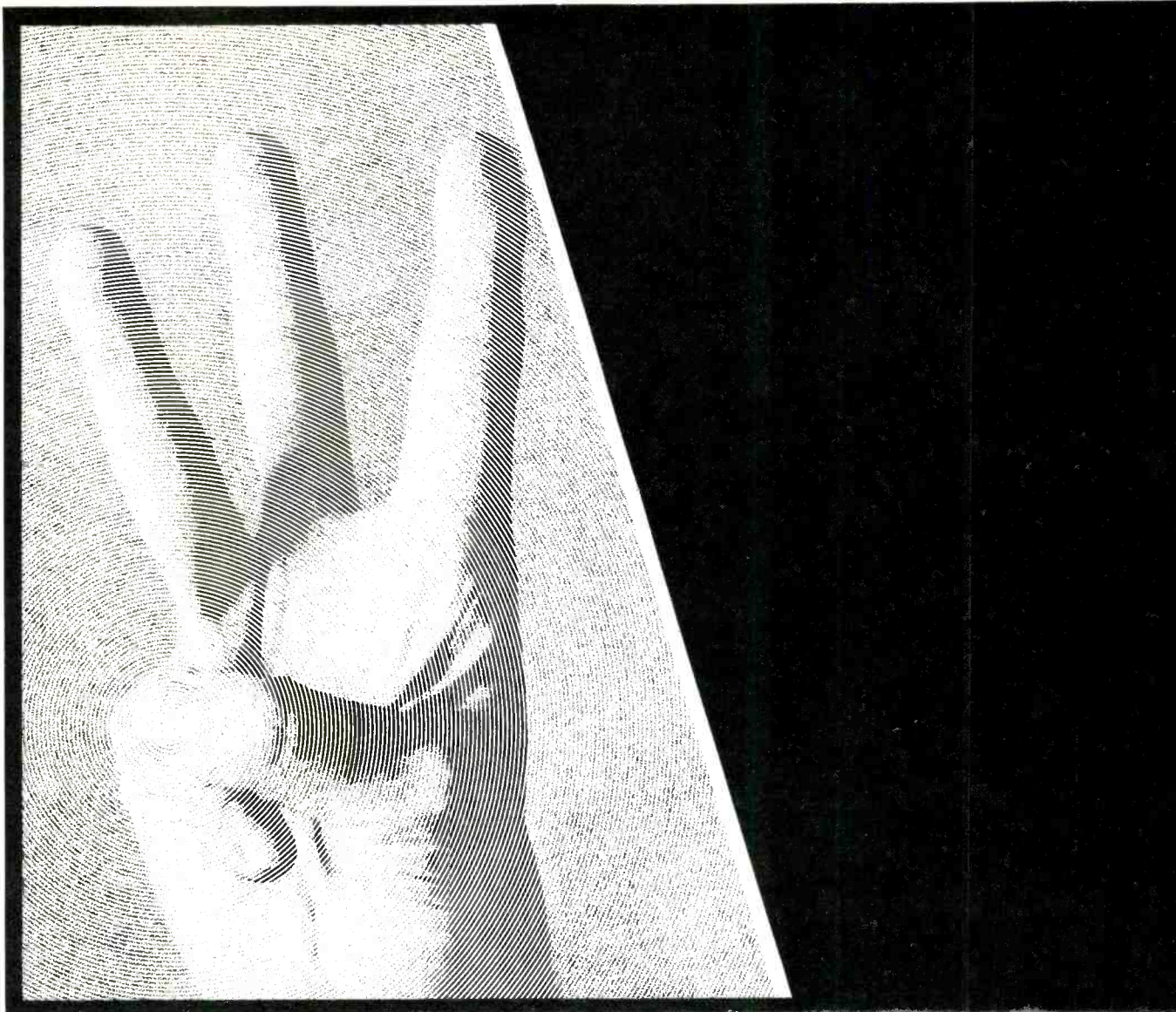

Best. best. best buys.

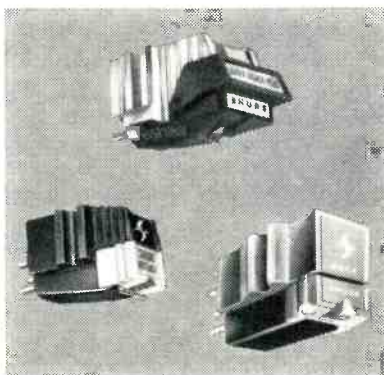

Fact: the lowest cost way to improve your whole high fidelity system is simply to upgrade the source of sound—the cartridge! If you're on a temporary austerity program, the Shure M44E can make a significant difference in sound over the cartridges supplied with many budget component systems. If your budget is a trifle more flexible, an M91ED can bring you into the area of high trackability (with performance second only to the V-15 Type III). And for those who can be satisfied with nothing less than state-of-the-art playback perfection, Shure offers the widely acclaimed V-15 Type III, the recognized number one cartridge in the industry, which, in truth, costs less than a single middle-of-the-road loudspeaker. To read about what a Shure cartridge could do for your system, write:

Shure Brothers Inc.
222 Hartrey Ave., Evanston, IL 60204
In Canada: A. C. Simmonds & Sons Limited



Manufacturers of high fidelity components, microphones, sound systems and related circuitry.

Check No. 25 on Reader Service Card

PIEZOELECTRIC

HEADPHONES

Martin Clifford

A TRANSDUCER is a device for changing one form of energy to another; a headphone is a transducer, and so is a loudspeaker, since both change electrical energy to sound energy. A motor is also a transducer and so is an electric light bulb. Crystalline substances, such as quartz, are transducers and quartz crystals have been used for decades in radio transmitting stations to produce the fundamental frequency of the carrier wave.

Because of the way the crystal behaves, quartz is *piezoelectric*. Piezo (pressure) is from the Greek *piezein*, meaning "to squeeze." When quartz is subjected to pressure by compression, stretching, or twisting, an electric charge appears between surfaces, generally the two largest ones. The reverse effect, a change in the crystal's shape, can be obtained by putting the crystal between a pair of flat metal plates and applying a voltage to them. This crystal is comparable in size and shape to a postage stamp. Thus, when voltage is applied to a quartz crystal, a mechanical force is produced via the crystal deformation, and a voltage is produced when the crystal resumes its normal shape. This voltage is a.c. of constant frequency and far above the audible range.

In addition to quartz, various other crystalline substances are used as piezoelectric transducers, including Rochelle salts, tourmaline (a semiprecious mineral), and barium titanate. The Rochelle salts crystal has been used as a piezoelectric transducer in speakers, microphones, and phono cartridges. Barium titanate is a crystalline ceramic with both ferroelectric and piezoelectric properties and is used in the manufacture of compact capacitors and transducers, including the ceramic photocell.

These substances, quartz, Rochelle salts, and the others,

are inorganic, that is, they were never part of any living tissue. However, some organic substances, such as wood, bone, and silk, have been found to have piezoelectric properties. These are interesting but thus far impractical, for audio applications.

Recently other electroacoustic transducers have been made for applications in headphones, speakers, microphones, and also in phono cartridges. Unlike the slab-like quartz crystals, these use extremely thin piezoelectric polymer films. The polymer can be either a natural or synthetic compound and has high molecular weight, which is produced through the repeated linkage of millions of monomers. A monomer is any molecule which can be chemically bound as a unit of a polymer.

One of the earliest of the synthetic piezoelectric high polymers was gamma methyl L-glutamate. Its piezoelectric properties, however, were too small to make this substance of practical value and thus, it was said to have a small *strain constant*. *Strain* is the deformation resulting from a physical stress and can be compared to the excursion of a voice coil resulting from the current flowing through it. If the voice coil moves only slightly or not at all, the sound reproduced by the attached cone is either negligible or nonexistent.

A New Material

Quite recently however, a new piezoelectric substance, vinylidene fluoride, was developed by Pioneer in Japan. This has properties allowing it to produce frequencies in the audible range with relatively low distortion. These properties include a strain constant about 10 times higher than quartz, which remains stable at temperatures up to 212° F (100° C), and its elastic stiffness is about five percent that of

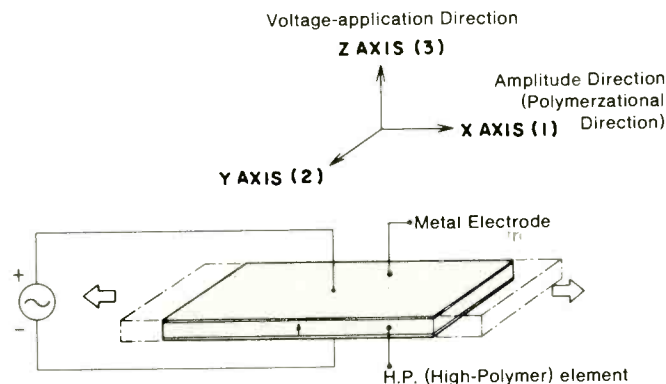

Fig. 1—When voltage is applied across the plates (Z axis), the piezoelectric element moves along the direction of the X axis.

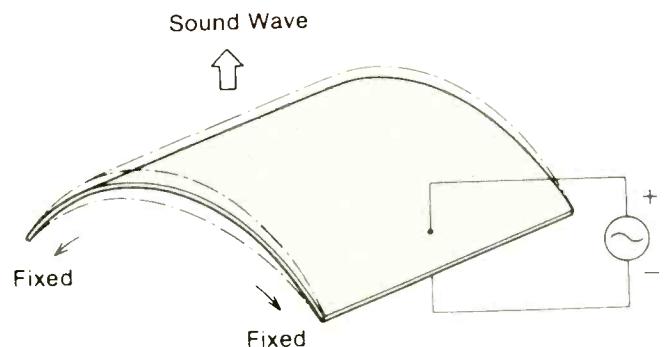

Fig. 2—When an a.c. voltage is applied to the aluminized surfaces, the piezoelectric material expands and contracts. Since the edges are clamped, the element is forced to move as shown.

quartz. This lightweight substance can also be formed into an extremely thin film, which, together with its relatively low mechanical stiffness, makes it suitable as an audio transducer. The use we will consider here is in headphones, the first product in which this polymer has been used.

The production of piezoelectric vinylidene fluoride as a high polymer essentially follows the techniques used in making piezoelectric ceramics. The material is stretched along a single axis to about four times its original length. Then aluminum is deposited on both sides by evaporation to form the electrodes. Finally a high d.c. voltage is applied to the electrodes to polarize the dielectric material.

The effect of the polarization is analogous to charging a capacitor, with the potential voltage difference remaining across the capacitor after the charging voltage is removed. In the case of this aluminum-coated polymer, we get residual piezoelectric effect after the polarization voltage is removed. This acquired property is stable and is not affected by moisture or dust.

The magnitude of the displacement of a piezoelectric body depends on its applied charge. A greater bending effect can be had by joining a pair of piezoelectric units so that the application of voltage to one of them will expand while the other contracts. This arrangement is called a *bimorph element*, or more casually, a bimorph. The technique is similar to that used in a bimetallic thermostat. The effect of this arrangement is to reduce the mechanical impedance.

A Practical Assembly

Figure 1 shows a high polymer piezoelectric assembly. When an a.c. voltage is applied along the Z axis (3), the unit compresses and expands at right angles to the applied potential. In the example shown in Fig. 1, the physical motion would be in the horizontal plane (or X axis) as shown by the arrows. The compression and rarefaction of the surrounding air molecules is produced by the ends of the assembly. But since these ends have a relatively small surface area, the sound resulting from this limited motion would be equally limited.

If the voltage applied along the Z axis is a.c., the high polymer element will expand and contract along the horizontal plane in step with the alternating pulses of the a.c.

voltage. Conversely, when an external mechanical force is applied from the amplitude direction (the X axis, also called the polymerization direction), voltage is generated toward the Z axis (voltage application direction).

However, if the piezoelectric assembly is curved, as shown in Fig. 2, and if the edges are clamped in position, both the upper and lower surface areas become involved. With the edges fastened, the assembly is forced to move in the direction shown by the arrow in Fig. 2. Because of the greater area in motion, there is now more movement of the nearby air molecules, and thus we now hear sound. (If you move a fan so its motion is parallel to its surface, there is little air motion. But move the fan perpendicularly to its surface and the volume of air moved is considerably greater.) It is in its curved and edge-clamped form that the high polymer piezoelectric is used as a direct radiator in headphones, microphones, and loudspeakers.

The a.c. voltage indicated in Fig. 2 could be that supplied at the headphone output terminals of a receiver. Note that the action of the diaphragm is completely unlike the piston motion of the conventional cone-shaped diaphragm of a dynamic unit. Instead, the high polymer film works as a driver by expansion and extraction.

What's Inside

Figure 3 illustrates the inner construction of a production piezoelectric headphone. The vinylidene fluoride diaphragm is curved and is backed with urethane foam padding, which is in turn backed by a perforated suspension board. The edges of the circular diaphragm fit into a supporting ring which is part of the framework of the headpiece. The open-back construction helps avoid a feeling of isolation. Headphones of this construction weigh from 10 to 13 ounces.

The construction of a piezoelectric headphone also invites comparison with a capacitor, as it is built like the basic flat two-plate capacitor with its separating dielectric. But while the aluminum electrodes are quite close to each other, a condition necessary for capacitance, the static capacitance is low, actually only about $0.1 \mu\text{F}$ —small enough to have substantial capacitive reactance even at the higher audio frequencies. The result is that the high-frequency audio loss is negligible, though a steep rolloff occurs just above 20 kHz.

Practical Advantages

While the tonal characteristics of the piezoelectric headphone are comparable to those of good electrostatics, the piezoelectric film can be driven by a relatively small input voltage as compared with the high input voltages required for electrostatics. A signal drive of only 3 volts can produce a sound pressure level of 100 dB with piezoelectric headphones. Also, these units do not require the biasing power supply which electrostatics need. Piezoelectric headphones can be plugged directly in place of conventional dynamic types in standard receivers or amplifiers. They can also be connected to a tape deck or tuner, though generally these components will not have enough signal output to drive piezoelectric headphones satisfactorily.

Frequency response of the first model produced, Pioneer's SE-700, was measured at 20 to 20,000 Hz, using a B & K model 4153 ear. Harmonic distortion was less than 1% at output sound pressure levels of up to 110 dB. They operate at any output impedance from 4 to 16 ohms.

It is apparent that Pioneer has made interesting application of this new polymer in the design, engineering, and production of these stereo headphones. Pioneer has also shown prototypes of speakers, using this new material to produce both tweeters and mid-range units.

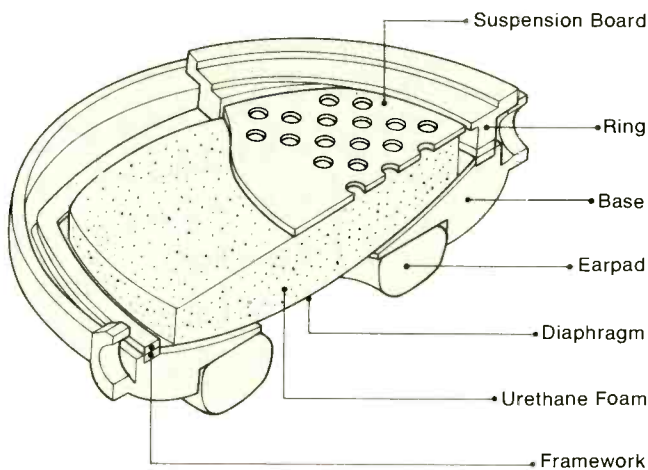

Fig. 3—Inner construction of a piezoelectric headphone.

Speaker Tests - Polar Response

Richard C. Heyser

THE DIRECTIONAL characteristics of a speaker are important in determining not only the modifications in timbre and quality that occur as one moves around in front of the speaker, but also the gross effects of sound reflection due to room and boundaries. Since angular dependence is important to the sound one hears, *Audio* provides measurement of this property.

Because it is almost impossible to find any simple combination of frequencies that will properly represent the way one subjectively perceives the changes of timbre that occur with change of angle, *Audio* abandoned the conventional practice of plotting amplitude response versus angle for single frequencies. The parameter chosen for angular measurement comes from the fact that most program material is dynamic and aperiodic in nature. No single sine wave measurement could be expected to properly represent such program material. *Audio* uses the total energy in the 20 Hz to 20 kHz band which a loudspeaker generates for a perfect impulse and plots this as a function of angle. We call this the polar energy.

The basis for this measurement is the one-meter frequency response. The square of the amplitude of the frequency response is a measurement of the total energy density for a single frequency, while the total

energy for all components from 20 Hz to 20 kHz is the sum of this density throughout the frequency range. This amounts to the area under the curve formed by plotting the square of the amplitude response on a linear vertical axis versus a linear horizontal, frequency axis. To make this measurement, we integrate the square of the frequency response between the 20 Hz to 20 kHz limits.

Angular Energy Measurement

This energy measurement is a single number and represents how much work could be done against a microphone (or an ear) for a given input power, distance, and angle. This energy value is converted to a logarithmic basis in dB to relate this relative measure of this energy to a familiar form identifiable with psychoacoustic properties.

In making this measurement, the speaker under test is mounted on a rotatable platform on an adjustable tripod assembly. The platform is driven by a motor and rotates in a fashion similar to a record turntable, but much slower. A precision potentiometer picks off the angle of the platform, and the pot's output is used to position a pen on a recorder.

Each computation of energy takes one second. The plotter is programmed to draw straight lines be-

tween each energy value and its corresponding angle as the speaker is rotating on the platform, and a measurement is made every 1.5 degrees. The reference angle for all measurements was arbitrarily chosen as the front axis of the speaker, so that if one is directly in front of the speaker, one is also at the defined zero degree point.

Incidentally, this tripod configuration is also used for the anechoic frequency response and the energy-time measurements. As a matter of good practice, the frequency response is observed for every reasonable angle one might assume in listening. Thus, while we normally only present only the zero-degree, anechoic frequency response, we have an excellent idea of the behavior off axis and present any special plots and observations which might be of value.

Polar Response Plot

The term "polar" refers to the use of a polar coordinate system using magnitude and angle. The magnitude is shown as distance from the center of the plot and is the relative measure of energy in dB. Since this measure is logarithmic, the center of the plot is not zero energy, but some value below peak response, such as -25 dB, since we have arbitrarily chosen zero dB as the value of energy

at the outer-most circle of the plot. In making up the curve, the value in dB corresponding to the center of the chart is automatically taken into account. Thus, a curve which passes through or remains at the center of the chart through a substantial angular range doesn't necessarily mean no sound will occur at that angle, but simply that the level of the sound will be at least 25 dB below peak (to use the above example). This is the result of choosing a scale factor which shows the major effects of listening angle change on a chart of reasonable size.

Most stereo or quadraphonic program material is oriented either left or right, rather than up or down. For that reason, we plot the energy response in the horizontal plane (or azimuth) in preference to the vertical plane (or elevation) when a single plot is shown. The major sonic effects in vertical angle can be seen in the three-meter room response since the floor and ceiling boundries influence the early sound to a great extent.

The polar plot is presented as a view looking down on the speaker so that "leftness" and "rightness" are in proper perspective. Thus, one good way to use this data is to imagine the chart placed on top of the speaker with the indicated front axis aligned with the front of the speaker. Looking down on the chart will show the location of the relative energy levels for wide-band material. An excellent test signal to check this is off-channel FM noise, which is quite close to white noise in uniform spectral density after compensation for demodulator de-emphasis.

One very important characteristic to look for in the polar response is left/right symmetry, and a surprising number of speaker systems are not symmetrical. If no precautions are taken with such systems, they will never be truly balanced in their stereo reproduction when listened to in their normal symmetric left/right placement. The general subjective effect of this will be a badly wandering center-stage stereo image when one moves left or right of center in the listening area. In most cases, this can be cured by rotating one or both speakers to give a balanced sound.

A highly directional response is an allied problem that is occasionally observed. Such speakers are generally excellent for corner locations since most listening is then done in an on-axis configuration, but they will seldom give satisfactory stereo imagery if flush mounted against a wall and with a wide stereo base.

Conversely, a speaker with a

"flower petal" polar pattern should not be placed in a corner. The side lobes of radiated energy will scatter off the corner walls and cause severe interference with the direct sound.

Strange peaks and dips in polar energy, particularly if they are not symmetric about the front axis, indicate diffraction or scattering. The fronts of all too many speaker enclosures are designed more for cosmetically pleasing lines than through proper acoustic theory, perhaps because one looks at a speaker for longer periods of time than one listens to it. These acoustic blemishes frequently show up in the polar response, and if exceptionally bad, they

may result in listener fatigue and general dissatisfaction with the stereo or four-channel image.

Acoustically hard reflecting surfaces should be positioned in line with polar energy peaks only if substantial sound scattering is to your liking. There are many who prefer the broad-base stereo effect due to such reflections, and some speaker systems are designed with this type of reproduction as a goal. Many other listeners prefer a less-diffused sound image. Regardless of one's taste in the matter, the polar energy plot is an indicator one can use to decide if a speaker is compatible with the room in which it will be used. 



Phase II

IN KEEPING WITH the finest editorial traditions of Murphy's First Law, it seems that my December *Audio* article describing loudspeaker phase measurements was printed out of phase. The paragraphs defining the term "minimum phase" were split apart and redistributed so that the intended conclusion of the article was tucked neatly into the central portion of the text. The type gremlins also scrambled a point I was trying to make about the fact that it is not necessary to have a peak in speaker response in order to have the sound we call a resonance, but that we can also have this sound due solely to certain types of phase changes even if the system measures "flat." I apologise for any confusion which these errors may have caused. (*And I apologize both to our readers and to Mr. Heyser for these errors. Those who would like a sheet showing the correct order of the article's paragraphs should write me.—Editor.*)

Importance of Phase

After many decades of being ignored, phase response is now becoming acknowledged as a very important consideration in high quality sound reproduction. *Audio* has received several letters requesting some description of the physical aspects of non-minimum and minimum phase response networks. In partial repayment for the inadvertent confusion the disordering of my phase response article may have caused, I would like to summarize two

very important physical reasons why it is important to know if an audio system is of minimum-phase type in its reproduction.

First is the consideration of accuracy in the reproduction of transients. If a system is minimum phase, then the best transient response always occurs when the frequency response is adjusted to be the flattest possible. Most amplifiers are minimum phase; most loudspeakers and magnetic tape recorders are non-minimum phase.

Second is the consideration of naturalness. The sounds we hear in our everyday experience contain subtle cues which we use to identify naturalness. All of us from birth become very adept at processing this "software" without ever realizing we are doing this. If an audio system alters these cues in such a way that they are contrary to what is expected from natural sound, then we may find the reproduced sound to be unnatural. Such alterations can occur with non-minimum-phase transmission systems. If, for example, in reproduced sound the overtone structure from every instrument in an orchestra is heard slightly before the musical fundamentals which give rise to these overtones, then we may sense that something is wrong with the reproduced sound without really being able to say exactly what bothers us. It just doesn't sound natural.

There are other physical considerations of minimum-phase behavior but any discussion of them or even an elaboration on the details just outlined would fill a good-sized book.

R.C.H.

Equipment Profiles

Scott R77S AM/FM Stereo Receiver



MANUFACTURER'S SPECIFICATIONS

FM Section

IHF Sensitivity: 1.8 μV . **S/N Ratio:** 70 dB. **Selectivity:** 75 dB. **Capture Ratio:** 1.2 dB. **Harmonic Distortion:** Mono, 0.3%; Stereo, 0.4%. **Stereo FM Separation:** 1kHz, 40 dB.

AM Section

Sensitivity: 100 μV /meter (internal antenna). **Selectivity:** 32 dB. **Harmonic Distortion:** 50% Modulation, 1.5%.

Amplifier Section

Power Output: 70 watts continuous per channel, 8 ohms, 20 Hz to 20 kHz with no more than 0.3 total harmonic distortion. **THD at Rated Output:** 0.3%. **IM Distortion:** 0.3%. **Frequency Response:** 8 Hz to 40 kHz \pm 1 dB.

General Specifications

Dimensions: 18 in. W. x 5 $\frac{3}{4}$ in. H. x 15 in. D. **Weight:** 40 lbs. **Power Consumption:** 450 watts maximum (100, 117, 220, or 240 V, 50/60 Hz). **Price:** \$499.95.

This somewhat abbreviated list of specifications above is no indication of abbreviated performance capability for this top-of-the-line receiver from H.H. Scott, Inc. As many *Audio* readers are aware, Scott is one of the oldest and most venerated names in high fidelity. Several years ago, when other U.S.-based companies sought to fight rising costs by producing their products abroad, Scott insisted on maintaining a total "made in the U.S.A." stance and found itself unable to compete in the high fidelity marketplace. Since then, the balance has shifted somewhat, and, buoyed by outside financing, the company is very much alive and back in business at its plant in New England. Initial output consisted of many models which were carried over from earlier designs, but the Model R77S represents Scott's first totally redesigned receiver under its new management and engineering team. The new approach seems to be to give the consumer lots of good performance on the inside without cluttering the front panel with superfluous controls and switches (and, apparently, without cluttering the spec sheets with too many technical terms and specifications). The result is one of the neatest and cleanest looking front panels we have seen in some time. Silver in color, it has five machined, rotary, control knobs at the lower left which handle *Input source*, *Bass*, *Treble*, *Balance* and *Volume* adjustments. Both tone controls and the balance control have

easy-to-feel detent positions at their mid-rotation points (for flat response and equal gain to both channels). At the lower right of the panel is a push-button *Power on/off* switch and a stereo phones jack. Immediately to the left are two neat rows of five pushbuttons each. The lower row is devoted entirely to speaker selection and, since it is possible to connect three sets of speakers, offers selection of individual sets plus a pair of buttons for 1 & 2 or 1 & 3. There is no provision for operating all three pairs of speakers simultaneously since this could present dangerously low output impedance to the amplifier section.

The blacked-out tuning area lights up in soft green when power is applied, disclosing a long AM and FM dial scale, an illuminated dial pointer (red), and illuminated signal-strength and tuning meters. Program source selection is also indicated by means of lit-up words below the dial scale. A rotary tuning knob, equal in size to the other control knobs, is located at the extreme right of the dial area. Flywheel action is moderately effective.

The rear panel, pictured in Fig. 1, shows the three sets of speaker terminals, which are the spring-loaded, push-to-insert-cable type, as is the chassis ground terminal. Screw

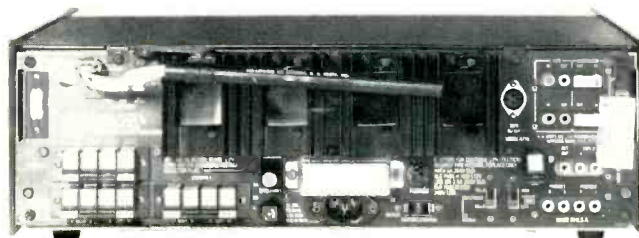

Fig. 1—Rear view of receiver.

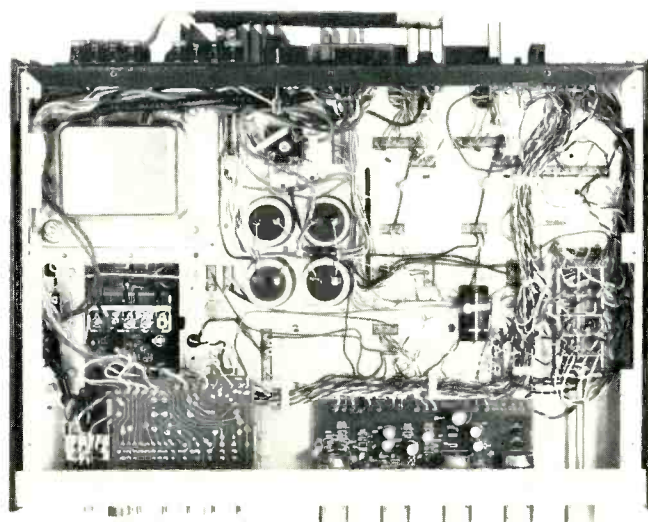

Fig. 2—Internal view of the receiver.

terminals are provided for 300-ohm FM and external AM antenna connection while a coaxial connector is supplied for 75-ohm FM antenna installation. There are individual speaker line fuses as well as a power line fuse, a switched a.c. receptacle, twin pairs of phono inputs (one pair of which is equipped with a slide switch for varying input sensitivity from 3 mV to 6 mV), *Tape In* and *Out* jacks (for the tape monitor facility), extra tape input jacks, and a detector output jack for use with future 4-channel FM adaptors. A pair of jumpers interconnect sets of *Accessory* jacks. These really constitute a second *Tape Monitor* circuit interruption point, rather than the more familiar preamp-amp separation facility. There is a slide switch for changing FM de-emphasis from 75 microseconds to 50 microseconds (used in Europe). Scott could have easily (and may yet) provided a 25 microsecond position for Dolby FM instead, since there is no reason for the 50 microsecond position in the U.S. A DIN connector can be used instead of the *Tape In* and *Out* jacks if your tape deck is so equipped. Pivotal AM ferrite antenna and power line cord are unpluggable for packing and shipment.

Circuit Description

An internal view of the receiver is shown in Fig. 2, and a complete block diagram of the unit is in Fig. 3. The silver-plated FM front-end features a MOS-FET used for r.f. amplification. The i.f. section includes a pair of 6-pole lumped filters and two high-gain integrated circuits. Limiting is provided by the second i.f. amplifier and the ratio detector. AGC is provided from the i.f. strip in a d.c. feedback loop to the

FET r.f. amplifier on the front-end. All multiplex decoding functions are performed by an IC chip which uses a phase-lock loop (there are no coils to adjust) and contains the equivalent of 58 transistors and four diodes.

The AM tuner section uses an FET r.f. amplifier and mixer and an IC circuit for the i.f. section. AM detection is by a voltage doubler circuit.

Negative feedback is used both for RIAA equalization in the preamplifier and for FM de-emphasis as noted previously. The power amplifiers have differential input with full complementary power-output configuration for direct coupling to the speakers. A dual voltage feedback regulator circuit powers all circuitry except the power amplifiers. In addition to the speaker fuses, the receiver has a fast-acting electronic protection circuit which protects output devices even in the event of a short-circuit across the speaker terminals.

FM Measurements

In reading the instruction manual supplied with the receiver, we noted that some of the specifications listed are at variance with those supplied in the published advertising brochure. For example, the booklet claims 1.9 μV IHF FM sensitivity (which is exactly what we measured) whereas the brochure claims 1.8 μV . Fig. 4 is a plot of signal-to-noise (quieting) and distortion characteristics in mono and stereo for a 1 kHz audio signal. 50 dB quieting in mono was obtained for a signal strength of just under 5 μV , while ultimate S/N measured 71 dB, a bit better than claimed. Maxi-

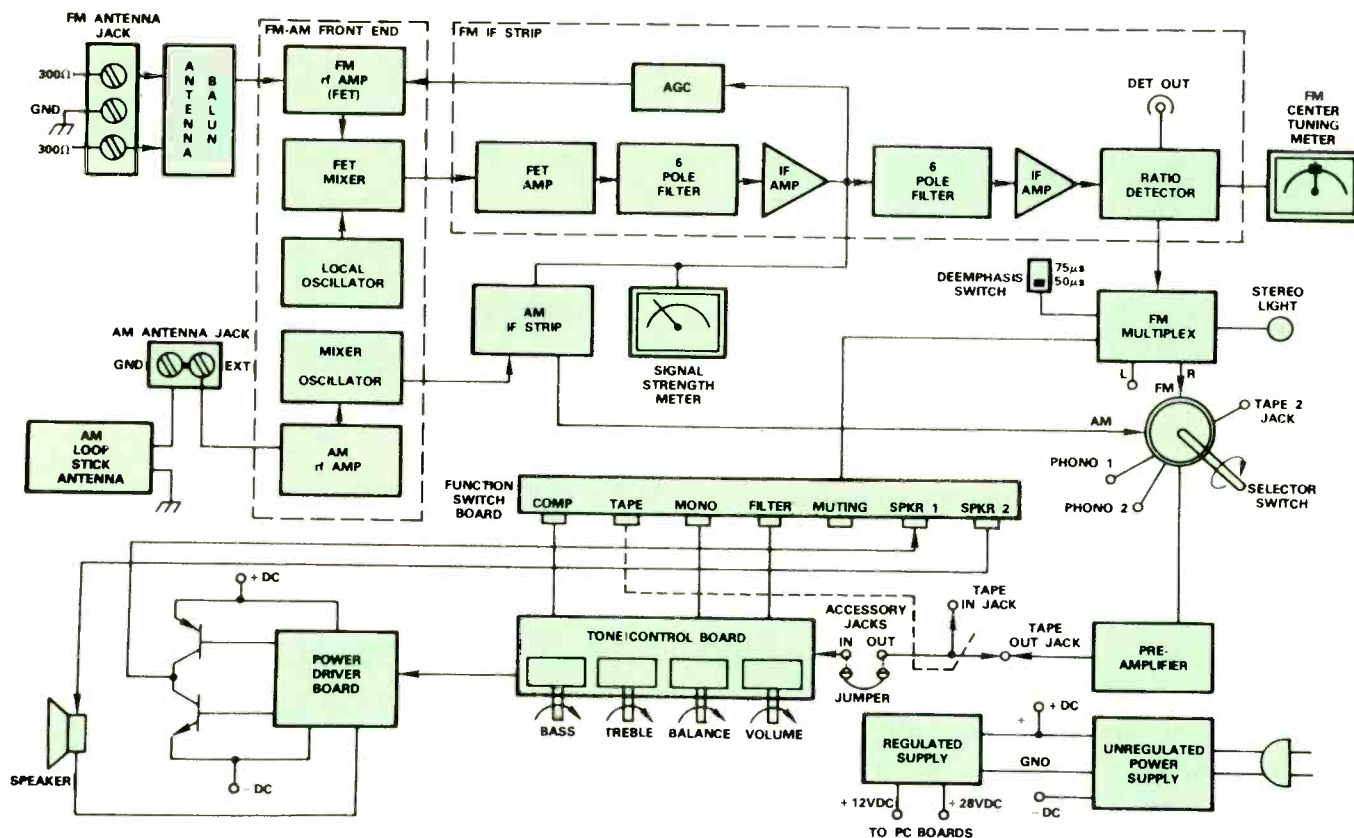

Fig. 3—Block diagram of Scott R77S receiver.

imum S/N in stereo measured 64 dB. THD for strong signals was 0.26% in mono, 0.45% in stereo. Selectivity was considerably better than claimed, measuring 87 dB, while Capture Ratio measured 1.4 dB. Image Rejection and Spurious Response Rejection (not supplied in the specs) were 58 dB and 90 dB respectively.

As shown in Fig. 5, stereo FM separation reached a maximum of 40 dB at mid frequencies, tapering off to 32 dB at 50 Hz and just under 30 dB at 10 kHz. THD was well under 0.5% for all audio frequencies in mono and below 1.0% for all significant audio frequencies in the stereo mode.

Amplifier Measurements

Both the specification sheet and the instruction manual of the R77S were printed prior to the effective date for the new FTC power rule and, in addition, the brochure lists rated THD and IM for the power amplifier section at 0.3% while the owner's manual lists 0.5%. In order to have a point of re-

ference, our measurements were based on 0.3%. As shown in Fig. 6, the amplifier delivered 75 watts per channel at mid-frequencies for 0.3% THD. At all power levels below this point, THD was well under 0.1% and IM distortion was below 0.05%, a figure we would normally expect to find in separate amplifiers of highest quality, rather than in all-in-one receivers. Based upon the 0.3% THD rating, the receiver falls short of maintaining full power output capability (70 watts per channel) down to 20 Hz, as can be seen in the graph of Fig. 7. Under those conditions, the power band (as the FTC calls it) extends from 33 Hz to above 20 kHz. If the 0.5% THD rating is to govern, power band (full power at rated distortion) would be stated as extending down to 25 Hz or so. At half power output (35 watts per channel), THD remains consistently well under 0.1% for all audio frequencies.

Phono input sensitivity was measured at 2.8 mV and 7.5 mV, depending upon the setting of the sensitivity switch on the rear panel. Phono input overload was 45 mV for the high sensitivity position and 140 mV for the lower sensitivity setting. Tone control range, as well as loudness compensation and high-cut filter characteristics are plotted in Fig. 8. The filter and loudness circuits are activated by two of the upper row of five buttons on the front panel, other buttons in that cluster taking care of such functions as *Tape Monitor*, *FM Muting* and *Mono/Stereo* switching. The loudness circuit adds boost at both low and high frequencies with major compensation occurring at the low end. Curve shown is for a setting of -30 dB with respect to maximum volume control position. The high frequency cut-off filter has a turn-over frequency of about 4 kHz, making it more effective in reducing scratch and hiss than might be with the treble control.

Damping factor was measured at 35, referred to an 8-ohm load. The high level inputs ("Tape 2") have an input sensitivity of 410 millivolts. Hum and noise in the high sensitivity phono position measured 65 dB, while in the low sensitivity setting, a reading of 75 dB was observed for residual hum

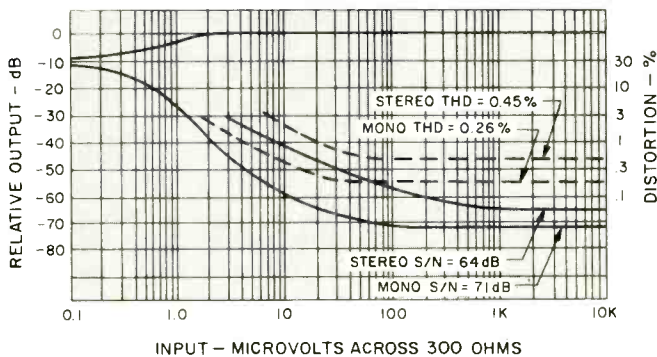

Fig. 4—FM quieting and distortion characteristics.

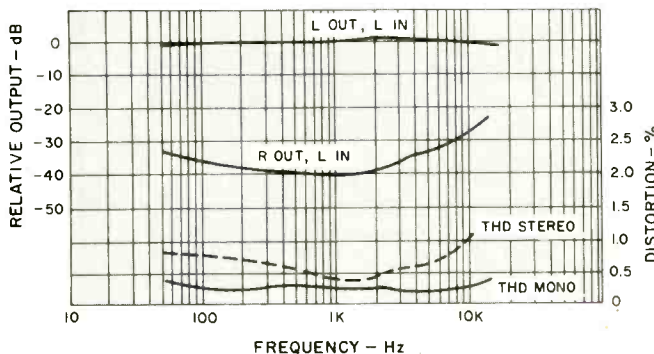

Fig. 5—FM distortion and separation vs. frequency.

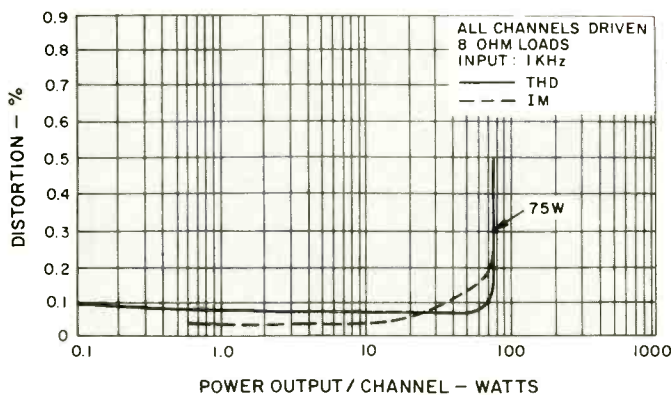

Fig. 6—Harmonic and intermodulation distortion of amplifier.

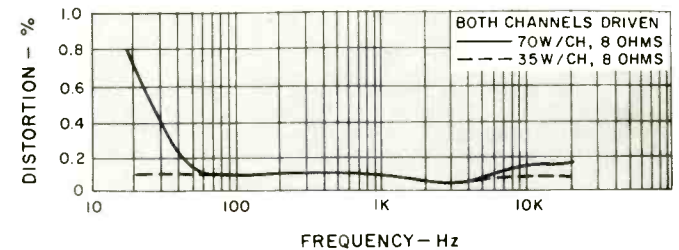

Fig. 7—Amplifier distortion vs. frequency.

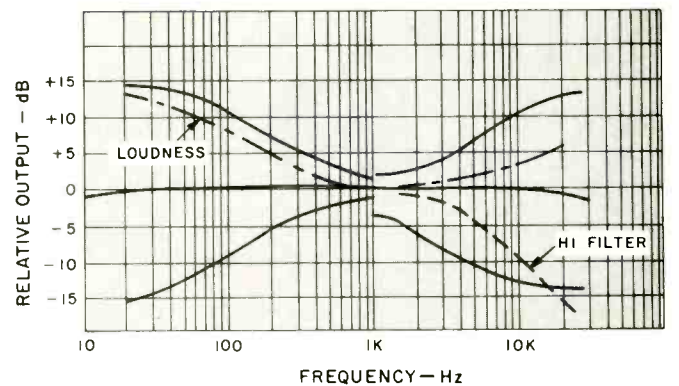

Fig. 8—Tone control range, filter and loudness compensation.

*Dolby is a trademark of Dolby Laboratories, Inc.

450.

The Inevitable Teac.



We have two basic requirements for every product we make — it must work well, and it must do so for a long time. The inevitable result of this philosophy in cassette recorder design is the 450.

It works well indeed: it has wow and flutter of less than 0.07% WRMS which is better than most reel to reel recorders. It has Dolby* with FM/Copy control, which lets you record Dolby broadcasts (or any other Dolby source) directly, or decode them for listening if your tuner doesn't have Dolby built in.

It has a host of other features and impressive specifications. We'd like you to know what they are, and we'd like you to hear the audible improvement they make.

If you'd like that too, check out your local TEAC dealer. You can find him by calling this toll free number (800) 447-4700, in Illinois call (800) 322-4400.

The 450, from TEAC. Inevitably.

TEAC

The Recorder. Always has been.

TEAC Corporation of America, 7733 Telegraph Road, Montebello, California 91764.

and noise. All of these readings are excellent, since *no weighting curve* was applied and all readings were referred to full power output. Hum level in *Tape 2* (which is really an *AUX* position) was 81 dB referred to full output, while with volume control set to its minimum position, residual hum and noise measured 85 dB below full output.

Listening and Use Tests

Scott has chosen just the right threshold points for stereo switching and interstation muting. With a stereo switching threshold set at 7 μ V, stations received in stereo during our listening tests were sufficiently free of noise (even the weaker ones) to justify that switching level. While station counting has become meaningless in our area (we encounter virtually no interstation regions on the dial, with the exception of a couple of MHz at the low end of the band, where educational FM comes and goes), we can say that reception was clean and low in distortion, and tuning was precise and not nearly as critical as on some competitive units we have measured. Center-of-channel indication on the meter corresponded exactly with minimum distortion points and dial calibration was just about perfect. Interstation muting is set at about 7 microvolts, so that when this

feature is used, one is assured that any stations which overcome the threshold are received with well over 50 dB of quieting. FM DX-ers have the option of defeating the mute circuit, but we found this unnecessary and were able to pick up normally weak signals with ease and without having to listen to interstation noise for that privilege.

The Scott R77S is definitely in the "high" power class, and so we used it to drive low efficiency book-shelf speakers in our listening tests. We were able to achieve more than adequate listening levels in a large listening room, and there was no audible evidence of amplifier clipping or distortion, even when records with wide dynamic levels were played.

The receiver is simple to operate and we urge prospective users not to be deterred by the seeming lack of complexity on the front panel. (Some hi-fi buffs still judge a product by the number of gadgets, switches, knobs and levers on the front panel.) Despite its "simple" outward look, the R77S is a sophisticated, up-to-date stereo receiver that ranks with the best of them. It is conservatively designed, meets most all of its specifications, and does very well in those secondary aspects which the company chose not to specify, too. In terms of its price/performance ratio, this Scott receiver is well worth its price. *Leonard Feldman*

Check No. 71 on Reader Service Card

Polk Audio Model Nine Speaker System

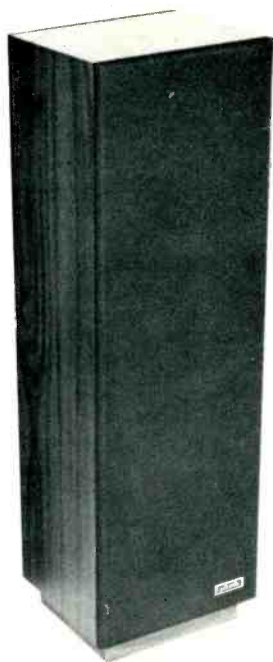

MANUFACTURER'S SPECIFICATIONS

System Type: Two-way, plus passive bass radiator. **Drivers:** Woofers, four 4½-in. extended-range cone radiators, one 8-in. passive radiator; tweeter, ceramic element. **Impedance:** 8 ohms. **Dimensions:** 33½ in. H. x 10½ in. W. x 9 in. D. **Weight:** 36 lbs. **Price:** \$165.

The Model Nine speaker system manufactured by Polk Audio is one of the new speakers which use a ceramic crystal element tweeter in place of the more conventional moving-coil or electrostatic tweeters. This is stated to give improved transient performance and wider frequency characteristics with natural low-frequency discrimination which eliminates the conventional crossover network.

A little less than a meter tall, this floor-standing design contains four extended-range cone drivers, an 8-in. passive radiator, and the piezoelectric tweeter. The Model Nine is a bipolar loudspeaker with what Polk calls a "controlled dis-

persion" radiation pattern. The tweeter and one of the four cone speakers face forward toward the listener to provide primary direct radiation, mostly of the upper frequencies. The remaining three cone speakers and the 8-in. passive radiator are mounted on the back of the enclosure. The purpose of this, according to Polk, is to provide primarily indirect radiation of the bass and lower mid-frequencies. This effect can be enhanced by placing the Model Nine a short distance in front of a wall to augment the front radiation. The system is capable of realizing the full potential of a 100 watt-per-channel amplifier without damage. (Editor's Note: Polk informs us that a new 1-in. soft-dome tweeter has replaced the piezo tweeter in the most recent production models. It is intended to give smoother, more extended frequency response and wider dispersion.)

The enclosure is finished on the sides and top with walnut vinyl. The front and back are covered by a nonremovable, heavy, black grille cloth. Speaker connection is made to a well-marked, heavy-duty barrier strip on the bottom of the enclosure. There are no controls which the user can adjust.

The Model Nine's enclosure has a relatively small top surface and its 33-in. height makes the placement of lamps and other objects quite convenient, and care should be exercised if small children are around since they could easily pull such an object off the top and hurt themselves. The system itself, however, is not unstable, and it would be difficult for most children to tip over.

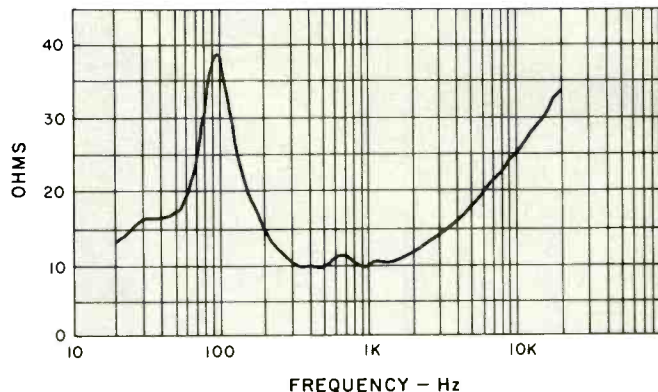

Fig. 1—Impedance.

There are no quality compromises in the Philips SC 102A. It's a stereo control center/pre-amplifier that matches the very best high fidelity systems.

Take the Opto-Mute™ for example. It's an optical/electronic muting innovation found only on the 102A. (Only the best pre-amps and receivers have muting devices at all. And ours is superior to any of them.)

Basically, the Opto-Mute works when you turn on the 102A. It gives you a 15 second safety margin while the power stabilizes. (A pilot light tells you the 102A is working.) With today's high performance amplifiers

and wide range dynamic music, this guards against start-up power surges "blowing" your system.

Since the Opto-Mute is all electronic, there are no mechanical parts to get dirty and cause intermittent mechanical noise.

The entire 102A is solid-state with modular printed circuit boards. (In the laboratory we found distortion levels so low they were practically non-measurable.)

Input selections: Phono, tuner, tape and auxiliary. Mode, tape monitor and balance control, bass and treble equalization, volume and phono gain controls are provided. Plus subsonic filter and bass and treble flat switches.

You could pay over \$600 for a pre-amp that has the 102A's specifications. Or you could pay less than half for the 102A. At better audio shops.

The SC 102A's surprising specifications.

Maximum Output: 10 V rms into IHF Load
Frequency Response: 2 Hz-80 kHz ± 0.5 dB at rated output.

Total Harmonic Distortion: $\leq 0.05\%$, 20-20 kHz at rated output.

IM Distortion: $\leq 0.02\%$ at rated output (SMPTE)

Total Hum and Noise: High Level: ≥ 100 dB below rated output, IHF "A" weighted. Phono: 80 dB below 10mV input.

Tone Control Range:

Bass: ± 18 dB at 20 Hz.

Treble ± 15 dB at 20 kHz.

AC Convenience Outlets: two switched, one non-switched.

Dimensions: 12½ x 4 x 9"

Optional cabinet and rack mount.

PHILIPS AUDIO VIDEO SYSTEMS CORP.
AUDIO DIVISION
91 McKee Drive, Mahwah, N.J. 07430

Super specs. Super price.

You could pay twice as much and not get much more.



PHILIPS®
TM—N.V. Philips, Holland

Check No. 16 on Reader Service Card

www.americanradiohistory.com

Each Model Nine is warranted to be free from defects in materials and workmanship for a period of five years from date of purchase.

Technical Measurements

The measured impedance is plotted in Fig. 1 and shows the slightest hint of an extra peak at 95 Hz which results from the use of the passive radiator for low bass augmentation. The lower peak is near 32 Hz. The lowest value of impedance occurs around 400 Hz and is just under 10 ohms. This means that the Model Nine may be treated as an 8-ohm system from the standpoint of amplifier loading and interconnecting wire size.

The one-meter anechoic frequency response is shown in Fig. 2 for the sound pressure level measured directly on axis. The 8-in. passive radiator and three of the four active drivers covering the low frequencies are located on the back of the enclosure where they can radiate away from the listening position and disperse sound from the wall(s) behind the unit. One cone and the piezoelectric tweeter radiate from the front of the enclosure in the direction of the measuring microphone. As a result, this echo-free measurement is dominated by the high frequency frontal sound, but the Model Nine is stronger in the lower frequencies than this standard measurement might seem to imply. The absorption dips at 1.4 kHz, 5 kHz, 9 kHz, and 14 kHz are due to the interaction of the 4½-in. driver with the tweeter. The measuring microphone is placed exactly in front of the geometric center of the enclosure. Consequently, the path length between the two drivers is not equal, and absorption dips result.

This may be more readily discerned in the one-meter phase measurement shown in Fig. 3. The phase measurement is corrected for the average acoustic position of the extended range driver. From below 300 Hz to 1.4 kHz, the 4½-in. driver carries the load and is precisely in phase. Above that frequency, the piezoelectric driver begins to take over. The discrete 180-degree jumps and eventual lagging phase are due to the fact that the tweeter has a slightly longer path length than the 4½-in. driver for this microphone position.

Overall balance is rather good from the midbass up through about 12 kHz, though Figs. 2 and 3 indicate that some tonal coloration will be experienced with change of the vertical location of the listener relative to the front of the speaker. There is a dominant peak at around 8 kHz for direct sound which might tend to exaggerate the background "scratch" of already noisy program material. This can be corrected by program equalizers of the octave or one-third-octave variety, but will be difficult to remove by conventional tone control circuits without losing too much top end.

Figure 4 is the three-meter room response of the Polk Model Nine, with the speaker placed 14 in. away from a flat wall, in accordance with Polk's instructions. The micro-

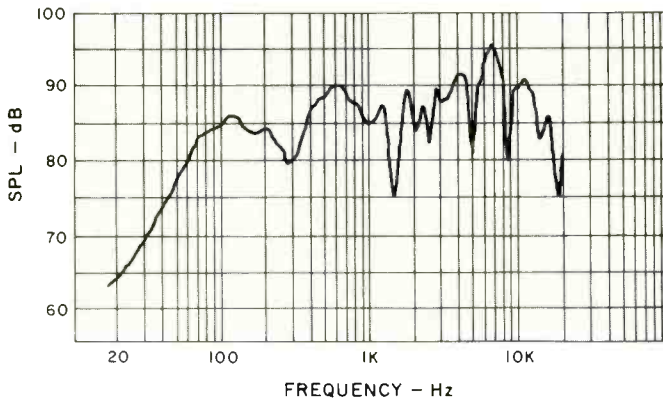

Fig. 2—One-meter anechoic sound pressure level.

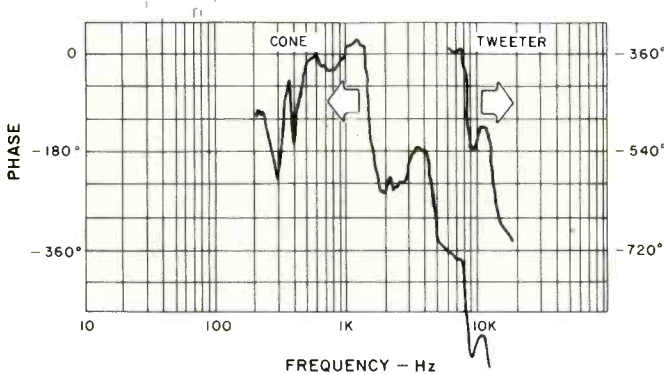

Fig. 3—One-meter anechoic phase response.

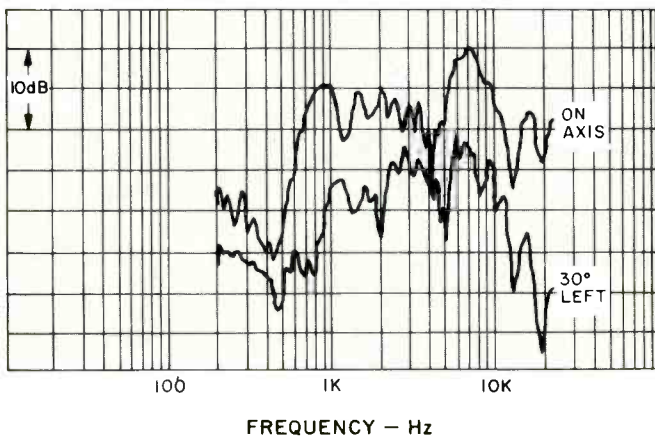

Fig. 4—Three-meter room response.

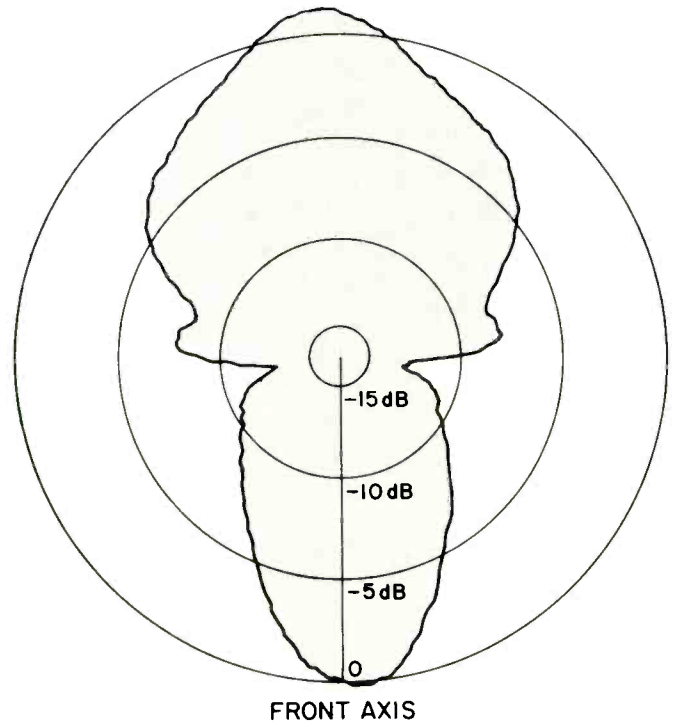

Fig. 5—Horizontal polar energy response.

pre•ci•sion (pri-sizh'ən), n.
[Fr.; L. *praecisio*], the quality
of being precise; exactness;
accuracy; definiteness.

A turntable is a mechanical
device. It spins a disc under an
arm, cartridge and stylus.

Simple.

Not so simple.

For it must spin the disc at
precise speed, without rumble,
wow and flutter. It must protect
the delicate disc. And it must
function at maximum standard
for a long, long time.

Now here's a problem. While
devices and ideas are patentable,
advertising rhetoric is in the
public domain. We see words
like "precision," "high quality
engineering" and "state-of-the-
art," applied to equipment
considerably below the promise
inherent in those descriptions.

How then, can you tell the
differences among turntables?
Of course you can buy one
because it's "best selling" or
"on sale" and discover its
attributes and flaws afterwards.

We offer this suggestion.
Meticulous engineering has a
look and a feel. Literally. We're
counting on your recognition
of it. Look carefully at the
Tannoy/Micro Turntables.
Operate them. Use the cueing
control. Change the speed.
Move the tonearm. Do all of
the things you would do at
home. Then look at the
specifications.

We know what you'll find.
For Tannoy/Micro Turntables
are an accurate expression of
"precision," "high quality
engineering" and "state-of-
the-art!"

TANNOY/MICRO

For an illustrated color brochure write:
Tannoy/Micro Department F
1756 Ocean Avenue, Bohemia, N.Y. 11716
Check No. 28 on Reader Service Card

Tannoy Limited of England enjoys
a worldwide reputation for the supremacy
of its high quality transducers. Micro Seiki
Co., Ltd. of Japan is equally noted for the
engineering, design and manufacture of
superb tonearms and turntables. Their
talents and commitment to the ultimate in
high fidelity have now been combined
in a way which gives new dimensions to the
interaction between technology and art.



phone was placed one meter above a carpeted floor and three meters away from the front of the enclosure to simulate a conventional listening position. The frequency response of the first ten milliseconds of "early" sound is shown in Fig. 4 for both a direct on-axis measurement and a 30-degree stereo left-channel location. The measurements are displaced 10 dB for clarity of presentation. The "shadowing" effect of the enclosure on the on-axis mike position prevents the back radiating, lower frequency energy from being included in the 10 mS "window" of the early sound.

Both positions show a substantial frequency dip at around 400 Hz, approximately the frequency that might be expected for a radiation from the rear-mounted speaker to reflect off the wall and arrive out of phase with the front-

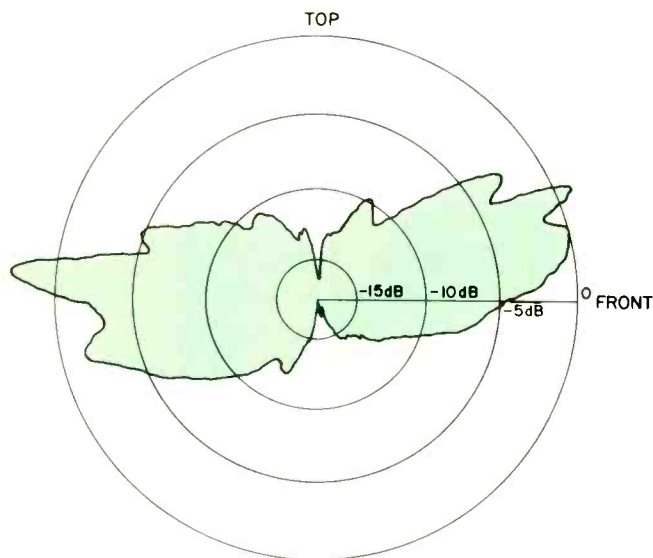

Fig. 6—Vertical polar energy response.

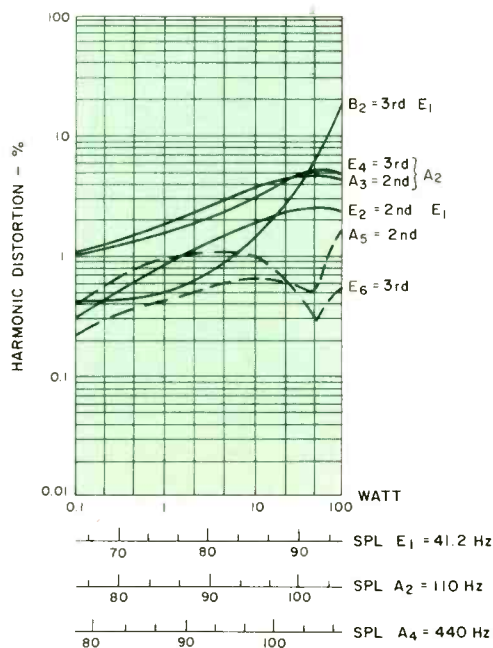

Fig. 7—Harmonic distortion for the tones E1 (41 Hz), A2 (110 Hz), and A4 (440 Hz).

mounted speaker. The measurements indicate the 30-degree stereo position has a more uniform tonal balance than the position directly in front of the speaker. The dip in response at 400 Hz can be reduced by angling the speaker toward the listening position, but the top end—around 7 kHz—might become too strong for some tastes if this is done. Angling the speakers farther away from the listening position than normal stereo placement will begin to lose too much top end. The measurements of Figs. 2 and 4 indicate that the speakers could either be pulled farther away from the back wall than Polk suggests or placed in front of sound-absorbing material, such as heavy drapes, if the middle octaves of music are not to become adversely affected.

The horizontal polar energy is shown in Fig. 5, which charts the left-right change of total energy from 20 Hz to 20 kHz. As expected, the Model Nine is approximately a doublet radiator, with about as much total energy coming from the rear as the front, and a significant drop in energy at the sides. The highest frequencies are radiated from the front with substantial lower frequency energy coming out the rear. This is shown by the more directional response from the front. There is no significant "leftness" or "rightness" of the radiation so that normal stereo imagery can be expected for wide range program material. If the violins are supposed to be heard on the left, they will come from the left and not be spread from left to right with changes in musical pitch as sometimes occurs for those speakers whose polar pattern varies with frequency.

Figure 6 is the vertical polar energy measured in front of the speaker. The response is again roughly that of a doublet, but energy from the front is definitely launched in an upward direction. This means that a brighter sound will occur for a high listening position, as compared to a seated listening position. The more nearly horizontal spread of rear radiation, together with the lower frequency dominance shown in Fig. 5, explain why the room measurement of Fig. 4 only has a single lower frequency interference at 400 Hz rather than similar problems at 800 Hz, 1200 Hz, etc. Figure 6 indicates that the speaker may be placed on either a rug surface or a hard floor with little change in timbre of "early" sound since floor reflection is efficiently suppressed. Both of these measurements show that the Model Nine must not be mounted in a corner of the room.

Harmonic distortion is shown in Fig. 7 for the musical tones E1 (41 Hz), A2 (110 Hz), and A4 (440 Hz). The use of multiple drivers for the frequency range above 100 Hz clearly reduces the harmonic distortion at high power levels. However, the drop in distortion with decreasing power is not as much as this reviewer would like to see.

The intermodulation of A4 (440 Hz) by E1 (41 Hz) when both have the same voltage drive is given in Fig. 8. At low

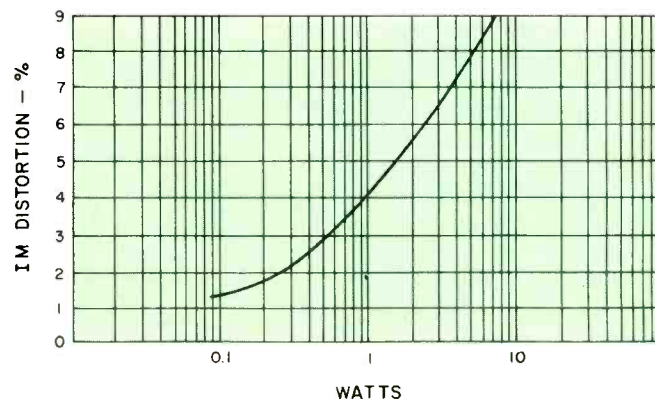

Fig. 8—Intermodulation of A4 (440 Hz) by E1 (41 Hz), mixed 1:1.

The Nakamichi Revolution. It's Freedom.



Freedom to record anything. Anywhere. Anytime.

That's the promise implicit in the latest engineering triumph from Nakamichi, the 550 Dual-Tracer.

For with the 550, Nakamichi engineers have extended their revolution in cassette technology to in-the-field recording.

The Nakamichi 550 is basically a battery powered version of the highly regarded Model 500 Dual-Tracer, which *Stereo Review* (April 1975) described as, "...an exceptional recorder... We would say that in the key specifications of frequency response, S/N, and distortion, it is at least the equal of any under-\$500 cassette recorder we have tested, and better than most."

Like the 500, the 550 features Nakamichi's Focused-Gap head for superb high frequency response and extremely low distortion. Extended range, 45dB peak level meters for a precise, unambiguous indication of program level. A pulse controlled, DC servomotor for unconditional speed stability. And, of course, Dolby* Noise Reduction circuitry.

In addition, the 550 boasts three separate microphone inputs, each with its own level

control to facilitate mixing. And professional quality, low distortion mic preamps with a 130dB dynamic range.

On batteries, the Nakamichi 550 will operate continuously for 15 hours without a trace of speed fluctuation.

Add a special headphone amplifier, a bias/equalization switch, an end-of-tape alarm, built-in battery and footage indicators, adaptors for both AC and car/boat battery operation (at no extra cost) and you have an unusually versatile cassette system. The only high performance cassette recorder that can truthfully be called universal.

At home, on location, anywhere, the Nakamichi 550 is your passport to freedom.

To achieve your full measure of freedom now, enlist in the Nakamichi Revolution.

For complete information and the name of your nearest dealer write: Nakamichi Research (U.S.A.), Inc., 220 Westbury Ave., Carle Place, N.Y. 11514. In California, 1101 Colorado Avenue, Santa Monica 90404.



PERFECTION THROUGH PRECISION.

NAKAMICHI®

Check No. 13 on Reader Service Card

*Dolby is a trademark of Dolby Laboratories, Inc.

levels the distortion is primarily due to phase modulation. At an average power of one watt, the 440-Hz tone has peak-to-peak angular modulation of 3 percent. At ten watts, this increases to 12 degrees angular modulation and 10 percent amplitude modulation. Both the angular and amplitude modulation are primarily 41 Hz with no substantial harmonics, which means that the combined vibrato and tremolo may not be subjectively obvious as the high numerical intermodulation reading of Fig. 8 indicates. At this ten-watt level, however, the 440 Hz is dropped in acoustic level by 1 dB over what it would be without the 41 Hz tone. This is because (for this particular test unit) the speaker cone migrates outward from the magnet assembly under the combined drive. The subjective impression will be that some musical instruments appear to move a bit in space when high energy, low frequency components are present.

The crescendo-handling property of the Model Nine for wide-band signals is moderately good. Instantaneous peaks, such as hand claps and cymbal crashes, can be handled up to about 250 watts before the inner musical voices are noticeably affected.

The ability of the Polk to pass pure impulsive signals is shown in the energy-time curve in Fig. 9. The microphone

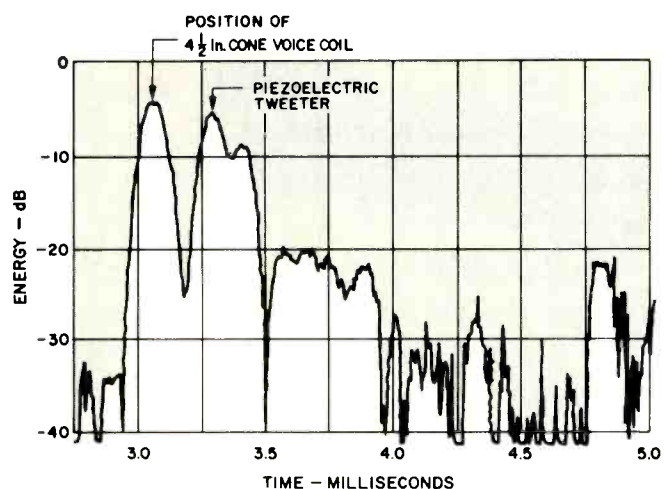

Fig. 9—Energy-time response.

Check No. 72 on Reader Service Card

position is the same as that for the anechoic response measurement. The first sound occurs at 3.05 milliseconds and is due to the front-mounted cone. This is substantially over when the first sound from the piezoelectric tweeter arrives at 3.3 milliseconds. Both speakers are phased so that a positive voltage impulse applied to the positive speaker terminal produces a pressure increase for the first sound arrival. Some enclosure diffraction occurs from 3.5 to about 4 milliseconds, as may be seen from the uneven character of this lower level signal. The energy peak at around 4.8 milliseconds is sound diffracting from the top of the enclosure. The time spread for signals within 10 dB of the peak energy is only about 0.5 millisecond.

Listening Test

A variety of listening positions were tried, and no single position seemed to be best suited for all musical material. A certain amount of experimentation with room position may be required when the units are first set up by a purchaser.

The overall sonic impression prior to tone control equalization was that the midrange was down in level, the top end was a bit peaky, and the midbass was good but extreme low bass was lacking. A bothersome peak at around 200 Hz, just below middle C, was evident in all positions tried. On an overall basis, the best compromise of tonal balance was obtained with the speakers about 12 inches out from the wall and with slight bass and treble cut.

The stereo imagery is somewhat "up front," which means that instrumental voices are pulled slightly toward a position closer to the plane passing through the two speakers. Basic stereo imagery is quite good in lateral placement. The apparent design intent of using direct- and rear-projected sound to produce a wider stereo image is fulfilled.

Vocals are very clean in reproduction with only a small bite in high frequencies. Choral groups do not come off quite as well and in this reviewer's opinion appear pushed together in space and suffer from a degree of sibilant emphasis. Articulation is excellent, however. Most musical instruments are well reproduced with the slightest tendency to sound bigger than life.

The Polk Model Nine is well suited for those rooms where space is at a premium and the need is for the sonic illusion of a wide stereo stage.

Richard C. Heyser

Technics RS-676 Cassette Deck



MANUFACTURER'S SPECIFICATIONS

Wow and Flutter: 0.08% or better. **Overall Frequency Response:** 40 Hz to 12 kHz, +2 dB, -3 dB with LN tape. 40 Hz to 13 kHz +2 dB, -3dB with CrO₂ tape. **Signal/Noise Ratio:** 50 dB; 58 dB or better with Dolby. **Distortion:** 2.0% at 0 VU, 1

kHz. **Input Sensitivity:** Mike, 0.3 mV; Line, 60 mV; Tuner, 100 mV. **Output:** 0.42 V. **Heads:** 2. **Motors:** 2. **Dimensions:** 16³/₈ in. W. x 14³/₈ in. D. x 5¹/₂ in. H. **Price:** \$459.95.

Cassette recorders are getting more and more professional in styling, and there is a definite trend towards front loading with the more expensive machines. A good example of both trends is the Technics RS-676, and very impressive it looks with its instrument-type controls and satin aluminum and black finish. The cassette compartment is on the left and a touch of the eject button will release the door catch so it can be opened by hand. The cassette is loaded by placing it inside the "oven" and pressing it downwards. The compartment is illuminated and a large glass window in the door allows one to see whether the tape is rotating. But, you may say, this is all very nice, but how about cleaning of this exercise, and for good reason. However, in this case, we can report that head cleaning is really not difficult. The heads are placed right up front and there is a detachable cover which helps a lot, as does a mirror mounted at the rear.

NOW...an AUDIO exclusive:

This timely **SOUND ADVICE** suggestion: A Comprehensive Guide to the Music/Record Business . . .

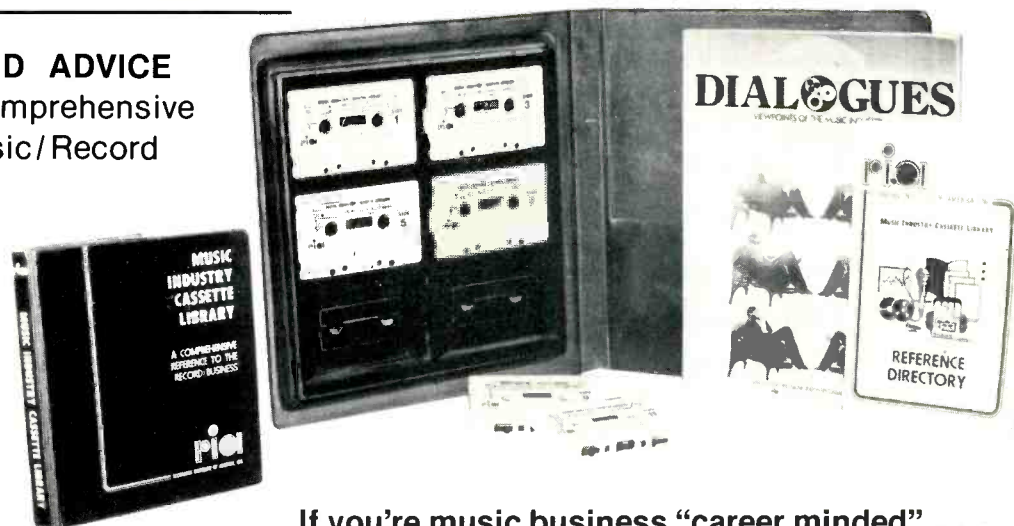

If you're music business "career minded" . . .

Hear the facts for yourself in taped interviews straight from the "pros"

Compiled from Recording Institute of America's interviews with key executives and "hit-makers", plus Reference Directory and Dialogue Viewpoints of industry "stars".

Listen to the industry "pros" describe the workings of the Music Business. Hear the most respected attorneys of the entertainment field define and discuss the legal terminology of Recording Contracts, Songwriter Contracts, Professional Management Contracts. Over 3½ hours of professional reference . . . could be the most important 200 minutes of your life!

Plus . . . RIA Reference Directory, including sample songwriter affiliation forms, sample artist contracts, writer contracts, etc., in addition to a Directory of Record Manufacturers, Music Publishers, Personal Managers, Producers and Booking Agents. Also **Record World's "Dialogues"** with over 50 candid interviews from **Record World** magazine, and a cross-section of "star" personality interviews.

You get all the above (regularly \$49.95) for only \$39.95 for Audio readers.

*Interviews include:

Pete Bennett Promotion, Apple Records
 Sid Bernstein Personal Manager and Promoter
 Rick Blackburn Dir. of Sales, Columbia Records
 Terry Cashman Pres., Cashwest Productions, Inc.
 Bob Cato V. P., Creative Services, United Artists
 Kip Cohen V. P., A&R, A&M Records
 Al Coury V. P., Production, Capitol Records
 Al DeMarino V. P., Music Department, CMA
 Tom Draper Dir., R&B, RCA Records
 Kenny Gamble Pres. & Producer, Phila. Int. Rec. Co.
 David Glew V. P., Marketing, Atlantic Records
 Barbara Harris Dir., Artist Relations, Atlantic Records
 Emil LaViola Prof. Mgt., Chappell Publishers
 Michael Martineau Booking Agent, Premier Talent
 Mark Meyerson A&R, Atlantic Records
 Barry Dslander West Coast Prof. Dir., Jobete Music Co.
 Richard H. Roemer Law Firm of Roemer & Nadler
 Alvin Teller V. P. Merchandising Marketing,
 Columbia Records
 Peter Thall Law Firm of Casper & Thall, P. C.
 Ron Weisner V. P., Artist Relations, Buddah Records

. . . and many others

10 DAYS FREE APPROVAL — MAIL TODAY

Book and Learning Systems Division
 NORTH AMERICAN PUBLISHING COMPANY
 134 North 13th Street, Philadelphia, Pa. 19107

Send me the complete "MUSIC INDUSTRY CASSETTE LIBRARY." If I decide to keep this after 10 days examination I will remit the purchase price plus postage and handling, or return it for cancellation of all charges.

Name (please print) _____

Signature _____

Firm or Inst. _____

Home Address _____

City, State, Zip _____

SAVE MONEY. My payment is enclosed. Publisher pays all postage and handling. Same money-back return privilege.

Technics has recently started "guaranteeing" its five most pertinent specifications, meaning that the unit will either meet or beat this level of performance. As we shall see, this means Technics is now being even more conservative in its ratings than previously. The firm is also actively encouraging owners to bring in their equipment for test and adjustment if they feel the unit isn't up to snuff, and the company is also distributing a booklet giving detailed descriptions of their test procedures and standards.

Now for a look at the controls. First, to the right of the "oven" is a set of six bar switches, two large ones for *Play* and *Stop*, and the others for *Fast Forward*, *Fast Reverse*, *Record* and *Pause*. Both the last-named show a visible indication and the *Record* button is unusual as it is not interlocked. In other words, the machine is ready for recording as soon as this button is depressed. You can, of course, set the recording level first as the VU meters are connected at this point. Above these controls are a digital counter and a memory switch, and to the right are two *Dolby* lever switches (I'll explain later) and a dual-concentric microphone input level control. Underneath is a large (very large) control knob that adjusts the recording levels for both chan-

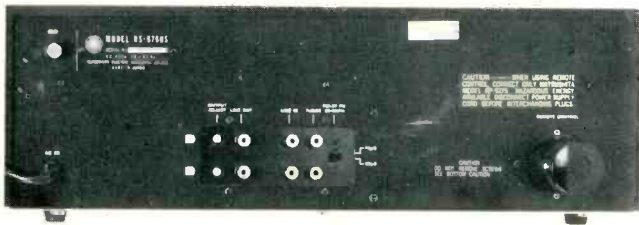

Fig. 1—Rear view of Technics RS-676.

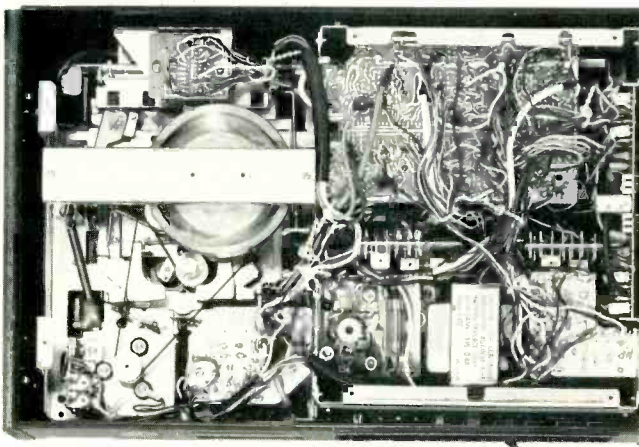

Fig. 2—Internal view of cassette deck.

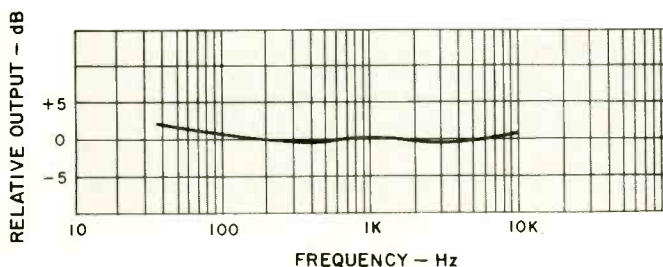

Fig. 3—Playback response using standard test tape.

nels and it is used with a balance control next to it. Further to the right is a three-position selector switch marked *Mic*, *Line-In/Mic*, and *Tuner-mic*. At the bottom is a *Tape Selector* switch for *Normal* and *CrO₂* tapes, two pre-set *Dolby* calibration controls, headphone and microphone sockets, plus the *On/Off* switch. The two VU meters are at the top and between them is a small push-button switch which changes the meter constants from average to peak values. There are two scales, one going up to +6 VU and the other calibrated in percentages with 100% corresponding to 0 VU.

At the rear are the usual *Line In* and *Line Out* sockets, two *Output* controls, a switch to change the *Dolby* de-emphasis constant from 75 μ S to 25 μ S and a socket for a *Remote Control* unit.

And now for some explanations. *Normal* on the *Tape Selector* switch refers to low-noise tapes such as TDK SD, TDK ED, or BASF SK. The *CrO₂* equalization is 70 μ S, instead of the older 120 μ S standard. Technics claims this provides worthwhile improvement in signal-to-noise ratio, which is indeed the case. If one has recordings made with the 120 μ S equalization, using the *Normal* position of the switch will give the proper equalization. The 676 is also equipped with an auto-switching feel tab which engages with the latest chrome cassettes to switch over to the correct equalization automatically. The reason there are two *Dolby* switches is because one is intended for FM recordings and it has a filter position attenuating the response above 18 kHz so the 19 kHz carrier will not upset the *Dolby* operation. Decoded signals can be taken from the cassette unit and fed to the amplifier if desired and the switch at the rear is for use when recording programs from FM stations using the new 25 μ S time constant (which will soon become standard). The

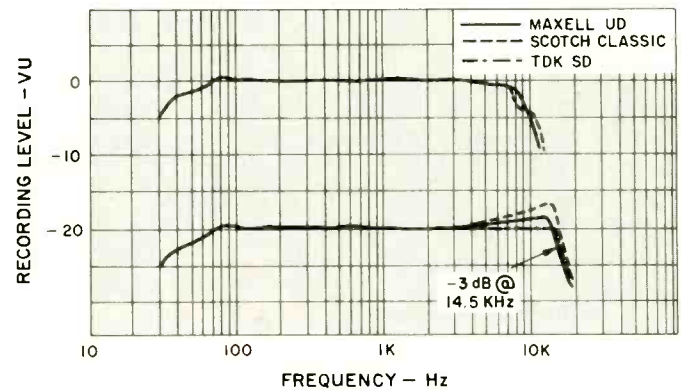

Fig. 4—Record/play response at 0 VU and -20 VU, with Maxell UD, and with Scotch Classic tapes.

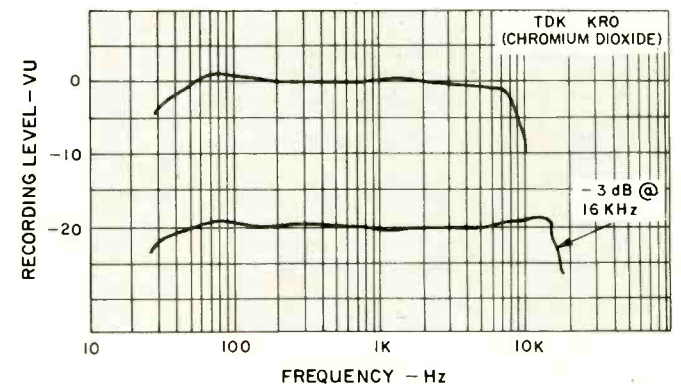

Fig. 5—Record/play response with TDK KRO tape.

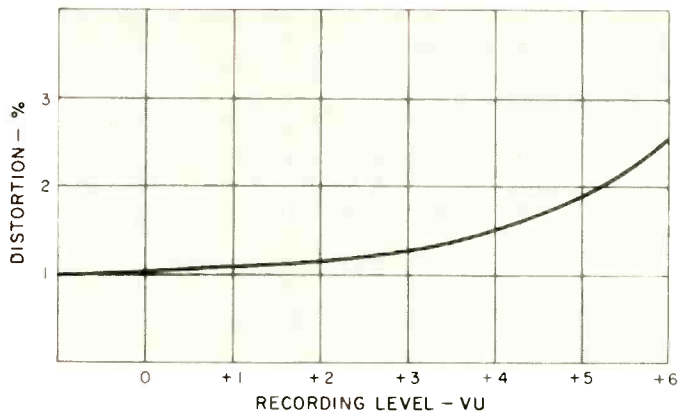

Fig. 6—Distortion at 1 kHz

Memory-Play switch is a little unusual, as it sends the tape back to a pre-determined point and then the tape doesn't just stop; it immediately goes into playback mode. Instant replay? Well, almost. The Selector switch—the one labelled Mike, Line and Tuner allows a microphone signal to be mixed with the inputs from a tuner or other source.

Tape functions are controlled by solenoids and special muting circuitry is employed to prevent switching clicks from being recorded. Two motors are used, an electronically regulated d.c. type for the capstan drive and another d.c. motor for the cassette drive. A photo-electronic automatic stop disengages the transport mechanism at the end of a cassette, regardless of whether the tape is in the fast-forward, rewind, or playback mode. It operates even if the a.c. power goes off.

Measurements

Figure 3 shows the playback response from a standard test tape, and Fig. 4 shows the Record/Play response with Maxell UD and Scotch Classic tapes. The latter is a hybrid ferric-chrome formulation and it really needs different equalization. As it is, its rather hotter top end response can be tamed by turning down the amplifier's treble control slightly during playback.

Figure 5 shows the response with CrO₂ tape. It will be seen that the upper response extends to 16 kHz. The specifications quote the 3 dB point for normal tape at 12 kHz and 13 kHz for CrO₂. Both were exceeded by a comfortable margin. The CrO₂ tape was TDK KROM, but similar results will be obtained with other makes as most use DuPont chromium dioxide. Distortion at 1 kHz measured 1.0% at 0 VU (see Fig. 6) increasing to 2.5% at +6 VU.

Distortion versus frequency is shown in Fig. 7, and here I also illustrate a problem I encountered. The VU meters are not linear with frequency. While it is not uncommon to tailor VU meter response to read higher at frequencies above 5 kHz or so, since this provides some safeguard against tape saturation, these meters read low below 100 Hz! Thus, an input signal level that produced a zero VU reading at 1 kHz would only cause the meters to read -10 dB at 50 Hz and if the signal were increased to make the meters read zero VU overloading of the tape would result. The upper graph (Fig. 7) shows the meter response and the lower curve indicates the distortion measured with a constant input level based on 0 VU at 1 kHz.

Input signal for 0 VU was 55 mV line, 80 mV tuner, and 0.26 mV microphone. Output under these conditions was 410 mV. Signal-to-noise ratio measured 52 dB, increasing to 62 dB with Dolby (DIN weighted, ref. 0 VU). The Dolby sys-

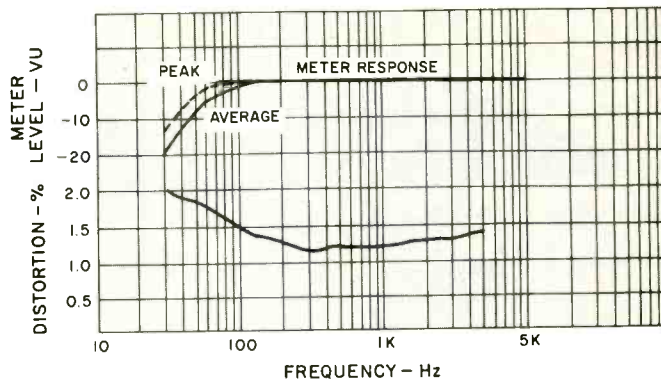

Fig. 7—VU meter characteristics (top) and distortion (bottom) versus frequency.

tem worked according to specifications with a tracking error of just over 1 dB. Wow and flutter was exceptionally low at 0.05% (DIN Record/Play) and speed clocked in at 0.4% slow. Finally, cassette rewind speed was 65 seconds for a C-60.

Listening and Use Tests

On test, the 676 was connected to a Soundcraftsmen PE 2217 preamp with a Phase-Linear 400, and discs were taped via a Thorens TD 125 Mk II with a Audio-technica AT20 phono cartridge. Unfortunately, we do not have a local FM station using a Dolby encoder (any time now!) but recordings were made from "normal" FM stations, records, and transfers from an open-reel machine. I found the single control recording arrangement very easy to use and I don't think there is any real danger of accidental erasure once you have got used to it. The VU meters were left in the peak indication mode for most of the time as this gave more accurate transient readings. Because of the well-designed transport system with its two motors, wow and flutter is as low as I have found with any cassette recorder. Indeed, it is comparable in this respect to an expensive open-reel machine. The signal-to-noise ratio is excellent, too. All-in-all the Technics RS-676 is a well-designed machine which will appeal to the most discriminating. It's not cheap at \$459.95, but you do get a lot for your money. George W. Tillett

Check No. 73 on Reader Service Card



MIKE EDDINGER

"Just think, my Fred is going to uphold the new Federal power-output ruling!"

Dynaco Stereo 400 Power Amplifier

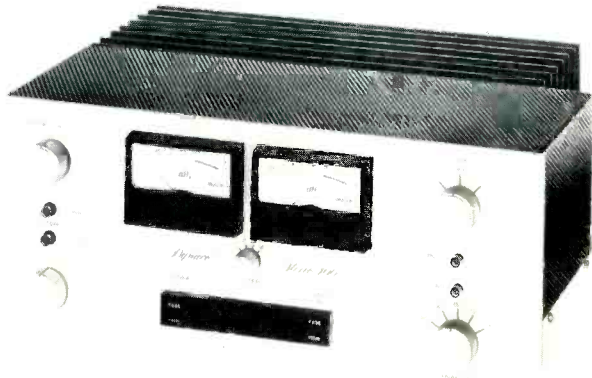

MANUFACTURER'S SPECIFICATIONS

Power Output: 200 watts per channel, both channels driven into 8-ohm loads at any frequency from 20 to 20,000 Hz with less than 0.25% total harmonic distortion; 300 watts per channel at 4 ohms; 100 watts per channel at 16 ohms, 600 watts at 8 ohms, monophonically. **Intermodulation Distortion:** Less than 0.1% at rated output for any combination of frequencies between 20 and 20,000 Hz. **Frequency Response:** 20 to 20,000 Hz ± 0.5 dB at rated output. **Input Impedance:** 50 K ohms. **Input Sensitivity:** 1.6 volts. **Hum and Noise:** 100 dB below full output, 20 to 20,000 Hz. **Damping Factor:** More than 80 up to 1 kHz, 8 ohms; more than 30 up

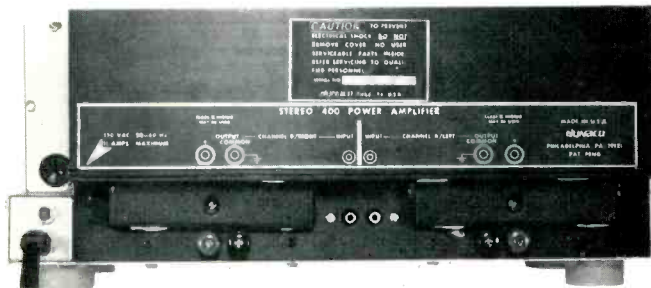

Fig. 1—Rear panel of amplifier.

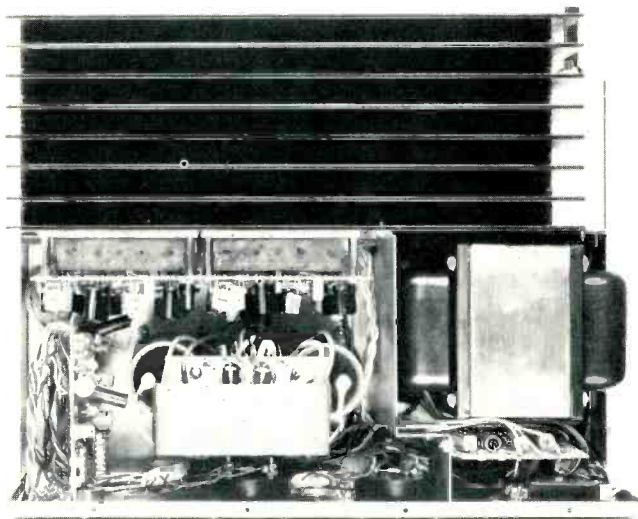

Fig. 2—Interior view.

to 10 kHz. **Dimensions:** 17 in. W. x 14 in D. x 7 in H. **Weight:** 52 lbs. net. **Power Consumption:** 11 amps maximum. **Price:** Factory wired, \$669.00; with meters, \$769.00; as kit, \$499.00; meter kit \$85.00.

The Dynaco stereo 400 is a rugged, solidly-built 200-watts-per-channel power amplifier. The units reviewed were one wired by the factory with MC-4 optional meter and a kit, built but not measured. Most of the circuitry is on printed boards with considerable hard wiring interconnecting the various boards, front-panel controls, and output transistors. The heat sink on this amplifier is very large and quite effective; it is made of eight $\frac{1}{8}$ -in. thick, black-anodized, extruded aluminum fins.

Front-panel controls consist of two input-gain controls, high- and low-cut filter switches, a four-position meter-sensitivity switch, a five-position Dynaguard control switch, and a three-position (On/Off/On) phase-reversing power switch. Also on the front panel are the two output meters, two speaker fuses, and Dynaguard indicator, overtemperature and pilot lamps. The back panel has RCA input jacks and a pair of dual binding posts for the speaker connections.

While usefully large, the output meters on this amplifier might have been more attractive if they were flush mounted and a bit further apart as on some other amps. I have to admit this is a matter of taste. The zero dB power markings for this meter system are 156, 78, 20, and 5 watts into 8 ohms. The ranging and marking system this reviewer would have preferred to see is a watts scale, with rated power into 8 ohms marked zero dB, and a range switch which changes meter deflection in 10 dB steps, i.e. full power, 10% of full power, 1% of full power, etc. With this scheme, no conversion of relative dB to power is required.

Circuit Description

Figure 3 shows a block diagram of the main power amplifier section of the Dynaco 400. The differential input amplifier shown in the diagram is preceded by a gain-of-one isolation amplifier, whose purpose is to lightly load the 100 K input level control and provide a low output impedance to drive the high- and low-cut filters and the Dynaguard output-power limiter. The filters are two-section passive RC types and provide ultimate attenuation of 12 dB per octave with normal cutoff frequencies of 50 Hz and 15 kHz. Q1 and Q2 form a differential input pair fed by constant-current source Q3. The push-pull (differential) output of Q1 and Q2 is fed into the input of the second differential amplifier, Q4 and Q5. The output of Q5 has the proper phase to drive the output stage, which is effectively a complementary emitter-follower.

The usual practice at the predriver point in a power amp would be to have a bootstrapped resistive collector load for the predriver, or a transistor current source. Neither of these options uses the opposite-phased signal which is available at the collector of Q4 which would be tied to signal ground. The 400 uses this signal phase, coupling it through a common-base voltage-translator stage, Q6, up to the base of Q7, a common-emitter inverting stage. The collector of Q7 is connected down through the bias regulator to the collector of the predriver, Q5. This accomplishes two desirable objectives. The first is that both push-pull signal phases have been combined in a differential input to the single-ended output predriver circuit. Even harmonics generated in the first and second differential stages tend to cancel in the combined output. The second feature of the circuit is that the output of the predriver can drive the output stage equally hard in both directions. The disadvantage of this scheme is that the signal from the collector of Q4 has to pass through two more potentially distorting devices before it

combines with the output of Q5.

The bias regulator circuit, consisting of Q8 and Q9, provides a temperature-compensated voltage difference between the two input drive lines to the output stage. It is a two-stage-shunt voltage regulator instead of the more usual single transistor or diode circuit.

The output stage is effectively a complementary emitter-follower with complementary emitter-follower drive. The composite NPN and PNP output and driver devices are made up of two series-connected transistors to increase the safe operating area. The upper driver bases of Q12 and Q15 are driven off voltage dividers from the amplifier output buss up to the respective supplies, plus and minus, for Q12 and Q15 respectively. The action of these dividers causes the instantaneous voltage across the series pairs to be divided about equally between the series devices. Overall negative feedback is applied from the output to the inverting input of the input stage, the base of Q2.

Dynamic voltage/current limiting is accomplished by shunting the output stage drive lines to the output buss through limiting transistors Q10 and Q11. Both voltage and current of the output stage are sensed and applied to the bases of these limiter transistors.

This amplifier has, in addition to dynamic EI protection of the output stage, a number of other protective circuits that protect both the load and the amplifier. These include fuses in the amplifier output lines, fuses in the B+ supply lines in both channels, the input high- and low-cut filters which keep excessive subsonic and supersonic energy from entering the amplifier (when switched in), a time-delay and output d.c.-detection circuit, and the Dynaguard power-output limiter circuit.

The time-delay and d.c. detector circuit provides a turn-on time delay which keeps the speaker relay open long enough to prevent turn-on thumps. If the output line of either channel exceeds a nominal plus or minus 1½ volt d.c., a comparator circuit that senses the output line d.c. level will open the speaker relay and thus protect the speaker from potentially destructive d.c. voltages.

The Dynaguard power limiter circuit operates by reducing the instantaneous peak value of the input signal to the power amplifier. Limiting action commences after a time delay that depends on how much greater the output signal is than the power limit selected. The greater the output power compared to the selected power limit, the shorter the time delay before limiting commences. This delay allows short signal transients to pass unaltered up to the clipping power of the amp while holding the average continuous power to the preselected value or less. The front-panel control switch has five positions: *Off, 120, 80, 40* and 20 watts. When limiting takes place, front-panel indicators (located between the speaker fuses) light up.

The power supply consists of a large power transformer, bridge rectifier, and two 10,000 μF, 80 V capacitors. The ±75 V d.c. developed for the power amp is reduced by Zener regulators to ±13 volts for the Dynaguard circuit and the input buffer amp.

Kit Builder's Note

Since I'd previously put together a number of kits, I was not surprised to see how thoroughly the manual detailed assembly and wiring, theory of operation, tests prior to plug-in, and tests and checks for qualified technicians. The 40-page manual even included a quick course on soldering,

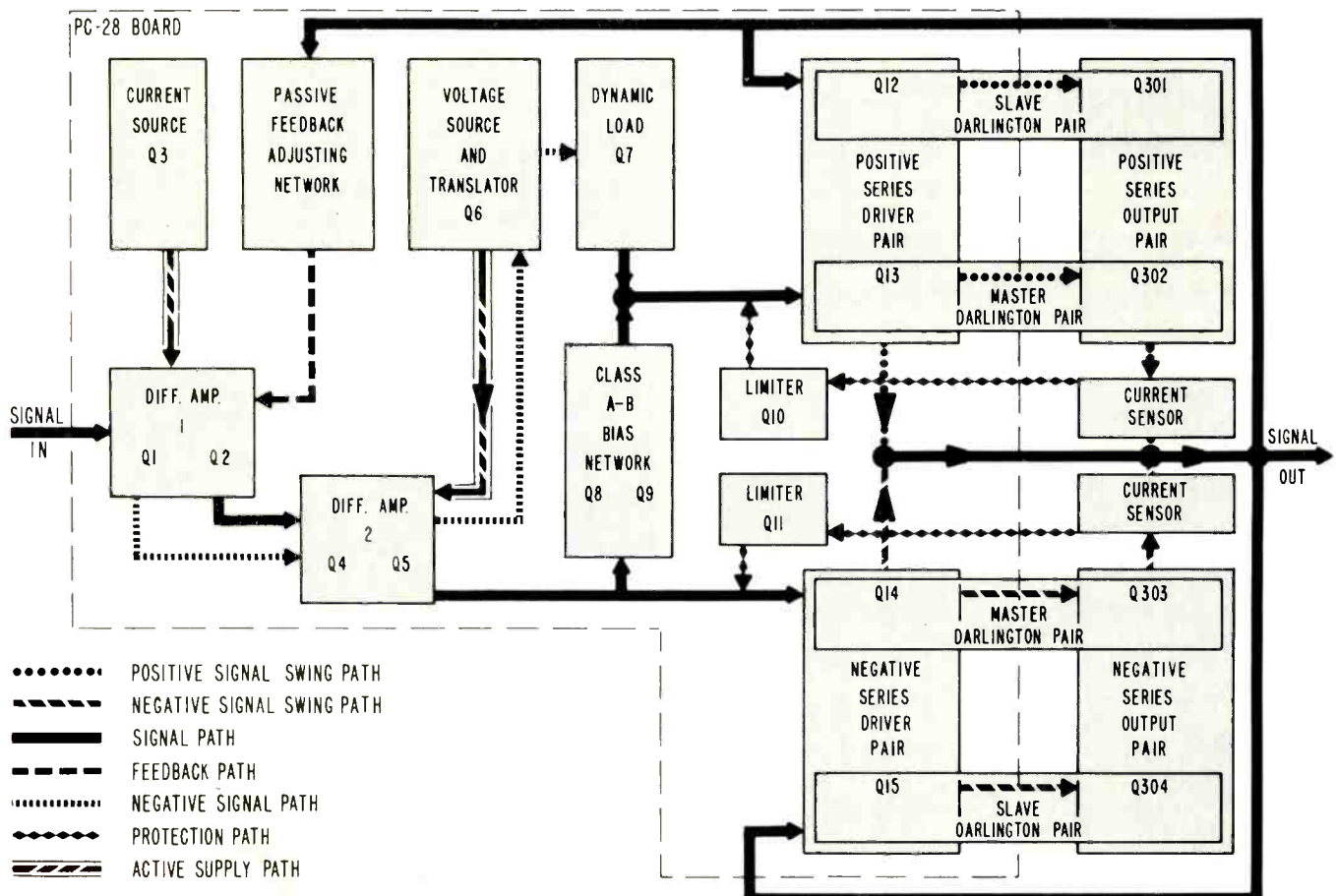

Fig. 3—Block diagram of main power amplifier section.

though I wouldn't recommend anyone put this kit together until he'd assembled at least one somewhat simpler project. I'd also recommend that anyone who's not good at soldering, practice soldering several wires compactly to a lug before attempting that job in this kit. The company supplies a 2-x-3-ft. pictorial diagram printed in five colors, showing exactly where every wire and part goes.

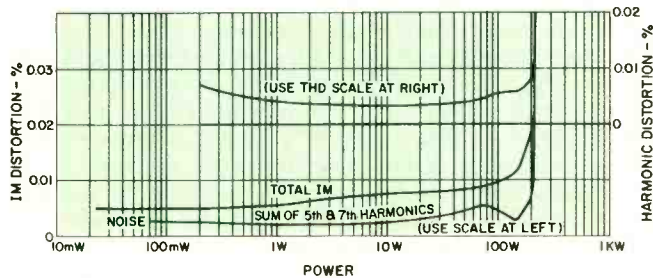

Fig. 4—Harmonic and intermodulation distortion vs. power output, 1 kHz, 8 ohms.

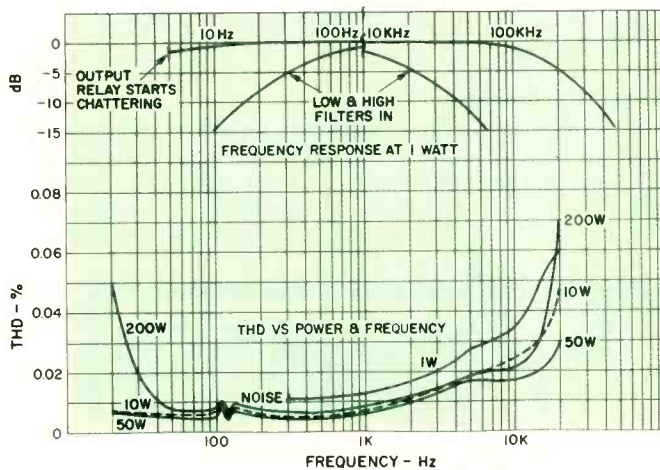

Fig. 5—Frequency response (top) at one watt, with filters in and out (note that spectrum from 100 Hz to 10 kHz is omitted). Lower curves show distortion vs. power and frequency.

About 99% of the small components (resistors, capacitors, transistors, and integrated circuits) were already mounted on the four printed circuit boards. The only major parts not so mounted were the very heavy power transformer, two 10,000 μ F power supply capacitors, the protective relay, big circuit breaker, a.c. power switch, input gain controls, and attenuator switches, plus the rear terminal panel, the gold-finished front panel, black perforated metal cover, and the massive heat sink (the biggest in the business, Dynaco says) for the power output transistors.

Altogether there were 14 pages of instructions, and the total number of wiring and assembly steps were 212. Conveniently broken down into some five sections, each took three to four hours. Total time, not counting the hour or so of familiarization nor troubleshooting time at the end, was 19 hours. Someone less at home with a soldering iron would take longer.

The actual assembly and wiring went rather smoothly, in great part because the pictorial diagram is so clear that one could almost put the kit together just using that. Working from the step-by-step instructions, and referring each time to the pictorial diagram, made it quite straightforward.

The only tools needed were a pair of diagonal cutters for cutting and stripping the wires, a pair of long-nose pliers for reaching into close quarters, a medium-sized screwdriver, and a soldering iron. Dynaco supplied solder and six hanks of different colored wire.

When I'd completed the assembly and wiring I went through the preliminary tests Dynaco includes. I found that I had a *dead short* in one channel. Quickly consulting the instructions *In Case of Difficulty*—(what to do for) *Failure In Preliminary Tests*, I found I had one diode wired in backwards (not the cause of the short) and a splash of solder which was shorting part of one PC board to one ground terminal. Correcting these errors enabled the amplifier to pass the preliminary test steps, and connecting up the other components, I had sound! How does it sound—awesome. . .

Summing up, this is a project most people could successfully accomplish, much like other Dynaco or Heath kits. I would recommend it only to those who have put together at least one other kit previously and who can be extremely careful in following the instructions to the letter (this applies to all electronic kits). There is nothing esoteric about the assembly or the wiring, even though the circuit is quite

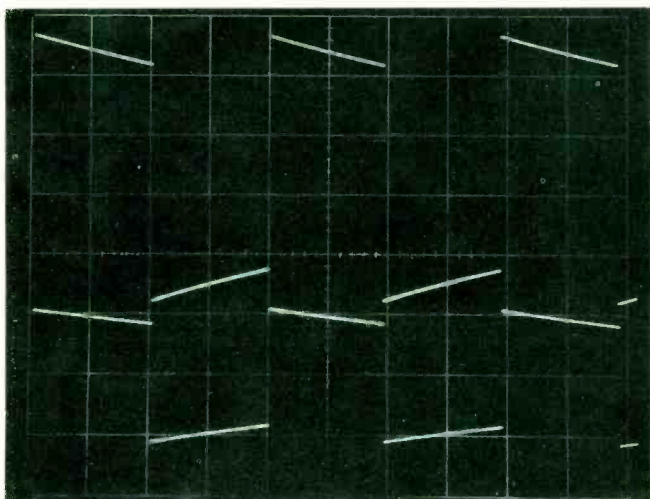

Fig. 6—10-volt (p-p), 50-Hz square wave output, 8-ohm load. Top shown at 20 V/cm; bottom, 5 V/cm.

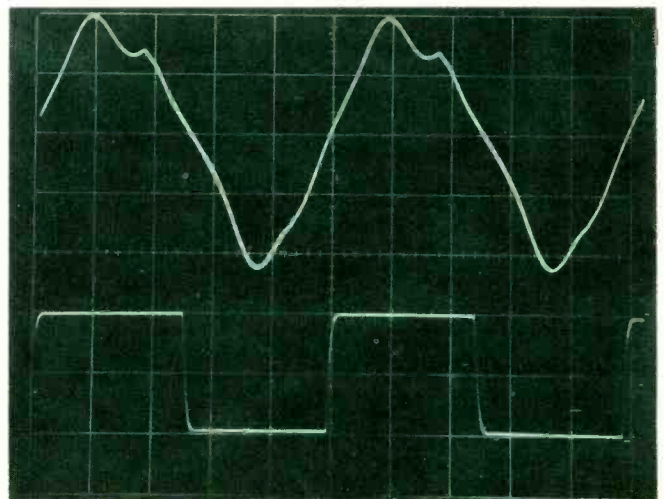

Fig. 7—10-volt, 20-kHz square wave output, 1 μ F load (top). 10-kHz output, 8-ohm load (bottom).

sophisticated and the unit physically big, and heavy (52 lbs, net).—C.G.

Listening Tests

The Dynaco 400 was compared aurally to a number of other fine solid-state amplifiers. Cartridges used for record listening were a Supex SG-900 and a Fidelity Research FR-1 Mk II going through a tube-type phono preamp, specially made by the reviewer, which has the extra gain needed for use with low-output moving-coil pickups.

Overall, the sound of the 400 is as good or better than most of the 150- to 300-watts/channel amps available, though at times some of the other amps were able to score points in handling certain sorts of difficult material. Bass was tight and defined and generally was at least as good that produced by these other amps. The midrange and high end were quite good, though the amp was judged at times to have a bit of graininess and edginess and thus not as sweet and clean as might be desired.

Editor's Note: *Dynaco informs us that a very recent change in the value of the resistor R305 to 1.8 ohms reducing the Q of the output inductor-resistor combination effects an improvement in high-end sound quality. This is easily made on existing Stereo 400s by adding a 2.2 ohm resistor (2 W. min.) in parallel with each output inductor (choke coil assembly) on top of the relay mounting plate. This will also noticeably improve the square wave trace into a capacitive load, especially at low drive levels.*

Measurements

The first test run on the Dynaco 400 was the FTC power test, running at 1/3 rated power with a 1 kHz test signal for one hour. This test was passed with flying colors and is a tribute to the excellent heat-sink design of the 400.

Voltage gain into a 8-ohm load was measured and found to be 26X, or 28.3 dB, with the input controls set at maximum.

IM distortion and THD at 1 kHz versus power output are shown in Fig. 4. Both THD and IM are satisfactorily low. THD versus frequency and power is shown in Fig. 5. The ripples in the curves near 120 Hz are due to a small amount of beating between the signal frequency and 120 Hz harmonic of the power supply. Also shown in Fig. 5 is the one-watt frequency response. This was not measured below 5 Hz as the speaker relay started to chatter at about 5 Hz because these

low frequencies begin to appear as d.c. to the comparator circuit which controls the output relay.

Scope photos of the amplifier response with different frequencies and loads are shown in Figs. 6 through 9. 50 Hz and 10 kHz square waves with 8-ohm loads at 10 V p-p are good, generally about the same as other top-rated amplifiers we've tested. The 10-kHz, 10-V square wave with a 2 μ F capacitive load is typical of most solid-state power amps with LR output buffer networks.

The large signal 50-Hz and 20-kHz square waves into 8-ohm loads are excellent. In particular, the symmetry of the 20-kHz response is an excellent commentary on the use of the differential input to single-ended converter predriver stage. The large signal response with capacitive loads isn't as good, as evidenced by the somewhat slower slew rate on the 10- and 20-kHz square waves with 2 and 1 μ F loads. The 400 was not able to deliver a full 200 VA and 20 kHz and at slightly over 100 VA exhibited about 1 percent THD.

Output noise as a function of measurement bandwidth is shown in Table I, with both high and low filters in and out. Damping factor was slightly greater than 80 from 20 Hz to 1

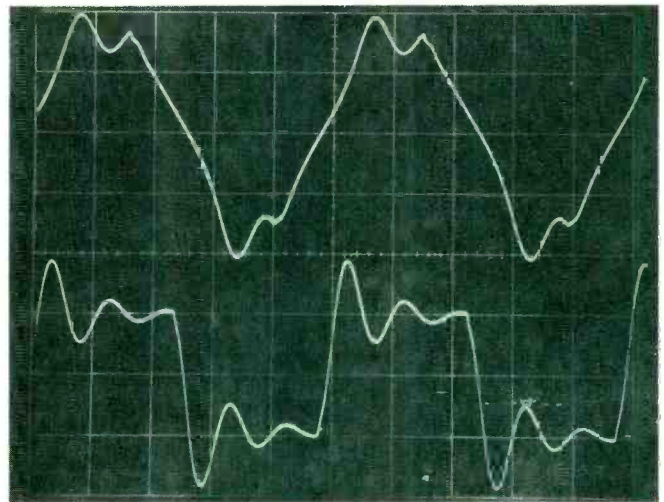

Fig. 8—10-volt, 10-kHz output, 2 μ F load. Top shown at 20 V/cm.; bottom, 5 V/cm.

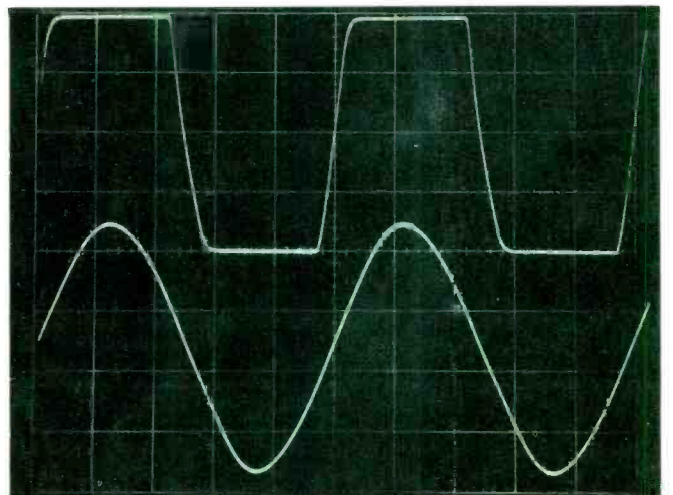

Fig. 9—10-volt, 20-kHz output, 8-ohm load (top). 30-volt, 20-kHz output, 1 μ F load; 1% THD (bottom).

Table I—Output Noise (microvolts)

| Filters Out | Left | Right |
|------------------|------|-------|
| 20 to 20,000 Hz | 238 | 210 |
| 400 to 20,000 Hz | 140 | 90 |
| Filters In | | |
| 20 to 20,000 Hz | 230 | 150 |
| 400 to 20,000 Hz | 130 | 75 |

Table II—Dynaguard Limiting (watts)

| Switch Setting | Power Needed to Maintain Limiting | Power Needed to Light Indicators |
|----------------|-----------------------------------|----------------------------------|
| 20 | 14.6 | 15.7 |
| 40 | 24.5 | 30.0 |
| 80 | 56.2 | 63.3 |
| 120 | 98.0 | 105.1 |

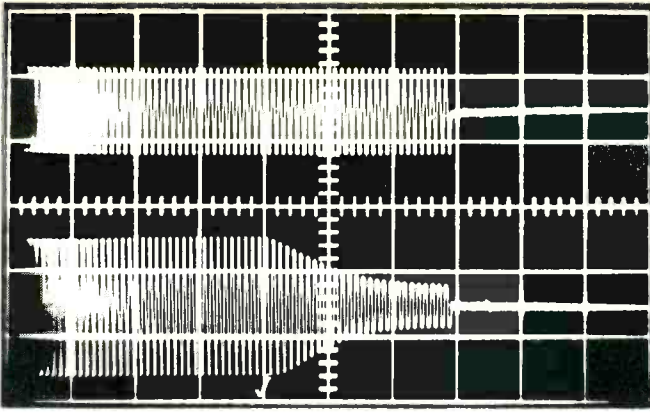

Fig. 10—Input (top) and output (bottom) 90 Hz signal, 100-watt output level, showing Dynaguard action at 20 position. Total time, 1 second.

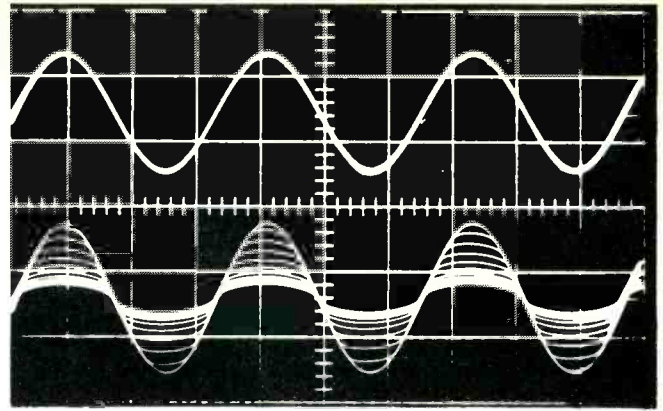

Fig. 11—Input (top) 150 Hz signal. Bottom traces show progressively smaller output as Dynaguard at 20 setting reduces output from full 200 watts to one-fifth that level.

kHz, decreasing smoothly to 33 at 10 kHz and 19 at 20 kHz.

Power output at on-set of clipping into 4-, 8-, and 16-ohm loads was 324, 221, and 132 watts, respectively.

The performance of the Dynaguard limiter was checked by noting the steady-state power that just sustained limiting and the steady-state power that caused the front-panel indicators to light, both as a function of power levels indicated on the front panel. In general, the power for maintenance of limiting was lower than that which caused the indicators to light and both were somewhat lower than the levels indicated on the front panel. Since the right channel's adjustments were off a bit, so that its limited power was somewhat lower than the left channel's, measurements for

Check No. 74 on Reader Service Card

the left channel only for 8-ohm loads are shown in Table II. 'Scope photos from the Dynaco manual, indicating some of the dynamics of the Dynaguard limiting action, are shown in Figs. 10 and 11.

To sum up, the Dynaco 400 is another good performer in the 200-watts-per-channel class. Its overall sound is good, and its protective features make it difficult, if not impossible, for someone to blow this amp or a speaker connected to it. Considering the 400's price and performance, particularly when purchased as a kit, this unit represents good value. If one desires an amp in this power class, the Dynaco 400's performance and features should be considered.

Bascom H. King

BASIC BLACK

THE DAYTON WRIGHT MODEL SPS Mk.3



A sophisticated state of the art ultra high definition preamplifier designed for the audiophile who can accept no compromise in his sound system. Write to us for specifications and the names of exclusive dealers who can show you this and other Dayton Wright quality components.



**DAYTON
WRIGHT**
ASSOCIATES LIMITED

P.O. BOX 419, THORNHILL, ONTARIO, CANADA. L3T 4A2

Designers and Manufacturers of Electrostatic Loudspeakers, Graphic Equalizers and Professional Studio Equipment.

Check No. 5 on Reader Service Card

Canby's Capsules

Edward Tatnall Canby

Clazzics?

(Note: Musical categories are breaking up fast—I get all sorts of clazsic oddities for review, and try them too—you never can tell. And not all that's new is *Third Stream*. Gershwin and Joplin now rate as Red-Seal-type classic—that's why they send 'em to me. E. T. C.)

Gershwin Plays Rhapsody in Blue, other works. Klavier KS 124, stereo, \$6.98.

Gershwin's own piano version, from 1925 Duo-Art piano rolls—and only one nagging question: are tempi correct, speeds right? He plays remarkably fast and lightly. In 1925, they *should* have had good regulation, yes? An important point. Backside has typical G. Gershwin short arrangements, mostly of others' music in his stylings.

George Feyer plays the Essential Gershwin—40 beloved melodies. With rhythm acctpt. Vanguard Twofer VSD 61/62, stereo, \$6.98.

Feyer is an old-time cocktail-lounge entertainer (born in Hungary, studied classical) and his Gershwin is very much that way, expertly fingered but casual and not too obtrusive, hi-level background music. The tunes are in continuous "suites," run together; string bass and drums add a good touch. Probably best for your own partying, but listenable too.

Gershwin: An American in Paris; Rhapsody in Blue. Vivian Rifkin, pf., Vienna Symphony, Dean Dixon. Olympic 8121, stereo-QS, \$6.98.

This Everest-offshoot disc is marked stereo and QS—is this to be regular policy? My dating puts it maybe pre-stereo, out of the first heady tape-LP days, Americans in Vienna, LPs right & left. Dixon (Black, American) puts good life into the alien orchestra but Rifkin's piano is tensely classical, not good Gershwin—also too distant. Labels are reversed.

SECRETS FROM THE AUDIO FILE

Wanna dirty recording?



ADVICE FROM: Hugh B. Davies, recording engineer, Capitol Records, Inc.

PROBLEM: No one wants dirty recordings. They sound flat, dull, lifeless. The problem could be all in your heads. Dirty. Dirty. Dirty. Oxide shedding of 20 millionths of an inch—on invisible film no thicker than a fingerprint—can affect cassette performance by as much as 6 db at 10 KHz. If you record dirty and play back dirty, you could lose as much as 12 db.

RECORDING TIP: Keep a clean machine. Inspect and gently clean recording heads, capstan and pinch roller before recording. Every time. Clean them every 4 to 10 hours of playback time. The safest cleaner is isopropyl alcohol on a cotton swab. It's cheap. Sold at drugstores. And, because it dissolves away deposits instead of scraping, you can't clean too often. To move the cassette heads forward for easy cleaning, fool the machine into thinking it's playing. Press the "play" button (and interlock, if machine has one).

TAPE TIP: Those problem deposits are oxide debris from your recording tape. Switch to The Music Tape by Capitol. Its heavy duty binder prevents oxide shedding. So there's less gunk. (No bunk.)

When you record ordinary things, use an ordinary tape. But when you record music, record on

the music tape™
cassette • cartridge • open reel

BY CAPITOL



CAPITOL MAGNETIC PRODUCTS

A DIVISION OF CAPITOL RECORDS, INC.

REG. TM OF CRI LOS ANGELES, CALIFORNIA 90028 • A MEMBER OF THE EMI GROUP TM OF EMI LIMITED



Check No. 4 on Reader Service Card

Advertising Index

| Advertiser | Page | Advertiser | Page | Advertiser | Page |
|--|------|--|------|--|------|
| Acoustical Mfg. | 60 | Koss 5 | | Revox 4 | |
| Amplifiers | | Electrostatic Speaker | | Beyer DT-48 Headphones | |
| Write Direct to Advertiser | | Check No. 8 on Reader Service Card | | Check No. 48 on Reader Service Card | |
| Audio Dynamics Corp. | 17 | Lee West Inc. 57 | | Rhoades & Co. 69 | |
| Cartridges | | Lee Music Chair | | Teledaptor | |
| Write Direct to Advertiser | | Check No. 9 on Reader Service Card | | Write Direct to Advertiser | |
| Bell & Howell Schools..... | 8-11 | Logic Newsletter 68 | | Ruxton Electronics..... 62 | |
| Correspondence Courses | | Sample Copy | | Speaker and Amplifier Kits | |
| Write Direct to Advertiser | | Write Direct to Advertiser | | Check No. 21 on Reader Service Card | |
| Bose Corp. 64 | | Marantz Co. Cover 3 | | SAE, Inc. 58 | |
| 1800 Amplifier | | Imperial 8 Speaker System | | High Fidelity Components | |
| Write Direct to Advertiser | | Check No. 43 on Reader Service Card | | Check No. 22 on Reader Service Card | |
| Bozak 63 | | Maxell 26 | | Sansui Electronics 14, 15 | |
| Speaker Systems | | Recording Tape | | Receivers | |
| Check No. 2 on Reader Service Card | | Check No. 11 on Reader Service Card | | Check No. 23 on Reader Service Card | |
| British Industries Co. 3 | | McIntosh Lab 61 | | Saxitone Tape Sales..... 70 | |
| Turntables | | Free Catalog | | Recording Needs | |
| Check No. 3 on Reader Service Card | | Check No. 12 on Reader Service Card | | Write Direct to Advertiser | |
| Capitol Magnetics..... 51 | | Nakamichi Research 41 | | Schwann Record & Tape Guide..... 65 | |
| Recording Tape | | 550 Cassette Recorder | | Sample Issues | |
| Check No. 4 on Reader Service Card | | Check No. 13 on Reader Service Card | | Write Direct to Advertiser | |
| Dayton Wright 50 | | PAIA Electronics 64 | | Sherwood Electronics..... Back Cover | |
| SPS Mk. 3 Preamplifier | | Synthesizer Kits | | S7244 4-Channel Receiver | |
| Check No. 5 on Reader Service Card | | Check No. 14 on Reader Service Card | | Check No. 24 on Reader Service Card | |
| Discwasher 2 | | Phase Linear 18 | | Shure Bros. 27 | |
| Record-Cleaning Devices | | High Fidelity Components | | Cartridges | |
| Write Direct to Advertiser | | Check No. 15 on Reader Service Card | | Check No. 25 on Reader Service Card | |
| Dokorder 21 | | Philips A-V Systems Corp..... 37 | | Sound Technology Research..... 16 | |
| 7140 Tape Deck | | High Fidelity Components | | Speaker Systems | |
| Check No. 6 on Reader Service Card | | Check No. 16 on Reader Service Card | | Check No. 26 on Reader Service Card | |
| GTE Sylvania 13 | | Pickering & Co. 23 | | Tannoy 39 | |
| RS4744 Receiver | | Cartridges | | Turntables | |
| Check No. 27 on Reader Service Card | | Check No. 17 on Reader Service Card | | Check No. 28 on Reader Service Card | |
| Great American Sound 58 | | U.S. Pioneer Electronics Cover 2, 1 | | TEAC 35 | |
| Preamplifier | | Tape Decks | | 450 Cassette Recorder | |
| Check No. 7 on Reader Service Card | | Check No. 18 on Reader Service Card | | Write Direct to Advertiser | |
| Hi-Fi World News 71 | | Polk Audio 59 | | Teletronics 59 | |
| Free Test Reports | | Model 9 Speaker | | Construction Plans | |
| Write Direct to Advertiser | | Check No. 19 on Reader Service Card | | Check No. 29 on Reader Service Card | |
| IMF Products..... 62 | | RTR Industries..... 61 | | United Audio 7 | |
| Loudspeaker System | | HPR12 Magnum Speaker | | Dual Turntables | |
| Check No. 10 on Reader Service Card | | Check No. 20 on Reader Service Card | | Check No. 30 on Reader Service Card | |
| | | Recording Institute of America 43 | | | |
| | | Music Industry Cassette | | | |
| | | Write Direct to Advertiser | | | |

Classical Reviews

Edward Tatnall Canby

Symphony No. 2: Charles Ives. Philadelphia Orch., Ormandy. RCA ARDL 0663, CD-4, \$6.98.

Good! This is early Ives, written around 1900 or so, though its first performance seems to have been Bernstein's broadcast of a half century later, which old Ives heard at home on a kitchen portable radio. There is mostly a lot of very pleasing writing like Brahms and his ilk, but intimations of the later Ives' individuality abound—they surely rated as clumsy faults in his day. The first two movements, fill up side 1, they are the parts that will get your musical ear.

A lovely, gentle, sweet quality of melody, the best of the Ives inner radiance, which manages to get through even his most raucous later works if you play enough of them. He was human! In the rest of the symphony you will find the usual collection of dis-a and data, old familiar tunes worked carefully into the somewhat academic fabric, this being a piece written while he was still trying to impress the powers that be. Ives soon gave *that* up. Ormandy fits it perfectly and so does his Philadelphia Orchestra.

Violin Concerto in D. Saint-Saëns; **Introduction and Rondo Capriccioso:** Tchaikovsky. Eugene Fodor; New Philharmonia Orch., Leinsdorf. RCA ARD1 0781. CD-4 quadraphonic, \$6.98.

Chez RCA these days, CD-4 seems to mean Tchaikovsky. Eugene Fodor, who plays this one, is 24, looks like Jagger and won one of those Contests in Russia. He plays just as you might expect. A fabulously easy technique, accurate, agile, the music always in tune and the rhythm correct—he's the contest-winning type all right. But his music is as bland as his wrinkle-free face; his styling (as it should be) is according to the best models, but without personality. He sounds, in short, exactly the way he looks. A handsome, wide face without a wrinkle on it. If you enjoy this kind of youthful expertise, then this is for you. But there are much stronger, more personal performances else-

where. When Fodor gets to the more informal (but no less difficult) Saint-Saens, he warms up and comes through much more positively. But that is less than half of side 2.

Like the other Philadelphia CD-4s, this one makes a fine quadraphonic effect, with vast, easy ambience and the solo violin never too loud or too big for the quadraphonic projection. (Stereo—and mono—solos can sound like monsters when mixed for the quadraphonic space.) There's another RCA Fodor album (stereo), a batch of standard fiddle solo pieces, with piano.

Lemmens Vierne Dupré Widor. Michael Murray, organ at Grace Cathedral, San Francisco. Advent 5009, stereo, \$6.98. **Bach.** Michael Murray, von Beckerath organ, Columbus. Advent 5010, stereo, \$6.98. (Advent Productions, Box 635, Manhattan Beach, CA, 90266)

This young Michael Murray is an absolutely remarkable organist. Maybe he doesn't have the fastest feet and fingers in the Guild, but what he does have is an altogether unusual sense of organ style and appropriateness, over a range of organ music that is rarely all played well by one man. He is definitely for us, we who listen to music first and organ fingerwork second. So is the recording—very fine sound from Advent Productions in these two, though utterly different in impact.

Murray goes out and chooses his organs to fit the music. I first heard him in his excellent César Franck record (Advent 5007). Then comes the above French-school item, played on one of those monster big old-fashioned-style organs, the roaring sort. Amazing sound! Advent curiously has had to cut the disc at what seems a low listening level; but the VU meter tells you why: vast bottom-bass rumbles which make for very wide excursions, at not much volume, the ears being set up that way in all of us listeners. On the other hand, the Bach organ, which is a modern tracker (mechanical action) job out of the old

the great Escape



Cue up your favorite record, sit back, relax . . . suddenly you're surrounded by total sound. A spectacular and utterly different musical experience —

The Lee Music Chair.

The Lee Music Chair is a new version of the famous Lee Sound Chambers. Designed on the principle of the sound engineer's anechoic (echoless) chamber, it's the ideal relationship between listener and sound source.

Inside the chair, you enjoy full volume sound in an acoustically perfect environment. No speaker system in the world gives you such a sense of involvement. The world stays outside. Your sound stays inside. Family and neighbors remain undisturbed.

Best of all, the new Lee Sound Chair with ottoman is available factory direct to save you money. Total cost, chair and ottoman is only \$399 including shipping. Ask about our money back guarantee and 10 day free trial. Plan your escape, send now for an illustrated brochure on the Lee Music Chair.



LEE WEST, INC.

2824 Metropolitan Place
Pomona, California 91767
714/593-3531

name _____
address _____
city _____ state _____ zip _____

Innovation!



The Mark VIII FM Digital Tuner perpetuates SAE's leadership in FM digital tuners established by the SAE Mark VIB. Features include: A quartz-crystal-referenced digital readout using an L-E-D display; P-L-L (phase-locked-loop) multiplex; a five gang, MOS-FET front end, linear-phase monolithic IF filters; no-thump F-E-T muting and switchable de-emphasis for use with special noise reduction systems. We invite you to audition the Mark VIII from SAE—where innovation is a tradition.

SAE
*Components
for the
Connoisseur*

SAE, Inc., Dept. A575
P.O. Box 60271, Terminal Annex
Los Angeles, California 90060

Gentlemen:

Please rush free information on the Mark VIII
by return mail.

Name _____

Address _____

City _____ State _____ Zip _____

Check No. 22 on Reader Service Card

German Baroque, has the opposite effect—its sound is brilliant and crammed with overtones so that the audible level appears to be very loud. Interesting.

The First Congregational Church in Columbus has one of the finest big Baroque-type organs I've ever heard. Takes me back to a priceless recording among the earliest Capitol mono LPs, Bach via an older 78 recording, played on an organ at Potsdam, near Berlin, which was subsequently destroyed in the war. That organ had this same shiny, copper-brass sound. Try side 2 first. It takes some getting used to, but the impact is terrific and Murray is too good to be believed in his Bach—after all that French stuff!

Paganini: Violin & Guitar. György Terebesi, Sonja Prunnbauer. **Telefunken SAT 22548**, stereo, \$6.98.

Here's a lengthy documentation of this story we keep hearing—that Paganini's "second instrument" was the guitar, even if he was the greatest fiddle genius of all time and, supposedly, in league with the devil himself and his tricks, on that instrument. His published works, oddly, contain much more guitar music than violin. Here's a lot of it.

Well—I can't figure it out. It's happened on other recordings too. You never heard such bland nothing-music as this guitar stuff! Not a devil's trick in a carload. Mostly, the guitar just plays modest little chords, long, long rows of them, like a beginner's exercise. Once in a blue moon, a bit of melody line comes out. Hardly ever! The violin does all the work. The guitar barely accompanies. I think somebody just dreamed up all this talk about the "favorite second instrument" and everybody else is just copying it off, the way writers too often do.

Not that Paganini's music is ever very profound—just brilliant. But when you remove most of the brilliance, what you have is sort of skimmed milk. Very pure and lovely and it'll reduce you mostly to boredom.

I should also note, and speculate, that perhaps in the early 19th century the guitar's technique was actually *this much undeveloped*—they couldn't realize, back then, what we, in the great guitar age (including acoustic) have learned to do with what is essentially a very modest and basically simple stringed instrument. I think maybe here is the truth of the matter. All guitarists, then, should take a listen to this record, just to give themselves perspective on their own art. Makes you feel pretty good—better than a Paganini!

The Pre-Amp is Coming!

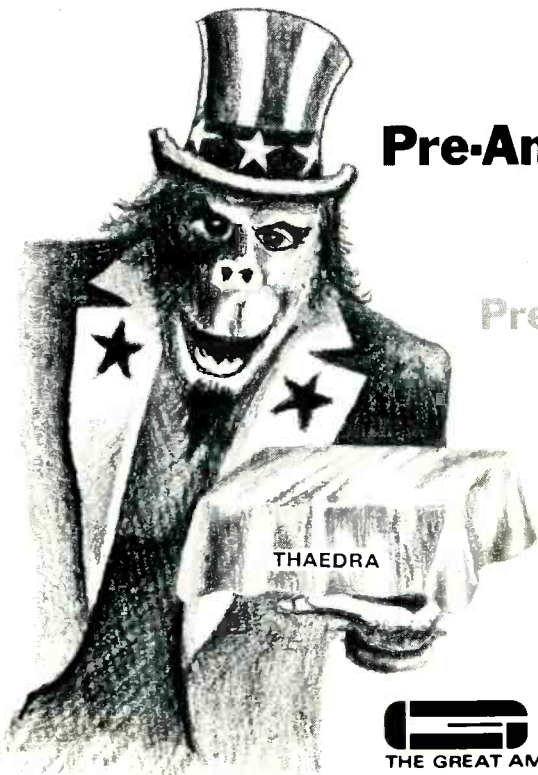

Pre-Amp is Coming!

Pre-Amp is Coming!

THAEDRA
THE GREAT AMERICAN SOUND COMPANY, INC.

8780 Shoreham Drive, W. Hollywood, CA 90069 - (213) 659-2486

Check No. 7 on Reader Service Card

Jazz & Blues

The New Quartet: Gary Burton.
Musicians: Burton, vibes; Michael Goodrick, guitar; Abraham Laboriel, bass; Harry Blazer, Drums.
Songs: *Open Your Eyes, You Can Fly; Coral, Tying Up Loose Ends, Brown-out, Olhos De Gato, Mallet Man, Four or Less, Nonsequence.*
 ECM 1030 ST, stereo, \$6.95.



At the Newport Jazz Festival in 1964 pianist Dave Brubeck with whom Gary Burton appeared, rhapsodized in his introduction of the now-famous vibraphonist. "Here is a young man who has achieved a level of competence and perfection on his instrument higher than most of us will in a lifetime." Brubeck went on to say, "He is a true virtuoso. It's an honor to play with him; there is no limit to what he may do in the future." I couldn't agree more. Gary Burton was 24 at the time.

Burton indeed is the artist supreme. It was he who initiated the fusion of jazz and rock with his original quartet featuring Larry Coryell. It was he who became the first jazz artist ever to record in Nashville, the seat of country music. And it was Gary Bur-

ton who won the 1972 Grammy Award for the Best Jazz Performance album *Alone At Last* (Atlantic S-1598). In short, Gary Burton is one of the most accomplished musicians I've heard. I cannot begin to say enough good things about him.

This album shows why, and it joins his two previous best efforts, *Duster*,

and *Alone at Last*. The choice of material is excellent, and Burton plays with three previously unknown musicians, who won't stay anonymous for long! They are guitarist Michael Goodrick, bassist Abraham Laboriel, and drummer Harry Blazer.

Open Your Eyes, You Can Fly by Chick Corea is an up-tempo number which finds Burton flitting all over his vibes, ranging far and wide and moving along with doe-like swiftness. Bassist Laboriel is quite discernible, plucking extremely low notes while guitarist Goodrick chatters away beneath him. Drummer Harry Blazer is intriguingly busy as well.

Keith Jarrett's *Coral* is a slow, lovely piece, a jewel wherein Burton's vibes resemble ringing chimes while drummer Harry Blazer makes good use of

Direct-Coupled



The Polk Audio Model 9 is a high-definition floor-standing system which employs many unique concepts in order to recreate the sound field of a live performance. A dipolar sound source, it combines an 8 inch passive radiator, four extended-range 4½ inch drivers, and the exceptional Polk Audio wide-dispersion, soft-dome high-frequency unit, without the use of distortion-introducing electrical crossover networks.

Price: Still \$165.00

Dealer Inquiries Invited

polk audio

4900 Wetheredville Road

Baltimore, Maryland 21207

(301) 448-2000

Check No. 19 on Reader Service Card

now available for the
 telephone experimenter

COMPLETE CONSTRUCTION PLANS

TELEPHONE PLANS: \$1.00 each.
 Answering Device, Automatic Dialer, "Black Box", Call Divorcer, Call Limiter, Conference Bridge, Central Dial Exchange, Melodic Ringing Generator, Recorder-Actuator, Remote Control, Schematics, Speakerphone, Teletalk, Burglar Alarm, Voice Scrambler, Dial/Tone Converter, Tone/Dial Converter.

MISC. PLANS: \$6.00 each.
 Biofeedback Conditioner, Multifrequency Encoder Network, Horticulture Simulator, Dodecahedron Speaker Enclosure, Photographic Pinhole Camera.

ALL OF THE CONSTRUCTION PLANS ABOVE: \$24.95 AIRMAILED.

PURCHASED MONTHLY LEARN THE SECRETS OF YOUR TELEPHONE PURCHASED MONTHLY



Have you ever wondered what lies behind that telephone dial? Now you can learn the tricks of the telephone trade. Get the inside story of telephone systems—their quirks and flaws, and remain up to date on vital occurrences within the telephone industry. TELEPHONE ELECTRONICS LINE is a publication designed for the telephone enthusiast, Phone Phreak, and experimenter, containing interesting articles which offer a wealth of hard to find information. Technical theory is also discussed, among the following items: **Current News Items • Code Numbers Illustrations • Games • Facts • Plans Projects • History • Comics • Stories Facts previously Tel. Co. confidential is now published in TEL!**
 One year subscription rate: United States \$6.00, Canadian & foreign \$8.00.

ALL OF THE CONSTRUCTION PLANS ABOVE PLUS A ONE YEAR SUBSCRIPTION TO TELEPHONE ELECTRONICS LINE: \$29.95 AIRMAILED.

THE LEGAL ASPECTS OF INTERCONNECTION

\$20.95 AIRMAILED
 The complete reference book to your LEGAL RIGHTS as a telephone subscriber. Study toll evasion, tariffs, wiretapping, customer provided equipment, and many more!

ALL OF THE CONSTRUCTION PLANS ABOVE AND A ONE YEAR SUBSCRIPTION TO TEL PLUS "THE LEGAL ASPECTS OF INTERCONNECTION": \$49.00 AIRMAILED.

TELETRONICS COMPANY OF AMERICA
 22035 BURBANK BLVD., WOODLAND HILLS CA 91364 USA

Check No. 29 on Reader Service Card

his brushes. It reminds me of **Undercurrent**, the recording pianist Bill Evans made with guitarist Jim Hall some years back. Burton and guitarist Goodrick complement one another so well, the latter playing a delicately incised solo here.

Quite a contrast to *Coral* is *Tying Up Loose Ends* with Burton changing the pace. This tune by Gordon Beck has almost a Bach fugue quality, the theme constantly being set down by one player while the others take off, improvising over him.

Brownout, by Burton, is fast, funky,

and jivey. It begins with Goodrick repeating a single phrase, then Burton coming in, and the entire group bouncing along over the drums, which serve as ballast for them. Laboriel takes an innovative solo here, his fingers flying like the wind.

Olhos De Gato, by Carla Bley, strikes a somber and pensive mood. Burton plays a minimum of notes here, sticking to the basic theme. The way he interweaves and resolves it is beautiful.

Mallet Man, by Gordon Beck, is absolutely brilliant. It is Burton at his

very best, and is my favorite of the eight tunes in this album. Taken at a furious pace, it has Burton skittering all over his vibes, guitarist Goodrick moving around and about his strings, and bassist Laboriel taking a remarkable solo. As if this isn't enough, drummer Blazer plays an excellent, complicated solo. I defy you not to move while you listen to this one. It will leave you with your tongue hanging out! And Burton rounds it out nicely, as he does all his tunes.

Two Mike Gibbs tunes, *Four or Less* and *Nonsequence*, show deeply contrasting moods. *Four or Less*, after a long, turbulent, seemingly introductory passage by all, has Burton going into a slow melody with guitarist Goodrick repeating a single phrase, then, playing the theme, an ascending melody. *Nonsequence*, by contrast, is extremely fast, and bassist Laboriel (who, in my opinion, is great) solos early on. Then Burton flies away with it.

The sound reproduction is superb throughout.

Gary Burton's technique is so complex that it defies explanation. He is talented, well ahead on his time, and by far the best on his instrument today. In addition his music is somehow always joyful.

This highly sensitive and compact group really has it all together. If you haven't already been exposed to Gary Burton and Friends, hear them now; if you already know them, this disc is indispensable for your Burton collection. Let them fill your ears for 45 minutes. I promise you will not regret it. *Martha Sanders Gilmore*

Sound A Performance A+

Charles Mingus: Mingus Revisited
Trip TLP 5513, stereo, \$5.98.

I have always admired the fierce, expressionistic jazz of Charles Mingus, but I enjoy it most when he tackles the music of Duke Ellington, whom he reveres. This album, reissued by Trip from sessions recorded by Mercury in 1960, might be more accurately titled *Mingus Visits Ellington*. While these performances are 15 years old, they stand up as a fresh, exhilarating look at the Duke's music by the volcanic bassist/composer/arranger/leader.

Because much of the album is anchored in Ellingtonia, the results are less of a musical maelstrom than one usually gets from Mingus. Two selections, *Do Nothing Till You Hear From Me*, and *Take the A Train*, are high tension reworkings of the Ellington

Again and Again and Again

Given the time, the patience, and the money, one can connect* fifty 303 amplifiers nose to tail so that the programme goes through one after the other gradually deteriorating along the way.

Deteriorating? The fact is that apart from a very slight background hiss — akin to a good tape recording — the programme will sound exactly the same at the end as when it started.

*Of course one must fit an attenuator to reduce the signal back to its original level between each amplifier.

Send postcard for illustrated leaflet to Dept.(AU)

Acoustical Manufacturing Co. Ltd., Huntingdon PE18 7DB.
Telephone (0480) 52561.

QUAD

Products of
the Acoustical Manufacturing Co. Ltd.
for the closest approach to the original sound.
QUAD is a Registered Trade Mark

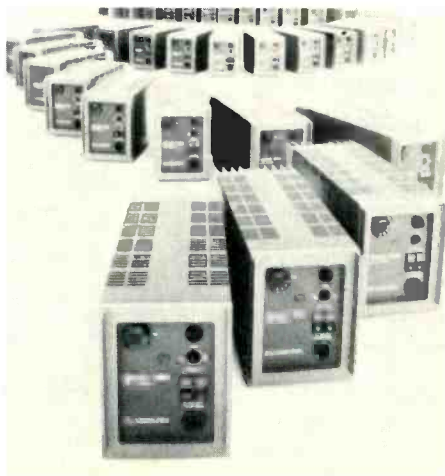

standards. *Do Nothing*, which romps at an unusual up-tempo pace, spots full-blooded, swaggering solos by tenor man Yusef Lateef and altoist Eric Dolphy, while *A Train* is a delightful piano romp by Roland Hanna. The ballad *Bemoanable Lady* is Ducal in character, with avant gardist Eric Dolphy, whose later work is filled with tormented, probing messages, surprising the listener with his mastery of the ballad. There are moments when he almost sounds like Johnny Hodges shorn of Hodges' lushness and heavy vibrato.

Half Mast Inhibition, which takes up most of side two, is an ambitious, three-part work showing the influence of Stravinsky and Ravel with traces of Ellington. But Mingus blends these elements with his own fresh melodies and textures into an original kaleidoscope of sound. It spotlights the bassist in a handsome solo, his rich, cello-like lines expertly woven into the fabric of this expansive and imaginative composition.

By contrast *Chazz Fingers* is straightforward (for Mingus) jazz that pulses with excitement provided by trumpet chase choruses (Clark Terry and Richard Williams), and an agile tuba that actually swings (Don Butterfield). *Weird Nightmare*, a bit of bluesy surrealism, has a so-so vocal by Lorraine Cousins compensated by a strong obbligatos and solos by Lateef on tenor and flute. All in all, *Mingus Revisited* is a handsome package and the stereo sound is first class.

John Lissner

Sound: A Performance: A+

European Jazzmen's Reference Book. Published by and available from European Jazz Federation, P.O. Box 671, A-1011 Vienna, Austria, \$4.

This 48-page, 9x9 in. booklet lists, country by country, European jazz musicians (by instrument), clubs, record companies and stores specializing in jazz, jazz associations and publications, radio and TV producers, and agents—all with detailed addresses and phone numbers. The Soviet Union is included, and there's a special listing of U.S. jazzmen resident in Europe.

What country has the most musicians? Denmark, by far. The most clubs? Germany, also by far. Though aimed at the professional and/or specialist, this handy reference guide will also prove useful to all jazz-minded tourists and travelers, though the record store listings are incomplete, not surprisingly.

Dan Morgenstern

FREE McIntosh CATALOG and FM DIRECTORY

Get all the newest and latest information on the new McIntosh Solid State equipment in the McIntosh catalog. In addition you will receive an FM station directory that covers all of North America.



MX 113

FM/FM STEREO - AM TUNER AND PREAMPLIFIER

SEND TODAY!

McIntosh Laboratory, Inc.
East Side Station P.O. Box 96
Binghamton, N.Y. 13904
Dept. 1

NAME _____

ADDRESS _____

CITY _____ STATE _____ ZIP _____

If you are in a hurry for your catalog please send the coupon to McIntosh. For non rush service send the *Reader Service Card* to the magazine.

Check No. 12 on Reader Service Card

RTR turns your tame receiver into a mighty tower of power.

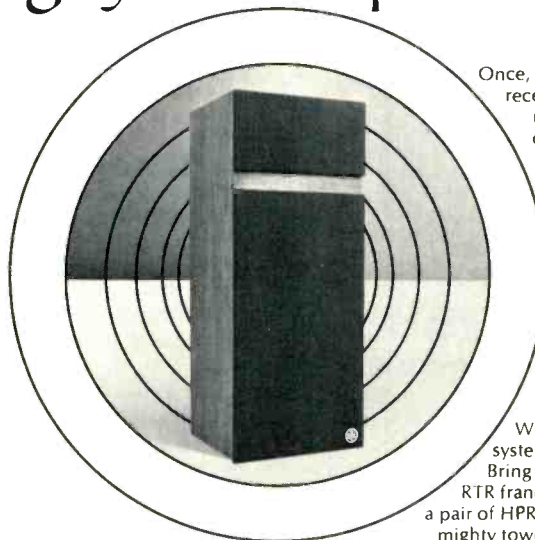

Once, owning a low-powered receiver meant settling for an under-powered system. All components had to be equally tame. A disappointing compromise for the audiophile.

Now, RTR brings audiophile performance and high efficiency to the average receiver with the HPR12 Magnum. With RTR's own lusty 12" woofer and new piezo-electric super tweeter, this speaker delivers clean, clear reproduction from all good receivers.

What a transformation in any system! Now prove it for yourself. Bring your receiver down to your RTR franchised dealer. Plug it into a pair of HPR12 Magnums. Hear a mighty tower of power! \$249



For a dealer list and complete information, write: RTR Industries, Dept. 46, 8116 Deering Ave., Canoga Park, CA 91304.

Check No. 20 on Reader Service Card



**THE
IMF
MODEL R**
loudspeaker

is a new high output version of the world famous "IMF sound". It is totally different in concept, drive system, and enclosure from ordinary "commercial" loudspeakers. (see picture).

MODEL R is now at your franchised IMF dealer. Or, request Brochure R and Newsletter 10, "Impulse Development of Loudspeakers".

IMF PRODUCTS

7616 City Line Ave.
Philadelphia, Pa. 19151

Check No. 10 on Reader Service Card

the sound build-up

Professional results — the basis of our home constructor speaker and amplifier kits

Genuine walnut veneer cabinets, plus the finest component parts, make our kits outstanding value for money.

A 50% saving over built-up units. Send for free catalog now!

NAME _____

ADDRESS _____

CITY _____

STATE _____ ZIP _____

**ruxton
electronics**

P. O. Box 30312 Santa Barbara
California 93105



Check No. 21 on Reader Service Card

The Column

Fred DeVan



Blood on the Tracks: Bob Dylan
Columbia PC-33235

As I sit writing this, with tonight's mellowing treasures, a midnight fondeue, and Elliot Carter's String Quartets 1, and 2 (Advent CR/70 Cassett D-1007), I can't help thinking about the days of extensive listening that went into the April column. Actually there were two, and fate played a cruel April fool trick on me by providing me with a fire in my N.Y. apartment building that has had me busy and homeless for months. The pre-fire column was a honorarium to Prof. I. Lirpa and to phenomenon deserving of all he represents. I trust he or his students will be in presence elsewhere in the issue. So now April column #1 will appear at another time and you will have part one of April column #2.

I have long believed that members of the general public for the most part are now aware of how much the personality of the record company colors inspires the specific performance by its artists. This is seen almost perfectly in the recent and unfortunate misadventures of Bob Dylan with Elektra/Asylum records. In contrast, we now have the reunion album of the artist and his previous record company, Columbia. A celebration on

vinyl. A triumphal bash of the returned gladiator, etc.

Residing on a totally different level than all the hoopla around it, we have the album itself. **Blood on the Tracks**, the record, is frankly to me a total surprise and easily earns at least the rank of "the most honest Dylan album since **Highway 61 Revisited**" and this explains the fact that really the only Bob Dylan that would wash at Columbia is the Dylan his now greying public wanted to hear. Well, Bob Dylan is greying right along with the rest of us and I hope that we all have mellowed and gotten wiser because of life lived and dues paid.

Since we all knew an album was coming, the tendency to generate preconceptions was unavoidable. There are many of us who will put down this record for its nicest character; that it is the Bob Dylan form we insist on. Yet, it is possible that Bob agrees that this is what he wants to do now. If that is the case there are some very justifiably smug, I-told-you-so faces at Columbia staring at the sales charts. If this is not the Dylan that everybody wants (including Dylan), I would like to know why not! **Blood on the Tracks** is not what I expected either, but it is certainly more than I asked for. I concede that if I could

find any fault at all, it is the low excitement level of the entire thing. All the fal de ral about what led up to this record has put undue pressure on the man and his music. Somehow this time Bob perseveres because of his music. For, with all the muted, mellow, essence of this work, it manages to be simply the most musical he has ever done. His early records were simply folk and part of the definition of what is folk music: "its got to be somewhat crude." Dylan has passed through sophisto-crude to a well-conceived, relaxed, unhyped personal music. Even if you were to consider his style a hype (and I assure you it's not), the style has mellowed too. (It's unobtrusive time in Woodstock.) Best of all, along with a more sensual Dylan we get a bonus in a yet more poetic, more sensitive, and more sensual Dylan all at once. No longer the Boy Troubadour prancing with consciousness and causes! Now the man-traveler who sings like one who experiences rather than observes. Like one who feels his lyric is his gut, not just his head.

I don't know if you should listen to me. I even liked *Self-portrait* and will defend its appearance in its time to anyone. Now with *Blood on the Tracks* we do hear a new Bob Dylan who has developed more mature eccentricities. The final product listens comfortably. The performance and sound is very relaxed and a few cuts almost disappear into easy listening. The standouts are *Tangled up in Blue*, *Simple Twist of Fate*, *You're a Big Girl Now*, and *Lily, Rosemary and the Jack of Hearts*. The production and Phil Ramone's engineering are excellent. I would like to be more intense about it all but *Blood on the Tracks* itself runs counter to the "All About Dylan, With Daggers and Hip Boots" Syndrome. Listen to it and you'll probably enjoy it. The sound is clear, strong and intelligible. The backing is sparse but very musical. All in all a job well done. Welcome back, Bob Dylan. I hope that the *Blood on the Tracks* is a foundation for more from you of this quality.

Performance: A Sound: A+

Miles of Aisles: Joni Mitchell and the L.A. Express
Asylum AB-202

This is a truly superb record album by a triumphant Ms. Mitchell, a vocal tour de force. It is one of the finest, if not the finest live albums ever made. A truly remarkable new Joni is heard here. Her delivery is so much assured and emphatic that it totally captivated

Bozak Electronic Units for Your Music System ... You'd Never Believe the Difference They Can Make

A Perfect Complement to Your Bozak Speakers!

Now the same standard which has kept Bozak in the forefront of quality loudspeaker manufacturers for more than a quarter century — designing to take full advantage of modern technology without overstepping the boundaries of science — has been incorporated into what we believe are the finest audio electronics on the market. They are intended to give a lifetime of pleasure.

MODEL 919 Audio Signal Processing Center

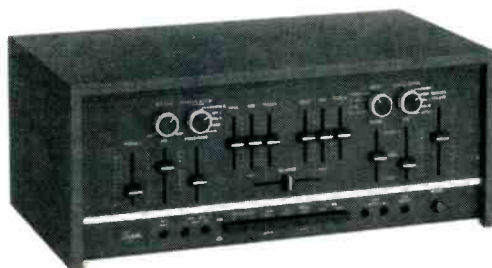

This new Bozak mixer/preamplifier gives your sound system a degree of capacity and flexibility approaching that of professional sound studios. You can mix and blend inputs from two stereophonic sources — phono with phono, tape or tuner — and a microphone, simultaneously. Complete cueing and monitoring facilities are provided; output modes include stereo, stereo blend, reverse stereo, stereo plus and monophonic.

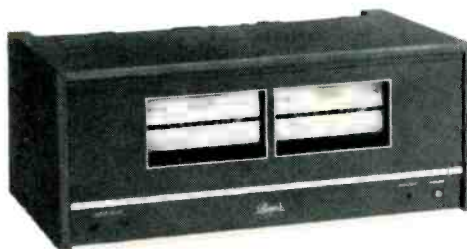

MODEL 929 Audio Power Amplifier

Designed for use in major home music systems, the Model 929 is at its best when driving full-size speaker systems capable of accurately reproducing the full dynamic range of the Model 929 and of utilizing the power available from these magnificent amplifiers. For the ultimate sound system, Model 929 is equipped for simple plug-in conversion for bi-amplification use.

Power output from each of the 929's two channels is 150 watts continuous minimum sine wave power into 8 ohms from 20 to 20,000 Hz at less than 0.2% total harmonic distortion.

Our free booklet "Audio Electronics by Bozak" contains complete specifications.



Bozak, Inc.

Box 1166, Darien, Connecticut 06820 (203) 838-6521

Check No. 2 on Reader Service Card

me. She really must feel best in live surroundings, singing to and for people who can be seen, touched, and responded to. The way she lifts her voice assuredly through *Cold Blue Steel* and *Sweet Fire* shows just how much a singer she is. Her version of *Woodstock* is a masterpiece. Her band, The L.A. Express, plays a big role in making this cut a beauty and they manage to maintain their posture throughout the parts of the album where they have the experience of sharing the making of fine music with Joni Mitchell. Loud applause to Electra/Asylum and the Wally Heider remote recording unit for their role in making this fine music. Surely their presence affected the performance; the result is a totally positive enhancement and exhilaration to all in attendance. The recording leaves nothing to be desired. A little hiss at the start of *Cactus Tree* is forgivable, because the

good sound surrounds it, and because you can lose that electronic sound back in the shadows of the performance.

All 18 songs on the album are stunning. The sequencing and the tempo of the program make one want to listen straight through. Don't play this album just before an appointment; you'll probably be late. Armed with 18 winners, it's hard to choose the notables. But her new versions of songs like *Blue*, *You Turn Me On, I'm a Radio*, and *Circle Game* are my personal favorites. Two love songs, *Jericho*, and *Love or Money*, are most appealing of all to me.

Miles of Aisles will be around as a sterling stand-out recording for a long time. I have not heard a record that was so satisfying on first hearing for a long time.

The recording responds exquisitely to any form of quadrasonic synthe-

sizing (ambience) as well as real SQ or QS decoding. Its level allows for rich dynamic range. This recording is so clean and rich that only a half-track 15 ips tape could surpass it. Believe me, that is saying a lot for a commercial disc.

Joni Mitchell, the L.A. Express, and all the rest of the people involved in making *Miles of Aisles* did it right. All of it. Well, there is a cover art problem. The liner looks so blah that it's hard to find among a group of other albums and one is thus forced to keep it out in sight (where it belongs). But it still is ugly! Let's hope they brighten up the cover for the CD-4 version.

Sound: A Performance: A

Live: David Bowie
RCA CPL2, stereo, \$6.98.

Just as sure as there is good luck and bad luck, there will be records that deserve being listened to and there will also always be a David Bowie album! Or even worse! Well, indeed, here is a live David Bowie album. It is unique because it is the worst! Worse than a studio David Bowie album. Worse than anything! PHOOEY! The only thing that saves Bowie from being the worst here is the release of a new Mick Ronson al-

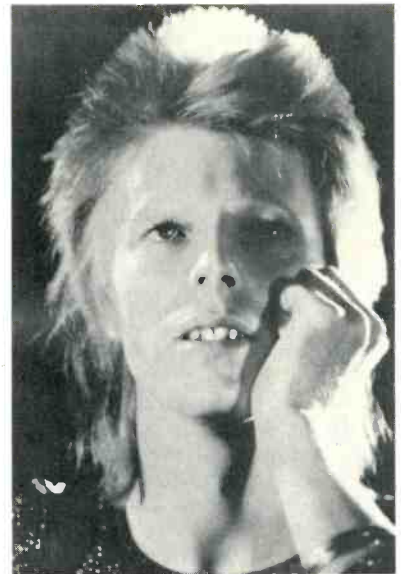

bum, *Play, Don't Worry* (he does neither). Thankfully either of these records will come in handy to dog-owning residents of Gotham City. If dipped in boiling water they can be shaped into useful utilitarian scoops, attached to sticks, and used to keep our city streets neat and safe for pedestrians. Thank heaven for civic-minded dog owners—without them the blokes with orange hair might starve to death!

Sound: Z- Performance: ZZ-



THE GNOME FILLS A VARIETY OF NEEDS!

- TO THE SEASONED PERFORMER... It's the extra voice that completes a composition while leaving expensive equipment free for more demanding tasks.
- TO THE BEGINNER... It's a low cost introduction to synthesizers that won't be obsolete when more expensive instruments are purchased.
- TO THOSE IN BETWEEN... the GNOME's portability and ease of operation make it great for "toy boxes," sound effects or just for fun.

PAIA's FREE CATALOG... features the GNOME and other electronic music kits. Check our Reader Service Number or Write: PAIA Electronics, Dept. A, 1020 W. Wilshire Blvd., Okla. City, OK 73118



THE GNOME
MICRO-SYNTHESIZER
KIT

#3740 GNOME KIT
\$48.95
plus shipping & insurance 4 lbs.

Check No. 14 on Reader Service Card

take advantage

Don't settle for just any professional power amplifier. Take advantage of the BOSE 1800.

Advantages like high power, ruggedness, reliability, serviceability, LED power indicators, and a full 5-year warranty.

The 1800 gives performers the advantage by providing them with all the power they need to handle the dynamics of their music.

BOSE 1800 pro power amp: designed to be taken advantage of.



BOSE 1800

Please send information on the BOSE 1800 to:

Name _____

Address _____

City/State/Zip _____

BOSE, The Mountain, Framingham MA 01701
(617) 879-7330 Dept. AP

(Continued from page 18)

have over 20 years of semiconductor experience. These V-FET's aren't just anybody's, they're Sony's. And because our amplifiers are a lot more than just this output device, we can offer you the best sound you may have ever heard.

Dan Gallagher,
Sony Corp. of America,
New York, N.Y.

Classified

SPEAKERS

MUSICAL SPEAKERS REPAIRED
ALTEC WARRANTY STATION
Hughes Electronics Service
45 Dunn St., Asheville, N.C. 28806

INSTRUCTION & EDUCATION

DIGITAL ELECTRONICS! Design and understand Digital Circuits. Increase technical competence. Complete and guaranteed course is highly effective. \$10.00. Free literature. DYNASIGN, Box 60AM, Wayland, Mass. 01778.

SELF-STUDY CB RADIO REPAIR COURSE. There's money to be made repairing CB radios. This easy-to-learn course can prepare you for a career in electronics enabling you to earn as much as \$16.00 an hour in your spare time. For more information write: CB RADIO REPAIR COURSE, Dept. 5-A, 531 North Ann Arbor, Oklahoma City, OK 73127

PHONO CARTRIDGE SEMINAR

MICRO-ACOUSTICS CORP., manufacturer of the QDC-1 Stereo Phono Cartridge, is offering a seminar on Phono Cartridge Design and Manufacturing to interested groups in the U.S.A.

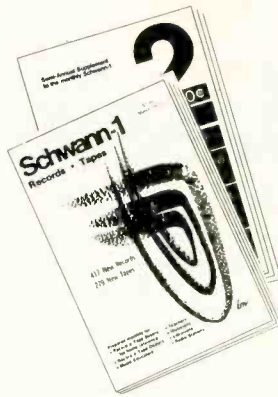

Goldmine

If the recorded music you purchase and listen to is important in the way you enjoy life . . . you ought to know about a goldmine of helpful information for every record collector.

Schwann Record & Tape Guide

is a compilation of information about records and tapes of many classifications. This wonderfully useful catalog uncovers titles you didn't know were available, helps you select versions by conductors and artists whose work you prefer . . . shows you money-saving reprints on budget labels . . . and much, much more.

More than 65,000 records and 8-track and cassette tapes are listed in the monthly *Schwann-1* and its semi-annual companion, *Schwann-2*. All are available through your record dealer if you ask for them by Schwann title and number. Schwann opens up rich rewards in your record collecting hobby. See your record dealer for latest copies.

Schwann-1 Monthly. Lists the month's new releases in every category. Also nearly 45,000 available recordings on 702 record labels, 231 tape labels, 82 quadraphonic labels, in classical, recent popular, rock, jazz, musical shows, country, opera, ballet, electronic, etc. \$1.00 at your dealer's.

Schwann-2 The semi-annual companion catalog for specialized categories: pop more than two years old, classic jazz, classical classics of the pre-stereo era, also the great re-issue catalogs; international pop & folk on domestic labels, spoken, educational, religious, etc. 90c at your dealer's.

SPECIAL PRICE SAMPLE OFFER

If your favorite store doesn't carry Schwann, order samples by mail, but please try your dealer first. Prices include postage and handling.

- Latest Schwann-1 (monthly)..... \$1.60
- Latest Schwann-2 (semi-annual)..... \$1.40
- Combination Offer: latest Schwann-1 (monthly) and latest Schwann-2 (semi-annual)..... \$2.75
- Newly revised Basic Record Library booklet.
Lists 1,000 suggestions in classical music by musical periods for your enjoyment.
Send 50c for cost of handling and postage.

I enclose \$.....for the items checked above.

Name _____

Address _____

City _____ State _____ Zip _____

Dealer's Name & Address. _____

Schwann Record & Tape Guide

137 Newbury Street, Boston, Mass. 02116

AU

Classified

Additional classified ads will be found on page 65.

FOR SALE

CASSETTE LABELS

Plain white cassette labels, Norelco cleaners, paper mailer boxes hold Norelco type plastic box, famous brand cassettes. "Like new" 10-1/2" metal reels. Send for open reel and cassette discount catalog.

| | 1-910-99 | 100 | 1000 | 10M |
|-----------------------------------|----------|------|------|------|
| Cassette Labels (Multiples of 10) | .02 | .015 | .01 | .007 |
| Norelco Cassette Cleaner | .65 | .60 | .55 | .50 |
| Cassette Paper Mailer boxes | .03 | .025 | .022 | .02 |
| *Scotch Cassette SC90HE | 2.72 | 2.55 | 2.44 | 2.39 |
| 10-1/2" Metal, NAB Hole, Used | 1.00 | 1.00 | .90 | .80 |
| *Buy 10, SC90HE, get 5 free | | | | |

Plus Postage by Weight and Zone **Minimum Order: \$5.00**

OPEN REEL STEREO TAPE BUYERS!

At last! An open reel catalog, including titles, songs, etc. of 95 long play, 2-3 hour albums, by American Airlines or Ampex 4 track stereo tapes. Send \$1.00 — and we will also mail you a 140-page Harrison stereo tape guide — so you'll get both for \$1.00 — and this \$1.00 is refundable on your first \$10.00 purchase of open reel stereo tapes at our 30% discount.



SAXITONE TAPE SALES 1776 COLUMBIA ROAD, N.W., WASHINGTON, D.C. 20009

RECORDING TAPE CLOSEOUT: Dozen reels 2400', \$12.00. Dozen 1200', \$8.00. 24 reels 900', \$6.00. 24 600', \$5.00. Postpaid! Guaranteed. Mitchell, Box 132A, Flushing, N. Y. 11367.

CROWN D1200 & M2000 on demo in our showroom. The cleanest amp ever made, driving RTR STUDIO MASTERS. Cyberacoustic Laboratory, 503 Haverford Ave., Narberth, Pa. 19022. 215-667-3048.

N. CALIFORNIA'S CUSTOM IMF DEALER is now offering:

IMF SMALLER MONITOR - Smaller version of the world-acclaimed MONITOR!

IMF MODEL R11 Flat to 20 Hz. Stunning transient attack! Uses new version of KEF flat woofer. At \$330 - extraordinary!

IMF SUB-WOOFER KIT - Dual transmission line system flat to 6 Hz - \$200!!

STUDIO IIIIB and MONITOR MK IV - Both newly "impulse" revised!

Custom demonstrations in The IMF Listening Room. For information and/or listening appointment, write or call Russ Goddard, **CUSTOM IMF DEALER**, 1171 W. Latimer, Campbell, California 95008, (408) 374-4697. **Mail order customers:** For your convenience, all orders are shipped prepaid and insured, by air!

OPERA TAPES. Historical performances of past 40 years. Unbelievable treasures and rarities. ALSO LP RECORDS. Free catalog. Ed Rosen, 66-33 Saunders St., Rego Park, N.Y. 11374.

LOW NOISE RESISTORS - 1/4W, 5%, carbon film from 10 - 3.3 Megohm for 3 1/2¢ each. Fifty of one value for \$1.25. 1N4148 diodes for 6¢. Ceramic capacitors. Free samples/specifications. **COMPONENTS CENTER -A**, Box 134, New York, N.Y. 10038.

FOR SALE

CONNECTICUT: Yamaha, Celestion, IMF, Infinity, Braun, Revox, Stellavox, Thorens, ESS, Mark Levinson, Supex, BGW. Will ship prepaid. **AUDIOCOM**, 177 Sound Beach Avenue, Old Greenwich, Conn. 06870. (203) 637-3621.

WANT TO GO BI-AMP?

DeCoursey Electronic Dividing Networks are available from \$89.10 (Monaural bi-amp) to \$205 (Stereo tri-amp). Price includes plug-in Butterworth filters; 6, 12, or 18 db per octave at any desired cutoff frequency. Write for brochure. DeCoursey Engineering Laboratory, 11828 Jefferson Blvd., Culver City, California 90230.

FLASH—WORLD'S FIRST HIGH OUTPUT MOVING-COIL CARTRIDGE WITH REPLACEABLE STYLUS is now in stock! The revolutionary new **SATIN M-15L** series easily surpasses ALL other cartridges in clarity, separation, and ultra-low distortion. Has rock-solid bass definition, and the realism heard from solo or massed violins is incredible. \$265., with choice of conical, elliptical, or Shibata-type stylus; cartridge with all three (interchangeable) styli purchased together, \$450. Sister models with similar qualities, \$145. and \$215. At better dealers, or direct from exclusive U.S. distributor, **AUDIOPHILE IMPORTS**, 8 East Erie, Chicago, IL 60611.

LOWEST DISCOUNT PRICES ANYWHERE on audio equipment. All major brands discounted. Write for quotes, **K&L Sound Services**, 75 N. Beacon St., Watertown, Mass. 02172.

DIAMOND NEEDLES and Stereo Cartridges at Discount prices for Shure, Pickering, Stanton, Empire, Grado and ADC. Send for free catalog. **LYLE CARTRIDGES**, Dept. A, P.O. Box 69 Kensington Station, Brooklyn, New York 11218.

SPEAKER SPECIALIST. **TOBY** Corporation of America, 4620 Camp Bowie, Fort Worth, Texas 76107.

THE MONEY SAVER! Write **STEREO SPEC-TRUM**, Box 1818, Miami Beach, FL 33139.

ARP SYNTHESIZERS!

Pro-Soloist \$920. Odyssey \$1230. String Ensemble \$1385. #2600 \$2385. Dickstein Distributing, 1120 Quincy Avenue, Scranton, Pennsylvania 18510.

TWO NEW 15" ALTEC 604-E duplex speakers with dividing networks, 16 ohms. \$140.00 each. One mint 12" Stevens Gold dia-cone speaker, 8 ohms. \$45.00 R.E. Bennett, 1460 W. 20th St., Long Beach, Calif. 90810.

CERWIN-VEGA PRODUCTS (312) 581-7436.

QUOTES ON 60 POPULAR BRANDS. Specializing in "high end" and hard to find equipment—Ace Audio, Cizek, Fulton, Phase Linear, Phillips—much, much more. **Sound Center**, 219 E. 17th, Bloomington, Indiana. (812) 332-4252.

FOR SALE

STEREO AND QUAD COMPONENTS. Low discount prices; major brands. Write for free brochure, quotes. Reply Box A55-1, c/o Audio Magazine.

NORTHWEST'S FINEST AUDIO DEALER—Audio Research, Dayton Wright, IMF, Fulton, Hartley, Mark Levinson, Dahlquist, Infinity, Radford, Crown, BGW, Quad, Decca, Supex, Phase Linear, Braun, Tandberg, Linn Sondek, and Many More. **HARTLEY ELECTRONICS**, 1502 Butternut, Richland, WA 99352 (509) 947-5026 after 5:00 PM weekdays, all day weekends.

TUNED ROCK P.A.'s. Customized high intensity touring/permanent installation sound systems, including narrow band (5'hz!) feedback suppression, detailed regenerative response, Acousta-Voicing/environmental equalization (±dB at your ears), room design/measurement/treatment, <15% articulation loss of consonants, 1000's of customized professional products including ... fiberglass horns, consoles, comp/rms/peak limiters, 18db continuously variable electronic crossovers, digital/acoustic delays, omnipressors, phasors, reverb, echo, doubling/tripling effects. P.A. noise reduction, piezo transducers, frequency shifters from ... J.B.L./Altec Pro., Tascam, U.R.E.I., Eventide, Gately, Schoeps, Beyer, Crown, Community Light/Sound, Mom's Audio, McIntosh, Bozak, Allen Heath, Gauss, Cetec, Langevin, Electrodyne, etc., etc. All shipped prepaid/insured. **Music & Sound Ltd.** 1 1/2 Old York Rd., Willow Grove, Pa. 19090 (215) 659-9251.

FLORIDA AUDIOPHILES! Phase Linear, IMF, Linn Sondek, Klipsch, RTR, B&O, Revox, Quad, Thorens, Sony, Marantz, Barzilay cabinets. Sales & repairs. **INTERIORS PLUS SOUND**, 3038 N. Federal Highway, Ft. Lauderdale, Fla. 33306. (305) 566-3511.

AUDIO RESEARCH MAGNEPLANARS and Electronics, ESS, Infinity, Ohm, Dahlquist, EPI, Audionics, Radford, Crown, Citation, BGW, Transcripator, Linn-Sondek, Keith Monks, ERA, Connoisseur, SME, Supex, Decca, Grace, Sony, Spectrum Scanning Tuner, Epicure Amplifier, Marantz 500, DBX, ADC, Nakamichi, B&O, Tandberg, Celestion, Marc Levinson, Stax, Dayton-Wright, others. **THE GRAMOPHONE LTD.**, 757 Asp St., Norman, Okla. 73069. 405-364-9477.

FIREWORKS NEWS MAGAZINE—Covering Commercial — Display Fireworks, Sources, Construction, Black Powder, Fuse, Literature. Firecrackers To Bombshells! Interesting Catalog—25¢. With Sample—\$1.00 Pyro Press, Box 12010-P, Lexington, Kentucky 40511.

THORENS 150AB TURNTABLE, Shure M93E cartridge with new stylus. \$100.00. Call (815) 729-3279 after 6 P.M.

Rates: 35¢ per word per insertion for noncommercial advertisements; 60¢ per word for commercial advertisements. Frequency discounts as follows: 3 times, less 10%; 6 times, less 15%; 12 times, less 20%. Closing date is the FIRST of the second month preceding the date of issue. Payment must accompany all orders. Use the handy self-addressed, postage paid card at the back of this issue. When replying to AUDIO box number ads, send letters c/o AUDIO, 34 North 13th Street, Philadelphia, Pa. 19107. For more information about classified advertising, circle Reader Service Card #135.

FOR SALE

QUINTESSENCE, PHASE LINEAR, Bang & Olufsen, Ortofon cartridges & speakers, Infinity, Bozak, TAPCO, Technics by Panasonic, A.C. Recording, 7 US Hwy. 206, Raritan, N.J. 08869. (201) 526-1777.

ADVENT, CROWN INTERNATIONAL, McINTOSH, REVOX, THORENS, SME, IMF, JBL, EPI, CITATION, BEYER, FULL SERVICE ON ALL EQUIPMENT!!!

STEREO SOUND
320 Route 10,

East Hanover, New Jersey 07936
(201) 386-0050

ORTOFON — SUPEX CARTRIDGE OWNERS; our Micro-Preamp outperforms any transformer. Free literature. Huntington Electronics, Box 2009-A, Huntington, Conn. 06484.

C/M PRE-AMP CC2 \$200.00. Pr. Infinity Monitors \$640.00. Koss ESP-6A \$85.00. (201) 356-0004.

ELECTRONIC CROSSOVERS—ALL TYPES. Definitive booklet describes applications; how to improve speaker systems: \$5.00, credited to first purchase. Huntington Electronics, Box 2009, Huntington, Conn. 06484.

AUDIO EXCELLENCE from Advent, Audio Research, BGW, B&O, Fulton, Grace, Dahlquist, Levinson, Infinity, Quintessence, Phase Linear, SAE, STAX, Supex, RTR, Revox 700, Nakamichi, Tandberg, Technics, Magneplanar. "Certified Audio Consultant," STEREO SHOP, 107 Third Ave. SE, Cedar Rapids, Iowa 52401. 319-365-1324.

THE SS-3 PORTABLE MIXING CONSOLE provides unmatched performance in remote recording applications. Available in 2, 4, 8, 16 and 24 track configurations. Write for specs. Reply Box No. A47-1.

AUDIOMART

Avoid commission-hungry middlemen! Buy, swap, or sell equipment directly through our classified newsletter. Absolutely NO CHARGE for personal ads. AUDIOMART, Box 821, Stratford, Conn. 06497. SUBSCRIBE! \$4/12 issues - satisfaction guaranteed!

KLIPSCHORN-KLIPSCHORN-KLIPSCHORN Only the finest in Audio. Superior Sound Stereo Center, 2780 Erie Blvd. E., Syracuse, N.Y. 13224.

IMF LOUDSPEAKERS. Transcriptors turntables. PML Microphones, headphones. Brown English Auditorium headphones. C/M Labs pre-amplifiers. Leak Stereo-20 tubed amplifier, new \$200. Leak FM-Tuners, tubed, rare \$175. Dynaco SCA-80Q amplifier, mint \$250. Jensen Fives speakers, beautiful \$290 pair. Beovox #2600 speakers, mint \$179 pair. Most audio equipment quoted. Trades accepted. **WANTED:** Marantz - HI-FI HQ tubed amplifiers. Audiocraft, South Rockwood, Michigan 48179. (313) 379-9945.

REVOX, DAHLQUIST DQ10, Bowers and Wilkins DM2A, Bang & Olufsen, Epicure, Mark Levinson, Soundcraftsman, Onkyo, Braun LV1020, Tandberg, Ortofon, Beyer. The best full range electrostatic in the world to be demonstrated soon in the best sound rooms available in the Northeast. The Audio Workshop, Inc., Latham, N.Y. (518) 783-9810.

ONE STOP for all your professional audio requirements. Bottom line oriented F.T.C. Brewer Company, P.O. Box 8057, Pensacola, Florida 32505.

TYMPANI-1A

Audio Research Magneplanar Speaker, \$850. Larry Beiter, 3829 Logans Ferry, Pittsburgh, Pa. 15239. (412) 327-7193.

FOR SALE

BUILD YOUR OWN SPEAKERS AND SAVE UP TO 50%. You can assemble your own high quality, multi-element stereo speakers in a few hours and save up to half the cost of comparable speakers. Send for our free 32-page catalog of speaker kits, raw speakers and accessories. **SPEAKERLAB,** Dept. A2, 5500—35th N.E., Seattle, WA 98105.

CANADIANS — DYNACO COMPONENTS AT TREMENDOUS DISCOUNTS. Write En-Jay Sales, Hornepayne, Ontario.

CYBERACOUSTIC LABORATORY: only one of its kind! Featuring Crown, IMF, AKG, UREI, RTR, DBX, Infinity, Rabco, Decca, Mark Levinson, more. Crown warranty service. Featuring Crown tape recorders: Audiomodtronics by our engineers. Barclay—503 Haverford Ave., Narberth, Pa. 19072. 215-667-3048.

MAXELL TAPES, AKG microphones, Stax headphones at DISCOUNT prices. Box 3065, Seattle, Washington 98114.

WESTCHESTER AND FAIRFIELD COUNTY AUDIOPHILES TAKE NOTE! THE AUDIO-PHILE, 231 BEDFORD STREET, STAMFORD, CONN. specializes in equipment for the connoisseur. Audio Research, ADC, Citation, Crown, Dahlquist, IMF, Infinity, Janszen, Philips, SAE, SME, TEAC, Technics, Thorens and many more. (203) 348-3551 (Closed Mondays).

REVOX A77, MK III, with illuminated remote, dustcover, carrying case, 10-1/2" NAB adaptors. Superb condition. Less than 25 hours use. \$675. J. Enix, 301 Moisselle, Midwest City, Oklahoma 73110. (405) 737-8223.

BOSE 1801 AMPLIFIER, 400 watts rms. 1 yr. old. \$750. Call 304-755-3184.

NOW AVAILABLE FAMOUS REFLECTING SYSTEM'S 4 1/2" REPLACE- MENT DRIVERS. \$7.98 POSTPAID. BIG QUANTITY DISCOUNTS. FREE SPECIFICATIONS. AURATONE, BOX 580-19A, DEL- MAR, CALIFORNIA 92014.

MAGNECORD TAPE DECK 1024, \$500.00; Ampex tape deck 1260, \$200.00; Concord tape deck Mk-III, \$175.00; Kenwood AM/FM stereo tuner KT-7001, \$250.00; Fisher AM tuner AM80, \$45.00; Paco AM/FM tuner ST45W, \$35.00; EICO stereo power amp HF87, \$50.00; EICO mono power amp HF30, \$30.00; 2 JW Davis speakers, \$50.00. (713) 485-1735. Rt. 4A, Box 203, Pearland, Texas 77581.

TRANSMISSION LINE PLANS \$5.00 - foam damping material available. Wide assortment of drivers. E&E Audio, 2816 Church Ave., Brooklyn, N.Y. 11226.

NEUMANN MICS & ACCESSORIES. DBX Gately Pro kits and mixers. Most models in stock. Immediate prepaid shipment. Mastercharge. Write or call Dick McGrew Recording Service, 902 N. Industrial Blvd., Dallas, Texas 75207. 214-691-5107.

THE AUDIO RESEARCH ROOM. The complete line of Audio Research equipment on display under ideal listening conditions. **AUDIO SYSTEMS & DESIGN,** 5421 South 84th St., Lincoln, Nebraska 68516 (402) 489-9888.

AMPEX TAPE—NEW 1800' on 7" reel 12 for \$18 POSTPAID; 1200' 12 for \$13 POST- PAID—free list—WIDE RESPONSE, 6114A SANTA MONICA BLVD., HOLLYWOOD, CA. 90038

BOZAK B-211. Have excellent single. Will sell or buy mate. W. M. Holder, National Life Center, Nashville, Tenn. 37250.

ELECTROENCEPHALOPHONE: brainwave monitor. Professional biofeedback instruments. J&J 8102-A, Bainbridge, WA. 98110.

FOR SALE

LOGIC MICRO/MINI-
COMPUTER NEWS

LOGIC NEWSLETTER[®]

SAMPLE COPY \$1.00
LOGIC NEWSLETTER
POB 252
WALDWICK, N.J. 07463

MAGNEPLANAR TYMPANI I-U speakers, perfect, \$650; SAE MK-IVB (60+ w/ch) w/case, perfect, \$230. G. Lyddon, 870 Hilgard Ave., Box 403, L.A., CA. 90024. (213) 474-7721.

2 ALTEC 605-A'S in enclosures, 1 Magnecord 728 with 4 heads, 1 1024 Magnecord w/4 heads, 1 M-20 Altec condenser microphone. M.J. Mauer, Jr., 210 Branch Ave., Red Bank, N.J. 07701

AUDIOPHILES! Quality Sounds of Maryland has come to your rescue. Write to me for system quotes you won't believe! Send requests for equipment prices to Quality Sounds of Maryland, Gerard White, Sales Manager, P.O. Box 63, College Park, Maryland 20742.

OREGONIANS WITH UNCOMMON EARS: Hear Magneplanar, Dayton-Wright, B&W, Audionics, Infinity Servos, Braun, Quad, Ohm, Crown, BGW, Radford, Quintessence, Yamaha, Mark Levinson, Linn-Sondek, Transcriptors, Vestigal, SME, Thorens, Philips, Ferrograph, Stax, Decca, Supex, Ortofon, KMAL, Passive Crossovers, Transmission-Line Speaker Kits, Basic Drivers. Shipped Pre-paid in most cases. **AUDIO- Uncommon, Inc.** 8600 N.E. Sandy Blvd. Portland, Oregon 97220. (503) 254-6202.

AMPEX AG-500-2 7 1/2/15 ips 2-track stereo recorder in portable case in excellent condition. \$800.00. Steve Lewis, 6427 N. Ridge Blvd., Chicago, Ill. 60626. (312) 338-9459.

JAPANESE TRANSISTORS, Kit \$23.44 contains 24 most widely used transistors, including 14 power transistors. Over 500 types available. Free catalog **WEST PACIFIC ELECTRONICS,** Box 25837, W. Los Angeles, Calif. 90025.

BAY AREA AUDIOPHILES: AUDIO RESEARCH, AUDIONICS, BRAUN, CONNOISSEUR, CROWN, DAHLQUIST, DECCA, DYNACO, FERROGRAPH, F.M.I., GRACE, KMAL, LINN SONDEK, MAGNEPAN, MARK LEVINSON, NAKAMICHI, PANASONIC (SP-10), QUINTESSENCE, RADFORD, R.T.R., SEQUERRA, SHURE, SUPEX, TANDBERG, WIN LABS, McINTOSH (USED). Compare any of our products through our switching device using 1/1 Mark Levinson master tapes at GARLAND AUDIO, 2960 Stevens Creek Blvd., Suite D, San Jose, Calif. 95128 (408) 244-6724.

SPECTACULAR MUSIC PATTERNS ON COLOR TELEVISION from your amplifier. Easy. Won't affect TV. "TV Color Organ" plans \$5.00. Malvern Electronics, Box 338A, Malvern, Ohio 44644.

KLH-9's, MINT - original factory cartons. \$800.00 pr. Stephen Bruenn, 3609 N.W. 4th Ct., Boca Raton, Fl. 33432.

DENVER'S SPECIALISTS in High Definition Sound Systems offer Audio Research, B&O, Crown, ESS, IMF, Lipsch, Phase Linear, Quad, Radford, Transcriptor, Yamaha and more. Visit ListenUp, 685 South Pearl, Denver, Colorado 80209. 303-778-0780.

MARK LEVINSON—PHASE LINEAR— McIntosh — Dahlquist — Nakamichi — Braun — JBL — Supex — Linn Sondek — Tandberg — B&O — Quatre-Technics. Hear the Supex cartridge with the Levinson cartridge preamp at Stereo One, 1229 Post Rd., Fairfield, Conn. 06430. Phone 203-255-5939.

Listen to TELEVISION IN STEREO



The TE-200 TELEADAPTER EASILY CONNECTS TO ANY TV & STEREO SYSTEM. Using our coupling and matrix circuit, teledapter takes a low impedance output from the television and delivers two HIGH IMPEDANCE CHANNELS OF SIMULATED STEREO, to drive any amplifier. Frequency response is maintained so you can hear the tinkle of bells or booming bass sounds as it happens on TV. With service warranty and hookup instructions \$16.95 ppd. Guaranteed to make your TV 100% more enjoyable.

OUR NEW TE-300 VHF-UHF HI-FI TUNER IS NOW AVAILABLE. A complete and self contained 110 volt tuner. VHF-UHF antenna connections - Recording and amp output jacks. Five year service warranty \$149.95 ppd. From our factory.

SEND: CHECK MASTER CHARGE NO. for TE-200 TE-300 or \$5.00 for C.O.D. TO: RHOADES NATIONAL CO. DEPT AD P.O. BOX 817 HENDERSONVILLE, TENNESSEE 37075

NAME _____
ADDRESS _____
CITY _____ STATE _____ ZIP _____

FOR SALE

10 1/2" RECORDER SPECIALISTS: Fresh new Scotch L/N 3600 ft. on new 1/4" NAB metal reels five for \$35.00. New Ampex GRANDMASTER tape on 10 1/2" metal reel, six for \$73.00. New 4 channel 8-track blank cartridge loaded with 40 minutes Scotch L/N tape, \$23.00 per dozen. Reconditioned NAB metal 10 1/2" reels, \$24.00 per dozen. 10% on above for postage. Sound Investment, POB 88338, Dunwoody, Ga. 30338.

CENTRAL NEW YORK HI-FI ENTHUSIASTS—Britain's finest loudspeakers on demonstration—THE IMF STUDIO AND ALS40—as well as Marantz, Pioneer, Revox, Beyer, Epicure (3 lines), Thorens, Ortofon, XLM, Discwasher... THE SOUND SHOP, 96 Seneca Street, Geneva, N.Y. 14456 (315) 781-0215.

AMPZILLA. Available at Creative Audio. Call (517) 799-6013 for appointment 6:00 - 11:00 PM or write 5877 Ambassador Drive, Saginaw, Mich. 48603.

YOUR ROOM IS THE MISSING LINK
A state of the art system is usually junk in the typical poor listening environment, and therefore a rip-off. Our acoustical consulting division will have a calibrated "reverberation curve vs. frequency" measurement performed in your room, and our engineering dept.'s plan of correction, loudspeaker placement, and room equalization, all at no cost with your purchase or upgrade. Music & Sound Ltd., 11 1/2 Old York Rd., Willow Grove, Pa. 19090. (215) 659-9251.

CONSIDER YOUR SOURCE FOR SOUND

I. Credentials

College instructors in audio/acoustics, Inventors/graduate electrical engineers, Recording & disc mastering engineers;

Members: United Inventors & Engineers
Acoustical Society of America
Institute of Electronic Engineers

II. Facilities

Anechoic Chamber: >.95 working floor
\$50,000 research laboratory
Factory authorized "A" warranty stations

III. Our Distinguished Suppliers

Audio Research, Sequerra, Satin, Transcriptors, F.M.I./R.T.R., Linn Sondek, Nakamichi, Dayton Wright, Dahlquist, Crown, Infinity, I.M.F., London Decca, Quad, Rogers, Sendor, Stax, B&O, Grace, Supex, Micro Acoustics, Custom Rabco, Braun, Revox A-700, Ortofon, Damped S.M.E., Scully, dbx, Mark Levinson.

+
1000's of PROFESSIONAL products (see Tuned Rock P.A. ad).

Music & Sound Ltd., 11 1/2 Old York Rd., Willow Grove, Pa. 19090. (215) 659-9251.

Whom Would You Trust?

THOUSANDS OF LIKE NEW LP's and pre-recorded tapes. Catalogue \$1.50. House of Records, Hillburn, New York 10931.

FOR SALE

RTR EXCLUSIVE PHILA. SHOWROOM All RTR Speakers on demo including the new 1600E, 280DR/ESR15's. Two and three way electronic cross overs. Don't buy any speaker until you've heard RTR. Appointment 215-667-3048; 503 Haverford Ave., Narberth, Pa. 19072.

AUDIO RESEARCH, AUDIONICS, BANG & OLUFSEN BOZAK, CROWN, DBX, KLIPSCH, KMAL, LINN SONDEK, NAKAMICHI, PHASE LINEAR, RADFORD, REVOX, SEQUERRA, STAX, TANDBERG, BEYER, SENNHEISER, and other fine instruments for the reproduction of music. Send for list of top-grade used equipment **AUDIO SYSTEMS AND DESIGN**, 5421 South 84th St., Lincoln, Nebraska 68516 (402) 489-9888... and 4408 Capital Ave., Omaha, Nebraska 68131. (402) 556-7559.

1938 SCOTT RECEIVER CHASSIS (see January Audio) with schematic \$175. Scott #130 tube stereo preamp \$100. Acrosound 60 watt tube amplifier \$60. Shure V15II \$25. J.H. Blackburn, 304 Shady Land Drive, Smithfield, North Carolina 27577.

INFINITY MONITORS - mint. \$275 each. Quad 33 control \$125. (515) 278-0566.

CROWN SX724 recently serviced, new capstan, low usage. 301-840-1138.

CASSETTE LABELS—Reorganize outdated, marred cassettes with attractive, easily read, pressure sensitive labels. Standard size. Custom designed. 24 only \$1.25. Courted Creations, Dept-A, 306 Busse Hwy., Park Ridge, Ill. 60068.

PORTLAND'S OWN HAWTHORNE STEREO offers the sophistication and expertise of the East with the friendliness of the West. Featured lines: AKG, Advent, Audio Research, Beyer, Braun, Citation, Dahlquist, Infinity, Linn-Sondek, Magneplanar, Marantz, McIntosh, Nakamichi, Phase Linear, Phillips, RTR, Rabco, SAE, Sennheiser, Sony Corp., Soundcraftsman, Spectro-Acoustic shipped from stock to your door—fully pretested and insured. Write for information and price quotations: Hawthorne Stereo, 3580 S.E. Hawthorne Blvd., Portland, Oregon 97214.

COMPONENTS FOR THE CONNOISSEUR LOUDSPEAKERS: Audio Research T-3A, 1B, Braun LV 1020, Dahlquist DQ10, Dayton-Wright XG-8 MK11B, ESS, Fulton J Modular System, Hartley Concert Master, Hegeman 1A, & 2, IMF Monitor, Studio, ALS 40, Magneplanar MG2167-F, RTR 280 DR, ESR 6, 15. **COMPONENTS:** Audio Research, BGW, Burwen, Connoisseur, Dayton-Wright, Hervic, Linn-Sondek, M&K super woofers and crossovers for T-3ATM, 1B, etc., Mark Levinson Products, Ortofon, Panasonic SP 10, Quad, Quintessence, Radford, SAE, Shure, SME, Supex, Thorens Transcripator and SEQUERRA. Brochures available.
PAUL HEATH AUDIO
354 STATE STREET
ROCHESTER, N.Y. 14608
(716) 232-2828

HONG KONG, TAIWAN, JAPAN, Asia Directory. World products information. Mail-orders, bulk-orders. Listings. Directory and Information \$1.00 today. World Trade Inquiries. Box 6224, Spokane, Wash. 99207.

MIDDLE & NORTH JERSEY AUDIOPHILES - Stereo Sound of East Hanover offers personal, friendly service and "state-of-the-art" equipment: Quintessence, RTR, SAE, Ortofon, Transcriptors, Stax, Bang & Olufsen, Phillips, Crown, McIntosh, IMF, JBL and more. Full demo & service facilities for our customers!!!
Stereo Sound
320 Route 10
East Hanover, N.J. 07936
201-386-0050

FOR SALE

HIGH PERFORMANCE HIGH FIDELITY WITHOUT THE "HYPE". Suffolk Audio takes a rational, no nonsense viewpoint on high performance audio equipment. Our advice and opinions are based in objective fact, not mythology and folklore. All equipment is pre-tested for maximum performance. Our distinguished suppliers include: Allison Acoustics, Bowers and Wilkins, Quad, Linn Sondek, Decca, Mark Levinson, Revox (incl. A-700 series), KMAL, Ortofon, BGW Systems, Radford, Beyer, Connoisseur, and much, much more. Call or write for information.
SUFFOLK AUDIO, INC.
1105 Mass Avenue
Cambridge, Mass. 02138
Ph (617) 868-1080

PROTECT YOUR LPs. Poly sleeves for jackets 8c round bottom inner sleeves 6c Poly lined paper sleeves 15c White jackets 30c Postage \$1.00. House of Records, Hillburn, New York 10931.

SOUND ADVICE - an audio journal published REGULARLY (every two months) features, in its first issue, equipment reviews: Amplifiers-Ampzilla, Sony FET, Quintessence, Quatre, Audio Research, Marantz 500 and Yamaha FET; Cartridges - High Output Supex, Fidelity Research, Win Labs, Decca, Satin, Micro-Acoustics and the legendary Stax; Speakers - Magneplanars, Dayton Wright, Bi-amped ESS Heil; Ohm F and Philips Motional Feedback; Articles - "A Hard Look at 'State of the Art' Recordings from Amphiphon, Sheffield, Levinson and Fulton" and "Behind the Scenes at Sheffield Recording the New Direct Discs." Plus BEST BUYS, a column recommending near State of the Art equipment at moderate prices. Free classified ad with all subscriptions received by May 15. Four issues \$9 (\$12.50 foreign). Sound Advice, 225 Kearny Street, San Francisco, California, 94108.

PIEZO TWEETERS - Write for information. Speakit, Box 326, Sandwich, Mass. 02563.

DKL SOUND LAB
THE DKL SOUND LAB IS THE ONLY "STATE-OF-THE-ART" DEALER IN THE ENTIRE WASHINGTON DC, SUBURBAN MARYLAND, NORTHERN VIRGINIA AREA. COME SEE AND HEAR THE WORLD'S FINEST SOUND COMPONENTS AT:
DKL SOUND LAB
943 BONIFANT ST.
SILVER SPRING, MARYLAND 20910
OR CALL (301) 588-6257
MONDAY, WEDNESDAY, THURSDAY,
SATURDAY 2-8 PM
(A DIVISION OF THE DKL LABORATORY, INCORPORATED)

IN STORE DEMONSTRATION and appointment only showroom with Audio Research, Audionics, FMI, Radford, ESS, RTR, Magneplanar, Dynaco, Quatre, SME, Supex, Transcriptors, Teac, Sony Corp., Thorens, Soundcraftsman, Stax, and more. Audio-Tronics, Ltd. E. 120 Wellesley Ave., Spokane, Wash. 484-1300.

SAVE 25% to 50% on most popular stereo components. For specific quotes, free illustrated guide to high fidelity, and catalog featuring special closeouts and systems, write: Eastern Audio Specialists, P.O. Box 72, Amherst, Mass. 01002.

CROSSOVER NETWORKS - hifi or PA - write specifying needs: Full-range heavy duty 4 1/2" speakers \$7.50 each/ 18 for \$115 prepaid; Speakers reconed and repaired. dB Engineering, 139 Sagamore Street, Quincy, Mass. 02171.

AUDIO RESEARCH - DUAL 51, \$400; EC-3 crossover with cabinet, \$400; 4 sets matched pair GE655D tubes by Audio Research \$50 (unused). Dr. M. Fisher, 4015 Jefferson Hwy., New Orleans, La. 70121. (504) 885-9865.

FOR SALE

COMPRESSION IS DISTORTION. ELIMINATE IT. Clarity in dynamic expansion is finally available with the IAD Expander. Smooth expansion and decay adds up to +20dB in program material without embarrassing pumping, breathing and veiling for all who listen. Advanced engineering and esthetic design for the real audiophile. Brochure available upon request. Dealer inquiries invited. IAD, 10 E. Erie St., Chicago, Ill. 60611.

INFINITY SERVO-STATIC I, walnut. Mint. \$1200. Jim, 215-744-8651.

CHECK AUDIO CABLES THE EASY WAY. New cable fault indicator checks 2 or 3 circuit phone, RCA, Cannon XLR 3 or 4 pin cables. Led display indicates shorts, opens, crosswiring. Advanced I.C. design \$89.95 (net) plus postage. Crossroads Audio, Box 19671, Dallas, Texas 75219. Dealer inquiries invited.

HEAVY DUTY GREEN RECORD SLEEVES - 45, 78 rpm — Send for free samples & price list. GREENSLEEVES, 423 Greenway Ave., Trenton, N.J. 08618.

AUDIO RESEARCH D75A: \$550, D51: \$375, TYMPANI 111's: \$1025, PHASE LINEAR 700B: \$530, BGW 500R: \$495. K. Clark, 1502 Butternut, Richland, WA 99352. Phone: (509) 947-5026 after 5:00 PM.

HIGH DEFINITION SUPERWOOFERS - The world's finest woofer systems-The Hartley 24 inch and 18 inch high power woofers in an optimized transmission line. Available only through Hartley Electronics, 1502 Butternut, Richland, WA 99352. Phone: (509) 946-4459 and 947-5026 after 5:00 PM.

CROWN DC-300, \$400/offer. (213) 476-3798.

BIG DISCOUNTS ON L.P.'s, cartridges, cassettes, "singles." Stereo and Quad, all labels! all artists. No fees, no gimmicks. Same-day service, postpaid. Send stamp for free details and Schwann Basic Record Library pamphlet listing 1000 pieces of classical music arranged by musical period and composer. Or, send \$1.00 each (refundable) for Schwann Record and Tape Guide, Harrison Tape Catalogue; or "Golden Oldie" singles catalogue (listing over 5000 45 RPM's). DISCO-TAPE UNLIMITED. Mail Order Dept. AO, Box 817, LaPlace, La. 70068.

PIEZO SUPER HORN TWEETERS \$7.95 P.P. Cont. U.S.A. Daily Mfg. Co. (Mfr. of quality loudspeaker systems since 1951), 100 Liberty St., Rockwell, N.C. 28138.

WE HAVE A FEW competitively priced used Revox A77 decks available. These have been completely reconditioned by Revox, are virtually indistinguishable from new and have the standard Revox 90 day warranty for rebuilt machines. Satisfaction guaranteed. One example is an A77 Dolby for \$675 plus shipping. Please write stating your requirements to ESS1, Box 854, Hicksville, N.Y. 11801 (212-895-9257).

CANADIANS: Shure M91ED \$24.88. Dynaco A25 \$68.00; Pioneer SX424 \$179.95; Dual 1216 \$119.00; Leak Delta 75 \$289.00. Garrard Mini changer \$13.99. Free Hi-Fi discount catalog. Etco (Au), Box 741, Montreal H3C 2V2.

SHURE M3D-\$9.95, M91E-\$27.50, KOSS KO/727B-\$29.95 TUBES, ACCESSORIES LIST-10c. F & M ELECTRONIC DIST., BOX 236, DEPT. H, MASPEETH, N.Y. 11378.

AUDIO RESEARCH SP-3 and EC-3, \$450 each - Mint, 866-4798 Olympia or 693-7283 Vancouver, Wash.

DISCOTHEQUE MIXERS from \$325, equalized speakers with built-in power amplifiers, bi-amped systems, and complete portable discotheque systems. Write us for literature. Dealer inquiries invited. GLI, P.O. Box 2076, Dept. A, Brooklyn, New York 11202.

FOR SALE

AUDIOPHILES WANTED !! Put your knowledge to use, earn an excellent spare time income. We need campus representatives to sell name brand stereo equipment at substantial discounts in your area. High commission, bonuses. No investment necessary. For information and application please write: James Wetherill c/o I.C.M. Associates, Box 28-SMC, Storrs, Ct. 06268.

DEALERS: We will buy your excess stock. ALL lines, no quantity too large or small. Cash paid immediately. Call M. Gasman 617-924-0561.

REVOX A77 WITH DOLBY. Excellent condition. \$850 including case. Alan Jacobsen, 2507 W. Phoenix, Grand Island, NE 68801

JBL SOVEREIGN S8R speakers \$650.00 each. Matching equipment cabinet \$350.00. Like new. 516-621-3456.

ESS TRANSTATIC I speakers. Pair, \$700. (505) 293-8425.

BUY DIRECT FROM GERMANY. REVOX, BRAUN, DUAL, MIRACORD-ELAC, OTHERS CARRYING WORLD-FAMOUS "MADE-IN-GERMANY"-TAG BECAUSE WE ARE LOCATED RIGHT THERE WHERE IT'S MANUFACTURED. PRICES ARE LOWER THAN YOU'VE DREAMED POSSIBLE. EVERYTHING SHIPPED IN FACTORY-CARTONS. FOR QUOTATION WRITE TO: GLOBAL AUDIO, P.O. BOX 1372, D-5020 FRECHEN, WEST GERMANY

FAMOUS MAKE PIANOS AND ORGANS shipped prepaid anywhere at tremendous saving. State make and model wanted for our quotation. File this advertisement for future reference. Greenwich Music Center, Greenwich, N.J.

"ULTRA-DEFINITION"

THE DKL LABORATORY, INCORPORATED PROUDLY ANNOUNCES THEIR EXPANDED LINE OF PRODUCTS AND SERVICES:

DKL 1 - "ULTRA-DEFINITION" amplifier designed specifically for electrostatic tweeters and headphones.

DKL 2 - The famous "SUPER-RABCO" modification for Rabco SL8 (E).

DKL 3 - Our exclusive "Hand-Tuning" service for Decca Mk V and "Export".

DKL 4 - Individually engineered "Ultra-Definition" crossover networks for bi- and tri-amplification.

DKL 5 - Unique modifications to Infinity 2000A.

DKL 6 - An inexpensive "Ultra-Definition" pre-amp

DKL 7 - The larger amplifier designed for electrostatic transducers.

DKL 8 - Resonance dampening modifications for SHURE, SME, and other fine tonearms.

DKL 9 - The "AMAZING \$760, WONDER SPEAKERS" with flat response from 28-22,000 Hz.

DKL 10 - The DKL Client Information File - a service that will give "Ultra-Definition" to any sound system.

FOR MORE INFORMATION WRITE:

**The DKL Laboratory, Incorporated
P.O. Box 683
Severna Park, Maryland 21146**

OR CALL:

(301) 588-6257

**Monday, Wednesday, Thursday
Saturday 2 - 8 PM**

DON'T LET VOLTAGE TRANSIENTS ZAP YOUR HI-FI. Solid State Equipment Protector. Plugs into outlet. Check or money order \$6.95. Kopp Sales & Service, 1650 William, Buffalo 14206. Free brochure - send SASE.

GRACE G707 TONEARM, new/unused, \$70.00. R. Leschasin, 201-1687 Pembina Hwy., Winnipeg, Manitoba, Canada R3T 2G6.

FOR SALE

STEREO CARTRIDGES AND STYLUS REPLACEMENTS for ADC, B&O, GRADO, EMPIRE, MICRO-ACOUSTIC, PICKERING, ORTOFON, SHURE, STANTON NEEDLE IN A HAYSTACK, INC., 6749 Springfield Mall, Springfield, Va. 22150.

NAME BRAND RECORDING TAPE, custom loaded. Available in cassettes, reels, and cartridges. Huge savings direct from manufacturer. MJS, 516 Brooks, San Jose, Calif. 95125.

NOW IN PRODUCTION: World's heaviest 12" woofer. 17Hz resonance. Over 200 watts RMS. Sand cast frame. \$59.00 delivered U.S.A. Rockwell Systems, Inc., 100 Liberty St., Rockwell, N.C. 28138.

"FIDELITY FIRST (an unrehearsed experiment)" Average records don't make it on quality stereos. Quality records don't make it on average stereos. Many companies are working on the paradox. We're working on quality. We invite your opinion. \$6.50 prepaid per disc. INSIGHT RECORDS, dept 1A, 7726 MORGAN Ave. South, Richfield, Minnesota 55423

MINT USED EQUIPMENT - Audio Research Tympni III's, \$1200; SP-2 \$400; SP-3 \$525; SP-3A \$625; D51 \$600; Bose 1801 \$750; 901's \$375; Infinity Monitors \$650; SAE MkIVC \$350; Marantz 7c \$300; Crown IC-150 \$250; Citation 11a \$275, and more. All equipment inspected and guaranteed. We accept trades. SOUND ADVICE, 536 State Road, Emmaus, Pa. 18049.

JBL HARTSFIELD and many rare items. 150 White Cottage Rd., Angwin, Calif. 94508. Phone (707) 965-2680.

FOR SALE - THE INFINITY SERVO-STATIK I system w/special factory mods & test data. Call me. Marantz 120B w/cab - \$400.00. Thorens TD125 MkII AB/DC/V-15 III - \$350.00. All 6 months new! Call 602-967-5249.

WESTCHESTER HEADQUARTERS for the great sounds in the world. Quad, Ohm, Cambridge, Dahlquist, Bose ESS, Braun, SAE, EPI, Crown, Phase Linear, Tandberg, Thorens, Yamaha, Nakamichi, Technic, BGW, Dual, Revox, Kenwood, Pioneer, The Listening Room, Inc. 590 Central Ave., Scarsdale, N.Y. 10583 (914) 472-4558.

QUOTATIONS on all major components and musical instruments. No fair trade in Nevada. Lowest Prices. Southern Nevada Music Co., 2295 E. Sahara Ave., Las Vegas, Nevada 89104, (702) 457-4558.

NEW YORKER'S-WE ARE COMMITTED! Consult with us about your audio needs. We have what you want, we offer FULL service. IMF, BGW, SAE, OHM, INFINITY, KLIPSCH, ORTOFON, KENWOOD, THORENS, SME, TECHNICS, ALLAN-HEATH, SOUND CRAFTSMEN, HECO, INTERFACE-A, PIONEER, LEVINSON JC7, many others.
INNOVATIVE AUDIO
129 DeGraw Street
Brooklyn, NY 11231
(212) 596-0888
Call For Appointment

AUDIO RESEARCH SP3-A (N), converted to SP3-A-1. \$500. (919) 449-4132, 449-6912.

McINTOSH 2505 (7 months old) 400.00. Thorens TD125 Mk 11 with Shure SME Improved. Shure V15 type 111—375.00 (6 months). Nakamichi 1000 with remote control, 12 Nakamichi tapes—800.00. McIntosh MPI-4—425.00. All four for 1800.00. Benjamin Moore, 123 York St., New Haven, Conn. 06511.

CUSTOM SPEAKER ENCLOSURES, systems, kits, foam grills. Low prices. CSS, 8460 Marsh, Algonac, Mich. 48001.

FOR SALE

SANSUI QS-500 4-channel rear amplifier, Marantz 1060 stereo amplifier, Pioneer stereo tuner TX-7100, JVC CD-4 disc demodulator 4DD-5. Best offer. All mint condition. Murray C. McConnell, Route 2, Nevada, Iowa 50201.

TASCAM SERIES 70 recorder/reproducer, 4 track with 501 electronics. New \$2100.00. Includes service manual and new spare plug in PC boards. (516) 766-8512.

SONY TA2000F PREAMP, PERFECT CONDITION, STILL UNDER WARRANTY IN ORIGINAL FACTORY CARTON, PAID \$569; ASKING \$360. ALOIS OSTI, GREENWICH, N. J. 609-451-8805.

MILWAUKEE & WISCONSIN'S only audiophile dealer. Specialists in components by Crown, Dahlquist, Transcriptors, Integral Systems, Epicure, Nakamichi, Bozak, Citation, Ohm, SME, Ampzilla, DBX, Infinity, SAE, RTR, ESS, Revox, Phase Linear and 50 others. Wisconsin's only Audio Research dealer with the entire product line on demonstration. WACK ELECTRONICS INC., 5722 W. North Ave., Milwaukee 53208. 414-442-3441.

KENWOOD SYSTEM—Enjoy a component 4-channel system. Kenwood models KA-7002, KT-7001, KN-7044, KM-8002, KC-6060A, KF-8011, KSQ-20 sent ppd. \$900.00. All in excellent condition with original boxes. Call or write J. O. Young, D-6078 Neu-Iseburg, Frankfurterstr. 184, No. 1404, West Germany. 06102-34102

SOUTH FLORIDA'S ONLY AUDIO RESEARCH DEALER. Full Audio Research Systems on display: SP3-A/Dual 76/Dual 51/Magneplanar Tympani 1-B/Tympani 111A. Plus Advent, B&O, ESS, Harman-Kardon, McIntosh, Marantz, Phase Linear, SAE, Supex, Stax, SME, Sennheiser, Tandberg, TEAC, Thorens, Technics, Nakamichi, Mark Levinson. Complete audio counselling and custom installations. Sound and Sight, 20 N. Federal Highway, Boca Raton, 33432, (305) 391-1843; 141 Lakeview Avenue, West Palm Beach 33401, (305) 655-2236.

FACT: One of the largest and oldest exotic audio stores is now open at their brand new location. No other store combines the display facilities, the equipment and the service quite like **TRANSCENDENTAL AUDIO LTD.** in all of the United States.

A. ROOMS—three perfect sound rooms with complete working demonstration—generally live tape.

B. EQUIPMENT—Dayton Wright XG8Mk11B speakers and SPS preamps. Cambridge Audio TL 200 transmission line speakers and P140X, P70X amplifiers, J.E. Sudgen "Class A" amps, ERA 48 pole belt-driven turntables, Radford, Quad, Revox, Audionics, AKG, B&O, B&W Ltd., BGW, Celestion, DBX, Epicure, Technics, SAE, Infinity, Sequerra, Phase Linear, Supex, Levinson, Grace, Transcriptors, ESS, Braun, Magneplanar, Yamaha, Stax, Marantz, Harman-Kardon, Wizard Phono., Ortofon.

C. SERVICE—Anechoic Chamber, test equipment from Hewlett Packard, Crown, B&K Sound Technology, etc.

D. USED EQUIPMENT—Ton! Dahlquist DQ10, Audio Research D51, D76, SP3A & speakers, RTR 28DR, Phase Linear 4000, Quintessence, Infinity Monitors, preamp, IMF speakers and amp, much, much, more. **TRANSCENDENTAL AUDIO, LTD., 773 NIAGARA FALLS BLVD., BUFFALO, NEW YORK 14226. 834-3100 & 834-3101.**

TRANSIENT OUTPUT MONITOR for audio amplifiers. L.E.D. readout indicates ¼ to 1000 watts average and transient power output. Hand assembled, calibrated, tested, \$100. Free literature. Analogic Design, P.O. Box 7753, Phila., Pa. 19101

FOR SALE

SAN DIEGO, CALIFORNIA

ADC, Advent, AKG, AR-LST, Audio-Research, BGW, Citation, Crown, Dahlquist, DBX, Dynaco, FMI, Janszen, Linn Sondek, Magneplanar, Marantz, Micro-Acoustics, Ohm, Phase Linear, Philips, Quintessence, Rabco Revox, RTR, Sennheiser, SME, Stax, Supex, Tandberg, Yamaha.

Sound Company

4701 College Ave., (714) 582-4148
3675 Sports Arena Blvd., (714) 224-2844

CAN YOU IMAGINE a magazine that recommends components in four categories from no-holds-barred to best-for-the-money? The *Stereophile* does it. For info write Box 49A, Elwyn, Pa. 19063.

THE FIRST (1962) UNDERGROUND audio publication of them all, the *Stereophile* is the subscriber-supported perfectionist's magazine the others are trying to imitate. Free dope sheet explains why. Box 49A, Elwyn, Pa. 19063.

IF YOU BUY AUDIO EQUIPMENT, you can't afford not to read the *Stereophile*. Write Box 49A, Elwyn, Pa. 19063 for free blurb sheet.

ALLISON ACOUSTICS LOUDSPEAKERS have stabilized Radiation Loading. Years of intensive research by Roy Allison (formerly of Acoustic Research, Inc.) on the interaction between loudspeakers and room boundaries has yielded a new high standard of uniform bass performance. New Convex Diaphragm Mid-Range and High Frequency drivers achieve phenomenal wide dispersion (−3db 90 degrees off axis at 20kHz!) Literature and price information available upon request.

SUFFOLK AUDIO, INC.

1105 Mass Avenue
Cambridge, Mass. 02138
Ph. (617) 868-1080

BALTIMORE-WASHINGTON AREA AUDIOPHILES REJOICE! At last a store for you. Come to Myriad Sound and hear the finest in state of the art audio equipment. Featuring the complete Audio Research line, Polk Audio Model Nines, ESS Heils, Janszen, S.A.E., Altec, Citation, R.T.R., B&O, Thorens, S.M.E. etc. all accompanied by Fred Huggins himself. Main store at 9619 Reisterstown Rd., Garrison, Md. 21055 (2 miles North of Balt. Beltway exit 20) (301) 363-1733.

WESTCHESTER AND FAIRFIELD COUNTY AUDIOPHILES TAKE NOTE! THE AUDIOPHILE, 231 BEDFORD STREET, STAMFORD, CONN. specializes in equipment for the connoisseur. Audio Research, ADC, Citation, Crown, Dahlquist, IMF, Infinity, Janszen, Philips, SAE, SME, TEAC, Technics, Thorens and many more (203) 348-3551 (Closed Mondays).

INFRA WOOFER™ world's largest, deepest, most powerful sub-woofer system can be had only at Music and Sound, Ltd. 50 dB per octave crossover, bandpass 16 Hz ... \$1295.

F.M.I. & I.M.F. SUB-WOOFERS, for the closest approximation to dipole definition—\$180-\$350! Also, the rave five-way Fulton/R.T.R. super speakers. Shipped prepaid/insured Music and Sound, Ltd., 11½ Old York Road, Willow Grove, Pa. 19090 (215) 659-9251

AKG, ALTEC, AUDIO RESEARCH, Beyer, CROWN, DAHLQUIST, DBX, DECCA, INFINITY, KLH 9s, Koss, Mark Levinson, Nakamichi, Ortofon, PHASE LINEAR, PML, REVOX, SAE, Sennheiser, Sequerra, Sony, Stanton, Stax, Supex, Tandberg, TASCAM, Technics, Thorens, etc.

HI-FI HAVEN

28 Easton Ave.
New Brunswick, N.J. 08901
201-249-5130

TARZAC CASSETTES: C-1 thru C-90. CUSTOM CASSETTE LABELS. Free samples. 638 Muskogee Avenue, Norfolk, Virginia 23509.

FOR SALE

ARE YOUR TAPES IN DANGER ... Playback on magnetized equipment can ruin them. Now you can measure and eliminate damaging magnetic residuals. Standard Audiophile Hand-D-Kit \$29.75. Delux Hand-D-Kit \$51.00, delivered in USA on prepaid orders. Free data on request. Annisco, 1103 N. Delaware, Indianapolis, Indiana 46202.

TEXAS AUDIOPHILES! On demonstration: Dahlquist, Nakamichi, Transcriptors, Linn-Sondek, Infinity, Braun, Advent, Crown, Phase Linear, Ortofon, Levinson, Supex, Quad, Klipsch, IMF, Keith-Monks, ESS, Decca, B&O, Radford, Stax, Audionics, Philips, Revox, Citation and many others. Audio Concepts, 2021 Guadalupe, Austin, Texas. Phone 512-478-7421.

HI-FI ENTHUSIASTS WANTED!! Earn more than just spare money in your spare time. We need campus representatives to sell name brand stereo components at discount prices in your area. High commission, no investment required. Serious inquiries only, please. Contact: Mike Santillo K&L Sound Services Co. 75 N. Beacon St., Watertown, Mass. 02172.

ROGERS B.B.C. MONITOR, IMF, B&W Ltd., Celestion, Radford, Decca, ERA, Connoisseur, Audionics TL-90, Goldring, Revox, Beyer, Lamb and more. Custom design and modifications. **SUFFOLK AUDIO, INC.** 1105 Mass. Ave., Cambridge, Mass. 02138. (617) 868-1080.

DAHLQUIST DQ-10, RTR, INFINITY, BOSE, ESS, KLIPSCH, SAE, CROWN, PHASE LINEAR, HERVIC, CITATION, YAMAHA, QUINTESSENCE, BURWEN, BEOGRAM 4002, THORENS, LINN SONDEK, TECHNICS, TRANSCRIPTORS, PHILLIPS, CONNOISSEUR, A&D, SME, REVOX, SONY, ADC, ORTOFON, SHURE, MUCH MORE

STEREO CENTER,

2539 VESTAL PKWY, EAST,
VESTAL, NEW YORK 13850
(607) 729-6191

PROPRIETARY CUSTOMIZED MODS reduce tone arm friction, damp spurious resonances, minimize torsional forces, improve tracking, and reduce record wear. For **S.M.E.'s—\$30.00.** For **Rabco SL-8(E)—\$100.00.** For **Transcriptors—free*** (*with purchase).

NOW

LISTEN to our calibrated Satin Ortofon/Supex moving coils. **B&O/Grace/Micro-Acoustics.** From the laboratories of Music & Sound Ltd., 11½ Old York Rd., Willow Grove, Pa. 19090 (215) 659-9251.

+Levinson Cartridge Preamp+

DON'T PAY THE HIGH MAIL ORDER PRICES THIEVES WAREHOUSE OF TAMPA, 1531 SOUTH DALE MABRY, TAMPA, FLORIDA 33609.

MARANTZ SLT-12U Turntable, Perfect, \$250.00. Write Box 2009, Huntington, Conn., 06484, or phone 203-929-5255.

1 SME 16INCH tonearm, complete with 1 M15E Super pickup; both items practically unused. A bargain at \$79.00. Cash-and-carry. Phone: (212) Wy 2-1674.

PROVEN SCHEMATICS: Mixer-Compressor, \$2.00 Microphone preamp drives unshielded line. \$1.00. Millers, 1896 Maywood, South Euclid, Ohio 44121.

MEASUREMENTS STANDARD FM SIGNAL GENERATOR, model 210A, \$160.00. V. Palulis, 8 E. Erie, Chicago, Ill. 60611.

MOVING COIL CARTRIDGE OWNERS: Your alternative is here! Our MCP-1 Moving Coil Cartridge Preamp, featuring audible superiority at a reasonable price, is now available. For information write R B AUDIO, P.O. Box 574, Eatontown, NJ 07724.

FOR SALE

ALTEC 724A tuner/preamp and Dynaco stereo-80 amp (factory built). Mint with original cartons. \$730 new - best offer together or Altec only. Will consider partial trade for mint JBL SE460 with carton and instructions. James Reynolds, P.O. Box 518, South Dennis, Mass. 02660. Evenings - 617-385-8119.

BERKELEY, CALIFORNIA

| | |
|----------------|-------------|
| Audio Research | M & K |
| Mark Levinson | Quad |
| Quintessence | Braun |
| Radford | Fulton |
| Citation | Klipsch |
| Quatre | Dahlquist |
| Hervic | Magnepan |
| Revox | Audionics |
| Grace | Keith Monks |
| Supex | Linn-Sondek |
| Dbx | Connoisseur |

STEREO WORKSHOP

2985 College Avenue
Berkeley, California 94705
(415) 843-5836 open 2-8 TWThF, 12-6 Sat

DON'T PAY THE HIGH MAIL ORDER PRICES. THIEVES WAREHOUSE OF BETHESDA, P. O. BOX 34251, WEST BETHESDA, MD. 20034.

CURRENT AND RECOMMENDED:

CAMBRIDGE AUDIO P70 and **P140** integrated amplifiers with toroidal power supply and state of art preamp. \$350 and \$550. Also **TL100** and **TL200** transmission line speakers. \$400 and \$500 each.

GRACE BL and **8C** stereo moving magnet cartridges. We feel the **8C** is the finest cartridge available which does not require a transformer or peamp or damped tone arm. Amazingly uncolored. \$80 and \$95.

FIDELITY RESEARCH cartridge and transformer. The best moving coil yet. Highly regarded even by resident Decca freak. Great depth of image and smoothness. \$280 with toroidal transformer.

DECCA BRUSH. Over a million conductive bristles eliminate need for liquids and reduce static. \$15.

C/M LABS RR805 receiver. Unusually quiet, low distortion tuner. Fully complementary power amplifier. "C" panel 19 in. rack mount. \$600.

also: Radford, Audionics, BGW, Yamaha, Sony, Revox, FMI 80, Celestion, Braun, IMF Monitors, Micro Seiki headphones, ERA, Transcriptors, Connoisseur, Dual 601, 701, damped tone arms, Decca export, Supex, Ortofon, ADC, Sennheiser, Beyer.

Shipped free anywhere in U.S. and Canada

GREENWOOD SOUND, INC.

5331 S.W. Macadam
Portland, Ore. 97201
503 224-1776

the Water Tower at John's Landing

DYNACO AF-6 tuner, 8 months old, \$200. Willard Ramsey, 456 Hillside Drive, Newcastle, N.B., Canada E7V 2P1.

CROWN DC-300 super power amp with cabinet, \$450. Mint condition. Joe Saluzzi, New Jersey. Call (201) 967-0492 after 8 P.M. EST.

PHILLIPS GA-212 turntable with Audio-technica 15s 8mo. \$150. Marantz 4100-120rms-\$225 Conn. Phone: (203) 389-5148

FAIRCHILD COMPANDER with custom stereo 10 watt RMS driver amp. Dynaco PAT-4 preamp. MINT. Best offer basis, Box 259 Brooklyn New York 11234.

RFI SUPPRESSED—SOLID STATE. Push ON-Push OFF & DIMMER Control. Set the mood in your home or apartment!!! Add life to expensive bulbs. Conserve Energy!!! Guaranteed 2 Yrs. Send \$7.98 plus 50¢ Handling to "YOUNIQUE" ENTERPRISE 1AP Box 703 Maysville, Ky. 41056

FOR SALE

SONIC ATTENUATORS (low pass filter-equalizer combination) are necessary for cleaning up old noisy recordings. Ideal for taped dubs. \$125 per channel. Demo tape \$2.00 deductible. Box 259 Brooklyn, New York 11234.

CHOICE LENGTHS, blank 8-track cartridges. Discounts. Sound Production, Box 281, Norfolk, NE 68701

MCINTOSH MR-71 TUNER, Marantz 7T preamp, Mattes SSP-200 power amplifier, asking \$265, \$210, \$150 respectively or all for \$550. Also Sony TC-777-4 tape deck, best offer. Reply Box A55-2.

TAPE FULL of your favorite oldies. You name them, we tape them - hits from 1956 to present. \$10 per tape sent C.O.D. Thomas, Box 1044, Baton Rouge, La. 70821.

MCINTOSH MA6100 w/cabinet. Sony TC-755 w/10-1/2" Sony tapes. Dual 1229Q complete w/Shure V-15 III, Sennheiser 424's. Extras. All 1 yr. old and excellent. Original cartons and warranties. \$1000. Delivery within 100 miles. Gregory Trimble, R.D. #1, Kirkwood, Pa. 17536.

MARANTZ 4300, \$695; Dual 1229, \$7; Technics 4xscope, \$225. Full packing & manuals. 805-325-0990. P.O. Box 726, Bakerfield, Calif. 93302.

NORTHERN N.J.'S FINEST AUDIO STORE, 20 minutes from NYC. Bozak, B&O, Magneplanar, Marantz, Phase Linear, DBX, IMF, Dahlquist, Ortofon, Quintessence, Thorens, Pioneer, Kenwood, Dual. Write or call - University Stereo, 57 E. Ridgewood Ave., Ridgewood, N.J. (201) 447-5700.

PAIR PIONEER CS44A'S; Sansui 200A amp, PE2040 turntable, Panasonic RS-295US cassette. All new or as new, \$500.00 G. Vaughn, 4427 So. 24th, Ft. Smith, Ark. 72901.

LOW PRICES on stereo components. List of brands, plus "special" sheet 50¢. Refundable. Custom Audio, 4226 Robert St., Red Wing, Minn. 55066.

MIXER MODULES. Modules designed to provide an economical route to studio-type mixing consoles. Modules have plastic element slide faders and a module for E.Q. At last there is a bridge between the high-cost pro gear and components for the audio enthusiast. Send for free info to Wall of Sound, 2406 Mountain Road, Pasadena, Maryland 21122.

SERVICES

HIGH FIDELITY SPEAKERS REPAIRED
AMPRITE SPEAKERS SERVICE
655 Sixth Avenue, New York, N.Y. 10010
212-CH3-4812

THE ABSOLUTE SOUND™, in its new issue, takes its first look at tuners. To judge the sonic accuracy of nine tuners, the staff broadcast its own FM signal (fancy that) and the results may shake up some cherished notions. Among the tuners tested: The Sequerra; the \$1200 Yamaha; the Marantz 10B; the Onkyo 3055; Citation's 14 & 15; the Sherwood; McIntosh MR78 and MX110. But that's not all. We test (finally) the Phase Linear 4000. Also: Dyna's PAT-5; the Micro-Acoustics cartridge; the Hegeman 2; the B&O 4002; the Quatre amplifier; the Paoli amplifier; the Yamaha FET amplifier; the Denon moving coil cartridge; Audio Research's improved SP-3a; the Stanton 6B1eee semi-pro tape machines from TEAC (3340S) and Pioneer (1055); the Avid 103 and Audio Analyst AX100 and much more. Much. The cost of the magazine: \$10 (four issues) U.S.; \$11 Canada. Add \$2 for first class mail. Foreign: \$12.50 (air). Back issues (there are 5): \$3 each. The Absolute Sound, Box 5C, Northport, New York 11768.

SERVICES

TAPE RECORDER HEADS brought back to spec. Wear removed. Brilliant finish. \$10.00 each. One day service. E. Maher, 5 Evans Place, Orinda, Calif. 94563.

DON'T PAY the high mail order prices. Thieves Warehouse is coming to your area. Franchises available. Thieves Warehouse, P.O. Box 8057, Pensacola, Florida 32505.

NASHVILLE RECORD PRODUCTIONS WILL PRESS HIGH QUALITY PURE VINYL RECORDS FROM YOUR TAPES. SEND FOR SAMPLE RECORD AND PRICE LIST. ALSO FINEST DISC MASTERING 1819 BROADWAY, NASHVILLE, TENNESSEE 37203.

CUSTOM RECORDING SERVICE, Tape and disc. Stereo and mono. Live and copies. Editing, Masters and pressings. High quality at reasonable rates. Joseph Giovanelli, Audio-Tech Laboratories, 2819 Newkirk Ave., Brooklyn, N.Y. IN 9-7134.

CUSTOM TAPE DUPLICATION 8 track and cassette. We specialize in small runs. CUSTOM AUDIO c/o Dick Walen, 4226 Robert St., Red Wing, Minn. 55066.

TAPE RECORDER HEADS brought back to spec. Wear removed. Brilliant finish. \$10.00 each. One day service. E. Maher, 5 Evans Place, Orinda, Calif. 94563.

STEREO SOUND LABS

FACTORY SPECS OR BETTER BY 10% ON ALL REPAIRS ON MAJOR BRANDS. WARRANTY 90 DAYS PARTS AND LABOR. SHIP US YOUR GEAR PROPERLY PACKED AND INSURED. 4419 JOHN MARR DRIVE, ANNANDALE, VIRGINIA 22003. (703) 941-5707.

AUDIO EXPERT, technical consultant, technical representative, designer or teacher for service seminars. Contact: R. Thomas, P.O. Box 568, Jackson Hts., N.Y. 11372.

RECORDS

SHOW ALBUMS—Rare. Out of Print LP's. 52 page list 50¢. Broadway/hollywood Recordings Georgetown, Conn. 06829.

OLDIES—45 RPM Original hits. Catalog 50¢ C&S Record Sales, Box 197, Wampsville, N.Y. 13163.

WHILE YOU WERE LOOKING for out-of-print records, you should've been looking for us. Discontinued, 216 N. Rose, Burbank, California 91505.

FILM-STAGE SOUNDTRACKS. Large free list. A. Lutsky, Box 557342, Miami, Fla. 33155.

CATALOGS. Broadcasts, soundtracks. Personalities of Thirties, Forties. Box 225, New York, N.Y. 10028.

SOUNDTRACKS - JAZZ - POP. Vincent, Box 5202, Long Island City, N.Y. 11105.

SOUNDTRACK RECORD ALBUMS—Mail Auction. Free List—Whalon, 2321A Hill—Redondo Beach, Calif. 90278.

FREE 200-PAGE CATALOG. 1,400 New Stereo Recordings. Renaissance, Baroque, Classical, Romantic, Modern Music. Not sold in stores. Not listed in Schwann's. Highest quality! Budget label prices! Available only by mail. MUSICAL HERITAGE SOCIETY, Box 932 AU, New York, N.Y. 10023.

SOUNDTRACKS/OC, JAZZ/PERSONALITY—FREE NEWSLETTER! RTSA, 3700 S. Plaza Drive, Bldg. F/211, Santa Ana, California 92704.

QUADRAPHONIC RECORDS AND TAPES - World's largest selection - all labels, over 1000 titles - at discount prices! For your free illustrated quad catalog, write: SOUND CONCEPTS, 2713 West Radan, Dept. C5, Peoria, Illinois 61604.

FIVE FREE COMPARISON TESTS!

...as an introduction to our new, personalized Hi-Fi Newsletter, established in 1970. Please check () FREE Tests (optional air mail delivery, 50¢) () Sample Issue, \$3, Free with () Cancellable Subscription (4 issues) \$10. Send request or remittance to: HFVN, Box 593, Hialeah, FL 33011

EQUIPMENT WANTED

DORIS DAY RECORDS wanted, all speeds. Send list to: Bruce Adams, P.O. Box 86, Uniondale, N.Y. 11553.

WANTED: OLD SCOTT model LK - 72 stereo amp for use for parts. Transformers must be good. Will consider used unit in working order. D. Biggs, P.O. Box 1177, Silsbee, Texas 77656.

WE MUST HAVE YOUR USED COMPONENTS

Premium Trade or Cash for: McIntosh tube (pre) amps & tuners, Marantz tube (pre) amps 7 tuners, Marantz 7(T), 15, 16 (B) Futterman H-3, J.B.L. 400, 500, 600 series electronics, J.B.L. Hartsfield, L-101, Metrogon, Minigon, Music & Sound Ltd., 11 1/2 Old York Rd., Willow Grove, Pa. 19090. (215) 659-9251.

CASH FOR Mint Ips & prerecorded reel tapes. Records, Box 323, Hillburn, New York 10931.

MARANTZ 7C, 9: McIntosh C22. John Fong, 1238 Green St., San Francisco, Calif. 94109.

WANTED: MCINTOSH MA6100 amp. State condition and price. Gary Hall, 93 Morgan Rd., Binghamton, N.Y. 13903.

JBL 175DLH 16ohm speaker. Stephen Karkos, 12 Ransom Road, Brighton, Mass. 02135.

MAGNECORD WANTED, USED. (212) 793-3927

WANTED: NEW OR USED ALTEC Barcelona, JBL L101, Olympus, McIntosh C22, C28. Mr. Kazuhiko Murota, 1-67-203, Tsurumaihigashi, Nara City, Japan.

WANTED: CONCORD MK-III Tape Deck. Bohdan Czerwinski, Box 527, Iron River, Michigan 49935.

WANTED: MCINTOSH MR-67 tuner, MC-275 amplifier; Fairchild 412-4 (electronic control) turntable, Fairchild SA-12 arm; JBL pre-amp SG520, power amps SE400S, SE460. Mint condition only. John Simpson, 3912 Big Sky N.E., Albuquerque, N. Mex. 87111.

MARANTZ 7, McIntosh 275. Box 26541, Tempe, Ariz. 85282.

DOES ANYBODY HAVE a Marantz 10B wood case, a 7 rack panel, or a 10B rack panel they would like to sell? M.S. Wilkouski, 5252 N. California, Chicago, Ill. 60625. (312) 561-4056.

DYNACO, MARANTZ, Fisher, Radford tube pre and power amplifier. Sherwood Scott tube tuner. Citation 12. State condition and price. Pierre Royer, 10781 St. Julien #3, Montreal H1H 3Y1, Canada.

WANTED - Pioneer SX-1010 & SA-9100; ESS-AMT series; Garrard Zero 100 SB or 100C; Sony & Tascam tape equipment; cartridges new or top condition only. Send specs, lists & prices to: Louis Sonier, 139 Dawes Road, Toronto, Ont. M4L 501.

HIGH FIDELITY

DYNAKITS, IAD, lowest prices. Underground HI-FI Sales, 324 Broadwater Road, Arnold, Md. 21012. (301) 647-0919.

NOW AVAILABLE ... FAMOUS REFLECTING SYSTEM'S 4 1/2" REPLACEMENT DRIVERS. \$7.98 POSTPAID. BIG QUANTITY DISCOUNTS. FREE SPECIFICATIONS. AURATONE, BOX 580-19, DEL MAR, CALIFORNIA 92014.

TAPE & TAPE RECORDERS

SCOTCH RECORDING TAPE, lowest prices. TAPE CENTER Box 4305B, Washington, D.C. 20012.

CASSETTE DUPLICATION, Cassettes, and SCOTCH Recording Tape. PRODUCTIONS, Box 185, Allendale, Mich. 49401.

SPECIAL OFFER!

Free tape to introduce you to our invaluable service. No obligation to buy anything. Send 25¢ to cover costs of postage and handling. Specify rock, country or classical. Also specify 8-track, cassette or open reel. Send to Hartley, 2015 Shore Parkway, Bklyn, N.Y. 11214.

SCOTCH, CAPITOL. Blank cassettes, cartridges, reels. Discount prices. Lawson's, Box 510, Livermore, CA 94550

TAPE DECK OWNERS, Got those retail store blues? Low wholesale prices on Scotch and Maxell. Send for prices now and receive \$1.00 credit on first order. N.A.B. Audio, P.O. Box 7, Ottawa, Illinois 61350.

AUTO ACCESSORIES

REVOLUTIONARY Auto Air Conditioner. You can build for under \$50. Saves Gas. Free Detailed information. Space Age Research Co., Box 770, Dept. Au-5, Columbus, IN 47201.

SANDBLASTERS - \$39.50-\$839.50. Free Catalog. Truman, 1330A Market, Youngstown, Ohio 44507.

BUSINESS OPPORTUNITIES

BREAK INTO RADIO, D. J. tells how. Explains jobs, salaries, etc. \$2.00. General, Box 467, AE, Landing, N.J. 07850.

\$2000 MONTHLY POSSIBLE addressing and stuffing envelopes. Information: Rush 25¢, stamped, addressed envelope. K&F Enterprises, 1935A Campbell, Royal Oak, Michigan 48067.

MUSICAL INSTRUMENTS

UP TO 60% DISCOUNT. Name brand instruments. Catalog. Freeport Music, 455R Route 110, Melville, N.Y. 11746.

RADIO PROGRAMS

1930-1962 RADIO PROGRAMS, Reels, \$1.00 hour! Cassettes, \$2.00 hour! Mammoth catalog \$1.25. AM TREASURES, Box 192M, Babylon, New York 11702.

OLD RADIO PROGRAMS on tape and cassette. Catalogues 50¢. 30 minute sample tape with catalogue \$1.25. Satellite Broadcasting, Box 512, Miami, Florida 33165.

GOLDEN AGE RADIO—your best source for radio tapes. Box 25215-D, Portland, Oregon 97225.

OLD RADIO PROGRAMS ON TAPE. Thousands available. Low prices, finest quality, immediate service. Catalogue 25¢. Nostalgic Radio, Box 29K, Peoria, Ill. 61601.

VINTAGE RADIO IN QUALITY SOUND ON REELS, 8-TRACK, OR CASSETTES. BUY FROM PROS IN THE BUSINESS WHO KNOW SOUND! THOUSANDS OF PROGRAMS AVAILABLE. CATALOGUE: \$1.00; SUPPLEMENT: 50¢ (REFUNDABLE) TO: THE VINTAGE VOICE, BOX 687, TIBURON, CA. 94920

RADIO PROGRAMS

YESTERDAY'S RADIO PROGRAMS ON TAPE. Reels, cassettes - fast reliable service. Catalog \$1.00 refundable with first order. ADVENTURES, 1301-A North Park Avenue, Inglewood, California 90302.

EXTANT RADIO SHOW LISTING. \$3.00. Lists 3000 juvenile, mystery broadcasts. Date, plot information, alphabetical. Jerry Chapman, 337 W. Neptune, N.I.U. DeKalb, Illinois 60115.

BOOKS

BOOKS. Send 50¢ for Catalog. Refundable with Order. Also Egyptian Dream Book 35¢. Books, P.O. Box 11965, Philadelphia, Pennsylvania 19145.

GOVT. SURPLUS

MANUALS FOR GOV'T. SURPLUS Radios, Test Sets, Scopes. List 50¢. Books, 7218 Roanne Drive, Washington, DC 20021.

SHORTWAVE

HEAR POLICE FIRE Dispatchers. Catalogs show receivers: exclusive directories of "confidential" channels. Send 10¢ stamp. Communications, Box 56AU Commack, New York 11725.

POLICE-FIRE MONITORS. Scanners, Crystals, Discount Priced, Box 19224, Denver, CO 80219.

PHOTOGRAPHY

PHOTO BUTTONS made from your photograph or any slogan, advertising, picture, etc. Only \$2.00 postpaid. Arcan Products, Rt. 1, Box 278, Waldorf, Md. 20601.

TAPE RECORDINGS

RENT Open Reel or Cassette Prerecorded tape. All labels. Catalog \$1.00. Tape & Time, P.O. Box 740, Hopkins, Minn. 55343.

EVERYTHING ON OPEN REEL! Prerecorded classical/popular tapes. Latest releases. Dolby. Quad. 96-page catalogue \$1. Barclay-Crocker, Room 857A, 11 Broadway, NYC 10004.

LIVE OPERA TAPES. Professional reel, cassette copies. Extensive sound coded catalogue. Quality guaranteed. Also records. A Fischer, Box 83 Fordham Station, Bronx, N.Y. 10458.

AMBIPHON'S QUADRAPHONIC TAPES. Highest quality available anywhere. Stereo compatible. Format: 1/4", 7-1/2 ips, 4-track discrete reel-to-reel on highest quality mastering tape. Includes precision test segment. Send stamped envelope to: Amphiphon Records, Dept. A, P.O. Box 341, Kingsbridge Station, Bronx, N.Y. 10463

HALF TRACK STAGGERED stereo tapes wanted. Bel Canto, etc. sell/trade - 1/4 track copies. R. Brewster, Box 90, Oak Ridge, Tenn. 37830.

8-TRACK TAPES, \$4.00. Free catalogue. Galen Hively, Somers, Iowa 50586.

MONEY

HISTORIC PAPER MONEY OFFER!! 10,000 (ten thousand!) German Marks yours to treasure for just \$5. Terrific collectors' items. Immediate delivery. Send to: Finkelstein, 2056 Cropsey Avenue, Brooklyn, New York 11214.

"A Marantz Imperial 8 speaker can handle 125 watts of integrated program material, but reproduces full realism with a fraction of that."

In August, 1974, sound engineers and audiophiles were invited to examine and discuss the Marantz Imperial 8 Floor-Standing Speaker System. The following comments were taken from that taped discussion.

"Because Imperial 8's are so efficient, they offer a wider dynamic range for any given amplifier. Even if a guy has a 30 watt amplifier he'll get full realism for that amp. With the Imperial 8 Speaker System he'll never have to go to multiple amps to get the kind of sound pressure he's looking for.

"These speakers are of a base reflex design so they're inherently more efficient."

"The port tends to reinforce the loading when the speaker moves. There's lots of control over the cone which means it follows the program material very accurately and lowers the distortion."

"Clean sound... plenty of sock. Ultimate realism and maximum high-power handling capabilities"

"Each speaker has a custom manufactured 12" woofer with a variable density cone — a stiffer cone with less doubling"

"The most unique feature here is the rotatable array consisting of three mid range and two tweeter elements. This allows excellent mid and high frequency coverage characteristics regardless of speaker placement"

"Marantz calls the rotatable array mirror imaging — mid range and tweeter elements can be adjusted so that they're exact mirror images of each other for proper dispersion and the best possible stereo separation."



"There's 360 degrees of change possible by simply rotating the array. This means you can adjust the angle of dispersion to get the most high frequency material in any given area"

"When you consider that no two rooms are exactly the same, the more adjustments you have within a speaker the better the sound is going to be. Imperial 8 Floor-Standing Speakers have more flexibility, more control, more variables to compensate for differences in room configurations."

The Marantz Imperial 8 Speaker System is just one of two exciting Marantz floor-standing speaker models. The step-up model Imperial 9 with two 10" woofers is designed for higher power handling capabilities as well as high efficiency and mirror imaging. Both models reflect the kind of technical expertise and engineering excellence that has made Marantz the choice of professionals world-wide. Stop by your local Marantz dealer and see the complete line of floor-standing and bookshelf speaker systems starting as low as \$59.95. Each features an exclusive five year guarantee** on parts and labor. Marantz. Ask an expert.

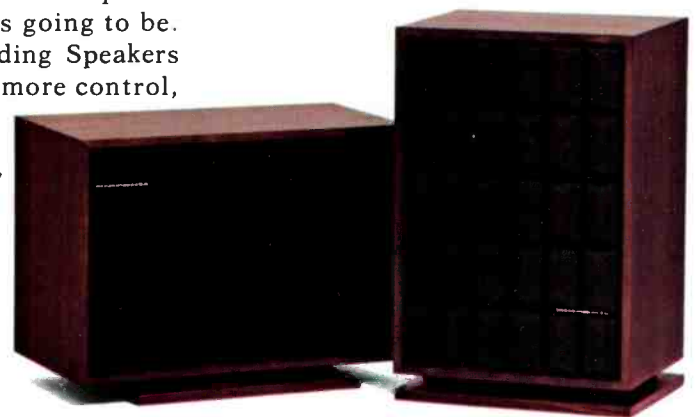

marantz®
We sound better.

*Marantz Co., Inc. guarantees to the original registered speaker owner that all parts will be free from operating defects for five years from purchase date. Product will be repaired or replaced free of charge in the sole discretion of Marantz Co., Inc., provided it was purchased in the U.S.A. from an authorized dealer. The serial number cannot be altered or removed. Product must be serviced by authorized Marantz repair technicians only. ©1974 Marantz Co., Inc., a subsidiary of Superscope, Inc., P.O. Box 99, Sun Valley, CA 91352. In Europe: Superscope Europe, S.A., Brussels, Belgium. Available in Canada. Prices and models subject to change without notice. Consult the Yellow Pages for your nearest Marantz dealer. Send for free catalog.

Check No. 43 on Reader Service Card



Announcing the Sherwood 2+2+3

One great deal gets you stereo, quadraphonics, and 3 SQ™ albums —for the price of stereo all by itself.

It takes little effort to see that Sherwood's S7244 can hold its own with leading contenders in its price range—even as a stereo-only unit.

The power base is substantial; operational flexibility, unsurpassed. And the overall performance, unbelievably good.

But that's only half the picture. Because the S7244 is also an excellent quadraphonic system. Full-Logic SQ

circuitry produces discrete 4-channel sound [again, with power enough to get the most out of the model]. And it's fully compatible with your present equipment: SQ doesn't depend on special turntables or cartridges.

No other gear gives you more for less. But during our special 2+2+3 deal, you get even more than usual.

For a limited time,* if you purchase an S7244,

we'll send you three of the SQ albums listed below. Free.

All you have to do is complete this coupon, have it authorized by your Sherwood Dealer, and mail it in.

Check out the 2+2+3 soon. It adds up.

Specifications:

Minimum RMS power output @ 0.6% maximum total harmonic distortion, all channels driven:

- Stereo mode: 50 watts per channel [8 ohms, 20-20,000 Hz]
- 4-channel mode: 20 watts per channel [8 ohms, 20-20,000 Hz]
- 1.9 μV FM Sensitivity [IHF]
- Capture Ratio: 1.5 dB

SQ and Logic Integrated Circuits
 FM Four-Channel Ready [Aux. 2 input]
 Price [includes walnut-grained case].
 \$499.95

Buy an S7244 during our special 2+2+3 offer, and get any three of these nine Columbia SQ albums at no extra cost:

- A) MSFB: Love Is the Message
- B) Chicago VII [counts as two albums]
- C) Charlie Rich: Behind Closed Doors
- D) Santana's Greatest Hits
- E) Herbie Hancock: Head-Hunters
- F) Barbra Streisand: The Way We Were
- G) Paul Simon: There Goes Rhymin' Simon
- H) Copland Conducts Copland
- I) Bernstein Conducts Nielsen Symphony #2



SHERWOOD

The word is getting around.
 Check No. 24 on Reader Service Card

Indicate album selections by letter in spaces provided. Dealer's signature and serial number of unit purchased validate this form. Mail completed coupon [allowing 4-6 weeks for delivery] to:

Sherwood Electronic Laboratories, Inc.
 4300 North California Avenue
 Chicago, Illinois 60618

Name: _____
 Address: _____
 City: _____ State: _____ Zip: _____
 Serial Number of S7244: _____
 Dealer's Signature _____
 Album Selections: [1] [2] [3]

SQ is the registered trademark and exclusive property of CBS Records, Inc.
 *Offer expires August 15, 1975