

Audio
ETC

Audio

THE AUTHORITATIVE MAGAZINE ABOUT HIGH FIDELITY • MARCH 1975

75¢ ®

47425 

U0803760 0476 30725005P0101212
DON L HUNTER
2608 CENTRAL BLVD
EUGENE



Adoption of the Westrex 45/45 System

Do Record Cleaners Really Work?

Amplifiers,

phase distortion, plus substantially better stability with four double tuned phase linear ceramic filters and four monolithic IC's in the IF section.

6-stage limiters

The IF section includes 6-stage limiter circuits. Used in conjunction with differential amplifiers in monolithic IC's, noise interference is completely eliminated with a signal to noise ratio of 75dB.

Exclusive Phase Lock Loop (PLL) IC circuitry in the TX-9100 multiplex section

Developed and used for the first time by Pioneer, the Phase Lock Loop (PLL) circuit is actually an electronic servomechanism. It maintains continuous and precise phasing between the pilot signal and the subcarrier, supplying optimum channel separation. Completely drift free, no alignment is ever required.

The PLL cannot be affected by humidity or temperature since there are no coils or capacitors to be detuned. This provides complete stability and reliability.

New pulse noise suppressor in the TX-9100 operates with computer control

This circuit operates automatically when it is switched on. It effectively blocks radiated noise from airplane and auto ignition systems, neon and traffic lights, etc. It does not interfere with frequency response and stereo separation. Whether the signal is weak or strong, this automatic 'brain' decides when the PNS gate circuit is to operate.

Unique muting control

A 2-position variable muting control uses electronic switching as well as reed relay switching. This eliminates interstation noise and the popping noise of tuning and detuning.

Complete command with a wide variety of controls

Whether it's for AM, FM or headset output levels, Pioneer provides greater operating precision with three independently operated output level controls. A headset may be used without a following power amplifier. Precision tuning is achieved with the aid of signal strength and tuning meters.

AM section highlights IC's

The entire AM section, following the front end, is a unitized IC. A monolithic IC replaces 84 individual components plus a ceramic filter. By using a differential amp circuit and a balanced mixing circuit, there are better spurious characteristics and special AGC amplification.

Great specs for great performance

	TX-9100	TX-8100	TX-7100
FM Sensitivity (IHF)	1.5uV	1.8uV	1.9uv
Selectivity	90dB	80dB	60dB
Capture Ratio	1dB	1dB	1dB
S/N Ratio	75dB	70dB	70dB
Image Rejection	110dB	100dB	85dB
Stereo Separation	40dB	40dB	40dB
Distortion (THD)			
Mono	0.2%	0.2%	0.2%
Stereo	0.3%	0.4%	0.4%
Spurious Response	110dB	100dB	100dB

The Amplifiers: SA-9100, SA-8100, SA-7100

Two separate power supplies utilize 30,000 uF total capacitance

You read it right. The power supply in the SA-9100 uses a total capacitance of 30,000 uF. 15,000 uF each for the balanced positive and negative power supplies. This completely eclipses anything now available in integrated amplifiers. This super high capacitance results in an absolutely pure DC voltage supply. There's constant DC voltage regulation regardless of line voltage changes and signal input.



Two 15,000uF power supplies eclipse anything now available in integrated amplifiers.

Even at extremely low frequencies, there's stable power output, excellent transient response and low total harmonic distortion — not greater than 0.1% at any power level up to 60 watts minimum continuous power per channel, at any frequency from 20Hz to 20,000 Hz, using 8 ohm loads.

These positive and negative power supplies provide absolute stability in all stages, even in the equalizer amp and preceding to the control and power amps. Therefore, the signal lines become zero potential to completely eliminate the usual (and annoying) click noise of operating controls and switches.

Stability is increased even further by the differential amplifier used in the first stages of the equalizer and control amplifiers (also the power amp.) 100% DC negative feedback supplies excellent stability and transient response; it also eliminates distortion.

To further increase

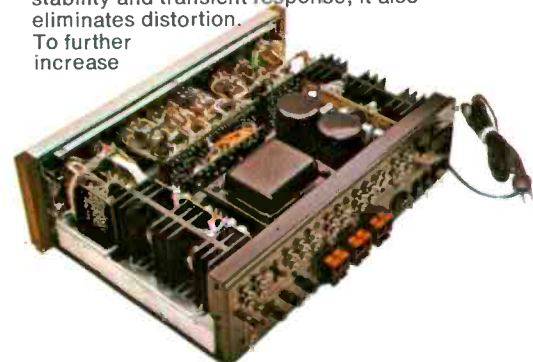

Interior view. SA-9100

In tuners and amp Pioneer is the very best.



The time has come to completely re-evaluate the standard you now use to judge high fidelity performance.

With this new line of tuners and amplifiers, Pioneer presents many ingenious innovations in circuitry that are being used for the first time. However, this exclusiveness is only secondary. While each new circuit can be considered revolutionary by itself, what is even more important is that their combined capabilities achieve precision and performance heretofore unattainable.

The Tuners: TX-9100, TX-8100, TX-7100

FM front end — an engineering triumph
The height of sophistication, the TX-9100's stabilized, drift-free front end replaces printed circuit boards with completely metallized construction. The same used in high precision communications equipment. Employing three dual gate MOS FET's and a buffer circuit in the local oscillator,



Exclusive heavy gauge die cast aluminum housing assures uncanny stability.

there's exceptionally high gain with extremely low noise. Two tuned FF stages with a 5-gang variable tuning capacitor contribute to the highest selectivity (90dB) and astonishing FM sensitivity (1.5uV). The exclusive use of a heavy gauge die cast aluminum housing assures uncanny stability.

IF section — the epitome of advanced research

In the pursuit of excellence, significant new IF section technology was developed. The result is optimum selectivity with minimum

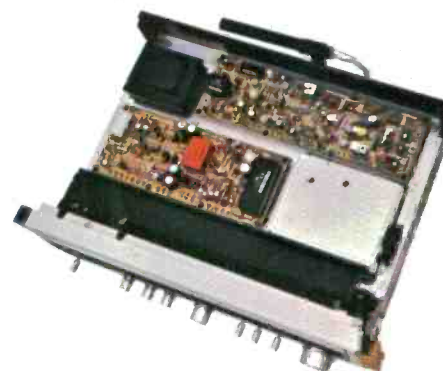

TX-9100 interior view. Chrome plated shielded front end housing and multiplex section.

Critics acclaim...



HIGH FIDELITY: "... The performance of the SA-9100 is so exceptional and the many extras in the way of switching options, and so on, so eminently useful, that we find it the most exciting piece of audio hardware we've yet tested from this company."

STEREO REVIEW: "... The TX-9100 unequivocally outperforms anything we have tested up to this time."

HI-FI STEREO BUYERS' GUIDE: "(The SA-9100) is a powerhouse of sound level, performance and features. Works like something the chief engineer had built for his own use."

"The Pioneer TX-9100 AM/FM stereo tuner offers notably excellent performance and sound quality."

AUDIO: "You can't buy better audible performance than is achievable with Pioneer's new TX-9100 (AM-FM stereo tuner) at any price."

STEREO REVIEW: "This (SA-9100) is an essentially distortionless, bug-free, and powerful amplifier with exceptional flexibility... A highly complex array of electronic circuitry has been packaged into a consumer product of relatively modest price without a trace of 'haywire' or slipshod assembly. It almost seems a pity to hide internal workmanship."



Complete reprints available upon request.

stabilization, special electronic regulator circuits are used. Transient response is also improved with a superb damping factor of 70.

The unique equalizer amplifier

To make certain that extraneous signals do not interfere with the input signal, the equalizer amp is totally enclosed and sealed to shield it against leakage.

There's also extra assurance of precision with special low noise metal film resistors and styrol capacitors. Both are manufactured under continuous computer control to highest laboratory test equipment tolerances: $\pm 1\%$ for resistors; $\pm 2\%$ for capacitors. Until now such precision has been unheard of in hi-fi equipment. Deviation from the ideal RIAA curve is only $\pm 0.2\text{dB}$.

Since a direct-coupled SEPP complementary circuit is used in the equalizer amplifier, virtually any dynamic phono cartridge can be accommodated without overloading or distortion. For example, with 2.5 mV sensitivity, the overload at 1KHz is an unbelievable 250mV, and 1200mV at 10KHz!

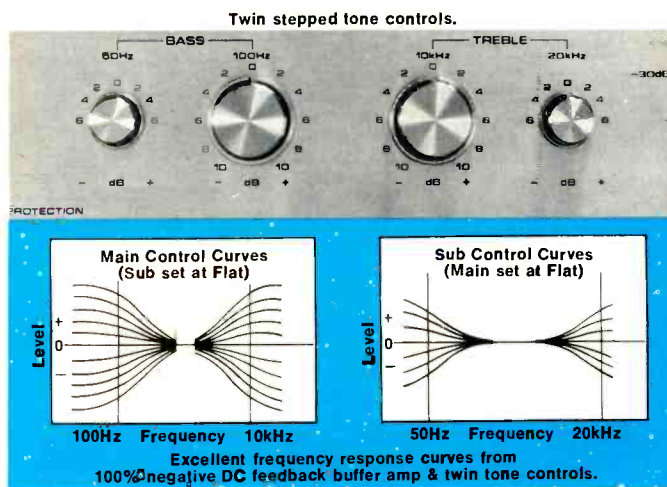

The control amplifier: Twin stepped tone controls custom tailor your listening.

Now you can make the most critical bass and treble adjustments with supreme ease. In fact, there are 5,929 tonal combinations to suit your listening room acoustics and to compare or compensate for component frequency response.

On the SA-9100 and SA-8100 four tone controls (two for bass, two for treble) make 2dB (2.5dB with SA-8100) step adjustments for the entire audio spectrum. Working together with the tone controls is a buffer amplifier with 100% negative DC feedback. The main bass control governs $\pm 10\text{dB}$ at 100 Hz; the sub-bass, $\pm 6\text{dB}$ at 50 Hz. The main treble control governs $\pm 10\text{dB}$ at 10KHz and the sub-treble, $\pm 6\text{dB}$ at 20 KHz. This, plus the tone defeat control (described in the next paragraph) makes the SA-9100 the most exciting-to-use amplifier that has ever powered any hi-fi system.

New tone defeat switch

Because of the extremely wide variety (5,929) of frequency adjustments made possible by the twin tone controls, the tone defeat switch adds extra flexibility. Adjusting the tone controls to your satisfaction, you can flip the tone defeat switch. Bass and treble responses instantly become flat. When it is switched off you return to the original tone control settings.

The power amplifier

To sustain the ultra sophistication of the equalizer and control amp sections, the power amp has a direct-coupled pure complementary SEPP circuit, double differential amplifiers and two constant current loads. The combined effect is the achievement of wide power frequency range and excellent transient response. 100% negative DC feedback is supplemented by 66dB dynamic negative feedback for minimum distortion and absolute stability. The pre and power amps can be used independently with a separation switch.

Exclusive direct-coupling in all stages

Until now direct-coupling has been used only with the power amplifier. Pioneer takes it a dramatic step further in the SA-9100 and SA-8100. Direct-coupling in all stages from the equalizer amp to the control amp to the power amp. More effective? Absolutely. It achieves the finest transient response, wider dynamic range, with no greater than 0.1% total harmonic distortion. It's an incredible achievement.

Level set, volume and loudness contour controls adjust to listening preference

Three controls working together adjust to any degree of loudness. The level set control is the primary volume control. Its maximum loudness setting is 0dB.

Successive settings of -15dB and -30dB result in lower gain. Once the desired volume is obtained, the volume control is used for fine adjustments within the given

range. While the loudness contour boosts bass and treble, it may also be used with the level set control. The more advanced the position of the level set control, the lower the effective range of the loudness contour.

The original and positive speaker protector circuit

Since the signal is fed directly to the speakers because of direct-coupling, an automatic electronic trigger relay system is incorporated into the power amplifier. This protects the speakers against damage from DC leakage which can also cause distortion. It also prevents short circuits in the power transistors.

Maximum convenience for program source selection

While there is a multiple function rotary switch for microphone, phono 2 and two auxiliaries, Pioneer has included an

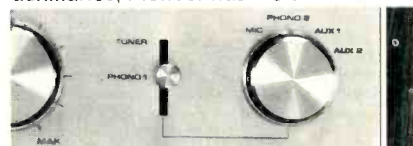

Convenient program source selection switch & control lever.

PIONEER
when you want something better

additional convenience. A separate flip type lever control for instant switching between the more widely used tuner and phono 1 and any other single program source. Incidentally, both switches are shielded to protect the input against undesirable extraneous signal pickups.

Two-way tape duplicating and monitoring

There are two separate flip type switches on the front panel of the SA-9100 for tape-to-tape duplicating and monitoring. Two tape decks can be connected for recording, playback and duplicating in either direction, with simultaneous monitoring.

Level controls for phono 2, aux 2

In order to match the level of various inputs, individual level controls are provided for phono 2 and aux 2.

Speaker B control

This special control helps in the use of two pairs of speaker systems of different efficiencies. There is no sacrifice of damping or distortion when switching from one pair to the other.

Impedance selector for phono 2

An easy-to-use switch allows you to employ any phono cartridge input (25K, 50K, 100K ohms).

Two-position high & low filters

The low filter switch on the SA-9100 and SA-8100 has subsonic (below 8Hz) and 30Hz positions. The high filter switch has 12KHz and 8KHz positions.

Maximum versatility in program sources

	SA-9100	SA-8100	SA-7100
Inputs			
Tape monitor—S/N	2-90dB	2-90dB	2-90dB
Phono—S/N	2-80dB	2-90dB	2-80dB
Auxiliary—S/N	2-90dB	2-90dB	2-90dB
Microphone—S/N	2-70dB	2-70dB	1-70dB
Tuner—S/N	1-90dB	1-90dB	1-90dB
Outputs			
Speakers	3	2	2
Headsets	1	1	1
Tape Rec.	2	2	2

Consistent power for every requirement

Continuous power output per channel, both channels driven into 8-ohm loads, at any frequency from 20 Hz to 20,000 Hz. at no more than the total harmonic distortion indicated.

	Rated Power	Rated Maximum	Total Harmonic Distortion
SA-9100	60 watts, minimum		0.1%
SA-8100	40 watts, minimum		0.3%
SA-7100	20 watts, minimum		0.5%

This new lineup of Pioneer tuners and amplifiers is unquestionably the most advanced available today. Yet despite this overwhelming sophistication, they're sensibly priced.

See your Pioneer dealer. He'll show you how this series of fine instruments can outperform any units in their price range. All prices include walnut cabinets. SA-9100—\$449.95; SA-8100—\$349.95; SA-7100—\$249.95; TX-9100—\$349.95; TX-8100—\$249.95; TX-7100—\$199.95

While not discussed here, Pioneer is also introducing the SA-5200 stereo amplifier and the TX-6200 stereo tuner for high quality hi-fi on a low budget. Only \$139.95 each, with walnut cabinet.

U.S. Pioneer Electronics Corp.,
75 Oxford Drive, Moonachie,
New Jersey 07074

West: 13300 S. Estrella, Los Angeles
90248 / Midwest: 1500 Greenleaf, Elk
Grove Village, Ill. 60007 / Canada: S. H.
Parker Co.

RESIDUE PROOF

Every record cleaner claims to remove dirt. But never mentions what it leaves behind. Recent independent tests show that this omission may be more than just oversight. See for yourself.

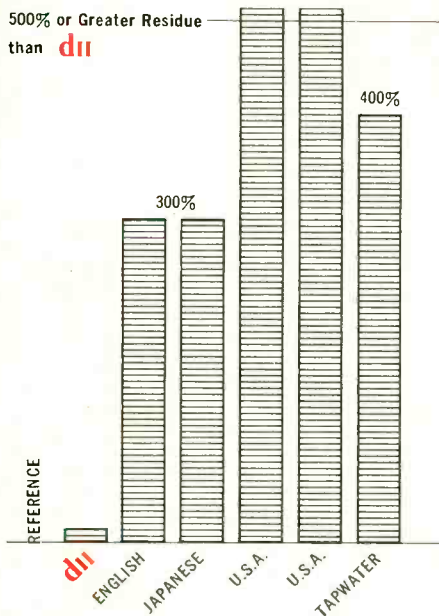

Actual dry weight measurements of best selling record cleaners.

The chart is just half our story. Only discwasher's directional pile brush (Pat. Pending) lifts fluid and any residue off the record by capillary action. So things aren't left to air dry.

Discwasher—the superior record cleaner is at Audio Specialists world wide.



Discwasher Inc.
909 University, Columbia, Mo. 65201

Audio

March, 1975

"Successor to **RADIO** Est. 1917"

Vol. 59, No. 3

Feature Articles

- 20 Record Cleaners—Do They Really Work?/B. V. Pisha
- 24 Adoption of the Westrex 45/45 System/Ralph W. Wight
- 56 The Many Worlds of Sun Ra/Tom Bingham

Equipment Profiles

- 31 Technics SA-8500X 4-Channel Receiver
- 36 Soundcraftsmen PE2217 Equalizer
- 42 Ferrograph Super Seven Tape Deck
- 46 Hitachi HS-300 Speaker System
- 49 Kenonic C-200 Control Amplifier/P-300 Power Amplifier

Record and Tape Reviews

- 64 The Column/Fred DeVan
- 68 Classical Reviews/Edward Tatnall Canby
- 72 Theater Music/Donald M. Spoto
- 74 Jazz & Blues
- 78 Tape & Turntable/Bert Whyte

Audio in General

- 4 Audioclinic/Joseph Giovanelli
- 6 Tape Guide/Herman Burstein
- 10 Behind the Scenes/Bert Whyte
- 14 Audio ETC/Edward Tatnall Canby
- 58 Advertising Index
- 80 Classified

EDITOR Eugene Pitts III
ASSOCIATE EDITOR Edward Tatnall Canby
ASSOCIATE EDITOR Bert Whyte
ASSISTANT EDITOR Charles Graham
ADVERTISING PRODUCTION Peggy Bicknell

PUBLISHER Jay L. Butler
MARKETING DIRECTOR Sanford L. Cahn
DESIGN Janet Lee
CIRCULATION MANAGER Jean Davis

Contributing Editors: Herman Burstein, Martin Clifford, Fred De Van, Leonard Feldman, Martha Sanders Gilmore, Joseph Giovanelli, Richard C. Heyser, Bascom H. King, C.G. McProud, B.V. Pisha, Alexander Rosner, Donald M. Spoto, George W. Tillett.

AUDIO (title registered U.S. Pat. Off.) is published monthly by North American Publishing Co., Irvin J. Borowsky, President; Frank Nemeyer, and Jay L. Butler, Vice Presidents; R. Kenneth Baxter, Vice President/Production; Nate Rosenblatt, Promotion Director; Mary Claffey, Circulation Director.

RATES—United States only: 1 year for \$7.00, 2 years for \$12.00, 3 years for \$17.00; outside the U.S.: 1 year for \$9.00, 2 years for \$16.00, and 3 years for \$23.00. Printed in U.S.A. at Columbus, Ohio. All rights reserved. Entire contents copyrighted 1975 by North American Publishing Co. Second class postage paid at Philadelphia, Pa. and additional mailing office. Back issues, \$2.00 each.

REGIONAL SALES OFFICES: Jay L. Butler, Publisher and Sanford L. Cahn, Marketing Director, 41 East 42nd St., New York, N.Y. 10017, telephone (212) 687-8924.

Jay Martin, 2525 West 8th St., Los Angeles, California, 90057, telephone (213) 385-2917.

REPRESENTATIVES: Continental Europe: John Ashcraft, 12 Bear St., Leicester-Square, London W.C.2, telephone 930-0525. For Benelux and Germany. W.J.M. Saunders, Mgr., Herengracht 365, Amsterdam, Holland, telephone 24.09.08.

Japan: Japan Printing News Co., Ltd., No. 13.2 Chome Ginza Higasi, Chuo-ku, Tokyo, telephone 541-5795.

AUDIO Editorial and Publishing Offices, 134 N. 13th St., Philadelphia, Penna. 19107
Postmaster: Send Form 3579 to the above address



In the beginning there was folded horn bass reflex acoustic suspension.

And now B·I·C VENTURI

For about 40 years, speaker designers have been juggling the characteristics they wanted from speakers: Compact size, high efficiency, high power-handling, and deep ranging, pure, clean, gut-reaction bass.

They tried folded horns: efficient, clean, good power-handling, but too large for most homes, quite expensive. They tried the bass reflex: Efficient, compact, but limited by uneven, one-note bass. Ditto the labyrinth, but far less efficient.

Today's favorite, the acoustic suspension: Compact, smooth, deep-ranging bass. But inefficient (requiring costly, high-powered amplifiers) and limited dynamic range.

A virtue here, a virtue there -- but all with corresponding compromises.

Ironically, the principle that combines these objectives into one compact cabinet has been around for some 180 years: The VENTURI principle of fluid motion transformation, reapplied in a form better suited to acoustics (patents pend). Our simplified diagram shows how the scientifically formulated VENTURI coupled path functions as a step-up transformer. Up to 140 times more bass energy comes from the duct than comes directly from the woofer. And bass is reinforced broadly over the low frequency spectrum, not at a single "tuned" frequency.

The B·I·C VENTURI coupled path also operates as a low pass acoustic filter, cleansing harmonics and distortion components from the bass waves. So, the bass not only goes down further and is louder, it's cleaner and more natural. And requires a fraction of amplifier power of other speakers of comparable size and performance. Yet, even though B·I·C VENTURIS need less amplifier power, they can handle more. This new principle eliminates compromises in cone, suspension and magnetic design to "match" cabinet characteristics.

Above the woofer, you can see our mid-range. To match the exceptional high efficiency of the bass section, we had to invent a new horn, combining two different types of flare, conical and exponential, BICONEX™ (pats pend). It provides wide, smooth dispersion in both horizontal and

vertical planes, so placement in the home won't be critical. BICONEX covers the full midrange to well beyond 15,000 Hz without crossover network interruptions, for distortion-free, smooth response.

Our super tweeter handles just a half octave from 15,000 to over 23,000 Hz. While you can't hear single frequency tones in that range, the accuracy of musical "timbre" depends upon those frequencies being added in proper proportion to the complex tones you do hear. An important subtlety.

Because you hear less bass and treble at low and moderate levels, we built a DYNAMIC TONAL COMPENSATION circuit (patents pending)

into the speaker. It adjusts speaker frequency response as sound pressure output changes, automatically. Amplifier "loudness contour" controls can't do that. Result: aurally "flat" musical reproduction always, regardless of volume control settings.

Our Formula 2 is the most efficient speaker system of its size, yet can be used with amplifiers rated up to 75 watts per channel! Formula 4 has deeper bass and can be used with amplifiers up to 100 watts. Formula 6, the most efficient, will handle 125 watts. The Formula 1, newest and smallest model, handles up to 50 watts and needs only a few watts input for clean, high level sound. Hear them at franchised B·I·C VENTURI dealers. Or write for brochure: BRITISH INDUSTRIES CO., Westbury, N.Y. 11590, Div. of Avnet, Inc.

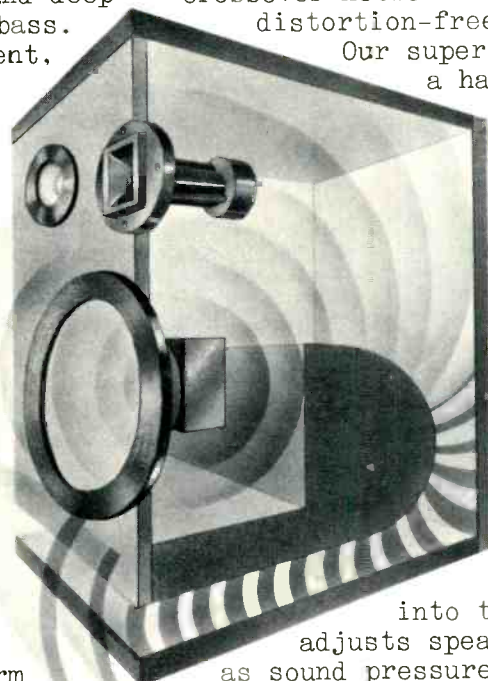

B·I·C VENTURI 



Check No. 9 on Reader Service Card

audio tests
the complete
and easier
way

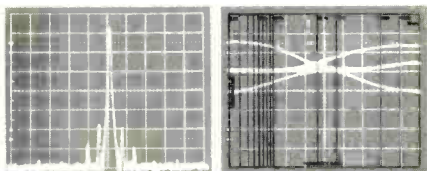
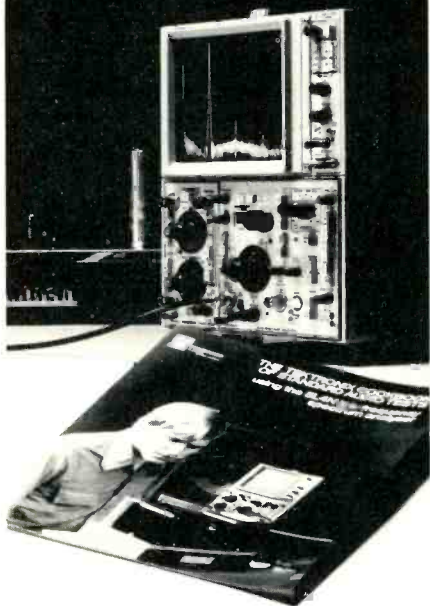

The *Cookbook* is a free booklet of simple test procedures for anyone with a basic technical background. The audio specialist too will find the procedures provide new time-saving ways to spec and troubleshoot audio amplifiers. With the *Cookbook* procedures and a moderately-priced 5L4N Spectrum Analyzer you can spec, troubleshoot, and produce graphic results like those shown. We'll be happy to mail you a free copy of this valuable booklet. Write Tektronix, Inc., Box 500A, Beaverton, Oregon 97077. In Europe, write Tektronix Limited, P.O. Box 36, St. Peter Port, Guernsey, Channel Islands.



TEKTRONIX®

committed to
technical excellence

Check No. 37 on Reader Service Card

Audioclinic

Joseph Giovanelli

Record Changer Muting Problem

Q. When the tonearm on my record changer comes down on a record, I hear a thump in my right speaker only. Otherwise the changer performs well. Could this noise be caused by a bad ground on my cartridge or improperly grounded changer frame?—William Hernandez, FPO, Spain.

A. I do not believe your thump problem relates to grounding. When grounding problems develop, they usually produce hum and/or lowered signal.

Record changers usually have a muting system designed to prevent any sound produced by the cartridge from being audible during the change cycle. This muting system should come into play just before the tonearm lifts from the surface of the disc and continue until just after the stylus has set down on the next record.

The purpose of the muting is to eliminate the annoying thumps associated with the lifting and landing of the stylus. Besides being annoying, this thump is potentially damaging to some speakers used with high-powered amplifiers. Because you hear a thump on just one channel, at the time of stylus set-down, it's apparent that the muting contacts are not working in this particular channel.

This could result from oxidation of the contacts, or being bent so they just don't make physical contact. You'll need to trace this down visually. Often careful examination underneath the chassis will reveal the trouble and permit its repair. In some cases you'll have to get a service manual from the manufacturer, or take the changer to a repair dealer.

Changes in Auditorium Acoustics

Q. Why does dance music played in

an auditorium with few people in it let the vocals over-ride the instruments when similar music played in a crowded auditorium tends to submerge the vocals under the instruments?—Mel Burgess, Oakville, Ontario, Canada.

A. When an auditorium is empty, sound is reflected from one wall to the other, and from floor to ceiling (and back) unless appropriate acoustic treatment has been applied. The sound produced in such an area is often harsh and unpleasant, with highs which are too strong. Under these conditions, singers' voices may be projected clearly and very up front.

When the auditorium is filled, the people act as sound absorbers. Under these conditions the sound does not reflect as much as it did when the room was empty. Because highs are more readily absorbed than lows, the crispness of the singer's voice tends to get lost, placing the voice further down in the mix.

Repairing Cracked Speaker Cones

Q. I have a 12-in., high-efficiency speaker which has a crack in the cone extending 2 in. from the outer rim toward the center. Can I repair this crack without completely ruining the speaker's performance?—P.G. Ruuth, North Highland, Calif.

A. If a speaker cone is cracked but not badly torn, repair is relatively simple, and will not degrade the performance of the speaker greatly.

Cut a piece of onion skin paper just a bit wider and longer than the crack in the cone. Place a bit of glue, such as Elmer's, both on the cone and on the patching strip. Accurately align the strip over the crack. Place a finger under the cone to support it gently while you smooth the paper down. When the glue hardens the repair is complete.

About The Cover: Spring is just around the corner, and we thought that you might like to see the current crop of phono cartridges in our garden.

If you have a problem or question on audio, write to Mr. Joseph Giovanelli, at AUDIO, 134 North Thirteenth Street, Philadelphia, Pa. 19107. All letters are answered. Please enclose a stamped, self-addressed envelope.

Before you buy a manual turntable, consider what "manual" really means.

"Manual" means more than just "single play." Every time you play a record, you must pick up the tonearm and move it to the record. And at the end of play, you must stop whatever you're doing, go to the turntable and return the tonearm to its resting post. All by hand.

Not only is this inconvenient, it's also risky, because the business end of a tonearm is virtually weightless. Handling it without damage to the delicate stylus and your fragile records takes a very steady hand.

What about the automatic's extra moving parts?

An advantage often assumed for the manual turntable is simplicity: few moving parts. The automatic turntable does have additional parts, but they serve only to move the tonearm to and from the record when cycling. During play, a fully automatic Dual turntable has no more moving parts than a manual: motor, platter and drive system.

What's more, every manual turntable requires one additional moving part that no Dual ever requires: you.

Why many manual turntable owners switched to Dual.

From warranty cards, we know that many Dual owners formerly owned manual turntables and switched to enjoy Dual's quality performance plus fully-automatic convenience and safety.

For many years, more audio experts—hifi editors, engineers and record reviewers—have

owned Duals than any other make of quality turntable. So have the readers of the leading music/equipment magazines. Certainly no group is more concerned about record protection and the quality of music than these people.

Even the lowest priced Dual, model 1225, at \$129.95 has more precision than you are ever likely to need. As for the highest-priced Dual, the \$400 electronic, direct-drive model 701, test reports have been extraordinary. Most independent test labs acknowledge that its rumble, wow and flutter are below the measuring capability of their test equipment.

A word for those who still think they want to play manually.

Despite all the above, you may still prefer to play your records manually. The Dual tonearm gives you

this option, because it is as free-floating during play as any manual-only tonearm. Thus you can always place it on the record or lift it off—manually.

However, we predict that you will soon take full advantage of the convenience and security of Dual's full automation. Which is what most Dual owners prefer.

And considering what kind of people own Duals, that's something you really should consider.



United Audio Products

120 So. Columbus Ave.,
Mt. Vernon, N.Y. 10553
Exclusive U.S. Distribution Agency for Dual



The multi-play automatic Dual 1229Q, \$259.95; Other multi-play automatics from \$129.95. All less base and dust cover. Single-play automatics are the Dual 601, \$270; and the electronic direct-drive Dual 701, \$400. Both include base and dust cover.

Check No. 38 on Reader Service Card

Why not get all the music you paid for?

You've built your music library with a critical ear and a good amount of money.

Have you considered that your present amplifier might be short-changing your listening with elements of distortion and hum or noise?

You're entitled to pure unadulterated music... the original. Nothing more, nothing less.

And this is the whole idea of the Crown DC-300 A.

"Like lifting a curtain" was how one Crown owner described his experience.

Why not get an amplifier that gives you all the music in your collection, but no more than that!

Make this simple comparison:

- (1) Listen with a critical ear to your favorite recording at home; then
- (2) Listen to that same recording with a DC-300 A at your Crown dealer.

We rest our case on your ears!

Power output: 155 watts/channel min. RMS into 8 ohms stereo. 300 watts min. RMS into 16 ohms mono, over a bandwidth of 1-20,000 Hz, at a rated distortion of 0.05%. Intermodulation distortion less than 0.05%, 0.01 watt to rated output, into 8 ohms stereo, 16 ohms mono.

Is Crown crazy?

To guarantee **parts and labor**, and pay for **round-trip shipping** for three full years. (We'll even send you a shipping carton if you didn't save yours.) That takes nerve... and faith in your product!

At **Crown**, reliability is a way of life. Long life... with you.

 **crown**

WHEN LISTENING BECOMES AN ART.

Check No. 10 on Reader Service Card

Tape Guide

Herman Burstein

Tape Deck Options

Q. I have a KLH Model 41 tape deck which has been modified to use the Scotch Dynarange series of tapes. This was done according to factory specifications by a qualified technician. The deck works perfectly with Dynarange tape. My question is: What other tapes will it work equally well with, if any? I am particularly interested in your opinion about how it would perform with the new BASF low-noise, high-output tape, TKD-SD tape, and Sony SLH-180. Do all of these tapes require approximately the same bias setting? Is it the same setting I now have after the Modification for DynarangeP I realize the real test is to try them, but that can get expensive.—E. W. Hodges, Newark, Del.

A. Conventional tapes of various brands require very nearly the same bias for optimum performance. Similarly, low-noise tapes require nearly the same bias as each other, although somewhat different bias than conventional tapes (low-noise tapes require somewhat more bias). In order for one manufacturer to compete with others making the same general kind of tape, he cannot afford to require substantially different bias. On the other hand, for fine adjustment of a tape machine in order to extract the most out of it in terms of good performance (flat frequency response, high signal-to-noise ratio, and low distortion), bias may have to be adjusted slightly from one brand of tape to another. In other words, for a given kind of tape, one setting should do pretty well for most brands of tape.

High Frequency Loss

Q. I have a Uher 24 Special (Model 9000 in America, I believe). I have played it an average of 5 to 10 hours

per month over a four-year period, and have cleaned the heads about every two months with isopropyl alcohol. However, I never demagnetized the heads until very recently. During the past year I have noticed a loss volume and a loss of high frequencies, usually in one channel, but sometimes in both. I again cleaned the unit, which didn't help; then I checked the circuitry and the alignment instructions accompanying the recorder, which didn't help either. Finally I decided that demagnetizing was the factor that I had overlooked. Furthermore, I read about "wet demagnetizing" with tape head cleaner and decided to try that. The results were marvelous. But, alas, these good results were very short lived. On repetition of cleaning and demagnetization, I found that the improved sound quality would last only about 10 to 30 seconds before deterioration again set in.—Stephen R. Snow, Eugene, Or.

A. It may be that you are operating your machine too soon after cleaning your heads, so that the still-wet heads are picking up tape oxide. The resultant slight spacing between the tape and the heads (specifically the playback head) causes high frequency loss. More likely, the problem lies in a worn head, with too wide a gap. Therefore head replacement is indicated. You should take your machine to an authorized service agency, unless you have the technical competency and necessary test instruments yourself.

If you have a problem or question on tape recording, write to Mr. Herman Burstein at AUDIO, 134 North Thirteenth Street, Philadelphia, Pa. 19107. All letters are answered. Please enclose a stamped, self-addressed envelope.

The A-2340...

a stereo deck...

Play pre-recorded tapes, or make them yourself — tailored to your specific tastes, your changing moods.

a 4-channel deck...

Enjoy the exciting world of true 4-channel sound — four discrete tracks on tape.

a 4-track Simul-sync recorder...

If you play a musical instrument, or know someone who does, take full advantage of the A-2340's music making capabilities. With Simul-sync, you can record each part of the tune, one track at a time, in synchronization, until all of the music is the best it can be.

a superb machine for only \$739.50...

No matter how you use the A-2340 — to learn, to create, to enjoy — you can count on using it for a long time. It was made to withstand the paces you'll put it through. And that's as it should be.

We gladly invite comparisons, and we'd like you to hear the A-2340, to operate it yourself. You'll find that our retailers are well informed and helpful in general, rare qualities so there can't be many of them. You can find the one nearest you by calling (800) 447-4700*. We'll pay for the call.

*In Illinois, call (800) 322-4400.

TEAC

The leader. Always has been.

TEAC Corporation of America, 7233 Telegraph Road, Monroeville, California 90640.



Our new series is so advanced, we expect our first customers to be Audio Research & Crown.

They'll haul it back to their labs. And play it. And play with it. And in general, examine it to pieces to find out How We Did It.

Sony's Vertical Field Effect Transistors: What our competitors are eating their hearts out about.

It's a shame the term "state of the art" has been worn ragged in dozens of "This is It, this is finally and really It" stereo ads. Because anyone in the business will tell you that V-FET's are the biggest thing since the invention of the vacuum tube. V-FET's combine all of the advantages of both triode vacuum tubes and conventional transistors. With none of their disadvantages.

But nobody else can take advantage of these advantages yet. Ask anybody else how their V-FET's are coming. The responses will range from a forthright and candid "we're working on it," to an equally forthright and candid "buzz off." Sony is the first company in the world making commercially available equipment with V-FET's. A power-amp and integrated amp.

Herewith a partial and oversimplified explanation of just what in the world we're talking about.

Triode vacuum tubes: Pros and cons.

To belabor the obvious for a moment, in amplifiers, the name of the game is distortion. And until now triode vacuum tubes have yielded the lowest levels around. That's because of their non-saturating voltage versus current characteristics. Also, they do not suffer from carrier storage effect (which is standard equipment with regular transistors, and causes notch distortion and deterioration in transient response).

So much for the good points of tubes. They also tend to be inefficient, begin to deteriorate as soon as you use them, and wear out. Their high impedance characteristics generally require an output transformer to drive the speakers. And there's no way you can set up a true complementary circuit with vacuum tubes, so there's no way you can get true wave form symmetry.

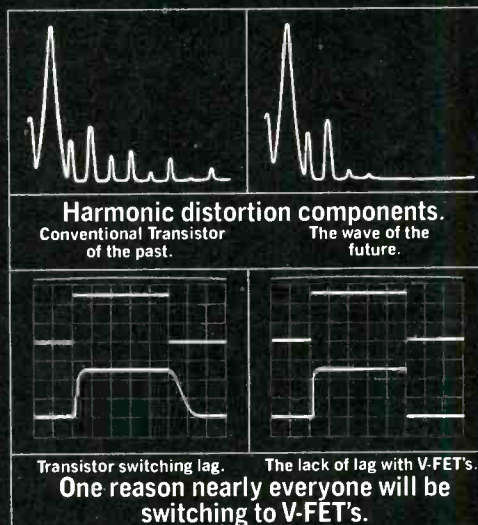

Conventional Bi-polar transistors: Pros and cons.

The advantages of bi-polar transistors can be dealt with in a sentence. They're very reliable, very efficient and last almost forever. But there are a number of bugs in the ointment.

Bi-polar transistors can become saturated with current. And they all cause switching lag distortion. To obtain acceptably low levels of distortion, plus wide frequency response, you need to pump in a lot of negative feedback. Which can make the amp unstable.

Plus (at no extra charge), as they heat up, bi-polar transistors have a

marked tendency toward thermal runaway (which is a fancy way of saying they try to self-destruct).

V-FET's: All pros. And that's no con.

First off, V-FET's are very reliable, very efficient and last almost forever. They also match the highly defined tonal quality previously provided only by vacuum tubes. V-FET's don't become saturated with current. But at the same time, they protect themselves as temperatures build up. So there's no possibility of thermal runaway. Their low impedance characteristics mean no output transformer (the less gizmos in the circuit, the better the sound). The use of V-FET's allows for better control of negative feedback, making the amp more stable. V-FET's don't have carrier storage effect to cause switching lag. And you can use V-FET's to build a true complementary circuit, thus obtaining true wave form symmetry. And isn't that what it's really all about?

One more thing. We'd be less than forthright and candid if we didn't admit that our new amplifiers are a bit pricey. As much as \$1300 a piece.

At Sony, we've always maintained that, in the end, the best way to buy equipment is to hear it for yourself. So we're making what's probably the best offer you've ever heard. Have your dealer hook up our new V-FET equipment against *anything* made by *anybody*. If we sound sure of ourselves, we are.

And we're sure your own ears will tell you we've got the best sound you've ever heard.

SONY®

Check No. 65 on Reader Service Card

Behind The Scenes

Bert Whyte

LAST MONTH I reported on the audio press junket arranged by Philips and AKG, and covered some of the interesting new developments we were shown at the Philips facilities in Eindhoven. The second half of our trip was through the courtesy of the AKG company, and early on a Sunday morning we flew from Amsterdam to Vienna where AKG is headquartered.

Once installed in our hotel, those who had the stamina were free to explore the historical sights and to soak up the *gemütlichkeit* of the living monument that is Vienna. The last time I was in Vienna just happened to be the day after the Russian occupation of the city ended, and a tearful, joyful populace was celebrating.

There was still quite a bit of damage from the bombing and shelling of the war, but as was apparent to our press group on the occasion of this visit, a major proportion of Vienna's historical buildings and landmarks had miraculously escaped destruction.

I must say that AKG really went "all out" in entertaining us. Early Sunday evening a group of AKG executives met us at our hotel and invited our press group to climb into an assembly of 18 horse-drawn open carriages, and then this procession was given a tour through the streets and byways of Vienna. Of course, I gave my most gracious "Queen Elizabeth 2nd" hand waves to the people lining our route, as we wended our way into the cobblestone courtyard of the Palais Schwarzenberg. Our group was escorted into a reception room, a great high-ceilinged place aglitter with crystal chandeliers, the gleam of parquet floors, hung with rich tapestries and paintings, and in one corner, standing fully 8-ft. tall, one of those incredible blue and white porcelain stoves so reminiscent of the Hapsburg era. A bar was at one end of the room and while we enjoyed our champagne and orange juice (very "in" and very European!), we were formally introduced to our hosts. Feeling that we had somehow be-

come a part of a typical Viennese operetta, we made our way into an opulent dining room, and as we started on our delicate smoked sturgeon with whipped cream/horseradish sauce, we heard the *Third Man Theme*, played on the zither by none other than the composer, Anton Karas. At the conclusion of our superb dinner, Dr. Gorike, the head of AKG gave us a welcoming speech and an outline of our activities in the technical aspects of our visit.

AKG—Akustische und Kino-Gerate GmbH—was founded some 29 years ago by Dr. R. Gorike and Herr E. Pless for the production of film projectors (that's the *Kino* in the company name). In their work a need arose for a microphone which would record in one direction while discriminating against the unwanted background noise of the projector. Thus in 1953, they marked the AKG D-12 cardioid dynamic microphone which quickly established AKG's reputation as a manufacturer of high-quality microphones.

From that point on, microphones became the principal product of AKG. Mass production methods were developed to produce high-quality dynamic microphones at a reasonable price and their types D-11, D-19, D-24 and D-119 became a familiar sight in recording studios throughout the world. Early on, AKG did pioneering work in the manufacture of condenser microphones, one of the most famous being the C-12, which featured remote control change of pick-up patterns. As manufacturers of electro-mechanical transducers, it was only natural that AKG would undertake the production of headphones, and many high-quality types emerged, including back in 1959, the first "open-aire" types, which are now becoming so popular.

In the ensuing years, AKG has become one of the best-known manufacturers of dynamic and condenser microphones. Their latest dynamic microphone, the D-200, has created great interest because of its unusual

design. It is known as a "two-way" cardioid as it employs separate high-frequency and low-frequency diaphragms and a crossover network, as in many loudspeaker systems. In the field of condenser microphones the model C-414 is quite versatile with patterns switchable from omnidirectional, cardioid, hyper-cardioid, and figure eight. The C-451 is a whole system of condenser mikes with the mike handle containing an FET pre-amplifier, and accepting seven interchangeable "capsules" of different pick-up patterns. The same system has now become available with electret capsules.

With growth has come diversity, and AKG is in the fields of digital delay, artificial reverberation, and ultrasonic transducers. The company holds over 600 patents in electro-acoustics. More than 750 people are employed by AKG, and they have expanded to facilities in Munich, London, and Zurich. As mentioned last month, AKG products are marketed in the U.S. by North American Philips Co.

On a Monday morning, a half-hour bus ride brought our group to the AKG factory. There we met a number of the AKG engineers and scientists, including Chief Engineer W. Fidi, and inspected some of the extensive research facilities. Then with the aid of AKG marketing director Herr H. Schnabel, Herr Fiki, and several other engineers, we all sat down to a sort of AKG products symposium and "interchange of ideas" conference.

With AKG's involvement in electro-mechanical technology, it wasn't too surprising when it was announced that they were entering into the manufacture of phonograph cartridges. Sometime during 1975, a full line of magnetic cartridges will be introduced, including a special model for the CD-4 quadradisc. A thorough briefing on the special qualities of various AKG microphones followed, in preparation for the next day's inspection of the production facilities. Following this we were shown the

Keep on trackin'

© 1974 Empire Scientific Corp.

Empire's new wide response 4000D* series phono cartridge features our exclusive "4 Dimensional"TM diamond stylus tip.

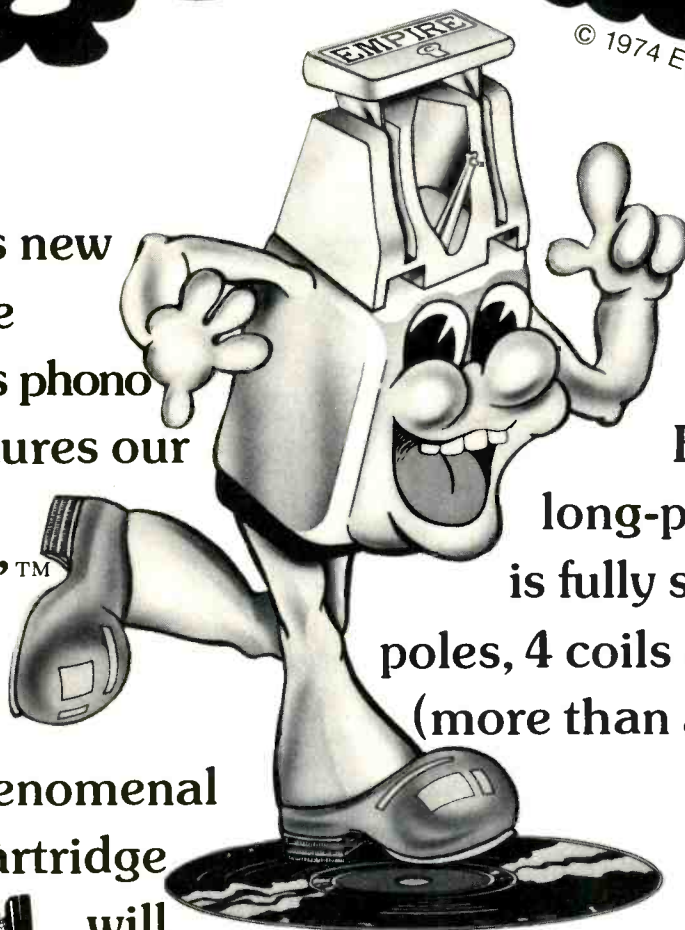

ing prevents any discernible record wear.

Every Empire long-playing cartridge is fully shielded with 4 poles, 4 coils and 3 magnets (more than any other brand).

This phenomenal cartridge will track any record below 1 gram and trace all the way

to 50,000 Hz.

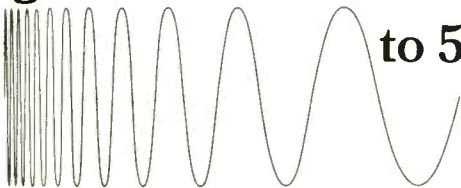

Empire's "4 Dimensional"TM diamond has a 0.1 mil radius of engagement yet the very low force required for track-

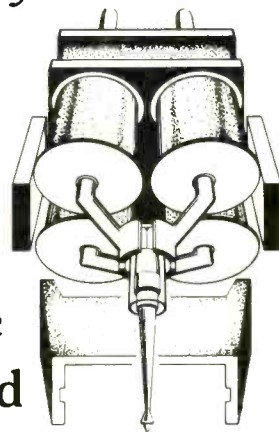
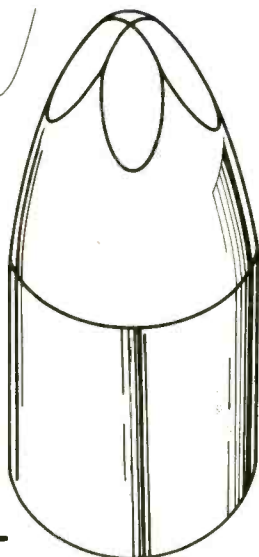

For a free Guide to Sound Design write to:
EMPIRE SCIENTIFIC CORP.
Garden City,
N.Y. 11530.



EMPIRE

Mfd. U.S.A.

* Plays any 4 channel system perfectly. Plays stereo even better than before.

Check No. 13 on Reader Service Card

AKG digital-delay system, which is somewhat similar to the Blesser and Eventide units in the U.S. The main thrust here is in retaining the performance of the device, while making a most determined effort to reduce the cost of the unit. There is a very compelling reason for this, as you will see a bit later on. After a break for lunch at the charming medieval-style inn, not far from the AKG plant, it was back to our conference.

The afternoon was devoted almost entirely to a discussion and demonstration of the AKG BX-20 reverberation device, including its use in some unusual applications. At the risk of offending some of the AKG microphone people, this BX-20 demonstration was, in my opinion, the highlight of the AKG visit.

Let me preface this description of the BX-20 by stating that it is in essence a coil spring reverb device, even if it is rather euphemistically called a "torsion transmission line" or TTL. Such devices have been absolute anathemas to me, as any I have ever heard have been plagued by the curse of the characteristic "boingggg" coloration of sound they produce. Needless to say, such spring reverb units have not found favor with professional recording engineers. However, it turned out that the BX-20 was a new breed of spring reverb, since in several hours of listening to it, none of us could detect even a smidgin of the "boingggg" coloration.

The BX-20 is designed to be a portable unit and consists of three main parts... the electro-mechanical reverb unit proper, the electronic circuits, and the elastic support.

The BX-20 is a two-channel unit with independent control of decay time of each channel. Thus, it can be used for stereo or mono recording. The length of the spring is 47.2 inches as calculated for the desired delay time. To make the spring fit into a reasonable size enclosure, the spring has been bent twice. At each end of the spring are moving coil systems. Each moving coil consists of two coils which have a rigid mechanical connection between them and which vibrate in a strong magnetic field. The signal to be reverbed is fed into one half of the coils and picked up by the other. There are mechanical dampers inserted at specially calculated intervals along the coil spring. On plug-in printed circuit boards are an input amplifier, output amplifier, and two attenuation amplifiers for each channel. The two springs with the magnet systems and various supporting systems are mounted in a rigid cardboard tube which is filled with porous foam material. The tube is mounted on a single-point pendulum

suspension, whose natural resonance is below 1 Hz. The whole unit is mounted inside a strong wooden box, with additional sound insulating material.

The "dry" signal to be reverbed is fed in phase to each moving coil half on the ends of the spring. The reverberated signal is picked up by the two remaining coil halves, amplified, and connected in opposite phase. Motion feedback is used in the attenuation amplifiers permitting the variation of decay continuously from 2 to 4.5 seconds in each channel. Because the amplifiers are controlled by a d.c. voltage, remote control is possible. Input and output levels of the amplifiers are plus 6 dB, with an input impedance of 1 k ohms and an output impedance of 50 ohms.

Okay... so what is different about these spring reverb units that prevent the "boingggg" coloration of the signal?

The secret is in the preparation of the spring wire itself. By a special "denting" process, the wire is "etched" and thus has thousands of discontinuities along its length. As much as 20 percent of the wire material is removed during this process which reduces the mass of the wire, which is an aid in the propagation of higher frequencies. Below 1 kHz, the individual turns of the spring are deformed by bending parts of the coils toward the spring axis. Selection of the turns that are to be deformed is done statistically, so that along the length of the spring some coils are quite stretched and elongated, while at other intervals, some coils are considerably compressed. All of this is in aid of maximum non-homogeneity of the surface of the wire, which permits a high degree of statistical diffusion in frequency and time domains. In other words, for the production of as non-coherent a sound as possible. The system works and not only is the "boingggg" eliminated but the reverb itself has an exceptionally natural character akin to a good chamber.

Having briefed us on the BX-20, the AKG engineers took us into an adjoining room, where there was a typical stereo system set up in front of several rows of chairs. However, in addition to the pair of Tannoy speakers up front, there was another pair in the rear of the room, facing forward.

The demonstration began with the playing of a record of Bruckner's 7th Symphony, in straight stereo through the front speakers. Nice enough, but nothing spectacular. Then the same recording, plus 30 milliseconds of delay through the AKG digital delay unit to the rear speakers. Aha! A very

considerable improvement in acoustic perspective. Next, the same recording, sans digital delay, but with about 2.5 seconds decay through the BX-20 unit to the rear speakers. A different perspective, but interesting and much preferable to straight stereo. Finally, the same recording, plus the 30 mS digital delay, plus the 2.5 seconds decay through the BX-20. WOW!! This was sensational. It is by now a cliché, but the walls of the room did indeed seem to "fall away," giving a tremendously enhanced "concert hall" perspective to the sound. This was pseudoquadraphony of a very high order, and it was hard to believe that a stereo recording could be processed to achieve such a thrilling and very desirable sound. Why, this could revitalize even the oldest of stereo recordings.

Ah, well! A great sound, but the digital delay unit is expensive (and now you know why AKG is so anxious to reduce its cost) the BX-20 is over \$3500, and that makes the whole thing "blue sky," right? Well, friends, not entirely. After this demonstration, the AKG engineers flipped us by handing around a very junior version of the reverb spring, and calmly stating that it was the prototype of a consumer version, to sell for "around \$300." To be sure, it would have a restricted decay, on the order of 1.8 to 2.4 seconds, but that would be enough to do the trick. There already exists a BX-10, with essentially the same performance as the larger unit but simplified and with some frills removed... and at half the price! I expect to have one of these AKG reverb units before long, which I will combine with my UREI Cooper Time Cube acoustic delay line (At least I hope it can be used!), and see if I can come up with that great sound I heard in Vienna.

The following day we visited the microphone production facilities at AKG and were impressed with how many parts such as diaphragms, moving coil assemblies, miniature transformers, etc. are made with such precision, many on proprietary machines designed for these fabrications. It was apparent that mass production of high-quality microphones requires very specialized facilities.

That final evening, we were driven over 80 miles north west of Vienna, to the medieval town of Durnstein, where we enjoyed cocktails on a bluff overlooking the Danube, and then a superb dinner in the Refektorium, amid much wine and good fellowship. The people of AKG were great hosts, who did themselves proud in the best tradition of Viennese hospitality. We learned a great deal, under the most pleasant auspices. 

New Dynaco PAT-5

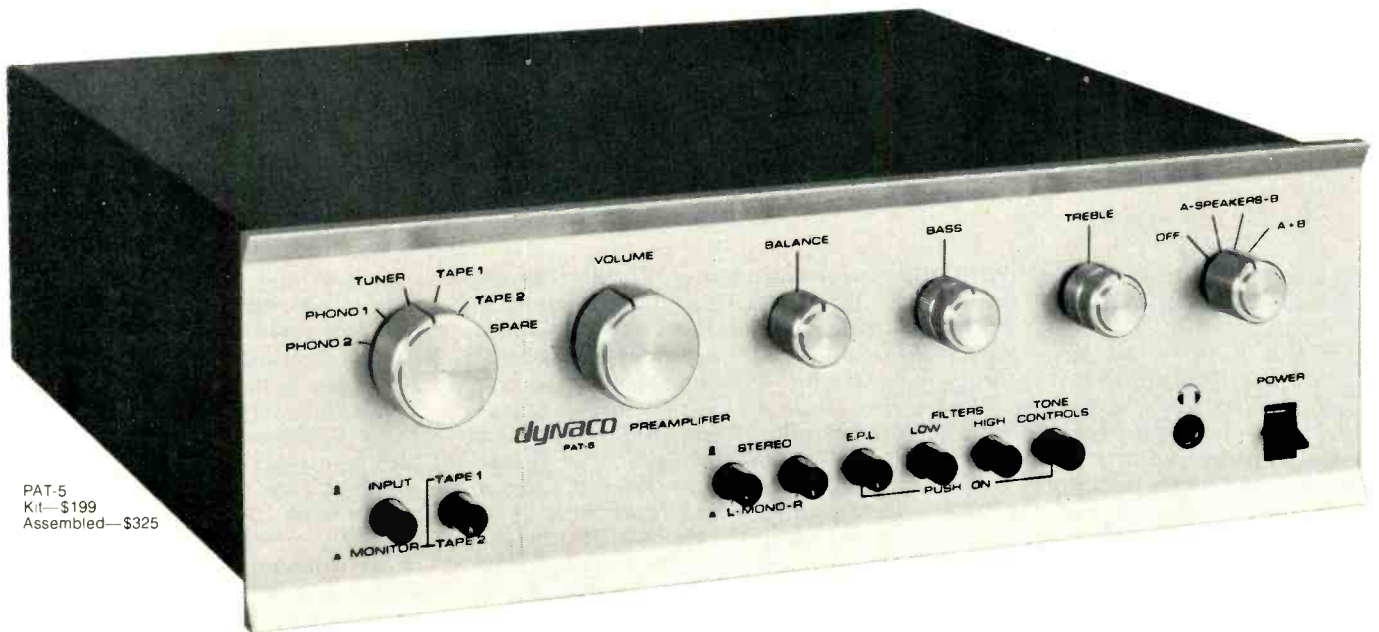

PAT-5
Kit—\$199
Assembled—\$325

It Sounds Better

Coming from Dyna, that's really news. Never before in 20 years has Dynaco claimed marked sonic improvements when it has introduced a new model. Every Dynaco product has been designed for the perfectionist. The simple fact that the PAT-5 preamplifier is clearly superior to previous Dynaco tube and transistor designs is history making. Until now, *they* were classed with the most expensive competitors.

It includes complete facilities for two tape recorders, truly useful tone controls, external processor loop, monster-amp power and speaker switching capability, extra phono gain option, low impedance headphone output, 3-stage regulated supply, and it is *quiet!*

Best of all, it's a DynaKIT. Easy assembly, superior parts quality, assured results from complete in-circuit testing of every fully-assembled audio circuit board.

Dynaco
Division Tyco Laboratories

Box 88, Blackwood, N. J. 08012

Also available in Canada from Dynaco of Canada Ltd.

Please send complete test reports and full specifications on all Dynaco amplifiers, tuners and loudspeaker systems.

Name _____

Address _____

City _____ State _____ Zip _____

A 3

Audio ETC

Edward Tatnall Canby

I HAVE been saying for years that the business of audio is music. In the home, at least, 95 percent of our audio is music in spite of a respectable area held down by recorded speech. The other day, then, I received a recording of music with a note enclosed from the Editor of a well-known audio publication saying "This is a must review Gene." Of course I played it *toute de suite*. And in two shakes of a stylus' tail I knew that it merited much more than a mere mention. Or even a mere review.

The disc is entitled, with classical simplicity, **Portsmouth Sinfonietta Plays Popular Classics**, licensed to Columbia by an English outfit called Transatlantic Records, Ltd. A sober black jacket with color photo of the Sinfonietta indicates what you might expect, a proper classical offering. Unless you happened to notice, as I did, a dim Columbia K designation—KC 33049—in the upper left corner. K (in place of M for Masterworks) could mean Special Show Stuff? A hint that perhaps more than meets the eye is about to assault the virgin ear. A closer look at the photo said even more—but more on that in a moment.

If I may say so, the British taste in popular classics is rather more restricted than our own, tending towards such amiable chestnuts as *Peer Gynt* (*Hall of the Mountain King*, etc.), *The Nutcracker*, *Air for the G String* (early pornography?), the *Blue Danube*, all of which appear on this disc. In addition there are some foreshortened arrangements, elements of the *Fifth Symphony*, a fragment from Holst's *The Planets* (astrology to the fore) and ha! an eye and an ear for 2001—the ominous opening of *Also Sprach Zarathustra*. Not the first disc to capitalize on that film classic. All in all, a rather tame repertory for a Sinfonietta. One might have anticipated at least an early Mozart, a bit of Henry

Purcell and a few of Vivaldi's *Seasons*.

Let us not beat further about the bush. Put stylus demurely to this disc, side 1 band 1 (*Peer Gynt*), and presently the most appalling noise you have ever heard sails loudly out of your loudspeakers, whether by two or by four. How can I describe? Thirty-two classical players here, if I count 'em rightly, and a representative of every orchestral element of usual interest—each of them sounding precisely as it might if you sat down to an oboe, a fiddle or a trombone, trumpet, horn, string bass, sax, viola, cello, for the very first time, and barged right in, all unafraid. And I mean you, the audio buff, not one of those talented pop players who tosses off solos on any of a dozen instruments without half rehearsing. You, who never before had a musical instruments in your hands. Or hardly ever.

There are the fiddles, ear-splitting squeals, like a hundred alley cats at two in the morning but much less melodious. Cats with tails caught in doors. Cats with sore throats and hernias. Then, oboes, like a worn-out automatic auto transmission about to freeze into a solid lump. Sheer agony. Oboes like sharp buzz saws. (Ed, the jacket doesn't mention oboes. —Ed.) And clarinets as strident as geese (the analogy is close: a conical bore with single reed and suppressed odd overtones). Screaming flutes, tromping trombones, horny horns, trumpets à la cub scout. Plastered percussion, pig-grunt string bass, oink oink. How can I go on? And the whole of this hopelessly, tantalizingly out of time and, oh yes, o my yes, OUT OF TUNE. So unbelievably out of tune that I ran to get me an onion to peel so I could cry properly. Of these and other classical sounds, there are no less than an interminable and unremitting eleven cuts, two whole sides, in sure-enough stereo. Enough to last a life time.

The most uncanny sound of all, in all this cacaphony, is the occasional

sweetness of a genuine professional note or two, right in the midst. I suppose that a few legitims were taken in to keep a semblance of order which, alas, there is, most of the time, more or less. But the effect of those beautiful distillations of normal music in such a situation is worse than manic, it is manic. How do they do it? And the more I think about it, how do any of these performers do it? Not a bang nor a whimper of audible laughter, from start to finish. Self control, in respect to giggles and break-up, which is simply beyond understanding. Deadpan seriousness. Not a muscle quivers anywhere. Just look at the picture on the album. No smiles. Not one. That's precisely the way it *sounds*, as though these young players were uncomprehending zombies going through a sort of subhuman act, in deadly earnest.

It is you, the listener, of course, who will fall into pieces in seconds. You will gasp, then gape, then pull in a huge breath and dissolve into hysteria. Just try not to. And what is most astonishing is that—as you will see when you look really closely at the Sinfonietta performers on the cover of the album—this is a youth orchestra. I couldn't say whether they are still wet behind the ears, since only two pairs of ears are completely visible, one of those a girl's. But the quantity of hair per head and the paucity of male bearditude indicates a teenage average. Also the green shoes, the fluorescent red socks, the blue pants, and the open shirts. These, in a word, are kids. With aplomb. So much so that I really wonder—are they *faking it*? Could they, indeed? I doubt it.

Oh yes, I have a few morals to point. I think the most vital is that here, astoundingly, is the obverse of something we take entirely too much for granted in life, and especially in record listening—professional technique.

The trouble with so much of our

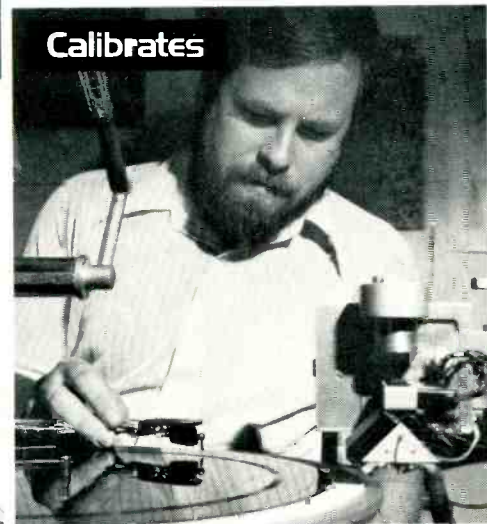

Capitol Records Calibrates · Evaluates · Approves · Tests · Repairs · Quality Controls · and Reviews with the Stanton 681 Cartridge Series

The physical process of making phonograph records is not for amateurs. It is a job for craftsmen of the highest order, craftsmen who know exactly what they are doing. Naturally, they need the precisely right tools to do the job.

In the case of Capitol Records, the highest quality tools are employed throughout the process. That is why Stanton 681 Calibration Standard Series Cartridges are used, with various styli that are designed specifically for each critical measuring and listening job.

It has proven to be a great advantage to Capitol Records to standardize their entire operation with the 681 Series and three basic styli:

- The D6807A — for cutting system check-outs.
- The D6800EEE (our famous Triple-E) — for the most critical listening.
- The D6872AMC — for tough nickel-plated "mothers".

The Stanton 681 Calibration Standard Series enjoys almost universal acceptance throughout the Recording

Industry. After all, it was created in order to satisfy the need for a cartridge of sufficient sophistication to be used as a primary Calibration Standard in system check-outs for linearity and equalization. Stanton Magnetics met this need by producing an "absolute" cartridge standard . . . stereo cartridges of such linearity and overall quality as to gain immediate acceptance within the Recording and Broadcasting Industries.

The fact that Capitol has selected the Stanton 681 Calibration Standard Series for use throughout its operation is a testament to its quality.

All Stanton Calibration Standard Cartridges are guaranteed to meet specifications within exacting limits. Their warranty comes packed with each unit . . . the calibration test results for that individual cartridge.

Whether your usage involves Recording, Broadcasting or Home Entertainment, you can enjoy professional audio quality with Stanton Products.



Write today for further information to Stanton Magnetics, Inc., Terminal Drive, Plainview, N. Y. 11803.

Check No. 24 on Reader Service Card



FREE

**YOUR CHOICE OF 5
CAPITOL® OR ANGEL® LPs
(value up to \$35) with each
purchase of a pair of
BOSE 901s or 501s.
Offer good Feb. 20-
Mar. 31, 1975**

What's the return on your record investment?

Your largest hi-fi investment will probably be in your record collection. Yet it is generally known that the quality of music you hear from your records is determined primarily by your loudspeakers.

The technology of DIRECT/REFLECTING® speakers offers you the opportunity to increase the return on your record investment. This technology, developed from twelve years of university research on musical acoustics¹, brings music to your ears that is much closer to that of a live performance than can be achieved by conventional speakers. The result is a new dimension of clarity and realism. Owners comment they now hear music on their records never heard before.

Compare a BOSE DIRECT/REFLECTING® speaker with any other in your own living room. You will appreciate why BOSE has received the highest reviews from around the world.²

Your return on your record investment is, after all, measured by your enjoyment. Shouldn't you consider increasing it?

1. The design, development, and technology behind the BOSE Direct/Reflecting® speakers is presented by Dr. Bose in the article, "Sound Recording and Reproduction," published in TECHNOLOGY REVIEW (MIT), Vol. 75, No. 7, June '73. Reprints are available from BOSE for fifty cents.

2. For copies of the reviews, write BOSE Rm. A

BOSE®

The Mountain, Framingham, MA 01701

audio music is that it is so polished, so pro, so utterly expert in performance right down the (recorded) line, that nine-tenths of our soft-bellied listeners haven't the slightest idea how much sheer *technique*, what incredible skills go into those easy sounds nor how many thousands and thousands of painstaking hours of practice stand behind each smoothly tailored phrase of music of whatever sort. And to think that so much of it ends up as musical wallpaper, elevator (lift) music, background stuff—measured by the yard or the minute, reduced to the nearest approach to nothing which ingenuity can devise. A crying shame, I always say, and what musician will disagree?

Now, in this recording, we have the sound of music *without* technique, and it is for most of us a revelation. Who would know, otherwise? How many of us, for instance, have tried out an oboe or a clarinet or a trombone or a fiddle in person? Have you heard a beginner at one of these? Your own child? Well, at least you know!

I tried an oboe, just once. I thought it might be for me, if I could manage. Squawked like an old crow for a few moments, and that was that. Also a clarinet, on which, to my astonishment, I produced nothing but a strangled hissing. When the thing finally did speak, it gave such a realistic duck quack that I jumped. And the reed tickled my lips until I sneezed. Like many an amateur, I ended up with a recorder, on which I could produce some mildly pleasant sounds if the music was slow enough. Great little instrument for the frustrated. Flute? As far as I am concerned, it is merely an animated steam pipe. I get steam sounds out of the mouthpiece, nothing more, though I go red in the face. These things one must know and experience, before one can really appreciate what a musician can do when he does things right. Trumpet? My trumpet sounds exactly like my farmer neighbor's stud bull, come spring. A real desperate sound and very expressive, but not yet Beethoven.

Curiously, this Portsmouth recording falls into an honorable British tradition of great age and popularity, though in the U.S. it is rare. I mean performing humorously out of tune and unlikely and unseemly sounds. Perhaps the recent quaintness of this was in the famed Hoffnung Festival recordings, which Angel took down from live concerts that were done up on a monumental scale before immense audiences. Remember the concerto for vacuum cleaner

hose? With the great horn player Dennis Brain (or was it his father, Aubrey?). You can still get these on Angel. And then there are those Flanders & Swan things, and their successors of the sort; come to think of it, the whole British "music hall" tradition comes straight from the same aura of tunelessness and may be said to have had a potent effect upon our own musical comedy heroine, who sings exactly the same way. Somehow, though, we don't double up with laughter quite as quickly as the British do at the hint of the musical grotesque, the off-tune, off-beat parody. Peter Sellers. Even he. And maybe Ringo Starr, who sings so perfectly off tune.

Now I do call to mind a number of similarly healthy excursions into atunality, serving to make precisely the same point as do the inscrutable youth players of Portsmouth. One example, and no youth by a long shot, was the cryptic diva, Florence Foster Jenkins, who for many years gave song recitals to piano accompaniment by a man with the unlikely name of Moon, was it Cosmo Moon? Mr. Moon played impeccable Schubert, Brahms, Puccini, what have you, even Mozart, on a very in-tune piano, a visible and sonic picture of propriety. Ms. Jenkins, though, first got herself up in outlandish costumes, sometimes changed to match each piece, and at the end of every number she threw armfuls of rosebuds into the ecstatic audience, then retrieved them so she could toss them again. But the singing was what mattered. Such excruciating, incredible, absolutely astounding out-of-tuneness, that in itself it amounted to sheer genius. Audiences instantly collapsed—but the lady seemed unaware, and sailed along as though every note were the acme. *Did she know?* Was it an act? Was she just amiably insane? Nobody ever really could tell, which was the best part. It was all acutely, deliciously embarrassing, and the more so for those who held off, out of a false propriety, for fear of offending. Not a chance! The more they howled, the more she beamed. And yet it was cruel in a way, like making fun of a cripple. A final monster concert was organized, with every Beautiful Person who could be dug up for the occasion, and the lady died within the week, as I remember. Yes, she made a few scratchy 78 records. Some were once issued on an RCA 10-inch LP.

That deadpan act is what really gets me. For, you see, I have been in a few ventures of this sort myself, directly or indirectly. In the 1950s I went to one of those folk dance and recorder playing summer camps. Having learned a bit of good music on the recorder, I

signed up for a recorder ensemble class and turned up bright one morning to play. Well, there were a dozen or so ardent ladies with soprano recorders in hand and the instant the first piece started I got the giggles. Such an incredible squalling you never heard (except thanks to Portsmouth). Each lady tuned her own, and all of them were blissful. Things beat, each instrument against the next, so that the composite was a fiercely potent *brrrrrr*, ear-curdlingly treble. A synthesizer with a dozen oscillators in square wave might roughly approximate it. Needless to say, I was frowned upon, and as a matter of fact I was quite helpless because you simply cannot giggle into a recorder. It sounds like one of those whistle cut-outs they put on mufflers of high powered cars in the 1920s, *ker-TWEET, TWEET*, snort.

An even worse occasion happened when I found myself involved in a performance of Haydn's *Toy Symphony*, before an audience. This little piece is in fact a joke, though most ingenious, and there are even Toy-Symphony kits, furnished with tin horns and one of those water-filled birds that you blow into for a realistic gurgly bird song. They had them in the 18th century. When played soberly, the music is delightful and funny—but how to play it soberly? (Imagine the recording sessions which have somehow got it down on LP. See catalogue.) OK when everything is 100 percent pro, on time and in tune. But then the fun is minimal; it's much nicer when the sounds are truly rustic, as Haydn so obviously intended. He was a wise, gentle soul and fond of humor, much less sadistic than the younger Mozart, who wrote out horn parts in wild colors for his horn playing friend and pencilled in unspeakable jokes at crucial points to break the poor man up in performance.

Anyhow, I came bravely on stage with my performing friends and my recorder and we started—you may call it nerves but within three seconds I exploded with one of those loud TWEET-snorts, and from that moment on, try though I would, I could not produce two notes in a row before another explosion occurred. I was totally undone. And so were the others, mostly. It was a shambles. I was utterly remorseful, but what could I do? It takes an experienced and imperturbable pro to play an amateur part of that sort. Maybe like these Portsmouth kids.

So go listen to Portsmouth and more power to you. And do not ever again forget (after you have recovered) what it means to play a musical instrument well. Even for wallpaper music.



Introducing one of the finest collections of stereo receivers in the world: the MX 1580.

Power* of the Sony 7065. FM Sensitivity* of the Pioneer 338. Selectivity* of the Sherwood 7900A. Capture ratio* of the Marantz 2270. THD* of the JVC VR-5660.

All specs subject to change without notice.

Specs of competitive receivers taken from manufacturers own published data sheets.

*Manufacturers' suggested retail price; optional with dealer.



And it almost didn't happen.

Before we designed the MX 1580, we asked ourselves a simple question: "With so many excellent AM/FM stereo receivers around these days, who needs another?"

The answer: nobody. So instead of making just "another" receiver, we collected the most significant specs and useful features of five of the best, and "combined" them in one: the MX 1580.

Of course, some of these five receivers have features our one doesn't have (we think you can manage without two phono inputs, for example).

But then, ours has features they don't have: features you *shouldn't* do without.

You pay for — and get — what you really need.

The MX 1580 has exclusive ASNC, which automatically reduces the noise level on weak stereo stations without reducing separation on strong ones.

And special thermal protec-

tion for output transistors and the power transformer.

And a special speaker matrix for surround-sound effects.

Plus lots more we were able to include and, at \$479.95***, save you a few bucks in the bargain.

How? It wasn't easy. But we had help.

The oldest new company in the business.

Although we're a completely separate engineering group and manufacturing facility, we were able to draw on the resources of a company that's been a leader in the industry since 1915. So we could afford to wait until we had the MX 1580 right.

And now it's so right, we insist that every single one be inspected twice before it's shipped. (If your MX 1580 isn't right, our final inspectors don't pass it. Or ship it.) After all, we have one of the world's finest stereo collections to protect.

See and hear MX 2- and 4-channel receivers, speakers and automatic turntables at your MX dealer. For his name, write to: MX High-Fidelity Components Series, The Magnavox Company, 1700 Magnavox Way, Fort Wayne, Ind. 46804.

Features:

- Sensitive front-end with three dual gate MOSFET's and 4-gang tuning capacitor.
- Two 6-pole linear phase filters for improved selectivity and phase response.
- High gain IC quadrature FM detector.
- Switchable signal-strength/center-tuned meter for accurate tuning.
- Phase lock loop IC circuit for FM stereo multiplex.
- Computer designed low pass audio filters for suppression of ultrasonic frequencies.
- Balanced AM detector for low distortion AM listening.

• OCL direct-coupled differential amplifier for extended frequency response and wide power bandwidth.

• Automatic Protection Circuit to protect speakers and amplifiers.

• Electronic loudness switch to provide smooth low- and high-frequency boost at low listening levels.

• Extra-heavy heat sink to keep output transistors cool at maximum power.

• Full complement of controls with low noise pre-amp IC circuit.

• High/low filter switches for special high/low frequency attenuation effect.

• Auto-off power switch, when used with MX automatic turntables, will automatically shut off the system when the last record is played.

*Specifications:

FM Tuner Section:

- Usable sensitivity (IHF) 1.8uV
- Selectivity (IHF) 75dB
- Capture ratio (IHF) 1.5dB
- 50dB signal to noise mono . . . 2.5uV
- Stereo separation @ 1kHz . . . 50dB
- @ 10kHz . . . 40dB

Harmonic Distortion:

- Mono 0.2%
- Stereo 0.3%
- Image rejection 97dB
- Spurious rejection 94dB
- AM suppression 45dB

AM Tuner Section:

- Usable sensitivity (IHF) . 250uV/m
- Selectivity (IHF) 31dB

Amplifier Section:

- Continuous power 60 watts/Ch
- Band 20Hz-20kHz
- Distortion 0.5% THD
- Load 8 ohms
- IM distortion 0.8%
- Frequency response . . 20Hz-25kHz
- Dimensions 6"Hx19"Wx15"D
- Weight 30 lbs.
- Construction Veneer with grained walnut finish.



We'll be heard from.

Check No. 18 or Reader Service Card

brushes in the unit when the records are removed. When the brushes were separated mechanically before removing the record, the static charge was not increased. The static charge introduced on the records made with the new RCA compound dissipated within a minute or two.

Another device, the Staticmaster 500 (from Nuclear Products, P.O. Box 1178-A, El Monte, Calif. 91734), was also checked for its advertised static-reducing ability. Generally sold through photographic stores, this device combines a mildly radioactive polonium element with a retractable 3-in. wide brush. Ordinary stereo LPs were used to test this device; they were left for three days to accumulate dust and a quick check with the electrostatic meter before treatment showed that they had a high static charge. For use, the element should be about one half inch from the record and the bristles pointing counterclockwise or against the mo-

tion of the disc on the turntable. After treatment with the Staticmaster 500, there was no measurable static charge on the records and the brush was able to do a moderately effective job of removing dust from the surfaces as seen under the microscope. While this device was highly effective in removing the static charges, it should be noted that it is not a true cleaner as are the Discwasher or Manual Parastat, and, of course, the disc can easily pick up a new static charge. Polonium elements, available from the maker, will need to be replaced on a one to two year basis.

Cleaning Tests

To test the cleaning ability of the various record cleaning devices, a number of records were left exposed to the room air for a period of more than two months, with temperatures ranging from 68° to 85° F. and the relative humidity ranging from 35 to 75 percent. When examined with the

unaided eye, the record surfaces were uniformly quite dusty, a whitish-gray color. When examined with a wide-field stereoscopic microscope, the surface and the grooves of each record were *truly* dirty.

Additional records were treated with dust removed from a vacuum cleaner. This was done out-of-doors, at night, and with the records illuminated with a slanting light beam. A small quantity of dust was tossed up in the air about two feet laterally from the records and allowed to fall freely with no breeze being present to scatter the dust. Each record had a high static charge, and as the dust descended close to the vertically-oriented records, the static charge would pull dust particles onto the record, the process being observed in the light beam. The dust settled fairly evenly on all the records. Another group of records was subjected to cigarette ashes sprinkled on them, which were then blown off, and a duplicate set had the cigarette ashes smeared on them by hand. A few records were also left exposed to the room dust for a period of about 24 hours, this being about the longest length of time a record would commonly be left out of its sleeve. Finally, a set of records was subjected to varying degrees of naturally oily finger marks over their entire surface. All of the records were examined under the microscope to ensure a reasonably equal amount of "dirt" on the surface and in the grooves. In looking at these artificially produced dirty records, it seemed very doubtful that anyone would have records this dirty. Each of the cleaning devices examined was then used according to the instructions accompanying that device.

All of the cleaning devices did a good job of removing dust from the surfaces and grooves of the records left exposed for 24 hours, as viewed with the unaided eye. However, when examined microscopically, some of the records had a limited amount of dust remaining in the grooves. To our surprise, the Vac-O-Rec unit left a dust streak on the record the width of the mohair brush. This dust streak was visible with the unaided eye when the record surface was illuminated at an angle. We examined two additional units with similar results, and concluded that the suction developed by the unit is probably not sufficient to remove the accumulated dust from the mohair bristles. The unit would probably be more efficient were it possible to mechanically separate the opposing walls a little before the record is removed. We took one unit

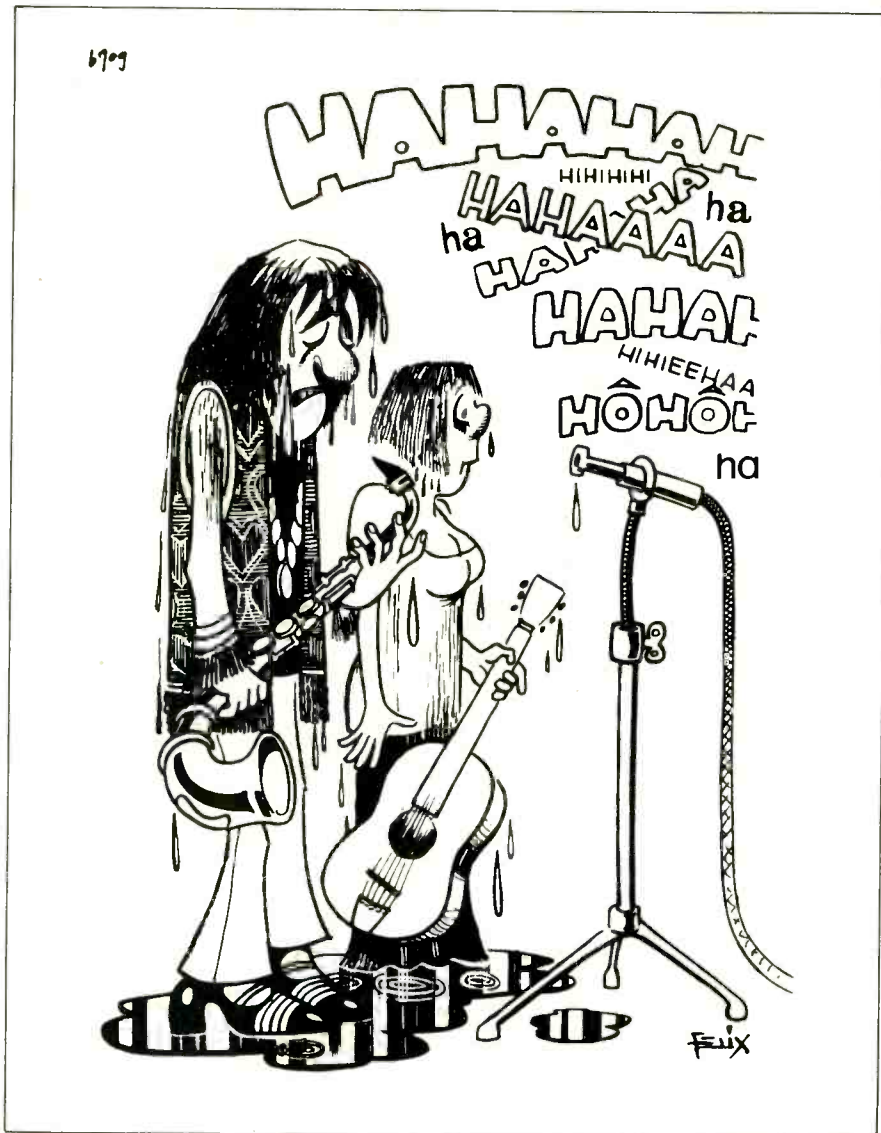

apart, held it together manually while a record was being cleaned, then separated the walls about one-half inch before removing the record. The dust streak was absent when the record was examined under oblique light and microscopically. Microscopic examination of the mohair bristles revealed an accumulation of dust that could easily be brushed out or vacuumed out with a household-type vacuum cleaner.

Only the Discwasher and the Manual Parastat were able to truly clean the remaining dirty records, including those with finger marks. Microscopic examination revealed only a limited amount of dirt remaining in the record grooves with either device after one cleaning. After cleaning both devices, the records were cleaned two more times. All the remaining dirt from the grooves was totally removed. The Audio-technica AT-6010 Record Cleaning Kit did a creditable job but repeated efforts did not remove *all* the dirt from the grooves. All the cleaning devices except the Vac-O-Rec did an excellent job of removing the naturally oily finger marks; the Vac-O-Rec is not intended for this purpose, as is stated in their instruction booklet.

To sum up, no ordinary record cleaning device tested was able to eliminate the surface static charge to an acceptable degree. All of the devices did an excellent job of removing dust accumulated in a period of less than 24 hours. Only the Discwasher and the Watts Manual Parastat were successful in returning very dirty records to their original clean state. Although it is desirable to remove the static charge with its accompanying noise, we would venture an opinion that it is more important to utilize a device that thoroughly removes the various record pollutants that are responsible for long-term cumulative noise.

To preserve records in as near new condition as possible, a regular maintenance program should be put into practice. Records should be handled only by the edges and label area to avoid oily finger marks on their surface; they should be cleaned before each playing with a cleaning device such as those discussed above; when a disc has finished playing, it should be cleaned and immediately placed in its polyethylene-lined sleeve and then its jacket, and stored in a vertical position to prevent warping. If the record did not come in a polyethylene sleeve, such sleeves can be purchased at most record stores or through various sources in *Audio's* classified section.

A very important part of record maintenance is the cleaning of the cartridge stylus. The stylus should never be permitted to accumulate dirt and encrustations which can transfer to the record groove as well as scratch the delicate groove walls during play. A soft, small-bristled, camel hair brush should be used to gently clean the stylus. The cleaning motion should be in the same direction as the record moves, i.e. from the back forward and at a 45-degree angle from left to right and vice versa, again from the back to the front. **Never** use a back-and-forth motion to clean the stylus since this

can easily bend the very delicate cantilever, thus destroying the stylus assembly. The camel hair brush may be moistened with any solution recommended for stylus cleaning. This will assist in loosening any encrusted deposits on the stylus for easier removal. A most damaging practice, sure to harm the cantilever, is flicking the stylus with your finger.

Remember, as many audio manufacturers have stated, your greatest investment is in the records, not in the equipment—so keep them clean if you want to retain the signal originally cut on the record. 

TRACER I

DELIVERS FULL SPECTRUM SOUND

● Now, you can hear the full rainbows of sound that are there in your recordings or in the waves of your favorite stereo broadcasts. Tracer I delivers that spectrum with the crystal clarity of fresh rain presented to a spring morn'. *Transparency and presence*,—that's Tracer I, forming a new standard of comparison that your good ear will know the moment you listen. A sound that is the result of speaker characteristics combined in ways unachieved 'til now...including cross-over elimination that inhibits phase distortion

- linear response ● dual phase coupling ● solid state tweeter ● full spectrum efficiency. Bring that good ear to your hi-fi dealer. Treat it to this auditory excellence.* Then observe the price tag. You'll find it hard to believe. For Tracer I delivers all that fidelity and presence and a new standard of value! (Dealers: Your inquiries are invited)

... and makes it fresh-rain clear!



BML Electronics, Inc.

Acoustics Division • P.O. Box 711
Wheeling IL 60090 • 312 271-7755



*and now this auditory excellence has been extended to produce TRACER II!

"I See What You Mean!"

How the Westrex 45/45 System Was Adopted by the Record Makers

By Ralph W. Wight

IN THE *Home Furnishings Daily* of Thursday, September 26, 1957, out of New York under the by-line of Henry Brief, it was pointed out that "the future of stereophonic sound, which has been closely linked with tape and tape recorders in the past few years, may now have to share or perhaps even be dominated by stereo phonograph records."

The article then described the recently developed stereophonic disc recording and reproducing system being shown to the record industry by Westrex Corp., then a wholly-owned subsidiary of Western Electric Co.

Subsequent events bear out Mr. Brief's appraisal of the situation. However, the events leading up to the final acceptance of the Westrex 45/45 System as the American standard, make a very interesting story.

Prior to the introduction of the "StereoDisk," the record industry had been stumbling along the best way it

could in the face of competition from tape in the home entertainment field. The ready adaptation of tape to stereo left the record people with practically no place to go and business was showing the effects. Indeed most record producers were swinging into the tape field as fast as practical, but none were happy with the price of the end product nor were they willing to give up on records. By March of 1957 the stereo tape business was undergoing a phenomenal boom, and it was felt that a stereophonic record at approximately half the price would greatly broaden the market.

Because of the early success of its tape program, RCA had decided to also explore all developmental work going on associated with the recording and reproducing of stereo on records. Major Westrex disc recording licensees at that time included RCA, Decca, Columbia, London-Decca, and others. All were clamoring for a com-

petitive stereophonic record system and were following any lead, foreign and domestic, in this direction.

BY September of 1957 RCA had become the largest single user of 1/4-in. tape in the country, recording six million feet a week for home entertainment use.

For a year prior to the height of the tape boom, Westrex had been quietly working on a stereo cutter to replace the outmoded monaural Westrex cutter. The new cutter was to be capable of functioning with the many Western Electric and Westrex feedback amplifiers then in use.

Development of the new cutter progressed slowly on a more or less routine basis in the Westrex Hollywood laboratory until on August 16, 1957, when out of the blue, a call was received from A.L. McClay, General Manager of Record Manufacturing and Engineering at the RCA Victor Record Division in New York City, telling us that "if we had anything to show on stereo for records, we had better do it and do it now." Otherwise the industry might be forced to accept a vertical-lateral system being promoted by Sugden of England and Telefunken of Germany. This telephone call was based on information obtained by RCA's Allen Pulley (Manager of RCA's recording studio in New York City) on a recent trip to England and the Continent where he had listened to a demonstration of the Sugden vertical-lateral stereophonic recording system, both the recorder and reproducer having been designed and built by Sugden. Pulley reported that the reproduced quality

About The Author

From 1951 to 1958 Ralph W. Wight was Manager of the Recording Equipment Division of Westrex Corp. with headquarters in Hollywood, Calif. In 1958 Westrex Corporation was sold to Litton Industries under the terms of a consent decree entered into between the United States Justice Dept. and AT&T Company. In 1959 Mr. Wight became Vice President of the Westrex Division of Litton Industries, and in 1960 was made Vice President of Litton Systems, Inc.

From 1962 to 1972 Mr. Wight was President and Vice President of

Technical Products Engineering Co., which he formed to engineer, manufacture, and install radio communications control center equipment for governmental subdivisions such as police, sheriffs, and fire departments.

In 1972 Mr. Wight formed Ralph W. Wight Associates, a consulting organization working in the radio communication control center field and associated areas. The firm currently has offices at 10920 Wilshire Blvd., Los Angeles, Calif., 90024.

Introducing the KLH Research X Model Sixty Turntable:

A solid triumph in human engineering.

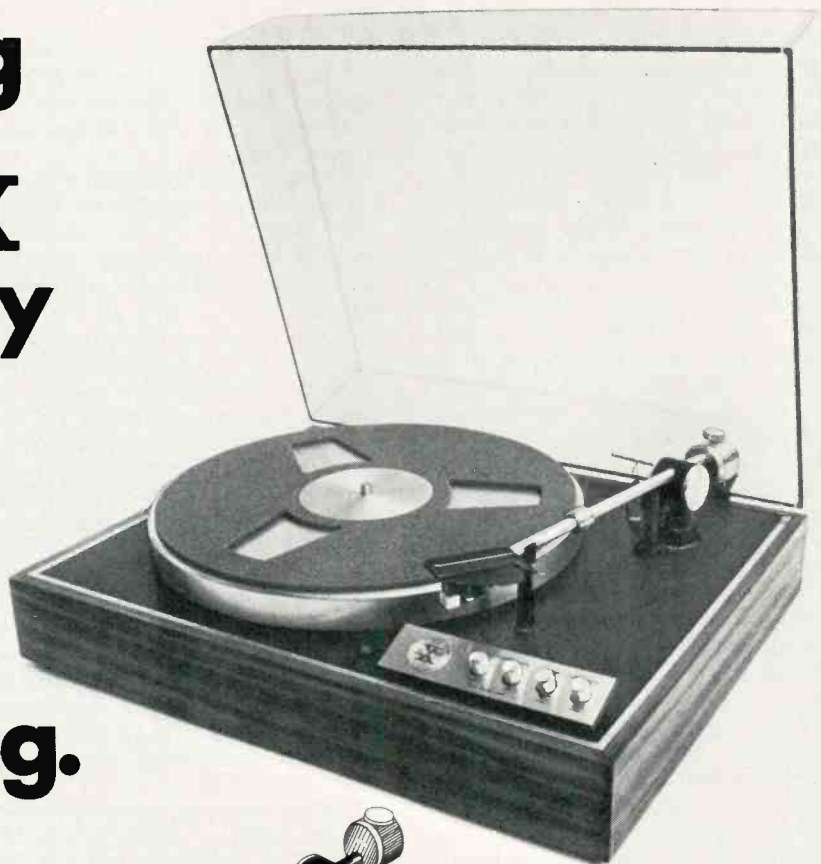

There are more manual turntables to choose from these days than ever before. And most of the better models share many of the same fine features and specifications.

So why make a turntable? (And we are making it—not just slapping our name on someone else's product. Every part is hand assembled in our plant in Cambridge, Mass.)

The answer is in the product itself. The Model Sixty is a two speed, belt-driven, transcription quality turntable that combines all of the most wanted features with exceptional performance and a maximum of something we call "human engineering."

What is human engineering?

It's designing an electro-optical system that automatically shuts off the turntable at the end of the record and gently lifts off the tonearm. This is achieved through the use of a light detector resistor

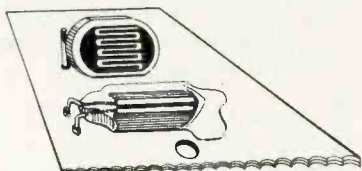

(shown here) rather than a mechanical device which would have to be tripped by the side force of the tonearm. Since our system requires no side force, it virtually eliminates all potential distortion and side thrust problems.

Human engineering is designing a special low mass aluminum tonearm and unique low friction pivot block and post assembly to such exacting standards that

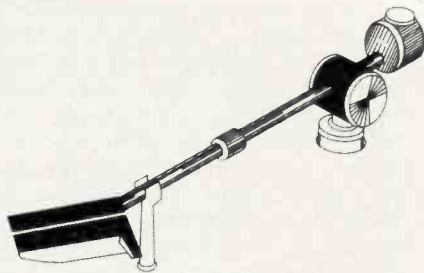

usage deterioration and performance deviation is all but eliminated.

Human engineering is designing all of the electronic controls into an upright module for incredibly simple and convenient operation. It's also making the controls feel as good as they look.

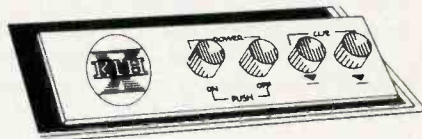

(Just one touch and you know there's something substantial here.)

In short, human engineering is finding out what people want and need in a product and putting it there. That's why the Model Sixty also features push-button electronic cueing, anti-skating control, a discrete suspension system that minimizes rumble, acoustic feedback and vibrations, one piece dynamically balanced platter, 24-pole synchronous motor and every other important feature you could want in a precision turntable.

All for \$150.

Now that's human engineering.

The Model Sixty. Another superb new product from KLH Research X—a new era in audio.

For more information, visit your KLH dealer or write to KLH Research & Development Corp., 30 Cross St., Cambridge, Mass. 02139.



Specifications

Rumble: -58 dB (CBS-RRL), exceeds DIN requirements.

Wow & Flutter: .09%, lower than one half of DIN requirements.

Tracking Force: Continuously adjustable from 0.5 to 4.0 grams, with precision calibrated scale.

Average Absolute Tracking Error: 0.5° less than 0.01 radian.

Arm Structure: Low inertia, precision ground, high strength aircraft aluminum alloy.

Suspension: Tripoint seismic suspension of arm and turntable on single precision casting, damped to minimize influence of external vibrations causing high order resonances.

300 RPM Motor: Precision polyphase synchronous low speed motor for minimal vibrations and optimum instantaneous speed accuracy and freedom from counter-rotation.

Timing Accuracy: Better than 5 seconds per average LP side; twice as good as DIN requirements.

Speeds: 33 $\frac{1}{3}$ & 45 RPM

Record Sizes: 7", 10", 12"

Operates on: 105-125 volts, 60Hz only, pilot light indicates power "ON"

Dimensions: 17" (W) 13 $\frac{3}{8}$ " (D) 6 $\frac{1}{4}$ " (H) with dust cover.



KLH Research X Division
KLH Research & Development Corp.
30 Cross St., Cambridge, Mass. 02139

Check No. 16 on Reader Service Card

would be quite acceptable commercially and that Sugden was then working on some 10 recorders which were about 15 to 20 percent complete when he visited the plant. Design problems were being experienced with the reproducer but it was thought that reproducers would be available in limited quantities by the first of 1958.

Pulley next visited London-Decca where their Dr. Haddy was experimenting with vertical-lateral recordings made on a Telefunken recorder and played back on a reproducer developed by Dr. Haddy. Pulley reported that the quality of reproduction there was also quite acceptable, and he had been advised Telefunken was in a position to go into manufacture on their vertical-lateral recorders at once. Because of the progress reported from two different sources in Europe, McClay was very anxious to find out what progress Westrex was making. He felt it was imperative that the Westrex position be made known not only to RCA but to the other licensees at the earliest possible moment, since it was felt that, from the progress reported from Europe, the market might be flooded with European vertical-lateral stereo recordings within the next six months.

Even though Westrex had only two hand-made models of the new StereoDisk cutter, it was decided that the system should be unveiled immediately. It was also decided that the first exposure should be at the engineering level and that it should be done in Hollywood. Arrangements were made at once for such a demonstration.

Appropriate listening facilities were set up in the Hollywood laboratory of Westrex and engineering representatives of all interested organizations were invited to attend a single session so that there could be no possible complaints of favoritism. The demonstration was held on August 26, 1957.

Dr. Haddy of London-Decca came and brought with him a trunkful of equipment plus vertical-lateral recordings he had made on the Telefunken recorder. He also brought his own hand-made reproducer, and displayed some excellent test material.

Westrex had not advanced very far in the development of a reproducer, but had one in the design stage. The first Westrex test reproducer consisted of two ESL cartridges taped together. The reproducer built by Dr. Haddy was a superior device which appeared to function equally well on either vertical-lateral or 45/45.

Dr. Haddy's demonstration material had been developed over a consi-

derable period of time and was excellent. The Westrex 45/45 material was also excellent, particularly when played back via the London-Decca reproducer.

An interesting facet of the demonstration was the reaction of the audience, many of whom had never heard stereo from a phonograph record and did not know quite what to expect. A representative of one of the major companies, whose responsibility had been that of furniture and packaging of home entertainment systems, expressed the opinion that he had been through similar demonstrations many times and had yet to hear any new development involving an improvement sufficiently outstanding for the average customer to detect. The listening room where the demonstration was held happened to be an almost optimum size and shape and had been treated acoustically to provide the correct reverberation time for this type of use. Two Altec professional corner-type two-way speaker system were used and placed for the most pleasing effect.

Capitol Records, although not a Westrex licensee, was located close to the Westrex laboratory and furnished invaluable cooperation and assistance in providing test material. The material initially used for the demonstration was obtained by re-recording Capitol's tape "Introduction to Stereo" (with which most everyone is familiar) to the Westrex StereoDisk system. Facilities were provided in the laboratory so that the original tape and the re-recorded StereoDisk version could be played back in the listening area.

Switching facilities were provided to permit instantaneous comparisons between both types of material. Colored lights indicated the material to which the audience was listening.

At no time did the demonstration take on the appearance of a contest between vertical-lateral and the Westrex 45/45. This was easily accomplished since neither London-Decca or Dr. Haddy were equipment suppliers. They were simply concerned with doing what they could to come up with a better product to help bail the industry out of an insecure business situation.

Various tests and counter tests were made, listening to Westrex recordings on Westrex equipment and London-Decca recordings on Westrex equipment, the process then being reversed to play the same material in all possible combinations. We were careful to seat the obvious skeptics in the preferred location. After only three or four revolutions of the turn-

table, our firmest skeptic stood up and said "I see what you mean."

After a full day of listening it was the consensus that, while both systems exhibited excellent reproducing characteristics, it appeared the Westrex 45/45 system was the more practical since it recorded two separate recordings of identical sound quality and therefore did not require different electrical equalization characteristics for each track, as would be required with vertical-lateral.

Another governing factor was that a vertical recording/reproducing system was more susceptible to turntable rumble than a lateral system. Thus, if rumble was present on the vertical-lateral, it would be more pronounced in one channel than the other. While the Westrex 45/45 system appeared to have more susceptibility to turntable rumble than a conventional lateral system, at least the rumble was the same in both channels.

While it was by no means the prerogative or responsibility of those attending this Hollywood demonstration to set the standard for the industry, the reaction of those present actually accomplished exactly that. The Westrex 45/45 system was formally adopted as the American standard by the Record Industry Association of America (RIAA) on December 27, 1957.

Immediately after to the initial demonstration, tremendous pressure was put on Westrex to supply cutters to its licensees. As a stopgap measure, it was agreed that a sufficient number of units would be hand-made to provide one cutter to each licensee at the earliest possible moment, after which Westrex would go into production on a substantial quantity of cutters on a routine basis.

Additional demonstrations were made on October 11, 1957, before the 9th Annual Convention of the Audio Engineering Society held in New York City. The following week further demonstrations were made at the Park Sheraton Hotel in New York City for record and phonograph company representatives.

Looking through various old records recently, I came upon one entitled "Westrex StereoDisk Recording, Heifitz-BSO-Beeth. Conc." Also scratched in the surface was the name "C.C. Davis 7-12-57." This record is the original first full-length cut on the experimental model of the Westrex 45/45 feedback cutter. Although there are a few ticks and pops, the record exhibits excellent sound quality and an amazing dynamic

JVC's exclusive SEA prevents wasted watts!

\$50 out of every \$100 you spend on a hi-fi receiver may be on wasted sound!

Poor room acoustics . . . thin walls . . . low ceilings . . . unusual room layouts . . . individual characteristics and mismatches of the various components can all rob you of the sound you're paying for.

That can't happen with a JVC receiver featuring our exclusive Sound Effect Amplifier . . . SEA . . . circuitry which gives you complete freedom and control over sound throughout the entire audio frequency range. SEA allows you to adjust the acoustic response of the typical home listening room to provide a flat and uniform response. Just look at the curves in two typical rooms before and after room equalization. SEA divides the audible spectrum into five crucial frequency zones or ranges permitting you to compensate for room acoustics, poor room layout or to match sound characteristics of the different components. It even provides an unlimited choice of tonal balance to suit your personal tastes for various kinds of music . . . allowing you to create your own sounds when listening or while recording.

So don't pay for **wasted sound** — control it with SEA — a patented graphic equalizer tone control system only in JVC components.

JVC HI-FI the best value your money can buy.

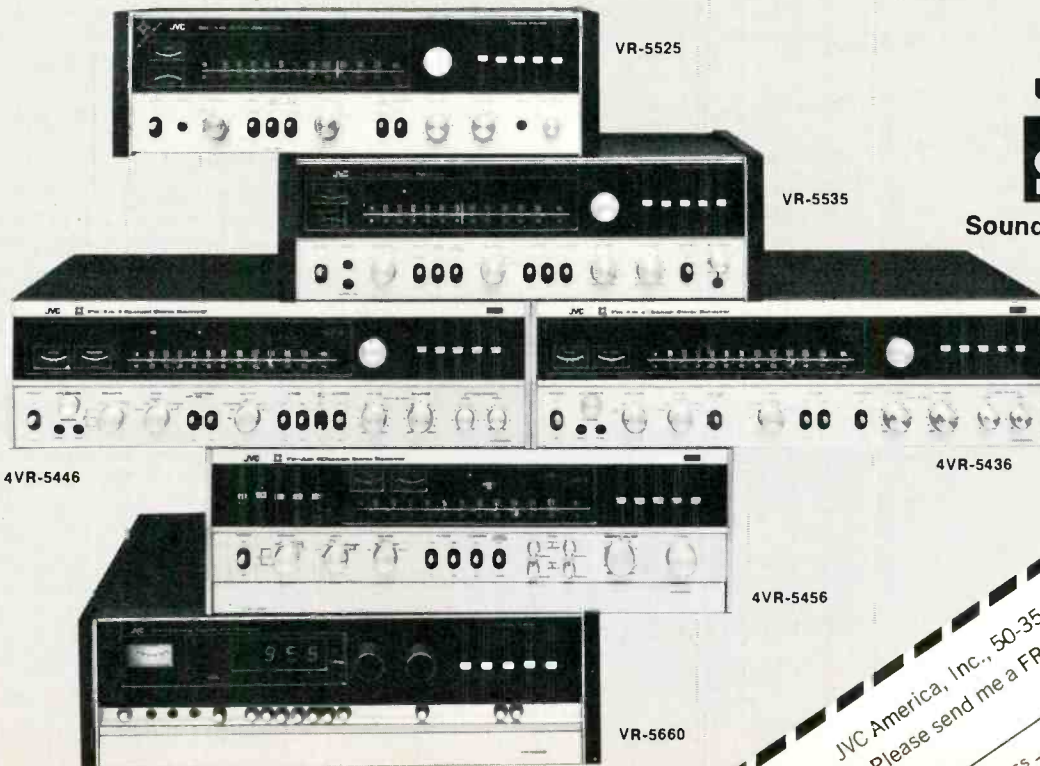
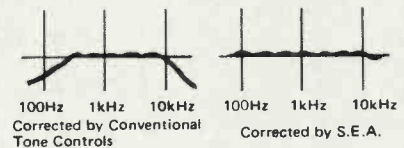
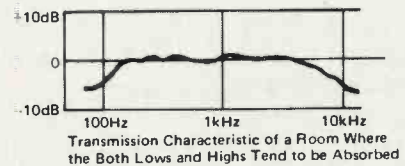
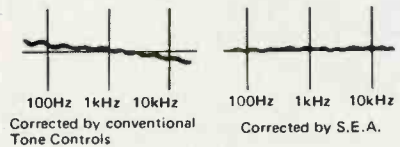
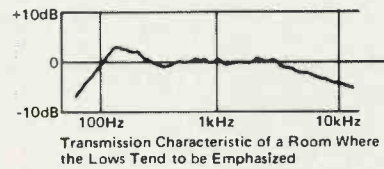

Sound Effect Amplifier

Check No. 15 on Reader Service Card

www.americanradiohistory.com

JVC America, Inc., 50-35 56th Road, Maspeth, New York 11378
Please send me a FREE copy of the New JVC Hi-Fi Brochure.

Name _____ Age _____
Address _____
City _____ State _____ Zip _____
Dealer _____

JVC

a new twist in tape recording

lets you make professional quality
tapes on your home recorder



dbx 120 series noise reduction

For the first time in tape history, you can record live music on your audiophile recorder and achieve better signal-to-noise performance than professional studio recorders.

The new dbx 120 tape noise reduction system provides about 40 dB noise reduction with reel-to-reel, cartridge or cassette recorders. For live recordings, tape hiss and background noise are completely eliminated. For taping off-the-air or dubbing from records or tapes, no noise is added beyond the noise content of the material being copied. (We do not attempt to remove noise present in the original input signal, however.)

dbx 120 units also decode the newly released dbx encoded "noiseless" discs which offer over 100 dB dynamic range with no audible surface noise at any listening level.

Model 122 is a two-channel tape noise reduction system, switchable to record or play, with a dbx disc decode feature, priced at \$259.00.

Model 124 is a four-channel tape noise reduction system, switchable to record or play, which will also provide simultaneous record and play for two-channel recording, with a dbx disc decode feature, priced at \$379.00.

Words cannot adequately describe the experience of listening to recorded music with over 100 dB dynamic range. We don't expect you to believe it possible until you hear it for yourself.

For the most dramatic recorded music demonstration of your life, hear the dbx encoded "noiseless" disc at your demonstrating dbx dealer.

For complete product information and dealer list, circle reader service number or write to:



dbx

Incorporated, 296 Newton Street
Waltham, Massachusetts 02154

Check No. 11 on Reader Service Card

range. The material looks like an early vinyl-type base.

Charlie Davis, more than anyone else, was the moving spirit in development of the Westrex 45/45 cutter. His contributions to this form of entertainment have gone largely unrecognized although many of his basic equipment developments and operating techniques are still being practiced. Davis, however, cannot be given credit for the "invention" of the 45/45 system since the Bell Telephone Laboratories had anticipated the possibility of this type of recording in patents issued to them covering certain elements of the early "hill and dale" vertical recording method as well as those covering the Western Electric lateral feedback monaural recorder.

During his lifetime, Charlie Davis made three significant contributions to sound recording and reproducing. His first contribution was the development of the "Davis Drive," used in film recording machines by professional motion picture agencies throughout the world. The Davis Drive involved the first "Tight Loop" mechanical filtering system resulting in a uniformity of film motion which set new worldwide standards. The basic principles of this system are still in use by most manufacturers of film recording and reproducing equipment.

Davis applied the same design philosophy he used in high-speed film-pulling mechanisms to low-speed disc drives and came up with the same accurate mechanical motion. Low-frequency flutter and wow has not been much of a problem for many years in the disc recording and reproducing field because of his pioneering work. Uniform motion is no longer a problem even in reasonably inexpensive drive mechanisms.

Charlie Davis was very ably directed in his efforts by Dr. John G. Frane, Engineering Manager of Westrex for a long period of time. Dr. Frane is well known and highly respected for his contributions to the technology of professional motion picture recording, as well as the disc recording and reproducing field.

Others who played a prominent part in making the 45/45 system the American standard and bringing it to its present state of perfection include Bill Miltenberg and Bob Moyer of RCA; Dr. G.F. Dutton of the Record Division of EMI, Hayes, Middlesex England; Ed Uecke, Chief Engineer of Capitol Records; Dick Crane, Bob Davis, and Ed Dickinson of the Westrex Hollywood laboratory, and many others. Enjoy their efforts!

Equipment Profiles



MANUFACTURER'S SPECIFICATIONS

FM Tuner Section

IHF Sensitivity: 1.9 μ V. **S/N:** 65 dB. **Selectivity:** 65 dB. **Capture Ratio:** 1.5 dB. **THD:** Mono, 0.3%; Stereo, 0.4%. **AM Suppression:** 50 dB. **Image Rejection:** 55 dB. **I.F. Rejection:** 60 dB. **Spurious Response Rejection:** 60 dB. **Stereo Separation:** 40 dB, 1 kHz. **Frequency Response:** 20 Hz to 13 kHz \pm 1 dB. **Carrier Suppression:** 50 dB.

AM Tuner Section

IHF Sensitivity: 20 μ V. **Selectivity:** 25 dB. **Image Rejection:** 40 dB. **I.F. Rejection:** 40 dB.

Amplifier Sections

Power Output Per Channel, Minimum Continuous (RMS), All Channels Driven, 8-ohm Loads at Maximum Total Harmonic Distortion of 0.5%: 26 watts, 4-channel mode; 80 watts, 2-channel mode. **Damping Factor:** 20, 8 ohms. **Input Sensitivity:** Phono, 2.0 mV; AUX, Tape, 180 mV. **Hum and Noise:** Phono, 70 dB; AUX, 90 dB; residual, 1.5 mV. **Frequency Response:** Phono, RIAA \pm 1 dB; AUX, 7 Hz to 70 kHz, +0, -3 dB. **Tone Control Range:** Bass, \pm 11 dB @ 50 Hz; treble: \pm 10 dB @ 10 kHz. **Low Filter Cut-Off:** 200 Hz @ 6 dB/octave. **High Filter Cut-Off:** 7 kHz @ 6 dB/octave.

General Specifications

Maximum Power Sumption: 360 watts, at 120 V, 60 Hz. **Weight:** 37.3 Lbs. **Dimensions:** 21-3/8 in. W x 6-1/8 in. H x 15-1/2 in. D. **Retail Price:** \$739.95.

For many, the chief objection to earliest all-in-one four-channel receivers was their low power output per channel in return for quadrasonic flexibility, and the apparent aim of the new SA-8500X is to counter these objections, which it does most successfully. Here is a receiver that supplies more than 25 watts per channel into 8-ohm loads at all audio frequencies, in accordance with the strict power output disclosures required by the new FTC power rule. Switch it to what Technics calls the BTL mode (more familiarly known as "strapped" two-channel operation) and you have at your command up to 80 watts of power for each of the two channels then available.

Having gained experience with the CD-4 quadrasonic disc format (Technics by Panasonic was one of the first companies to champion quadradiscs in this country), they have refined that circuitry in this latest receiver, making it much easier (and less critical) than in earlier products. Matrix de-

coding, however, takes a back seat to CD-4 demodulation, with two simple matrix positions available, but with no logic circuitry added. One of the two matrix positions corresponds to RM (Regular Matrix, as standardized in Japan), the other comes close to SQ parameters (though Technics neither says so nor labels the position that way).

The front panel of the SA-8500X is one of the most impressive we have seen since the dawn of four-channel sound in home equipment. The upper, blacked-out area (illuminated when power is applied) has four level meters at the left, one for each channel. In addition to assisting you in balancing all four channels, I must confess that psychologically I always feel better when tinkering with four-channel program sources when I am able to SEE (as well as hear) different things happening in each channel. A 10-dB push-button switch has been wisely added, so that meter sensitivity can be increased by that amount and meters be read easily even when sound levels are fairly low. The well-calibrated AM and FM dial scales are surmounted by channel indicator lights which spell out mode of operation (4-CH DISCRETE, 4-CH. MATRIX, STEREO, etc.), while below the scale are more illuminated words which identify pushbuttons such as the three available tape monitor buttons, FM MUTING switch, and the aforementioned meter sensitivity switch. Lights also tell you program source chosen while at the extreme right is a signal-strength tuning meter active in both FM and AM modes. A separate power ON/OFF switch is located center-left on the panel.

The lower section of the panel contains a pair of headphone jacks (for four-channel phones), bass and treble controls, a large master-volume control surrounded by four individual channel-level controls, mode selector, program-selector switch, and a large tuning knob. Secondary controls in this area include low- and high-filter switches, loudness control, and audio-muting switch (not to be confused with FM muting) which lowers overall volume level by a fixed 20 dB when answering the phone, doorbell, etc. Finally, there is a CD-4 "High Blend" switch intended for use when CD-4 records are unduly noisy. With the switch in use, noise is reduced with some minimal sacrifice in high-frequency channel separation—much like the familiar "MPX filter" popular on some stereo tuners and receivers for accomplishing the same objective when listening to weak or noisy stereo FM signals. The now almost-standard "radar light" blinks on whenever a CD-4 record is played, appearing in the upper dial-scale area along with the other previously noted lights.

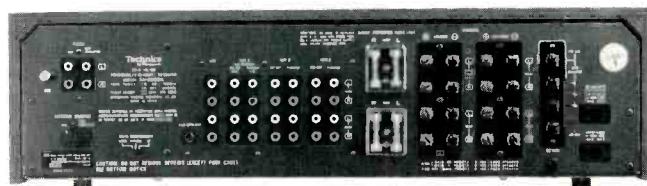

Fig. 1—Rear panel of the SA-8500X

The rear panel of the SA-8500X, shown in Fig. 1, may set a new record for number of input and output jacks and terminals. Three full tape-monitoring facilities (in four-channel) means no less than 24 jacks, in addition to a full four-channel AUX input arrangement, enough speaker terminals for two four-channel speaker setups, 300-ohm, 75-ohm, and AM antenna terminals, switched and unswitched a.c. convenience outlets, and a four-channel FM detector output jack for future use with a four-channel FM decoder. Each speaker line is fused, with transparent covers over each pair. Two types of phono inputs are provided. Conventional ones for magnetic cartridges require no further explanation. The other pair, intended for semiconductor cartridges (one of which is manufactured by Technics by Panasonic), deliver a bias voltage required by this type of phono pickup, so that no separate power supply is required when they are used with this receiver. A two-position switch near the phono inputs selects either pair of terminals (they cannot both be used simultaneously), while three-position slide switch, identified as a 30-kHz compensator switch, is intended to help adjust frequency response of the CD-4 input circuitry to compensate for less than perfect CD-4 cartridge that have dips or peaks at the high end of the response. With reasonably good cartridges, this switch position should be left in the NORMAL position.

Circuitry Highlights

An internal view of this massive chassis is pictured in Fig. 2. Power amplifier circuits, seen standing vertically, each include a first-stage differential amplifier, followed by direct-coupled circuitry out to output-capacitorless power stages. Operation in the strapped mode (in which pairs of amplifiers are effectively paralleled for greater power output) is selected on the front panel by the speaker-selector switch. A direct-coupled I.C. circuit is used for the phono equalizer section of the receiver. Perhaps the most outstanding new feature of the CD-4 portion of the receiver is that fact that separation and carrier level adjustments are no longer required (they were with all earlier receivers whenever you changed or installed a new cartridge).

The FM front-end uses a four-pole MOSFET and the variable capacitor is designed so that dial calibration is linear. The i.f. section employs five stages, three of which are differential amplifiers, and there are three two-element ceramic filters for achieving desired band-pass characteristics. The AM section also employs a ceramic filter. The stereo FM decoder circuit includes a monolithic IC which incorporates two differential switching or demodulation circuits.

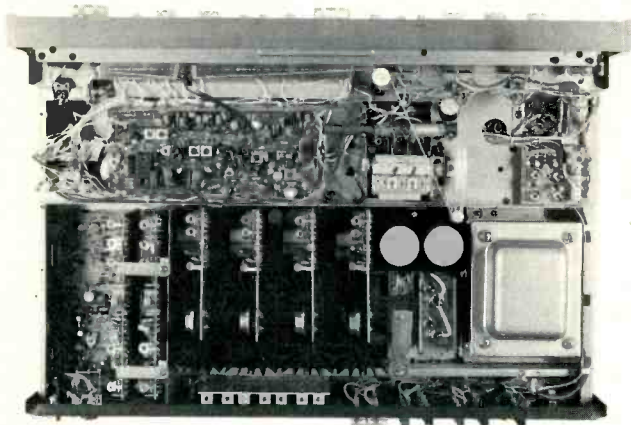

Fig. 2—Internal view.

FM Performance Measurements

We measured an IHF sensitivity of exactly $1.8 \mu\text{V}$ for the SA-8500X receiver, but in terms of quieting, 50 dB of S/N was reached under signal input conditions of only $2.0 \mu\text{V}$, as shown in Fig. 3. Ultimate quieting in mono was 71 dB, considerably better than the nominal 65 dB claimed by the manufacturer. THD in mono was also excellent, at 0.2% for mid-frequencies. In stereo, the same test resulted in 0.32% THD, still very good, and the best signal-to-noise ratio obtained was 65 dB. Selectivity was closer to 70 dB than to the 65 dB claimed, while capture ratio measured 1.3 dB, image rejection was 60 dB, and AM suppression was 53 dB.

Stereo-FM separation, plotted in Fig. 4, was 42 dB at mid frequencies, remaining as high as 40 dB all the way down to 50 Hz, and decreasing to 30 dB at 10 kHz. Figure 4 also shows that THD is maintained at low levels for all audible frequencies. At 7 kHz, THD measured 0.5% in mono, 1.0% in stereo.

AM sensitivity was measured as $25 \mu\text{V}$, via the external antenna terminal input, while selectivity actually proved to be a bit better than claimed, measuring 27 dB on our sample.

New Measurements For Amplifiers

In keeping with the editorial policy of AUDIO magazine, we have begun testing power amplifiers and the power amplifier sections of receivers in accordance with the new Federal Trade Commission Rule which went into effect last November. While we do not agree with all the provisions and requirements of this rule, it does serve a useful purpose in partially clarifying power output claims and, until it is modified or something more meaningful (and even less ambiguous) comes along, we shall continue to report our findings as la the FTC rule.

First, it should be noted that the literature supplied with our unit (including the owner's manual) was printed before the rule went into effect, and so we had to search through several kinds of power ratings before arriving at the fact that Technics by Panasonic claims 26 watts per channel from 20 Hz to 20 kHz, with 8-ohm loads, all channels driven, at no

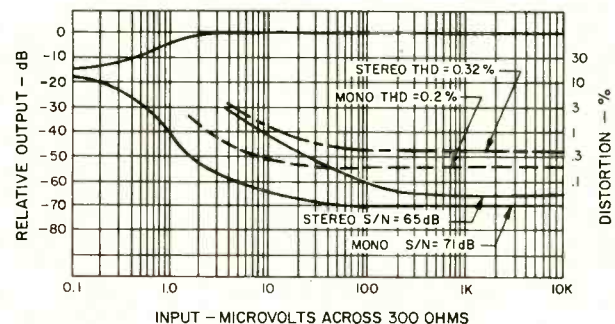

Fig. 3—FM quieting and distortion characteristics.

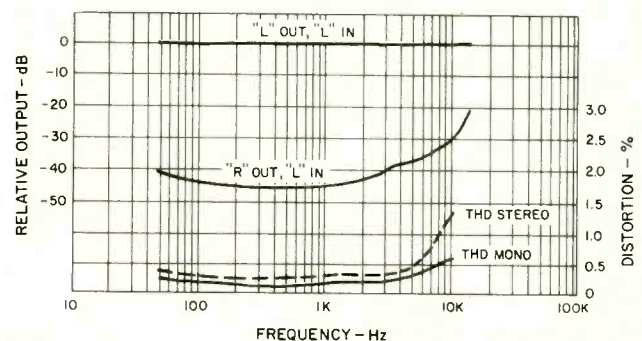

Fig. 4—FM separation and distortion versus frequency.

Speakers are a matter of taste.

Yours.

No other component in your high fidelity system will influence your enjoyment of music as much as your choice of speakers. Every speaker design has its own individual characteristics, and actually imposes its own personality on any music you play.

What kind of a sound do you prefer? The tight sound of an acoustic suspension speaker? The open sound and flexibility of an omni-radial speaker? Or the presence and realism of a multi-directional speaker?

No matter which you choose, Sansui makes a speaker to match your taste. And they are all superior in performance, delivering sharp definition, and a smooth, but crystal clear dynamic attack over a wide range.

Yes, speakers are a matter of taste. Only you can decide which one of the seven Sansui speakers is really the best speaker you ever heard. So stop in at your nearest Sansui dealer...and listen.

Check No. 31 on Reader Service Card

SANSUI ELECTRONICS CORP.

Woodside, New York 11377 • Gardena, California 90247

SANSUI ELECTRIC CO., LTD., Tokyo, Japan • SANSUI AUDIO EUROPE S.A., Antwerp, Belgium

Sansui

more than 0.5% THD. (We shall continue to use the abbreviation THD even though the FTC says it is an unfamiliar term and must not be used by manufacturers who are required to spell out "Total Harmonic Distortion" each time. If any reader still has doubts about the meaning of THD at this point, please forgive our attempt at brevity).

On that basis, we ran the receiver, with all channels driven to a power output of 8.7 watts into 8-ohm loads for one hour continuously. This is the so-called preconditioning test about which there has been so much debate within the industry. The SA-8500X heat sinks warmed up considerably (as would be expected) but no fuses popped, no circuits failed, and we were able to go on with full-power measurements. Not only were we able to produce 26 watts per channel in the four-channel mode at 20 Hz and 20 kHz following this preconditioning test, but the THD observed at these two frequency extremes was 0.1% at 20 Hz and 0.13% at the high end—both well below the 0.5% maximum claimed by the maker. Breathing a sigh of relief, we went on to find that at mid-frequencies (where, FTC notwithstanding, there is still much music to be heard), each channel produced just over 35 watts into 8-ohm loads, as plotted in Fig. 5. IM distortion (up to now ignored by the FTC) measured 0.5% at an output of 32.7 watts per channel, also plotted in Fig. 5.

In the "strapped mode," we only made one measurement—and that was at mid-frequencies, where we observed an output of 87 watts per channel, with both channels driving 8-ohm loads. Those technically familiar with the "strapping" circuit will appreciate that using ordinary bench test equipment it is difficult to make complex measurements because of "common ground" problems. When receivers are used in this mode in home applications, however, no problem is encountered since each speaker has its own twin-wire cable leading back to the receiver and there are no "common ground" points. It should be noted that Technics by Panasonic claims 80 watts per channel in the strapped mode, into 8-ohm loads, from 20 Hz to 20 kHz and, based on the reserve measured at mid-frequencies, we have no doubt but what they "make it."

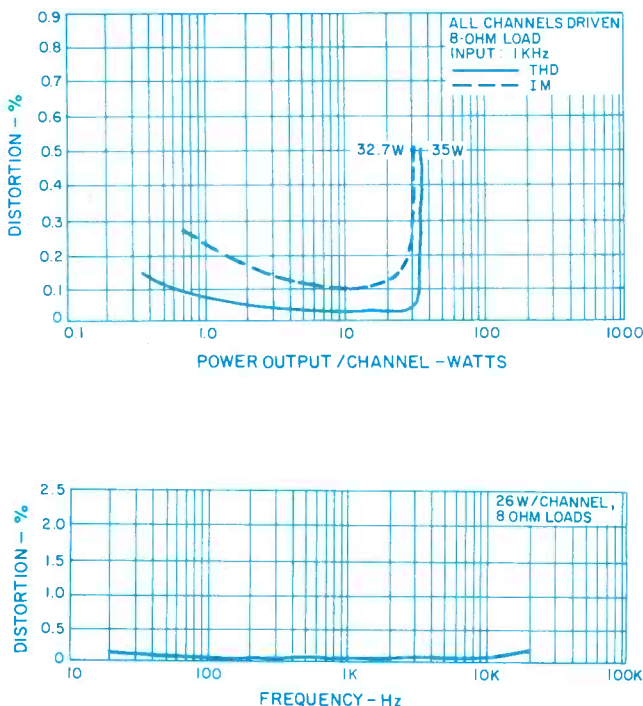

Fig. 6—Distortion versus frequency.

Not content with just end-frequency measurements, we plotted full-power output (26 watts per channel, etc. etc.) at all frequencies against THD and the results are shown in Fig. 6.

Figure 7 shows tone-control range, filter action, and loudness compensation referenced at -30 dB from full volume. The low filter, though sloped at only 6 dB per octave, is more effective than a bass control in reducing audible rumble with minimum loss of lows, whereas the high-cut filter does little more than the treble control rotated to nearly its most counterclockwise position.

Phono and high-level input sensitivities corresponded closely with published claims, while phono overload capability was measured as 60 millivolts RMS. Hum, in phono was 70 dB exactly as claimed. Hum referred to high-level inputs was in excess of 80 dB. Frequency response from high-level inputs to output, with tone controls set for mechanically flat position was within 1 dB of "flat" all the way from 3 Hz to 30 kHz.

Listening and Use Tests

Most of our listening tests were confined to CD-4 records, since it is in this area of circuitry that Technics by Panasonic seems to have made greatest strides in this new receiver. We purposely substituted a few of the earlier CD-4 cartridges we have in our possession just to see if they would produce any better results with the new CD-4 circuitry than they did when tested a year or two ago with "earlier" demodulators. They did! This new CD-4 circuit certainly makes up for deficiencies elsewhere in the CD-4 chain, whether it be in less than perfect records or cartridges. But to really appreciate how good some CD-4 records can sound, you should equip your tonearm with a late model CD-4 cartridge of known reputation, set a recent CD-4 release to spinning, and feed those complex signals through that new demodulator circuitry. It may change your mind (if you've been negative) about the future of CD-4. In this reviewer's opinion, it's here to stay—so long as we can find equipment like the SA-8500X through which to play it!

There's not much we can say about the matrix circuitry incorporated in the SA-8500X, other than to point out that it does about what you would expect from circuitry without "logic" augmentation. With all those tape-monitoring facilities, you'll probably have room for an add-on matrix decoder if you want better matrix separation than is obtainable from either the MATRIX 1 or MATRIX 2 switch settings on the SA-8500X. Of course, you can always decide about that later on. No doubt many music lovers will be content with the simple matrix system already built in.

While we were impressed with the 80+ watts capability of the receiver in the strapped mode, our listening tests were

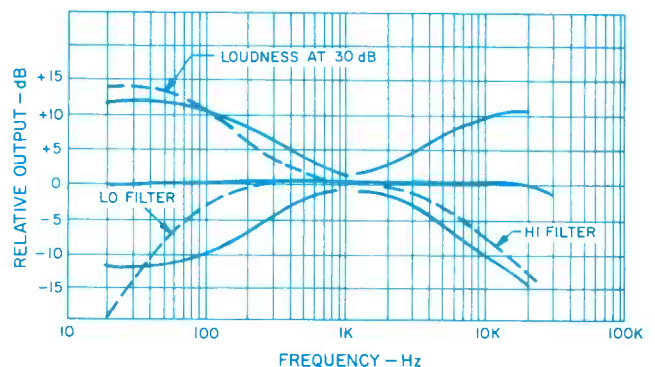

Fig. 7—Tone-control range, and filter and loudness circuit characteristics.

The BASF 90-minute sale.

Buy one BASF 90-minute cassette or 8-track cartridge at the regular price, and get a second one at half price.



That amounts to 45 minutes of free music. And not just free, but fabulous because BASF cassettes and tapes are the best in the world. Every 90-minute cassette and 8-track cartridge BASF makes is included in this half-price sale:

BASF LH Super Cassette.

Quite simply, the best high-density ferric oxide tape your money can buy. It gives you less noise, more pure sound. It also provides 50% more playback volume at the same record level—the very ultimate in sound reproduction on any equipment.

BASF Chromdioxid: the world's finest cassette. For the most demanding music selections. It brings the

brilliance of LP discs or open-reel tape to equipment designed for chromium dioxide cassettes.

BASF SK / LH Cassette.

The tape used by many professional studios. It's a low-noise, high output cassette that reproduces the best sound with great clarity and distortion-free fidelity, and at a very attractive price. Like all BASF cassettes, it has our patented Special Mechanism that makes it guaranteed jamproof.

BASF LH 8-Track Cartridge. A low-noise tape with a remarkably high output. Ideal for music, because its dynamic range is far superior to that of other ferric oxide tapes.

BASF LN 8-Track Cartridge,

a low-noise tape combining BASF quality with unmatched low-noise performance at an economical price. The BASF 90-minute half price sale is on right now. So hurry down to your BASF dealer, stock up and save money on the BASF tape you like the best. For more information, call or write BASF Systems, Crosby Drive, Bedford, Massachusetts 01730. Telephone: (617) 271-4000.

Available at participating dealers only while supply lasts.



confined to four-speaker applications, but we found that the SA-8500X offered plenty of drive power for our moderately low efficiency test speakers. Since the SA-8500X is, first and foremost, a receiver, we devoted the remainder of our listening time to FM and were happy to note that the low stereo-switching threshold (about 4 μ V) plus the excellent quieting-slope characteristics of the tuner section enabled us to enjoy all the mono and stereo stations received in our area with relative freedom from noise and audible distortion. If only a single tuning meter was economically feasi-

ble, we would have preferred a center-of-channel type (and been willing to forego meter action in AM), but it's a relatively minor quibble. Even stereo broadcasts are more fun when "dematrixed" into synthesized quadraphonics we find, and that's the way we listened to them (as well as to the few four-channel matrix broadcasts we encountered) and will continue to listen to them until the FCC gives us something to plug into that FOUR-CHANNEL DETECTOR jack at the back of this excellent receiver. Leonard Feldman

Check No. 60 on Reader Service Card

Soundcraftsmen PE 2217 Preamp-Equalizer

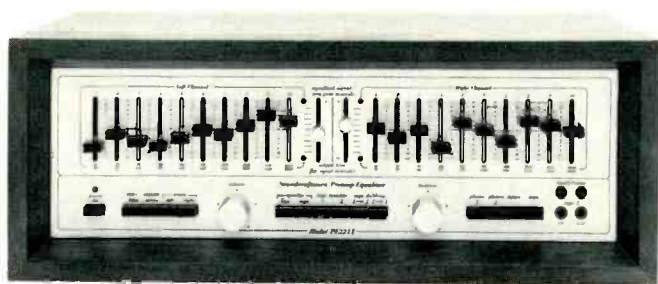

MANUFACTURER'S SPECIFICATIONS

Frequency Response: $\pm 1/4$ dB 20 Hz to 100 kHz. **Harmonic Distortion:** Less than 0.05% at 1.0 volt. **Intermodulation Distortion:** Less than 0.05% at 1.0 volt. **Signal-to-noise Ratio:** Phono, 84 dB below 10 mV input; Equalizer Section, 90 dB below 1 volt input. **Input Impedance:** Phono, 47 K; High Level, 50 K. **Maximum Output:** 5 volts into high impedance; 2.5 volts into 600 ohms. **Dimensions:** 20 in. W x 11 1/4 in. D x 7 1/2 in. H. **Price:** \$499.50. Simulated walnut case supplied. Walnut wood case optional, \$50.

No doubt about it, an equalizer is a most useful piece of equipment to have, particularly for tape enthusiasts or those who have poor listening rooms (I refer to the acoustics, *not* the decor—I once saw a magnificent room furnished in good taste with heavy plush carpeting which extended *right up the walls!* As you might expect, it was hopeless as a listening room. Even the Steinway piano sounded muffled. No equalizer could have corrected sufficiently.)

The only possible disadvantage in using a graphic equalizer is the extra shelf space and cable connections required. If you also have a preamplifier, an FM tuner, and a quadraphonic decoder, connecting an equalizer could complicate matters if you also wish to hook up a tape recorder. Partly to simplify things, Soundcraftsmen has now combined a graphic equalizer with a state-of-the-art preamplifier. In so doing they've made it possible to save space and simplify cabling, at the same time reducing the cost of the total setup.

The equalizer section is very similar to the Model 20-12 which we reviewed in *AUDIO* in December 1971. It has 10 slide controls for each channel, each handling about one octave, and providing maximum boost or cut up to around 14 dB. An added feature is a set of four visual indicators called *Test Lites* which permit balancing the signals going into and coming out of the equalizer section.

Watching these Test Lites one can readily control the overall gain of the equalizer section to keep it at (or near) zero. This is necessary because it is possible to adjust several of the octave tone equalizers for maximum gain, thus sup-

plying too much signal to the amplifier following the preamp-equalizer. To set the controls properly one has only to set them so that the two Test Lites for the input signals and those for the output signals have roughly the same brilliance. The adjustment is not at all critical.

A separate pushbutton controls the use of the Test Lites; if that button is in the *off* position the upper two lights will monitor the output of the equalizer.

Looking at the controls, at the bottom left we find a bank of four buttons for Test-Lites, Reverse, Mono-left, and Mono-right. After the Volume Control comes a group of six pushbuttons. These switch the equalizer in or out of the main amplifier signal path, or the tape recording signal path. They also select *tape 1* or *tape 2*, and permit dubbing from either of two tape decks onto the other one. Next comes the channel balance control, and a last group of four buttons for *phono 1*, *phono 2*, *tuner*, and *AUX*. Jacks for stereo headphones (two sets) and 1 for Tape In and Tape Out are at the right hand end.

The power on-off switch is at the extreme left, while directly in the center of the unit, between the banks of equalizer sliders are the four Test Lites and the two gain controls.

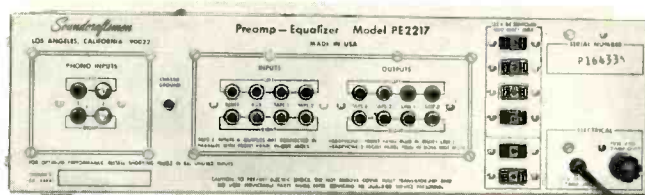

Fig. 1—Rear panel of the Soundcraftsmen PE2217 Preamp-Equalizer.

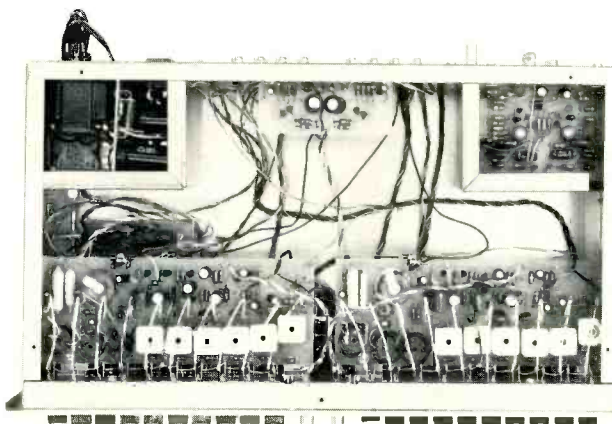

Fig. 2—Internal view of the chassis.

Introducing BASF/LH Super.

A technical breakthrough
in sound reproduction.



Our LH Super tape isn't just a new tape on your dealer's shelf. It's a technical breakthrough in sound reproduction. We've actually redesigned the surface of ferric oxide recording tape.

When you listen to a playback on LH Super, you'll know you're listening to something new. The volume will be up 50 per cent at the same record level. Noise will be down, perceptibly. Highs will be strong and clean. All this, yet distortion will not be increased.

If you record LH Super on a late-model, high-quality deck at 1 7/8 ips, the dynamic range and frequency response will exceed hi-fi standards. You'll get twice the playing time for the same money. On the other hand, if you prefer to record at 7 1/2 or 3 3/4, the sound may even exceed *your* standards.

Technically, it's easy to understand what we've done if you can imagine con-

ventional recording tape as a cobblestone road, with large, unevenly shaped magnetic particles as the rough cobblestones. In this arrangement, a

great deal of sound "slips through the cracks" and never gets recorded.

LH Super is more like a brick road. The magnetic particles are smaller. And they're all the same shape. This allows us to arrange them close together in even rows. Which gives LH Super a smoother, quieter surface and reduces the size of the "cracks" between magnetic particles, so less sound "slips through."

The result is a reel-to-reel tape that gives you more pure sound — and less noise — than any other ferric oxide tape.

For more information, call or write BASF Systems, Crosby Drive, Bedford, Massachusetts 01730. Telephone: (617) 271-4000.



On the rear panel are the numerous input and output jacks, along with no less than six a.c. power outlet sockets—two unswitched by the front panel power button, and four switched. There are two sets of magnetic phono inputs, and enough inputs and outputs for two complete stereo tape decks, with provision for dubbing from either one to the other. These are in addition to the jacks on the front panel which permit connection of yet a third tape machine.

Finally, note that the equalizer section may be switched into either the tape inputs, or so that it comes after the tape outputs.

Circuit Description

The circuit can be divided into five sections: phono preamp, equalizer, Test Lite drivers, line amplifier, and power supply. Figure 3 shows the basic circuit of the phono preamp. It is a fairly conventional NPN-PNP arrangement of Q1 and Q2. Equalization is provided by the frequency-selective feedback loop consisting of C1, C2, R1 and R3. The output of the preamplifier section feeds Q3, and emitter follower, which in turn feeds the equalizer section and the Test Lite drivers. The basic circuit of the equalizer is seen in Fig. 4. Only one control network is shown, the other nine being identical except for their component values. All 10 networks are connected in parallel to points Y and Z. The output at point Z also goes to four one-transistor amplifiers, which drive the Test Lites, and a two-stage line amplifier, which terminates at the line outputs on the rear panel. The line amplifiers use a single transistor with an emitter follower and, like the equalizer section, employ heavy current feedback. Gain is very low but the distortion is insignificant.

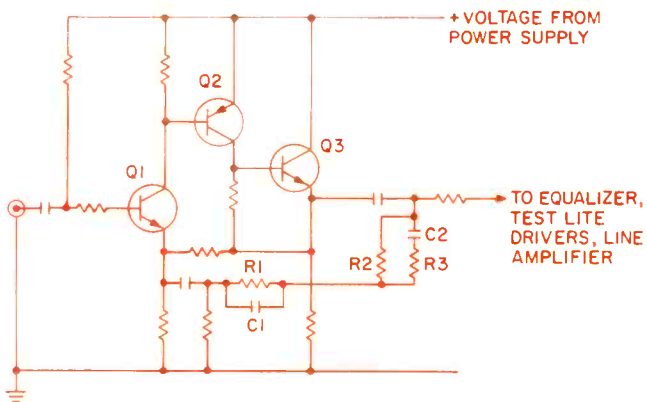

Fig. 3—Basic circuit of phono preamplifier.

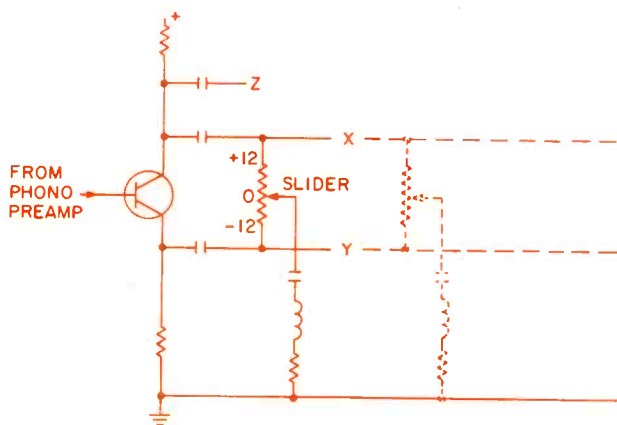

Fig. 4—Basic equalizer circuit.

Five transistors are used in each Test Lite circuit, and another two in the regulated power supply, making a total of 32 in the entire circuit of the 2217. A muting relay prevents transient surges during turn-on from being applied to the power amplifier, thus preventing undesirable "thumps."

Measurements

Figure 5 shows the response with each of the controls set at maximum, and at minimum. Figure 6 shows a typical response curve tailored to correct certain poor room acoustics and compensating for some loudspeaker deficiencies. Note that the low frequency boost under 100 Hz is attenuated below 45 Hz. This is something you just can't do with ordinary tone controls. Although we cannot hear most of these low frequencies, they can cause severe intermodulation distortion in loudspeaker systems.

The boost in the 2,000 to 8,000 Hz range will improve the overall sound when used with loudspeakers like the Dynaco A-25 or the Hegeman 1, especially if the room is heavily damped (lots of rugs, drapes, and so on). On the other hand, speakers with "presence" peaks (the so-called "West Coast" sound) can be made tolerable by lowering the mid-range response.

Output level is plotted against both types of distortion in Fig. 7. It shows that distortion is almost unmeasurable below a volt or so. At three volts output, both the IM and the THD were below 0.03%, and at 4.0 volts it was still less than 0.1%. Switching in the equalizer made no significant difference, regardless of where the controls were set.

Frequency response was within 1.0 dB from 4.0 Hz to near 200 kHz, and square wave tests showed no signs of ringing or instability. The phono sensitivity was 1.2 mV for one volt output. High level input sensitivity was a mere 43 mV. The phono input overload point was 105 mV, quite comfortable, but this fell to 31 mV when the equalizer was switched into the circuit—lower than I would have liked.

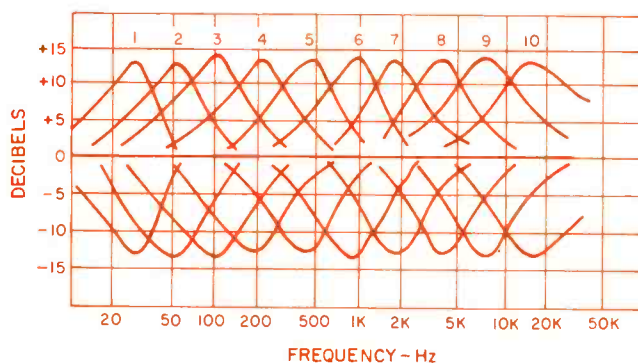

Fig. 5—Response curves, controls at min. and at max.

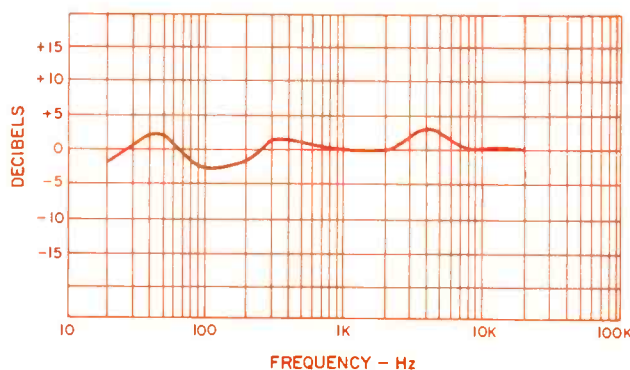
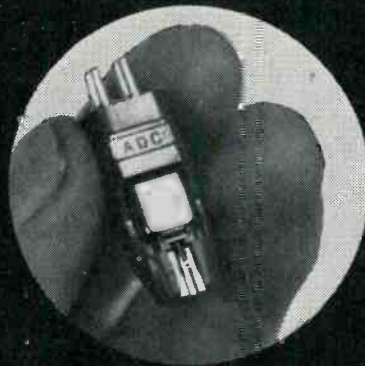

Fig. 6—Typical equalized response curve.



The Un-common Cartridges

from

ADC

The patented low-mass design assures lower distortion and greater tracing accuracy.

The cartridge is the least expensive but one of the most critical components in a hi-fi system. Its stylus is the only contact with the complicated modulation of the record groove. To extract every note without distortion, especially at the high frequencies of the audible spectrum, is the problem.

Lower mass = higher accuracy.

Since the magnet itself in a moving magnet cartridge contributes significantly to its mass, ADC created and patented an "induced magnet" cartridge that reduces the mass in the moving system. This allows the stylus to track with a lower force resulting in superior tracing accuracy and low distortion.

You can actually hear the difference.

Ask your hi-fi dealer to demonstrate the comparison between an ADC cartridge and any other brand. There is an audible difference that can easily be distinguished.

A modestly priced ADC cartridge may be all you need to upgrade the sound of your entire hi-fi system—and there's a model compatible with every brand of manual turntable or record changer.

Send for a free detailed brochure of the complete line of ADC cartridges.

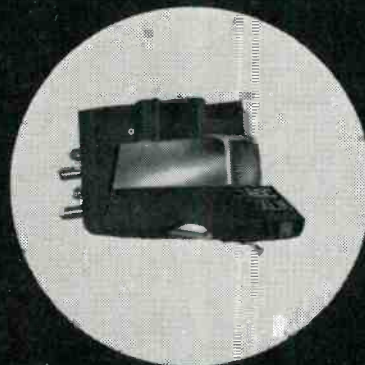

XLM MK II



**Super
XLM MK II
CD-4 with
Shibata type
stylus**

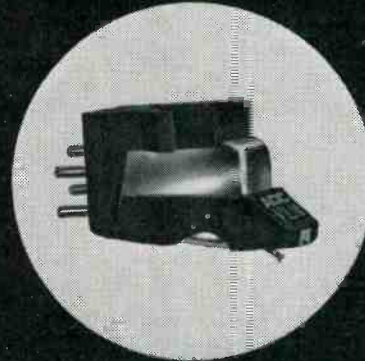

VLM MK II



AUDIO DYNAMICS CORPORATION

A BSR Company • New Milford, Conn. 06776

Listening Test

The 2217 was paired with a Phase Linear 400 amplifier and other equipment included a Nakamichi 500 super cassette recorder, a Sony TC 755 open-reel machine and a Dynaco AF-6 tuner. No equalization is needed in the listening room but the lab itself is another story and a Soundcraftsmen 20-

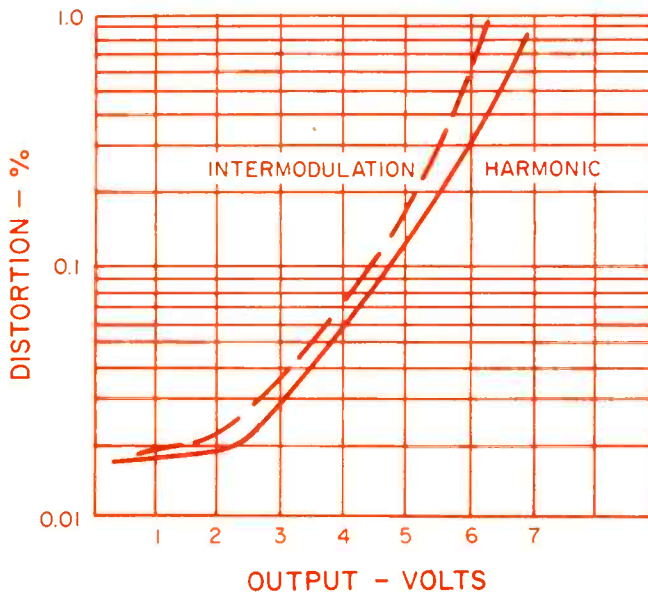

Fig. 7—Output level vs distortion 10 K load.

12 is permanently installed there. Thus, it was easy to substitute the 2217 and duplicate the control settings previously set up on the 20-12. Balancing the input-output signals with the Test-Lites was simple. The instruction manual suggests that FM interstation noise can be used for precise adjustment, but this was not found necessary. The equalizer controls would normally be set once and left but the tape recording enthusiast would probably use them much more often and a number of chart forms are provided for what Soundcraftsmen call "Instant Programming."

All 20 controls are reproduced on the forms just as they appear on the actual panel and all you have to do is to mark each special equalization curve accordingly. Because of the tape dubbing facilities and the provision for three recorders, the 2217 is specially recommended to the tape enthusiast but it will also appeal to those who want a top quality preamp with equalization controls.

It has become fashionable in some circles to describe sound quality as "grainy," "sweet," "dry," or even "a gray color" but I hesitate to use such terms. After all, one man's "dry sound" might be "sweet sound" to someone else! In this case, extended listening tests with first-rate program material confirmed the impression that the 2217 is completely neutral—it neither added coloration nor distorted signals audibly.

The excellent signal-to-noise ratio of this unit places it alongside the two or three other top preamplifiers, and at its price, it's a bargain. Incidentally, the simulated walnut cabinet supplied is really intended just to protect the unit in shipping. The real wood cabinet (\$50 extra) is much more attractive.

George W. Tillett

Check No. 61 on Reader Service Card

Ferrograph Super Seven Model 7504-AHW 4-Track Tape Deck



MANUFACTURER'S SPECIFICATIONS

Speeds: 15, 7½, and 3¾ ips. **Wow and Flutter:** Less than 0.08% at 15 ips; 0.10% at 7½ ips; and 0.15% at 3¾ ips. **Frequency Response:** 30 - 20,000 Hz ± 2dB at 15 ips; 30-17,000 Hz ± 2dB at 7½ ips, and 40-14,000 Hz ± dB at 3¾ ips. **Signal-to-Noise Ratio:** Better than 60 dB referred to 0.2% THD, unweighted. **Input Levels:** Line, 50 mV to 10 V; Microphone, 300µV to 15 mV. **Output Levels:** 2.0 V at 600 ohms; 300 mV at 10,000 ohms.

General Specifications

Dimensions: 20¼ in. W x 17½ in. H x 10 in. D. **Weight:** 55 lbs. **Price:** \$1025, plus \$125 for Dolby B, \$50 for amps and speakers.

Ferrograph is highly respected not only in England, its country of origin, but it is known all over the world for solid, well-engineered products (what we used to call "built like a battleship"). The original makers of the Ferrograph tape recorder, Wright and Weaire, were established back in the 1920s and I remember buying tuning coils from them in the late 30s. Huge copper can monsters they were, wound with Litz multistrand wire on glass formers, and boasting a fantastic Q-factor.

Their tape recorders were among the first made in England and the machines' reliability soon made them a first choice for many airports and shipping lines. The Super Seven, then, comes with an impeccable pedigree based on more than 20 years experience. At first glance it looks much like any other semi-professional recorder but there are significant differences, some innovations and, let's face it,

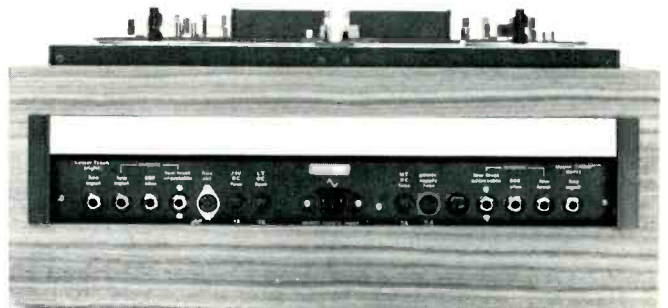

Fig. 1—Socket panel.

The Speaker.

Rather than starting with an existing speaker, Yamaha began with a speaker idea.

A speaker system with the lowest distortion and coloration, and the best possible transient response.

Instead of merely modifying one, Yamaha has re-invented it. And in doing so, has improved every aspect of speaker design.

We call it the NS-1000 M Monitor.

Transparency and The Dome.

Existing technology has largely solved a major problem of speaker design through the use of the acoustic suspension driver: extended frequency response. Today, what's missing from most sound in most people's living rooms is something a touch more subtle. It's called transparency.

The hemispheric dome tweeter allows a wider dispersion of high frequencies.

But the dome's own material weight causes it to lag behind the input signal. It simply doesn't respond fast enough, creating an opaque, masked sound that lacks fine detail and definition.

The ideal dome material for mid-range and high frequency drivers would be extremely rigid and, most importantly, virtually weightless.

Introducing the Beryllium Dome.

Why did it take so long?

After all, beryllium is the lightest, and most rigid metal known, and has a sound propagation velocity twice that of commonly used aluminum.

Beryllium is lighter and stronger and propagates sound better than other metals.

	ATOMIC WEIGHT	RIGIDITY (ELASTIC MODULUS) kg/mm ²	SOUND PROPAGATION velocity m/sec
BERYLLIUM (Be)	9.013	28000	12600
MAGNESIUM (Mg)	24.32	4500	5770
ALUMINUM (Al)	26.98	7400	6420
TITANIUM (Ti)	47.90	11000	5990
IRON (Fe)	55.85	19700	5950

But because of beryllium's inherent characteristics, it resisted attempts by any manufacturer to form it into a diaphragm, let alone a dome.

Until now.

The New Yamaha Beryllium Dome, formed by Yamaha's unique vacuum deposition process, is lighter than any other speaker diaphragm found today. So it's more responsive

to direction changes in amplitude and frequency of the input signal.

	SIZE OF DOME	THICKNESS	WEIGHT
YAMAHA NS-1000 M (BERYLLIUM DOME)	3 cm	0.03 mm	0.03 g
TYPICAL SOFT DOME	3 cm	0.3 mm	0.1 g
CONVENTIONAL DRIVER	2.5 cm	0.45 mm	1.03 g

This is called transparency. It can be noticed best in complex musical passages and can be best described

possible for a midrange driver. It extends the linear portion of its response curve.

The midrange driver's frequency response is so wide that we can select only the choice flat section of its frequency response, thereby eliminating the peaks and valleys most competitors are forced to use.

The Beryllium Dome creates simply the flattest response; least colored, most natural sounding midrange of any speaker around.

Carefully designed acoustic equalizers flatten the frequency

system that holds the beryllium dome to the speaker frame with less contact allowing it to move more freely. It's called the Tangential Edge. (You may not hear the difference at first, but you will.)

The crossover system was specially designed to have a very low DC resistance, increasing the system efficiency.

Most highly accurate systems need a large amp to drive them properly. The NS-1000 M Monitor requires only 15 watts RMS to fill an average room with loud music, yet can handle RMS power outputs exceeding 100 watts.

By Our Own Skilled Hands.

Yamaha's philosophy is one of self-reliance.

That's why, for example, we build the critical speaker components (like cone materials and speaker baskets) rather than purchase them.

That includes the speaker enclosure made from material designed for anti-resonance characteristics. (Our piano making experience was essential here.)

There are enough speaker system modifications and copies around, already.

This is something original.

Proudly Presenting the NS-1000 M. It's not inexpensive or easy to find.

The NS-1000 M is sold as right and left-hand units, and by the pair only.

They cost \$960.00 the pair, when you can get them.

Yamaha is making them as fast as we can, but you may have to wait a short while until your Yamaha Audio Dealer has a pair for you to audition. (He also features Yamaha speakers based on the same technology and quality at less money.)

Patience, please.

Part of the Yamaha System.

The NS-1000 M Monitor is the ultimate air suspension speaker system.

That is a strong claim to make.

In the future, Yamaha will present the ultimate power amplifier, tuner, preamplifier, and turntable.

Actually advancing the state-of-the-art of the major components of a music reproduction system.

In short, the ultimate system.

We're convinced that no matter what you think is the best today, we'll make you dissatisfied with it.

Don't say we didn't warn you.



as highly defined and finely detailed. Only Yamaha has it.

Midrange: The Voice of Your Speaker. It's no secret that between 500 Hz and 6 KHz is where most audible differences in speakers occur.

It's where we hear the human voice, and it is the hardest part of the frequency spectrum to reproduce accurately.

Once again, beryllium solves the problem of uneven response. Since it's so lightweight, the dome can be made larger and lighter than before

response curve even further.

The NS-1000 M Monitor is so accurate that you may even hear enhanced detail in a recording you once thought already perfect.

Re-thinking the Woofer.

Some respected speaker manufacturers buy their low frequency drivers wholesale.

Yamaha doesn't buy them. We make them.

Even the very cone material itself was researched and developed and manufactured specially by Yamaha. (It's made much more dense than most cones. That means a tighter, cleaner sound.) And the frame is cast in our own foundry so we can control quality.

A plucked string of a bass sounds like a plucked string bass note.

Instead of a dull thud.

The Tangential Edge and Other Extras. Yamaha designed a special suspension

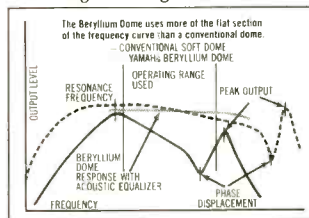

 **YAMAHA**

INTERNATIONAL CORP., P.O. BOX 6600, BUENA PARK, CALIF. 90620

Check No. 39 on Reader Service Card

some idiosyncrasies. The unit tested has built-in Dolby B and the three speeds are 3¾, 7½ and 15 ips. It's also available without the Dolby, or with 1⅞, 3¾, and 7½ ips speeds. Another option is a pair of built-in 10-watt amplifiers with small loudspeakers mounted on the sides behind grilles.

Styling is neat and workmanlike with the charcoal black center section housing the head assembly contrasting nicely with the satin aluminium panel and controls. Looking at the left, there are two dual-concentric controls, one for *Microphone* and *Line* input for channel 1 and the other for *Equalization*. Then come the two VU meters and in between is a mode switch for selecting upper track, lower track or stereo. To the right of the second VU meter are two more dual controls, the first a level control (marked *Volume*), the second is the *Microphone* and *Line* input control for channel 2.

At the bottom are *Bass* and *Treble* controls for each channel, tape monitor switches, and in the middle are two push-buttons marked U>L and L>U (more about these later), a *Bias* switch, a *Dolby* switch and one for MPX filter. Under the VU meters are preset controls for adjusting the bias which is indicated on the meters by using the bias switch. A nice idea—and it works! That's one of the innovations. . .

At the left, beside the head assembly, is the tape motion control lever with the functions indicated by *Fast*, *Stop* (reset), *Pause*, and *Run*. A small locking catch is just above that, and on the right side is a *Fast Wind* knob and another for reel size, *10 inch* and *Others*. In the center is a large red *Record* bar switch, a digital counter, and a *Reset* light. At the top is the three-speed control, and at the very top is a tiny *On-Off* switch.

The head assembly is exposed by lifting a lid and inside is a retractable lever to facilitate tape loading. *Microphone* input sockets are in recessed positions at the left and right on the bottom panel, and all the other inputs are located on a recessed panel at the top. (That is, if you operate the machine in the vertical position, otherwise you could say the socket panel is at the rear!) There are three output sockets for each channel, a high impedance at 300 mV, another bypassing the level control, and a 600-ohm output from an emitter follower connected to a point prior to the tone and level controls. Also located on this panel are a.c. power line fuses, d.c. fuses, and a socket for a remote control unit.

Now for some explanations: that *Reset* light comes on whenever an incorrect setting is made, as for example, if the equalization or speed change knobs are turned when the tape is running. It also operates when the automatic stop is

activated. The procedure is to return the tape motion lever to *Stop*, as the machine will not function when the light is on. Having done that, you then put the controls in the correct positions.

The two push-buttons inscribed U>L and L>U are for track transferring. In other words, the recorded signal from one track can be transferred to a second track. This signal can in turn be transferred to the third or fourth tracks to produce a kind of multiplay recording. As there has to be a small delay between the record and replay signals, it is possible to obtain some echo effects too.

The *Fast Wind* arrangement is a little unusual as there are two controls. The function lever is turned to *Fast* and then the *Fast Wind* knob is rotated left or right to give direction and speed.

An MPX switch cuts the frequency response above 18 kHz so that the 19 kHz FM carrier will not interfere with the Dolby operation. The equalization switch is marked *High*, *Medium* and *Low*, referring to the tape speeds. These are selected by a knob at the top which rotates an indicator disc located behind a window just below. And if you select the wrong equalization for a particular speed, you know what happens!

The rest of the controls are conventional enough, although tone controls are rarely found on tape recorders this side of the Atlantic. If you prefer to use the amplifier tone controls, you can disregard those on the recorder or you can use the 600-ohm output sockets. On the other hand, if you play non-standard tapes, the instruction manual gives the correct tone control settings to compensate. By non-standard, I mean tapes made to other standards such as CCIR and IEC (European).

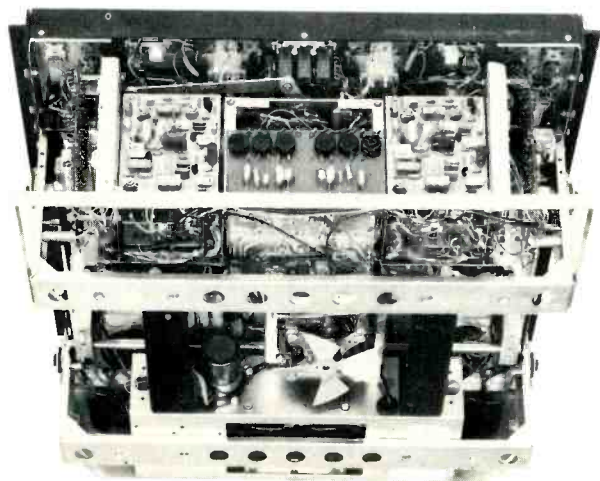

Fig. 2—Interior view.

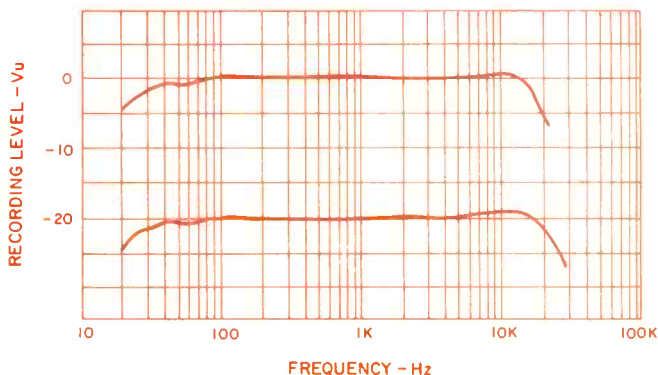

Fig. 3—Record/Play response, 15 ips, Maxell UD-35 tape.

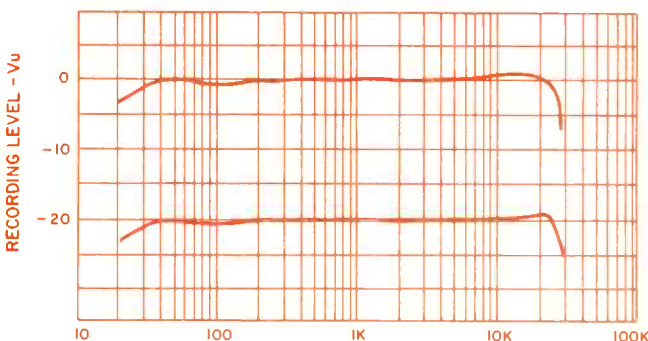
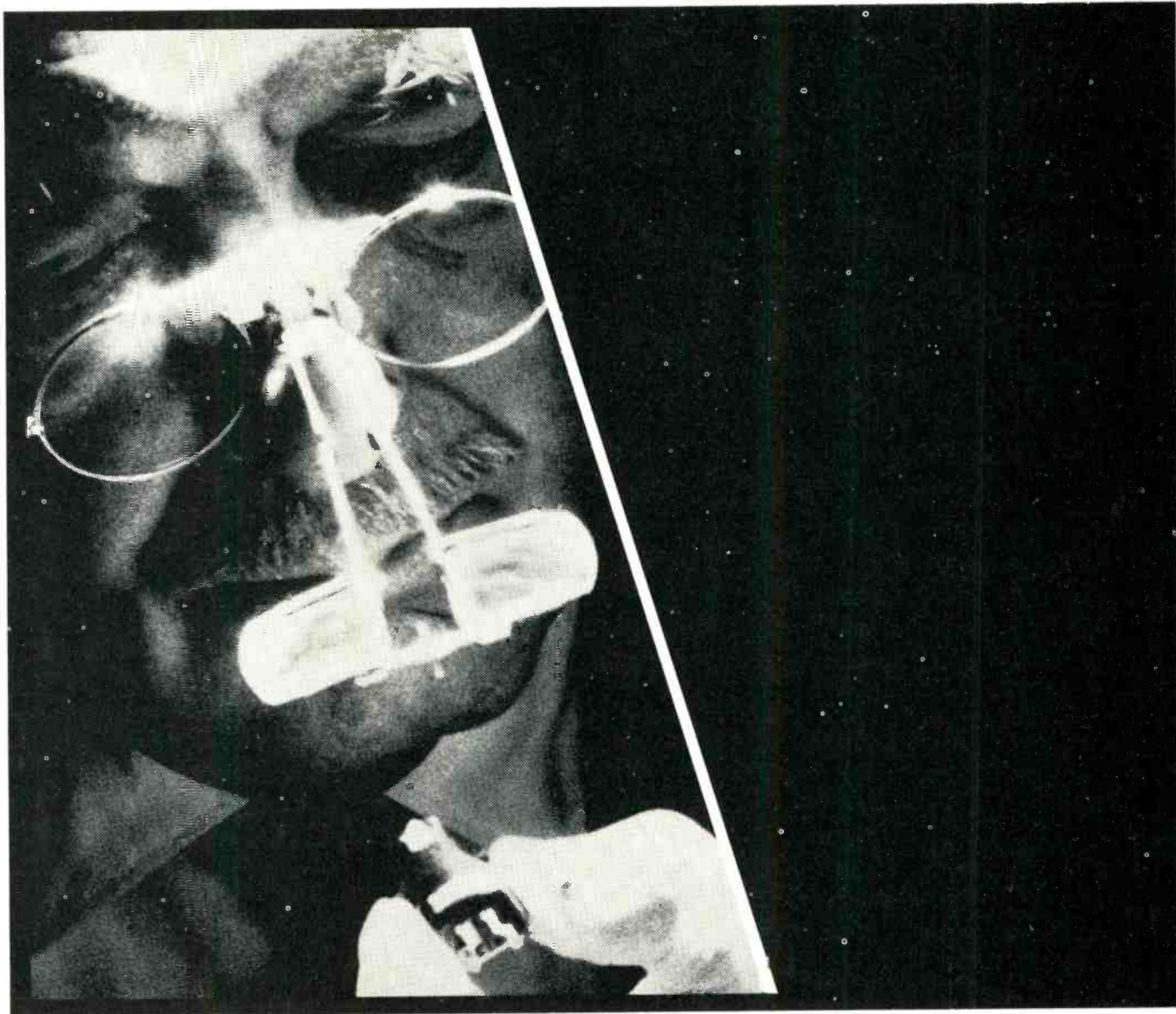
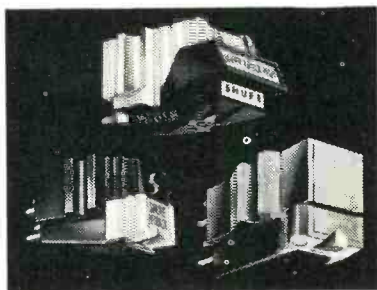

Fig. 4—Record/Play response, 7½ ips.



Our "U" and you.



Every Shure phono cartridge comes equipped with its own "U" Factor. The "U" stands for *uniformity* in rigid production standards . . . tough quality control . . . and satisfying listening pleasure. By maintaining these high standards in every phase of engineering, production, and inspection, Shure provides a better cartridge . . . over, and over, and over. And, with routine maintenance, your Shure cartridge will continue to perform at the published specifications. You may not see the U Factor, but you'll always *hear* it.

Shure Brothers Inc.
222 Hartrey Ave., Evanston, IL 60204
In Canada: A. C. Simmonds & Sons Limited



Manufacturers of high fidelity components, microphones, sound systems and related circuitry.

Check No. 33 on Reader Service Card

Three motors are used, one for the capstan drive and two capacitor-start types for the reels. When the switch is set to Fast, these two are connected in series but with the *Fast Wind* control in parallel so its resistance can be divided between them to produce a rotation in either direction. The capstan motor is a split-phase induction type so its speed is controlled, within certain limits, by the power supply frequency.

Measurements

Before taking any measurements, the bias was checked by pressing the switch so its value appeared on the VU meters. According to the instruction manual a setting of 0 VU is suitable for Scotch 203, BASF LGS 35, and similar low-noise tapes and this was found to be the optimum value for the tapes used. Figure 3 shows the Record/Play response with Maxell UD-35 tape at 15 ips and Fig. 4 shows the response at 7½ ips. Results with Scotch Classic tape were very similar.

At 15 ips the 3dB point was 23.5 kHz and at 7½ ips response is down the same at 21 kHz. Tape saturation was slightly less at 15 ips but the effect of saturation can be clearly seen in Fig. 5 which shows the response at 3¾ ips. The

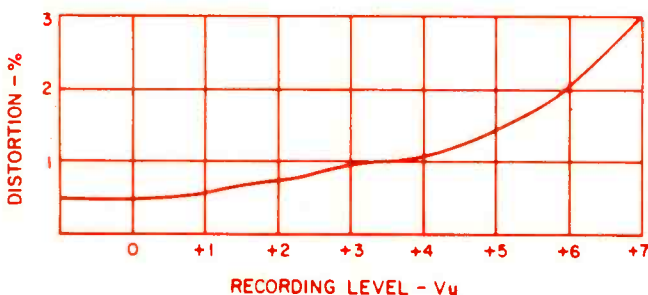

Fig. 5—Record/Play response, 3¾ ips.

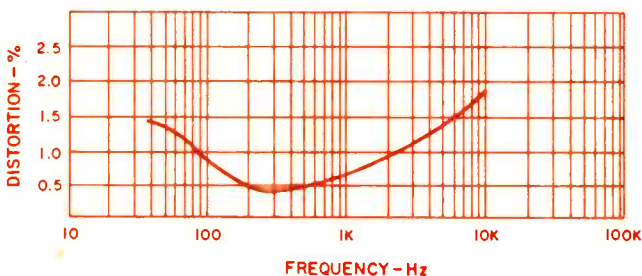

Fig. 6—Distortion versus recording level (1 kHz, 7½ ips).

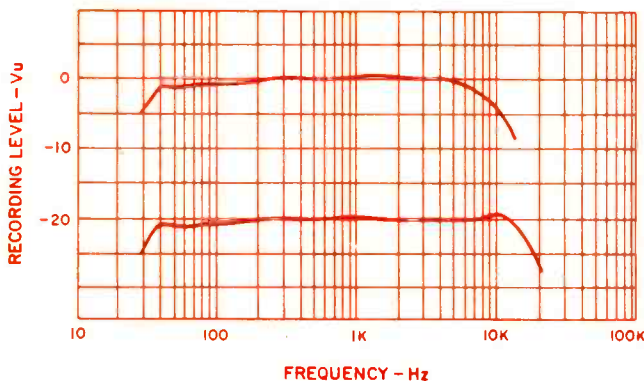

Fig. 7—Distortion versus frequency, 7½ ips, 0VU.

dB point was 15.5 kHz. Distortion for various recording levels at 7½ ips, 1 kHz is shown in Fig. 6. Note that the 3% distortion level is not reached until + 7 dB, indicating ample recording headroom. Distortion versus frequency can be seen in Fig. 7, and playback response with a standard (Amplex) 7½ ips tape is shown in Fig. 8.

Input required at the line input for 0 record level was 19 mV and 250 μV for microphone. Output levels were measured to be 360 mV at the high impedance output jacks and 1.9 volts at the 600-ohm outputs. Signal-to-noise ratio was 56 dB (ASA weighted) referred to 0 VU, or 63 dB referred to the 3 percent distortion level. Using the Dolby system added another 10 dB, as expected. Wow and flutter measured 0.07 percent at 15 ips, 0.09 percent at 7½ ips, and 0.15 percent at 3¾ ips, very satisfactory indeed.

Fast rewind time was 72 seconds for a 1200-ft. reel. Finally, the Dolby system was checked and found to be well within specification, but more about this later.

Listening Tests

For most of the listening tests the Super Seven was teamed up with a Soundcraftsmen PE 2217 preamp and a Phase Linear 400. I must confess it took a little while to get used to some of the controls, specifically the two separate ones for speed change and the two controls for fast rewind (or forward). But I imagine it's like changing from a Detroit Automatic 8 to a Mercedes or Porsche: there's a lot more flexibility. There's that forward-to-reverse rewind facility and the bias adjustment and multitrack switching. All these will score heavily with the serious recording enthusiast. And that reset warning system is really foolproof. At one point in the tests I had set all the controls correctly but the red light still said "no." So I looked again and found that I had not put the tape around one of the tape guides!

One question many will ask is this: is the Dolby system really necessary with a machine having such a high standard of performance? Well, there is no doubt whatsoever that the Dolby system is *relatively* more effective with cassette recorders but even so, the extra 10 dB of noise reduction is worth having. You can use it to get that much more

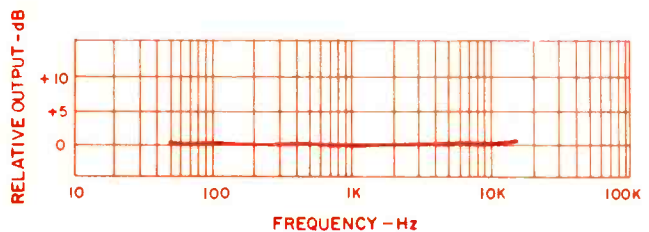

Fig. 8—Playback response with standard test tape, 7½ ips.

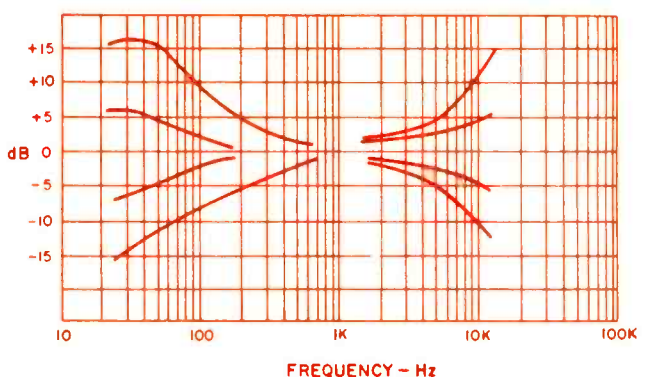

Fig. 9—Tone control characteristics.

AFTER YOU LOOK AT TEAC, LISTEN TO DOKORDER.



We're one of two major companies seriously and exclusively into the manufacture of high performance tape recorders. The smaller one.

When you work with a tape recorder the only thing that counts is how well it works with you, not the size of the company that made it.

For sure they sell more tape recorders than we do. But you're only interested in the one you buy. They spend more on advertising,

too. But you're buying a tape recorder, not an ad.

They have a sophisticated assembly line and so do we. Theirs is just longer. They have a big quality control department and ours is smaller. But only one man can check one machine at a time and it's the commitment to quality that matters.

They're continually working on new products...we are, too. And good ideas have nothing to do with size.

So if you compare specs, features and functions you'll find yourself comparing two excellent tape recorders. One of them, however, takes significantly fewer dollars to buy. Ours. And that's the difference.

You won't always find TEAC and DOKORDER at the same store; we're too much alike. Naturally they have more dealers, so you may have to look around a little.

But that's the only price you'll have to pay for paying a lower price.

TEAC 2340	
Motors	3
Heads	3
4-Channel Record and Playback	Yes
Built-in S-O-S/Echo	No
Overdub	Yes
Frequency Response at 7½ ips	±3 dB, 40-18,000 Hz
S/N	55 dB
Wow and Flutter at 7½ ips	0.08%
Manufacturer's suggested retail price	\$739.50

DOKORDER 7140	
Motors	3
Heads	3
4-Channel Record and Playback	Yes
Built-in S-O-S/Echo	Yes
Overdub	Yes
Frequency Response at 7½ ips	±3 dB, 30-23,000 Hz
S/N	58 dB
Wow and Flutter at 7½ ips	0.08%
Manufacturer's suggested retail price	\$629.95

Features and specifications as published by respective manufacturers in currently available literature.

DOKORDER

5430 Rosecrans Avenue, Lawndale, California 90260

7140

Check No. 12 on Reader Service Card



headroom or dynamic range. So the answer is, no, it's not necessary but it does give you more latitude when making recordings. This was confirmed by some recordings made with high quality microphones using the 3¼ speed.

Summing up then, the Ferrograph Super Seven is a well-engineered machine with most impressive specifications, all of which were met or exceeded by a comfortable margin. It

must certainly be included in that exclusive list of the top four or five recorders made for the exacting home user as well as the professional. Are there any criticisms? Yes, I must say I didn't like the tiny on-off switch, I much prefer a nice large lever type. But of course this is a minor point and I don't suppose everyone would agree! *George W. Tillett*

Check No. 62 on Reader Service Card

Hitachi HS-300 Speaker System



MANUFACTURER'S SPECIFICATIONS

System Type: Two-way, vented, floor type. **Drivers:** Woofer, 8-in. (20-cm.) gathered-edge suspension; tweeter, 2½-in. (6½-cm.) cone type. **Frequency Response:** 55 to 16,000 Hz, -8 dB; 45 to 19,000 Hz, -15 dB. **Crossover Frequency:** 3.8 kHz. **Nominal Impedance:** 8 ohms. **Maximum Input Power:** 50 W (music). **Dimensions:** 11½ in. W x 27 in. H x 10-5/8 in. D. **Weight:** 28.6 lbs. **Price:** \$189.95.

The Hitachi HS-300 is a two-way, vented-box speaker system. In place of the more traditional outer edge surround, the Hitachi woofer uses a gathered-edge type of suspension which looks like the bellows of an accordion when

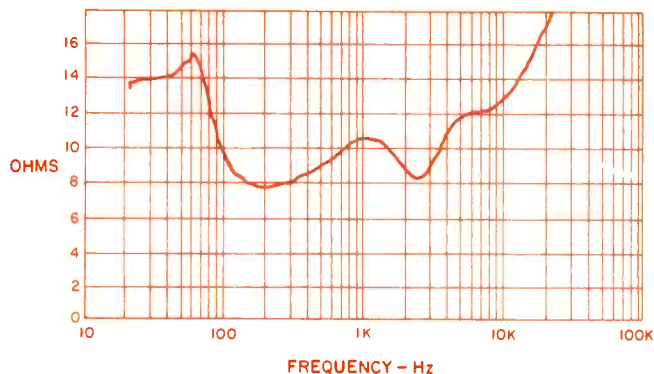

Fig. 1—Impedance.

viewed from the front. One's first impression is that this rigid-looking fold shouldn't work, but a slight finger pressure on the cone quickly shows that it not only moves, but moves a great distance very freely. Great care has obviously been taken in the design of the woofer itself, and it uses an aluminum voice-coil bobbin, both aluminum and copper shorting rings in the magnet circuitry, and a coating on the back side of the cone to prevent breakup.

The cone tweeter is mounted behind what Hitachi refers to as an acoustic lens, which to this reviewer more nearly resembles a diffraction grating. Whatever you call it, the lens does provide good horizontal dispersion of the very high frequencies.

The enclosure is a vented system of 30-liter volume (1830 cu. in.) which has a suitable amount of absorbing material included to provide a high degree of internal damping.

Designed as a floor-standing system, the enclosure is finished on the sides and top with natural wood. Connection is made to well-marked, quick-access terminals in a recessed cavity on the rear of the enclosure. The front grille cover is removable, but in the absence of controls it is unlikely that the user need concern himself with this feature.

A very thorough set of measured curves accompanies each speaker, which is really "putting it on the line" for any manufacturer. This, coupled with a well-written instruction manual, is a real help to the user in obtaining the best performance in his (or her) listening situation.

A three-year warranty is extended to the original purchaser against defects in materials and workmanship.

Technical Measurements

The measured impedance as a function of frequency is shown in Fig. 1. The Hitachi HS-300 is a vented enclosure, but is suitably packed with absorbing material to make it a highly damped system. As a result, this system has a single resonance peak, rather than the two peaks generally found in the more conventional vented systems. The sharp-pointed, low-frequency peak and the flat slope of the low-frequency impedance are hallmarks of this class of design. This speaker can be safely considered to be an 8-ohm system from the standpoint of amplifier requirements.

Figure 2 shows the one-meter axial sound pressure level (SPL) for one-watt drive under anechoic conditions. The

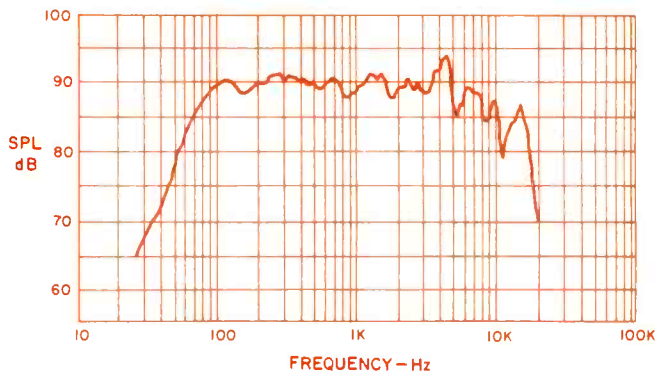

Fig. 2—Anechoic amplitude response at one meter with one-watt input.

general response throughout the major frequency range is quite uniform and shows no structural acoustic difficulties. The low-frequency performance is commendable down to about 70 Hz, then falling off in a well-mannered fashion. The peak followed by a dip at around 4 kHz is attributable to diffractive scatter from the removable front grille frame, and the precise nature of the grille diffraction depends substantially on microphone position. The response is smoother in the 2 to 5 kHz region when the grille is removed, however, without the grille, the system is not as attractive as with the grille in place, and this could be an invitation to probing toddler fingers. Therefore, leaving the grille in place is recommended.

Figure 3 is the one-meter phase response corresponding to Fig. 2. The woofer and tweeter are in phase throughout the audible spectrum. The response has no discernable non-minimum phase characteristics, and the only detractions from an otherwise excellent transient response will be due to the rapid amplitude and phase transitions at 4 kHz and 10 kHz.

The response to be expected in a room is shown in Fig. 4. The HS-300 was placed on a carpeted floor and flat against a wall. The frequency spectrum of the first 13 milliseconds of "early sound" is plotted for an on-axis and for a left-channel stereo position, which are displaced 10 dB for clarity. The rather wide dispersion of the speakers maintains the general frequency characteristic over the angular spread required for good stereo, however, floor placement takes a toll in middle-frequency response due to scatter. Depending on room layout, it might be advisable to experiment with an off-floor placement for greater accuracy of sound. One interesting point with this test is that high-frequency response is better than middle-frequency response, where with the anechoic test, the reverse was true.

The horizontal polar energy response is shown in Fig. 5, and good stereo imagery is indicated by this polar plot. The

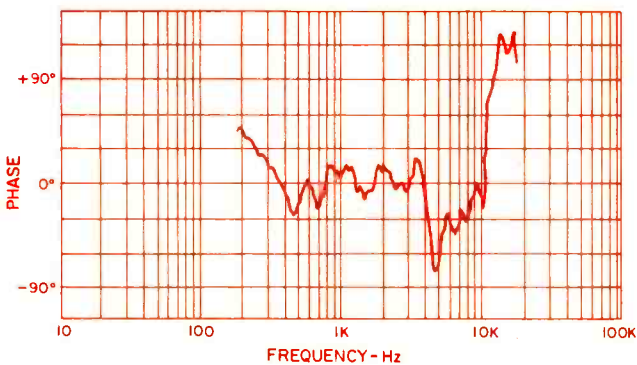

Fig. 3—One-meter phase response.

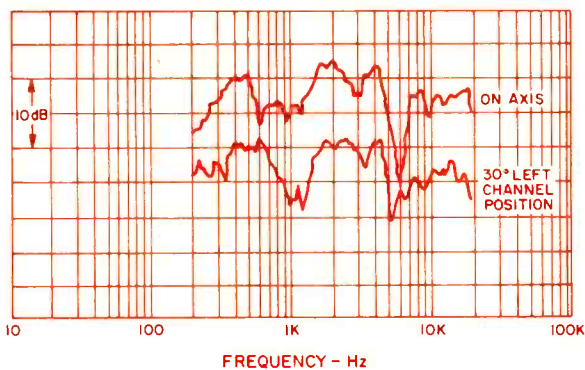

Fig. 4—Three-meter room test.

left-channel speaker of a stereo installation will be a little "hotter" than the right channel for average speaker placement, and will require a slight increase in level to the right speaker for optimum energy balance. The HS-300 has a wide dispersion of sound, and large objects, such as lamps, book-cases, and the like, should not be placed adjacent to the speaker if substantial reflection of sound is to be avoided. Figure 6 is a plot of the vertical energy response. The sound is launched in a slightly vertical direction, as it should be for a floor-mounted system, but ceiling and floor reflections

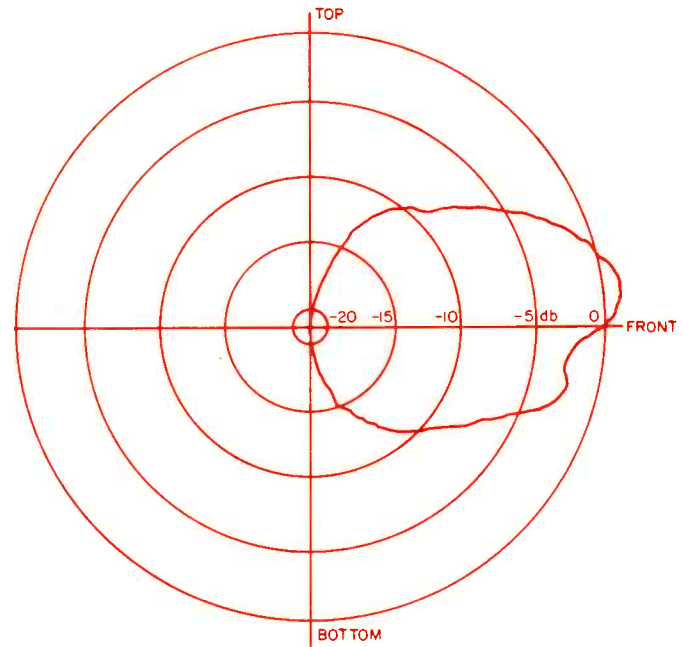

Fig. 5—Horizontal polar energy.

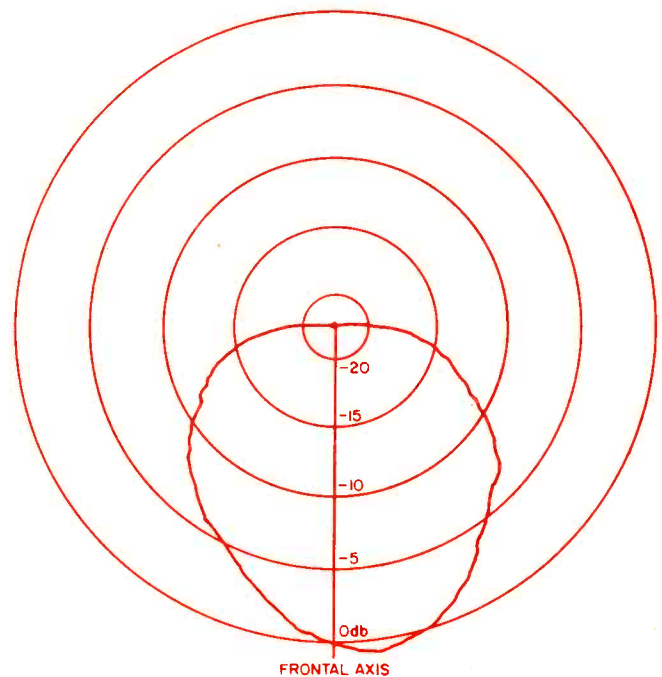

Fig. 6—Vertical polar energy.

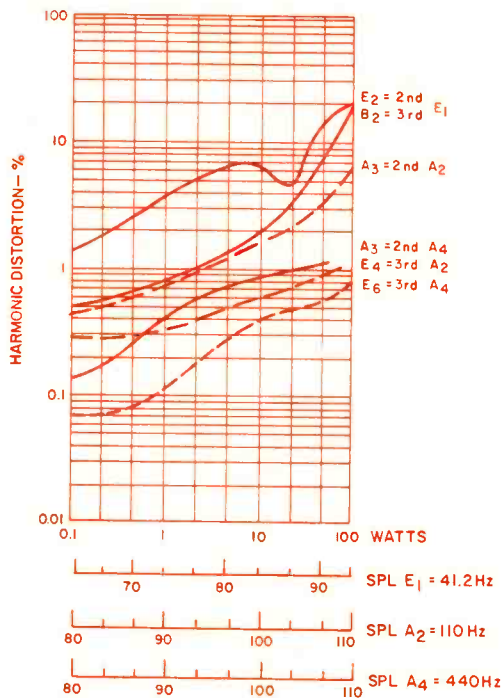

Fig. 7—Harmonic distortion for the musical tones E_1 (41 Hz), A_2 (110 Hz), and A_4 (440 Hz).

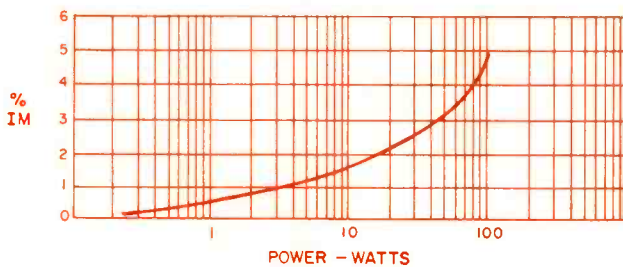

Fig. 8—Intermodulation of A_4 (44 Hz) by E_1 (41 Hz) mixed one to one.

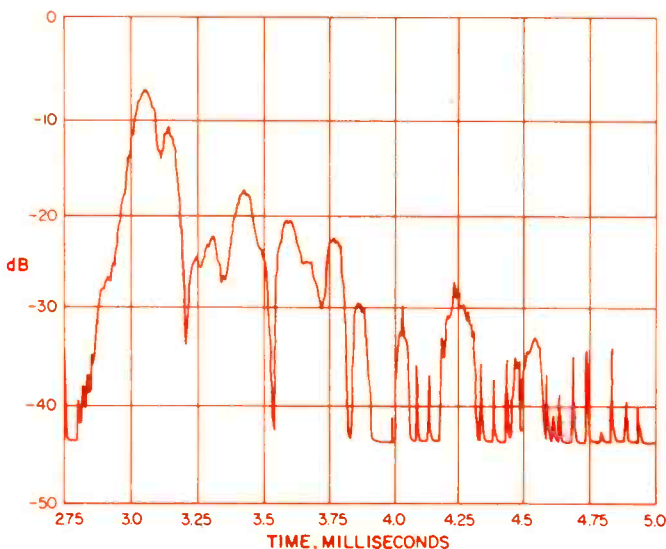

Fig. 9—Energy-time plot.

should be expected from a floor-mounted configuration, as this plot verifies.

Harmonic distortion for the musical tones E_1 (41 Hz), A_2 (110 Hz), and A_4 (440 Hz) is shown in Fig. 7. Except for the lowest bass, the distortion remains quite low up to about 75 watts. The speaker shows a sudden distortion overload above about 80 watts average. The droop in the curve for E_2^2 (82 Hz), the second harmonic of E_1 (41 Hz), is due to non-linearities associated with the damping in the vent. Above 10 watts there is sufficient motion of air in the front-located vent that the damping material and the mesh grille on the inner side of the vent come into contact causing a "buzzing" sound. This sound was not discerned in the earlier listening test on musical material but can be heard on high level sine-wave test signals. While it is unlikely that a listener would play "flat" musical material at such a high level, this measurement does indicate that severe bass boost should not be applied to the HS-300.

Figure 8 shows intermodulation of A_4 (440 Hz) by E_1 (41 Hz). The IM is quite low all the way up to the maximum test level of 100 watts and is almost purely amplitude modulation.

The musical tones of middle C (262 Hz) and A_4 (440 Hz) were used to check crescendo-handling ability. The acoustic transfer function decreases very slightly with increase in drive. A random crescendo 20 dB louder than a middle C inner voice will not noticeably reduce the level of the inner voice even up to a peak level over 300 watts. The HS-300 can thus handle hand claps and cymbal crashes without causing a muddying of a middle C tone. The tone of A_4 , however, is more affected and is reduced by almost one dB for peak crescendos of about 80 watts.

Figure 9 is the plot of received energy for a perfect transient pulse. This curve is the true envelope of the impulse response and shows an excellent initial transient, followed by diffraction signals. Almost the whole of the arrival from 3.6 to 3.8 milliseconds is due to scatter from the removable grille housing, as is the central peak at around 3.4 milliseconds. With these exceptions, the remainder of the energy-time plot indicates excellent transient response. The initial peak of energy at 3.05 milliseconds is due to the frequency components below 10 kHz while the smaller peak at 3.15 milliseconds is due to the spectrum above 10 kHz.

Because this is a vented system, the woofer was checked for its susceptibility to subsonic record-warp frequencies. The woofer is clearly a long throw driver, but at very high levels it can be run out of its linear range by a warped record, producing a very unpleasant program modulation. I recommend that the preamplifier rumble filter be used for this system to prevent low-frequency cone excursions.

Listening Test

The listening test was performed under the conditions outlined by Hitachi in their excellent instruction manual. The speakers were placed against a hard wall in a configuration such that the opposite wall, facing the speakers, was covered with drapery providing some sound absorption. The floor was carpeted, which Hitachi recommends to provide de-emphasis of the bass level to some extent.

The overall impression of tonal balance, to this reviewer, was that the extreme low bass was absent, low and mid bass up to the octave below middle C was slightly prominent, the middle frequencies were somewhat irregular, and the extreme top was down in level. A modest touchup with conventional treble control is able to restore the balance on the high frequencies. Tone control equalization of the bass frequencies could not reduce the small amount of heaviness without dropping out too much low bass. A better cure, under the listening conditions for this review, was made by pulling the HS-300's slightly away from the wall. Some

experimentation, however, may be necessary to suit individual preference for tonal balance.

The characteristic most apparent with extended listening is that the HS-300 is unobtrusive. It does not project any extreme coloration into reproduction which can cause listening fatigue. It has a polite sound which does not intrude upon enjoyment of good musical material. The lack of stridency gives a reasonably accurate presentation of piano and human voice.

The HS-300 has good transient response for percussion instruments. A good stereo stage presence exists for lateralization, and it isn't necessary to sit on a chalk mark to get good sound. A better stereo image was obtained, in this reviewer's opinion, by providing relatively wide speaker placement and angling the speakers toward the center of the listening area.

The stereo image tends toward a two-dimensional presentation. That is, instruments and voices are accurately

placed in angular location but the sound appears compressed in depth somewhat like a motion picture screen. This subjective impression was most evident for choral reproduction. This is, of course, a matter of taste and personal opinion and may not represent the way others perceive stereo presence on the HS-300.

This speaker system can run out of 50 watts of amplifier rather easily. A great deal of this is because the low distortion of the speaker lets you "hang out" a bit more of the program before it begins to sound "loud." While not specifically pointed out by Hitachi, I would recommend the use of a two-ampere, fast-blow fuse to protect the speaker from damage if you like your music loud.

In summary, the Hitachi HS-300 gives a good acoustic account of itself and makes an attractive addition to any listening room.

Richard C. Heyser

Check No. 66 on Reader Service Card

Kensonic Accuphase C-200 Control Amplifier P-300 Power Amplifier

MANUFACTURER'S SPECIFICATIONS

C-200 Control Amplifier

Frequency Response: 20 to 20,000 Hz +0 -0.5 dB. **Distortion:** 0.05% at rated output level, 20 to 20,000 Hz. **Hum and Noise:** Tuner, AUX, and Tape, 90 dB below rated output; Disc and Mike, 64 dB below rated input, 78 below 10 mV input. **Output Level and Impedance:** Main, 2.0 v, 200 ohms; Headphones, 0.75 v into 8-ohm load, and Tape Rec., 200 mV, 200 ohms. **Maximum Output:** 10 V at 0.05% THD. **Input Sensitivity:** Disc 1 & 2, 2 to 6 mV, changeable; Mike, 2 mV; Tuner, 200 mV; AUX, 200 mV, and Tape Play, 200 mV.



C-200 Control Amplifier

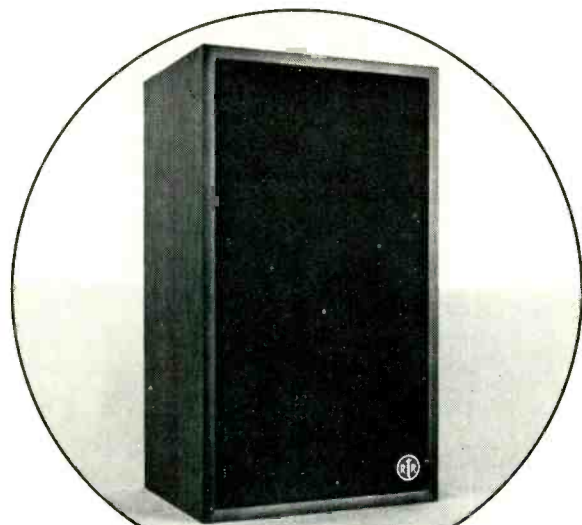

RTR EXP-8 AND EXP-12 - \$89 AND \$139



New bookshelf series!

RTR delivers the thinking man's system ...for less than you may think.

RTR's new EXP-8 and EXP-12... sophisticated bookshelf speaker systems for the audiophile who takes his music seriously. That means true high fidelity. Free of coloration. Full of transparent audio reproduction.

In other words, the new EXP series is pure RTR. Engineered and built from the voice coils up to reflect the most critical standards in the world of speakers. The wide-band tweeter exhibits the best transient performance from 1,000 to 15,000 Hz of any dynamic tweeter. And the woofers deliver hair-line delineation, natural boom-free bass. All this at a bookshelf system price.

Think about it. Then listen to the new EXP series at your nearest franchised RTR dealer. For a dealer list and complete information, write: RTR INDUSTRIES, Dept. BG, 8116 Deering Ave., Canoga Park, CA 91304.

Check No. 28 on Reader Service Card

Dimensions: 17½ in. W x 6 in. H x 14 in. D. **Weight:** 30.8 lbs. **Price:** \$600.00.

P-300 Power Amplifier

Power Output: 200 watts continuous rms watts per channel into 4 ohms with less than 0.1% total harmonic distortion with both channels operating simultaneously at any fre-

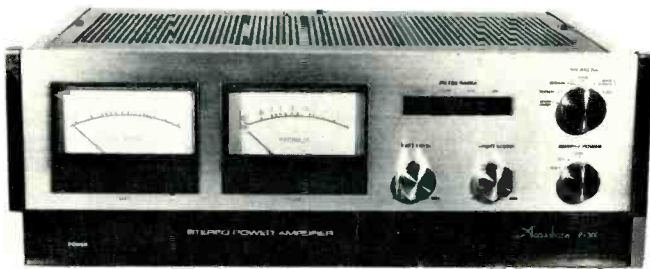

P-300 Power Amplifier

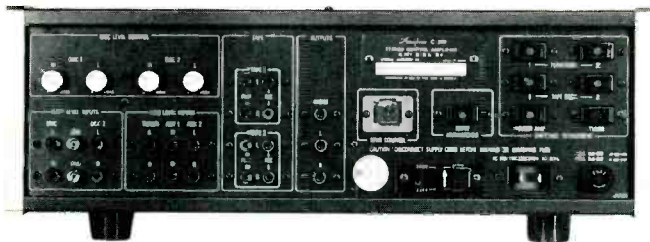

Fig. 1—Rear panel of control/preamplifier.

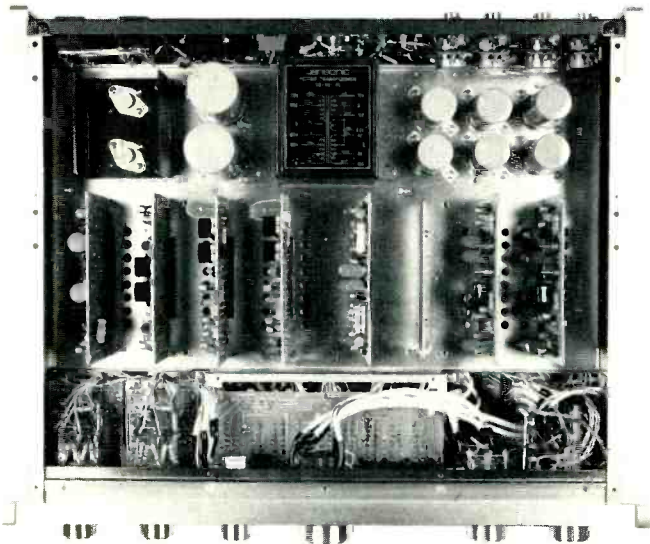

Fig. 2—Inside view of control/preamplifier.



Fig. 3—Rear panel of power amplifier.

quency from 20 Hz to 20,000 Hz; 150 watts continuous rms watts per channel into 8 ohms with less than 0.1% total harmonic distortion with both channels operating simultaneously at any frequency from 20 Hz to 20,000 Hz. **Intermodulation Distortion:** Less than 0.1% at rated output for any combination of frequencies between 20 and 20,000 Hz. **Frequency Response:** 20 to 20,000 Hz +0 -0.2 dB at rated output. **Input Impedance:** 100k ohms. **Input Sensitivity:** 0.5 V for rated output at maximum level control. **Damping Factor:** 40 at 4 ohms, 20 at 8 ohms for any frequency from 20 to 20,000 Hz. **Dimensions:** 17½ in. W x 6 in. H x 14 in. W. **Weight:** 55 lbs. **Price:** \$750.00.

The Kenosonic Accuphase C-200 control amplifier is a quite attractive, well-built, and very flexible preamplifier which has quite a few very nice features. The construction uses a subplate, about an inch off the bottom, on which are mounted a row of plug-in PC boards, the transformer, filter capacitors, and regulator power transistor heat sinks. There is extensive internal shielding, which was removed for Fig. 1. The unit appears nicely made, with good quality components. Kenosonic claims a 1 dB tracking error between channels in the volume control at any level, and measurement confirmed this, so this is an especially good volume control.

The P-300 power amp is a solidly built unit, weighing about 55 lbs. It also has a sub-chassis like the preamp, on which are mounted the nicely made power transformer, filter capacitors, and four PC boards. Two boards are power amp driver assemblies, containing all the transistors save the output devices; the other two are the protection circuit and the power supply regulator. The side-mounted heat sinks, essentially the height of the unit, are fairly large and have plenty of free-flow ventilation.

The front panel has two VU meters without power scales, however, pushbutton switches change the meter sensitivity from 0 to -10, or -20, zero being for 150 watts at 8 ohms, -10 15 watts, and -20 1.5 watts. This stepping of sensitivity is nice, as it's easy to remember that if you push -10, your scale is a factor of 10 different than the one above. The front panel also has a selector switch which selects *Main*, *Remote 1*, *Remote 2*, *Front Panel*, or *Main and Remote 1*. There are two level control pots, and a power switch which limits the amp to 50% or 25% of full output. On the bottom of the front panel is a nice hinged panel with a magnetic catch. Behind it are phone output and input jacks, a pair of front speaker output banana plugs, a filter switch which limits the bandwidth of the amp, and a switch between front and rear inputs.

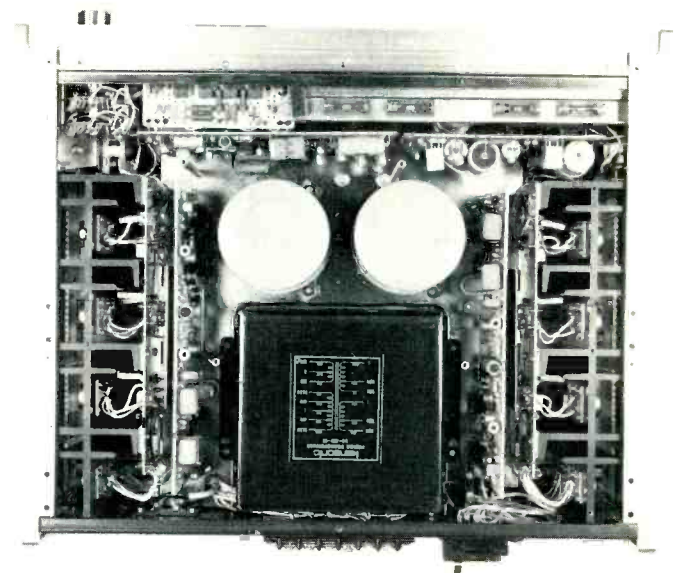

Fig. 4—Inside view of power amplifier.

On the rear panel is a set of high quality, barrier terminal strips for connection of three speaker sets, a pair of input jacks, a device to select 100, 117, 120, 220 or 240 V a.c., and an unswitched a.c. outlet, and the main a.c. fuse.

Preamp Circuitry

The C-200 design is unusual in several respects. First, it uses fully complementary circuitry and may have been the first on the market to do so. The block diagram, shown in Fig. 5, discloses six amp blocks per channel, phono preamp, high level amp also used for tone control action, low- and high-cut active filters, output buffer amp, and headphone amp. In normal use, when you're playing records and don't have the filters in, you go through the phono preamp, the high level amp, and the output buffer amp, making a total of three, with the C-200 driving a following power amp.

When the tone controls are switched in, a flat feedback network in the high level amp is replaced by switched RC networks. There is, therefore, little difference in performance when the tone controls are "in circuit," which is not the case with other designs that typically use another inverting gain-of-one amplifier. The high level amp is always in use, and when you use the tone controls you aren't adding any extra electronics. The high and low filters are, however, bypass switchable.

The C-200's design is also unusual in that the balance control comes after the high level amp, which follows the volume control; usually the balance and volume controls are together in a circuit. There is also a muting relay between the output of the high level amplifier and the balance control, which is connected to a time-delay circuit and prevents turn-on thumps.

The tape monitor facility has a tape-copy switch, separate from the monitor switch, which allows recording from one deck to another, independent of the signal to the speakers. This is a good feature, rather unusual, and works well.

The headphone amp is connected to the output of the main preamp output and in attenuated to about one-fifth of the main preamp's output voltage. It is a complete power amplifier that can drive 4, 8 or 16 ohm 'phones to about 200 mW. It has a low output impedance so that dynamic phones can get damping. This is unusual as most headphone amp circuits, which come in power amps, drop the feed to the 'phones through a large series resistor, so there is virtually no damping.

Figure 6 is a simplified schematic of the phono preamp, the most elaborate circuit used in the C-200; both the high level and headphone circuits are simplified versions. What is unusual about this phono preamp, aside from fully complementary design, is the high voltage used in the output stage of the preamp, ± 60 V, which to my knowledge is the highest supply voltage for any present day solid-state preamp output stage. The high supply voltage, combined with the ability to lower the circuit gain from 40 to 30 dB at 1 kHz by means of back channel pots, makes it virtually impossible to overload this phono preamp with any magnetic pickup. Such unusually high signal acceptance is very good.

Q1 through Q4 form a complementary-differential input amplifier which drives complementary inverting transistors Q5 and Q6. The collectors of Q5 and Q6 have signal currents in phase, but even-order harmonic distortion products are out of phase, and thus cancel—if the devices are completely and perfectly complementary.

Q7 through Q10 constitute a complementary compound

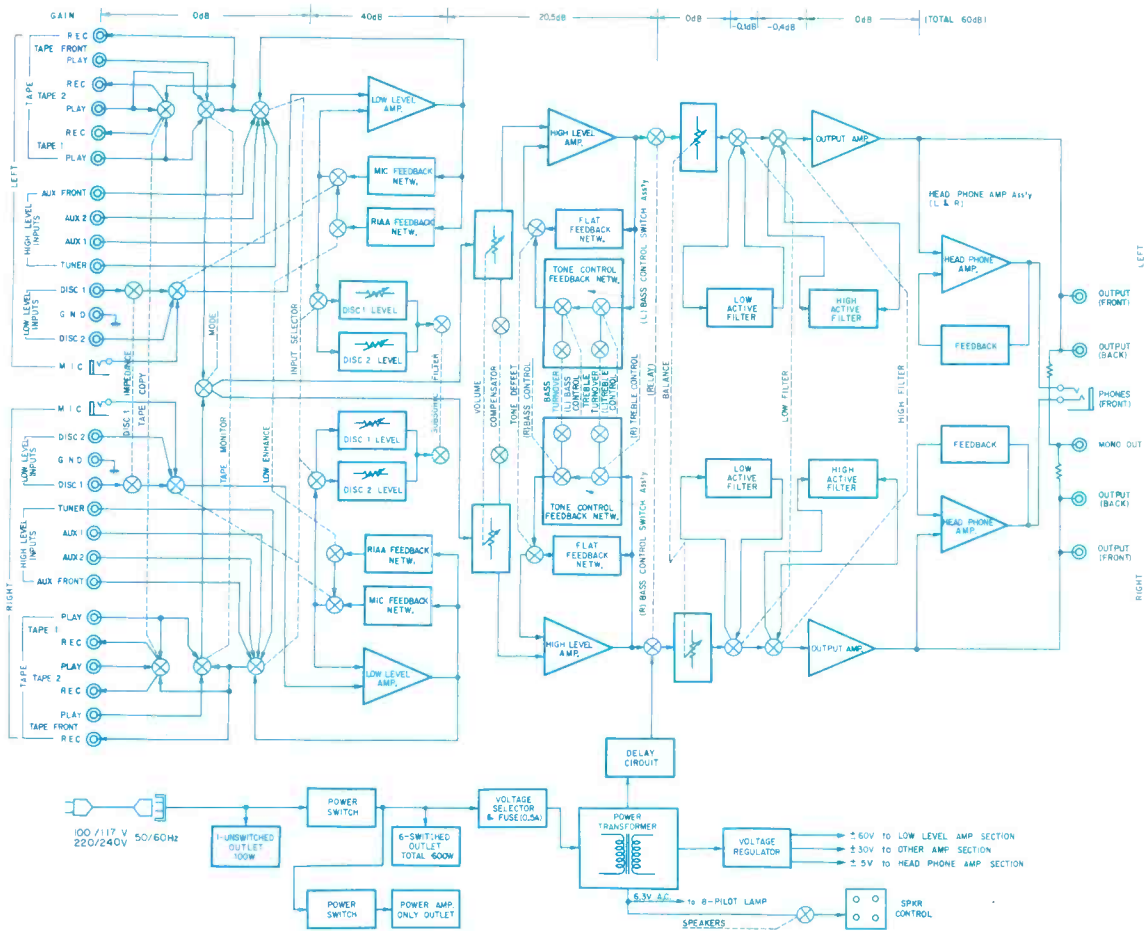

Fig. 5—Block diagram of control/preamplifier. Power supply is shown at bottom.



THE MANY WORLDS OF SUN RA

Tom Bingham

WAY BACK in the 1930s, pianist Herman Blount came north from Alabama with the Fess Whatley band. He worked in Chicago through the 40s, including a stint with Fletcher Henderson.

However, during the 50s, Blount underwent a strange metamorphosis. He changed his name to Sun Ra, formed his own band, began preaching a rather esoteric philosophy somewhat akin to what you might hear in a Grade-C space movie, and became housefather to a sizeable communal entourage of musicians, dancers, artists, and assorted "believers." After a couple conventional mid-50s big band albums, he formed his own record company, El Saturn Research, and began releasing albums at a surprisingly rapid clip.

As Sun Ra's philosophies became more arcane, his music became correspondingly more avant-garde, and his stage presentation (with costumed bandmen, dancers, light displays, and the like) more outlandish. Throughout the 60s, word began to spread from Chicago to New York to Europe about this bizarre visitor from another world (or so he claimed). With equal justification, he was considered as little more than a crackpot by the musical establishment, while receiving high praise as the greatest of all genius/innovators by a very tiny minority.

Until very recently, Sun Ra and his Arkestra (using such descriptions as Myth-Science, Solar, Astro-Infinity, Intergalactic Research, Intergalactic Infinity, and Intergalactic Discipline in front of the constant term "Arkestra") could only be heard on 30 to 35 albums released by El Saturn, ESP-Disk, Transition, Delmark, and Savoy. However, these labels have been so poorly distributed as to be near-non-existent as far as the average record buyer is concerned. In the last 1½

years, though, there has been a mild avalanche of Sun Ra recordings on nationally distributed labels. It is this new rash of albums (some new, some imports, some repackages of Saturn material) that is of concern here.

Over half of the recent Sun Ra releases are on ABC's Impulse label, one new set and four re-issues. The earliest of the Impulse albums is *Angels And Demons At Play*, recorded between 1955 and 1957. Side two of the album is straight 50s big band bebop, revealing Ra's musical origins in Dizzy Gillespie, Duke Ellington, and Charles Mingus. It's quite good for the era, though sounding rather dated now. However, it is on side one where Sun Ra demonstrates his unique approach to 50s jazz. *Tiny Pyramids* is mysterious Arabic-influenced flute music over an exotic camel-caravan rhythm. *Music From The World Tomorrow* is, appropriately enough, the strangest track, with dissonant strings, demented percussion, and Ra's crazed organ. The whole side is filled with odd voicings, off-beat spacey melodies, unusual structures, and floating rhythms, all in a 50s base. The album is only 23 minutes long, though Impulse seems to be issuing the Saturn albums intact.

Space Is The Place on Blue Thumb and *Astro Black* on Impulse are, as of this writing, the two most recently released new Sun Ra recordings. Though the subject matter is still outer space, these two albums find Ra not too far removed from 1970's possessive Black America. This is partly a case of the world catching up to Sun Ra in some small degree. However, it should be noted that Ra, always ready to utilize the gains of others if they fit his aesthetic, has reincorporated selective soul and jazz influences into his music.

Space Is The Place is the more commercial album, with contemporary

big band tunes, a madcap updating of his old *Rocket Number Nine*, and an exciting unison-soloing piece called *Sea Of Sounds*. The side-long title song features baritone saxman Danny Thompson on a repetitive riff, while the Space Ethnic Voices weave the title in and around some bristling reed solos. It is either hypnotic or boring, depending on your mood and receptivity. The entire album is a brief respite from the subtle complexities of earlier albums.

Astro Black is a more objectively creative record. The album abounds with all the usual modern Sun Ra elements—spurring moog and organ, June Tyson's cool singing, African rhythms, minor-key exotica, ingenious arrangements, excellent soloing by Allen and Davis, and highly intelligent compositions. Particularly fine is an ambitious, glowing three-part piece, *The Cosmo-Fire*, which ranks with the very best of his work.

Indeed, *Astro Black* proves that at the age of 60, at the peak of his popularity, Sun Ra has not forsaken his creative principles. At an age where he would be forgiven if he were merely to sit back and receive the accolades that have been so long in coming, Sun Ra continues to extend his search for new means of self-expression continually further. Even so, the music of Herman Blount—intense, personal, and innovative—is truly unlike anything anyone else has ever accomplished.

The Nubians Of Plutonia, recorded 1959 at Sun Ra's own El Saturn Studios, is more consistently strange. It finds him moving out of the big band framework, with many more avant-garde elements. Indeed, the straight and the bizarre clash almost ludicrously at times, with typically

(Continued on page 63)

Advertising Index

ADVERTISERPAGE	ADVERTISERPAGE	ADVERTISERPAGE
ATV Research..... 83 TV Camera Kit Write Direct to Advertiser	Empire Scientific..... 11 Cartridges Check No. 13 on Reader Service Card	Revox Corp..... 65 Tape Decks Write Direct to Advertiser
Acoustical Mfg. Co..... 66 Amplifiers Write Direct to Advertiser	Great American Sound Co..... 65 Amplifiers Check No. 14 on Reader Service Card	Rhoades & Co..... 82 Teledaptor Write Direct to Advertiser
Ahuja Radios..... 75 PA Systems Check No. 1 on Reader Service Card	JVC..... 27 Receivers Check No. 15 on Reader Service Card	Ruxton Electronics..... 76 Speaker and Amplifier Kits Check No. 29 on Reader Service Card
Audioanalyst..... 68 Loudspeaker Systems Check No. 2 on Reader Service Card	KLH..... 29 Model 60 X Turntable Check No. 16 on Reader Service Card	SAE..... 71 High Fidelity Components Check No. 30 on Reader Service Card
Audio Dynamics..... 39 High Fidelity Components Write Direct to Advertiser	Kirsch..... 76 Stereo Shelving Check No. 17 on Reader Service Card	Sansui Electronics..... 33 High Fidelity Components Check No. 31 on Reader Service Card
Avid..... 63 Loudspeakers Check No. 3 on Reader Service Card	Logic Newsletter..... 81 Sample Copy Write Direct to Advertiser	Saxitone Tape Sales..... 80 Blank Recording Tape Write Direct to Advertiser
BASF..... 35, 37 Blank Recording Tape Check No. 4 on Reader Service Card	Magnavox..... 18, 19 High Fidelity Components Check No. 18 on Reader Service Card	Schwann Record & Tape Guide..... 79 Current Listings Write Direct to Advertiser
BGW Systems..... 72 Amplifiers Check No. 6 on Reader Service Card	Magnepan..... 71 Magneplanar Speakers Check No. 19 on Reader Service Card	Sherwood Electronic Labs..... Back Cover High Fidelity Components Check No. 32 on Reader Service Card
BML Electronics..... 23 Tracer I Check No. 8 on Reader Service Card	Marantz Co..... Cover 3 Electrostatic Headphones Check No. 43 on Reader Service Card	Shure Bros..... 43 Cartridges Check No. 33 on Reader Service Card
Bose Corp..... 16, 70 High Fidelity Components Write Direct to Advertiser	Maxell..... 69 Blank Recording Tape Check No. 20 on Reader Service Card	Sony..... 8 Amplifiers Check No. 65 on Reader Service Card
British Industries Co..... 3 Venturi Speakers Check No. 9 on Reader Service Card	McIntosh Lab..... 73 Free Catalog Check No. 21 on Reader Service Card	Sound Technology Research..... 73 P12 Loudspeaker Check No. 35 on Reader Service Card
Crown International..... 6 High Fidelity Components Check No. 10 on Reader Service Card	PAIA Electronics..... 70 Synthesizer Kits Check No. 22 on Reader Service Card	Stanton Magnetics..... 15 Cartridges Check No. 24 on Reader Service Card
dbx, Inc..... 30 Audio Accessories Check No. 11 on Reader Service Card	Phase Linear Corp..... 78 High Fidelity Components Check No. 23 on Reader Service Card	TEAC..... 7 Tape Decks Write Direct to Advertiser
Discwasher Inc..... 2 Record Cleaning Materials Write Direct to Advertiser	Pioneer..... Cover 2, 1 Tuners and Amplifiers Check No. 24 on Reader Service Card	Tektronix..... 4 High Fidelity Components Check No. 37 on Reader Service Card
Dokorder..... 47 High Fidelity Components Check No. 12 on Reader Service Card	Polk Audio..... 76 Loudspeakers Check No. 25 on Reader Service Card	Teletronics..... 84 Subscription Information Write Direct to Advertiser
Dynaco..... 13 PAT=4 Write Direct to Advertiser	Quintessence..... 77 High Fidelity Components Check No. 27 on Reader Service Card	United Audio..... 5 Dual Turntables Check No. 38 on Reader Service Card
	RTR Industries..... 49 Loudspeakers Check No. 28 on Reader Service Card	Yamaha..... 41 Loudspeakers Check No. 39 on Reader Service Card

(Continued from page 57)
 unique dissonances, pervasive percussion timbres, exotic rhythms, and discomfiting horn voicings in abundance. Among the highlights are James Spaulding's first alto solo on *The Golden Lady*, the humming harmony vocal and Marshall Allen's melancholy flute on *Africa*, and the over-all weirdness of *Aiethopia*. Also included is an early version of *Watusa*, an Egyptian march, which is as close as Sun Ra comes to having a "theme song." The engineering is imbalanced and obscurant, but this only adds to the mysteriousness of the murky-textured music.

Two other Saturn/Impulse reissues, *The Magic City* and *Atlantis*, were unavailable for review. Both, however, are considered Sun Ra masterpieces, dating from around 1960. Other Sun Ra recordings of the '60s, during which he abandoned established forms to develop his own "black classical music" (improvised music using jazz instruments, but methods and concepts similar to post-war academic music), are still pretty much unobtainable.

The exception is *Pictures Of Infinity*, on Audio Fidelity's Black Lion label. Unfortunately, this is a straight big-band jazz album, albeit quite a good one. Dating from 1968 (released in the U.S. in late 1973), it has several forceful examples of Ra's most important contribution of the early

60s, the controlled "free" ensemble. On the opening *Somewhere There* (of which 10 of the 15 minutes are devoted to drumming) and the flippant band vocal, *Outer Spaceways Incorporated*, each member of the 10-man horn section appears to simultaneously blow a different, seemingly random, atonal improvisation. However, these unison passages are rather tightly masterminded by Ra, with the freedom given strict boundaries. Nonetheless, these wild, screaming, squealing ensembles are extremely exciting and spontaneous-sounding.

These ensembles reached their fullest development on *It's After The End Of The World*. By any standards, this 1970 German live album is an enthralling creative experience. Sun Ra's expansive compositions are brilliant launching pads for the swirling, visionary soloing. The album is filled with expressive woodwind textures (flutes, oboes, saxophones, and the angry sound of a bassoon fitted with a trumpet mouthpiece), with such longtime Sun Ra sidemen as Marshall Allen, Danny Davis, and Pat Patrick at the summit of their inventiveness. Sun Ra himself plays some of his most majestically powerful keyboard solos on record. There are also couple samples of Ra sermonizing his philosophies. The excellence of the music and its presentation make this the very best available introduction to the strange world of Sun Ra.

Sun Ra Discography

Angels and Demons at Play
 Impulse AS-9245, mono, \$5.98.
 Sound: B- Performance: B

The Nubians of Plutonia
 Impulse AS-9242, mono, \$5.98
 Sound: C- Performance: B+

Pictures of Infinity
 Black Lion BL-106, stereo, \$5.98

It's After the End of the World
 BASF 20748, stereo, \$5.98
 Sound: B+ Performance: A

Space is the Place
 Blue Thumb BTS-41, quadraphonic,
 \$5.98
 Sound: A- Performance: A-

Astro Black
 Impulse AS-9255, quadraphonic, \$5.98
 Sound: A Performance: A

Fate in a Pleasant Mood
 Impulse AS-9270, stereo, \$5.98
 Sound: B- Performance: A-

Super-Sonic Sounds
 Impulse AS-9271, stereo, \$5.98
 Sound: B- Performance: C

Heliocentric Worlds of Sun Ra, Vol. I
 ESP-Disk 1014, stereo, \$5.98
 Sound: A- Performance: A

Heliocentric Worlds of Sun Ra, Vol. II
 ESP-Disk 1017, stereo, \$5.98
 Sound: A- Performance: A+

Nothing Is
 ESP-Disk 1045, stereo, \$5.98
 Sound: B- Performance: B+

The Magic City
 Saturn LPB-711, stereo, \$5.98
 Sound: B Performance: A++

There are several other Sun Ra albums available through El Saturn Research, P.O. Box 7124, Chicago, Ill. 60607.

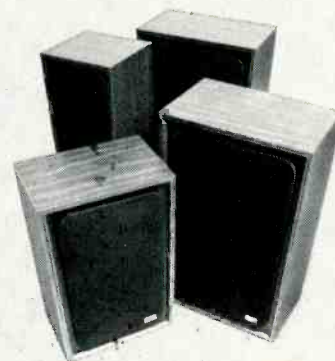

Before we started making speakers, we made something else.

A commitment.

The most acclaimed new line of speaker systems on the market today didn't get there by accident.

At Avid, we're totally dedicated to just one thing and one thing only: the design and construction of the cleanest-sounding, most accurate speakers in their price range.

Each and every one. And that's not just so much advertisingese. It's for real. And we're not the only ones who think so.

"A best in its class..."
 High Fidelity—August, 1974/
 Avid 100.

"Extremely smooth and neutral..." Len Feldman, FM Guide—December, 1974/
 Avid 102.

"Utter smoothness and freedom from undue emphasis or coloration..." Julian Hirsch, Stereo Review—April, 1974/
 Avid 103.

"One of the more sensational high-fidelity buys of our time..." Modern Hi-Fi & Stereo Guide—November, 1974/
 Avid 60.

But it's not what we think, or even what the critics think, that's important. It's what you think. See for yourself at your nearest Avid dealer.

AVID
 CORPORATION

10 Tripps Lane/East Providence, R.I. 02914

Check No. 3 on Reader Service Card

The Column

Fred DeVan



Illusions on a Double Dimple: Triumvirat.

Harvest ST 11311, stereo, \$4.95.

Three-man rock groups are becoming as rare as hen's teeth, but as typified by this German trio, those still around are worth listening to. This group is new to me and, I believe, new to these shores. The name of the album is as inexplicable as the name of the band, which might well itself cause confusion since it recalls an album (a disaster) which was titled *Triumvirate* (Dr. John's only recorded mistake, which he made with Mike Bloomfield and John Paul Hammond. Don't confuse this group with that album.)

Illusions on a Double Dimple is a well-done album from Germany which should not be overlooked. When you see the white rat coming out of an egg shell on the cover, don't feel stupid. I had no idea what that was all about either. The record inside is a totally different story. It is excellent. Much of the music the other musicians make is overwhelmed by the superb keyboard work of Jurgen

Fritz. His synthesizer and organ work is strikingly well conceived. Percussionist Hans Bathelt does much more than go chunka-chunka. He plays with precision and speed, embellishing every line and riff. Helmut Kollen would be totally submerged by the strengths of the other two were his bass, guitar, and vocal work less strong and solid.

Side One has a flow of ideas gathered under the title of the album, while Side Two is entitled *Mister Ten Per Cent*. Helmut Kollen delivers vocals and instrumentals in styles that normally turn me off, but not only do they grab me here; they are fully in keeping with the statement being made. His brash violent delivery of words and the dissonant bass line make a really interesting and exciting flow which segues into a number of broad, strong, statements. Hats off to this band!

It seems that today's musicians are out to make firm, often personal statements on the conditions of a musician's life. To name two: Janis Ian's *Stars*, a softly, sensitively-delivered, nine-minute condemnation

of what the music-biz had done to her and many others, and Rick Derringer's *The Airport Giveth*. There are many, many others. *Mister Ten Per Cent* does it with rawness and clout initially, and goes on with logical, uplifting smoothness into expressions that are mostly non-verbal, but easy to identify with. I suppose that is what makes a good concept album. A really well-done job of making music.

This German recording is on a par with the best of the classical and jazz discs coming out of that country. With ECM and DGG issuing their fine recordings, everybody else is kept busy trying to keep up. EMI Electrola GMBH (German Capitol) has pulled out all the stops.

Put this "stereo" record through an SQ decoder and you may be a bit confused as to what's happening. This disc, like many others, released as "stereo" has quadrasonic virtues which are inexplicably a well-kept secret. You just have to experience it to know what I mean.

Sound: A

Performance: A

Good Old Boys: Randy Newman
Reprise M5 2193, stereo, \$6.98.

It appears to me that Randy Newman intends his **Good Old Boys** album to be more than poking provocative humor and music at a (I hope dying) moral chink in our society. **Good Old Boys** can be treated as commentary on today's realities couched in an image of the Summer of '42 and southern political structure before the new south (i.e. a communal and profitable reform of social/economic spread and vitality) burst into life.

Randy Newman throws musical and lyrical darts at things the USIA and its mus-biz Doppelganger, the mass total of program directors and music directors hold dear. What their sins reflect is the mentality that provides interesting news. The good old boys of City Hall or the Chamber of Commerce tell them how to look and what to say. The rednecks of the world, of our time, of our nation are everywhere. From the White House to your gas tank and a.c. socket, it's the good old boys and the rednecks who ruin things of substance and who exploit things and people of value.

You will not hear most of Randy Newman's **Good Old Boys** on the radio. Indeed, I came across it through a friend who insisted that I listen to it. I did and he left without it. I had to borrow it from him right then and there. It is one of the most brilliantly conceived and executed records I have heard. Aside from the social commentary on past and present (its point of view is in the Thirties with many aspects of today interwoven), it is also a personal impression of what he saw and felt on a recent return to his ancestral home in Louisiana.

His words vary from biting cruel attacks on everything he can cram into four minutes to wry twisted humor that is so pervasive and intelligent, it forces one to look beyond the poetry of it all and peer into oneself. His songs travel a course so broad that one cannot take all the information in without repeated listenings. There are straight-out controversial and cleverly reflective songs like *Rednecks* and *Kingfish*; political satire on *Every Man A King* and *Mr. President* (have pity on the working man); and there are even a love song, a drinking song, a touch of Steven Foster, a dash of warm tenderness, plus a twisting tribute to Birmingham, Alabama, to cap things off.

Randy Newman has given us a documentary portrait of a sentimental, compassionate romantic, along with the genius of wit and metaphor he holds the patent on. He has not al-

AUDIO • MARCH, 1975

The Pre-Amp is Coming!

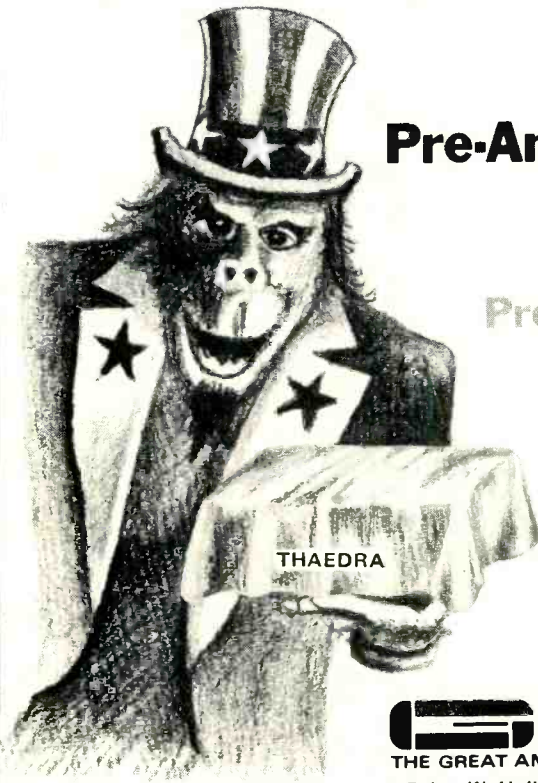

Pre-Amp is Coming!

Pre-Amp is Coming!

GAS
THE GREAT AMERICAN SOUND COMPANY, INC.

8780 Shoreham Drive, W. Hollywood, CA 90069 • (213) 659-2486

Check No. 14 on Reader Service Card

The best by far...
because Revox delivers what
all the rest only promise.



Revox Corp.
155 Michael Drive
Syosset, N.Y. 11791

Please tell me where I can see and buy Revox A77
Revox Good used machines*

Name _____ Address _____

* As and when available from our dealers.

SBF

ways applied it in the past, but he is without doubt one of the most important composer/writers around.

Popular music may not be important enough to lump him with Solzhenitsyn, Nabokov, or Schlessinger. But as an art it has generated social changes more than once. I think we take its material far too lightly. We fail to acknowledge the forces embodied in vinyl waffles. As circumspect as some of our singer/writers' wisdom is today, so was Mark Twain in his time. The little essays that are the songs of today are too available to be precious in our time, too transitory to have sustained relevance. Yet, happily, this will be part of some nostalgia kick in

the future and a lot of things we dismissed or ignored in this decade will find rebirth in the future.

Fortunately, you don't have to wait, you can truck down to your local record store and have this utterly perfect recording right now! I don't say this lightly—it is just that every intended goal has been realized. The music is brilliant, the execution is flawless, the sound is impeccable. It is one of those stereo records which sounds good in quad using either a QS or an SQ decoder to extract ambience information for the rear (side) channels. Any form of enhancement works, but it also sounds great in ordinary two-speaker stereo.

The instrumentation and musical structure were conceived along with the words and are part of the total work as opposed to being words set to music, or vice versa. If I could find any fault with this recording of any kind I would mention it. I can't. It is a unique record. No review can do it justice.

Sound: A Performance: A

Again and Again and Again

Given the time, the patience, and the money, one can connect* fifty 303 amplifiers nose to tail so that the programme goes through one after the other gradually deteriorating along the way.

Deteriorating? The fact is that apart from a very slight background hiss—akin to a good tape recording—the programme will sound exactly the same at the end as when it started.

*Of course one must fit an attenuator to reduce the signal back to its original level between each amplifier.

Send postcard for illustrated leaflet to Dept. (AU)

Acoustical Manufacturing Co. Ltd., Huntingdon PE18 7DB.
Telephone (0480) 52561.

QUAD

Products of
the Acoustical Manufacturing Co. Ltd.
for the closest approach to the original sound.
QUAD is a Registered Trade Mark

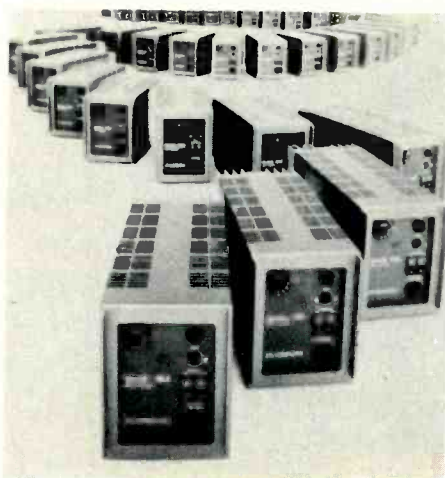

It's Only Rock 'N Roll: The Rolling Stones

Rolling Stone 79101, stereo, \$6.98.

I'm amazed to find myself writing this, but the Rolling Stones have a very pleasant record album. So much of what they've done in the past is totally unappealing, yet somehow they have always generated something that grabs me. I think beyond the hype and the image to the good music they have occasionally made.

When Jagger and company are doing their kind of rock and roll, they always manage to produce a pure gem—one or two per album. The music of The Rolling Stones that you hear most is (to me) ugly. I can rarely listen through a whole Rolling Stones album. Some of their newer things are really hard to deal with and are meant to be twisted and rough. The Rolling Stones are that way.

Now The Stones present us with a total admission of guilt. Guilty of subordinating music for perpetuation of their image. Guilty of trashing Rock and Roll for the sake of producing acoustic hysteria. The full title of this album and cut three, side one is: *It's Only Rock 'N Roll (But I Like It)*. They build a basis for this statement on the first two cuts which are standard grossed-out Rock and Roll Stones, at best tolerable. The rest of the record is uphill; it keeps getting better.

Time Waits For No One is a long rocker with one of Keith Richards' best solos and a lot of really nice piano by Nicky Hopkins.

As usual the sound is loud, usually with the density of granite. As usual, that very density is at odds with what good musical qualities they possess. Again, they have culled some excellent musicians from elsewhere to add color where ever it can shine through. They picked up the whole Blue Magic group to do background vocals on *If You Really Want To Be My Friend*. Among others they gathered in Billy Preston and Ian Stewart on piano, and Ray Cooper on percussion.

The quieter parts of the pressing I have are noisy by today's standards.

Sound: B Performance: B

(Continued from page 55)

citive load to the *Tape Out* jacks. An IHF load (1000 pF in parallel with 100K) causes a high frequency rolloff at 30 kHz. While the 1000 pF is rather extreme, if you do have some rather long *Tape Out* leads, you might get some audible high frequency rolloff. Output amplifier scope photos are shown in Fig. 11, and the amount of droop in the 20 kHz square wave about doubles when going from an IHF to a 10K load. When the filters are switched in, there is no increase in noise, as with some circuitry—a good feature.

Another good feature is that the balance control, due to its position past the high level amplifier, doesn't increase noise when it is rotated away from center.

Crosstalk between channels of the phono preamp at 20 Hz was about -68 dB, increasing to -61 dB at 1 kHz, and to -56 between 5 and 20 kHz. All measurements here are good. High level crosstalk, using *AUX 1* with the tone controls out, was -55 dB at 20 Hz, -72 at 1 kHz, and -49 dB at 20 kHz. With the tone controls in, the crosstalk is even better at high frequencies, about -62 dB at 20 kHz.

The maximum power output of the headphone amp is about 250 mW into 4 ohms, 245 mW into 8 ohms, and 202 mW into 16 ohms. The IM distortion here is mostly 2nd and 3rd harmonic, varying between 0.05% and a few tenths of a percent as voltage ranges from 1/2 V to 1 1/2 V, depending on load impedance. The output resistance is about 0.16 ohms, which might make dynamic phones sound better at low frequencies because of better damping.

The power amplifier had a voltage gain with the pots wide open of 43 to 1, or 34.6 dB, which is higher than the 34 to 1 specified. This amp passed the new FTC one hour burn-in at 1/3 full power test with no apparent problems. THD and IM are shown in Fig. 12, with one-watt frequency response and THD versus frequency and power in Fig. 13. Note that the 1 watt distortion versus frequency curve begins at 1 kHz, since at this point the distortion began to climb above the noise, indicating a small amount of high frequency crossover distortion.

Overall this amplifier measures very well, though it does have a tiny bit of odd harmonic distortion, about 0.01% which is not likely to be heard. Introduction of the band-pass filters raised distortion slightly at high power levels—from 0.01% to 0.016% at 100 watts, 1 kHz. Scope photos of various waveforms through the amplifier are shown in Figs. 14 through 17.

This amplifier has excellent high frequency power capability, as shown by the 80 V peak-to-peak, 20 kHz square wave and the 80 V p-p 10 kHz square wave with a two μ F load. Damping factor versus frequency varied from 100 at

low frequencies to about 23 at 20 kHz, decreasing smoothly above 500 Hz.

Power at clipping was 301 watts into 4 ohms. At 8 ohms, it was about 185 to 190 watts, and at 16 ohms about 110 watts.

Next measured was the output noise, with input shorted, for two bandwidths. From 20 to 20,000 Hz, the output noise is 160 mV in the left channel and 183 in the right, mostly random noise. With a 400 Hz to 20 kHz bandwidth, output noise was 83 μ V for the left channel and 87 for the right. All these are very good measurements, since for example, the 183 μ V right channel is 105.5 dB below rated power of 150 watts.

Bascom H. King

Check No. 64 on Reader Service Card

Table 3—Preamplifier noise vs. volume control position (Aux 1 input shorted).

Bandwidth (Hz)	Control Pos.	Right Out Noise (μ V)	Left Out Noise (μ V)
20 - 20 K	CCW	15	14
400 - 20 K	CCW	11	11
20 - 20 K	Worst case	97	82
400 - 20 K	Worst case	81	76
20 - 20 K	CW	28	25
400 - 20 K	CW	22	22

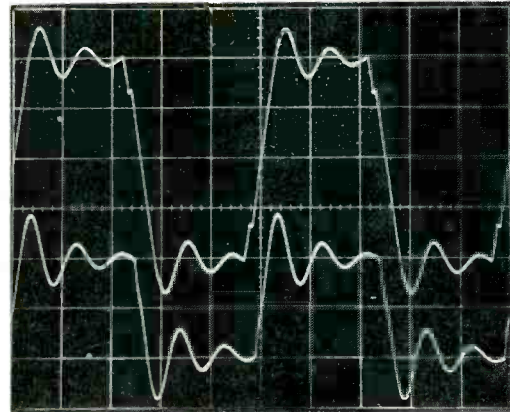
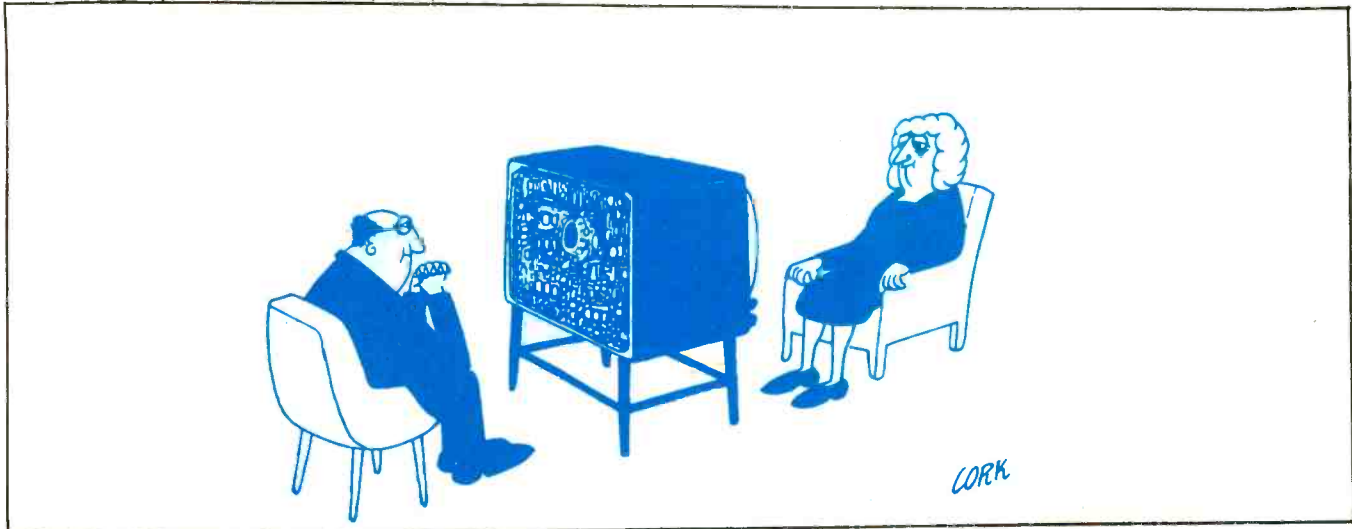

Fig. 17—10-kHz square waves into 2 μ F resistive loads; top is about 160 VA, bottom about 3 VA.



Classical Reviews

Edward Tatnall Canby

Francois Couperin: Les Nations. Quadro Amsterdam. **Telefunken TK 11550/1-2** (2 discs), stereo, \$13.96.

This is the ultimate French music of the Louis XIV and XV period, the very

essence of Frenchness—and isn't it curious that, as with the Italians, outsiders like these Dutch seem to do a much better job of playing it than the French ever do.

There are four of the special Couperin-type suites in this published collection, spaced out over much of his composing life, the latest from 1726. Each has a name, a country personified—*La Francoise*, *L'Imperiale*, *L'Espagnole*, *La Piemontoise*—but these are wholly fanciful and have nothing to do with the music itself, which, some of it, had earlier names quite different. PR stuff. Each has an Italian-based Baroque sonata at the beginning, six movements slow and fast, and then a suite of dances including a variation-like chaconne, 14 or 15 short movements altogether. No strain—it all goes forward smoothly and easily. The Dutch players, notably Frans Brügger, young genius of flute and recorder, and Gustav Leonhardt on the harpsichord, have so perfectly caught the French ambience that one almost expects them to Frenchify their names—Francois de Bruges? Gustave Coeur de Lion?

Carlo Gesualdo: The Complete Five-part Madrigals. Quintetto Vocale Italiano, Ephrikian. **Telefunken SJA 25086-T17** (7 discs), stereo, \$48.88.

Small choral groups, and a very few professional solo groups, occasionally tackle the strange, chromatic music of Don Carlo Gesualdo, an Italian nobleman and dilettante of the early 17th century. My own Canby Singers have sung a dozen or so of these works. Stravinsky and others in his league have been fascinated—*Gesualdo Monumentum*, a Stravinsky ballet score made out of three Gesualdo madrigals. We sang the three originals. But *all* of them?

There are six Books, published over many years, with from 15 to 20 works in each, many of them in two parts, double length. This was the age when the content of a later symphonic movement was crammed into a few minutes. Each of these takes long study and repetition—by singers or by listeners—if the meat and sense is to get through. Not that they are dull—far from it. Just concentrated, one idea right on top of another.

OK—so here are six books, the

Walt Ostrander, Audioanalyst, As Seen Through The Eyes Of His A-100X Speaker



His tortures drive drivers to drink.

Walt Ostrander, Nice Guy



This perfectionist believes results justify the individual bench testing of every single assembly. "Unusually flat toward the top of its price range" says High Fidelity of our A-100X bookshelf speaker. We say, a Six Year

Warranty on every speaker in the Audioanalyst line, \$94 to \$249.

Everyone boasts clean highs, low bass, a better driver. Fact. The best drivers are pretty much alike. It's what our Audio-

analysts do with them that's different. Is there a percentage in this kind of obsession? A sound one to be sure. To test our speakers, simply write to us. All we ask is that you give them what we give them. The works.

European and Mideastern distributor: Argo Hellas, Int'l. Hollstein Hotel in Taunus, 6382 Friedrichsdorf/Bad Hamburg, West Germany.

Distributed in Canada by Superior Electronics Inc.



Audioanalyst

P.O. Box 262, Brookfield, Conn. 06804
Monstrous About Perfection

Check No. 2 on Reader Service Card

works, and it must have taken these really excellent solo singers years to do the recording job. Indeed it did; the dates of recording are given. Curiously, their sense of the music and how to project it with musical force grows, as they move forward from book to book, session to session. But so also did G. himself grow! So his best late works are sung the best; the earlier madrigals are given appropriately less intense treatment. Complete texts and lots of annotations and a life time of listening for anyone who dares.

Leopold Stokowski, The Philadelphia Orchestra. De Falla: El Amor Brujo. Wagner-Stokowski: Love Music from Tristan. With Shirley Verrett, mezzo. **Odyssey Y 32368, stereo, \$3.49.**

Now here is the sort of "re-issue"—quotes are deliberate—which is a timeless bargain, even at a new low price of \$3.49. (Odyssey was once \$2.50.) "The Great Columbia Stereo Recordings" looks good as a high-flying ad phrase but it also happens to be moderately accurate. This one is indeed timeless in stereo sound and might have been done yesterday, unless you are one of those engineers who say, ah yes, those old Neumann mikes they used to use, and an RCA in the middle—don't you hear it? Not me. Good stereo is good, if in various styles according to period and circumstance, and this one definitely is good. Clean, and wide, and large in the bass.

It must have been an exciting day when old Stoky, who first took over this orchestra I think in 1912, came back to make stereo recordings such as these, before RCA took the orchestra away from Columbia. Undeniably, the orchestra's great days were under the durable old maestro, though it has always been potentially a superb instrument. Virtually the entire early output of 78 electrical albums in America came from Philadelphia and Stokowski, via Victor, of course, in its first proprietorship. This is in that sense a rerun. But the old fire is there and every man in the orchestra knew it. Imagine it—this old man still waving his hands after 60 years!

A vividly Spanish De Falla, sparkling, brooding—does Stoky know how to bring out this sort of drama! Busty, gutsy Spanish singing by Verrett. And on side 2 one of the famous "symphonic synthesis" works, in which Stokowski seamlessly joined bits of opera together for people who didn't like singers but wanted *Tristan*. They got it, and plenty else. All in all, a fine "reissue."

THE PRO/AM TAPE



Introducing Maxell Ultra Dynamic backcoated/open reel tape.

A professional studio engineer doesn't have time for dropouts, wow, flutter, tape noise, static, poor winding, edge damage or erratic tape traction. Maxell Ultra Dynamic tape has the backcoating that eliminates these recording obstacles.

That's why the professionals use it. And why you should too.

While your Maxell UD tape is running (and the backcoating is protecting your music) you can concentrate on mike placement, sound levels and the more creative side of audio...like shushing the kids in the next room.

Maxell Corporation of America, Moonachie, New Jersey 07074. Also available in Canada.

maxell.

For professional recordings
at home.



Check No. 20 on Reader Service Card

The Haydn Organs in Eisenstadt. Concertos by J. and M. Haydn, Albrechtsberger. Daniel Chorzempa; German Bach Soloists. Philips 6700 052 (2 discs), stereo, \$15.90.

A rather special organ disc, this one, both as to place and as to the musical style. After the great Baroque period of organ building and elegant stuff called "galant," all frills and furbelows. The organ! It really didn't suit that magnificent and somewhat formal instrument, but our composers, nothing daunted, went right ahead, since most of their music was played where the organs were a normal accompaniment.

This is music of the very early Haydn period, the low 1760s, when Mozart was a child and young Haydn

was already composer in residence at this great princely center for the Esterhazy clan. The music is as above, by "the" Haydn (Josef) and his brother (Michael) and by one Albrechtsberger; it all sounds much alike, pleasant, ornamental, lovely in the orchestral parts and doing nothing much in the organ department, just spinning frilly melodies. Almost exactly as it must have sounded on the same instruments 200-plus years ago, which apparently was very satisfactory to all concerned. Three different organs, and Philips curiously makes it difficult to find which of them plays which music, though there are excellent pictures of the instruments. Doesn't matter much—in recording, they sound pretty much alike to the

non-expert ear. The playing is light and expert, right in the style of the music.

If you know the little Mozart organ concerti, or the London organ works of Christian Bach (the youngest Bach son), you'll find this music the same, and just as elegant.

Jean-Pierre Rampal: The German Rococo Flute. (Gluck: Concerto in G Major; Telemann: Suite in A Minor.) Paris Philharmonic, Leibowitz. Olympic 8112 (Everest), QS quadromonic, \$4.98.

Well, here we go, and this will have to stand for umpteen Olympic releases in the "Classical Collection" that are mono oldies (some stereo) fashioned into QS simulated quadraphonic. Might say doubly simulated. As so often in the Everest family, it is a splendid musical performance, well worth bringing back on musical grounds. And as so often, too, the sound is so scratchy that I can't believe the original (was it Westminster, Urania?) wasn't a lot better, if mono. Typically, the opening chord (a) has a loud pre-echo and (b) slides up to pitch. Sloppy lathe work or machine work, and we can't waste a whole lacquer just for one little chord...

Rampal is one of the greatest flutists of the century and unusual in that, unlike the earlier French flute geni he specializes and is best at 17th and 18th century works, of the sort we have here. Rene Leibowitz, a top French serial composer and theorist, did a notable series of fine recordings soon after WW II was over and France got back into the act. That's what we have here. A surprisingly jaunty and elegant ("galant") concerto by Gluck, the opera man, and the familiar Telemann Suite, here played—so far back—with the correct rhythms and tempi, a thing that many an orchestra still doesn't do (Marlboro, for instance). Good stuff and you quickly forget the edgy sound if you are music minded. Just open up the filter.

Mozart: Piano Concertos No. 14, K. 449, 22, K.482. Paul Badura-Skoda; Vienna Symphony, Sterberg. Olympic 8104, sim. stereo, \$4.95.

It had to happen, I knew, as I ploughed my way through the piles of these many Everest-family reissues, in all sorts of quadramonic, stereo, simulated stereo, and maybe just mono. This one, turned over, displayed two



PAIA
ELECTRONICS, INC.

INTRODUCES
THE GNOME
MICRO-SYNTHESIZER
KIT



#3740 GNOME KIT
\$48.95
plus shipping & insurance 4 lbs.

THE GNOME FILLS A VARIETY OF NEEDS!

- TO THE SEASONED PERFORMER... It's the extra voice that completes a composition while leaving expensive equipment free for more demanding tasks.
- TO THE BEGINNER... It's a low cost introduction to synthesizers that won't be obsolete when more expensive instruments are purchased.
- TO THOSE IN BETWEEN... the GNOME's portability and ease of operation make it great for "toy boxes," sound effects or just for fun.

PAIA'S FREE CATALOG... features the GNOME and other electronic music kits. Check our Reader Service Number or Write: PAIA Electronics, Dept. A, 1020 W. Wilshire Blvd., Okla. City, OK 73116

Check No. 22 on Reader Service Card

listen

If your business is providing or operating quality sound systems for musical performances...

Listen to the sound of live music with a conventional reinforcement system and then with the unconventional BOSE 800 system.

Only BOSE lets through the clear, natural sound of the live musical performance... without traditional sound system coloration. Prove it to yourself. Just listen.

BOSE®



Please send information on the BOSE 800 to:

Name _____

Address _____

City/State/Zip _____

BOSE The Mountain, Framingham, MA 01701 Dept. AP

big columns of annotation—signed in large letters EDWARD TATNALL CANBY. So long ago, I did not even recognize a word of it! Don't think I was asked. The liner rights evidently go with the tapes which, maybe were Westminster? I'm not even sure. So I too am being reissued, along with the floods of old records revived. I feel like a fossil, or maybe a leprechaun.

Excellent music, as usual. Execrable sound. You can't tell me that any taped original, even c. 1954 maybe, could sound as scratchy and fuzzy as this. And painfully overloaded, as soon as the first loud *tutti* passage is reached. Awful. Too much. I expect I have the original of this one—I'll let you know if I can find it somewhere in the files. (Fat chance.)

And yet—Badura-Skoda emerged about that time as one of the finest Mozart players (Schubert too, any Viennese music) for recording. Like Gould he is better on discs than in the flesh, apparently. Jonathan Sternberg was one of the postwar reconstruction conductors, doing a job for the early Haydn Society recordings and then (I think here) for Westminster.

Good musical history on these records—it was the pioneer period for the LP via tape. But such a reconstruction as this scratchy disc? Well, it could be my stylus. (But why do the new Philips discs sound so good, same stylus?) Search through the rest of the Olympics on your own, and maybe put on ear flaps to contour the sound.

Baroque Organ Masters—Buxtehude, Boehm, Walther. Kenneth Gilbert, Casavant organs, Sts. Jean & Joliette, Quebec. **Orion ORS74155**, stereo, \$6.98.

Unusual among organ discs in that these modern Baroque-style organs are French Canadian, with (for my ear) a hint of the French Baroque in them, as of Louis XIV and XV. They are in two relatively modest Quebec churches and the sound is on the chaste side as here recorded, Joliette and Jean both. Partly due to modestly live acoustics, microphoned without any vast reverb. But the organs themselves, clearly out of the same builder's thinking, are almost aristocratically highbrow in sound though it is a lovely sound just the same. Kenneth Gilbert is a careful and accurate player who contributes his own relatively quiet expressiveness to the record. All this, in comparison to some of the showier recordings of the big old North German organs—which can be positively flamboyant when somebody (E. Power Biggs?) wants them to be! A good little recording of well-chosen music.

MAGNEPLANAR®

**They don't look like speakers.
They don't sound like speakers.
They sound like you're there . . .**

The company that developed the state of the art Tympani Magneplanar speakers has now developed a less expensive model, the MG-11, which is sold exclusively through Magneplan dealers.

With 85 square inches of tweeter and 500 square inches of total diaphragm area, this speaker produces a huge true to life sound so real it must be heard to be believed.

\$625.00 per matched pair.

formerly MG 2167-F

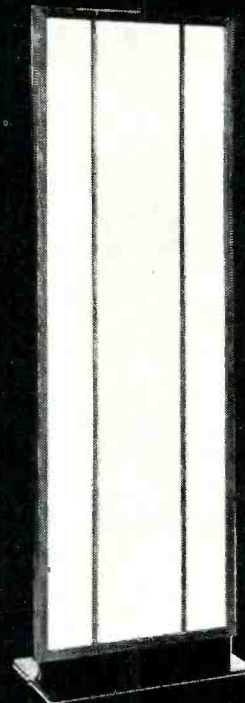

M A G N E P A N
MAGNEPLANAR® PRODUCTS

P.O. BOX 8642 WHITE BEAR LAKE, MINNESOTA 55110

Check No. 19 on Reader Service Card

Middle of the road?

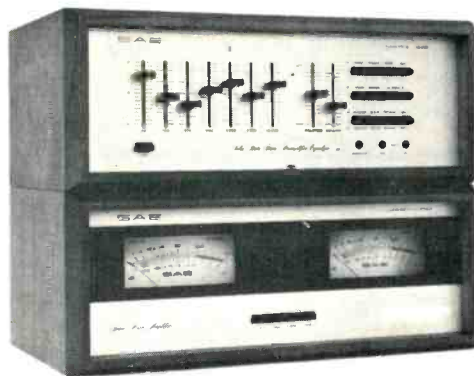

Not a chance! Even though the Mark IXB stereo preamplifier and the Mark IVDM power amplifier represent the middle of our product line, they by no means represent mediocrity. They both use only the highest quality parts such as 5% deposited-carbon resistors, military grade G-10 glass-epoxy circuit boards and Darlington transistors in the amplifier output stages. These are the same superior parts found in our most expensive components. Send coupon today for detailed information.

SAE

*Components
for the
Connoisseur*

SAE, Inc., Dept. A375
P.O. Box 60271, Terminal Annex
Los Angeles, California 90060

Gentlemen:

Please rush free information on the Mark IXB and Mark IVDM by return mail.

Name

Address

City State Zip

Check No. 30 on Reader Service Card

THESE AMPS SOUND BEST!



MODEL 250



MODEL 500D



MODEL 750A

BECAUSE THEY HAVE:

- No current limiting circuits to produce buzzes, rattles, or chirps at high levels.
- Enough muscle to create the effects for Universal Studios' great new movie sensation EARTHQUAKE.
- Incredibly accurate high speed OpAmp circuitry to eliminate phase shift and crossover distortion.
- Specs which meet the stringent, new FTC Regulation on Amplifier Ratings, while practically all others don't!

For data sheets and a reprint of the article "FTC Power Ratings: An Optimistic View," (Audio Magazine, Feb. 1975) write or call:



BGW Systems
P.O. Box 3742
Beverly Hills
CA 90212
(213) 391-0320

in Canada... Recrion, Limited
23 Vesta Drive
Toronto, Ontario
M5P 2Z6

Check No. 6 on Reader Service Card

Theater Music

Donald M. Spoto

Trouble in Tahiti: Leonard Bernstein Singers: Nancy Williams, Julian Patrick; Leonard Bernstein, conductor, with the Columbia Wind Ensemble. **Columbia EM 32597**, stereo, \$6.98.

The original mono recording of Bernstein's **Trouble in Tahiti** commands fancy scalpers' prices these days. Thus, this recent recording should command the interest of nostalgia-maniacs as well as Bernstein fans. It should also save members of these groups from paying inflated prices for the earlier discs, whose quality would be at least dubious.

Bernstein called **Trouble in Tahiti** "a lightweight piece. The whole thing is popular song-inspired and the roots are in musical comedy, or, even better, the American musical theater." He has wisely chosen to conduct this new release with the light touch it deserves, since the opera—a satire on the suburban good life, with dark undertones of disarray and discord—probably called "searingly honest" in 1952, has lost some of its oomph today. Two decades ago, suburban living was taken for granted as an ideal, so to demonstrate its insufficiency was at that time considered bold. (Middle-class values were religious ideals during the Eisenhower years, remember?) But the whole thing is a trifle naive after Stephen **Sondheim's Company**. The confrontations here between Sam and Dinah, the bored and estranged couple, lack subtlety. Bernstein is better off with someone else as his lyricist: Comden and Green did well for him in **Wonderful Town**. So did Sondheim in **West Side Story** and Richard Wilbur in **Candide**.

Still, the bittersweet finale is at least psychologically honest, with the couple failing to resolve their difficulties and going out to a movie, one of those examples of escapist Technicolor twaddle, **Trouble in Tahiti**.

The campy trio lilting in and out of the action like a Greek chorus has the best music Bernstein wrote for this bonbon, although I admire Nancy Williams and Julian Patrick for their solid voices and utter credibility as Dinah and Sam. Where Bernstein's

music for them unimaginatively recalls early Menotti (and Sam's fifth-scene aria is surely patterned on the famous soliloquy in **Carousel**), there are flashes of the sort of freshness he later brought to **Wonderful Town** in 1953 and his masterpiece, **Candide**, in 1956.

To Columbia's credit, the disc is free of warble or static; the musical preparation has obviously been careful, and the engineering serves the music well. Stereo separation is direct and reasonable, and there are no arbitrary pyrotechnics or sudden shifts.

Trouble in Tahiti is more than a curiosity but less than a masterpiece. Classify it as the work of a composer in progress, as Bernstein was then and, in his effort to do something on the grand scale, still is now.

Sound: B+

Performance: B

DYBBUK (Complete Ballet): Leonard Bernstein
New York City Ballet Orchestra, Composer Conducting; David Johnson, Baritone; John Ostendorf, Bass.
Columbia M33082, stereo, \$6.98.

New York's *wunderkind* has certainly come a long way since **Trouble in Tahiti**. His ballet music for Jerome Robbins' **Dybbuk**, which premiered May 16, 1974, is one of the most interesting compositions for dance in several years.

Dybbuk is the lost, restless spirit that enters the body of a living person to possess it. This certainly seems to be the age of the bizarre, and even the arts are not immune from trying to cash in. Bernstein has used a 12-tone system which employs (perhaps too relentlessly, at times) the complexities of the kabbalah, the traditional Hebrew system of numerology.

This may seem precious to the average listener, and I doubt there will be many music students anxious to decode it all, but the total effect of the music is strangely moving. In sections called *Witnesses of Birth, Possession,*

and *Exorcism*, the music has an eerie quality—Bernstein avoids easy cliches to which Robbins' choreography must be entirely apposite.

Numerology and dodecaphony notwithstanding, there are measures of almost unbearable tenderness (*The Children* and *Leah* invite reflection), suggesting that *Dybbuk* is not all head and no heart. And there are favorite chords from his earlier symphonies and from *Chichester Psalms*, too. The *kind* has certainly excited *wunder* this time, and I shouldn't be surprised if he supervised the stereo processing, too, which is happily free of muddy brassiness and excesses.

David Johnson and John Ostendorf try valiantly for a dozen phrases of indistinguishable Hebrew chant in the opening and closing sections. This will not appreciably further their singing careers.

Sound: A Performance: B

La Boheme: Puccini.

Singers: Caballe, Domingo, Milnes, Blegen: **Conductor,** Solti.

RCA ARD2-0371, CD-4, two records, \$13.98

I thought I was hearing this old chestnut for the first time. That's how good this new recording of Puccini's *La Boheme* is. The talents of Caballe, Domingo and Solti . . . and an absolutely beautiful quadrasonic effort from RCA. There are entire sections of this sweetly rapturous score that shine out like restored pictures; the third act opening, for example, and the brief interludes in the last scene. The usual muddiness that accompanies the second act crowd scenes has vanished.

To praise Caballe's *pianissimo* now is to state the obvious, but what may not be so evident is the real sensuous feeling with which she modifies the usually tepid renderings of the tubercular Mimi. Domingo's voice blends superbly with hers, and Maestro Solti modulates everything with a reverence that this opera does not ordinarily receive.

Judith Blegen's *Musetta* isn't quite as brash as it should be, but it is an appealing portrait. The entire recording, in fact, is a fine example of a cast and crew that you could never have on the stage (rather like the Sutherland-Pavarotti-Caballe *Turandot* under Mehta) without weeping with laughter, but the tears in the living room betray another emotion. This new *Boheme* would make an old softie out of Ming the Merciless.

Sound: A Performance: A

THE STR P12 IS ONE OF THE BEST SPEAKERS MONEY CAN BUY.

Here's Why:

Better Frequency Response

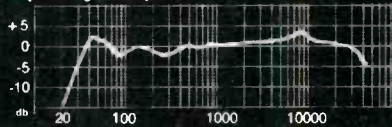

P12 Frequency Response

Note the absence of peaks in the 50-70 hz range. Some manufacturers deliberately put peaks in this range to make their systems sound bassy — they accomplish this by placing the system resonance in this range. But since useable response only goes down to at best one half octave below the system resonance the 20-35 hz range must be sacrificed to gain this boominess. Manufacturers that use this technique usually do not publish impedance curves because they show clearly where the system resonance lies. This brings us to the next reason why the P12 is so good.

The Impedance Curve

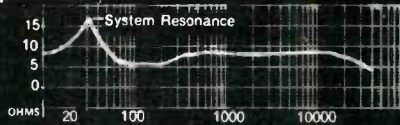

P12 Impedance Curve

Notice that the P12 has a system resonance of 31 hz which insures good response down to 20 hz. Also notice that the impedance curve is reasonably flat over most of its range.

Superior Flexibility

Full range controls on both the tweeter and midrange allow you to adjust the volume of both drivers independently from all the way off to all the way on. This insures that the P12 will sound as good in your living room as it did in the showroom.

Tomorrow's Technology — Yesterday's Craftsmanship

The P12 uses a sophisticated coupling cavity to extend the bass response of its "bottom loaded" woofer. Also three space age piezoelectric tweeters are housed in the P12's beautiful hand-made, hand-finished 80 lb. floor standing enclosure.

Better Warranty

Five years.

We will be pleased to send you an information package on our complete line if you will write or call.

STR

IN CANADA CONTACT
UNIVERSAL RESEARCH CORP.
NEW ADDRESS: 3000 ORANGE GROVE AVE.
N. HIGHLANDS, CALIF. 95660
NEW PHONE: (916) 488-6801

Check No. 35 on Reader Service Card

FREE McIntosh CATALOG and FM DIRECTORY

Get all the newest and latest information on the new McIntosh Solid State equipment in the McIntosh catalog. In addition you will receive an FM station directory that covers all of North America.



MX 113

FM/FM STEREO - AM TUNER AND PREAMPLIFIER

SEND TODAY!

McIntosh Laboratory, Inc.
East Side Station P.O. Box 96
Binghamton, N.Y. 13904
Dept. 1

NAME _____

ADDRESS _____

CITY _____ STATE _____ ZIP _____

If you are in a hurry for your catalog please send the coupon to McIntosh. For non rush service send the *Reader Service Card* to the magazine.

Check No. 21 on Reader Service Card

Jazz & Blues

Duke Ellington: **The World of Duke Ellington**; Columbia KG 32564, two discs, stereo, \$6.98.

The Duke Is On The Air: Aircheck #4, mono, \$5.98.

The Second Sacred Concert; Prestige 24045, two discs, stereo, \$6.98.

Duke Ellington, The Pianist; Fantasy F-9462, stereo, \$5.98.

While the death of Duke Ellington last May has not triggered the avalanche of issues and reissues one might have anticipated, the Ellington discography continues to grow at a steady pace, and Ellington collectors will surely require all four of these releases. Indeed, jazz buffs in general will find much that is valuable in all of them.

The Columbia double set is vintage, 1947—a perplexing year for

Ellington, and a very bad one for his fellow leaders on the then-declining big band scene. Nevertheless, while other bands were folding, Ellington persevered, returning to Columbia after a seven-year absence, where he cut these sessions for the label between August and December 1947. (In 1948 the American Federation of Musicians imposed a second recording ban, which kept bands from entering recording studios for the entire year. In retrospect, the AFM's short-sighted policy resulted in pop singers become increasingly important at the expense of instrumentalists.)

The material in *The World of Duke Ellington* is uneven; there are a number of trite pop tunes like *It's a Mad, Mad, World*; *Kitty*, and *You've Gotta Crawl Before You Walk*. They were re-

corded, suggests Stanley Dance, who wrote the album notes, "perhaps with an eye to a jukebox hit." Whatever the reason, none of this dross posed any threat to such jukebox heavyweights of the period as Frankie Laine or Jo Stafford. Far more productive musically are the many fine jazz instrumentals. *Hi Ya Sue*, which kicks off the first side is a vigorous, earthy, medium tempo blues with a flashing, high-stepping solo by altoist Johnny Hodges, and splendid followup choruses by trombonist Tyree Glenn and tenor-man Jimmy Hamilton. *Lady of the Lavender Mist*, which follows, is a vivid showcase for the sonorous, impressionistic Ellington ensemble sound. The flip side includes *Maybe I Should Change My Ways*, a tune from the Ellington-Latouche score of **Beggars' Holiday**; it's crisply and smoothly played by a very mellow sax section and spots expressive solos by trombonist Lawrence Brown and violinist Ray Nance. *Sultry Serenade* is another fine track in the robust dance band tradition of the 40s.

The high point of **The World of Duke Ellington** is a showcase for all the band's power and solo strength; *Three Cent Stomp*. *The Progressive Gavotte* is an example of Ellington whimsey—titled at a time when to be "progressive" in jazz was to be *au courant*. *Progressive Gavotte* is actually a good ballroom piece taken at a relaxed tempo from which Johnny Hodges emerges with an outstanding chorus—his lush, mellow tone, flowing phrases and swinging beat are joy to the ears. Hodges also buoys up the nonchalant *Take Love Easy*, another good tune from **Beggars' Holiday**, which features a low key vocal by Dolores Parker. *I Can't Believe That You're In Love With Me* is played with joyful elan in an informal jam session setting with rocking solos from practically everyone in the band. *How High the Moon*, another sizzler, is one of the best big-band interpretations of the jazz classic ever made. Side Four offer a straightforward and vigorous *Singin' In the Rain*, Al Hibbler on the now-standard, *Do Nothing 'Til You Hear From Me*, and the exquisite *On a Turquoise Cloud*, with a shimmering, worldless vocal by Kay



Davis. The arrangement is a marvel of sensual impressionism.

While **The World of Duke Ellington** is not the apex of Ellingtonia, it does display enough expressive writing and playing and the casually supreme caliber of Ellington's sidemen to make it an important addition to the Ellington discography. The sound transfer job, both from the original 78s and from an early 10-in. microgroove LP, is excellent. Kudos to Columbia engineer Tom Geelan.

Sound: A- Performance: A

The sonics of the release called **Duke on the Air** would certainly win no awards from the IHF, but considering it's a 1952 aircheck of a big band remote from Chicago's late, lamented jazz club, the Blue Note, the sound is adequate. This recorded rarity contains broadcast versions of Ellington standards like *Flamingo*, *Rockin' in Rhythm*, *Tulip or Turnip*, *Bakiff* and *Sophisticated Lady*, and makes for interesting comparison with the studio recordings.

In 1952, the year the Ellington band got out of the doldrums that were a holdover from the late Forties (in 1950 *Down Beat* magazine gave Ellington a scroll commemorating the fact that his was the only leading band from the magazine's 1949 poll still in existence!). Drummer Louis Bellson was the band's inspiration as it emerged from this difficult period, and he sparks the ensemble on driving performances of *The Hawk Talks*, *Jam With Sam*, and *Flying Home*. The Ellington orchestra, which now boasted the tremendous trumpet section of Clark Terry, Ray Nance, Willie Cook, and Cat Anderson, plays with a raw, urgent sound, and with fire in its belly.

Sound: C Performance: A-

Two decades later the sense of urgency had gone, and many devoted followers of Duke felt he was coasting through his final years and were dubious about his forays in religious music. Indeed, the **First Sacred Concert**, recorded in 1965, was not well received. But the **Second Sacred Concert**, just reissued by Prestige, performed and recorded at the Cathedral of St. John the Divine in 1968, is a rich, exultant work that may eventually be regarded as an important piece of American music.

The **Second Concert** is many faceted, with elements of sensuality, reverence, spirituality, and drama. The Ellingtonian orchestral effects are always in evidence—the idiomatic

cross-harmonies, polyrhythmic effects, unusual modulations and dissonances have been welded to passionate vocal declamatory passages. The outstanding *Heaven* section, which features Ellington's nimble, striding piano, a stunning recitative by the Swedish soprano Alice Babs, and an exquisitely phrased, flowing chorus by Johnny Hodges, is memorable and moving. Another highlight is an evocative solo by Duke called *Meditations*.

Sound: A+ Performance: A

Duke Ellington the pianist was always overshadowed by Ellington the leader/composer/orchestrator. Yet one of the special treats for the Ellington connoisseur was to occasionally savour Duke at the keyboard as soloist or accompanied by rhythm. Fantasy's *Duke Ellington, the Pianist* is taken from some casual sessions taped in New York City and Las Vegas. The New York performances are disappointing and do not compare with the superb Ellington trio recordings made in Hollywood for Capitol in 1963. The New York tracks cover Side One and part of Side Two, they are pleasant but superficial.

The chordal explorations and sinuous lines, incorporating the melodic curve of the blues that one comes to expect from this marvelous piano player are not present until we get to the 1970 Vegas sides, which are the last three selections on the LP. *Duck Amok*, is a rocking exercise in which Duke growls and stomps his way through a cluster of earthy chords; *Never Stop Remembering Bill*, dedicated to the late Billy Strayhorn is evocative Ellington at its best, tender and singing, the pianist embellishing the theme with magnificent arpeggios. *Fat Mess*, the final cut, swings urgently and is played cuttively by Duke, drummer Rufus Jones and bassist John Lamb. Remixed at the Berkeley Fantasy studios by Skip Shimmin and Orrin Keepnews, Duke Ellington, the Pianist offers splendid stereo sound.

John Lissner

Sound: A+ Performance: A-

Keep Your Lamp Trimmed and Burning: Fred McDowell.

Musicians: McDowell, vocal and guitar: Johnny Woods, harmonica: Mike Russo, guitar: John Kahn, bass: The Hunter's Chapel Singers.

Songs: *I Heard Somebody Calling*, *Amazing Grace*, *Where Could I Go*

The dependable public address equipment



All AHUJA products manufactured with scientific precision for sound communication are the last word in performance, reliability and finish. A wide product range includes

- Amplifiers—10 to 120 Watts RMS power ratings. AC, car battery and dry battery cells working.
- Microphones—Unidirectional dynamic for all purposes. Stand mount, hand-held and gooseneck types.
- Driver Units & Unit Horn Combinations 10 Watts to 40 Watts RMS with 8 ohms, 16 ohms and 100V line working.

With world-wide reputation, AHUJA is the leading choice in over 45 countries. Competitive prices and prompt deliveries.

AHUJA

bound to sound good

AHUJA RADIOS
215, OKHLA INDUSTRIAL ESTATE
NEW DELHI—110020 (INDIA)

Issued by: Engineering Export Promotion Council,
Calcutta (India)

Check No. 1 on Reader Service Card



Stereo Shelving with a Twist!

As versatile as it is beautiful—Kirsch® Freestanding Shelving. With just a twist to its exclusive Ring-lock™ design, add or remove units as you need them. Features new flush top design. Solid support. Resistance to stains. Best yet, it's reasonably priced. At fine stores that carry Kirsch. Or write: Kirsch Co., Dept. D-375, Sturgis Mich. 49091.

Kirsch

where quality still means something.

Check No. 17 on Reader Service Card

the sound build-up

Professional results — the basis of our home constructor speaker and amplifier kits.

Genuine walnut veneer cabinets, plus the finest component parts, make our kits outstanding value for money.

A 50% saving over built-up units. Send for free catalog now!

NAME _____
 ADDRESS _____
 CITY _____
 STATE _____ ZIP _____

ruxton electronics

P. O. Box 30312 Santa Barbara California 93105

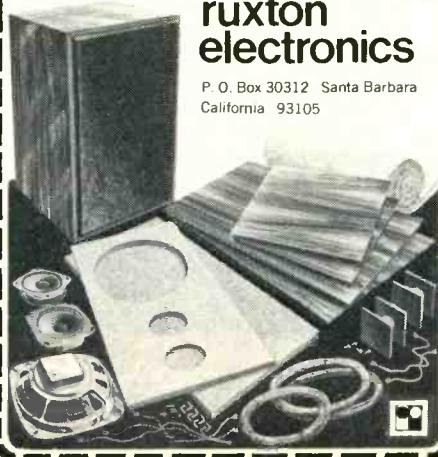

Check No. 29 on Reader Service Card

Direct-Coupled



The Polk Audio Model 9 is a high-definition floor-standing system which employs many unique concepts in order to recreate the sound field of a live performance. A dipolar sound source, it combines an 8 inch passive radiator, four extended-range 4½ inch drivers, and the exceptional Polk Audio piezoelectric high-frequency unit, without the use of distortion-introducing electrical crossover networks. Price: \$165.00

Canada: Edon Acoustics Ltd., Ottawa
 Dealer Inquiries Invited

polkaudio

431 Notre Dame Lane
 Baltimore, Maryland 21212
 (301) 532-8064

Check No. 26 on Reader Service Card

But To the Lord, Keep Your Lamp Trimmed and Burning, Bye and Bye, Dig My Grave With a Silver Spade, Don't Look For Me on a Sunday, Good Morning Little Schoolgirl, Little Girl, Little Girl, Levee Camp Blues.
 Arhoolie 1068, \$5.98.

Death came to Fred McDowell on July 3, 1972—an untimely tragedy that took him away from us at the height of his career. But Fred McDowell's music lives on after him. He has left a legacy of pure, unadorned blues for people the world over to enjoy and tap their toes to.

"Mississippi" Fred McDowell, as he was affectionately called, lived in Como, Mississippi where he plowed behind a mule and drove a tractor. Fred McDowell was a natural musician, and a very natural man.

In Como, Mississippi Fred would often play his guitar behind the choir of Hunter's Chapel or just sit around the house playing for his own satisfaction. Such a perfectionist was he that he'd stop even in the middle of a performance to tune his guitar.

As he began to travel around the countryside (and later the world) his career mushroomed, his reputation blossomed. During his lifetime Mississippi Fred made many appearances at the Berkeley Folk Festival and other places on the West Coast including Phil Elwood's class at Sonoma State College. McDowell played for Pete Feldman in Santa Barbara, at the Ashgrove in Los Angeles, for the Cate School in Carpinteria as well as in Portland, Oregon and Seattle, Washington. He played concerts and clubs in the East, appeared at the Newport Folk Festival and went abroad with John Lee Hooker, Doctor Ross, Buddy Guy, Big Mama Thornton, Eddie Boyd, and Big Walter Horton, among others.

By 1971 Fred began to get more bookings than he could handle, due in part to the Rolling Stones' recording of his composition *You've Got To Move* on their LP *Sticky Fingers*.

This recording has Mississippi Fred picking and singing in his high-pitched, haunting voice, a cross-section of good ol' country blues, all composed and arranged by the superb rural musician himself. Fred McDowell is not at his best here but neither is he at his worst. His eerie bottleneck sound comes right through in *I Heard Somebody Calling*, his guitar emulating his expressive voice which has a skywide range. One can hear his foot tapping alongside his guitar as he set up a cadence, varying the resonance of his instrument from a dull thud to a bright

glow. This part of the recording was recorded live and features Fred talking right through it.

The most jazzed-up version of *Amazing Grace* I've ever heard follows as Fred plays now soft, now loud. *Where Could I Go But To the Lord* features Fred accompanying the Hunter's Chapel Singers at a lilting bounce. Unfortunately, the seemingly free form singers sound a bit sloppy and unsynchronized.

Mississippi Fred delivers a pungent, spicy sound in *Bye and Bye*. Faster and faster he goes, his guitar playing extraordinary! The best sound on the recording is *Dig My Grave With a Silver Spade*, with Mike Russo on guitar and John Kahn on bass. It is a clear demonstration of the richness and fullness of McDowell's style. Fred implies or insinuates as much as he actually plays, thus leaving a great deal to the listener's imagination.

Don't Look For Me On a Sunday is taken at a very slow, sauntering pace, Fred seeming to drag his finger up a string while *Good Morning Little Schoolgirl* is the extreme opposite, with a sunny quality, moving along at a fast clip.

Fred makes a beautifully subtle entrance in *Little Girl, Little Girl* and it all comes to an end with *Levee Camp Blues* with his favorite harmonica player, Johnny Woods, joining him. They really wail together, and at one point play a truly amazing unison passage:

Sound quality throughout is variable, a mite muddy, but we must remember part of this was recorded in concert.

Whether you are a Mississippi Fred McDowell fan, or you've never heard him, come share with him, as he so generously did with us.

Martha Sanders Gilmore

Sound: B- Performance: B

Lookout Farm: Dave Liebman

Musicians: Liebman, soprano and tenor sax, flute; Richard Beirach, electric and acoustic piano, Frank Tusa, electric and acoustic bass; Jeff Williams, drums; John Abercrombie, acoustic and electric guitar; Armen Halburien, percussion; Don Alias, congas, bongos; Badal Roy, tablas; Steve Sattan, tambourine, cowbell; Eleana Sternberg, voice.

ECM 1039 ST, stereo, \$6.98.

A couple of years ago I went to hear the Elvin Jones Quartet at the Village Vanguard during the Newport Jazz Festival. Following a day of seemingly endless trekking around New York from one concert to the next, we arrived at the Vanguard pooped.

Well, snoozing in a corner of the bandstand was a young man, soprano sax in hand. Little did we know it was Dave Liebman.

As the group began playing, suddenly the soprano man arose from his deep sleep, swung up front with his axe, and began blowing! He conjured up a flowing solo with impeccable taste, dazzling variety and technique, with a rich, full-bodied tone. Many exciting choruses later he sat back down as abruptly as he'd arisen, and went back to sleep!

Well, here he is leading his own talented group. Dave's own solos are like what we heard at the Vanguard, just performed with a different band. Though most of these musicians may be unknown to you, don't despair. The group is tight; it cooks. And one listen to the album will make you eager for more. You will immediately want to remember these musicians' names. Their performances certainly show them to be talents deserving of wider recognition.

On sessions such as this one, which include both acoustic and electric instruments, all too often the acoustic instruments are used too little, e.g. only on the last chord of a tune or for the opening chord of another, with the rest of the number sounding like an explosion at Con Ed's main power plant. I had feared that might be the case here too, but not so. I was pleasantly surprised.

Richard Beirach does a tremendous job on acoustic piano on *Lookout Farm*. Following a very free first half, there is a complete turnaround into an up-tempo jazz four-beat. He takes another refreshing outing on *Pablo's Story*, an airy samba. Jeff Williams is consistently fresh and he employs a whole gamut of dynamics that many other drummers do not know. Don Alias is brilliant on congas as usual. Both play magnificently whether underlining rhythms in the ensemble or soloing. And Liebman's horn work should satisfy any musical appetite. His funky soprano work on *Sam's Float* and his brilliant quote from the diametrically-opposed *Andalucia Suite* by Ernesto Lecuona show off his rich and varied grab bag of tricks.

Those who are familiar with ECM's top recording techniques, as well as the quality of the music they package will expect nothing but their best from Dave Liebman's *Lookout Farm*. To those who are unfamiliar with ECM's albums I say, take a chance—you'll be glad you did.

Eric Henry

Sound: B+ Performance: A



WHO'S WATCHING YOUR SPEAKERS?

You and your ears, most certainly, but so is your amplifier. It watches through feedback, electrically sensing what your speaker is doing. Specifically, it watches the "back power" from the driver; power that is the product of *voltage* and *current*.

Feedback to your brain comes from your senses. Can you see 3-D with only one eye? Can you hear 3-D with only one ear? No, 3-D is the result of dual observation.

Power Amplifiers have two stages—a *voltage* or driver amplifier and an output or *current* amplifier, yet they only look at one part of the feedback from the speaker—the voltage. Not very 3-D if we want the speakers controlled as well as driven.

CURRENT X VOLTAGE = POWER

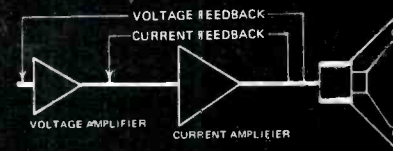

"Block Diagram of The Quintessence Group Ltd. Power Amplifier II"

The Quintessence Amplifier has two feedback paths: one for *voltage* and one for *current*; the result is controlled power. The electrical signal going to the power amplifier is a model of the sound we wish to produce—a controlled speaker reproduces this sound exactly, an uncontrolled speaker interprets it—interpretation should be left to the artist!

This dual feedback control dynamically reduces THD (total harmonic distortion), IM (intermodulation distortion), and TIM (transient intermodulation distortion) and assures stability and drive into any load.

Conservatively rated at 150 watts per channel into 8 ohms (FTC). The forced air cooled Quintessence Amp will drive over 500 watts into 2 ohms with no danger of overload.

In the Quintessence tradition of simplicity, symmetry, quality and reliability—a most interesting Power Amplifier. The audiophile price—\$1200 dollars; the warranty—for a lifetime.

"Aware Of The Finest . . ."

QUINTESSENCE GROUP LTD

1626 NORTH C ST.

SACTO. CALIF.

(916)441-5175



95814

Check No. 27 on Reader Service Card

Incredible.

How else would you describe a preamplifier with:

- A **Peak Unlimiter** that restores dynamics lost in recording to closely approximate the original.
- A **Downward Expander** that reads "gain riding" and expands dynamics down to precisely the intended level.
- An **AutoCorrelator** that makes record/tape hiss and FM broadcast noise virtually vanish without affecting musical content.
- **Plus** an Active Equalizer that gives you flat energy distribution over the full audio spectrum, Joystick Balance and Step Tone Controls that allow precise music tailoring to your listening environment and SQ* and Phase Linear differential logic for Quad Sound.



The 4000 is an advanced stereo preamp that actually puts back in what recording studios take out . . . lets your music (at last) reach life-like levels without distortion . . . lets you (for the first time) hear your music from a silent background. It is, in a word, incredible. Ask your dealer for an audition.

Warranty: 3 years, parts & labor.

Phase Linear 4000

THE POWERFUL DIFFERENCE

PHASE LINEAR CORPORATION
P.O. Box 1335 • Lynnwood, Wash. • 98036

*SQ is a trademark of CBS, Inc.

Check No. 23 on Reader Service Card

Tape & Turntable

Bert Whyte

SOME MONTHS ago there was a change of command at Ampex Stereo Tapes, and as a consequence all of their open-reel tape production virtually stopped. Since then several polls conducted by AST has shown that there is a large and sustained interest in open reel tapes, and fortunately for us, a new series of monthly tape releases has been initiated. Some tapes are now beginning to reach us, as witness this fine example:

Symphony # 4 (The Inextinguishable), Nielsen: Zubin Mehta, the Los Angeles Philharmonic.

Ampex/London L46848, open reel, 7½ ips, Dolby B, stereo, \$9.95.

Nielsen is enjoying a vogue at present, and this is reflected in the fact that most of his symphonic output has now been recorded. This 4th symphony is a broadly contrasting work, with long cantabile passages punctuated by violent orchestral outbursts and even some flirtation with atonality. The four movements are meant to be played without a break, and the finale has become something of a sonic showpiece (and a natural for stereo) wherein there is a tympanist at each side of the orchestra. The one at the left of the orchestra "battles" the one on the right with some thunderously loud and wonderfully intricate figures in this final passage.

Mehta is thoroughly at home with this kind of music and his taunt, compelling performance would be hard to top. There are some incredibly difficult unison string passages in this work and the L.A. Philharmonic traverses them with ease. The sound is broadly spacious, but with good orchestral detail in the London/Decca manner. Overall sound is slightly on the bright side, all elements very clean, inner balances good, and frequency and dynamic ranges very

wide. The tympani "duel" is exciting, but I would have liked a little sharper focus, a less resonant sound from the tympani. The Dolby B processed tape is virtually free of tape hiss and print-through.

Hugo in Wonderland: Hugo Montenegro and his Orchestra.
RCA APD1-0413, CD-4, \$6.95.

This is another outstanding example of four-channel sound from that master of the medium, Hugo Montenegro. Here he explores the music of Stevie Wonder in a group of his well-known ballads, including a super arrangement of *You Are The Sunshine Of My Life*. Once again the superbly clean and beautifully balanced recording is engineered by my former RCA colleague Mickey Croford, aided by Brian Christian.

Hugo artfully employs all the quadraphonic trickery . . . front-to-back switching, criss-cross, and pan-pot "swirl around the channels." The pinpoint localization of various instruments sets a new standard for CD-4 quality. The overall sound is certainly wide in frequency response, and would seem to refute the contention of some that CD-4 sound is restricted in bandwidth. Another plus is the excellent surface, a result of the new RCA record compound announced some months ago. All in all, one of the best CD-4 recordings on the market.

Organ Music From Westminster: Edward D. Berryman, organist.
Ark Records 10251-S, \$6.95.

For audiophiles in the know, this is a famous recording, being an outstanding demonstration record, especially for low frequency reproduction. Ark Records is a small company based in Minneapolis. I recently had the pleasure of meeting the owner (and recording engineer) of Ark, Bob

Fulton. Bob is a gifted person who runs a unique operation in Minneapolis, a combination of record producing company, speaker manufacturer, and audio research laboratory. One of the reasons for the super wide-range response of this recording is a special condenser microphone designed and built by Bob (for \$6000) and special recording electronics for his tape machine. Bob's Fulton Sound Company builds custom loudspeakers based on the modular principle . . . separate woofer enclosure, dynamic mid-range, and electrostatic top end. The speakers come in several sizes and prices.

Because the woofer is in its own enclosure, it is frequently sold as a sub-woofer for use in other bi-amplified systems. This unit operates from 155 Hz down, with response stated to be only 2 dB down at 19 Hz! I heard the organ recording through this woofer as part of Bob's Model J speaker system and must say I have rarely heard the gut-shaking thunder of the 32-ft. contra bourdon pedal reproduced with such low distortion and impressive sonority.

The organ in this recording is a Kimball revoiced by the M.P. Moller Organ Co. which reposes in a splendid acoustic environment in the Westminster Presbyterian Church in Minneapolis. The reverberation time of the church is long enough to lend spaciousness and grandeur to the sound, but not so long as to obscure detail.

Dr. Berryman is a fine, if somewhat conservative organist with impressive credentials as instructor at several colleges and the University of Minnesota.

The program chosen by Dr. Berryman is quite varied, including pieces by Sweelinck and Mozart, J.S. Bach, Mendelssohn, Vierne, and Widor. But the showpiece of this album and the one most used for demonstration is Dr. Berryman's transcription of Sibelius' *Finlandia*. It runs the gamut in frequency response and dynamic range from quiet reflective passages to a massive outpouring of sound from the full organ.

It is a thrilling recording, and if you want to probe the low frequency capabilities of your system, you will find this disc most demanding. The recording is one of a series which includes orchestral works, made by Bob Fulton, and I will be reporting on them in due course. This organ disc can be ordered through Fulton Electronics (Ark Records) at 4128 Zane Ave. North, Minneapolis, Minn. 55422, for \$5.95.

Who knows?

- What is new in recorded music.
- What favorites have been re-issued.
- Whether tapes are available.
- What can be obtained in quadrasonic.

Schwann knows.

Schwann is that world-famous, ever-so-useful compendium of record and tape information. Issued in two volumes—lists 60,000 currently available records and tapes in many different categories to suit every taste and every need. Schwann knows plenty and tells all!

Schwann-1 Monthly. Special new listing section has latest releases: records, 8-track cartridge and cassette tapes. Nearly 45,000 total listings on 773 labels in classical, recent popular, rock, jazz, musical shows, country, opera, ballet, electronic, quadrasonic, etc. **95¢ at your dealer's.**

Schwann-2 Semi-annual catalog for specialized categories: pop more than two years old, classic jazz, older and re-released mono and reprocessed stereo classical recordings, classical on lesser-known labels, international pop & folk on domestic labels, spoken, educational, religious, etc. **85¢ at your dealer's.**



Get more pleasure.

There's more joy in recorded music when you get exactly what you want. Keep Schwann at hand, and always refer to it before you buy.

SPECIAL PRICE SAMPLE OFFER

If your favorite store doesn't carry Schwann, order samples by mail, but please try your dealer first. Prices include postage and handling.

- Latest Schwann-1 (monthly).....\$1.50
- Latest Schwann-2 (semi-annual).....\$1.25
- Combination Offer: latest Schwann-1 (monthly) and latest Schwann-2 (semi-annual).....\$2.50
- Newly revised Basic Record Library booklet.
Lists 1,000 suggestions in classical music by musical periods for your enjoyment. Send 25¢ for cost of handling, also 10¢ stamped self-addressed long envelope.

I enclose \$.....for the items checked above.

Name _____

Address _____

City _____ State _____ Zip _____

Dealer's Name & Address _____

Schwann Record & Tape Guide

137 Newbury Street, Boston, Mass. 02116

AU

Classified

FOR SALE

CASSETTE LABELS

Plain white cassette labels, Norelco cleaners, paper mailer boxes hold Norelco type plastic box, famous brand cassettes. "Like new" 10-1/2" metal reels. Send for open reel and cassette discount catalog.

	1-910-99	1001000	10M
Cassette Labels (Multiples of 10)	.02	.015	.01 .007
Norelco Cassette Cleaner	.65	.60	.55 .50 .45
Cassette Paper Mailer boxes	.03	.025	.022 .02 .018
*Scotch Cassette SC90HE	2.72	2.55	2.44 2.39 2.34
10-1/2" Metal, NAB Hole, Used	1.00	1.00	.90 .80 .75
*Buy 10, SC90HE, get 5 free			
Plus Postage by Weight and Zone			Minimum Order: \$5.00

OPEN REEL STEREO TAPE BUYERS!

At last! An open reel catalog, including titles, songs, etc. of 95 long play, 2-3 hour albums, by American Airlines or Ampex 4 track stereo tapes. Send \$1.00 — and we will also mail you a 140-page Harrison stereo tape guide — so you'll get both for \$1.00 — and this \$1.00 is refundable on your first \$10.00 purchase of open reel stereo tapes at our 30% discount.



SAXITONE TAPE SALES 1776 COLUMBIA ROAD, N.W., WASHINGTON, D.C. 20009

RECORDING TAPE CLOSEOUT: Dozen reels 2400', \$12.00. Dozen 1200', \$8.00. 24 reels 900', \$6.00. 24 600', \$5.00. Postpaid! Guaranteed. Mitchell, Box 132, Flushing, N.Y. 11367.

CROWN D1200 & M2000 on demo in our showroom. The cleanest amp ever made, driving RTR STUDIO MASTERS. Cyberacoustic Laboratory, 503 Haverford Ave., Narberth, Pa. 19022. 215-667-3048.

YOUR CUSTOM IMF DEALER in N. CALIFORNIA offers you:

IMF "MONITOR-ORIENTED" LOUD-SPEAKERS—STUDIOS, ALS40's, and amazing **SUPER COMPACTS.** Monitor III's available on special order!

IMF SUB-WOOFER KIT!! Dual transmission line system flat to 6 Hz—\$180!

IMF "CUSTOM-KIT" SPEAKERS—Incorporating plastic cone technology and "line tunnel" damping. Kit 'Q'—\$80.00. Kit 'R'—\$175.00, uses new version of KEF flat woofer!

Custom demonstrations under ideal listening conditions. For information and/or listening appointment, write or call Russ Goddard, **CUSTOM IMF DEALER,** 1171 W. Latimer, Campbell, Ca. 95008. (408) 374-4697.

OPERA TAPES. Historical performances of past 40 years. Unbelievable treasures and rarities. **ALSO LP RECORDS.** Free catalog. Ed Rosen, 66-33 Saunders St., Rego Park, N.Y. 11374.

NEW AND AMAZING

The sound sensation that's sweeping the nation. Rolan Star with unusual characteristics changes walls, floors and ceilings into speakers. Act Now! Send for free literature. James A. White, 5302 Pine St., Phila., Pa. 19143.

FOR SALE

CONNECTICUT: Yamaha, Celestion, IMF, Infinity, Braun, Revox, Stellavox, Thorens, ESS, Mark Levinson, Supex, BGW. Will ship prepaid. **AUDIOCOM,** 177 Sound Beach Avenue, Old Greenwich, Conn. 06870. (203) 637-3621.

WANT TO GO BI-AMP?

DeCoursey Electronic Dividing Networks are available from \$89.10 (Monaural bi-amp) to \$205 (Stereo tri-amp). Price includes plug-in Butterworth filters; 6, 12, or 18 db per octave at any desired cutoff frequency. Write for brochure. DeCoursey Engineering Laboratory, 11828 Jefferson Blvd., Culver City, California 90230.

ARE YOU READY TO UPGRADE YOUR PRESENT SYSTEM??? You can incorporate the latest technological advances into your sound system by consulting with the staff of

The DKL LABORATORY, INC.

We offer expert advice and the experience of testing hundreds of "state-of-the-art" components to find those units that offer vast sonic improvements at the most reasonable prices. For a personal consultation:

Write: **The DKL LABORATORY, INC.**

P.O. Box 683

Severna Park, Maryland 21146

or Call: (301) 647-8918, during our convenient evening hours, 8-11 PM Eastern time.

LOWEST DISCOUNT PRICES ANYWHERE on audio equipment. All major brands discounted. Write for quotes. K&L Sound Services, 75 N. Beacon St., Watertown, Mass. 02172.

DIAMOND NEEDLES and Stereo Cartridges at Discount prices for Shure, Pickering, Stanton, Empire, Grado and ADC. Send for free catalog. **LYLE CARTRIDGES,** Dept. A, P.O. Box 69 Kensington Station, Brooklyn, New York 11218.

SPEAKER SPECIALIST. TOBY Corporation of America, 4620 Camp Bowie, Fort Worth, Texas 76107.

THE MONEY SAVER! Write **STEREO SPEC-TRUM,** Box 1818, Miami Beach, FL 33139.

ARP SYNTHESIZERS!

Pro-Soloist \$920. Odyssey \$1150. String Ensemble \$1380. #2600 \$2310. Dickstein Distributing, 1120 Quincy Avenue, Scranton, Pennsylvania 18510.

PIEZO-ELECTRIC TWEETERS. Write for specifications & prices. **The EAR DRUM,** 5146 W. Imperial Hwy., Los Angeles, Calif. 90045.

CERWIN-VEGA PRODUCTS (312) 581-7436.

QUOTES ON 60 POPULAR BRANDS. Specializing in "high end" and hard to find equipment—Ace Audio, Cizek, Fulton, Phase Linear, Phillips—much, much more. Sound Center, 219 E. 17th, Bloomington, Indiana. (812) 332-4252.

FOR SALE

OPERA TAPES-RECORDS "live" broadcasts. Complete Met broadcast cast list, \$1.00, deductible from first order. Hathaway, 49A Merbrook, Merion, Pa. 19066.

NORTHWEST'S FINEST AUDIO DEALER—Audio Research, Dayton Wright, IMF, Fulton, Hartley, Mark Levinson, Dahlquist, Infinity, Radford, Crown, BGW, Quad, Decca, Supex, Phase Linear, Braun, Tandberg, Linn Sondek, and Many More. **HARTLEY ELECTRONICS,** 1502 Butternut, Richland, WA 99352 (509) 947-5026 after 5:00 PM weekdays, all day weekends.

TUNED ROCK P.A.'s. Customized high intensity touring/permanent installation sound systems, including narrow band (5'hz!) feedback suppression, detailed regenerative response, Acousta-Voicing/environmental equalization (\pm 1db at your ears), room design/measurement/treatment, <15% articulation loss of consonants, 1000's of customized professional products including... fiberglass horns, consoles, comp/rms/peak limiters, 18db continuously variable electronic crossovers, digital/acoustic delays, omnipressors, phasors, reverb, echo, doubling/tripling effects. P.A. noise reduction, piezo transducers, frequency shifters from... J.B.L./Altec Pro., Tascam, U.R.E.I., Eventide, Gately, Schoeps, Beyer, Crown, Community Light/Sound, Mom's Audio, McIntosh, Bozak, Allen Heath, Gauss, Cetec, Langerin, Electrodyne, etc., etc. All shipped prepaid/Insured. Music & Sound Ltd. 11 1/2 Old York Rd., Willow Grove, Pa. 19090 (215) 659-9251.

FLORIDA AUDIOPHILES! Phase Linear, IMF, Linn Sondek, Klipsch, RTR, B&O, Revox, Quad, Thorens, Sony, Marantz, Barzilay cabinets. Sales & repairs. **INTERIORS PLUS SOUND,** 3038 N. Federal Highway, Ft. Lauderdale, Fla. 33306. (305) 566-3511.

AUDIO RESEARCH MAGNEPLANARS and Electronics. ESS, Infinity, Ohm, Dahlquist, EPI, Audionics, Radford, Crown, Citation, BGW, Transcripitor, Linn-Sondek, Keith Monks, ERA, Connoisseur, SME, Supex, Decca, Grace, Sony, Spectrum Scanning Tuner, Epicure Amplifier, Marantz 500, DBX, ADC, Nakamichi, B&O, Tandberg, Celestion, Marc Levinson, Stax, Dayton-Wright, others. **THE GRAMOPHONE LTD.,** 757 Asp St., Norman, Okla. 73069. 405-364-9477.

FIREWORKS NEWS MAGAZINE—Covering Commercial — Display Fireworks, Sources, Construction, Black Powder, Fuse, Literature. Firecrackers To Bombshells! Interesting Catalog—25c. With Sample—\$1.00. Pyro Press, Box 12010-P, Lexington, Kentucky 40511.

SONY TC-134SD Cassette Deck w/Dolby Used 5 hrs. \$180. Doug Rein, R.R.I., Winthrop Minn. 55396.

Rates: 35¢ per word per insertion for noncommercial advertisements; 60¢ per word for commercial advertisements. Frequency discounts as follows: 3 times, less 10%; 6 times, less 15%; 12 times, less 20%. Closing date is the FIRST of the second month preceding the date of issue. Payment must accompany all orders. Use the handy self-addressed, postage paid card at the back of this issue. When replying to AUDIO box number ads, send letters c/o AUDIO, 34 North 13th Street, Philadelphia, Pa. 19107. For more information about classified advertising, circle Reader Service Card #135.

FOR SALE

LOW NOISE RESISTORS— $\frac{1}{4}$ W, 5%, carbon film from 10-33 Meg. for $3\frac{1}{2}$ ¢ each. Fifty of one value for \$1.25 (10% discount over \$50.) 75¢ postage/handling. **COMPONENTS CENTER-A**, Box 134, New York, NY 10038.

ADVENT, CROWN INTERNATIONAL, McINTOSH, REVOX, THORENS, SME, IMF, JBL, EPI, CITATION, BEYER. FULL SERVICE ON ALL EQUIPMENT!!!

STEREO SOUND

320 Route 10,
East Hanover, New Jersey 07936
(201) 386-0050

ORTOFON — SUPEX CARTRIDGE OWNERS; our Micro-Preamplifier outperforms any transformer. Free literature. **Huntington Electronics**, Box 2009-A, Huntington, Conn. 06484.

SCA ADAPTOR KIT \$15.00. Send \$1.00 for diagram and information to: **Arnold McGall 9 Clarkes-Crossing, Fairport, New York 14450**.

ELECTRONIC CROSSOVERS—ALL TYPES. Definitive booklet describes applications; how to improve speaker systems. \$5.00, credited to first purchase. **Huntington Electronics**, Box 2009, Huntington, Conn. 06484.

AUDIO EXCELLENCE from Advent, Audio Research, BGW, B&O, Fulton, Grace, Dahlquist, Levinson, Infinity, Quintessence, Phase Linear, SAE, STAX, Supex, RTR, Revox 700, Nakamichi, Tandberg, Technics, Magneplanar. "Certified Audio Consultant," **STEREO SHOP**, 107 Third Ave. SE, Cedar Rapids, Iowa 52401. 319-365-1324.

THE SS-3 PORTABLE MIXING CONSOLE provides unmatched performance in remote recording applications. Available in 2, 4, 8, 16 and 24 track configurations. Write for specs. Reply Box No. A47-1.

AR, KLH, ADVENT, DYNACO, RECTILINEAR, ADC OWNERS—Our electronic equalizer gives your speakers a full octave of new bass, plus three broadband tone controls. Three reviews, literature, from **NORMAN LABORATORIES**, 2278 Industrial Boulevard, Norman, Oklahoma 73069.

KLIPSCHORN-KLIPSCHORN-KLIPSCHORN Only the finest in Audio. Superior Sound Stereo Center, 2780 Erie Blvd. E., Syracuse, N.Y. 13224.

ATTENTION

WESTERN NEW YORK AUDIOPHILES—Personalized friendly service, and quality equipment have made our new store a success. In addition to the incomparable Audio Research line, we carry the complete RTR speaker line, Hegeman (1a, II), SAE, Quintessence, Thorens, Connoisseur, Phillips, Dokorder, Infinity, Transcriptors, Levinson, Supex, Ortofon, B&O, Cerwin Vega, Sherwood, Linn Sondek, KMAL, Dahlquist, ADC, Soundcraftsmen, Technics, Fulton Music, Onkyo, Rabco, IMF, Phase Linear, more. The Stereo Emporium, 3407 Delaware Ave., Buffalo, N.Y. 14217. 716-874-3372.

NEW 3" CENTER PRECISION 10-1/2" reels loaded with new Ampex tape less than half price. $1\frac{1}{4}$ "x1-1/2 mil—\$7.00; 1 mil—\$8.00. $1\frac{1}{2}$ "x1-1/2 mil—\$9.75; 1 mil—\$10.75. S.I.C., POB 338, Dunwoody, Ga. 30338.

AUDIO RESEARCH Magneplanar Tympani III, \$900. (901) 323-7702.

ONE STOP for all your professional audio requirements. Bottom line oriented. F.T.C. Brewer Company, P.O. Box 8057, Pensacola, Florida 32505.

SHOTGLASS, AS SEEN IN ESQUIRE. Glass-cone Column Speaker. \$129.50 each. F.O.B. Moneyback Guarantee. **TACHYON™**, Box 1012, Roselle, Illinois 60172.

FOR SALE

BUILD YOUR OWN SPEAKERS AND SAVE UP TO 50%. You can assemble your own high quality, multi-element stereo speakers in a few hours and save up to half the cost of comparable speakers. Send for our free 32-page catalog of speaker kits, raw speakers and accessories. **SPEAKERLAB**, Dept. A2, 5500—35th N.E., Seattle, WA 98105.

CANADIANS — DYNACO COMPONENTS AT TREMENDOUS DISCOUNTS Write En-Jay Sales, Hornepayne, Ontario.

CYBERACOUSTIC LABORATORY: only one of its kind! Featuring Crown, IMF, AKG, UREI, RTR, DBX, Infinity, Rabco, Decca, Transduction, more. Crown warranty service. Featuring Crown tape recorders: Audiomodtronic by our engineers. Barclay—503 Haverford Ave., Narberth, Pa. 19072. 215-667-3048.

SHURE V15-III—\$50 plus your old cartridge. Shipped prepaid. **STEREO SHOP**, 107 Third Ave. SE, Cedar Rapids, Iowa 52401.

WESTCHESTER AND FAIRFIELD COUNTY AUDIOPHILES TAKE NOTE! THE AUDIOPHILE, 231 BEDFORD STREET, STAMFORD, CONN. specializes in equipment for the connoisseur. Audio Research, ADC, Citation, Crown, Hegeman, IMF, Infinity, Janszen, Philips, SAE, SME, TEAC, Technics, Thorens and many more. (203) 348-3551 (Closed Mondays).

NEW CATALOG of raw speakers, network kits & network parts, audio test equipment, fabric & foam speaker grids, speaker systems, electronic crossovers & active filters. Distributors wanted for our line of network kits and parts. **MIKE LEWIS/TSR, Inc.**, 3673 West 113th St., Inglewood, Calif. 90303. 213/678-1979.

NOW AVAILABLE . . . FAMOUS REFLECTING SYSTEM'S $4\frac{1}{2}$ " REPLACE-MENT DRIVERS, \$7.98 POSTPAID, BIG QUANTITY DISCOUNTS, FREE SPECIFICATIONS, AURATONE, BOX 580-17A, DEL MAR, CALIFORNIA 92014.

SCOTCH MAGNETIC TAPE, discount Box 167A Orwigsburg, Pa.

AUDIO DEALERS ATTENTION!!! Let us design your "house brand" speaker systems. Our engineers can put some quality into this neglected item. We design systems to suit your needs, supply parts and source list, cabinet plans, schematics & diagrams & cost figures. You arrange for local enclosure construction & system assembly and/or sell kits. Write for complete details on your letterhead. **TSR Engineering**, 3673 West 113th St., Inglewood, Ca. 90303. 213/678-1979.

NEUMANN MICS & ACCESSORIES. DBX Gately Pro kits and mixers. Most models in stock. Immediate prepaid shipment. Mastercharge. Write or call Dick McGrew Recording Service, 902 N. Industrial Blvd., Dallas, Texas 75207. 214—691-5107.

THE AUDIO RESEARCH ROOM. The complete range of Audio Research equipment on display under ideal listening conditions. By appointment. C.M. Santmire. **AUDIO SYSTEMS & DESIGN**, 5421 South 84th St., Lincoln, Nebraska 68516 (402) 489-9888.

AMPEX TAPE—NEW 1800" on 7" reel 12 for \$18 POSTPAID; 1200" 12 for \$13 POST-PAID—free list—**WIDE RESPONSE**, 6114A SANTA MONICA BLVD., HOLLYWOOD, CA. 90038.

CANADIAN WARRANTIES! Write for our quotes on your stereo component needs. **Browne's**, 541 Danforth, Sudbury, Ontario.

ELECTROENCEPHALOPHONE: brainwave monitor, Professional biofeedback instruments. **J&J 8102-A**, Bainbridge, WA. 98110.

FOR SALE

LOGIC MICRO/MINI-
COMPUTER NEWS

LOGIC NEWSLETTER[®]

SAMPLE COPY \$1.00
LOGIC NEWSLETTER
POB 252
WALDWICK, N.J. 07463

CROWN DC-300—\$475; Crown IC 150—\$245; Harman Kardon Citation 11—\$225; Dynaco PAT-4A (factory assembled)—\$75; Dynaco Stereo 120A (factory assembled)—\$95; Pair of Rectilinear III Lowboys—\$375; Pair of Onkyo 25A's—\$345; Empire 598 III—\$265; Concord MK-IV tape deck—\$145; Shure V15-III—\$40; Sony SQ-1000L logic decoder—\$65. All as new (in original factory pack). **S. Parazale**, 34 Stevenson St., Lynbrook, N.Y. 11563. call (516) 599-7311.

AUDIOPHILES! Quality Sounds of Maryland has come to your rescue. Write to me for system quotes you won't believe! Send requests for equipment prices to Quality Sounds of Maryland. **Gerard White**, Sales Manager, P.O. Box 63, College Park, Maryland 20742.

AR TURNTABLE OWNERS. Add cueing. Precision machined. Silicon damped. American made. \$16.00, postpaid. **Lyrelift**, 582 Franklin Street, Cambridge, Mass. 02139.

COLLECTORS ITEM: Two Fisher Lincoln Automatic Turn-over Turntables Model 70. Both are new and in perfect working condition. \$299.95 plus shipping. **Palmer Electronics**, 3560 N. High St., Columbus, Ohio 43214.

MARANTZ TUBE 10B, 7 & 8B with tube grille. 1953 dark mahogany klipschorn. Extremely good condition. Also one shorthorn. 4430 Wheeler, Houston, Texas 77004. 713-747-4682 - call anytime!

JAPANESE TRANSISTORS. Kit \$23.44 contains 24 most widely used transistors, including 14 power transistors. Over 500 types available. Free catalog **WEST PACIFIC ELECTRONICS**, Box 25837, W. Los Angeles, Calif. 90025.

BAY AREA AUDIOPHILES: AUDIO RESEARCH, AUDIONICS, BRAUN, CONNOISSEUR, CROWN, DAHLQUIST, DECCA, DYNACO, FERROGRAPH, F.M.I., GRACE, KMAL, LINN SONDEK, MAGNEPAN, MARK LEVINSON, NAKAMICHI, PANASONIC (SP-10), QUINTESSENCE, RADFORD, R.T.R., SEQUERRA, SHURE, SUPEX, TANDBERG, WIN LABS, McINTOSH (USED). Compare any of our products through our switching device using 1/1 Mark Levinson master tapes at **GARLAND AUDIO**, 2960 Stevens Creek Blvd., Suite D, San Jose, Calif. 95128 (408) 244-6724.

CUSTOM LOADED NAME BRAND POPULAR RECORDING TAPE: REELS, CASSETTES, CARTRIDGES. SAVE OVER 50%—HIGH ENERGY CASSETTES 10 for \$17.00 PD. **MJS**, 1126 Cobb St., San Mateo, Calif. 94401.

AKAI GX-400D - hardly used. N. Lilien, 37 Hickory Place, Livingston, N.J. 07039. 201-351-2846 days. 201-994-3913 after 7 PM.

DENVER'S SPECIALISTS in High Definition Sound Systems offer Audio Research, B&O, Crown, ESS, IMF, Lipsch, Phase Linear, Quad, Radford, Transcriptor, Yamaha and more. Visit ListenUp, 685 South Pearl, Denver, Colorado 80209. 303-778-0780.

MARK LEVINSON—PHASE LINEAR—McIntosh—Dahlquist—Nakamichi—Braun—JBL—Supex—Linn Sondek—Tandberg—B&O—Quatre-Technics. Hear the Supex cartridge with the Levinson cartridge preamp at Stereo One, 1229 Post Rd., Fairfield, Conn. 06430. Phone: 203-255-5939.

Listen to TELEVISION IN STEREO



The TE-200 TELEDAPTER EASILY CONNECTS TO ANY TV & STEREO SYSTEM. Using our coupling and matrix circuit, teledapter takes a low impedance output from the television and delivers two HIGH IMPEDANCE CHANNELS OF SIMULATED STEREO, to drive any amplifier. Frequency response is maintained so you can hear the tinkle of bells or booming bass sounds as it happens on TV. With service warranty and hookup instructions \$16.95 ppd. Guaranteed to make your TV 100% more enjoyable.

OUR NEW TE-300 VHF-UHF HI-FI TUNER IS NOW AVAILABLE. A complete and self contained 110 volt tuner. VHF-UHF antenna connections - Recording and amp output jacks. Five year service warranty \$149.95 ppd. From our factory.

SEND: CHECK MASTER CHARGE NO. for TE-200 TE-300 or \$5.00 for C.O.D. TO: RHOADES NATIONAL CO. DEPT AD P.O. BOX 817 HENDERSONVILLE, TENNESSEE 37075

NAME _____
ADDRESS _____
CITY _____ STATE _____ ZIP _____
SEND: MP TC CATALOG

FOR SALE

10 1/2" RECORDER SPECIALISTS: Fresh new Scotch L/N 3600 ft on new 1/4" NAB center metal reels five for \$34.00 or 10 Ampex 2500 ft new Acetate tape on new metal reels same price. Add \$.65 for a new box. Reconditioned metal 10 1/2" reels NAB centers \$2.75. New metal reels \$4.80. Edital splicing tabs for 1/4" tape 300 \$2.00. Sound Investment, POB 88338, Dunwoody, Ga. 30338

CENTRAL NEW YORK HI-FI ENTHUSIASTS—Britain's finest loudspeakers on demonstration—THE IMF STUDIO AND ALS40—as well as Marantz, Pioneer, Revox, Beyer, Epicure (3 lines), Thorens, Ortofon, XLM, Discwasher... THE SOUND SHOP, 96 Seneca Street, Geneva, N.Y. 14456 (315) 781-0215.

RECORDING TAPES, Rock bottom prices. McCord Electronics, Box 276A, Sylvania, Ohio 43560.

YOUR ROOM IS THE MISSING LINK

A state of the art system is usually junk in the typical poor listening environment, and therefore a rip-off. Our acoustical consulting division will have a calibrated "reverberation curve vs. frequency" measurement performed in your room, and our engineering dept.'s plan of correction, loudspeaker placement, and room equalization, all at no cost with your purchase or upgrade. Music & Sound Ltd., 11 1/2 Old York Rd., Willow Grove, Pa. 19090. (215) 659-9251.

CONSIDER YOUR SOURCE FOR SOUND

- I. Credentials
College instructors in audio/acoustics. Inventors/graduate electrical engineers. Recording & disc mastering engineers.
Members: United Inventors & Engineers
Acoustical Society of America
Institute of Electronic Engineers
- II. Facilities
Anechoic Chamber
\$50,000 research laboratory
Factory authorized "A" warranty stations
- III. Our Distinguished Suppliers
Audio Research, Sequerra, Transcriptors, F.M.I./R.T.R., Linn Sondek, Nakamichi, Dayton Wright, Dahlquist, Crown, Infinity, I.M.F., London Decca, Quad, Rogers, Spendor, Stax, B&O, Grace, Supex, Micro Acoustics, Custom Rabco, Braun, Revox A-700, Ortofon, Damped S.M.E., Scully, dbx, Mark Levinson,
+
1000's of PROFESSIONAL products (see Tuned Rock P.A. ad).
Music & Sound Ltd., 11 1/2 Old York Rd., Willow Grove, Pa. 19090. (215) 659-9251.
Whom Would You Trust?

THOUSANDS OF LIKE NEW LP's and prerecorded tapes. Catalogue \$1.00. House of Records, Hillburn, New York 10931.

FOR SALE

RTR EXCLUSIVE PHILA. SHOWROOM All RTR Speakers on demo including the new 400E HPR12 Super Magnum and 88D. Don't buy any speaker until you've heard RTR, call for an appointment 215-667-3048 or write 503 Haverford Ave., Narberth, Pa. 19072.

AUDIO RESEARCH, AUDIONICS TRANSMISSION LINE SPEAKERS, BANG & OLUFSEN, BOZAK, BRAUN, CROWN, DBX, KLIPSCH, KMAL, LINN SONDEK, NAKAMICHI, PHASE LINEAR, RADFORD, REVOX, TANDBERG, BEYER & SENNEHEISER MICS, and other fine instruments for the reproduction of music. Custom design and construction, component analysis, consultations, demonstration by appointment. Send for list of top grade used equipment. AUDIO SYSTEMS AND DESIGN, 5421 South 84th St., Lincoln, Nebraska 68516 (402) 489-9888 and 4408 Capital Ave., Omaha, Nebraska 68131. (402) 556-7559.

SCOTCH RECORDING TAPE, lowest prices TAPE CENTER Box 4305B, Washington, D.C. 20012.

BROADCAST QUALITY MIXER for creative D.J. audiophiles with facilities for simultaneous mixing of two stereo phonographs, a tape machine and a microphone. Precue for all inputs with built in monitor headphone amplifier. Discoteques, small radio stations, background music systems. Send for literature. \$325.00 G.L.I. Box 2076, Dept. A, Brooklyn, N.Y. 11202. (212) 875-6992.

PORTLAND'S OWN HAWTHORNE STEREO offers the sophistication and expertise of the East with the friendliness of the West. Featured lines: AKG, Advent, Audio Research, Beyer, Braun, Citation, Dahlquist, Infinity, Linn-Sondek, Magneplanar, Marantz, McIntosh, Nakamichi, Phase Linear, Philips, RTR, Rabco, SAE, Sennheiser, Sony Corp., Soundcraftsman, Spectro-Acoustic shipped from stock to your door—fully pretested and insured. Write for information and price quotations: Hawthorne Stereo, 3580 S.E. Hawthorne Blvd., Portland, Oregon 97214.

COMPONENTS FOR THE CONNOISSEUR LOUDSPEAKERS: Audio Research T-3A, 1B, Braun LV 1020, Dahlquist DQ10, Dayton-Wright XG-8 MK11B, ESS, Fulton J Modular System, Hartley Concert Master, Hegeman 1A, & 2, IMF Monitor, Studio, ALS 40, Magneplanar MG2167-F, RTR 280 DR, ESR 6, 15. **COMPONENTS:** Audio Research, BGW, Burwen, Connoisseur, Dayton-Wright, Hervic, Linn-Sondek, M&K super woofers and crossovers for T-3ATM, 1B, etc., Mark Levinson Products, Ortofon, Panasonic SP 10, Quad, Quintessence, Radford, SAE, Shure, SME, Supex, Thorens Transcripator and SEQUERRA. Brochures available.
PAUL HEATH AUDIO
354 STATE STREET
ROCHESTER, N.Y. 14608
(716) 232-2828

HONG KONG, TAIWAN, JAPAN, Asia Directory, World products information. Mail-orders, bulk-orders. Listings Directory and Information \$1.00 today. World Trade Inquiries, Box 6224, Spokane, Wash. 99207.

PANASONIC, GARRARD, DYNACO, Kenwood, Marantz, Pioneer, McIntosh, Sony, Ampex, AR, Advent, KLH, Rectilinear, Soundcraftsman, Audio Technica, any and all brands, at up to 60% off. That's right—60%! Write for free price quote on any Hi-Fi equipment. If we don't have it, we'll get it. All equipment in excellent condition in factory sealed boxes. Hurry! Some supplies limited. Write H. Simon Sales Co. Ltd., 4048 Bernice Rd., Seaford, N.Y. 11783.

FOR SALE

HIGH PERFORMANCE HIGH FIDELITY WITHOUT THE "HYPE". Suffolk Audio takes a rational, no nonsense viewpoint on high performance audio equipment. Our advice and opinions are based in objective fact, not mythology and folklore. All equipment is pre-tested for maximum performance. Our distinguished suppliers include: Allison Acoustics, Bowers and Wilkins, Quad, Linn Sondek, Decca, Mark Levinson, Revox (incl. A-700 series), KMAL, Ortofon, BGW Systems, Radford, Beyer, Connoisseur, and much, much more. Call or write for information.
SUFFOLK AUDIO, INC.
1105 Mass Avenue
Cambridge, Mass. 02138
Ph. (617) 868-1080.

THE EAR DRUM IS GOING STRONG with plenty of crossover parts plus raw frame speakers from ALTEC, JBL, BOZAK, CELESTION, PEERLESS, NORELCO, SENNEHEISER, ELECTRO-VOICE, GAUSS, HEPNER, CTS, UTAH, TRUSONIC, UNIVERSITY AND PIEZO-ELECTRIC TWEETERS ELECTRONIC X-OVERS. TOO! Plenty of technical information available. If you want to do it yourself, and do it right, the EAR DRUM is the only place to go. Open 11 til 7 (or later) 7 days. THE EAR DRUM, 5146 W. Imperial Hwy., Los Angeles, Ca. 90045 213/641-1930.

PROTECT YOUR LPs. Poly sleeves for jackets 8c round bottom inner sleeves 6c Poly lined paper sleeves 15c White jackets 30c Postage \$1.00. House of Records, Hillburn, New York 10931.

ORGAN RECORDS. Prize-winning Michael Murray records at Grace Cathedral, San Francisco, and St. Meinrad Archabbey. Superb low-end response. DBX-ed masters. European-quiet pressings. French Romantic composers \$6.98 each, or both for \$9.98. BACH on a Beckerath tracker organ, sold separately, \$6.98. Advent Records, Inc., 23366 Commerce Park Road, Cleveland, OH 44122.

HIGHEST QUALITY USED EQUIPMENT: IMF Studio II, \$275 ea.; Marantz 500, \$860; Marantz 33, \$270; Marantz 20B, \$500; McIntosh MC-2300, \$950; McIntosh MR-77, \$500; McIntosh MAC-1900, \$650; McIntosh ML-2C, \$425 ea.; Sony 2000F & case, \$380; Crown CX-822 & many access., \$1700; Hadley Basic, \$250; Heath AJ-15, \$150; Teac 450, \$325; Advent FBC, \$150; AR-LST, \$425 ea.; Bose 901, \$370 pair; Infinity 2000A, \$140 ea.; JBL 001, \$295 ea.; Thorens 125/Shure SME, \$300; Braun P9-600, \$150; JBL SE-401, \$200. All guaranteed 90 days parts and labor. Audio Consultants, 517 Davis St., Evanston, Illinois 60201. (312) 864-9565.

C/M LABORATORIES professional preamplifier, \$360 Levinson-Supex cartridge combination. IMF Monitor loudspeakers. Transcriptors turntables. Marantz - Futterman - McIntosh tubed equipment bought and sold. English Leak stereo preamp mint \$85. English Beam-Echo tubed amplifier, new \$195.00. Almost all audio equipment quoted. Trades accepted. **WANTED:** Marantz - Futterman - McIntosh tubed equipment. Audiocraft, South Rockwood, Michigan 48179 (313) 379-9945.

TRUSONIC FREE CONE SPEAKERS. Recognized 25 years as finest high efficient speakers made. Full ranges, woofers, mid-ranges, drivers, crossovers, co-axials. Discount prices. Ship anywhere U.S. and Canada. Dimension Hi-Fi, 2109 Bancroft Way, Berkeley, Calif. 94704. (415) 548-1218.

ABSOLUTELY THE LOWEST PRICES on name brand stereo components. Send for our free catalog to BOSTON AUDIO EXCHANGE, 1589 Commonwealth Avenue, Brighton, Massachusetts 02135.

FOR SALE

LEVINSON-SUPEX ultimate cartridge combination C/M Laboratories 400-watt professional amplifier, \$700 IMF Monitor Loudspeakers Hartley Speaker Sentry, Dahlquist loudspeakers. Fine automobile speakers. Transcriptors turntables. British "LEAK" tubed equipment Tubed equipment bought and sold. Trades accepted. **WANTED:** Marantz - Futterman - McIntosh tubed equipment. Audiocraft, South Rockwood, Michigan 48179 (313) 379-9945

INFINITY SERVO-STATIC I, walnut. Mint. \$1200. Jim, 215-744-8651

CHECK AUDIO CABLES THE EASY WAY. New cable fault indicator checks 2 or 3 circuit phone, RCA, Cannon XLR 3 or 4 pin cables. Led display indicates shorts, opens, crosswiring. Advanced I.C. design \$89.95 (net) plus postage. Crossroads Audio, Box 19671, Dallas, Texas 75219. Dealer inquiries invited.

FLASH—WORLD'S FIRST HIGH OUTPUT MOVING-COIL CARTRIDGE WITH REPLACEABLE STYLUS is now in stock! The revolutionary new **SATIN M-15L** series easily surpasses ALL other cartridges in clarity, separation, and ultra-low distortion. Has rock-solid bass definition, and the realism heard from solo or massed violins is incredible. \$225., with choice of conical, elliptical, or Shibata-type stylus; cartridge with all three (interchangeable) styli purchased together, \$375. Sister models with similar qualities, \$145. and \$195. At better dealers, or direct from exclusive U.S. distributor, **AUDIOPHILE IMPORTS**, 8 East Erie, Chicago, IL 60611

BUY! SWAP! SELL! Your personal ad placed **FREE** in **AUDIOMART**, the audiophile's classified newsletter. **SUBSCRIBE!** \$4/yearly. **AUDIOMART**, Box 821, Stratford, Conn. 06497.

BIG DISCOUNTS ON L.P.'s, cartridges, cassettes, "singles," Stereo and Quad, all labels! all artists. No fees, no gimmicks. Same-day service, postpaid. Send stamp for free details and Schwann Basic Record Library pamphlet listing 1000 pieces of classical music arranged by musical period and composer. Or, send \$1.00 each (refundable) for Schwann Record and Tape Guide, Harrison Tape Catalogue, or "Golden Oldie" singles catalogue (listing over 5000 45 RPM's). **DISCO-TAPE UNLIMITED**, Mail Order Dept. AO, Box 817, LaPlace, La. 70068.

ALTEC ACOUSTA-VOICETTE \$600. Matching H/P Sound Level Meter \$600. Wanted: Crown electronics. Cecil Erdly, 22 S. 4th St., Clearfield, Pa. 16830.

WE HAVE A FEW competitively priced used Revox A77 decks available. These have been completely reconditioned by Revox, are virtually indistinguishable from new and have the standard Revox 90 day warranty for rebuilt machines. Satisfaction guaranteed. One example is an A77 Dolby for \$675 plus shipping. Please write stating your requirements to ESSI, Box 854, Hicksville, N.Y. 11801 (212-895-9257).

CANADIANS: Shure M91ED \$24.88; Dynaco A25 \$68.00; Pioneer SX424 \$179.95; Dual 1216 \$119.00; Leak Delta 75 \$289.00; Garrard Mini changer \$13.99. Free Hi-Fi discount catalog. Etco (Au). Box 741, Montreal H3C 2V2

SHURE M3D-\$9.95 M91E-\$27.50 KOSS KO/727B-\$29.95 TUBES, ACCESSORIES LIST-10c F & M ELECTRONIC DIST., BOX 236, DEPT H, MASPETH, N.Y. 11378.

SAE MKIII amp, MKVI tuner, **MARANTZ** 7T & **QUAD** 33 preamps; 2 **JBL** 001 systems in C38 walnut enclosures; **SONY** TTS3000 turntable; **TECHNICS** RS263US Dolby cassette deck; **SOUTHWEST TECHNICAL** amp; **DECCA** MKV (new); **KEITH MONKS** MKII mercury arm. Seeking 2 **JBL** 150-4C woofers. Jeff Horen, 364 Mission Ct., St. Louis, MO 63130. (314) 863-6037

FOR SALE

RACK MOUNT MARANTZ EQUIPMENT:
10-B Tuner \$725
(2) 9 Amplifier \$395 ea.
7-C Preamp \$325

Standard Chassis Models
10-B \$695
7-C \$275

McIntosh MC240 Amps \$115 ea.

Ampex A9 500-2 ¼ tk Port \$995.

Music Box, Incorporated, 58 Central Street, Wellesley, Mass. 02181

7" MAGNETIC TAPE SPECIALISTS, Low discount prices on Scotch and others. Send for free price list now, and save \$1.00 on first order. N.A.B. Audio, Box #7, Ottawa, Ill. 61350

"ULTRA-DEFINITION"
THE DKL LABORATORY, INCORPORATED
PROUDLY ANNOUNCES THEIR EXPANDED LINE OF PRODUCTS AND SERVICES:

DKL 1 - "ULTRA-DEFINITION" Amplifier designed specifically for electrostatic tweeters and headphones.

DKL 2 - The famous "SUPER-RABCO" modification for Rabco SL8 (E).

DKL 3 - Our exclusive "Hand-Tuning" service for Decca Mk V and "Export".

DKL 4 - Individually engineered "Ultra-Definition" crossover networks for bi- and tri-amplification.

DKL 5 - Unique modifications to Infinity 2000A.

DKL 6 - An inexpensive "Ultra-Definition" pre-amp.

DKL 7 - The larger amplifier designed for electrostatic transducers.

DKL 8 - Resonance dampening modifications for SHURE, SME, and other fine tonearms.

DKL 9 - The "AMAZING \$720. WONDER SPEAKERS" with flat response from 28-22,000 Hz.

DKL 10 - The DKL Client Information File - a service that will give "Ultra-Definition" to any sound system.

FOR MORE INFORMATION WRITE:

The DKL Laboratory, Incorporated
P. O. Box 683

Severna Park, Maryland 21146

OR CALL:

(301) 647-8918

during our convenient evening hours

8-11 PM Eastern time.

CROWN D-60 AMP \$125.00; 2 **W.E. 728B** speakers \$45.00 each; 1 **W.E. 754C** speaker \$55.00. Phone: (404) 964-6213.

ARP 2600, LIKE NEW, with keyboard \$2400.00. Call (513) 274-7715.

PHONO PRE-AMP KIT using LM381. \$32.00. PC board and plans \$20.00. Schematic \$5.00. Gold Electronics, 7207 Stanford, University City, Missouri 63130.

TANDBERG 3000X - \$364. (301) 757-2357

QUAD 33 PREAMP, 1 year. \$135. Tom Groom, Box 766, Murfreesboro, Tennessee 37130. 615-893-4418.

AUDIO RESEARCH D51G - \$750; Heil ESS AMT3 with cards - \$800 pr.; Teac 3300-10 - \$450; DBX 119 - \$150; Pioneer CS99A - \$350 pr.; Braun PS6000 with Grado F3Et - \$175. Excellent condition. Hayden, McMahon, General Delivery, Columbia, Mo. 65201, (314) 443-2026.

CROWN IC-150 - \$200.00; Crown DC-300A - \$500.00; Crown DC-300 - \$390.00; Revox A77 - \$200; Revox A76 FM tuner - \$275.00; Base 901 - \$250.00; JVC VLB turntable & 4 channel cartridge - \$200.00; Lafayette 4 channel decoder - \$50.00; Sony Dolby cassette - \$165.00; Uher 4000 report - L mono portable recorder with complete accessories - \$225.00; Lamberto S. Lopez, M.D., Station 'A', Wingdale, New York 12594

BUILD A "SPACE-AGE" TV CAMERA!!



Only known self-state camera available in kit form for factory assembled. Ideal for experimenters, hobbyists, students, etc. Completely self-contained. Connects to any TV set without modification. High quality performance achieved by years of lab and field testing. Fully Guard-Insulated. Easy-to-understand, step-by-step assembly manual. Model KTV-114 series, 6 complete with vidicon tube only \$165.00. Postpaid delivery anywhere in USA, Canada and Mexico. Optional audio subcarrier also available. \$28.50.

PHONE or WRITE for CATALOG... DIAL 402-987-3771

BOX 453-AM **ATV Research** DAKOTA CITY, NEBR. 68731

FOR SALE

TWO WALNUT AR-3s, excellent - asking \$280.00. H. Lorenz, 2584 Traymore, Cleveland, Ohio 44118

AR3-A's - \$380 pr. EV 12" speakers in cabinets - \$220 pr (201) 991-6904.

1 OLD SHAW MIKE - want to sell - \$50.00; 1 Kustom PA 2 column 48" JBL's in each column 150 watt head 4 channel with masters - \$350.00; 1 Kustom bass amp. 2 - 15" JBL's. 100 watt head - \$200.00; 1 Fender strat. good condition - \$200.00. Will make deal for all. Thomas Murpy, 669 - 59 Street, Brooklyn, New York 11220.

ALTEC M-II CONDENSER MIC SYSTEM, \$130. 21-B capsule, cable, power supply (XLR-3 out) Jerry Immel, 1493A Druid Valley Dr. NE, Atlanta, Ga. 30329. (404) 634-0988. 892-1611

REVOX A77 WITH DOLBY. Excellent condition. \$850 including case. Alan Jacobsen, 2507 W. Phoenix, Grand Island, NE 68801

HADLEY 621 PREAMPLIFIER. Mint cond. Complete specs available \$250.00. Ted Jensen, 118 Hobart, New Haven, Conn. 06511

ESS AMT-1 OWNERS: Dissatisfied with bass? Our modification greatly improves performance. leaves warranty intact. Only \$69.95 plus tax and shipping. Free brochure **TRANS-BASS SYSTEMS**, P.O. Box 2763, Laguna Hills, Calif. 92653.

WESTCHESTER HEADQUARTERS for the great sounds in the world. Quad, Ohm, Cambridge, Dahlquist, Bose ESS, Braun, SAE, EPI, Crown, Phase Linear, Tandberg, Thorens, Yamaha, Nakamichi, Technic, BGW, Dual, Revox, Kbnwood, Pioneer, The Listening Room, Inc. 590 Central Ave., Scarsdale, N.Y. 10583. (914) 471-4558

HEATHKIT AA-2010 4-channel amp w/cabinet \$325. Fulton FM1 100A speakers \$195/pair. Thorens TD125B MKII turntable, SME 3009/S2 arm, ADC XLM cartridge, deluxe cover. All in mint condition. Alan Nerenberg, 885 Covington, Detroit, Michigan 48203 (313) 861-6925.

LOOKING FOR HIGH QUALITY "PREVIOUSLY OWNED" MERCHANDISE? Referral/resale service for industrial and professional audio equipment. All merchandise guaranteed to meet manufacturer's specification for 12 months (parts, labor, and round trip shipping included). Call or write **OHRWERKE**, 876 McVeagh Road, Westbrook, Conn. 06498, (203) 399-7367

CUSTOM PREAMPLIFIERS, ELECTRONIC X-OVERS, MIXERS, etc. Engineered to meet most stringent performance parameters. Call or write for additional information. **OHRWERKE**, 876 McVeagh Road, Westbrook, Conn. 06498, (203) 399-7367

LED POWER LEVEL DISPLAYS: Stereo Display, 6 LED/Ch, \$75.00, Deluxe \$100.00. Professional 4 Channel \$225.00; Stereo overload Indicator, 1 LED/Ch. \$25.00 Free information, Orion Audio, Box 145, Springfield, Virginia 22150

AUDIO RESEARCH Dual 75A converted to Dual 76, \$600. Dual 75 converted to 75A, \$500. 919/449-4132, days.

FULL AUDIO RESEARCH Tympani 3A with bass screens - new 919-449-4132.

SUBSCRIBE NOW!
**EVERYTHING YOU'VE ALWAYS WANTED TO
 KNOW ABOUT YOUR**
Telephone
BUT DIDN'T KNOW WHO TO ASK
 A UNIQUE REFERENCE GUIDE
 TO THE INSIDE STORY
 FROM THE HOBBIEIST TO THE TECHNICIAN
 Current News Items • Plans • Illustrations
 Stories • History • Comics • Facts • Games
 Code Numbers • Projects • And Many More
LEARN THE SECRETS OF YOUR TELEPHONE



FACTS NEVER PUBLISHED FOR THE PUBLIC
 One year subscription only \$3.00

TELEPHONICS COMPANY OF AMERICA
 P.O. BOX 3488
 LOS ANGELES, CA 90028

FOR SALE

AKAI GX-280D-SS, in original carton. Never used \$675 FOB Larry Riley, 4A Couch Street, Plattsburgh, New York 12901. 518-561-8333.

SOUTH FLORIDA'S ONLY AUDIO RESEARCH DEALER. Full Audio Research Systems on display: SP3-A/Dual 76/Dual 51/Magneplanar Tympani 1-B/Tympani 111A. Plus Advent, B&O, ESS, Harman-Kardon, McIntosh, Marantz, Phase Linear, SAE, Supex, Stax, SME, Sennheiser, Tandberg, TEAC, Thorens, Technics, Nakamichi, Mark Levinson. Complete audio counselling and custom installations. Sound and Sight, 20 N. Federal Highway, Boca Raton, 33432. (305) 391-1843; 141 Lakeview Avenue, West Palm Beach 33401, (305) 655-2236

FACT: One of the largest and oldest exotic audio stores is now open at their brand new location. No other store combines the display facilities, the equipment and the service quite like **TRANSCENDENTAL AUDIO LTD.** in all of the United States.

A. ROOMS—three perfect sound rooms with complete working demonstration—generally live tape.

B. EQUIPMENT—Dayton Wright XG8Mk11B speakers and SPS preamps. Cambridge Audio TL 200 transmission line speakers and P140X, P70X amplifiers. J.E. Sudgen "Class A" amps. ERA 48 pole belt-driven turntables. Radford, Quad, Revox, Audionics, AKG, B&O, B&W Ltd., Crown, BGW, Celestion, DBX, Epicure, Technics, SAE, Infinity, Sequerra, Phase Linear, Supex, Levinson, Grace, Transcriptors, ESS, Braun, Magneplanar, Yamaha, Stax, Marantz, Harman-Kardon, Wizard Phono., Ortofon, GAS.

C. SERVICE—Anechoic Chamber, test equipment from Hewlett Packard, Crown, B&K Sound Technology, etc.

D. USED EQUIPMENT—Ton! Dahlquist DQ10, Audio Research D51, D76, SP3A & speakers, RTR 28DR, Phase Linear 4000, Quintessence, Infinity Monitors, preamp, IMF speakers and amp, much, much, more.
TRANSCENDENTAL AUDIO, LTD., 773 NIAGARA FALLS BLVD., BUFFALO, NEW YORK 14226. 834-3100 & 834-3101.

TRANSIENT OUTPUT MONITOR for audio amplifiers. L.E.D. readout indicates ¼ to 1000 watts average and transient power output. Hand assembled, calibrated, tested, \$100. Free literature. Analogic Design, P.O. Box 7753, Phila., Pa. 19101.

FOR SALE

SAN DIEGO, CALIFORNIA

ADC, Advent, AKG, AR-LST, Audio-Research, BGW, Citation, Crown, Dahlquist, DBX, Dynaco, FMI, Janszen, Linn Sondek, Magneplanar, Marantz, Micro-Acoustics, Ohm, Phase Linear, Philips, Quintessence, Rabco, Revox, RTR, Sennheiser, SME, Stax, Supex, Tandberg, Yamaha. Sound Company

4701 College Ave., (714) 582-4148
 3675 Sports Arena Blvd., (714) 224-2844

CAN YOU IMAGINE a magazine that recommends components in four categories from no-holds-barred to best-for-the-money? The **Stereophile** does it. For info write Box 49A, Elwyn, Pa. 19063.

THE FIRST (1962) UNDERGROUND audio publication of them all, the **Stereophile** is the subscriber-supported perfectionist's magazine the others are trying to imitate. Free dope sheet explains why. Box 49A, Elwyn, Pa. 19063

IF YOU BUY AUDIO EQUIPMENT, you can't afford not to read the **Stereophile**. Write Box 49A, Elwyn, Pa. 19063 for free blurb sheet.

ALLISON ACOUSTICS LOUSPEAKERS have stabilized Radiation Loading. Years of intensive research by Roy Allison (formerly of Acoustic Research, Inc.) on the interaction between loudspeakers and room boundaries has yielded a new high standard of uniform bass performance. New Convex Diaphragm Mid-Range and High Frequency drivers achieve phenomenal wide dispersion (-3db 90 degrees off axis at 20kHz!) Literature and price information available upon request.

SUFFOLK AUDIO, INC.
 1105 Mass. Avenue
 Cambridge, Mass. 02138
 Ph. (617) 868-1080

BALTIMORE-WASHINGTON AREA AUDIOPHILES REJOICE! At last a store for you. Come to Myriad Sound and hear the finest in state of the art audio equipment. Featuring the complete Audio Research line, Polk Audio Model Nines, ESS Heils, Janszen, S.A.E., Altec, Citation, R.T.R., B&O, Thorens, S.M.E. etc. all accompanied by Fred Huggins himself. Main store at 9619 Reisterstown Rd., Garrison, Md. 21055 (2 miles North of Balt. Beltway exit 20) (301) 363-1733.

WESTCHESTER AND FAIRFIELD COUNTY AUDIOPHILES TAKE NOTE! THE AUDIOPHILE, 231 BEDFORD STREET, STAMFORD, CONN. specializes in equipment for the connoisseur. Audio Research, ADC, Citation, Crown, Hegeman, IMF, Infinity, Janszen, Philips, SAE, SME, TEAC, Technics, Thorens and many more. (203) 348-3551 (Closed Mondays).

INFRA WOOFER™ world's largest, deepest, most powerful sub-woofer system can be had only at Music and Sound, Ltd. 50 dB per octave crossover, bandpass 16 Hz ... \$1295.

F.M.I. & I.M.F. SUB-WOOFERS, for the closest approximation to dipole definition—\$180-\$350! Also, the rave five-way Fulton/R.T.R. super speakers. Shipped prepaid/insured. Music and Sound, Ltd., 11½ Old York Road, Willow Grove, Pa. 19090 (215) 659-9251.

AKG, ALTEC, AUDIO RESEARCH, Beyer, Crown, DAHLQUIST, DECCA, INFINITY, KLH 9s, Koss, Mark Levinson, Ortofon, PHASE LINEAR, PML, REVOX, SAE, Sennheiser, Sequerra, Sony, Stanton, Supex, Tandberg, TASCAM, Thorens, etc. ...

HI-FI HAVEN
 28 Easton Ave.
 New Brunswick, N.J. 08901
 201-249-5130

DON'T PAY THE HIGH MAIL ORDER PRICES THIEVES WAREHOUSE OF TAMPA. 1531 SOUTH DALE MABRY, TAMPA, FLORIDA 33609.

FOR SALE

ARE YOUR TAPES IN DANGER... Playback on magnetized equipment can ruin them. Now you can measure and eliminate damaging magnetic residuals. Standard Audiophile Hand-Kit \$29.75. Delux Hand-Kit \$51.00, delivered in USA on prepaid orders. Free data on request. Annisco, 1103 N. Delaware, Indianapolis, Indiana 46202.

TEXAS AUDIOPHILES! On demonstration: Dahlquist, Nakamichi, Transcriptors, Linn-Sondek, Infinity, Braun, Advent, Crown, Phase Linear, Ortofon, Levinson, Supex, Quad, Klipsch, IMF, Keith-Monks, ESS, Decca, B&O, Radford, Stax, Audionics, Philips, Revox, Citation and many others. Audio Concepts, 2021 Guadalupe, Austin, Texas. Phone 512-478-7421.

NEW, IMPROVED SME TONE ARMS correctly mounted in AR turntables. Audio Consultants, 517 Davis St., Evanston, Illinois 60201 (312) 864-9565.

HI-FI ENTHUSIASTS WANTED!! Earn more than just spare money in your spare time. We need campus representatives to sell name brand stereo components at discount prices in your area. High commission, no investment required. Serious inquiries only, please. Contact: Mike Santillo K&L Sound Services Co. 75 N. Beacon St., Watertown, Mass. 02172.

ROGERS B.B.C. MONITOR, IMF, B&W Ltd., Celestion, Radford, Decca, ERA, Connoisseur, Audionics TL-90, Goldring, Revox, Beyer, Lamb and more. Custom design and modifications. **SUFFOLK AUDIO, INC.** 1105 Mass. Ave., Cambridge, Mass. 02138. (617) 868-1080.

WISCONSIN'S NEWEST AUDIO RESEARCH dealer, now stocking Magneplanar Tympani 1B & 111 speakers, SP3A, D76, EC-2 & EC-4 electronics. Also—Crown, Quintessence, ESS, Dahlquist, Transcriptors, Epicure, Phase Linear, RTR, SAE, Infinity, Citation, Bozak, FMI, Nakamichi, Revox, AR-LST, Tandberg, 50 other brands. **WACK SALES CO.**, 5722 W. North Ave., Milwaukee, Wis. 53208.

PROPRIETARY CUSTOMIZED MODS reduce tone arm friction, damp spurious resonances, minimize torsional forces, improve tracking, and reduce record wear. For **S.M.E.'s—\$30.00**. For **Rabco SL-8(E)—\$100.00**. For **Transcriptors—free*** (*with purchase).

NOW

LISTEN TO our calibrated Ortofon/Supex moving coils, B&O/Grace/Micro-Acoustics. From the laboratories of Music & Sound Ltd., 11½ Old York Rd., Willow Grove, Pa. 19090. (215) 659-9251.

+ Levinson Cartridge Preamp +

IMF, B&W, DAHLQUIST, Nakamichi, Sequerra, Quad, Braun, B&O, McIntosh, Tandberg, Crown, Revox, Advent, Stax, Ortofon, Beyer, Phase Linear and many others. Also wide selection of first-class used equipment. Expert advice. No sale final until you are satisfied. **AUDIO CONSULTANTS**, 517 Davis St., Evanston, Illinois 60201. (312) 864-9565.

AUDIO COMPONENTS—lowest prices on all major brands. Write for quotes: Audio, Suite 47-947A Dyer Avenue, Cranston, Rhode Island 02920.

OREGON AUDIOPHILES: Hear some uncommonly good things—Radford, Crown, Quintessence, Mark Levinson, BGW, Yamaha, Integral Systems, Magneplanar, Dayton-Wright, Ohm, Quad, Janszen, Audionics, Decca, Supex, Stax, SME, Thorens, Transcriptors, Vestigal, Linn-Sondek, Braun, Ferrograph, Grace, Sony Pro-Mikes and Mixers, Super Woofer Systems, Passive Crossovers, Transmission-Line Speaker Kits, Basic Drivers. **AUDIO-Uncommon Inc.**, 8600 N.E. Sandy Blvd., Portland, Oregon 97220. 503-254-6202.

FOR SALE

ATTENTION!
ATTENTION!
The **DKL LABORATORY, INCORPORATED**
proudly announces the opening of their new
"STATE-OF-THE-ART" SHOWROOM
called

The **DKL Sound Lab**
located at

943 BONIFANT STREET

SILVER SPRING, MARYLAND 20910

Hours: Monday, Wednesday, Thursday, Saturday - 12-8 PM

or by appointment

EXCLUSIVE AREA DEALERS FOR: Audio Research, DBX, DECCA, Fulton, IMF, LINN-SONDEK, RTR, and lots more!!!
for further information,
call (301) 647-8918

DAYTON-WRIGHT SPEAKERS, Preamp-equalizer 519-945-8486

TASCAM - Model 10 mixing console. Lou Sauer, 1700 Market St., Philadelphia, Pa. (215) 864-7772

2 **SAE MARK IV** CM power amps, \$415 each, SAE Mark IX preamp w/case, \$325; 4 **ESS AMT5**, \$145 each; 4 **RTR 400E**, \$215 each; **SONY SOD-2020** full logic decoder, \$160; Technics SL-1100A direct drive turntable, \$250; Toshiba SR-50 turntable w/photoelectric cartridge, \$325; **JVC demodulator w/Audio Technica AT-14S** cartridge, \$115. (516) 799-7251.

MARANTZ 10B TUNER in case, mint condition, \$775.00 firm; R. Shannon, P.O. Box 277, Tipton, Calif 93272 209-752-4420.

STANTON 681EE cartridge \$36, new boxed 681EE stylus \$18; Orthofon RS 212 tonearm \$22 (212) 376-4842.

DECCA MKV - \$95 POSTPAID! KEITH MONKS MKII (IMPROVED) MERCURY ARM - \$125 POSTPAID! The Sound Affair, 364 Mission Ct., St. Louis, MO 63130. (314) 863-6037

DAHLQUIST DQ-10, RTR, INFINITY, BOSE, ESS, KLIPSCH, SAE, CROWN, PHASE LINEAR, HERVIC, CITATION, YAMAHA, QUINTESSENCE, BURWEN, BEOGRAM 4002, THORENS, LINN SONDEK, TECHNICS, TRANSCRIPTORS, PHILLIPS, CONNOISEUR, A&D, SME, REVOX, SONY, ADC, ORTOFON, SHURE, MUCH MORE

STEREO CENTER,

2539 VESTAL PKWY EAST,

VESTAL, NEW YORK 13850.

(607) 729-6191

STEREOPUS - A new quarterly devoted to thorough subjective equipment review and comment. First issue features reviews of Infinity Monitors, RTR ESR-6, Crown DC300a, Phase Linear 400, Citation 12, Grace cartridge, and more. Available January, \$9.00 year (\$11.50 foreign). StereoOpus, P.O. Box 269 Fort Walton Beach, Florida 32548

BERKELEY, CALIFORNIA

Quad	Yamaha
Braun	Quatre
Fulton	Dbx
Klipsch	Revox
Dahlquist	Grace
Audionics	SupeX
Magneplanar	Technics
Mark Levinson	Keith Monks
Quintessence	Linn-Sondek
Citation	Transcriptors
Radford	

STEREO WORKSHOP

2985 College Avenue

Berkeley, California 94705

(415) 843-5836 open 2-8 TWThF, 12-6 Sat

DON'T PAY THE HIGH MAIL ORDER PRICES. THIEVES WAREHOUSE OF BETHESDA, P O BOX 34251, WEST BETHESDA, MD 20034.

FOR SALE

USED EQUIPMENT: Gately Prokits SM-6, EQ-6, EK-6 mixing group - \$600; Revox A-700 7-1/2 ips, Half Track Recorder - \$500; (2) AKG D-224E Mikes - \$100 each. George Swanson, 2006 E. First St., Duluth, Minn. 55812. (218) 728-2695

TARZAC CASSETTES: C-1 thru C-90 CUSTOM CASSETTE LABELS. Free samples 638 Muskogee Avenue, Norfolk, Virginia 23509

COMPLETE CONSTRUCTION PLANS—TELEPHONE: Answering Device, Automatic Dialer, "Black Boxes", Call Diverter, Call Limiter, Conference Bridge, Central Dial Exchange, Melodic Ringing Generator, Recorder-Actuator, Remote Control, Schematics, Speakerphone, Telelink Burglar Alarm, Voice Scrambler, \$3.00 each. **ELECTRONIC—Biofeedback** Conditioner, Horticulture Stimulator, Multifrequency Encoder Network (Speeds telephone calling 500%)! \$5.00 each. **ONE YEAR SUBSCRIPTION:** Telephone Electronics Line (TEL) \$3.00 Super Illustrated CATALOG of plans, many more, 50 cents. **ALL OF THE CONSTRUCTION PLANS ABOVE PLUS A YEARS SUBSCRIPTION TO TEL AND A CATALOG, \$24.95.** TELETRONICS COMPANY OF AMERICA, P.O. DRAWER 3450, HOLLYWOOD, CALIFORNIA, 90028

QUAD ELECTROSTATIC LOUDSPEAKERS. 6 months old. Best offer over \$400. 203-288-4544.

SONY 2030, SQ DECODER AMPLIFIER, never used, \$140.00. **REALISTIC SCT-7,** Auto Reverse Cassette Deck, used one month, perfect condition, \$250.00. Either postpaid, money orders only. James Tunall, 502 S. Juniata, Lewis-town, Pennsylvania 17044

150W PA AMP-MIXER - \$395.00
6 MIC CHANNEL, HI-LO Z, FULL CONTROLS,
150W RMS, FULLY GUARANTEED
SPECIAL PURCHASE OF A MAJOR U.S.
MANUFACTURER'S OVER RUN LIMITED
QUANTITY. WRITE FOR FULL SPECS
Whitfield Loudspeakers, Inc.,
P.O. Box 352,
Lansdowne, Pennsylvania 19050

EQUIPMENT WANTED

WANTED: TEAC RA40s Recording Amplifier for TEAC 4000 tape deck. Send asking price to: Lete Connelly, 536 Dolphin St., Ft. Walton Beach, Fla. 32548

WANTED: MARANTZ 7, 10B; JBL SG-520, SE-400S; McIntOSH C-22, MC-275. Kazuo Takishima, 33-7-1421, Takashima-Daira, 2 Chome, Itabashi-ku, Tokyo, 175 Japan.

WE MUST HAVE YOUR USED COMPONENTS

Premium Trade or Cash for:

McIntosh tube (pre) amps & tuners, Marantz tube (pre) amps 7 tuners, Marantz 7(T), 15, 16 (B) Futterman H-3, J.B.L. 400, 500, 600 series electronics, J.B.L. Hartsfield, L-101, Metrogon, Minigon, Music & Sound Ltd., 11 1/2 Old York Rd., Willow Grove, Pa. 19090 (215) 659-9251

CASH FOR YOUR unwanted reel to reel tapes Record House, Hillburn, New York 10931

MARANTZ 7C AND 8B. State condition and price. J. Fong, 1238 Green, San Francisco, Calif. 94109.

KLIPSCHORN. Give details, firm price Tom Groom, Box 766, Murfreesboro, Tn 37130. 615-893-4418

WANTED: Marantz 7.8-B.9.10.SLT-12 McIntosh C-22, MR-71, MC-275 KLIPSCHORNS, D.L. Hughes, 312 International Trd Cent., Mobile, Ala. 36602-phone 205-433-5882.

WANTED - NAKAMICHI 700 or 1000: state condition and price. Mr. W. Hurt, Box 712, Morristown, N.J. 07960.

EQUIPMENT WANTED

DYNACO, MARANTZ, Fisher, Radford tube pre and power amplifier. Sherwood Scott tube tuner. Citation 12. State condition and price. Pierre Royer, 10781 St. Julien #3, Montreal H1H 3Y1, Canada

WANTED - Pioneer SX-1010 & SA-9100, ESS-AMT series; Garrard Zero 100 SB or 100C, Sony & Tascam tape equipment: cartridges new or top condition only. Send specs, lists & prices to: Louis Sonier, 139 Dawes Road, Toronto, Ont. M4L 501

SONY 770-2, J. Perkins, 189 Lexington Ave., Cambridge, Mass. 02138. 617-864-6359

INFINITY 2000A - Best offer under \$350 pr. Boschen, 7 Ravine, Tenafly, N.J. 07670 (201) 567-2684, evenings.

PIONEER OR MARANTZ electronic cross-overs, Maranta 5-s, 9's, 8B's, Collins, 915 East 6th, Sedalia, Missouri 65301.

WANTED: Xerox Copy of owners' manual for Marantz 10B Tuner, Will Pay, G. Coumanis, P.O. Box 6701, Mobile, Ala. 36606

WANTED: ACOUSTIC RESEARCH amplifier in excellent condition with cabinet. State price. Noel Lavallee, Tuslog Det. 8, Box G, APO New York 09294.

SERVICES

ANTIQUE PHONOGRAPHS REPAIRED AND RESTORED by specialists. Edison, Columbia, Victor, etc. Incomplete phonographs purchased. Evan Blum, 21 Brook Lane, Great Neck, N.Y. U.S.A. 11023 (516) 482-0371

NASHVILLE RECORD PRODUCTIONS WILL PRESS HIGH QUALITY PURE VINYL RECORDS FROM YOUR TAPES. SEND FOR SAMPLE RECORD AND PRICE LIST. ALSO FINEST DISC MASTERING. 1819 BROADWAY, NASHVILLE, TENNESSEE 37203.

HIGH FIDELITY SPEAKERS REPAIRED
AMPRITE SPEAKERS SERVICE

655 Sixth Avenue, New York, N.Y. 10010
212-CH3-4812

TAPE RECORDER HEADS brought back to spec. Wear removed. Brilliant finish. \$10.00 each. One day service. E. Maher, 5 Evans Place, Orinda, Calif. 94563.

DON'T PAY the high mail order prices. Thieves Warehouse is coming to your area. Franchises available. Thieves Warehouse, P.O. Box 8057, Pensacola, Florida 32505.

CUSTOM PRINTED CASSETTE LABELS: 50 to 1,000+. Finest quality. Complimentary samples TARZAC, 638 Muskogee Avenue, Norfolk, Virginia 23509.

FINEST MASTER LACQUERS AND ACETATE DEMOS. Precision cut using the Scully-Westrex computerized cutting system. Also short run record production—LP's/45's. Trutone Records, Dept. A, 428 Briarwood Lane, Northvale, New Jersey 07647 (201) 768-9212.

CUSTOM RECORDING SERVICE Tape and Disc Stereo and mono. Live and copies. Editing, Masters and pressings. High quality at reasonable rates. Joseph Giovanelli, Audio Tech Laboratories, 2819 Newkirk Ave., Brooklyn, N.Y. IN9-7134.

THE AUDIO WORKSHOP

Comprehensive practical training in **SOUND RECORDING, PRODUCTION, AND REINFORCEMENT TECHNIQUES** 24-TRACK FACILITIES for student projects. No prerequisites, accommodations available. 50 Union Park, Boston, MA 02118. (617) 266-7561.

RECORDS

SHOW ALBUMS—Rare. Out of Print LP's. 52 page list 50c. Broadway/hollywood Recordings Georgetown, Conn. 06829.

OLDIES—45 RPM Original hits. Catalog 50c C&S Record Sales. Box 197, Wampsville, N.Y. 13163.

MAKE THOUSANDS OF DOLLARS buying and selling old phono records by mail order. Free details. Aversa-Sweet Publications, Box 888A, Burbank, CA. 91503.

SEARCHING? WRITE: DISContinued RECORDS. 216 North Rose, Burbank, California 91505.

MONAURAL. Classical LP's Bought—Sold, Box 352, Huntington, N.Y. 11743.

FILM-STAGE SOUNDTRACKS. Large free list. A. Lutsky, Box 557342, Miami, Fla. 33155.

CATALOGS. Broadcasts, soundtracks, Personalities of Thirties, Forties. Box 225, New York, N.Y. 10028.

SOLD @ AUCTION—JAZZ—Soundtracks — Personalities O.C. Indicate List: Ray Macknic, P.O. Box 7511, Van Nuys, Calif. 91409 U.S.A.

SOUNDTRACK RECORD ALBUMS—Mail Auction. Free List—Whalon. 2321A Hill—Redondo Beach, Calif. 90278.

FREE 200-PAGE CATALOG. 1,400 New Stereo Recordings. Renaissance, Baroque, Classical, Romantic, Modern Music. Not sold in stores. Not listed in Schwann's. Highest quality! Budget label prices! Available only by mail. MUSICAL HERITAGE SOCIETY, Box 932 AU, New York, N.Y. 10023.

OCCULT MUSIC RECORDS! Meditation—Psychic—Witchcraft. Free Brochures! Burchette Brothers, Box 1363-A, Spring Valley, California 92077 (Dealers also needed).

QUADRAPHONIC RECORDS AND TAPES—ALL labels, over 800 titles—at discount prices! For your free illustrated copy of the world's most complete quad catalog, write: SOUND CONCEPTS, 2713 West Radan, Dept. C3, Peoria, Illinois 61604.

RARE RECORDINGS — Soundtracks, Shows, Personalities. Reasonable Prices. Large New Catalog. Free. Hiott, Box 440471, Miami, Fla. 33144.

SOUNDTRACKS/OC. JAZZ/PERSONALITY — FREE NEWSLETTER! RTSA, 3700 S. Plaza Drive, Bldg. F/211, Santa Ana, California 92704.

RECORDS, TAPES, OLDIES at tremendous savings. Catalog \$1.00. Beat. Dept. D, P.O. Box 68, Hartsdale, N.Y. 10530.

PERFECTLY CLEAR™ ultra hi-fi record Burwen Laboratories BL-2. The East Bay City Jazz Band—Big Bear Stomp. Oriental Strut. Louis-i-an-i-a Blues My Naughty Sweeties Gives to Me. Dans Le rue d'Antibes, etc. \$10.50 each postpaid \$70.00 postpaid in lots of 10. Send check or money order Massachusetts residents add 3% sales tax Dealers wanted. Burwen Laboratories Inc. 209 Middlesex Turnpike, Burlington, Massachusetts 01803 617-273-1488.

FOR DISCOUNTS on records and tapes, send 25c for catalog to K.D. Flenrich, P.O. Box 123, Hayes Center, Neb. 69032.

KNOW THE BEST-PERFORMED, best-sounding recordings of 50 favorite classical compositions. All currently available recordings covered - 841 discs rated. Ratings based on over 2100 reviews appearing in leading publications. 1958-1975. 80 pages of ratings and comments. \$3.95. RATINGS, Dept. H, 5245 W. Running Brook, Columbia, Md. 21044.

RECORDS

"THE RECORD LIBRARIAN"

Computer Printed Record Index Mailed to you Monthly. Give us your record numbers, we give you library listing cross referenced by Artist and Composition etc. Full Details from Box 220, Englishtown, N. J. 07726

TAPE RECORDINGS

RENT CASSETTE or Open Reel Pre-recorded tape. All Labels. Catalog 75c. Tape & Time, P.O. Box 740, Hopkins, Minn. 55343.

EVERYTHING ON OPEN REEL! Pre-recorded classical/popular tapes. Latest releases. Dolby Quad. 96-page catalogue \$1. Barclay-Crocker, Room 857A, 11 Broadway, NYC 10004.

LIVE OPERA TAPES. Professional reel, cassette copies. Extensive sound coded catalogue. Quality guaranteed. Also records. A Fischer, Box 83 Fordham Station, Bronx, N.Y. 10458.

OPEN REEL TAPES. All types music, old radio, comedy, accessories from personal collection. Stamp for list. Chuck, 2333 Old Hickory, Davison, Michigan 48423.

AMBIPHON'S QUADRAPHONIC TAPES. Highest quality available anywhere. Stereo compatible. Format: 1/4", 7-1/2 ips, 4-track discrete reel-to-reel on highest quality mastering tape. Includes precision test segment. Send stamped envelope to: Ambiphon Records, Dept. A, P.O. Box 341, Kingsbridge Station, Bronx, N.Y. 10463.

TAPE & TAPE RECORDERS

CAPITOL STACK-PACKS. Scotch cassettes, cartridges, reels. Discount prices. Lawson's, Box 510, Livermore, Ca. 94550.

LIVE OPERA TAPE Giveaway! Catalog: Newby, 36 Ballard Lane, Hicksville, New York 11801.

1/2 INCH VIDEO TAPE, \$7.25 PER HOUR on 7" reel. Low headwear, 0-9 mil polyester. Free literature. OREGON MAGNETICS Box 13374, Portland, Oregon 97213.

BUSINESS OPPORTUNITIES

REPRESENTATIVE FOR SPEAKER SYSTEM KITS in your area. Huge, never ending, untouched market. High energy, young, together, sound & business oriented individual will do best with this investment or commission opportunity. Requires very little attention after establishment in your protected territory. We must eventually meet for contractual arrangements. Send detailed resume to: Robb Favier/TSR Engineering, 3673 W. 113th St., Inglewood, Calif. 90303.

HOTTEST MAIL ORDER PLAN! Distributors make big profits selling revolutionary new memory improvement cassette line. Free Details. General, Dept. AM-124, Box 137, Northridge, CA. 91324.

EARNINGS to \$10,000 yearly working 6 hour weekends. Tape recorder needed. Details \$10.00. Reel Productions, 3021 Comanche Trail, Lafayette, IN 47905.

BREAK INTO RADIO, D. J. tells how. Explains jobs, salaries, etc. \$2.00. General, Box 467-AC, Landing, N.J. 07850.

BOOKS

BOOKS. Send 50c for Catalog. Refundable with Order. Also Egyptian Dream Book 35c. Books, P.O. Box 11965, Philadelphia, Pennsylvania 19145.

RADIO PROGRAMS

1930-1962 RADIO PROGRAMS. Reels, \$1.00 hour! Cassettes, \$2.00 hour! Catalog, \$1.25. AM TREASURES, Box 192M, Babylon, N.Y. 11702.

OLD RADIO PROGRAMS on tape and cassette. Catalogues 50c. 30 minute sample tape with catalogue \$1.25. Satellite Broadcasting, Box 512, Miami, Florida 33165.

OLD RADIO PROGRAMS ON TAPE. Thousands available. Low prices, finest quality, immediate service. Catalogue 50c. Nostalgic Radio, Box 29K, Peoria, Ill. 61601.

HIGH FIDELITY

DYNAKITS, lowest prices. Underground HI-FI Sales, Rt. 1, Box 177, Arnold, Md. 21012.

NOW AVAILABLE... FAMOUS REFLECTING SYSTEM'S 4 1/2" REPLACEMENT DRIVERS, \$7.98 POSTPAID. BIG QUANTITY DISCOUNTS. FREE SPECIFICATIONS. AURATONE, BOX 580-17, DEL MAR, CALIFORNIA 92014.

SHORTWAVE

HEAR POLICE FIRE Dispatchers. Catalogs show receivers, exclusive directories of "confidential" channels. Send 10c stamp. Communications, Box 56AU Commack, New York 11725.

SPEAKERS

MUSICAL SPEAKERS REPAIRED
ALTEC WARRANTY STATION
Hughes Electronics Service
45 Dunn St., Asheville, N.C. 28806

INSTRUCTION & EDUCATION

DIGITAL ELECTRONICS! Design and understand Digital Circuits. Increase technical competence. Complete and guaranteed course is highly effective. \$10.00. Free literature. DYNA SIGN, Box 60AM, Wayland, Mass. 01778.

PHOTOGRAPHY

PHOTO BUTTONS made from your photograph or any slogan, advertising, picture, etc. Only \$2.00 postpaid. Arcan Products, Rt. 1, Box 278, Waldorf, Md. 20601.

MUSICAL INSTRUMENTS

UP TO 60% DISCOUNT. Name brand instruments. Catalog. Freeport Music, 455R Route 110, Melville, N.Y. 11746.

GOVT. SURPLUS

MANUALS FOR GOV'T. SURPLUS Radios, Test Sets, Scopes. List 50c. Books 7218 Roanne Drive, Washington, DC 20021.

MONEY

HISTORIC PAPER MONEY OFFER!! 10,000 (ten thousand!) German Marks yours to treasure for just \$5. Terrific collectors' items. Immediate delivery. Send to: Finkelstein, 2056 Cropsey Avenue, Brooklyn, New York 11214.

Marantz Stereo Electrostatic Headphones—

you may never want to take them off.



The benefits of Marantz Electrostatic Headphones are as crystal clear as the sound you get. The Marantz SE-1S performs virtually free from distortion—not just at 1kHz or 10kHz, but consistently throughout the listening range. The result: Sound quality as close to perfect as technologically possible. An unsurpassed frequency response from 20Hz to 20kHz, full dynamic range and the ability to achieve high sound pressure levels with low distortion even at low frequencies.

The SE-1S owes its superiority to an electrostatic transducer diaphragm that's unequalled in its ability to track the audio signals from your amplifier. The diaphragm is six times thinner than the human eardrum and so low in mass that inertia is all but eliminated. The less inertia a diaphragm has, the more accurately and instantaneously it can track audio signals. And the better its tracking ability, the lower its transient distortion. That means you can listen longer without suffering listening fatigue. And the lightweight design incorporating soft ear cushions and accoustical seals lets you wear them comfortably for hours.

Marantz Stereo Electrostatic Headphones are powered by the EE-1 Energizer—a combination that makes the SE-1S the ultimate audio experience.

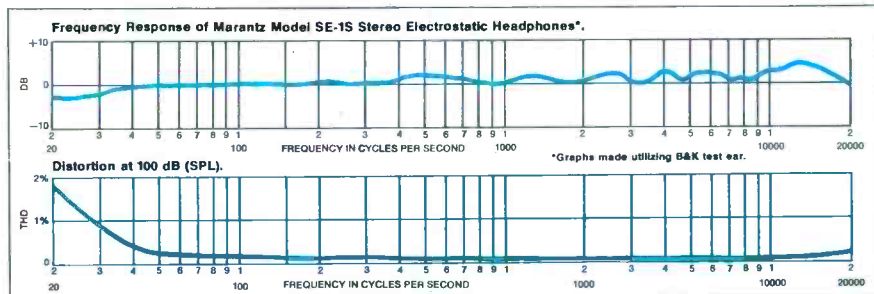

- The EE-1 needs only .3 watt for a 100dB sound pressure level, so it's at home with any amplifier. If severely overdriven, a protection circuit automatically shuts the energizer off—without an irritating pop.

- Its step-up transformers feature special cores developed by Marantz to provide excellent linearity and low distortion.

- It accepts two SE-1 headphones so you can share the pleasure of private listening. And headphone/speaker switching is built-in.

The Marantz SE-1S Stereo Electrostatic Headphone System costs \$129.95. It's the top of the Marantz line that also includes Marantz Dynamic Headphone Systems from \$39.95. Get our informative headphone brochure at your Marantz dealer. And try on a pair.

marantz®
We sound better.

©1974 Marantz Co., Inc., a subsidiary of Superscope, Inc., P.O. Box 99A, Sun Valley, Calif. 91352. In Europe: Superscope Europe, S.A., Brussels, Belgium. Available in Canada. Prices and models subject to change without notice. Consult the Yellow Pages for your nearest Marantz dealer. Send for free catalog.

Check No. 43 on Reader Service Card

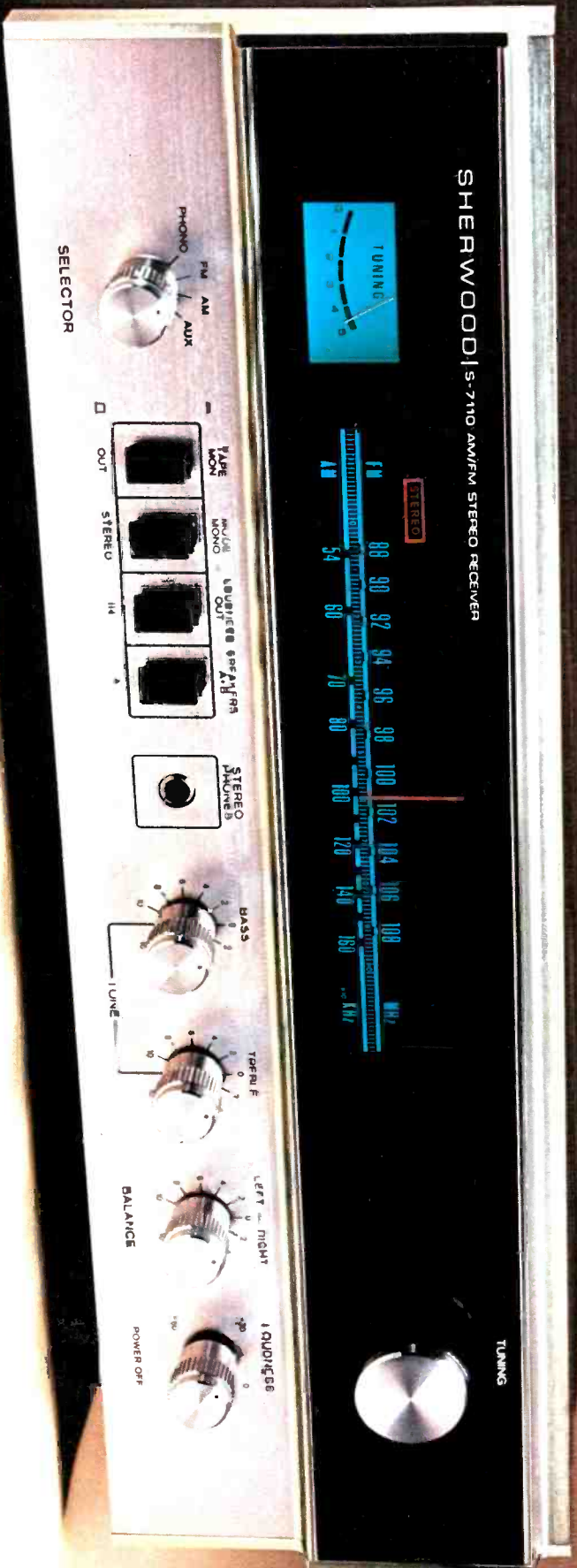

In tune with the times.

For years, Sherwood's Model S7100A stereo receiver has been considered the most popular unit in its class. For good reason.

And now the S7100A's successor — our new S7110 — seems destined to carry on the tradition. For equally compelling reasons.

Among them:
 Minimum RMS power output @ 0.9% total harmonic distortion

(both channels driven): 17 watts per channel (@ 8 ohms, 40-20,000 Hz).

Direct-coupled amplifier (Yields power bandwidth of 9-50 KHz.)
 Hermetically-sealed micro-circuits, FET circuitry.

2.0 μ V FM Sensitivity.
 Solid-State Ceramic FM IF filters.
 And, like all Sherwood products,

the S7110 has been designed for maximum enjoyment with minimal potential for malfunction. Because, in addition to utilizing only the finest of proved componentry, our engineering effort has always been directed toward the goal of design simplicity.

Careful design, the highest quality components and workmanship: they're not

credentials you commonly hear these days. Particularly in a receiver that lists for under \$240. But just listen to the difference they make.

Sherwood Electronic Laboratories
 4300 N. California Ave.
 Chicago, Illinois 60618

Sherwood
 The word is getting around.

Check No. 32 on Reader Service Card