



Audio

THE AUTHORITATIVE MAGAZINE ABOUT HIGH FIDELITY • JUNE 1974 75¢ ® ©

47425 

U0072661 0579 30606998P 0 5
TIMOTHY MARTIN
97 ROBERTSON ST
BRISTOL CT 06010

THE GRAMOPHONE:

Basis for an Industry

Magnetic
Phono-cartridge
Preamp

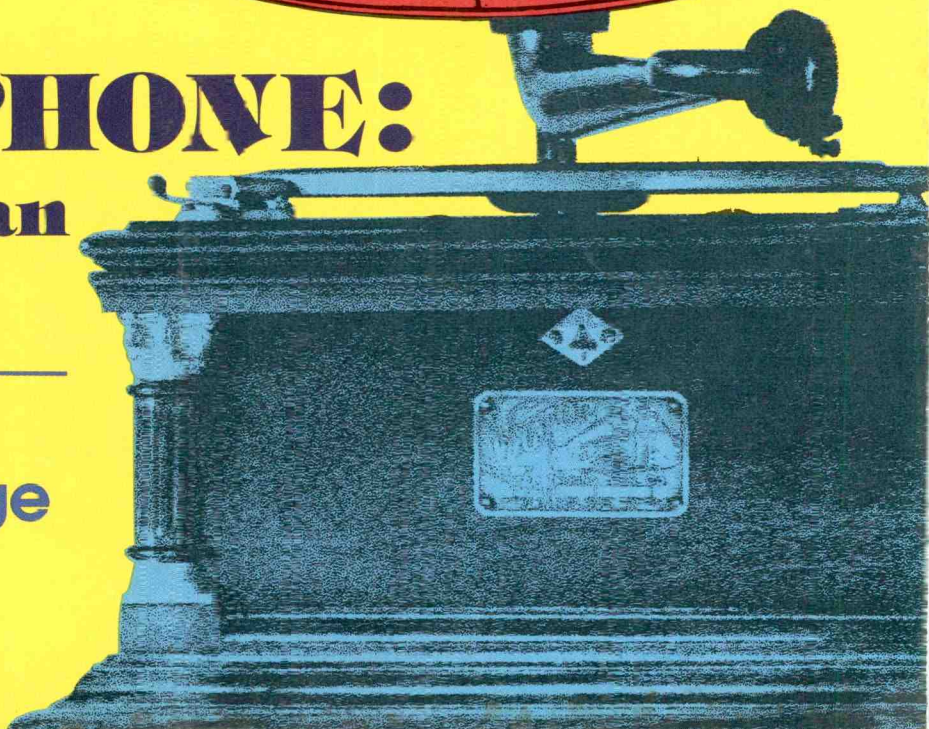

According to Audio Times, a leading publication devoted to audio manufacturing and retailing: "No piece of audio equipment is as eagerly awaited as the 'one four-channel unit that does everything — i.e., the receiver with built-in circuitry for SQ, RM and CD-4 record decoding.' "

It's here!

Pioneer has taken another giant step forward. Our new collection of quadraphonic receivers — QX-949, QX-747, QX-646 — has this total capability. They reproduce CD-4, SQ, RM and discrete four-channel sound without adaptors, add-on decoders or demodulators. And they're specifically designed to fully meet all of the standards established for these matrix and discrete program sources.

Bearing in mind that two-channel is, and will continue to be, a tremendous source of listening pleasure for many years to come, these new units are designed for it, along with their total quadraphonic capabilities. The QX-949 and QX-747 reproduce two-channel with augmented power due to Pioneer's new Power Boosting circuitry.

A whole new world of discrete sound with the built-in CD-4 demodulator

While many quadraphonic receivers have limited degrees of four-channel capabilities, Pioneer offers maximum versatility with built-in CD-4. Without

it you can't enjoy the increasing number of CD-4 discrete discs (the true four-channel record) from leading recording companies like RCA, Warner, Atlantic, Elektra, and others. CD-4 is a 'must' for optimum quadraphonic listening enjoyment.

Since the CD-4 circuit incorporates FET's and IC's, continuous, stable performance is assured. In addition, it uses a 30KHz subcarrier similar to that used in FM multiplex broadcasting. The subcarrier is demodulated by a Phase Lock Loop (PLL) circuit for each channel. The result is optimum channel separation — absolutely necessary to achieve the full, rich impact of quadraphonic reproduction. Convenient and simple-to-use front/rear left and right separation controls are on the front panels of all three models.

SQ and RM decoding bring to life the hidden ambience of matrixed and stereo records

With built-in FM circuitry, you can experience new brilliance from your present collection of two-channel stereo records and tapes. FM broadcasts, too. Also, new vistas of enjoyment unfold when you play the new four-channel SQ matrix records being released by Columbia, Capitol, Epic and Vanguard, to mention just a few of the prominent SQ record producers. No matter what the quadraphonic program source or the record label, Pioneer's new quadraphonic receivers flawlessly reproduce them all.

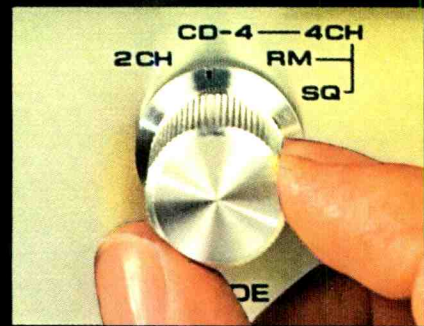

Total Capability Mode Switch — Fingertip switching to CD-4, SQ, RM quadraphonic sources, as well as two-channel stereo.

Matchless performance with powerhouse capabilities

As is traditional with all Pioneer receivers, the new quadraphonic units have power to spare. For example, the top model, QX-949, has a power output in four-channel operation, of 40 watts RMS/channel at 8 ohms, 20-20,000 Hz, four channels driven. THD and IM distortion is only 0.3% at 1 KHz.

Switching to two-channel operation, the new Pioneer Power Boosting circuit delivers 60 watts RMS/channel across the 20-20,000 Hz spectrum, with both channels driven, at less than 0.3% distortion.

By using super-size power transformers in the QX-949, in combination with four 10,000 microfarad electrolytic capacitors, this high power output is obtained at very low frequency. And it's further insured by direct-coupling in the output stage.

No overload with speaker protector circuit

Since direct-coupling feeds the signal directly to the speakers, an automatic



PIONEER 4 CHANNEL RECEIVER MODEL QX-949

Pioneer.

The very best





U.S. Pioneer Electronics Corp.,
75 Oxford Drive, Moonachie, New Jersey 07074

AN OPEN LETTER TO EVERYONE WHO HAS EVER BOUGHT
PIONEER EQUIPMENT -- OR HOPES TO

Many people who are ardent followers of the progress of high fidelity - and Pioneer's advancements, in particular - have asked us why we have limited our involvement in quadraphonic. The answer is quite simple.

By definition, high fidelity means pure, perfect sound reproduction. The number of channels has nothing to do with this state of perfection. Consequently, we have been directing our primary efforts to producing the finest 2-channel high fidelity equipment available. And we are continuing to do so.

During the past two years we have listened with great interest to the comments of consumers and audio dealers throughout the country. There appeared to be a 'wait and see' attitude because of the lack of 4-channel standardization on the part of manufacturers of equipment, records and tape.

However, the choice of a standard quadraphonic system has presently been narrowed down to where 4-channel is a viable, practical and delightful reality.

For this reason we have proceeded with every bit of enthusiasm and know-how at our command. The result is this new line of Pioneer quadraphonic receivers. These are total capability instruments. They embody all the presently known quadraphonic state-of-the-art. And they compare in all respects to the magnificent capabilities of Pioneer stereo instruments to produce the virtually perfect sound reproduction demanded by the audiophile.

If you've waited to buy a 4-channel receiver that could reproduce all quadraphonic reproduction systems - Pioneer has made the waiting worthwhile. We are proud to present to this industry these superb Pioneer "all-in-one" quadraphonic receivers.

Sincerely,

A handwritten signature in cursive script that reads "Bernard Mitchell".

Bernard Mitchell
President



Four-Channel Level Indicator — See what you hear. Make instant adjustments with left/right, front/rear level controls.

electronic trigger relay system is used to protect the speakers from DC leakage or overload.

New and exclusive Power Boosting circuit

When switching from four-channel to two-channel reproduction, power is substantially increased with the new and advanced Power Boosting circuit, as described above. This exclusive circuit is built into both the QX-949 and QX-747 models.

Another plus feature attributable to the Power Boosting circuit is simplified switching from four-channel to two-channel operation. It can be instantly achieved without the usual re-connecting of speaker wires. This, too, is a Pioneer exclusive.

A tuner section the equal of separate components

The FM tuner section of the QX-949 is truly an engineering accomplishment. It incorporates two dual-gate MOS FET's in the front end, plus three ceramic filters and 6-stage limiters in a monolithic IC in the IF stage. The result is superb sensitivity and selectivity, and excellent signal to noise ratio.

Advanced circuitry includes Dolby adaptor input/output and 4-channel broadcasting multiplex output terminal

In anticipation of the future use of discrete quadraphonic broadcasting, the QX-949 and QX-747 include a quadraphonic multiplex output terminal. Depending on the system finally approved, all that ever will be required is a simple adaptor unit. And speaking of adaptor units, both the QX-949 and QX-747 highlight an input/output for a Dolby noise reduction adaptor unit.

Unique 4-channel level indicator

Regardless which quadraphonic

source is in operation, the sound level of each channel can be monitored by viewing the large scope-type level indicator on the top two models. Left and right front/rear controls permit instant adjustment. Indicator sensitivity controls allow for a maximum of -30dB adjustments at any sound level. The level indicator may also be used to view CD-4 channel separation adjustments made with the CD-4 separation controls.

Inputs/Outputs for total versatility

Pioneer has endowed these models with terminals for a wide range of program sources. The only limitation is your own listening interests and your capability to experiment with sound.

Convenient features increase listening enjoyment

Along with the total capability of these receivers, Pioneer has incorporated a wide array of additional, meaningful features. All three instruments include: loudness contour, FM muting, an extra wide tuning dial, two sets of bass/treble

controls for front and rear channels, function and mode selector with multi-colored indicator lights. Further refinement is offered with the QX-949's multiplex noise and high/low filters, plus signal strength and center tuning meters in one housing.

Admittedly, these new Pioneer quadraphonic receivers, like fine sports cars or cameras, are not inexpensive. However, they represent the high fidelity industry's most outstanding value. We have built them with the same quality, precision and performance you've come to expect from Pioneer stereo equipment. We offer them to you with the same pride and conviction that has always compelled you to say — "Pioneer, the very best."

QX-949 — \$749.95; QX-747 — \$649.95; QX-646 — \$499.95. Prices include walnut cabinets.

U.S. Pioneer Electronics Corp.,
75 Oxford Drive, Moonachie,
New Jersey 07074
West: 13300 S. Estrella, Los Angeles
90248 / Midwest: 1500 Greenleaf,
Elk Grove Village, Ill. 60007
Canada: S. H. Parker Co.

Specifications

Amplifier	QX-949	QX-747	QX-646
4-ch. RMS power, 8 ohms, 4 channels driven, 20-20KHz	40 watts/channel	20 watts/channel	10 watts/channel (1KHz)
4-ch. IHF	240 watts (8Ω) 380 watts (4Ω)	160 watts (8Ω) 220 watts (4Ω)	80 watts (8Ω) 108 watts (4Ω)
2-ch. RMS power, 8 ohms, both channels driven, 20-20KHz	60 watts/channel	40 watts/channel	13 watts/channel (1KHz)
2-ch. IHF	150 watts (8Ω) 230 watts (4Ω)	120 watts (8Ω) 170 watts (4Ω)	40 watts (8Ω) 54 watts (4Ω)
THD/IM Distortion	0.3% (20-20KHz)	0.5% (20-20KHz)	1% (1KHz)
FM Tuner			
FM Sensitivity (IHF) (the lower the better)	1.8uV	1.9uV	2.2uV
Selectivity (the higher the better)	80dB	60dB	40dB
Capture Ratio (the lower the better)	1dB	1dB	3dB
S/N Ratio (the higher the better)	70dB	70dB	65dB
Inputs			
Phono	2	1	1
Tape Monitor	2 (4-ch.) 2 (2-ch.)	1 (4-ch.) 1 (2-ch.)	1 (4-ch.) 1 (2-ch.)
Dolby adaptor input	1 (4-ch.)	1 (4-ch.)	—
Auxiliary	1	1	1
Outputs			
Speakers	2 (Front) 2 (Rear)	1 (Front) 2 (Rear)	1 (Front) 2 (Rear)
Headset	1 (Front/Rear)	1 (Front/Rear)	1 (Front)
Dolby adaptor output	1 (4-ch.)	1 (4-ch.)	—
Tape Rec.	2 (4-ch.) 2 (2-ch.)	1 (4-ch.) 1 (2-ch.)	1 (4-ch.) 1 (2-ch.)
4-ch. MPX output	1	1	—



Discs Today are Different

There's a greater difference than meets the eye between today's records and older records. Modern technology in high-speed manufacturing can leave crystallized compounds on the surface of new discs. Quite frankly, only our fluid-based record cleaning system is designed to remove this audible problem.

That's because we carefully developed **d11** as a fully integrated system. Only **d11** fluid solubilizes ordinary dirt and debris as well as other contaminants. Then fluid, problems, and particulate matter are removed through capillary action onto our uni-directional brush fiber. The **d11** system is available from your audio specialist for \$12.95. **d11** fluid is \$2.25. (We also have a special formula for old 78's for \$2.00.)

Two years have made a terrific change in record quality. For some facts on today's discs, send 25¢ with a self-addressed, stamped envelope for our booklet *Clean Records and Chemistry*.

Discwasher, Inc.,

909 University, Columbia, Mo. 65201.

Audio

JUNE 1974

Successor to **RADIO** Est. 1917

Vol. 58, No. 6

FEATURE ARTICLES

- | | |
|---|---------------------------|
| 28 Gramophone—Basis for an Industry | <i>Robert E. Brockway</i> |
| 34 All About Q—Part I | <i>Don Davis</i> |
| 40 Constructing a Magnetic Cartridge Preamplifier | <i>Alan G. Ogilvie</i> |
| 50 Ragtime on Record | <i>Charles B. Davis</i> |

EQUIPMENT PROFILES

- | | |
|--------------------------------|----------|
| 56 Fisher Receiver | 4060 |
| 59 Sansui Amplifier | AU9500 |
| 62 Hitachi Cassette Deck | TRQ-2040 |
| 65 Applied Physics Lab Speaker | APL101 |

RECORD REVIEWS

- | | |
|----------------------|-------------------------------|
| 68 Classical Reviews | <i>Edward Tatnall Canby</i> |
| 78 Sherwood's Forest | <i>Sherwood L. Weingarten</i> |
| 84 Jazz & Blues | <i>Martha Sanders Gilmore</i> |

AUDIO IN GENERAL

- | | | | |
|-----------------------|--------------------------|---------------------------|-----------------------------|
| 4 Audioclinic | <i>Joseph Giovanelli</i> | 20 Audio—ETC | <i>Edward Tatnall Canby</i> |
| 4 Coming in July | | | |
| 6 Tape Guide | <i>Herman Burstein</i> | 26 Editor's Review | |
| 8 What's New in Audio | | 72 Advertising Index | |
| 12 Behind the Scenes | <i>Bert Whyte</i> | 86 Classified Advertising | |



EDITOR *Eugene Pitts III* PUBLISHER *Jay L. Butler*
 ASSOCIATE EDITOR *Edward Tatnall Canby* MARKETING DIRECTOR *Sanford L. Cahn*
 ASSOCIATE EDITOR *Bert Whyte* COVER DESIGN *John Kwasizur*
 ASSISTANT EDITOR *Peggy Bicknell* CIRCULATION MANAGER *Jean Davis*

CONTRIBUTING EDITORS: *Herman Burstein, Martin Clifford, Leonard Feldman, Martha Sanders Gilmore, Joseph Giovanelli, Richard C. Heyser, C. G. McProud, George W. Tillet, Sherwood L. Weingarten.*

AUDIO (title registered U.S. Pat. Off.) is published monthly by North American Publishing Co., Irvin J. Borowsky, President; Frank Nemeyer, Jay L. Butler and Roger Damio, Vice Presidents; R. Kenneth Baxter, Vice President/Production; Nate Rosenblatt, Promotion Director; Mary Claffey, Circulation Director.
RATES—United States only: 1 year for \$7.00, 2 years for \$12.00, 3 years for \$17.00; outside the U.S.: 1 year for \$9.00, 2 years for \$16.00, and 3 years for \$23.00. Printed in U.S.A. at Columbus, Ohio. All rights reserved. Entire contents copyrighted 1974 by North American Publishing Co. Second class postage paid at Philadelphia, Pa. and additional mailing office. Back issues, \$2.00 each.

REGIONAL SALES OFFICES: Jay L. Butler, Publisher and Sanford L. Cahn, Marketing Director, 41 East 42nd St., New York, N.Y. 10017, telephone (212) 687-8924.
 Jay Martin, 15010 Ventura Blvd., Sherman Oaks, Calif. 91403, telephone (213) 981-7852.

REPRESENTATIVES: Continental Europe: John Ashcraft, 12 Bear St., Leicester Square, London W.C. 2, telephone 930-0525.
 For Benelux and Germany, W.J.M. Saunders, Mgr., Herengracht 365, Amsterdam, Holland, telephone 24.09.08.
Japan: Japan Printing News Co., Ltd., No. 13-2 Chome Ginza Higasi, Chuo-ku, Tokyo, telephone 541-5795.

AUDIO Editorial and Publishing Offices, 134 N. 13th St., Philadelphia, Penna. 19107
 Postmaster: Send Form 3579 to the above address

We give you the softest soft to the loudest loud.

From our lowest price to our highest, you won't get 'clipped.'

Today's best recordings can reproduce music's full dynamic range, from the softest soft to the loudest loud. Most of today's popular low and moderate efficiency speaker systems can't. But BIC VENTURI speakers do.

A speaker's dynamic range depends mainly on its efficiency and power handling capacity. Low-efficiency speakers can't get started without a good deal of input power. And, they tend to get stifled when driven beyond their capability.

BIC VENTURI speakers are efficient! They need as little as one fifth the amplifier power of most air suspension systems for the same sound output. So, you can listen louder without pushing your amplifier to the point where it starts clipping the tops and bottoms of musical peaks.

Today's popular, low-efficiency speakers require about a 50-watt per channel amplifier to deliver lifelike sound levels. Even our Formula 2 will deliver that same sound level with only 25 watts of amplifier power; the Formula 4 with 20 watts and our Formula 6 with only 9 watts! With BIC VENTURI, your amplifier can loaf along with plenty of reserve "headroom" to reproduce musical peaks cleanly, effortlessly. It's as if your present amplifier suddenly became two to five times as powerful. BIC VENTURI can handle lots of power, too. A typical, low-efficiency system is rated for a maximum safe power input of about 50 watts. Feed it more power and you're likely to push it into distortion, or even self-destruction!

With a BIC VENTURI you can turn up the power, without distortion or speaker damage. Even our compact Formula 2 can safely handle 75 watts per channel. With that much power feeding it, it will deliver 210% more sound output than a low-efficiency system will at its

power limit. Drive our super efficient Formula 6 at its maximum, and it will deliver nearly 1300% more sound power!

That's the loud half of the story.

With soft music (or when you turn down the volume) you want to hear it soft.

With most speakers, turn down the volume slowly and you reach a point where the sound suddenly fades out because the speakers aren't linear anymore.

But BIC VENTURI's are. The sound goes smoothly softer, without any sudden fadeout, retaining all the subtle nuances that add to the character of the music.

But, even though BIC VENTURI speakers remain linear, there is a point where your ears do not. At lower sound levels, your ears lose their bass and treble sensitivity. So, our DYNAMIC TONAL BALANCE COMPENSATION™ circuit (pat. pending) takes over. As the volume goes down it adjusts frequency response, automatically to compensate for the ear's deficiencies. The result: aurally "flat" response, always!

Our Formula 2 is the most efficient of its size. The Formula 4 offers even greater efficiency and power handling. And the most efficient is the Formula 6. Hear them at your dealer. B·I·C INTERNATIONAL, Westbury, N.Y. 11590. Div. of Avnet, Inc. Canada: C.W. Pointon, Ltd., Ont.

 **BIC VENTURI**



Coming in
July

Progress Report on Quadraphonics—George Tillett brings us up to date on four-channel happenings.

Special Report on Education—Paul Moverman tells about schools specializing in education for the audio industry.

Equipment Reviews Include—

Tandberg 1055 Receiver
Technics SL-1200 turntable

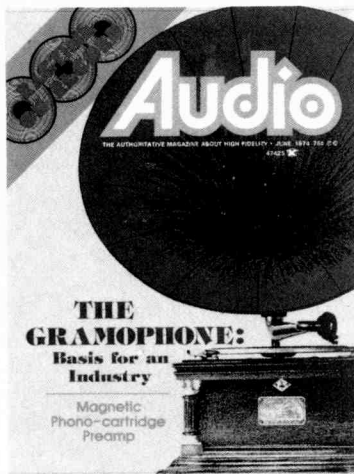

About The Cover: Our feature article this month describes Emil Berliner's invention of the gramophone, and we could think of no better cover illustration than this delightful item from the collection of Larry Robin.

Audioclinic

Joseph Giovanelli

A Reader's Comment About Phonograph Hum

Editor's Note—Some time ago, March, 1972 to be exact, I answered a reader's question with the hope of curing the hum in his phonograph. I do not know whether my suggestions were helpful. In any event, my answer prompted another reader to share his experience with all of us:

If your correspondent has (1) an older Garrard (such as a Lab-80) or (2) a Shure cartridge (such as an M91 or M93), he, himself, may be causing the hum problem because of improper installation of the cartridge.

The Lab-80 has a metal cartridge holder. The Shure cartridges have grounding straps attached to their cases and to the RG lugs on the cartridge. In the case of the combination of the Shure cartridges and the Lab-80, and worn lugs on the shell plugs, you can have one heck of a lot of hum without half trying. The cure is to pull the ground strap out of the cartridge (which it is designed to do). I almost went "bananas" trying to find the ground loop in my system after I changed over to an M91E from an M-44E (which does not have a metal case); of course, I knew what I was doing and did not bother to read the directions first. I found out that other folks did the same thing at the store I work for because this same problem showed up with other turntables and cartridges, where metal cartridges were involved.

For what it is worth . . . —Thomas N. Ronayne, Detroit, Michigan

Centering a Woofer on its Baffle

Q. One of my associates and I occasionally indulge ourselves in the construction of bookshelf-size speaker enclosures using both acoustic suspension and non-acoustic suspension loudspeakers. The enclosures are all essentially of the infinite baffle type—no bass reflex designs, etc. One of us claims that placing the woofer off-center on the front panel will give better results (such as bass response) than when placing it directly in the center. The other claims that plac-

ing the woofer in the exact center would be acoustically more desirable.

Barring changes in dimensions, total air volume or any other variable, who is correct as to the placement of the woofer? What would be the criteria for such placement?—Ken Clarke, Columbus, Ohio

A. I never center a woofer on a baffle board, neither vertically nor horizontally. If a woofer is centered, the baffle board is free to vibrate in two equal modes, adding to coloration. These modes tend to reinforce each other. By not centering the woofer, the baffle will still try to vibrate, but the modes of vibration will be different on each side of the woofer, thus considerably weakening the mechanical resonances which may be present.

There is no substitute for a heavy baffle board. Its weight will keep the amplitude of vibrations low and thus keep the sound cleaner than it would otherwise be, regardless of the placement of the woofer.

Scratch Filters

Q. Would you know of any company that markets a scratch filter for record surface noise?—Ronald R. Kostecky, Ramsey, New Jersey

A. I suggest that you inquire about such a unit by writing to the large mail order houses such as Allied and Lafayette. Noise is most perceptible to the ear in the range of about 3,000 to 5,000 Hz. Hence, one of the new breed of audio equalizers (quite expensive), which can shape frequency response over the span of as little as an octave or even one-third octave, could be of great help. Some audio preamps have quite effective scratch filters, and you might inquire of your audio dealer which are the best in this respect.

If you have a problem or question on audio, write to Mr. Joseph Giovanelli, at AUDIO, 134 North Thirteenth Street, Philadelphia, Pa. 19107. All letters are answered. Please enclose a stamped self-addressed envelope.



anatomy of the total performers

If you take apart one of TDK's new Dynamic-series cassettes, you might think it looks pretty simple. Five screws. Two hubs. A length of tape. Two rollers. Two cassette shell halves. A few other parts. What's so complicated about that?

Plenty! Unlike open reel tape, a tape cassette becomes an integral part of your recorder. Not just electromagnetically, but also mechanically. So in addition to good sound reproduction capabilities, a cassette must be an absolutely precise mechanism.

It took years of research, development and testing to produce the present-day TDK cassette. The result is a unique combination of superior electromagnetic characteristics and mechanical precision that make TDK cassettes completely compatible with any cassette recorder. And it permits them to deliver total sound reproduction and mechanical performance unequalled by any other cassette you can buy today.

Take the tape, for example. TDK cassette tapes are coated with exclusive formulations of ferric oxide powders in special binders, using proprietary TDK methods which result in the most desirable electromagnetic characteristics. Not just full-range frequency response and high-end sensitivity, but the proper balance of all the other characteristics essential to the faithful reproduction of "real-life" sound. Like high MOL (Maximum output level). Broad dynamic range. Wide bias tolerance. High signal-to-noise ratio. Low modulation and bias noise. Low print-through. Good erasability.

The housing is precision-molded of high-impact styrene. The transport mechanism uses tapered and flanged rollers with stainless steel pins, all-felt pressure pad, silicone-impregnated liners, and two-point hub clamps. Features first introduced by TDK. And all parts are manufactured to extremely fine tolerances to assure trouble-free operation and to

resist jamming, stretching, warping and tangling.

What does all this mean to you? Just that when you record on one of TDK's new Dynamic-series "total performer" cassettes, you can be sure of getting everything! All the highs and lows. All the important harmonics, overtones and transient phenomena. All the natural richness, fullness and warmth of the original performance. Plus reliable, trouble-free mechanical operation.

So look for TDK's total performers at quality sound shops everywhere. For sound you feel as well as hear, discover the dynamic world of TDK!

the new dynamic world of

TDK

TDK ELECTRONICS CORP.
755 Eastgate Boulevard, Garden City, New York 11530

Check No. 38 on Reader Service Card

Tape Guide

Herman Burstein

Noise Reduction

Q. Is the Dolby Noise Reduction System (or any other) primarily for the improvement of cassettes? Could one expect "meaningful" improvement when the noise reduction system is applied to a top quality open-reel deck? I have the same question regarding Crolyn tape. Is this being introduced only for the benefit of cassettes, or will the open reel decks be able to use and profit from this tape?

How critical are the connecting cable lengths between a cassette deck and the preamplifier? I am toying with an arrangement which would place the deck in a room some 50 or 60 feet from the other components. Is this possible without deteriorating a fine system?—Samuel Neiditch, Highland, California

A. When using high quality tape decks, the Dolby system will achieve the most "meaningful" improvement in S/N at tape speeds of 3¾ ips and lower. Thus cassettes, which operate at 1½ ips, have much to gain from the Dolby. If you plan to copy tapes, and possibly re-copy and re-re-copy them, as recording studios do, it may be advantageous to use the Dolby system. Small increments in noise with each copy eventually build up to a large addition of noise, and then the Dolby can be quite effective even at speeds of 7½ ips or higher.

So far as I know, the CrO₂ tape is not available in open-reel format.

If the tape deck has a low output impedance, say on the order of less than 1,000 or 2,000 ohms, chances are that you can use 50 or 60 feet of cable without significant treble loss. Use microphone cable of low capacitance per foot.

Insufficient Gain

Q. Recently I put a Nortronics head into a player to use as a reproducer for duplicating tapes. When I connected this head via shielded cable to the tape head input of a Dyna PAS-3, the gain did not seem sufficient at the normal volume level used for other sources. I then tried

a tape preamp and plugged its output into an auxiliary input of the Dyna. Still there was not enough gain. Next I tried matching transformers (3,000 ohms to 50,000 ohms) between the head and tape head input. There was some improvement in gain, but still not enough to be useful. I've run out of ideas. Can you be of any help?—Richard A. Shroyer, Charlotte, North Carolina

A. One possibility is that you have acquired a defective head. Another possibility is that the head is imperfectly aligned—with respect to azimuth and/or with respect to vertical position. Azimuth misalignment would mostly reduce treble response. Vertical misalignment would reduce gain in general. Still another possibility is that you have mistakenly acquired a head intended for recording rather than playback; if this were the case, treble response would be poor.

Improving Response

Q. I own a stereo tape recorder, which according to the manufacturer's specifications has a frequency response of 100 to 10,000 Hz. I would like to know if there is any way short of complete overhaul to extend the response, preferably approaching 20 to 20,000 Hz.—David E. Campbell, Tallahassee, Fla.

A. It would be a substantial task to extend the response to 20-20,000 Hz. And this could be done only at 7½ ips, not at 3¾ ips. Making the change would probably involve a new playback head (with a narrower gap than the original head for a good treble response) and modification of the record and playback equalization circuits. The new head would probably entail changes in bias and signal drive circuits for recording, plus a change in calibration of the record-level indicator; and the new head would have to be aligned for azimuth and correct vertical position.

Extending response down to 20 Hz may bring out hum to an unpleasant degree. Substantial hum is often found in less expensive machines, and manufacturers often get around this by limiting bass response.

My guess is that response from 100 to 10,000 is close to optimum for your machine, and that extending response beyond this range may bring up more problems than it will solve.

Low Frequency Crosstalk

Q. I have a used Sony 355 tape deck, and the only problem with it is excessive low frequency crosstalk with the adjacent track. I bought new heads, but the problem is still present, though not as bad as before. I own an Eico PR-100 tape deck, and the Nortronics heads on that unit exhibit no such problem. Would replacing the Sony heads with Nortronics heads cure the problem?

Another question. Would checking the play response of a 4-track stereo deck with a full-track alignment tape yield different results from a 4-track stereo alignment tape, assuming both tapes are otherwise the same?—John J. Cormack, Manlius, New York

A. Your crosstalk problem may be due to vertical mispositioning of the heads, to excessively long gaps in the Sony heads, or to some characteristic of the head that causes the entire head and not merely the gap to respond to low frequencies. Normally there is a tendency of the entire head to respond to low frequencies, but not to such an extent as to cause a serious crosstalk problem. I can't say for sure that use of Nortronics replacement heads would cure the problem. Your experience suggests they would.

Using a full-track alignment tape instead of a quarter-track one will produce somewhat different results in testing playback response; that is, the full-track tape tends to result in somewhat more bass.

If you have a problem or question on tape recording, write to Mr. Herman Burstein at AUDIO, 134 North Thirteenth Street, Philadelphia, Pa. 19107. All letters are answered. Please enclose a stamped, self-addressed envelope.

In the beginning there was folded horn bass reflex acoustics suspension.

And now BIC VENTURI

For about 40 years, speaker designers have been juggling the characteristics they wanted from speakers: Compact size, high efficiency, high power-handling, and deep ranging, pure, clean, gut-reaction bass.

They tried folded horns: efficient, clean, good power-handling, but too large for most homes, quite expensive. They tried the bass reflex: Efficient, compact, but limited by uneven, one-note bass. Ditto the labyrinth, but far less efficient.

Today's favorite, the acoustic suspension: Compact, smooth, deep ranging bass. But inefficient (requiring costly, high-powered amplifiers) and limited dynamic range.

A virtue here, a virtue there -- but all with corresponding compromises.

Ironically, the principle that combines these objectives into one compact cabinet has been around for some 180 years: The VENTURI principle of fluid motion transformation, reapplied in a form better suited to acoustics (patents pend). Our simplified diagram shows how the scientifically formulated VENTURI coupled path functions as a step-up transformer. Up to 140 times more bass energy comes from the duct as comes directly from the woofer. And bass is reinforced broadly over the low frequency spectrum, not at a single "tuned" frequency.

The BIC VENTURI coupled path also operates as an acoustic, low pass filter, cleansing harmonics and distortion components from the bass waves. So, the bass not only goes down further and is louder, it's cleaner and more natural. And requires hundreds percent less amplifier power than other speakers of comparable size and performance. Yet, even though BIC VENTURI need less amplifier power, they can handle more. This new principle eliminates compromises in cone, suspension and magnetic design to "match" cabinet characteristics.

Above the woofer, you can see our mid-range. To match the exceptional high efficiency of the bass section, we had to invent a new horn, combining two different types of flare, conical and exponential, BICONEX™ (pats pend). It provides wide, smooth dispersion in both horizontal and

vertical planes, so placement in the home won't be critical. BICONEX covers the full midrange to well beyond 15,000 Hz without crossover network interruptions, for distortion-free, smooth response.

Our super tweeter handles just a half octave from 15,000 to over 23,000 Hz. While you can't hear single frequency tones in that range, the accuracy of musical "timbre" depends upon those frequencies being added in proper proportion to the complex tones you do hear. An important subtlety.

Because you hear less bass and treble at low and moderate levels, we built a DYNAMIC TONAL COMPENSATION circuit (patents pending)

into the speaker. It adjusts speaker frequency response as sound pressure output changes, automatically. Amplifier "loudness contour" controls can't do that. Result: aurally "flat" musical reproduction always, regardless of volume control settings.

Our Formula 2 is the most efficient speaker system of its size, yet can be used with amplifiers rated up to 75 watts per channel! Formula 4 has deeper bass and can be used with amplifiers up to 100 watts. Formula 6, the most efficient, will handle 125 watts. Hear them at franchised BIC VENTURI dealers. Or write for brochure:

B·I·C INTERNATIONAL, Westbury, N.Y. 11590,
a div. of Avnet, Inc. Canada: C.W. Pointon, Ont.

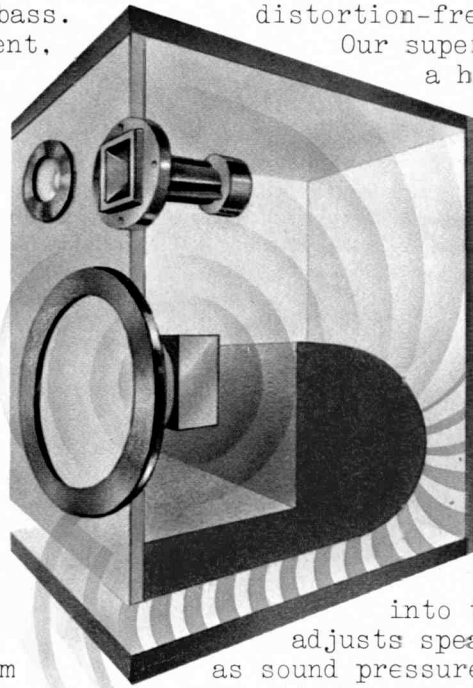

What's New in Audio

Trusonic Speaker

Designated JR-100M, this speaker is a 3-way tuned-port model featuring a 10-in. woofer and 5-in. midrange driver, both of which utilize viscous-damped fabric suspension said to suppress standing wave formation and harmonic distortion. The speaker also has a level control for both midrange and tweeter. Frequency response is 30-20kHz; power capacity, 80 W. peak; impedance, 8 ohms. The cabinet is walnut with a removable acoustical foam grille available in several colors. The JR-100M measures 23" W. x 14" H. x 10" D., weighs 33 lbs., and is priced at \$119.95.

Check No. 78 on Reader Service Card

Pickering Stylus Timer

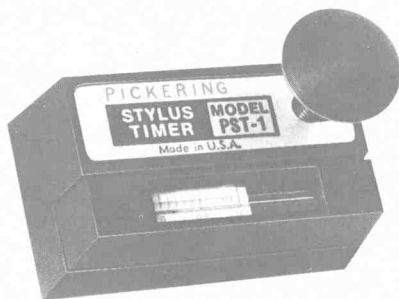

This device accurately measures actual stylus wear-time from 0 to 1000 hours (resettable to 0 hours). A patented mercury coulometer, in which an indicator dot travels along a mercury-filled, hermetically sealed capillary tube, records the flow of electrical current. Easily mounted on a turntable with no electrical connections necessary, the unit measures 2 $\frac{7}{8}$ " L. x 1" W. x 1" H. Price: \$13.95, including mercury battery.

Check No. 79 on Reader Service Card

Heath Dolby cassette deck

The AD-1530 Dolby cassette tape deck kit features Dolby noise-reduction circuitry and chromium dioxide tape equalization in a kit said to require only five evenings. Hum and noise are stated as -58 dB above 4,000 Hz with Dolby engaged. Response is 40 to 14,000 Hz \pm 3 dB with CrO₂ tape. Wow and flutter is less than 0.25% rms. Price: \$249.95.

Check No. 80 on Reader Service Card

Nagy Tape Splicer



Fast cutting and better splices are promised with the Model 6S25 Nagy Tape Splicer, which incorporates a self-sharpening shear, replacing the razor. A precision dovetail groove secures the tape during splicing, while the block itself may be secured via $\frac{1}{8}$ -in. mounting holes. The Model 6S15 handles cassette tape. Price: \$16.95.

Check No. 77 on Reader Service Card

Transcriptors Tonearm

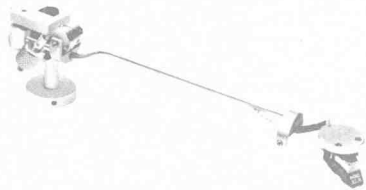

The Vestigal tonearm is said to be capable of accurately tracking highly modulated discs at 1/10 gram tracking pressure. Inertia or effective mass is specified as 6 grams horizontal and 0.5 grams vertical. These two characteristics, says Transcriptors, result in little or no stylus wear and degeneration of discs at least 40 times less than usual. Maximum variation in tracking pressure possible with the Vestigal arm is said to be less than 30 per cent, while conventional arms have constant variations up to 1000 per cent.

Check No. 76 on Reader Service Card

Literature

Practical Test Equipment You Can Build contains 204 pages of useful, economical and easy-to-build test equipment projects. Most of the projects can be completed and put to use in a single evening—and for your pocketbook, maximum use has been made of inexpensive components. Sections included are: semiconductor testing devices; measuring volts, ohms, and r.f. watts; dip meters and wavemeters; and,

useful test and measurement circuits. Basic though complex plans are explained and 157 illustrations make the going a little easier. The hardbound version is \$7.95 and paperback, \$4.95. Order book #669 from Tab Books, Blue Ridge Summit, PA 17214.

ESS Loudspeaker

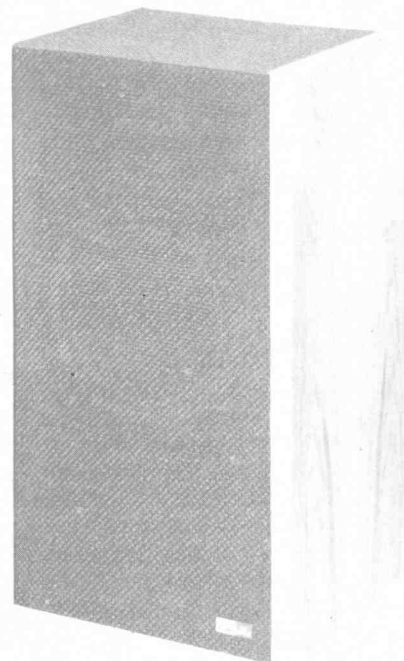

The two-way, floor-standing AMT 4 retains many of the features of the larger, previously introduced Heil air-motion transformer loudspeakers. Modified characteristics include slightly lessened loudness, smaller size and a Heil air-motion transformer which is $\frac{2}{3}$ the size of that used in the larger AMT models. Bass and mid-range frequencies are reproduced by a 10-inch air suspension driver. Other specifications include: frequency response, 40 Hz to 22 kHz; distortion, less than 1 per cent; power requirements, 20 W rms minimum; impedance, 4 ohms minimum; finish, hand rubbed oiled walnut. The AMT 4 measures 27 in. H by 15 $\frac{1}{8}$ in. W by 12 $\frac{1}{2}$ in. D. A lifetime warranty to the original owner covers the Heil air-motion transformer while the balance of the system is covered for five years, including parts and labor. Price: \$239.00.

Check No. 75 on Reader Service Card

Some of the reasons why other turntables don't perform quite like a Dual.

Because of the wide acceptance and acclaim Dual has earned over the years, especially among audio experts, many Dual features inevitably appear on competitive turntables.

To copy a Dual feature is one thing; to achieve Dual performance and reliability is quite another matter. The true measure of a turntable's quality is not its features alone, but how well the entire unit is designed and manufactured.

Following are just some of the ways in which Duals differ from other automatic turntables.

Gyroscopic gimbal suspension.

The gyroscope is the best known scientific means for supporting a precision instrument that must remain perfectly balanced in all planes of motion. That is why the tonearms of the 1218 and 1229 are suspended in true, twin-ring gimbals.

Every Dual gimbal is hand-assembled and individually checked with gauges especially developed by Dual for this purpose. This assures that the horizontal bearing friction of the 1229 for example, will be no greater than 0.015 gram, and vertical friction no greater than 0.007.

True single-play automatic tonearm.

A turntable of the 1229's caliber is used primarily in its single play mode, so the tonearm is designed to parallel a single record on the platter. For multiple-play, the entire tonearm base is moved up to parallel the tonearm to the center of the stack.

The 1218 tonearm provides the single-play adjustment within the cartridge housing, and the cartridge pivots around the stylus tip to maintain the correct overhang.

Stylus pressure around pivot.

Today's finest cartridges, designed to track at around one gram, have little margin for error. In the 1229, therefore, the tracking pressure scale is calibrated within 0.10 gram from 0 to 1.5 grams.

To maintain perfect balance on every Dual tonearm, stylus pressure is applied internally and around the pivot. This is accomplished by a very long spring coiled around the pivot. Only a small portion of the spring's length is needed to apply the required pressure, thus contributing greatly to the accuracy of the calibrations.

Avoiding sounds that weren't recorded.

The rotor of every Dual motor is dynamically balanced in all planes of motion. Each motor pulley and drive wheel is also individually examined with special instruments to assure perfect concentricity.

Any residual vibration within the motor is isolated from the chassis by a three-point damped suspension. Finally, every assembled Dual chassis is "tuned" to a resonance frequency below 10 Hz.

The best guarantee.

All these precision features and refinements don't mean that a Dual turntable must be handled with undue care. So we're not being rash when we include a full year guarantee covering both parts and labor for every Dual. That's up to four times the guarantee you'll find on other automatic units.

Now, if you'd like to know what several independent test labs say about Dual, we'll send you complete reprints of their reports.

Better yet, just visit your franchised United Audio dealer. You'll see for yourself that only a Dual performs precisely like a Dual.



Dual 1214, \$119.95

Dual 1216, \$154.95

Dual 1218, \$189.95

Dual 1229, \$259.95



United Audio Products, Inc., 120 So. Columbus Ave., Mt. Vernon, N.Y. 10553

Exclusive U.S. Distribution Agency for Dual.

Step up to the professional performers by **BOSE**®

800 speaker

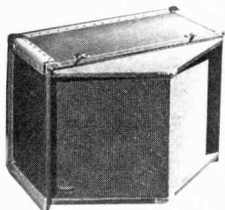

With BOSE Professional Products, the sound the audience hears is the sound the performers play... pure and simple.

1800 amplifier

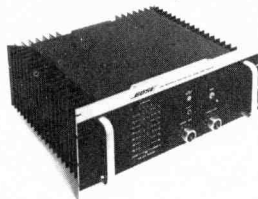

The 800 Professional Speaker offers clean, natural sound, in a rugged portable package. The 1800 Professional Amplifier offers 800 watts rms, LED displays, and high reliability, in a rugged package.

For information about BOSE Professional Products, mail this to BOSE, Dept. AP, The Mountain, Framingham, Massachusetts 01701.

NAME _____
 ADDRESS _____
 CITY _____ STATE _____ ZIP _____

Check No. 9 on Reader Service Card

CLASSIFIED

Want to buy, trade or sell components? Looking for a rare piece of equipment? Want to offer or buy a service? Want a job in the audio field? If your answer is "yes" to any of these questions, your ad belongs in Audio Classified. Rates are comfortably low—readership is astoundingly high. Use the handy order form to include your message in the next issue.

Model AT15S cartridge shown in Model AT1009 tone arm.



THE HOT TIP IS SHIBATA...and audio-technica!

The only phono stylus tip designed for the new discrete 4-channel records is the new Shibata multifaceted stylus.

It's the stylus we include on our AT12S, AT14S, AT15S & AT20SL Audio-Technica Dual Magnet*

audio-technica.

cartridges. To give you correct, long-lasting performance from discrete 4-channel records. And better sound from any matrix record or present stereo disc as well.

Audio-Technica Dual Magnet cartridges are brand new and loaded with features. Like a separate, independent magnetic system for each side of the stereo groove. And smooth response to 45,000 Hz and beyond. Plus very low moving mass for superior tracing ability.

Get a tip from leading audio showrooms throughout the country who are now stocking and recommending the Audio-Technica Dual Magnet cartridges. For every modern record you own.

*U.S. Patent No. 3,720,796; 3,761,647

AUDIO-TECHNICA U.S., INC., Dept. 64A, 1655 W. Market St., Fairlawn, Ohio 44113
 Check No. 7 on Reader Service Card

Schober Amplifier Kits

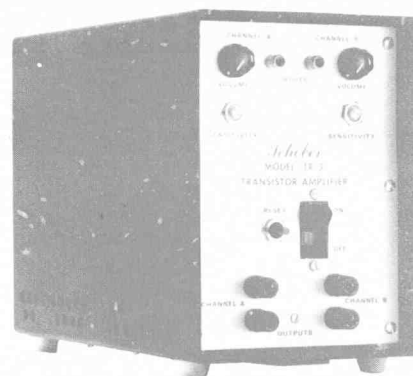

The TR-3 is a 70W/channel (into 8 ohms) basic power amp available in both mono and stereo versions. The unit features push-pull operation of all stages and direct coupling throughout. The amp accepts any load, including capacitance, and recovery from overload is said to be virtually instant. The manufacturer claims the problems of odd-order harmonic distortion, heating and power supply ripple are greatly reduced with the 100% push-pull operation. Power bandwidth is 5-40,000 Hz \pm 1/2 dB; THD, less than 0.1%; IM, less than 0.07%. Sensitivity is set with a special control that requires only 0.15 V at the input for full output. The amp measures 5 1/2 in. x 8 in. x 11 1/2 in. H. and takes 3 or 4 evenings to assemble. A 49-page instruction manual covers assembly, installation, operation and service. TR-3D (stereo): \$194.90. TR-3M (mono): \$142.00. Mono-to-stereo conversion kit (TCK-3): \$59.20.

Check No. 53 on Reader Service Card

Marantz 4-Channel Receiver

Model 4300 AM/FM receiver with Dolby is rated at 200 watts continuous power and delivers 40 watts per channel in the 4-channel mode. In stereo, bridging straps rear and front amps to produce 100 watts continuous power per channel. The unit's tuner/preamp section can be separated from the main amps so that external power amps and/or equalizers can be used. A hidden decoder pocket is built into the underside of the receiver to accept an optional Marantz SQ decoder. The receiver's mode switch has a discrete position for CD-4 discs and discrete 4-channel tape sources. Also featured are signal strength and FM tuning meters, illuminated function and mode indicators, 2- or 4-channel tape sources and jacks for stereo or quadraphonic headphones. Price: \$899.95.

Check No. 54 on Reader Service Card

You can't tell an amplifier by its cover.

Control Amplifier — Combination Amplifier and Preamplifier. It takes a source signal, such as a tuner or phonograph output, and electronically boosts the signal to a level usable by the speakers. It also has a section to manipulate tonal color with treble and bass controls and filters of various types. A control amplifier serves as the brain and function selectors for a stereophonic system. It is exemplified by the extraordinarily good design of the Sansui AU-9500.

The Sansui AU-9500 is the ultimate control amplifier for the serious audiophile. It combines a powerful 75 watt RMS per channel (both channels driven) amplifier with controls and input/output flexibility to make it the world's premier unit. Each channel is separately driven by the Sansui AU-9500's twin dual power supply system built around four large capacitors and separate windings. Parallel push-pull output circuits reduce distortion. The AU-9500 affords speaker and transistor protection three ways: 1) electronic protector circuit. 2) four quick-acting fuses. 3) current limiter circuit.

Two tape decks can be

monitored or, with a flick of a front panel switch, you can dub from one tape deck to another. The AU-9500 can also handle two phonographs, a microphone, a tuner and an auxiliary input. It can give you normal stereophonic or reverse the channels, monophonic or each channel separately. The unit is ready for 4-channel and the addition of a noise reduction unit.

Sansui also makes the AU-7500 control amplifier with 32 watts RMS per channel into 8 ohms and the AU-6500 with 28 watts RMS per channel into 8 ohms.

The AU-9500 by Sansui is the definition of a state-of-the-art Control Amplifier.

Tuner — A high fidelity tuner is an instrument used for the capture of radio signals. It requires an amplifier to yield signals usable by speakers. It can be either AM, FM, or FM Stereophonic (called Multiplex) or any combination of them. In an FM stereo tuner there are a number of important parameters: separation, selectivity, sensitivity, etc.

Sansui's new TU-9500 (a perfect match for the Sansui AU-9500, see control amplifier) is an AM/FM and FM stereo tuner with very good

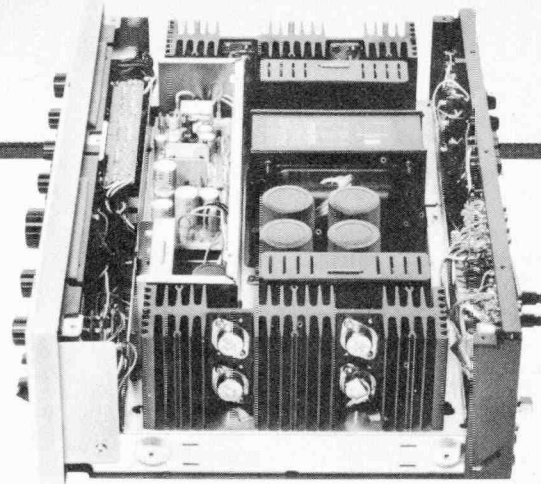

specifications and unusual features. Its FM IHF sensitivity is a very low 1.7 μ V, channel separation is better than 40 dB at 400 Hz and better than 30 dB at 10,000 Hz. Selectivity is an unusually high 80 dB. In addition, the Sansui TU-9500 features a remarkably low 0.3% Total Harmonic Distortion in Stereophonic. A newly designed Differential Demodulator Circuit (DDC) eliminates the SCA (Subsidiary Communications Authorization) sub-carrier beating and increases stereo separation.

The Sansui TU-9500 has set of output jacks that can go directly to a tape deck and a set that can go to an oscilloscope to check multi-path. This is in addition to the conventional output to amplifier jacks and the less conventional dis-

criminator output which makes this set 4-channel ready.

To the left of the wide linear dial scale are the signal strength (operating on AM and FM) and center channel meters. The TU-9500 has its own output level control, noise suppressor and FM muting switches and a rotary switch to yield AM/FM stereo or FM monophonic.

The AM section, frequently the step child of high fidelity, is not neglected here. It is newly designed for more selectivity and an advanced AGC (automatic gain control) circuit ensures minimal distortion.

Sansui also makes the TU-7500 with an IHF FM sensitivity at 1.9 μ V.

The TU-9500 by Sansui is the definition of a state-of-the-art quality tuner.

**To fully appreciate a Sansui amplifier or
tuner, you must hear the quality inside. That's the only
way to discover why Sansui means high quality
Hear the inner quality of Sansui high fidelity components.
at your nearest franchised Sansui dealer.**

Sansui

SANSUI ELECTRONICS CORP.

Woodside, New York 11377 • Gardena, California 90247
SANSUI ELECTRIC CO., LTD., Tokyo, Japan • Sansui Audio Europe S. A., Antwerp, Belgium
ELECTRONIC DISTRIBUTORS Canada

Check No. 30 on Reader Service Card

Behind The Scenes

Bert Whyte

A PROFESSIONAL MASTER tape recording of a live musical event is the ultimate expression of the quality we call high fidelity. A Dolby A, real-time copy of the master tape is virtually identical in quality. Some of us are fortunate enough to acquire such copies. If all parameters are carefully optimized, a Dolby B encoded high-speed dub of the master can be of exceptionally high quality. Quite a few people own open-reel Dolby B playback equipment and they can enjoy these commercial dubs. For most people, the closest approach to the quality of the master tape is via the oldest music storage medium of them all . . . the phonograph disc.

Because the disc is the least expensive, universally available playback medium, there are those who imagine that this somehow limits the sound quality. This, of course, is not true. It is not a valid premise now, nor has it been for many years. To be sure, the sonic qualities of the disc are dependent on the degree of care and skill exercised in the cutting and pressing of the disc. It is also obvious that the quality of the playback equipment, and close control of the many variables involved in the playback process, will determine the fidelity of reproduction from the disc. Far from being "short-changed," under ideal circumstances the fidelity of sound from a phonograph disc is nothing short of astonishing.

Recently, I was visited by a friend of mine who manufactures a highly regarded new loudspeaker. I was playing some master tape copies and other sonic goodies for him, and then urged him to listen to something special I had run across. In a moment, he heard the stirring strains of Berlioz' *Rakoczy March*, played by Paul Paray and the Detroit Symphony Orch. The sound was

beautifully clean, with excellent instrumental balances. There was big, fat, blaring brass and percussion of almost visceral impact. Dynamic range was very wide indeed. My friend flipped over the sound quality and simply couldn't believe he wasn't listening to a tape, but rather to a *13-14 year old Mercury disc!* I admit I helped things along by using the UREI Cooper Time Cube, to introduce a moderate level of delayed sound to rear channel speakers. Psychoacoustically, this gave the impression of an even bigger sound image. The pressing was exceptionally good, and had been played no more than a half dozen times, and with great good luck there wasn't a scratch, tick or pop to be heard. But beyond this was the fact that Bob Fine had made a superb original recording, and then had transferred it to a stereo disc using a specially modified Westrex 3C cutterhead, driven by a 200-watt-per-channel McIntosh amplifier. Sure, it was sort of a "brute force" approach, and while there were variable pitch and depth facilities on the Scully lathe, it was relatively primitive compared to the sophistication of today's record cutting equipment. Nonetheless it got the job done, and transient response was very good, as was overall level, and all without a great deal of groove "pinch effect." Of course another factor in the nice clean playback of the disc was a phonograph pickup cartridge and arm with groove tracing ability vastly superior to the same type of equipment 14 years earlier.

I vividly remember a scene from those times in which test pressings were played on the worst example of "El Cheapo" type of changer and cartridge found in mass-market radio/phono consoles. The rationale was that commensurate with the loudest levels that

could be cut on the disc, without groove-skipping on this cheap equipment, that was the dynamic level chosen for the commercial release. I regret to say that to a certain extent this procedure still is used, although things are a bit better since even the "El Cheapo" units of today are quite advanced in quality compared to their earlier counterparts.

Speaking of Mercury Records, some bright people in that company realized the value of the extraordinary sound qualities in the many recordings made by Bob Fine during Mercury's heyday with the Chicago, Detroit, Minneapolis and Rochester symphony orchestras. Selecting certain performances, these were remastered on the most advanced cutting equipment, and pressed by Phillips in Holland, and shipped back to the U.S. as "Golden Imports." Why this seemingly roundabout procedure? Sad to say, but Mercury was cognizant of the many complaints concerning the quality of domestic pressings, a fact that has been noted by discriminating audiophiles in the pressings of other U.S. companies as well. The Golden Imports command a dollar premium above standard U.S. prices, and there is a growing trend in some of the metropolitan areas to pay a premium for European pressings of other labels. Is the extra money worthwhile? I have sampled two of the Golden Imports thus far . . . SRI 75020, Schuman, *New England Triptych*; Griffes, *Poem for Flute and Orch.*; and Mennin, *Symphony #5*; SRI 75007, Hanson, *Symphony #2* and *Lament for Beowulf*. The records are extremely impressive . . . the new cutting has produced a strikingly clean sound, with all of Bob Fine's famous dynamic range fully preserved. If you want to give your speakers a workout, the massive per-



The Model 10 Mixing Console

When you've got more talent than money

Any mixing console is simply a creative tool. Getting the most out of it calls for imaginative insight into music and skill in the practical application of sound.

If you've got the talent but you don't have the money,

you're exactly who we built this board for.

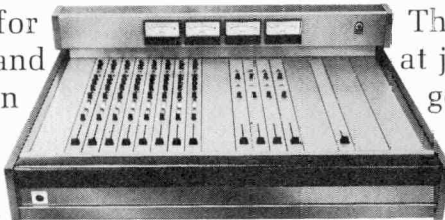

The basic 8-in, 4-out board starts at just \$1890. From there you can go to 24-in, with options and accessories enough to fill a studio.

The TASCAM Model 10. It gets your inside outside.

 **TASCAM** CORPORATION

5440 McConnell Avenue
Los Angeles, Calif. 90066

Check No. 40 on Reader Service Card

Introducing our new speakers.

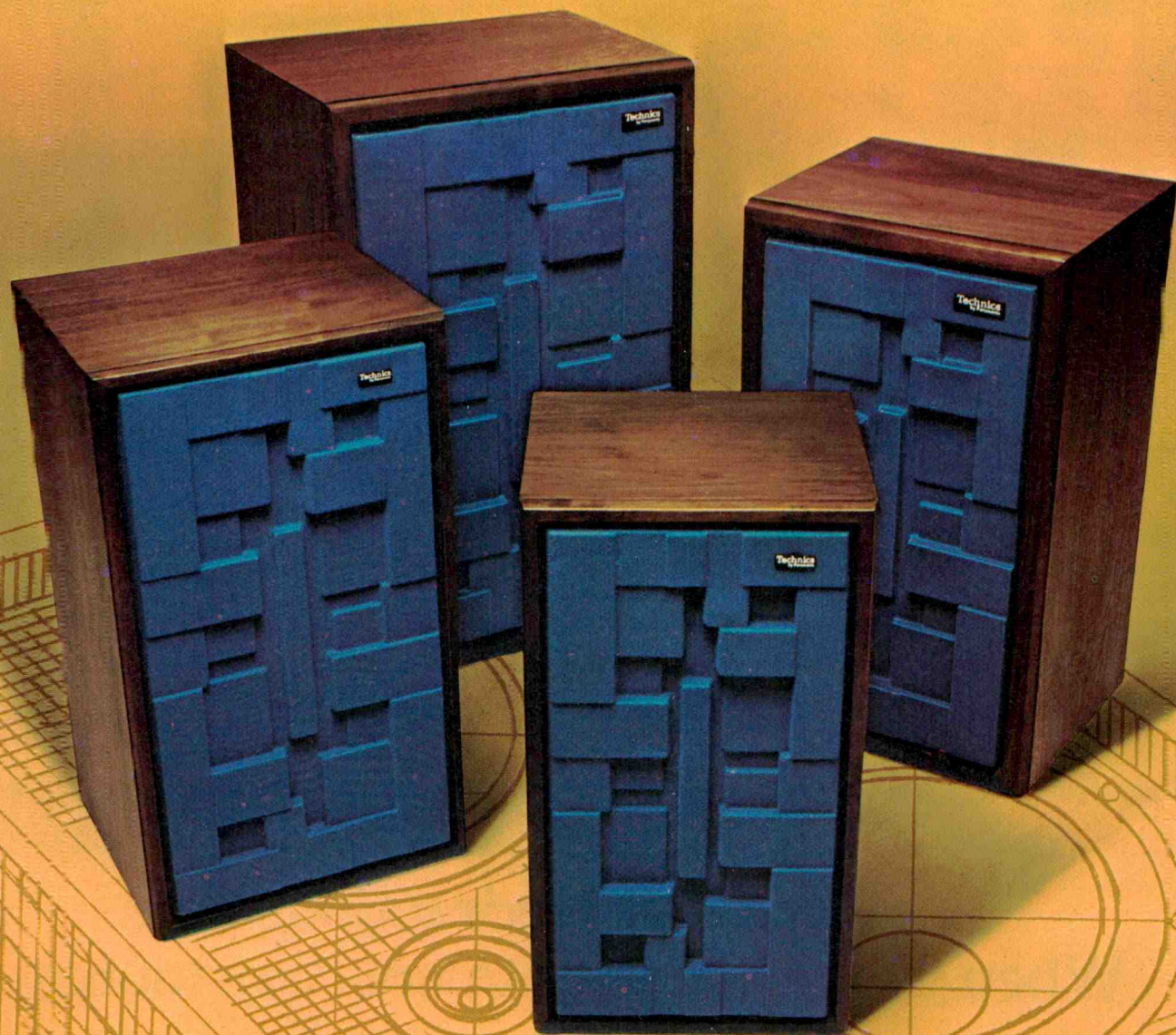

The best place to start listening to them is right here.

We think you'll find it easier to judge Technics speakers when you know how they're designed. How they perform. And the best way to listen to them.

Technics speakers are designed to be neutral. Designed to reproduce sound precisely, accurately, impartially. Without emphasizing one range of frequencies at the expense of another. Because tone shading is better left to the controls on your amp or receiver.

The performance you can expect from Technics speakers is indicated by their impressive roster of specifications. Which we've stated in meaningful terms in the chart.

Still, we know you don't buy specs. You buy sound. And that's something people measure better than machines. So, when you make your listening test, be objective:

Model	T-200	T-300	T-400	T-500
Freq. Resp.: free field	44-18kHz ± 3dB -10dB at 35Hz	40-20kHz ± 3dB -10dB at 30Hz	38-20kHz ± 3dB -10dB at 28Hz	35-20kHz ± 3dB -10dB at 25Hz
Dispersion: on axis-1m.	120° at 10,000 Hz	160° at 10,000 Hz	180° at 10,000 Hz	180° at 10,000 Hz
Power:				
minimum	10 watts	10 watts	10 watts	10 watts
max. music	100 watts	100 watts	100 watts	100 watts
max. 400Hz	40w-5 min.	50w-5 min.	90w-5 min.	100w-5 min.
Sensitivity: 3,000 cu. ft.	10w = 90dB SPL	10w = 90dB SPL	10w = 92dB SPL	10w = 92dB SPL
Drivers:				
woofer	10"	10"	12"	2-10"
midrange		3"	5"	5"
tweeter	1¾"	2"	3½"	2-1¾"
supertweeter			2-2"	2-2"
Controls: normal / -3dB	tweeter	tweeter midrange	tweeter midrange	tweeter midrange
Enclosure:				
oiled walnut	H-21¾" W-12"	H-24¾" W-13¾"	H-27" W-15"	H-29" W-18¾"
fully sealed	D-10½"	D-12½"	D-13¾"	D-14½"

1. Use components that are similar to your own. 2. Be alert for acoustic differences between the demo room and your listening room. 3. Compensate for unequal speaker efficiencies. 4. Listen to a wide variety of music — like jazz, classical, vocal, rock... everything. So you can hear how the speaker handles the entire frequency range. 5. Evaluate these sonic characteristics: pitch, dynamics, depth, directionality, ambiance and timbre. 6. Concentrate on one instrument. You should be able to follow it even through complex passages. And its reproduction should compare to its live sound. 7. Check the dispersion. Listen for highs as you walk a 180° arc in front of the speaker. They should be sharp and clean in at least 120°.

We want you to give Technics speakers this demanding test because we're confident that they will stand up to other speakers. Even ones with bigger reputations.

The concept is simple. The execution is precise. The performance is outstanding. The name is Technics.

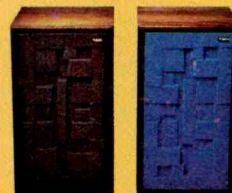

Grille available in brown or blue.

FOR YOUR TECHNICS DEALER, CALL FREE
800 447-4700. IN ILLINOIS, 800 322-4400.

Technics

by Panasonic

cussion in the opening of the *Lament for Beowulf*, will do the trick. The surfaces of these records are well nigh flawless . . . silky smooth and the way all record surfaces should be.

All of the foregoing comment on the quality of disc recordings was prefatory to bringing to your attention a most significant advance in disc recording techniques.

If you are a devotee of the disc, the Nonesuch H-71291 album of *Percussion Music* by the New Jersey Percussion Ensemble, is a landmark recording that

belongs in every library. Admittedly, percussion music is not to everyone's taste, and some of the material on this disc is pretty "far out," including the famous (or infamous, if you will) *Ionization* of Edgard Varese. However, taken sheerly as a sonic experience, it is quite incredible, and is a *must* recording for audiophiles.

The absolutely superb master tape recording was made by my friend Marc Aubort of Elite Recordings. Marc achieved a beautifully balanced recording, with all the complex scoring

for the percussion clearly delineated, with each instrument finely detailed, yet all is given a heightened "liveness" with a fairly spacious acoustic perspective. Most importantly, in such dynamic works, even in the shattering *fortissimo* sections Marc has avoided tape overload and saturation.

Now that we have a great master tape, how do you get this "sonic porcupine," fairly bristling with transients of great magnitude, onto the disc without distortion, especially at the inner grooves, and with maximum preservation of the dynamic range? Nonesuch turned to Sterling Sound Inc. of New York, one of the foremost disc mastering firms in the country. Sterling was the wise choice because at the moment they are the only one in the country with the new Neumann SAL-74 Cutterhead Drive Logic System and SX-74 stereo cutterhead. This is the most advanced disc cutting system in existence. The entire system consists of the Neumann VMS-70 disc mastering lathe (with, interestingly, a well-known piece of hi-fi gear, the Stanton 681A as standard playback cartridge) the SAL-74 package which comprises cutter adjustment modules, RIAA recording equalizers, feedback amplifiers, playback equalizers, automatic high frequency limiters, the very important TS-66 tracing simulator, two drive amplifiers of 600 watts (!) each channel, circuit breakers and monitor amplifiers, plus the dynamic stereo cutterhead the SX-74.

The tracing simulator is probably the major contributing factor which makes possible such clean, undistorted playback of the transients of such great amplitude on this Nonesuch disc. Tracing simulation, or "pre-distortion," for compensation of tracing distortion has been used before in somewhat differing manner, most notably in the RCA Dynagroove system. Incidentally, the RCA pre-distortion technique is just about all that is left of the Dynagroove system and one would presume that eventually it will be supplanted by the Neumann system. Perhaps an analogy for the tracing simulator would be the pre-emphasis in an FM signal transmission and the de-emphasis on FM playback. In the Neumann system, the tracing simulator provides a means for compensating tracing distortion by suitable addition of harmonics to the recording signal. Principal distortion occurs in the second harmonic. The analog computer in the SAL-74 logic dictates the amount of compensation for tracing distortion, and since the addition of second harmonic requires great power,

(Continued on Page 77)



NEW ASTATIC Cardioid Dynamic 857 Series Microphones

New production efficiencies permit Astatic to put a modest price tag on these excellent rated performers. Ball head design and polyester diaphragm combine to make a blast-proof design ideal for outdoor-indoor applications and close voice work. High quality in response, in unidirectional, anti-feedback, anti-reverberation characteristics. For rock groups, small orchestras, auditoriums, PA systems, recording, etc.

FEATURES

- 4 Models: low impedance and high impedance, with and without switch in cable connector.
- Heavy Satin Nickel Plating.
- Three-Pin Connector, for Switchcraft or Cannon types.
- Frequency Response 50-15,000 Hz.
- Output (Low Impedance) — 57 dB re 1 milliwatt/10 microbars.
- Output (High Impedance) — 57 dB re 1 volt/microbar.
- Front to Back Ratio 15 dB approx.
- Stand Adaptor Included.



THE ASTATIC CORPORATION • Conneaut, Ohio 44030

In Canada: Canadian Astatic Ltd., Scarborough, Metro Toronto, Ontario
Export Sales: Morhan Exporting Corp., 270 Newton Rd., Plainview, New York 11803, U.S.A.

Designers and Producers of Fine Quality Microphones for Four Decades

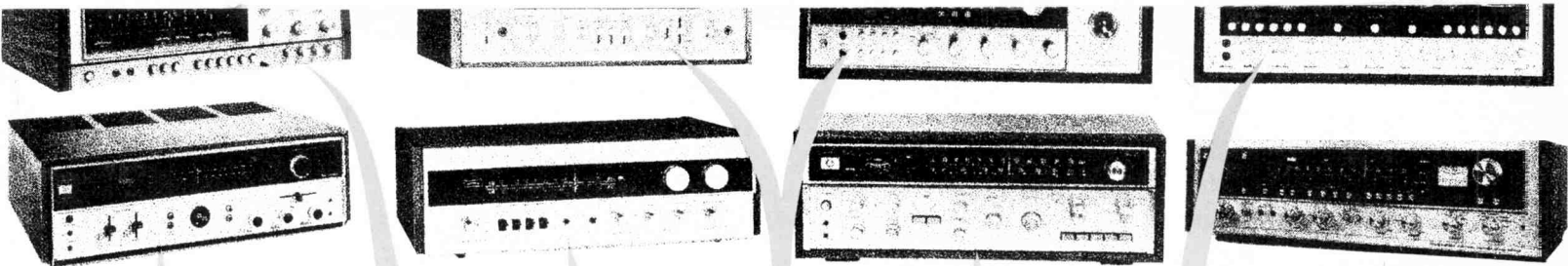

YOUR stereo system may be great, whether it's SONY, MARANTZ, H-K, SHERWOOD, PIONEER, KENWOOD, or...? ... BUT, it's NOT as great as it could be... IF you added a *Soundcraftsmen* EQUALIZER!

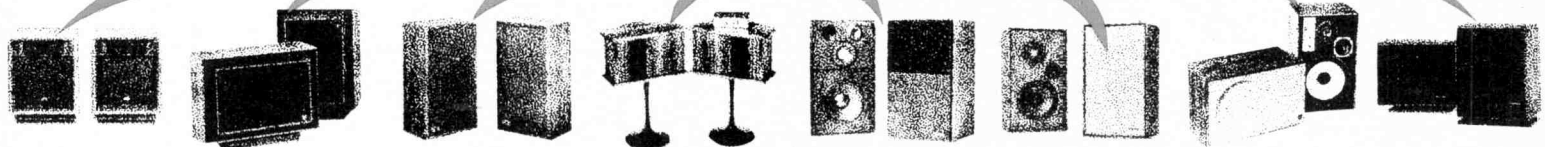
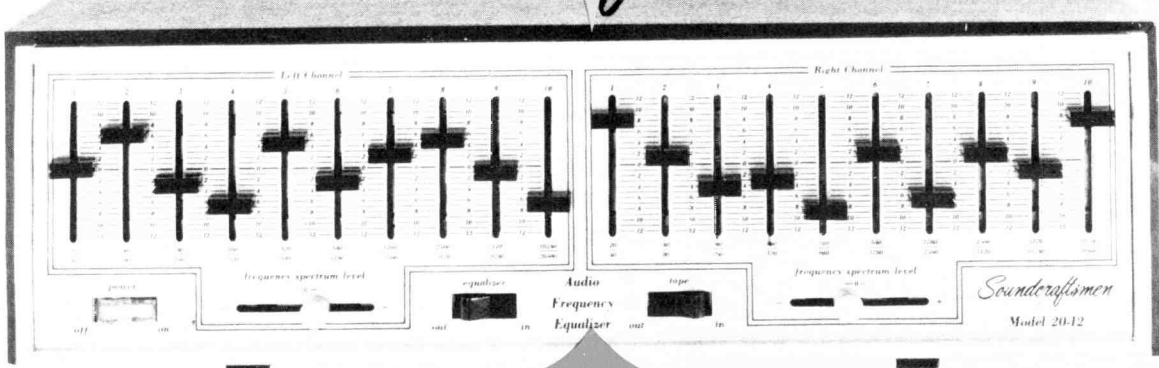

HERE'S WHAT OUR CONSUMERS REPORT TO US!
Actual reproductions of recent CUSTOMER WARRANTY CARDS on file at Soundcraftsmen.

<p>Please list any suggested improvements, changes, or other comments.</p> <p>WHAT A CHANGE IN MY SYSTEM!, I FEEL LIKE I AM IN A PROFESSIONAL RECORDING STUDIO</p> <p>SIGNIFICANT IMPROVEMENT IN SPEAKER PERFORMANCE - Thank you!</p> <p>Wonderful, I think every good sound system should have it!</p> <p>The transformation is unbelievable! a beautiful unit!</p> <p>EXCELLENT UNIT, DOUBLES VALUE OF COMPONENTS - AND MIND ARE STATE-OF-THE-ART, CANNOT THINK OF ONE THING TO IMPROVE!</p> <p>Please list any suggested improvements, changes, or other comments.</p> <p>Diffrence in sound is fantastic</p>	<p>Please list any suggested improvements, changes, or other comments.</p> <p>I feel that your product is worth twice the amount of price for the 1st time I can hear my music!!!</p> <p>I BOUGHT ONE UNIT 4 DAYS AGO AND WAS SO IMPRESSED I BOUGHT THE 2ND ONE FOR MY 4-CHANNEL SYSTEM</p> <p>SUPER! BEST THING I COULD HAVE DONE TO MY SYSTEM</p> <p>BOUGHT ONE FOR OUR SAIGON STUDIO, LIKED IT, I'VE AN GETTING THIS ONE FOR MANILA</p> <p>Great! It really helps!!</p> <p>Please list any suggested improvements, changes, or other comments.</p> <p>Performance and price are perfect</p>
---	--

GUARANTEED to enhance and improve any fine system!
Just plug 2 cables into your receiver's tape monitor jacks, and you are ready to enjoy a new experience in musical enjoyment!

- SPECIFICATIONS and FEATURES**
- TOROIDAL and ferrite-core inductors, ten octave-bands per channel.
 - FREQUENCY RESPONSE: $\pm 1/2$ db from 20-20, 480 Hz at zero setting.
 - HARMONIC DISTORTION: Less than 1% THD @ 2 v., Typ: 0.5% @ 1 v.
 - IM DISTORTION: Less than .1% @ 2 v., Typ: .05% @ 1 v.
 - SIGNAL-TO-NOISE RATIO: Better than 90 db @ 2 v. input.
 - INPUT IMPEDANCE: Operable from any source 100K ohms or less — (any Hi-Fi Pre-amp, Receiver or Tape Recorder).
 - OUTPUT IMPEDANCE: Operable into 3K ohms or greater — (any Hi-Fi Amp, Receiver or Tape Recorder).
 - CIRCUIT BOARDS: Military grade G-10 glass epoxy.
 - RESISTORS: Low-noise selected carbon-film.
 - RANGE: 12 db boost and 12 db cut, each octave.
 - MASTER OUTPUT LEVEL: "Frequency-spectrum-level" controls for left and right channels, continuously variable 18 db range, for unity gain compensation from minus 12 db to plus 6 db.
 - MAXIMUM OUTPUT SIGNAL: variable Master "frequency spectrum level" Controls allow adjustment of optimum output voltage for each channel, to exactly match amplifier capability, up to 7 v.
 - SIZE: designed to coordinate with receivers, comes installed in handsome walnut-grained wood receiver-size case, 5 1/4" x 18" x 11", or rack mount.
 - WARRANTY: 2-year parts and labor.

FREE! The "Why's and How's of Equalization",
An easy-to-understand explanation of the relationship of acoustics to your environment. This 8-page booklet also contains complete specifications, an editorial review of the 20-12 by J. Gordon Holt's Stereophile magazine, many unique ideas on "How the Equalizer can measurably enhance your listening pleasure," and "How typical room problems are eliminated by Equalization."

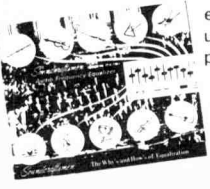

Soundcraftsmen
1721 NEWPORT CIRCLE SANTA ANA/CALIF

\$299.50 includes walnut-grain cabinet, or rack mount.
Check No. 35 on Reader Service Card

Audio—ETC

Edward Tatnall Canby

AS I TYPE this I am listening to the renowned Philadelphia Orchestra, once again. But not via Columbia or RCA records. This is a broadcast. For me it is an extraordinary event, evoking many a decade of past experience in the days when “live” broadcasts of classical music were in their prime, unimpeded by those four-minute slices of the same music available on 78 shellac. I am hearing a marvelous present-day example of the current relationship between that which is “live” and that which is recorded. You see, I really don’t know *which* this is. It is both, most likely.

“Today’s broadcast is coming to you from the Academy of Music.” But is it? A question! Am I actually hearing the great orchestra, playing *right now*, a Tuesday evening at 9:07 pm (the last item on the program)? Or am I merely hearing a tape, turning away in the studios of a nearby Connecticut station? One does not know. One is not told. Yet so much would seem to stem from this single determination, having to do with the nature of managed time!

I opt for the tape, natch. Nevertheless, this is a “live” broadcast, if on tape, and that is the most curious aspect of the whole thing as I listen. What is real time? We live in it, in our own bodies, yes. It remains essential to human life. But not nearly as essential as it used to be. The concept of timelessness, or near-timelessness, the basis for the art of recording, is now extended to so much of our perceptual lives that, if we stop to investigate, we can only be amazed.

My favorite example. The temperature and weather go on the New York air every seven minutes via the local news station. It is always “now.” The temperature is now 49 degrees. But of course it isn’t. That was the on-the-hour reading at one particular spot in Central Park, awhile back, and the reading stays

exactly the same until the next hour. Then it jumps, instantaneously, and stays put for another hour. Is this reality? Is it truth eternal? No—but it is useful. We reduce the heat of the atmosphere to a digital format, jumping discretely, and we get along just fine.

The Boss conductor is away, this evening in Philadelphia. (Or is it perhaps a Friday morning?) The Assistant has taken over, and this is one of those local-talent concerts, to fill in between the big events. Gotta keep the orchestra busy and the subscribers happy. All Mozart. Worthy idea. But a challenge which the orchestra does not meet. Sorry, this concert is only too clearly of the moment, that particular day (evening? morning?), a routine event to earn the daily bread rather than an artistic triumph. Two young soloists. They are good. And they come without contractual complexity or astronomical cost, we may assume. Young violinist, 23, bassoonist, 22, both at the local Curtis Institute, the music conservatory. An off day, though, for the orchestra. Everything tells you so. And yet—here am I, 150 miles away and how many days distant?—listening to that orchestra through precisely the same amplifiers and speakers that bring me the Philadelphia Orchestra so timelessly on records. Why?

Is there any distinction, quality aside, between a “live” broadcast, undated, and a recorded performance, which could justify the two formats in our day?

Well, of course there’s a long Tradition. Back in the 1930s, the very heyday of classical broadcasts, I spent dedicated hours keeping up with my weekly schedule of music on the air, mono, AM but very, very real. In those days there was no question about real time—things *happened* on the air, right then, as you listened. Every Sunday afternoon the

New York Philharmonic. Millions attended. Later on the New Friends of Music from Town Hall. The Frick Museum concerts. And those enterprising novelties, on into the 40s, the radio-only concerts, not in any concert hall but out of a genuine studio. The NBC Symphony—was it 1937 that it began so impressively under Toscanini in the superclosetlike studio 8H, complete with non-rustling limp silk programs for the elite audience? And the Wallenstein Sinfonietta on pioneer WOR, and the music from CBS, mainly directed by Bernard Hermann, if I spell him rightly. I used to visit that broadcast in person, via a lady friend at CBS, and I once chatted amiably with Leonard Bernstein just before air time. It was all very informal, over at CBS.

Real time! The format of the broadcast concert was built upon that age-old necessity, and it exists still, though the need has departed. Always the commentator, to fill up the stretches of unfilled time. His ingeniously written script, sentence by sentence, all about the music and the performers, written so that he could stop at any sentence, within seconds. That took clever writing. But you could always hear the man watching the stage for his cue to stop, reading on with that imperturbable voice which belied the mind that was saying, if I can just get through his next paragraph before the soloists make it to center stage. It didn’t always work. Sometimes the commentary was rudely interrupted by the opening notes of the music, starting too soon.

Same with intermission time. Milton Cross, serene and ancient, still presides at Texaco-Metropolitan as he has for maybe fifty years and all of my life and yours. Many another has come and gone but the problem has always been the same—until now. How to fill up the long, long breaks when nothing is



The most precise tonearm has been added to the most sophisticated electronic turntable ever produced.

When the now legendary Thorens TD-125 electronic transcription turntable first revolutionized the high fidelity world, Stereo Review acclaimed it as "unquestionably one of the elite among record players. It would be hard to imagine a unit that performs better." Impossible as it may seem, we've eclipsed ourselves with the Thorens TD-125AB Mark II.

To start, its completely new, nine inch straight tubular TP-16 gimbal suspension tonearm is mounted on polished ball bearings. The result is rock steady balance regardless of the gyrations in the groove. Then there's frictionless anti-skating control. No springs. No weights. Designed for ultra low tracking, you can use any quality high compliance cartridge in the plug-in shell. Tracking error is less than 0.2°.

Motor rotor speed must be precise. That's why the TD-125AB Mark II uses a solid state electronic motor drive system. A solid state Wien bridge oscillator governs the rotor speed of the instant-starting, high torque, belt-driven 16-pole synchronous motor. Rumble is reduced to inaudibility. You can make instant speed adjustments ($\pm 2\%$) and monitor them on the built-in illuminated stroboscope.

Other features include: precision, 2-way damped, front panel cueing control; 7 lb., 12-inch dynamically balanced non-ferrous die cast platter; tonearm and drive system isolated for shock-free operation; new resonant-free rubber turntable mat; 16 $\frac{2}{3}$, 33 $\frac{1}{3}$, 45 rpm speeds; walnut base.

Visit your Thorens dealer for a TD-125AB Mark II demonstration.

You'll see for yourself why High Fidelity said: "... This beautiful instrument provides a mark for others to aim at."

Elpa Marketing Industries, Inc.,
New Hyde Park, N.Y. 11040 / 7301 E.
Evans Rd., Scottsdale, Ariz. 85260 /
Canada: Tri-Tel Assocs.

THORENS®

TD-125AB MARK II



happening of a musical nature and yet the broadcast Must Go On, though the audience, prancing about the lobby en masse, is as unpredictable timewise as the guests at some impromptu party. Quiz games, the quizzes broken off in mid-question. Interviews, the artists puffing, out of breath and nervous about their upcoming performance in a few moments, impatient to get backstage. Not a very satisfactory radio experience except by accident when things went well. . . . And then, once again, the commentator with his eye on the clock and the stage door.

It was fun when a real delay occurred and the man ran out of script. "In just a moment, Maestro Pizzicati will proceed to the podium and we will hear—". But the Maestro doesn't proceed, and so back to the interminable biography of Beethoven's early years, and then an account of every last one of the day's or evening's soloists, and the upcoming concert tour of the orchestra down to the last city, punctuated by many an *ah* and an *er* (and nervous glances sidewise at the stage)—then suddenly, right in the middle of Oshkosh or Kalamazoo, "and-now-ladies-and-gentlemen-we-will-hear-Beethoven's —oops". The music has already started and the suave voice makes a hasty exit. Off mic, a sigh of relief, you can bet! And a bit of sweat.

Then there was the applause. It was, of course, not only real but in real time. The soloist walked on stage and if he was famous what we heard on the air was high-decibel white noise. Minute after minute. Phew! The hours of white noise I have endured in the interests of broadcast concert music are not to be imagined. No way to cut it. On and on. And the same at the end, except that, then, one could mercifully snap off the home-based switch and say good night. All that preposterous on again off again traipsing of soloists and conductor! "Now the Maestro has been recalled to the stage (ROAR) . . . he is approaching the podium . . . he accepts the plaudits of the vast audience." White noise. More white noise. To h. with the Maestro. Turn it off and get some sleep.

Yes, it was an era and a great one, the age of real-time broadcasting. The concert broadcast technique did in fact assume a dignity all its own, out of these rather cruel necessities, and the *genre* continues to this very day, a tribute to its aesthetic effectiveness and a triumph over the inconvenience of real time, as sent out upon the air. We still hear the gist of all I have described, from the traipsing Maestro and his white noise to the truncated, sentence-

by-sentence program notes, still often interrupted in mid-sentence as of yore—all those familiar attributes of the "live" occasion that tell us, so emphatically, *we are there*, right on the spot in real time. Though we aren't. Even the coughs, unedited. They do so much for realism. Why do the ladies and their bored husbands save these sonic reminders for the quietest parts of the slow movement? They did. They still do, augmented by Dolby and dbx. It's all utterly familiar to an old-timer like me.

And yet—is anything really the same? Only the form, not the technique! Real time? It now exists, so to speak, on sufferance. You can slice it up whenever you want to. How much of the white noise do you wish? Just fade, and cut. Long delay? Remove same, and throw out a mile or so of perfectly good used tape. Intermission? Who ever knows?

The amazing thing, to me, is that we do still have the old real-time forms though we are never sure from moment to moment whether they are real or no. This evening, for instance, the two young soloists at Philadelphia were interviewed during the intermission. Piotr Janowski, if I got it down right by ear, the excellent violinist in the Mozart *Fourth Concerto*, Polish, now at Curtis, and Alexander Heller, born in New York, brought up in Wisconsin, a bassoonist at 12 and now at 22 the soloist in Mozart's *Bassoon Concerto*. These two fellows weren't out of breath at all, though they came on only moments after the first half of the concert. *Was this in real time?* That was the implication, of course. But was it in truth studio recorded, maybe weeks before? Likely. Remarks such as "the Concerto that we will hear in a few moments . . ." are merely imaginative, these days. (And indeed, we will hear it, in our own slice of time.) I always use present tense for deceased recorded conductors—"Fritz Reiner is a great interpreter of Richard Strauss"—alive or dead. We hear him now, and again now, each time we play his recording. I got all worked up, trying to decide from the audible clues whether this really was intermission time down there in Philadelphia.

"Now our intermission is almost over, and so we return to the great stage of the Academy of Music . . ." or words to that effect. *Do we?*

To the younger generation, brought up on time that is seldom real in any of the media, this distinction may seem trivial. Who cares? Well, maybe so. But keep in mind that for 99.9999 per cent of the history of the human race, real

time has been the *only* time, and all the real history. It was five seconds ago, in our brief terrestrial sojourn, that we began to experience this easy transfer of time in so many slices, time stored, time patched, time repeated, time almost never *actual*, of this very moment.

So strange—or is it?—that we preserve the trappings of real time in so many ways where it is no longer necessary. The broadcast concert is now taped. It can be edited and made to fit. It is edited, to an extent. But the semblance of real time still determines its aesthetics, not only the music itself but all the ancillary trappings and fillings-up en route. If not, where would we be? Would a broadcast concert *be* a broadcast concert?

Records are better. You can talk about the glories of live music and you are right, within context. But it is a vivid truth that, real time aside, concert broadcasts are generally far inferior to recorded music. Absolutely no question about it.

No criticism implied! Live music is live music! But we should not expect it to do double duty as recorded music. This evening, Piotr Janowski, the young violinist, dreadfully flubbed the first three notes of his Mozart Concerto. Don't know what happened—a string slipped? Just nerves? Cold fingers? But there it was, and there it went, out on the air—or onto tape. No great tragedy, and the audience didn't mind a bit. Why should it? We wouldn't—if the concert were truly live, and *once only*.

Is it? Well—for each of us, listening in, yes. But if this product goes out on tape to hundreds of radio stations, and if these stations put the tape into their library and, perhaps, repeat it, later on? Then—ouch. A second mistake like that is unthinkable. No recorded version would ever appear with such a flub, needless to say. Does the Philadelphia limit its tapes to one playing on each station—then please destroy, or return? I wouldn't know.

A few years ago I remarked to myself that broadcast stereo techniques were remarkably far behind stereo for records, even allowing for difficult circumstances. Radio engineers. A different crew and perhaps out of touch with their record counterparts. I remember being shocked at the stereo sound of a Boston Symphony broadcast, as compared with RCA's sound for the same orchestra in the same hall. Now, things seem to be much improved, in spite of the obvious hazards of "live" technique.

Once I had reversed the phase of my big North-South long-distance antenna

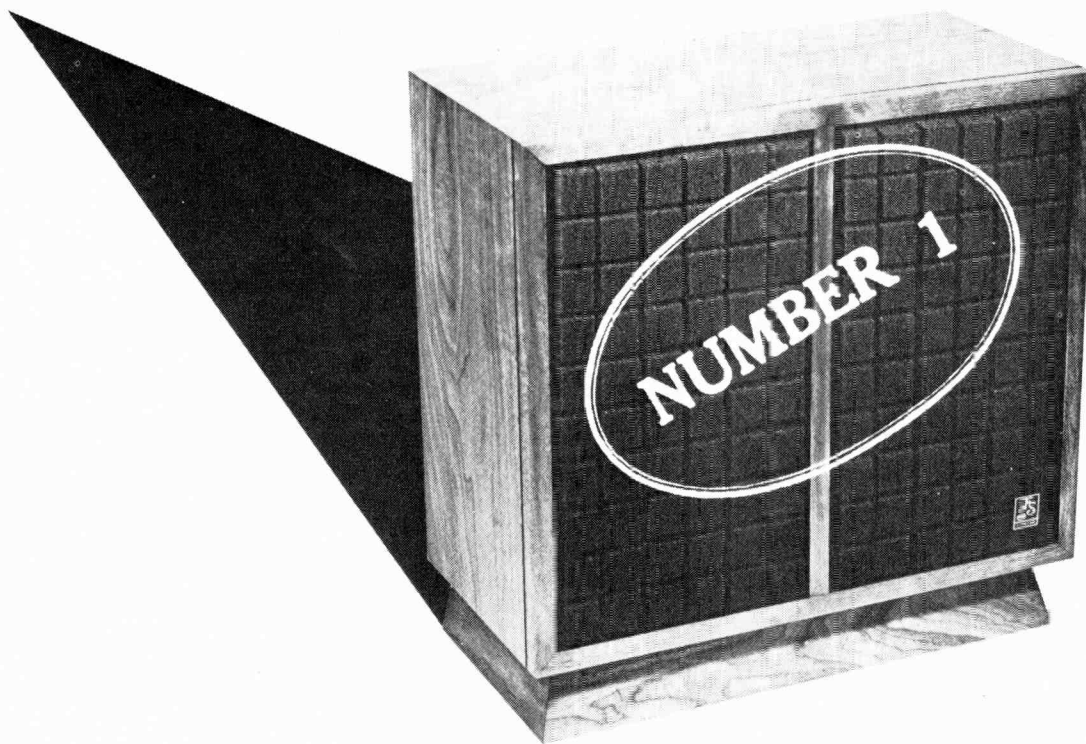

We're nothing less than ecstatic about having our newest speaker, the **FAIRFAX FX-400**, rated Number One out of a field of 20.

The reason we're so elated is that the last time a FAIRFAX speaker was tested—the Summer of '73—the **FAIRFAX FX-300** was Top Rated in a field of 22. That's consistency for you!

With a track record like that, shouldn't you be considering a FAIRFAX speaker for your system? Just look at what we have to offer in the FAIRFAX line.

The **FX-400**, with a retail price of \$269.95 is a floor-standing system featuring twin isolated chambers. It is a three-way, ducted-port design with two heavy-duty high compliance woofers, a five inch midrange and a 3½ inch tweeter specially constructed for wide dispersion.

Frequency response of the **FX-400** is 20 to 20 KHz with crossover points at 1 and 5.5 KHz. Impedance is 8 ohms and power capability is 8 watts minimum, 80 watts maximum. The oiled American walnut veneer cabinet measures 28 x 14 x 28 inches and weighs 105 lbs.

Our other speaker systems—there are seven models in the FAIRFAX line priced from \$79.95 to \$399.95—offer the same quality in workmanship and sound reproduction as our "Top Rated" models.

We suggest you visit your FAIRFAX dealer and have him demonstrate the line. We're confident that after listening to our speakers and comparing them to other speakers of the same or higher price, you'll agree **FAIRFAX IS NUMBER ONE.**

If your dealer is not a Franchised Fairfax Dealer, have him contact us and we will send him a pair of speakers for your evaluation—at our expense. Only FAIRFAX has the confidence in their product, and your judgment, to make such an offer.

FAIRFAX INDUSTRIES INC.
900 Passaic Avenue, East Newark, New Jersey 07029
In Canada: Omnimedia Corp. Ltd., Lachine, Quebec



Who Says Audiophile Components have to be Expensive?

No one really says so, but most people think so. The SAE Mark XXX Stereo Preamplifier and Mark XXXIB Stereo Power Amplifier offer the highest engineering excellence and quality parts available at a moderate price.

To find out what makes these units the most sought after components, fill out the coupon and mail today.



SAE
*Components
for the
Connoisseur*

SAE, Inc., Electronics Division (574)
P.O. Box 60271, Terminal Annex, Dept. A
Los Angeles, California 90050

Gentlemen:

Please rush free information on the Mark XXX and Mark XXXIB by return mail.

Name _____

Address _____

City _____ State _____ Zip _____

Check No. 31 on Reader Service Card

selecting a hi fi speaker

Confused by the rapidly growing
number of loudspeaker brands?

Before you invest, write for
our FREE Booklet to
help you make a
valid listening
judgment.

**BOZAK,
INC.**

P.O. BOX 1166
DARIEN, CONN.
06820 (DEPT "A")

Gentlemen:

Send a copy of your new FREE Booklet,
"Evaluating a Loudspeaker System."

NAME _____

ADDRESS _____

CITY _____ STATE _____ ZIP _____

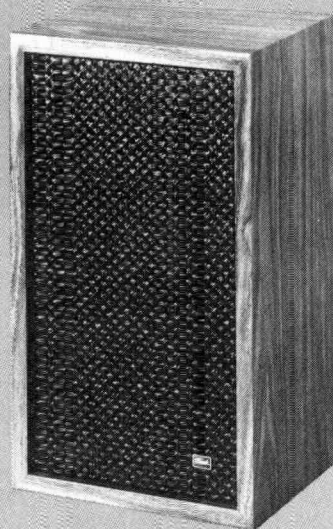

Bozak INC.

Our 25th Year of
Loudspeaker Design
and Manufacture

and hooked it up on top of the connections for my littler local East-West antenna (an odd but effective system which I stumbled upon, and cannot explain), I pulled in the Philadelphia stereo with a minimum of hiss at 50 miles (not from Philadelphia, from the local Connecticut outlet) straight through the intervening mountain behind my house. Not bad. Coughs, yes. But the stereo spread was rich and wide and very listenable. No problems here.

But the playing! As I say, this concert, whenever it was, came through as strictly run of the mill, which means normal or average. What more can you expect in concert after concert, month after month? The famed Philadelphia was, on a very high level, sloppy. Blurry fast notes. Absent-minded sound. Get through with it. This *is* the orchestra in its more human guise and it is what the subscribers hear much of the time. Same everywhere in the musical flesh. But for broadcast? For a species of *recording*? Even though "live."

On records we get the best. A recording session may be exhausting but it is a challenge of a sort that only the most extraordinary concerts can provide. It has to be *good*—it has to be right. Real time be hanged! Fifty takes, if need be, to get the right version down. Made more perfect, of course, by skilled tape editing. The old-timers hate it and the critics deplore. But, by golly, the art of music is enhanced. Remember that best seat in the concert hall? The recorded product, with luck, is *the best performance in the concert hall*, the ideal, the nearest-to-perfection. Maybe not really perfect, but they certainly work their heads off to make it so.

And then—we have to listen to some off-week routine performance, on the air? A come-down, if you ask me, though nobody is to be blamed.

If I didn't know how good the Philadelphia can be at its best, I'd call it a high-level hack orchestra after tonight. Understandable. Part of the live-music phenomenon, which necessarily ranges from out-of-this-world to tired-and-bored. We are human and so are musicians. But a recording should *never* be human in this sense. It is timeless, and so must be above occasion.

Should we still have broadcast concerts? Is it merely a habit? I'm really not too sure. I had a wonderful time listening tonight. It was a welcome change from too many records. Can't have perfection all the time. Unnatural. A recording is sort of like holding your breath. You just have to let it out sooner or later.

Æ

HOW TO MOVE YOUR TAPE RECORDING TECHNOLOGY AHEAD OF THE BROADCASTERS

A quartz crystal controlled three speed drive capstan, relay-less, large scale integrated circuit (L.S.I.) controlled triple motor tape transport, plus photo-electric and motion-sensing tape protection arrangements – put the Revox A700 into a class by itself.

A host of further technological features combine to make the Revox A700, in our opinion, the most desirable tape recorder ever built.

See it at your Revox Professional Equipment Dealer. Try the faultless tape handling. Explore the comprehensive mixing and audio control facilities. On top of all this examine minutely the precision of the detailed construction – something Willi Studer is already world famous for – but now executed so well it's breathtaking.

Some day soon, the recording and broadcasting industries will share its technology!

Discover the new Revox A700



the standard setter
in magnetic tape
recording now at your
Revox Professional
Equipment Dealer

REVOX

Editor's Review

DO YOU KNOW who you are, you readers of AUDIO? Have you ever wondered how much you're like the other readers of this magazine? Well, we are very interested in the answers to these and similar questions, so interested, in fact, that we hired an accounting firm to conduct a readership survey. The results were so interesting that I thought I'd share them with you.

As you probably know from prowling around the audio shops, most audiophiles are men. So are you readers of AUDIO, almost 98 per cent of you, and your median age is 29. ("Median" is a fancy word for average, if you don't remember it from your statistics courses.) And about 75 per cent of you are under 40.

Okay, all you young men out there, want to know what the other AUDIO readers do for a living? More than 30 per cent are engineers or technicians, and a bit over 21 per cent were lumped together as "professionals, managers, officials, and owners." (No, lumping you together doesn't mean you're lumps.) About 12½ per cent of you are students, and no matter what your instructors say, you're not lumps either. Almost 11 per cent of you fall into an education/research/science category. What all that means is that you guys have some pretty nice jobs, and my guess is that you got them because you're pretty smart. (Besides that, you're smart enough to be reading AUDIO.) Anyway, the survey backs me up on that point about your intelligence, because more than 52 per cent of you have a sheepskin from some college, and another 29 per cent have some college background. (Judging from that 12½ per cent who are still students, more of you will get degrees.)

You fellows do pretty well with the paycheck too. The median (that word again) income of your families is \$16,000; nearly 14 per cent earn over \$50,000; over 17 per cent from \$25,000 to \$50,000; 15½ per cent from \$20,000 to \$25,000; 21½ per cent from \$15,000 to \$20,000, and 26 per cent from \$10,000 to \$15,000. What this really means is that you've got a lot of money to spend on equipment, records, and tapes. More on that later.

We surveyed a few other things too, and found out that 55½ per cent of you have to contend with wives when you're considering where to place the speakers. However, 44½ per cent of you found a great solution, you bought homes, where presumably you have the ideal listening room. But, apparently, this didn't work out for 16½ per cent of you, since you went out and bought a second home, where you can put the speakers wherever you like. (I think that was a great idea because you can also use that second home for vacations.)

It looks like you fellows are pretty well respected for your knowledge of audio equipment, because over 91 per cent of you said that your relatives, friends, and neighbors called upon you for advice in purchasing equipment. We think that we help a bit here, since more than 64 per cent of you said AUDIO influenced your purchasing and that 44 per cent read only AUDIO of all the magazines in the hi-fi field.

But what astounded us was the amount of money you spent on equipment during the 12 months before the survey ended, more than \$80 million. The greatest single chunk of that was for various forms of tape equipment, generally for a tape deck or cassette recorder, which together accounted for over 37,000 purchases in that 12-month period. Speaker systems were the most purchased single item, with more than 47,000 of them finding their way into reader homes, but their overall value was second to the tape equipment. Phono cartridges ran a strong second in number purchased, at 42,000, but were far down the dollar list because of their generally lower unit value.

The questions about four-channel equipment produced some interesting answers, and apparently AUDIO readers are leading most other consumers in this area. Nearly 20 per cent of you fellows already have quadraphonic systems. However, of those who don't, nearly 50 per cent of you plan to purchase a four-channel rig or up-grade your present system to four channel.

A Rose By Any Other Name . . .

There have been a couple of name changes in our industry in recent months, and as readers and consumers, you should be aware that these "new names" actually represent a great deal of knowledge and experience in this field. Because of this background, these name changes are rather like handsome new suits; the persons underneath still have the same nice personalities and are still just as smart, but they present new, interesting, and inviting images, which should not be mistaken for those of a neophyte or newcomer.

The most recent of these is that of British Industries Co. to B•I•C International (that's "bee eye see," please, not "bic"). This firm has, of course, been marketing the English-made Garrard turntables for some 37 years, but after June 30 Plessey Ltd., the maker, will be doing that here. B•I•C, however, has advised us that it will introduce this fall an entirely new line of automatic turntables, built in the United States, and naturally will continue to market the B•I•C Venturi speaker line. The announcement about these turntables being American made is rather noteworthy since England, Germany, and Japan have pretty well had that market cornered until now.

The second name change, actually more of an addition, is that of "Technics by Panasonic" to designate a sophisticated line of high fidelity products from Panasonic. We have already reviewed one product in this line, the RS-279US cassette recorder, in the April, 1974 issue, beginning on page 55. If you've already read the review, you know that the designers of the Technics line have set their goals at the highest level. From the results of our tests on that recorder and the preliminary results of testing on other units in the line, it certainly appears they've been successful.

At any rate, we certainly wish both these firms the very best of luck with the new names and ventures. *E.P.*

*traceAbility™

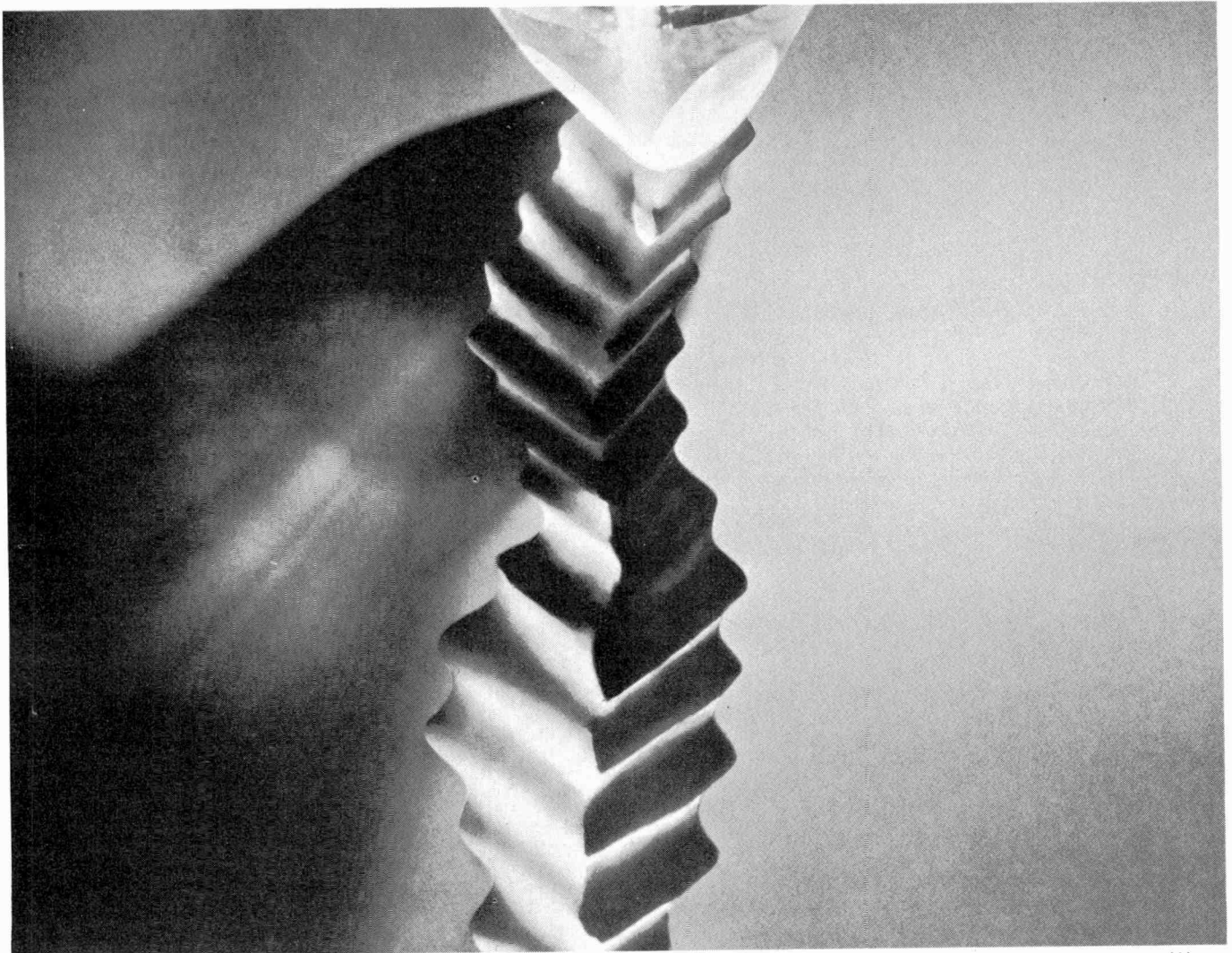

(A)

Pickering cartridges feature low frequency tracking and high frequency tracing ability*

You are looking at a model of a discrete groove, magnified 3,000 times (figure A). You can see it is made up of complex groove undulations. This makes the demands on the cartridge and its stylus

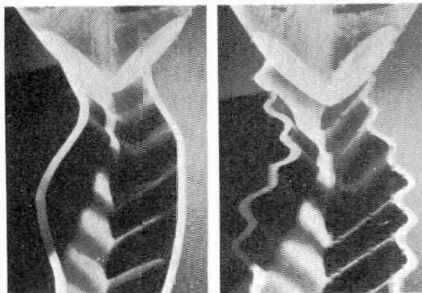

(B)

(C)

much greater than ever before. The left side of the groove possesses all of the information recorded on the left side of the room, and the right side likewise. The stereo signals for the front speakers are represented by the broad sweeps (figure B), and the special discrete high frequency tone carrier is represented by the wiggles on the same groove walls (figure C). This high frequency carrier centered at 30,000 Hz, demands a superior shaped stylus. The stylus must have low frequency tracking ability and high frequency tracing ability. In other words, it must possess **traceAbility**, Pickering's trademarked term for the ability to trace this difficult groove. The secret lies in the stylus assembly (and shape of the tip) which we call our **Quadraredral™**, another Pickering exclusive which makes it

possible for the stylus to trace both the stereo and discrete signals in the groove.

So, the quadraredral™ stylus picks up all 4 signals, which the computerized demodulator sorts for the amplifier, which, in turn, transmits the sound into the proper speaker.

Four-channel discrete sound becomes a fabulous reality in the home, and Pickering's UV-15 cartridges make it possible.

For further information write to
Pickering & Co., Inc., Dept. D
Sunnyside Blvd., Plainview, New York 11803



"for those who can hear the difference"

TM-PICKERING TRADEMARK

Check No. 23 on Reader Service Card

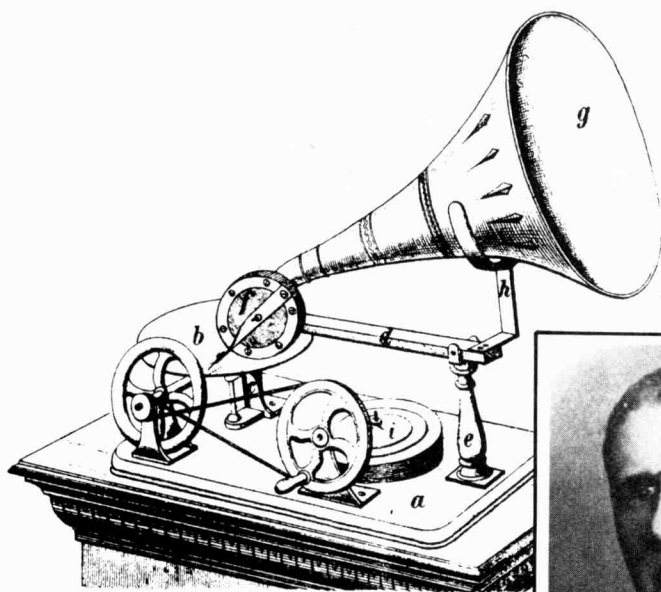

The sketch above accompanied the 1887 patent application by Emil Berliner, right. DGG's birthplace was a corner of a telephone factory, shown center. Joseph Berliner is second from the right.

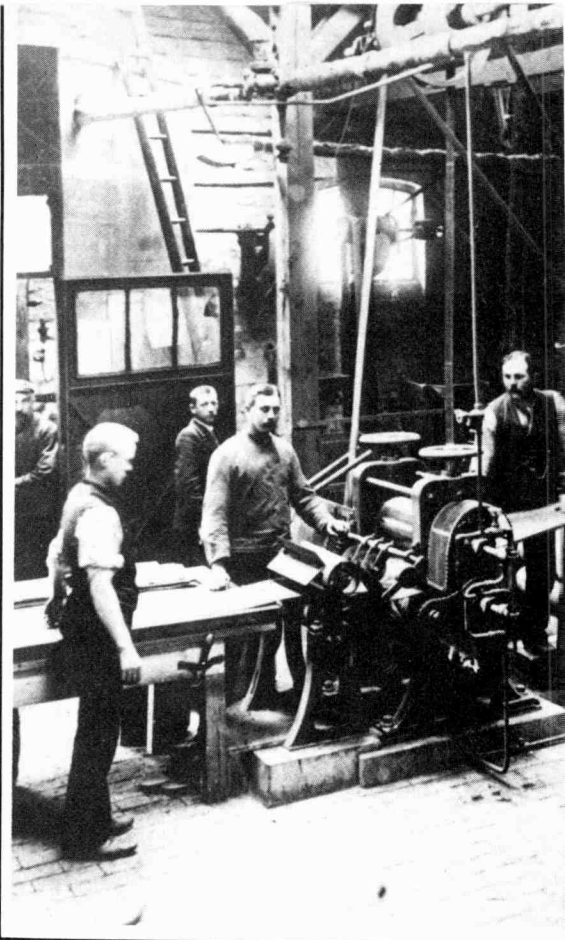
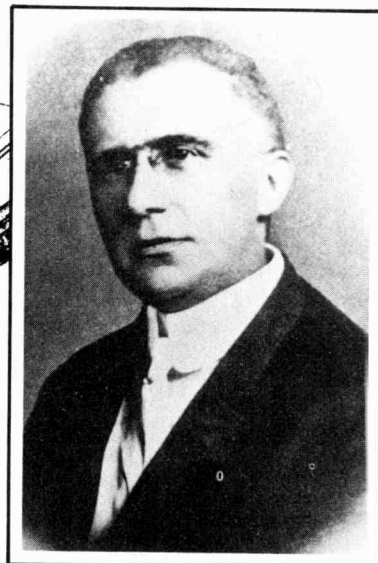

THE GRAMOPHONE:

Robert E. Brockway*

THE RECENT CELEBRATION of the 75th anniversary of the founding of DGG, Deutsche Gramophon Gesellschaft, recalls that the man who founded the record company, Emil Berliner, had also invented the first flat recording disc ten years earlier.

Unlike Columbus who made a flat world round, Berliner believed Edison's cylinder was the wrong approach and flattened it, whereon hangs the recording industry.

The flat disc was not Berliner's first contribution to communications, although it was his most significant. Earlier, in 1876, Berliner saw Alexander Graham Bell's telephone displayed at the Philadelphia World's Fair. Berliner knew a good idea when he saw one, but Bell's device lacked a vital ingredient. It had no way to pass sound along adequately.

By then Berliner had been in the U.S. six years, after arriving from

*President, Polygram Corp.

Hanover, Germany to become a dry goods store clerk in Washington, D.C. He quit before long to study acoustics and electricity at Cooper Union, New York. Setting up a laboratory of sorts in his room at a boardinghouse, he solved Bell's problem by inventing a microphone. He patented it and sold it to Bell for \$75,000.

This enabled Bell to launch his telephone business in competition with Western Union, which had come up with a carbon transmitter invented by Edison. By the standards of the time, this left Berliner a well-to-do young man with most of his life still ahead of him.

Berliner and Edison ideas collided again in the development of the phonograph. The word phonograph was apparently Edison's, although some controversy still exists on that subject.

There's no argument over who thought up the word gramophone.

Berliner coined it to describe the invention for which he applied for a patent on September 26, 1887, some ten years after the appearance of Edison's phonograph.

Near the end of December 1877, Edison had descended on the office of *Scientific American* with his cylinder-playing phonograph. The magazine reported: "Mr. Thomas A. Edison recently came into this office, placed a little machine on our desk, turned a crank, and the machine inquired as to our health, asked how we liked the phonograph, informed us that it was very well, and bid us a cordial good night."

Edison's gadget was simple to the point of crudity. The cylinder wore out after a few plays. It squawked indistinctly, but skeptics acknowledged that Edison's tin-foil cylinders really did record sound and play it back.

Ten years later, Berliner began the uphill battle to overcome the widely

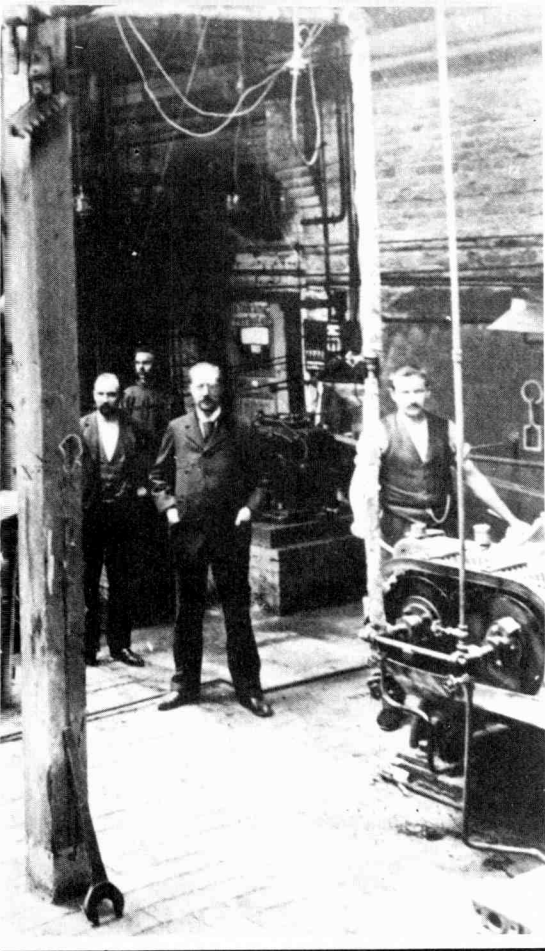

Gramophone discs had grooves on one side only, measured 17 cm (seven inches) across and the titles and artists' names were scratched on by hand. Emil Berliner's "trademarks" including the cherub inscribing a disc, were stamped on. In 1903, DGG moved out of the telephone factory into this building in the Celler Chaussee (later Podbielski Strasse).



Basis for an industry

acclaimed wax cylinder's lead. The matter was more or less settled in the first decade of the new century. It might have been harder if Edison hadn't taken time out to invent the electric light bulb and if he hadn't been convinced from the beginning that the phonograph was not destined to entertain but to be a business machine.

This view was shared by the Bell-Tainter Graphophone, which also foundered as an entertainment vehicle under the impact of the gramophone. All their early models were crude. Berliner's gramophone came with instructions for use which ran only half a dozen paragraphs. But additional "special instructions" ran several pages. Here's how simple the state of the art was as late as 1898 when Berliner's Deutsche Gramophon Gesellschaft began making its first players and discs. DGG characterized the advantages of the gramophone over the others this way:

"With *Tainter's Graphophone*, only the listening tubes can be used as otherwise nothing can be understood. This is mostly also the case with *Edison's Phonographs*. With the *Gramophone*, too, the reproduction of sounds is clearer through the tubes than through the horn and these can also be used by two people at the same time if each puts one listening piece in one ear and holds the other ear shut with a hand."

The special instructions with the DGG gramophone found it necessary to add: "In order to understand the speech of the Gramophone properly, the ear must first accustom itself to it, as is of course also the case with the *Telephone*, but this will happen in a short time."

Then there was the hand crank the listener presumably turned with his third hand while he held one tube to one ear and clamped his second hand over the other ear as earlier

instructed. Plainly, the hand crank required careful handling: "We would like to emphasize . . . that regular turning is an absolute necessity for the veracity and understanding of the sounds and words. Irregular turning gives irregular and therefore ununderstandable reproduction!" (The exclamation point is in the instructions.)

Cranking by hand was reduced to a time/energy formula: ". . . turn the drive wheel to the right at a speed of about 150 turns per minute and the apparatus will function." Timing the count must surely have distracted the user's attention from what he was playing.

The gramophone came with a supply of needles and this severe warning: "Care should be taken that when changing the needles . . . these are screwed in straight, that is, vertically and in a straight line with the sound box, and above all *tightly*."

It is further advised: "A needle which has worn down through long



1898—DGG's first year with only a few machines and a handful of workers.



Joseph Berliner

use and has been taken out must *never* be replaced as this, worn on one side, would cut the grooves of the plate with its sharpness and bent point." Extra needles would be furnished on demand, the 1898 buyer was assured, and: "In emergencies, one should use broken-off darning needles with good rounded points."

All this reflects no discredit on the early models which broke the ground for today's far-out equipment bringing higher fidelity to listeners than could have been dreamed of in 1898.

This 1911 photo shows society ladies and gentlemen waltzing to the strains of the Gramophone on the banks of the Rhine.



Berliner had begun experimenting with a plate glass disc surfaced with lampblack. Whether he hit on this himself or had heard of a scientific paper by Charles Cros, an obscure figure who in December 1877 contributed the idea to the French Academie des Sciences, can't be said. But Berliner carried out what Cros merely theorized.

He set his lampblack glass disc on a turntable and applied a stylus to it as it turned. Sound waves fed to the stylus produced a tracing in the lampblack which varied with the vibrations. Berliner varnished his tracing to preserve it and had it photoengraved in metal. The end product played back, proving to Berliner that he was on his way towards building a better mousetrap than Edison's.

He applied for a patent, aware that lampblack wasn't the answer and that slow, costly photoengraving had to be replaced by something cheaper and faster.

Instead of turning from his brain child to invent something else, as Edison had, Berliner continued to cut and try for better records. He soon turned to acid to engrave his master by chemical action. Eventually he tried film coating over zinc. When this laminate was inscribed by a stylus and dipped, the acid action proved effective but not excessive, creating even grooves which, in turn, yielded to the playing needle better sound reproduction than lampblack.

Berliner was ready for the first demonstration of the flat disc. On May 16, 1888, he presented some samples at the Franklin Institute in Philadelphia. It is remarkable that, at a time when Edison and Tainter were predicting success of their inventions as dictating machines, Berliner's talkup at Philadelphia heralded mass distribution of

Leave it to Realistic® to create...



a beautiful receiver at a down-to-earth price!

You want a new receiver. One combining top technology, features, looks. But you're not about to pay the price of an overpowered monster to get it. What you really want is Realistic's STA-80. With direct-coupled, fully protected output. Flat 20-20,000 Hz audio response. FET/IC tuner with crystal filtering on FM and AM, 300- and 75-ohm inputs, dual metering, FM muting. Glide-Path™ volume/balance controls. Perfect loudness.™ Walnut case. And more! Sensible 82-watt power ± 1 dB (48 watts RMS) — we don't create monsters. U. L. listed. #31-2046.

The STA-80.

249⁹⁵

Very down to earth.

Save \$44.40 on an STA-80 System

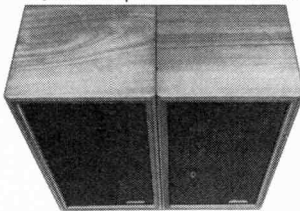

Optimus-2 floor or shelf speaker systems. Each regularly **69.95**

STA-80 AM/FM Stereo Receiver. Reg. **249.95**



LAB-24B with Realistic/Shure cartridge, base. Reg. **64.50**



Complete System **409⁹⁵**

REALISTIC at Radio Shack®

A Tandy Corporation Company

419



FREE 1974 CATALOG

AT 2000 RADIO SHACK STORES
OR MAIL THIS COUPON

180 Pages — Full Color! H-Fi, CB, Kits, Recorders, Antennas, Parts, More!

Name _____ Apt. # _____

Street _____

City _____ State _____ Zip

MAIL TO: Radio Shack, P. O. Box 1052, Fort Worth, Texas 76107

Retail prices may vary at individual stores.

recorded music, reproduction of unlimited numbers of discs from a single master, and the coming of artist royalties. Those prognostications proved more impressive than the demonstration itself. One reaction likened the sound of the improved Berliner disc to the braying of an ass. The playing machine was labelled not very impressive.

Not very discouraged, Berliner went to work to fulfill his prophecy of unlimited copies struck from a master. Before long he came up with the process of creating a master metal negative from the acid-dipped original, using the negative to press multiple copies.

Once Berliner perfected his original-to-negative-to-positive process, the stage was set for the growth of the multi-billion dollar record industry. Everything that has followed, right up to today's injection molding record pressing methodology, is refinement on the Berliner concept.

By 1893 Berliner was using hard rubber discs, had developed a reasonably reliable pressing process, and felt he was ready to go into business. He formed the United States Gramophone Company on Pennsylvania Avenue in Washington, D.C.

Before long the company was offering one-sided seven-inch records

with two minutes of playing time, priced at 50¢ a record, \$5.00 a dozen, featuring mostly obscure local talent. The gramophone itself came either electrically powered or hand cranked. The latter sold for \$12. In 1894 it was the cheapest on the market. It was available to buy, but almost nobody had one and it attracted very little attention. By late the following year, investors were found and the final struggle between disc and cylinder began. It ended in the early 1900's with the flat disc in firm control and the cylinder destined to retreat to attics and museums.

It wasn't until autumn 1898, some eleven years after he patented the flat disc, that Emil Berliner and his brother Joseph founded Deutsche Grammophon Gesellschaft, whose jubilee was just observed. At the same time, planning to concentrate his own efforts on European production centered in Germany, Berliner sent his American associate William Barry Owen to establish in England The Gramophone Company which today is known as EMI.

Berliner went on to invent an engine for airplanes that allowed lower in-flight speeds, leading to the helicopter years later. Research that Berliner conducted into improved methods for sterilizing milk cut infant mortality. In 1922 he made a gift to the City of Hanover of \$200 for acoustics improvement in the local assembly hall. Three years later he patented an acoustic tile that did the job. History doesn't tell us if they awarded him the \$200. But his invention made possible better sound distribution in churches and other large areas.

The name Deutsche Grammophon lives on in two ways. First, it continues as the world-famous DG Yellow Label. And although Polydor International has become the name of the worldwide music business that started as DGG, the German subsidiary of Polydor is still called Deutsche Grammophon Gesellschaft. Here in America, the group is represented by Polygram Corporation. Firms in 18 countries carry the Polydor name. The company's pop and classical repertoire is marketed throughout the world. Today, factories in 21 countries produce Polydor tapes and records.

Emil Berliner died in Washington, D.C. in 1929. He had made possible not only the DG and Polydor products, but the entire spectrum of recorded opera, symphony and popular music enjoyed by millions. It is not surprising that observances have been taking place not only in Hanover, where the company still has a production center, but in Hamburg, home of Polydor International, and at Polydor subsidiaries everywhere. **Æ**



700 WATTS never looked better.

Phase Linear presents the ultimate amplifier. For those interested in power, performance, reliability and appearance, the Phase Linear 700B offers the

- highest power
- widest frequency response
- lowest distortion
- most attractive design

of any stereo amplifier in the world.

Why 700 watts? "Anyone using a low-efficiency speaker with a 60 to 100 watt (total power) amplifier cannot approach a realistic listening level". . . "the reproduction of a solo piano at a natural volume level, using high-quality acoustic-suspension speaker systems, can easily require amplifier peak power of several hundred watts."

Julian Hirsch said it, we've always said it, and most audiophiles now agree. True high fidelity can only be reproduced when a reserve of power

is available to re-create the more difficult notes played in live recording sessions. The Phase Linear 700B can do the job, and at \$1.14 per watt RMS/8 ohms/both channels, 700 watts never looked better. At your dealer's now.

Protection—Patented electronic energy limiters. **Power**—Greater than 350 watts/channel R.M.S., both channels operating into 8 ohms, 1 to 20 kHz.

Hum and noise—Better than 100 dB, below 350 watts. **Harmonic and I.M. distortion**—Less than .25%, typically .01%. **Price**—\$799. Cabinet—\$37.

Warranty—3 years, parts and labor, normal use.

Phase Linear
700B

THE POWERFUL DIFFERENCE

PHASE LINEAR CORPORATION, P.O. BOX 549, EDMONDS, WASHINGTON 98020

Check No. 22 on Reader Service Card

AKAI takes a giant step backward and forward.

3 hours continuous record and playback with the "hands-off" wizardry of AKAI GXC-75D.

Just flip the magic switch and you never need to flip the tape. This is the stereo cassette wizard that thinks for itself. Record back and forth with automatic stop.

Playback can be one-way, both ways or continuous. Now you can tape an entire record collection, your favorite station or a live performance without missing a beat. The GXC-75D does it all for you, with incredibly faithful reproduction.

It has Dolby* noise reduction, AKAI's exclusive ADRS (Automatic Distortion Reduction System) and over-level suppressor.

FREE! AKAI includes with the purchase of any tape recorder, BASF low-noise, hi-output reel-to-reel tape or 8-track cartridge, or Chromdioxid™ cassette. Up to \$16.00 retail value. (Offer good only in continental U.S.)



Illuminated, color-keyed control indicators let you know what's happening.

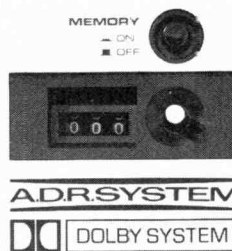
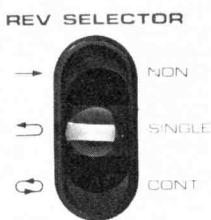

Precise switching controls one-way, round-trip, continuous playback and automatic stop.

Memory switch lets you return automatically to a pre-selected spot on the tape.

Get the wizard, just one of many ways to go cassette with AKAI, the innovators. From \$209.95 with Dolby.

*Dolby is the trademark of the Dolby Laboratories, Inc.

1079

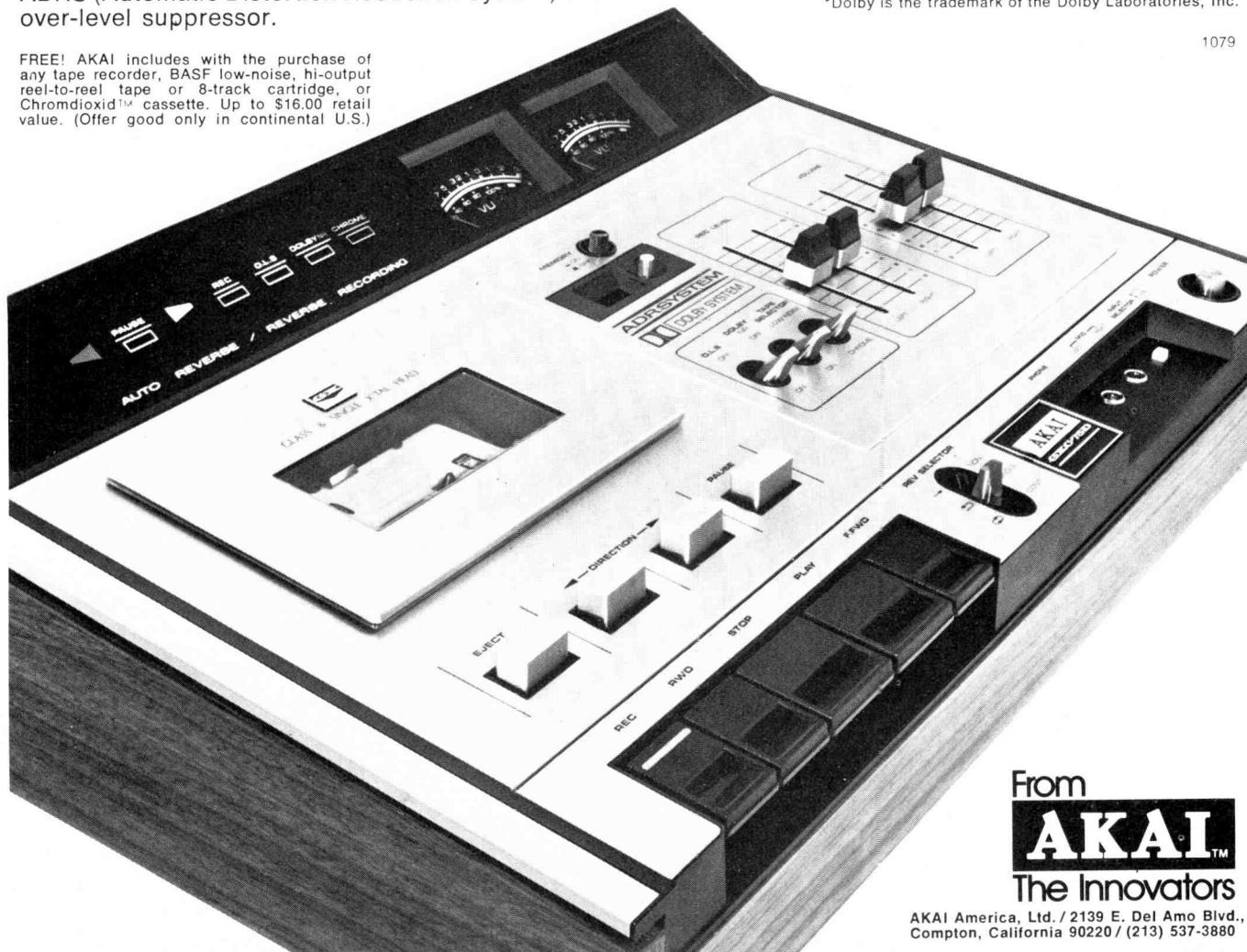

From
AKAI
The Innovators

AKAI America, Ltd. / 2139 E. Del Amo Blvd.,
Compton, California 90220 / (213) 537-3880

All About "Q"

PART 1

Don Davis*

A LOUDSPEAKER has two important parameters relative to its directional characteristics. One is the useful coverage angles assigned to it, typically the -6 dB points as measured on a polar response chart of its horizontal and vertical coverage. The second parameter is that of Q or Directivity Factor, D_f .

Many engineers and technicians tend to confuse these two concepts, or occasionally think of them as directly interchangeable. Even more confusing to the whole issue is the more prevalent use of Q as the symbol for the electric charge and its use in measuring the sharpness of a resonant circuit. (Loudspeakers have both mechanical and electrical resonance.)

Definition of Q (D_f)

In the Appendix V of the Seventh Edition of the *Handbook of Noise Measurement* by Arnold P.G. Peterson and Ervin E. Gross, Jr., directivity factor is defined as follows:

"The directivity factor of a transducer used for sound emission is the ratio of the sound pressure squared, at some fixed distance and specified direction, to the mean square sound pressure at the same distance averaged over all directions from the transducer. The distance must be great enough so that the sound appears to diverge spherically from the effective acoustic center of the sources. Unless otherwise specified, *the reference direction* is understood to be that of maximum response." (Italics by the author.)

In a note to the above definition it is stated that:

"This definition may be extended to cover the case of finite frequency bands whose spectrum may be specified. The average free field response may be obtained, for example, by integration of one or two directional patterns whenever the pattern of the transducer is known to possess adequate symmetry."

We will explore the manifold meanings and measurements this interesting parameter of a sound system makes possible.

*Synergetic Audio Concepts, P.O. Box 1134, Tustin, Calif. 92680 Copyright © October, 1973

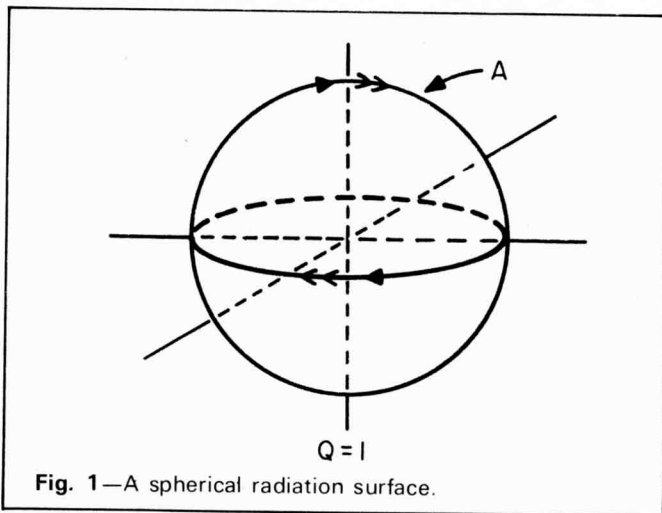

Why Measure Q?

Q appears in many acoustic equations. To the professional sound engineer Q is used to find:

1. The critical distance (the distance at which the reverberant field is equal to the direct sound field).
2. The acoustic power level from which the true efficiency of the loudspeaker is determined.
3. The relative attenuation with increasing distance, from which the absolute attenuation can be found.
4. The Directivity Index, from which the increased on-axis sensitivity of the loudspeaker can be evaluated.
5. The optimum room constant that allows the most favorable ratio of direct-to-reverberant sound.
6. The articulation loss of consonants as a percentage. Q becomes interchangeable with RT_{60} , V and distance.
7. The ratio of direct-to-reflected sound at any distance.

In addition to these already well-established uses of Q, there are many very exciting effects yet to be formulated into equations. This is especially true of those having to do with Q multipliers related to the placement of sound sources (placement along the center of a wall gives a $Q = 2$, placement along a wall and floor intersection gives a $Q = 4$, and in the corner of the room, $Q = 8$), and Q multipliers relative to the coverage area absorbing the output of the sound source.

These and many more projects yet to be conceived offer bountiful opportunities for major improvements in our understanding of how sound systems work in real rooms.

Once the operation of an effect is understood, then the opportunity to intervene leads to exciting new products and techniques. Q measurement is very meaningful, not only for its immediate uses in the field, but for the window it can provide on the, at present, unknown.

A Simplified Visual Q Explanation

Let's begin by imagining a perfect spherical radiation pattern from a loudspeaker, and imagine is *all* we can do. Figure 1 illustrates this ideal situation. The sound source or loudspeaker is at the center of the sphere. The sound pressure level, SPL, at any point at the surface of this sphere would be the same as any other point at the surface. By our definition given above, the ratio of the sound pressure at a given distance in any direction will be equal to the sound pressure averaged over the entire surface. Therefore, the Q of such a spherically radiating loudspeaker would be $Q = 1$.

One can ask, "What coverage pattern does such a loudspeaker have if expressed in the same terms as used in a manufacturer's specification sheet?" That is, what horizontal and vertical angles of coverage does it possess? Nine out of ten people given this question tend to intuitively reply $360^\circ \times 360^\circ$, which again proves why the scientific method has outdistanced Aristotelian Logic. If I swing around a point with a radius 360° , I inscribe a flat two dimensional circle. By putting this flat circular surface on gimbals and sweeping it 180° , its circumference sweeps out the surface area of the sphere. Therefore, a perfectly spherically radiating loudspeaker could be specified as having a coverage pattern of $360^\circ \times 180^\circ$.

The first speaker that doesn't sound like a speaker.

Saul Marantz and Jon Dahlquist, two prominent industry names, have pooled talents to bring you a new sonic experience—the Dahlquist DQ-10 Phased Array. The first loudspeaker that is capable of reproducing music and voice with such striking realism and life-like three-dimensional stereo and depth imaging.

This new loudspeaker has created a tremendous amount of interest since it appeared at selected dealers only a few months ago. Owners tell us that its performance is a revelation—unsurpassed by anything in their experience.

Its unique natural qualities are immediately obvious when you hear the DQ-10 perform. Open, non-boxy sound, with smooth continuity over the whole range. Stereo imaging and depth perception that is extraordinarily life-like. Clean, well dispersed highs that extend

far beyond human hearing. Low bass that is solid and free from detail-muffling resonances. Clear, well-defined details you didn't even know were on your recording.

The secret lies in our methods for preventing the unwanted effects of diffraction and time-delay (patents pending), together with the excellence of the special drivers used in this new five-way dynamic system.

It will be to your advantage to hear the DQ-10 Phased Array before you make a decision on your ultimate system. Write for detailed descriptive literature and the name of your nearest Dahlquist Dealer. And prepare yourself for a treat.

*Dahlquist, 27 Hanse Avenue, Freeport,
New York, 11520*



Power Output of a Spherical Loudspeaker

Since we have already imagined one impossibility, a perfect spherically radiating loudspeaker, let's imagine it has an additional impossible specification: that of being 100% efficient.

If we put 1 electrical watt into its input, it will radiate 1 acoustical watt at its output. For the sake of the present discussion and for those that will follow, let's make the distance from the center of our sound source to the surface of our sphere surrounding it, a standard measuring distance for loudspeakers, namely 4 feet. Now we have at hand a very handy reference level for dealing with acoustic powers.

The power level (PWL) is found by

$$PWL = 10 \log P_{\text{watts}} - 10 \log 10^{-12}$$

Where: PWL = The power level to a reference of 10^{-12} watts

P_{watts} = The acoustic power

Therefore, $10 \log 1 \text{ watt} - 10 \log 10^{-12} = 120 \text{ dB-PWL}$.

And at four feet, we can write

$$SPL = PWL_{12} + 10 \log Q - 20 \log r - 0.5 \text{ dB}$$

Where: r = the distance from the source in feet

Therefore:

$$SPL = 120 + 0 - 12 - 0.5 = 107.5 \text{ dB-SPL}$$

This is an interesting figure because it is the SPL a loudspeaker with a Q of 1 would produce at 4 feet if it were radiating 1 acoustic watt. Therefore, if we put in 1 electrical watt as an input power and measured 101.5 dB-SPL at 4 feet from a loudspeaker that we know has a $Q = 1$, we would then know that it was 25% efficient ($-3 \text{ dB} = \text{half power} = 50\%$, and $-6 \text{ dB} = 1/4 \text{ power} = 25\%$).

It is of interest to note that there are two commonly used reference levels for use with PWL, 10^{-12} and 10^{-13} . At a distance of 0.283 meters, 10^{-12} makes the $PWL \cong SPL$. At a distance of 0.283 ft., 10^{-13} makes the $PWL \cong SPL$. Since the equation for the surface area of a sphere is $S \cong 4\pi r^2$, then 10^{-12} has the $PWL = SPL \cong 120 \text{ dB}$ when flowing through 1 m^2 of surface area, and 10^{-13} has the $PWL \cong SPL \cong 130 \text{ dB}$ when flowing through 1 ft^2 of surface area.

The calculator must use caution with equations employing PWL to be sure that he knows which reference power was intended. Now, let's look at a hemispherically radiating loudspeaker.

A Hemispherical Radiator

Once more let's imagine that we have a source that radiates 1 acoustic watt, only this time the entire 1 watt passes through the surface of a hemisphere rather than the total spherical surface. Again, let's have the sound source 4 feet from the measuring point at the surface. We can immediately realize that the hemisphere has a total surface area $1/2$ that of a sphere with the same radius. Therefore, 1 watt is now flowing through $1/2$ the surface area it did before, with the obvious result that we now have double the power per unit of area. Double the power is $+3 \text{ dB}$. Looking again at our formula we can see that:

$$SPL = PWL_{12} + 10 \log Q - 20 \log r - 0.5 \text{ dB} = 120 + 10 \log 2 - 20 \log 4 - 0.5 \text{ dB} = 110.5 \text{ dB}$$

This matches our definition of the ratio of sound pressures for the two cases. We can also see that the increased on-axis sensitivity of a sound source increases as the Q increases and follows

$$D_i = 10 \log Q$$

Where: D_i = the directivity index in dB

Then, of course, another method of expressing Q would be:

$$\frac{D_i}{10}$$

$$Q = 10$$

We can see in Fig. 2 that the coverage angle of our theoretical loudspeaker with a $Q = 2$ would be, in the ideal case, $180^\circ \times 180^\circ$. Wall-mounted or ceiling-mounted cone loudspeakers approximate this case at low frequencies but as we

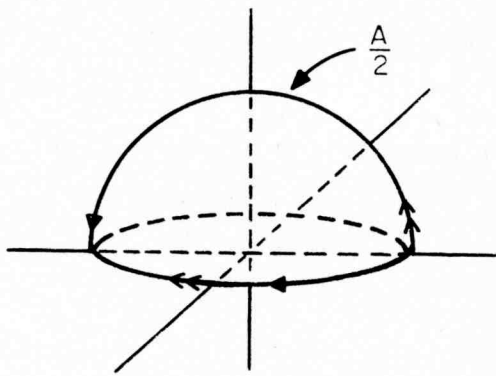

Fig. 2—A hemispherical radiation surface.

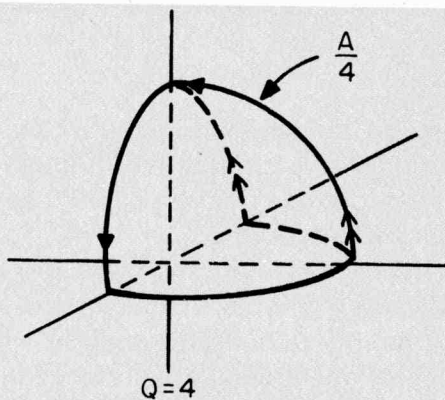

Fig. 3—A quarter-spherical radiation surface.

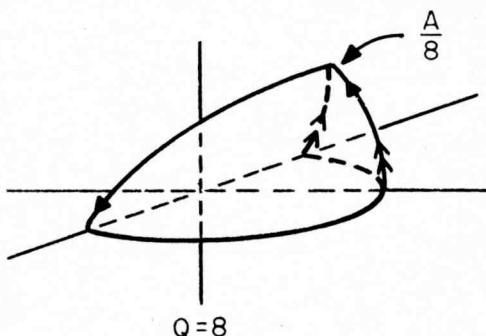

Fig. 4—An eighth of a sphere radiation surface.

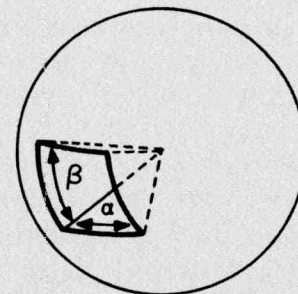
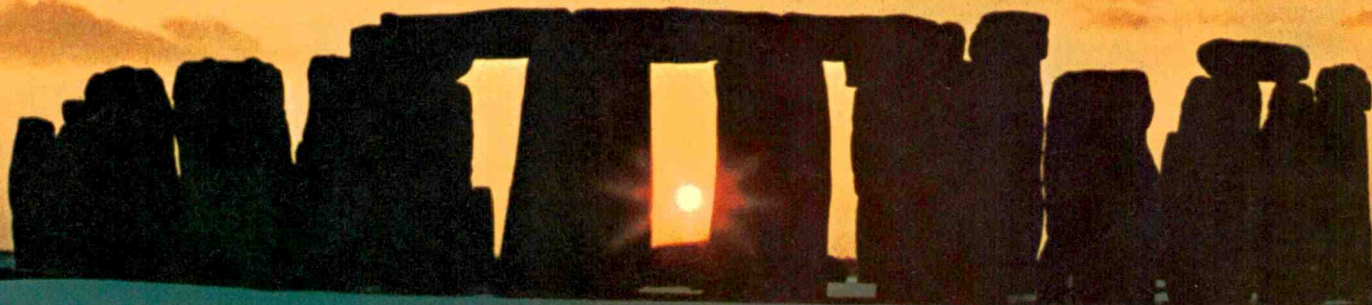

Fig. 5—Angular distribution of a point source defined as the angles formed by the interception of two spherical surface segments.



Stonehenge.

Britain's ageless Stonehenge. Eternal monument to man's quest for ultimate understanding of his world.

Altec's Stonehenge I. Fulfilling the quest of another age — for the ultimate speaker system to reproduce today's dynamic music. With all the power and precision originally captured by modern recording technology. Starting at the bottom, a hefty 12-inch frame bass driver delivers powerfully virile lows and mid-range. At 1800 Hz, the signal crosses over to an all-new direct radiator that produces crisp, definitive highs. The dividing network is front-mounted, with continuously variable high-frequency attenuation control. All totally designed to achieve a new level of accuracy in sound reproduction.

Altec's Stonehenge I. An ultimate in visual styling, as well. A tall, slender column, elegant and graceful. Stunningly crafted on all four sides of luxurious hand-rubbed Afrosian Teak, accented by a rich Raw Cocoa grille. And it occupies less than 1.4 square feet of floor area. Perfect for the small space dweller and quad enthusiast.

Stonehenge I. A new look. A new sound. An ancient mystery inspiring a classic of contemporary technology. From Altec.

Experience it soon.

ALTEC
the sound of experience



1515 S. Manchester Ave., Anaheim, California 92803

Check No. 1 on Reader Service Card

UNIQUE



That's the only word for MAGNEPLANAR® Tympani loudspeakers. Unique in design . . . unique in the clarity and naturalness of the sound they produce. MAGNEPLANAR Tympanis incorporate a host of advanced features. Low-mass, thin Mylar diaphragm with patented tympanic suspension; distributed magnetic field; bi-polar radiation; folding floor screen design. The speaker is a straight wire device with essentially no inductive or capacitive reactance. All elements that have plagued previous state-of-the-art attempts — including voltage supplies, step-up transformers, and complex crossovers — have been eliminated. When used with commensurate high quality associated components, MAGNEPLANAR Tympanis provide a listening experience surpassed only by a live performance. Fabric covers are available in several decorator colors to complement room interiors.

A variety of models and speaker configurations allow you to build the kind of sound system you want. See your Audio Research dealer for a demonstration of the MAGNEPLANAR Tympani loudspeakers. They're in a class by themselves.



**audio research
corporation**

Box 6003
Minneapolis, Minnesota 55406
Tel: (612) 721-2961

©MAGNEPAN, INC.

shall see, the situation becomes more complex when dealing with real-life cone loudspeakers at higher frequencies.

The Q and D_i for Spherical Segments

We can now construct a simple table of Q and D_i for spherical segments from the total sphere to 1/8 of a sphere. (See Figs. 3 and 4.)

SEGMENT OF SPHERE	ANGULAR COVERAGE	Q	SPL	DIRECTIVITY INDEX (D)
Sphere	180° x 360°	1	107.47	0 dB
Hemisphere	180° x 180°	2	110.47	3 dB
1/4 sphere	180° x 90°	4	113.47	6 dB
1/8 sphere	180° x 45°	8	116.47	9 dB

Idealized Angular Coverages

Figures 5 and 6 are intended to help you develop a conceptual view of Q and are not intended to be used to obtain actual Q's. Figure 6 shows what the Q would be for various combinations of angles if *all* radiation were confined to the angular coverage shown. So, while looking at these idealized coverages, remember that Q's for real loudspeakers *with these same coverage angles* also have side, back, top and bottom lobes that lower the mean Q, often drastically. Looking at Fig. 5, we can see an idealized horizontal and vertical angle defined from the center of a sphere to the intersection with its surface. We can call the horizontal angle "alpha" and the vertical angle "beta."

The chart in Fig. 6 now allows us to calculate the ideal Q and D_i for any two coverage angles between 180° and 40° (which incidentally covers all usable loudspeakers). From this chart, we can see that even an idealized cone loudspeaker sound column is limited to a Q = 9. A multicellular horn of 40° x 40° would reach an idealized Q = 26+ if it also produced no side, back, top, or bottom lobes.

More important to the sound engineer is the fact that it takes 5 dB less power, i.e., 1/3 less power, for the same SPL by using the multicellular horn with its higher D_i. When several thousand watts of power is involved such as for ball parks, airports, large arenas, etc., a 3-to-1 power advantage can make knowledge of a loudspeaker's D_i valuable.

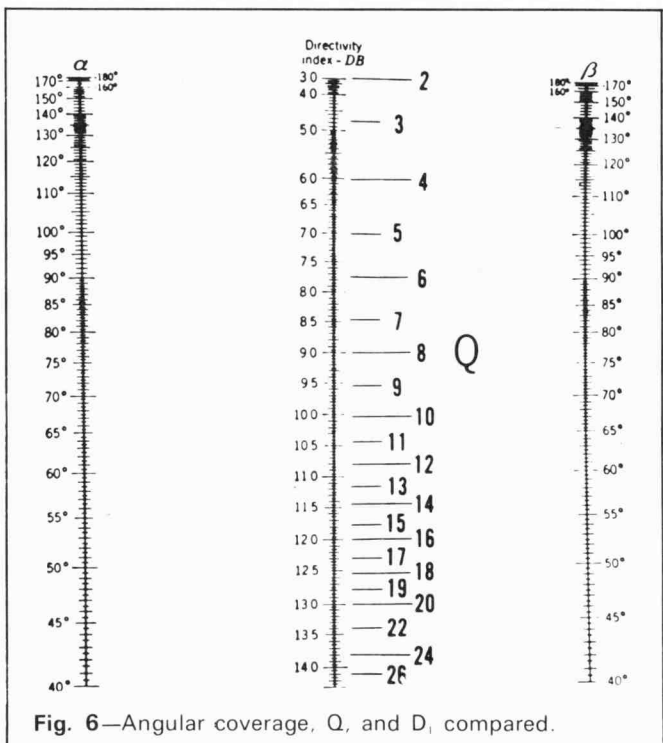

Fig. 6—Angular coverage, Q, and D_i compared.

ONKYO® TS-500

The world's first and only

Automatic

4 channel receiver



**Stack your 4-Ch. records in any sequence.
Sit back, relax and enjoy CD-4, SQ or QS
(RM) Automatically!**

And, for that matter, any and all matrix systems that have been developed! This *revolutionary* instrument from Onkyo lets you hear it all with one switch setting — “Automatic.” There’s no confusion. No guess work about proper system choice. No control switching or resetting. And, no deciphering of record jackets. Now, you can mix all of your 4-channel records in any sequence . . . and include your 2-ch. stereo discs. Then, sit back and immerse yourself in fine Onkyo sound. The secret is in Onkyo’s logic and analog computer circuitry which **Automatically** demodulates and decodes any 4-ch. program in any sequence.

The TS-500 delivers 25W RMS power per chan. 8Ω, 4-ch.

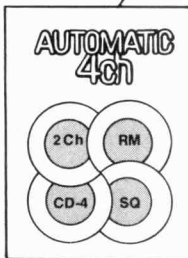

driven. It is BTL strapped for 2-ch. stereo at 50W RMS power, 8Ω, per channel. A 4 channel balance control, continuously variable, provides ideal program balance. And, you may use the manual switch control for selection of any individual 4-ch. mode. All functions, 4-Ch. and Stereo, **Automatically** light up on the dial for at-a-glance convenience. The TS-500 features differential and direct coupled amplifier circuitry to assure superb response and broad power bandwidth. FM sensitivity and selectivity are unparalleled. Distortion at rated power is a conservative 0.5%.



ONKYO®

Artistry in Sound

Onkyo Sales Section/Mitsubishi International Corp. 25-19 43rd Avenue, Long Island City, N.Y. 11101/(212) 729-2323

Check No. 21 on Reader Service Card

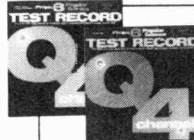

SPECIAL FREE OFFER!

Famous “Project 3/Popular Science” 4-Ch. Test Record Albums for CD-4 & SQ. Both FREE with purchase of Model TS-500. Set up, calibrate & check out your quad system! Offer limited. Ask your dealer.

EXTRA-COURTESY OFFER! Onkyo makes it easy for you to check out your own 4-Ch. system for proper operation. Order these unique test records today.

\$4.49 ea.

(Reg. \$6.98)

2 for \$8.00

Send check
or m.o. to

Project 3 Test Records

1133 Ave. of the Americas

New York, N.Y. 10036

CONSTRUCT A MAGNETIC-CARTRIDGE PREAMP

Alan G. Ogilvie

THIS ARTICLE describes the construction of a simple low-cost stereo preamplifier for use with magnetic cartridges. The project uses the minimum number of components and can be completed in one to two hours by anyone possessing the minimum of skill with a soldering iron.

A Signetics PA239 dual low-noise amplifier, or the equivalent, is the only active device used in the circuit. This device is a linear monolithic circuit featuring two identical matched 68-dB amplifiers designed for use with low-level signals in low-noise applications. Consequently, it is well suited for use with magnetic cartridges. An additional feature is an internal zero-regulated power supply which eliminates the need for l.f. or r.f. decoupling and allows the device to be powered from a single unregulated power supply. Channel separation at 1 kHz is typically 90 dB. The typical equivalent input noise voltage (100 Hz to 10 kHz) is 0.7 μ V rms or 1.2 μ V rms maximum, which gives a signal-to-noise ratio of 72 dB or 68 dB respectively, with a magnetic cartridge output voltage of 3 mV rms. The total harmonic distortion without feedback is typically 0.5 per cent.

The schematic diagram and connection diagram are shown in Figs. 1 and 2 respectively. Figure 3 shows the circuit required to match the amplifier response with the RIAA recording characteristics. The measured response of the amplifier is shown in Fig. 4 with the theoretical response shown dotted for reference. The corner frequencies are specified at $F_1 = 50$ Hz; $F_2 = 500$ Hz, and $F_3 = 2120$ Hz. The lower corner frequency F_1 is determined by the capacitance C_1 and calculated from the formula:

$$C_1 = \frac{A_f}{2\pi F_1 Z_3} \quad (1)$$

where A_f = the feedback gain 45 dB, or 178, at pin 3 and Z_3 = the input impedance, 2400 ohms, at pin 3.

Substituting in equation (1)

$$C_1 = \frac{178}{2\pi \times 50 \times 2400} = 236 \mu\text{F}.$$

The value 200 μ F was selected by the writer although the reader may wish to try 250 μ F as an experiment.

The midband gain is determined by letting $R_2 = 33$ ohms and calculating the value of R_1 from the formula

$$\text{Voltage Gain, } A_v = \frac{R_1 + R_2}{R_2} \quad (2)$$

A voltage gain of 40 dB was selected as this allows a useful dynamic range and gives sufficient amplification for cartridges with outputs of 3 to 5 millivolts rms to drive most power amplifiers.

Substituting in equation (2)

$$R_1 = 100 (33) \approx 3300 \text{ ohms.}$$

The corner frequency at F_2 is calculated from the formula

$$F_2 = \frac{1}{2\pi R_1 C_2}$$

$$C_2 = \frac{1}{2\pi F_2 R_1}$$

Substituting in equation (3)

$$C_2 = \frac{1}{2\pi \times 500 \times 3300} \approx 0.1 \mu\text{F}.$$

The corner frequency F_3 is calculated from the formula

$$F_3 = \frac{1}{2\pi R_1 C_3}$$

$$C_3 = \frac{1}{2\pi F_3 R_1}$$

Substituting in equation (4)

$$C_3 = \frac{1}{2\pi \times 2120 \times 300} \approx 0.025 \mu\text{F}.$$

An additional capacitor C_4 provides roll-off at high frequencies and is the compensation recommended by the manufacturer.

Printed circuit board layout is not critical with the PA239 as long as the input and output lines are kept separate. A suggested layout is shown in Fig. 5. Alternatively, a neat layout can be made with breadboard if printed circuit facilities are not available.

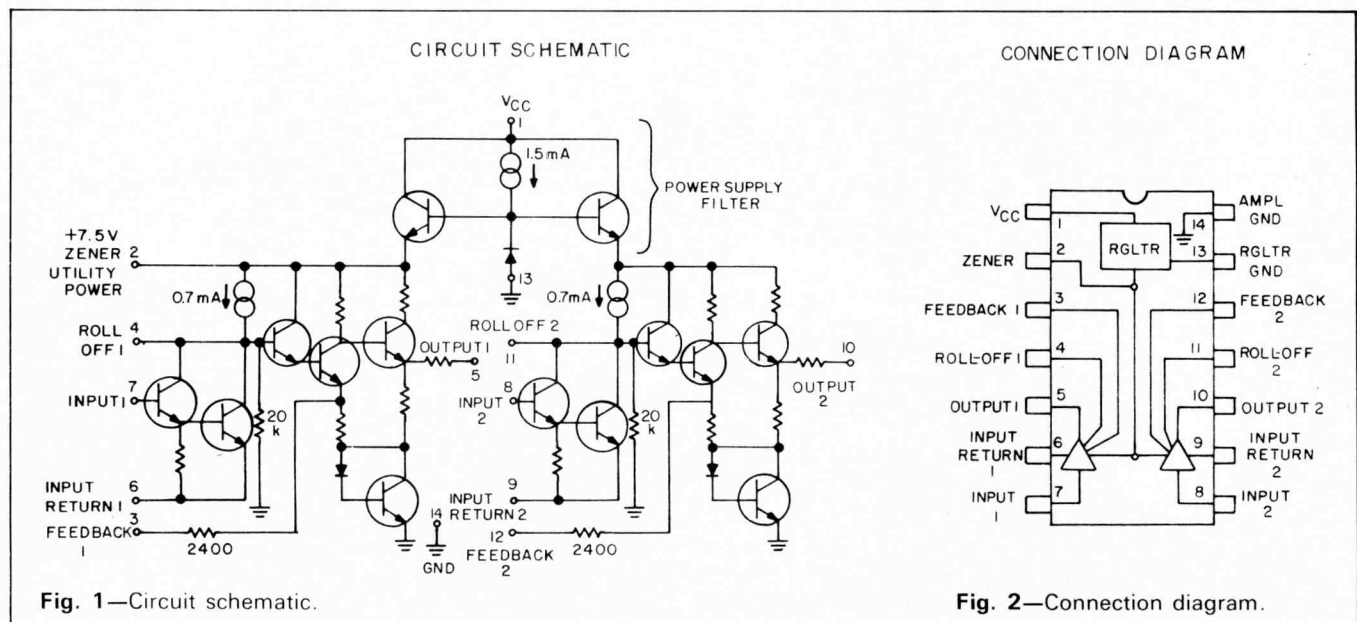

Fig. 1—Circuit schematic.

Fig. 2—Connection diagram.

"Make it great. Then make it better."

That's what Tandberg engineers have always done. And now they've done it again. After months of saying, "Wait—we just figured out another way to make it even better," our hard-nosed Norwegian perfectionists are ready to announce a remarkable new stereo cassette deck. We call it TCD-310.

Many impressive features go in.

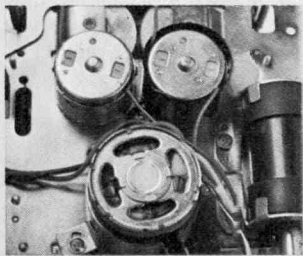

TCD-310 has three motors: One hysteresis synchronous drive motor and two unique servo-controlled direct drive spooling motors. Electronic push-button controls. Expanded range peak reading meters that warn you about distortion *before* it happens.

New input circuitry that makes it as easy to record "live" with mikes as it is to dub from records or FM. TCD-310 also has two flywheels and a dual capstan closed-loop tape drive for absolute stability.

Very impressive sound comes out.

We believe TCD-310 can produce the quietest cassette recordings in the industry. Measuring the way others do, we can claim a signal-to-noise ratio of 65 dB, IEC weighted with CrO₂ and Dolby.* For those who know, the unweighted figure is even more impressive—52 dB. That's tough to beat. TCD-310 also gives you extended frequency response, constant speed and inaudible wow and flutter. Ask your Tandberg dealer for a demonstration. You'll hear the difference. And we guarantee the performance. *Dolby is a trademark of Dolby Laboratories, Inc.

New TCD-310 Everything you hear is true.



We're our only competitor.

TANDBERG OF
AMERICA INC.

TANDBERG OF AMERICA, INC., LABRIOLA COURT, ARMONK, N.Y. 10504
A. Allen Pringle Ltd., Ontario, Canada

Check No. 39 on Reader Service Card

Note that each channel of the stereo cartridge has two wires going to the input of each amplifier and that neither wire is grounded. You may have to separate two wires on your pick-up terminal board as the majority of systems common one side of each channel, and then take it to ground/earth. If you do

have to separate two wires, take care to connect them to the same side of the dual amplifiers, e.g. pins 3 and 12 or 8 and 7, or you will reverse a phase on the cartridge and reduce the bass response of your system. If each pair of wires from the cartridge is screened and maybe a third screens the two screened pairs, all three screens should be earthed near pin 14. Note also the absence of the usual 47k or 68k ohm damping resistors across the cartridge coils. These have been omitted as their insertion did not improve the circuit performance. The reader may wish to verify this with his own cartridge.

The supply voltage is not critical—any value between 9 and 15 volts at 22 milliamperes is satisfactory. In fact, the current drain on some amplifiers is less than 16 milliamperes and therefore a small battery could be used. Obviously, if a battery is used, the internal regulator is not an advantage, but the hum input is zero and the reproduction of low level signals is improved.

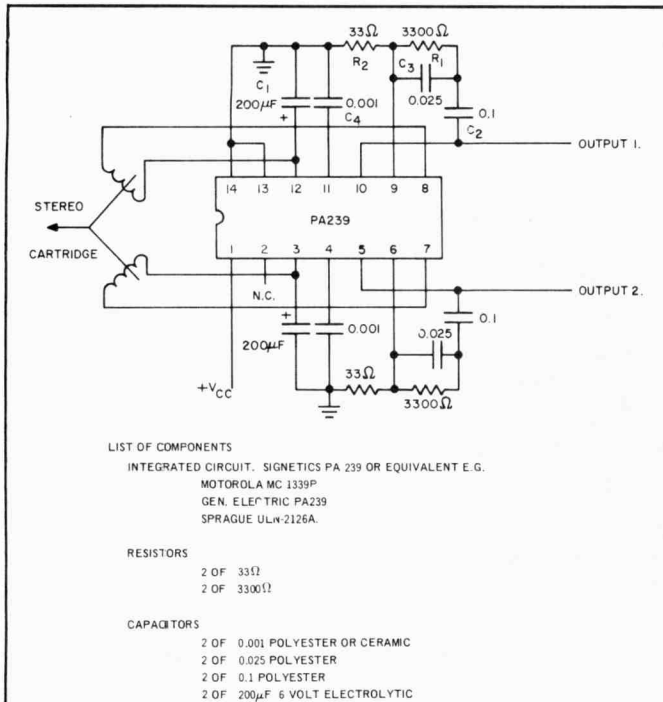

Fig. 3—Circuit showing RIAA compensation.

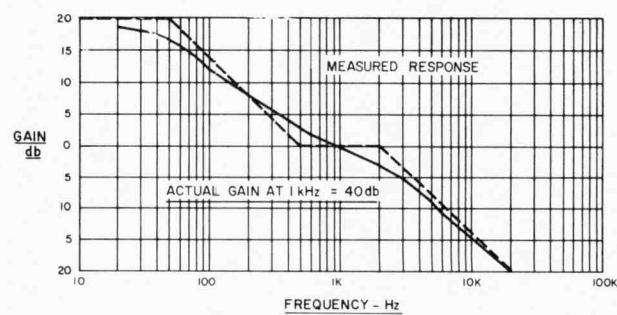

Fig. 4—Measured response of the amplifier.



Our engineers designed a changer worth \$200 to sell for under \$100! Boy, are our stockholders mad.

Our engineers and sales force have always had that spirit of friendly competition. But this time things have gone too far. No matter how slick a salesman is, he's going to have trouble convincing folks that an all-new and better line of changers has been designed and that they sell for under \$100 a copy.

Especially a changer like this. It has the lowest tracking and tripping forces of any changer even near it in price, antiskate, pause and cue, full size turntable, wood grain base, ball bearings all over the place, mag cartridge . . . this one is loaded with features other folks have been trying to get into a changer for years, and it's still under \$100.

We appreciate plain talk and honest dealing from our engineers, but who's going to believe it?

Well, like all great things it's ahead of its time, but we'll take a chance that a wise reader knows a good deal when he trips over it. As for the stockholders, let them eat cake.

GLENBURN better by design

GLENBURN CORPORATION, 787 Susquehanna Ave., Franklin Lakes, N.J. 07417 • (201) 891-8250

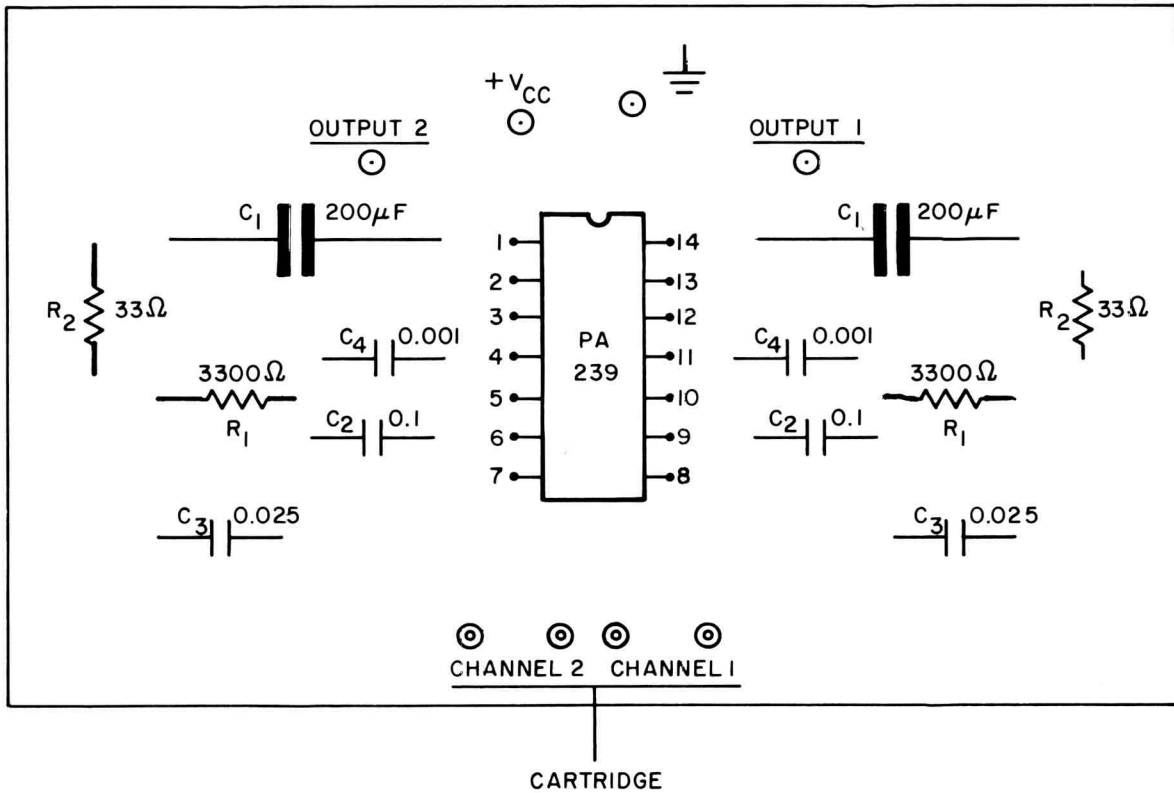
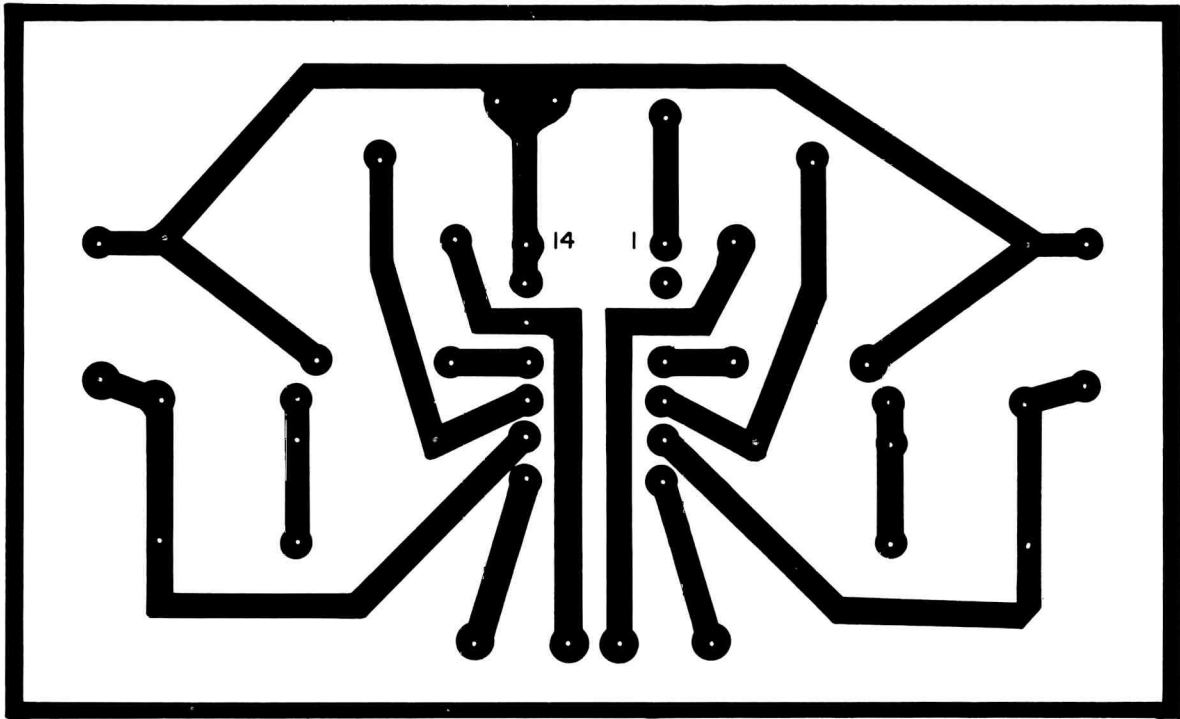

Fig. 5—Suggested layout.

MARANTZ

4400

Model 4400 Receiver

marantz

The control panel features a central scope display showing a green crosshair pattern. To the left are four knobs for 'L-PLAY-F CAL', 'DOLBY SYSTEM', 'L-RECORD-R LEVEL', and 'DOLBY LEVEL'. Below these are buttons for '400Hz TONE' and 'SCOPE DISPLAY'. To the right is a frequency tuner with 'FM' and 'AM' scales and 'STEREO', 'AM', 'FM', and 'PHONO' mode buttons. At the bottom are five large knobs labeled 'phones', 'dolby', 'selector', 'monitor', and 'mode', with various input and output options like 'PLAY', 'RECORD', 'PHONO', 'CD-4/AUX', 'TAPES', 'SOURCE', 'DISCRETE', 'VARI-MATRIX', and 'SQ-DECODER'.

THE WORLD'S MOST POWERFUL RECEIVER

antz

Stereo 2+Quadradial 4

CD-4 TAPE 1 TAPE 2 DOLBY

98 100 102 104 106 108 MHz

LOG

800 1000 1200 1400 1600 KHz

GYRO-TOUCH TUNING

REAR L REAR R

LOUDNESS FM MUTING FILTER LOW FILTER HI FILTER SPKR MAIN REMOTE

FRONT REAR FRONT REAR

bass mid treble volume power

SUPER POWER

And how! Over 125 watts RMS continuous power per channel at 8 ohms in the 2-channel mode. Over 50 watts RMS continuous power per channel at 8 ohms in the 4-channel mode. And all under 0.15% total harmonic distortion from 20 Hz to 20 KHz!

Built-in Dolby noise reduction

Dolby is the virtual standard for noise reduction in home audio equipment. Marantz full-process Dolby has six controls for ultimate flexibility—including "off-the-tape" monitoring. (Equivalent to the most expensive Dolby-B system costing as much as \$259.95 and it's built-in.) Permits noise-free reception on Dolbyized FM broadcasts. Silences hiss for noise-free Dolbyized recording and playback using virtually any cassette or reel-to-reel tape deck system.

Phase Lock Loop

The tuner section of the receiver has Phase Lock Loop FM Multiplex Demodulator. This sophisticated Marantz integrated circuit locks precisely on the FM sub-carrier signal. The results: maximum separation (40 db at 1000 cycles) and minimum distortion (under 0.2% in tuner).

Marantz 4300—the world's second most powerful 2 + 4-channel receiver!!

The Marantz 4300 has slightly less power than the 4400 but still delivers that unparalleled Marantz performance. At **200 watts RMS continuous power** the Marantz 4300 is second only to the Model 4400. Power to spare and features that won't quit at just \$899.95. See the Marantz 4300 and the full line of Marantz stereo and 4-channel receivers starting as low as \$239.95 at your Marantz dealer.

marantz®
We sound better.

VARI-MATRIX

Marantz built-in Vari-matrix synthesizes 4-channel sound from any 2-channel material so your stereo collection will never be obsolete. And the Vari-matrix Dimension Control lets you change the apparent size of your listening area from an auditorium to a small club by recovering ambient information lost in ordinary stereo playback.

Built-in OSCILLOSCOPE

The exclusive Marantz 4400 oscilloscope has three separate functions for precise visual display: tuning, audio and multipath. Signals on the screen let you SEE "dead center" of channel for maximum separation; SEE the signal source and the effect of the mode switch; and SEE the correct antenna position, for minimum distortion.

4-channel Balance Controls

Marantz 4-channel balance controls provide more versatility for balancing your music system than the conventional, single-control "joy-stick." Two separate controls for the front and rear channels and another control for front to rear balancing to accurately balance all four speakers to any listening position.

QUADRA POWER

The Marantz Quadra Power bridging circuit assures total flexibility for stereo or 4-channel operation. More than twice the rated 4-channel power per channel in the stereo mode for top performance with your existing 2-channel records and tapes.

REMOTE CONTROL

Adjust volume, balance and loudness from any listening position. Plug the RC-4 quadradial remote control unit into the remote jack for accurate remote control. The cost? Just \$39.95.

NON-OBsolescence

Marantz with the exclusive interchangeable matrix decoder eliminates 4-channel obsolescence. Easily and economically updates your Marantz receiver for any future 4-channel development. Plug any of the optional matrix decoders into the built-in pocket. All Marantz 4-channel units accommodate SQA-1, SQ/QS-1 or full logic SQA-2 and QS-3 matrix decoders, priced from \$49.95 to \$79.95. If CD-4 is your 4-channel choice, there's an optional Marantz CD-400 adaptor at just \$99.95 (when sold with a Marantz receiver). Marantz... never obsolete.



1TM Dolby Labs, Inc. 2SQ is a trademark of Columbia Broadcasting System, Inc. 3QS is a trademark of Sansui Electric Co., Ltd. 4CD-4 is a trademark of Victor Company of Japan. 5Marantz Co., Inc. guarantees the original registered owner that all parts are free from operating defects for three years from purchase date except tubes which are guaranteed for 90 days. Products are repaired or replaced free of charge during this period provided you bought them in the U.S.A. from an authorized dealer. Naturally, the serial number cannot be altered or removed. 6Marantz Co., Inc., a subsidiary of Superscope, Inc., P.O. Box 99C, Sun Valley, Calif 91352. In Europe: Superscope Europe, S.A. Brussels, Belgium. Available in Canada. Prices subject to change without notice. Send for free catalog.

250 watts continuous power makes the Marantz 4400 the world's most powerful receiver. Stereo or 4-channel. (It's both.) It delivers the same walloping performance as the finest separate components. Yet the feature-packed Marantz 4400 with built-in Dolby¹ Noise Reduction costs about 25% less. Just \$1250 for the highest power and the lowest total harmonic distortion (less than 0.15%) available in any receiver at any price.

The Marantz 4400 with "Stereo 2 + Quadradial[®] 4" design will never be obsolete. That's because Marantz does not have an inflexible matrix system permanently installed in the equipment—like most other brands. Instead, Marantz receivers have an exclusive built-in 4-channel matrix decoder pocket for plug-in/plug-out SQ², QS³ and SQ/QS matrix decoders; plus facilities for a CD-4⁴ adaptor. Result: you can use any or all of the systems currently available, and easily and economically change for any future 4-channel improvements. And Marantz flexibility doesn't stop there. There's Quadra Power[®] for more than twice the rated power per channel in the 2-channel mode (over 125 watts continuous power per channel). And discrete 4-channel at the flip of a switch.

The 4400 brute receiver, like all Marantz products, is backed by a full, three year guarantee.⁵ See it at your Marantz dealer.



The Workbench

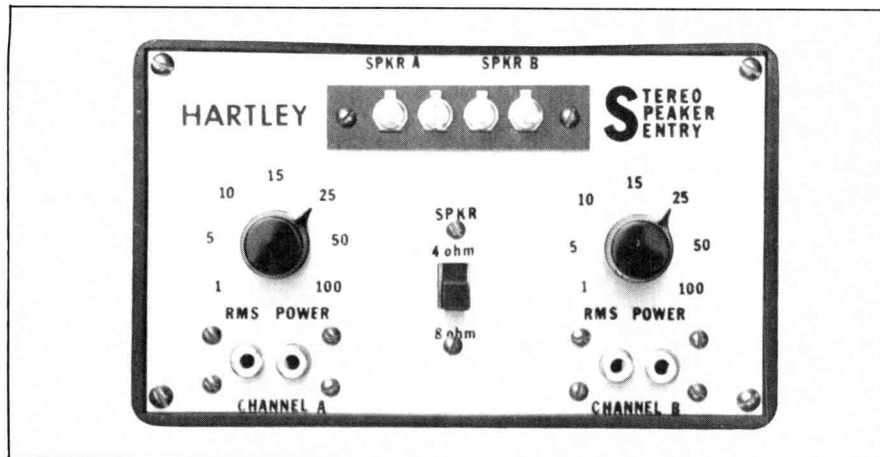

Hartley Stereo Speaker Sentry

HIGH POWER AMPLIFIERS like the Crown, Phase Linear, and the Bose are becoming increasingly popular among the "snobs" and some form of loudspeaker protection is desirable on occasion. One unit I have tested recently is the Hartley Speaker Sentry. It works by using the output voltage to operate a clamp or limiter at the input stage. Figure 1 shows the basic arrangement: The voltage from the speaker terminals is applied to the diode, D_1 via C_1 , R_1 and the variable control, VR_1 , which is calibrated in rms watts. The rectified voltage across D_1 is fed to an LED diode which illuminates a small photo cell. With no illumination, the cell's resistance is quite high, but it falls rapidly with applied light and so puts a low resistance across the output at V . This is connected to the preamplifier via the tape monitor circuit or between the pre-amp and the main amplifier.

On test, the Sentry worked very well indeed. All you have to do is to turn the knob down to limit the output power to whatever *sounds* right. It's best to ignore the calibration figures, as they cannot be accurate under all conditions with a wide range of preamplifier impedances.

Attack time was about 0.5 milliseconds with 0.4 seconds recovery, and there was no sign of any pumping action except at very low levels. Insertion loss will vary somewhat, but with a Sansui

AU 9500 it was exactly 2 dB when connected in the preamp-amp circuit and 1.3 dB in the tape monitor loop. There was no measurable effect on the amplifier output. As the input and output circuits are effectively isolated by the diode-photo cell arrangement, there will be no phasing problems or instability—in other words, the Sentry is completely foolproof.

Obviously, you wouldn't invest in a 400-watt super amplifier and then permanently stifle it with a gadget like this, but there must be times when you want to make certain that a particular speaker will not be subjected to the full power. So the Hartley Speaker Sentry is recommended to your attention—at \$35 it might be a bargain! *G. W. T.*

Check No. 50 on Reader Service Card

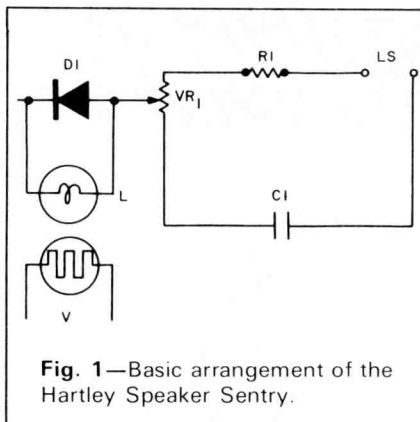

Fig. 1—Basic arrangement of the Hartley Speaker Sentry.

Low Pass Filters

Non-Linear Filters offers Model IP1 non-linear low pass filter for use in shot noise filtering, digital communications, FM carrier spike attenuation, amplitude demodulation, etc. The unit filters without phase shift either inside or outside of the pass band, and corner frequency is settable from d.c. to 10 kHz (usable to 20 kHz) by capacitance change. Supply and input voltages are $\pm 18V$. Price: \$100, with discounts for quantity orders.

Check No. 73 on Reader Service Card

Xcelite heat sink

The No. 80 heat sink has copper jaws, for high heat dissipation, with nickel-plated surfaces, which prevent adhesion of solder. The spring-loaded gripping surfaces will not slip, yet have a smooth finish to prevent scratching fine wires. Insulating cushion grip prevents burns when handling. Length, 3¼ in.; weight, ½ oz. Price: \$2.40.

Check No. 72 on Reader Service Card

General Radio offers a "Primer of Plant Noise Measurement and Hearing Testing," a 24-page booklet giving capsule analysis of the current government regulations on industrial noise and monitoring employee hearing as well as describing techniques and equipment used to measure plant noise and employee hearing.

Check No. 51 on Reader Service Card

Beyer mic stands

The ST212, a giant stand, is designed for professional recordings and consists of a heavy-duty tripod with a telescopic stand that extends to a maximum height of 7 ft., 6 in. and a boom that reaches over 6 ft. and can position a mic up to 13 ft., 6 in. above the floor. The ST199 is a versatile, lightweight stand that telescopes down from a height of 4 ft., 8 in. to a compact 17 in. and weigh about 2 lbs. Prices: ST212, \$84.00; ST199, \$13.50.

Check No. 52 on Reader Service Card

To the world of "as good as an electrostatic" RTR offers "the real thing" in an all new three-kind speaker system

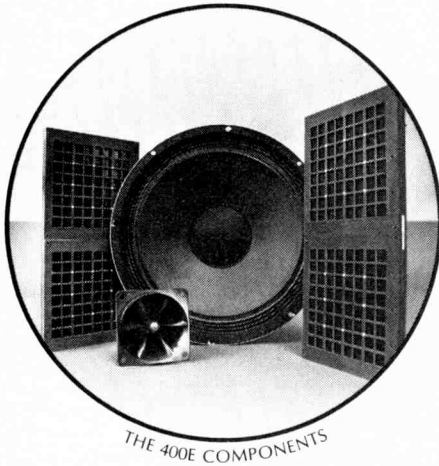

It seems like a lot of new transducer ideas have sprung up lately. Zig-zag elements, diaphragm elements with huge magnetic structures, and various other super gimmicks designed to produce "The Sound of an Electrostatic."

As the largest producer of electrostatic elements in the United States, RTR offers the discerning audiophile "the real thing," the all new RTR model 400E. Incorporating three kinds of transducer types, the 400E sets a new standard in compact system performance.

MAGNETIC WOOFER

For thundering bass response, a special 12-inch woofer was engineered and built by RTR for the 400E. This acoustically suspended woofer employs a two inch voice coil wound on an epoxy impregnated core. It covers the audio range from a window rattling 30 Hz to 470 Hz.

ELECTROSTATIC MID-RANGE

Four RTR electrostatic panels cover the mid-range from 470 to 7800 Hz. These electrostatics feature RTR's exclusive wide excursion panels for maximum band width and presence you can almost feel.

The electrostatic panels are acoustically isolated from the woofer by an angled divider which is ducted at the top of the cabinet. This increases the dispersion of these bipolar radiators and adds a room filling ambience.

SOLID-STATE TWEETER

A solid-state technology piezoelectric tweeter is used for unparalleled treble response from 7,800 to 25,000 Hz. This new tweeter operates on the piezoelectric principle, a dual ceramic element is electrically torqued by the audio input resulting in an output which is acoustically coupled to the air.

Although the 400E is moderately priced, less than \$300, it is designed for use with only the best components. Minimum power requirement is 20 watts with maximum input capability of 100 watts program material.

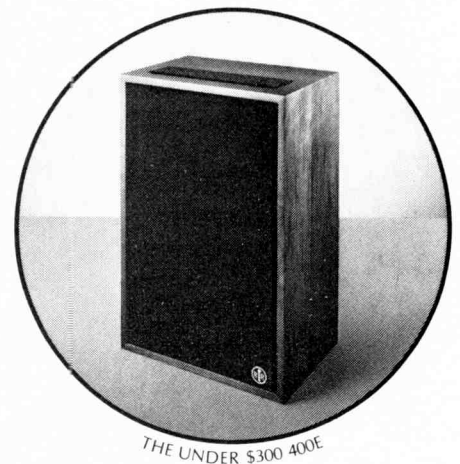

For more information on RTR's total capability in speaker design, circle the number below or write
RTR Industries, Dept. AU, 8116 Deering Ave., Canoga Park, CA 91304



RAGTIME ON RECORD

Charles B. Davis, Jr.

THE EXPANDING INTEREST in ragtime at present is gratifying to one who has followed its ascension over the past 11 years. In that time, two organizations with their own publications have been started to help nourish the movement: The Ragtime Society of Weston, Ontario (P.O. Box 520) and its newsletter, *The Ragtimer*, and *The Rag Times* which is printed by the Maple Leaf Club of Los Angeles, 5560 West 62nd St., zip 90056.

The first book devoted to the history of ragtime is *They All Played Ragtime* by Rudi Blesh and the late Harriet Janis. Now in its third edition, it is published by Oak Publications. The pictures and text bring the composers and performers to life.

Last year marked the appearance of another book on ragtime called *The Art of Ragtime* by William Schafer and Johannes Riedel. It is published by L.S.U. Press.

My first acquaintance with a ragtime pianist was with Knocky Parker of the University of South Florida in Tampa. One critic has called him the Palgrave of ragtime because of his numerous recordings. He always insists on slow to moderate tempi as well as playing on a finely-tuned and regulated grand piano to show off their beauty. Ewing Nunn of Audiophile Records has captured Knocky's interpretations in high fidelity recordings.

His ragtime recordings are on AP-49, **Old Rags**, which contains an excellent version of *Fig Leaf Rag*, one of Scott Joplin's most beautiful rags. In the early 1960s, the **Complete Piano Works of Scott Joplin** was released on AP71-2. Since then, a piece attributed to Joplin called *Silver Swan* was found on a piano roll in California. Knocky does not play the rags exactly as written, however, his additions never detract from the music. The best example of this is in *Scott Joplin's New Rag* where he transposes it from C major to Eb major and with his additions, his paraphrase comes across as the most convincing on record.

Pictured clockwise from top: Knocky Parker, Eubie Blake, Jelly Roll Morton, Max Morath, Joshua Rifkin.

His best overall set of records is the **Complete Piano Works of James Scott** on AP 76-7. Scott's rags are not as consistently fine as Joplin's, however, *Ragtime Oriole* and *Grace and Beauty* are two of the finest rags ever written.

The next set was an ambitious undertaking covering four LPs. This is the **Treasury of Ragtime** on AP 89-92. On these recordings, he departs from playing the piano exclusively and substitutes a harpsichord and celeste on different strains. He is also backed at times by banjo, string bass, drums and tuba. This same idea was also carried into another set of four LPs on music by Jelly Roll Morton.

Max Morath has been in the public eye more than any other ragtime performer with his appearances on Arthur Godfrey's radio show and the Bell Telephone Hour. The recently released album on Vanguard, VSD 39-40, called **The Best of Scott Joplin and Other Rag Classics**, is one of the best bargains in the field of ragtime as well as being an artistic success. The second record in the set was originally issued on Arpeggio 1204S, the label of the Ragtime Society. On it, you will hear the piano joined by banjo and guitar. The arrangements are so effective that the rags sound like a kind of light and carefree chamber music. The first record offers Max in a piano solo format. *Silver Swan* makes its debut in this collection. Max has personal ideas on tempo which defy tradition, however, he makes each piece a testimony to his artistic integrity.

John Arpin, a Canadian performer and past president of the Ragtime Society, has one fine LP out on the Canadian Harmony label, HES 6026. Included are a few rags and other tunes from the present that adapt to ragtime stylizations. His best ragtime efforts are now, unhappily, out of print. It is hoped that the Rag Society will issue both *Concert in Ragtime* and *The Other Side of Ragtime* in an album format. John takes the rags at a brisk tempo while adhering strictly to the score. His feeling for dynamics and accents is a thrill to hear.

Joshua Rifkin has recently released two LPs on the Nonesuch label, H-71248 and H-71264. He plays the rags in slow drag tempi and never

loses the musical meaning of Joplin's music. Some critics chastise him for this reason, but I disagree.

A few years ago, I visited Roy Carew, the late patron saint of ragtime. He played them the same way Mr. Rifkin does, so there is definite validity in his playing.

Ann Charters, wife of the jazz and blues historian Sam Charters, played in a similar manner on her own record on the Portents label. She also recorded portions of Joplin's opera *Treemonisha* on the same label.

William Bolcom on Nonesuch H-71257, **Heliotrope Bouquet**, plays ragtime in the same manner as John Arpin. However, Bolcom embellishes the music at times. On this record, he surveys a number of ragtime composers. His *Pork and Beans* recording matches Luckey Roberts' own recording, which will probably be released in Jazzology's **Jazz Piano Heritage** series. *Seabiscuits Rag* and *Graceful Ghost* are two of his fine rags on this record as well as parts of *Brass Nuckles*, which has to be the funniest rag on record. More of his compositions can be heard on Jazzology JCE-72.

MOVING AWAY FROM the academically inclined pianists, we encounter the midwestern style of ragtime with its proponents: Bob Darch, Trebor Tichenor, Tom Shea, and Charles Rasch. This style can be thought of as the "high class saloon style" of ragtime piano playing as compared to the refined or "parlor style" of the aforementioned players.

Bob Darch is known as a pianist and historian. He gathered material for the television show, *Those Ragtime Years*, hosted by Hoagy Carmichael in 1960. In 1962, he brought Joe Jordan, Eubie Blake, and Charles Thompson together to record, on the Stereoddities label, **Reunion in Ragtime**, S 1900, still listed in Schwann 1. **Evening in a Fine Saloon** features Bob, Eubie and Joe on a private issue, Jan 1, which can be purchased through The Maple Leaf Club.

Tom Shea has two fine LPs on the Ragtime Society's label. They are **Classic and Modern Rags**, RSR-1 and **Prairie Ragtime**, RSR-2. *Brun Campbell*

Express is one of the finest rags to come from the present ragtime revival. Besides this, he features other compositions of his own and older material.

Paul Affeldt, of California, is an enterprising owner of an independent label, appropriately called Euphonic. The first two LPs are devoted to Brun Campbell, the only white pupil of Scott Joplin, Dink Johnson of New Orleans, and Euday Bowman of Kansas City. Not only do we have a link here with the musical past, but we also get to hear the differences found in various geographical areas of the United States on ESR 1201 and ESR 1202.

WITH MASS COMMUNICATION today, popular music as well as the groups that play it find it easier to trade ideas and sounds. But this was not so over sixty years ago. Bands as well as soloists could be identified by the region from which they came.

Vintage Piano, ESR 1203, features the late Paul Lingle in a live club date playing with more zest than on his *Good Time Jazz* LP, L-12025. Once you get past the low fidelity, you will hear some extraordinary piano playing.

Bill Mitchell shares the reverse side of this LP. He plays some of the more obscure ragtime pieces plus a few others. Recently he has recorded **Ragtime Recycled** on the Ethlyn label.

Barrelhouse Blues and Stomps are on ESR 1204-5 and they contain some fine blues, rags and boogies by a number of fine pianists. These are all originals and not reissues.

Creative Ragtime contains two of the more recent performers now playing: Neville Dickie of England and David Jasen of Long Island. Both are interesting performers and have recently released discs devoted to each: David on *Blue Goose* 3001 and Neville on *Piano Contour* 287190.

Charlie Rasch, of Michigan, is featured solo on **Ragtime Down the Line**, RSR-4 of the Ragtime Society. *Casa Loma Stomp* and *Cum Bac Rag* are two of the best tracks on this record.

Recently he and his partner Kate Ross released a disc of their joint efforts on the CK label. Here are excellent piano and banjo duets as well as fine solo excursions by both performers.

Trebor Tichenor is well known for his outstanding collection of ragtime piano rolls and sheet music. He contributed an excellent series of articles on

the analysis of Scott Joplin's rags and Joe Lamb's rags to various magazines. He can be heard solo on **Mississippi Valley Ragtime** on Scroll LSCR-102 and with the excellent band, the St. Louis Ragtimers, on Audiophile.

Anthologies represent a fine way to sample a number of different pianists playing their favorite pieces. **Ragged Piano Classics** on the Origin Jazz label, No. 16, is an excellent reissue of some of the more obscure pianists from the past. *Dew Drop Alley Stomp* by Sugar Underwood is one of my favorites on this LP.

Maple Leaf Rag by Scott Joplin is the greatest of all ragtime pieces and has been recorded greatly since its publication in 1899. David Jasen has put 15 different views of it on Herwin 401.

An anthology of recently discovered and recently written rags is on **They All Play Ragtime**, Jazzology JCE-52. All of the scores can be found in the revised edition of Blesh and Janis' book.

The Biograph label is making avail-



able an excellent series of piano roll recordings produced by Arnold Caplin in association with Mike Montgomery and Trebor Tichenor. Three LPs are devoted to Scott Joplin: BLP-1006Q, BLP-1008Q, and BLP-1010Q. The first contains the only known examples of Joplin's playing. The others are devoted to machine-cut and hand-played rolls of his rags.

An earlier anthology was issued on the Folkways label, RBF-7, by Trebor Tichenor. This is devoted mainly to hand-played versus machine-cut rolls.

With the number of Scott Joplin recordings coming out recently, I would be remiss not to mention **An Evening with Scott Joplin** produced by Nonesuch in association with the New York Public Library. It features the talents of Bill Bolcom, Joshua Rifkin and Mary Lou Williams as well as excerpts from *Treemonisha*.

After covering so many pianists, mention should be made about orchestrated ragtime. Numerous jazz bands have recorded rags but they usually

used them as a basis for improvisation. The group that follows the old scores with care is The New Orleans Ragtime Orchestra. Their first efforts were recorded by a fellow tarheel, Sonny Faggart on his Pearl label. Their best efforts, though, are on Arhoolie 1058.

From the Maple Leaf Club ranks, the Dawn of the Century Ragtime Orchestra has made two fine LPs on Arcane, AR 601-2. These are well performed and catch the spirit of the times beautifully.

The best effort in the orchestral guise has been released on Angel S36060. The New England Conservatory Ragtime Ensemble under the direction of Gunther Schuller gives an excellent account of every piece they play. Piano solos of two of the rags performed by the group are on the record for comparison. It is called **Scott Joplin: The Red Back Book**.

There is one gentleman living today who can claim the distinction of having lived during this era, written excellent rags and recorded on piano rolls, 78s and LPs. Eubie Blake of Baltimore is his name and he represents the East Coast or stride style of ragtime. His recording on Columbia, **The Eighty-Six Years of Eubie Blake**, received much critical acclaim when released in 1970.

Since then, he and Carl Seltzer have produced records on Eubie's own label, located at 284 A Stuyvesant Avenue, Brooklyn, N.Y. 11221. EBM-1 features Eubie with Ivan Harold Browning. EBM-2 is called **Rags to Classics** and features Eubie soloing. EBM-3 contains Eubie, Edith Wilson, and Ivan. EBM-4 is the beginning of a reissue series of his recordings from the past.

Eubie made piano rolls from 1917-1921 and these are well documented on Biograph BLP-1011/2Q.

The ragtime era has been well documented on records and at this writing all of the above records are available. If they cannot be bought locally, write to the clubs mentioned at the beginning of this article for help.

With the number of recordings of piano playing ragtime, one wonders about the possibility of its availability on any other instrument. William Neil Roberts of California has filled the bill with two excellent albums of Joplin rags played on the harpsichord, produced by Klavier records—KS 510 and KS 516. Beautifully played and beautifully recorded, these make an excellent addition to a collection of ragtime. Here you get a sound closer to the banjo on which ragtime originated. **Æ**

BEST.

Unanimously, critics have called our HD 414 the world's best headphones. Praising its wide response, unusual smoothness and superior transient abilities. No less important, from their standpoint, is the HD 414's exceptional comfort, thanks to its exclusive open-air* design that eliminates uncomfortable ear seals, and keeps the unit's weight to just 5 ounces. Review after review, in magazine after magazine, has helped make the HD 414 one of high fidelity's most remarkable success stories.



*U.S. Patent No. 3,586,794

BETTER.

The reviews aren't in yet, because the HD 424 is so new. But even our conservative engineers believe the HD 424 is something better. Thanks to significant technical advances that provide even greater accuracy and linearity at extremely high and low frequencies. There's an additional measure of comfort, as well, with even lower pressure on the ears, thanks to wider, thinner ear cushions and improved earpiece geometry. Plus a comfort-cushioned headband, that feels as good as it looks. Naturally, the HD 424 costs a bit more.



Try them once, and you'll probably be spoiled for any other kind of headphones. Then the choice is easy. You can buy the HD 414 and have the best. Or pay a little more, and have something better. Either way, you can't lose. Sennheiser Electronic Corporation, 10 West 37th Street, New York, N.Y. 10018 (212) 239-0190. Manufacturing Plant: Bissendorf, Hannover, West Germany.

Check No. 33 on Reader Service Card

first came the word...



And then there was music.
And then came Sony tape recorders
to capture the words and music
with perfect fidelity. Right from the
start, Sony has always been first with
the best, the newest and the broadest

selection of tape recording equip-
ment in the world. Sony tape
recorders, Sony accessories, Sony
microphones, Sony recording tape.
We could go on and on and on.
We are. **SONY** Ask anyone.

Brought to you by **SUPERSCOPE.**

Check No. 63 on Reader Service Card



Equipment Profiles

Fisher 4060 2/4-Channel Receiver



MANUFACTURER'S SPECIFICATIONS

FM TUNER SECTION

IHF Sensitivity: 2.5 μ V. **S/N:** Mono, 64 dB. **THD:** Mono, 0.5%; Stereo, 0.8%. **Selectivity:** 40 dB. **Capture Ratio:** 2.5 dB. **Image Rejection:** 46 dB. **I.F. Rejection:** 70dB. **Spurious Rejection:** 85 dB. **Stereo FM Separation:** 35 dB at 1 kHz.

AM TUNER SECTION

IHF Sensitivity: 350 μ V/meter. **Selectivity:** 36 dB. **Image Rejection:** 40 dB. **I.F. Rejection:** 40 dB.

AMPLIFIER SECTION

Power Output: Four-channel, 15 watts/channel; two-channel strapped, 36 watts/channel. **Rated THD:** 1.0%. **Rated IM:** 0.8%. **Power Bandwidth:** 30 Hz to 30 kHz. **Damping Factor:** 30. **Input Sensitivity:** Phono, 2.5 mV; Aux and Tape, 200 mV. **Maximum Input Signal:** Phono, 45 mV; Aux and Tape, 3.5 V. **Frequency Response:** Phono, RIAA \pm 2 dB; Aux and Tape, 20 Hz to 20 kHz \pm 2 dB. **Hum and Noise:** Phono, 60 dB; Aux and Tape, 66 dB. **Bass Control Range:** \pm 12 dB @ 50 Hz; **Treble Control Range:** \pm 12 dB @ 10 kHz. **High Filter:** -8 dB @ 10 kHz.

GENERAL SPECIFICATIONS

Dimensions: 19 $\frac{1}{4}$ in. W x 5 $\frac{1}{2}$ in. H x 16 $\frac{3}{4}$ in. D. **Weight:** 24 $\frac{1}{4}$ pounds. **Power Consumption:** 220W/250 VA. **Price:** \$369.95.

This trim-looking receiver should go a long way towards dispelling the idea that in order to "get into" quadraphonic sound, one needs to apply for a second mortgage on the home and car. Retailing for just about the same price as a good-quality stereo receiver of similar power-output capability, the Model 4060 "2/4-Channel Receiver" offers many features found in higher priced units. While it lacks built-in CD-4 demodulation circuitry, it does incorporate an SQ-matrix decoder circuit which will decode matrix records as well as matrix four-channel FM broadcasts.

The front panel bears a family resemblance to other Fisher receivers. The upper, blacked-out section contains two tuning meters (signal-strength and center-of-channel); mode indicator

lights which denote two-channel, four-channel, and matrix settings of the mode switch; well-calibrated FM, AM, and logging dial scales, and a good-sized tuning knob. The lower half of the panel contains a pair of headphone jacks for use with two- or four-channel headphones; a power/speaker switch (which turns on power, selects main or remote sets of speakers, as well as the "strapped," two-channel, higher-power mode); bass and treble controls; rear- and front-balance controls; dual concentric-clutched, master-volume controls; mode switch, and program-selector switch. Four additional push buttons activate such secondary circuits as loudness-contour, high frequency filtering, FM interstation muting, and tape monitoring. By designing the volume control as a pair of friction-clutched dual controls, the need for a front-back balance control is eliminated. The dial pointer of the 4060 is illuminated for easy viewing, and the dial scale numerals light up in a soft blue color when power is applied.

The rear panel, pictured in Fig. 1, is equipped with antenna terminals for 300-ohm FM antenna and external AM antenna connections. There are inputs for phono, four-channel auxiliary (such as the output of a four-channel tape deck), and four-channel recorder-out/tape-in jacks. Well-separated speaker terminal screws accommodate two quartets of speakers—for main and remote operation. In the two-channel, "strapped" mode, however, only one pair of speakers can be used. The reasoning here, of course, is that once a customer owns four speakers he will more than likely want to connect them for quadraphonic use, rather than as main and remote stereo pairs. If desired, however, the latter arrangement could be worked out by setting the mode switch to the two-channel position while leaving the power/speaker switch in the four-channel position. Under those conditions, the same stereo information is applied to front and rear pairs of speakers, which could then be located in different listening locations.

The rear panel also contains an FM detector output jack for future use with an adaptor to decode four-channel, discrete FM broadcasts when and if such broadcast service is authorized by the FCC. Four speaker-line fuses, a power-line fuse, a switched a.c. receptacle, and a pivotable AM ferrite-bar antenna, plus a chassis-ground terminal, complete the rear panel layout.

The view of the 4060 (Fig. 2) with walnut cabinet enclosure removed discloses a neatly laid-out group of circuit-board

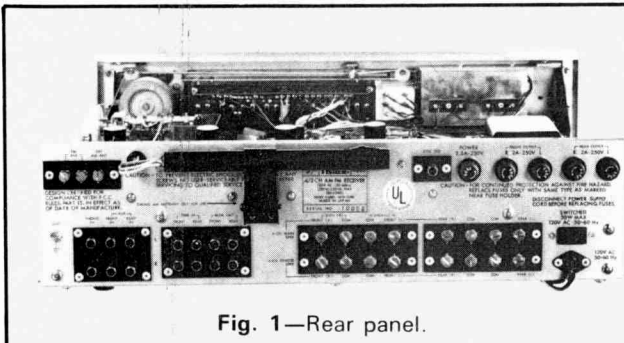

Fig. 1—Rear panel.

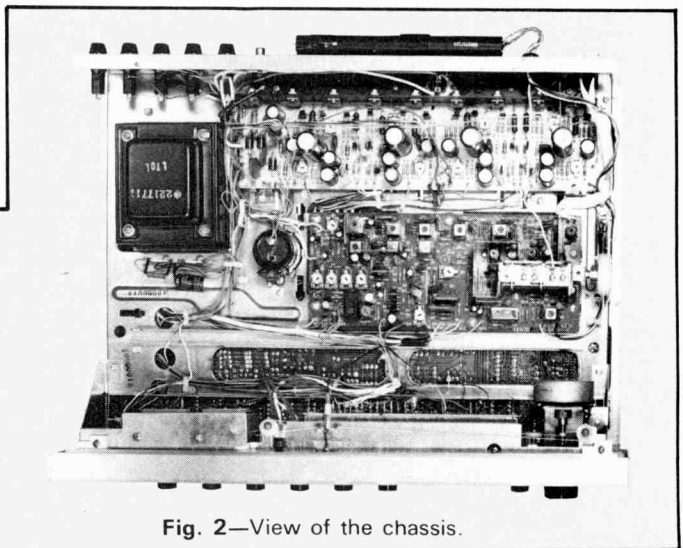

Fig. 2—View of the chassis.

modules, the centrally located one of which contains the entire AM, FM, and stereo-decoder circuitry. A field-effect transistor is used in the FM front-end, along with a three-section variable capacitor. A three-stage, integrated-circuit i.f. section is used in FM, while the AM section uses a two-section variable capacitor and a three-stage i.f. amplifier. Tone control circuits are of the negative-feedback Baxandall type, while output stages are of conventional push-pull design and utilize eight medium power transistors mounted on a common heat sink, which can be seen at the rear of the chassis. Output-circuit protection is afforded by means of the individual speaker-line fuses mentioned earlier. The presence of a full set of four-channel auxiliary inputs would make it easy to add a CD-4 outboard demodulator to this receiver and still permit the use of a four-channel tape deck, since the latter could be connected to the four-channel tape-monitor in-and-out jacks. If the user desired to add a separate matrix decoder to the system (for the purpose of achieving "logic" enhancement of separation — a feature not included in the self-contained SQ-decoder circuit), this accessory could be accommodated as well, since such decoders usually provide four-channel monitor jacks for the then-displaced four-channel tape deck of the system.

Tuner Performance Measurements

While the Fisher 4060 claims an IHF FM sensitivity of $2.5 \mu\text{V}$, we did better than that in our measurement of the sample supplied to us. It read $2.2 \mu\text{V}$ and, more importantly, provided an impressive 50 dB of quieting with only $2.5 \mu\text{V}$ of signal applied. At 6 microvolts, mono THD was down below 1.0%, reaching an ultimate low figure of 0.2% at full (1000 μV) signal strength. Ultimate S/N in mono reached 72 dB, 8 dB better than claimed, while in stereo, best signal-to-noise ratio obtained for strong signals was an impressive 68 dB. Stereo switching occurs at an input signal strength of about 7 microvolts, at which point THD is already down to about 1.5%. Ultimate THD in stereo measured 0.76%, a bit better than the 0.8% claimed by the manufacturer. Results of these measurements are plotted in Fig. 3.

Additional specifications confirmed include a capture ratio of 2.5, as claimed, selectivity of 42 dB (a bit better than claimed, but not particularly impressive), and spurious response rejection of 85 dB as claimed.

Figure 4 shows stereo FM separation as well as THD versus frequency for both mono and stereo. Mid-frequency separation measured 38 dB, decreasing to 25 dB at 10 kHz, and 34 dB at 50 Hz. THD in mono remains below 0.5% from about 100 Hz to 8 kHz, never rising above 0.65% at any frequency measured. Stereo THD remains well below 1.0% for frequencies below 2 kHz, rising to 2.7% at 7 kHz, largely because of non-harmonically related "beat" frequencies which appear at the higher frequencies.

AM performance of the Fisher 4060 was just average, as might be expected from this typical, minimal AM circuit design. Orientation of the ferrite bar antenna did enable us to receive the expected number of AM stations reasonably well, but measured signal-to-noise did not exceed 40 dB. THD under test conditions measured 1.3% for 30% modulation at 1000 μV .

Amplifier Measurements

With all four channels driven with a 1 kHz signal, and in the four-channel mode, THD at rated continuous-power output of 15 watts per channel (into 8-ohm loads) was a mere 0.12%. We were able to drive the amplifiers to an output of 17.7 watts each before reaching rated THD of 1.0%, as plotted in Fig. 5. Rated IM of 1.0% was reached for an output of 16.7 watts per channel, again better than the 15 watts per channel claimed. THD was also plotted for the "strapped" two-channel mode, in which front and back channels are

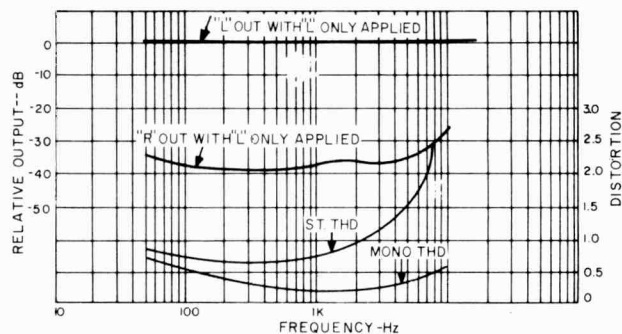

Fig. 3—FM quieting and distortion characteristics.

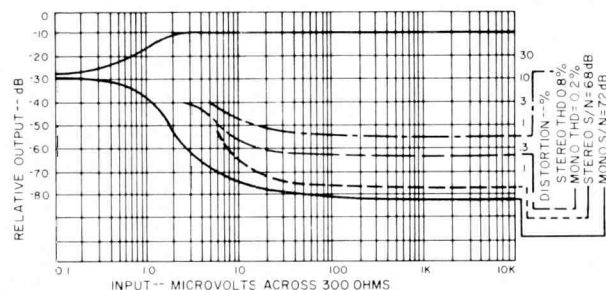

Fig. 4—Separation and distortion vs. frequency.

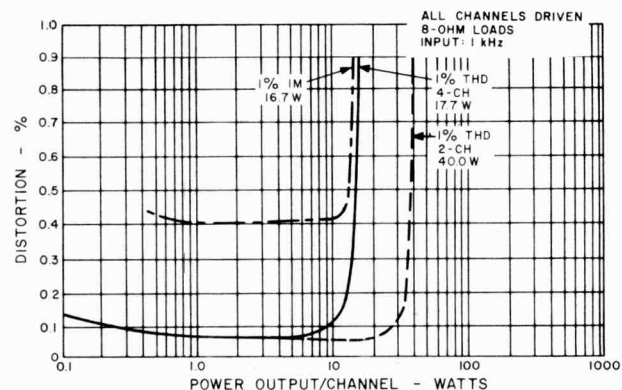

Fig. 5—Harmonic and intermodulation distortion characteristics.

paired together to provide more than twice the power per channel for stereo use, compared with quadraphonic operation of the receiver. Under these conditions, power output reached 40 watts per channel (as against 36 watts claimed) before rated THD of 1.0% was noted. In our opinion, Fisher's technique of having the "strapping" switch available as a front-panel control (part of the speaker selector switch), and not having to reconnect the pair of desired speakers to special sets of speaker terminals, are both very desirable aspects of this circuitry. Even the quadraphonic listener may, occasionally, want to "switch back to stereo" (with only two of his four speakers playing), either for comparison purposes or because of musical preferences, and it is nice to be able to affect this switching without having to go around to the back of the unit—which may well have been custom-installed in a cabinet or mounted on a shelf against the wall.

Power bandwidth, plotted in Fig. 6, extends from 25 Hz to 25 kHz, as against 30 Hz to 30 kHz. The 15-watt-per-channel capability at less than 1.0% distortion extends all the way out to 20 kHz or better, but at the bass end of the spectrum, that THD is reached for a frequency of 70 Hz, while at 50 Hz, attempting to reach full power output results in a THD of 2.0%. At half-power output (7.5 watts per chan-

nel), the "under 1.0%" THD reading is maintained down to 20 Hz.

Tone-control range is typical of this type of circuit and is plotted in Fig. 8. While the high frequency filter has a slope of only 6 dB per octave, its crossover point is set somewhat higher than is obtained by full counterclockwise rotation of the treble control. This makes it a bit more effective in reducing scratches and hiss than would be possible if the treble control were rotated fully to achieve the same effect—preserving some of the higher frequency musical content of the programming. Loudness-control contouring was measured for a setting of -30 dB from maximum volume, and corresponds closely with Fletcher-Munson prescribed effects. Slight treble emphasis is also provided in this particular loudness circuit.

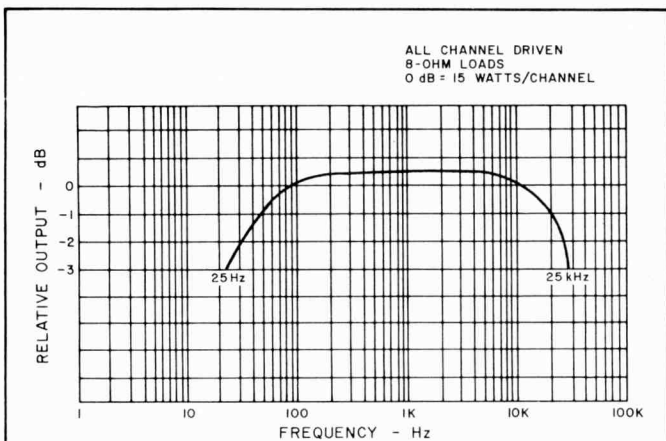

Fig. 6—Power bandwidth characteristics.

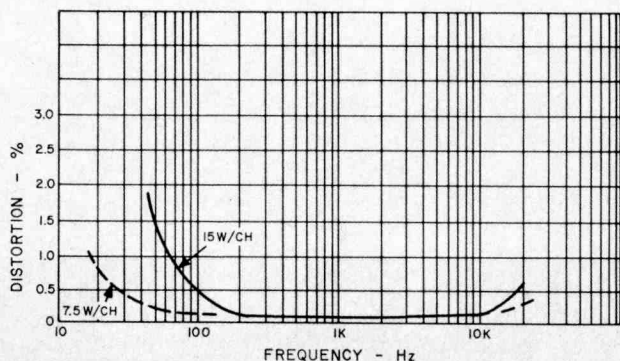

Fig. 7—Distortion vs. frequency.

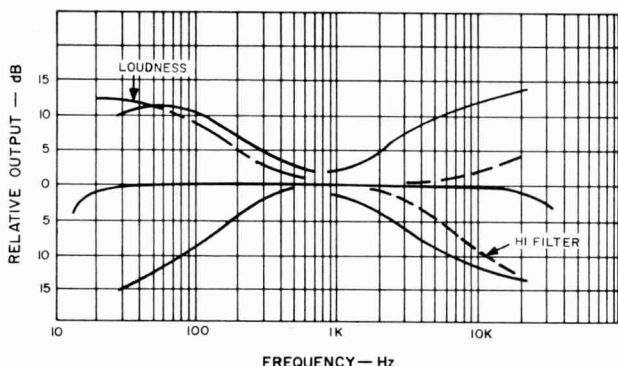

Fig. 8—Tone control range, filter and loudness characteristics.

Miscellaneous Measurements

Overall frequency response of the Fisher 4060 was 16 Hz to 28 kHz \pm 3 dB. Volume-control tracking (operating the twin controls clutched together) was accurate within 1 dB down to -50 dB from full clockwise setting. Phono hum measured -61 dB, referenced to 2.5 mV input, while phono overload did not occur until an input of well over 100 mV was applied. Fisher conservatively rates phono overload at only 45 mV—somewhat of an "injustice" to this important parameter, we think. Residual hum and noise in AUX position measured -75 dB, while amplifier residual noise and hum with volume set at minimum was down some 93 dB. Muting level on FM (which is non-adjustable by the user) is set for a threshold of 25 microvolts—a bit too high for our taste in view of the fine quieting characteristics of the receiver. With no filters inserted between the output of the receiver and our meters, residual 38 kHz output products were down 44 dB in stereo FM, a bit high for those tape recorders not equipped with "multiplex filter" circuits. While FM and AM calibration were "right on" across the dial scale, we found that the center-of-channel meter was slightly "off center" for minimum distortion tuning of FM. This minor flaw is, of course, easily corrected by a slight touch-up of detector alignment and is probably not typical of production units in general.

Listening Tests

Using medium- and high-efficiency speaker systems, the Fisher 4060 performed well both as a stereo receiver and in quadrasonic use. There was plenty of sound in our 14 x 18 ft. listening room, though at very high levels, when playing quadrasonic matrix records with primary programming information coming from all channels, it was possible to detect some distortion during particularly bass-heavy passages. While this is not the receiver for achieving 110 dB sound pressure levels in listening rooms, few home listeners would ever demand that kind of ear-splitting level. Separation and spatial effects attained while listening to some recent SQ-matrix releases were surprisingly good, when one considers the fact that no logic circuits are present in the decoder circuits. The recent emphasis in the literature on the need for very sophisticated and costly logic circuitry in reproducing matrix quadrasonic records may well be doing a disservice to the listening public, since from a musical point of view, a well-engineered and produced SQ record can provide all the "four-channel effect" many listeners demand—even in the absence of such extra circuitry, as evidenced by the performance of the Fisher 4060. Certainly, if you are interested in a versatile receiver that will do well in stereo or four-channel, performs more than adequately in FM and stereo FM, and is compact, good-looking, and moderately priced (considering its features), the Fisher 4060 represents one of the easier ways of "getting into four-channel sound."

Leonard Feldman

Check No. 81 on Reader Service Card

ADDENDUM

The following table was inadvertently omitted from the ESS amp and preamp equipment profile in the May issue. We regret this oversight.

Table 1—Phono Overload

Frequency	Output	Equivalent Input
20 Hz	6.7 V rms	9.03 mV rms
1 kHz	6.7 V rms	90.3 mV rms
10 kHz	6.7 V rms	437 mV rms
20 kHz	3.0 V rms	404 mV rms

**Sansui AU-9500
Integrated
Amplifier**

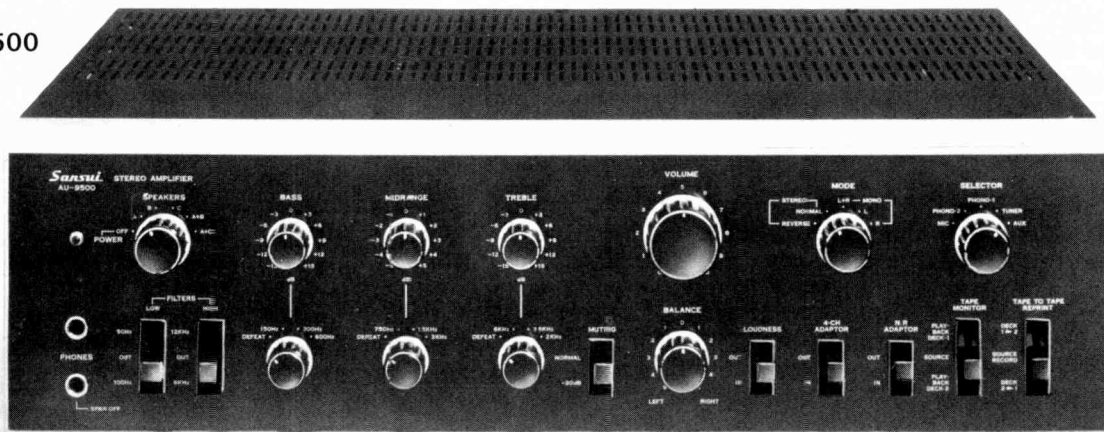

Manufacturer's Specifications

Power Output: 20 to 20,000 Hz; 75 + 75 watts (8 ohms); 115 watts (4 ohms). **Distortion:** Less than 0.1% THD and IM. **IHF Power Bandwidth:** 5 to 40,000 Hz. **Frequency Response:** 15 to 40,000 Hz +0, -1 dB. **Damping Factor:** 50. **Input Levels:** Phono, 2.5 mV; Mic, 2.5 mV; High Levels, 100 mV. **Impedances:** Phono 1, 50 k; Phono 2, 30 k, 50 k, and 100 k. **Hum & Noise:** Phono, better than 75 dB; Mic, 65 dB; Others, 85 dB. **Dimensions:** 19¾ in. W x 13¾ in. D x 5½ in. H. **Price:** \$519.95.

There are several good 100 plus 100 watt integrated amplifiers around, but offhand I cannot think of any with all the features of the Sansui AU-9500. Consider this: There are not only tone controls for bass, mid, and treble, but *each one* has a choice of three turnover frequencies! Then there are switched two-position filters for both high and low frequencies, a loudness control, two phono inputs, microphone jacks, and provision for tape dubbing from one machine to another.

There is a mute switch, another for the connection of a quadraphonic decoder, and yet another for a Dolby unit. Add to this a choice of three phono load resistors, preset input controls for AUX inputs, provision for using the pre-amplifier and amplifier separately, and facilities for three speaker systems, and you have some idea how versatile this super amplifier really is.

The front panel is black with satin trim and knobs to match—11 of them—plus eight lever switches. The first control on the left is the speaker switch which is combined with the ON/OFF switch. One can choose combinations of three speaker systems—A, B, or C, then A plus B or A plus C. Under this knob are the two filter switches and two head-phone jacks. Why two of the latter? Well, one mutes the speakers, one doesn't—I told you the 9500 is versatile! Next comes a group of six controls, the upper three being the tone controls and the lower three the turnover switches—more about those later. To the right is a large knob for

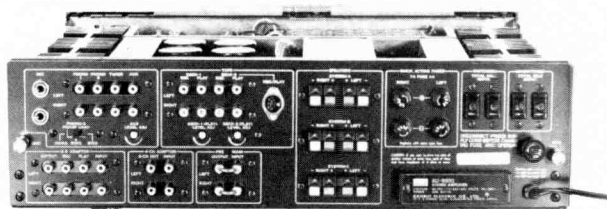

Fig. 1—Back panel.

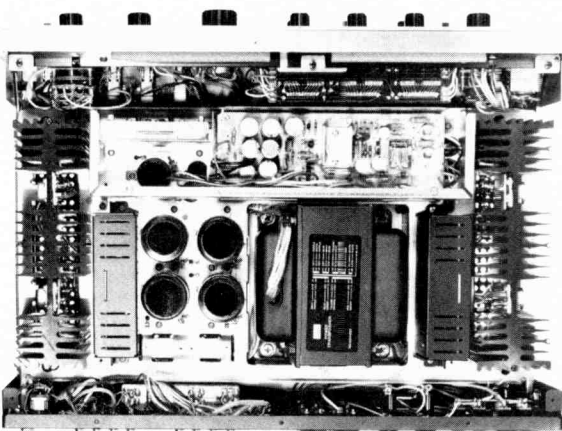

Fig. 2—View of the chassis.

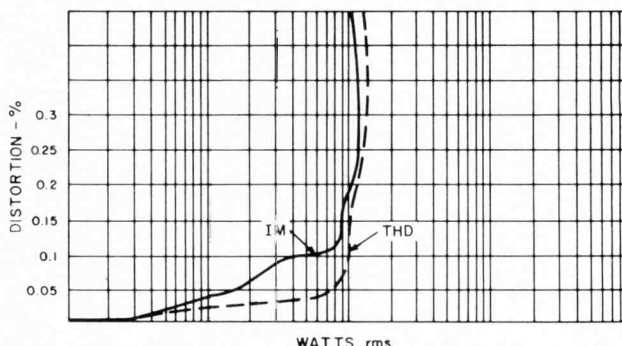

Fig. 3—Power output and distortion, both channels driven, 4-ohm loads.

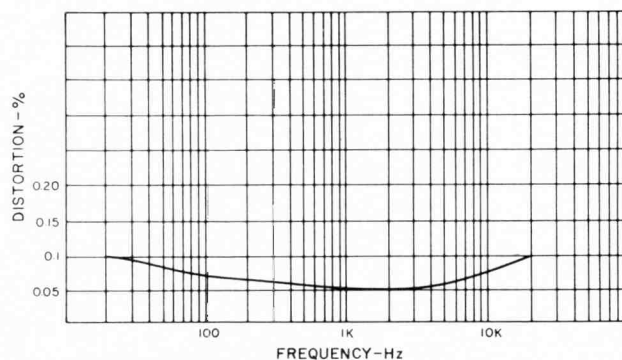

Fig. 4—Distortion versus frequency.

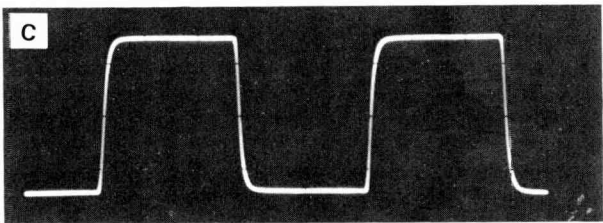
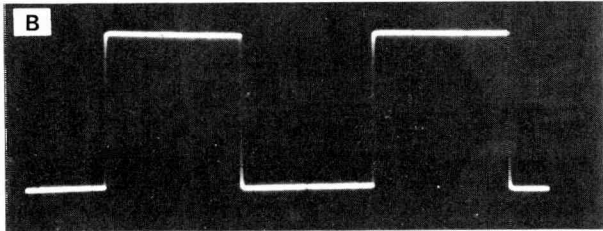
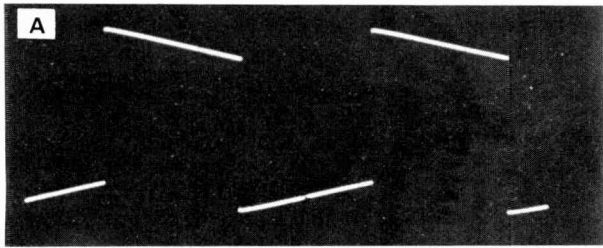

Fig. 5—Square wave resolution. A is 100 Hz, B is 1 kHz, and C is 10 kHz.

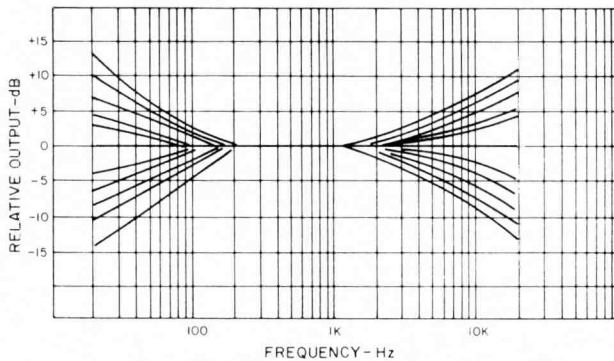

Fig. 6—Tone control characteristics, 150 Hz bass turnover 6 kHz treble turnover.

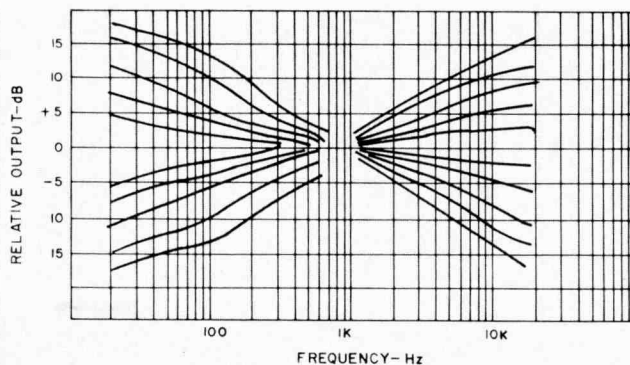

Fig. 7—Tone control characteristics, 600 Hz bass turnover and 2 kHz treble turnover.

volume, and underneath is the muting switch, followed by the balance control, then switches for loudness, four-channel adaptor, Dolby unit, tape monitor, and tape-to-tape. At the extreme upper right are the mode switch and input selector. At the rear is a formidable array of input sockets including microphone jacks, a DIN socket and preamp-amplifier link connectors. There are also preset level controls for AUX already mentioned, and two more for tape recorders. The speaker connectors are the spring-loaded clip type (much easier to use than screw terminals) and there are two switched a.c. power outlets and two unswitched. Five fuses are also to be found at the rear—one in the a.c. power supply and four in the d.c. circuits. (See Fig. 1.)

The massive power transformer can be seen in Fig. 2 and next to it are the four large (4700 μ F) capacitors. The output transistors are mounted in their heat sinks placed at the sides instead of the rear. Workmanship appears to be excellent and all the components are of high quality. Incidentally, the 9500 turns the scales at 52 lbs.—it's no lightweight so make sure that shelf will take the strain!

Circuit Details

The input stage is a PNP-NPN-PNP configuration with the usual equalization feedback loops for phono and microphone. High level inputs are taken to the next stage—an FET which is coupled to an amplifier stage and an emitter-follower. This feeds a two-transistor tone control stage which in turn is coupled to another two-transistor stage for the filter circuits. Output from the preamplifier is connected to a parallel transistor which acts as a "turn-on" surge limiter. The first stage of the main amplifier is a differential pair which is connected via pre-driver stages to Darlington pairs and the four-transistor complementary output stage.

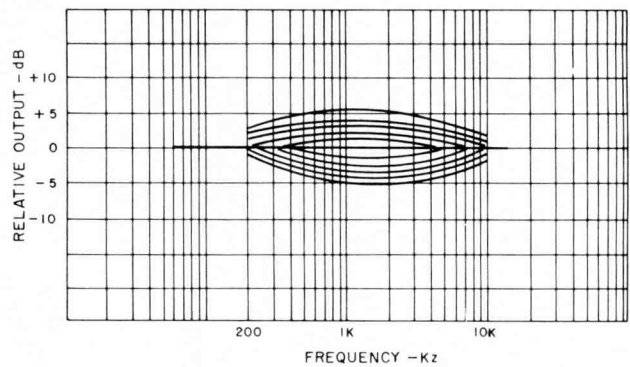

Fig. 8—Midrange control, 750 Hz turnover.

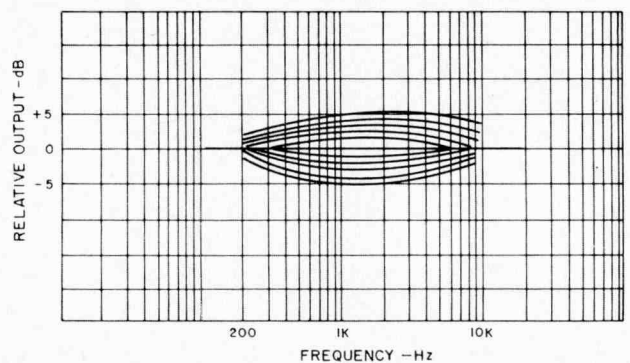

Fig. 9—Midrange control, 1.5 kHz turnover.

Two transistors are used for a standard current-sensing limiter circuit and two more are connected to a relay which switches off the speakers in the event of a short circuit or overload. The stabilized power supply for the preamp and driver stages uses no less than four transistors and the output stages are fed from separate bridge rectifiers. D.c. voltage is 49 plus 49. The grand total of transistors employed in the 9500 is 58—plus 42 diodes of one kind or another.

Measurements

Figure 3 shows the power output and distortion characteristics, using 4 ohm loads, both channels driven. Output at 0.1 per cent THD was 120 watts and with 8 ohm loads, the figure was 87 watts. Power bandwidth extended from below 10 Hz to over 50 kHz (3 dB points) and the distortion versus frequency curves can be seen in Fig. 4. Overall frequency response was -5 dB at 100 kHz and 5 Hz, with -1 dB points at 10 Hz and 40 kHz. As might be expected, square wave performance was very good indeed with little degradation at both high and low frequencies. Figure 5 shows the square wave resolution at 100 Hz, 1 kHz and 10 kHz. The tone controls—all three of them—employ step switches giving 5 plus and 5 minus positions and the turnover switches each give a choice of three frequencies. Figure 6 shows the characteristics with the turnover set to 150 for bass and 6 kHz for treble, while Fig. 7 shows the results with a bass turnover of 600 Hz and treble of 2 kHz. The other positions (not shown) offer turnovers of 300 Hz and 2.5 kHz. The midrange control has a choice of three turnover frequencies—750 Hz, 1.5 kHz and 3 kHz, as shown in Figs. 8, 9, and 10. It will be seen that the maximum lift and cut are each about 5 dB, or 10 dB total, which is more than adequate for most applications.

Now for the filter controls: Here we have a choice of two positions each—50 and 100 for the low frequency and 1.2 kHz and 6 kHz for the high frequency. All four are shown in Fig. 11. The loudness control characteristics at -10, -20, and -30 dB are given in Fig. 12.

At overload point, the clipping was symmetrical as shown in Fig. 13, which represents a power of 145 watts into 4 ohms. There was no sign of low level crossover distortion, and Fig. 14 shows a sine wave signal of 10 milliwatts. Hum and noise came out at a creditable 70 dB for phono (see Fig. 15) and 80 dB for high level inputs. High level sensitivity was 110 mV and phono, 2.6 mV. Dynamic range on the latter input was one of the highest we have found—overload point was not reached until the input signal was increased to a whopping 280 mV! In other words, the phono input stage can handle more than *four times the signal* it is

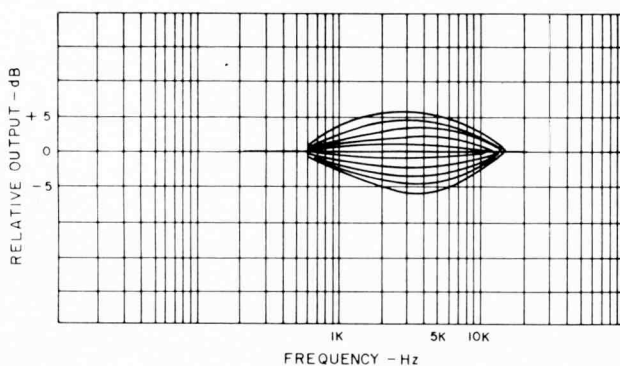

Fig. 10—Midrange control, 3 kHz turnover.

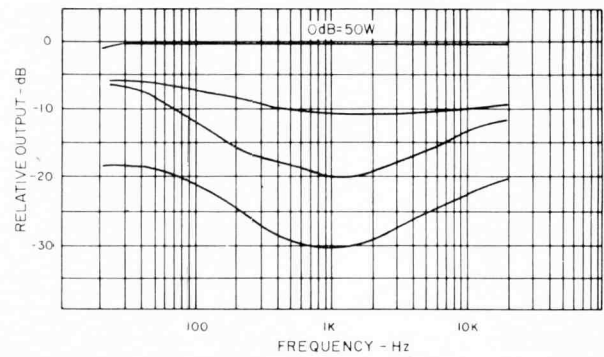

Fig. 11—High and low pass filters.

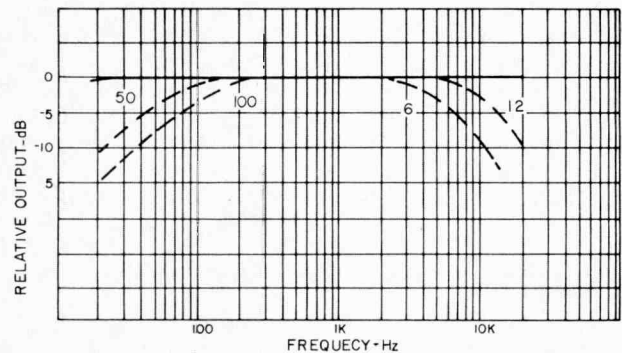

Fig. 12—Loudness control characteristics.

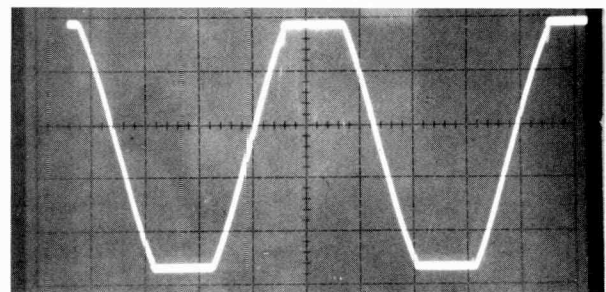

Fig. 13—Showing symmetrical clipping. Power is 145 watts.

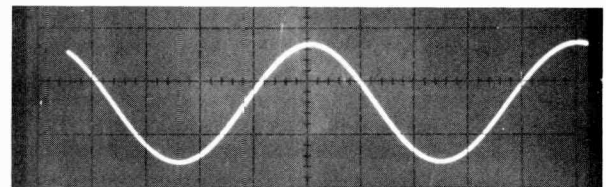

Fig. 14—1 kHz sine wave at 10 milliwatts

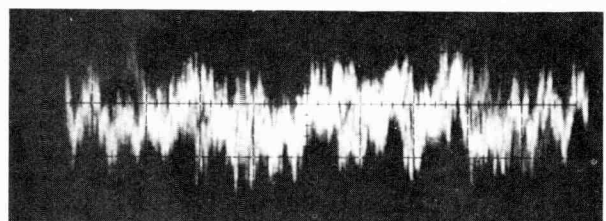

Fig. 15—Hum and noise (phono) 70 dB.

ever likely to get. (Many of the early transistor amplifiers could only handle signals of about 30 to 50 mV, which meant that there was some peak clipping and distortion when used with high or even moderate output phono cartridges.)

Listening Tests

Most of the listening tests were carried out with the lab standard speaker systems (dynamic-electrostatic combination) and AR LSTs. The program sources included records played via a Shure V-15 Mk III and a Thorens TD-125AB, tapes from an AKAI 4000DS open-reel recorder, and FM using a Dyna AF-6—now being tested. A cassette unit (Wollensak 4780) was also used for a period, mainly to transfer some tapes.

Using the aforesaid speaker systems, there was no particular need to switch in the tone controls, except for two or three recent recordings which I found to be "bass heavy" and here the 150 Hz turnover was just right to give the necessary correction—at least to my ears. I *did* connect up a pair of Hegemann systems which sounded a little distant due to a slight dip in the upper midrange, so I set the mid-range control at 3 kHz with the lift control at position three and the difference in sound had to be heard to be believed! I found the 12 kHz filter position useful for dealing with some distortion present on some FM transmissions and the 6 kHz filter had its uses too. The ordinary tone control just cannot reduce tape hiss and other high frequency distortion without removing a good deal of the music in the process!

That 150 Hz bass turnover would be effective for equalizing the response of small bookshelf speaker systems without producing that "chesty" speech coloration caused by tone controls operating from the 1 kHz region. You might ask, will anyone use a small bookshelf system with such a luxury amplifier as the 9500? The answer is yes, if space is restricted, and in any case, even large speaker systems might be happier with a little bass lift on occasion. The only effective way of doing this is with an equalizer or a tone control system like the 9500's. With such an array of tone controls and filters, all kinds of things are possible—correction for program deficiencies, equalization for old tapes and records, the generation of special effects with electronic musical instruments and so on. The tape enthusiast will find the other features like tape-to-tape dubbing switch useful too, so will those who want to use a Dolby unit and/or a quadraphonic decoder. The 9500 is not only recommended for its versatility—it has other virtues. Like the almost immeasurable distortion, clean power output up to 100 watts and more, plus excellent signal-to-noise and wide bandwidth. What else could you want in an amplifier? If the answer is more power, then you would have to buy separate units (a preamplifier and a power amplifier). But for many people, 100 plus 100 watts (times two for four-channel) is more than adequate—unless the loudspeakers are very inefficient or the listening room is exceptionally large. *George W. Tillett*

Check No. 57 on Reader Service Card

Hitachi TRQ-2040 Cassette Recorder

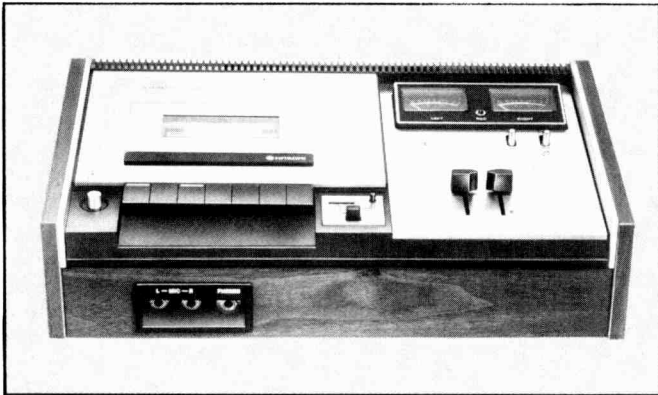

MANUFACTURER'S SPECIFICATIONS

Frequency Response: 40 to 12,000 Hz with regular tape; 40 to 16,000 Hz with CrO₂. **Wow and Flutter:** 0.25%. **Signal to Noise:** Better than 53 dB. **Output Level:** 0.775 volts, variable. **Output Impedance:** 100 ohms. **Headphone:** 8 ohms. **Dimensions:** 16 in. W by 10¼ in D by 3¾ in. H. **Weight:** 10.3 lbs. **Price:** \$199.95.

Hitachi is one of the largest Japanese electronic companies and they make all kinds of things from cathode ray tubes to ICs and high power radio stations to tape recorders and other high fidelity products—not forgetting Maxell tape! The cassette recorder reviewed here is a typical Dolbyized unit with provision for CrO₂ tapes, slide controls, memory rewind and so on. It uses 11 transistors and eight ICs—Hitachi, of course. Looking at the top panel, the seven piano keys on the left are for EJECT, REWIND, FAST FORWARD, RECORD, PLAYBACK, STOP, and PAUSE. The fast forward and rewind keys are latched so they lock into place if pressed to the limit. Next to these controls are the digital counter and memory switch and to the right are the two slide controls for record levels. At the

top right are the VU meters, mounted on an inclined panel, and just in front is the Dolby switch and tape selector which is labelled CrO₂ and NORMAL. The power on-off switch, a push button type, is on the extreme left and the microphone and headphone sockets are located in a recess at the front. Input and output sockets are at the rear with a pre-set ganged level control. A DIN socket is also to be found at the rear. One novel feature which could well be copied by other manufacturers is the removable head cover. It cannot be emphasized too strongly that heads in cassette recorders must be kept absolutely clean for best performance.

The motor is a 4-pole hysteresis synchronous type fitted with a heavy flywheel and the transport mechanism is automatically returned to the stop position at the end of a cassette. The tape head is made of ferrite.

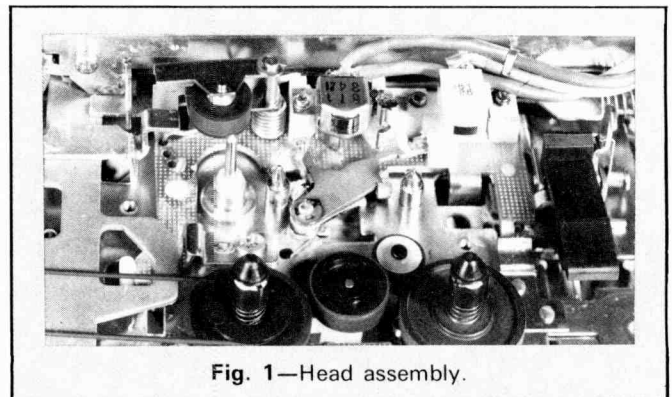
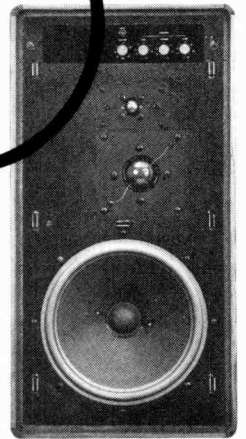

Fig. 1—Head assembly.

INVISIBLE SOUND



For the first time in your life, you can hear music precisely as it was recorded. Down to the last incredible detail.

Until now, the very best high fidelity loudspeakers have been described as transparent. Now, innovative design and precision engineering have made it possible to take a giant step beyond transparency—to the Invisible Sound of Braun speakers.

Music passes through Braun speakers with such natural clarity the speakers seem to disappear. Only the music is real. Once you experience the Invisible Sound of Braun speakers—the ear-opening sound of live music in your living room—you'll never be satisfied with conventional speakers again.

We'll be happy to explain to you how and why Braun, and only Braun, is able to achieve Invisible Sound. We'll also describe our complete line of speakers in detail, and send you the names of the selected group of Braun dealers in your city. Write: Braun Loudspeakers, 377 Putnam Avenue, Cambridge, Massachusetts 02139. Phone: 617/492-0970.

THE

SOUND OF **BRAUN**

Check No. 16 on Reader Service Card

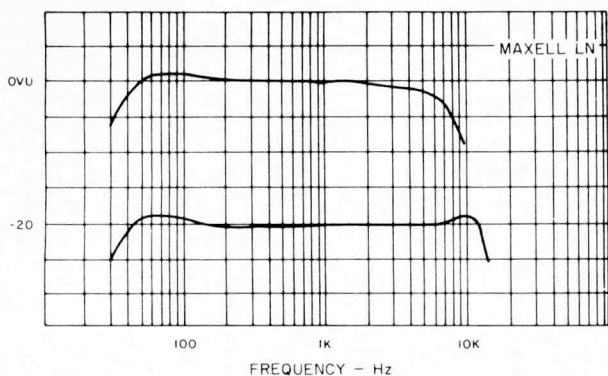

Fig. 2—Record-replay response with Maxell LN.

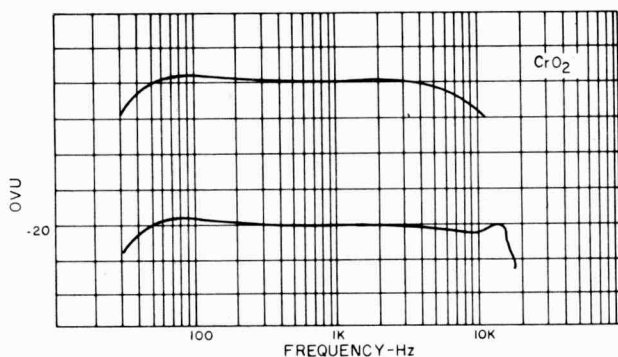

Fig. 3—Record-replay response with CrO₂ tape.

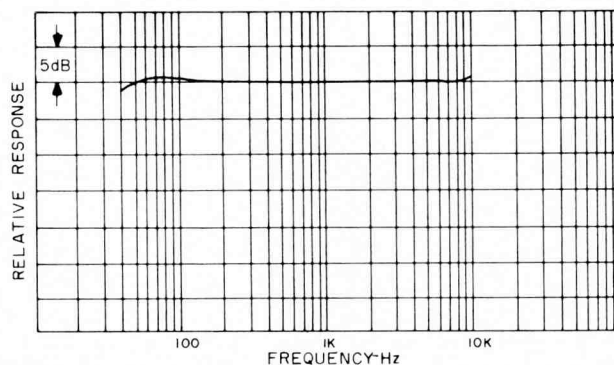

Fig. 4—Playback response with standard test tape.

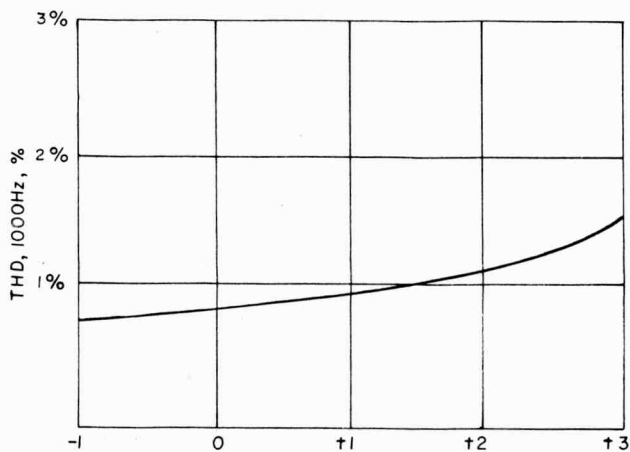

Fig. 5—Distortion at 1 kHz.

Measurements

Figure 2 shows the record-replay response with Maxell LN tape. The 3 dB point is at 12.7 kHz. Maxell UD gave a somewhat wider response extending the 3 dB point to nearly 14 kHz at the expense of a rise of 2.5 dB at 10 kHz, 3 dB at 12 kHz falling to 0 dB at 13 kHz. Flattest response of all tapes tested on this machine (on the NORMAL tape setting) was Capitol 2 which was within 0.5 dB from 1 kHz to 11 kHz with a 3 dB point at 12.5 kHz. Several CrO₂ tapes were tested, including Advent, Norelco and TDK KROM—all of which came out pretty much the same as shown in Fig. 3. It will be seen that there is a bigger margin between CrO₂ tapes and low-noise tapes on this machine than with some other recorders—probably because of the parameters adopted for normal tapes.

Figure 4 shows the playback response from a standard test tape and the distortion characteristics can be seen from Figs. 5 and 6. Distortion at 0 VU, 1 kHz was less than 1 per cent, increasing below 100 Hz although it fell sharply at -3 VU. Signal-to-noise came out at 51 dB ref. 0 VU increasing to 57 dB with Dolby switched in. If the figures are related to 3 per cent, they would be 55 dB and 61 dB respectively. The Dolby characteristics were checked and showed no significant variation in frequency response—less than 1 dB in fact. Input voltage for 0 VU was 64 millivolts line and 0.22 millivolts for microphone. Output voltage under these conditions checked out at 0.78 volts. Wow and flutter was 0.21 per cent (record-replay) which is excellent for a recorder not using an elaborate servo-controlled system, but the type of motor used is notable for good regulation. Tape rewind time clocked in at 67 seconds for C-60 and tape speed was less than 1 per cent slow.

Listening Tests

The TRQ-2040 proved to be a very easy recorder to use. The piano keys all worked smoothly without undue pressure and were nice and positive. The pause control functioned with just a slight touch and it would lock into position by pressing a little harder—a nice touch (if I can be forgiven for the obvious pun). It was possible to use the playback and rewind keys for inching, that is moving the tape a short distance back and forth to find a particular spot. And then there is the memory rewind feature that permits the tape to be returned to a predetermined position—a gadget that I find handy at times. Several tapes were made, mostly from records transferred via a Shure V-15/III and a Thorens 125, and, as might be expected, the CrO₂ tapes were superior. No, there was not a *great* difference, especially when the Dolby system was switched in, but it could be heard.

Summing up, the 2040 impressed me as being a well-made machine with a good all around performance and above average reliability.

G.W.T.

Check No. 56 on Reader Service Card

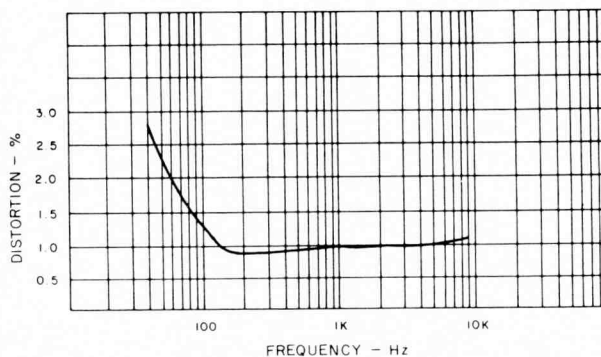
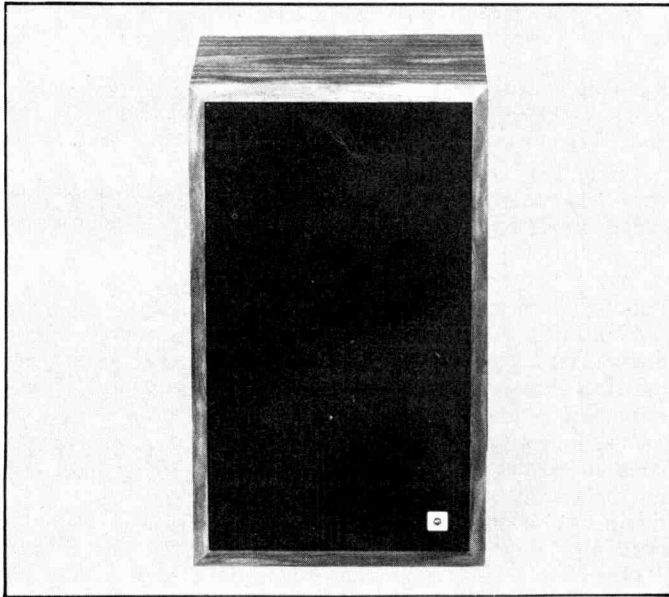

Fig. 6—Distortion versus frequency.

Applied Physics Laboratory APL-101 Speaker System



MANUFACTURER'S SPECIFICATIONS

System Type: Acoustic Suspension. **Drivers:** One 10-in. woofer with 1½-in. voice coil and 2-lb. magnet structure; one 1½-in. Mylar dome tweeter with 1-lb. Alnico magnet structure. **Crossover:** RLC network; tweeter level control has 6 dB range. **Nominal Impedance:** 8 ohms. **Dimensions:** 15 in. W x 10 in. D x 25 in. H. **Weight:** 40 lbs. **Price:** \$122.00.

One of the newest additions to the speaker line of the Knoxville, Tenn., based Applied Physics Laboratory is the APL-101. While the modest size of this speaker allows ready use as a bookshelf unit, the enclosure is quite sturdily built and weighs in at a healthy 40 lbs. A 10-in., high-compliance woofer, which is acoustically loaded by the sealed enclosure, handles the low bass frequencies and the midband up to around 1 kHz. The upper midrange and high frequencies are reproduced by a 1½-in. hemispherical dome tweeter.

The cabinet is finished on four sides with a wood-grain vinyl, and the rear of the cabinet is stained a matching color. The cloth grille is attached to a solid frame, and the whole assembly then closely fits into the front shadow frame in such a way as to obviate the need for fastening devices.

Connection of hookup wiring to the speaker is made through a terminal strip contained in a recessed cavity on the rear of the cabinet. This is a screw-terminal type of mounting which will take either spade lugs or bare wire. The screw terminals are rather close together, and no mechanical barrier is provided between the exposed metal of the terminals. If stranded wire is used for hookup, care should be exercised to prevent an amplifier-damaging short circuit.

The speaker terminals are not identified with polarity marks, and on the units tested by AUDIO, the rightmost terminal, adjacent to the tweeter level control, is the positive terminal. While polarity can easily be determined, the inclusion of this information would be helpful to those who wish to use the APL-101 as a quadraphonic add-on speaker set, although this is not of as great a consequence if these are the only speakers in the system.

The tweeter level control is a three-position switch with adjustments made by rotating a fluted plastic shaft. The letters "H, M, and L" above the shaft signify high, medium, and low tweeter levels, and a counterclockwise shaft rotation increases tweeter level. The plastic shaft extends beyond the plane of the cabinet so that a vigorous push against a hard wall while

mounting or cleaning could result in a broken shaft. This reviewer hopes that Applied Physics Laboratory will choose to improve the engineering of the rear panel control and connection strip so as to minimize problems of setup for the hasty or inexperienced user.

There were no instructions or recommendations included with the APL-101's which could assist a non-technical buyer in setup or give information about precautions to be observed. Again, this reviewer feels that such information about appropriate hookup configuration is worthwhile in that it provides assistance to enhance ultimate music enjoyment, as well as warning the user against possible abuses which might void the warranty.

The APL-101 is provided with an unconditional five-year warranty against defects in either materials or workmanship. In addition, these speakers carry a most unusual lifetime warranty to the original owner, which goes into effect when the warranty card is returned to the factory.

Technical Measurements

The impedance as a function of frequency for each of the three tweeter level positions is shown in Fig. 1. The low frequency peak occurs at 55 Hz with the higher frequency peak, due to the tweeter, at 1 kHz. The minimum impedance of 5 ohms occurs at slightly over 100 Hz. As a consequence of its relatively low impedance, this speaker should not be paralleled for drive from most amplifiers, such as might be done for adding a speaker in a remote location.

Figure 2 shows the one-meter anechoic response for amplitude with a drive equivalent to one watt into an 8-ohm load.

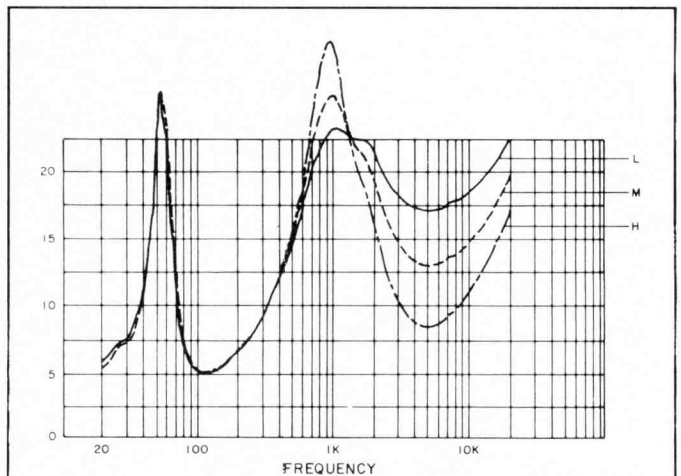

Fig. 1—Impedance versus frequency.

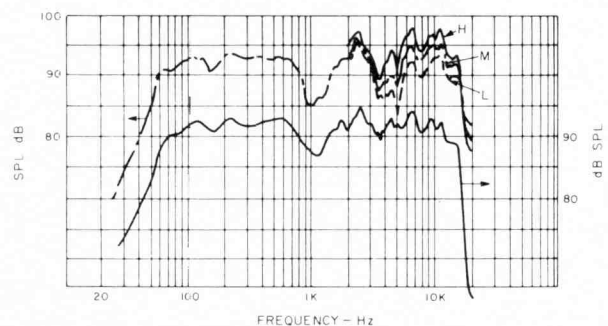

Fig. 2—One-meter anechoic amplitude response for one-watt input and two microphone positions.

Two sets of curves are shown. The upper curves, with one-watt drive SPL readings on the left scale, refer to a measurement made exactly on the geometric center line of the enclosure. This is our standard physical configuration, and the measurement is made for the three positions of the tweeter control.

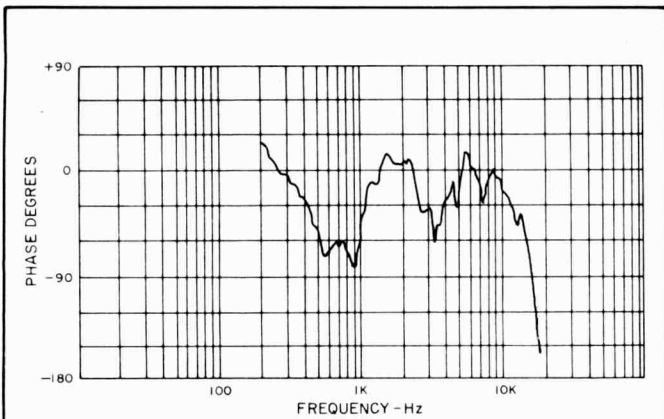

Fig. 3—One-meter phase response.

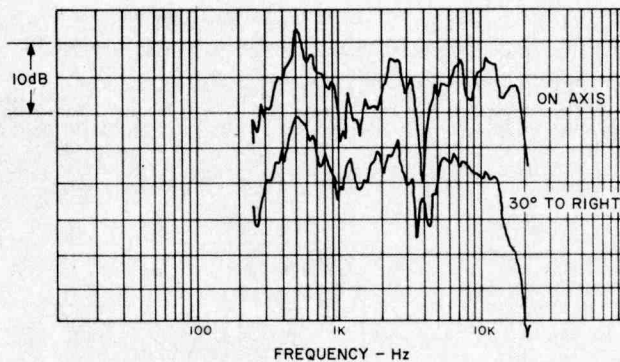

Fig. 4—Three-meter room response.

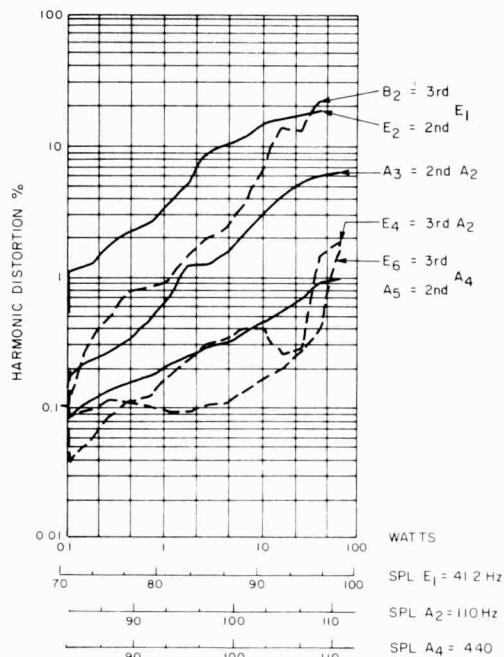

Fig. 5—Harmonic distortion for the musical tones E_1 (41 Hz), A_2 (110 Hz), and A_4 (440 Hz).

The effect of the tweeter control amounts to approximately 2 dB response difference above 3 kHz.

In many cases, a much smoother anechoic response can occur for selected positions of the geometric axis, and the lower curve, with SPL readings on the right, shows such a case for the APL-101. In this case the microphone was moved five inches so as to lie one meter directly in front of the woofer. This curve was taken with the tweeter control in its medium position. In all cases, the APL-101 ranks as a relatively efficient speaker when compared with most other speakers in its price range, and good sound level can be expected from a 25-watt amplifier.

Figure 3 is the one-meter phase frequency response corresponding to the geometric center amplitude response marked "M" in Fig. 2. Both the woofer and tweeter are in phase, which means that a positive-going voltage produces a corresponding pressure increase at the microphone. The response is non-minimum phase above 10 kHz for this measurement. The hemispherical dome tweeter has the unusual property of a constant 90 degree phase lag at close measurement. As the microphone is moved back from the tweeter, the phase lag diminishes. As can be seen, there is still a residual lag on the order of 15 degrees even at one meter. The phase break below 1 kHz indicates the approximate acoustic crossover between tweeter and woofer.

Figure 4 shows the amplitude response due to the first 10 milliseconds of sound arrival in a room. The APL-101 was mounted flat against a wall with its geometric center one meter above a carpeted floor. The microphone was three meters away and one meter above the floor, simulating an average listening position. The response was measured directly in front of the speaker and in a 30-degree off-axis position corresponding to a left channel stereo position. The medium tweeter control level was used for both measurements, and the curves are displaced 10 dB for clarity of presentation. This measurement indicates a speaker sound that is suppressed in the portion of the midrange spectrum normally considered the "presence" range and with substantial reinforcement of the octave between A_4 (440 Hz) and A_5 (880 Hz). The off-axis effect is indicated as slightly down in the highs with an average drop-off of about 1 dB per octave.

Figure 5 is the measured harmonic distortion for the musical tones E_1 (41 Hz), A_2 (110 Hz), and A_4 (440 Hz). The relatively rapid increase of low bass distortion above an SPL of 90 dB suggests that the use of bass boost in a preamplifier should be discouraged when reproducing material with substantial bass demand, such as pedal notes on the organ. The tweeter was measured at 2 kHz and found to be quite clean, with second harmonic distortion rising smoothly from a low of 0.1 per cent at 0.1 watt to a value of one per cent at 10 watts. The 2 kHz third harmonic stayed well below 0.2 per cent throughout this power range.

Figure 6 is the measured intermodulation of A_4 (440 Hz) by E_1 (41 Hz) when mixed in equal ratio. This intermodulation was mostly phase modulation with a small amount of amplitude modulation. During both the harmonic and intermodulation tests, it was noticed that the transducer gain, which is the ratio of output acoustic level to electrical drive level, decreased with increase in drive. At the 10-watt IM level, for example, the acoustic response at 440 Hz dropped 0.5 dB. Suppression increased to 1.5 dB at the highest level of this test. This was reproducible, and the effect is similar to dynamic compression, which might account for an observation made during the listening test.

This effect was also evident in the crescendo handling test, in which white noise, band limited to 20 kHz, is mixed at an average power level 20 dB above that of a pure tone. The total power level at which the tone is reduced 1 dB in

level when the noise is added, is the limit we set for the ability of a speaker to handle random crescendos without affecting inner musical voices. The APL-101 suppressed 440 Hz by 1 dB with a peak speaker noise voltage of 25 volts. For an 8-ohm system, this translates to an 8-watt average noise level and a peak input just below 80 watts. This suppression occurs only with the woofer, since a 2-kHz tone showed no suppression even up to much higher levels. The technical conclusion of this measurement is that program material below 1 kHz will be partially dynamically compressed by the total energy in that range.

Figure 7 is the measured polar energy response for all components in the 20 Hz to 20 kHz frequency range. Some beaming is evident, and this reviewer recommends turning the speaker in toward the listening position for better stereo separation.

Figure 8 is the measured time response one meter on axis. This measurement is the time equivalent of the on-axis frequency response of Figs. 2 and 3 and shows the time spread for the transient signal having the perfect 20 Hz to 20 kHz frequency spectrum used to generate Fig. 2. The equivalent positions of the front and rear of the cabinet are shown for comparison on this plot. The multiplicity of regularly spaced peaks following the initial sound arrival is similar to those to be expected from diffractive scatter from structures closely associated with the tweeter. The net energy remains 20 dB below the peak after one-half millisecond, so the sonic effect is probably not as prominent as this plot indicates.

Listening Test

For the listening test, the APL-101's were placed slightly over three meters apart as flat against a wall as possible and with the center of the enclosure one meter above the floor. Both horizontal and vertical mounting positions were tried. Since the vertical mounting position gave the better stereo image, this was the position chosen for the majority of the listening.

The lowest registers are robust without sign of any resonance or hangover down to 50 Hz, as determined from listening to the **Sessions** test record made for use in such tests. On dynamic program material, the general impression this reviewer had was that of a mild midbass bump in response with the very high frequencies down a bit in level. In addition, it was this reviewer's opinion that the midrange lacked the strong punch demanded by contemporary music.

Even though the very lowest bass is down in level, classic organ sounds reasonably balanced without need for conventional equalization. Choral selections could be brought up to a respectable realistic spectral balance by treble boost, but too much boost led to a "spitty" top end. Orchestral brass could not be equalized to this reviewer's satisfaction by conventional tone control equalization, and vocal and piano material was similarly suppressed in the midrange.

Basic stereo imagery was well balanced though dependent upon seating position when the angle of speaker separation was greater than about 60 degrees.

The listening test, conducted prior to technical measurements, disclosed an unusual sonic effect, jotted down in notes as an "impression of dynamic compression," and which was obvious only when rapid comparisons were made between the APL101's and a test speaker playing the same material. The observation was made regarding the reproduction of material including Carly Simon's **No Secrets**, Elektra EQ-5049. To put this effect in perspective, the sound levels used for this test were definitely well above normal apartment listening levels, but within the speaker's safe-operating area.

The APL-101 can be recommended as a primary speaker system in an apartment or other situation where a much larger system would be inappropriate and the music is not intended to be the ear-blasting variety. These speakers can in addition be recommended as a good four-channel add-on to augment existing good-quality primary speaker systems.

Richard C. Heyser.

Check No. 55 on Reader Service Card

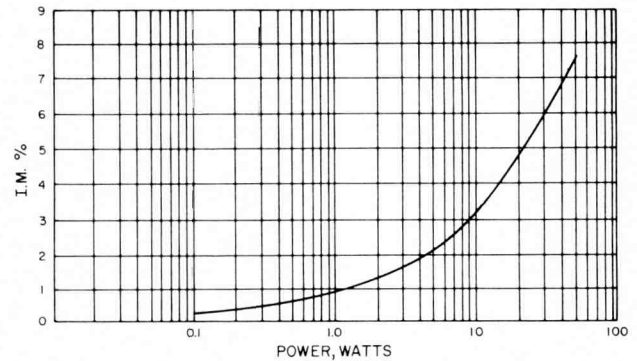

Fig. 6—Intermodulation of A_4 (440 Hz) by E_1 (41 Hz) mixed 1:1.

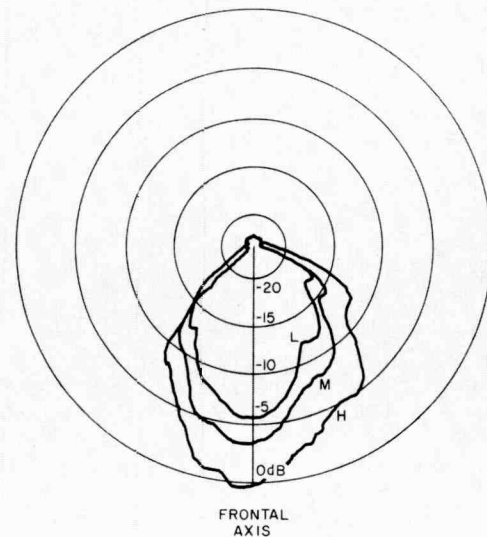

Fig. 7—Polar response.

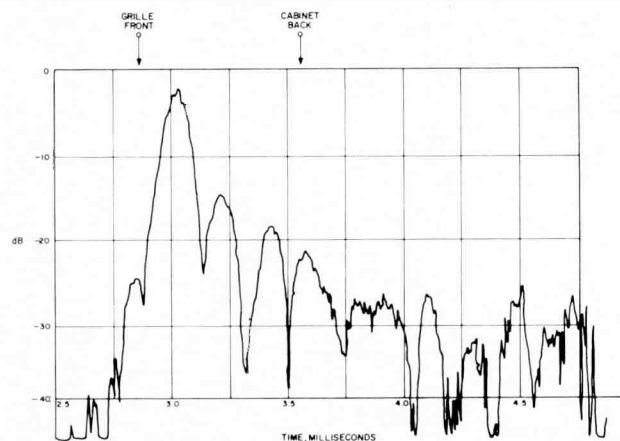

Fig. 8—Energy-time response one meter on axis.

Classical Reviews

Edward Tatnall Canby

Richard Strauss. (*Till Eulenspiegel; Salome's Dance; Jap. Festival Music; Rosenkavalier waltzes.*) Assorted orchs., Strauss (1931, 39, 41). **First Editions FER-1**, mono. (200 West 57th St., NYC 10019.)

Wilhelm Furtwangler. (Wagner and Mendelssohn). Berlin Philharmonic (rec. 1929, 30, 33). **First Editions FER-2**, mono.

Paul Hindemith. (*Concert Mus. for Piano, Harp and Brass; Ov. Cupid and Psyche; Concerto for Orch.*) Berlin Philh., Hindemith (rec. 1957). **First Editions FER-3**, mono.

I once watched Strauss conduct Mozart in the 1930s—was bored. Right! A curiously martinet-like approach, chilly, if competent, fast and professionally impatient. Not very good models for history but fascinating even so. Japanese music, Tokyo 1940 as Nazis wooed Japan, is big Straussian rehash, not very good Axis propaganda! Rest here is familiar. Clean 78 recordings, but distant and colorless, the mic style of the day.

Another story—a superb conductor revealed, ultra-meticulous yet flexible, with astonishing sense for dramatic shaping and climax already in his early years. Three standard Wagner items, two Mendelssohn—the finest *Hebrides Overture* (Fingal's Cave) I've ever heard, bar anybody. Typical early 30s 78 sound, distant, metal-edge (use heavy filter, as was intended), end-of-side deteriorations—and too much wow. LP wow as well as 78; check your copy for out-of-round arm sway. Even so, worth every minute and easily enjoyable.

The audio sleeper of 1957—one of the finest recordings I've ever heard, such ambience you'd swear it's stereo. Late-mono tape original. Three potent works, two from the 20s, surprisingly Bartokian, all drive and color, one from Philadelphia 1943, much the same. Hindemith conducts his music ideally; these are true models—taut, exciting playing (he had returned to Germany after years of Nazi-WW II exile). Don't miss this one.

Note: A new license operation here, via D-G, German masters spanning mono electric period, before, during and after the Nazi-WW II years—whether these were lost or merely "forgotten" is not exactly clear. No matter; all are new to the U.S. and valuable both as documents and entertainment. E.T.C.

Toots and Suites

The Intimate P.D.Q. Bach. Featuring Prof. Peter Schickele and the Semi-pro Musica Antiqua. **Vanguard VSQ 40016**, SQ quadraphonic, \$6.98 (also in stereo).

By sheer accumulation, many of us have come to know a zany musical comedian who masquerades under the above name, a "rediscovered" Bach whose character in recent years has multiplied alarmingly to encompass everybody who is anybody in the classical world. P.D.Q., properly known as Peter Schickele, has three unusual talents. First, of course, is his sheer persistence. Where Flanders & Schwann put forth a couple of meek LPs and Laurel & Hardy an infinite no. of you-know-whats, this man gets out a whole new show each year, live, staged, visible and audible, each of which is promptly turned into LP. And each is a compendium of musical outrage such as you can scarcely believe, going on and on, replete with idea after idea, each more preposterous than the last.

Persistence, yes, but also the most dreadful ear for the pun that any student of the quirks of the human mind could

ever hope to discover. Talk about Shakespeare! P.D.Q. is the musical Dr. Spooner as well, and he can match the Bard p. for p., straight out. The man can't utter three words without two of them punning.

But it's the third talent that adds up. This P.D.Q. Schickele, or maybe Peter Q. Bach, is a supremely frustrated composer out of the 18th and 19th centuries, born much, much too late. His little musical imitations could easily be no more than the sort we usually hear in skits, or the worst of Anna Russell, or the famed Hoffnung series of parodies from Britain (the best were very good). People would laugh just as hard and success would be as great, for the Schickele puns, the Schickele stage grotesqueries, the superbly silly instruments he digs up or invents, are a show all of themselves and could carry any series of theatre/disc presentations, even unto full SQ quadraphonic.

Instead, these musical oddities are sometimes startlingly beautiful in an apologetic and modest fashion. The man has a real piece of musical genius, if grotesquely misaligned. He is a purist. He parodies only the best, whether

Beethoven, Bach, Mozart or a dozen more, and his product in its little way is often darned near as good as a fragment of the original. Not really as good . . . and yet—

Take the *O.K. Chorale*, from the *Toot Suite* (double pun) for calliope four hands, Schickele 212°, beginning of side 2. The calliope is actually a rather lovely little portable (portative) organ, all toots and suites, so to speak, and the music itself is a take-off of Bach's familiar organ chorale prelude *Wachet auf* (we used to call it "Wash it Off"), with inserts of a highly unexpected sort. A musical gem, hiding almost too much serious and pure expression behind its exterior humor. A *tour de force* of counterpoint, too, nicely underplayed.

Then there are the *Erotica Variations* (the Timely Pun, a P.D.Q. specialty) for banned instruments (ugh!) (pun!) and piano, introduced by the Prof. himself, deadpan, and played on an astonishing series of noise makers—slide whistle, giant pipes of pan (the windbreaker), a curious whirled lasso (lasso d'amore), kazoo, startlingly blatty foghorn and a genuine, on-pitch gargle. Listerine. All very amusing, and yet the

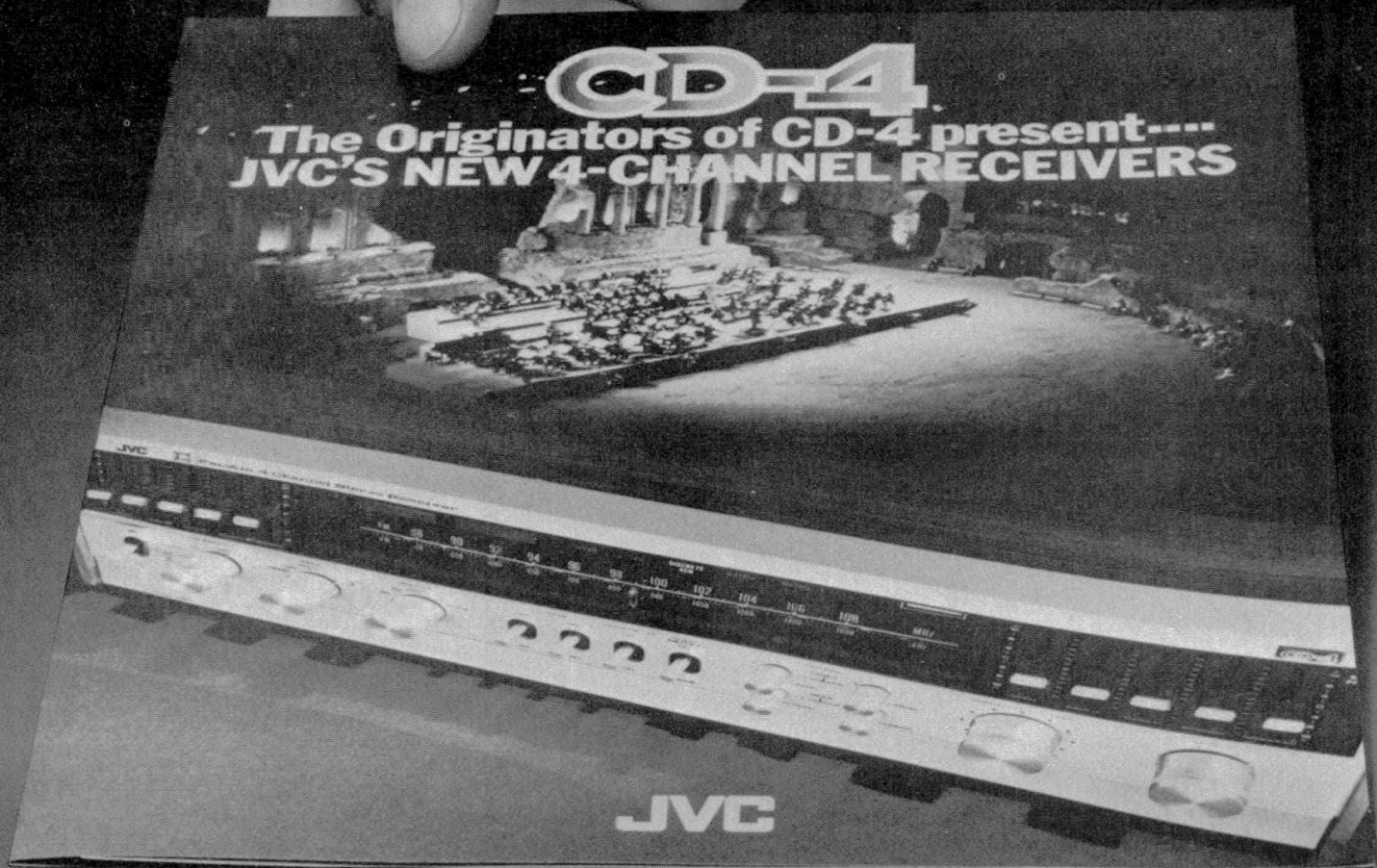

be discrete

Going quad — you'll want to know everything there is to know about 4-channel and our discrete 4-channel system, CD-4. For the ultimate in quad, JVC introduces 3 receivers designed for all of today's 4-channel sources . . . plus advanced engineering features for future 4-channel innovations, like discrete 4-channel broadcasting.

The new JVC receivers — 4VR-5436, 46 and 56 feature a built-in discrete CD-4 demodulator plus matrix decoder circuits with an automatic switching computer (4VR-5446 & 56) so you can play a mixed stack of CD-4 and matrix discs without making any adjustments. Each CD-4 receiver is equipped with JVC's patented Sound Effect Amplifiers that break the sonic spectrum into 5 bands so you exercise tonal control and complete freedom over sound in all crucial frequency ranges to compensate for room acoustics and individual tastes. Then there's JVC's Balanced Transformer Less Circuitry that links up the amps so that all four are used when playing 2-channel stereo for double the rms output power.

These are only a few of the many JVC innovations that reflect the ultimate in 4-channel engineering and performance. Get all the facts today. Write for your copy of this brochure. Use the handy coupon or visit your local JVC Hi-Fi Dealer. For his name and address, call this toll free number: 800-243-6000. In Conn., call 1-(800)-882-6500.

JVC
CD-4
 Compatible Discrete
 4-Channel Record System

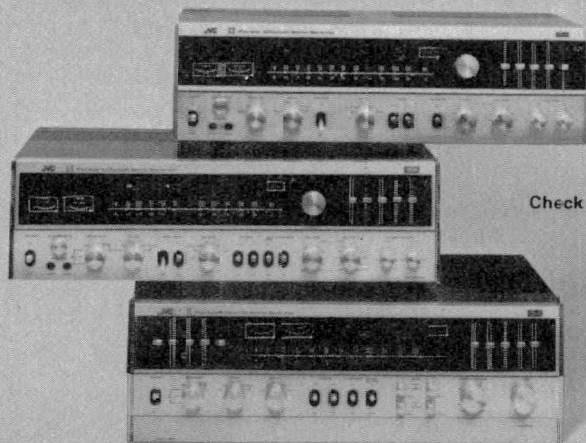

Check No. 46 on Reader Service Card

JVC America, Inc., 50-35 56th Road, Maspeth, New York 11378
 Please send me a FREE copy of the New JVC Brochure "The Originators of CD-4 present . . . JVC'S NEW 4-CHANNEL RECEIVERS".

Name _____ Age _____
 Address _____
 City _____ State _____ Zip _____
 Dealer _____

JVC
 Hi-Fi

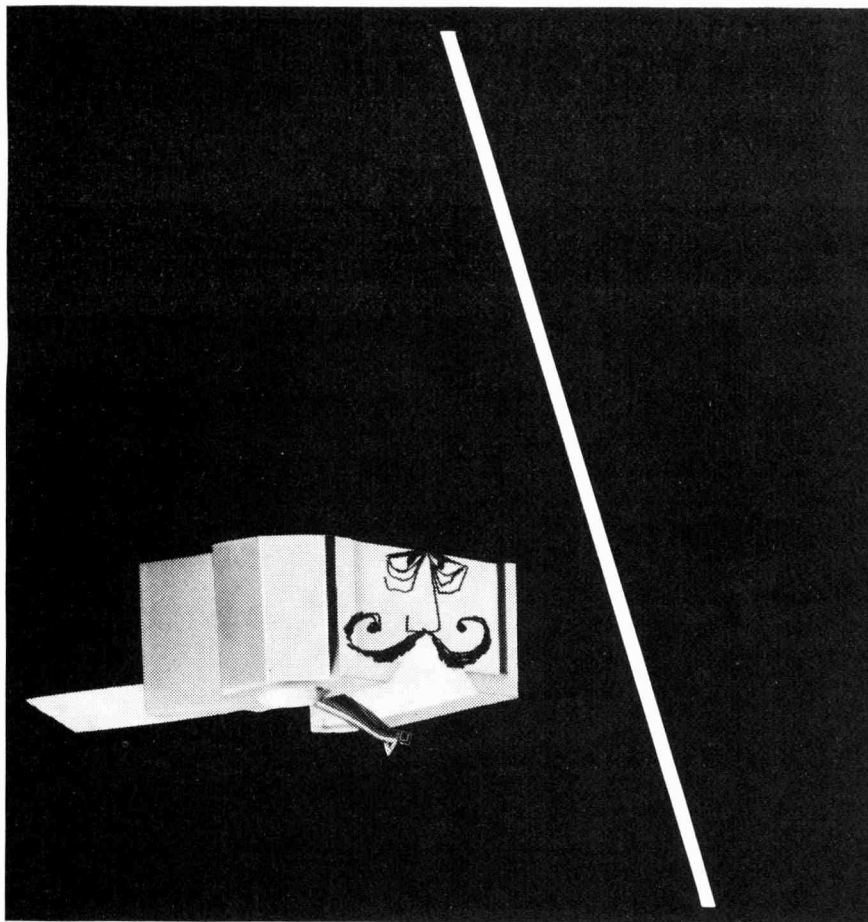

Wolves in cheaps clothing.

Design charlatans around the world have found a lucrative business in selling spurious replacement styli. And because Shure phono cartridges are asked for by more knowledgeable hi-fi enthusiasts than any other cartridges, our styli seem to be imitated more than any others. Now, flattery notwithstanding, Shure design engineers see red when they see these impostors, because they know that

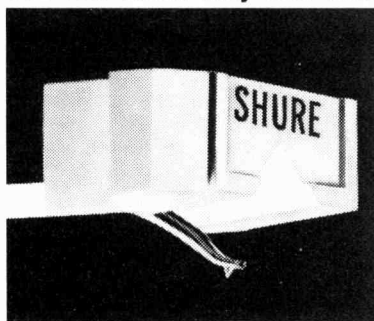

the performance of your Shure cartridge *absolutely* depends upon the *genuine* Shure stylus assembly — so to protect your investment and to insure the original performance of your Shure cartridge, insist on the real thing: Look for the name SHURE on the stylus grip (as shown in the photo, left) and the words, "This Stereo Dynetic[®] stylus is precision manufactured by Shure Brothers Inc." on the box.

Shure Brothers Inc.
222 Hartrey Ave., Evanston, Ill. 60204
In Canada: A. C. Simmonds & Sons Limited



Check No. 34 on Reader Service Card

music of Beethoven's *Eroica Variations* is so beautifully understood that there are moments which are quite breathtaking, and no pun intended at all.

Say no more of the lesser fare here, the *Art of the Ground Round* (triple pun), after 17th century British glees, catches—and rounds as well as grounds, both these being proper musical terms. And a not so esoteric opry, side 1, called *Hansel and Gretel and Tom and Alice*. The brief moments of real musical penetration are worth the whole shebang, which otherwise would be just one more musical comedy act. The P.D.Q. performance has able assistance (assistants) in the person of John Ferrante, billed as a bargain counter-tenor, and a persuasive young pianist, David Oei. Keep up with P.D.Q. et al!

Performance: A Sound: A-

Handel: Harpsichord Suites in D Minor, G Minor; Chaconne in G. Malcolm Hamilton. **Delos DEL 15322**, stereo, \$5.98.

D. Scarlatti: Sonatas, Vol. 1. Malcolm Hamilton, harps. **Delos DEL 15321**, stereo, \$5.98.

Malcolm Hamilton is a mature, forceful Canadian-born harpsichordist, the sound of his instrument as massive as the bulk of his own physique. His powerful playing and incisive rhythm remind me of the great Wanda Landowska, the lady who soon after the turn of the century was the first to revive the harpsichord as an acceptable modern concert instrument and the first to relearn its proper performing traditions. Those who know Landowska's late recordings will hear the resemblance. Even the recorded sound is like hers, monumental, impressive, too big for the actual instrument—this is the way we used to record harpsichord. Like Landowska, Hamilton is remarkable for his total command of those added ornaments that were supposed to fill out the somewhat bare written-down Handel music; his is prolific and falls astonishingly easily under his fingers. His "double-dotting," again like Landowska's, is masterful and a model for any keyboard artist who wants to play this period music as it must be played.

Maybe this aura of the thirties to fifties relates to Hamilton's study with two other European lady harpsichordists of the Landowska era, Isabelle Nef and Alice Ehlers. (Somewhere in my 78 collection I have Ehlers from the early 1930s.) Curious, and in considerable contrast to the sound of most young harpsichordists today, as is the recording technique itself. An unintended evocation of an era.

Back in the thirties, Landowska's remarkable harpsichord Scarlatti disc was the first most of us ever heard. Again curiously, Hamilton's Scarlatti disc includes a number of her favorites, notably the celebrated *Cortège* in E, colorful as hers nor as delicately Romantic but the incisive rhythms and strength of phrasing are there.

What manner of construction in the harpsichord—and what use of mics—could serve to produce this nostalgic replica of 1930s sound? The instrument itself isn't old; it dates from 1962. Perhaps a different mic placement would have made a lighter, more modern-type recording in the sound, less massive, as is the recording style today? In any case, the sound we have, whether via the instrument or the mics, is exactly suited to the Hamilton performance. It all adds up. A pair of discs well worth study, especially if you own other harpsichord recordings.

Performance: A— Sound: B

J.S. Bach: Partitas 1 & 2. Joao Carlos Martins, piano. **Connoisseur Society CS 2057**, stereo, \$5.98.

These keyboard suites, stylishly called *Partitas*, are familiar to every pianist and until our own day were virtually always heard on that instrument rather than the harpsichord. In all truth, they adapt beautifully to the modern piano (whereas the Handel harpsichord suites are generally too thin as written, and the necessary added ornament doesn't go well on the piano). All the famed Bach pianists played the *Partitas* ad infinitum, Harold Samuels, Myra Hess and on to those of our present era, when Bach on the piano begins to seem a bit odd to most ears.

This Brazilian is a natural Bach pianist who hears everything there is to hear in the music and brings it all out in a quite original style: He likes a very light staccato in the bass, for a lute-like effect, and he plays with virtually no pedal blur, as is musically right (but it's much easier if you use the pedal). His ear is perfect and his Bach is lovely.

The Baldwin S-10 here has a woody, twangy sound in its treble along with a very solid bass, and the recording is made in a big resonance, the conflicting background reverb tending to blur the clean harmonies and melodic lines. Piano Bach is one sound that is good in a dead surround. (This piano appears in other Connoisseur recordings with quite a different sound. Place? Mics?)

Performance: A Sound: B

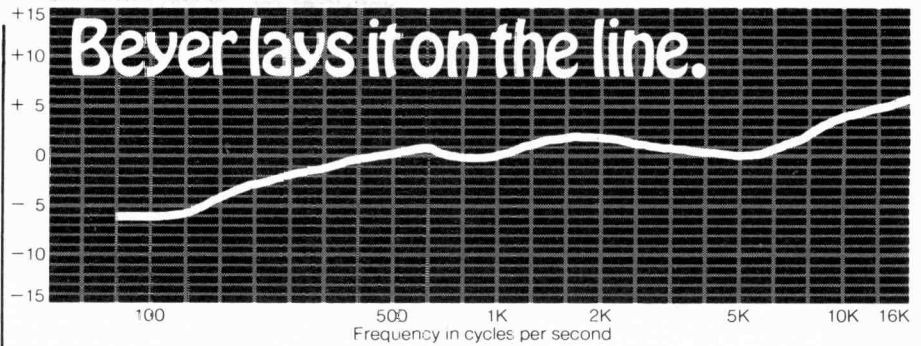

For the demanding professional, some mike manufacturers furnish a frequency print out as proof of performance.

Unfortunately, when it comes to low cost mikes for home use that practice is not only costly, but could prove embarrassing. Besides, you shouldn't expect a guarantee with an inexpensive mike.



Or should you?

You can if you buy the new Beyer 550.

At only \$37.50, the Beyer 550 provides authenticated performance at a price you can afford.

And what performance. In one elegant package you get smooth, wide frequency response, omnidirectional pickup pattern, low distortion and high signal-to-noise ratio.

Finally, you get the most generous warranty in the industry and that's another way Beyer lays it on the line.

Another innovation from Beyer Dynamic, the microphone people. Revox Corporation, 155 Michael Drive, Syosset, N.Y. 11791

Check No. 28 on Reader Service Card

A breathtaking accomplishment in dynamic sound reproduction. Distortion-free at all listening levels. 13 front panel controls provide infinite sound variations. Extraordinary precision features throughout. Elegant, diminutive cabinetry. The ultimate listening experience - under \$400. At fine stores everywhere. Or write.

New Music Might!



GROMMES 533A
AM/FM 100 Watt Stereo

MADE IN THE U.S.A.

Grommes
9101 KING • FRANKLIN PARK, ILL 60131

Check No. 25 on Reader Service Card

reference standards?

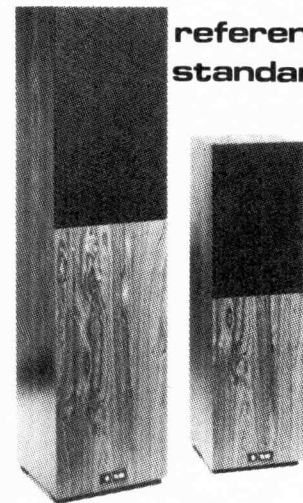

We would not claim our TL30 or 50 to be the highest performance systems available—yet they offer performance that almost always causes the listener to compare them with far more expensive systems. The TL30 and TL50 are transmission line loudspeakers that offer exceptional value for dollar, striking yet efficient styling, and most important, performance to satisfy the audiophile. If you are considering the purchase of loudspeakers you really can't afford not to investigate the Audionics TL Series. Write for the name of your nearest dealer.

AUDIONICS, INC.

8600 NE Sandy Blvd.
Portland, Oregon 97220

Check No. 5 on Reader Service Card

Advertising Index

ADVERTISER	PAGE	ADVERTISER	PAGE	ADVERTISER	PAGE
AKAI	33	Fairfax Industries	23	Rhoades & Co.	89
GXC-75D Cassette Deck		Loudspeakers		Teledaptor	
Write Direct to Advertiser		Check No. 17 on Reader Service Card		Write Direct to Advertiser	
Altec	37	Glenburn/McDonald	42	Sansui	11
Loudspeaker Systems		Turntables		High Fidelity Components	
Check No. 1 on Reader Service Card		Check No. 18 on Reader Service Card		Check No. 30 on Reader Service Card	
Aria Corp.	63	JVC	69	Saxitone Tape Sales	88
Braun Components		High Fidelity Components		Magnetic Tape	
Check No. 16 on Reader Service Card		Check No. 46 on Reader Service Card		Write Direct to Advertiser	
Astatic Corp.	16	Logic Newsletter	86	Schwann Record & Tape Guide	82
Microphones		Sample Copy		Current Listings	
Check No. 2 on Reader Service Card		Write Direct to Advertiser		Write Direct to Advertiser	
Audioanalyst	81	Magnepan	77	SAE	24, 85
Speaker Systems		Loudspeakers		High Fidelity Components	
Check No. 3 on Reader Service Card		Check No. 19 on Reader Service Card		Check No. 31 on Reader Service Card	
Audio Dynamics Corp.	77	Marantz Co.	44-47	Loudspeaker Systems	
Loudspeakers		Model 4400 Receiver		Check No. 32 on Reader Service Card	
Write Direct to Advertiser		Write Direct to Advertiser		Sennheiser	53
Audionics	71	McIntosh Lab	85	High Fidelity Components	
Loudspeaker Systems		Free Catalog		Check No. 33 on Reader Service Card	
Check No. 5 on Reader Service Card		Check No. 20 on Reader Service Card		Shure Brothers	70
Audio Research Corp.	38	Onkyo	39	Cartridges	
High Fidelity Components		High Fidelity Components		Check No. 34 on Reader Service Card	
Check No. 6 on Reader Service Card		Check No. 21 on Reader Service Card		Soundcraftsmen	19
Audio-Technica	10	PAIA Electronics	87	Equalizers	
Cartridges		Synthesizer Kits		Check No. 35 on Reader Service Card	
Check No. 7 on Reader Service Card		Write Direct to Advertiser		Sound Technology Research	83
BSR (USA) Ltd.	83	Phase Linear Corp.	32	Loudspeakers	
Turntables		700B Amplifier		Check No. 36 on Reader Service Card	
Check No. 8 on Reader Service Card		Check No. 22 on Reader Service Card		Superscope, Inc.	
Bose Corp.	10	Pickering & Co.	27	High Fidelity Components	54, 55
High Fidelity Components		Cartridges		Check No. 63 on Reader Service Card	
Check No. 9 on Reader Service Card		Check No. 23 on Reader Service Card		Compact Music Systems	92, Cover 3
Bozak	24	U.S. Pioneer Electronics	Cover 2, 1	Check No. 37 on Reader Service Card	
Loudspeakers		Four-Channel Receivers		TDK Electronics	5
Write Direct to Advertiser		Check No. 24 on Reader Service Card		Blank Cassettes	
BIC	3, 7	Precision Electronics	71	Check No. 38 on Reader Service Card	
High Fidelity Components		Grommes Components		Tandberg	41
Check No. 11 on Reader Service Card		Check No. 25 on Reader Service Card		TCD-310 Cassette Deck	
Venturi Speaker Systems		RTR Industries	49	Check No. 39 on Reader Service Card	
Check No. 12 on Reader Service Card		Speaker Systems		Tascam Corp.	13
Crown International	79	Check No. 26 on Reader Service Card		Model 10 Mixing Console	
High Fidelity Components		Radio Shack	31	Check No. 40 on Reader Service Card	
Check No. 13 on Reader Service Card		STA-80 Receiver		Technics by Panasonic	
Dahlquist	35	Check No. 27 on Reader Service Card		Turntables	Back Cover
Speaker Systems		Revox Corp.	25, 71	Check No. 41 on Reader Service Card	
Check No. 14 on Reader Service Card		Open-Reel Tape Decks		Speaker Systems	14, 15
Discwasher	2	Write Direct to Advertiser		Check No. 42 on Reader Service Card	
Disc Cleaning Methods		Beyer Mics		United Audio	9
Write Direct to Advertiser		Check No. 28 on Reader Service Card		Dual Turntables	
Elpa Marketing	21	Utah Electronics	80	Check No. 44 on Reader Service Card	
Thorens Turntables		Loudspeakers		Utah Electronics	80
Write Direct to Advertiser		Check No. 45 on Reader Service Card		Loudspeakers	

(Continued from page 16)

hence the 600-watt-per-channel drive amplifiers. Of course, there are protective circuit breakers to prevent destruction of the SX-74 cutterhead from this great power, as well as thermal and mechanical shutdowns in case of overload. To aid in the thermal situation the cutterhead is helium cooled.

The SX-74 cutterhead and the SAL-74 logic add up to some mighty impressive cutting figures. Frequency response ranges from 7 Hz to 25 kHz plus or minus 3 dB, with a rather incredible 15 Hz to 16 kHz plus or minus a half decibel! Channel separation from 40 Hz to 16 kHz is 35 dB, which as you may note is better than many stereo pickups can achieve. The SX-74 can achieve a maximum velocity on lateral cut at 10 kHz continuous operation of up to 28.5 centimeters per second, and on 10 kHz tonebursts of 10 mS impulse, the mind-boggling velocity of 100 cm/sec!

Bob Ludwig, the resident disc cutting genius at Sterling Sound, presided over the cutting of this Nonesuch recording and he has done a fantastic job. Within the five percussion pieces on this disc are a vast variety of percussion instruments—bass drums, side drums, snare drums, bongos, triangles, sleigh bells, chimes, tam-tam, gongs, claves, finger cymbals, crash cymbals, xylophone, wood blocks and on and on. As noted, the dynamic range is very great, and fortunately record surfaces are good, so there is no interference in that respect. The amplitude of some of the transients, especially some wood blocks and slapsticks as well as glockenspiel, that are cleanly reproduced on this recording is hardly believable. Needless to say, in order to reproduce what is on this record you must have virtually state-of-the-art equipment from pickup cartridge, to arm, turntable, pre-amp, amplifier, and speakers. And everything must be optimally adjusted. Bob Ludwig tells me that this record was cut with state-of-the-art playback equipment in mind. There was no attempt to cut to the dictates of the "El Cheapo" type units.

Unquestionably, the Neumann SAL-74 and SX-74 disc cutting system ushers in a new era in ultra-quality phonograph records. Given a high quality master tape, it would appear that the way now exists for virtually facsimile transfers to disc. One looks forward to this type of disc cutting with more conventional music. In the meantime, on this Nonesuch disc you can get a good foretaste of the super records to come. **Æ**

Introducing the WDDS-12 Pritchard Loudspeaker System

More confusion?

There are literally hundreds of speakers on the market. There are 2-way systems, 3-way systems, omnidirectional, rearward sound projection, et al. All, according to their makers, are outstanding. And, frankly, several are.

Small wonder the public is confused. And good reason why serious listeners rely on expert opinions, as well as recommendations from knowledgeable equipment owners.

Our new Pritchard System will surely add to the confusion. And our claims will fall, unfortunately, on many deaf ears.

But among those people who, over the years, have learned to separate fact from fiction...who trust their own ears...and who respect "inside" opinions, this new speaker will be a revelation.

If you're a serious listener, unfamiliar with ADC speakers, we urge you to talk to people familiar with our products. They know that, among the relatively few outstanding speaker systems on the market, ADC's line ranks among the best.

And, now, with the introduction of the Pritchard System, ADC's probably number one!

For most, the confusion about speakers will continue. For some, the WDDS-12 Pritchard System will shout "hello."

**ADC speakers
-the insider's choice.**



ADC AUDIO DYNAMICS CORPORATION
Pickett District Road, New Milford, Conn. 06776

Write for free WDDS-12 Pritchard Loudspeaker technical bulletin.

Now read the best of Audio in this hi-fi handbook

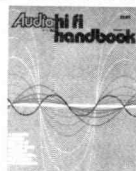

a complete reference guide to all hi-fi and stereo equipment including prices, specifications and comparisons!

Read about amplifiers... pre-amplifiers... tuners... receivers... turntables and tone arms... phono cartridges... speakers... open reel tape recorders... headphones... microphones and much more.

Over two-hundred pages of articles and charts in this directory give you the latest and best guide to hi-fi and stereo equipment.

The directory presents specifications for more than 1,100 audio components in a convenient tabular form.

To get your copy of **AUDIO hi fi handbook**, simply fill out and mail the coupon below with a check or money order for \$3.50 which includes postage and handling.

Audio 134 N. 13th St., Phila., Pa. / 19107

- Enclosed is my check for \$_____. Send me _____ copies of the HI-FI HANDBOOK at \$3.50 which includes postage and handling.
- I want monthly information about the hi-fi field. Start my subscription to AUDIO MAGAZINE.
- 1 year \$7.00 2 years \$12.00

Name _____
 Address _____
 City _____ State _____ Zip _____

MAGNEPLANAR™ loudspeakers are . .

extremely realistic sounding — and they're only 1" thick. Our top-of-the-line Tympani series which look like folding floor screens are sold through Audio Research dealers. We now have smaller, less expensive models available at the following dealers:

- University Stereo / Ridgewood, N.J.
- Transcendental Audio / Buffalo, N.Y.
- Hi-Fi Gallery / Indianapolis, Ind.
- Hi-Fi Gallery / Evansville, Ind.
- The Stereo Shop / Cedar Rapids, Ia.
- The Gramophone Ltd. / Norman, Ok.
- Audio Uncommon / Portland, Or.
- Sound Center / Beverly Hills, Ca.
- Stereo Hi-Fi Center / Gardena, Ca.
- Garland Audio / San Jose, Ca.
- Audio Arts / Livermore, Ca.
- Romans / Minneapolis, Mn.
- Audio Labs / Ames, Ia.
- Wallace Electronics / Peru, Ind.
- Stereo Showcase / Vallejo, Ca.
- Stereo Showcase / Sacramento, Ca.
- United Audio Centers (2 stores) / Chicago, Ill.
- United Audio Centers / Deerfield, Ill.
- Gill Custom House / Palos Hills, Ill.

Contact us if there is no dealer in your area.

MAGNEPLANAR
MAGNEPLANAR™ PRODUCTS
P. O. BOX 8642, WHITE BEAR LAKE, MINNESOTA 55110

Dealer inquiries welcome.

Check No. 19 on Reader Service Card

Sherwood's Forest

Sherwood L. Weingarten



THUD! DESPITE THE biggest ballyhoo from Hollywood since *Cleopatra* made an asp of any who predicted great things for that flick, *The Great Gatsby* is a spectacular artistic flop. When it opened a couple of months back at the extravagant New York City premiere, the stars—Mia Farrow and Robert Redford—didn't even have the chutzpah to show up. Perhaps they knew that the critics were waiting like starved vultures to pick at the bones of the celluloid travesty of F. Scott Fitzgerald's classic novel.

Thud!

Despite an ultra-slick attempt to pass off the original soundtrack album as something equally spectacular, Paramount has produced a secondary dud. **Nelson Riddle** did have the guts to appear on vinyl, but he might have been better off skipping the festivities too. The two-record set contains 24 cuts, 14 of them period songs, the other 10 character-related themes by Riddle, who conducts his own music.

THE GREAT GATSBY (PAS 2-3001) as a recording may represent Hollywood all too well: It is unfeeling, superficial, as shimmering and valueless as an artificial diamond.

Riddle's themes (there are 14 more in the actual soundtrack that buyers of the LP have been spared) vainly attempt to recapture the mood of the 20s; though the instrumentation tends

to be authentic, the actual sounds are something akin to plush mush.

What'll I Do, the Irving Berlin Standard, is used as a theme throughout the film and the score; its overuse is not only grating, but almost destroys the tune's inherent merit.

The only Riddle piece from the movie, produced by David Merrick, that really evokes any emotion from the listener is *A Long Time Ago*, which spotlights some mournful, marvelous solo clarinet. As for the look backward, *Yes, Sir, That's My Baby* does manage a fair rerun of the Dixieland sound, *Charleston* revives that exuberant dance tune, and *Whispering*, with its bleating horns mirrors some of the saccharine-schmaltz of the era. But that's not much excitement or interest when you have to sit through two discs.

Some of the other oldies, which will appeal perhaps to nostalgia buffs (especially the rocking chair set), include W.C. Handy's *Beal Street Blues* plus *The Sheik of Araby*, *It Had To Be You*, *Alice Blue Gown* and *Kitten on The Keys*.

And for those who are *really* desperate for yesteryear, 76-year-old Nick Lucas sings three more: *Five Foot Two*, *Eyes of Blue*, *I'm Gonna Charleston Back to Charleston* and *When You and I Were Seventeen*.

Most people will label this album pop; my tag is only a letter away, pap. It is a must-buy, however, for those

whose collection already includes a Dewey button and an Edsel.

Lest you fear that the entire recording industry is promoting glossy garbage, there *are* six superior LPs floating around (and six out of seven ain't bad).

David Essex, versatile performer who provides multiple changes of pace, is spotlighted via **ROCK ON** (Columbia, KC 32560). Talent personified is what he is, and it seems a sure bet that there is a lot of envy existing among established recording stars who too quickly have been overshadowed by Essex' ability to put it all together. The odd thing is that Essex often appears to be holding back, not quite giving everything, almost as if he were Genesis to the rest of the Bible.

The year 1974, it has been predicted, will mark the show business explosion of a new talent, one who will direct the decade musically, the way Elvis did 20 years ago and the Beatles did in the 60s; Essex, should he expand on what he has already shown, could be that super figure.

To me, the LP's highlight is *Bring in the Sun*. It starts simply and slowly, building to a gospel-like crescendo joined by full orchestration; it softens in reprise fashion, returning to the opening strains, builds again and then gently slides away. It truly has more to offer than the title tune, a chart-buster containing waves of music against a steady, heavy background.

Also noteworthy among the 11 cuts (which include seven penned by the singer himself) are *Lamplight*, which finds Essex, raspy-voiced, doing a jazz and blues mixture with overtones of soft rock; *Turn Me Loose*, old-fashioned rock 'n' roll of the simplest (but perhaps most effective) nature; *On and On*, sort of a male torch song; *Streelfighter*, similar to the title tune at the beginning, but then turning more jazzy and featuring exciting Moog work; *Ocean Girl*, a slick reggae; *We All Insane*, another rocker that utilizes a synthesizer well; and *Tell Him No*, a rock 'n' roll semi-standard turned here into a blues-like, dirge-like, ballad-like winner, if you can imagine such a thing.

Interesting for its differences, rather than similarities to Paul Simon's original, is *For Emily, Whenever I May Find Her*. Here it is music box delicate at the onset, getting stronger and jazzier as it progresses, returning ultimately to that initial brittleness.

If this is to be a banner year for rock, perhaps that banner should read: "Rock On, David Essex, Rock On."

Avant-garde is an easy label to pin on **Oregon**, a four-man outfit, but that's an oversimplification. If fusion hadn't

Honest Sound

FOR THOSE
WHO TAKE
MUSIC
SERIOUSLY

If music is too important to settle for anything less than totally realistic sound, you need Crown components. Crown's experience in producing professional studio equipment demands absolute faithfulness to the original performance. Crown components are not tuned to sound "bright" or "rich" or "mellow" or in any way artificial. Each is designed to reproduce the purest, most realistic, 100% honest live sound, as accurate as the most advanced engineering can make it. We leave the tuning function to you and your control center and equalizer.

Crown components reproduce mono, stereo and discrete quadraphonic sound. They can also be used with any existing four-channel matrix decoder or CD-4 demodulator. Your audio specialist will help you choose from Crown's broad selection the models that best fit your needs and your price range. Whichever you select, you can be sure they are all matched pieces for a totally compatible system. And all are professional quality with painstaking craftsmanship. Anything less just wouldn't be Crown.



Crown Components... the sound closest to total reality.



BOX 1000, ELKHART
INDIANA, 46514

Check No. 13 on Reader Service Card

CROWN

MADE ONLY IN AMERICA

already been used as a name by a rock group. I'd suggest that as the most fitting, for Oregon's music neatly amalgamates classical, jazz and soft rock motifs with a heavy dose of Eastern sounds.

DISTANT HILLS (Vanguard, VSD 79341) is almost anti-pop in that it requires much work on the part of the audiophile to appreciate the LP. Five of the seven tracks are intricately structured and demand close attention by the listener; it's worth the effort, though, for the ear's enjoyment surpasses that derived from the vast majority of extant

albums. The other two cuts, not incidentally, are sharp contrasts in that they are "free improvisations" that have more of a sense of emotional immediacy, less of a feel of studied perfection. *Mi Chinita Suite*, in particular, is an atonal, forward-looking composition that doesn't even surprise by ending abruptly.

This, the group's second album (the first, *Music of Another Present Era*, drew critical acclaim but comparatively few sales), will ensure Oregon a place in musical history; unfortunately, it is

unlikely that buyers of recordings by Donny Osmond or The Rolling Stones or other such pop-rock superstars will go anywhere near this: It's too close to modern chamber music to appeal to those who want their beats simple, their songs to have earthy lyrics, their ear-drums to tremble to a high decibel count. And how many *really* desire a true merging of East and West when it comes to music or anything else?

Composition of the group may help show what it's all about. Paul McCandless plays oboe and English horn; Glen Moore plays violin, flute, electric bass, bowed bass and piano; Ralph Towner plays piano, 12-string guitar, trumpet and mellophone, and Collin Walcott plays tabla, sitar, clarinet, piano, marimba, congas, guitar, tamboura and drums.

McCandless, who was named Outstanding Soloist at the Villanova Intercollegiate Jazz Festival in 1967 and was a finalist in the English horn auditions for the New York Philharmonic in 1971, has played with such diverse groups as the Winter Consort (appearing at Fillmore East and West) and the Pittsburgh Symphony. Moore has played jazz groups including Kenny Burrell, Bill Evans, Chico Hamilton, Marion McPartland, Tony Scott and Zoot Sims. Towner, a theory and composition major in college who subsequently appeared with Tim Hardin at the Woodstock festival, has premiered an orchestral concerto with the Indianapolis Symphony. And Walcott, a disciple and sitar student of Ravi Shankar and tabla student of Alla Rakha, composed and performed music for films (*Last Summer* and *Been Down So Long It Looks Like Up to Me*) as well as appearing on recordings with Miles Davis, Richie Havens and others.

Aurora shows the group's ability with a quiet jazz piece. *Dark Spirit*, on another hand, indicates the influence of Indian raga and mysticism (McCandless, by the way, sits this one out). *Distant Hills* is placid, insisting all the while that the listener *feel* those hills, *see* that horizon, *breathe* the fresh air. *Canyon Song* is almost a traditional jazz thing, and *Song for a Friend* (only Moore and Towner appear on this one) is blatantly melancholy.

All in all, there's a gamut of emotions evoked by the music *despite* most of it being a head trip. It's really the culmination of a lot of 60s stuff, putting together what once had to be considered experimental but now can be said to be fully-realized, highly-accomplished fusion.

ALLEE WILLIS, CHILDSTAR (Epic, KE 32575) is an extraordinary

3 of the World's Best Sellers!

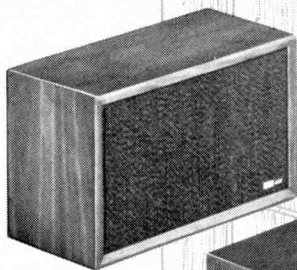

AS-2AX 8" 2-WAY
\$59.95 NET

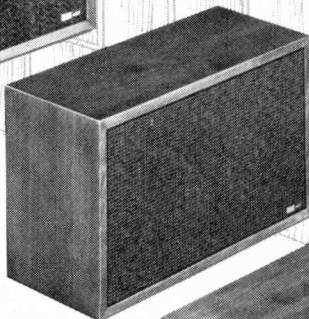

WD-90-12" 3-WAY
\$99.95 NET



HSI-C-12" 3-WAY
\$119.95 NET

Utah
sells more
speaker systems
than anyone else

Chances are very good that you have heard our sound. In fact, if you listen to many great speaker systems, you couldn't miss us. We haven't promoted the name too much, since engineering, sound technology and manufacturing techniques are our real forte. All this means to you is **incomparable** sound for astonishingly low prices. IT'S NO WONDER, WE ARE NUMBER 1! Here are three examples of quality systems that sell by the thousands.

FINISH: (ALL MODELS) Genuine Walnut Veneer, handsome hand-rubbed, oil finish.

Please write to UTAH ELECTRONICS for detailed information on Model or Models of your choice.



HUNTINGTON, INDIANA

UTAH SPECIFICATIONS

AS-2AX: 8" 2-WAY ACOUSTIC SUSPENSION SYSTEM—\$59.95 NET (8" Woofer, 3½" Tweeter, Weight—22 pounds, Size—11" x 18" x 9")

WD-90: 12" 3-WAY ACOUSTIC SUSPENSION SYSTEM—\$99.95 NET (12" High Compliance Woofer, 8" Midrange, 3½" Tweeter, Weight—33 pounds, Size—14" x 23" x 10")

HSI-C: 12" 3-WAY SPEAKER SYSTEM—\$119.95 NET (12" Heavy Duty Woofer, Midrange Compression Horn, 5" Tweeter, Weight—46 pounds, Size—15" x 25¾" x 14")

album that almost defies description. Although Ms. Willis' liner notes are flip, her lyrics are anything but, reflecting a torment, a loneliness, a sense of rejection. In short, emotions that are all too universal.

Her voice is something else, a squeaky, nasal, non-resonant item that is markedly individual. Beautiful in the normally defined sense, it isn't, but meaningful and poignant it is. Sort of like a mouse in a sore throat that wants desperately to be transformed into a nightingale in a healthy one.

The honesty of it all, however, is almost overwhelming, even to the point that the melodies Ms. Willis composes are unpolished, unspectacular, ordinary. There's just no pretension.

The pain in many of her songs brings empathic reactions from the listener; we've all *been there* all too often. A world of misfits, emotions raw, with just the faintest glimmer of hope. And, naturally, there's some of that cutesy-poo coverup we all use from time to time to hide the fact that we're bleeding.

Ms. Willis, more talented than, let's say, Bette Midler, another up-front reject, looks the part she sings about. She's frumpy, chunky, has hair that could replace a well-worn mop in an ad pleading with the consumer to get a new one; in brief, she looks like Mama Cass on a particularly bad day, as if she'd been caught in a heavy rainstorm after eating too many chocolates at a Charlie Chaplin film festival.

Among the best numbers are *Into Feeling Lonely*, *Who You Gonna Be* and *Missing Something Special*.

The first sums up a lot:

Oh I'm into feeling lonely—

It's the only thing I can do well today.

You were my best friend yesterday,

But today you seem so far away.

The second deals with an identity problem, apparently a very real thing for the songwriter-singer who was born in Detroit, studied at the University of Wisconsin, and worked as a reporter before becoming a writer of ads and LP jacket notes for Epic and Columbia:

You can always be anybody anytime you want to.

But who are you gonna be when someone wants you.

The third is a look backward, and who among us cannot remember this feeling:

Love was born in an innocent age;

I wish I was young again.

Because I'm missing something special that I had.

It's the kind of reality we sometimes like to avoid, but when we give up being children and/or ostriches, it's nice to

know there's someone willing to share her own feelings with us.

Hoyt Axton, who penned *Joy to the World* and sent Three Dog Night starbound, is one of the most consistently underrated performers in the pop arena. Many more of his tunes (*Greenback Dollar* and *The Pusher*, to name only two) have catapulted others into the limelight, to the top of the charts. Unfortunately, he, himself, hasn't achieved that vaulted position.

LIFE MACHINE (SP-3604) is his second A&M album, and it has more

pure pleasure attached to it than any recent pop LP by anyone. Axton, who accompanies himself on acoustic guitar, has the kind of voice that can be velvety smooth one moment, even considering it being deep and countrified, and rough and harsh the next.

Eleven cuts comprise the vinyl, eight of which Axton composed, and the changes of pace are a proverbial wonder to behold. *Maybelline*, the Chuck Berry classic, for instance, is somehow more original than the original; it is gutsier, with more of a rock

Audioanalyst

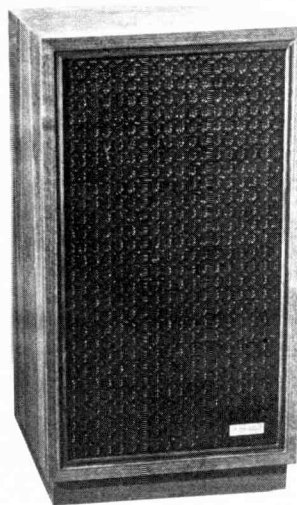

HEAR CLEAR

We are the people who design high fidelity loudspeakers to the criterion of *highly accurate* response.

This "accuracy" of sound can best be understood as a kind of clear reproduction closely illuminating music to its *real* dimensions.

To this end we develop and adhere to superior specifications; which, by the way, are easily available to you at your dealer.

While you're there . . .

Audioanalyst

P.O. BOX 262, BROOKFIELD, CT. 06804

**SPECIALISTS IN ENVIRONMENTAL
HIGH ACCURACY LOUDSPEAKERS**

Who knows?

- What is new in recorded music.
- What favorites have been re-issued.
- Whether tapes are available.
- What can be obtained in quadrasonic.

Schwann knows.

Schwann is that world-famous, ever-so-useful compendium of record and tape information. Issued in two volumes—lists 60,000 currently available records and tapes in many different categories to suit every taste and every need. Schwann knows plenty and tells all!

Schwann-1 Monthly. Special new listing section has latest releases: records, 8-track cartridge and cassette tapes. Nearly 45,000 total listings on 773 labels in classical, recent popular, rock, jazz, musical shows, country, opera, ballet, electronic, quadrasonic, etc. **95¢ at your dealer's.**

Schwann-2 Semi-annual catalog for specialized categories: pop more than two years old, classic jazz, older and re-released mono and reprocessed stereo classical recordings, classical on lesser-known labels, international pop & folk on domestic labels, spoken, educational, religious, etc. **85¢ at your dealer's.**

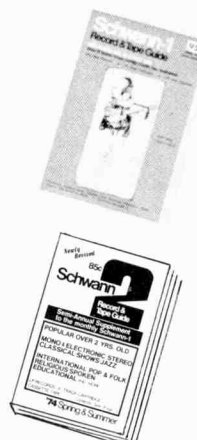

Get more pleasure.

There's more joy in recorded music when you get exactly what you want. Keep Schwann at hand, and always refer to it before you buy.

SPECIAL PRICE SAMPLE OFFER

If your favorite store doesn't carry Schwann, order samples by mail, but please try your dealer first. Prices include postage and handling.

- Latest Schwann-1 (monthly).....\$1.50
- Latest Schwann-2 (semi-annual).....\$1.25
- Combination Offer: latest Schwann-1 (monthly) and latest Schwann-2 (semi-annual).....\$2.50
- Newly revised Basic Record Library booklet.
Lists 1,000 suggestions in classical music by musical periods for your enjoyment. Send 25¢ for cost of handling, also 10¢ stamped self-addressed long envelope.

I enclose \$.....for the items checked above.

Name _____

Address _____

City _____ State _____ Zip _____

Dealer's Name & Address _____

Schwann Record & Tape Guide

137 Newbury Street, Boston, Mass. 02116 AU

and less of a blues aura. Unique, rather than a carbon copy as most performers seem likely to offer. At an opposite pole, though, is *I Dream of Highways*, a lovely ballad about losing love. On this, co-composer Renee Armand joins Axton to sing so sweetly the eyes grow misty.

That's All Right is bluesy, in Ray Charles style, and *Good Lookin' Child* is bouncy folk-rock. *Pet Parade* is childish, funny and clever—with the potential of becoming a children's standard. *Geronimo's Cadillac* is a chart-buster revisited, but again with individuality, and *Billie's Theme* is another haunting, superb ballad.

For masterful wit superimposed on a heavy statement of woe, however, none can best Axton doing *Boney Fingers*. It's upbeat country music, all purity and corn. And it contains one of the most succinct bits of humor in recent pop history:

Work your fingers to the bone—what do you get?

Boney fingers . . .

Axton also has taken pains to surround himself with some of the best modern musicians. Namely, Michael Utley on piano, Terry Reid on electric guitar, Tom Scott on horn and Leland Sklar on bass. And there are backup vocals, in addition to Renee Armand, by Clydie King, Merry Clayton, Linda Ronstadt and Douglas Dillard (who doubles on banjo).

But the star is Axton, his voice, his mind, his fingers. He's dangerous, though, addictive; like a pill-popper's dream, a carload of uppers, he's always there to make you feel good.

Cleo Laine is another singer to which the American public needs more of an introduction. She's been a stellar performer in London for a decade, but just recently has begun to make an impact stateside (partially because she was afraid to test our reaction, it appears). A recent club tour, however, has broken some of the barriers, and her RCA recording **CLEO LAINE LIVE!!! AT CARNEGIE HALL (LPL1-5015)** should do a number on the rest.

The 45-year-old thrush (don't sneer, that's only seven more than Elvis), whose original name is Clementina Dinah Campbell, is supported by a group that includes her husband, John Dankworth, on clarinet and sax. But it's her voice, an instrument by itself, that's the real show.

Basically a jazz singer, Cleo proves via 13 cuts from the October, 1973 concert that she's a good deal more. On *Music*, for instance, she roams all over the scale, not unlike a jazzy Ella Fitzgerald or a classical Uma Sumac. But

her voice is prettier than either.

And on *Gimme a Pig Foot and a Bottle of Beer*, she brings back memories of Bessie Smith, who some 40 years ago turned the blues piece into a one-singer song. Cleo retains the authentic feel of it, but it's no longer an antique.

Perdido, a memory from the age of swing, becomes for Ms. Laine a scat vocal unbelievable in richness, and *Control Yourself*, a novelty tune, becomes fun-filled by virtue of her inclusion of humor via bits from other, better-known melodies.

The singer's dramatic abilities, moreover, are quickly evident on *Send in the Clowns*, which is incisive, perhaps the best version of it ever, through understatement, and *Bill*. The latter is soulful and exceptionally real and now, even though she sang it more than 400 times while playing in *Show Boat* in Britain.

Too often critics are tempted to call someone a Compleat Performer without sufficient cause; in this case, however, it's almost impossible to avoid placing that designation on her.

SOFT MACHINE 7 (Columbia, KC 32716) is another exercise in cerebral music, material that must be heard carefully to be appreciated. Again, it's definitely worth the trip through the musical mazes, the intricate journey to the land of rock-jazz.

The four-man group originated in early '67, one of the first to utilize light show techniques and bizarre stage outfits. Through six other albums, and many changes in personnel, however, the group's *thing* has always been its music, stretching as far as its collective imagination could take it, sometimes beyond that point to pitfalls. But never could it be said that its creations were dull.

This time around, the dozen cuts are highlighted by *Nettle Bed*, a driving, frenzied outing that refuses to let up; *Carol Ann*, a haunting, almost eerie piece that sharply contrasts with the rest, and *Penny Hitch*, Eastern in flavor but rockish in a soft way, intricate on one hand, simple on another—but always a listening pleasure.

Karl Jenkins (who plays oboe, baritone and soprano saxes, recorder and electric piano), Mike Ratledge (who fondles the synthesizer, organ and electric piano) and John Marshall (drummer-percussionist) wrote what you hear. Roy Babbington, the remaining member of the quartet, apparently sticks to playing bass guitar and acoustic bass.

No matter who does what, though, it's all worth hearing and hearing and hearing.

BSR 810. For the record.

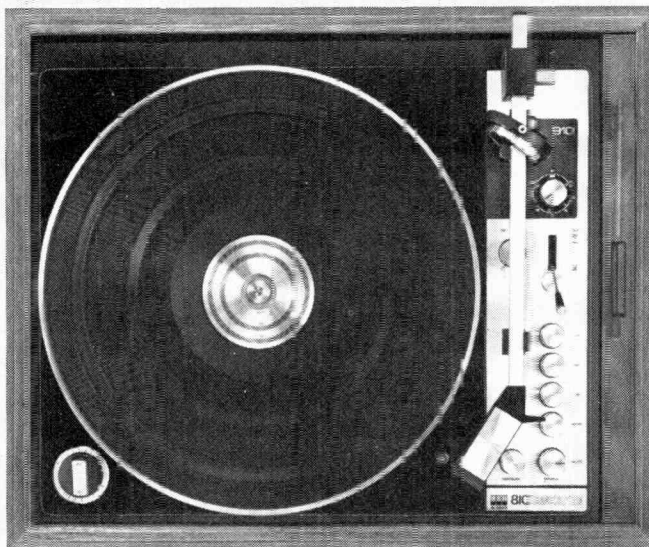

The BSR 810 starts as a record player, a machine to spin discs and generate music.

It's a pretty special machine, loaded with engineering advances, design innovations, and all kinds of fancy hardware that impresses even professional audio experts who don't impress easily. The 810 looks classy, runs smoothly, keeps quiet, and is probably more reliable than any other record changer you can buy.

The 810 is all of these things; it fills many complex needs for many kinds of people. But if you just want to play records, it's just fine. You shouldn't settle for anything less... and you just can't find anything more.

BSR

BSR (USA) LTD.
BLAUVELT, NEW YORK 10913

Check No. 8 on Reader Service Card

STR

Sound That Penetrates The Clouds

How did we do it? Simple. We built in the sharp highs from piezoelectric tweeters with power lows for an induced field magnet woofer joining them with a precise transmission line midrange. That's the secret of an uncloaked sound. Every sound in the listening spectrum comes through to give you a good feeling about the money you spent. Or as we at STR like to say, "you get more uncloaked sound for your money."

We will be pleased to send you an information package on our complete line if you will write or call:

SOUND TECHNOLOGY RESEARCH
3515 LaGrande Boulevard
Sacramento, CA 95823
916 / 422-0440

Jazz & Blues

Martha Sanders Gilmore

EARL HINES: Quintessential Continued

Musician: Earl Hines, piano.

Songs: *Glad Rag Doll*; *Down Among the Sheltering Palms*; *Love Me Tonight*; *73 Varieties*; *Deep Forest*; *Cavernism*; *Another Child*.

Chiaroscuro CR-120, stereo, \$6.98.

The irrepressibility of Earl Hines gives me an *irrepressible* urge to review this recording!

Earl Hines quite ably demonstrates on this LP that he is the very quintessence of modern jazz pianists. At his best as a piano soloist here, Hines' breathtaking piano orchestrations call for no backup group or rhythmic boost that so many pianists depend upon. Thus, comments fellow jazz pianist Dick Wellstood, in his praiseworthy notes about Hines: "The trio's oscarine petercisism, a crutch for many, is a cage for Hines."

'Tis indeed true when one listens to this effervescent pianist who literally boils over with enthusiasm and brilliance in a style that is so rich, so complex, and so full of life it is virtually undefinable and indescribable.

The music here has it all including Hines' unctuous grunting in the background as he rumbles and roars through *Glad Rag Doll*, filling it with runs that tumble gracefully forward or fall back upon themselves pell-mell. A tour de force for Hines, *Glad Rag Doll*'s sparkling treble is punctuated by appropriate bass chords, barroom rolls, and tremelos, those utter purveyors of rhythmic freedom.

After a slow, thoughtful beginning that gives one pause, Hines shows what a droll and unpredictable artist he can be in *Down Among the Sheltering Palms*, winding, intertwining, and slithering through the familiar melody, modulating easily and effortlessly. Then Hines nearly triples the time, taking us for a lilting, joyful rhythmic stride in a true theme and variations, tagging on a delayed ending that is utterly charming.

Hines disseminates his fast finger-tangling message in *Love Me Tonight*, playing way up in the high register. An ultra-busy pianist, his undertakings will leave you breathless. It is no small wonder that Hines has been the recent winner of the *Down Beat* International Critics Poll for Best Jazz Pianist.

In the four remaining tunes on the album, Hines showcases his songwriting skills. *73 Varieties* is a bluesy, unrushed piece into which Hines instills a touch of Erroll Garner via his repeated, left handed chording. And in spite of Hines' many embellishments he loses not a beat, interjecting some beautiful interplay at the top of the keyboard.

The darkness of *Deep Forest* is announced by bold, dissonant chords in the bass, a very pretty slow tune that flows along like a river. Hines achieves some excellent dynamic shading in this one.

It is clearly evident in *Another Child* what a seemingly inexhaustive pianist Hines is. In fact, his pianistic mechanisms are so complicated that it is difficult to pick out the melody on this one (for several choruses, anyway). Hines goes into ragtime here, among other things, changing his touch from a hardy pound to a mere brush of notes.

Permit me to quote from Dick Wellstood's notes again which portray Hines so well and so succinctly: "... his twitchy, spitting style uses every cheesy trick in the piano-bar catalog to create moving cathedrals, masterpieces of change, great trains of tension and relaxation, multi-dimensional solos that often seem to be *about* themselves or about other solos."

The sound throughout rings out effervescently.

Earl Hines is indeed a showman, a pianist extraordinaire. For Hines, each piece is a spontaneous poetic musical exercise. This is Earl Hines unleashed. If you haven't tuned into the phenomenon that is Earl Hines, do so NOW!

Performance: A Sound: A-

* * *

Luis Russell and His Louisiana Swing Orchestra

Musicians: Luis Russell, piano; Bob Shoffner, trumpet; Preston Jackson, trombone; Albert Nicholas, clarinet and alto sax; Barney Bigard, tenor sax; Johnny St. Cyr, banjo; Louis Metcalf, trumpet; J.C. Higgenbotham, trombone; Charlie Holmes, alto

sax and clarinet; Teddy Hill, tenor sax; Bill Johnson, guitar and banjo; Bill Moore, tuba; Paul Barbarin, drums; Bill Coleman, Red Allen, trumpets; Albert Nicholas, alto sax and clarinet; Pops Foster, bass; Otis Johnson, trumpet; Greely Walton, tenor sax; Jesse Cryor and Andy Razaf, vocals; Gus Aiken, Leonard David, trumpets; Rex Stewart, cornet; Jimmy Archer, Nat Storey, trombones; Henry Jones, alto sax and clarinet; Bingie Madison, tenor sax; Lee Blair, guitar.

Songs: *Plantation Joys*; *Please Don't Turn Me Down*; *Sweet Mumtaz*; *Folly Mine*; *Savoy Shout*; *Call of the Freaks*; *It's Tight Like That*; *African Jungle*; *Slow as Molasses*; *Feeling the Spirit*; *Jersey Lightning*; *Broadway Rhythm*; *The Way He Loves*; *Doctor Blues*; *Saratoga Shout*; *Song of the Swanee*; *Give Me Your Telephone Number*; *Higgenbotham Blues*; *Louisiana Swing*; *On Revival Day*; *Poor Li'l Me*; *Muggin Lightly*; *Panama*; *High Tensions*; *Darktown Strutters Ball*; *My Blue Heaven*; *The Ghost of the Freaks*; *Hokus Pokus*; *Moods*; *Ol' Man River*.

Columbia KG 32338, 2 discs, mono, \$6.98.

Charles Lindbergh's pioneering flight across the Atlantic in 1927 made him an international hero and also gave birth to the name of a dance—the Lindy Hop—a special kind of exultant dancing that exploded in New York City's black dance halls like the Savoy and spread downtown to the hipper white dance emporiums. From 1927 until the early 30s, New York (and to some extent Chicago) was ahead of the rest of the country as a center for hot, swinging "big band" jazz. At the Savoy, Connie's Inn and the Cotton Club in Harlem, and downtown at the Roseland, black jazz bands were playing "lindy" music, while the rest of the country danced to the stodgy fox trots of Whiteman, Goldkette, George Olsen and Rudy Vallee; "middle" America would not catch up to the lindy until Benny Goodman opened its ears in 1935.

It was Duke Ellington and Fletcher Henderson who led the way in New York, but Chick Webb, Cab Calloway

and Luis Russell were not far behind, playing pulsing, driving swing that made the floor boards at the Savoy vibrate. Between 1929 and 1931, when most of the sides in this fascinating Columbia collection were made, Luis Russell led a band that was, for all intents and purposes, the Savoy's house band.

Most of the Russell musicians were New Orleans men and had worked with King Oliver in Chicago. It is hardly surprising then that the Russell band displays a greater affinity for the New Orleans sound than any other big band of the period. The earliest Russell recordings on side 1 are interesting examples of big band modifications of the New Orleans style.

But things don't get swinging until the arrival of string bassist George "Pops" Foster. Prior to Foster's joining, Russell used the tuba and the ponderous instrument never gets the rhythm section off the ground. With Foster aboard the rhythm changed radically; his big, full tone and fantastic, propulsive drive can be heard on such numbers as *Jersey Lightning*, *Doctor Rhythm* and *Saratoga Shout*.

Luis Russell's band was knee-deep in important jazz talent and the simple arrangements allowed these gifted musicians plenty of scope to improvise. Outstanding soloists are featured throughout—*Call of the Freaks*, for example, focuses attention on Charlie Holmes, a fine soprano and alto sax player, and probably the only man who could challenge Ellington's Johnny Hodges on his own ground. The fiery and dynamic trumpeter Red Allen, who drew on Louis Armstrong for inspiration, is spotlighted on solos that have excitement, drive and power. J.C. Higgenbotham's aggressively gutty trombone shouts bouyantly on *Higgenbotham Blues*, *Give Me Your Telephone Number*, and *On Revival Day*, and the melodiously smooth Creole clarinet of Albert Nicholas is a consistent joy.

In the history of big band jazz, the Luis Russell orchestra is overshadowed by Ellington, Henderson, Lunceford and Basie. But as this collection reveals, at its best, the Russell band could play with extraordinary verve and passion. Columbia is to be congratulated for digging these rare items out of its vaults and doubly commended for the excellent electronic re-editing of the original Columbia and Okeh 78 rpm's.

John Lissner

Sound: B+

Performance: A-

S A E

The most respected name in electronics introduces state-of-the-art loudspeakers.

MARK X Dynamic Transducer Three-way Speaker System utilizing four drivers (1—12", 1—5", 2—2"), with low and mid-frequency control. Oiled walnut

MARK XI Dynamic Transducer Three-way Speaker System, utilizing seven drivers (1—12", 2—5", 4—2"), with low, mid and high frequency control. Oiled walnut

MARK XII Solid State Electrostatic Transducer, three panel array of electrostatic elements, 1—12" low frequency driver, 1—5" driver, for lower mid-frequencies, electronic protection circuit, with low, mid and high frequency control. Oiled walnut

MARK XIV Solid State Electrostatic Transducer, six panel array of electrostatic elements, 1—12" low frequency driver, 2—5" mid-frequency drivers, with low, mid and high frequency control. Oiled walnut or rosewood.

Components for the Connoisseur

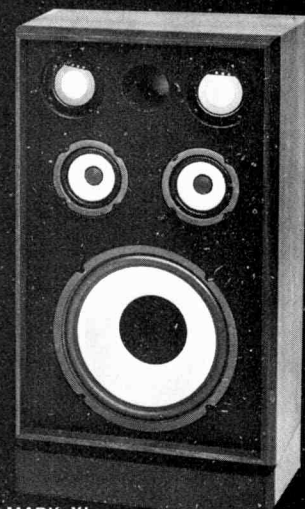

MARK XI

Scientific Audio Electronics, Inc.
Acoustics Division
P.O. Box 60271, Terminal Annex, Dept. A-34
Los Angeles, California 90060
Please send comprehensive data on SAE state-of-the-art loudspeakers.

Name _____
Address _____
City _____ State _____ Zip _____

Check No. 32 on Reader Service Card

FREE McIntosh CATALOG and FM DIRECTORY

Get all the newest and latest information on the new McIntosh Solid State equipment in the McIntosh catalog. In addition you will receive an FM station directory that covers all of North America.



MX 113

FM/FM STEREO - AM TUNER AND PREAMPLIFIER

SEND TODAY!

McIntosh Laboratory, Inc.
East Side Station P.O. Box 96
Binghamton, N.Y. 13904
Dept. 1

NAME _____

ADDRESS _____

CITY _____ STATE _____ ZIP _____

If you are in a hurry for your catalog please send the coupon to McIntosh. For non rush service send the *Reader Service Card* to the magazine.

Check No. 20 on Reader Service Card

Classified

FOR SALE

FREE 64 PAGE CATALOG offers hundreds of recordings of rare Renaissance, Baroque and Classical music. Some records priced as low as \$1.00 each! All late recordings. In stereo only. Musical Heritage Society, Box 932-AU, New York, N.Y. 10023.

FIREWORKS NEWS—Monthly magazine covering Fireworks, Construction, Sources of Supplies, New Firms—Products. **FREE** Fireworks Catalogs with Subscriptions! \$9.00 per calendar year. Pyro Press, Box 12016, Lexington, Kentucky 40511.

THE AUDIO RESEARCH ROOM. The complete range of Audio Research equipment on display under ideal listening conditions. By appointment C.M. Santmire. **AUDIO SYSTEMS & DESIGN**, 5421 South 84th St., Lincoln, Nebraska 68516 (402) 489-9888.

TRANSCENDENTAL AUDIO, LTD. BUFFALO, N.Y. 716-897-3984.

JAPAN HONG KONG DIRECTORY. World Products information, \$1.00 today World Trade Inquiries. Hillyard, Washington 99207.

PROFESSIONAL AUDIO EQUIPMENT: Microphones, recorders, equalizers, limiters, turntables, lathes, cutterheads, disc mastering systems, portable mixers, consoles, alignment tapes. Package deals and installations. Request Flyer. Wiegand Audio, Middleburg, Pa. 17842 717-837-1444.

CIZEK LOUDSPEAKERS Lowest price in the country. Quotes on your favorite system. Sound Center, Box 1242, Bloomington, Indiana 47401 812-332-4252.

NEW LEVINSON PREAMPLIFIER reveals detail you've never heard before! And retains sweet, open sound of tubes. Write **STEREO WORKSHOP**, P.O. Box 951, Berkeley, CA 94701.

ARE YOUR TAPES BEING SPOILED by recording or playback on equipment that may be magnetized? The magnetic signal "printed" on tape is quite sensitive to subsequent magnetic field exposure. You can now actually measure such components using an Annis Audiophile Han-D-Kit. Write for Bulletin & copy of article "Notes On Demagnetizing" R. B. Annis Co. 1103 N. Delaware, Indianapolis, Ind. 46202.

DIGITAL: THEORY, DESIGN,
CONSTRUCTION
LOGIC
NEWSLETTER [®]
SAMPLE COPY \$ 1.00
LOGIC NEWSLETTER
POB 252AA
WALDWICK, N.J. 07463

FOR SALE

MAGNEPLANAR® LOUDSPEAKERS are extremely realistic sounding. Our top quality models are sold thru **AUDIO RESEARCH** dealers, some of which advertise on these pages. We now have two less expensive models for sale. They are the MG1672-P Room Divider and the MG2167-F Floor Standing Model. You may buy direct from the manufacturer until there is a dealer in your area. Write us for details. Magneplan Inc., P.O. Box 8642, White Bear Lake, Minn. 55110.

ONE STOP for all your professional audio requirements. Bottom line oriented. F. T. C. Brewer Company, P.O. Box 8057, Pensacola, Florida 32505.

NAB HUB ADAPTERS—Fit Revox, Crown, TEAC, Robert, \$3/pair postpaid. No C.O.D. Quantity prices available. John Kountz, 1065 Van Dyke Dr., Laguna Beach, Calif. 92651.

MAKE A SOUND CHOICE. Our switching equipment allows instant comparing of all our products. Audio Research, Magneplanar, B&O, Braun, Crown, DBX, Decca, Infinity, Phase Linear, Rabco, SAE, Soundcraftsmen and many more.
SOUND SYSTEMS
Palo Alto, Calif. (415) 328-3761.
Mill Valley, Calif. (415) 383-6556.

DECCA MK V EXPORT—HAND SELECTED. Custom lateral damping for SME tone arms (for maximum performance)
SOUND SYSTEMS
Palo Alto, Calif. (415) 328-3761
Mill Valley, Calif. (415) 383-6556

LOWEST DISCOUNT PRICES ANYWHERE on audio equipment. All major brands discounted. Write for quotes, K&L Sound Services, 75 N. Beacon St., Watertown, Mass. 02172.

DIAMOND NEEDLES and Stereo Cartridges at Discount prices for Shure, Pickering, Stanton, Empire, Grado and ADC. Send for free catalog. **LYLE CARTRIDGES**, Dept. A, P.O. Box 69 Kensington Station, Brooklyn, New York, 11218.

SPEAKER SPECIALIST. TOBY Corporation of America, 4620 Camp Bowie, Fort Worth, Texas 76107.

10½" RECORDER SPECIALISTS: Used boxed 10½" metal and fiberglass recording reels NAB center Metal \$2.00 each fiberglass \$1.25 each. New 1 mil quality tape on above metal reel 5 for \$24.00 on fiberglass 5 for \$19.00. Replacement content labels for 10½" tape box samples \$.25. Sound Investment Co., POB 88338 Dunwoody, Ga. 30338.

MARK LEVINSON AUDIO SYSTEMS, F.M.I. Audio Research, RTR, SME, Ortofon, SL 15E Mark II. The Stereo Lab, 158 Captains Walk, New London, Conn. (203) 447-9802.

FOR SALE

SCOTCH RECORDING TAPE, lowest prices. TAPE CENTER Box 4305B, Washington, D.C. 20012.

SCOTCH MAGNETIC TAPE, discount Box 167A, Orwigsburg, Pa.

THE MONEY SAVER! Write **STEREO SPECTRUM**, Box 1818, Miami Beach, FL 33139.

NORTHERN N.J.'S FINEST AUDIO STORE, 20 minutes from N.Y.C. Bozak, B&O, Hartley, Infinity, Magneplanar, Marantz, Phase Linear, Quintessence, SAE, Thorens. Write or Call **UNIVERSITY STEREO 57 E. RIDGEWOOD AVE., RIDGEWOOD, N.J. 201-447-5700.**

CANADIANS—DEEP DISCOUNT PRICES. Name Brand Hi-Fi components. All "Canadian Warranty" protection. No catalogues. Send quotation requests to Cartronics, Box 820, Hazeldean, Ontario.

IMF, B&W, DAHLQUIST, QUAD, BRAUN, B&O, McINTOSH, TANDBERG, CROWN, REVOX, ADVENT, STAX, ORTOFON, BEYER, PHASE LINEAR, and many others. Also wide selection of first-class used equipment. Expert advice. No sale final until you are satisfied. **AUDIO CONSULTANTS**, 517 Davis St., Evanston, Ill. 60201. (312) 864-9565.

FLAT FREQUENCY RESPONSE TO 18 Hz. Sound Systems presents its new Earthshaker One woofer system. The system includes an electronic crossover variable from 20 to 300 Hz and 100 watt rms amplifier.

SOUND SYSTEMS
Palo Alto, Calif. (415) 328-3761.
Mill Valley, Calif. (415) 383-6556.

AKG, ALTEC, AUDIO RESEARCH, Beyer, Crown, DAHLQUIST, DECCA, INFINITY, KLH 9s, Koss, Ortofon, PHASE LINEAR, PML, REVOX, SAE, Sennheiser, Sony, Stanton, Tandberg, TASCAM, Thorens, etc. . . .

HI-FI HAVEN

28 Easton Ave.
New Brunswick, N.J.
201-249-5130

QUADRAPHONIC ADAPTOR—\$12.95 postpaid. Converts any stereo into 4 channel, concert hall sound. Free information. **ELECTRO-RESEARCH**, P.O. Box 20285, Ferndale, Michigan 48220.

ROGERS B.B.C. MONITOR, IMF, B&W Ltd., Celestion, Radford, Decca, ERA, Connoisseur, Audionics TL-90, Goldring, Revox, Beyer, Lamb and more. Custom design and modifications. **SUFFOLK AUDIO, INC.**, 120 Boylston St., Suite 220, Boston, Mass. 02116. (617) 423-2051.

RECORDING TAPE: Dozen reels 2400', \$14.00; dozen 1200', \$11.00; 24 reels 900', \$8.00; 24 600', \$6.00. Postpaid, Guaranteed. Mitchell, Box 132, Flushing, N.Y. 11367.

Rates: 25¢ per word per insertion for noncommercial advertisements; 50¢ per word for commercial advertisements. Frequency discounts as follows: 3 times, less 10%; 6 times, less 15%; 12 times, less 20%. Closing date is the FIRST of the second month preceding the date of issue. Payment must accompany all orders. Use the handy self-addressed, postage paid card at the back of this issue. When replying to AUDIO box number ads, send letters c/o AUDIO, 134 No. 13th St., Phila., Pa. 19107. For more information about classified advertising, circle Reader Service Card # 135.

FOR SALE

BUY DIRECT FROM ENGLAND'S HI FI MAIL ORDER SPECIALISTS! SAVE ON SME, LEAK, DECCA, TANDBERG, REVOX, GOLD SPEAKERS, ELECTROSTATIC SPEAKERS, B&O, CELESTION, TRANSCRIPTOR, CAMBRIDGE, AUDIO DESIGN, ORTOFON, LOWTHER, GOLDRING, KEF. INSURED SHIPPING QUOTES FREE OR SEND \$2.00 BILLS TO INCLUDE LITERATURE. GOODWIN LIMITED, 6 BROADWAY, WOOD GREEN, LONDON, N. 22 VISITORS WELCOME TO SHOW ROOMS PHONE 888-0077.

OPERA TAPES. Historical performances of past 40 years. Unbelievable treasures and rarities. ALSO LP RECORDS. Free catalog. Ed Rosen, Box 97, Freeport, N.Y. 11520.

WORLD'S FINEST LOUDSPEAKERS on DEMONSTRATION—AUDIO RESEARCH CORPORATION'S NEW T-1A, T-II, T-III, IMF MONITOR III, STUDIO III, ALS 40, ESS AMT-1, RTR 280DR, ESR-6, CERWIN VEGA 320 MT—320C, HEGEMAN, QUAD. BROCHURES AVAILABLE. PAUL HEATH AUDIO, 354 STATE, ROCHESTER, N.Y., 14608 (716) 232-2828.

CUSTOM LOADED MAXELL UD C-90 CASSETTES. TEN FOR \$17.00. PRIVATE LABELING AND OTHER CUSTOM LENGTHS AND TAPES AVAILABLE. MJS, 1126 Cobb St., San Mateo, Calif. 94401.

DON'T PAY THE HIGH MAIL ORDER PRICES THIEVES WAREHOUSE OF TAMPA, 1531 SOUTH DALE MABRY, TAMPA FLORIDA 33609.

INDUCTORS, MYLAR CAPACITORS, networks & raw speakers plus, new 4 channel (commode/satellite) speaker system component kits. Custom networks (manufacturers inquiries invited). New catalog, Mike Lewis, 3673 W. 113th St., Inglewood, Ca. 90303.

ANTIQUES—700 CYLINDER RECORDS, \$3500 the lot. Birnborn, 3655 Ridgewood, Montreal.

GRAPHIC EQUALIZER PLANS: Novel circuit very effective/inexpensive, requires no inductors. Ten knobs (octave bands) compensate your Hi-Fi/Tape providing better listening. Complete plans rushed only \$3.00 GREEN BANK SCIENTIFIC, Box 100C, Green Bank, WVa. 24944.

BOSE 800 SPEAKERS and amplifiers, Phase Linear amplifiers, Shure mikes, mixers. Specialists in Professional Sound and Service. COMM-TROMICS, 108 W. Poplar, Mankato, Minn. 56001. 507-387-8291.

HI-FI YEARBOOK 1974 Complete guide to British stereo. 460 pages, hard cover. Specifications on 2000 products. 800 photos. Directories of British magazines, books, dealers, manufacturers. \$8.95 plus 50¢ postage. AUDIOPHILE SYSTEMS, 5242 N. Keystone, Indianapolis, Indiana 46220.

FREE ROOM EQUALIZATION with purchase of filters. This is **not** a misprint. Music and Sound, Ltd., 11½ Old York Road, Willow Grove, Pa. 19090 (215) 659-9251.

Inventors—Engineers

OUR INDIVIDUALLY CALIBRATED London Exports, Ortofon and Supex moving coils, B&O and Grace supers are incomparable in our **customized damped S.M.E.'s.** Music and Sound, Ltd., 11½ Old York Road, Willow Grove, Pa. 19090. (215) 659-9251.

+ Levinson Cartridge Preamp +

AUDIO RESEARCH SP-3 PRE-AMP—Dahlquist Phased Array Speaker, brand new—E.C.—3 Electronic Crossover, Magneplanar 1 + speakers. reasonable prices. (919) 467-9198 nites or weekends.

FOR SALE

FOR ADULTS ONLY—Outstanding Comedy tapes on open reel—8 track cartridge—cassettes. Write for flyer and prices. House of Comedy, 1613½ N. Mariposa Ave., Los Angeles, Calif. 90027.

HI-FI ENTHUSIASTS WANTED!! Earn more than just spare money in your spare time. We need campus representatives to sell name brand stereo components at discount prices in your area. High commission, no investment required. Serious inquires only, please. Contact: Mike Santillo K&L SOUND Services Co. 75 N. Beacon St. Watertown, Mass. 02172.

ENGLAND'S LEADING MAIL ORDER AND DISCOUNT SPECIALIST OFFERS:—SME, B&W, Sansui, Cambridge Audio, Revox, Celestion, Armstrong, Decca London Mk V, KEF, Garrard Decks at very competitive price for Personal Export. Reply by Airmail, shipped immediately. Freight collect. Southern Audio Services Ltd., 43 High Street, Kingston-Upon Thames, Surrey, England, Telex no. 935437.

PROPRIETARY CUSTOMIZED MODS reduce tone arm friction, damp spurious resonances, minimize torsional forces, improve tracking, and reduce record wear. **For S.M.E.** series I, II, and low mass—\$3.00. **For Rabco SL-8E**—\$100.00. From the laboratories of Music and Sound, Ltd., 11½ Old York Road, Willow Grove, Pa. 19090. (215) 659-9251. New products shipped prepaid/insured.

Special! Dynaco ST-70 Mods!

AUDIO RESEARCH, AUDIONICS TRANSMISSION LINE SPEAKERS, BANG & OLUFSEN, BOZAK, BRAUN, CROWN, KLIPSCH, LINN SONDEK, PHASE LINEAR, QUINTESSENCE, RADFORD, REVOX, SAE and other fine instruments for the reproduction of music. Custom design and construction, component analysis, consultations, demonstration by appointment. Send for list of top grade used equipment. **AUDIO SYSTEMS AND DESIGN,** 5421 South 84th St., Lincoln, Nebraska 68516 (402) 489-9388.

THOUSANDS OF LIKE NEW LP's and pre-recorded tapes. Catalogue \$1.00. House of Records, Hillburn, New York 10931.

AUDIO RESEARCH, RADFORD, PHASE LINEAR, CROWN, QUAD, ALTEC, INFINITY, DECCA, GRACE, AKG, REVOX, BRAUN, PANASONIC SP-10, ESS, TANDBERG and many more Hartley Electronics (Audio Consultants) 1502 Butternut, Richland, Wa. 99352 (509) 947-5026 after 5 p.m. weekdays, all day weekends.

OREGON'S ONLY AUDIOPHILE STORE has some uncommonly good things. Radford, Crown, BGW, Integral Systems, Quintessence, Magneplanar, Dayton-Wright, Ohm, Janszen, Decca, Stax, Thorens, Braun, ADC, Connoisseur, Linn-Sondek, ERA, Supex, SME, Grace, passive and speaker crossover kits and basic drivers. Audio-Uncommon, 8600 N.E. Sandy Blvd., Portland, Oregon 97220 503-254-6202.

FULTON F.M.I. SUB-WOOFER, for the closest approximation to dipole definition—\$300! Also, the rave **five-way** Fulton/R.T.R. super speakers. Shipped prepaid/insured. Music and Sound, Ltd., 11½ Old York Road, Willow Grove, Pa. 19090 (215) 659-9251.

MCINTOSH, AUDIO RESEARCH, CROWN, ESS, QUINTESSENCE, HEGEMAN, BOSE, ADVENT, EPI, STAX, REVOX, RABCO, CITATION, PIONEER, TEAC, FISHER STUDIO-STANDARD and many more. Finest Service on premises. Stereo Designs, Mercury Mall, Hampton, Va. 23666 (804) 838-6394.

FOR SALE

INFRA WOOFER®, world's largest, deepest, most powerful sub-woofer system can be had **only** at Music and Sound, Ltd. **50 dB per octave crossover, bandpass 16 Hz.** . . . \$1295.

AUDIO RESEARCH. Magneplanar, Crown, McIntosh, Thorens, Decca, Stax, Revox on display. Free List used equipment. Stereo Shop, 107 3rd Ave. SE, Cedar Rapids, Iowa 52401. 319-365-1324.

PROTECT YOUR LPs. Poly sleeves for jackets 6¢ round bottom inner sleeves 5¢ Poly lined paper sleeves 12¢ White jackets 27¢ Postage \$1.00. House of Records, Hillburn, New York 10931.

TUNED ROCK P.A.'s + MULTI-TRACK RECORDING STUDIOS. Customized touring sound systems, including narrow band (5 Hz) feedback suppression, detailed acoustics-voicing/environmental equalization **± 1 db at your ears,** room design/measurement/treatment. 100's of our **customized** professional products, including fiberglass horns, consoles, omni/comp/limiters, electronic crossovers, phasors, digital delays, **1-way noise reduction,** transducers, frequency shifters from . . . J.B.L. & Altec Pro., Tascam, DBX, U.R.E.I., Eventide, Gately, Schoeps, Beyer, Crown, Community Light & Sound, McIntosh, Mom's Audio, etc., etc. All **shipped prepaid/insured** from Music and Sound, Ltd., 11½ Old York Road, Willow Grove, Pa. 19090. (215) 659-9251.

Inventors—Engineers

AR, KLH, ADVENT, DYNACO, RECTILINEAR, ADC OWNERS—Our electronic equalizer gives your speakers a full octave of new bass, plus three broadband tone controls. Three reviews, literature, from **NORMAN LABORATORIES,** 2280 Industrial Boulevard, Norman, Oklahoma 73069.

AUDIO RESEARCH modified Dynaco electronics, Dual 75A, BRAUN 15 ips. Select DECCA Export Mk. 5, IMF, H-K CITATION, ESS-HEIL, MAGNEPLANAR Tympani I \$795 (limited quantities), THORENS ORTOFON, RABCO, TOMLINSON, STAX,—and other rare and unusual goodies for the serious audiophile at the South's only state-of-the-art stereo shop. **BACK DOOR STEREO,** 2065 Piedmont, Atlanta, Ga. 30324. (404) 874-9493.

PAIA HAS... synthesizer KITS



BUT DID YOU KNOW WE ALSO HAVE... A DEMO RECORD FOR 75¢ AND A FREE CATALOG LISTING DOZENS OF OTHER GOODIES

PAIA ELECTRONICS BOX M14359, OKLAHOMA CITY, OK 73114

CASSETTES

PLAIN WHITE CASSETTE LABELS NORELOCO CASSETTE CLEANERS
PAPER MAILER BOXES** HOLDS NORELOCO TYPE "LASTIC" BOX
FAMOUS BRAND CASSETTES METAL OR FIBERGLASS 10" REELS
(100-1000)
*QUANTITY 1 9 10 99 100 1000
CASSETTE LABELS (MULTIPLES OF 10) 02 15 01
NORELOCO CASSETTE CLEANER 65 60 55 50
SCOTCH CASSETTE SCORNER 7.72 (BUY 2, GET ONE FREE)
10" FIBERGLASS REELS USED 50 40 35 25
**PLUS POSTAGE BY WEIGHT AND ZONE MINIMUM ORDER \$3.00
SAXITONE TAPE SALES 1776 COLUMBIA ROAD N.W.
WASHINGTON D.C. 20009

FOR SALE

JVC PST 1000 PREAMP. (Model just prior VP10.) Beautiful custom engraved panel. \$300.00 816-763-0279 weekdays or Audio Box A46-1.

VACUUM TUBE EQUIPMENT has been recognized by many of us as capable of producing the finest and most pleasing reproduction of recorded music. NEW YORK ELECTRIC GRAMOPHONE WORKS is pleased to announce a new program for the supply and maintenance of classic vacuum tube equipment. We have undertaken to rebuild Marantz and other makes of classic tubed sets to equal or better original specification. How? Write or call for details, or an appointment to visit. We can supply equipment or refurbish your own. We are at 47 Jane Street, #10, New York City. (212) CH3-6822.

!!THE INVENTORS, ENGINEERS, COLLEGE INSTRUCTORS, AND PROFESSIONAL MUSICIANS at Music & Sound Ltd. offer their clients a new standard of technical competence, certain proprietary testing procedures, a real anechoic chamber, a mind boggling research laboratory, and a host of the most advanced professional services, including hand-picked component alignment/customization, room acoustical design/treatment, calibrated environmental equalization ± 1 db at your ears, and the most flexible demonstration facilities anywhere!! 11 1/2 Old York Road, Willow Grove, Pa. 19090. (215) 659-9251.

Total "A" Warranty Station Service

OUR DISTINGUISHED PRODUCTS come from Audio Research, Sequerra, Dayton-Wright, Dahlquist, Infinity, Crown, London Decca, I.M.F., Quad, Rogers, Sendor, B.B.C. Monitors, Stax, E.S.S., B&O, J.B.L./Altec Professional, Schoeps, Beyer, Custom Rabco, Gately, Braun, Tascam Grace, F.M.I., R.T.R., Supex, Revox Pro, damped S.M.E., Ortofon, DBX, Linn Sondek, etc., etc. All shipped prepaid/insured Music and Sound, Ltd., 11 1/2 Old York Road, Willow Grove, Pa. 19090. (215) 659-9251.

Full "A" Warranty Service Station

SENSATIONAL NEW VACUUM RECORD CLEANER removes dust and pollution for better sound. Battery operated. Satisfaction guaranteed or money refunded, \$10.95 postpaid, Calif. residents add sales tax. Ruxton Electronics, PO Box 30312, Santa Barbara, Calif. 93105.

QUAD SOFTWARE SOURCES. Discrete disc, cartridge or open reel. Each list \$2 All 3 \$5.00 check or M.O. to Quad Info, P.O. Box 50, Kalamazoo, Mich. 49005.

CANADIAN WARRANTIES! Write for our quotes on your stereo component needs. Browne's, 541 Danforth, Sudbury, Ontario.

LOW NOISE RESISTORS—1/4W, 5%, carbon film for 3.5¢ each. Fifty of one value for \$1.25. All 5% values from 10 to 3.3M in stock. Specifications upon request. 75¢ postage and handling charge per order. Deduct 10% on orders over \$50. COMPONENTS CENTER-A Box 134, NY, NY 10038.

AUDIO RESEARCH SYSTEM: Tympani 1-U, D-75, D-50 fib, SP-2C. System price \$2200 or will sell separately. Cross, 1817 Birch, Richland, Wash. 99352. (509) 946-5200.

FOR SALE

WISCONSIN HEADQUARTERS FOR QUALITY AUDIO GEAR. CROWN TAPE RECORDERS: SX724 (\$1095), SX824(\$1495), SX744(\$1995). Immediate delivery, send for catalog. WACK SALES CO., INC. 5722 W. NORTH AVE., MILWAUKEE, WISC. 53208.

CANADIAN ELECTRONICS CATALOGUE featuring Sinclair audio modules, speaker kits, Audionics products, hundreds of other products. Write Gladstone Electronics (Aud), 1736 Avenue Rd., Toronto.

FINEST CUSTOMIZED LABELS for Cassettes and Cartridges. Free samples. TARZAC, 638 Muskogee Avenue, Norfolk, Virginia 23509.

HOW TO GET THE BEST AUDIO/TAPE BUYS, SAFELY. Insider's information by leading equipment reviewer lists models and pitfalls. Tells how, where to buy intelligently for greatest savings. 20 pages \$1.00 or send stamped envelope for details. US Audio Testing Laboratories, Box 1570 LICNY, 11101.

WISCONSIN HEADQUARTERS FOR QUALITY AUDIO GEAR. Crown, ESS, RTR, Phase-Linear, EPI, Infinity, AR-LST, B&O, Marantz, Citation, Rabco, Teac, Bozak, Thorens, & Tandberg, over 50 other brands plus immediate delivery. WACK SALES CO. INC., 5722 W. NORTH AVE., MILWAUKEE, WISC. 53208.

NEW AND AMAZING . . .

The sound sensation that's sweeping the nation. Rolen Star with unusual characteristics changes walls, floors and ceilings into speakers. Act Now! Send for free literature. James A. White, 5302 Pine St., Phila., Pa. 19143.

BUILD YOUR OWN SPEAKERS AND SAVE UP TO 50%. You can assemble your own high quality, multi-element stereo speakers in a few hours and save up to half the cost of comparable speakers. Send for our free 32-page catalog of speaker kits, raw speakers and accessories. SPEAKERLAB, Dept. A2, 5500—35th N.E., Seattle, WA 98105.

ATTENTION

WESTERN NEW YORK AUDIOPHILES our new store is going strong, due to our personalized friendly service. In addition to Audio Research, we carry the new Polk Audio Model Nine Speaker System, RTR Speakers, Hegeman, Quintessence, Thorens, Connoisseur, Phillips, Pilot, Dokorder, Infinity, B & O, SME, Soundcraftsmen, Cerwin Vega, Sherwood, Onkyo, Fulton Musical Industries, ADC, others. THE STEREO EMPORIUM, 3407 Delaware Ave., Buffalo, N.Y. 14217 716-874-3372.

PIONEER TAPE DECK RT1020L, 7" or 10" reels—Brand new '74—Minimum fair trade \$700—must sell \$490. Bob Kay, 6164S27176— or 2622 Brooklyn S.E., Grand Rapids, Mich. 49507.

10 1/2 INCH FIBERGLASS REELS. Like new \$7.50 for each lot of 30. Pete Kurzovich, 24575 Donover Rd., Warrensville Hts., Ohio 44128.

YOU HAVEN'T LIVED till you've visited our new Audio Research room featuring Tympani III's Also on display: IMF, B&O, Phase Linear, Klipsch, Crown, Citation, Pioneer, Technics, Thorens, Braun, EPI, and more. Listen Up, 685 South Pearl, Denver, Colorado 80209. 303/778-0780.

QUICK READING KIT \$2.95 Doubles reading speed while you read normally; Quick Read Dept. A, Box 5002 Oakland, Cal. 94605.

CANADIANS—DYNACO COMPONENTS AT TREMENDOUS DISCOUNTS. Write En-Jay Sales, Hornepayne, Ontario.

FOR SALE

WESTCHESTER AND FAIRFIELD COUNTY AUDIOPHILES TAKE NOTE! NOW OPEN—THE AUDIOPHILE, 231 BEDFORD STREET, STAMFORD, CONN. Audio Research, Citation, IMF, Janszen, TEAC, ADC, Marantz, many more. Custom installations.

CYBERACOUSTIC LABORATORY: only one of its kind! Featuring Crown, IMF, AKG, UREI, RTR, DBX, Infinity, Rabco, Decca, Transduction, more. Crown warranty service. Custom specially modified Crown tape recorder: Audiomodronics by our engineers. Barclay—503 Haverford Ave., Narberth, Pa. 19072; 215-667-3048.

DAHLQUIST PHASED ARRAY, RTRESR6—FULTON 80—FULTON J2 WOOFER MODULAR SYSTEM, LINN SONDEK OIL BATH TURNTABLE, SP10, KMAL MERCURY BATH SILICONE DAMPED ARM, SME, MARK LEVINSON PRODUCTS, SUPEX CARTRIDGES, RADFORD, QUINTESSENCE, BGW, ESS, QUAD, AUDIO RESEARCH CORPORATION SP-3, D-76 AMPLIFIERS, PAUL HEATH AUDIO, 354 STATE, ROCHESTER, N.Y. 716-232-2828.

AUDIO RESEARCH MAGNEPLANARS and Electronics, ESS, Infinity, Ohm, Dahlquist, EPI, Audionics, Radford, Crown, Citation, BGW, Transcriptor, Linn-Sondek, Keith Monks, ERA, Connoisseur, SME, Supax, Decca, Grace, Sony Spectrum Scanning Tuner, Epicure Amplifier, Marantz 500, DBX, ADC, Nakamichi, B&O, Tandberg, Celestion, Marc Levinson, Stax, Dayton-Wright, others. THE GRAMOPHONE LTD., 757 Asp St., Norman, Okla. 73069. 405-364-9477.

CANADA'S FIRST AUDIO RESEARCH DEALER. SP-3 Dual 76, Electronic Crossovers, Tympani IA and Tympani II (Tri-amped). Prices will be less than USA plus duties. Also McIntosh, SAE, Citation, ESS, Tandberg, JBL, Ortofon and Allen & Heath Mixers. Contact: PETER LOUGHNANE, HI FIDELITY SHOP, 1600 BAYVIEW AVE., TORONTO, ONTARIO M4G 3B7. 416-487-4613.

SERVO-STATIK I

Electrostatic Stereo Speaker System. Excellent condition. Very transparent. Wide dynamic range. Very low distortion. Costs \$2000 new. Sacrifice \$995. Rick Meyer, 2670 Cupid St., New Orleans, La. 70114. Call (504) 361-3267.

AUDIO RESEARCH SP-3 and SP-2C Pre-amps. Dual 50F-1B Amp, Magneplanar 1-U Speakers and brand new Magneplanar T-III Bass Panels; Soundcraftsmen 20-12 Equalizer; Decca International Arm, Export Mark V and SC-4E Cartridges. J. O'Connell, 22 Bremond St., Belleville, N.J. 07109.

NEW 14" NAB AMPEX aluminum flanges have never been removed from original box. Package of 10 \$8.20 prepaid. Sound Investment Co. POB 338 Dunwoody, Ga. 30338.

AMPEX 300-4 PROFESSIONAL 1/2" four track tape machine with late model 351 electronics; sync added. Very good condition. \$2100—will consider trades. P.O. Box 139, Rhinecliff, N.Y. 12574. 518-537-4420 evenings.

DYNACO STEREO 720 MODIFICATION increase RMS output, tighten low end, produce a clean, open detailed sound, unmatched for electrostatic or dynamic systems. Modification schematic detailed instructions—basic parts—\$10.00.

AMERICAN ELECTRONICS

Box 17312 Cleveland, Ohio 44117

SONY TTS 4000 direct drive turntable with Stax UA-7 tone-arm. S. Anderson, 6219 Silverton Way, Carmichael, Calif. 95608.

NEW, IMPROVED SME TONE ARMS correctly mounted in AR turntables. Audio Consultants, 517 Davis Street, Evanston, Illinois 60201. (312) 864-9565.

FOR SALE

BALTIMORE-WASHINGTON AREA AUDIO PHILES REJOICE! At last a store for you. Come to Myriad Sound and hear the finest in state of the art audio equipment. Featuring the complete Audio Research line, Polk Audio Model Nines, ESS Heils, Janszen, S.A.E., Altec, Citation, R.T.R., B & O, Thorens, S.M.E., etc. all accompanied by Fred Huggins himself. Main store at 9619 Reisterstown Rd., Garrison, Md. 21055 (2 miles North of Balt. Beltway exit 20) 363-1733.

TYPE OR DRAW YOUR SLIDE! Sizes 3 1/4 x 4—\$2.25 per 50 and 2 x 2—\$2.75 per 100. Radio Mat Slide Company, 444 N. Peninsula Drive, Daytona Beach, Fla. 32018.

CENTRAL NEW YORK HI-FI ENTHUSIASTS— Britain's finest loudspeakers on demonstration—THE IMF STUDIO AND ALS40—as well as Marantz, the Pioneer TX9100, Celestion, Epicure, Ortofon, Philips, Discwasher and others. Trades accepted. THE SOUND SHOP, 96 Seneca Street, Geneva, NY 14456 (315) 781-0215.

ADVENT 100 DOLBY, \$150, 10 RTR 6 x 6 ESL Tweeters with power supplies \$150. ARIW's \$50 each. DYNA PAT 4 \$50 two Decca 4 RC \$25 each; Heath IMW 25 \$90. J. P. Sammut, 432 Chestnut Ave., San Bruno, Calif. 94066.

IMF INCOMPARABLE LOUDSPEAKERS. Futterman custom-engineered amplifiers. Fulton loudspeakers. Grundig rare #505 Compact Receiver/Changer, only \$440. Decca SC4E cartridge regularly \$125, special \$88.88. Bang/Olufsen #1800 tape recorder demo \$440. Bozak 4000's with Janszen 130's, mint, special \$500 pair. Ortofon tonearm, mint \$25. Trades taken. Audiocraft, South Rockwood, Michigan 48179. Telephone: (313) 379-9945.

CANADIANS: Brand name audio at warehouse prices. FREE price list. Baltimore Audio Inc., 2385 Eglinton Ave. E., Scarborough, Ontario, Canada M1K 2M5.

RTR EXCLUSIVE PHILA. SHOWROOM. All RTR Speakers on demo including the new 400E HPR12 Super Magnum and 88D. Don't buy any speaker until you've heard RTR, call for an appointment 215-667-3048 or write 503 Haverford Ave., Narberth, Pa. 19072.

SOLAR ENERGY HANDBOOK, \$6.50 Ficoa-m, 2901 S. Wentworth, Milwaukee, Wis. 53207.

COLOR ORGAN DISPLAY on your color tv, no conversions used. 1000 variations, easy instructions \$3.00. Godar TV, 4413 West North, Milwaukee, Wisc. 53208.

HEY YOU . . . Looking for the lowest prices around on almost all makes of audio equipment. Write or call for quote. GOOD SOUNDS, 47 Gaywood Ave., Colonia, N.J. 07067, (201)-382-0678.

ELECTROENCEPHALOPHONE: brainwave monitor, Professional biofeedback instruments. J&J, 8102-A, Bainbridge, WA. 98110.

2 J.B.L. S-8 SYSTEMS in J.B.L. "Flair" cabinets—6 months old—\$1250.00. TEAC 6010A—\$400. PIONEER SC100 stereo preamp—\$225.00. Call Ron Johnson at 602-967-5249.

ACOUSTECH X SPEAKER SYSTEM, complete, \$800.00. Keene, 120 Gary Lane, Cocoa, Florida 32922.

S.A.E. MARK I PREAMPLIFIER Equalizer, mint, \$300.00. Selected Decca V used three weeks with warranty, \$60.00. 516-489-2645.

ANTIQUÉ POOLEX RECORD CABINET. Patent 1910; Mahogany; Numerically Files, Selects, Ejects 150 Records. \$200. 215-EV2-5859.

FOR SALE

STAX SR-X SRD-7 ELECTROSTATIC HEADPHONES Acclaimed through-out the world as the finest available. \$235 shipped prepaid, insured. David Beatty Stereo, 1616 West 43rd Street, Kansas City, Missouri 64111. 816/531-3109.

CROWN-SX824—with case 1 year old—as new condition. \$990.00. C. Brello—999-98th Ave., Oakland, Cal. 94603.

ONE AM/FM STEREO RADIO in Good Cond. Priced at \$70.00. For details contact Charles Daniel, Cruz Bay, St. John, U.S.V.I. 00830.

DAHLQUIST PHASED ARRAY SPEAKERS Brand new \$600.00. 919-467-9198.

ONE BRAUN RECORD PLAYER PS600 BASE AND DUST COVER, LIKE BRAND NEW used less than a year, mint condition. JOHN A. DONMOYER, 2635 PARKWAY ALLENTOWN, PENNA 18104.

PRE-RECORDED CASSETTE TAPES SUPER QUALITY 5 FOR \$20 air ppd. 550 different labels, Free list. Excellent Trading Corporation, GPO Box 16424, Hong Kong.

NEUMANN MICS & ACCESSORIES. DBX, Gately Pro kits and mixers. Most models in stock. Immediate prepaid shipment. Mastercharge. Write or call Dick McGrew Recording Service. 7027 Twin Hills, Dallas, Texas 75231. 214—691-5107.

CUSTOM BARZILAY CABINET with Dual 1019 turntable, Roberts tape deck, Harmon Kardon Amp, Altec Lansing Speakers—Sacrifice all for \$600. T. Mangum, 865 Sorrelwood, Westlake, Calif. 91361—(805) 497-4155.

1—GARRARD TURNTABLE, 95B—complete with Stanton 681EE pick-up. Virtually new. \$100.00 cash and carry. Bronx. WY2-1674.

SET OF 8 BELL LABS DISCS by Victor, 1927-30, excellent condition, demonstrating filters, pitch recognition, phase distortion, acoustic reflections, etc. Best offer. J. Wollock, 941-42nd St., Brooklyn, N.Y. 11219.

1973 REVOX A77 TAPE DECK, Excellent cond. Less than 100 hrs. use. \$750. Write Bill Zwicker, 123 Belchertown Rd., Amherst, Mass. 01002.

CITATION 12—assembled by engineer from specially tested components. Exceeds all specifications. \$180. T. Paide, 1805 Allan Dr., Silver Spring, Maryland 20902 (301) 681-7462.

PAIR PATRICIAN 800, Crown SX824 Recorder, McIntosh 2105 & C28, Thorens T.T. TD125 MKII, McIntosh MI3 Scope, Rek-O-Kut T.T. Phone 205-853-6401. T.A. Ray, 433-15 Terrace N.W., Birmingham, Ala. 35215.

ESS TRANSTATIC-I rosewood pair, \$800; ESS AMPLIFIER, 500w rms, \$350; JBL PREAMPLIFIER, SG-520 Graphic Controller, \$250; EMPIRE CARTRIDGE 1000-2EX, \$30; All perfect condition in original cartons. 919-967-5723.

AMPLIFIER KITS—60-60W RMS basic amplifier only \$149.50. The very latest low distortion stable design in easy to assemble kit form with quality components for substantial savings over retail. Buy factory direct and save. Send stamped self-addressed envelope for exciting full details. Ruxton Electronic PO Box 30312, Santa Barbara, Ca. 93105.

DAYTON-WRIGHT XG-8 MKII with ST-300. 4 panels \$2300. 2 panels \$1500. Firm. Natural aluminum finish. Still warranty. Private. 416-225-8619 (Toronto, Canada).

STUDIO EQUIPMENT FOR SALE: All in excellent condition. Tascam, Teac, Gately, AKG, EV, Sony, etc. Write for info. Ron Shagula, 1203 Hickory, Abilene, Tx. 79601.

LISTEN TO TV THROUGH YOUR STEREO WITH TELEDAPTER!



Works with any television & stereo. No wiring, just takes a minute to plug in. Now enjoy all TV programming with a full new sound. Complete and ready to use with instructions. 10 day money back guarantee. SEND ONLY \$2.00 for C.O.D. or save C.O.D. charges and send \$16.95 in check, cash or mastercharge No. to:

RHOADES & CO.
P.O. Box 817 Hendersonville, TN. 37075
—Dealer inquiry invited—

FOR SALE

SUPLEX MOVING-COIL CARTRIDGE is the **ULTIMATE!** Use with Levinson cartridge preamp for utterly transparent and silky smooth sound. Write **STEREO WORKSHOP**, P.O. Box 951, Berkeley, CA 94701.

AMPEX AG440-2 NEW CONDITION: used 76 hours. \$1990.—firm. Sullivan, 205E 1500 Worcester Road, Framingham, Mass. 01701 617-879-8652.

PIEZO-ELECTRIC TWEETERS. Write for specifications & prices. The EAR DRUM, 5146 W. Imperial Hwy., Los Angeles, Calif., 90045.

NEW CATALOG of raw speakers, network kits & network parts, audio test equipment, fabric & foam speaker grids, speaker systems, electronic crossovers & active filters. Distributors wanted for our line of network kits and parts. MIKE LEWIS/TSR, Inc., 3673 West 113th St., Inglewood, Calif., 90303, 213/678-1979.

AUDIO DEALERS ATTENTION!!! Let us design your "house brand" speaker systems. Our engineers can put some quality into this neglected item. We design systems to suit your needs, supply parts and source list, cabinet plans, schematics & diagrams & cost figures. You arrange for local enclosure construction & system assembly and/or sell kits. Write for complete details on your letterhead TSR Engineering, 3673 West 113th St., Inglewood, Ca. 90303, 213/678-1979.

THE EAR DRUM IS NOW OPEN. L.A.'s people oriented audio store is starting with: Kenwood, GTE, Audio Technica, Teac, Shure, Saras, Dual & TSR. Our engineer headed service department will design & modify equipment. Other store facilities & services are: High speed tape duplicator "while you wait", large selection of quality "raw" speakers, networks & network parts, audio test equipment sales & rentals, technical reference library, component rentals, CD-4 & SQ records stocked in depth, low capacitance cables in stock. See us soon. EAR DRUM, 5146 West Imperial Highway, Los Angeles 90045 (San Diego Freeway at Imperial) 641-1930.

DAYTON WRIGHT XG8 Mk II B, SPM, SPS, SPG Preamps, Bass bottoms/X-Overs. **J.E. SUGDEN** P51/Class A Power Amp. **LEVINSON, ESS, BRAUN, CROWN, PHASE LINEAR, BGW, EPICURE, B&O, STAX, QUAD, ORTOFON, B&W, CELESTION, AUDIONICS, REVOX, MAGNEPLANAR, INTEGRAL SYSTEM, SONY, RADFORD, HERMAN KARDON, INFINITY, THORENS, ERA, SHURE/SME, QUINTESSENCE, AND TONS OF USED EQUIPMENT. TRANSCENDENTAL AUDIO, LTD., 1214 WALDEN AVE., BUFFALO, N.Y. 14211.**

JAPANESE TRANSISTORS, wholesale prices, free catalog. **WEST PACIFIC ELECTRONICS,** Box 25837. W. Los Angeles, Calif. 90025.

FOR SALE

PROFESSIONAL SOUND REINFORCEMENT

Don't compromise your system's performance by using Hi-Fi Equalizers, Limiters and Electronic Crossovers. For studio quality equipment, built for pro sound reinforcement, at a reasonable price, call or write: Mom's Wholsome Audio, 2019 Naudain St., Phila., Pa. 19146. (215) 545-3488.

CERWIN-VEGA PRODUCTS (312) 581-7436.

ONE OF FLORIDA'S ONLY AUDIO RESEARCH DEALERS. Complete Audio Research on demonstration. SP-3/Dual 75/Dual 51/ Magneplanars and Bass Panel (Tri-Amped). Plus Phase Linear, Crown, McIntosh, Hartley, Decca, Stax, S.A.E., Braun, Tandberg, Advent, B&O, Rabco, J.B.L., Thorens, E.S.S. (Heil). Complete audio counseling. Sound and Sight, 20 N. Federal Highway, Boca Raton, Fla. 33432. (305) 391-1843. 141 Lakeview Ave., West Palm Beach, Fla. 33401. (305) 655-2236.

BGW 500R-\$600. Crown IC-150-\$250. Thorens TD-160-\$150. EPI 201's-\$350. Koss ESP-9's-\$90. Excl. cond. 6 mos. old. R. Stafford, P.O. Box 14024, Gainesville, Fla. 32603.

STEREO WORKSHOP IN BERKELEY has the finest! Supex, Levinson, Grace, Dayton-Wright, Klipsch, Crown, Radford, Audionics, Quad, ERA, Braun, Revox, etc. Competitive prices and excellent service. **STEREO WORKSHOP**, P.O. Box 951, Berkeley, CA 94701 Phone (415)-843-5836 TWThF 2-8, Sat. 12-6 (PDT)

TAPES & TAPE RECORDERS

CAPITOL STACK-PACKS. Scotch cassettes, cartridges, reels. Discount prices. Lawson's, Box 510, Livermore, Ca. 94550.

8-TRACK TAPES \$1.75

By joining Star Tape Club. Buy as many as you want or none. No obligation. Big name hit tapes. Rock, Soul, Popular, Best of, Religious, Bluegrass, Classical, Country, Jazz, also Party. Join direct from this ad. Send \$4.00 to:

STAR ENTERPRISES

35-AM Woodcrest Ave., Dayton, O. 45405

MUSIC

RARE ROMANTIC PIANO SCORES—Moscheles, Henselt, Herz, Litloff, Scharwenka, Scriabin, etc. Free catalog. **MUSIC TREASURE PUBLICATIONS**, 620 Ft. Washington Ave. 1-F, New York, N.Y. 10040.

INVENTIONS WANTED

PROSECUTE YOUR OWN Patent Application. All Material Necessary—Write Inventors Service, Box 3574, Washington, D.C. 20007.

RECORDS

PILITA CORRALES—Winner 1973 International Music Festival—Tokyo sings about "LOVE", Stereo \$6.00. AIRMAILED!! Record-Handicraft catalog \$1.00 (Refundable) ARABELL CO., PITOGO, QUEZON E-327, PHILIPPINES.

RARE TAPES. 7½ open reel. quality. Band Era, Radio transcriptions. Krupa, Nat Cole Trio, Ellington, Christy, Kenton. Catalog 25¢. Tara Productions, 565 Parkview Drive, Burlington, N.C. 27215.

WORLD'S LARGEST SELECTION OF RARE SOUNDTRACKS, OC, JAZZ, ROCK & PERSONALITIES! Send want lists &/or subscribe to Music Gazette—\$5/year. RTSA, 3700 S. Plaza Drive, Bldg F, Suite 211, Santa Ana, California 92704.

FREE MOVIE CLASSICS Soundtrack Catalog. Wilson, 823 Timberlane, Galion, Ohio 44833.

EQUIPMENT WANTED

WANTED: MARANTZ model 7C, 8B; JBL, SG-520E, SE-400SE; McIntOSH C-22, MC-275. Kazuo Takishima, 33-7-1421, Takashima-Daira, 2 Cho-me, Itabashi-ku, Tokyo, 175 Japan.

CASH FOR YOUR unwanted stereo LP's and reel to reel tapes. Record House, Hillburn, New York 10931.

WANTED: CROWN, R.O.M. Write Jim Hollinger, Galen Hall Rd., Rt. #3, Wernersville, Pa. 19565.

WANTED: RACK MOUNT PANEL for Marantz 7C. Burkhard Joepchen, Gutenbergstreet 89, Cologne, Germany.

WANTED: PAIR JBL 375 DRIVERS with HL93 Horn Lens. Please state condition. G. Velux, 5343—17th Ave. S.W., Calgary, Alberta, Canada T3E 0E8.

WANTED 12" MODEL 98 Audio Empire pick-up arm. Satin aluminum. Mono or stereo. Name your price. Bennett, 1460 W. 20th St., Long Beach, Cal. 90810.

QUAD 303 AS NEW. Thank you, William Z. Johnson, C.R. Cail, 1984 Wellbourne Drive, #2, Atlanta, Ga. 30324.

ELECTROVOICE PATRICIAN IV OR 700. Price & Cond. To: John Champagne, Route 11, Lafayette, N.Y. 13084, 1-315-677-3793 after 9 PM.

WANTED USED PHASE LINEAR 400. Best Price. Room 595, 1001 Sherbrooke W., Montreal, Quebec.

SONY 770 OR 772 TAPE RECORDER. Mike Coughlin, 17 Bellis Circle, Cambridge, MA 02140.

WANTED—WHARFEDALE W15FS WOOFER—Super 3 tweeter. Write stating condition and price. Robert diBenga, Heritage Gardens Q-7, Poughkeepsie, New York 12601.

PROMOTIONAL PHOTOS of R&B vocal groups from the 1950's wanted. Best prices paid. Tom Hight, 240 Burmont, Drexel Hill, Pa. 19026.

WANTED: MARANTZ MODEL 7 PREAMP and Model 8B stereo amp mint condition. Call or write (412) 361-6665. L. J. Javersack, 5506 Baywood St., Pittsburgh, Pa. 15206.

JENSEN G610 SPEAKER. Meier, 3320 Noeske, Midland, Michigan 48640.

KENWOOD KR6060 LAB SCOPE. Must be mint, with box and papers. Seymour, 4 West Central Street, Natick, Mass. 01760.

MARANTZ 30 AMPLIFIER. Mint. Dennis Wayne, 1755 Merivale Rd., Ottawa, Canada.

GOVERNMENT SURPLUS

JEEPS, TRUCKS, Cars From \$31.50, Airplanes, Typewriters, Clothing, Multimeters, Transceivers, Oscilloscopes, Photographic-Electronics, Equipment . . . 100,000 Surplus Bid Bargains Direct From Government Nationwide Typically Low as 2¢ on Dollar! Complete Sales Directory and Surplus Catalog \$1.00 (Deductible First \$10 Order From Included Catalog). U.S. Surplus Disposal, 2200 Fuller 601B-AUD, Ann Arbor, Michigan 48105.

SITUATION WANTED

EMPLOYMENT SOUGHT in the field of Audio Research with special interest in recording industry. Will have Electronics Engineering Technical Degree in August. Willing to work hard and extend learning. Will relocate. For resume and information write: Gery Blackburn, 3408 W. Chartwell Rd., Peoria, Illinois 61614.

AUDIO-DISKMASTERING ENGINEER/SALES- MAN with solid audio background seeks permanent, career studio/sales position in N.Y., N.J. area. Salary negotiable. Box A46-2.

AUDIO HI-FI HANDBOOK

COMPLETE REFERENCE GUIDE to all hi-fi and stereo equipment including prices, specifications and comparisons of over 1,000 audio components —\$3.50 which includes shipping and handling. Write: Jean Davis, Audio Handbook, 134 N. 13th St., Phila., Pa. 19107.

TAPE RECORDINGS

BLANK CASSETTES: C-20's thru C-100's. Buy direct from manufacturer and save! Example: C-20's 40¢. TARZAC, 638 Muskegoe Avenue, Norfolk, Virginia 23509.

RENT CASSETTE or Open Reel Prerecorded tape. All Labels. Catalog 75¢. Tape & Time, P.O. Box 740, Hopkins, Minn. 55343.

RENT 4-TRACK open reel tapes—all major labels. 3,000 different. Free brochure. Stereo-Parti, 55 St. James Drive, Santa Rosa, Cal. 95401.

EVERYTHING ON OPEN REEL! Prerecorded classical/popular tapes. Latest releases. Dolby Quad. 96-page catalogue \$1. Barclay-Crocker, Room 857A, 11 Broadway, NYC 10004.

MAX STEINER'S MUSIC LIVES ON. Available on Reel or Cassette. Join The Max Steiner Music Society-World's Largest. MSMS, Dept. A, 1880 Fairway, Kankakee, Illinois 60901.

SOUNDTRACKS—O.C.—Personalities & Jazz Auction Lists From: Theo's, P.O. Box 4994, Panaroma City, Ca. 91412.

QUADRAPHONIC TAPES, ¼" 7½IPS discrete 4tk reel-to-reel format. Each tape made on advanced mastering equipment, has precision test segment, is stereo compatible and duped on 3M206 tape. Brochure 25¢. Ambiphon Records, PO Box 341 Kingsbridge Station, Bronx, New York 10463.

AUTHORS, BOOKS

PUBLISH YOUR BOOK! Join our successful authors: All subjects invited. Send for free appraisal and detailed booklet. Carlton Press (Dept. VRF) 84 Fifth Avenue, New York 10011.

BOOKS. Send 50¢ for Catalog. Refundable with Order. Books, P. O. Box 11965, Philadelphia, Pennsylvania 19145.

"1974" SURVIVAL. Military-Books/Manuals. Catalog 35¢. Hillcrest Publications, IJ-25, McDonald, Ohio 44437.

JETT MARTIN COMEDY CLASSICS—free joke book! Enclose two 10¢ stamps. Talk-O-Graphic Books, Box 85, Totowa, New Jersey 07511.

BUSINESS OPPORTUNITIES

MAILORDER MILLIONAIRE helps beginners make \$500 weekly. Free report reveals secret plan! Executive 1Q6, 333 N. Michigan, Chicago 60601.

FOR SALE: RECORDING STUDIO

16—12—8—4 track API console. AKG Echo—Neuman Mics—MAC Amps. Grand piano, B-3 Amps, Drums. Low monthly rent on studio. Office in prime NYC location. Geoff Daking, 212-245-8221.

REPRESENTATIVE FOR SPEAKER SYSTEM KITS in your area. Huge, never ending, untouched market. High energy, young, together, sound & business oriented individual will do best with this investment or commission opportunity. Requires very little attention after establishment in your protected territory. We must eventually meet for contractual arrangements. Send detailed resume to: Robb Favier/TSR Engineering, 3673 W. 113th St., Inglewood, Calif. 90303.

SERVICES

CUSTOM RECORDING SERVICE Tape and Disc. Stereo and mono. Live and copies. Editing. Masters and pressings. High quality at reasonable rates. Joseph Giovanelli, Audio Tech Laboratories, 2819 Newkirk Ave., Brooklyn, N.Y. IN9-7134.

DON'T PAY the high mail order prices. Thieves Warehouse is coming to your area. Franchises available. Thieves Warehouse, P.O. Box 8057, Pensacola, Florida 32505.

HIGH FIDELITY SPEAKERS REPAIRED
AMPHRITE SPEAKERS SERVICE
655 Sixth Avenue, New York 10, N.Y.
212-CH3-4812

RECORDS MADE FROM YOUR TAPES. Also, editing and mastering. Send for free brochure. Nashville Record Productions, Inc., Dept. AM 204 19th Ave., So., Nashville, Tennessee 37203.

TAPE RECORDER HEADS brought back to spec. Wear removed. Brilliant finish. \$10.00 each. One day service. E. Maher, 5 Evans Place, Orinda, Calif. 94563.

EXCITING ANNOUNCEMENT
UNIQUE APPROACH TO AUDIO REPORTING
AUDIO REVIEW QUARTERLY, a unique publication featuring revealing, in-depth discussions of controversial issues, **EQUIPMENT REVIEWS**, ratings, recommendations, audio highlights and more. **AUDIO REVIEW QUARTERLY** reports issues and ideas other magazines ignore by exposing factual "behind-the-scenes" information. Upcoming issues feature **PROFESSIONAL EQUIPMENT REVIEWS**, exciting exposes, **BUYERS DISCOUNT SERVICE** with so much more! Special Introductory Subscription Rate: \$7.50/year. Write **AUDIO REVIEW** for exciting details on many new services available to subscribers. Take advantage of this offer and mail your subscription TODAY! **AUDIO REVIEW**, Box 175, North Branford, Conn. 06471.

STEREO MASTERS, RECORDS AND ALBUMS. Check our prices. Newest type high level cutting equipment featuring: Neumann VMS 70 Computer control lathe, Parametric Equalization, Dolby, DBX, and the new SX74 Cutting System by Neumann. Special package prices on album and single record production. Stereo LP masters \$30.00/side, 7" stereo masters \$10.00/side. 1000 45RPM stereo singles \$217.50 including mastering. Write or call for brochure. Dick McGrew Recording Service, 7027 Twin Hills, Dallas, Texas 75231, 214-691-5107.

TAPING SERVICE. Will duplicate any tape or record, onto any tape format (except Q8-T). Will matrix or CD-4 decode any disc onto open reel, also matrix encoding available. Reply Box #A44-3.

NEED CONCORD PARTS? Parts for most Concord tape recorders and receivers in stock. Write for quotes. Stereo Lab II, Inc., 262A Main St. E., Setauker, N.Y. 11733.

MERCURY SPEAKER RECONING—Mail speaker prepaid and \$1.50 per inch—\$8.00 minimum or write for information—2018 W. Division, Chicago 60622.

SHORT RUN RECORD PRODUCTION (100 & UP) FROM YOUR TAPES. We do it all—from the master—to the pressing—to the album jacket LP's or 45's. Trutone Records, Dept. A, 6411 Bergenwood Ave., North Bergen, New Jersey 07047. 201-868-9332.

MASTERS AND ACETATE DEMOS (STEREO OR MONO) PRECISION CUT using the Scully-Westrex 3D cutting system. Request brochure—you'll be surprised at our prices. Studio discount available. Trutone Records, Dept. A, 6411 Bergenwood Ave., North Bergen, New Jersey 07047. 201-868-9332.

SERVICES

E.M.I. SPEAKERS REPAIRED. Our nearly 10 years experience gives you the benefit of truly expert service. Write or call for quotes. (Specify model number) (516) 751-1633.

RADIO PROGRAMS

RADIO PROGRAMS. CATALOGUE OF THOUSANDS: \$1.00 (Refundable). **THE RADIO VAULT.** BOX 9032-TV. WYOMING, MICHIGAN, 49509.

THOUSANDS OF OLD RADIO COMEDIES, Dramas, Band Remotes, Mysteries, etc. \$6.00 for 6 Hour Reels. Catalogue \$1.00 (Refundable). Cassettes also available. **RADIOVOX 1756** Washnetaw, Ypsilanti, Michigan 48197.

1930-1962 RADIO PROGRAMS, Reels, \$1.00 hour! Cassettes, \$2.00 hour! Catalog. \$1.00. **AM TREASURES, Box 192M, Babylon, N.Y. 11702.**

GOLDEN AGE RADIO—your best source for radio tapes. Box 25215-D, Portland, Oregon 97225.

OLD RADIO PROGRAMS ON TAPE. Thousands available. Low prices, finest quality, immediate service. Catalogue 25¢. **Nostalgic Radio, Box 29K, Peoria, Ill. 61601.**

CABINETS

COMPONENT CABINETS

Direct from the factory at low factory prices. Finished Unfinished Kits. Free brochure.

AUDIO ORIGINALS
546 S. Meridian St.
Indianapolis, Ind. 46225

INSTRUCTION & EDUCATION

LEARN TO READ MUSIC IN ONE EVENING! Free details. Write: Anthony Cappeloni, 130 Meloy Road, West Haven, Conn. 06516.

AUTO ACCESSORIES

CAPACITIVE DISCHARGE IGNITIONS. Kit or assembled. Huge discounts. **Rodgers & Son, Box 3583AM, Anaheim, CA 92803.**

CHANGE YOUR OIL without getting under your car with Qwik-Change Motor Oil/Fluid Transfer Pump. Drains oil from crankcase/transmission through dip stick tube on top side of car. Transfers gasoline, changes oil on motorcycles, lawn mowers, inboard/outboard motors. Guaranteed. \$6.99. Mail Order Enterprises, 27 Arbor Drive, Norwalk, Connecticut 06854, Dept. 1DD5.

SHORTWAVE

HEAR POLICE FIRE Dispatchers. Catalogs show receivers: exclusive directories of "confidential" channels. Send 10¢ stamp. **Communications, Box 56AU Commack, New York 11725.**

HOME MOVIES

CAGNEY! BOGART! DRESSLER! FAIRBANKS! FLYNN! TEMPLE! SWANSON! Many more! The usual, the unusual; 16-S8-8mm sound & silent 200 ft. S8-8mm sampler \$2.00 Cat. free. **Thunderbird Bx 4081-AM, Los Angeles 90054.**

HELP WANTED

SERIOUS RECORDISTS NEEDED. Excellent remuneration. We train and equip. Modest investment required. Write Box 278, Englewood, Ohio 45322.

MUSICAL INSTRUMENTS

30% DISCOUNT. Name Brand Musical Instruments. Free Catalog. **Freeport Music, 455R Route 110, Melville, N.Y. 11746.**

RECORDS

CATALOGS Broadcasts, soundtracks. Personalities of Thirties, Forties, Box 225, New York, N.Y. 10028.

SHOW ALBUMS—Rare Out of Print Lp's. 52 page list—50¢. **Broadway/Hollywood Recordings, Georgetown, Conn. 06829.**

OLDIES—45 RPM Original hits. Catalog 50¢ **C&S Record Sales, Box 197, Wampsville, N.Y. 13163.**

FREE 200-PAGE CATALOG. 1,400 New Stereo Recordings. Renaissance, Baroque, Classical, Romantic, Modern Music. Not sold in stores. Not listed in Schwann's Highest quality! Budget label prices! Available only by mail **MUSICAL HERITAGE SOCIETY, Box 932 AU, New York, N.Y. 10023**

FILM STAGE SOUNDTRACKS. Large free list **A. Lutsky, Box 557342, Miami, Fla. 33155.**

FREE LP CATALOG—Deleted Soundtracks Shows, Nostalgia. **A. Roseman, P.O. Box 16083 Phila. Pa. 19114.**

RECORDS—soundtracks, show, cut-outs. Send wants—we'll quote. **Lesco, 2205 Marylane, Broomall, Pa. 19008.**

SOUNDTRACKS, original casts and personality recordings—Many hard-to-find titles at reasonable prices. Send for large, new catalog free. **Robert Hiott, Box 471, Miami, Florida 33144.**

PSYCHIC MEDITATION-WITCHCRAFT MUSIC RECORDS. Free Brochure! (Dealers Welcome) Brotherhood, Box 1363, Spring Valley, California 92077.

SOUNDTRACK RECORD ALBUMS—Mail Auction. Free list—Whalon, 2321A Hill—Redondo Beach, Calif. 90278.

RARE RECORDS. SEND WANTS. Box 5202, Long Island City, N.Y. 11105.

RARE RECORDINGS—Soundtracks, Shows, Personalities. Reasonable Prices. Large New Catalog. Free. **Hiott, Box 440471, Miami, Fla. 33144.**

SOUNDTRACKS—JAZZ. Free lists. **Vincent, Box 5202, Long Island City, N.Y. 11105.**

QUADRAPHONIC RECORDS AND TAPES—All labels, over 500 titles—at discount prices! For your free illustrated copy of the world's most complete quad catalog, write: **SOUND CONCEPTS, 2713 West Radan, Dept. C6, Peoria, Illinois 61604.**

MOMO TO STEREO SYNTHESIZER. Works on the same principles as professional studio equipment for stereo enhancing of mono records or tapes. Simplified and adjustment free for use with home equipment. Bring your mono collection back to life. Send check or m/o for \$34.95 or write for literature. Dealer inquiries invited. **TSR Engineering, 3673 W. 113th St., Inglewood, Calif. 90303.**

HIGH FIDELITY

LOUDSPEAKERS-4½" HIGH-COMPLIANCE Replacements for nationally advertised multiple speaker systems. \$7.98 Postpaid. Quantity Discounts. Free specification sheet. **Auratone, Box 580-9, Del Mar, California 92014.**

SERIOUS ABOUT SPEAKERS? We are. Catalog \$1.00. Refunded first order. **CY Electronics, Box 1471, Tucson, AZ 85702.**

SPEAKER PROTECTION

HI-DAMP SPEAKER PROTECTORS. For systems rated 40W RMS — 8 Ohms. Protect your investment. Kits \$2.50 pair, assembled enclosed units \$5.98 pair. Postpaid. **CAEH, Box 1471, Tucson, Arizona 85702**

©1974 Superscope, Inc., 8150 Vineland Ave., Dept. J, Sun Valley, Calif. 91352. In Europe: Superscope Europe, S.A. Brussels, Belgium. In Canada: Superscope Canada Ltd., Toronto, Ontario. Prices and models subject to change without notice. Consult the Yellow Pages for your nearest Superscope dealer. Send for free catalog.

*Superscope, Inc. guarantees the original registered owner that all parts are free from operating defects for one year, two years or three years from purchase date depending upon product purchased. Product is repaired or replaced free of charge, provided you bought it in the U.S.A. from an authorized dealer. Naturally the serial number cannot be altered or removed. **TM Dolby Labs, Inc.



Complete your Superscope compact music system with a Superscope stereo cassette deck like the CD-302 with built-in Dolby** Noise Reduction.

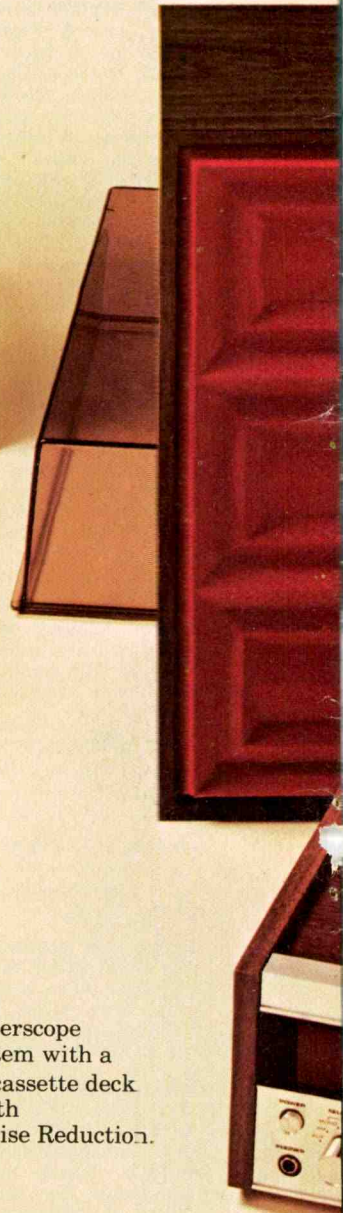

Superscope has done what no one else has been able to do.

Build a line of compact music systems that delivers the high fidelity performance of separate-component systems.

Back them with a strong, three-year guarantee.*

Offer them to you for as little as we do.

How did we do it? Years of experience building Marantz, the world's finest audio components, has enabled Superscope to create a new generation of compact music systems: Superscope compact music systems with true component quality at modest prices.

No other comparably-priced compact music system offers Superscope's superb stereo component circuitry featuring: **3-GANG TUNED RF CIRCUITRY AND LC FILTERING.** Superscope exclusives for razor sharp reception, greater pulling power and a minimum of spurious noise. Until now found only in expensive separate tuners, never in a compact in this price range.

UNIQUE FET EQUALIZING PREAMPLIFIER. Custom matches the signals from the phonograph cartridge to the amplifier and speaker systems. Assures the performance of expensive separate components, all in one budget-priced compact. **Quadrphase circuitry.** An audio refinement beyond stereo. Retrieves hidden ambience in stereo recordings and reproduces it for incomparable 4-channel sound realism.

BSR precision, three-speed automatic turntable.

Input selector. Up to six positions instead of the usual two or three. You can connect other sound sources including a TV or even a guitar. Tape inputs and outputs let you record direct from the sound source with an optional Superscope stereo tape deck.

Full-blackout, magenta, illuminated tuning dial. Illuminated, large signal strength tuning meter. Allows faster, more precise tuning. Unique in this price range.

Superscope speaker systems. Component-quality, high fidelity speaker systems engineered by the same experts that engineer Marantz speakers. Interchangeable color grilles are available in standard brown or optional sundance orange, shadow blue and harvest gold.

Extruded aluminum front panel. And spun-aluminum knobs.

Walnut grained wood cabinetry. Real wood - not plastic.

8-Track tape player. Available in certain Superscope compact models. Features automatic program selector and tape eject switch.

Superscope's exclusive three-year guarantee.*

Superscope compact music systems are just part of the full line of reasonably-priced Superscope audio equipment at your Superscope dealer. He's in the yellow pages.

From the makers of Marantz.

SUPERSCOPE®

Listen to us.

Check No. 37 on Reader Service Card



Our most expensive turntable has direct drive. So does our least expensive.

When Technics introduced direct drive, we set new standards for turntable performance. That's why we use direct drive exclusively in all Technics turntables.

No other system measures up to direct drive. Wow and flutter are less than 0.03% WRMS. And rumble is down to -65dB (DIN A) and -70dB (DIN B).

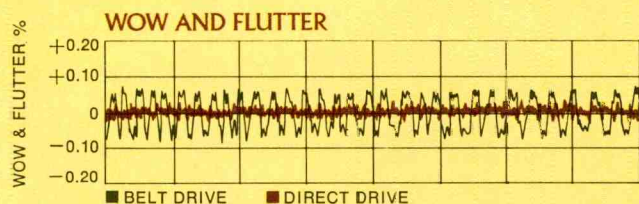

Our DC motor has no noise- or static-producing brushes and virtually none of the hum normally found in AC motors. It reaches playing speed in half a revolution and has electronic speed control that prevents speed changes due to line fluctuations.

All Technics turntables have illuminated stroboscopes, cast aluminum platters and variable pitch controls. The SL-1200 also has a precision tone arm, viscous damped cueing and low-capacitance 4-channel phono cables.

So does the SL-1100A but with a heavier platter, bigger motor and longer tone arm.

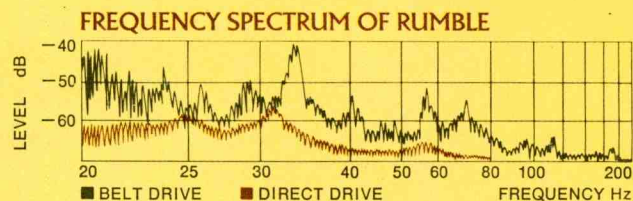

And the SP-10 is for those who insist on choosing their own tone arm.

No matter which Technics turntable you choose, you get the finest drive system that money can buy. But don't take our word for it. Read the reviews.* And you'll agree.

The concept is simple. The execution is precise. The performance is outstanding. The name is Technics.

*SP-10: Audio, 8/71; Stereo Review, 9/71.
SL-1100A: Stereo Review, 7/73; High Fidelity, 9/73.

200 PARK AVE., N.Y., N.Y. 10017 FOR YOUR NEAREST AUTHORIZED TECHNICS DEALER, CALL TOLL FREE 800 447-4700. IN ILLINOIS, 800 322-4400.

Technics

by Panasonic

Check No. 41 on Reader Service Card

