

**Audio  
ETC**

# Audio

THE AUTHORITATIVE MAGAZINE ABOUT HIGH FIDELITY • JULY 1973 60¢ ® A  
23602

**SQ Update--by Ben Bauer**

**Evolution of Four-Channel  
Equipment --by Len Feldman**

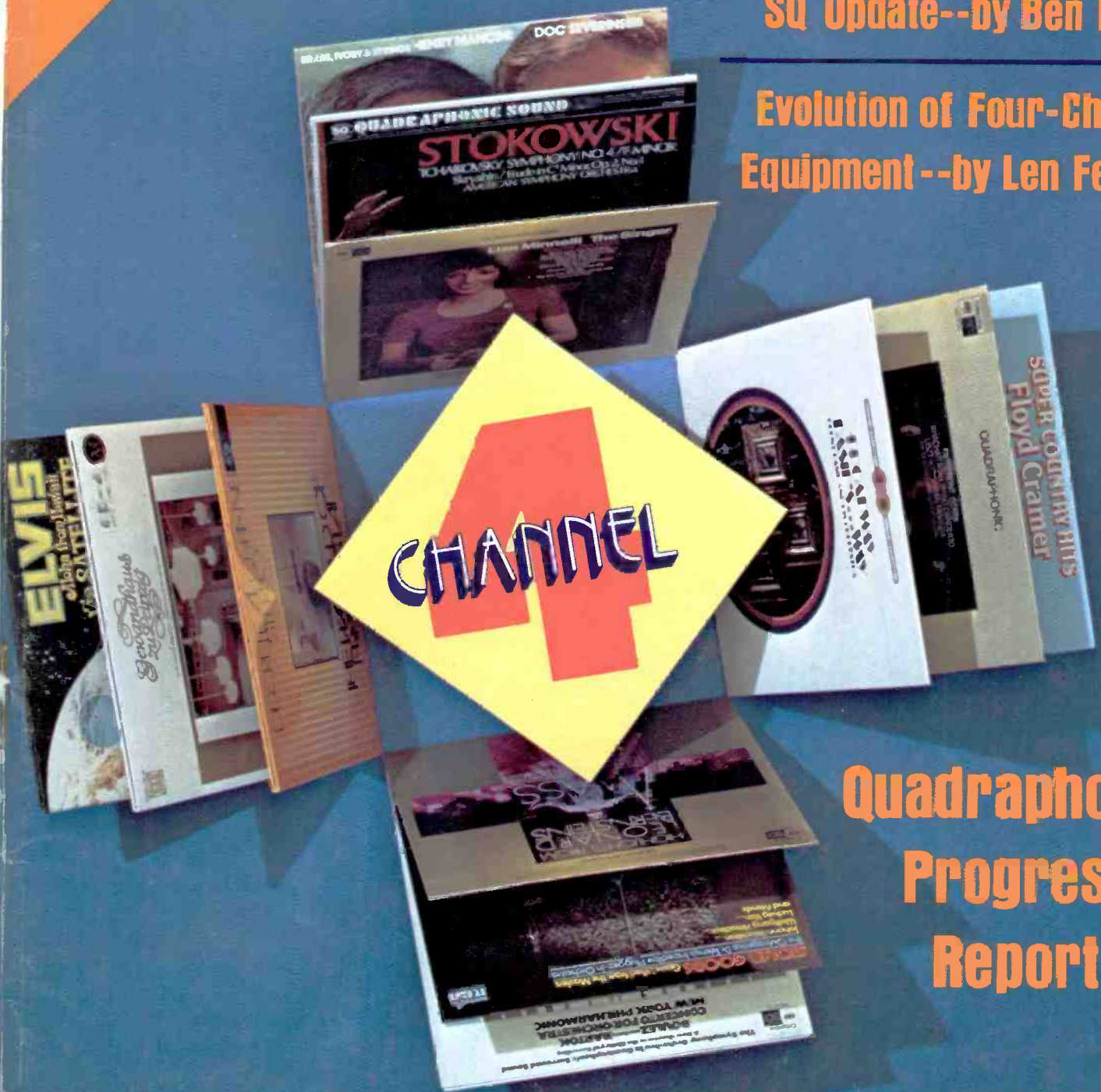

**Quadraphonic  
Progress  
Report**

# The critics unquestionably agree...



## AUDIO (George Tillett)

"The Pioneer R300 is a rather unusual speaker system — both in styling and design . . . Bass was solid and tight . . . the sound had an immediate projected quality. Stereo image was excellent . . . Can be recommended to those who require a good system at a reasonable price and one that would give outstanding results from a modestly powered receiver."

## STEREO & HI-FI TIMES (Larry Zide)

" . . . This (R500) speaker will please many with its big, bright sound . . . The middle ranges . . . are most prominent, but there is more than enough good bass, too . . . The high end response is excellent; midrange and tweeter contribute to a smooth, wide range sound that goes well beyond audibility . . . It's time that we began to demand appearance along with performance. This, Pioneer is certainly giving us with this model, and they are to be commended for the effort . . . The R500 is a quality speaker and deserves your attention."

## HIGH FIDELITY (CBS Laboratories)

"The R700 did a fine job with any program material we fed into it . . . The clean, smooth, honest, wide-range performance of the R700 puts it unquestionably among the more attractive speakers in its class."

## MODERN HI-FI & STEREO GUIDE (Robert Angus)

"There are some important differences between the R series . . . and most other bookshelf speaker systems on the market . . . The R500 is designed to make electronic rock music sound more dramatic . . . There's no doubt that with either folk or rock music, these speakers really produce brilliant sound . . . bass is remarkably clean and full under any circumstances . . . Sound is clean and undistorted up to 18,000 Hz . . . at the low end, clean frequency response is measurable down to 22 Hz."

## FM GUIDE

"If you think it's time for a new sound sensation and you suspect your present speaker system is holding out on the lows and highs, try Pioneer's R500 speaker system."

## OPERA NEWS (Hans Fantel)

"The cadre of relatively low priced high-performance speakers has recently been augmented by a distinctive newcomer: Pioneer's R300, whose tonal characteristics have been tailored to the results of extensive preference-testing with large groups of listeners. The R300 has a quality of 'presence' and immediacy which made Salome's murderous ecstasies positively scary when I listened, and the massive sonorities of the Strauss score didn't faze this speaker a bit."

Too often these days superlatives are used to camouflage mediocrity. Let's just say you'll be excited with the magnitude of the achievement of the new Pioneer series R speaker systems, once you hear them. They represent the culmination of our more than six years of intensive research in every phase of speaker design on just this series alone.

We investigated, tested and evaluated every known area: frequency response, dispersion, distortion, transients, drivers, configurations, cabinetry — rejecting, accepting, improving until we were completely satisfied that we had the perfect combination. The sound most people would prefer when compared with the conventional speakers now available.

#### The story behind the grille

To achieve this exceptional sound reproduction, Pioneer has endowed the new series R with a host of meaningful refinements that have become the hallmark for our extensive collection of high fidelity components.

**Flush mounting.** Unlike other speaker systems on the market today, the R series' drivers are flush mounted to the face of the enclosure, rather than recessed. Combined with the advanced design of the individual speaker units, there is added vitality to the mid tones and wider dispersion.

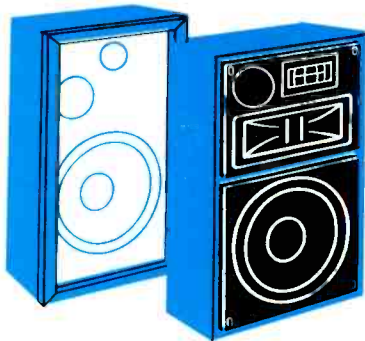

Conventional recessed speaker mountings.

New up-front flush mounting of Pioneer series R.

**Exclusive FB cones** assure robust bass, clear mid and high tones, improve damping, while keeping distortion at an absolute minimum. High input signals are handled with complete ease.

	R700	R500	R300
Speakers	12" woofer, midrange horn, multicell horn super tweeter	10" woofer, 5" midrange, horn tweeter	10" woofer, horn tweeter
Maximum Input Power	75 watts	60 watts	40 watts
Crossovers	750 Hz, 14,000 Hz	800 Hz, 5,200 Hz	6,300 Hz
Dimensions	15" x 26" x 13 $\frac{1}{16}$ "	13 $\frac{3}{4}$ " x 24" x 12 $\frac{1}{16}$ "	13" x 22 $\frac{1}{2}$ " x 11"
Price	\$229.95	\$159.95	\$119.95

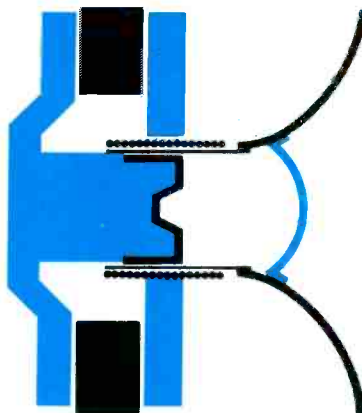

**Unique concave center pole design and pure copper cap/ring combination.** The concave center pole of the drivers' magnetic structure is covered with a pure copper cap. Not only does this reduce the inductance of the voice coil, it also decreases the voice coil's intermodulation distortion generated by the magnetic field. The result: vastly improved bass and midrange transient responses. Another example of Pioneer's meticulous engineering detail.

**Improved design horn tweeters** of die-cut aluminum have completely replaced the more conventional (and less costly) cone and dome-type tweeters in the entire series. You can hear the difference with wider dispersion, and you gain all the advantages of horn drivers, such as high transient response and lowest distortion.

**Crossovers** are precisely designed in each model. In contrast to other speakers that rely on the capacitance method only, Pioneer has combined both inductances and capacitances for minimum intermodulation distortion. And you'll never hear bass tones wandering to the tweeters, or highs intruding on the woofers. You couldn't ask for better linear response.

**The acoustically padded enclosures** are sturdily built and faced with handsome two-piece, two-color, removable grilles. The staining process of the hand selected walnut requires ten steps alone, and utilizes an exclusive oil created by Pioneer. Each unit is produced as if it was the only one.

**Sound-absorbing foam polyurethane surrounds the woofers** of the R700 and R500 to reduce distortion even further. The three R series models each employ long-throw voice coils providing greater cone movement for higher excursions.



There are many technical reasons why you should buy a pair of the new Pioneer series R speakers systems. But, in the final analysis, when you compare them with comparably priced speakers at your Pioneer dealer, their absolute superiority in sound reproduction is why you will buy them.

U.S. Pioneer Electronics Corp.  
178 Commerce Rd., Carlstadt,  
New Jersey 07072

**PIONEER**  
when you want something better

You're  
reading  
this page  
for the  
same  
reasons  
we build  
our  
speakers.

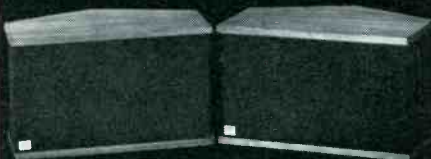

Better music, wherever you listen. Real fundamental, bass, including the attack of tympani and organ. An almost tactile feeling of presence. And transparent highs, providing unusual instrumental definition.

First and foremost, we built the LDL 749 to satisfy our own desire for musical enjoyment. Including the spatial sensations: from the intimacy of small groups to the awesomeness of full orchestra.

With their precise combination of forward-radiated sound and panoramic reflection, LDL 749's are a compact, elegant way to put the concert hall in your listening room. At \$300 per pair,\* the price is as realistic as the sound!

\*Prices slightly higher in south and west. Dealer inquiries invited.

  
**Linear  
Design  
Labs Inc.**

20 Willeff Avenue, Port Chester, N.Y. 10573

# Audio

JULY 1973

Vol. 57, No. 7

## FEATURE ARTICLES

- |    |  |                             |
|----|--|-----------------------------|
| 18 | SQ Update—1973                         | <i>Ben Bauer</i>            |
| 26 | The Evolution of 4-Channel Equipment   | <i>Leonard Feldman</i>      |
| 36 | Why You Should Buy 4-Channel Sound Now | <i>Harry E. Maynard</i>     |
| 40 | Status: The CD-4 System                | <i>George W. Tillet</i>     |
| 64 | Audio ETC                              | <i>Edward Tatnall Canby</i> |

## EQUIPMENT PROFILES

- |    |                                 |                 |
|----|---------------------------------|-----------------|
| 42 | Realistic Receiver              | <i>QTA-790</i>  |
| 52 | Bozak Loudspeaker               | <i>Sonora</i>   |
| 54 | Technics by Panasonic Tape Deck | <i>RS-740US</i> |
| 56 | Microstatic Loudspeaker         | <i>MS-1</i>     |

## RECORD AND TAPE REVIEWS

- |    |                       |                               |
|----|-----------------------|-------------------------------|
| 58 | Classical Reviews     | <i>Edward Tatnall Canby</i>   |
| 67 | Off the Record        | <i>Sherwood L. Weingarten</i> |
| 69 | Jazz and Blues        | <i>Martha Sanders Gilmore</i> |
| 73 | Recorded Tape Reviews | <i>Bert Whyte</i>             |

## AUDIO IN GENERAL

- |   |                     |                          |                   |                        |
|---|---------------------|--------------------------|-------------------|------------------------|
| 4 | Coming in August    | 10                       | Behind the Scenes | <i>Bert Whyte</i>      |
| 4 | Audioclinic         | <i>Joseph Giovanelli</i> | 16                | Editor's Review        |
| 6 | Tape Guide          | <i>Herman Burstein</i>   | 46                | Advertising Index      |
| 8 | What's New in Audio |                          | 74                | Classified Advertising |



EDITOR *Eugene Pitts III*

PUBLISHER *Jay L. Butler*

ASSOCIATE EDITOR *Edward Tatnall Canby*    MARKETING DIRECTOR *Sanford L. Cahn*

ASSISTANT EDITOR *Peggy Bicknell*    COVER DESIGN *John Kwazizur*

SUBSCRIPTION MANAGER *Jean Davis*

CONTRIBUTING EDITORS: *Herman Burstein, Martin Clifford, Leonard Feldman, Richard Freed, Martha Sanders Gilmore, Joseph Giovanelli, C. G. McProud, Harry E. Maynard, Alexander Rosner, George W. Tillet, Sherwood L. Weingarten, Bert Whyte.*

**AUDIO** (title registered U.S. Pat. Off.) is published monthly by North American Publishing Co., Irvin J. Borowsky, President; Frank Nemeyer, Jay L. Butler and Roger Damio, Vice Presidents; R. Kenneth Baxter, Vice President/Production; Nate Rosenblatt, Promotion Director; Mary Claffey, Circulation Director.  
**RATES**—U.S. Possessions, Canada, Mexico, \$6.00 for one year; \$10.00 for two years; all other countries, \$9.00 per year. Printed in U.S.A. at Columbus, Ohio. All rights reserved. Entire contents copyrighted 1973 by North American Publishing Co. Second class postage paid at Philadelphia, Pa. and additional mailing office. Back issues, \$2.00 each.  
**REGIONAL SALES OFFICES:** Jay L. Butler, Publisher and Sanford L. Cahn, Marketing Director, 41 East 42nd St., New York, N.Y. 10017, telephone (212) 687-8924.  
Jay Martin, 15010 Ventura Blvd., Sherman Oaks, Calif. 91403, telephone (213) 981-7852.

**REPRESENTATIVES, United Kingdom:** The American Magazine Group, 9 Warwick St., London, W 1, England.  
**Continental Europe:** John Ashcraft, 12 Bear St., Leicester Square, London W.C. 2, telephone 930-0525. For Benelux and Germany, W.J.M. Saunders, Mgr., Herengracht 365, Amsterdam, Holland, telephone 24.09.08.  
**Japan:** Japan Printing News Co., Ltd., No. 13, 2 Chome Ginza Higasi, Chuo-ku, Tokyo, telephone 541-5795.

**AUDIO** Editorial and Publishing Offices, 134 N. 13th St., Philadelphia, Penna. 19107  
Postmaster: Send Form 3579 to the above address

# HERE IS THE WORLD'S ENTIRE SELECTION OF AUTOMATIC TURNTABLES WITH ZERO TRACKING ERROR.

There they are. All one of them. Garrard's Zero 100, the only automatic turntable with Zero Tracking Error.

Not that there haven't been attempts by other turntable makers. Many have tried. This is the first to succeed. And it has succeeded brilliantly. Expert reviewers say it's the first time they've been able to hear the difference in the performance of a record player...that the Zero 100 actually sounds better.

It's all because of a simple but superbly engineered tone arm. An articulating auxiliary arm, with critically precise pivots, makes a continuous adjustment of the cartridge angle as it moves

from the outside grooves toward the center of the record.

This keeps the stylus at a 90° tangent to the grooves. Consequently tracking error is reduced to virtual zero. (Independent test labs have found the test instruments they use are incapable of measuring the tracking error of the Zero 100.) Theoretical calculations of the Zero 100's tracking error indicate that it is as low as 1/160 that of conventional tone arms.

Zero tracking error may be the most dramatic aspect of Zero 100, but it has other features of genuine value and significance. Variable speed control; illuminated strobe; magnetic anti-skating;

viscous-damped cueing; 15° vertical tracking adjustment; the patented Garrard Synchro-Lab synchronous motor; and exclusive two-point record support in automatic play.

The reviewers have done exhaustive reports on Zero 100. We believe they are worth reading, so we'd be happy to send them to you along with a 12-page brochure on the Zero 100. Write to us at: British Industries Co., Dept. G-13 Westbury, N.Y. 11590.

**GARRARD  
ZERO 100**

**\$199<sup>95</sup>**

less base and cartridge



coming in  
**August**

**Trackability Revisited** by Jim Kogen, the story behind the Shure V-15 III.

**AUDIO** reviews six phono cartridges.

**The Language of High Fidelity**—Part II of Martin Clifford's guide for beginners.

#### Equipment Reviews

##### Include:

Pioneer TX-9100 tuner  
KLH Model 52 receiver  
Rectilinear loudspeaker

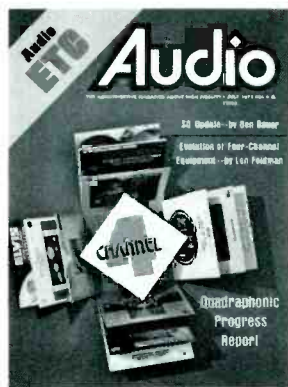

**About the cover:** This month our editorial theme is quadraphonics, and it seems appropriate to show the jacks of the latest discs. There is no doubt but that there have been major strides by all who are running in the four-channel race, and the results achieved with all systems are a good deal better than those of a year or two ago. Our reports begin on page 18.

# Audioclinic

Joseph Giovanelli

## Further Notes About the Recording Field

In the March, 1973 Issue of AUDIO MAGAZINE I wrote a piece dealing with careers in the recording field. Among other items was a list of schools which offer courses to train people for employment in the recording field.

Since then I have received the names of four more schools doing this same work. I am taking this opportunity to print their names and addresses. As was true of the original list of schools, neither AUDIO MAGAZINE nor I are recommending any of these; we are printing this information with the hope that it will aid those seeking to enter this most exciting profession.

Should we hear from other schools, I will again print their addresses.

Fanshawe College  
P. O. Box 4005  
Terminal C  
London, Ontario, Canada  
Valparaiso Technical Institute  
Valparaiso, Indiana 46383

Humphreys College  
6650 Inglewood Avenue  
Stockton, California 95207  
Brown Institute  
3123 E. Lake Street  
Minneapolis, Minnesota 55406

## Connecting Dolby Units and Equalizers

*Q. Here is a problem which no one seems to be able to answer.*

*My components include a Quad-Sansui 6500 with preamplifier connections, two A.N. 180 Dolby units. Eventually I plan to buy an equalizer.*

*My question is: Can I connect the Dolby units into my preamplifier and my equalizers into my Dolby units and still obtain proper performance?*

*Shall I forget the whole thing and hook the Dolbys into the tape monitor? Should I then connect the equalizers into the preamplifier setup?*—William J. Ashworth, Independence, Missouri.

A. If you wish to play back Dolby processed tapes and use equalization, the equalizer must be placed between the output of the Dolby system and the input of the receiver. Whether you use the "tape monitor" or "preamplifier" section of the equipment is not important. You could even have the tape machine in the "tape monitor" section and the equalizer connected to the

preamplifier section of the equipment. This will all depend on what you plan to do with your system. In any case, the only consideration here is that the equalizer should not be placed between the output of the tape machine and the input to the Dolby playback circuitry.

If you want to record a Dolby encoded tape, but with equalization on the program source, the equalizer must be placed between the program source and the recording input of the Dolby system. The equalizer must never be placed between the tape machine and the Dolby, since it is neither related to the playback nor recording functions of the Dolby system. The Dolby "box" and its various connections to the tape machine must not be interrupted by any other piece of equipment.

If you plan to use your equalizer for introducing correction during recording or to introduce it during playback, you will need to make provisions for reconnecting it to accomplish these functions because there is no one place to which you can leave the equalizer connected permanently and still have all functions performed properly.

You may find it necessary to make up some kind of switching system to make all connections rapidly, or perhaps a patch panel will be required in order to provide you with the required flexibility.

## RC or LC Filtering

*Q. I have an old tube amplifier which has only a 100 ohm resistor to filter the B plus, along with the usual capacitors. Would a 120 ohm, 8 Henry choke be better than the resistor?*—Name Withheld.

A. If your power amplifier is now reasonably free from 120 Hz hum, there is no reason for switching to an inductor. I do not think that the improvement, though measurable, could be detected aurally. If there is hum, perhaps the choke would be best. Chances are, however, that the hum you now have is a result of aging filter capacitors which are in need of replacement. Do this before adding the choke.

If you have a problem or question on audio, write to Mr. Joseph Giovanelli, at AUDIO, 134 North Thirteenth Street, Philadelphia, Pa. 19107. All letters are answered. Please enclose a stamped self-addressed envelope.

# The ADC-XLM "...in a class by itself."



That's the way Stereo Review described our XLM. High Fidelity head-lined their review, "Superb new pickup from ADC" and went on to say, "...must be counted among the state of the art contenders." And Audio echoed them with, "The ADC-XLM appears to be state of the art."

With the critics so lavish in their praise of the XLM, there's hardly any necessity to add anything. Far better to let the experts continue to speak for us.

**Frequency response** The CBS STR-100 test record showed less than  $\pm 1.5$ dB variation up to 20,000Hz. *Stereo Review*  
... response is within  $\pm 2$ dB over the entire range. *Audio*  
Frequency response is exceptionally flat. *High Fidelity*

**Tracking** This is the only cartridge we have seen that is really capable of tracking almost all stereo discs at 0.4 grams. *Stereo Review*  
The XLM went through the usual torture test at 0.4 grams (some top models require more than a gram). *High Fidelity*  
The XLM is capable of reproducing anything found on a phonograph record. *Audio*

**Distortion** Distortion readings ... are almost without exception better than those for any other model we've tested. *High Fidelity*

The XLM has remarkably low distortion in comparison with others. *Audio*  
At 0.6 grams the distortion was low (under 1.5 per cent). *Stereo Review*

**Hum and noise** The XLM could be instrumental in lowering the input noise from the first stage of a modern transistor amplifier. *Audio*  
The cartridge had very good shielding against induced hum. *Stereo Review*

**Price** This would be a very hard cartridge to surpass at any price. *Stereo Review*  
We found it impossible to attribute superior sound to costlier competing models. *High Fidelity*  
Priced as it is, it is a real bargain in cartridges. *Audio*

**The Pritchard High Definition  
ADC-XLM \$50.**

 **AUDIO DYNAMICS CORPORATION**  
Pickett District Road, New Milford, Connecticut 06776

Check No. 3 on Reader Service Card

## A Question of Quality

*Q. The boys in the shop have a little problem. Given two tape recorders, both listing for \$300, one with a single motor and cross field head, and the other with three motors and no cross field head, which is more desirable? The unit with the cross field head claims response to 20 KHz at 7½ ips, while the other unit claims response to 15 KHz. Please settle the argument.—Harry Sitkoff, Far Rockaway, N.Y.*

A. I am afraid you have asked the following type of question: Is it hotter in the summer or in the country? Do you walk to work or carry your lunch?

The fact that one machine has 3 motors while the other has one motor does not necessarily make the 3-motor unit better. What is the quality of the motor(s)? What is the quality of the engineering behind their use? Similarly, the fact that one machine has a cross field head and the other does not, fails in itself to designate which is the better machine. I can well visualize a situation where a tape recorder with one motor and no cross field head is the better of the two owing to better design, better construction, better parts, and better quality control.

## Crosstalk and Alignment

*Q. A couple of years ago I bought a Uher 24 Special at a closeout price with the thought that it would be a perfect playback deck for use in copying tapes. It operates all right with the exception that it has a bad lack of channel separation, a problem that gets more annoying all the time. When a quiet passage comes along, one can hear crosstalk from the other two channels if the tape has been recorded in both directions. The recorder is very sensitive to head adjustment changes, and the problem varies from one prerecorded tape to another. A minor adjustment the factory made on the playback head is worthless, and I have fastened the head down solid. I will appreciate any information which might help.—M. Glen Bair, Idaho Falls, Idaho.*

A. You indicate that crosstalk only occurs when the tape is recorded in both directions. This eliminates the electronics as the source of crosstalk and points to the heads. The problem may lie in vertical mispositioning of the heads. It may lie in the heads them-

selves; that is, their gaps may be too long (vertically), so that they tend to pick up signal from the adjacent tracks. It may lie in the tape guides, which permit the tape to weave up and down, so that adjacent channel signals are picked up as the tape weaves.

## Quality In Cassettes

*Q. I am purchasing blank tape cassettes and have been confronted with a bewildering number of brands sold at a wide range of prices. Many are advertised as low-noise and/or wide-range, and one (Norelco) offers a life-time guarantee. Are there significant differences between tape brands? In shopping around, TDK and BASF seem to be rated best, with Scotch, Norelco, and some others making the second echelon, and Lafayette, Hitachi, Ampex, and Audiopak trailing. But these are only salesmen's suggestions. Your opinions on tape quality, taking noise, dynamic range, frequency response, and life expectancy in mind, would be most helpful.—Gerald Goodman, Brooklyn, N.Y.*

A. Generally speaking, the quality of tapes is proportional to the prices paid for them. I cannot make recommendations as to specific brands, for the policy of AUDIO prohibits my doing so. I can say that the low-noise tapes have been finding increasing favor, for they do result in somewhat lower noise along with improved treble response. However, your tape machine has to be properly adjusted to take advantage of these tapes.

## Good Recordings

*Q. I am using two Electro-Voice RE-20 cardioid and two Neumann U-87 omni-cardioid microphones with the Crown CX822 stereo tape recorder for on-location recording. I would like the following questions answered: (1) Why am I not getting quality recordings from these microphones? (2) Is the Crown CX822 considered a "professional recorder" or should I purchase a Scully or Ampex recorder which I know is considered "professional"?—Louis Tousana, Jr., Chicago, Illinois.*

A. It is difficult to answer your questions about the microphones because I do not know the exact manner in which

you are using them, nor the exact problems you are having with them. Is it possible that you are overloading the tape recorder (really the tape) and therefore getting distorted response along with poor treble? In making live recordings, you have to be very careful not to allow the recording level to get too high. It takes skill and experience to properly interpret a VU meter reading and to adjust tape recording level on the basis of the meter and the type of sound.

As for your question about the various brands of tape machines, the policy of AUDIO prohibits me from making comment.

## Making Phase Outs

*Q. I am trying to achieve a special effect. It is a whirling, swishing sound that effects the total sound where it is used. The sound seems to rise, dip, and then "null out" and start all over again. I have heard this called "rephasing" and "phasing out." How is this sound produced? Is there a special machine that produces it? I would appreciate your giving me some information on this sound effect.—Michael Caponera.*

A. I cannot refer you to a special machine for "phasing out." Perhaps you can achieve the desired effect with a stereo amplifier with suitable features. Assume that you feed the same signal to two channels, but out of phase with each other (many stereo amps permit you to reverse the phase of one channel). Next, assume that you can combine the two signals to a varying degree (as many stereo amplifiers enable one to do). Depending upon the setting of the control that governs degree of mixing of the two channels, you will have "phasing out." Varying the setting of the control as you feed the amplifier output into a tape recorder will vary the amount of "phasing out." The mixing control has to be of high quality so that it will not "scratch" (produce noise) as you vary its setting.

If you have a problem or question on tape recording, write to Mr. Herman Burstein at AUDIO, 134 North Thirteenth Street, Philadelphia, Pa. 19107. All letters are answered. Please enclose a stamped, self-addressed envelope.



# The 400 millisecond miracle.



Most people seem to take for granted the smooth, effortless way in which a Revox works.

And that is as it should be.

For a great deal of time, effort and sophisticated engineering have gone into translating extremely complex function into lightning quick, responsive operation.

For example, when you press the play button of a Revox, you set in motion a sequence of events that take place with the precision of a rocket launching.

It begins with a gold plated contact strip that moves to close two sections of the transport control circuit board.

Instantaneously, the logic is checked for permissibility. If acceptable, a relay is activated.

Within 15 milliseconds, power is supplied to the pinch roller solenoid, the brake solenoid, the back tension motor, a second relay and, at the same time, the photocell is checked for the presence of tape. If present, Relay One self-holds.

Elapsed time, 25 milliseconds.

At 30 milliseconds, Relay Two closes and puts accelerating tension

on the take-up motor.

The logic checks are now complete and power is available to actuate all necessary functions.

From 30 milliseconds to 300 milliseconds, mechanical inertia is being overcome and the motors and solenoids are settling down.

By 300 milliseconds, the brakes have been released, the pinch roller is in contact with the capstan shaft, the tape lifter retracted, the playback muting removed and the motors have come up to operating speed.

At 350 milliseconds power is cut off from Relay Two, which changes over to another set of contacts, releasing the accelerating tension on the take-up motor and completing a circuit through Relay One that, in turn, restores normal tension to the take-up motor.

Total elapsed time, 400 milliseconds. The Revox is now in the play mode.

And it's all happened in a fraction of the time it takes to read this sentence.

The 400 millisecond miracle. **More proof that Revox delivers what all the rest only promise.**

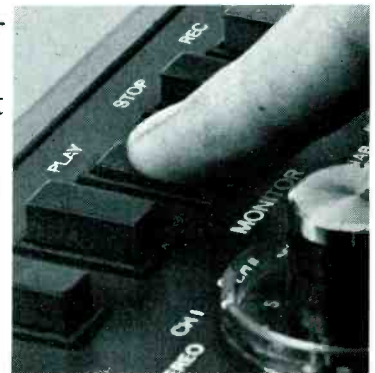

**Revox Corporation** 155 Michael Drive, Syosset, N.Y. 11791. Calif.: 3637 Cahuenga Blvd. West, Hollywood 90068  
England: C.E. Hammond & Co., Ltd., Lamb House, Chiswick, London W4 ZPB. Available in Canada.

Check No. 39 on Reader Service Card

# What's New in Audio

## Fisher 2/4 Channel Receivers



Featured in both the 4020 and 4060 receivers, are "strapped" amplifiers permitting combination of the four amp channels and eliminating wasted power when only two channels are in use. Both receivers also feature SQ decoder, CD-4/aux position, and front and rear channel dual volume controls. The 4060 is rated at 68 W total rms power (at 1 KHz) all four channels driven at 4 ohms, while the 4020 is rated at 48 W total rms power, all channels driven at 4 ohms. Prices, including woodgrain cabinet: 4060, \$369.95; 4020, \$299.95.

Check No. 102 on Reader Service Card

## Columbia Magnetics Magna-See



This solution is used to detect any errors in the azimuth of a recording head. Recorded tape is dipped in the liquid, allowed to dry, placed between glass slides and examined through an ocular. Recorded tracks are completely visible and adjustments can be made to the recording head by examining the tape. Complete kit is \$12.

Check No. 103 on Reader Service Card

## Pioneer SE-505 Headphones



Featuring volume and tone controls for both left and right channels, these headphones have a two-way speaker design with both woofer and tweeter in each earpiece. Impedance is 8 ohms. Frequency range is 20-20,000 Hz with a sensitivity of 108 dB/0.3 volt. Weighing 24 oz., the price of \$59.95 includes a 16-ft. coiled cord and permanent storage case.

Check No. 104 on Reader Service Card

## Sansui AU-7500 Amplifier.



This medium-power unit offers IHF power output of 150 watts or 40 watts per channel at 8 ohms with both channels driven, power bandwidth of 5-40,000 Hz, and total harmonic and intermodulation distortion is less than 0.1%. Special features include 3 tone controls—bass, midrange and treble—two mic inputs, two stereo phono inputs with switchable impedances, stereo inputs for tuner and aux sources, inputs and outputs for two tape decks, and inputs and outputs for a four-chan. adaptor. The AU-7500 will accommodate two pairs of stereo speakers, switch selectable, and has three a.c. accessory outlets. Price: \$299.95.

Check No. 105 on Reader Service Card

## Schurman "Free-Hand" Solder Feeder

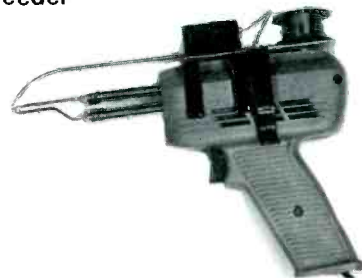

This trigger-operated device attaches to all popular brand soldering guns and leaves your second hand free to handle small parts. The unit is sturdy and easy to use and solder flow is variable for maximum control and economical use. Trigger is adjustable for left or right hand use. Price: \$8.95, including 10-ft. spool of solder.

Check No. 106 on Reader Service Card

## EECO A C Capstan Motor Controller

Designed for use with EECO's BE-450 Wide Range Synchronizer, this unit provides controlled a.c. drive power for all types of a.c. capstan-driven magnetic tape recorders. D.c. error signals are accepted from the Synchronizer and are converted into a variable a.c. power source. The 4" x 8" x 10" unit is suitable for mounting in the base of an audio tape recorder unit and includes all connectors and cables necessary for installation. Price: \$795.

Check No. 107 on Reader Service Card

## Literature

A new reference book, *Four Channel Sound*, by AUDIO contributing editor Leonard Feldman, is now available. Mr. Feldman discusses the operation of 4-channel sound, discrete and matrix discs, 4-channel sound on tapes and 4-channel FM broadcasting. Also explained is how to convert to and select 4-channel equipment. An appendix defines the new terminology related to this field. Price: \$4.50 from Howard W. Sams & Co., Inc., 4300 W. 62nd St., Indianapolis, Ind. 46268.

# There really is a difference

If you think that *most* cassette decks look alike... you're right.

If you think that *most* cassette decks are alike... you're right again.

But there is one so different that it defies comparison. And you can own one for no more than the "look-alikes."

There are a lot of technical similarities, but *only* AKAI gives you the incredible GX (glass and crystal ferrite) head. A head so remarkable that it is virtually wear free... Its low-noise single crystal and glass coated surface make it dust-free too. And its high frequency response is completely superior to any other head on the market today.

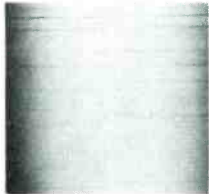

AKAI GX head after 500 hrs.

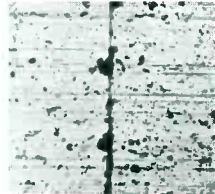

Pressed-Ferrite head after 500 hrs.

Low frequency noise and high frequency distortion are characteristic of the low tape speed of cassette players (1-7/8 ips). That's why professional reel-to-reel recordings are usually made at 15 inches per second. The Dolby® system provided the answer to low frequency noise. (Of course, we use Dolby too.) But *only* AKAI's exclusive ADRS system provides the means to eliminate *almost all* high frequency distortion over 8 KHz.



Without ADRS



With ADRS

It all adds up to the *real* difference in fine tape equipment... GX heads, ADRS and Dolby. No one else gives you all three. Why settle for less than the best?

Listen to the AKAI GXC-46D. It may *look* similar... but you get so much more.

"Dolby" is a Trade Mark of Dolby Laboratories, Inc.

## And you don't have to be an engineer to understand it

From

# AKAI™

The Innovators

AKAI America, Ltd. / P. O. Box 55055,  
Los Angeles, California 90055



# Behind The Scenes

Bert Whyte

AT THE AES convention at the Waldorf-Astoria last fall, I talked with Tom Dempsey, the genial V.P. of BASF Systems. I remarked that though I had been using magnetic tape since 1949, I had never seen it made. Tom promptly invited me to inspect the BASF plant in Bedford, Mass., and to visit BASF headquarters in Ludwigshafen, Germany.

The plant in Bedford is located in a pleasant industrial park, and it is a marvel of clean, functional design, efficiency, and cleanliness. The plant is highly automated, yet hundreds of employees are required in the various departments. This plant manufactures open-reel, cassette, and cartridge tape, and such special items as computer tape and magnetic discs for computers. Not far from the main plant, BASF operates its own plastics factory, which turns out reels of various sizes and shells for cassettes and cartridges, as well as hubs and other cassette parts. Tom Dempsey makes his headquarters in the Bedford plant as does Gerry Berberian, National Sales Mgr., and Heinz Kreuels, Marketing Mgr. Heinz is "Mr. Fixit," generally in charge of "visiting firemen," and making arrangements for overseas visits to BASF.

The Bedford plant is similar to the main BASF plant in Germany. However, there are additional facilities in the main plant, so I will describe the tape manufacturing process as conducted in this facility.

On Valentine's Day, my wife Ruth and I deplaned in Frankfurt and were driven to Mannheim. on the West bank of the Rhine, just across from Ludwig-



shafen. No one would want to stay in Ludwigshafen, as it is literally a "Devil's Cauldron," steam jetting everywhere, multi-hued smoke issuing from myriad stacks, and the most exotic galaxy of noisome stench I have ever encountered. Needless to say, this has an environmental impact, and BASF spends over \$35 million annually in combatting pollution.

Badische Anilin und Soda-Fabrik (BASF) is an offshoot and new manifestation of the famous (or infamous) I.G. Farben Industrie chemical and anilin dye cartel, which was disbanded by order of the Allies after the war. BASF is now the third largest chemical company in the world, with annual sales exceeding 3.5 billion dollars.

Allied bombers completely leveled the Ludwigshafen works during the war. Thus it is hard to believe what you see at present. The term "mind-boggling" is totally inadequate to convey the impression of this industrial colossus. The works stretches along the Rhine for over *four miles* and extends inland a *mile and a half!* There are more than 1,500 buildings and the landscape is dotted with chemical processing installations that look like a surrealist's nightmare. Soaring towers, retorts, condensers, fractionators, all connected by miles of sinuously twisting multi-colored pipes and plumbing. There is a huge railroad complex within the works, as well as docks for the big Rhine barges. Fifty thousand tons of raw material per day are transported within the works. With all the complex processes involved, daily electrical consumption is equivalent to the whole of Denmark! This

vast array of plants produces over 5,000 different products.

After we recovered a bit from "jet lag," Mr. Wilhelmus Andriessen, Mgr. of BASF audio products evaluation, drove us to nearby Heidelberg, the famous university town. Mr. Andriessen is very knowledgeable about magnetic tapes and recorders, and a man who knows and loves classical music. He proved an ideal host and after we had visited the great castle we went to one of the typical Heidelberg "Student Prince" drinking stubes, where we supped on Black Forest trout washed down with the fabulous local brews.

The next morning we were off to the rural town of Willstaad, about 75 miles from Mannheim, where the BASF tape manufacturing plant is located. This site was chosen for its relatively clean air, and nearby stream of pure water from the Black Forest (obvious qualities not to be found in Ludwigshafen). Another consideration was the proximity of Strasbourg, France, which furnishes a much-needed labor pool, with workers crossing and recrossing the border every day, happy to earn the higher German wages.

The tape plant was opened in 1966, and purportedly is the most modern magnetic tape manufacturing facility extant. There are about eight rather stark buildings, which were designed for maximum efficiency in the progression of raw material input, to finished tape output. All the facilities give a rather "clinical" impression, much in keeping with the almost fanatic obsession with the exclusion of dust and dirt from the processing areas.



## SONY PS 2251: a declaration of independence.

Independence of belts, pulleys, idler wheels and all the other paraphernalia that can cause wow, flutter and rumble. Independence from fluctuations in power line voltage that can effect the precise speed of the turntable. And independence of acoustic feedback. The new, direct-drive Sony PS-2251 has declared itself independent of all these potential intruders upon the enjoyment of your records.

Most turntables use belts, pulleys, idler wheels to make their turntables spin at the record's speed, instead of the motor's. Look underneath Sony's new PS-2251 and all you'll see is the motor. We don't need all those extras, because our motor's speed is precisely the same as the record's.

Eliminating all those parts also eliminates the wow and flutter and rumble they can cause. So, our rumble figure is a remarkable  $-58\text{dB}$  (NAB).

And because our motor turns so much slower than conventional ones, the rumble frequency is lowered too, making the rumble even less audible than that  $-58\text{dB}$  figure indicates.

To maintain precise speed accuracy at slow speeds, we use an AC servo system (superior to a DC servo system because of its uniform magnetic field strength). Its precise speed is not affected by variations in line voltage or in line frequency. But its speed can be varied  $\pm 4\%$  by the built-in pitch control and returned to a precise  $33\text{-}1/3$  or  $45\text{ rpm}$ , with the built-in self-illuminated strobe.

Then we matched it with a statically-balanced tonearm that tracks records as precisely and faithfully as our turntable turns them. We added viscous-damped cueing and effective anti-skating. And we mounted the PS-2251 on a handsome wood base using an independent spring suspension system to completely isolate

it from externally caused vibrations. At \$349.50 (suggested retail) including arm, wood base and hinged dust cover, the PS-2251 is today's most advanced turntable.

We also offer a moderately priced, single-play component turntable with the convenience of automatic operation, the PS-5520. The complete system: turntable, arm, walnut base and hinged dust cover, \$159.50. (suggested retail) Sony Corporation of America, 47-47 Van Dam St., Long Island City, N.Y. 11101.



Check No. 33 on Reader Service Card

The BASF tape plant has an important advantage shared by few, if any other tape manufacturers. All the raw materials . . . the plastics, the base film, iron oxide, lacquer, and solvents . . . are manufactured by BASF, mostly in the Ludwigshafen plant. They pride themselves on the rigid quality control checks such a situation makes possible. For example, solvents arriving at the



**Coating plant**—the dispersion is spread evenly and precisely onto a wafer-thin plastics carrier film.

Willstaet plant can be immediately utilized since their purity has been determined beyond question at the main plant.

For their recording tape BASF manufactures both polyester and "Luvi-therm," a PVC film. The BASF tape plant in Bedford uses a lot of Mylar, purchased from DuPont. When the "carrier film" (as the base is called professionally) has been rolled to a uniform thickness, it passes on to a "calendering roller," which gives the film a very smooth surface, increases the suppleness of the tape, and pre-stretches it sufficiently to prevent distortion by the mechanical stresses of running through the tape recorder.

There are, of course, various iron oxide formulations but in general, the material is a gamma ferric oxide, with extremely fine acicular (needle) shaped crystals . . . actually they are less than one micron in length and can only be viewed under an electron microscope. The iron oxide is mixed by the ton in huge ball mills. These are containers filled with thousands of steel balls, which when the oxide is added and rotated continuously for long periods, grind the oxide down to the tiny needle particles. The iron oxide powder is mixed with a lacquer substance and a solvent, which from its highly volatile odor I guessed was acetone or something similar. This combination is now called a dispersion (known as "slurry" in our country) and is mixed very thoroughly to assure uniformity. Now the dispersion is a liquid in which each single iron oxide particle is enveloped

in a lacquer coating so that the individual particles . . . no matter how infinitesimal . . . no longer have any direct contact. To guard against any possible agglomerations of particles, the dispersion is put through a special filtration process before being pumped to the coating machines.

The coating machines are in the "white" section, which means all entrance and exit are through air locks. There dust is evacuated by vacuum, and special air conditioning insures constant temperature control. All personnel must wear special dust-free clothing. All these precautions against the intrusion of dust are important for regular types of magnetic tape and even more so for the finicky users of computer tape. The coating machines are of proprietary design and much the same in both the Willstaet and Bedford plants. At the feed end of the coater, the carrier film is washed and dried, and then the liquid dispersion is coated on the base by precision equipment assuring a constant uniform flow. Following the coating station is an inspection device to check the thickness of the coating. In turn, a magnetic field is set up covering the entire width of the film. Since the coating is still moist, the needle particles of oxide are still able to move, and the field orients the particles in the longitudinal plane of the coated film. The freshly coated film passes through a drying tunnel which evaporates the solvent by hot air. The solvent/air mixture is drawn off, liquified, cleaned, and stored for reuse. The now finished magnetic film is checked a second time

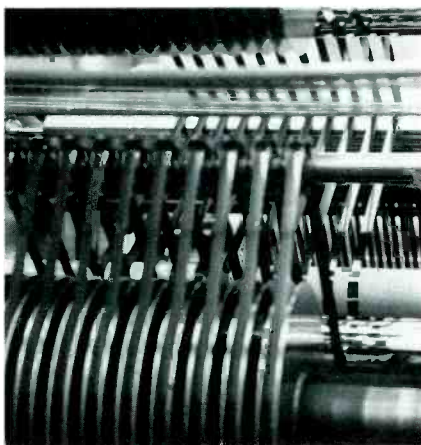

**High precision cutter** unit for computer tapes which cuts the film into individual tapes with extreme accuracy.

for uniformity of coating and then wound onto large rolls called "blocks."

Before the wide magnetic film is fed into the precision slitting machines, it

passes once again through a "calendering" roller where a combination of heat and pressure improve the surface smoothness and subsequent mechanical "wrap" of the tape. I always had the notion that the slitting machines used razor sharp knives, and that the scalloped edges we used to get now and then were simply a case of a dull knife. Not so at all. The cutters are spaced sort of wheels, and the edges of the wheels do the trick with a shearing scissor-like type of cutting. There are various slitting machines for different tape widths and by far the most fascinating is that for cassette tape. Before your eyes, this approximately 30-in. wide tape becomes dozens of strands of cassette stock. After slitting into various widths, the tape is sent to the girls in the packing sections, to become open reel, cassettes, and with the special back-lubricated tape . . . cartridges. The special tape for computers is literally inspected inch by inch by a squad of girls, who also test the tapes on standard computer tape drives.

There in essence is how tape is made . . . certainly a fascinating process, and interesting to watch, but you must be careful you don't get "high" on the solvent fumes!

After being guided through the Willstaet tape manufacturing facility, Hans Cabus, the indefatigable PR man from BASF, took us through the cassette assembly area, where we watched automated machinery putting together upper and lower shells with their tape packs. In this plant the cassettes were assembled with screws. In Bedford the cassette joining is by sonic welding. I don't know why the difference, and I have heard pro and con on the worth of each method. In still another section Mr. Cabus proudly showed us a battery of about 10 Gauss Electrophysics cassette tape duplicators, busily spinning away and producing the world's first Dolbyized chromium dioxide pre-recorded cassettes. Incidentally, BASF makes its own CrO<sub>2</sub> tape under du Pont license. Yes, BASF has entered the music business with a bang. In fact, they are even going to make discs as well. The music is both pop and classical, the latter being drawn from the Harmonia Mundi catalog. I have some of the new cassettes and they are really top quality.

After Willstaet, it was over to the immensity of Ludwigshafen, and thence to the lair of Willi Andriessen. In his laboratory, there were scores of cassette machines undergoing tests with BASF tapes. Many "standard" cassette "test beds" did repetitious testing of some aspect of BASF cassettes. The same held true for cartridges, with many units involved in life testing.

# Can you live without a 400 watt amplifier?

Maybe. If you're content to listen to music at a less than realistic level. Or if you don't mind the loss of quality caused by clipping during the more dramatic passages in your favorite records. On the other hand, if you want to listen at a real-life level without distortion, you need at least 400 watts of amplifier power. Other things being equal, the more power you have to drive those fine speakers, the more faithful the sound. Julian Hirsch put it this way: "Anyone using a low-efficiency speaker . . . with an amplifier in the 30 to 50 watt class cannot approach realistic listening levels without severe clipping." And *Audio*, after listening to the Phase Linear 400, said, ". . . many people do not realize just how much power is necessary to handle peaks without clipping . . ."

*Stereo Review* summed up: "A superb amplifier, furnishing the essential qualities of the (Phase Linear) Model 700 at a much lower price (almost a bargain in today's market)."

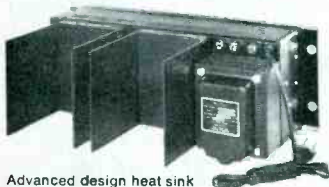

Advanced design heat sink provides protective cooling.

At \$499.00 why live with anything less than the Phase Linear 400? Ask your dealer for an audition.

## Phase Linear 400

THE POWERFUL DIFFERENCE

PHASE LINEAR CORPORATION  
P.O. BOX 549  
EDMONDS, WASHINGTON 98020

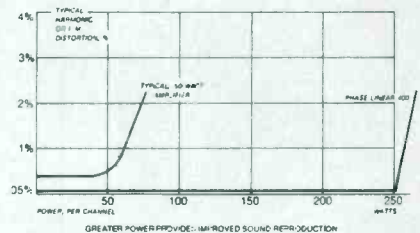

**Phase Linear 400**  
400 watts RMS direct coupled solid state stereo power amplifier.

**POWER:** Greater than 200 watts/channel RMS both channels driven into 8 ohms. Power at clipping typically 250 watts/channel into 8 ohms and 400 watts/channel RMS into 4 ohms. **HARMONIC OR I.M. DISTORTION:** Less than .25%; typically less than .05%.

**PROTECTION:** Patented protection circuit monitors energy, shuts down amplifier if safe operating levels are exceeded. **HUM AND NOISE:**

Better than 100 db below 200 watts. **STABILITY:** Absolutely stable with all speaker loads including electrostatic units.

**WARRANTY:** Three years, parts and labor.

**PRICE:** \$499.00

**WALNUT CABINET:** \$37.00.

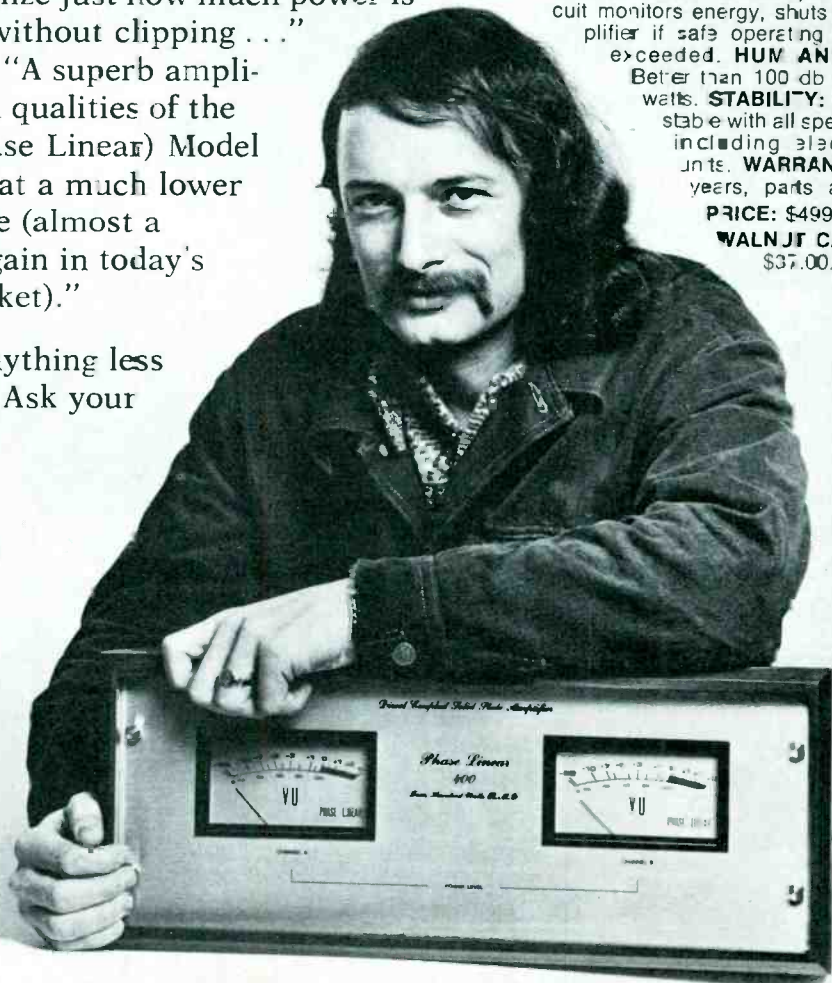

Check No. 25 on Reader Service Card

# imagine:

THAT A MANUFACTURER  
DEVELOPED A TRANSMISSION  
LINE SPEAKER THAT COULD  
EQUAL OR BETTER THE  
BEST BOOKSHELFS FOR

## \$150-\$200

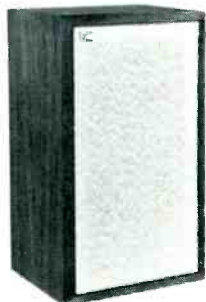

RSL 211S

# imagine:

YOU COULD BUY IT  
WHOLESALE FOR

## \$99.95

# ROGERSOUND LABS

# A REALITY!

MANY MODELS TO CHOOSE  
FROM—ALL FACTORY DIRECT.

FREE TRIAL ON ALL  
RSL SPEAKERS



6319 VAN NUYS BLVD.  
VAN NUYS, CA. 91401  
Phone: (213)78-SOUND

Check No. 30 on Reader Service Card

Then there were many specialized devices for testing such parameters as tensile strength, stretch resistance, abrasive qualities vs. head wear, and many more.

Our BASF friends did not forget the social amenities and we were regally wined and dined. One night we were the guests of PR chief Mr. Hans Vorier and his charming wife in the little village of Neustadt in the Palatinate wine country which is not too far from Ludwigshafen. We went to this old inn and drank some crisp clean wines and some of the sweeter "spatlese," which don't travel well and we never see in our country.

All in all, we certainly enjoyed our trip and learned a great deal about magnetic tape. Our German friends at BASF made every effort to assure us a good time. They are gracious and discerning hosts.

So it was that Ruth and I boarded the wonderful "Rembrandt" train to go up the west bank of the Rhine through the wine country to Amsterdam and thence to Rotterdam for the European convention of the AES.

Mention of current happenings concerning the CD-4 discrete system were inadvertently omitted from this column in May. We complete that article now to keep you up to date.

Warner/Elektra/Atlantic record group announced they would adopt the CD-4 system for their quadraphonic recordings. Thus the discrete disc camp gets a tremendous boost, since the WEA group is one of the dominant companies in the pop field. Between RCA and WEA, the CD-4 system can now claim to be used by one third of the industry. JVC also claims that since the WEA announcement, licensing negotiations are now proceeding with other record companies, including a prominent and prestigious European company. JVC further announced that virtually all hardware manufacturers in Japan with the exception of Sony, have signed licensing agreements to use CD-4 in their equipment. Also, because of the WEA agreement, JVC is setting up a cutting system in Los Angeles, which they claim can cut 200 CD-4 masters per month. This cutting channel will be a half-speed (16 $\frac{2}{3}$ ) unit. Speaking of which, I recently visited Bill Dearborn, chief engineer of RCA Records, and he showed me his CD-4 cutting channel. His unit still operates at 11.33 rpm, which was the original CD-4 speed, and which had certain limitations. Bill expects to go to half-speed operation shortly, and points out that the Neumann lathe has provision for a standard

plug-in 16 $\frac{2}{3}$  rpm speed change module, and that the Dolby A units have long had 16 $\frac{2}{3}$  cards available. Bill is also using a new cutting stylus with a back angle of 35 degrees instead of 45 degrees. (Incidentally, the cutter is now helium cooled.) This change in back angle enables cutting further into the inner diameters of the lacquers with good resolution; thus the time factor on a CD-4 disc, a somewhat controversial point, is extended and Bill claims that 28-29 minutes per side, even with relatively high velocity material, is possible. Another advantage of the 16 $\frac{2}{3}$  speed is that the lowest frequency involved is 15 Hz, rather than the 11 Hz of the 11.33 rpm operation. In practical terms, this means better bass response on playback.

RCA has finally begun to release more CD-4 discs. I have an excellent new Mancini recording of some Sousa marches . . . plenty of rousing brass and good bass drums. Best of all, is a fine classical output, mainly Philadelphia Orchestra recordings of such as the Sibelius 2nd Sym., Scheherazade, La Mer, Rachmaninoff 2nd Piano Conc. with Rubenstein, some Bach Double Fugue orchestral transcriptions. JVC has now over 200 CD-4 discs in Japan, and while none of these were allowed to be imported into the U.S. up to now, a new agreement with RCA allows some to reach our shores . . . providing there is no conflict in terms of repertoire. So the software picture which has been a weak point of the Quadradisc program is being improved, and of course, with the anticipated WEA releases, the output will increase rapidly.

Does all this CD-4 activity mean that the matrix people . . . the QS and SQ proponents, are losing ground? A hard question to answer, but I still feel that we are to have co-existence of these systems for quite a while yet. SQ still has a formidable amount of software on the market, and plenty of equipment is equipped to decode the discs. QS has an excellent variable matrix decoder that is now beginning to appear on some new Sansui receivers. Recently Ben Bauer, the genial "quadfather" of the CBS SQ system, let me hear his new "Parametric" matrix decoder, and it certainly provided an impressive four-channel sound. It would be silly to deny that all the CD-4 activity in recent weeks, hasn't had a big impact with many record companies. Some say it is the beginning of a trend. I personally think it will be interesting to see what happens when in the next month or so, the SQ logic IC chip and the Panasonic demodulator chip arrive on the market almost simultaneously!



# QRX-3500

## the Sansui

### all-in-one

### 4-channel

### receiver

Phase Matrix

QS Synthesize

QS Regular Matrix

Discrete



The trouble with most four-channel components available today is that many of them aren't capable of handling all kinds of four-channel program material.

Not so with the new Sansui QRX3500. This versatile unit:

- decodes records, tapes and broadcasts made with the superior Sansui QS matrix encoding process;
- decoded SQ program material (and does it better than many other competitive units).
- creates magnificent four-channel sound from regular two-channel sources (rather than just offering you two-channel amplifier sections strapped together for "double stereo" which sounds phony).
- accepts the output of any discrete demodulator via its "discrete" input position;
- handles two four-channel and one two-channel tape decks;
- has extremely low distortion figures (less than 0.5%) and is conservatively rated at 180 watts (IHF), coupled with wide frequency response for brilliant, clean reproduction.

Sansui's new vario matrix is the main reason for the QRX 3500's great versatility. It decodes better and it synthesizes better than any other quadrasonic circuitry available. And the QRX 3500 has a host of other features including individual bass and treble controls for each channel, sensitive FM/AM tuning section and provision for an optional "joystick" remote control.

See the QRX 3500 at your nearest franchised Sansui dealer soon and hear what it can do.



#### SANSUI ELECTRONICS CORP.

Woodside, New York 11377 • Gardena, California 90247

SANSUI ELECTRIC CO., LTD., Tokyo, Japan • Sansui Audio Europe S. A., Antwerp, Belgium

Check No. 31 on Reader Service Card

# Editor's Review

---

**A**FTER LAST MONTH'S test reports on quadraphonic headphones, it seemed appropriate to review the latest developments in four-channel decoding hardware as well as in recordings. Ben Bauer leads off this month with a discussion of CBS technology and discs. Next, we have an article recapping the history of quadraphonic equipment by Len Feldman, who finds four distinct phases in that history. Contributing Editor Harry Maynard tells us why four-channel equipment is a good buy *now* even though there will be further important developments in the field, ones which could well make present equipment obsolete. Finally, we have several reviews of the latest JVC/RCA discs, together with a brief discussion of that system. Some of these records, says our reviewer, are quite impressive.

## Cassette & Cartridge Recorders

A nationwide survey of male owners of cassette and cartridge recorders/players reveals that 9.8 million men own cassette recorders and 6.7 million have cartridge tape units. Carried out by Leisure Time Research on a sample of 6,000 males over 15, the survey also showed that discount stores lead in total number of blank cassette purchasers, but that department stores attract most of the heavy users. Blank cartridge buyers favor hi-fi stores, an outlet which ran a strong third in blank cassette sales. Interestingly, half of the cassette tape customers bought both blank and prerecorded cassettes, but of these who bought only one type, twice as many purchased blank tape. Some 20 per cent of the blank tape buyers preferred chromium dioxide coating, and 64 per cent bought 60-minute cassettes. While the use of stereo cartridge units in automobiles remains important, there are more than twice as many of these units in homes, says the survey.

Musical preferences were as follows: For cassette customers, their favorite music was popular at 30 per cent; rock at 29 per cent, and classical with 20 per cent. Among cartridge tape buyers, 34 per cent preferred rock; 26 per cent popular music, and 20 per cent country-western.

While all the implications of this data are not clear, we do know that high quality (and more expensive) cassette recorders have become a great deal

more popular for home use in the past few years. The greatest spurs to this have probably been the noise-reduction systems and better transport systems, though much work has been done on CrO<sub>2</sub> and LN tape formulations as well.

It would be interesting to speculate on the possible effects created by the release of huge numbers of four-channel cartridges. Quite a few are already available, according to the Schwann catalog, and many releases are only available on tape, with no four-channel disc version mentioned.

Cartridge machines have not as yet benefitted greatly from the work done on the cassette medium. However, it would be very nice to see some of the cartridge machines incorporate the high quality transports and the noise-reduction systems, such as are used in cassette machines. With this sort of development, the cartridge medium might well move ahead of the cassette in the hi-fi bug's esteem.

## "Helping The Handicapped"

Billy G. Brant's article in the May, 1973, issue of *AUDIO*, with the above title, sparked a letter from Fred Brufloft of Michigan State University's news bureau, who says the MSU will soon be starting a service very similar to that at Univ. of Kansas. Called "Radio Talking Book," the program on MSU's WKAR (90.5 MHz) will also use a sub-carrier receiver, fix-tuned to the special subchannel. Programming will consist of readings of current newspapers, magazines, and best-selling books. According to the station's general manager, Richard Estell, there will be an initial distribution of 500 of the special receivers, which are expected to cost about \$50.00 each when purchased in quantity. Mrs. Florence Harvath, coordinator of special projects for WKAR, says funds for the programming include \$61,000 from the Dept. of Health, Education, and Welfare and \$50,000 in matching funds from the university. However, Mrs. Harvath points out that an additional \$65,000 will be needed for the first year of operation. Community support for the project is strong, she says, noting that more than 125 persons have volunteered to read the materials. "We figure that we need about 100 volunteers each donating about three hours a week," says Mrs. Harvath. E.P.



Warranty Registration 6977

Stanton Dynaphase Sixty  
To protect your guarantee, mail this card at once. All information must be supplied in order to validate the warranty.

Purchased by STAN OTTENBREIT 94606 CAL  
(Please type or print)

Address 338 PORTLAND AVE # 7 OAKLAND,

Date of Purchase 18 DECEMBER 1972

Dealer's Name MUSIC'S STEREO City BERKELEY

TYPE OF USE:  
 Professional  
 Home

Where did you first learn of product?  
 Advertising  
 Dealer  Other

Your age (check one)  
 under 25  
 26-35  
 over 35

Your comments on sound quality and overall design: FINEST I HAVE HAD  
EVER - TOTALLY SUPERIOR TO OTHER MODELS I SAMPLED

Do you own another headset?  yes  no  
 If yes—give make and model: STANTON

## Say it again, Stan— We love the sound of your words!

As a matter of fact, Stanton has so many wonderful quotes on the warranty cards that purchasers send in, that we are letting them write this ad.

- “The best sound I have ever heard from my sound system — fantastic!”  
Jeff E. Booker, 4425 N. 150th St., Brookfield, Wis. 53005
- “Very comfortable. Stylish, Excellent Sound.”  
Gary A. Wanlin, 3266 Cropley Ave., San Jose, Calif. 95132
- “Absolutely Great — especially by comparison.”  
John E. Robinson, 199 Middle Rd. F, Portland, Me.
- “The headphone is the best I’ve heard.”  
Eddy Schreyer, 5701 Cahill Ave., Tarzana, Calif. 91356
- “Good sound, much better than other comparable brands. Excellent design.”  
Terry Ames, 2602 Calhoun St., Alameda, Calif.
- “Excellent bass response. Comfortable headset.”  
Phil Lulewicz, 15335 Stetson Rd., Los Gatos, Calif. 95030
- “The most amazing, most natural sound I’ve ever heard.”  
Stephen Sandoz, 6815 S.W. 12th Ave., Portland, Oregon
- “Excellent. Best I’ve listened to.”  
J. L. Hubbard, 3625 Pine, Long Beach, Calif.
- “The best I have ever used or heard.”  
Howard J. Millbank, 2260 Adair St., San Marino, Calif. 91108
- “Sound quality is vibrant and separation is excellent. Prefer Stanton over [censored]”  
Thomas L. Saunders, 2408 Phillips Dr., Alexandria, Va. 22306
- “Excellent performance. Fantastic Power handling capability.”  
Todd Sadow, 20 Black Hawk Road, Scarsdale, N.Y. 10583

- “The best I have ever heard.”  
Ronnie Lustig, 933 Percy Warner Blvd., Nashville, Tenn.
- “Excellent, best I have ever heard.”  
Richard Sirois, 508 S. Michigan, Plymouth, Ind.
- “Excellent.”  
Florence A. Davis, 191 Congress Ave., Providence, R.I.
- “Excellent.”  
Steven D. Melchior, 4540 Hazeltine Ave., No. Hollywood, Calif.
- “The headset is the most comfortable and best sounding I have seen.”  
Craig Biggs, 285 Andsbury Ave., Mt. View, Calif. 94040
- “The best of 20+ headsets tested.”  
Michael Fink, 17162 Erwin Lane, Huntington Beach, Calif. 92647
- “FANTASTIC!”  
Brian D. McCarty, 364F Vinton Ave., Palms, Calif. 90034
- “FANTASTIC!”  
James P. Schwider, 5520 W. 190th St. 151, Torrance, Calif. 90503

And, that is only a sampling... we have thousands more!

For complete information write Stanton Magnetics, Inc., Terminal Drive, Plainview, New York 11803.



“Manufacturers of the World Famous Stanton Calibration and Professional Broadcast Cartridges.”

Check No. 44 on Reader Service Card

# SQ UPDATE--



Benjamin B. Bauer\*

# 1973

**T**O THE SQ system, the past year has brought significant progress, major technological improvements, and an established public acceptance. SQ (a trademark of CBS, Inc.) effectively has become the standard matrix system worldwide.

With respect to progress, 75 brands of audio equipment produced by SQ licensees are now available or are about to become available in the USA and abroad. These 75 brands account for over 75 per cent of world's sales of audio equipment. It is estimated that over 1/2-million SQ decoders currently are in the hands of music lovers the world over.

A basic U.S. patent No. 3,708,631 has been issued to CBS covering broadly various aspects of logic decoders. A cross-license agreement has been concluded with Electro-Voice with respect to a basic Scheiber patent, No. 3,632,886 and this has enabled SQ licensees to enjoy the developments and the protection of both patents.

\*CBS Laboratories, Stamford, Conn. 06905

Some of the best known record labels in the USA and throughout the world have issued SQ-encoded records. More than 200 SQ albums are now commercially available.

World-renowned artists and conductors have given the SQ system an enthusiastic endorsement and have adopted it in the performance of major works. While the majority of these are of traditional "concert-hall ambience" variety, some have been especially planned for quadraphonics—such as Bernstein's *Mass*, Biggs at the Organ of St. George's Church, and Boulez' Interpretation of the Bartok *Concerto*. The greats in the worlds of jazz, rock, and country and western music have been able to create more intimate sense of identification with the listeners by applying the SQ surround-sound technique.

Stereo-FM broadcasting stations have found the SQ records to be an ideal source of quadraphonic program. SQ records are transmitted and received as conventional stereo programs on existing FM-multiplex receivers, and are readily converted



Lafayette LR-4000 AM/FM receiver



Sony Model SQD 2020 "full logic" SQ decoder

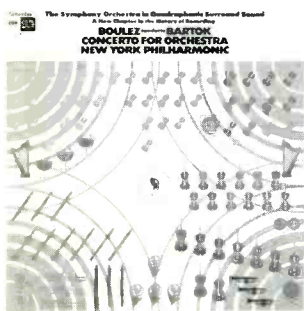

# Are you playing your records or ruining them?

If you're like most music listeners, you never think about your records after putting them on your record player.

You just sit back and enjoy the music.

Chances are you'd be less relaxed, if you knew that your records might be losing something with every play.

Like the high notes.

It's something to think about. Especially when you consider how many hundreds or even thousands of dollars you have invested in your record collection. And will be invested in the future.

## What happens during play.

Even the cheapest record changer can bring its tonearm to the record and lift it off again. But what happens during the twenty minutes or so of playing time is something else.

The stylus is responding with incredible speed to the roller-coaster contours of the stereo grooves. This action recreates all the music you hear, whether it's the wall-shaking cacophony of a rock band or the richness of a symphony orchestra.

The higher the frequency of the music, the more rapidly the contours change, and the sharper the peaks the stylus has to trace. If the tonearm bears down too heavily, the diamond-tipped stylus won't go around those soft-vinyl peaks. Instead, it will lop them off. The record will look unchanged, but your piccolos will never sound quite the same again. Nor will Jascha Heifetz.

## It's all up to the tonearm.

What does it take for the stylus to travel the obstacle course of the stereo groove without a trace that it's been there?

It takes a precision tonearm. One that can allow today's finest cartridges to track optimally at low pressures of one gram or less. For

flawless tracking, the tonearm should be perfectly balanced with the weight of the cartridge, and must maintain the stylus pressure equally on each side wall of the stereo groove. And in order to

maintain this equal pressure during play, the tonearm must not introduce any drag. This requires extremely low friction pivot bearings.

There is much more to the design and engineering of tonearms and turntables. But this should be sufficient to give you the idea.

## Dual: the music lovers' preference.

By now you probably understand why serious music lovers won't play their precious records on anything but a precision turntable. And the most serious of these people, the readers of the leading music magazines, buy more Duals than any other make of quality turntable.

If you would like to know more about Dual turntables, we'll send you lots of interesting literature, including an article on how to buy a turntable, and reports by independent test labs. Or better yet, just visit your franchised United Audio dealer and ask for a Dual demonstration. You will never have to worry about your records again.

**Dual**

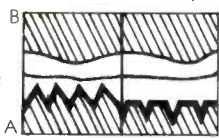

High frequency peaks can be lopped off as in A right. Less fragile low frequency contours are shown in B.



Dual 1214, \$109.50

Dual 1218, \$169.50

Dual 1215S, \$125.00

Dual 1229, \$225.00

## How Dual protects your records.



Tonearm counterweight is elastically isolated from shaft to absorb any external shock, and is continually adjustable on vernier threads for perfect balance.

Gyroscopic gimbal suspension of 1229 and 1218 is best known scientific means for balancing precision instruments that must remain balanced in all planes of motion.

In all Duals, stylus pressure is applied around the pivot maintaining perfect dynamic balance of tonearm.

1229 tonearm is 8 3/4" from pivot to stylus, essentially eliminating tracking error while maintaining one-piece stability.

Unlike conventional tonearms, the 1218 and 1229 track records at the original cutting angle. The 1229 parallels single records, moves up to parallel changer stack. The 1218 has a similar adjustment in the cartridge housing.

For perfect tracking balance in each wall of the stereo groove, separate anti-skating calibrations for conical and elliptical styli are provided on all Duals.

United Audio Products, Inc., 120 So. Columbus Ave., Mt. Vernon, N.Y. 10553

Exclusive U.S. Distribution Agency for Dual.

Check No. 41 on Reader Service Card

to quadraphonic reception by means of an SQ-decoder and two additional loudspeakers. A four-channel tape can be broadcast in the SQ mode by passing it through an SQ encoder and straight on to the transmitter. More than 200 FM stations are estimated currently to be transmitting SQ programs in regular program series.

The main reason for overwhelming popularity of the SQ system in broadcasting is the fact that, with respect to the stereophonic listener, full front-channel separation is preserved; and for the monophonic listener (80% of all FM receivers are still monophonic!), all four channels are reproduced at precisely equal levels. This capability of the SQ system is most important with the great new classical works as well as with the popular programs which use the surround-sound technique (with the artists distributed more or less equally in all channels). The SQ system is the only known matrix system which possesses both these desirable characteristics.

### Decoding Advances

On the technical front there have been a number of major SQ advances. It should be noted that these advances have not, in any way, changed the original SQ concept which remains precisely as it was at the time of its public introduction at Montreux, Switzerland, in June of 1971.

Important improvements have been made in the area of home-type instruments, with the result that better and more economical SQ-type equipment has been produced. A solid-state integrated matrix chip (Model MC 1312) has been introduced by Motorola, under CBS sponsorship, and this has made it possible for all SQ licensees simply and inexpensively

to produce precise SQ matrix decoders, both of the free-standing variety and built in to FM receivers and phonograph amplifiers.

With the recognition that the ultimate realization of SQ resides in the implementation of the logic system, a number of excellent logic decoders have been introduced in the marketplace. The simplest of these are of the front-back logic variety, which enhance the center front and back separation, allowing the naturally broad side-to-side separation of the SQ Matrix to be utilized. The more advanced ones add a "wave-matching logic" to the front-back logic circuit, allowing a 20 dB separation to be maintained all the way around the room. An even more advanced form of logic, which includes a "variable blend" together with the wave-matching logic allows the SQ decoders to maintain virtually infinite separation between the front and the back pairs of channels for corner signals, while permitting a 20 dB channel separation to be provided in all front-back modes.

Unique among the noteworthy full-logic decoders is a new Model SQD-2020 full-logic decoder introduced by Sony and a Model LR-4000 AM-FM receiver produced by Lafayette.

Again in cooperation with Motorola, two more SQ integrated circuit decoder modules have been designed: A full-logic module MC 1315, which embodies, in a postage-stamp size IC, a front-back logic and a wave-matching logic; and a power-transfer module MC 1314 which has the dual purpose of accepting the logic commands and translating them into enhanced quadraphonic action. The MC 1314 also acts as a gain control and loudspeaker balance element and it permits the gain of all four channels to be adjusted, with a tracking error not in excess of 1 dB over an 80 dB volume range. This action is realized with but a single potentiometer: Anyone who has attempted to obtain a well-tracking four-channel

Sony's Ferrite and Ferrite recording heads let you record all of the baritone flute. All of the tenor sax. That's because this unique Sony development controls the width of the gap over which your tape passes during recording to the exact tolerance necessary for truly fine sound reproduction. When you record with Sony quality engineered Ferrite and Ferrite heads, your playbacks have all the high and low frequencies of the original sound.

What's more Sony's Ferrite and Ferrite heads are cleaner, stronger and more durable than ordinary heads. The edges of Sony's Ferrite and Ferrite heads are virtually chip resistant. No pits and cracks to distort the sound and collect dust. And Sony's Ferrite and Ferrite heads reduce eddy-current losses to the very minimum.

Experience the performance breakthrough of Sony's Ferrite and Ferrite head tape recorders with exclusive closed-loop dual capstan tape drive system in both reel-to-reel

## Don't lose your



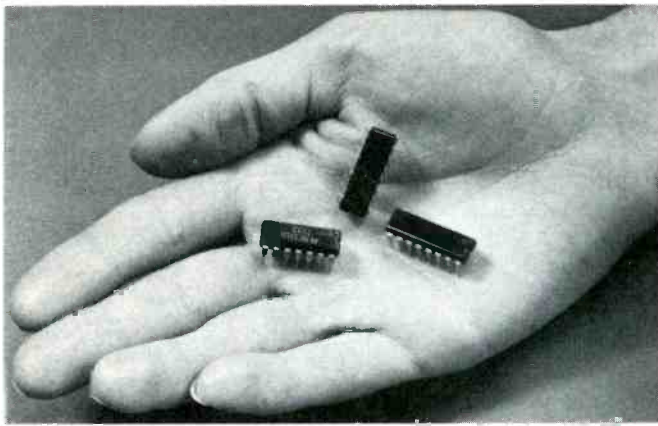

The SQ "full logic" decoder is comprised of these three IC chips from Motorola.

potentiometer for a master volume control of a quadraphonic system will at once recognize the advantage of such an arrangement. The balance action also is obtained with but three potentiometers: balance between the front pair of loudspeakers, the back pair of loudspeakers, and front-to-back.

A further refinement in the logic control module allows the logic action to be adjusted in order to compensate for the acoustical conditions of the listening room—a living room with carpet, drapes, overstuffed furniture usually has sufficiently good acoustics to perform well with "normal" logic action, while a room with harder boundaries and little absorption may require a super-normal amount of logic action to produce superior quadraphonic separation. The flexibility of the

new IC chips permits the user readily to optimize the quadraphonic performance in his own living room, at the same time enjoying the significant savings of the IC construction.

It should be emphasized that the above developments do not detract from the decoders already manufactured using discrete solid-state circuitry. They merely result in greater manufacturing convenience and economy. Also, it should be kept in mind that every SQ decoder, even the simplest one, in every sense of the term is a high-fidelity decoder. Its frequency characteristic, dynamic range, freedom from distortion, signal-to-noise ratio—all meet the strictest demands of high-fidelity standards. The addition of logic—even of the most sophisticated type—contributes only to precision of directional response; and so far as we have been able to ascertain most music lovers don't particularly care if, in a surround-sound situation, an instrument appears to play, say, from a northeast by east or a northeast by north direction. For the professional who *does* care about extreme directional precision the more advanced full-logic decoders provide complete satisfaction—but at a higher price.

### Recording Advances

Significant improvements have been made in the area of professional encoding equipment. Again, these improvements have not resulted in the introduction of any incompatible changes—but to the artist, producer, and recording engineer, they have brought important new tools for creating more effective and satisfying SQ records. A new SQ encoder module Model 4211 has been designed replacing the original Model 4200 encoder. The Model 4211 module in addition to the "standard" SQ encoder mode also provides a so-called "front-looking encoding mode" especially desirable for broadcasting quadraphonic tapes not previously produced with the SQ tech-

©1973 Superscope, Inc., 8142 Vineland Ave., Sun Valley, Calif. 91352. Prices and models subject to change without notice. Send for free catalog.

# flute in the gap!

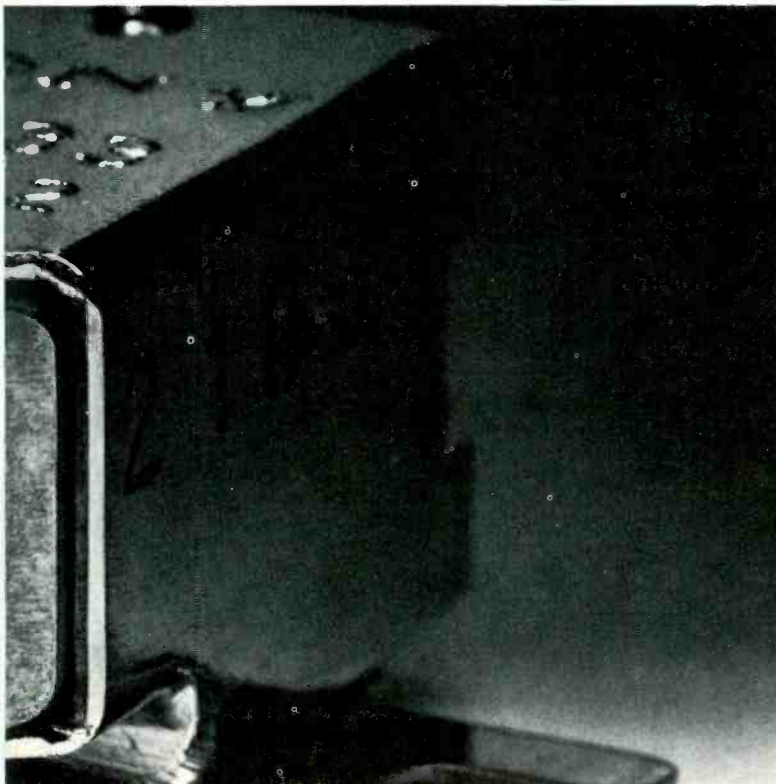

and cassette deck models. In reel-to-reel choose either the TC-280 at \$199.95 or the TC-377 at \$299.95. If a stereo cassette deck is what you're looking for, there's the TC-134 at \$239.95 or the TC-161SD at just \$299.95. Get the clear crisp sound of Sony with Ferrite and Ferrite in the model that best meets your recording needs. They're just part of a full line of superior Sony recording equipment starting as low as \$99.95 at your nearest Sony/Superscope dealer. He's in the yellow pages.



Sony Tape Recorders  
A Product from **SUPERSCOPE**

Check No. 63 on Reader Service Card

nology in mind and a "back-looking encoding mode" for providing special effects within the SQ code requirements. The Model 4211 module also provides input terminals for improved side-mode encoding which results in enhanced separation for center-side signals.

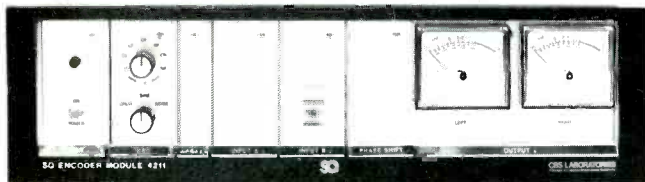

CBS Laboratories' improved Model 4211 encoder module

The Model 4211 module also is capable of accepting one or more pan pot modules, Model 4212. Each pan pot module has 8 directional potentiometers which allow optimum encoding conditions to be achieved over 360° horizontal circle. By using two pan pot modules, for example, each channel of a 16-track master machine may be connected directly to its corresponding pan pot, which allows the producer readily to place any sound in any desired location or to move it about at will. Again, by the flip of a switch, each pan pot may be caused to guide the sound in a figure-eight mode, allowing the signal to be "panned" across the front and back walls or along the diagonals, and even to achieve "diagonal splits" with the outputs appearing preferentially in the left front-right back loudspeaker pair or in the right front-left back pair.

It should be noted that the SQ system is the only matrix system which allows the diagonal pairs of splits to be achieved.

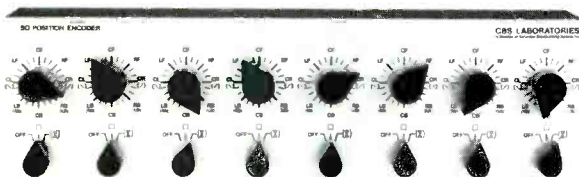

CBS Laboratories' Model 4212 "pan pot" position encoding module

A third encoding module is the discrete module Model 4213. This also plugs into the 4211 encoder translating whatever pan-pot positions have been selected for the SQ-encoded tape onto four discrete outputs. With the Model 4213 module, two master tapes are produced simultaneously: An SQ-encoded two-channel tape, which at once can be used to cut an SQ record, and a discrete four-channel tape, which simultaneously can be used to produce Q-8 cartridges. Therefore, one tape generation is saved resulting in increased fidelity of the final product.

A very significant economic advantage of the new position encoder described above is that it allows any stereophonic editing console to be converted into quadraphonic console, thus saving thousands of dollars and months of time to the studio manager.

An improved professional studio decoder, Model 2400A (Screw Terminals) and 2400B (with Cannon Plugs), has been introduced by CBS Laboratories providing the recording studio with precision means of decoding the encoded program, thus verifying the results to be obtained from the encoded master tape, or the reference disc, in an optimum manner.

### Public Acceptance

The test of merit of an artistic product is the acceptance accorded to it by the artistic and scientific community and its reception by the listening public.

On both scores, the SQ system has been eminently successful. Mark Kanny in *FM Guide* for February 1972, speaking of Bernstein's rendition of *Also Sprach Zarathustra* says, "... what I heard from the SQ disc is very different: the sound is rich and full-bodied and the performance carries conviction. I heard Bernstein conduct this piece in Philharmonic Hall, and frankly, Columbia's record sounds much better." Referring to the SQ issue of the Broadway-cast album "Company," Robert Long of *High Fidelity* magazine asserts "... there is real excitement in the album, and it reconfirms my feeling that the four-channel medium should be able to help Broadway scores escape from the patness—the canned-ness if you will—that can make the recording seem like a pale reflection of the theatre performance." Writing about the Boulez-Bartok SQ release, Martin Meyer, in a recent *Esquire* article, predicts: "It will ... greatly influence the future of musical composition," and *Newsweek* magazine refers to the recording as a "milestone." The SQ broadcast of Ormandy conducting the Philadelphia Orchestra playing Tchaikovsky's *1812 Overture*, during President Nixon's Inaugural Concert this year, has attracted an immense amount of favorable comment.

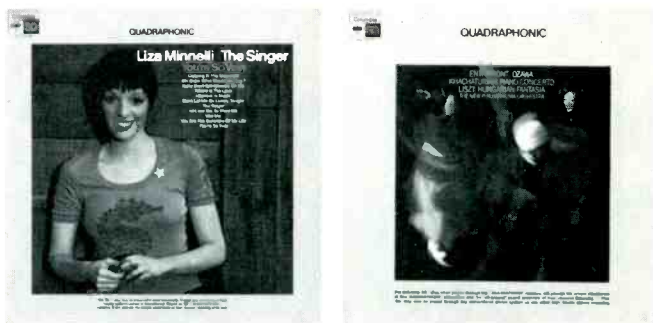

The public has been responding to the SQ product with unexpected alacrity. Sales of SQ records, despite the \$1.00 higher list price compared to the stereo counterparts, have been increasing steadily each month for over 2 years and currently are running, on the average, at over twice the monthly rates of last year's sales. SQ has brought about an unexpected renaissance of interest in the classical repertoire: The SQ issues of all new releases are outselling many of the corresponding stereo records by a significant factor.

An important factor in the popularity of SQ records is the recognition by the users that they can be readily played on existing stereophonic phonographs producing quality equal (or as some claim, superior!) to that currently enjoyed with the stereophonic product, without in any way impairing or endangering their quadraphonic capability which at once becomes evident when the record is played on a quadraphonic reproducer.

The age of Quadraphonics is truly here, and SQ is paving the way to its universal acceptance as a new standard of musical enjoyment in the home.



Dynaco A-25  
\$89.00

# Experts Agree: the Dynaco A-25 loudspeaker is unquestionably the best!

"... (The Dynaco A-25's) are quite probably the best buy in high fidelity today."

The Stereophile Magazine

"... The Dynaco had a remarkably neutral quality ... The A-25 had less of this coloration than most speakers we have heard, regardless of price ... Nothing we have tested had a better overall transient response ... Not the least of the A-25's attraction is its low price ..."

Julian Hirsch in Stereo Review

"... it was its outstanding transient response which really impressed us. Tone bursts throughout the meaningful frequency range showed up its excellence. In truth, the A-25 produced the finest tone-burst response of any speaker in this manner, regardless of price."

Audio

**dynaco inc.** Division Tyco

3060 JEFFERSON ST., PHILADELPHIA, PA. 19121  
Also available in Canada from Dynaco of Canada, Ltd.

DYNACO INC. A  
3060 Jefferson Street, Philadelphia, Pa. 19121

Gentlemen:

Please send me your new 1973 full color Dynaco catalog.

Name \_\_\_\_\_

Address \_\_\_\_\_

City \_\_\_\_\_ State \_\_\_\_\_ Zip \_\_\_\_\_

# Some infrequently-frequency response

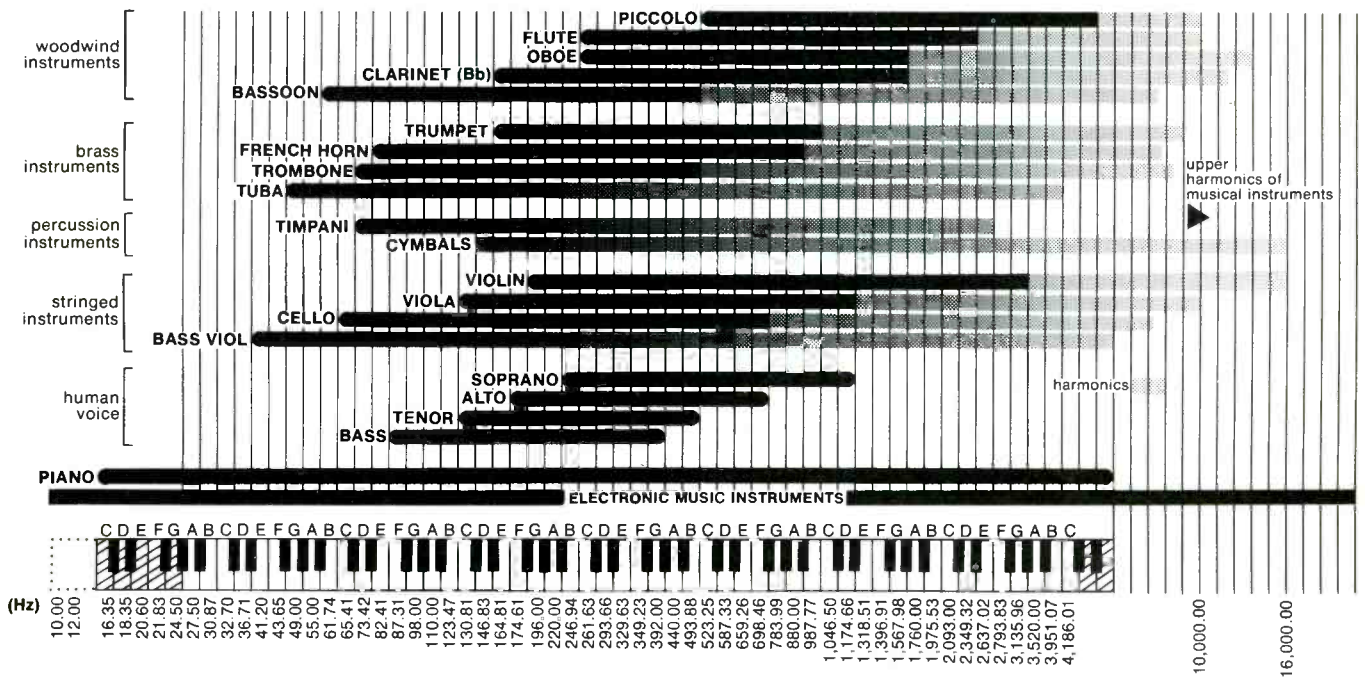

Chart 1. Frequency ranges of musical instruments and the human voice.

## Chart 2.

An approximation of volume levels of various types of orchestral music.

(This is a guideline chart, naturally subject to variables of orchestration, micing and mastering equalization.)

1. Electronic music (rock, underground and synthesized)
2. Semi-electronic music (pop-rock, some country-western and contemporary jazz)
3. Average "normal" acoustic orchestra (classic, semi-classic, "easy-listening" and jazz)

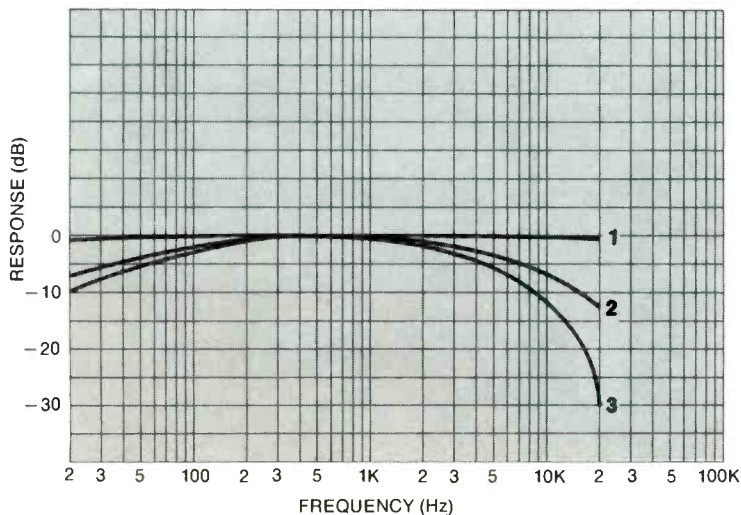

## Chart 3.

Showing high-end frequency-response loss at various dynamic levels, and comparing this phenomenon for different tape formulations.

(Note: Tape response characteristics will vary somewhat from brand to brand, and machine to machine).

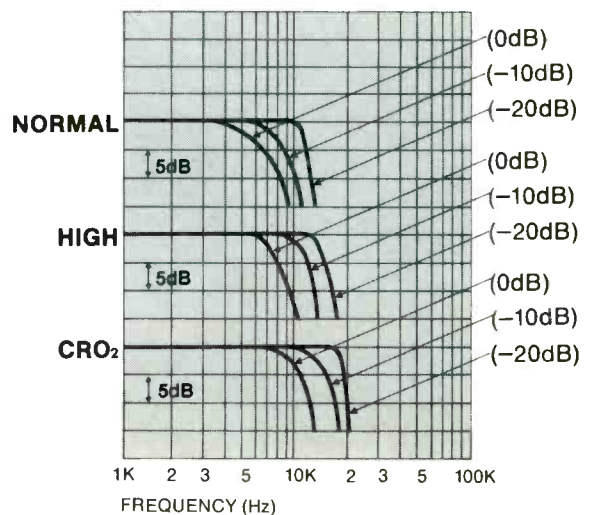

# Known facts about

Audio buffs are discovering that even with increasingly sophisticated equipment, their recordings sometimes lack high-end frequency response. Despite your careful attention to recording levels, as shown on the meters, this high-end roll-off can occur with all decks—reel-to-reel and cassette—and at all recording speeds. However, it is more evident in cassette recording. It results from a phenomenon of tape called “saturation.”

Once you understand the cause, the cure is simple.

High-end frequency-response losses occur when the head is unable to impress on, or retrieve from the tape's oxide particles the shorter wave lengths of the signal. In other words, when the wave length is actually shorter than the gap in the playback head, the head is simply unable to detect the signal. Increasing the record levels past this point demands more of the oxide particles than their magnetic properties permit, and distortion and saturation occur. However, this phenomenon, while somewhat due to the limitations of tape, is to a great extent a function of speed.

To put it another way: tape can only take so much high-end at high levels before losing response. Let's look at some reasons.

## 7½ is longer than 1⅞

With reel-to-reel, all the information in one second of time is distributed over 7½ inches of oxide particles. In the case of cassettes, this identical amount of information must be contained within 1⅞ inches of oxide particles. Thus, cassette tape flowing slowly at 1⅞ is more vulnerable to revealing distortion and high-end saturation. Reel-to-reel tape flowing at 7½ ips is much more “forgiving”. The magnetic fields are longer, and these aberrations of the signal tend not to be revealed.

## How music differs from music

Most “normal” music—that is, classical and jazz recorded with acoustic instruments—is well within acceptable levels, and there is little danger of saturation. However, rock and the “new music” recorded with electronic instruments are loaded with high frequencies at excessively high levels. Look out. This is where a cassette

transfer made at a “normal” –4 to 0 VU will saturate. Back off to around –8 to –4.

Chart 2 shows the volume levels of various types of music. A normal acoustic orchestra shows normal

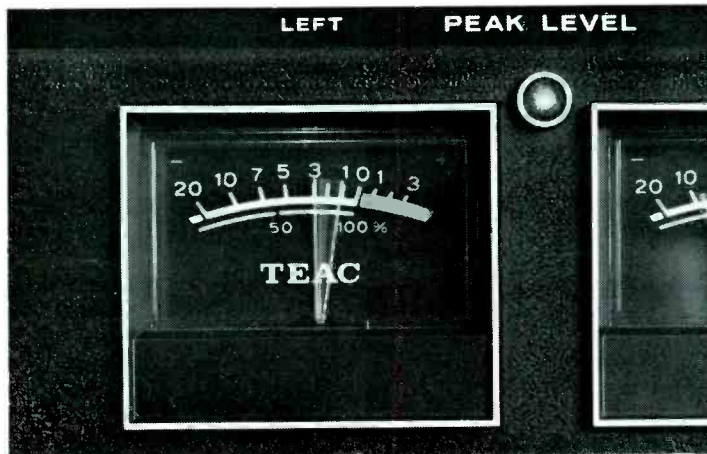

volume levels, with a “natural” rolloff at the high end. (Natural harmonics at 15 kHz are generally down over 20 dB). With this type of orchestra high-end loss will not be a problem.

However, look at the contours of pop and electronic music; these high-frequency, high-level signals will saturate quickly at 1⅞. So back off to a level that will give you a satisfactory compromise between frequency response and signal-to-noise. Remember, contemporary music puts extraordinary demands on cassette decks, so keep cassette limitations in mind. To help you avoid high-frequency loss, TEAC suggests you consider some not-so-evident facts:

## Level meters and TEAC's LED: guides, not gods

Any type of meter is a limited instrument. It cannot respond accurately to transient highs—those sharp, high-level sounds that last a fraction of a second, just long enough to saturate your tape. For this reason, TEAC has a Light Emitting Diode (LED) as featured on our top-of-the-line stereo cassette decks, to help you avoid tape saturation. TEAC's LED will supplement the meters by giving you an instantaneous peak-level indicator. When the LED flashes, you're saturating—regardless of what your meters

are telling you. The LED should be your overriding guide; if it is flickering and your music characteristically has high frequencies at high levels, back off 2 to 5 dB on your meters. However, with “normal” music an occasional

LED flicker is tolerable. Remember, your meters and LED are indicators, not controls. Look at Chart 3 showing high-end droppoff at various levels. You'll note that chromium dioxide tape resists saturation somewhat more than the new ferric oxides which saturate at a lower level, and normal ferric oxides saturate at a lower level yet.

## The ultimate input: your own creativity and judgement

There are compromises to be made all down the line, and your personal taste is the final arbiter. If you're not getting good frequency response, analyze the elements we've discussed. Then experiment. Make a test recording, backing well off on your meters to keep your LED from flickering (but not so far that on playback level you bring up “hiss” and suffer signal-to-noise loss). Regardless of what the ads say, even the finest equipment has limitations. Learn them.

Remember, saturation isn't normally caused by your tape deck—it's caused by a combination of the music, the tape and your judgement.

TEAC's LED is one guide we've developed to help you enjoy your equipment. Like every new TEAC feature, it was designed as a problem-solver—an extension of the TEAC leadership philosophy. (And if you want any other information on improving your recording

techniques, write us. We'll be happy to discuss them with you).

Enjoy your tape deck. And remember—use your wrist. It's good for your ear.

TEAC Corporation of America  
Headquarters: 7733 Telegraph Road  
Montebello, California 90640  
TEAC offices in principal cities in the United States,  
Canada, Europe, Mexico and Japan.

# TEAC®

The leader. Always has been.

Check No. 29 on Reader Service Card



# THE EVOLUTION OF FOUR-CHANNEL EQUIPMENT



Leonard Feldman

The 4-channel era is less than four years old and we have already witnessed at least four generations of equipment suitable for home reproduction of surround sound. There seems to be a frenetic endeavor on the part of component high fidelity manufacturers to be "first" with innovative products, and it is this very desire to reach the marketplace ahead of all competition that has given rise to a sometimes confusing array of add-ons, conversion components, interim components and finally, "universal" products which purport to solve all four-channel needs—now and in the future.

The transition from monophonic to stereophonic sound which, from the audiophile's point of view, took place some ten or twelve years ago had fewer "false starts." viewed in retrospect. Few stereo converts ever bothered to add a second amplifier component equipped with any sort of "combining" controls. Typically, the consumer who wanted stereo sound simply went out and bought a two-channel receiver or a two-channel integrated amplifier as the "first phase" of his transition. Later, when stereo FM broadcasting began, he either added a multiplex adapter (these devices were popular for only two or three years) or, if he

was fortunate enough to have separate amplifier and tuner facilities, he disposed of his single-channel tuner and purchased a stereo tuner. The age of solid-state equipment arrived at a very opportune moment in terms of home stereo systems, since anyone who owned a mono tube-type receiver was provided with additional incentive to buy an all-in-one solid-state stereophonic receiver. He thereby acquired state-of-the-art electronics and stereo reproduction with one new investment.

From the time stereo conversion was completed, a measure of stability descended upon the industry. Equipment up-dating from the mid-sixties to the present was largely confined to improved performance rather than change of basic formats.

## Four-Channel—Phase One

The first, hesitant entry into four-channel equipment on the part of the buying public is best characterized by the block diagram of Fig. 1—a diagram which appeared in literally dozens of tutorial articles and on countless manufacturers' brochures. Users were advised to buy a second stereo amplifier (its power output capability was the subject of much debate), a second pair of speakers (their similarity to the first

pair is *still* a subject of debate) and some form of matrix decoder with which to tie the whole thing together. At just about the same time, two additional alternatives were offered. There were the early quadraphonic amplifiers, which were simply four amplifier channels mounted on a single chassis with *no* matrix decoding facilities. There were also a group of decoder/amplifier products which offered one or more matrix decoder circuits *plus* a pair of amplifying channels and a master volume control which controlled the level of all four channels simultaneously. Some of the early decoder add-ons recognized the importance of this control and included it in their products as well. The four-channel amplifiers sans decoding facilities have just about vanished from the scene, since they are neither fish nor fowl. Owners of stereo systems would find no need for them, and newcomers desiring four-channel sound at the outset certainly had no desire to have to add a separate decoder after making a heavy investment in a four-channel integrated amplifier. Decoders and decoder/amplifiers still abound, but their character and complexity have been altered considerably since those first, simple matrix "black boxes" were first offered to the public.

## Four-Channel—Phase Two

Early auditions of four-channel sound were subjected to two kinds of public demonstrations. There was, of course, discrete four-channel programming on open-reel tape. RCA adopted a position that any four-channel programming offered by them would have to be discrete (as opposed to "matrix"), with "full separation." Since the viable discrete disc was still a development of the future, RCA introduced Q-8 cartridges, similar in form to the popular 8-track cartridges which had gained popularity in automobile and home use. Despite their limited signal-to-noise and frequency response, the Q-8 format taught the four-channel listener that "discrete" channel separation was audibly superior to the rather minimal separation achieved by most simple matrix systems.

There then began a race on the part of many manufacturers to introduce "second generation" matrix decoders which included "logic circuitry." Logic, or gain-riding circuitry, simply senses which channel is instantaneously dominant and either increases the gain

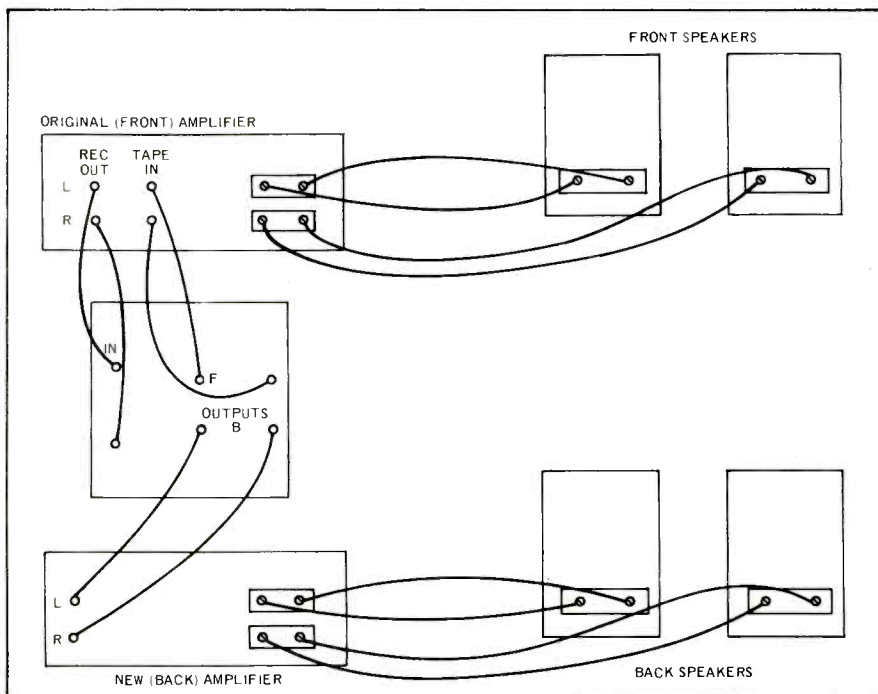

Fig. 1—"Classical connection diagram for connecting matrix decoder via tape monitor jacks of existing amplifier or receiver.

# IF OUR \$1000 SPEAKER DOESN'T GET YOU, MAYBE OUR \$55 ONE WILL.

People who hear about the Linear Sound of EPI invariably ask, "How much?"

To which we respond: "It depends."

If money is no object, we're only too happy to recommend our Model 1000. "The Tower," we call it.

This is a \$1000 item (each), and it is the absolute epitome of EPI's Linear Sound. (The Tower is *The Stereophile's* most recent addition to its select list of five Class A speakers.)

On a frequency response graph, the Tower will record a virtually straight line from the lowest bass to the highest treble. Meaning that what you hear is a pure, uncolored, natural sound from bottom to top. With no artificial boosting of the bass to impress the innocent. And all the nuances and overtones at the treble end that, on ordinary speakers, just fade away.

In short, what you hear is something rather sensational. (At \$1000 a crack, you might say it *ought* to be sensational. It is.)

But since, for most people, money is an object, you'll be happy to know our

Model 1000 is just one of eight Linear Sound speakers from EPI.

In the middle of the line, for example, you'll find our Model 400, "The Mini Tower," at \$389. Of this speaker, *Stereo Review* said, "The airy, open quality... in our view earns it a place in the select group of superb speaker systems."

Then, for the budget-minded, is our Model 50 at an attractive \$55 each.

Don't let the price fool you.

The EPI Model 50 produces a true linear sound. It has the same 1" air spring tweeter you'll find in the Tower and the same 6" long-throw woofer you'll find in the Mini Tower.

When *Audio Magazine* reviewed the Model 50, it recorded a response that "extended from 45 to 16,000 Hz  $\pm 3$ db, and dispersion was excellent." When *Audio* tested 14 small speakers for dispersion, our Model 50 beat the pack of them.

So, getting back to the question of the cost of EPI's Linear Sound:

How much did you want to spend?

(You can reach us at Epicure Products Inc., Newburyport, Mass. 01950.)

**THE LINEAR SOUND  
OF EPI.** 



in that channel or reduces the gain in non-dominant channels (or performs some of each gain change at once). The result is improved apparent separation for most musical situations. The most popular matrix method is that proposed by CBS and called SQ. Another matrix system vying for consideration is QS—proposed by Sansui Corporation of Japan. This latter form of matrix conforms to the so-called “regular matrix” sound field adopted by many other Japanese manufacturers. What the two systems have in common, however, is that they offer an inherent separation limitation of only 3 dB of actual separation. In the case of CBS-SQ, left to right separation is fully maintained, while front-to-back and diagonal separation is limited to 3 dB in their simple matrix system. In the case of Sansui QS matrix discs, diagonal separation is total, while adjacent flanking channels are limited to only 3 dB of separation. CBS’s dominance in the software field resulted in the availability of hundreds of SQ discs which, if played on simple SQ decoders, left much to be desired in the way of separation. QS decoders were supplied by Sansui to many radio stations and recording studios as well, so that the preponderance of four-channel program material suffered from “lack of separation” if played on simple decoding equipment.

Sansui offered its “variomatrix,” a sophisticated “logic circuit” arrangement designed to offset these limitations in separation, while CBS, through its hardware manufacturing licensees offered first “front-back” enhancement circuits and, finally, “double logic” circuits which accentuated both front-back separation and side-to-side separation when required. Thus, a whole new breed of “matrix decoder” products appeared upon the market and those listeners who had hastily purchased “simple” matrix decoders found that their very recent purchases no longer represented the latest four-channel technology.

During this same “phase two” period, receiver manufacturers quickly designed and developed integrated four-channel receivers which included one or more simple matrix decoders. Most featured at least three-position switches with settings for SQ, Regular Matrix and “Stereo Enhancement” (a matrix similar to the original Electro-Voice proposal which offered greatest front-back separation and was therefore particularly effective in keeping “front-and-center” vocalists up front, where they belong, while permitting out-of-phase random signals of stereo discs to wander around

towards the rear to simulate a four-channel effect). Most of these receivers offered moderate power output capabilities—around 10 to 20 watts per channel was typical. Despite the recent flurry of high-powered stereophonic receivers on the market, the lower powered quadraphonic units were justified by their manufacturers because, after all, with four channels operating simultaneously there was that much more acoustic power being pumped into the listening room. The obvious flaw in this argument occurs if a listener prefers to play some of his program material in two-channel stereo, in which case two of the four amplifying channels simply idled along and did nothing. The wastefulness of this arrangement must have become obvious to manufacturer and user alike very early in the four-channel evolution and undoubtedly accounted for new system purchasers’ reluctance to invest in these new receivers. Many listeners felt that the amount of program material then available for four-channel listening was at best limited and wanted to start their systems by purchasing only two speakers. These buyers were in somewhat of a bind, in that they were reluctant to purchase stereo receivers as well, recognizing that it would not be long before they would, indeed want to “switch to four-channel.” The idea of then having to add a decoder and a second amplifier did not appeal to such new purchasers. They felt that if they were just starting to assemble a system that they should certainly not have to “add on” and “make do” in just a few months. As a result, the “brute force” and obvious type of four-channel receiver did not enjoy the success its manufacturers had hoped for and the anticipated race towards four-channel slowed down to a veritable crawl!

#### Four-Channel—Phase Three

It would be difficult to assign the credit for the first two/four channel “bootstrapped amplifier” receiver to a single high fidelity component manufacturer. So as not to become involved in the argument as to who was first, let’s assign the credit to Bell Laboratories who some years ago published a technical paper describing a method of connecting two solid state amplifiers in a bridge-like configuration to obtain more than twice the power output capabilities of each. Whether it was by grapevine communication or industry-wide inspiration, several manufacturers, almost simultaneously, designed and produced a new kind of quadraphonic

receiver which offered distinct advantages to the perplexed audiophile.

For the hesitant quadraphonic equipment buyer, the new receivers offer full-powered stereo, with four amplifier channels bridged or combined to provide higher-powered two-channel operation. Thus, the purchaser who wants to begin his home system by purchasing two speakers is secure in the knowledge that half his power output capability is not being wasted. Then, when he’s convinced that four-channel is here and that there’s enough happening by way of program material, broadcasts and the like, he can purchase that second pair of speakers, flip a switch and, like biological cells, the two amplifiers divide into four, albeit at somewhat reduced total power. Typically, such a receiver producing about 50 watts per channel in the stereo mode would be expected to deliver about 20 watts per channel when the quadraphonic switch is thrown. Naturally, all of these receivers contain matrix and control facilities similar to their less flexible predecessors, and that brings us to what we hope is the *final* phase in this quadraphonic equipment revolution.

#### Four Channel—Phase Four

While these hectic three phases of equipment development underwent their gestation and production periods, the people who gave immortality to a little dog listening to an acoustic phonograph horn (and have since deserted “little nipper” in favor of a more avant garde corporate image, much to the distress of nostalgia buffs such as myself) have not been idle. Having put their money on the “discrete” four-channel approach, they huffed and they puffed and finally declared that the discrete disc was “ready.” It turned out to be none other than the CD-4 disc which had been developed by Japan Victor Company of Japan and which had been briskly selling in the Orient for nearly two years. RCA, however, improved, refined, perfected and renamed the disc—and now we have quadradiscs, plus the need for a new kind of decoder called a demodulator. It appeared for a while that “Phase Four” would consist of the addition of yet another “black box” and the need for six more audio pin-to-pin cables, in order to hook-up for Quadradisc playback, as shown in the block diagram of Fig. 2. Furthermore, RCA grudgingly admitted that in *most* instances a new phono cartridge and stylus would be required if the high frequency content of these new Quadradiscs was to be properly traced. No mention was made of the fact that the



If you're seriously into music or sound reinforcement you want more than hi-fi products can give you. But full professional studio gear costs an arm and a leg, and you pay for a lot of things you may not really need.

**You pay for what you need** up to four additional input modules and other optional accessories including talkback, remote transport control, quad panner, and headphone monitor.

That's why there's a TASCAM Model 10. It's an 8-in, 4-out mixing console, and it's just \$1890.

With the Model 10 you get what you have to have. Without sacrificing a single necessary function.

Each input module gives you mic and line attenuation, three bands of peak and dip equalization (two with frequency selection), pre- and post-echo send and receive circuitry, pan function, and a unique straight-line fader.

Each of the four submasters has a meter control switch (line/echo), independent monitor level control, echo receive level control, and a straight-line fader. You also get a master gain module and 4" VU meters with LED peak indicators. Plus pre-wired facilities for

That's what you need and that's what you pay for. Some things, however, you may or may not need, and we leave that choice up to you. For instance, the basic Model 10 is high impedance in and out, but studio line impedances are available optionally. You'll probably want low impedance mic inputs, but you may not need all low impedance line inputs. So we don't make you pay for them. You can order any combination of high and low input/output impedances according to your application.

Details and specs on the Model 10 are available for the asking. At the same time we'll tell you about our new Series 70 Recorder/reproducers.

We've got what you need.

**TASCAM CORPORATION**  
 5440 McConnell Avenue  
 Los Angeles, California 90066  
 Check No. 38 on Reader Service Card

**Dreaming  
about a pair  
of \$300  
condenser  
microphones?**

**Think  
seriously  
about these:  
\$39.75\* each!**



**Model 1710 Electret Condenser Omnidirectional Microphone**

All of the great condenser advantages are here without compromise. Flat, extended range, excellent transient response, high output, low noise, and ultra-clean sound. But the new E-V electret condenser microphones need no high voltage power supply. Just an AA penlite battery to operate the built-in FET impedance converter. The result is studio performance without complications and at a dramatically lower price.

There are 4 new E-V electret microphones, including cardioid models, from \$39.75 to just \$75.00, audiophile net. Second-generation designs with unusually high resistance to heat and humidity. Hear them today at your nearby Electro-Voice soundroom. Or write for details.

**More U. S. recording studios use Electro-Voice microphones than any other brand.**

\*Suggested retail price. Microphones shown on Model 421 Desk Stand, \$12.00 each.

**Electro-Voice®**

ELECTRO-VOICE, INC., Dept. 732A  
602 Cecil Street, Buchanan, Michigan 49107  
In Europe: Electro-Voice, S. A., Römerstrasse 49,  
2560 Nidau, Switzerland

**Gulton  
COMPANY**

Check No. 11 on Reader Service Card

new "demodulator" included low-level preamplification circuitry, thereby obsoleting the preamplifier section of one's existing receiver or amplifier, but this is apparent from the connection arrangement shown in Fig. 2. In short, if you were a four-channel pioneer dating back to "phase one," you might have ended up with a total system shown in the block diagram of Fig. 3—heaven help you!

Well, for the moment, the only separate demodulators offered for sale are those made by JVC and Panasonic (who endorses the "discrete" approach along with RCA), and in view of what seems to be happening in "phase four," such separate demodulators are likely to be around for an even shorter period than the "matrix decoders" of "phase one" and "phase two." The new crop of receivers, as you may have guessed,

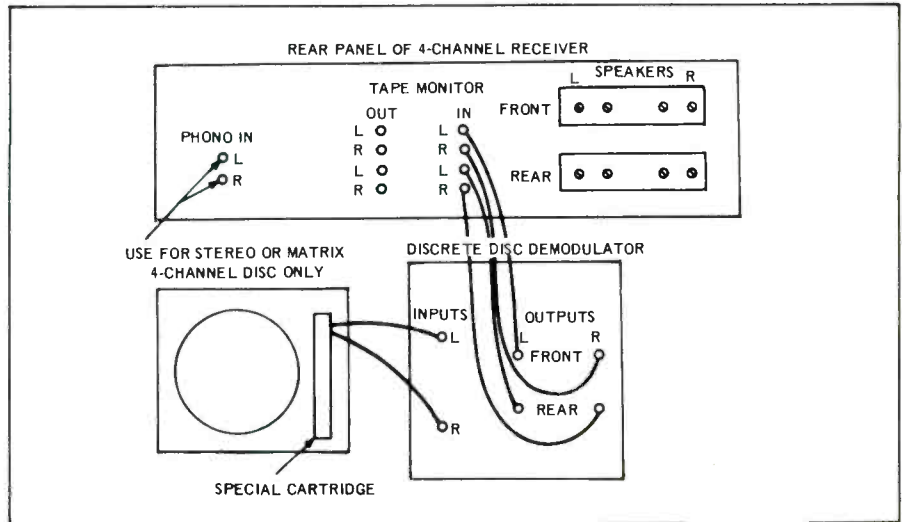

**Fig. 2—Most "4-channel receivers" offered to date still require an externally connected Quadradisc demodulator if RCA discs are to be played.**

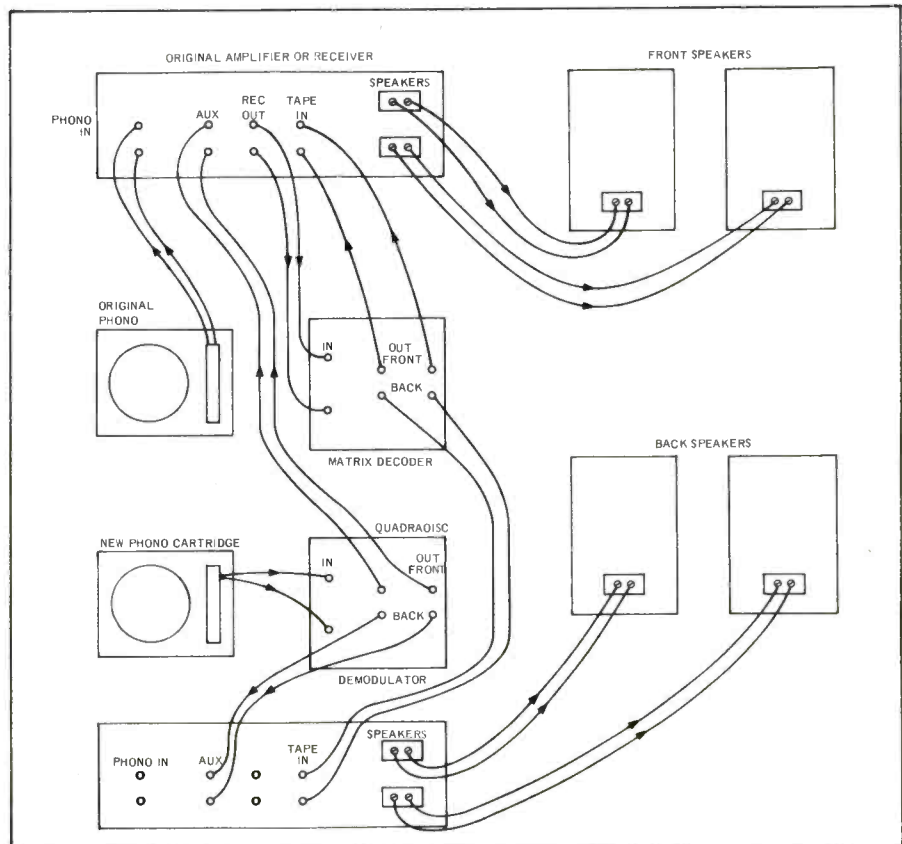

**Fig. 3—Anyone keeping pace with 4-channel equipment from "the beginning" would end up with the components shown above.**



The classics from KLH. Four bookshelf loudspeakers of such extraordinary quality that each has set the standard of excellence in its price range. Pictured to the far left, our popular little Thirty-Two (\$55.00†). Next, one of the best selling loudspeakers in the country, the Seventeen (\$79.95†). Up front, everybody's favorite, the Six (\$139.95†). And finally, our most spectacular bookshelf model, the Five (\$199.95†). If you really

want to know what KLH is all about, we suggest you listen to any one or all of these fine loudspeakers. And when you do, we're sure you'll agree that KLH is about the best thing to happen to bookshelves since books.

For more information, visit your KLH dealer or write to KLH Research and Development Corp., 30 Cross Street, Cambridge, Mass. 02139.

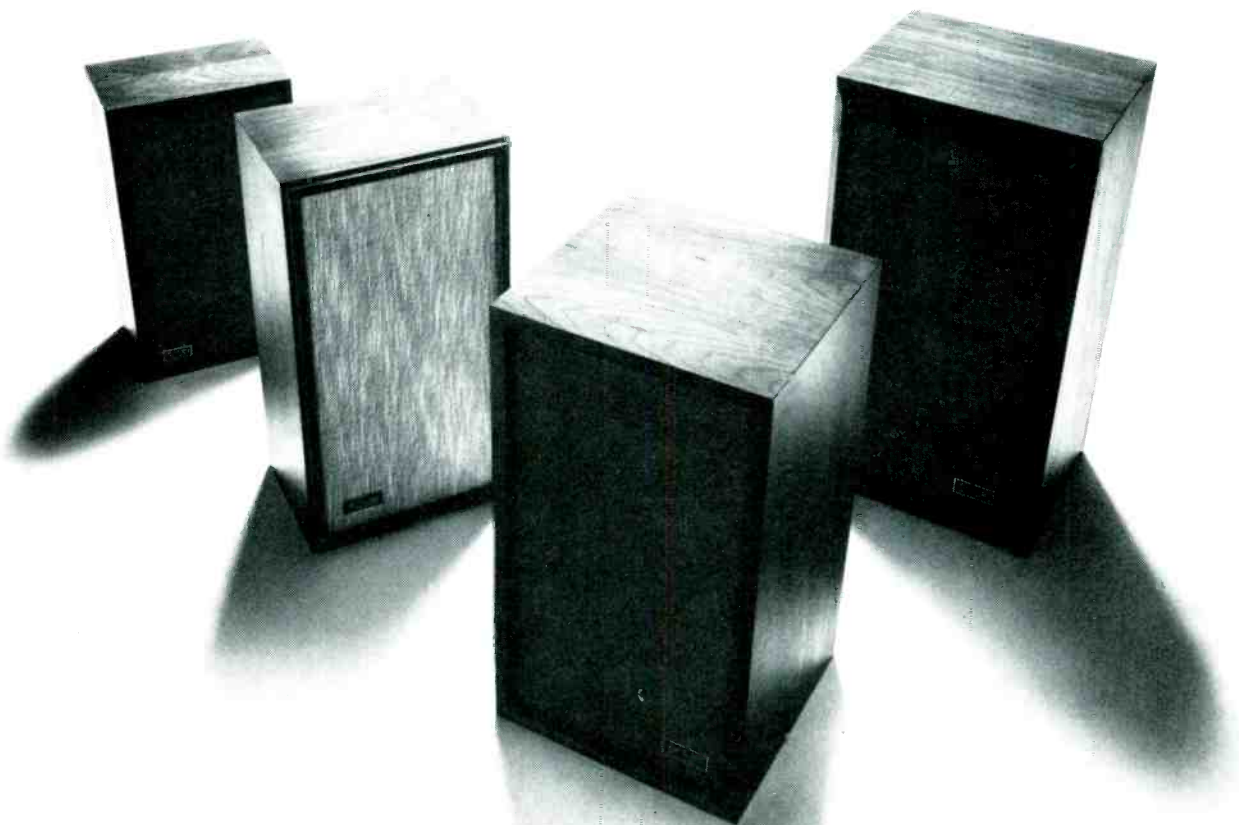

## What's a bookshelf without the classics?

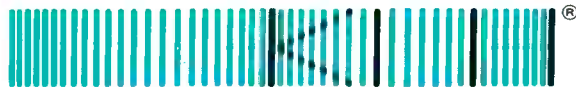

KLH RESEARCH AND DEVELOPMENT CORP.  
30 Cross St., Cambridge, Mass. 02139

†Suggested retail prices—slightly higher in the South and West.

Check No. 20 on Reader Service Card

[www.americanradiohistory.com](http://www.americanradiohistory.com)

includes (at very least) a *four* position switch for Quadradiscs, SQ-discs, Regular Matrix and, in some cases, 2-channel enhancement. With this arrangement, there is a minimum of circuit redundancy and the electronics of your system settles down to one all-inclusive piece (or, at most two if you prefer a separate tuner) once again.

#### Future Phases of Four Channel

Before you breathe a sigh of relief,

you had better know that it's not all over just yet. For one thing, there remains the question of "logic circuitry." Some of the new receivers equipped with both matrix and "discrete" demodulator circuits will still lack sophisticated logic circuitry for use in their matrix modes. The use of such receivers is likely to give RCA a much needed boost, because when discrete discs are compared with matrix discs played through simple matrix decoders there's

no question about the superiority of the quadradisc (if we confine the comparison to separation or image placement). Some receiver manufacturers, therefore, are going all the way and including both matrix-logic circuitry and quadradisc demodulator circuits in their latest products and such products (however costly they must be) are sure to become "favorites" in the immediate future. In time, the "strapping" feature will no doubt be dropped, as buyers are increasingly convinced that the only way to listen to music is in four-channel surround sound. Elimination of the "bootstrapping" feature may partly offset the cost of including logic-matrix *plus* quadradisc playback capability.

Lurking behind the scenes, however, is one more technological breakthrough—and that has to do with four-channel FM broadcasting. Obviously, the many stations currently featuring quadraphonic programming are confined to one or another matrix system. Since only two channels (however encoded) need be transmitted for this format, present FCC broadcast rules relating to stereo broadcasting are adequate and need not be modified. If past performance is any guide, the purists among us will not settle for this form of four-channel broadcasting forever and sooner or later there will be an approved method of discrete four-channel FM transmission. Committees are already at work on the problem and some seven proposed systems are currently under consideration. It's likely to take at least several more years before the FCC gives the nod to one of these systems (or to an as yet unproposed system), but when they do, you'll no doubt have to run right out again for still another black box—for which a back-panel jack is already being provided on today's receivers and tuners. You can be sure that the progressive and eager manufacturers in the high fidelity component industry would add the needed circuitry for four-channel discrete reception *right now*—if only they knew which circuits to add. Since that depends upon a government ruling, however, you'll have to be content with the equipment you purchased during the first four phases of the quadraphonic equipment revolution.

Actually, the stages in this evolution are nothing for the dedicated audiophile to grumble over. What sort of a hobby would this be if new and exciting equipment failed to come upon the scene every couple of years? At least model changes in *this* industry result in better sound—rather than in just fancier front panels. . . . **AE**

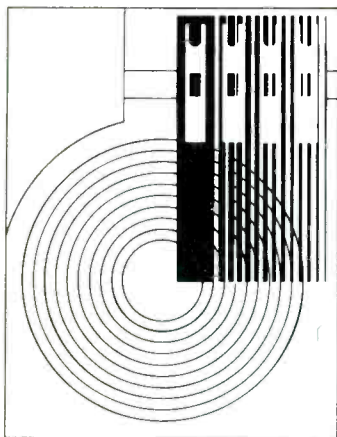

## We've got the best anti-skating device ever... none at all

Master records are made by machines that drive the cutting head *in a straight line* across the record. But when you play *your* disc with a conventional pivoted arm system, the revolving groove pulls the stylus towards the center. This is called "skating force"

Skating force causes wear on the inner wall of the groove and the stylus, and results in a loss of separation as well as distortion levels simply not acceptable to the serious listener.

Most good pivoted arm systems *do* have anti-skating devices. But they can only be set for "average" skating force—and an anti-skating device that remains *constant* cannot fully compensate for all of the *varying* forces exerted during the playing of a record. Even the *total* elimination of tracking error does not eliminate the *inherent* problem of the pivoted arm—skating force.

The RABCO pickup moves in a straight line. The record is played precisely as it was originally cut. There is no anti-skating device for one simple reason: The RABCO system eliminates skating force.

We want to tell you more about how we eliminate both skating force *and* tracking error. Drop us a note and we'll send full information straight away.

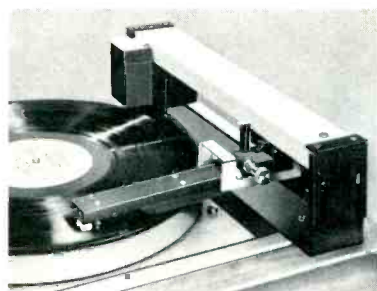

**The RABCO SL-8E**  
A straight tracking tone arm for your turntable



**The RABCO ST-4...**  
A professional turntable with the RABCO tone arm system

# RABCO

A division of Jervis Corporation

DEPT A  
55 Ames Court  
Plainview, New York 11803

Check No. 28 on Reader Service Card

# HERE'S WHAT OUR CONSUMERS REPORT TO US!

Please list any suggested improvements, changes, or other comments:

**One Hell of an improvement TO what I thought was a good sounding system.**  
 Purchased from: HI-FI-Music City Mt. Pleasant State Ill. 60076

**I thought my system was the best sounding system going, but this equipment makes it sound un-real. (Keep up good work)**  
 Purchased from: Lafayette radio, pennsauken State N.J. P.S. send any literature that you may have.

**Wester's Dictionary has a word that describes the 20-12 - SUPERLATIVE**  
 Purchased from: M-D MICHIGAN ELECTRONICS City EAST LANSING State Mich.

**Wow!!! WHAT A CHANGE IN MY SYSTEM!**  
 Purchased from: SOUND EX City WILLOW GROVE State PA

**EVEN "MAY" I RECEIVED OUT OF MY WIFE TO**  
 Purchased from: FRANKFURT AUDIO CITY FRANKFURT State CO

**An excellent device - what my system needed for total versatility with son**  
 Purchased from: Frankfort Audio Club City Frankfort

**LEAVE IT ALONG - IT'S PERFECT**  
 Purchased from: LEONARD RADIO City NYC

**LEAVE IT ALONG - IT'S PERFECT**  
 Purchased from: J & J ENGINEERING City KOKOMO



**Soundcraftsmen presents**

the new component that is a "must" with every fine stereo system...

the new **Audio Frequency Equalizer** guaranteed to improve any fine stereo system!

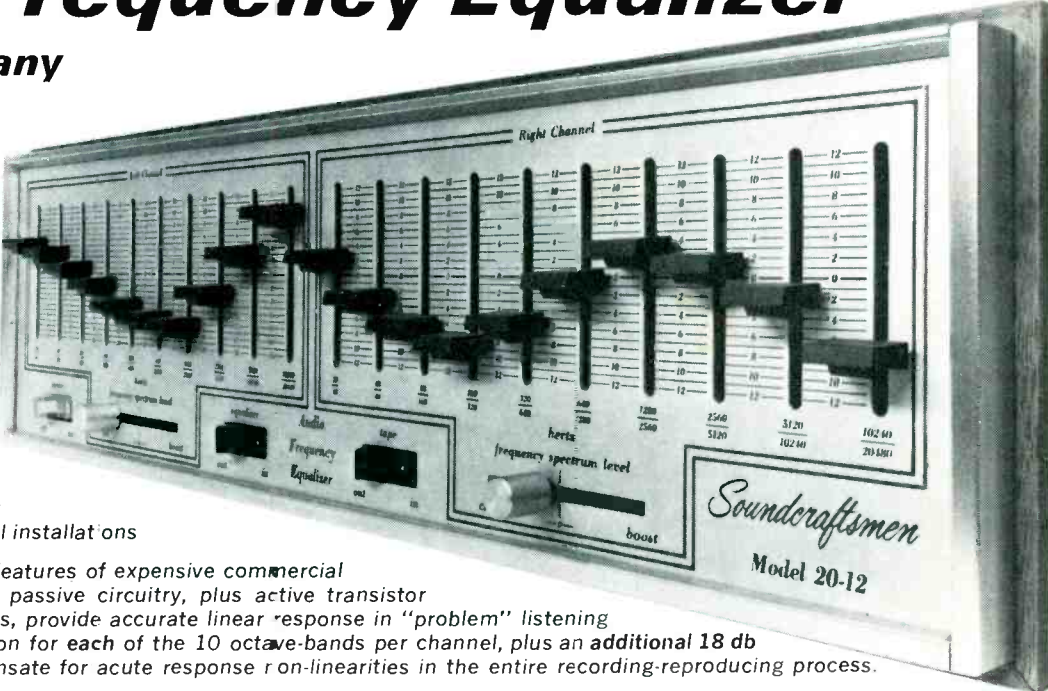

Now, in a few minutes, you can accurately "tune" the frequency response of your stereo system and room environment to a flat  $\pm 2$  db! All you need are your own ears and the 20-12 (with its step-by-step instruction record) to transform any stereo system and room environment into an acoustically-perfect concert hall! Or, to provide any special acoustical effects you desire! The 20-12 enables you to instantly compensate for frequency response variations, in system and room.

**\$299.50** includes walnut cabinet or rack mount for commercial installations

PATENT-PENDING design combines the best features of expensive commercial equalizers: Toroidal and ferrite-core inductor passive circuitry, plus active transistor circuits and active master level control circuits, provide accurate linear response in "problem" listening areas. Allows a full 24 db range of equalization for each of the 10 octave-bands per channel, plus an additional 18 db range of full-spectrum boost or cut to compensate for acute response non-linearities in the entire recording-reproducing process.

## ROOM EQUALIZATION, SPECIAL EFFECTS, PLAYBACK and RECORDING

**EQUALIZING FOR ROOM CHANGES:** For example, here are some factors that would call for definite changes in your Equalizer settings: (1) Draperies open or closed. (2) Sliding glass door open or closed. (3) Room full of people. (4) Seating arrangements changed. (5) Major changes in furniture arrangement. (6) Relocation of speakers. . . . **EQUALIZATION OF RECORDS:** You can compensate for old 78 record deficiencies (surface noise, absence of highs or lows, etc.) or favorite recordings that have never sounded quite the way you felt they should sound. . . . **COMPENSATING FOR RADIO STATIONS:** Some stations are noted for excesses in either low or high frequencies. Make out a Computone Chart for each of your favorite stations so that you can easily achieve the ideal tonal response each time you change stations. . . . **EQUALIZING TAPES:** Compensating for pre-recorded, or home-recorded, tapes that are under or overemphasized in certain frequency areas. . . . **CHANGING OVERALL BALANCE:** You can make up for many deficiencies in recordings to more

accurately duplicate the sounds of the original performance, or shape each curve to your own listening interests to greatly enhance your enjoyment of your recordings. . . . **SPECIAL EFFECTS:** You can boost or cut the loudness of a specific instrument or groups of instruments to obtain more pleasing instrumental balance or to add presence to a solo. . . . **IMPROVING RECORDING OF TAPES:** Use the Equalizer for tape dubbing, to create a near-perfect tape out of one that may have serious deficiencies. (Make your own corrected recording of records, station programming, or other tapes, and no further adjustment of the Equalizer will be needed for playback.) (See Operating Instructions). . . . **COMPUTONE CHARTS:** After you have achieved the equalization of sound that you prefer use the Computone Charts, supplied with each Equalizer, to mark the settings, so that you can duplicate the settings easily.

## SPECIFICATIONS and SPECIAL FEATURES

**TOROIDAL** and ferrite-core inductors, ten octave-bands per channel.  
**FREQUENCY** response:  $\pm 1/2$  db from 20-20,480 Hz at zero setting.  
**HARMONIC DISTORTION:** Less than .1% THD @ 2 v., Typ: .05% @ 1 v.  
**IM DISTORTION:** Less than .1% @ 2 v., Typ: .05% @ 1 v.  
**SIGNAL-TO-NOISE RATIO:** Better than 90 db @ 2v. input.  
**INPUT IMPEDANCE:** Operable from any source 100K ohms or less - (any Hi-Fi Pre-amp, Receiver or Tape Recorder.)  
**OUTPUT IMPEDANCE:** Operable into 3K ohms or greater - (any Hi-Fi Amp, Receiver or Tape Recorder.)  
**CIRCUIT BOARDS:** Military grade G-10 glass epoxy.  
**RESISTORS:** Low-noise selected carbon-film.

**RANGE:** 12 db boost and 12 db cut, each octave.  
**MASTER OUTPUT LEVEL:** "Frequency-spectrum-level" controls for left and right channels, continuously variable 18 db range, for unity gain compensation from minus 12 db to plus 6 db.  
**MAXIMUM OUTPUT SIGNAL:** variable Master "frequency spectrum level" Controls allow adjustment of optimum output voltage for each channel, to exactly match amplifier capability, up to 7 v.  
**SIZE:** designed to coordinate with receivers, comes installed in handsome walnut-grained wood receiver-size case, 5 1/4" x 18" x 11", or rack-mount  
**WARRANTY:** 2-year parts and labor.

Soundcraftsmen: 1310 E. Wakeham Ave., Santa Ana, Cal. 92705 Ph: 714-836-8375  
 Check No. 34 on Reader Service Card



# WHY YOU SHOULD BUY FOUR-CHANNEL NOW



Harry Maynard

Don't buy a four-channel system now, or adapt your current stereo to play four channel because it's new, or just to impress your friends. Buy a four-channel system now because per dollar invested it will give you far better sound than the equivalent invested in adding niceties to your two channel system. Stated simply, \$500 or \$1,000 invested in a four-channel system playing even your two-channel stereo records will give you better sound than the equivalent investment in stereo sound.

There are certain things a stereo system can't do. It can't properly distribute bass around a 360 degree perimeter, and it can't significantly enhance your existing investment in stereo recordings. Studies show that if you are typical, you have considerably more invested in software (recordings) than you have in hardware. There is also FM radio—FM means free music. FM is also the listening booth for most people who purchase stereo recordings. Most FM stations have record libraries running into the hundreds of thousands of dollars, at your command to decode in the four-channel mode.

U.S. consumers like you have already invested over nine and a half billion dollars in stereo recordings since 1954. With any one of the better matrix four-channel decoders with, of course, two extra speakers and another stereo amplifier, this huge recorded repertoire is at your service for enhancement. Sure, you'll also have the ability to play the growing number of four-channel recordings. But if history is any measure, the transition from stereo to quadrasonic sound will take years. The bulk of all recorded repertoire for many years will be in stereo and often what you will want in recorded sound will only be available in stereo. Some great historical performances will never be recorded in quadrasonic sound. Some great stereo performances that sound dead or inadequate in stereo can, with a good 4-chan. system, be brought back to life to a considerable degree. There is a lot of enjoyment to be mined from your existing recording collection when played in the four channel mode.

Here are some non-expert, authentic

reactions on this point addressed to my radio program, "Men of Hi Fi." "After much hesitation and deliberation, I finally purchased an inexpensive third speaker and hooked up the Dynaco system. The result—a new world of stereophonic enjoyment has been opened up for me. The results are nothing less than astounding. Listening to old records is a new experience as if they were being played for the first time. The third speaker has increased my enjoyment by 100 percent. Fantastic!" Or, "I spent many delightful hours rediscovering my record collection."

Hundreds of letters addressed to my show have similar words and reactions from those using the simplest decoders to the most sophisticated matrixed decoders such as the Sony 2020, or the decoder included in the Lafayette LR 4000. Ninety-nine percent of the letters indicate that they now keep their rear speakers on most of the time, even listening to two channel material. Listen—"I have not been able to live with the rear speakers off since I installed the decoder . . . the presence is phenomenal. The Mormon Tabernacle has been airlifted to my basement."

Your reaction now may be, *but these are novitiates in audio*. So what does Julian Hirsch, a dean of audio equipment evaluation of Hirsch-Houck Labs, say? "On almost any kind of stereo material, the EV-4 added a sense of spaciousness that we found most pleasing. In a sense, it was not unlike the Dynaco which adds this quality to many programs. It was interesting to find that there frequently was a definite front/rear separation in ordinary stereo programs, often with a hint of separation between the rear speakers as well. In fact, some normal stereo records sounded at least as good as some of the encoded records!"

This four-channel decoding of stereo records is more than a serendipitous bonus. As Hirsch goes on to say, "We are enjoying playing some of our old forgotten stereo discs and discovering a new dimension of sound hidden in the grooves. Four-channel playback generates a sense of involvement with sound which is so easy to accept that after awhile one

may be unaware of its existence. On many occasions we switched off the rear speakers and the contrast was striking. It can only be compared to turning off most of the lights in a well-lit room, after one has become adjusted to a high ambient light level."

Finally, like many leading audio critics, Julian says what so many listeners have written to me on my radio show, "We had been highly skeptical of early claims that four-channel sound was as much of an improvement over two channels as the latter was over mono. At this point we are ready to eat crow. Going back to mono is an intolerable prospect for a real stereo addict."

For knowledgeable people in audio it's been an open secret that many stereo records have been matrixed for years. Even the so-called discrete CD-4 records are matrixed in the recording process and, incidentally, decode nicely with a matrix decoder. When you encode a four-channel recording, you are primarily making more calculated, and sometimes more satisfactory and efficient use of the two-sided groove wall of a stereo disc by more organized use of rear phase material.

I have often found that the latest generation of matrixed decoders, with their front-to-back logic and full wave matching logic, on a stereo record significantly improve front-to-back separation and give more precise localization of voice and instrument, as well as increase separation, which was precisely what they were intended to do with an especially encoded four-channel record.

Now the purist will complain at this point that what we are hearing out of the rear speakers was never intended by the artist, record producer, and recording engineer. True. Perhaps if I were mixing this stereo record for four-channel listening, and this includes some especially encoded four-channel recordings, I might not have placed the instruments as they are placed or aimed for the total effect of this recording. But generally, the effect is definitely more pleasureable, and of course I can always turn off the rear speakers if I find it really offensive to my sensibilities.

But I have found as hundreds of my listeners have that I keep my rear

speakers on 99 percent of the time. Let some of my listeners describe their reactions: "It adds a great deal of excitement to music, which for myself, stereo did not," or, "During the listening (I) shut off the two rear speakers for a little while. No one in his right mind could fail to notice the difference. Then (I) put all four speakers on again. The sound seems flat and dead by comparison. With four channel sound we are living in a new world that Toscanini, Caruso, yes and even Paganini, would have loved. Let's appreciate the beautiful sound we now can enjoy (from stereo discs) until the F.C.C. decides that discrete is better."

For me, the last sentence of this letter indicates why the discrete-matrixed debate is for all practical purposes not as meaningful a debate as it appears, and has tended to muddy the water of today's enjoyment. I believe that both systems will exist side by side for years, but that is the subject of another piece. Suffice it to say that the matrixed four-channel disc is the natural evolution of the stereo disc. Any good four-channel system needs four-channel matrix decoding facilities to enhance two-channel stereo records, because stereo records for now and for the near future constitute the bulk of recorded repertoire available to the public. It took fifteen years for the mono/stereo shift. It will take years for the stereo/quad shift. Yes, I know four-channel recordings have got off to a much faster start than stereo did, in a far shorter time period.

Right now, I'll even grant the discrete camp that I find discrete tapes and discrete discs sound better than the best of the matrix system commercially available. But I've heard the laboratory prototype decoders of the two main matrix camps, Q.S. (Sansui) and S.Q. (Columbia), and I've been impressed (with no encoding changes) with their tremendous improvements in separation and other criteria. I can't tell the difference between the master four-channel tapes and the matrix decoded material. These prototype models will be converted to IC chips by late 1973 and 1974.

Most informed observers of the four-channel scene agree that we won't have an F.C.C. approved form of four-channel discrete broadcasting for several years. It's taken fifteen years of stereo broadcasting just to get one-third of America's FM stations to go stereo, partly because of the cost involved. Four channel will require an equivalent or bigger invest-

ment by radio stations. Since by now the reader has obviously gotten the point that I believe the enhancement effect alone on stereo records is sufficient reason for setting up for four-channel listening. From where I sit, the proponents of discrete four-channel sound should have invented matrixed four channel sound until discrete four channel can be broadcast. Matrix four-channel sound is the natural bridge from the stereo age into the quadraphonic age.

One thing I'm sure of—four-channel sound is not a put-on. If anything, it's been too long in arriving in the commercial market place (subject for another article). It's certainly here to stay with retailers such as Lafayette, the nation's second largest hi fi component dealer, reporting that 60 percent of their total component hi fi sales is in four-channel equipment, and other dealers reporting a real upsurge in sales in four-channel recordings and equipment.

But if four channel has a natural resistance point, much research by this reporter shows that resistance point and fear is **OBSOLESCENCE** of both the consumer investments in software (recordings) and in hardware. People hate to hear that the recordings and equipment they have carefully acquired, grown to love, and invested much money in, now have to be thrown out. It you don't believe this, stand and overhear the hundreds of conversations I've heard, or read the mail addressed to my radio program. For example, here's a letter addressed to Jim Gabbert, one of four channel's pioneer broadcasters, the head of the National Association of FM Broadcasters engineering committee and editor of its newsletter, *FM Engineering*, "Well I see it (four-channel) is on its way in all its glory. Equipment manufacturers are drooling like mad dogs on the Fourth of July, while their greedy little heads whirl at the thought of those dollars rolling in from stupid suckers who will buy anything if it costs money. I refer to your report on quadrasonic, quadraphonic quadrou, quadrafool, quadraput-on, surround sound as described in your newsletter."

"I can just see it now—broadcast antennas, new transmitters, new control consoles, new cartridges, new home hi fi systems, complete with infinite baffle speakers built into all walls of every house (which calls for new houses). It staggers the imagination when one considers how easily Yankee ingenuity has made all present audio equipment (from which incidentally

manufacturers made their fat little profit) **OBSOLETE!**"

For AUDIO's readers I don't think it's necessary to refute this letter in detail. Many readers could, I'm sure, do a better job than I, knowing that most of your investment in quad if you already have a good stereo system, is add-on equipment, i.e. another stereo rear amp, and two rear speakers, plus whatever level of matrix decoder you desire. Nothing is made obsolete. Most decoders or four-channel systems (of audio component quality) now being offered to the public have auxiliary four-channel inputs which can be used to play four-channel tapes, four-channel tape cartridges, and even add a demodulator (price \$100) to play the new CD-4 records.

To sum up, don't forget what a four-channel system will do for those unforgettable stereo records you own, or may still buy. Martin Mayer, *Esquire's* audio-record critic, a recent convert to four-channel sound, suggests as I do that with all the shouting about what's new about four-channel, "the advantages of four-channel sources even on ordinary stereo material is much greater than one could imagine without trying it. The experience of Janos Starker playing "Bach Cello Suites" (a two-channel recording) through four cornered omnidirectional speakers was a great musical moment in my house, because it was indistinguishable from what one would hear if the artist were playing in the room. The sound of the live cello in a room does not seem to come from a point source or from the front wall. The whole room plays . . . the whole room resonates. No area is louder than the other so far as you can tell." I remind you that Mayer's reaction is to a two-channel recording played quadratically.

Mayer's experience is not atypical for those who have lived with four-channel stereo. It's confirmed by thousands of my radio listeners and lecture audiences who have told me essentially the same thing. So if you want to double the sonic value of many of the recordings you already own, and step up your psychic income, invest in four-channel now. There is a lot of four-channel gold in them thar two-channel stereo recordings that cannot be mined with your existing two-channel stereo equipment, no matter how much you spend. For the added investment needed to convert your two-channel system to four-channel, you'll get a lot more sonic value than the equivalent investment in two-channel niceties.

**Our new receiver can  
demodulate or decode any kind  
of 4-channel  
including some that haven't  
been invented yet.**



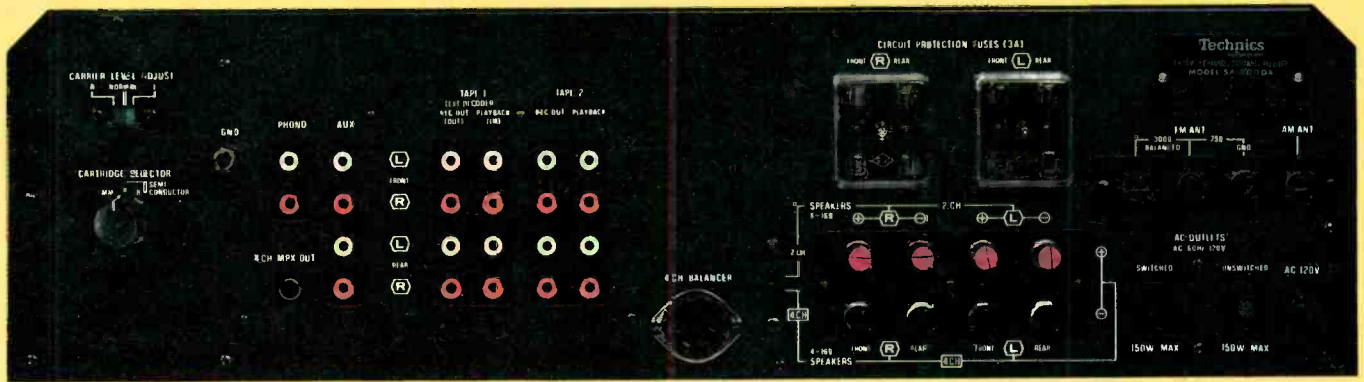

The Technics SA-8000X is a 4-channel expert. Not just one kind of 4-channel. All of them. And it translates each one accurately.

We are particularly proud of its discrete capabilities. Because it has a demodulator for CD-4 records. Built in! And it adapts to any CD-4 cartridge instantly. Via front-mounted carrier level and separation controls.

The SA-8000X has an exclusive combination of controls and circuitry that adjusts to the coefficients of any matrix method. The Acoustic Field Dimension (AFD) controls and the Phase Shift Selector provide a variety of blendings that encompass every popular matrix system. Even some that haven't been tried yet. And the same controls can compensate for poor room acoustics. Or undesirable but unavoidable speaker placement.

The Technics "Total 4-Channel" concept shows just as clearly in the rest of the front panel. A well-thought-out set of controls manage both volume and balance. There's a large master gain surrounded by separate controls for each channel. And any balance set with the individual knobs is maintained when the master is adjusted.

The rear panel reflects the same versatility. With plug-ins for three 4-channel tape decks. Plus provisions for future discrete FM.

Technics' attention to detail continues inside the SA-8000X. With sophistications like a pair of 4-pole MOS FETs and a 3-gang linear tuning capacitor. A trio of 2-element ceramic IF filters, a new type of epoxy resin coils as well as monolithic IC's in the multiplex circuit.

The four directly coupled amplifiers are very gutsy in the bottom end and can be "strapped" together. So that in stereo, four amplifiers work as two, which more than doubles per-channel wattage in that mode.

The combined effectiveness of the whole design produces specifications like these:

FM TUNER SECTION		AMPLIFIER SECTION	
Sensitivity	1.9 $\mu$ v	1 kHz RMS Power (all ch. driven at 8 $\Omega$ )	
Selectivity	65 dB	4-channel operation	64w
S/N Ratio	65 dB	2-channel operation	84w
Capture Ratio	1.8dB	IHF Music Power (4 $\Omega$ )	160w
		4-channel operation	160w
		Power Bandwidth (all ch. driven at 8 $\Omega$ )	5Hz-40kHz,-3dB

The concept is simple. The execution is precise. The performance is outstanding. The name is Technics.

200 PARK AVE., NEW YORK, N.Y. 10017  
 FOR YOUR NEAREST AUTHORIZED  
 TECHNICS DEALER, CALL TOLL FREE  
 800 447-4700. IN ILLINOIS, 800 322-4400.

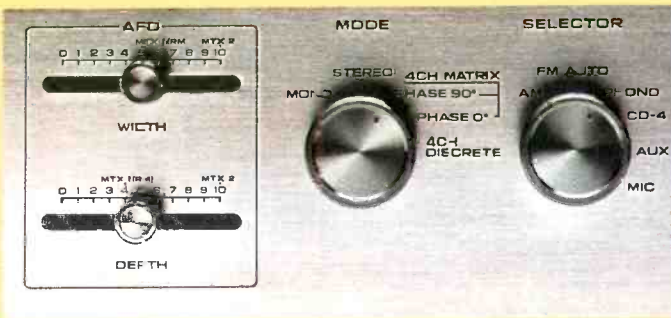

# Technics

## by Panasonic

Check No. 24 on Reader Service Card



# STATUS: THE CD-4 SYSTEM

George W. Tillett

**J**VC AND RCA have made considerable progress with their "discrete" disc during the past year or so. The first releases had a reduced playing time, lower output and dynamic range, and quite high distortion. There were problems associated with the 30 kHz carrier and the phono cartridge—plus a high noise level. But now, all—or most—of these difficulties have been overcome with improved circuitry, new record materials, and better cutter heads. Not forgetting that Shibata stylus! Recent CD-4 issues are comparable with two-channel or matrix discs, but before we take a quick look at some of them, it will be appropriate if we describe the basics of the CD-4 system. (Readers who are familiar with the principles can skip this section.)

Figure 1 shows the signal arrangement in a CD-4 disc. The inner groove wall carries the modulations from the front-left and rear-left channels and the 30 kHz carrier contains the fre-

quency-modulated front-left minus rear-left (FL-RL) signals. Likewise, the outer groove wall carries the front-right *plus* rear-right (FR+RR) signals while the FR-RR signals are taken by the carrier.

The frequency modulation is really a combination of FM and phase modulation. Below 800 Hz, FM is used, then PM takes over up to 6 kHz, and then FM again. It is claimed that this division achieves a better dynamic range.

The playback unit, called a demodulator, does much the same job as the MPX decoding circuits in a FM tuner. It unscrambles or retrieves the four signals. Figure 2 shows a block diagram of the demodulator. Output from the phono cartridge is equalized, and then the signal is divided into a base band and a carrier by low-pass and high-pass filters (LPF and HPF). The low portion, 30 to 15,000 Hz (the sum signal), passes through a potentiometer, which is linked to the separation control

screw, then undergoes RIAA equalization in its upper range. Presence of the carrier signal activates the four-channel "CD-4 Radar" indicator lamp on the front panel. If a carrier is *not* present, a muting circuit cuts off all signals. The difference signal is retrieved in the FM detector, passes through an FM/PM equalizer, and then through a low-pass filter which eliminates any residual carrier frequency. After expansion in the ARNS noise reduction system, the difference signal enters the operation circuit where the four discrete channel signals are retrieved. What happens if the selector switch is on "four-channel" but an ordinary two-channel disc is played? The muting circuit will prevent any signals from going through the demodulator and to the front.

## New CD-4 Discs

One of the first RCA CD-4 records was "The Fantastic Philadelphians," featuring the Philadelphia Orchestra with Eugene Ormandy. This had a reduced playing time and the original pressing was somewhat noisy. Volume 2 (ARD1-0017) was a big improvement; it included Smetana's *Dance of the Comedians*, Ponchielli's *Dance of the Hours*, de Falla's *Ritual Fire Dance*, and Brahms' *Hungarian Dance No. 3*. Rear channels carry mostly ambience and reverberation. The overall sound is spacious with good balance. The next record to appear was quite a contrast: "Stolen Goods" presented Ken Howard and Alan Blaikley with Dr. Teleny's Incredible Plugged-In Orchestra, playing *Gems Lified From the Masters*. The gems included *Rhapsody from Hunger*, *Johann Sebastian Rock*, and *Wolfgang Wigs Out*. The titles give you some idea of the kind of record this is! Some of it is good fun; some is—well—painful... The recording itself is good with full

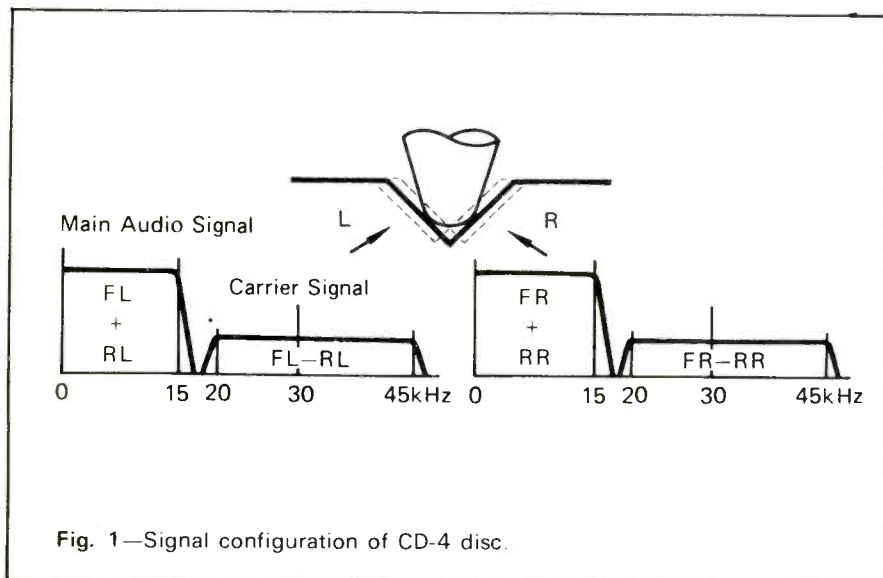
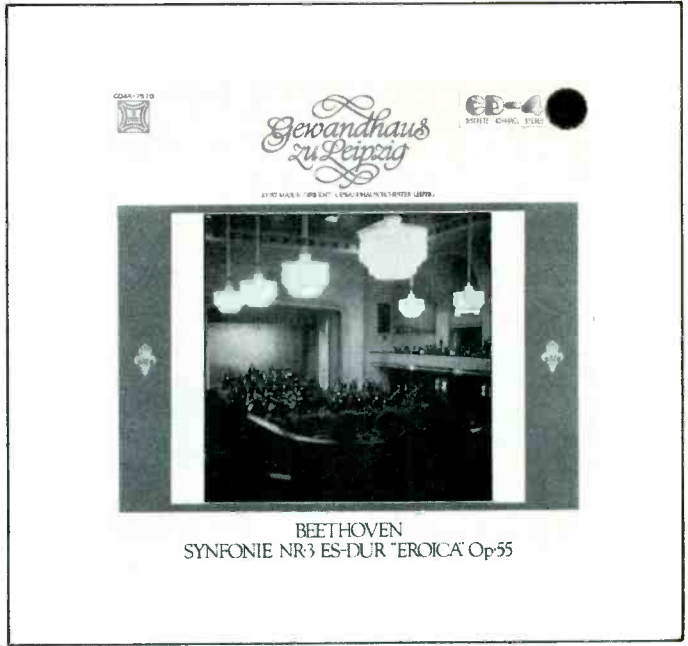
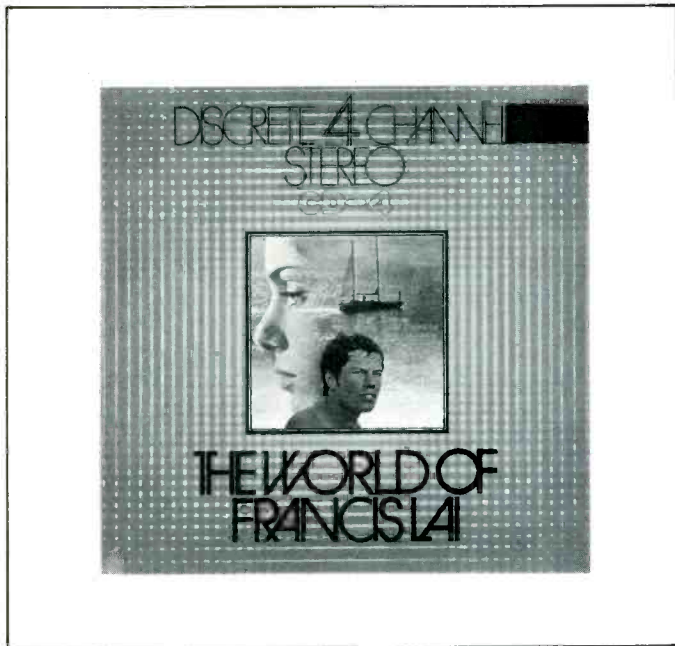

Fig. 1—Signal configuration of CD-4 disc.





use of the four channels. The number is ARD1-0015.

Henry Mancini has made two excellent CD-4 records. They are "Mancini Salutes Sousa" (APD1-0013) and "Brass Ivory, and Strings" (APD1-0098). The former is played by an orchestra consisting of "The cream of Hollywood's musicians"—at least that's what the label says. They are certainly first-class players and Mancini leads them through old warhorses like *Semper Fidelis* and *El Capitan* with great enthusiasm. Sound is very clean with a good impression of movement. There's even an airplane flying overhead during a march past! The second record is more sedate, with *Love Theme from Laura*, *Theme from Doc*, and *I Can't Get Started*. "Doc" is Doc Severinson, who plays his famous trumpet.

Danny Davis and the Nashville Brass playing *Travelin'* presents a good example of the clean sound possible with CD-4 (APD1-0034). Good separation and not too gimmicky. Another nice recording is called "Carolyn Hester" (APD1-0086). Carolyn has a pleasing voice but unfortunately it was spread too wide, and it was difficult to know where the singer was supposed to be!

Now for a set of three JVC records which should soon be available here. They are the Beethoven Symphonies 3, 5 and 6, and the orchestra is the Leipzig Gewandhaus under Kurt Masur. The Pastoral includes the *Egmont* overture and *Coriolan* is paired with the 5th. In general, the sound is spacious with good definition, but occasionally I was too conscious that there are four separate sound sources. Very disconcerting.

### Summing Up

In terms of absolute fidelity, there is no doubt that the present CD-4 disc has come a long way. The original releases were cut at one-third playing speed but recently the speed has been increased to one-half and further advances in cutter heads will enable them to operate up to 50 kHz at full speed. At the moment, or so it seems to me, much has to be learned about recording techniques, so as to take full advantage of the four-channel medium in the musical sense. Channel separations of 20 dB or more are not needed for classical music—in fact, they are undesirable. On the other hand, having four separate channels gives much more scope to the composer of contemporary music.

Electronic music can take on a new dimension and the CD-4 system can give the effect of movement not possible with matrix systems. However, there are still disadvantages—it is not possible to broadcast CD-4 records and then there is the question of compatibility with ordinary two-channel records. They can be played through a matrix decoder to get surround sound; a CD-4 decoder does nothing for them. No one wants to feel that their collection of records is obsolete! Furthermore, most of the quadraphonic records available are CBS SQ or Sansui matrix so it looks as if both systems will live side by side for some time to come. Many of the new receivers, in fact, will have both CD-4 discriminators and SQ decoders built in. Such is progress!

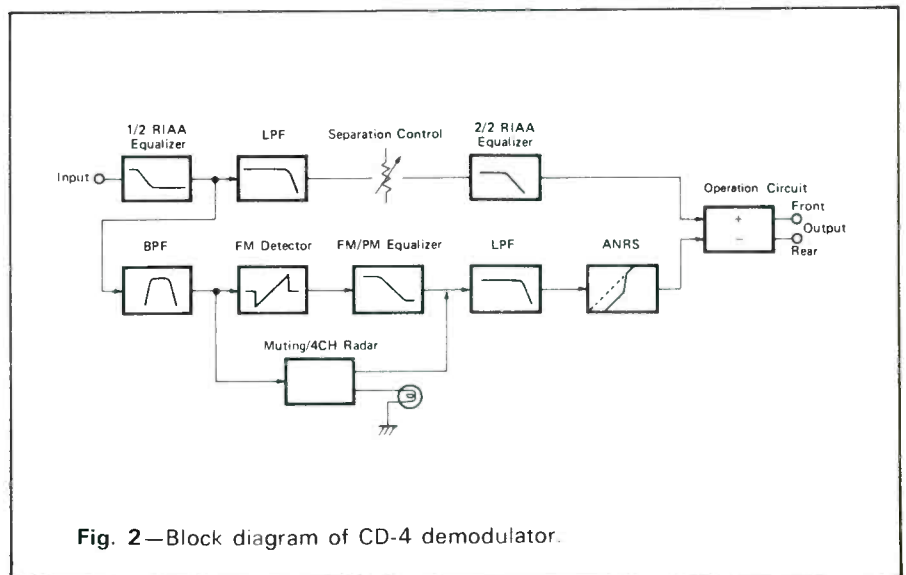

Fig. 2—Block diagram of CD-4 demodulator.

# Equipment Profiles

Realistic QTA-790 Receiver ..... 42  
 Bozak Sonora Loudspeaker ..... 52

Technics by Panasonic RS-740-US Tape Deck ..... 54  
 Microstatic MS-1 Loudspeaker ..... 56

## Realistic Model QTA-790 4-Channel/Stereo AM-FM Receiver With Remote Control



### MANUFACTURER'S SPECIFICATIONS

**FM TUNER SECTION.** IHF Sensitivity: 2.0  $\mu$ V. S/N Ratio: 60 dB. THD (Mono): 0.3%. Selectivity: 55 dB. Capture Ratio: 1.5 dB. Image Rejection: 78dB. Stereo FM Separation: 35 dB.

**AM TUNER SECTION.** IHF Sensitivity: 7  $\mu$ V. Selectivity: 23 dB. S/N Ratio: 50 dB. Image Rejection: 45 dB.

**AMPLIFIER SECTION.** Power Output: 36 watts/channel, 8 ohm loads. Rated THD: 1.0%. Power Bandwidth: 18 Hz to 45,000 Hz. Frequency Response: 20 Hz to 30,000 Hz (No tolerance given). Input Impedance, Phono, Aux, Tape: 50 K ohms. Input Sensitivity: Phono, High: 5.0 mV; Low: 2.5 mV. Aux: 200 mV; Tape: Adjustable from 0.2 to 2.0 volts. Tone Control Range: Bass:  $\pm 12$  dB @ 100 Hz; Treble:  $\pm 12$  dB @ 10,000 Hz; Mid-Range:  $\pm$  dB @ 1500 Hz.

**GENERAL SPECIFICATIONS.** Power Requirements: 120 V, a.c., 60 Hz (40 to 400 W. Max). Dimensions: 18 $\frac{3}{4}$  in. w. x 5 $\frac{1}{2}$  in. h. x 18 in. d. Retail Price: \$598.00 including wood cabinet and separate remote control unit.

The roster of four-channel receivers keeps growing, and this Realistic Model (produced for and sold by the Radio Shack stores around the country) does offer a great deal for its price. We are a bit distressed, however, by some of the verbiage employed by this company in promoting their product—as reflected in their advertising literature and in the owner's manual that comes with this basically fine product. The manual notes that they do not rely “on the usual confusing array of Manufacturer's Specifications, most of which are, sad to say, irresponsible,” but then, on the very next page, they list quite an impressive array of their own “manufacturer's specifications” and include a power output spec of “280 watts total  $\pm 1$  dB”! Come, now, gentlemen, you've got a good re-

ceiver here that produces an honest 35 watts per channel of continuous audio power with all four channels going at once—and that totals 140 good clean watts (against the 144 you claim for the “continuous” power rating) of power. If you really believe that most published specs are “misleading” and shouldn't be relied upon, how about dropping *that* misleading “ $\pm 1$  dB,” as most of your competitors have done!

The QTA-790 is a handsomely designed *big* receiver, as can be seen in the front panel photo. The panel itself is made of a single solid casting, with a blackout plastic insert at the top, a brushed-gold aluminum panel below, and polished gold-colored framing around the entire perimeter. The blacked out portion contains a signal-strength meter, a dial scale for AM and FM frequencies, a softly illuminated dial pointer and five small vertically calibrated dials which are used to pre-select favorite FM stations by means of combination rotate/push buttons located directly below the five dials. Below the dial scale, but still in the black portion of the panel, are power ON/OFF pushbutton, SPEAKER A/ SPEAKER B buttons, tape monitor button, MONO/STEREO selector button, filter buttons (HIGH and LOW), mute ON/OFF button, an AFC ON/OFF button, a loudness control ON/OFF button, and a manual tune and “remote” button. The lower portion of the panel includes dual headphone jacks (for four-channel headphone connection), dual concentric clutch-type bass, treble and mid-range tone controls, a mode switch for selecting STEREO (front channels only), SQ MATRIX (for SQ or other types of matrix recordings and FM broadcasts) STEREO ALL (two-channel material fed to front and rear speakers) and AUX 4 (discrete four-channel inputs such as tape or the outputs of a “discrete” Quadradisc demodulator). A separate volume control for these Aux 4 inputs is provided and works independently from the master volume control located further to the right. Three slide-controls provide all the “balancing” facilities one would need in a four-channel setup. The two horizontally sliding controls provide left-right balance for either front or rear channels, while the vertical sliding control balances front levels against rear—rather a nice arrangement for that. The program selector comes next, offering positions for AM, FM, PHONO and AUX. The AUX position offered here is an additional stereo AUX position over and above the four-channel Aux inputs previously mentioned. The master volume control comes next, followed by a tuning knob which is *not* flywheel coupled for reasons which will become clear in a moment.

At the upper right of the panel is a small concave depression covered with fine metallic grill material. This permits supersonic tones from the remote control unit to impinge upon the rear-mounted transducer (microphone) which is connected to the “remote control receiver” to be discussed later.

The rear panel, shown pictorially in Fig. 1, has almost as many interesting features as the impressive front panel. There are two-channel phono and aux inputs, with a slide switch to select high and low sensitivities for different types of phono cartridges. There are the four “discrete” aux inputs for four-channel program sources from tape, as mentioned. In addition to the usual “tape out” and “tape in” pairs of jacks, there is a pair called “dub out” which permit recording from one tape recorder to another or recording from a program source

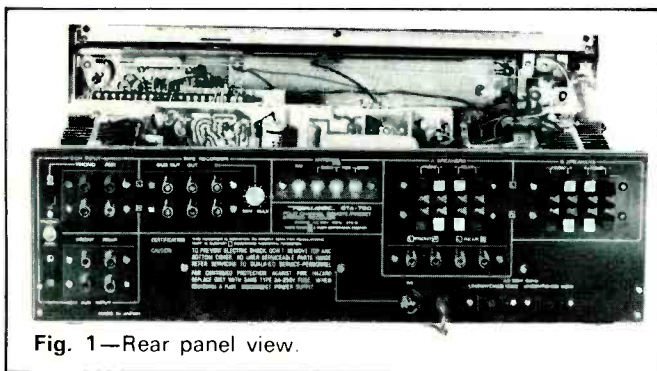

Fig. 1—Rear panel view.

selected within the receiver (AM, FM or phono or aux) onto two tape recorders simultaneously. The tape playback input jacks have an input level control associated with them, to compensate for the widely differing line output levels which exist between commercially available reel-to-reel, 8-track and cassette machines these days. Screw terminals are provided for external AM antenna, 300 ohm or 75 ohm FM antennas. The line cord of the QTA-790 is equipped with a metal clamp which acts as a small capacitor if connected to the FM antenna center terminal, thus utilizing the length of the line cord (plus who knows how many unmatched yards of house wiring) as an "FM Antenna." We promptly disconnected this clamp and connected a legitimate antenna for our listening tests after measurements were completed. Speaker terminals for up to eight speakers (two full sets of quadraphonic systems) are of the very practical and easy-to-use "piano key" type which, when depressed, disclose a small hole into which the stripped ends of your speaker wires are simply inserted. Letting go of the "keys" clamps the wires firmly in place and, if you don't strip away too much insulation, this arrangement absolutely precludes the possibility of speaker cable shorts. (If you do strip away too much insulation, just snip off the exposed copper wire to about 1/4 inch of length and the system works perfectly.) Just in case you happen to own speakers equipped with pin-plug connectors, four jacks, paralleling the "A Speaker" terminals are also provided below the speaker terminals. Two unswitched convenience a.c. receptacles and a holder for 3 ampere fuses complete the back-panel layout.

Considering the enormous amount of circuitry contained in the QTA-790 receiver, the chassis layout is neat and very well laid out.

There are 12 separate modules used to make up the circuitry of this receiver, some of which can be seen in the photo of Fig. 2. The FM front-end, manufactured by Alps, is about the smallest we have seen, largely because it does not contain a variable capacitor. All FM tuning is accomplished electronically, by applying well regulated d.c. voltages to varactor diodes. Each of the station pre-sets referred to earlier is, therefore, actually nothing more than a multi-turn potentiometer which "picks off" a selected amount of d.c. voltage and "tunes" the front-end to the desired frequency. Even the manual tuning knob is simply geared down to a single turn potentiometer which "scans" voltages required to tune from 88 MHz to 108 MHz, and therefore no flywheel was used in the arrangement.

The small front-end is mounted directly on a large "tuner board" module which includes a two-gang AM variable capacitor and a minimal amount of AM circuitry. The FM i.f. section is quite elaborate, however, and includes a permanently tuned ceramic filter, three interstage transformers, three transistors, an integrated circuit, and a conventional ratio-detector circuit. The FM stereo circuitry is also contained on this module and utilizes a 4-diode bridge in its time-division demodulation circuit. The SQ decoder board is of interest in that it utilizes a total of 15 transistors to accomplish the necessary phase-shifting, summing, and decoding required in the SQ system. The phono preamp module contains four transistors, two per each channel of equalization and preamplification. Two channels of power amplification are mounted on each of two power output modules, attached to fairly massive, sturdily mounted heat sinks, each of which houses four 2SC1111 power output silicon transistors in TO-3 housings. Other modules examined include a separate tone-control module (four two-transistor negative-feedback Baxandall circuits), a power supply module, a remote control receiver module (no less than 21 transistors required on this one), a pre-set remote control module (ten more transistors, 3 IC's and five relay-switches) plus several other minor modules for voltage amplification, dial pointer illumination, and circuit protection. In all, we counted no less

than 103 transistors, not including the two used in the separate remote control hand-held unit.

### Laboratory Measurements

Important monophonic performance characteristics are plotted in Fig. 3. IHF sensitivity turned out to be 1.7  $\mu\text{V}$ , quite a bit better than the nominal 2.0  $\mu\text{V}$  claimed by the manufacturer. More important, 50 dB of SN was attained with a mere 3  $\mu\text{V}$  of signal input, an extremely impressive figure.

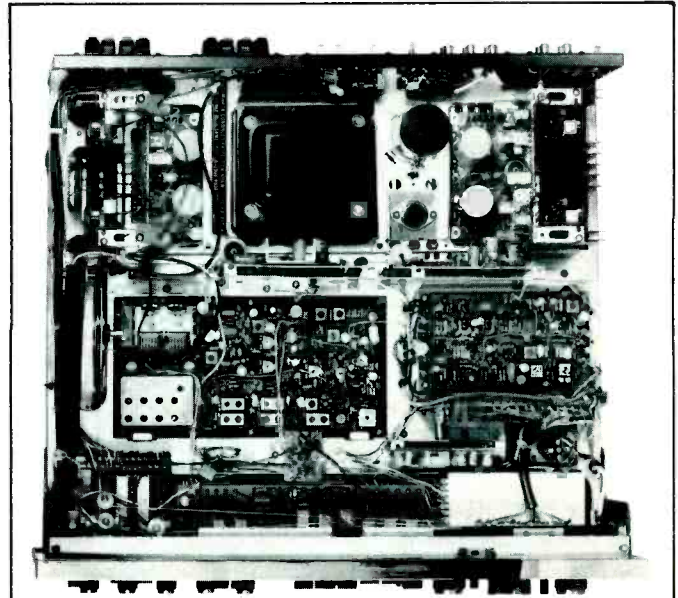

Fig. 2—Inside view of chassis layout.

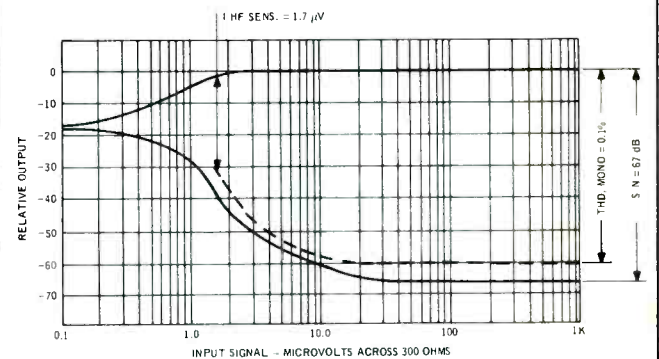

Fig. 3—Mono FM characteristics.

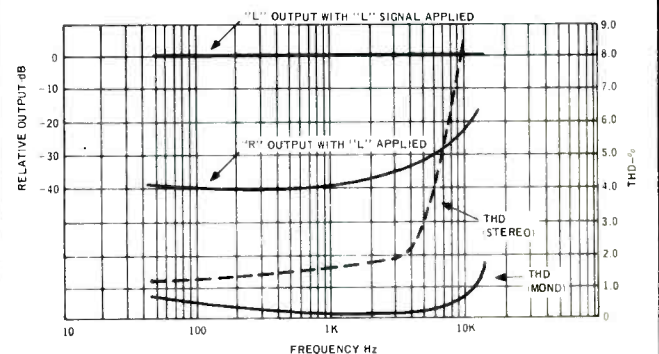

Fig. 4—Distortion and separation characteristics.

Ultimate S/N was 67 dB, achieved for all input levels above 50  $\mu$ V, and again, much better than the 60 dB claimed for the FM section. THD in mono reached an incredibly low 0.1% for 100% modulation. This is as low as we have ever measured and corresponds to the guarantee provided for our excellent Sound Technology FM Stereo Generator. The manufacturer only claims 0.3% for this specification and possibly they have no way to measure the low figure actually realized by the receiver. A complete plot of THD versus frequency is shown in Fig. 4. Although mono THD does rise a bit at the extremes of the audio range, it remains comfortably below 1.0% to 10 kHz and reaches no higher than 0.5% at the low end of the audio spectrum. However, in stereo mode the THD is not as good, hovering at about 1.5% at mid-band and low frequencies and climbing above the 2% mark for frequencies above 5 kHz. The distortion content at these high frequencies was both harmonic and "beat frequency" in nature, with the latter contribution rising as higher frequencies were tested. Under music listening conditions, this "beat" contribution is less offensive than the purely harmonic contribution and, therefore, the amount measured at 10 kHz, for example, is not nearly as "audible" a distortion as you might suppose.

Stereo separation at low and mid frequencies was 40 dB, much better than the 35 dB claimed, decreasing to about 25 dB at 10 kHz. Both left and right channels behaved similarly in this respect, and so only the right output is plotted in Fig. 4 for separation characteristics.

By our measurements, the QTA-790 is capable of producing 35 watts per channel at a THD of 1% or less, measured at 1000 Hz. These measurements were made with all four channels driven to full output, and is certainly close enough to the 36 watts claimed by the manufacturer—since one meter needle

"pointer width" would account for such a small difference. THD versus power output is plotted in Fig 5, and for all power levels below 25 watts or so, THD hovers around a very low 0.1%. IM distortion, also shown in Fig. 5, is about 0.2% for all power levels below 20 watts and reaches 1% for an output of about 28 watts per channel. At 32 watts per channel, IM reached 3.0%.

Although the manufacturer makes no claims for wattage output capability at the extremes of the audible frequency range, it is clear from Fig. 6 that the 35 watt power figure is a mid-band capability. At half rated power, the THD remained below 0.5% across the entire audio band, while at 1 watt nominal listening levels, the 0.1% or better figure applied across the entire audio spectrum.

Power bandwidth, shown plotted in Fig. 7, turned out to be from 18 Hz to 45 kHz, exactly as claimed.

Other data relating to both r.f. and audio performance were taken, though not specifically plotted in graph form. These include a capture ratio of 1.5 dB as claimed, selectivity of 58 dB (somewhat better than claimed), and confirmation of the various input sensitivity specifications stated by the manufacturer.

Phono hum level, though not stated by the manufacturer, is one specification they should have been proud to publish. It measured 68 dB below rated input signal in the "high" sensitivity position and 72 dB in the "low" setting. Aux hum for rated output with rated input was about 75 dB, while amplifier residual hum (volume at minimum) measured about 80 dB.

Other preamp-control characteristics are plotted in Fig. 8. These include plots of the three tone controls. Of particular interest is the range of the "mid-range" control, that third (Continued on page 51)

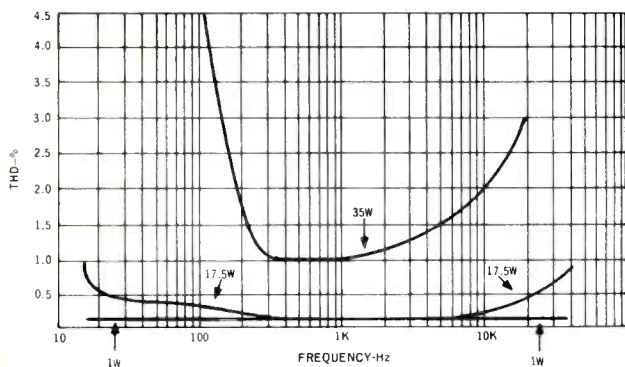

Fig. 5—Power output vs distortion.

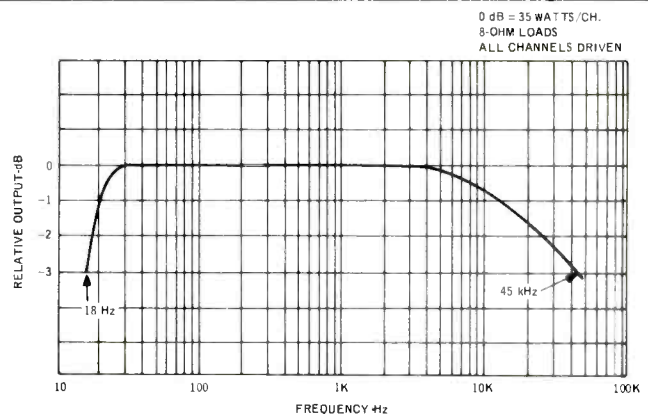

Fig. 7—Power bandwidth.

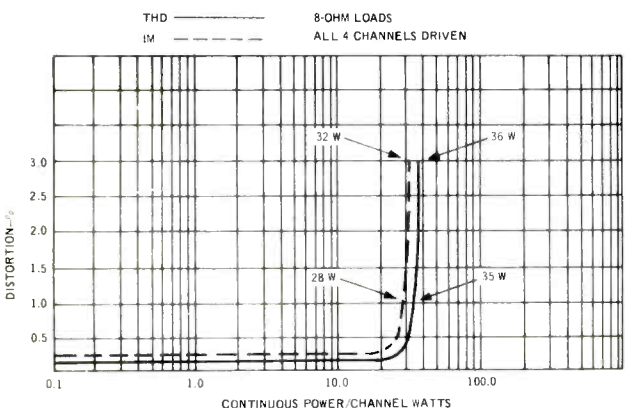

Fig. 6—Harmonic distortion vs frequency.

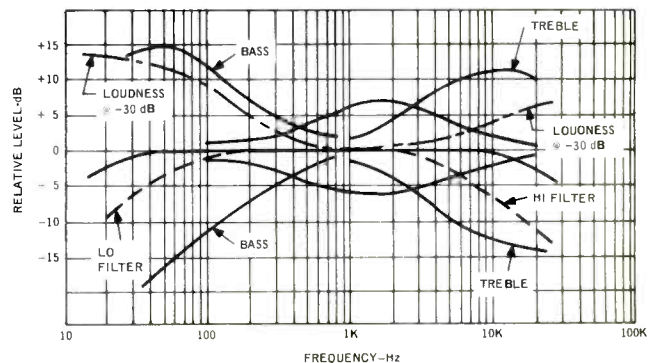

Fig. 8—Frequency response, tone control range, and loudness characteristics.

# Listen



## to the irresistible sound of Martin Speakers

The sound of Martin Speakers can be as quiet and irresistible as the gentle meeting of sand and surf. Or vibrant and deepthroated as the roar of thunder in the summer sky.

Martin Speakers, for people who are attuned to the irresistible sounds of the audible universe.



**MARTIN SPEAKER SYSTEMS • A DIVISION OF EASTMAN SOUND MANUFACTURING CO., INC.**

Harmony Road and Route 295  
Mickleton, New Jersey  
08056

Martin Speakers from \$44.50 to \$350.00

"A new standard of performance built  
by people who listen."

Check No. 10 on Reader Service Card

# Advertising Index

ADVERTISER	PAGE	ADVERTISER	PAGE	ADVERTISER	PAGE
Akai America, Ltd. GXC-46D Cassette Deck Check No. 1 on Reader Service Card	9	Hitachi Loudspeakers Check No. 17 on Reader Service Card Maxi-Fi Components Check No. 18 on Reader Service Card	61,63	Rogersound Laboratories Loudspeakers Check No. 30 on Reader Service Card	14
Audio Dynamics Corp. ADC-XLM Cartridge Check No. 3 on Reader Service Card	5	Innermedia Electronics Speaker Systems Check No. 19 on Reader Service Card	61	Sansui Electronics Corp. QRX-3500 Receiver Check No. 31 on Reader Service Card	15
Audio-technica, U.S., Inc. Shibata Stylus Check No. 4 on Reader Service Card	71	KLH Research & Development Bookshelf Speakers Check No. 20 on Reader Service Card	33	Saxitone Tape Sales Magnetic Tape Write Direct to Advertiser	77
Audio Warehouse Mail Order Discounts Check No. 5 on Reader Service Card	75	Linear Design Labs LDL 749 Speaker Write Direct to Advertiser	2	Schwann Record & Tape Guide Current Record & Tape Listings Write Direct to Advertiser	72
BSR Equalizer Check No. 6 on Reader Service Card	71	Marantz Co., Inc. Receivers Check No. 43 on Reader Service Card	Cover 3	Shure Brothers Inc. V-15 Type III Cartridge Check No. 32 on Reader Service Card	59
Bose Corp. Model 800 Loudspeaker Check No. 46 on Reader Service Card Personnel Check No. 7 on Reader Service Card	73, Back Cover	Maximus Sound Corp. Speakers Check No. 21 on Reader Service Card	70	Sony Corp. of America PS-2251 Turntable Check No. 33 on Reader Service Card	11
British Industries Co. Garrard Zero 100 Turntable Check No. 8 on Reader Service Card	3	McIntosh Laboratories MX-113 and Free Catalog Check No. 22 on Reader Service Card	66	Soundcraftsmen Equalizers Check No. 34 on Reader Service Card	35
Crown International DC300A Amplifier Check No. 9 on Reader Service Card	69	Midwest Hi Fi Mail Order Discounts Check No. 23 on Reader Service Card	68	Southwest Technical Products Corp. 207 Amplifier Check No. 36 on Reader Service Card	68
Dynaco Loudspeakers Write Direct to Advertiser	23	Panasonic Technics SA-8000X Check No. 24 on Reader Service Card	38,39	Stanton Magnetics Headsets Check No. 44 on Reader Service Card	17
Eastman Sound Martin Speakers Check No. 10 on Reader Service Card	45	Phase Linear Corp. 400 Amplifier Check No. 25 on Reader Service Card	13	Superscope, Inc. Tape Decks Check No. 63 on Reader Service Card	20,21
Electro-Voice, Inc. Microphones Check No. 11 on Reader Service Card	32	U.S. Pioneer Electronics Series R Speakers Check No. 26 on Reader Service Card	Cover II, I	Tandberg of America Tape Decks Check No. 37 on Reader Service Card	57
Empire Scientific Corp. 598 II Turntable Check No. 12 on Reader Service Card	66	Quatre Loudspeakers Check No. 27 on Reader Service Card	73	Tascam Corp. Mixing Console Check No. 38 on Reader Service Card	31
Epicure Products Inc. Loudspeaker Systems Check No. 13 on Reader Service Card	27	RTR Industries, Inc. ESR-6 Loudspeakers Check No. 47 on Reader Service Card	62	TEAC Corp. of America Frequency Response Facts Check No. 29 on Reader Service Card	24, 25
Harman Kardon High Fidelity Components Check No. 16 on Reader Service Card	53	Rabco Turntables Check No. 28 on Reader Service Card	34	Trusonic JR 200M Loudspeaker Check No. 40 on Reader Service Card	65
		Revox Corp. Tape Deck Check No. 39 on Reader Service Card	7	United Audio Dual Turntables Check No. 41 on Reader Service Card	19
				Wholesale Audio Mail Order Discounts Check No. 42 on Reader Service Card	74

(Continued from page 44)

control lately being added by several receiver and amplifier manufacturers. It acts much like a "presence" control, emphasizing voice frequencies and, while we feel that in the case of the QTA-790 its mid-point of action is a bit high in frequency (it centered at about 1500 Hz), it is *most* effective in use and well worth having. Loudness, high and low filter action were typical (filters had a slope of 6 dB per octave), and the designers of this equipment chose to include a moderate amount of treble emphasis in their loudness circuit, as well as the usual bass-lift with decreasing volume settings.

### Remote Control Unit

Before commenting upon our listening experience with the QTA-790, a brief description of the included remote control unit would be appropriate. When first confronted with this "extra" we presumed that it would perform the same "station scanning" function performed by other "remote control" units we had seen. Well, it does select stations, but only those you've selected on the five pre-set dials, and actually, that's really quite sufficient. What we really had hoped for in a remote control unit was a means of controlling volume level. Sure enough, this one *has it*. In addition to the station selector button (which, when pushed, successively chooses pre-sets one through five), there is an "up" button and a "down" button. When these are pushed, the entire volume control on the receiver *actually rotates* clockwise or counterclockwise—slow enough for you to "zero in" on just the volume level you want. A geared-down miniature motor is actually coupled to the volume control shaft within the receiver and the motor is actuated by part of the 2I-transistor "remote control module" we mentioned earlier.

A schematic of the hand-held "transmitter section," which is powered by a standard 9-volt "transistor" battery, is shown in Fig. 9 and, as you can see, the three switches or buttons simply actuate an ultra-sonic oscillator at three predetermined frequencies. The output of the electronics drives a transducer (think of it as a super-super-tweeter, if you like), whose sonic energy is picked up by the "microphone" transducer mounted on the front panel of the receiver. Sounds simple, of course, but it meant quite a bit of additional electronics in this already "full" receiver. All-in-all, the remote feature was very well executed, and we used it for nearly a week in our listening tests and neither it, nor the receiver, ever "did the wrong thing."

### Listening Tests

Much of our listening with this receiver was devoted to SQ encoded records, since this is, after all, a four-channel receiver. SQ decoding was fine, but of course only the basic SQ matrix decoding is used, with no "logic circuitry" provided. As is true with all previously SQ products tested, effective four-channel spatial distribution under these circumstances is highly dependent upon proper listener position.

In our opinion, the SQ matrix is not particularly effective in "synthesizing" four-channel effects from older two-channel discs, though of course some ambience is recovered in this format. We would have preferred to see a second "matrix" position available for such playing, as well as for more effective reproduction of other matrix-type discs such as QS or "regular matrix."

The muting circuitry of the FM section is set to about 7 microvolts threshold, which in itself is not an unwise choice. However, the transition from mute to non-mute is not quite instantaneous and, in listening to FM, we were able to encounter situations that were "borderline" and tended to "con-

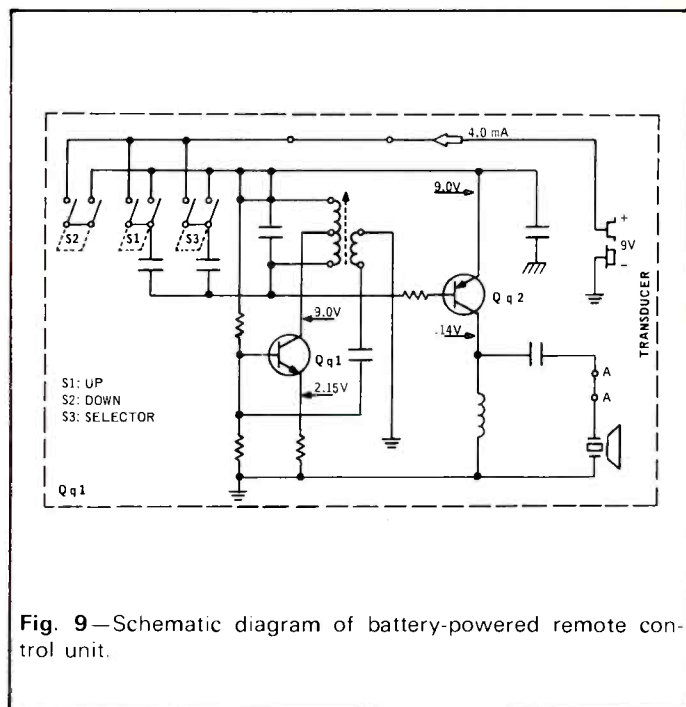

Fig. 9—Schematic diagram of battery-powered remote control unit.

fuse the muting circuit." Disabling the mute button corrected these few situations, however. Stereo threshold, on the other hand, is set at about  $5 \mu\text{V}$ , and is quite positive in its action. Signals below that input level would not be satisfactory if heard in stereo, and the action is automatic in restoring mono reception under those circumstances.

FM mono performance was without any flaws, but we were slightly conscious of distortion when listening to stereo FM stations. Frequency calibration was a bit off (about 500 kHz at the low end, about 150 kHz at the high end) on the unit we tested, but this could no doubt be easily corrected by more careful alignment of the electronic voltage-tuning circuitry. Sensitivity was excellent not only at mid-band, but at all points on the FM dial, as evidenced by the 54 signals we were able to pick up with our stationary outdoor Yagi antenna directed towards New York City some 20 miles away.

We found that amplifier power capability was adequate for driving our low-efficiency, air-suspension speaker systems to loud listening levels, but at really ear-shattering levels, bass overload was detected on some passages of rock recordings we used for our auditioning. Unless you are equipped for four-channel sound (and have four speakers in your listening room), stereo operation of this receiver limits its use to two of its four 35 watt channels. On the other hand, if you do have four speakers in your room but choose the STEREO ALL position of the mode switch, that effectively adds 6 dB of sound-pressure level to your overall sound, even when stereo program sources are used. Certainly, if four-channel material is used (either matrix or discrete), 36 watts per channel times four seemed to us like more than enough for our "average" size living room (14 × 19 feet).

Certainly, the complexity possible in a four-channel receiver goes beyond that designed into this Realistic Model QTA-790. On the other hand, so do some of the prices for these four-channel all-in-ones. All things considered, at \$598.00 this receiver manages to provide many of the goodies the budding four-channel enthusiast is likely to look for—and is likely to be able to afford.

—Leonard Feldman

Check No. 100 on Reader Service Card

## The Bozak Sonora Loudspeaker System

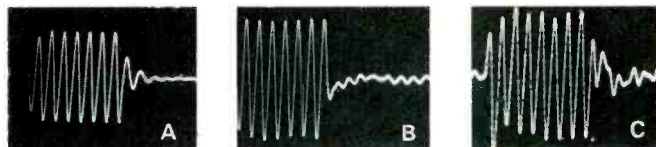
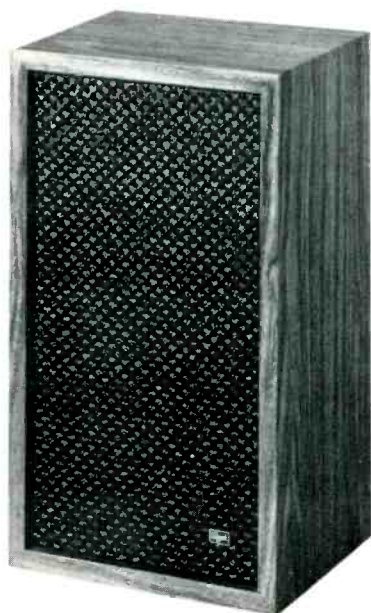

Fig. 2—Tone-burst response. A is 100 Hz; B, 500 Hz; and C, 5000 Hz.

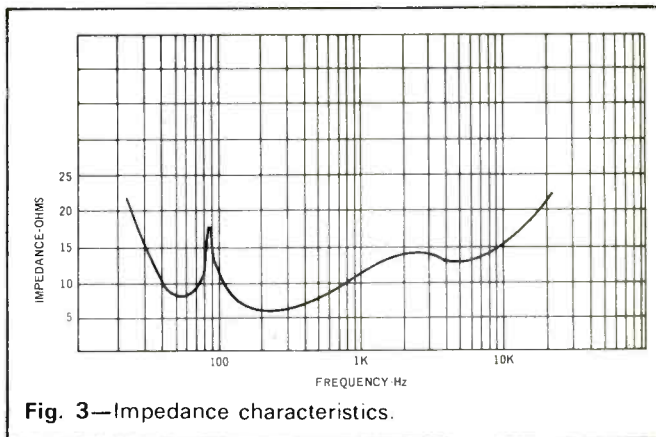

Fig. 3—Impedance characteristics.

### MANUFACTURER'S SPECIFICATIONS:

**System Type:** Two way, totally enclosed. **System components:** 8-in. bass, 2½-in. cone tweeter. **Crossover frequency:** 1800 Hz. **Frequency response:** 45 to 20 kHz. **Recommended amplifier power:** 10 watts (min.). **Nominal Impedance:** 8 ohms. **Dimensions:** 11¾ x 20¼ x 10 inches deep. **Price:** \$94.50.

The name Bozak has always been associated with big sound, large domestic systems or high power speakers for public address. However, they do make bookshelf systems and a few months ago announced the Sonora which is a small system costing less than \$100. It employs an 8-in. bass unit with a 2½-in. cone tweeter—both having metal cones. The HF unit is mounted behind the baffle board which is chamfered to form a kind of horn. Crossover is about 2 kHz and no level control is provided. The system is a tube-vented reflex and the resonance measured 89 Hz. Cabinet finish is walnut and the grille is detachable.

### Measurements

Figure 1 shows the response measured with one-third octave pink noise. A was taken on-axis, B at 60 degrees off-axis, and C is an average of five positions. Tone-burst responses at 100,

500, and 5000 Hz are shown in Fig. 2. The impedance characteristics are given in Fig. 3 and it will be seen that the lowest point is around 7 ohms. Low frequency THD and some SPL figures are shown in Fig. 4. Power outputs were 5 and 10 watts. The Sonora could handle 24 watts continuous power at 40 Hz without distress and 45 watts at 100 Hz. White noise tests showed a slight "boxy" coloration.

### Listening Tests

Efficiency of the Sonora is somewhat above average and a genuine 10 to 15 watts per channel will be adequate to produce a room-filling sound. The receiver actually used for most of the tests was a Pioneer 424, which is an inexpensive model costing less than \$200. This receiver has the advantage of a speaker switch, thus enabling quick comparisons to be made. The first impression of the Sonora was a smooth sound, but a *big* sound typical of a much larger system. The extreme bass was missing, of course, and the high frequency response seemed just a little attenuated. On the other hand, it was free from spurious presence peaks and consequently quite easy to listen to. If you are looking for a good system in the \$100 class, put the Bozak on your list.

T.A.

Check No. 110 on Reader Service Card

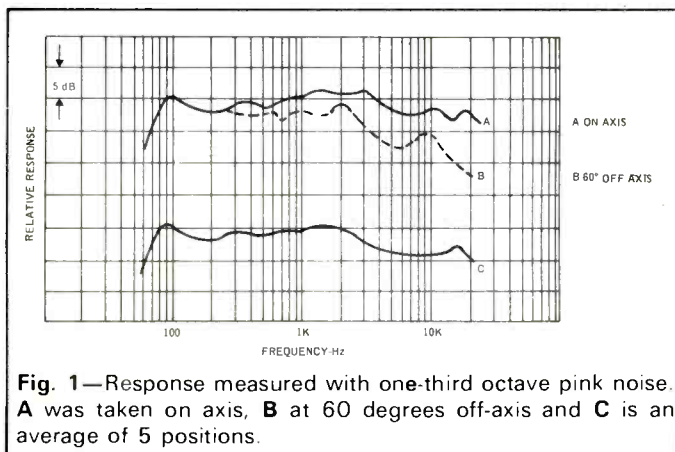

Fig. 1—Response measured with one-third octave pink noise. A was taken on axis, B at 60 degrees off-axis and C is an average of 5 positions.

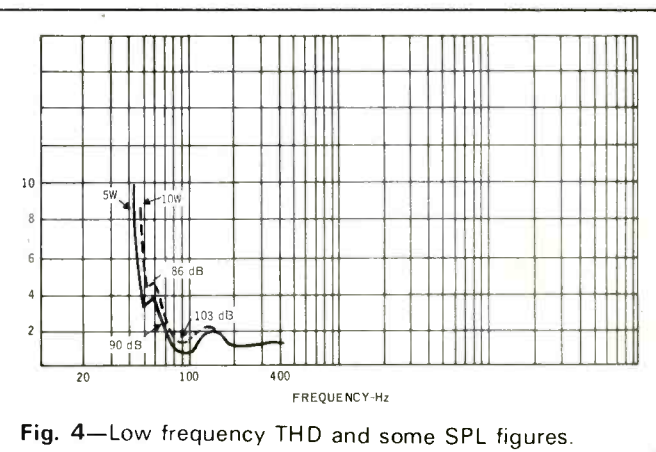
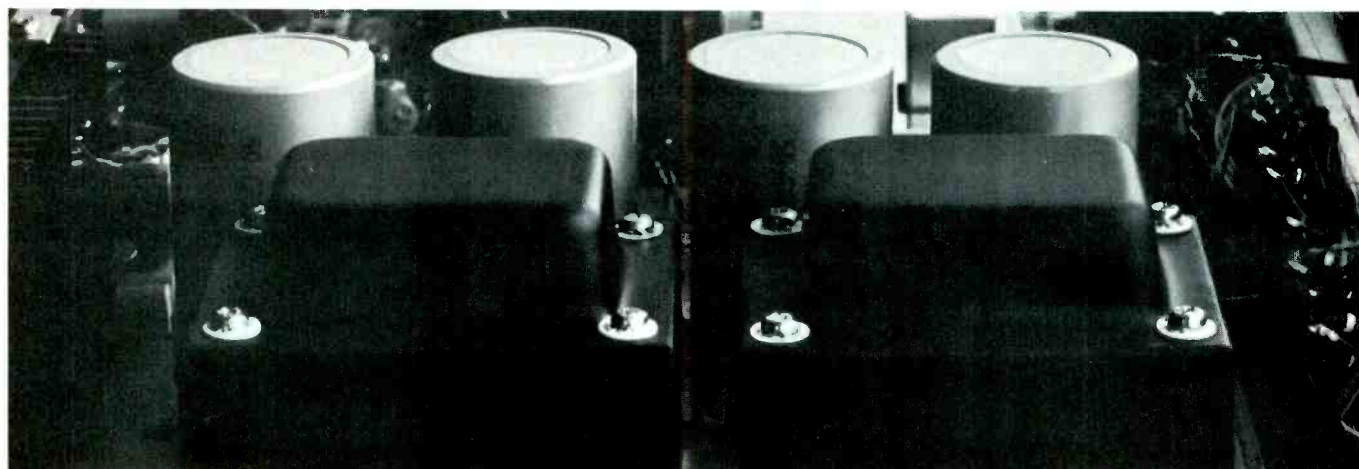

Fig. 4—Low frequency THD and some SPL figures.



# WE'RE STILL THE ONLY ONES WHO ARE FIRST WITH IT.

And we're still the ones with the best square wave response because of it. Twin-power, in receivers by Harman/Kardon.



Harman/Kardon Inc., 55 Ames Court, Plainville, N.Y. 11803, U.S.A. Also available in Canada.

Check No. 16 on Reader Service Card

**Technics by Panasonic Quadraphonic Tape Recorder  
Model RS-740US**



**Manufacturer's Specifications**

**Tracks;** 4, quadraphonic. **Speeds:** 3¼ and 7½ ips. **Frequency Response:** 30 to 23,000 Hz at 7½ ips; 30 to 20,000 ± 3 dB. **Wow and Flutter:** Less than 0.1% at 7½ ips; less than 0.13% at 3¼ ips. **Inputs:** Mic, -65 dB (4 circuits) 5k to 20k ohms impedance; line, -30 dB, 220k ohms impedance. **Output:** Line, 10,000 ohms impedance; headphones, 8 ohms. **Dimensions:** 16¼ in. W x 15¼ in. H. x 8 in. D. **Price:** \$449.95.

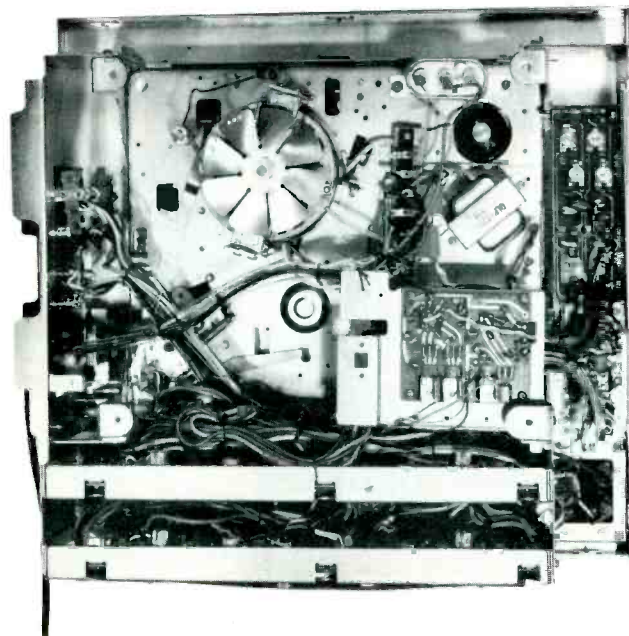

Fig. 1—Showing the underneath view.

The RS-740US is a quadraphonic tape deck having a good all-round performance for its modest price of \$449.95. It is one of the first products to be designated Technics by Panasonic, a name designating top quality equipment for the audiophile. The first thing that strikes the eye is the neat row of six knobs at the bottom. Reading from the left, the first pair are dual-concentric types controlling the input signal. The next pair are also dual concentric and they control the output. The third pair are labelled "separation," and they can blend the front and rear channels. If both are turned to maximum, then the front and back pairs form a double two-channel. To the right are two headphone sockets, and at the extreme left are four microphone input sockets. Above these are the record switches and the usual digital counter. To the right of the meters are the tape selector and the equalizer switches. The tape selector enables either normal or low-noise tape to be used, and the equalizer switch has to be used in conjunction with the two-position speed selector switch which is located at the top, between the two reels.

The large knob above the tape selector is the function lever and it controls the playback, record, fast-forward, reverse, pause, and stop functions. To the right is the push button ON/OFF switch. In a recess on the right hand side of the machine is a panel on which the input and output sockets (including DIN) are located. Also on this panel are output sockets for 'scope monitoring. Figure 1 shows the view underneath, and the head assembly is seen in Fig. 2. A single motor is used—a four-pole induction type.

**Circuit Details**

The basic design is fairly straightforward, with four record and four playback amplifiers. The basic circuit for a playback amplifier is shown in Fig. 3.  $R_1$  forms a d.c. stabilizing loop between the emitter of  $T_2$  to the base of  $T_1$ . The capacitor  $C_4$  prevents a.c. feedback. The network  $VR_1$ ,  $VR_2$ ,  $C_1$ ,  $C_2$ , and  $R_2$  form a frequency-selective, negative-feedback loop for equalization. The next two stages,  $T_3$  and  $T_4$ , both have current feedback in the emitter circuit ( $C_5$  is only 0.01  $\mu$ F), and the line and scope outputs are taken from the collector of  $T_4$ .  $T_5$  is an emitter-follower feeding the VU meter and headphone transformer.

A total of 36 transistors are used—plus two in the push-pull bias oscillator and another in the stabilized power supply.

**Measurements**

Figure 4 shows the record replay response at 7½ ips; the upper solid-line curve was taken at -20 VU and the broken line shows the response at 0 VU. Response at 3¼ ips is shown at

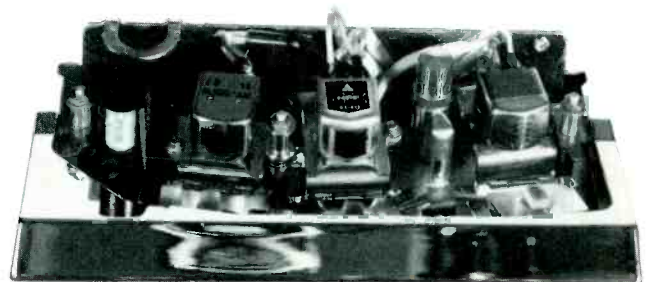

Fig. 2—Head assembly.

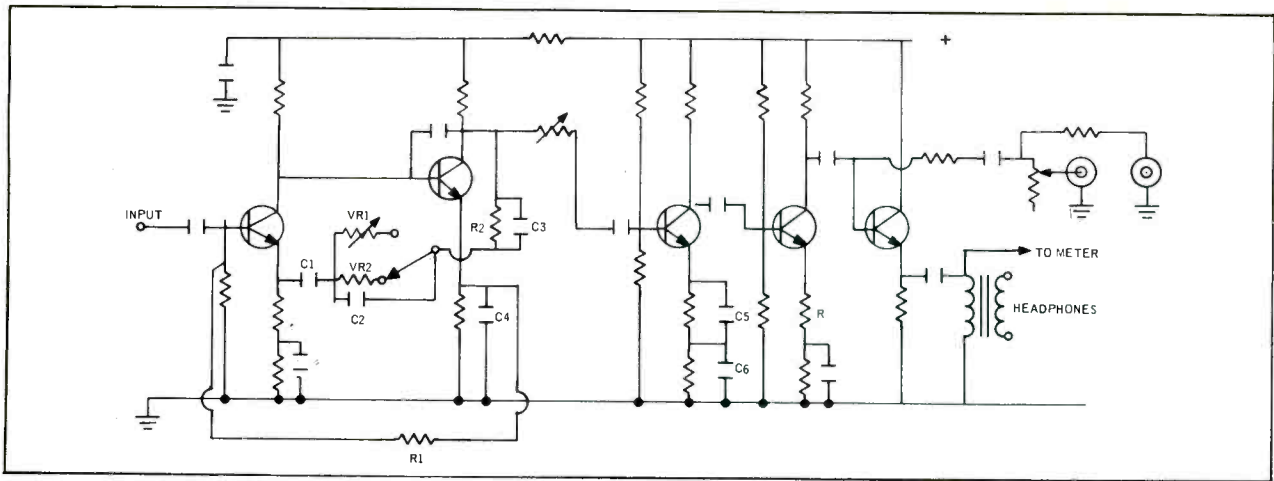

Fig. 3—Basic circuit of a playback amplifier.

B for both levels. It will be seen that the 3 dB point is at 24 kHz at 7½ ips and 13 kHz for 3¾ ips—very creditable. The response from a standard playback tape is given in Fig. 5. Distortion at 0 VU measured 0.8% at 1 kHz and increased to 1.4% at +3 dB, as can be seen from Fig. 6. THD versus frequency is shown in Fig. 7. Signal-to-noise ratio measured 59 dB referred to 0 VU or 63.5 dB referred to the 3% distortion figure. Incidentally, the tape used for these tests was Maxell UD, but similar results were achieved with TDK SD and BASF 35. Wow and flutter is specified as less than 0.10% at 7½ ips. Our measurements came very close with 0.12% at 7½ ips and 0.14% at 3¾ ips. Input sensitivity was 27 mV for 0 VU and the output was 500 mV.

### Listening Tests

For our tests we used the 740 with a Technics by Panasonic SA 6800X four-channel receiver and four EPI 100s. We found the deck easy to use, and the controls were smooth and positive. The monitoring facility is, of course, almost essential for the serious recording enthusiast, as is the provision for low-noise tapes. In fact, the reason why the overall results were better than the specifications might be due to the use of these tapes. Be that as it may, a distortion of less than 1% at 0 VU with a frequency response only 3 dB down at 24 kHz compares very favorably with machines costing much more. And the 740 is a four-channel deck into the bargain! Quadraphonic sound is an exciting field for the enthusiast—there are all kinds of recording methods to be tried: spaced mics, co-axial, omnidirectional, cardioid, and so on. And, don't forget, you can play your ordinary two-channel tapes on the 740 as well.

G. W. T.

Check No. 109 on Reader Service Card

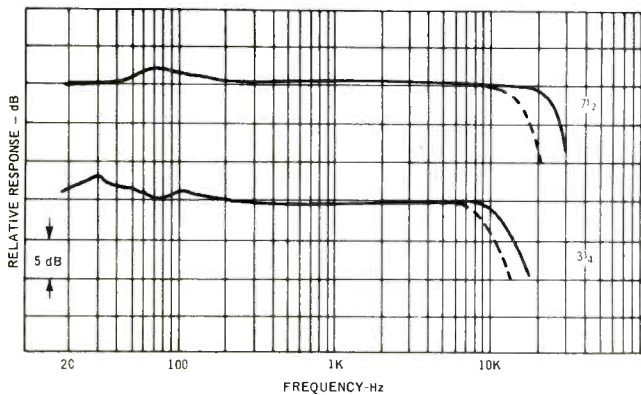

Fig. 4—Record-playback response at 7½ and 3¾ ips.

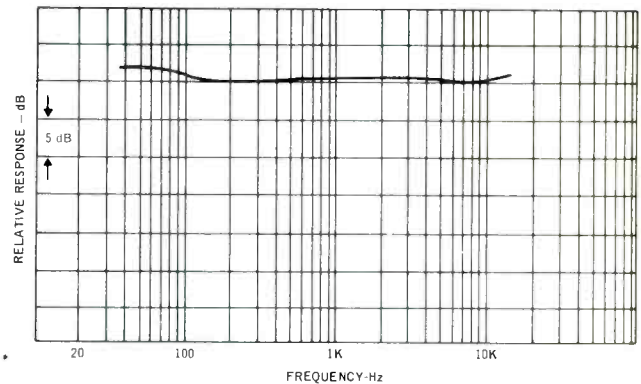

Fig. 5—Response from standard playback tape.

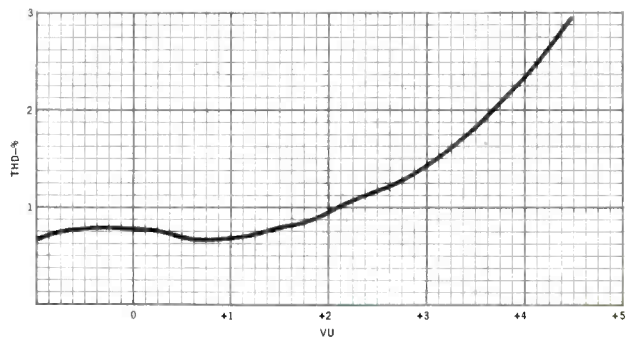

Fig. 6—Distortion at 1 kHz.

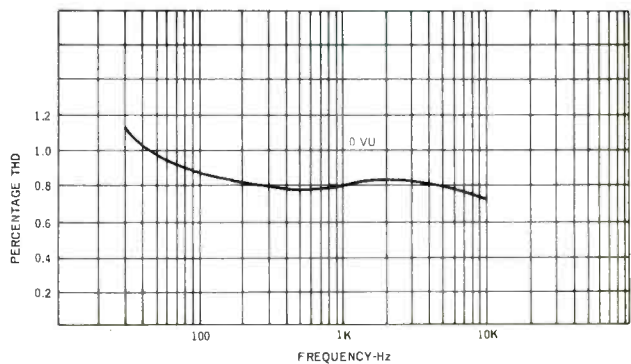

Fig. 7—THD versus frequency

## Microstatic MS-1 Add-On Speaker



### Manufacturer's Specifications

**Frequency Response:** 3.5 kHz to 30 kHz; 3.5 kHz to 18 kHz  $\pm 2$  dB. **Dispersion:** 180 degrees. **THD:** Less than 0.45% below 15 kHz, 20 watts input. **Nominal Impedance:** 16 ohms. **Maximum Power Handling:** 60 watts rms. **Drivers:** 4. **Dimensions:** 9 in. W. x 5 1/4 in. D. x 3 in. H. **Finish:** Solid Walnut. **Price:** \$117.00 per pair.

There is no doubt that many otherwise good speakers fall off in frequency response above 10 kHz or so. Many others radiate a narrow beam at high frequencies, thus restricting the stereo image, and so the idea of marketing a simple add-on unit was born. The Microstatic units have been available for some time now and we have received many letters from people who have been very satisfied with them. E. T. Canby tested them some time ago, and he said, "I can think of more than

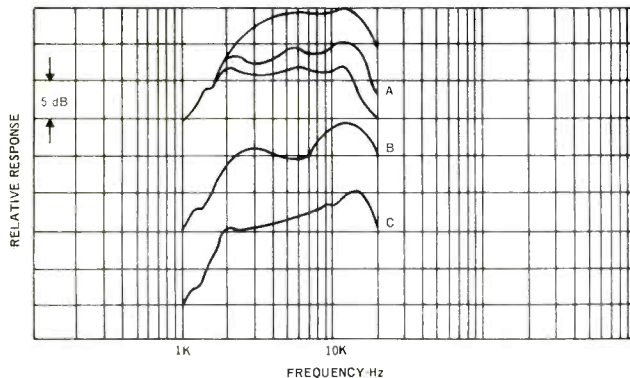

Fig. 1—Response with the switch in the 3.5 kHz position, taken with one-third octave pink noise. **A** shows the effect of the level control, while **B** was measured at 30 degrees off-axis, and **C** at 60 degrees.

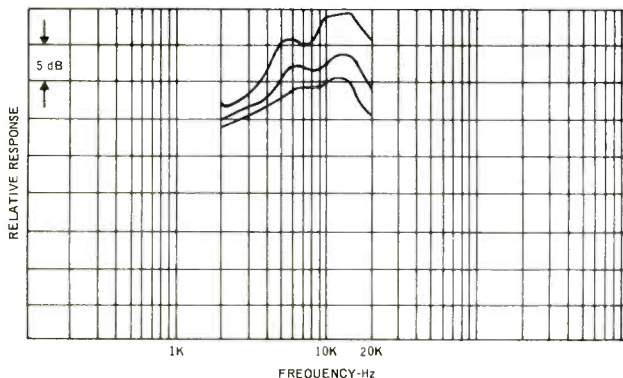

Fig. 2—Response with the switch in the 7 kHz position. Taken on-axis with level control in three positions.

one pair of speakers I would like to update with a set of Microstatics." However, this is the first opportunity we have had to test them ourselves. The system uses four small cone speakers, two 1 1/4 in. and two 1 3/4 in., mounted in an arc so that the dispersion is 180 degrees—not omnidirectional as described in one leaflet. There is a choice of crossover points, 3.5 kHz and 7 kHz, and a variable level control is provided. Our pair was supplied with a switch, possibly so we could demonstrate to ourselves the difference which occurs when the unit is connected.

### Measurements

Figure 1 shows the response measured with one-third octave pink noise with the switch in the 3.5 kHz crossover position. **A** was taken on-axis with three positions of the level control. **B** was measured at 30 degrees off-axis, and **C** at 60 degrees. Figure 2 shows the response on-axis with the switch in the 7 kHz position. It will be seen that suitable adjustment of the level control will give a response within 2 dB from 2 kHz to 16 kHz with little variation in radiation pattern. Figure 3 shows toneburst characteristics at 5, 10, and 15 kHz and Fig. 4 gives the impedance curve. White noise tests showed very low coloration. So much, then, for the measurements, except to mention that the impedance is high enough not to affect amplifier loading.

### Listening Tests

For our listening tests, we assembled a variety of speakers: a large Advent AR 3a, ADC 303ax, Martin Crescendo, and a Dyna A-25. The greatest improvement was noticed with the A-25. To quote the owner, "It sounds like a \$200 speaker!" Overenthusiastic? Perhaps, but the overall sound was much more airy and spacious. With the A-25, the 3.5 kHz crossover was used. The Advent sounded best with the switch in this position too, but the ADC 303ax and the AR 3a were better with the higher crossover. The AR speaker still did not sound like an LST, but the difference in dispersion was noticeable. Dispersion with the ADC 303ax and the Martin Crescendo is already quite wide, but here again the contribution from the Microstatics made a difference. Summing up, the Microstatics can be recommended with confidence. They are not particularly cheap but they do what they are supposed to do: what else can we say?

T.A. G.W.T.

Check No. 108 on Reader Service Card

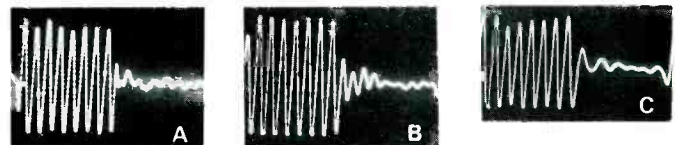

Fig. 3—Toneburst response. **A** is at 5 kHz, **B** at 10 kHz, and **C** at 15 kHz.

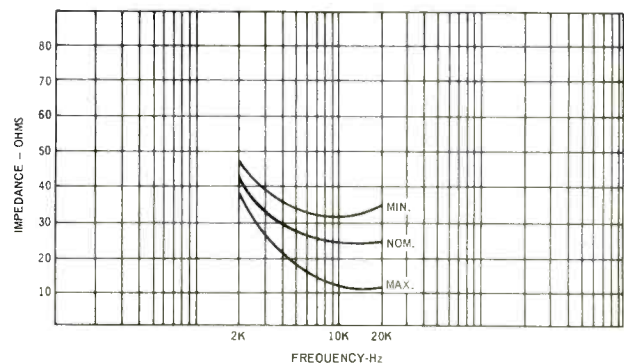

Fig. 4—Impedance characteristics at various frequencies.

# Tandberg tops Tandberg three ways

With the new 9000X 3-motor tape deck,  
the new 3300X medium-price deck.  
And the new TCD-300 stereo cassette deck.

At Tandberg we aim for just one level of quality . . . the highest. Now we've topped ourselves. With three new tape machines unmatched in sound and specifications.

Our new top-of-the-line is the three motor 9000X with the most sophisticated logic control system in tape recorder history. 15 integrated circuits do the work of almost 700 transistors to assure flawless, fingertip operation and proper sequential functions. True one hand tape threading.

And a rugged new remote controllable transport, with servo brakes, tape tension arms for maximum stability and gentle tape handling.

We have even improved our unexcelled Crossfield recording technique, that provides startlingly true full frequency response and noise free recording at 3<sup>3</sup>/<sub>4</sub> ips. In fact, the 9000X is limited only by the quality of tape you record with. Linear motion input/output potentiometers, sound on sound, echo, mono mixing, monitoring, front panel 8 ohm headphone output.

The 9000X is a professional quality machine for home use. Just \$649.50

Tandberg's brilliant new 3300X will set a new standard of excellence in the medium price field. A slightly less sophisticated version of the 9000X, it features a rugged new transport, with improved Tandberg Crossfield recording. Its record/playback response and signal/noise ratio are better at 3<sup>3</sup>/<sub>4</sub> ips than most other recorders at twice the price and at twice the speed. The 3300X features easy to use illuminated peak reading meters to eliminate guesswork, slide potentiometers, echo, sound on sound, mixing, front panel headphone jack and monitoring facilities with photoelectric end-stop. All for just \$399.90

And now—the world's first three motor, dual capstan, ferrite head, Dolbyized\* cassette recording deck—The Tandberg TCD-300.

That's right—three motors. One precise hysteresis synchronous drive motor for constant tape speed. Two D.C. reel motors which let you wind or rewind a C-60 in 40 seconds. Dual capstans to provide maximum stability and minimum wow and flutter—even with poor cassette tapes. Dolby\*, CrO<sub>2</sub> tape switches to optimize performance and produce an incredible 63 dB s/n ratio. Real head room to minimize distortion.

Dual Peak Reading meters, electronic push button control, servo-controlled wind, rewind and autostop, built in micro-

phone preamplifiers, and a recording/playback quality equal to many reel-to-reel recorders.

At last a true music fidelity cassette recorder. Sound exciting? You bet, and only \$399.90.

So there you have them—a Tandberg trio of newsmakers. And they're made the only way we know how . . . better.

\*DOLBY is a registered trademark of DOLBY LABORATORIES, INC.

## TANDBERG

We're our only competitor.

TANDBERG OF AMERICA, 8 THIRD AVENUE, PELHAM, NEW YORK 10803  
A. Allen Pringle Ltd., Ontario, Canada

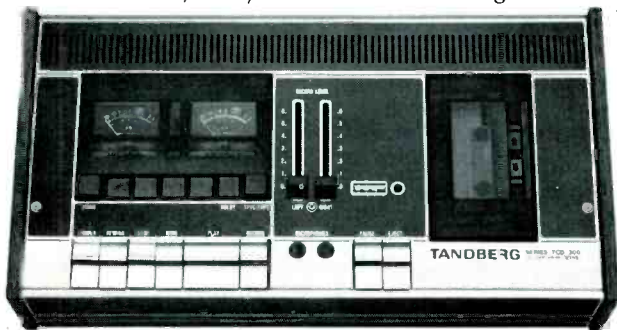

# Classical Record Reviews

Edward  
Tatnall  
Canby

**E. Power Biggs—24 Historic Organs in 8 Countries Covering 7 Centuries of Music by 24 Composers. Columbia MG 31207, 2 discs, stereo, \$11.98.**

This excellent set of two discs highlights the reissue technique in its most useful and constructive area, not a straight repeat issue nor, yet again, a mere cursory sampling but an important stage in between. Mr. Biggs' travels with CBS technicians and recorders brought back material for a long series of LPs, generally each one devoted to the organs of one European country—Spain, Italy, Germany, France, or to a composer—organ music by Haydn or Mozart or Handel. It was, and is, a pleasure to delve so deeply (relatively speaking) into the instrumental styles of each of these particular elements; we can always profit from detailed examination. On the other hand, a sampling of a sort from the total output would surely have a place, too.

This one is commendably inclusive. That is—each face of the two records is devoted to one major area, except the last, which covers Spain and Italy plus music by Mozart and Haydn. (There was, of course, proportionately less major organ activity in these areas—or Mr. Biggs thought it less important in terms of his available recorded material.)

I liked the single-minded approach for each side, which made it easy to follow the drift of things without too frequent consulting of the notes. I enjoyed again many of the memorable recordings, the superb sounds of the old Dutch organs and the North German, the blatty foghorn effects of those curious Spanish "trumpet" pipes, the conservative sound of the Oldest Organ at Sion in Switzerland. Musically, the very top highlight in the album is that incredibly great and late Mozart Organ Fantasia K. 608, one of his last and most profound works, with all of Bach, and Beethoven too, in its furious, des-

perately changing harmonies. I played it three times over, and could not leave it.

Performances: B+      Sound: B+

**Martin Berenbaum. (Hayden, Hummel Trumpet Concerti, Torelli: Sonata A Cinque No. 7, Albinoni Concerto "Saint Marc")** With the English Chamber Orch., Johannes Somary. **Vanguard VCS 10098 stereo** \$5.98; **VSQ 30012 SQ quadr** \$6.98.

Martin Berenbaum is a purely American musical product, a superb trumpeter whose sound very clearly reflects his background. How? Not easy to describe (and he uses more than one trumpet here), but there is that rich American fruitiness of tone, a trace of vibrato, a solistic emphasis. No great criticism! Other players hereabouts merely sound like trumpeters—playing some music or other. Berenbaum's technique is outstanding, but so is his genuine attention to the music and its sense, which makes all the difference for those of us who listen to music first and trumpets second.

The ultra-familiar Haydn is at its genial best and—wonder of wonders—the cadenzas don't take up half the record. Thanks, Mr. B! The really novel item, however, is the big Hummel Concerto, a work midway between the late Haydn and Beethoven styles, with a very considerable appeal. It's always good to hear from the also-rans, the near-greats who surrounded the top giants, Beethoven, Mozart and so on—and were forgotten. In their day, they were vital to music and a Beethoven, Mozart and so on—and were forgotten. In their day, they were vital to music and a Beethoven could not have existed without the complementary Hummels, Spohrs, Dusseks, Clementis and Fields.

The two short Baroque pieces are in harmonious contrast, a five-voiced Sonata by the excellent Torelli ("A Cinque") and a transcribed violin work by Albinoni. Johannes Somary is by now a seasoned and lucid conductor of Baroque and classic orchestral music. His leadership, I'd say, has a good deal to do with the good styling of these performances.

Performances: A-      Sound: B+

P.S. The two parallel releases of this trumpet recording, in stereo and in SQ quadraphonic, gave me my first chance to AB the two types of release via full SQ-with-logic decoding. Maybe I'm a cynic, but I didn't expect *too* much difference. A dollar's worth?

Understand, of course, that I play *all* my records, quadraphonic *or* regular stereo, via four speakers. Have been for a couple of years. I have found that the simpler non-logic or "plain" SQ decoding (found in lower-cost equipment items) does a splendid job on standard stereo discs, preserving the frontal stereo as claimed, spreading out the sound via the extra channels in a smoothly symmetrical fashion, very musical.

The same standard stereo sound via SQ-with-logic tends towards more variable randomness, as the logic circuits grasp for clues as to how to act—and find only happenstance. (The normal recording has no specific SQ encoded message, but contains a lot of random triggering information.) On logic SQ, the standard stereo sound seems to wave gently in the breeze, so to speak. Curious effect, gentle and not at all unpleasant. A kind of slow sonic rippling, here and there.

By itself, then, the trumpet recording in standard stereo played very well via SQ with logic. Entirely satisfactory, in spite of the mild image shifting as the logic circuits worked away at random clues. But when I

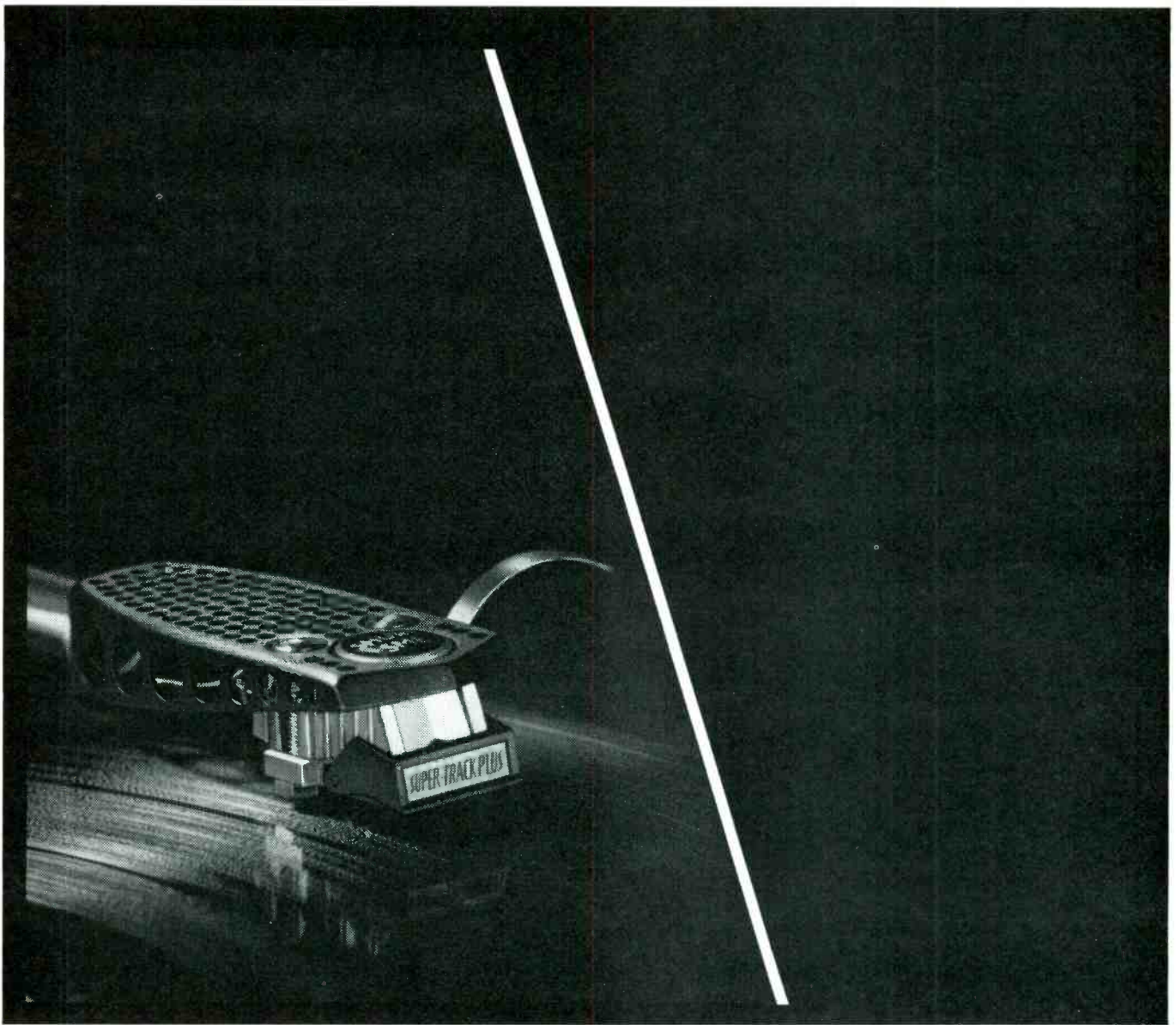

## anything II could do III can do better!

Several years ago, we decided that our next challenge would be to go beyond the best there was. Our computers told us we had taken the existing cartridge structure and stylus assembly of the V-15 Type II Improved as far as we could, and that hereafter, any improvement in one performance parameter would be at the expense of performance in some other parameter.

Therefore, over the past several years, a wholly new *laminated cartridge* structure has been developed, as was an entirely new stylus assembly with a 25% reduction in effec-

tive stylus mass! These developments have resulted in optimum trackability at light tracking forces ( $\frac{3}{4}$ - $1\frac{1}{4}$  grams), a truly flat, unaccented frequency response, and more extended dynamic range than was possible even with the Type II Improved, without sacrificing output level!

If you like its sound today, you will like it even more as time goes on. In fact, to go back to any other cartridge after living with the Type III for a short while is simply unthinkable, so notable is its neutral, uncolored sound. You must hear it. \$72.50.

INTRODUCING THE NEW

### **SHURE** V-15 TYPE III Super-Track "Plus" Phono Cartridge

Shure Brothers Inc. • 222 Hartrey Ave. • Evanston, Ill. 60204

In Canada: A. C. Simmonds & Sons Ltd.,

Check No. 32 on Reader Service Card

put on the same music in the SQ quadraphonic version, the sound instantly smoothed out, the ripples ceased, the space grew larger and less watery, the music was clarified, keener simpler, more incisive in effect. Yes—that dollar makes a difference.

Curious side-observation: the standard stereo had a heavier, tubbier bass than the SQ. I like the SQ bass better.

### Single Mic Technique

**The Kubelik Legacy. Chicago Symphony Orchestra.** Vol. I (Moussorgsky, Tchaikowsky, Mozart, Smetana); Vol. II (Tchaikowsky, Dvořák, Hindemith, Bartók). **Mercury MG 3-4500/4501** (3 discs each) mono \$17.94 ea.

Now here is a prize reissue, that caught my wandering eye in a trice. About time! For years, back in the Fifties, Mercury's "Living Presence" mono LP releases, done with the difficult single-mic technique that is now gone forever, were show-stopping items at all the shows and standard demo stuff for every hi fi living room. Who will forget that ringing trumpet in "Pictures at an Exhibition"? Here it is, large as life, 22 years later. The notable Mercury series under Chicago's short-term Czech conductor Rafael Kubelik, recorded from 1951 to 1953, is back on a pleasingly revived Mercury classical label and the sound is as good as anybody then thought, the music stands up extremely well to the later RCA Chicago recordings (among the first in stereo) with a more famous conductor, Fritz Reiner. Definitely, these tapes—were they quarter-inch full-track, or 35 mm. film size?—were sonic state of the art. They are clean, beautifully balanced and as quiet as Dolby.

The single-mic technique depended on finding the one, critical spot in a hall where (a) the instrumental balance was ideal and (b) the ambient reverb precisely matched the direct pickup. Too close—and the sound, as Shakespeare put it, was stale and unprofitable. Too distant, and all was hazy, flat and uninspiring. But at the exact point of perfection, one-mic music seemed to spring to life. A curious phenomenon, almost a resonance. Mercury got so it could bull's-eye in for almost any sort of music.

True, our tastes today have changed and in fact we have found the means, via many mics and assorted extramicro aids, to get down a sharper, more detailed definition of music onto our multi-track tapes. In a way, we have sacrificed the warmth and

simplicity of the older technique—just try it here—for what could be called a higher relief in the sculptural sense, a greater density of information. We have done this willingly and with immense success—I am not one who longs for the good old days! For it is inevitable that a medium which is *not* a concert hall but, mainly, a living room, should drift away from the concert hall itself towards whatever sound brings the most music into that living room environment.

But we must recognize the heights of achievement along our continuing route, admit that there are values and objections to *any* recording technique as a matter of course—and keep on working. Mercury's one-mic wonders are an inspiration, and we can thank the new owner, Philips, for bringing them back so handsomely.

Kubelik's music, of course, is the reason here behind the single mic. He was a relatively gentle leader, not the fierce disciplinarian that Fritz Reiner was well known to be. The Kubelik Bartók (Music for Strings, Percussion and Celesta) doesn't project the steely fury of the Reiner version. (Well, maybe this was the Orchestra's first try at it.) Kubelik's voltage is lower. The Kubelik Tchaikowsky, the Fourth and the Sixth, is good because it doesn't fray the nerves. Just full-bodied, and solid. The famous Moussorgsky "Pictures" is even better and more solid and was rightly almost played to death in our early hi fi years. The Mozart (the "Prague" Symphony—what else!) is clean and neat and a bit old fashioned. Needless to say, the Czech composers are the best of all—the Dvořák "New World" and, particularly, the Smetana duo, *Ma Vlast*. The familiar old Moldau goes rolling along in really lovely cascades of sound.

All hail to the single mic! It sounds good even in quadraphonic.

Performances: B+                      Sound: A-

**Schumann: Davidsbündlertänze, op. 6 Nachtstücke, op. 23.** Claudio Arrau, piano. **Philips 6500 178** stereo \$6.98

Schumann's piano specialty was the long, Romantic suite of dance-like and song-like movements, often tied together by various symbolic themes, anagrams of letters and what-not. The two characters of Schumann's imaginative personality—split sides, alas, for his eventual mental disintegration—are often present: the tender, slightly sheeplike Eusebius and the florid, flam-

boyant Florestan, reflected in contrasting musical moods.

There is, of course, a certain almost hysteric rigidity in these never quite adult musical forms, full of dogmatic repeats, seldom extended beyond a child-like confine. And yet, of course too, they are beautiful simply because Schumann was a first-rate genius at musical expression. But for the modern performer, they aren't easy. One must somehow *believe* in these early-Romantic conceits (that's easier today than yesterday) and somehow feel a bit paranoid or schizoid as well, to project the simple intensity of the music, whether the restrained Eusebius or the dangerous Florestan, on the very edge of hysteria.

All of which is a prelude to a surprise for me. I can only say that Arrau, for all his celebrity as an elder statesman of the piano, has never been a favorite of mine (I have disliked him even without knowing who was playing)—but this time, in this Schumann, I was very much impressed. It is good, and specifically at the very highest level. This somewhat reserved person, on the undemonstrative and shy side away from the piano itself, has decidedly found the answer to the composer's ultra-difficult keyboard personality. He plays impeccably, forcefully, yet without exaggeration and, somehow, gets across exactly the right pitch of intensely serious yet controlled emotion, totally direct and disarming. Romantic but without a trace of pre-tentiousness. That can, indeed, take a lifetime to learn.

There are numerous other Arrau Schumann discs, if this one is agreeable, including the familiar *Carnival*, Op. 9. Perhaps it was the very unfamiliarity of the works on the present record that made them both easier to play and easier in the listening. The Arrau repertory on Philips goes far beyond Schumann, into Liszt, Beethoven, the big works with orchestra.

Performance: A-                      Sound: B+

**Dvořák: Piano Trios: B flat, G minor, Opp. 21, 26; F minor, Op. 65; E minor, Op. 90 ("Dumky").** Beaux Arts Trio. **Philips LY 802 917/18/19** stereo \$6.98 ea.

These three Dvořák discs, issued at intervals during the last year, make a fine set, though they are available separately. The Beaux Arts Trio is not exactly Czech, with Manahem Pressler, piano, Isidore Cohen, violin and Bernard Greenhouse, cello, but the



three new world musicians have the Czech spirit down perfectly, as far as these Trios are concerned. It is lifting, spring-fresh Romantic music, lyric even in its serious moments, full of pleasing tunes and dance rhythms.

The powerhouse of the group is the pianist, Manahem Pressler, a rarely communicative artist whose powerful touch and superb rhythm and phrasing radiate the same sort of enthusiasm that Rudolph Serkin conveys—as though constantly saying, Look! Isn't this terrific! He is a pleasure to hear. Second in musical command is Bernard Greenhouse, whose cello in the occasionally important solos for the instruments sings out in perfect tune and eloquently. A fine cellist interpreter. For some reason, the violinist, Isidore Cohen, nominally the leader, seems a trace tired and not always secure, though his tone is often lovely enough. One senses less force here, though only relatively, the other two being so strong.

I wish I knew what motivates recording engineers in situations like this. Sometimes the piano is a mere accompaniment to ultra-close solos, violin, cello—as in Columbia's Stern/Rose/Istomin recordings of Schubert. Here, it is the opposite—the piano dominates, the two strings, especially the fiddle, are sonically on the weak side. In the early Dvořak this is fine. The first two Trios are in the older Mozart tradition, where violin and cello are mostly subordinate to the piano. But in the late works, especially the "Dumky" with its abundance of cello solo, the balance is a bit too pianistic. Better than the other way around, I'll have to admit!

Let's hope we hear more of Manahem Pressler, who has been around quite awhile. He is an absolutely splendid ensemble pianist, and a born communicator on records.

Performances: A— Sound: B

**Mozart in Chelsea. Divertimenti and Contredances.** Arr. Erik Smith. Academy of St. Martin in-the-Fields, Mariner. **Philips 6500 367**, stereo, \$6.98.

An unusual disc, this, in more ways than one. Mozart, first of all, was in Chelsea at the ripe age of *eight*, along with Papa Mozart and his sister Nannerl; the purpose—exploitation of the young genius. But Papa got the flu or equivalent (he called it a cold but was down for weeks). They lived in the "village" of Chelsea—could it be the present Chelsea district, just barely out

## The cassette for high frequency lovers and noise haters.

Hitachi's Ultra Dynamic cassette tapes give you beautiful music without those annoying background noises. By use of new, superfine, iron oxide power Ultra Dynamic cassettes achieve a frequency range that is twice as wide as standard tape.

Fewer harmonic distortions, an S/N ration of over 5 dB and an uncommonly low noise level make Ultra Dynamic cassette tapes quietly fantastic. Available in UDC-60, 90, and 120.



For more information, write: Hitachi Sales Corp. of America, 48-50 34th Street, Long Island City, N.Y. 11101

Quality always comes first at **HITACHI**

Check No. 17 on Reader Service Card

## CLASSIFIED

Want to buy, trade or sell components? Looking for a rare piece of equipment? Want to offer or buy a service? Want a job in the audio field? If your answer is "yes" to any of these questions, your ad belongs in Audio Classified. Rates are comfortably low—readership is astoundingly high. Use the handy order form to include your message in the next issue.

*The Sound of Excellence*

Tri-Planer III \$75

Tri-Planer II \$175

Tri-Planer I \$250

Tri-Planer, a line of speaker systems that produces the live, present, and tight sound of true percussion, with a true, smooth bass; clean, crisp, yet not harsh highs; and the smooth voice of fine orchestration.

TREAT YOURSELF TO THE INNERMEDIA EXPERIENCE OF FULL DIMENSIONALITY

**NNERMEDIA**  
ELECTRONICS

4503 E. RAILROAD AVENUE  
SACRAMENTO, CA 95826  
(916) 452-3341

DEALER INQUIRIES WELCOME

Check No. 19 on Reader Service Card

of downtown London? Little Mozart, left to his own devices and away from Papa's normal rigorous routine of instruction, got himself a note book and began jotting down music in semi-shorthand. Little orchestral-style tunes, with one-line figured bass accompaniments. He didn't yet know how to write out orchestral music but he knew very well what it sounded like.

Erik Smith has "realized" a batch of these remarkable little pieces into orchestral form, in the style of Mozart's

own later works of the very same sort, and the results are impeccable as well as remarkable. The one-line bass is filled out into harmony for strings and a few winds, the standard small Mozart orchestra of Salzburg; groups of the little pieces are put together into suites or, in Mozart fashion, Divertimenti. It is all very convincing, beautifully played and natural—and the music, for an eight-year-old Mozart, is—well, Mozart! Hard to believe. Only occasionally is there an audible clinker, a clumsy

change, a platitude. Mostly, as Smith observes, little Wolfgang was already ahead of his grown-up contemporaries in sheer power of musical invention. Listen for yourself.

Performance: A- Sound: B+

**Zuckerman Plays and Conducts Vivaldi The Four Seasons.** English Chamber Orchestra. **Columbia MQ 31798**, SQ quadraphonic, \$5.98.

One of the occasional debits of the star system is miscasting. It can be awful, or merely a minor miscast, as here. Zuckerman doesn't really have the right sort of fiddle technique for Vivaldi, though he has here approximated it with a great deal of intelligence. As conductor, he has come a long way (he is young) towards a natural feeling for this music as it should be done today—and has been done on umpteen other competing recordings. (Though this is the first in quad.)

Nothing wrong with the English Chamber Orchestra, which is ideal for the music. Not much wrong with Zuckerman's conducting, though it tends a bit towards softness and some tempi are, for today, a bit slow, the endings tend to slow down in the old fashioned way, no longer right in such music. Not quite up to date in style—but leagues ahead of some hideously Romantic versions by older conductors who should know better!

As a fiddler, however, Zuckerman's sound and his technique are basically out of the grand tradition; his fiddle has a Heifetz sound to it, decidedly, that rich, luscious tone so good against a large modern (i.e., 19th century) symphony orchestra, that tight, taut vibrato which helps the sound to stand forth heroically. Being young though, Zuckerman is, shall I say, modified Heifetz. In the slow Vivaldi he is able to play the rigorous, totally accurate, limpid tone, minus vibrato, that is necessary for this music. He manages most of the very fast passages beautifully, too, and with the right brilliance of effect. Good. Yet in a few spots, quite a few, the lightning-fast chordal arpeggios fail to hang in the air, whole chords of fiddle tone, as they definitely do in some other of the available performances. Zuckerman, in other words, makes an excellent try in an area that is not central to his acquired technique.

A big, fat, tank-like reverberation to the quadraphonics, lots of strong back reflections but the source clearly up front.

Performance: B Sound: B

## The New Columns



### Where it's at . . .

Alco Home Entertainment  
79 S. 3rd St., San Jose, CA 95113  
Audio Arts  
1870 First St., Livermore, CA 94550  
Audio Vision  
2304 E. Main St., Ventura, CA 93003  
California HiFi  
7437 Van Nuys Blvd., Van Nuys, CA 91405  
California HiFi  
2054 Davie St., City of Commerce, CA 90040  
Henry's Radio & Electronics  
931 N. Euclid St., Anaheim, CA 92803  
International Sound  
821 W. Roseburg Ave., Modesto, CA 95350  
Kustom Hi Fi  
1100 Burlingame Ave., Burlingame, CA 94010  
Shelley's Audio Inc.  
721 W. 9th St., Los Angeles, CA 90015  
Skinner, Hirsch & Kaye  
229 Kearney St., San Francisco, CA 94108  
Sound Co.  
4701 College Ave., San Diego, CA 92115  
Stereo City  
619 Fifth St., Eureka, CA 95501  
Mal Sykes TV & Hi Fi  
1720 Fulton Ave., Sacramento, CA 95827  
Woodland Stereo  
2118 Ventura Blvd., Woodland Hills, CA  
Garehime's Music Co.  
955 E. Sahara Ave., Las Vegas, NE 89105  
Gill Custom House  
8813 W. 95th St., Palos Hills, IL 60465  
George Filip Music  
20 E. Downer Place, Aurora, IL 60504  
Gibson Audio of New Orleans  
1418 Shreveport Bardsdale Hwy., Shreveport, LA 71105  
Quail Creek Stereo Inc.  
754 Shreveport Bardsdale Hwy., Shreveport, LA 71105  
Audio King  
7010 France Ave. So., Minneapolis, MN 55435  
Jensen's Stereo  
1247 Nolan Ave., Stillwater, MN 55082  
Roman's Audio Classics  
8012 Cedar Ave., Minneapolis, MN 55420  
Stereoland  
208 Broadway, Fargo, ND 58102  
Frey's Electronics  
522 S. Main, Aberdeen, SD 57401  
Arnold & Morgan Music Co.  
510 S. Garland, Garland, TX 75040  
Audio Concepts Unlimited  
1322 W. Hickory, Denton, TX 76201  
Sounds Unlimited  
4835 S. Alameda, Corpus Christi, TX 78412  
Toby Corp.  
4620 Camp Bowie, Ft. Worth, TX 76107  
Lloyd E. Dissmore  
4001 24th St., Kenosha, WI 53140  
Paul Heath  
354 State St., Rochester, NY 14608  
Sego Worldwide Elec.  
101 W. 45th St., New York, NY  
Utica Audio  
228 Columbia St., Utica, NY 13502

The RTR columns are a new concept in transducer application which by design exhibit a broad band of preferred loudspeaker characteristics. Each elegant walnut enclosure houses multiple ultralinear butyl edge suspension woofers; one of which is planar resistive loaded. This technique is accomplished by floor loading a woofer through a predetermined planar slot, which yields maximum acoustic low frequency coupling, increased damping, and a smooth rolloff above 100 Hz. This powerful low frequency concept is the cornerstone of the new RTR column speaker system. Write for complete information and specifications for:

**MODELS 180D and 280 DR\* (COLUMNS)**  
**MODELS ESR 6 and HPR 12**

\* Patent applied for



**RTR INDUSTRIES, INC.**  
8116 DEERING AVE.  
CANOGA PARK, CA 91304  
(213) 883-0116

Check No. 47 on Reader Service Card



## We'd rather have you rave about the musicians' performance than our performance.

You can hear a lot of fantastic sounding stereo equipment these days.

But that's the trouble with them.

They sound fantastic. Not real.

Hitachi figures you'd rather listen to music than engineering. So we build our Maxi-Fi® components to deliver pure, natural sound.

Free of distortion, coloration and gimmicks. And trouble.

For instance we've developed a new long-life type of transistor called LTP (for Low Temperature Passivity). It reduces amplifier noise to practically nil. And it increases FM tuner sensitivity at the same time.

We also did away with input and output transformers on many of our models in favor of ITL-OTL circuitry. Doing away with one of the major causes of frequency distortion and deterioration.

Our patented

gathered-edge woofers are more flexible than conventional bellows-type suspension speakers. And our damped bass reflex enclosure, with a special ducted port, produces a deep, rich sound without that "boxed-in" effect familiar to so many bookshelf speaker systems.

In fact, so much of what goes into Hitachi stereo components is made by Hitachi, we guarantee our tuners, amplifiers, receivers and speaker systems for a full three years.

If anything goes wrong with any one of them, bring it in and we'll fix it free. Parts and labor for the full three years.

And we go even further with our transistors. They're guaranteed for five years.

For more about Hitachi Maxi-Fi components write for our brochure, Dept. A-4 Hitachi Sales Corp. of America, 48-50 34th Street, Long Island City, N.Y. 11101.

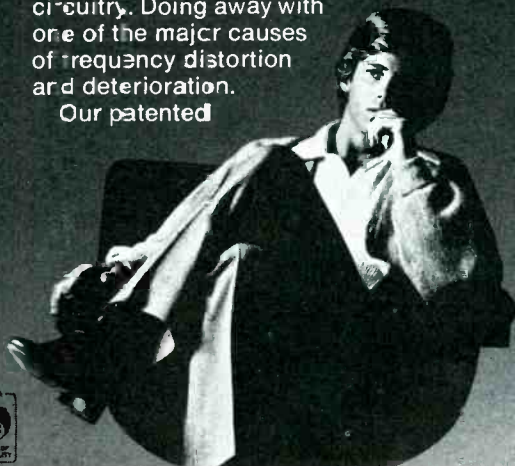

Quality a ways comes first at  
 **HITACHI**

Check No. 18 on Reader Service Card



## Those Channels.

After some eighty or so years we still use the inherently faulty spiral disc groove, rather than the inherently superior groove on a cylinder. We haven't yet finished our work in catching up with the asymmetries of disc performance. The inherently faulty swivelled tone arm, too, is still with us in spite of admirable progress towards tracking perfection *chez* Garrard and others. It is always the same story: (a) the disadvantages can gradually be minimized and (b) they are balanced by emphatic advantages in the incidental or side characteristics of the mechanism: (c) the "disadvantages" may often be turned to profit, as with the minimal *literal* realism of two-way stereo reproduction. Stereo is much *better* than merely *literal*.

Our present arguments between matrix and discrete, (both in theory and practice) are basically along these traditional lines, and are not unlike those concerning disc vs. tape over many years. Tape is in ideal respects a better sound medium than the disc (though not as "better" as we once thought); and yet tape had enormous disadvantages, and very nearly died of them in the consumer market not so long ago. Oddly, you see, the tables often turn (bad pun) to aid the theoretically superior product out of its practical secondary inferiorities! In the very struggle for existence, tape has made astonishing progress against serious problems, notably in mass production, not to mention the fi/speed ratio and the S/N factor. Again—same story: inherent disadvantages are gradually reduced, allowing inherent superiorities to emerge and grow.

And so there may be a constructive see-saw effect in the coming years as between matrix and "discrete" systems of LP disc encoding—always remembering that a total, radical changeover, to something on the order of the new TV discs, would involve millions of dollars' worth of sudden incompatibility and the vanishing of the entire present phono structure and its century of cumulative progress.

The matrix-discrete see-saw could bring the slower-developing "discrete" system to the fore because it *is* inherently superior in some basic respects. Its disadvantages have already given rise to constructive advances—

tougher discs, the excellent (but tricky) Shibata stylus, new wider-range cartridges—all of which will feed back into the whole audio industry, for whatever hi fi we may produce.

Meanwhile, the matrices march on because they are, even further, in the great aesthetic tradition of the art of recording. You complain that many SQ quadrasonic recordings are made especially to fit the SQ virtues and to avoid its weaknesses? Isn't that the very art of recording? What else?

We no longer, for instance, walk our stereo opera stars around the stage in (two-way) stereo because in playback it was found that they seemed, rather, to float like fat balloons through the operatic air, or to fade out of one place and into another in a disconcerting and most unrealistic fashion. We play up discrete stereo separation, without motion, because it *works*. We use our medium for what it can do, and we find new things for it to do well almost every day. If making use of the convenient matrix's capabilities, and avoiding its faults, is wrong, then let's get back to concerts and "live" stages and forget recording.

Finally, keep in mind that what is most important for today's listeners isn't quadrasonic recording at all, on disc or tape—it is *four discrete channels in the home*. For all sound, of any type.

Once you are accustomed to that superiority, once the effect of four is familiar and comfortable, you will not go back to two for *anything*, any sound. How do you think I listen to mono news broadcasts and sports? How else but four-way! I listen to *all* my music, radio, records, tape, via four channels. I find the superiority of the four-way reproduction of standard (two-way) stereo is so great, that I no longer really want to listen to any standard stereo via two front channels alone. I can, of course. But I don't. I've found something better for my present discs and all the rest.

Even without a single quadrasonic recording in my home, I now would be sold on the four-way home system, and that is from personal inclination after a number of continuous years of it. Take this as a prognosis for those who are a bit behind us reviewers and specialists in terms of length of ex-

perience. We are now, so to speak, in mid-1975: we've been into four-way listening for a long time. Take our word for it! In this frame of reference the actual quad disc (or tape) is an added frill, a very definite advance-in-detail over the impressionistic musical effect of standard stereo via our four-way systems. But what matters (yes—you equipment people!) is the playback equipment we have and are accustomed to, the hi fi in every corner. For my money, you can plug *that* until you are blue in the face and I won't mind a bit.

## Mighty Mite

No, it's not Mickey Mouse. Just another speaker. The impulse to build small speakers, remember, is always with us and will not die. It led, after all, to the present not-so-small "bookshelf" systems. (I sometimes wonder how that term has managed to persist. Have you ever seen a bookshelf that would take a bookshelf speaker?) That impulse, having produced bookshelves with optimum parameters, still continues. Let's shave off a bit of performance and make it even smaller; or, more constructively, let's try again and see whether we can't have even more of our cake and eat it too. One product of such thought is this tiny box called Mightymite, of which I have a pair on hand.

This is by no means the only small heavy duty speaker around, especially if you move up in size just a bit, a few inches here and there. But it does represent some interesting extremes in the parameters. Wow! It measures 11 by 6½ by 7 and is it heavy. Massive, stone-dead chipboard with woodgrain formica over it, *two* speakers inside, each with a 1¼ inch voice coil, and a whopper of a pair of magnets totalling 24 ounces and 28,000 maxwells (it says). How big are the drivers? I can't see 'em but they appear to be all of four inches wide each. Whizzer mechanical tweeter attached in front of each.

How do they sound? Loud! All I can say, is that as a stunt I detached my big back speakers and inserted these babies (sitting on top), on each side. Up front were two AR 3a monsters, with added Micro-static wide-angle tweeter distributors on top of

each. Some comparison! To be fair, I jiggered the tone controls, putting the back lows on full boost (imagine what that fed into the babies in the rear) and rolling off the ARs, until I had a rough tonal balance between front and back. The Mightymites (that's their TM) proved to be more efficient than the ARs in their proper middle range and I had to adjust volume too.

Once all this was done, I proceeded to listen to four-way sound for a number of days on this addled system with no pain at all. A switch from back to front would show up some difference in color and, of course, there was no bottom bass on the Mightymite spectrum. (It gets to .60 Hz pretty well, though.) But as to volume—nobody would believe what those babies will take. I haven't blown them out yet, though I have tried. The original specs called for 22 watts R.M.S. power handling, but that has been upped to "10-50" watts, after some not-so-discreet experiments with a Phase Linear amp. I put in thirty good watts, if my amp specs are right, and it came out LOUD.

I wouldn't say the Mightymite is the hi fi man's answer for ultimate sound. I suspect that some of the speakers that are, say, merely twice as big, can produce a better over-all sound spectrum though, by golly, I'll bet it won't be any LOUDER. But if you are intrigued by this highly ingenious new try towards having that very special speaker cake, super miniaturization, you had better listen here. And do not confuse this speaker with those zillions of even small affairs mounted in semi-cardboard streamlined boxes with snazzy grill covers which, alas, go under the name of Hi Fi in these unlicensed days. The Mightymite is interesting because it is so definitely not in that category; it is a real component speaker, its only oddity, and its resulting performance, being the extremes of its chosen parameters. If it weren't so oblong, I'd be tempted to call this one an audible cupcake. (Well, maybe a pound cake.) Made by Priority Electronic Corp. in New York.

#### Two per ear

Now look! I wouldn't for the world want to risk being an old fashioned spoil sport and I am surely no pessimist. But I just don't think it will work. I refer, of course, to the newest form of four-channel listening. So economical. Two channels per ear. Right up close.

Now I could be wrong, and I hope, if so, that you manufacturers will tell

me so in reasonably polite terms. No offense intended—just pure scientific questioning. But if I am right, then I also trust that somebody in the sci fi community will, *please*, back me up and quick. I may need the help. And if any advertisers are advertising these things in our magazine, I do indeed beseech them to keep RIGHT ON, and don't stop just because of me or anything, for goodness' sake. As I say, I might be wrong and I am not a scientist, just a writer type, BUT—

Well, how can I say it? The way you perceive a front left signal is by the usual dual-purpose teaming of two ears. There is a phase difference between the signal reaching each ear which indicates a source to the left; and/or there is a volume difference for similar result. A signal, however, which is heard *in one ear only* has no spatial directionality whatsoever. Listen to a loudspeaker with one ear covered tightly and you are unable to locate it at all. It is everywhere and



Sound is to the audiophile what salt is to pepper, diamond's to a girl, or an oasis to a desert. Each has a most important relationship. That's why an audiophile, a real sound expert prefers TRUSONIC JR-200M's magnificent studio quality reproduction. Clean, undistorted sound from this 12" 3-way speaker system again demonstrates the incomparable electronic technology of TRUSONIC. THE PRICE? You can pay twice as much, but you won't find a better studio quality system. Write TRUSONIC for complete information on JR-200M.

Just a few of JR-200M's impressive engineering features are 12" woofer for distortion-free low frequency bass performance 5" mid-range speaker for clean voice and horn reproduction, and a horn-loaded dome radiator tweeter for high frequency. A carefully engineered crossover network, plus individual level controls to adjust midrange and tweeter sound independently, are included. Size is: 24" x 15 1/4" x 12" deep. Finish: Hand-rubbed oil finish, Walnut veneer.

**NET \$149.95**



1100 E. Franklin Street, Huntington, Indiana 46750  
West Coast Facility: 4950 Santa Anita Ave.  
Temple City, California 91780

Check No. 40 on Reader Service Card

**"A silent giant that's built to last - probably forever..."**

**Stereo & Hi-Fi Times**

"The feel of precision machinery... rumble was inaudible."

*Hi-Fi Stereo Buyers Guide*

"No acoustic feedback even directly in front of loudspeakers."

*Hirsch Hauck Laboratories Stereo Review*

"The turntable suspension is almost impervious to jarring or bumping."

*Audio Magazine*

"Absolutely no speed error at either 33 1/3, 45 or 78 rpm."

*High Fidelity*



Write for your free "Empire Guide to Sound Design."

**EMPIRE Scientific Corp.**



Garden City, New York 11530

Check No. 12 on Reader Service Card

**FREE McIntosh CATALOG and FM DIRECTORY**

Get all the newest and latest information on the new McIntosh Solid State equipment in the McIntosh catalog. In addition you will receive an FM station directory that covers all of North America.



**MX 113**

**FM/FM STEREO - AM TUNER AND PREAMPLIFIER**

**SEND TODAY!**

McIntosh Laboratory, Inc.  
 East Side Station P.O. Box 96  
 Binghamton, N.Y. 13904  
 Dept. 1

NAME \_\_\_\_\_

ADDRESS \_\_\_\_\_

CITY \_\_\_\_\_ STATE \_\_\_\_\_ ZIP \_\_\_\_\_

If you are in a hurry for your catalog please send the coupon to McIntosh. For non rush service send the Reader Service Card to the magazine.

Check No. 22 on Reader Service Card

nowhere. It takes interaction between two ears to produce the basic sense of direction.

How about forward vs. back? That is a more subtle thing by far, as those who have studied binaural recording know (and see my own article on the same).

It is, if I am right, partly by context, first of all. Never underestimate context! Like the symphony orchestra, many sounds are up front because you see them up front. You know they are there—so how could you hear them in back?

Also, front vs. rear would seem to have to do with the complex shape of the ear flaps, which do much to differentiate sounds from forward and rear. Also, still further, with your particular head shape and ear spacing, plus your own unique ear flaps. Somebody else's head and flaps won't do at all, for you. This might account for some perplexing failures in experiments to design a surrogate head for binaural listening. Nobody to my knowledge has yet really produced an accurate, trustworthy binaural reproduction of sound in terms of fore and aft.

OK. So now you are about to feed four channels into two ears, the right pair *exclusively* to the right ear, the left pair *exclusively* to the left ear. Double binaural, I'd call it. Definitely not stereo, mind you. There, each ear hears all the channels, whether two, four or umpteen. In this new system, you are simply feeding a pair of binaural right-left signals into one set of ears.

Yes, of course you'll get a right and a left differentiation. Both pairs of channels will give you that, one superimposed on top of the other. Two ears, working together, for an effect that is already familiar enough in plenty of private listening. What I ask, though, is if the left front channel is fed to the forward part of a small enclosed space around the left ear—and nowhere else—and the left rear channel is fed to the rear portion of that same small enclosed space, *does that ear hear forward-and-back directionality?*

Well, there you are. I say it's spinach and to heck with it. But again, I might be very wrong. All I know is, if you *don't* hear forward and back in that small enclosed space, to go with the side-to-side perception, then you sure aren't hearing quadrasonic sound. You're just receiving four channels paralleled into two. Something like a quadrasonic disc played on a two-channel stereo system, only binaural.

Did I hear somebody mutter something about head phones? Don't look at me. I haven't even mentioned the term.

# Weingarten: Off The Record

Sherwood L. Weingarten

**S**HADES of Arthur Murray! Youth has discovered that it's possible to dance while holding a partner. The fox trot, rumba and other ballroom steps are coming back. My, how the pendulum swings!

And with that turnabout, recorded music is getting softer. No longer, apparently, do manufacturers insist that in order to blow your mind, your eardrums must be blown too.

Instrumentals, mood music, silk-like smoothness—all are returning to the airwaves. Top 40 radio, with its artificial hit-making repetitionrepetitionrepetition, is waning, and the public is responding by purchasing more of the soft stuff that managed to weather the electronic, electric storms.

Not too long ago, Mantovani was almost as big a joke as Henny Youngman (despite the loyalty of the rocking chair set). But now, young people are discovering that his orchestrations aren't without feeling. His newest LP, for example, isn't far removed from what their rock superstars tried—and usually failed—to do, incorporate classics and pop. **GYPSY SOUL** (London "Phase 4 Stereo," XPS 900) provides a dozen cuts, exciting yet lush instrumental arrangements of some items that have been kicking around the top of the historical charts. Such as *Czardas*, *Golden Earrings*, *Carmen: Gypsy Dance*, *Hora Staccato* and Liszt's *Hungarian Rhapsody No.2*.

Perhaps you prefer the mastery of Arthur Fiedler and The Boston Pops. Their latest, **GREATEST HITS OF THE '70S** (RCA QuadraDisc, ARDL-0035) takes another direction, heavily orchestrated interpretations of recent chartbusters. Represented are some of today's best composers, Paul Simon (*Me and Julio Down by the Schoolyard*), Ray Stevens (*Everything Is Beautiful*), Kris Kristofferson (*Help Me Make It Through the Night*) and Neil Diamond (*Song Sung Blue*). And the traditional *Amazing Grace* is given new sparkle.

Or is Andre Kostelanetz and his orchestra more to your liking? If so, there's **LAST TANGO IN PARIS** (Columbia, KC 32187), which offers a dozen melodies ranging from the traditional (*September Song*) to the modern (*Oh Babe, What Would You*



*Say?*), from the hokey country revivals (*Jambalaya*) to the most modern of flicks (the title tune). Pick any one of the renditions, or all, for zest is the keynote.

Would you rather hear a vocalist? You can choose between the old or the new, Tony Bennett or Andy Kim. The former, on **LISTEN EASY** (MGM-Verve, MV-5094), does a number on 11 sparklers that never had it so good. Highlights from the pop master include a six-minute, thirty-second tour de force, *Tell Her It's Snowing*, as well as *My Funny Valentine* and *On the Sunny Side of the Street*. Kim, who penned all ten of the things he does, is in the middle of the soft rock-pop-folk idiom. On **ANDY KIM** (Uni, 73137), he shows an ability to change both mood and tempo even within one song, as in (*Fancies of a Child*), to perform a think-piece (*Who Has the Answers?*), to be poignant (as in *Michael*, a touching saga of love between brothers). But mostly, he's just plain pleasant and entertaining.

Maybe you like more than one voice at a time. Try **ROSIE** (A&M, SP-4386), spotlighting the folk-rock quintet called Fairport Convention. The emphasis here is on traditional folk melodies, (leaning heavily on Britain, Scotland and the sea) though the songs are all new. Or listen to **WILLIE AND THE LAPDOG** (A&M, SP04384), with Gallagher and Lyle exhibiting a cool soft rock sound not unlike the BeeGees.

If light jazz is what you desire, **BRASS, IVORY AND STRINGS**

(RCA QuadraDisc, APDL-0098) is provided by Henry Mancini's piano and pen, and Doc Severinson's trumpet. Best of the ten tracks are *Ben*, *Love Theme for Laura*, *Round Midnight* and *Make It With You*.

Soundtracks aren't as frenzied as they were either. Witness **THE HEARTBREAK KID** (Columbia, S 32155), which contains both music and dialogue from the Elaine May-directed comedy. Included on the LP are the Bacharach-David hit, *They Long to Be Close to You*, and *Don't Ask Me Why*, which features lyrics by Sammy Cahn, who weathered a few musical storms himself.

—**BLOODSHOT** (Atlantic, SD 7260) showcases nine rock and roll cuts by the J. Geils Band, a sextet that includes its hit single, *Give It to Me*. It's okay, if you like that sort of thing, but the group's greatly overrated, in my estimation.

—**HEAVEN HELP THE CHILD** (Elektra, 75055) is a fine LP by folk-singer-composer Mickey Newbury. The eight self-penned tunes are mostly soft, pleasant, poetic, and easy to take. Best of the bunch, which sticks pretty close to a folk-rock format, is the oft-recorded *Sweet Memories*.

—**THE LOVABLE LUSH** (Decca, DL7-5395) features the most famous drunk since Dean Martin, Foster Brooks. The 60-year-old storyteller is in fine form and in character as he delivers his anecdotes and jokes from the stage of the Hilton Hotel in Las Vegas. The audience seems to appreciate him more than it's worth, but there's definitely a chuckle or three here.

—**RAY CHARLES LIVE** (Atlantic, SD 2-503) is a fantastically exciting reissue of two concerts, one in Newport in 1958 and one in Atlanta in 1959. Highlights of the two-disc package include *In a Little Spanish Town*, *I Got a Woman*, *A Fool for You*, *Yes Indeed!* and the classic *What'd I Say*. Charles is what soul is all about.

—**CHILD OF THE '50S** (Burt, 6001) is an extremely amusing LP by comedian Robert Klein. The disc, distributed by Buddah, spoofs civil defense scares, teenage sex drives, FM deejays, *Our Gang* comedies and early television series.

# Why pay retail for hifi?

Buy direct from us, and you save money with our high- volume prices on more than 100 name brands. Order from the branch nearest you to save time and money on freight.

# Midwest Hifi

WHOLESALE & MAIL ORDER DIVISION

Send for our free catalog!  
2455b Wisconsin Ave, Downers Grove,  
Illinois 60515 (Attn: Allen Maxwell)  
or  
3309 E. J W Carpenter Frwy,  
Irving, Tex 75062 (Attn: Albert Marcus)

Check No. 23 on Reader Service Card

## IM-Maximum-.01%



That's right .01% up to full rated output of 60 Watts. Thanks to our unique new all push-pull circuits we are able to offer an amplifier with performance that you are going to find hard to believe. Bandwidth is 5 to 150,000 Hz at the -1.0 db points. Our circuit features a complementary differential amplifier input, a triple in the output and volt-amp limiting.

The amplifier is supplied complete with the meter and perforated cover as shown. Front panel is standard 1/4 rack size for maximum convenience when multiple units are used. Single channel construction makes expansion of a stereo system to quad simple. Circle the number on the reader reply card, or write for a schematic and additional details.

# 207/A Amplifier Kit - 14 lbs. - \$ 75.00  
# 207-AA Assembled - 14 lbs. - \$105.00



SOUTHWEST TECHNICAL  
PRODUCTS CORPORATION

219 W. Rhapsody, San Antonio, Tex. 78216

Check No. 36 on Reader Service Card

## HELP!

Anytime you have a question about your Audio subscription, please include a mailing label to insure prompt service on your inquiry.

### CHANGE OF ADDRESS

If you're about to move, please let us know approximately four weeks before the move comes about.

Or, if there is anything wrong with your current mailing label, please let us know on this form also. Simply affix your present label here, and carefully print the updated information below.

### PLEASE HELP US TO SERVE YOU BETTER

AUDIO MAGAZINE

134 N. 13th Street • Phila., Pa. 19107

Name \_\_\_\_\_  
(Please Print)

Company \_\_\_\_\_

Address \_\_\_\_\_

City \_\_\_\_\_ State \_\_\_\_\_ Zip \_\_\_\_\_

AFFIX  
LABEL  
HERE

-THE SINGER (Columbia, KC 32149) proves that Liza Minnelli really has come of age. Best of the 11 cuts by the singer are *I Believe in Music*, *Baby Don't Get Hooked on Me*, *I'd Love You to Want Me* and *You're so Vain*.

-THE VOICE OF THE EAGLE (Vanguard, VSD-79321) is authenticity personified. Robbie Basho offers eight cuts of modern American Indian sounds difficult for the ordinary turntable turner to appreciate. It takes a lot of listening to get into.

-A TRIBUTE TO DUKE ELLINGTON, WE LOVE YOU MADLY (Verve, 2-V6S-8818) is a magnificent compendium on two records. The package, distributed by MGM, is a musical collage of things the Duke wrote. Even though the cuts are re-issues, the cast, filled with yesteryear's stars of the jazz world, is superb. Among them, in order of appearance, as the cliché goes, are Ella Fitzgerald, Count Basie, Oscar Peterson, Ray Brown, Coleman Hawkins, Stan Getz, Al Hibbler, Wes Montgomery, Gene Krupa, Billie Holiday, Dizzy Gillespie, Louis Armstrong, Johnny Hodges, Buddy Rich, Lester Young, Benny Carter, Charlie Shavers, Barney Kessel and Roy Eldridge. 'Nuff said!

-FIRST RUSH (Atlantic, SD7257) is a very funny LP by a relative newcomer. Chris Rush, who not infrequently slips into the style of Woody Allen. He's hip and probably offensive to older audiences. Stress is on euphemisms for bodily functions, grass, black movies.

-BILL WITHERS LIVE AT CARNegie HALL (Sussex, SXBS 7025-2) is a double-disc entry with 14 tracks of rockin' vocal soul. Best of the Buddah-distributed LPs are *Lean on Me* and *Ain't No Sunshine*. Withers' high-rolin' smash singles, plus *Friend of Mine*.

-SAND (Barnaby, BR 15006) is an album that relies heavily on a gimmick. The mediocre rockish music won't sell it, and it's unlikely the gimmick itself—having one record (with eight cuts) on two discs, to provide "continuous flowing Sand"—will do a thing. It's distributed by MGM, if anyone cares, since the best sides are the blank ones.

MUSIC FROM TRUE VINE (Mercury, SRM 1-627) finds Mike Seeger in his normal folk idiom. His voice, unfortunately, is inadequate. But his playing of fiddle, banjo, and guitar can make this an audiophile's joy, at least in parts. Still, he can't hold the proverbial candle to the performances by his kin.



# Jazz & Blues

Martha Sanders Gilmore

## Loudon Wainwright III

**Songs:** *School Days; Hospital Lady; Ode to a Pittsburgh; Glad To See You've Got Religion; Uptown; Black Uncle Remus; Four Is A Magic Number; I Don't Care; Central Square Song; Movies Are a Mother To Me; Bruno's Place.*

Atlantic SD 8260, mono

Loudon Wainwright III: Album II

**Musicians:** Loudon Wainwright, guitar, vocals; Saul Broudy, harmonica.

**Vocalist:** Kate McGarrigle

**Songs:** *Me and My Friend the Cat; Motel Blues; Nice Jewish Girls; Be Careful, There's A Baby in the House; I Know I'm Unhappy; Suicide Song; Glenville Reel; Saw Your Name in the Paper; Samson and the Warden; Plane; Too; Cook That Dinner, Dora; Old Friend; Old Paint; Winter Song.*

Atlantic SD 8291, mono

Loudon Wainwright has impact. He will startle you. His vocals fairly throb with intensity. And can he ever wring out a lyric! His is poetry set to his guitar, the poetry seeming most often to come before the music. With Wainwright it's the message that counts, the transmission of thoughts in his half-talk, semi-singing voice.

Wainwright combs the land in his thoughts. He sings of the seasons in *The Winter Song*, commenting that the "corn turns to candy in fall," reminding us that then too birds' nests lose their camouflage. He recounts almost every physical detail of the interior of a plane in *Plane; Too*, omitting nothing including vomit bags. And Wainwright accomplishes some pretty picking—he usually strums—in *Motel Blues*, a track in which the sound is especially lucid and well separated.

The material on these two records is composed by Wainwright except for *Old Paint*, a traditional folk song which you might find in an old trunk in your grandma's attic and which Wainwright handles admirably here. Saul Broudy plays some talking harmonica and Kate McGarrigle assists with the vocals. Two LP's of primarily your own work is no mean artistic feat. Wainwright's songs are asymmetrical and complex, rife with double meanings, his imagery vivid, blatantly bold, graphic, and at times shocking, strange, and even oblique. *Black Uncle Remus* should stir up some fire, the man

whose "tears have rusted his banjo strings" while *Hospital Lady* borders on the morbid.

Loudon Wainwright disseminates his messages in a rather plaintive tormented voice that cuts through with a bit of a country twang fringed with velvet. And it wouldn't surprise me one bit if he had listened to some Simon and Garfunkel. They appear to be cut out of the same contemporary cloth although Wainwright goes to more extremes.

The sound in the second release is immaculate, outshining the first which relies more upon electronic devices, although it too comes off well.

Loudon Wainwright is an original voice. Some of his work suffers in taste but the bulk is brilliant and of a high intellectual content. To listen to him is jolting. He is no ordinary stylist. Far, brooding, melancholy, he boils over with ideas that compel one to listen.

Sound A-

Performance B

**KEITH JARRETT:** *Birth*

Atlantic SD 1612; Stereo

**Musicians:** Keith Jarrett—piano, soprano sax, steel drum, recorder, voice, banjo; Dewey Redman—tenor sax, Chinese musette, bells, voice, percussion, clarinet; Charlie Haden—bass, conga drum, clappers, steel drum; Paul Motian—drums, steel drum, bells, miscellaneous percussion

**Songs:** *Birth; Mortgage On My Soul; Spirit; Markings; Forget Your Memories; Remorse*

How can this one miss with Keith Jarrett, one of the most innovative and exciting musicians at work today as leader and composer, backed up by such stalwarts from Ornette Coleman's group as Dewey Redman and Charlie Haden along with drummer Paul Motian.

The collection is many things, a little bit 'o this, a little bit 'o that ranging from rock with its incumbent electronic wah-wah in *Mortgage On My Soul* to the abstract tone poem *Markings* lasting only 35 seconds to the very contemporary percussive sounds which reflect the cultural interchange and awareness born of mobility.

The group is competent in every way, thoughtful and tender when required as in the beautifully uncluttered *Birth* with Jarrett's pianistic notes falling one upon the other light as flower petals,

## The first NEW amplifier design since

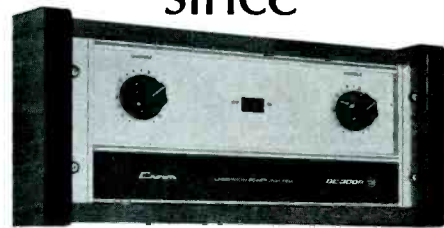

## the ORIGINAL Super Amp

You remember the first super power amplifier - the Crown DC300. Well, most of its competitors are still using those six year old circuit designs pioneered by Crown. Most every amp but Crown's new **DC300A** - a totally redesigned amplifier inside and out. Frankly, the DC300A is not created for the hi fi mass market, but for demanding commercial and professional applications. However, we know there are discerning audiophiles, perhaps like yourself, who can appreciate the difference.

The new DC300A has double the number of output transistors, effectively twice the muscle of the old DC300 for driving multi-speaker systems. Each channel has eight 150-watt devices for 1200 watts of transistor dissipation per channel. Advanced electronic output protection permits the DC300A to drive the toughest speaker loads at higher outputs before going into protection, and even then there are no annoying flyback pulse noises or DC fuses to blow.

The new DC300A has unprecedented signal purity. IM and harmonic distortion ratings are .05%, although typically below .025%. Hum and noise rating is 110dB below 150 watts, while typically -122dB. The difference in increased listening comfort is impressive.

Although totally new, the DC300A has inherited some important traits from its predecessor:

**PRICE** — still under \$700

**WARRANTY** — three years on all parts, labor and round-trip shipping

**POWER RATING** — 150 w/ch continuous at 8 ohms; power at clip-point typically 190 w/ch at 8 ohms, 340 w/ch at 4 ohms, 500 w/ch at 2.5 ohms, or plug in two parts for 600 watts continuous mono power at 8 ohms.

There are many new super-power amplifiers. But when you buy a Crown DC300A, you're buying more than just an amp. You're buying the Crown company — a professional audio equipment manufacturer with a 26-year reputation for solid quality and lasting value. There are thousands of Crown amps in the field still working to their original specifications, and still outperforming most new amps. Visit your Crown dealer to hear the difference. For detailed product data, write Crown International, Box 1000, Elkhart, Indiana, 46514.



**crown**

Check No. 9 on Reader Service Card

# by any name...

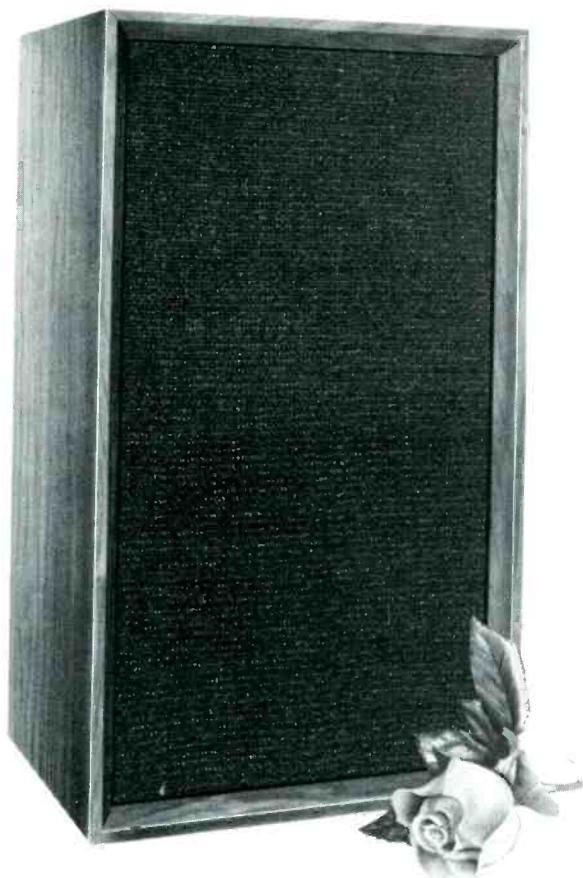

# you'll LOVE it!

A Maximus made speaker by any name sounds as sweet. Your favorite dealer may well be one of the many who have Maximus made speakers under their own name. If so, the sweetest buy in sound may soon be yours.

Look for the Maximus  Hallmark of manufacture. It is your assurance that the highest principles of sound technology were used to create speaker systems *especially* for that dealer.

**You needn't mention our name...**

## MAXIMUS SOUND CORPORATION

1000 Zeckendorf Boulevard, Garden City, N.Y. 11530 (516) 877-2500  
MAXIMUS WEST, 1530 El Segundo Boulevard, Gardena, Calif. 90249 (213) 770-1284

Check No. 21 on Reader Service Card

and forceful when need be as in *Forget Your Memories* in which Haden is all over his bass but selects his notes wisely.

Jarrett sings and plays no less than six instruments but his most interesting effort lies within his banjo picking in *Remorse* wherein he bends plucked tones and carries the instrument to near unrecognizable percussive limits until one believes one is hearing a sitar instead or some such instrument out of the Eastern hemisphere. Redman proves that he is a viable force on tenor sax and clarinet throughout.

*Spirit* whisks us away to tribal realms via mewing percussive effects and the distinctly varying pitches of a steel drum played by Jarrett. There are bells that jingle-jangle-jingle and the "miscellaneous" percussion by Paul Motian fairly rustles.

As remix engineer, Lew Hahn does an imaginative job, crisscrossing the sound from channel to channel. The corporate result is a pleasure.

A supreme accomplishment by all in totally Jarrett material that falls into no category. This is music in which one can discover something new upon each replay. More soon from Keith Jarrett, let's hope.

Performance: A

Sound: A-

**Furry Lewis with Bukka White and Gus Cannon:** *On the Road Again*  
**Musicians:** Furry Lewis, Guitar, vocal; bukka White, guitar, vocal; Gus Cannon, banjo, vocal; Dewey Corley, kazoo, bass can; B. Sam Firk, guitar.

**Songs:** *On the Road Again; My Wife Is Getting Old; Why Don't You Come Home Blues; Lela; Oh! Babe; I've Got a Bird To Whistle; Give Me An Old Lady; Furry's Worried Blues; Gibson Hill.*

**Adelphi AD 1007 S, stereo.**

Furry Lewis and Bukka White were both born in Mississippi and this recording belies the strong-hitting, low-down character of the blues that come out of the Deep South. At 76, Furry Lewis, despite a wooden leg, is a moving and powerful proponent of the blues. Once a hobo himself and blessed with a kind of rugged humor, Lewis sings of hopping freights on "that Santa Fe", *Fe* pronounced by Furry to rhyme with *bee* in *On the Road*, depicting the days when railroad was king. Lewis takes his blues at a lope, lanquishes in them, his fuzzy voice accompanied by his pick/strum technique of blues guitar on a J45 Gibson.

One of his most intriguing compositions—Lewis is a confirmed composer—is *I've Got a Bird To Whistle*. Furry's *Worried Blues* also bears replay, made all the more attractive by B. Sam Firk who creates a delicate lacework obbligato on his Gibson J200. Interesting and informative that Adelphi takes the trouble to explicitly name the types of guitars, but with a talent such as Firk, it would have been nice if they had mentioned him in the title along with Lewis, White, and Cannon.

Bukka White, recently billed as the "Soulful Bluesman of the Mississippi Delta" is a growling, guttural singer whose voluminous, raspy tones require a National steel guitar in *My Wife's Getting Old* and in a fine example of slide technique, *Gibson Hill* which is perhaps what this LP is all about anyway.

And, oh yes, there is a masterful example of blues banjo, a rare commodity, by Gus Cannon in *Lela*, in which he tunes his 5-string instrument such that the fifth string is "two octaves above the fourth, rather than below it in pitch."

There's nothing unauthentic about this Adelphi Memphis-made recording and for burgeoning guitar pickers, it's a must.

Sound B +

Performance B +

**BOBBY HACKETT:** *The Bobby Hackett 4*

**Hyannisport HR1001**

**Musicians:** Bobby Hackett—cornet, Dave McKenna—piano, Ernie Hackett—drums, Tony Defazio—bass, Tony Eira—bass.

**Songs:** *Sweet Lorraine; In A Mellow Tone; Cherokee; New Orleans; Fascinating Rhythm; Savoy; Stardust; Wolverine Blues; Goodnight, My Love.*

There is an ambiance about this recording that is absolutely irrepressible. The conviviality that Bobby Hackett conveys here is contagious. Recorded live at Jack Hackett's Lakeside in Topsfield, Massachusetts, it has all the immediacy that chatter and clinking glasses contribute to a musical setting and it all reminds me of good old Sunday afternoons at the Jazz Workshop in Boston. It's as if you were there!

The highly respected cornetist Bobby Hackett, whose career dates back to the thirties, joins forces here with a fellow Cape Codder, Dave McKenna, a pianist described by New York Times music critic John S. Wilson as "the

## From across the wide Pacific comes the new Shibata stylus and Dual Magnet™ design for better 4-channel and stereo sound.

Model AT14S,  
\$75.00 suggested retail



For the past 10 years, Audio-Technica phono cartridges have been sold primarily in the Orient and Europe.

Now they are here. Eight models in all. Including three designed to meet the rigorous demands of discrete 4-channel records while actually *improving* performance with regular and matrix stereo.

Response of these three extends to 45,000 Hz and beyond. It's a direct result of the unique Shibata stylus plus the exclusive Audio-Technica Dual Magnet\* cartridge construction.

Even the least expensive Audio-Technica cartridge offers unusually flat response and excellent tracking. Read the entire story in our free brochure, available for the asking. Or better yet, hear Audio-Technica products today at leading high fidelity specialists. It's worth the trip.

\*Patents pending

# audio-technica



AUDIO-TECHNICA U.S., INC., Dept. 73A, 1655 W. Market St., Fairlawn, Ohio 44313  
Check No. 4 on Reader Service Card

**"Once you have used an Equalizer for a couple of days, you'll wonder how you ever managed without it. There are few audio products that can be so legitimately useful and so darned much fun too."**

**MICHAEL MARCUS**  
Audio Editor of Rolling Stone Magazine



Have you ever listened to a record and said to yourself, "how the (bleep) could that (bleep)ing studio engineer make such a (bleep)ing bad mixdown? That (bleep)ing guitarist is beautiful, man, and that (bleep)ing engineer buried the guitar riff under a bunch of other (bleep).

Well, man, now there's a neat little thing that lets you remix the record after you buy it. The BSR-Metrotec Equalizer has tone adjustment circuits that work in five different frequency ranges, so you can boost that guitarist above the level of the other musicians. Hell, it's your record, why not play it the way you like it?

And that's not all it does. You can use the Equalizer to match your components to your listening room, make lousy speakers sound pretty good, make good speakers sound better. You can eliminate tape hiss and record scratch noise, compensate for wax in your ears, equalize your recorder for the fancy new tapes, make Melanie sound like Broderick Crawford or your electric train sound like the real thing. Even make those old 78's and radio show tapes sound better than new, and a whole bunch of other fun stuff. Write and we'll tell you all about it. We'll also send you a copy of Mike's Equalizer Report from Rolling Stone Magazine.  
BSR (USA) Ltd.,  
Blauvelt, N.Y. 10913.

Check No. 6 on Reader Service Card

**BSR**  
**METROTEC**

# STOP

**BEFORE YOU BUY  
THAT RECORD . . .**

**WAIT A MINUTE!**

**IS IT REALLY A BARGAIN?  
IS IT THE PERFORMANCE YOU REALLY WANT?**

Check the other performances and recordings in the latest Schwann Record & Tape Guide.

If it saves you disappointment over one poor purchase, it's well worth the time to look in Schwann first.

**Schwann-1** Monthly. Special new listing section has latest releases: records, 8-track cartridge and cassette tapes. Nearly 45,000 total listings on 773 labels in classical, recent popular, rock, jazz, musical shows, country, opera, ballet, electronic, quadrasonic, etc.

**Schwann-2** Semi-annual catalog for specialized categories: pop more than two years old, classic jazz, older and re-released mono and reprocessed stereo classical recordings, classical on lesser-known labels, international pop & folk on domestic labels, spoken, educational, religious, etc.



## SPECIAL PRICE SAMPLE OFFER

If your favorite store doesn't carry Schwann, order samples by mail. Prices include postage and handling.

- Schwann Sampler one Schwann-1 (monthly) and one Schwann-2 (semi-annual) .....\$2.00
- Latest Schwann-1 (monthly) .....\$1.25
- Latest Schwann-2 (semi-annual) .....\$1.00
- Newly revised Basic Record Library booklet.

Lists 1,000 suggestions in classical music by musical periods for your enjoyment. Send 15¢ for cost of handling, also 8¢ stamped self-addressed long envelope.

I enclose \$.....for the items checked above.  
 Name \_\_\_\_\_  
 Address \_\_\_\_\_  
 City \_\_\_\_\_ State \_\_\_\_\_ Zip \_\_\_\_\_  
 Dealer's Name & Address \_\_\_\_\_

**Schwann Record & Tape Guide**

137 Newbury Street, Boston, Mass. 02116

AU

elusive, mysterious genius of the piano.”

If you haven't heard McKenna yet, hear him now. He is an extremely fertile and exacting pianist, having played with Woody Herman back in the fifties and the venerable Buddy Rich. Hackett is most generous with him here, permitting him almost half of side one in which McKenna shines brilliantly, walking away with highest honors. His sizzling solo on Ray Noble's immortal *Cherokee* is a felicitous 8-minute statement of beautiful, unbroken runs taken way to the top of the ivories. McKenna's touch is a lovely, legato one, never harsh or abrasive. He is a pianist with whom every note counts. Two bassists assist on the recording. Tony Defazio and Tony Eira, unidentified sorrowfully as to cut. But the Tony who plays the sawhorse bowed bass in *Cherokee* puts on an extraordinary performance as he engages in conversation with McKenna.

The Bobby Hackett 4 come up with a host of familiar old standards, the gently graceful *Sweet Lorraine* with Hackett submitting a tasteful amount of filigree; *In A Mellow Tone* in which he is droll and playful, and Gershwin's *Fascinatin' Rhythm*, a bright, cheerful rendition with Hackett showing not a hint of strain in his delivery.

The group gives *Stardust* a ballad treatment that includes the introduction, one of the prettiest parts of the song. This shows Hackett's gift as a superb lyricist as he lingers precisely the right amount of time over notes, coloring them with his burnished tone and modulating down after McKenna's solo. They play a perky *Wolverine Blues*, a Jelly Roll Morton composition, with son Ernie Hackett keeping the pace and doing a fair job on drums.

The audio is only fair throughout; one gets the feeling it was recorded in a cave. For instance, there was apparently no microphone in McKenna's piano and it sounds as though it has been stuffed under a pillow. One can better hear the bass and drums. Hackett doesn't come through as clearly as he could. In addition, there is perhaps too much chatter and clatter, particularly in *In a Mellow Tone*.

But all in all, this loose and free-wheeling recording never bogs down and is filled with lovely sonorities that will warm your heart. It is Hackett's first album for Hyannisport and is available from Hyannisport Record Co., Box 337, Hyannisport, Mass. 02647, if you can't find it at your local record dealer's.

Sound B-                      Performance B+

# Recorded Tape Reviews

Bert Whyte

**Gotta Travel On**—Arthur Fiedler and the Boston Pops **Ampex/Polydor POL M 5035**, open reel, 7½ ips, \$7.95.

When Deutsche Grammophon took over the Boston Symphony Orchestra from RCA, they acquired a great orchestra, one of the best recording halls in the world, and the legendary Arthur Fiedler. With all due respect to the hallowed names of Koussevitsky, Monteux, and Munch, and their many fine recordings, it was the indefatigable Fiedler who "paid the freight" . . . RCA's "bread and butter" conductor whose Boston Pops recordings always sold well. Evidently Deutsche Grammophon feels that the "grand Panjandrum of Pop" still has legions of fans . . . enough to justify a series of Boston Pops recordings, in spite of the staggering cost of recording in this country. This recording is typical of maestro Fiedler's recent output. Which is to say that the repertoire keeps getting further and further away from the light "pop" classics for which he is so well-known, and more into the contemporary pop ballad scene. Thus we have such items on this tape as *Leaving on a Jet Plane*, *By the Time I Get to Phoenix*, *Wichita Lineman*, the title song *Gotta Travel On*, the *King of the Road* and others of like calibre. The musical arrangements by Dick Hayman are properly scaled for a large orchestra, and as is typical with this fine musician the instrumentation is tasteful, interesting and rarely overblown or padded. Fiedler is as vigorous as ever, and elicits a zestful, exuberant performance of these bon-bons from his splendid players. Sonically this recording differs from RCA's efforts in that the DGG engineers opt for a broader acoustic perspective, capturing more of the liveness of the hall. There is more of an awareness that you are hearing an essentially symphonic orchestra, playing pop music in a large hall. For all this, orchestral definition does not suffer appreciably, and brass and percussion has plenty of punch. Overall sound is quite clean, with fairly wide dynamic range. Tape processing is good, with moderate hiss levels and just an occasional smidgen of print-through.

**A Salute To Glenn Miller**—The Ted Heath Orchestra **Ampex/London L77186**, Q8 cart., \$6.95.

Ampex Stereo Tapes has recently been offering some quadraphonic cartridges with music from the London catalog. This is one of the first I've had a chance to audition, and I'm happy to report that London has done a first rate job of quadraphonic mixing that bodes well for future four-channel offerings from this label. Instrumental assignments to each of the four channels are well thought out and afford a good dynamic balance. Interplay between channels is consistently interesting, while maintaining solid musical values. Of course, it doesn't hurt to have as your musical source the great Glenn Miller music. All the favorites are here . . . *Moonlight Serenade*, *In The Mood*, *Little Brown Jug*, *Chattanooga Choo-Choo*, *String of Pearls*, *Tuxedo Junction*, etc. etc. It is strictly nostalgia time as the Ted Heath Orchestra recreates the Glenn Miller sound and arrangements down to the semi-quaver. The added fillip of quadraphonic sound affords an interesting new perspective to the familiar melodies. Generally nice clean sound here, but oh the terrible tape hiss! Somebody *must* . . . repeat, *must* take the plunge and start Dolbyizing cartridges, if this tape format is to live up to its potential in the home listening market.

**Six by Six**—The Maynard Ferguson Sextet **Ampex/Mainstream, REDM-5372**, Dolby Cassette, \$5.95.

**The Brass Ring**—Phil Bodner **Ampex/Project 3, PRJM55067**, Dolby cassette, \$5.95.

**Bein' Green**—Urbie Green **Ampex/Project 3, PRJM55066**, Dolby cassette, \$5.95.

Herewith three cassettes featuring some of the best jazz talent active today. This is really outstanding music making, a collation of typical pop numbers, played with the virtuosity and easy assurance of some of the top pros in the business. All have exceptionally good clean sound and are prime examples of how good Dolby cassettes can be when everything falls into place in the processing chain. Unreservedly recommended.

HOW GOOD SHOULD A REINFORCEMENT SYSTEM SOUND? SO GOOD YOU DON'T HEAR IT!

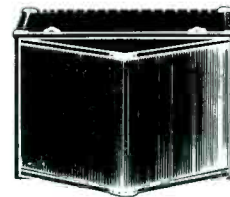

Listen to the remarkable

**BOSE 800™**

Portable Loudspeaker System and all you'll hear is the performance, without artificial coloration. After all, isn't the performance really what the audience comes to hear?

**Bose 800, The Unobtrusive One**

Please send complete information to:

Name \_\_\_\_\_

Address \_\_\_\_\_

City \_\_\_\_\_ State \_\_\_\_\_ Zip \_\_\_\_\_

Return to Bose Corp.  
The Mountain  
Framingham, Mass. 01701  
Dept. OA

Check No. 46 on Reader Service Card



**Technically  
it is  
perfect  
\$95\***

**QUATRE 8000**

is a three-way loudspeaker incorporating a woofer, a midrange, and a mylar dome tweeter. It was designed using a 26 independent variable parametric optimization computer program. \*It sells for \$95.00 (assembled of course) in the service system, finished in flat black. Accessory furniture finished panels are available in a variety of fine veneers.

**QUATRE** (213) 886-2771  
18727 Napa Street Northridge, Calif. 91324  
Dealer and Rep inquiries invited

Check No. 27 on Reader Service Card

# Classified

Rates: 25¢ per word per insertion for noncommercial advertisements; 50¢ per word for commercial advertisements. Frequency discounts as follows: 3 times, less 10%; 6 times, less 15%; 12 times, less 20%. Closing date is the FIRST of the second month preceding the date of issue. *Payment must accompany all orders under \$10.00.* Use the handy self-addressed, postage paid card at the back of this issue. When replying to AUDIO box number ads, send letters c/o AUDIO, 134 No. 13th St., Phila., Pa. 19107. For more information about classified advertising, circle Reader Service Card #135.

## FOR SALE

**FREE 64 PAGE CATALOG** offers hundreds of recordings of rare Renaissance, Baroque and Classical music. Some records priced as low as \$1.00 each! All late recordings. In stereo only. Musical Heritage Society, Box 932-AU, New York, N.Y. 10023.

**WORLD'S LARGEST, DEEPEST, MOST POWERFUL SUB WOOFER SYSTEM** can be had only at Music and Sound Ltd., 11½ Old York Road, Willow Grove, Pa. 19090. 215-659-9251. From \$1,000.

**OUR RABCO SL-SE SOUNDS BETTER THAN SL-SE!!** For \$100 we'll convert "yours" to "ours." Professional Products Div., Music and Sound Ltd., 11½ Old York Road, Willow Grove, Pa. 19090. 215-659-9251. Dealer inquiries invited.

**SCOTCH MAGNETIC TAPE**, discount Box 167A, Orwigsburg, Pa.

**BUY DIRECT FROM ENGLAND'S HI-FI MAIL ORDER SPECIALISTS!** Save on SME, Leak, Goldring, Decca, Tandberg, Revox, Gold Speakers, Garrard, Wharfedale, KEF, Celestion, Transcriptors, Cambridge etc. Insured shipping quotes free or send \$2.00 bills for catalog (\$4.00 air post) credited on first purchase over \$100. Goodwin Ltd., 7 Broadway, Woodgreen, London N22. Visitors welcome to showrooms.

**HAND-PICKED DECCA LONDON EXPORT SERIES & MK VIII!!** At long last the ultimate cartridges, guaranteed from Music and Sound Ltd., 11½ Old York Road, Willow Grove, Pa. 19090. 215-659-9251.

**JAPAN HONG KONG DIRECTORY.** World Products information. \$1.00 today. World Trade Inquiries, Hillvard, Washington 99207.

## TEST FREE COMPARISONS

Comparisons by Pittsburgh's Audio experts of over 100 speakers, receivers, changers, and cartridges included in the most informative catalog of its kind. Complete with lowest wholesale prices.

**Wholesale Audio Inc**  
3916 SAW MILL RUN BLVD., D-2  
PITTS., PA. 25527 (412) 884-8797

Check No. 42 on Free Information Card

## FOR SALE

**DIAMOND NEEDLES** and Stereo Cartridges at Discount prices for Shure, Pickering, Stanton, Empire, Grado and ADC. Send for free catalog. All merchandise brand new and factory sealed. **LYLE CARTRIDGES**, Dept. A, P.O. Box 69, Kensington Station Brooklyn, New York 11218.

**ELECTROENCEPHALOPHONE:** brainwave monitor. Professional biofeedback instruments. J&J. Rt. 8, Box 8102, Bainbridge Island, Wash. 98110.

**B&W 70CA PHASE LINEAR, THE WORLD'S FINEST SPEAKER AMPLIFIER COMBINATION.** JVC 5011 super preamp. Transcripator, EPI Tower, Quad, Electrostatic specialists. Finest, best equipped laboratory in the country. Formerly supplying to professionals only. Now you can benefit from the unique services of THE AUDIO-LAB, 146 French St., New Brunswick, N.J. 08901 201-249-9191.

**CONNECTICUT AREA** Audio Research speaker and amps. Dyna-mod kit and Transcripator turntables. The Stereo Lab, 168 State St., New London, Conn. (203) 447-9802.

**HI FI FURNITURE?** See Toujay Designs at SEE 70, Hi Fi Expo, 443-A, Park Ave. S., NYC, 10016, Tues. to Fri. 11-5, Sat 11-4. Full line brochure 25¢.

**FREE BARGAIN CATALOG.** Transistors, diodes, resistors, thermocouples, precision potentiometers, parts. Chaney, Dept. A., Box 15431, Lakewood, Colorado 80215.

**CANADIANS: FREE 120 PAGE BARGAIN** electronics catalog. Etco (Au), Box 741, Montreal.

**AUDIO RESEARCH, SAE, CROWN, PHASE LINEAR, INFINITY, KLIPSCH, TANNOY, BRAUN, QUAD, DECCA, REVOX, STAX, TRANSCRIPTORS, RADFORD,** and many more. Factory authorized service on all brands sold. No appointment necessary. Hoffman's "House of Stereo", 5931 Smith Rd., Cleveland, Ohio 216-243-2772.

**TV & RADIO TUBES 36¢ EA.** Free 48 page Color Catalog, Cornell 4215 A University, San Diego, California 92105.

**CUSTOM** Engineered Electronic Equipment. Equalizers, Power Amplifiers, Test Equipment. 50¢ for Catalog (Refunded first order). C. D. Electronics, Box 12584, El Paso, Texas 79912.

**STEREO COMPONENTS** Lowest discounts. \$1.00 for catalog. Defa Electronics, 2209 Broadway, N.Y., N.Y. 10024. Tel.: 212-874-0900.

**CASH FOR YOUR UNWANTED STEREO LPs** & reel to reel tapes. Record House, Hillburn, N.Y. 10931.

## FOR SALE

**BUY IRISH TAPE** at discount prices, get Free leaders, trailers. Write for catalog and order form. Also ask for pre-recorded specials. Direct Mail Cassette Corp, Box 71, Plainview, N.Y. 11803.

**LOWEST DISCOUNT PRICES ANYWHERE** on audio equipment. All major brands discounted. Write for quotes; K&L Sound Services, 264 N. Beacon St., Watertown, Mass. 02172.

**KARLSON**—Fantastic new line of patented advanced technology speaker systems for stereo, p.a., and music now available. Write Karlson Research & Mfg. Corp., Box 117, W. Hempstead, N.Y. 11552.

**AUDIO RESEARCH CORP'S** Magneplanar\* Woofer Screen\* SP 3 Preamp\* EC-384 Cross-overs\* Dual-51 & 75 Amps\* Dual-400 Tone Arm\* Normally shipped from stock, pre-paid insured Music & Sound Ltd., 11½ Old York Road, Willow Grove, Pa. 19090. 215-659-9251.

**THE INVENTORS, ENGINEERS, COLLEGE INSTRUCTORS AND PROFESSIONAL MUSICIANS** at Music & Sound Ltd. offer their clients a new standard of technical competence, certain proprietary testing procedures, a mind boggling research laboratory, and a host of the most advanced professional services, including hand picked component matching/customization/assembly/alignment, room acoustical design and treatment, calibrated environmental equalization, total "A" warranty station service, and the most flexible demonstration facilities anywhere for the distinguished array of products from: Sequerra, Infinity, Crown, Decca, I.M.F., Quad, Rogers, Spondor, B.B.C. Monitors, Stax, E.S.S., B&O, J.B.L. Professional, Schoeps, S.S.I., Beyer, Custom Rabco, Gately, Revox, Braun, Tascam, shipped pre-paid insured. Music & Sound Ltd., 11½ Old York Rd., Willow Grove, Pa. 19090. 215-659-9251.

**MEMORIES SEMICONDUCTORS FREE FLYER,** UTI, P.O. Box 252, Waldwick, N.J. 07463.

**BASF, MEMOREX, SCOTCH** reels, cassettes. 8 tracks. Lowest prices. Satisfaction guaranteed S&S Audio, Box 523 Skokie, Ill. 60076.

**PROTECT YOUR LPs** poly sleeves for jackets 5¢ round bottom inner sleeves 5¢ Poly lined paper sleeves 11¢ White jackets 25¢ Postage \$1.00. House of Records, Hillburn, N.Y. 10931.

**AUDIO RESEARCH, B&O, BOZAK, BRAUN, CROWN, DECCA, KLIPSCH, HARTLEY, PHASE LINEAR, QUAD, RADFORD, REVOX, SAE, SENNHEISER MICS.** Others. Custom designed and constructed music reproduction systems for homes, musicians, and auditoriums. Each component analyzed and optimized. Demonstration by appointment. Phone or mail consultations. C.M. Santmire, AUDIO SYSTEMS AND DESIGN, 5421 South 84th Street, Lincoln, Nebraska, 68516. (402) 489-9888.

**10½" REEL SPECIALISTS:** Used boxed 10½" metal recording reel. Excellent condition. Pre-paid 1-9 \$2.00 each. 10-24, 1.75; 25 or more 1.60. Nab Centers. Used Fiberglass 10½" small hole half above price. Box 15¢ extra. Any make recording tape available, new or used. SOUND INVESTMENT CO. POB 88338. DUNWOODY GEORGIA 30338.

**LISTEN TO YOUR TELEVISION THROUGH YOUR STEREO** with TELEDAPTER. Supplied with all cables—ready to plug into your stereo. Only \$16.95 ppd—10 day money back guarantee. Send check, cash, money order or Master Charge # & expiration date to Rhoades & Co., P.O. Box 817, Hendersonville, Tennessee 37075. Dealer Inquiry Invited.

## FOR SALE

**MINT USED COMPONENTS**—KLHs, B & W 70s, Super Quad, JBLs, Quad Speakers, ARCD-75, 50 F.B. Citation 11, 12; Marantz 9s. Paul Heath Audio, 354 State Street, Rochester, N.Y. (716) 232-2828.

**ADVENT, B & O, EPI, FISHER, ORTOFON PHASE LINEAR, REVOX, SANSUI, TANDBERG THORENS, HI-FI SHOP EVANSVILLE, IND. 47714.**

**PRINTED BOARD DESIGN AND FABRICATION.** Write to P.C.D.S., 10 Melville Ave., Fairfield Ct. 06430.

**MEMOREX TAPE LOWEST PRICES. WRITE FOR FREE INFORMATION.** SOUND DYNAMICS. BOX M-3. FREMONT, CALIFORNIA 94537.

**PRESTO 28N**—(2 8N lathes in one console w/control panel). Perfect condition, includes 2 Presto 1-D heads. Best offer. Tritone Records, 6411 Bergenwood Ave., North Bergen, N.J. 07047 201-868-9332.

**SAE MARK I \$450, SAE Mark IV \$300, CITATION 11 \$295, PHASE LINEAR 400 \$450, MARANTZ 30 \$300, MARANTZ 7T \$195.** All above used equipment in excellent condition. C.M. Santmire, AUDIO SYSTEMS AND DESIGN, 5421 South 84th, Lincoln, Nebraska. 68516. (402) 489-9888.

**A FULL OCTAVE OF NEW BASS** from your AR, KLH, ADVENT, DYNACO, ADC, RECTILINEAR bookshelf speakers, using low cost electronic equalization. Three test reports, comprehensive literature, from NORMAN LABORATORIES. 520 Highland Parkway, Norman, Oklahoma 73069.

**CIZEK LOUDSPEAKERS** Lowest price in the country. Quotes on your favorite system. Sound Center, Box 1242, Bloomington, Indiana 47401. 812-332-4252.

**COMPLETE DIRECTORY OF BRITISH STEREO COMPONENTS, MANUFACTURERS, AND DEALERS: HI FI YEARBOOK 1973.** 464 pages, hard cover. Specifications on over 2000 products. 790 photos. \$8.95 plus 50¢ postage. AUDIOPHILE SYSTEMS. 851 West 44th Street Indianapolis, Indiana 46208.

**MOTION PICTURE EQUIPMENT, 16mm & 35mm Projectors, Cameras, Free Listing.** Cine-Vision, 206 14th Street, N.W., Atlanta, Georgia 30318. (404) 874-2952.

**E.V. PATRICIAN 800 CONTEMPORARY \$1,400 PR. MINT.** EDMOND HAMMITT BOX 96 WILLISTON, OHIO 43468. 419-836-6011.

**AUDIO RESEARCH.** Radford, Phase Linear, Crown, Quad, Stax, Infinity, JBL, Braun, Panasonic SP-10, ESS, Tandberg, Hartley Electronics (Audio Consultants) 1502 Buttnut Richland, Wa. 99352. (502) 947-5026 after 5 p.m. weekdays, all day weekends.

**SAVE MONEY BY THE BUSHEL WHERE THE CORN GROWS** . . . Fantastic Savings on Name Brand Stereo Equipment—WRITE FOR QUOTE. MIDWEST AUDIO WHOLESALERS. P.O. Box 1132, WATERLOO, IOWA 50704.

**WE HAVE THE FINEST!** Dayton Wright, Audio Research, ESS, SAE, Quad, Radford, Stax, Decca, B&W, ERA, Revox, Panasonic, Professional, B&O, Celestion, Braun, Phase Linear, Crown, Audio Systems, 2985 College Ave., Berkeley, Calif. 94705. 415-548-5212.

**SPEAKERS CUSTOM BUILT** Folded or straight axis horns for the perfectionist. These horns will provide the finest sound in the world. Duluth Electronics Co., 24 East 1st, Duluth, Minnesota 55801. 218-624-4153.

## FOR SALE

**AUDIO RESEARCH, BRAUN, CERVIN-VEGA, DECCA, ESS, HEGEMAN, IMF, MAGNUM, OPUS, PHASE LINEAR, QUAD, QUINTESSENCE, RABCO, RADFORD, SAE, STAX.** Paul Heath Audio, 354 State Street, Rochester, N.Y. 14608. (716) 232-2828.

**FLORIDA AUDIOPHILES!** E.S.S. AMT 1; Phase Linear, Klipsch, Sony, Marantz, B & O, Quad, Revox, Barzilay. **INTERIORS PLUS SOUND** 3038 N. Federal Hwy., Ft. Lauderdale, Fla. 33306 (305) 566-3511.

**INDUCTORS, MYLAR CAPACITORS,** nylon bobbins, complete networks & raw speakers. Write for list. Mike Lewis, 3673 W. 113th St., Inglewood, Calif., 90303.

**McINTOSH PREAMP C-28,** 9 months old. \$395.00. J. McAfee, 273 Alexander Ave., Bronx, N.Y. 10454. (212) MO5 8475.

**MAGNEPLANAR® LOUDSPEAKERS** are extremely realistic sounding. Our top quality models are sold thru AUDIO RESEARCH dealers, some of which advertise on these pages. We now have two less expensive models for sale. They are the MG 1672-P Room Divider and the MG2167-F Floor Standing model. You may buy direct from the manufacturer until there is a dealer in your area. Write us for details. Magneplanar Inc., P.O. Box 8642, White Bear Lake, Minn. 55110.

**NEUMANN MICS & ACCESSORIES** Gately Pro kits and mixers. Most models in stock. Immediate prepaid shipment. Mastercharge. Write or call Dick McGrew Recording Service, 7027 Twin Hills, Dallas, Texas 75231. 214-691-5107.

**J.B.L. S7R SOVEREIGN** Enclosures 1 year old \$1000. T McMullen, 72 Sherwood Ave., Webster, N.Y. 14580.

**WHOLESALE STEREO COMPONENTS.** Most Major Brands. Audiovox, Garrard, Pickering, etc. S & B Distributors P.O. Box 330 Woodmere, N.Y. 11598. Send 10¢ for Catalog.

**AUDIO RESEARCH,** Magneplanar, Crown, McIntosh, Thorens, Decca, Stax, Revox on display. Free List used equipment. Stereo Shop, 107 3rd Ave. SE, Cedar Rapids, Iowa 52401. 319-365-1324.

**SEND FOR LATEST STUDIO CLEARANCE** sale list featuring microphones, tape recorders, equalizers, limiters, turntables, lathes, cutter heads, loudspeakers, mixing consoles, organs, and pianos. Only professional studio equipment listed. Wiegand Audio Laboratories, RD #3, Middlesburg, Pa 17842 717-837-1444.

**JBL PARAGON**—oiled walnut; absolutely perfect condition. \$2100.00. Phone 203-929-5255 or write Howard Megee, 14 Poplar Drive, Shelton, Conn. 06484.

**CROWN CX 824**—1969 model. 20 hrs. use. 10Z, remote, etc. \$1200 (Cost \$1600.) K.E. Ryan, 14538 Cortina Dr., La Mirada, Calif. 941-8464.

**SOUND SYNTHESIZER** kits imitate nature's background music. Surf \$11.95. Wind \$11.95. Wind Chimes \$16.95. Electronics Songbird \$6.95. Also electronic music accessories waa waa, sustain, many more. Catalog Free. PAIA Electronics, Box D14359, Oklahoma City, Okla. 73114.

**IMF ALS 40.** Possibly the finest bookshelf sized speaker system ever made! Listen to them for half hour . . . then try to listen to something else. **THE SOUND SHOP,** 96 Seneca Street, Geneva, New York 14456. (315) 781-0215.

**MARANTZ 7T \$200, 8B \$150,** mint condition. Zalinsky, 260 Old Post Road, Edison, N.J. 08817.

**HUGE SAVINGS ON FAMOUS BRAND STEREO COMPONENTS**

**DISCOUNTS**

**ON NATIONALLY ADVERTISED TURNTABLES • CARTRIDGES**

**COMPACTS • RECEIVERS**

**AMPLIFIERS • TAPE RECORDERS**

Wholesale Prices! Audio Warehouse Sales, One of the Capitol's largest stereo wholesalers will fill and deliver all your mail orders promptly in factory sealed cartons, at prices that will amaze you.

Write for quote on Famous Brand, Stereo Components. We guarantee satisfaction.

**AUDIO WAREHOUSE SALES**  
3310 NEW YORK AVE. N.E.  
WASHINGTON, D.C. 20002  
(202) 832-1616

Check No. 5 on Reader Service Card

## FOR SALE

**ALPHAPHONE®** headset—brainwave trainer. Free literature. Aquarius Electronics, Box 627-S, Mendocino, Ca. 95460.

**SPEAKER SPECIALIST TOBY** Corporation of America: 4620 Camp Bowie, Fort Worth, Texas 76107.

**DAYTON WRIGHT, QUINTESSENCE, SEQUERA \$1600 TUNER, BGW SYSTEMS, B&W LTD., IMF, Quad, E.P.I. Infinity, Crown, B&O, ERA, E.S.S., Stax, Celestion, Phase Linear, Decca, Satin, Transcriptors, Hegeman, Radford, A.K.G., Panasonic, Professional, Revox, Tascam, DBX, Rabco, Connoisseur, PE, Spondor, JBL, Professional, TRANSCENDENTAL AUDIO, 1214 WALDEN AVE., BUFFALO, N.Y. 14211. 716-897-3984**

**SENSIBLE SYSTEMS & PRICES:** Hegeman, IMF LTD, Celestion, ARP Synth AR-LST, JVC, Citation, Marantz, BGW Thorens, B&O, Connoisseur, Equa, Akai, Dokorder, Tandberg, Revox-Beyer Soundcraftsmen, BGW, Hartley, JansZen, 54 other makes. Trades, 89 Day Speaker Approvals. By appointment only (404) 252-8569. Write for famous "Blue Sheet" ATLANTA AUDIO PROJECT Ltd. Suite 106-108, 141 West Wieuca Rd. Atlanta, Ga. 30342.

**ATTENTION ALL SERIOUS CASSETTE ENTHUSIASTS**—At last—No nonsense cassette labels. Send for free samples. Joe Bly Enterprises, 339 W. 88th St., N.Y., 10024.

**CUSTOM LOADED MAXELL C-90UD** cassettes. 10 for \$15.00 postpaid. \$1.65 each. Other custom lengths & tapes available. MJS. 703 Menker Ave. #1, San Jose, Calif. 95128.

**We Don't Have Gimmicks  
Just Low Prices**

# Southern Sound Wholesalers

Every Major Brand

Mail Order Discount Prices  
Same Day Service

•Memorex      •Sherwood  
•Garrard      •Koss  
•Dynaco      •ADC  
•KLH          •Shure  
•Scotch      •Miracord

To Mention a Few!  
"Ask For A Quote"

P. O. Box 44  
Magnolia, N. J. 08049

Check No. 35 on Reader Service Card

## FOR SALE

**SENSATIONAL IMF STUDIO MK-III, ALS-40.** MONITOR MK-III loudspeakers in stock. Decca's superb 4RC cartridge special \$63.00. MISCO 6x9 automobile speakers sensational quality \$10.00 each. Electron tubes, all types less than wholesale, send your requirements, immediate quotes. SAE MK-4B amplifier, mint \$275.00. Hadley 622 amplifier, demo \$235.00. Advent large speakers, mint pair \$180.00. AR-3 speakers, big woofer, excellent pair \$250.00. We take trades. Audiocraft, South Rockwood, Michigan 48179. Telephone: (313) 379-9945.

**EVERYTHING ON OPEN REEL!** Thousands of prerecorded classical/popular tapes. Latest releases. Discounts 96-page catalogue \$1. Barclay Crocker, Room 333C, 11 Stone Street, NYC 10004.

**CYBERACOUSTIC AND EQUIPMENT TESTING** laboratory. CROWN tape recorders, amps. AURLINEARS, warranty service station, IMF and Infinity monitors, AKG, Rabco, Decca, UREI, Fairchild and more. Barclay, 503 Haverford Avenue, Narberth, PA 19072 (215) 667-3048 or 120 Villa Crest Drive, State College, PA 16801 (814) 466-6500.

**SAE MARK VI FM DIGITAL TUNER** \$700. Mark I preamplifier \$400. Mark III A amplifier \$400. Perfect. (614) 488-8178.

**HI FI ENTHUSIASTS WANTED!!** Earn more than just spare money in your spare time. We need campus representatives to sell name brand stereo components at discount prices in your area. High commission, no investment required. Serious inquiries only, please. Contact: Mick Santillo, K&L SOUND Services Co., 264 N. Beacon St., Watertown, Mass. 02172.

**+ STEREO PLUS** The store owned by engineers. All items lab. tested, data supplied, response curves, graphs. Best makes kept prices. Unique loudspeaker try before you buy plan. Free advice by experts. Stereo Plus, Parkway Center, South High St., West Chester, Penna. 19380.

## FOR SALE

**JBL S8R SOVEREIGN ENCLOSURES** and equipment cabinet. Dark oak. Perfect. \$1600. (614) 488-8178.

**WORLD'S FINEST COMPONENTS.** ESS Heil AMT-1 speakers, Advent, Astrocom, Bose, BSR, Decca, Dual, ESS, Garrard, Grado, Hamman-Kardon, Infinity, JVC, Kenwood, Marantz, Phase Linear, Rabco, Revox, Sony, Stax, Thorens, Vega, and others. Shipped from stock. Interior Systems, 4443 West Charleston Blvd.; Las Vegas, Nev. 89102.

**THE LDL 749 REFLECTOR SPEAKER SYSTEM.** The concert hall you can own with full frequency response. Low distortion and 300 watts rms power handling ability. Isostatic Audio Systems, 66 Dale Drive, Town of Tonawanda, New York, 716-695-1535.

**QRK TURNTABLES,** the standard of the broadcast and recording industry. Isostatic Audio Systems, 66 Dale Drive, Town of Tonawanda, N.Y. 14150. 716-695-1535.

**REK-O-KUT TURNTABLES AND TONE ARMS** now available from IAS. Isostatic Audio Systems, 66 Dale Drive, Town of Tonawanda, N.Y. 14150. 716-695-1535.

**DENVER'S SPECIALISTS** in high definition sound systems offer IMF, Connoisseur, Citation, Klipsch, Phase Linear, EPI, Thorens, Braun, Ortofon, ADC, Discwasher, Stellavox, and more. Visit Listen Up, at 685 South Pearl, Denver, Colo. 80209. 303-778-0780.

**TWO PAIRS KLH-9 ELECTROSTATIC SPEAKERS:** as is—price negotiable. N.Y. area. Will not ship. C. Berenyi, Box 675, Stony Brook, N.Y. 11790.

**AMPEX 350 DECKS** Full track mono heads, 7½-15 ips, excellent cond., \$695 each, ship collect. Reply to C. Blackman, 350 Glenview Drive, San Francisco, Calif. 94131.

**MARANTZ 7T. SOLID STATE CONTROL CENTER—Excellent—\$190.00.** Altec 838 A (Carmel) speaker systems—\$425.00 for pair (you handle packing and shipping). Classical Records—\$1.00 each. Other items—list available. RDD, 1807 Elm Crest, Arlington, Texas 76012.

**ELECTRONIC ORGAN KITS, KEYBOARDS,** and many components. Independent and divider tone generators. All diode keying. I.C. circuitry. With our kits you can build any type or size organ desired. 25¢ for catalog. DEVTRONIX ORGAN PRODUCTS, Dept. A, 5872 Amapola Dr., San Jose, Calif. 95129.

**AUDIO RESEARCH D-75.** New 2/73, \$650.00. DAYTON WRIGHT Pre Amp latest circuit with OPAMPS 2 phono, 2 tape, 2 aux. inputs A-B and B-A dubbing, \$200.00. MUST SELL C. Dusyn, 75 Lark St., Buffalo, N.Y. (716) 892-4467.

**ATTENTION LEAK SANDWICH OWNERS!** Unbelievable opportunity awaits you—write: ERCONA CORPORATION, 2121 Bellmore Ave., Bellmore, N.Y. 11710.

**DAYTON-WRIGHT SPEAKERS: RADFORD AMPS,** Pre-Amps & Speakers; ERA imported perfectionist turntables; Quad Electrostatic speakers; Other Audiophile gear available—ESS, Phase Linear, etc. Audiophile consulting and custom installation 405-364-6297. Box AJUL 3-2.

**EQUALIZE YOUR TAPE RECORDINGS OR HI-FI** with inexpensive, easy-to-build TEN KNOB GRAPHIC EQUALIZER PLANS—\$2.50. GREEN BANK SCIENTIFIC, Box 100B, Green Bank W. Va. 24944.

**SEND STAMPED ENVELOPE FOR RARE SOUND TRACK ALBUM LIST.** Allen Hinkle 613 Lemar Ave., Harrisburg, Penna. 17112.

## FOR SALE

**FIREWORKS NEWS—**Monthly magazine covering Fireworks, Construction, Sources of Supplies, New Firms—Products. FREE Fireworks Catalogs with Subscriptions! \$9.00 per calendar year. Pyro Press, Box 1202P, Lexington, Kentucky 40501.

**DETROIT PRICES** on Major Brand Hi-Fi components. Write for a quote. R.A.E., P.O. Box 436, Rochester, Mich. 48063.

**MEMOREX CASSETTE AND 8 TRACK BLANKS.** Regular and Chromium Dioxide. No lower prices ANYWHERE!! Send 10¢ for catalog. S&B Distributors, P.O. Box 330, Woodmere, New York 11598.

**THEATRE AND AUDITORIUM PORTABLE SOUND, AUDIO, EQUIPMENT.** Closed trailer, speaker pairs, EV Sentry IV in adjustable stands for 6' to 10' high. Mic pairs EV RE20, RE55, RE666, with 513 filters. One mini RE51. All shock mounts and stands. Aluminum hang booms. MAC 2100. Ampex AM10 with all extras and extra new in and out boards. Turntable, mag cartridges, recorder, many cables and connectors, trans, accessories. Few hours use, guaranteed new condition. Bid only for all. Huge discount. After 4 o'clock, phone 616-946-8294.

**CROWN SS724—NEW HEADS—4 SPEEDS—** 1 mic and 1 line input per channel—10½" Reel adapters—wood case—\$695. or best offer. Box 453, Shamokin, Pa. 17872.

**SAE MK IV B STEREO POWER AMPLIFIER.** Absolutely perfect condition. Must sacrifice for immediate sale: \$250.00. Jeffrey S. Sibley, 230 Vendome, Grosse Pte., Mich. 48236.

**FLORIDA'S ONLY AUDIO RESEARCH DEALER.** Complete Audio Research on demonstration. SP-3/Dual 75/Dual 51/Magneplanars and Bass Panel (Tri-amped). Plus Phase Linear, Crown, McIntosh, Hartley, Decca, Stax, S.A.E., Braun, Tandberg, Advent, B&O, Rabco, J.B.L., Thorens, E.S.S. (Heil). Complete audio counselling. Sound & Sight, 20 N. Federal Highway, Boca Raton, Fla. 33432. (305) 391-1843.

**SCOTCH RECORDING TAPE,** lowest prices. TAPE CENTER, Box 4305B, Washington, D.C. 20012.

**AUDIO RESEARCH DUAL 51 Amplifier.** Brand new. \$600.00. (916) 363-9054.

**AUDIO RESEARCH PRODUCTS—20% OFF.** Also trade-ins and/or demos. McIntosh C28, C26, C24, Mr73, Mx11Z, MC250, Z-Mc2105, 1900, ML1C's. Marantz 33, Roger's amps from England, IMF/Galacticon IC-10 amp, Quad tube amps, sound craftsmen RO10-12R, 2 Thoren TD 125, 1 SME 3009, 1 Rabco SL8, ESS M500 amp. Call for new list. **TRANSCENDENTAL AUDIO, 1214 WALDEN AVE, BUFFALO, N.Y. 14211.** 716-897-3984.

**DELAY LINES:** Custom built, highest fidelity, no tubing. \$200. Synthetic Quad or true binaural reproduction. CINEVO, 126 St. Marks, N.Y., N.Y. 10009. 212-473-7450.

**DALQUIST PHASED ARRAY LOUDSPEAKER SYSTEM** Immediate delivery, \$350 each. This great speaker, introduced by the renowned Saul B. Marantz is the answer to the perfectionist's dream. It has the deep bass, power handling of the best dynamic speakers combined with the balance, smoothness, and transparency of the finest electrostatics. Free literature, expert advice. Opus One, 400 Smithfield, Pittsburgh, Pennsylvania, 15222, (412) 281-3969.

**PANASONIC AND ROSS EQUIPMENT:** Low sale prices. Send \$2.00 (refundable) for big illustrated guide, or write for details. Phase III, 420 North Howe, Southport, N.C. 28461.



## FOR SALE

**ACOUSTECH 10S** Mint \$1100. pair; Hadley 621 Rack Mtd Pre Amp & 622 Amp Mint \$500; Marantz 10B Rack Mtd. Super mint \$625. Klipschorns, 4 way \$900.; Sony 777 1/4 \$300. Sony Electronic Xover \$120.; SAE Mk III Amp mint \$425. Magnecord 1028. 7 1/2, 15 1/2 track mint \$700. Infinity Pre Amp mint \$600. Klipsch Woofer \$75. JBL Hartsfield \$650.00. Makray, Box 30312, Santa Barbara, Calif. (805) 682-2024.

**A COMPLETE 600 OHM STEREO** Professional Console for mastering tapes, 4 channel Sparta 10B mixer, Schafer 8TBU 25 cycle Tone Disseminator w/remote, Langruin Equalizers (2) custom remote control selector, two Thorens turntables, 2 Shure SEI Pre Amps, 6 channel remote control monitor switch, Scope, Patch Bays, 2 Ampex AC 350 1/4 track rack mtd., Ampex 14" custom made 1/4 track Playback with reverse deck, all mint—Cost \$25,000 plus for \$9,000. MAKRAY, Box 30312, Santa Barbara, Calif. 93105 (805) 682-2024.

**QUINTESSENCE GROUP COMPONENTS ARE AVAILABLE** in New York City exclusively thru the New York Electric Gramophone Works. By appointment please call (212) 677-2068. AWARE OF THE FINEST?

**ESS TRANSTATIC I** speakers; Audio Research SP-2C preamp and Dual 50F-1B amp; Decca international arm with motor lift; Decca SC4E and Mark V cartridges; Pioneer SF-700 Crossover; Phase Linear 400 amp. Best offers. Private. J. O'Connell, 22 Bremond St., Belleville, N.J. 07109.

## SERVICES

**MULTI CHANNEL TAPES** Processed from YOUR Mono Records Tapes. Demo Tape \$1.50. R. R. Faulkner, Box 26, Redondo Beach, Calif. 90277.

**DON'T PAY** the high mail order prices. Thieves Warehouse is coming up to your area. Franchises available. Thieves Warehouse, P.O. Box 8057, Pensacola, Florida 32505.

**HIGH FIDELITY SPEAKERS REPAIRED**  
AMPHRITE SPEAKERS SERVICE  
655 Sixth Avenue, New York 10, N.Y.

**RECORDS MADE FROM YOUR TAPES** Also, editing and mastering. Send for free brochure. Nashville Record Productions, Inc., Dept. AM 204 19th Ave., So., Nashville, Tennessee 37203.

**TAPE RECORDER HEADS** brought back to spec. Wear removed. Brilliant finish. \$10.00 each. One day service. E. Maher, 5 Evans Place, Orinda, Calif. 94563.

**CUSTOM RECORDING SERVICE** Tape and disc. Stereo and mono. Live and copies. Editing. Masters and pressings. High quality at reasonable rates. Joseph Giovanelli, Audio Tech Laboratories, 2819 Newkirk Ave., Brooklyn, N.Y. IN9-7134.

**"HOW TO BUY 4 CHANNEL"** THE MOST COMPLETE USER'S GUIDE TO QUADRAPHONICS HOW TO GET THE MOST FOR YOUR MONEY. SEND \$1.00 TO THE STEREO SHOP BOX 10550 CLEVELAND, OHIO 44110.

**BOSTON MASS. AREA** Authorized-Service for Panasonic J.V.C.-Fisher-V.M.-Webcor-Magnavox-Lloyd's-Motorola-Juliette-Ross-York. "Where the faults go out and the quality goes in". Al's Radio and TV. 1592 Columbus Ave., Roxbury, Mass. 02119. (617) 442-8850.

**HEATHKITS—PROFESSIONALLY BUILT** and aligned for years of trouble-free service. Send for quote. Michael Leibowitz, 198-23 51 Avenue, Flushing, N.Y. 11365.

## SERVICES

### "BATTLE OF THE GIANTS"

Crown DC-300 vs. Phase Linear "700"

Order today your copy of this in-depth comparative lab and listening test. Only \$1. Sent FREE with subscription. \$7.50 per year (6 issues) in USA. \$8 in Canada. \$10 elsewhere. Other test reports available. Please inquire. Send your remittance today to: The Hi-Fi Newsletter, Box 593, Hialeah, FL 33011. The HFN is an independent publication founded solely by audiophiles all over the world.

**QUADRAPHONIC DUPLICATIONS.** Unsurpassed quality. High-speed CASSETTES REELS from your Quadtapes. NATIONAL TAPE DUPLICATORS 111 Valley Wilmington, DE 19804.

**NOW . . . LOWEST PRICES FOR STEREO MASTERS** expertly cut on a Scully lathe with the Westrex 3D stereo cutting system. Stereo: 12"—\$33 per side 7"—\$12 per side Mono: 12"—\$22 per side 7"—\$7 per side. Trutone Records 6411 Bergenwood Ave. North Bergen, N.J. 07047 201-868-9332.

**THE NEW YORK AUDIO SOCIETY** is a hi-fi club with a comprehensive activities program and numerous member benefits. Come and be our guest at one of our meetings and see what we have to offer. For details write N.Y. Audio Soc. Dept. A, Box 5889 Grand Central Sta., N.Y., N.Y. 10017 or call M-Fri. 10AM-6PM (212) 242-3900.

**THE ABSOLUTE SOUND**, a reader-supported quarterly about sound and music, reviews, in its current issue: The Magneplanar; Crown DC-300a; Shure V-15 III; The Hegeman Model One; The Decca Arm and Cartridge (Mk V); Audio Research SP-3. There are two essays: Movie Music, Beyond the Sea Hawk and The Death of the American Symphony Orchestra. And more. Coming up in September: Quintessence pre-amp; Audio-Technica Arm and AT20SL cartridge; the Ohm A speaker; both the Satin and Grace moving coil cartridges and the Bachorn. Still not satisfied? Well, in December, we shall be taking a look at Radford's electronics, among other things. \$8 annually (four issues). The Absolute Sound, P.O. Box 115J, Sea Cliff, New York, 11579.

**HAVING TROUBLE GETTING A GOOD DEMO AT A GOOD PRICE?** Trutone Records cuts the finest quality demos available, and you'll be surprised at our low, low prices. STUDIO DISCOUNT AVAILABLE. Request brochure. P.S. We also do complete record production. 6411 Bergenwood Avenue, North Bergen, N.J. 07047 (201) 868-9332.

## HELP WANTED

**EPICURE PRODUCTS, INC.** is seeking quality applicants to meet expansion needs. Applicants must be willing to travel extensively four or five days per week; be knowledgeable of, or willing to learn, all aspects of the hi fi industry—products, policies, and future developments. Position requires a professional approach to sales, and a person interested in rapid advancement into a growing management team. Base salary and monthly incentive. Epicure Products, Inc. Newburyport, Mass. 01950. Call: Robert Fuller, Personnel (617) 462-8191.

**RECORD MANUFACTURER** is seeking field representatives and recordists. No gimmicks or fees. Send resume to: EWING, Box 343, West Milton, Ohio 45383.

**SERIOUS RECORDISTS NEEDED** Excellent remuneration. We train and equip. Modest investment required. Write Box 278, Englewood, Ohio 45322.

SCOTCH BRAND CASSETTES	1-9	10	48
SC 45 Low Noise, 45 Min.	1.35	1.21	1.15
SC 45 High Energy, 45 Min.	1.65	1.48	1.40
SC 60 1-Hr. Low Noise	1.50	1.35	1.21
SC 60 1-Hr. High Energy	1.80	1.62	1.54
SC 90 1 1/2 Hr. Low Noise	2.25	2.02	1.92
SC 90 1 1/2 Hr. High Energy	2.70	2.43	2.31
SC 120 2-Hr. Low Noise	3.30	2.70	2.56

### OPEN REEL TAPE RIOR

NEW FACTORY FRESH SCOTCH LOW NOISE 212-R90; #207-R90 (7" REELS 1800 FT. 1 MIL POLYESTER); SCOTCH #203 (3600 FOOT 10 1/2" METAL REEL); OR AMPEX #611. 1200 FT. 7 INCH REEL (ACETATE):

QUANTITY	1-9	10	36
#211-R90 SCOTCH 7"	3.32	2.92	2.77
#207-R90 SCOTCH 7"	3.83	3.34	3.17
611-12 AMPEX 7"	1.68	1.50	1.39
203-36 SCOTCH 10 1/2"	7.95	6.99	6.79

CASSETTES & REELS ASSORTABLE FOR BEST QUALITY PRICE. SHIPPING/HANDLING +10%, 7% OVER \$20.00. 5% OVER \$80.00.

### SCOTCH MAGNETIC TAPE (USED)

#150. 1800 ft. 7 inch reel, 1 mil polyester, recorded once, bulk erased (no box), 99¢ plus 10% shipping & handling (min. order \$10.00); slightly used 10 1/2 inch fiberglass reels, 3/4" hole. 50¢ each, plus shipping by weight and zone.

### SAXITONE TAPE SALES

1776 Columbia Rd., N.W., Washington, D.C. 20009



## BUSINESS OPPORTUNITIES

**ADDRESSERS, MAILERS** wanted. Application 25¢. Keneco 1101 Worth, Durham, North Carolina 27701.

**SUCCESS AND POPULARITY**—Six ways to Develop your Creative Powers. A Formula to Guarantee Success and Prestige in Any Endeavor. Send \$2.00 J.N. TRINIDAD—2731 W. Cortez—Chgo. Ill., 60622.

**MAILORDER MONEYMAKING KIT** Home Business Valuable lists, concrete information, detailed steps. Capital unnecessary. Free Details. Pictures Meadows, Box 327-AU7, Boston, 02199.

**MAILORDER**—Carry no stock. Companies will pack, ship under your label. One-man operation capable of \$10,000—\$20,000 year. Details Free! Distributors, Box 9—M, East Rockaway, New York 11518.

**QUALITY EQUIPMENT OWNERS** to make on-location recordings for profit. No investment. Box 264, Union, Ohio 45322.

**MAILORDER MILLIONAIRE** helps beginners make \$500 weekly. Free report reveals secret plan! Executive (1Q5), 333 N. Michigan, Chicago 60601.

**AUDIO VISUAL SERVICING, T.V.** Repair Equipment and Inventory For Sale. Must Sell. Write For Details—19326 19th SE #20, Bothell, Washington 98011.

**\$25.00 HUNDRED** stuffing envelopes. Immediate earnings. Beginner's Kit. \$1.00 (refundable). Lewcard, A392 DU, Brea, California 92621.

## AUTO ACCESSORIES

**SPEAKERS**—Acoustically designed and built for 1/4—1/2 cost of factory speaker systems. SAVARD 600 East Roosevelt Box 360 Baton Rouge, LA. 70802.

## REAL ESTATE FOR SALE

**IDEAL 5 ACRE RANCH** Lake Conchas, New Mexico \$3,475. No Down. No Interest, \$29 mo. Vacation Paradise. Money Maker. Free Brochure. Ranches, Box 20035M, Alameda, California 94501.

## MISCELLANEOUS

**SEND \$1.00 RECEIVE JEWELRY CATALOGUE** \$3.00 certificate. Schick Enterprise, 6519 South Claremont, Chicago, Ill. 60636.

## EQUIPMENT WANTED

**WANTED: JBL HARTSFIELD C&F** at my expense. Dr. Fumihiko Umezawa, M.D., Jujin Hospital, 1-12-5 Shinbashi Minato-ku, Tokyo, Japan.

**WANTED: McIntOSH MC-3500**, Sunn Coliseum radial horns, Sunn 115SR Bass horns. State condition and price. Bill Fitch, RD #2, Pottstown, Pa. 19464. (215) 469-6082.

**WANTED: 2 MODEL 20s** with grill cloth removed. HiFi 4 channel tape decks, RS-858US Willie C Robinson 2515 Benton, Kansas City, Mo. 64127.

**CASH FOR YOUR unwanted LP's** and pre-recorded tapes. Record House, Hillburn, New York 10931.

**BOZAK COLONIAL 305'S** and/or equipment cabinet; or bargain 4000 classics; or plans, kit instructions. John Farris, 13184 Putnam Cricle, Woodbridge, Va. 22191.

**WANTED: PRE AMP FOR SERIES 90** concertone tape deck, also remote for same, 16" turntables. Greg Holden, 415-W-22, Vancouver, British Columbia.

**KOSS/ACOUSTECH 6 PREAMP**; Keene, 120 Gary Lane, Cocoa, Fla. 32922.

**WANTED: ALLIED MODEL 888 HC** 3-way speaker cone only, or model 888 BHC. J. Lechner, 4376 Lee Heights, Warrensville Hts., Ohio 44128.

**WANTED: SONY TC 864** in good condition. Dr. John McDevitt, 55 E. 87th St., New York, N.Y. 10028.

**ALTEC 808-B CAST MULTICELLULAR HORNS**, Marantz SLT-12 turntables. Box AJul 3-1.

**TEAC TCA-42 DECK AND PRE-AMPS** in good condition with simul-sync. F.J. Mitchell, 3927 Primrose, Paducah, Ky. 42001.

### FRANCHISING MANUALS

**FOREIGN ENTERPRISE STARTING A FRANCHISING OPERATION** abroad, needs operation manuals, contract specimen and other business tools of electronic franchisor such as Lafayette, Team, Allied Radio Shack. Will pay US \$1,000.00 for a complete set. Xerox copies acceptable. Mail detailed offers to Mr. H. Rueckheim, 105 Washington Street, New York, N.Y. 10006, 4th Floor. Secrecy guaranteed.

**GENERAL RADIO 1304-B OSCILLATOR**, State price and condition. Roger Russell, Normandy Court, Binghamton, N.Y. 13903.

**WANTED: KENWOOD QUADRIXER, KF8011, AX 801, KA 7002.** Also Electro-V 7445. Price and condition to Box 4, Tennent, N.J. 07763.

## GOVERNMENT SURPLUS

**JEEPS** Typically From \$53.90 . . . Trucks from \$78.40 . . . Boats, Typewriters, Knives, Airplanes, Clothing, Multimeters, Oscilloscopes, Transceivers, Photographic Electronics Equipment, Wide Variety Condition 100,000 Bid Bargains Direct from Government Nationwide. Complete. Sales Directory and Surplus Catalog \$1.00 (Deductible on Orders From Separate Included Catalog). Surplus Service, Box 820-AUD Holland, Michigan 49423.

## COLOR SLIDES

**ART-EDUCATIONAL-TRAVEL**, 50,000 individually sold . . . Samples-Catalog \$1.00 refundable. Visuals D21 440 N.W. 130 Street, Miami, Florida 33168.

## PLANS & KITS

### COMPONENT CABINETS

Direct from the factory at low factory prices. Finished-Unfinished Kits . . . free brochure.

### AUDIO ORIGINALS

546 S. Meridan St.  
Indianapolis, Ind. 46225

## INSTRUCTION & EDUCATION

**BIBLE** Degrees—Correspondence—Fundamental Bible Seminary. P.O. Box 942, Elk City, Oklahoma 73644.

**LOGIC** trainers catalogs 50¢. UTI, POB 252, Waldwick, N.J. 07463.

**TAPE RECORDING COURSE:** Taught by studio engineers. Free information. NNA, Box 721E, Rye, New York 10580.

**EARN COLLEGE DEGREES AT HOME.** Many subjects. Ministerial studies, high school equivalency diploma. Florida State Christian University, Post Office Box 1674, Fort Lauderdale, Florida. 33302.

**"SHERHAND-3"**, everyone's simplest shorthand, \$5.35, "Said", Box 601, Elmira, N.Y. 14902.

## RECORDS

**CATALOGS** Broadcasts, soundtracks. Personalities of Thirties, Forties, Box 225, New York, N.Y. 10028.

**SHOW ALBUMS**—Rare. Out of Print LP's. Free large list. Broadway/Hollywood Recordings Georgetown, Conn. 06829.

**SOUNDTRACK RECORD ALBUMS** from films, original, rare, free list. Whalon, 2321—N. Hill, Redondo Beach, Calif. 90278.

**SOUNDTRACK ALBUMS** Write, Call William Koutek, 1125 Ives Lane, Minneapolis, Minn. 55441, 544-0867.

**RARE Deleted Motion Picture Soundtrack and Show Albums.** Steiner, North, Goldsmith, Waxman, Young, Bernstein, Styne, etc. "ONLY THE BEST." Send 25¢ for new quality catalog to ReCollections, P.O. Box 197, Roselle Park, New Jersey 07204.

**OLDIES—45 RPM** Original hits. Catalog 50¢ G&S Record Sales, Box 197, Wampsville, N.Y. 13163.

**RARE RECORDS**—Send wants. Box 410, Bronx, N.Y. 10469.

**SOUNDTRACKS**—O.C.—Personalities & Jazz. Want lists to: Theo's Records, P.O. Box 4994, Panaroma City, Ca. 91412.

**OLDIES-45 RPM** original lables & repress over 8,000 from personal collection for sale. Reasonable prices. Try me for the ones you've given up hope in finding. Call or write, Robert Fenster, 1503 Ave. J., Brooklyn, N.Y. 212/258-5121.

**FILM-STAGE SOUNDTRACKS.** Large free list. A. Lutsky, Box 7342, Miami, Fla. 33155.

**FREE 200-PAGE CATALOGUE** offers over 1,200 fine recordings of Renaissance, Baroque, Classical, Romantic, and Modern music. All stereo recordings. Highest quality at budget label prices. Available only by mail from MUSICAL HERITAGE SOCIETY, Box 932 AU, New York, N.Y. 10023.

## PHOTOGRAPHY

**12 EXPOSURE ROLL KODACOLOR FILM** developed-printed jumbo, \$1.50. Capri Color, Box 831, Laredo, Texas 78040.

**AUDIOVISUAL EQUIPMENT HEADQUARTERS.** Slides come alive with synchronized tape sound track. Free literature. "Slides with Sound". S&S Supply, Box 12375D, North Kansas City, Mo. 64116.

## MUSIC

**RARE ROMANTIC PIANO SCORES**—Moscheles, Henselt, Herz, Litolif, Scharwenka, Scriabin, etc. Free catalog. MUSIC TREASURE PUBLICATION, Box 127, Highbridge Station, Bronx, New York 10452.

## TAPE RECORDINGS

**RENT 4-TRACK** open reel—tapes—all major labels, 3,000 different. Free brochure. Stereo-Parti, 55 St. James Drive, Santa Rosa, Cal. 95401.

**RENT ANY CASSETTE** or Queen Reel Pre-recorded tape. All Labels. Catalog 75¢. Tape & Time, 1116 4th Ave., No. Sauk Rapids, Minn. 56379.

**COBALT ENERGIZED CASSETTES** Ultra high frequency tape special price C40—\$1.00; C60—\$1.25 C90—\$1.58. Special Low Noise tape 1800' 1 mil 7"—\$1.50 all ppd DAK Dept. A81, P.O. Box 69920 Los Angeles, Calif. 90069.

**VALUABLE RECORDED TAPES** lose highs and become progressively noisier each time they are played on equipment that is not thoroughly demagnetized. You can measure damaging magnetic residuals with the Pocket Magnetometer and really demagnetize recorder components with the powerful Han-D-Mag. Now available, complete Audiophile Han-D-Kits including: Magnetometer, Probe, Han-D-Mag, experimental sensors and "Notes" Kit 20/B5 \$29.75, Kit 25/S5 \$51.00, postpaid U.S.A. Literature available. R. B. Annis Company, 1103 North Delaware, Indianapolis, Indiana 46202.

**KENNEDY/TIPPIT/OSWALD MURDERS!** Actual episodes & police recordings! Reels/cassettes: \$10. Majestic, 9651 Foxbury, Rico-Rivera, California.

**"8" TRACK TAPES** only \$3.00 each postpaid. Send for our free catalog. Lists over 400. G.M.O., 58 Hillside, Verona, N.J. 07044 Dept. 8TRAm-73.

**8-TRACK TAPES** \$4.00. Sample and list \$2.50. Metco, Box 246-A, Marion, Ct. 06444.

**PROFESSIONAL ALUMINUM BLOCK** parallel precision grooves expertly splices 250 or cassettes. Tabs included. Guaranteed \$4.95 plus .75 handling. Details NRP, Box 289, McLean Va. 22101.

**NEW TAPE EXCHANGE CLUB.** All Formats. Details 25¢. Bob Musial, Box 11907-A, Chicago, Ill. 60611.

## RADIO PROGRAMS

**RADIO MEMORIES.** Custom recorded reels and cassettes. Professional quality equipment assures best sound, but at prices YOU can afford. Large catalog and supplement \$1.00 (refundable). 1033 Gypsum, Salina, Kansas 67401.

**REMEMBER RADIO?** On cassettes or reels. Amos & Andy, Inner Sanctum, Jack Armstrong, Fred Allen, I Love a Mystery, Your Hit Parade, Grand Ole Opry, All your Favorites live again. High quality, low prices. Catalog only 50¢. Remember Radio, Inc., Box 2513-B, Norman, Okla. 73069.

**NOSTALGIA RADIO PROGRAMS** traded. Private collection. Drawer 3226, Newport, Delaware 19804.

**1930-1962 RADIO PROGRAMS ON TAPE** Huge catalog! Hour samples!! \$1.24, refundable!! AM Treasures, Box 192M, Babylon, N.Y. 11702.

**FREE CATALOG.** Radio mysteries. Detective House, 218 Orangeview Lane, Lakeland, Fla. 33803.

**REMEMBER AMOS AND ANDY AND INNER SANCTUM** from the 1940's? For only \$2.00 you receive the 2 oldtime 30-minute radio shows plus a 42-page printed catalog. Specify cassette or reel. Radio, Box 53A, Allentown, Pa. 18105.

## TUBES

**TUBES** receiving, factory boxed, low prices, free price list. Translronic Inc., 1306 40th Street, Brooklyn, N.Y. 11218. Telephone: 212-633-2800.

# I bought a Marantz 4 channel receiver because I refuse to be stuck with an electronic antique.



Not one to tolerate obsolescence (planned or unplanned), I considered the stereo vs. 4-channel question carefully, then purchased a Marantz receiver for three compelling reasons.

One. Marantz has Dual Power. This means you get full power of four discrete amplifiers working all the time. When you're listening to regular 2-channel tapes and records you can combine the power of all four channels into the front speakers. This means even if you're not ready to commit yourself to a complete 4-channel system, you can buy Marantz now and when you get the other two speakers just flip a switch. You have 4-channel. Meanwhile, you're not compromising 2-channel because you're getting more than twice the power for super stereo.

Reason number two. Marantz receivers feature the exclusive snap-in snap-out adaptability to any 4-channel matrix decoder. This means that your Marantz stereo will never be made obsolete by any future 4-channel technology because the Marantz snap-in SQ\* module is designed to keep up with the changing state of the art. What's more, Marantz receivers have Vari-Matrix—a built-in circuit that will synthesize 4-channel sound from any stereo source (including your stereo records and tapes) and will also decode any matrix encoded 4-channel disc or FM broadcast.

Reason number three. Marantz receivers, from the Model 4230 up, feature built-in Dolby\*\* noise reduction to bring you the quietest FM reception ever. And you can switch the built-in Dolby into your tape deck for noise-free, no-hiss recording from any source. A real Marantz exclusive.

I chose the Marantz Model 4270 because it suits my needs perfectly. It delivers 140 watts continuous power with under 0.3% distortion. And it's literally loaded with features. However, your requirements may be more modest than mine. In which case you can own the Marantz Model 4220 which delivers 40 watts with Dual Power. Or you can go all the way and get the Marantz Model 4300 with 200 watts. It is the very best. Choose from five Marantz 4-channel receivers from \$299 to \$799.95.

The point to remember is this—whichever model Marantz 4-channel receiver you do buy, you can buy it today without worrying about its being obsolete tomorrow. Look over the Marantz line of superb quality receivers, components and speaker systems at your Marantz dealer. You'll find him listed in the Yellow Pages. Think forward. Think Marantz.

**marantz.**  
We sound better.

\*SQ is a trademark of CBS Labs, Inc.  
\*\*TM Dolby Labs, Inc.



©1973 Marantz Co., Inc., a subsidiary of Superscope Inc., P.O. Box 99A, Sun Valley, Calif. 91352. In Europe: Superscope Europe, S.A., Brussels, Belgium. Available in Canada. Prices and models subject to change without notice. Consult the Yellow Pages for your nearest Marantz dealer. Send for free catalog.

Check No. 43 on Reader Service Card

# BEHIND IT ALL

"Behind the products that have received unprecedented reviews and worldwide reputation as the best; behind the research; behind the technology and the quality control -- is the most important asset of BOSE Corporation: the most highly qualified team of technical people assembled in the high fidelity industry. I would like you to meet some of them.



Charles Barker  
S.B.  
M.I.T.



Paul Chestna  
S.B.  
M.I.T.



Frank Ferguson  
B.S., Iowa State  
S.M., M.I.T.



Tom Froeschle  
S.B., Purdue  
S.M., M.I.T.



Sherwin Greenblatt  
S.B., S.M.  
M.I.T.



Stan Hendryx  
S.B., S.M.  
M.I.T.



Roy Komack  
S.B., S.M., M.I.T.  
M.B.A., Boston U.



Bill Linder  
B.S.  
Worcester Polytech



Tom Miller  
S.B., M.I.T.  
S.M., Harvard



Lou Poulo  
S.B., S.M., E.E.  
M.I.T.



Mario Rapagnola  
B.S., Institute  
Pacifico Valussi, It.



Eric Rosenfeld  
S.B., S.M.  
M.I.T.



Jerry Ruzicka  
B.E.S., J. Hopkins  
S.M., M.I.T.



Joe Veranth  
S.B., S.M.  
M.I.T.

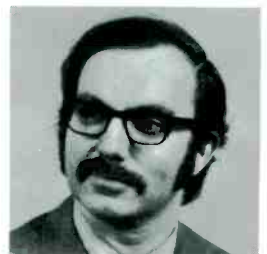

John Wawzonek  
S.B., S.M., E.E.  
M.I.T.

"The need for basic research in high fidelity has long been evident. All too regularly we optimize designs to archaic and inappropriate specifications, and we fail to study the fundamental processes of human hearing, which ultimately control our perception of all musical performances and our ability to distinguish the quality of high fidelity systems.

"For years BOSE Corporation has devoted its efforts to gathering the finest staff of scientists and engineers to study these fundamental issues. These men, working in their new 76,000 square foot facility atop "The Mountain" in Framingham, are dedicated to the proposition that the product comes after the research.

"This technical staff and its continuing research are the best guarantees that when music can be reproduced more accurately in the home, it will be by BOSE."



*A. J. Bose*

A.G. Bose  
Technical Director &  
Chairman of the Board

For complimentary copies of the reviews, circle your reader service card or write Dept. OA

You can hear the difference now.

**BOSE**

The Mountain, Framingham Mass.

Check No. 7 on Reader Service Card