

**SPECIAL  
LOUDSPEAKER  
ISSUE**

# AUDIO

MARCH  
1972 60c

The Authoritative Magazine About High Fidelity® A

23602

"lets you hear every sound clearly and distinctly"

...recognized by their superior sound qualities...

*"Finest units of their type available anywhere!"*

...a spatial effect unobtainable in any other system...

"The largest step forward in speaker design in perhaps two decades."

*"The people-tested speakers."*

**"Rated Best of 50 Speakers!"**

**"Rated excellent or superior in every music category."**

...world's most **per'snickety** speaker maker...

## 12-PAGE BUYERS GUIDE TO **LOUDSPEAKERS**

Also: Ed Long On Crossover Design  Testing Amplifiers with a Bridge  Ralph West on Speaker Response Curves

# The best speaker system you can buy for under \$100 is the new Scott Design 51

After 27 months of development effort, Scott engineers have realized a new speaker system which significantly improves upon the performance of presently available designs. The new Design 51 speaker is a full frequency range, floor standing, two-way acoustic suspension system using Scott's exclusive controlled impedance concept which achieves an optimum match to contemporary amplifier output characteristics.

The Design 51 has a long throw woofer with a four-layer voice coil and highly compliant butyl suspension that extend its useful range down to 30 Hz so you can really feel the low "C" organ pedal tone in Also Sprach Zarathustra. And Scott's tweeter goes right out to 20 kHz. It has a transparency and clarity which make the percussive section in Capriccio Espagnol sound like real tambourines, triangles and cymbals instead of the diffuse metallic clatter many medium priced systems offer.

*Make us prove that our new Design 51 is the best speaker system you can buy for under \$100. Tell your Scott dealer you'd like to audition the Design 51 speaker at \$89.90. Then, let him demonstrate everything else he has for under \$100. We think after you've heard all the rest you'll take home a pair of Design 51's.*

#### **Design 41**

For smaller listening rooms or bookshelf placement, try Design 51's little brother, Design 41. It's got the same state-of-the-art component design, but it's a smaller unit with power handling capacity of 35 watts instead of 60 watts, weighs 20 pounds less, and costs only \$69.90. Circle reader service number to receive specifications on both Design 51 and Design 41.

 **SCOTT**<sup>®</sup>  
*where innovation is a tradition*  
H. H. Scott, Inc., 111 Powdermill Road, Maynard, Mass. 01754

Check No. 100 on Reader Service Card

# 1



# 3

## The TEAC TCA-43 Four-Channel Deck has everything plus the kitchen sync.

Back in the days when we all lived in a place called radioland, the studio "kitchen" was where the sound engineer produced prodigious sound effects with whatever was at hand. Everything from Silver's whinny to the ruckus in McGee's Closet.

Today in the sophisticated seventies, there is a four-channel mastering deck that has everything you need for now and the foreseeable four-channel future: TEAC's TCA-43. It records and plays back a variety of program material in any number of formats. Four-channel stereo. Two-channel stereo record with auto-reverse playback. Four-track monaural formats. Sound-on-sound or synchronized sound/music film tracks. And 1/2-track playback by scanning with 1/4-track heads.



(less cradle stand)

4-channel/2-channel stereo and Simul-Sync record/playback • 4 heads • tape/source monitor  
4 large VU meters • 3-motor, solenoid-operated transport • 8 solid-state record/playback pre-amps • auto-reverse 2-channel stereo playback.

Versatile? The TCA-43 has an added something called Simul-Sync™ that lets you do the wildest

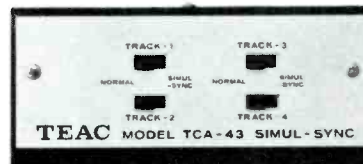

multi-track recordings and over-dubs the way they're done by the most innovative professional performing groups.

What with TEAC's Simul-Sync head function controls and the optional TEAC AX-20 Mixdown Panel for dubs from four- to two-channel stereo, you have unlimited flexibility to develop special-effects recordings that a sound engineer of the thirties would have given half his kitchen to get.



Optional  
TEAC AX-20  
Mix-down Panel

# TEAC

TEAC Corporation of America, 7733 Telegraph Road, Montebello, California 90640  
TEAC Corporation, 1-8-1 Nishi-shinjuku, Shinjuku-ku, Tokyo, Japan • TEAC EUROPE N.V., Kabelweg 45-47, Amsterdam - W. 2, Holland  
In Canada: White Electronic Development Corp., Ltd., Toronto

Check No. 29 on Reader Service Card

# 2



For complete TCA-43 description and specs, rush this coupon to: TEAC Corporation of America, 7733 Telegraph Rd., Montebello, CA 90640.

Name \_\_\_\_\_

Address \_\_\_\_\_

City \_\_\_\_\_ State \_\_\_\_\_ Zip \_\_\_\_\_

A1/1



# 4





all you need in headphones is expert engineering, the best materials, great styling, fine craftsmanship and not a trace of sound distortion.

That's all!

That's what Sharpe Stereophones are all about. We make them in the best possible way so that you get the best possible listening. Not just regular listening. The Sharpe kind of listening. The two are worlds apart.

That's because Sharpe units are true scientific instruments. That's where we leave the others behind. We care all the way from research to delivery to you. There's a Sharpe model for every kind of music lover and for every budget.

Models that are guaranteed for life, listed top-rated, make best introductory or advanced listening buys. For your nearest dealer and literature, check the reader service card.

## SHARPE AUDIO DIVISION

SCINTREX INC.

Tonawanda, N. Y. 14150



Export Agents:  
ELPA MARKETING  
INDUSTRIES, INC.  
New Hyde Park,  
N. Y. 11040

# AUDIO

MARCH 1972

Successor to RADIO, Est. 1917

Vol. 56, No. 3

## FEATURE ARTICLES

- |    |   |                             |
|----|---|-----------------------------|
| 14 | Quadraphonic News                       |                             |
| 18 | What Price Loudspeaker Response Curves? | <i>Ralph West</i>           |
| 24 | Testing An Amplifier With A Bridge      | <i>Andrew R. Collins</i>    |
| 34 | Crossover Network Design                | <i>Edward M. Long</i>       |
| 70 | The Corporate Block                     | <i>Edward Tatnall Canby</i> |

## BUYERS GUIDE TO LOUDSPEAKERS

- |    |  |
|----|--|
| 38 | Directory                                  |
| 58 | Loudspeaker Q's & A's—Mainly For Beginners |

## EQUIPMENT PROFILES

- |    |                           |  |
|----|---------------------------|--|
| 60 | TEAC Integrated Amplifier | <i>Model AS-201</i>  |
| 64 | Four Stereo Headphones    | <i>Beyer DT-480, Ercona RDF-224, Sharpe 770, &amp; Telex Studio I Model W70E</i> |
| 69 | Wharfedale Speaker System |  |

## RECORD AND TAPE REVIEWS

- |    |                           |                               |
|----|---------------------------|-------------------------------|
| 75 | Classical Record Reviews  | <i>Edward Tatnall Canby</i>   |
| 78 | Canby's Capsules          | <i>Edward Tatnall Canby</i>   |
| 80 | Weingarten Looks At . . . | <i>Sherwood L. Weingarten</i> |
| 82 | Jazz & Blues              | <i>Martha Sanders Gilmore</i> |
| 85 | Tape Reviews              | <i>Bert Whyte</i>             |

## AUDIO IN GENERAL

- |   |                                       |    |                                     |
|---|---------------------------------------|----|-------------------------------------|
| 4 | Coming In April                       | 8  | What's New In Audio                 |
| 4 | Audio Clinic <i>Joseph Giovanelli</i> | 10 | Behind The Scenes <i>Bert Whyte</i> |
| 6 | Tape Guide <i>Herman Burstein</i>     | 16 | Editor's Review                     |
| 6 | \$ For Tapes                          | 87 | Classified Advertising              |
| 6 | Errata—Tone Burst Generator           | 90 | Advertising Index                   |



EDITOR *George W. Tillet*  
ASSOCIATE EDITOR *Edward Tatnall Canby*  
ASSISTANT EDITOR *Eugene Pitts*  
DESIGNER *Rowena Kendall*

PUBLISHER *Jay L. Butler*  
MARKETING DIRECTOR *Sanford L. Cahn*  
COVER DESIGN *John Kwasizur*  
SUBSCRIPTION MANAGER *Jean Davis*

ADVERTISING PRODUCTION *Sharon Mancini*

CONTRIBUTING EDITORS: *Herman Burstein, Leonard Feldman, Richard Freed, Joseph Giovanelli, C.G. McProud, H.E. Maynard, Alex Rosner, S.L. Weingarten, Bert Whyte*

AUDIO (title registered U. S. Pat. Off.) is published by North American Publishing Co., I. J. Borowsky, President; Frank Nemeyer and Roger Damio, Vice Presidents; R. Kenneth Baxter, Vice President/Production; Nate Rosenblatt, Promotion Director; Mary Claffey, Circulation Director.

SUBSCRIPTION RATES—U. S. Possessions, Canada, and Mexico, \$5.00 for one year; \$9.00 for two years; all other countries, \$8.00 per year.

Printed in U.S.A. at Columbus, Ohio. All rights reserved. Entire contents copyrighted 1972 by North American Publishing Co. Second class postage paid at Philadelphia, Pa. and additional mailing office.

REGIONAL SALES OFFICES: Jay L. Butler, Publisher, and Sanford L. Cahn, Marketing Director, 41 East 42nd St., New York, N.Y. 10017, telephone (212) 687-8924.

Jay Martin, 15010 Ventura Blvd., Sherman Oaks, Calif. 91403, telephone (213) 981-7852.

REPRESENTATIVES. United Kingdom: Overseas Newspapers (Agencies) Limited, Cromwell House, Fulwood Place, London W.C.1, telephone 01-242 0661, cables, WESNEWS, London PS4.

Continental Europe: John Ashcraft, 12 Bear St., Leicester Square, London W.C. 2, telephone 930-0525. For Benelux and Germany, W. J. M. Saunders, Mgr., Herengracht 365, Amsterdam, Holland, telephone 24.09.08.

Japan: Japan Printing News Co., Ltd., No. 13, 2 Chome Ginza Higasi, Chuo-ku, Tokyo, telephone 541-5795.

AUDIO Editorial and Publishing Offices, 134 N. 13th St. Philadelphia, Penna. 19107  
Postmaster: Send Form 3579 to the above address





**ZERO 100** Garrard's newest model, is the only automatic turntable achieving zero tracking error. Modestly priced at \$189.50, this most advanced record playing unit is a fabulous array of imaginative, responsible innovations: Variable speed control; illuminated strobe; magnetic anti-skating (an entirely new principle); viscous-damped cueing; 15° vertical tracking adjustment; the patented Synchro-Lab synchronous motor; and Garrard's exclusive two-point record support. An engineering triumph, the articulating tone arm, is demonstrated below.

## True Tangent Tracking First time in an automatic turntable!

The diagram over the photograph shows how the tone arm articulates, constantly adjusting the angle of the cartridge, and keeping the stylus perpendicularly tangent to the grooves throughout the record. Space-age pivoting and computerized design have made it possible to play the record at exactly the same angle as it was cut. Reproduction is truer, distortion sharply reduced, record life lengthened.

Consider that there are 3,600 seconds of arc in a degree—and that a conventional tone arm will produce up to 4 degrees tracking error—or 14,400 seconds at full playing radius. Compare this to the Zero 100 tracking error, calculated to measure a remarkable 90 seconds (160 times lower!) and you will see why this Garrard development obsoletes the arm geometry of every other automatic turntable.

□ Test reports by some of the industry's most respected reviewers have already appeared, expressing their enthusiasm. These reports are now available with a 12-page brochure on the Zero 100 at your dealer. Or, you can write to British Industries Company, Dept. C 12, Westbury, New York 11590.

Mfg. by Plessey Ltd. Dist. by British Industries Co.  
Check No. 2 on Reader Service Card

CARTRIDGE ANGLE ADJUSTS AS TONE ARM MOVES...KEEPS STYLUS ALWAYS TANGENT AT 90° TO GROOVES

**GARRARD  
ZERO 100**  
**\$189.50**  
(less base and cartridge)



# coming in March

- **Special Reel-To-Reel Tape Recorder Issue**
- **Buyers Guide**
- **What The Future Holds for the Tape Enthusiast**—by Herman Burstein
- **The Tape Recorder**—by H. W. Hellyer

**Equipment Reviews Include:**  
The Marantz VI Loudspeaker  
TEAC A-24 Cassette Deck

## PLUS

Record and tape reviews and all the regular features.

**About The Cover:** There are probably more wild claims made about loudspeakers than anything else—except cold cures. The only way to judge is to read the test reports and listen in your own home!

# Audioclinic

Joseph Giovanelli

## Cable Properties

*Q. While investigating cable properties for use in some long runs from preamplifier to crossovers, amplifiers, and a remote control system, I became confused at the profusion of coaxial cables and their various properties. The main properties in question are (1) impedance, (2) capacitance from conductor to shield, (3) capacitance from conductor to conductor, (4) per cent shield coverage, and, of course, (5) wire size.*

*It appears that as nominal impedance rises, capacitance per foot decreases. The question is: What are the most desirable characteristics to look for?*—Harry W. Kunz, Old Tappan, N.J.

A. The impedance of a piece of transmission line has no bearing on audio work. Cable of the type you have been examining is used for radio frequency work, where the impedance of the line becomes a factor. For your application, however, you need good shielding, reasonably low capacitance per foot, and flexibility. This latter consideration is helpful when wiring the system initially.

Fortunately for all of us, the output impedance of most equipment is quite low. We can accept, therefore, a considerable amount of capacitance per unit length of cable and still not suffer any loss of frequency response. Good shielding is important in order to minimize hum. Therefore, in those circuits where this is a problem, it is well to use a cable whose percentage of shield coverage is high.

The wire size of the inner conductor or conductors of a shielded cable becomes important where the cable is to carry large amounts of current. The applications for which you plan to obtain cable are not at all stringent as regards the amount of current the cable must carry. Therefore, the wire gauge of the inner conductor can be quite small. However, do not use the smallest possible wire diameter because it is too difficult to handle, and it can break if the cable is flexed too often. No. 20 or 22 gauge inner conductors work very well. You did say in your question that some of the cable is to be used for some kind of remote control system. This could involve current for relay control and the like. Therefore, consult wire tables to determine whether a given gauge conductor can handle the current you will use.

For all-around usefulness, use the ordinary "hi-fi" interconnecting cable.

This cable will not be suitable for microphone lines. Much of what has been said regarding shielded cable does apply to microphones. Very often, the microphones being used are high impedance. This means that high frequency losses will be greater than will occur in devices having low impedance. For this reason, microphones used for high impedance circuits should have less capacitance per foot than cables used with low impedance circuits. Another consideration is that shielded cable tends to produce noise when it is handled. This does not show up where the cable is fed from high-level sources. However, when microphones or other low-level devices are involved, the handling noise produced by some cables can produce significant output. Special cable has been developed to meet this need. Cables of this sort are specified by their manufacturers as designed for microphones and other low-level audio signal applications.

## Four-Channel Tapes from Discs

*Q. Can four-channel tapes be made by taping from two-channel turntable and two-channel discs?*—Sp/4 James G. Gunter, APO San Francisco, Calif.

A. If the discs are encoded, they can be taped in the ordinary manner, using two-channel equipment, and the tapes can be played using the decoder and be heard as a four-channel product. Of course, if the tapes or discs being copied happen to be discrete four-channel products, they must be copied on a four-channel recorder in order for the information to be received in its original form. Some recovery of the four channels of information could be obtained if you had a four-channel encoder. The four discrete channels would feed the proper inputs of the encoder, whose two outputs would be connected to a two-channel tape recorder. The tape could then be played through a decoder corresponding to the original encoding system, and you would once again have four channel output. Primary rear information would not be nearly so precisely pinpointed as it was on the discrete four-channel original tape or disc.

If you have a problem or question on audio, write to Mr. Joseph Giovanelli at AUDIO, 134 North Thirteenth Street, Philadelphia, Pa. 19107. All letters are answered. Please enclose a stamped self-addressed envelope.



# Our receivers have something you'll never hear. Our amplifiers.

Because our amplifiers don't have those circuits that can distort the sound. We took out the input transformer, the output transformer, and the output capacitor. Now the amplifier circuit is coupled directly to the speaker terminals. So you get less than 0.5% distortion. In all Panasonic FM/AM, FM stereo receivers.

We call this new system direct coupling. It improves transient response and damping. So cymbals go crash instead of pop. And a high C doesn't sound like a screech.

We offer you this more direct route in 4 different receivers. Starting with the SA-5500 and its 70 watts of music power (IHF) Plus features we put in our more expensive models. A high-filter switch. A loudness switch. Two

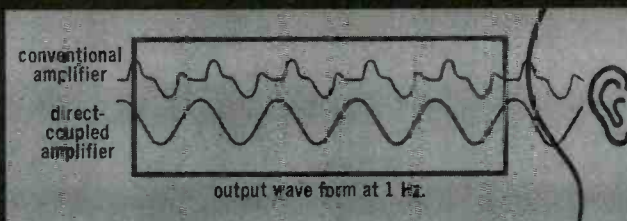

4-pole MOS FET transistors. To pull in stations you thought were out of reach. Even an FM muting switch to cut down on interstation noise. When you put all this in numbers, it means 1.8 $\mu$ V FM sensitivity and a frequency response of 20-50,000 Hz  $\pm$  1dB.

The SA-5500 also makes tuning easier with a linear-dial scale to separate FM stations. A sensitive tuning meter to measure signal strength. And dual-tone controls for custom-blended sound.

If all this isn't enough, we have models with even more features and power. You can move up to 100 watts with the SA-5800. Or

take another step up, and get 150 watts of power on the SA-6200.

But if you want the most, there's the SA-6500. It has 200 watts of power. Plus features that the leading receivers in this price range can't match. Like a power bandwidth of 5-60,000 Hz. A crystal filter in the FM IF Amp. A Lumina-Band dial that lights up. Two 4-pole MOS FET transistors. And, of course, direct coupling. Besides all that, the SA-6500 gives you a low-filter control. Two tuning meters. And linear-sliding controls for bass, treble, volume and balance.

You can hear all our receivers at your franchised Panasonic Hi-Fi dealer. But it's not just what you hear that counts, it's what you don't hear.



SA-5500



SA-6200



SA-5800



SA-6500

**Panasonic**  
just slightly ahead of our time.

200 Park Ave., N.Y. 10017. For your nearest franchised Panasonic Hi-Fi dealer, call 800 631-1971. In N.J., 800 962-2803. We pay for the call.

Check No. 5 on Reader Service Card

www.panasonic.com



## Sound-On-Sound

*Q. Can you please tell me if one can record four separate things with a tape machine that features sound-on-sound?—Barry Edelson, Brooklyn, N.Y.*

A. If the tape machine truly contains provision for sound-on-sound, you can superimpose any number of recordings over each other. However, with each successive recording the noise level goes up. Hence as a practical matter about three or four sound "layers" are about the limit for high quality recording. By true sound-on-sound I mean the following: As you play a given track, say track 1, you can record the track 1 sound in synchronization with a fresh sound source onto a second track, namely track 3. Then as you play track 3 you can combine this with a fresh sound source onto track 1. Etc.

## Cross-Field Biasing

*Q. Limited dynamic range is one of the significant disadvantages of tape recording today. The cross-field biasing technique is claimed to improve the S/N ratio, which is a measure of dynamic range, by about 6 db. Specifications of one of the original tape recorders (Roberts) incorporating cross-field biasing indicate S/N of only 45 db in comparison with 50-54 db claimed by several medium-quality machines relying on the conventional biasing technique. If these figures mean anything, can you explain the discrepancy?—S. V. Desai, Kalamazoo, Mich.*

A. The discrepancy in S/N claims probably arises in the reference recording level. For home tape recorders the reference level most popularly used is one that causes about 3% harmonic distortion at 400 Hz. Sometimes, however, the reference level is one that causes about 1% harmonic distortion. The difference between the two levels is about 6 to 8 db. And this would pretty much explain the difference in the S/N figures you cite.

Keep in mind that the cross-field technique, according to claims, permits

## Errata

Tone Burst Generator, Pt. III

Figures 1, 2 and 3 were inadvertently printed up-side down. The last sentence in the caption for Fig. 7 should have referred to the d.c. zero line as being the second from the bottom.

a given amount of bias to be applied to the tape with less treble loss than would otherwise occur; or permits more bias to be applied than otherwise, resulting in the same treble loss but less distortion. Thus the cross-field technique permits an extension of treble, or a reduction in distortion (which in turn makes possible higher S/N), or a combination of the two. In the case of the Roberts, the manufacturer may have been going entirely for an extension of treble, with no improvement in S/N.

## Reel vs. Cassette

*Q. Is the pre-recorded reel-to-reel tape being phased out of production? With the advent of the cartridge and cassette machines, will the catalog of reel-to-reel prerecorded tapes dwindle, or may we lovers of pre-recorded tapes still hold out hope?—Thomas J. Schuyt, South Deerfield, Mass.*

A. I doubt that reel-to-reel prerecorded tape is being phased out. Though the quality difference between reel-to-reel and cassette (or cartridge) has narrowed, hopefully there are too many persons enamored of the reel for the market to evaporate.

## Using VU Meters

*Q. The following two questions have been puzzling me: (1) The VU meters in many tape recorders read the incoming signal instead of the one off the tape, and therefore read the same for all tapes. If the meters read the same for all tapes, how do you find the overload point for each type of tape? (2) Using VU meters to set initial channel balance while recording from a stereo source can be uncertain because you're*

*never really sure that the signal from both channels is of identical volume. Is there anything that could be built or bought which would temporarily mix the signal from both channels so that a proper balance could be achieved?—John Vader, Montreal, Quebec, Canada*

A. (1) Recording level should be adjusted on the basis of the amount of distortion produced on the tape. Typically the VU meter is set to read 0 VU when a 400 Hz signal produces 1% harmonic distortion on the tape, as measured in playback. The recording level that results in 1% distortion varies somewhat with the brand and kind of tape. Thus the VU meter should be adjusted on the basis of the particular tape that is to be used. I should add that the meter is adjusted after the bias has been adjusted for the particular tape used. (2) Most audio amplifiers, from which you obtain the signal to be recorded, contain facilities for mixing the left and right signals, or for feeding one of these signals into both the left and right tape outputs.

## Cassettes and Hiss

*Q. How should I store my cassettes? Is print-through noticeable in cassettes; what can I do to prevent it? Is there any way to get rid of tape hiss?—Robert Simon, Flushing, N.Y.*

A. Store your cassettes at room temperature. Store them end up (not flat). Keep them away from electromagnetic fields, such as generated by motors, transformers, and the like. You can minimize print-through by not recording at excessively high levels and by rewinding the tape prior to playing it; also by storing it tail-out, that is, with the last part of the recording at the outside (so you have to rewind the tape prior to playing it). Tape hiss depends on quality of the tape machine and on the speed at which it operates: more audible hiss at slower speeds. Hiss also depends on the tape used, with low-noise tape giving improved results. Recording at too low a level exaggerates hiss in relative terms.

## \$ For Tapes \$

Many readers must have tapes which they are particularly proud of. AUDIO will pay \$50.00 for the best tape of the month—cassette or reel-to-reel. They will be judged on technical excellence and content. Selected tapes can be processed and marketed—if the owner wishes. Who knows, that old tape may make you a fortune! Please mark your entries TAPE COMP. and send them to AUDIO, 134 No. 13th St., Philadelphia, Pa. 19107.

If you have a problem or question on tape recording, write to Mr. Herman Burstein at AUDIO, 134 North Thirteenth Street, Philadelphia, Pa. 19107. All letters are answered. Please enclose a stamped, self-addressed envelope.

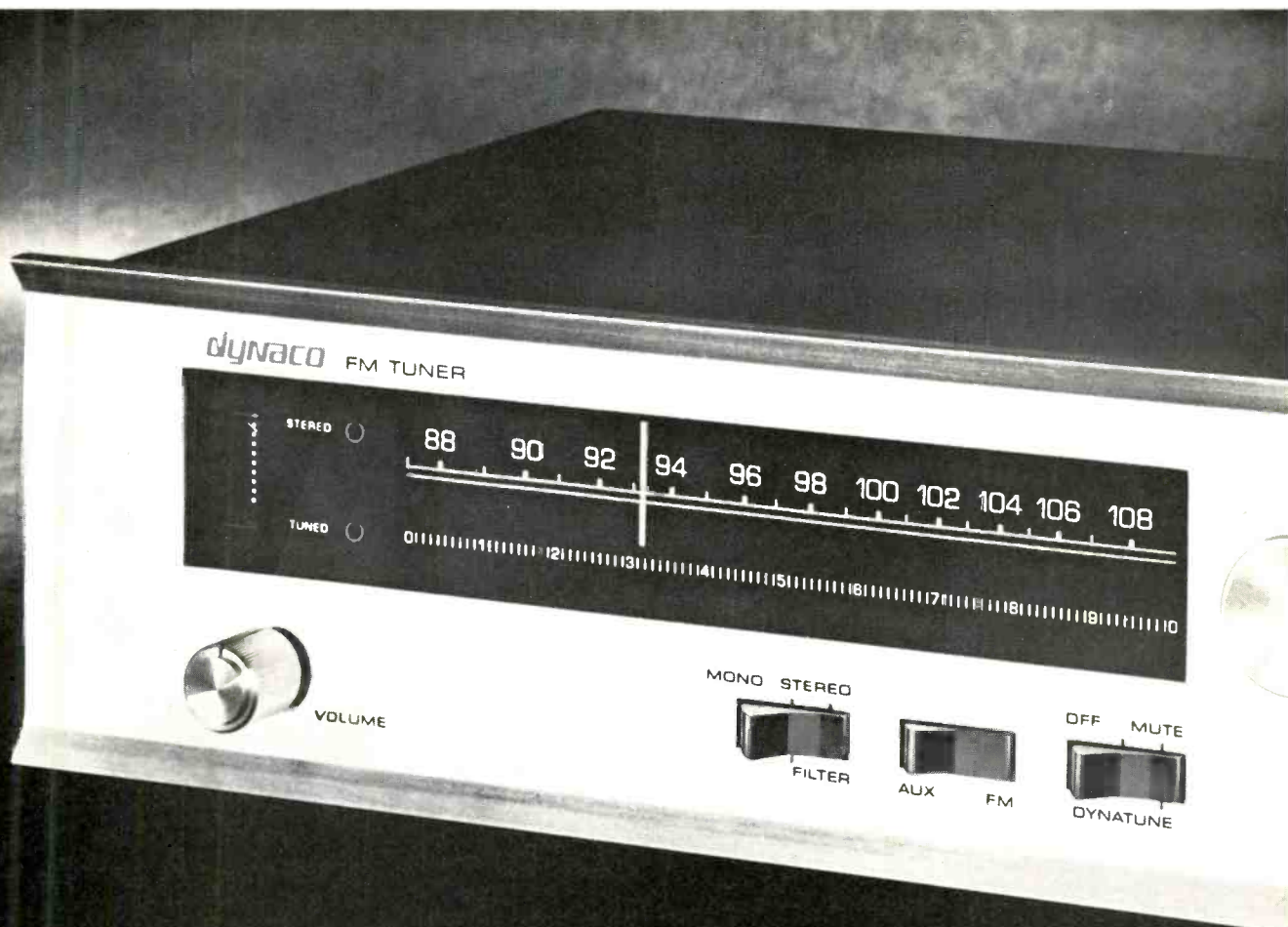

# dynaco fm-5 tuner kit

Excellence—the FM stereo tuner you'd expect from Dynaco. Traditional value is evident in unsurpassed performance, consummate operating ease, unparalleled versatility, easiest kit construction at modest cost.

Ideal tuner operation is achieved for the first time: Every station in **exact** tune for lowest distortion, or just absolute silence. Automatically, the DYNATUNE logic circuit zeros in on the precise center of channel more accurately than any other tuner. Off station, you are treated to the smoothest, quietest, most sophisticated muting circuit extant. High sensitivity ( $1.75 \mu\text{v}$ ) plus exceptional phase integrity and lowest distortion in all signal modes, provides superior 4-Dimensional stereo reception. See and hear it at your Dynaco dealer.

\$149.95 k.t.; \$249.95 assembled

**DYNACO INC.** 3060 Jefferson Street, Philadelphia, Pa. 19121



# What's New in Audio

## An infinite choice of speeds.

The variable control Lenco manual turntables offer an infinite selection of speed—a continuous sweep from 30 to 86 rpm. At the standard 16-2/3, 33-1/3, 45 or 78.26 rpm, there are click stops that can be precisely set or adjusted at any time.

With this, you can slow down a complex rush of notes, the better to appreciate the inner voices when you listen next at normal speeds. You can tune a recorded orchestra to match the instrument you play, and join in. Your tuning is not restricted to a paltry fraction of a note, either. You can exercise your urge to conduct, choosing whatever tempo suits you. And you can use it to extend your knowledge of the dance or language, or to accompany your slide or movie shows.

And at every one of these speeds, Swiss precision takes over. For example, the Lenco L-75's sleekly polished transcription tonearm shares many design concepts (such as gravity-controlled anti-skating, hydraulic cueing, and precision, knife-edge bearings) with arms costing more alone than the entire L-75 arm and turntable unit. And the dynamically balanced 8.8 lb. turntable reduces rumble, wow and flutter to inaudibility.



The L-75 complete with handsome walnut base at \$99.50 offers professional quality and versatility but at far less than studio-equipment prices. The B55 (lighter platter and an arm of almost equal specification) is only \$85.00 with base. Both are available now at your Benjamin/Lenco dealer. Benjamin Electronic Sound Corporation, Farmingdale, N.Y. 11735, a division of Instrument Systems Corporation.

## Lenco turntables from Benjamin

Prices subject to change without notice.

Check No. 8 on Reader Service Card

### Maxell recording tape

A wide variety of tape is available, from low-noise cassette tapes, for normal or high bias, standard reel-to-reel tapes, to low noise reel-to-reel tapes, high energy-high bias reel-to-reel tapes, and blank 8-track cartridge tapes. All are available in various recording lengths, and the reel-to-reel tapes come in four thicknesses.

Check No. 6 on Reader Service Card



### BGW 1000 power amplifier

Power output of this basic amp is specified at 200 watts continuous per channel into 8 ohms. Other specifications are better than 100 dB hum and noise into 8 ohms, less than 0.2% harmonic distortion from 20 to 20,000 Hz at 200 watts per channel, and +0 -0.5 dB power response from 20 to 20,000 Hz at 200 watts per channel. Rated damping factor is greater than 500 at 8 ohms. Price: \$1200.00

Check No. 10 on Reader Service Card



### Clark Red Baron headphones

With a specified frequency response of 20 to 17,000 Hz, these headphones have brilliant red domes and are supplied with Maltese Cross decals. Impedance is 8 ohms. The 10-ft. coiled cord has a molded-on plug. Price: \$21.00.

Check No. 48 on Reader Service Card



### Advent 100A noise reduction unit

This unit incorporates two pairs of Dolby system circuits, one for making tape recordings, and the other for decoding Dolby-processed tapes and FM broadcasts. Individual level controls are used for the two mixable pairs of high level inputs, with no interaction between any of the inputs or their level controls. A master record level control is also provided. An accessory stereo microphone preamp, the MPR-1, allows the use of two low-impedance balanced (as well as unbalanced) mics, providing either 40 or 60 dB of gain. Price: Model 100A, \$260.00; Model MPR-1, \$25.00.

Check No. 20 on Reader Service Card

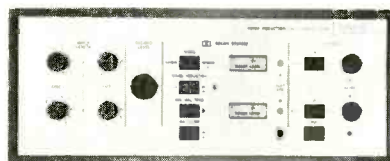



# All cartridges are different. Empire cartridges are more different than others! Take a technical look for yourself.

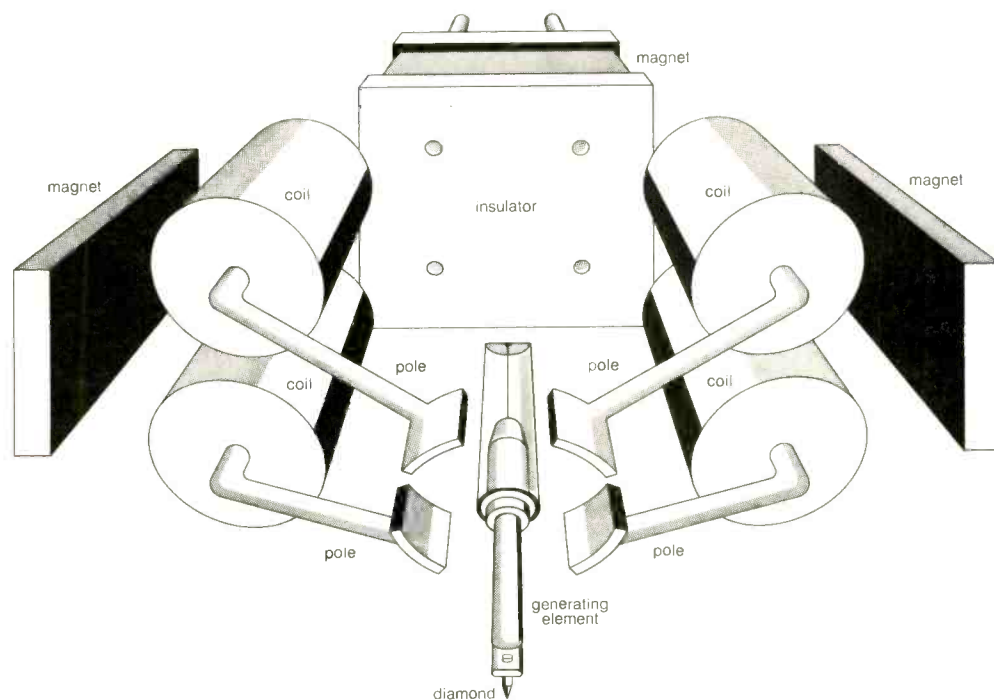

## How it works.

If you know how moving magnetic cartridges are made, you can see right away how different an Empire variable reluctance cartridge is. With others, a magnet is attached directly to the stylus, so that all the extra weight rests on your record. With Empire's construction (unique of its type), the stylus floats free of its three magnets. So naturally, it imposes much less weight on the record surface.

## Less record wear.

Empire's light-weight tracking ability means less wear on the stylus, and less wear on your records. Laboratory measurements

show that an Empire cartridge can give as much as 50 times the number of plays you'd get from an ordinary cartridge without any measurable record wear! HI-FI SOUND MAGAZINE summed it up very well by calling the Empire cartridge "a real hi-fi masterpiece . . . A remarkable cartridge unlikely to wear out discs any more rapidly than a feather held lightly against the spinning groove."

## Superb performance.

The light-weight Empire cartridge picks up the sound from the record groove with amazing accuracy. Distortion is minimal. (None at all could be measured at normal sound levels with Empire's

1000ZE/X and 999VE/X.) AUDIO MAGAZINE said of the Empire cartridge "outstanding square waves . . . tops in separation." HIGH FIDELITY noted ". . . the sound is superb. The performance data is among the very best." While STEREO REVIEW, who tested 13 different cartridges, rated the Empire tops of all in light-weight tracking.

X Designates newest improved version.

World Famous Long Playing Cartridges

**empire**



For further details write:  
 Empire Scientific Corp.,  
 Garden City, N.Y. 11530. Mfd. USA  
 Check No. 9 on Reader Service Card

# Behind The Scenes

Bert Whyte

**D**URING 1971 a considerable number of cassette tape machine manufacturers adopted the Dolby System. The year ended with the giant Sony Corp. becoming a Dolby licensee. In January of this year, Panasonic and JVC concluded licensing arrangements with Dolby Laboratories, and their signing means that virtually every major cassette machine manufacturer in Japan will be producing Dolbyized equipment. As predicted in these pages months ago, the Dolby System is well on the way to becoming an "industry standard."

With Advent/Wollensak in this country and most of the European manufacturers already in the Dolby fold, the lone *major* holdout is, ironically, the originators of the cassette concept, the great Phillips Corp. In the face of the overwhelming acceptance of the Dolby System, it would not be too surprising if sometime before this year is out, Phillips decides to sign with Dolby.

The importance of all this for us music lovers is, of course, the proliferation of Dolbyized cassette equipment on such a large scale that the other major record companies will join Columbia and London/Decca in issuing Dolby "stretched" recorded cassettes. I can tell you that a major *American* record company has already been running tests with the Dolby product on their high speed duping equipment, and there is every reason to expect commercial production within the next few months. If all the record companies begin producing Dolbyized cassettes, it is going to help improve the overall quality of this format. Their concerted engineering efforts should be able to correct such annoyances as modulation noise and dropouts, which occurs with exasperating frequency in present recorded cassette production. I think it's fairly safe to predict that by this time next year, we will have Dolbyized cassettes from most of the major record companies with an overall high level of quality that should win new converts to this format.

Okay, so the Dolby cassette situation is well in hand. Now how about what is near and dear to my heart and that of a great number of audiophiles . . . Dolbyized open reel tapes? I have received quite a few letters from readers who query why I have not championed this cause. Sorry friends, but if you will just peel your eyeballs a bit sharper you will find that I have commented on

this situation a number of times over the past two years.

The fact is that I have made many overtures to Ampex to initiate the release of Dolbyized open reel tapes. With all due respect to the cassette advocates, I feel that the open reel tape enthusiast has always been the foremost proponent of high quality audio. For years he has lived with a format which has been condemned as "clumsy" (mostly by fumble-fingered nervous nits who don't deserve such good quality in the first place) and he has paid a premium price for his music on tape. The open reel people have put up with these inconveniences for all the good qualities of the format. But the one cross all open reel advocates have had to bear in mutual misery, and the prime reason for the lack of open reel tape growth, is the ever-present, pernicious bug-a-boo of tape hiss. Open reel tape processing by Ampex has reached a consistently high level of quality except for the tape hiss. It is extremely rare to encounter any modulation noise or dropouts, and even print-through and crosstalk are either greatly attenuated and infrequent or absent altogether. By Ampex's own estimate, there are over ten million open reel recorders in use in this country and the recent success of their open reel tape-by-mail program has shown them this market is far from dead. I have talked to hundreds of open reel enthusiasts in hi-fi salesrooms and at hi-fi shows, who are unanimous in their plea for B Type Dolby tapes. If Ampex will issue these tapes, I guarantee they will be astonished by the vitality and size of the open reel market.

All it takes on the part of Ampex Stereo Tapes to establish a renaissance of the open reel market is an executive decision to produce B Type Dolby recorded tapes. They have the Dolby A Type units to playback their Dolby A copies of the master tape furnished by the record companies they have under contract (which is sonically equivalent to the master tape itself). They have the Model 320 Dolby B Type processor. They have everything they need to produce Dolby open reel tapes, and it won't cost them a nickel. Perhaps the reason they have not taken this step is that they feel it would not be economically feasible to produce a special run of Dolbyized tapes in addition to regular production. The obvious way around this of course would be to Dolbyize all the tapes, in the same

fashion Columbia is doing with its cassettes. Perhaps they have the fear that if they did this, consumers not equipped with Dolby equipment would have an "incompatible" product. No more so than obtains with the cassette, and probably the same procedure of treble attenuation would work as well in this case, as it does with the cassette.

I know my audiophile open reel enthusiasts. For the boon of a Dolbyized tape, they would gladly pay a dollar or dollar and a half more than the regular price. This should be more than enough for Ampex to justify a special Dolby production run. I suggest too, that Ampex issue at least initially, Dolby B Type recorded tapes made only from Dolby A masters. London/Decca has been recording Dolby A masters since 1966, there are plenty of Vanguard Dolby A masters, and now that Deutsche Grammophon has Dolby A equipment (all the DGG Boston Symphony recordings are Dolby) there is no dearth of Dolby A masters. I further suggest that tape speed remain at 7½ ips. The open reel enthusiast generally has fairly high quality amplifiers and speakers and if he is going to pay extra for his Dolby tapes, he doesn't want to compromise in any way. He doesn't want the Dolby System to be used as a crutch for 3¾ ips!

Now friends, if we want to convince dear old Ampex that "thar's gold in them Dolby open reel tapes," don't write to me, write to Mr. Don Hall, Vice-President and General Manager of the Ampex Music Division, 2201 Lunt Avenue, Elk Grove Village, Illinois 60007. Tell him your desires, tell him if you have to pay extra for Dolbyized open reel tapes, you're willing to make this sacrifice.

\* \* \*

On the four-channel stereo front, Peter Scheiber, the matrixing pioneer, has been issued U.S. Patent 3,632,886 covering his encoding and decoding matrixing techniques. As you are probably aware, Peter is now associated with Electro-Voice which announced it feels the patent is "basic and will cover all current or announced matrixing systems." That this will further complicate the already snarled situation in four-channel stereo matrixing vis-à-vis the competing systems of Electro-Voice, Sansui and Columbia SQ, is to put it mildly. Well, whoever comes up a winner, there is a situation developing which will require some positive action. No one argues that classical music now



# 7 arguments in favor of building your own speaker system from scratch.

The easiest way to buy high fidelity speakers may not always be the best. Because a complete pre-packaged system may be far from what you need. Consider some of the advantages of separate component loudspeakers:

1. You choose from an almost infinite variety of sizes and levels of performance. Your system will exactly reflect your specific listening preferences.
2. You save space by building speakers into walls, ceilings, closet doors, even in floors! Or use existing cabinets or custom-built enclosures that better suit your decor than any mass-produced system.
3. You enhance the illusion of "live" music by hiding or disguising the sound source. You listen to the music — not the speakers.
4. You end the conflict between fine sound and handsome decor by making the speaker system an integral part of the room or the furniture.
5. You save money by paying only for performance.
6. You can up-date your component system as often as you wish to meet advances in the state of the art.
7. You can use the building-block method of planned improvement as your budget permits. There's no problem of

being "stuck" with a compact that fits today's budget but can't meet your ultimate listening goals.

Take a few minutes to study the variety of Electro-Voice component speakers. 21 models from \$22.00 to \$290.00. From super-tweeters to giant 30" woofers. Consider how they can aid in creating a speaker system that uniquely expresses your musical needs. And ask your Electro-Voice high fidelity specialist for his recommendation. Finally, take the time to listen carefully.

Freedom of choice. It's at the nub of high fidelity.

ELECTRO-VOICE, INC., Dept. 324A,  
602 Cecil Street, Buchanan, Michigan 49107

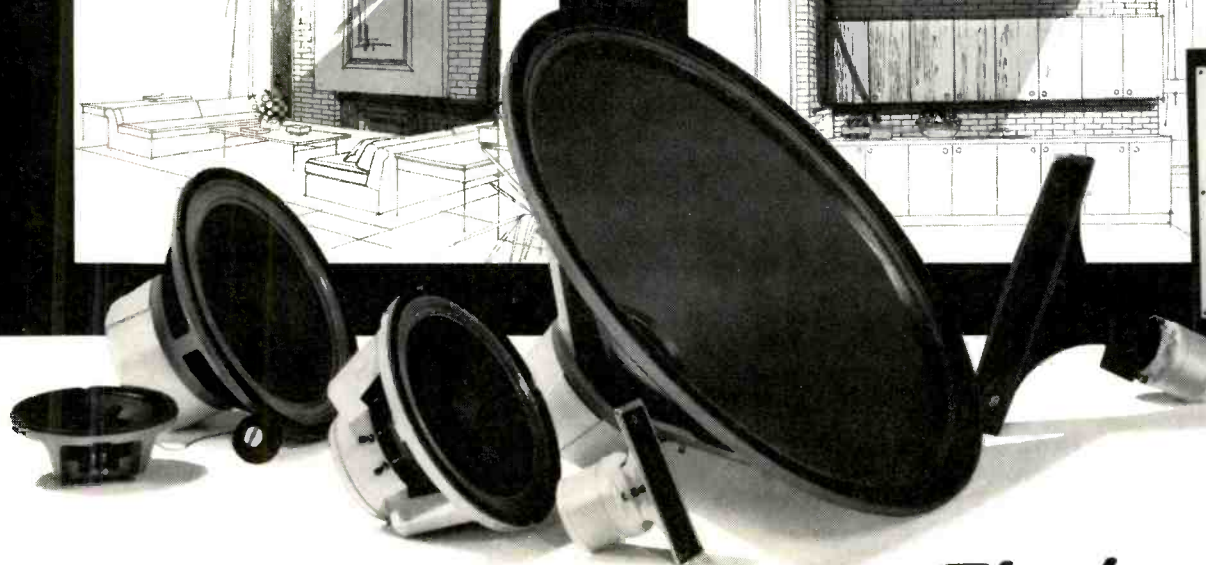
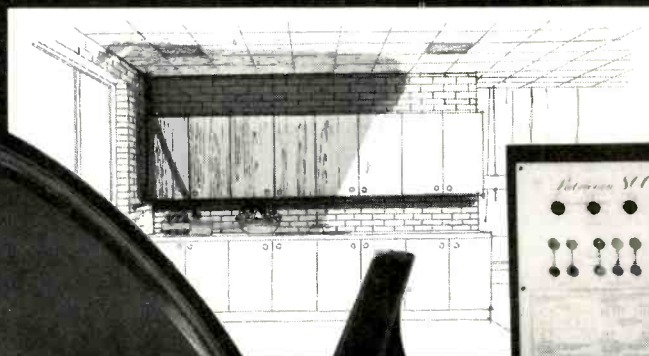
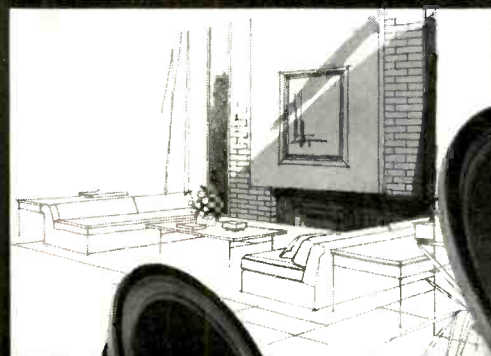
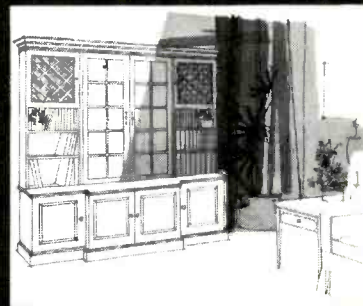
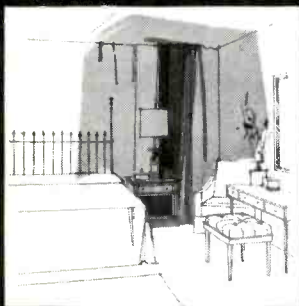
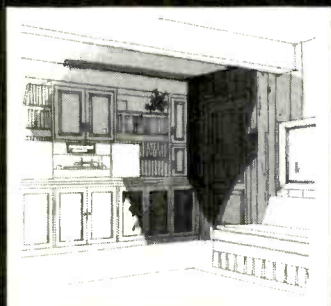

**Electro-Voice**<sup>®</sup>

a GULTON subsidiary

Check No. 11 on Reader Service Card



# The Stradivarius of Speakers? MARTIN

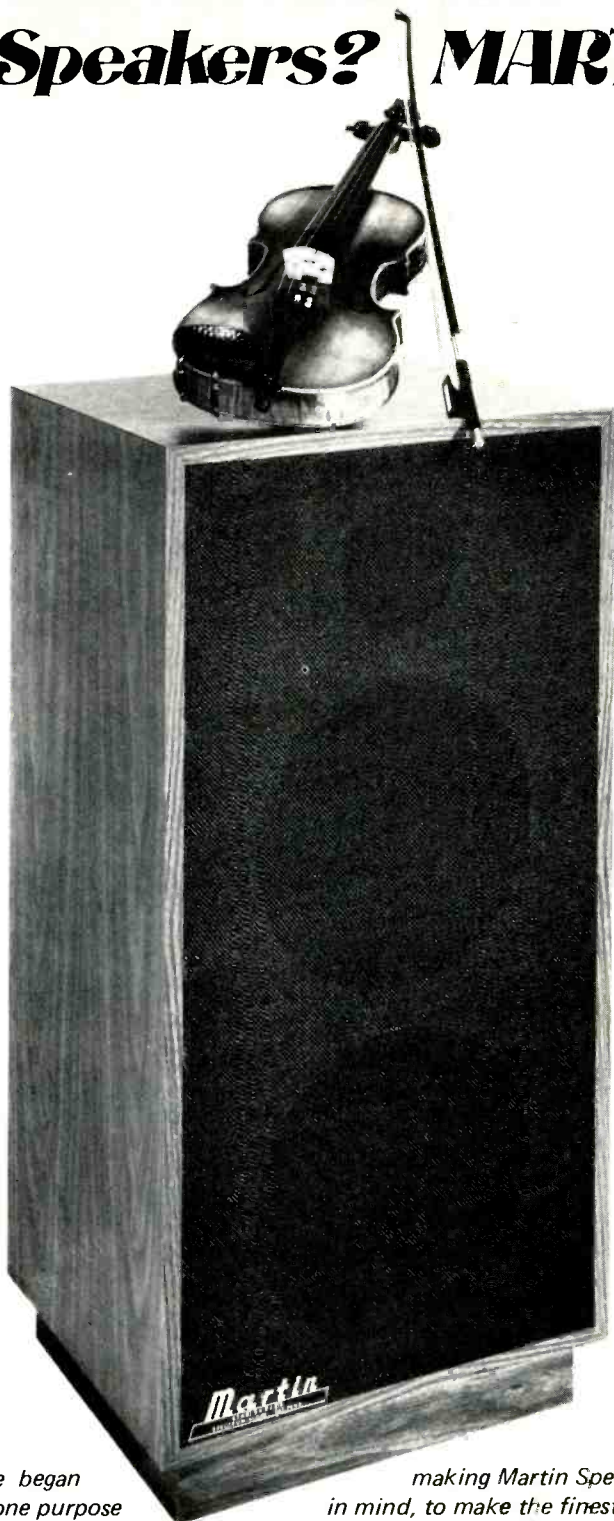

*When we began making Martin Speakers we had but one purpose in mind, to make the finest speaker in the world. To this day each speaker system is designed on the most advanced equipment available, and then, like the Stradivarius, hand tuned and calibrated for maximum performance. We believe Martin speakers are unexcelled anywhere in the world.*

*Is Martin the Stradivarius of speakers? Go to your favorite Hi-Fi dealer today and judge for yourself.*

Martin Speaker systems from \$44.50 to \$350.00

**MARTIN**

*a new standard of performance built by people who listen.*

Martin Speakers by Eastman Sound / 126 Gill Ave. / Paulsboro, New Jersey.

Check No. 12 on Reader Service Card

is a mere 5 percent of the record market. Sad, but true! Nevertheless, even this minuscule portion is going to want their favorite classics in the four-channel stereo format. The kicker is that there aren't very many discrete four-channel masters available. Vanguard, of course, has the original recordings which started this whole four-channel ball rolling. Columbia has some, RCA perhaps a half dozen, the only London/Decca recording I'm positive of is the Mahler 8th Symphony, and the Deutsche Grammophon/Boston Symphony recordings are all four-channel stereo recordings. The situation is further complicated by the sheer economics of the recordings, especially in this country. We are not going to be able to indulge in the same practices as obtained in the transition from monophonic to stereo. In those balmy days, the recording companies gradually re-recorded all the important repertoire in stereo. Today, even a work as basic as the Beethoven 5th Symphony can cost more than \$25,000.00 to record. The thought of just recording the nine Beethoven, four Brahms and six Tchaikovsky symphonies is enough to give a company fits. You can be sure that a work is not going to be recorded specifically for four-channel stereo. It will have to be something the company is going to record to fill a need in the normal stereo market, with the four-channel picked up as a "bonus." Of course, the situation will gradually improve as quadraphonic sound becomes established in Europe, and the recording companies will record four-channel stereo as a normal function.

In this country, the only recourse would seem to be to utilize the Eargle process, or something like it. In this manner, all of the thousands of classical recordings in the vaults of the recording companies would be available for conversion to quadraphonic. The Eargle process was described by me in the April, 1971 issue of AUDIO. My friend Bill Putnam of United Recording Co. in Hollywood has recently listened to some Eargle four-channel stereo and is so enthusiastic about its possibilities that he is contemplating adding an Eargle processing facility to his studio. What with Bill manufacturing the Cooper delay tube, this frees him from the use of the 80 ips tape speed delay used in the original Eargle process and presumably affords more flexibility. With a crackerjack engineer like Bill Putnam in charge, and with John Eargle available for consultation just a few miles away at his Altec office in Anaheim, this may someday be an important source of quadraphonic recordings. We will watch this with keen interest. **Æ**

# People who listen to records for a living are the best ones to ask about turntables.

Most people who decide they want components turn to a friend who knows something about components. And if the friend happens to be someone who reviews recordings, that's even better.

Record reviewers must select their equipment with great care, since they must listen with great care. To such things as the interpretation of the artist. To the recording and microphone techniques. And to the quality of the record surface itself.

All this is why the professional listeners select their turntables so carefully.

## What most serious listeners know.

Professional listeners know that what they hear (or don't hear) often depends on the turntable.

After all, the turntable is the one component that actually handles records, spinning them on a platter and tracking their impressionable grooves with the unyielding hardness of a diamond. And the professional realizes that much depends on how well all this is done.

Which is why most record reviewers listen to their records on a Dual.

They know that a record on a Dual will rotate at precisely the right speed, to give precisely the right pitch. (If a record happens to be off-pitch, a Dual can compensate for it.)

They know that a Dual tonearm will let the most sensitive stylus track the wildest curves ever impressed on a record groove, and not leave a trace of its passage.

And they know that a Dual will perform smoothly, quietly and reliably

year after year after year. Despite all the precision built into a Dual, they know it's one turntable that doesn't have to be handled with undue concern. (Even if the tonearm is locked when play is started, or if the tonearm is restrained in mid-air while cycling, no damage will result.)

## If you'd like to know more.

A few examples of Dual precision engineering are shown in the illustration at the right. But if you would like to know what several independent test labs say about Dual, we'll send you complete reprints of their reports. Plus a reprint of an article from a leading music magazine that tells you what to look for in record playing equipment.

Better yet, just visit your franchised United Audio dealer and ask for a demonstration.

You'll find Dual automatic turntables priced from \$99.50 to \$175.00, including our new Integrated Module, complete with base, dust cover and magnetic cartridge at \$119.50.

These may seem expensive at first, but not when you consider your present and future investment in records. And now that you know what the professional listeners know, doesn't it make sense to own what they own?

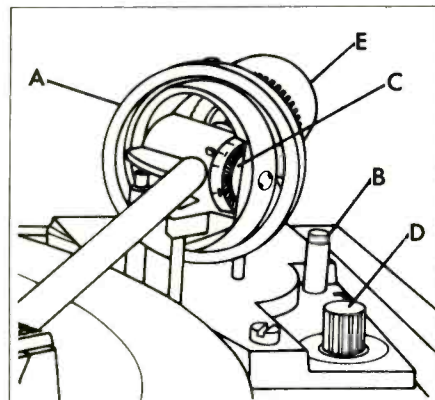

Typical examples of Dual precision that preserves and brings out the best in stereo records. A) Twin-ring gimbal suspension that lets tonearm pivot like a gyroscope for total freedom and perfect balance in tracking. B) Special control that lets stylus track at perfect angle in single play and at center of stack in multiple play. C) Tracking force is applied at pivot, maintaining perfect dynamic balance of tonearm. D) Separate anti-skating calibrations for elliptical and conical styli are provided, as each type skates differently. E) Tonearm counterbalance is elastically damped and has vernier adjustment with click-stops for convenience in changing cartridges.



Dual 1215, \$99.50

Dual CS16, \$119.50  
with base, cover,  
cartridge

Dual 1219, \$175.00

Dual 1218, \$139.50

United Audio Products, Inc., 120 So. Columbus Ave., Mt. Vernon, N.Y. 10553.

Exclusive U.S. Distribution Agency for Dual.

Check No. 13 on Reader Service Card



# Quadraphonic News

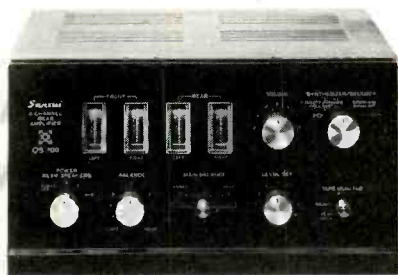

**I**N OUR OCTOBER ISSUE, we described all the important matrix systems at some length, and after making a plea for standardization, we said that all the systems were compatible to some extent. In other words, records made with system A could be played with decoder B or C, but localization would not be exactly as recorded. Furthermore, a *surround sound* of some kind could be produced from two-channel or even monophonic sources. Since then much has happened: E-V decided to modify their decoder to play SQ records (a step in the right direction!); another system, the Cooper-Denon UMX, entered the arena (square?), and more records have become available. One of the records, a pair of discs in fact, has proved invaluable in assessing the merits of the competing systems. As mentioned in the last issue, they

were made by Bill Putnam of the United Recording Corp. and four systems were used—the Sansui, CBS SQ, the new E-V compatible, and the UMX. On the discs are localizer tone burst signals, the Chowning<sup>1</sup> “Moving Sound Sources,” and four musical selections played by Stan Kenton. Instrumental positioning charts are given, together with ambient delay times, microphone bearing angles, and calibration charts. As an example of the meticulous way in which the data has been prepared, there is even a correction chart giving bearing errors due to the small changes caused by the Dolby system in recording the tone burst signals where there is a level difference of more than 6 dB!

Eventually, four decoders were lined up for evaluation. No actual measurements were taken initially; the systems were compared by A-B, or rather A-B-

C-D, listening tests using a fairly typical room of about 16 by 15 ft. and four wide-dispersion speaker systems (ADC 303AX's). Compatibility was checked and mono and two-channel records were also used. Here are the results. First, all systems worked well when used with their respective records, separation varied somewhat depending on whether the designer increased front separation at the expense of front/rear (or vice versa), but it was not possible to say any one system is superior *on all counts*. And, of course, all produced a pleasing surround sound from mono or two-channel sources. How about compatibility—what do the differences really amount to? The findings are shown in the chart.

The UMX system is like the original Scheiber arrangement in that it is symmetrical as regards amplitude but it also has *phase symmetry*. Phase is distributed at the rate of 0.5 degree of phase per degree of azimuth<sup>2</sup> to make it proportional to the difference between source and speaker azimuths. A 180 degree polarity reversal gives a greater apparent separation but Professor Cooper claims, with some reason, that it also tends to move the image away from its proper position. Incidentally, UMX means Uniform MatriX—so now you know!

## Conclusions

The four systems are reasonably compatible, and it's probable that under domestic conditions small differences will be masked by room acoustics, position of the listener, and possibly loudspeaker dispersion characteristics. The lack of rear channel directivity noted with the older E-V decoder is of

1—AES preprint 726, “The Simulation of Moving Sound Sources,” John Chowning, Stanford Univ.

2—Paper presented at the 41st AES convention.

(Continued on page 79)

TABLE I: Compatibility of the Various Decoders

Decoder	Records	Results
CBS SQ (Sony)	Sansui	Front separation good, rear poor. Rear image tended to appear between the loudspeakers.
	UMX	Similar to SQ
	E-V (new)	Similar to SQ
UMX	CBS	Front separation good, rear image displaced slightly.
	Sansui	Front separation good, reduced separation at rear.
	E-V (new)	Front and rear separation fairly good; rear image displaced slightly.
Sansui	CBS	Front and rear separation fairly good.
	E-V (new)	Separation fairly good; high right-front to left-rear and left-front to right-rear.
E-V (old)	UMX	Front and rear separation fairly good.
	CBS	Front separation good, rear confused.
	Sansui	Front separation fair, rear poor.
	UMX	Front separation fair, rear poor.
	E-V (new)	Front separation good, rear confused.



# if you go for four channel...

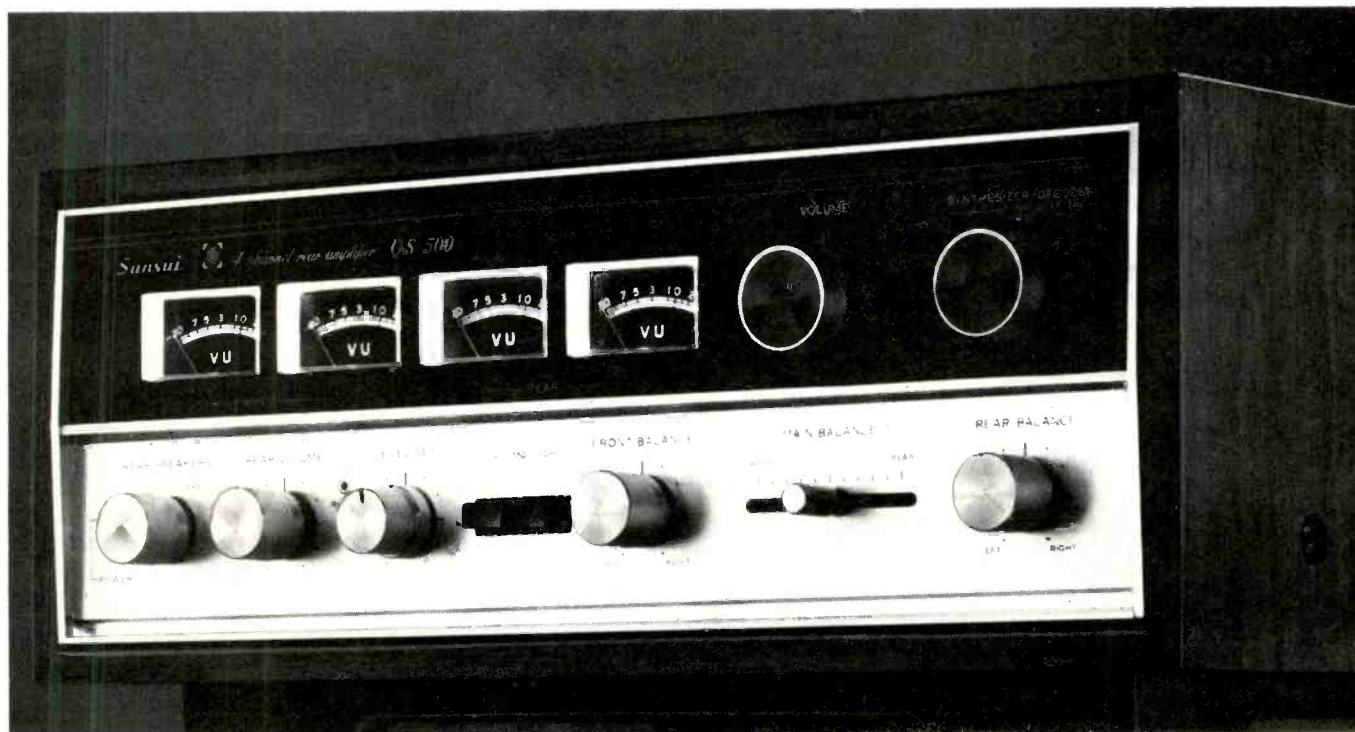

## you don't have to go for broke

Buy yourself a miracle for as little as \$214.95. That's all it takes to get your conventional two-channel stereo to do anything any total four-channel receiver and control center can do, now or in the future.

The Sansui QS500 and QS100 converters are complete Four-Channel Synthesizer-Decoder-Rear-Amplifier-and-Control-Center combinations that transform standard two-channel stereo totally. The only other equipment you need is another pair of speakers.

You can decode any compatibly matrixed four-channel broadcasts or recordings and reproduce them in four authentic channels. You can detect the ambient signals present in most two-channel recordings or broadcasts and propagate them through the rear channels. In Sansui matrixing, the exclusive phase-shift technique prevents the cancellation of some signals and the change in location of others that occur in many matrixing systems. And the exclusive phase modulators restore the effect of the live sound field.

You can plug in a four-channel reel-to-reel or cartridge deck or any other discrete source. In the future — if you should have to — you can add any adaptor, decoder or what-have-you for any four-channel system for disc or broadcast that anyone's even hinted at. And a full complement of streamlined controls lets you select any function or make any adjustment quickly and positively.

The QS500 features three balance controls for front-rear and left-right, separate positions for decoding and synthesizing, two-channel and four-channel tape monitors, electrical rotation of speaker output, alternate-pair speaker selection, and four VU meters. Total IHF power for the rear speakers is 120 watts (continuous power per channel is 40 watts at 4 ohms, 33 watts at 8 ohms), with TH or IM distortion below 0.5% over a power bandwidth of 20 to 40,000 Hz. In its own walnut cabinet, the QS500 sells for \$289.95.

An alternate four-channel miracle-maker is the modest but well-endowed QS100, with total IHF music power of 50 watts (continuous power per channel of 18 watts at 4 ohms and 15 watts at 8 ohms). In a walnut cabinet, it sells for \$214.95.

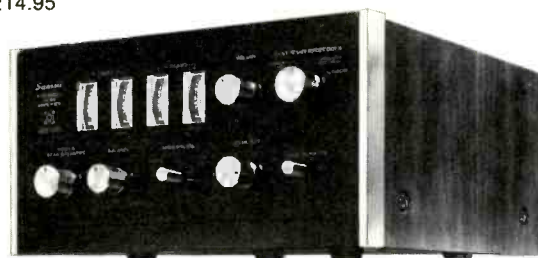

**SANSUI ELECTRONICS CORP.**

Woodside, New York 11377 • Gardena, California 90274  
SANSUI ELECTRIC CO., LTD., Tokyo, Japan • Sansui Audio Europe S. A., Antwerp, Belgium

Check No. 16 on Reader Service Card

© COPYRIGHT BY SANSUI

**L** OUDSPEAKERS used to be considered the weak link in the chain and although they have improved tremendously during the past few years, so have amplifiers, receivers, and the "other links." We must concede that loudspeakers still leave a lot to be desired but whether they are worse than most of the program sources is a moot point. For instance, here in Philadelphia, I can receive about 20 or 30 FM stations but only one or two really qualify as high fidelity. And direct, live transmissions, common in Europe, are almost unknown. Moreover, the percentage of top-quality records and tapes is not that great either. But, I digress . . . Let us *return to our muttons*, as the French say with remarkable logic. On page 39 to 56 will be found a directory of loudspeakers listing over 275 models. Observant readers will note that there are many new ones not included in the September directory—these are easy to spot as they are marked with a dagger (†). It was the original intention to only list these new models, but after some thought it was decided to have as complete a directory as possible, as this would facilitate comparisons and so on. I hope you like it.

\* \* \*

Much nonsense is still talked about loudspeakers—"revolutionary new theories" dressed up in pseudo-scientific language, old ideas dreamed up again and trotted out as new, etc. Readers often ask, why do we permit advertisers to make exaggerated claims or, at the other extreme, quote meaningless performance figures? We believe that most readers are sensible enough to translate, to weed out the truth from the copywriter's exuberant prose. The alternative, to censor advertisements, is unthinkable—where would we draw the line? The inflated claims are soon deflated by the test reports anyway.

### What's 6 dB Between Neighbors?

I have noted that the classical music lover tends to listen to quadraphonic sound at a higher overall level. However, research by three Californian professors, whose names escape me, have shown that rock enthusiasts listen to four-channel at a level five or six dB *lower*. Professors have a different image these days; even so I find the mental picture of a covey of earnest professors at rock sessions armed only with sound level meters an intriguing one. But why the lower sound levels? I can understand the classical *aficianado*

listening at higher levels because the ambience and reverberation that quadraphonic sound brings helps to give an impression of *being there* in the hall. So naturally there is a tendency to increase the sound to a more realistic level. But perhaps we should not inquire too deeply into the reverse phenomena—if rock enthusiasts get as much satisfaction from four-channel at 110 dB instead of 115, why should we complain?

### Midwest Acoustic Conference

The annual Midwest Acoustic Conference will be held at the Technological Institute of Northwestern University, Evanston, Illinois, on Saturday, April 15. This year the broad theme is "Four-Channel Sound Reproduction, Creation and Re-creation of a Sound Field." Among the speakers are Marvin Camras, James Cunningham, James Kogan, and Daniel Queen. Full information can be obtained from Daniel Queen, 5524 West Gladys Ave., Chicago, Illinois 60644.

### Wharfedale "Voluphone"

The moving coil earphone shown here was made by Wharfedale in 1937. According to the leaflet, the unit, called a *Voluphone*, "concentrated the output of the set (receiver) so that, without disturbing other occupants of the room, people who are quite seriously hard of hearing can enjoy every note and every word of the broadcast. The acoustic output in the region of 5000 to 9000 cycles is greater than that from the average full-size Moving Coil Speaker." The *Voluphone* came with an elegant velvet-lined case and cost about \$5.00, but alas, it was born before its time and had a short life with production finishing after only two years. Fortunately, Gilbert Briggs was not too discouraged!



### Humor in Advertising

From a leaflet put out by AFS ". . . enclosures constructed of phase-oriented acoustic fiberboard that produce clean sound completely free of superimposed resonance." Imagine trying to work with two pieces of fiberboard 180 degrees out of phase!  
G.W.T.



# Choosing the wrong cartridge for a record player is like putting low octane gas in a high-performance car.

## Here's how to choose the right cartridge.

Matching stereo cartridges to turntables and record changers is as important as putting the right kind of gas in your car. Low octane gas just won't work in a high performance car. And high octane gas in an economy car is a waste of money. It's the same with cartridges. In fact, a cartridge that's great for one system could be disastrous for another.

So, we've developed a simple way for you to precisely match one of our XV-15 cartridges to whatever kind of record player you have

or plan to buy. It's called the Dynamic Coupling Factor—DCF for short.

DCF is a numerical index, like an octane rating, that our engineers have assigned to the XV-15 cartridges by pre-analyzing all the electrical and mechanical specifications of all major record changers and turntables. The more sophisticated the record player, the higher the DCF number.

But how we devised the DCF rating system isn't as important to you as knowing what it does. Using

our DCF chart to choose your XV-15 makes sure that you get optimum performance when you play your records. And that you can walk into your high fidelity dealer and know just which XV-15 to ask for.

After all, you don't just drive into a gas station and ask the man to "fill 'er up", do you?



"for those who can hear the difference"  
101 Sunnyside Blvd.,  
Plainview, N.Y. 11803

Check No. 17 on  
Reader Service Card

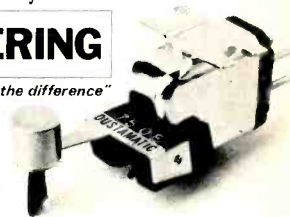

### Cut out this handy DCF Guide.

IF YOU OWN	MODEL NUMBER	Use a Pickering XV-15 cartridge with this DCF Number	
		ELLIPTICAL	SPHERICAL
Acoustic Research	XA	750, 400	350
Benjamin Miracord	50H, 750, 770H	750	350
	40H, 40A, 40, 630, 620, 610, 18H, 10, 10F, 10H	400	
Dual (United Audio)	1219, 1209, 1019, 1215, 1015, 1015F	750	350
	1009SK, 1009E, 1009	400	
	1212, 1010A, 1010	200	150
Garrard (British Industries)	SL95B, SL95, SL75B	750, 400	350
	SL75, LAB80MK11, LAB80	400	350
	SL72B, 70MK11, A70, 60MK11, SL65B, SL65, SL55B,	200	150
	SL55, SP20B, SP20, A, AT60, AT6		
	40, 40B, 50MK11, 50, 40MK11, 40Autoslim, Autoslim/P, T11, RC98, 210, 4HF, 301, RC80, RC88	140	100
Lenco	L-75	750, 400	350
McDonald (BSR)	600, 610, 500A	200	150
	510, 500, 400, 310	140	100
Pioneer	PL-30	750	350
	PL-25, PLA-25, PL-41C, PL40F, PL-41A	400	
Perpetuum-Ebner	PE-2018, PE-2038, PE-2020, PE-2040	750, 400	350
Sony	TTS 3000, PS 1800A	750, 400	350
Thorens	TD 125	750	350
	TD 150AB, TD 124	400	

Elliptical styli, because of the way they rest in the record groove, track with less radius distortion, and therefore are capable of playing records in good condition with less overall distortion.

Spherical styli are more rugged and can be used with higher tracking forces.

All Pickering cartridges are designed for use with all 2 and 4-channel matrix derived compatible systems.

# What Price Loudspeaker Response Curves?

Ralph West\*

IT HAS OFTEN been said that loudspeaker response curves can be very misleading. For those who press for further explanation, one may say that even the closest examination of the curve tells very little about what the loudspeaker actually *sounds* like. Every manufacturer knows this only too well; he may well have learned to his cost, in the past, that it does not do to rely overly much on curves in deciding when to freeze the design and start production. A relatively flat curve, obtained after much sweat and tears, may turn out to be a shocking noise. Again, two very similar irregular curves (they usually are!) may produce entirely different sounds in practice, so much so that one may suspect the accuracy of the measurements.

Now, the frequency response of an amplifier, a recording system or a microphone, does give meaningful information as a rule, sometimes all that is needed. Add to that distortion and signal handling capacity, and assume reasonable noise and transient behaviour, and one has a pretty good picture of its sound.

But these are relatively simple devices in that the signal has generally traversed the device, from input to output, in a few microseconds, at most, a tiny fraction of one cycle of the highest audio frequency. As long as a device treats all frequencies alike, and ampli-

fiers, etc. usually do, within a few percent, we are happy.

Now a loudspeaker is far more complicated. It may take several milliseconds for the signal to reach all parts of its active area. Not only are these different parts very likely to vibrate independently, but they are all at different distances from our ears and from all the reflecting surfaces that surround them in normal use. The resulting sound then depends on just how these many independent parcels of sound add together or subtract. This varies with every change of frequency and with change of listening position, *i.e.* it is hopelessly complicated.

On the score of transients, the starting and stopping of signals, everything except the speaker is reasonably trouble-free. A good modern amplifier can start and stop in a microsecond or so, and a microphone in a few microseconds as its moving parts are small, light and easily damped. A loudspeaker, on the other hand, as it has to be so much larger and heavier—and stronger—to produce enough noise, has to be given so much energy to start it moving that there is a lot of stored energy to dissipate when the electrical input signal stops. Various patches of the cone are likely to go on wobbling long after the input has ceased. Moreover, none of this bad behaviour may show on the frequency response curve, which is a steady-state measurement.

The steady-state measurement is relatively easy to make and conse-

quently is often performed, but transient behaviour is very difficult to measure—requiring a long-winded and tedious series of tests that could take days. The ear just listens and decides in seconds!

As engineers, we mistrust subjective assessments as they are liable to prejudice, peculiar likes and dislikes, and to variations from day to day. Objective measurements are far more reliable and repeatable, but still no use if they fail to give useful answers. In defense of the subjective assessment, one must realize that it involves also the services of an extremely complex computer, the brain, that can not only “measure” dozens of independent variables simultaneously, but also has a memory store several orders of magnitude larger than any man-made computer. It is therefore quite a formidable measuring tool.

A further look into some of the reasons why a response curve tells so little might be illustrated by the following. Place half a dozen people in a good row of seats in one of our large cathedrals to enjoy an organ recital and they would probably all agree that the sound was good, without adverse criticism. Now give them sound-level meters and graph paper, and get the organist to play slowly up the scale. The resulting graphs would be like cross-sections of the Rocky Mountains, and all different!

Of course the frequency response curve does show up *some* things we can hear. If the general level over large parts of the curve varies considerably—for instance, the average level for frequencies above 1 kHz is several decibels lower than that below 1 kHz—the sound will be dull and distant. If the level falls away steadily above 2 kHz (Fig. 1) it will sound muffled, whereas falling away below 1 kHz it will sound thin and shrill, crying out for considerable bass boost. These are matters of balance and they show up reasonably clearly.

Excessively high output over a narrow range of frequencies will also always produce an audible effect, possible because output is higher in this region, but more likely because there is also a resonance or series of reso-

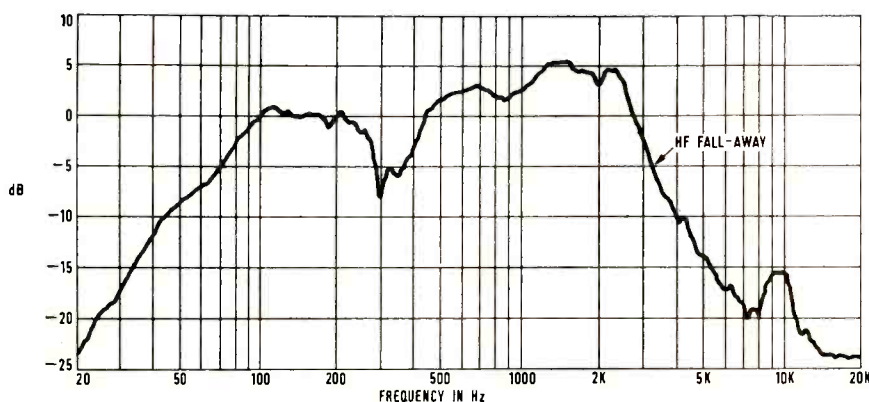

Fig. 1—Small sealed-box system with tweeter disconnected.



# oh?

**This is what people say when they hear the price of the Sony 6200**

# ah!

**This is what people say when they hear the Sony 6200**

The unusually high price of the new Sony 6200 receiver is a come-on. For once you know it, you can hardly resist the temptation to hear it perform and justify its lofty price. And once you hear it perform, you'll have to own this superb component.

The real joy of the 6200 lies in its performance. Balanced positive and negative power supplies permit direct coupling all the way through to the speakers for unusual clarity. There is power to spare by whatever measure: 360 IHF watts into 4 ohms. 70+70 watts *continuous* power into 8 ohms with both channels driven; a minimum of 60+60 at all frequencies from 20 to 20,000 Hz.

FM performance is equally distinguished. The FET front end raises the sensitivity to its theoretical limit (1.2  $\mu$ V for 20 dB quieting; 1.8  $\mu$ V IHF), while retaining the ability to handle strong local stations without overload and spurious response. Solid state i.f. filters ensure that the superb performance you hear today you'll enjoy many years later.

However, the true revelation of the 6200 is your own listening experience and the "ah" of your reaction to it. For many that "ah" will prevail over the "oh" engendered by its price. See it at your Sony dealer or write: Sony Corporation of America, 47-47 Van Dam Street, Long Island City, New York 11101.



**SONY® 6200 Stereo Receiver**

Check No. 22 on Reader Service Card

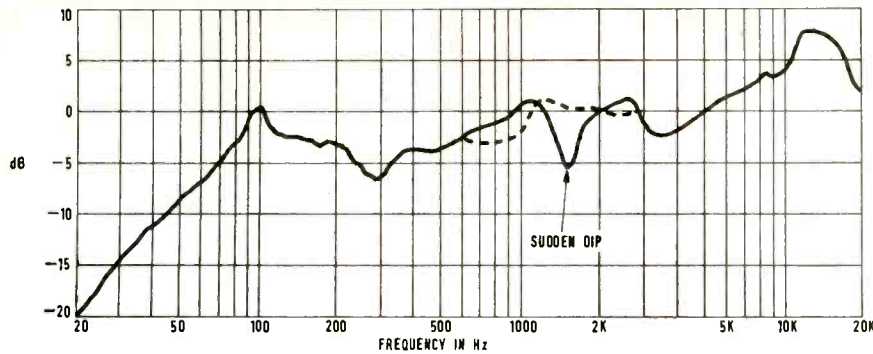

Fig. 2—Woofer and tweeter out of phase.

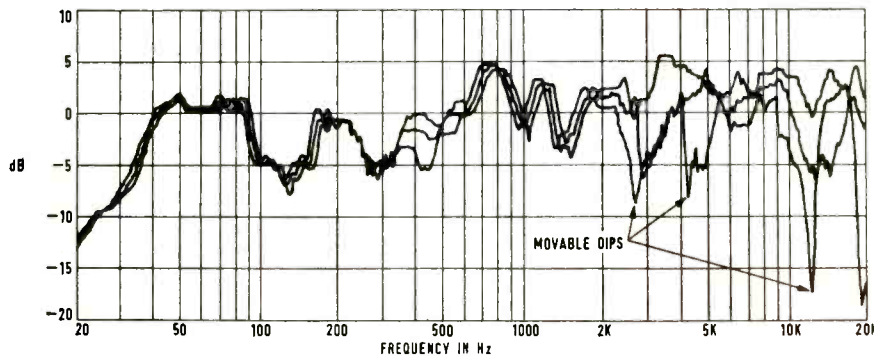

Fig. 3—Three microphone positions.

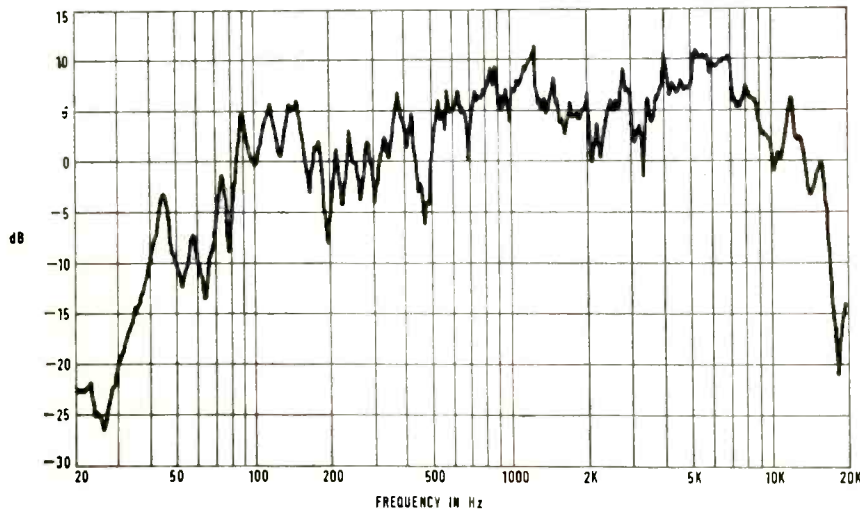

Fig. 4—Speaker "X" on left position.

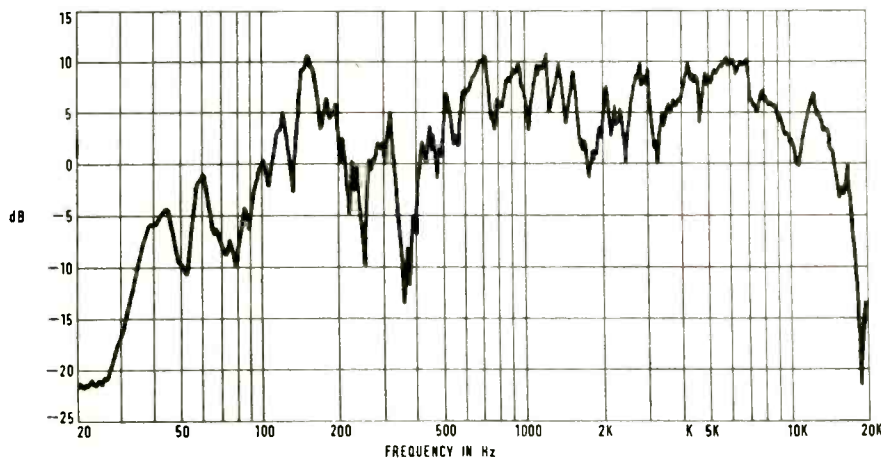

Fig. 5—Speaker "X" in right position.

nances close together. A resonance means a slow build-up of artificially exaggerated sound (not too serious) and a slow decay (very serious and one of the main dislikes of our ears, unless it is wideband natural decay like dying reverberation).

A large dip in a response curve is not quite so serious, as one cannot hear what is not there; but something will be heard, often a "hollowness," depending where it lies in the spectrum.

A large dip in the curve at the crossover frequency (Fig. 2) usually denotes a reversed phase between woofer and tweeter. On mono it may sound OK, but in stereo it often produces the most odd effects. Some instruments appear to pop over to the other side of the stage to play some notes, or an instrument may keep on altering its apparent width. Any sudden change in level on the curve is viewed with suspicion and often indicates something wrong that may produce an audible manifestation.

Any two-unit system can produce a whole series of different curves, depending on the exact position of the measuring microphone. Suppose the microphone is on the tweeter axis, it is then a little farther away from the woofer, and sound from the latter arrives a little later. If it is half a cycle later, it will subtract and the curve shows a dip. If perchance the two sounds are of equal intensity, and they should be at the crossover frequency, they will cancel, leaving nothing. Move the microphone slightly and this huge dip will disappear (Fig. 3).

Things like this, while they show up clearly on the frequency curve, cannot be heard in use. We listen with two ears, not one, the music is constantly changing, our head is continually slightly on the move, and in our domestic surroundings there are a whole host of reflections which complicate the pattern of variations still further. Even a single cone will still do this, as all parts of its area cannot be the same distance from the measuring microphone—and if they could be, it is unlikely that all these bits of the total area will be in step or in phase. (Only an electrostatic might manage.)

So, summing up thus far, the frequency curve of a loudspeaker has lots of wiggles that we shan't hear and a few wiggles we shall hear, but we cannot predict which. Only the big humps, hollows, and slopes are directly meaningful to a listener. Finally, looking at two different loudspeaker curves and trying to decide which is the better speaker of the two is almost a complete waste of time.

To the engineer, however, developing a new design, these measurements are



# The AR Laboratory Standard Transducer

**A speaker for professional use  
from Acoustic Research**

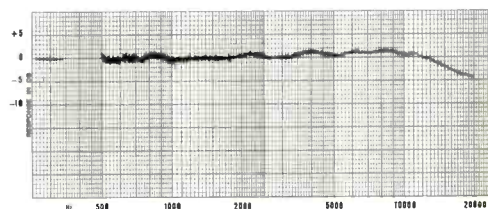
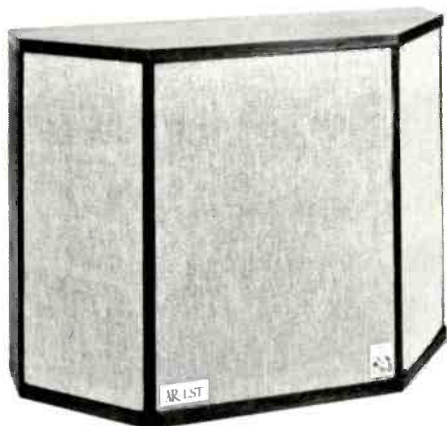

**ACCURACY AND FLEXIBILITY:** The AR-LST offers a total of six different energy profiles — all accurately known and repeatable at the turn of a switch, which is located on the front of the cabinet. This permits a degree of control and precision that is usually found only in electronic equipment.

**FLAT ENERGY CAPABILITY:** The AR-LST is capable of a flat energy output characteristic that, in our judgement, establishes a new state of the art. The graph shown above represents the acoustic power output produced by the AR-LST with its control set to the “flat” position. The horizontal line below 500 Hz indicates the relative woofer level.

**LOW DISTORTION:** As with the AR-3a, harmonic distortion measurements down to the lowest audible frequencies are, to the best of our knowledge, the lowest of any loudspeaker system available.

**WIDE DISPERSION:** AR’s hemispherical dome tweeters produce exceptionally smooth, wide dispersion of midrange and high frequencies, even in room or studios that are acoustically rather dead.

**POWER HANDLING:** Multiple drivers for midrange and high frequencies enable the AR-LST to handle power levels significantly higher than AR’s finest speakers designed primarily for home use.

Detailed information on the AR-LST is available on request. Mail the coupon below.



**Acoustic Research, Inc.**

24 Thorndike Street  
Cambridge, Massachusetts 02141, Dept. AU-3

Please send the booklet describing the AR-LST to

NAME \_\_\_\_\_

ADDRESS \_\_\_\_\_

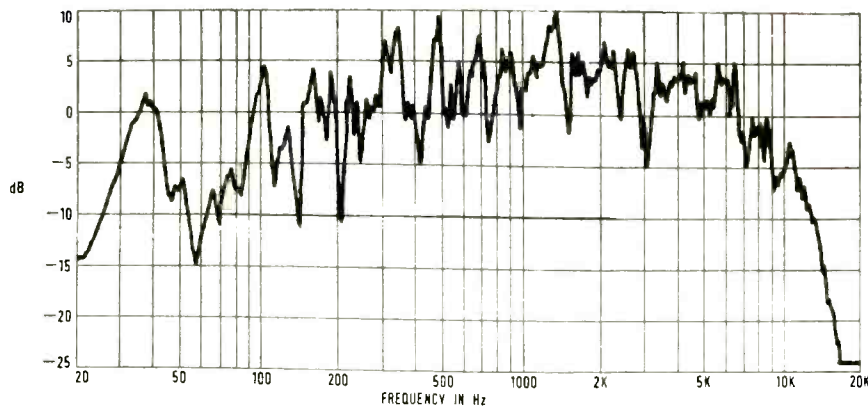

Fig. 6—Speaker "X" from Seat "A."

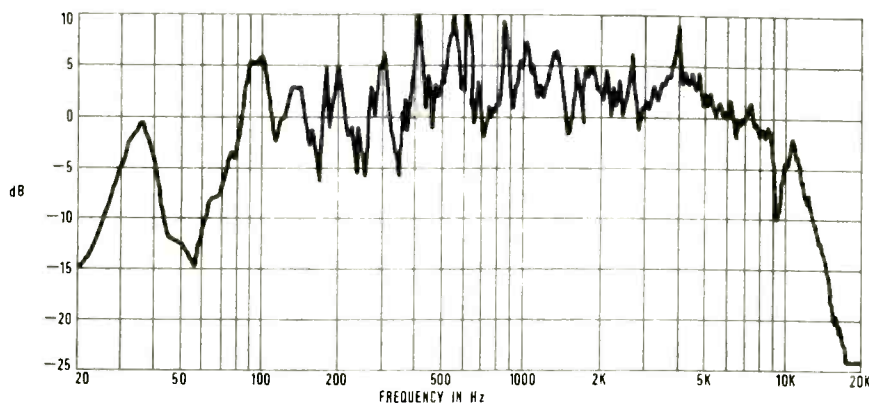

Fig. 7—Speaker "X" from Seat "B."

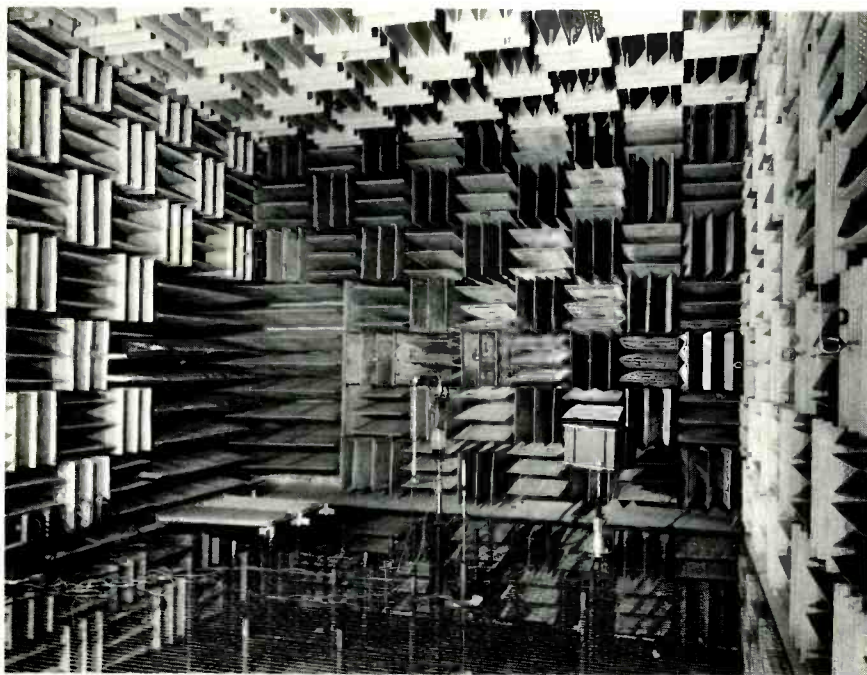

Fig. 8—An anechoic room for use in loudspeaker testing. Photo courtesy Jensen Sound Laboratories.

very useful. The curve will show, for instance, whether his design modification to increase or reduce the sound output at a particular point in the frequency spectrum has had the desired effect. If he is wise he will still listen to it to see if this modification has produced any undesirable effects that may not show on the curve. To the production engineer, regular measurements done under *exactly* the same conditions will show if standards are being maintained or if any changes are creeping into the product as supplies and staff, etc. change with time.

Having seen some slight justification for a loudspeaker response curve, how is it made? One merely puts a microphone with a flat response in front of the loudspeaker (one meter is the standard distance), varies the input frequency, keeping the voltage at the speaker terminals constant, and measures the microphone output. This sounds straightforward enough and does not take very long to do if one has a level recorder which plots the curve automatically. However, *where* is this done? The most obvious place is in typical listening room conditions. Speaker X, it had better be nameless (very non-standard), had the measuring microphone rigidly fixed to it with a light and acoustically transparent girder structure, to make sure we were always measuring the same speaker the same way. Placed in the left stereo speaker position, (Fig. 4) shows its measured behaviour. Placed on the right side, it gave Fig. 5. Out of sheer curiosity the speaker was placed in the center of the far end of the room and the microphone removed and placed, in turn, at ear level above two adjacent chairs from which listening normally takes place (Figs. 6 and 7). Any resemblance between Figs. 4, 5, 6, and 7 is (almost) purely accidental.

Quite clearly we are measuring the room more than the loudspeaker, especially in Figs. 6 and 7. This is why this measurement must always take place in non-reflecting surroundings. Ideally this is out of doors on a quiet, windless day, with the speaker and microphone about 20 ft. from the ground hung from a crane. This has been done, but is not too convenient, even if the weather permits. so at great cost we build anechoic chambers. These are very large rooms, preferably sound-proof, with walls, floor and ceiling completely covered with a very thick layer of sound absorbing material. The most effective form of absorbent seems to be a mass of wedge-shaped members, with their thin ends pointing



Think of  
everything you've ever wanted  
in a stereo receiver.

The new SX-828 and SX-727 are Pioneer's top two entries in a new, dynamic line-up of four AM-FM stereo receivers with increased performance, greater power, unsurpassed precision and a wide range of features for total versatility.

If you lust for power, here it is — to spare. SX-828, 270 watts IHF; SX-727, 195 watts IHF. Employing direct-coupled amplifiers and dual power supplies, you'll hear improved bass while transient, damping and frequency responses are greatly enhanced. Distortion is infinitesimal.

Whichever model you select, advanced FM sensitivity deftly plucks out those stations a hairline away from each other on the dial, and excellent selectivity zeros in on your program choice.



At Pioneer, we believe our engineers have really outdone themselves by designing features like: a new and exclusive circuit that protects your speakers against damage and DC leakage, ultra wide linear dial scale, loudness contour, FM muting, mode lights, click-stop tone controls, high & low filters, dual tuning meters, audio muting, plus a

full range of connections for turntables, tape decks, headphones, microphones, speakers — and even 4-channel connections, when you're ready.

To top this total combination are Pioneer's sensible prices — SX-828, \$429.95; SX-727, \$349.95, including walnut cabinet. If all this doesn't impress you, listening to them will. See and hear these magnificent new receivers as well as the new moderately priced SX-626 and SX-525, at your local Pioneer dealer.

U.S. Pioneer Electronics Corp.,  
178 Commerce Road,  
Carlstadt, New Jersey, 07072

**PIONEER®**  
when you want something better

# Pioneer has more of everything.



WEST: 13300 S. ESTRELLA AVE., LOS ANGELES, CALIF. 90248 • CANADA: S. H. PARKER CO., ONTARIO

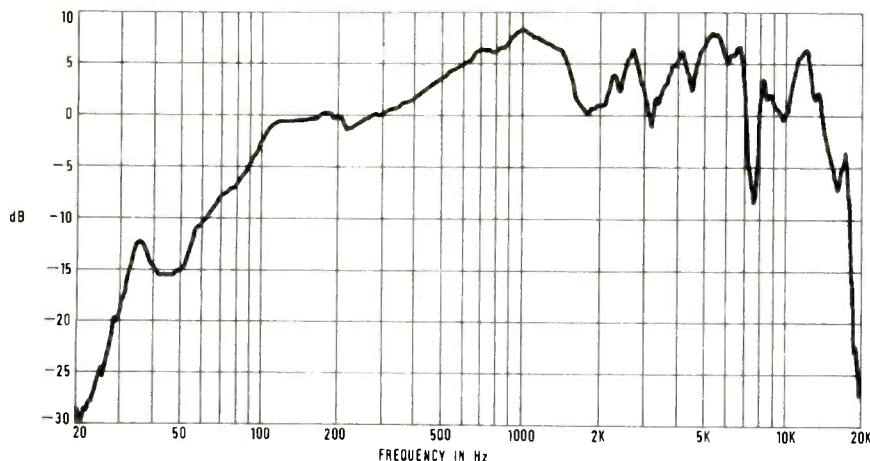

Fig. 9—Anechoic room.

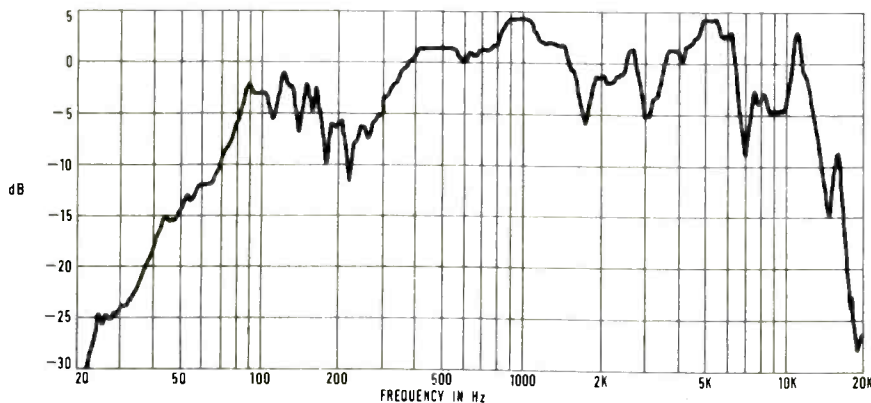

Fig. 10—Free-field (speaker on ground facing up).

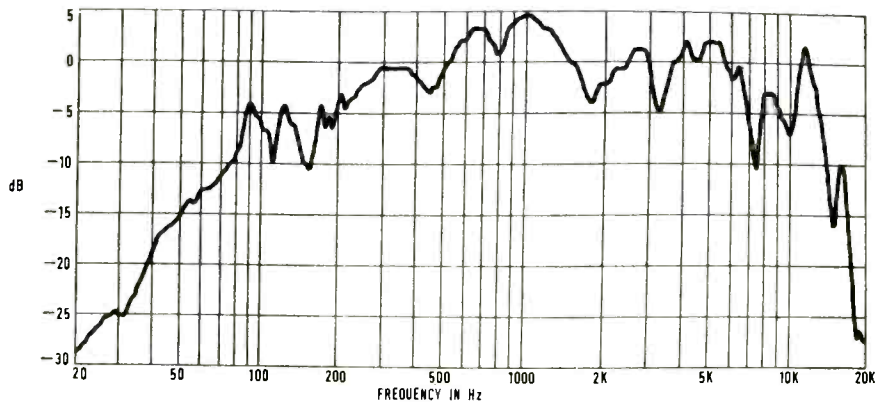

Fig. 11—Free-field (speaker raised 21 cm or 8 1/4 in.).

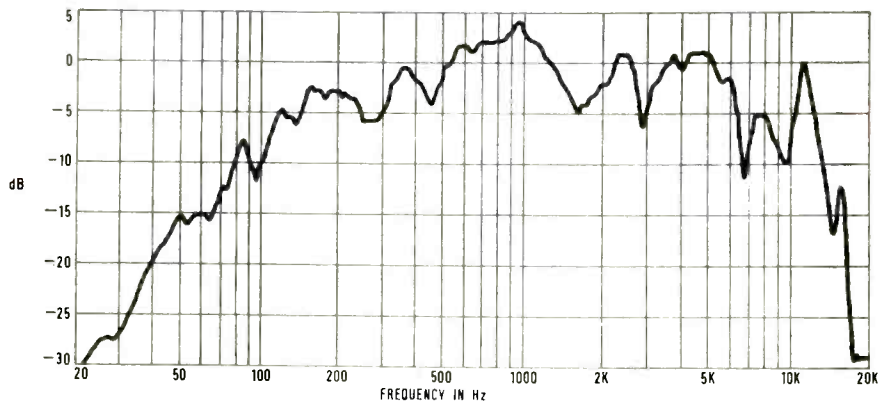

Fig. 12—Free-field (speaker raised 54 cm or 21 1/4 in.).

into the chamber. Special grades of polyurethane foam or rockwool in thin cotton bags are the most successful materials to date (Fig. 8). The length of the wedges determines the lowest frequency down to which practically 100% absorption takes place. To go down to 20 Hz the wedges would need to be about 12 ft. long! (I don't think there's even one in the world with 6 ft. wedges.) If the working space is large, then 5 ft. wedges give very small errors above, say, 30 Hz, and anyway one can always allow for a constant error.

Speaker X, with its attendant microphone, was taken to an anechoic chamber and gave the curve in Fig. 9. The little bump at 35 Hz is where the room is no longer absorbing most of the incident sound.

The poor man's anechoic chamber has to be the open air, and very useful results can be obtained quite simply. Ideally one should bury the speaker flush with the surface of the ground and hang the microphone directly above. Not wishing to dig up the lawn, or spoil the cabinet work, Speaker X was laid in the middle of the lawn well away from walls and buildings, and the curve of Fig. 10 resulted. This curve is better than Fig. 9 at the very low frequencies, but has a nasty series of dips in the 140-220 Hz range. This is due to some sound (from the woofer) reflecting from the ground (not too much as it's lawn) and arriving at the microphone half a cycle late and subtracting. Raising the speaker on to a low stool (21 cm) increases the path difference and cancellation takes place at a lower frequency: 100-200 Hz (Fig. 11). The three dips are thought to correspond to the three distances—over the side, over the bass end, over the tweeter end. Further raising on to a 54 cm stool and 185 cm step-ladder gave progressive lowering of the cancellation frequencies, and also less actual cancellation as the reflected sound is weaker due to greater distances travelled and more time for dispersion (Figs. 12 and 13). Fig. 13 is very close to the anechoic room curve; a few more feet higher and it would be acoustically superior. (*Memo: must order scaffolding!*)

Figure 14 shows a measurement taken with the speaker standing up normally on the same ground, the microphone now only 18 in. or so above the lawn. The bass end is now good, but the cancellation has moved up to 700 Hz and deepened. There is also evidence of reflections at higher frequencies too.

Apart from Fig. 14 the correlation above about 1 kHz is excellent for all



# Some Pertinent Information on the Smaller Advent Loudspeaker

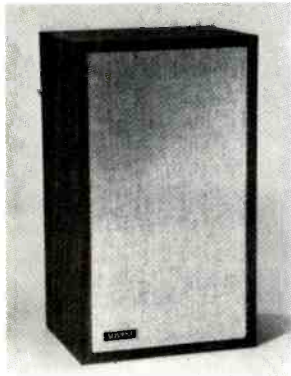

The original Advent Loudspeaker was designed to equal or surpass the audible performance of any speaker system used in the home, regardless of price. Its reviews, reprints of which we will be happy to send for the asking, indicate how well that objective was met.

The Smaller Advent Loudspeaker has the same audible performance, except that it will not play as loud. Since the original system was and is an unusual bargain at \$116\*, the newer and smaller system, at \$70\*, obviously deserves a full description to the prospective buyer. Accordingly, the following questions and answers:

## What Is It For, and Just How Good Is It?

The Smaller Advent Loudspeaker is meant to make it possible to buy a complete stereo system in the \$400 range, for use in an average living room under the usual listening conditions, that will provide the kind of sound quality associated with the most expensive stereo systems. Specifically, it exceeds the frequency bandpass and freedom from distortion of most far more expensive speakers, and provides the final, lowest octave of bass offered by only a handful of the most expensive speakers—and by none in or near its own price class. It is intended for use with any of the several sufficiently powerful present receivers in the \$200-\$250 price range (from Kenwood, Marantz, Pioneer, Sansui, Scott, Sherwood, Sony and others) that will deliver 18-25 watts per channel of continuous power into 4 ohms.

## How Does It Do What It Does?

The overall sound quality of the original Advent Loudspeaker was achieved in a smaller and less expensive speaker through careful, unmythical design that gives up some of the efficiency and maximum total loudness of the original, and through the choice of a 4-ohm voice coil impedance that draws about one-third more effective power (from present solid-state equipment) than an 8-ohm design.

A further reason for its lower cost was the selection of a walnut-finish vinyl cabinet of simple design.

## Who Should Be Interested In It?

Anyone, we believe, who has a living room of average size (about 2000-3000 cubic feet) and no reason to play music at thunderingly loud levels under normal conditions. The speaker's maximum sound level is con-

siderable (and well beyond what would be considered tolerable in most homes), but not as great as our larger and more expensive system's.

It's worth making clear that there is no real advantage in buying an expensive super-high-powered receiver or amplifier to drive the system, since the speaker is so exactly tailored to the power capabilities of moderately-priced equipment—with which it will sound as expensive as you please. But it's also worth stressing that the moderately-priced equipment for which the speaker was designed may *not* do the trick in the usual store (big, sound-absorbent, and full of people) where it's demonstrated. If a good receiver in the \$200-\$250 range sounds strained trying to drive the speaker in a showroom, it is still likely to be more than ample at home. Higher-priced equipment probably will have an audible advantage only in the showroom.

## Any Special Considerations?

Nothing special is needed to use the Smaller Advent Loudspeaker in standard stereo or four-channel hook-ups. Because it is a 4-ohm design, we suggest you use a 3-ohm, 5-10 watt resistor (from your dealer or free from Advent) in the speaker line when you intend to use more than one speaker per channel at a time—as in a household where main and extension speakers are used simultaneously. The resistor will prevent the combined impedance from dropping below the 4-ohm optimum.

## Where Can I Hear It?

If you don't know where to find the nearest Advent dealer, please write us at the address below. And let us know if you would like more information before going to look and listen.

Thank you.

**Advent Corporation, 195 Albany Street, Cambridge, Massachusetts 02139.**

*\* Slightly higher in some parts of the country.*

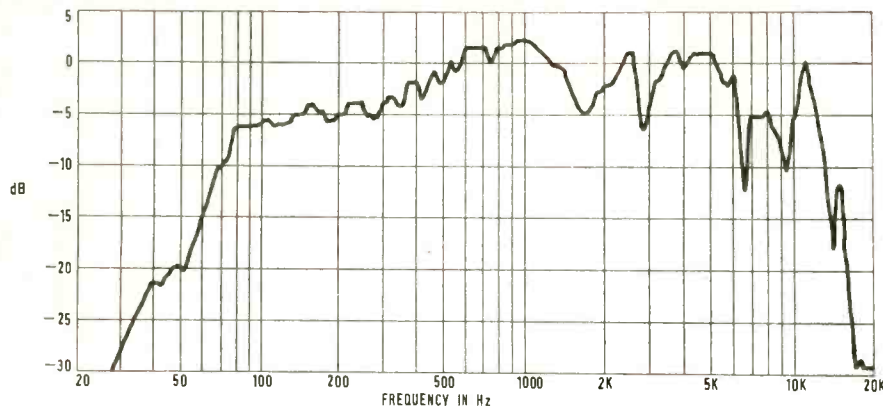

Fig. 13—Free-field (speaker raised 1.8 m or 5 ft., 10<sup>3</sup>/<sub>4</sub> in.).

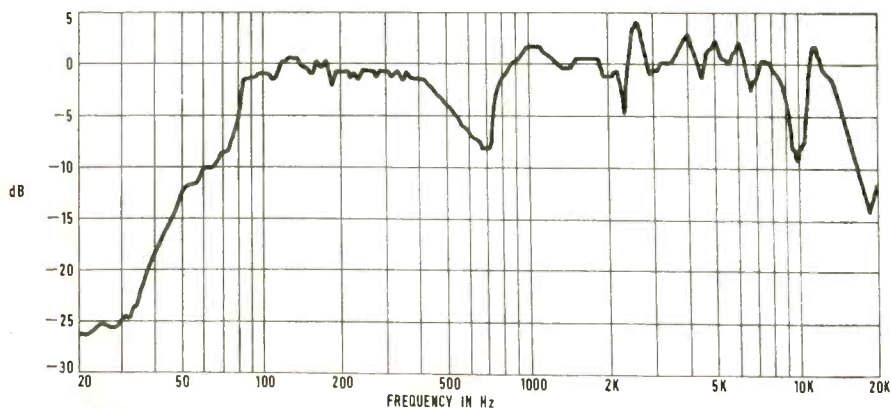

Fig. 14—Free-field (speaker on ground facing forward).

the other outdoor results. This is because the higher frequencies do not spill out over the cabinet edges like the low frequencies. With an omnidirectional speaker, of course, one would have to hoist it aloft.

There is a small flaw in the validity of anechoic measurement, be it in a good chamber or hoisted aloft. This is bass loading. Aloft, at low frequencies the sound energy spreads in all directions. At home, our speaker is never far from floor and two walls, probably very close to one of them. Under these conditions, the bass is increased as the same power is now concentrated into something less than equal to a hemisphere. Comparing either Fig. 10 or Fig. 14 with Fig. 13, both show a good 3 dB higher level at 30 Hz. What should we do? And how would one measure something like a Klipsch corner horn? I give up! —No, there is more work to be done.

*Editor's Note:* AUDIO does not test speakers in an anechoic chamber with a mike three feet away. (Who listens that way?) Instead, speakers are measured in a typical listening room with "pink noise" (which avoids room effects), on and off axis, plus an average curve. Taken together with the other measurements, we feel it gives a reasonable review of the performance. **AE**

## Not all legends are elusive.

In the past, Thorens turntables were exclusively sought by those select few who demanded the ultimate and had the unlimited purse to indulge their tastes. Many others with similar discerning preferences, but with more moderate means, were obliged to compromise their critical standards.

Happily, this situation has now been resolved. Because Thorens now offers the TD-150 Mark II 2-speed integrated transcription turntable. Incorporating many of the advanced engineering features and refinements of Thorens' more sophisticated models, it enhances the legend of Thorens quality.



Priced at \$140, including tonearm and base, the TD-150 Mark II is a concession only to economics, not to our traditional quality and precision. If you've always wanted a Thorens turntable, we suggest you visit your Thorens dealer today.

Now there's no reason to settle for less than the best.

Elpa Marketing Industries, Inc.,  
New Hyde Park, N. Y. 11040.  
West: Scottsdale, Ariz. 85253.



# THORENS

Check No. 26 on Reader Service Card



## The new ADC-XLM



**Superb performance.  
Lowest mass.  
Unbeatable price.  
And it's guaranteed for 10 years.**

If you're like most audiophiles, you've probably spent a great deal of time, effort and money looking for the "perfect" cartridge.

We know what you've been through. After all, we've been through it ourselves.

That's why we're especially enthusiastic about our newest cartridge, the ADC-XLM. It does everything a well designed cartridge should do. It may not be perfect, but we don't know of any that are better, and few that even come close.

Now, we'd like to tell you why.

### The lighter, the better.

To begin with, it is generally agreed that the first consideration in choosing a cartridge should be low mass. And as you may have guessed by now, the LM in our model designation stands for low mass.

Not only is the overall weight of the ADC-XLM extremely low, but the mass of the all-important moving system (the stylus assembly) is lower than that of any other cartridge.

Translated into performance, this means effortless tracking at lighter pressures with less distortion.

In fact, used in a well designed, low mass tone arm, the XLM will track better at 0.4 gram than most cartridges at one gram or more.

### A new solution for an old problem.

One of the thorniest problems confronting a cartridge designer is how to get rid of the high frequency resonances common to all cartridge systems.

Over the years, various remedies have been tried with only moderate success. Often the cure was worse than the disease.

Now thanks to a little bit of original thinking, ADC has come up with a very effective solution to the problem. We use the electromagnetic forces generated within the cartridge itself to damp out these troublesome resonances. We call this self-correcting process, "Controlled Electrodynamic Damping," or C.E.D. for short.

And if it seems a little complicated, just think of C.E.D. as a more effective way of achieving lower distortion and superior tracking, as well as extending frequency response.

Naturally, there's much more to the new ADC-XLM, like our unique induced magnet system, but let's save that for later.

### Guaranteed reliability plus.

At ADC we've always felt that reliability was just as important as any technical specification. That's why we now guarantee every ADC-XLM, exclusive of stylus, for a full ten years.

But this unprecedented

guarantee\* involves something more than just an assurance of quality. It is also an expression of our conviction that the performance of this cartridge is so outstanding that it is not likely to be surpassed within the foreseeable future.

### And something more.

In addition to the superb ADC-XLM, there is also a new low mass ADC-VLM, which is recommended for use in record players requiring tracking pressures of more than one gram. The cartridge body is identical for both units, and so is the guarantee. Only the stylus assemblies are different. Thus you can start out modestly and move up to the finest and still protect your investment.

And that brings us to the important question of price, which we are happy to say is significantly lower than what you might reasonably expect to pay for the finest. The suggested list price for the incomparable ADC-XLM is \$550 and the runner-up ADC-VLM is only \$40.

But no matter which low mass ADC you choose, you can be certain that they share the same outstanding characteristics... superb tracking, very low distortion and exceptionally smooth and extended frequency response.

\*We guarantee (to the original purchaser) this ADC cartridge, exclusive of stylus assembly, to be free of manufacturing defects for a ten year period from the date of factory shipment. During that time, should a defect occur, the unit will be repaired or replaced (at our option) without cost. The enclosed guarantee card must be filled out and returned to us within ten days of purchase, otherwise this guarantee will not apply. The guarantee does not cover damage caused by accident or mishandling. To obtain service under the guarantee, simply mail the unit to our Customer Service Department.



Pickett District Road, New Milford, Connecticut 06776

Check No. 27 on Reader Service Card

# Testing Amplifiers With A Bridge

Andrew R. Collins\*

**T**HE AMPLIFIER is an essential part of any sound reproducing system and it can be argued that the high quality present-day amplifier is the component least likely to degrade the realism of the reproduced sound. However, it is in the nature of things that some amplifiers will be good and some bad, and thus comparing various amplifiers often introduces difficulty.

In general terms, two basic forms of testing are available to us—listening tests and measuring tests. The listening test is useful for assessing background noise level under no-signal conditions and little else. The resolving power of the ear is just not adequate to give any reasonable indication of frequency response, distortion, etc. in the presence of other signals unless the faults in these areas are gross. However, even though such faults are not readily detectable, their presence may give rise to a subtle feeling of unease after a period, and this indicates that these faults are audible but well masked by the program material.

The technical tests are easier to carry out and tend to give more reliable results than the purely subjective interpretations of listening tests. In particular, the measurement of frequency response can be carried out under steady-state conditions with no trouble whatever in about five minutes using an automatic curve-tracer. Distortion measurements in their simplest form are made by feeding the amplifier with a sine wave of high purity, loading the amplifier output with a suitable resistor and examining the shape of the output waveform. The harmonic distortion analyzer is fed with this waveform, a filter in the analyzer removes the original sine wave, and the remaining signal—which has been added by the amplifier—is displayed on an oscilloscope and its magnitude indicated by a meter as a percentage of the total output.

In practice, however, the listener will not use the amplifier for listening to pure steady tones of constant frequency and amplitude. Instead he will listen to a complex musical program made up

of an infinite variety of signal frequencies and amplitudes. The inter-modulation distortion test attempts to simulate these conditions by feeding the amplifier a mixture of two sine waves, one low frequency and one high frequency. The amplitude of the low frequency component is usually 10 to 20 dB higher than that of the high frequency component. (*EDITOR'S NOTE: AUDIO regularly uses the SMPTE test, 60 and 7,000 Hz mixed four to one, respectively.*) The inter-modulation distortion analyzer examines the effect that the low frequency signal has on the way in which the amplifier operates on the high frequency signal. In effect, the high frequency signal is used as a probe tone to measure the slope of the amplifier's input-output transfer characteristic while the low frequency tone sweeps up and down this transfer characteristic.

Tests of this nature can become more and more elaborate but a limit is set on the complexity of the input signal as the output signal must always be processed by an electronic network that will remove the original signal to enable the contribution due to the amplifier to be examined in isolation. These conventional tests will therefore never tell the whole story about how an amplifier will actually sound when reproducing music, and furthermore the results that are obtained are not easy to interpret. For example, we have no real idea of how low distortion should be before it is no longer offensive. Again, we have no agreement on the relative annoyance values of 1% third harmonic distortion at 8 kHz against 0.1% seventh harmonic at 1 kHz. Obviously, there are other examples.

To carry out a meaningful distortion test, we must feed the amplifier with the kind of signal it will receive in use and compare the output from the amplifier with the original input by subtraction. We can then listen to the distortion introduced by the amplifier without the masking effect of the music, and this is very useful as the performance of an amplifier under dynamic conditions may be significantly worse than its performance under steady state conditions, particularly in class B transistor amplifiers which have not

been subject to the most rigorous design procedures. In such an amplifier a loud passage in the program can cause the temperature of the output transistor junctions to rise considerably even though these transistors may be fitted on an efficient heat sink. The thermal resistance between the junction itself and the cool heat sink prevents the device reaching thermal equilibrium in the short periods under consideration. The junction temperature rises, the base-emitter voltage therefore falls, and the bias conditions for the output stage alter. The failure of amplifier designers to appreciate these changes under dynamic conditions was one reason for the poor audible performance of early class B transistor amplifiers which appeared to give good results when measured under steady-state conditions. It is probably safe to say that five years ago the best transistor amplifiers in mass production were significantly worse than the best tube amplifiers then current, and the serious music listener would understandably eschew the new amplifiers in favor of the proven tube designs. The situation has now changed, and certain transistor amplifiers are considerably better than the best tube designs, though in some circles prejudice lingers on.

The distortion measurement technique described here allows it to be shown that on any input signal—simple, composite, or musical—the distortion introduced by the transistor amplifier in question is well below audibility at any any output level up to the onset of clipping and is 20 or 30 dB less than the distortion introduced by its highly regarded tube predecessor. The basic test setup is shown in Fig. 1, where a unity-gain non-inverting amplifier is tested. The signal on the monitor is the difference between the amplifier input signal and its output signal. Clearly, with an ideal amplifier, this will be zero and no sound will be heard from the monitor. For testing an inverting amplifier which has gain, the circuit is rearranged as in Fig. 2. The input attenuator reduces the input signal to the power amplifier such that its output voltage is the same in magnitude as the input signal to the attenuator.

\*Acoustical Mfg. Co. Ltd. (Quad), Huntington, England.



# Our greatest test has come

Sherwood's brilliant new SEL-300 Digital Readout Tuner faces laboratory scrutiny at *Audio Magazine*. To say they liked it is the understatement of the year.

"The new Sherwood SEL-300 Tuner is truly the embodiment of 'an idea whose time has come.' It provided us with a whole new series of performance features which cannot, for the moment, be compared with any similar units."

They're talking about our exclusive "Le Gendre" 12 pole toroid filter yielding an alternate channel selectivity in excess of -85 dB. FM sensitivity of  $1.5 \mu\text{v}$  (IHF). An exclusive FET sideband variable hush control. And the industry's lowest distortion.

*Audio* puts it this way: "...sensitivity figures are unequivocally the best we have checked to date and selectivity characteristics were so good we were able to tune in several channels which were only 200 kHz

removed from strong, local stations."

And: "The stereo separation characteristics are seen to be every bit as good as FCC transmitter requirements."

Our features are as exciting as our engineering. Digital readout tubes have a life of 100,000 hours. There are multipath outputs for an oscilloscope. Headphone jack with built-in amp. A 3 year parts and labor warranty. And adaptability to both conventional and discrete four channel systems.

As *Audio* says, "talk about non-obsolescence!"

For the serious FM listener this means you can confidently own the finest tuner on the market today. The Sherwood SEL-300 is one tuner that passed its test. With flying colors.

Sherwood Electronic Laboratories, 4300 N. California, Chicago, Ill. 60618.

## Sherwood sounds expensive



Check No. 30 on Reader Service Card

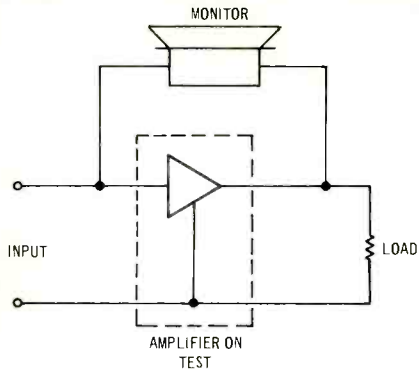

Fig. 1—Basic test set-up for unity-gain non-inverting amplifier.

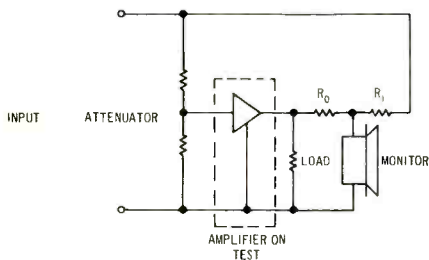

Fig. 2—Test set-up for inverting amplifier which has gain.

In the ideal case the currents in the two resistors  $R_o$  and  $R_i$  will be equal in magnitude and opposite in phase, thus no current will flow in the monitor and it will produce no sound. If the amplifier distorts, the current in  $R_o$  will differ from the current in  $R_i$  and a resultant current will flow in the monitor.

In practice the circuit used is more complex than that shown in Fig. 2, as the output from the amplifier is not exactly 180 degrees out of phase with the input at all frequencies and the amplifier gain is not independent of frequency. At the high and low ends of the frequency spectrum, the gain falls and the input-output phase shift alters. The phase and frequency response characteristics of the amplifier can be measured quite easily by steady-state tests and can be compensated for by adding a completely passive circuit, using only resistors and capacitors, in the reference signal path. The added circuit has the same phase and frequency characteristics as the amplifier on test but, as it is passive, it is completely linear and cannot introduce distortion.

By way of example, the complete circuit used for testing the Quad 303 power amplifier is shown in Fig. 3. The three low-frequency roll-offs in the network simulate the effect in the

amplifier of the input and output coupling capacitors and the feedback decoupling capacitor, the two high frequency roll-offs simulate the predominant two high frequency roll-offs in the closed loop. There are five variable controls to allow adjustment of the network to compensate for component tolerances in the amplifier on test. The insertion loss of the input attenuator is variable over small limits; the voltage gain of the amplifier can be between 32 dB and 33 dB and provision must be made for this in the test equipment. The switch fitted on the input to the monitor chain allows the monitor to be fed with the output from the amplifier, the input signal via the R-C network, or the sum of these.

When in use, it is generally found easiest to adjust the variable elements in the R-C network using a white-noise program source. Even then the setting-up can be quite time-consuming until experience is gained, as the controls are to some extent interdependent. The monitor chain consists of a high quality calibrated preamplifier with switched gain control feeding a power amplifier and a loudspeaker. As the variable elements are adjusted towards balance, the preamplifier gain is increased to allow more sensitive adjustment. Thus if we wish to examine the distortion products 70 dB below the output level,

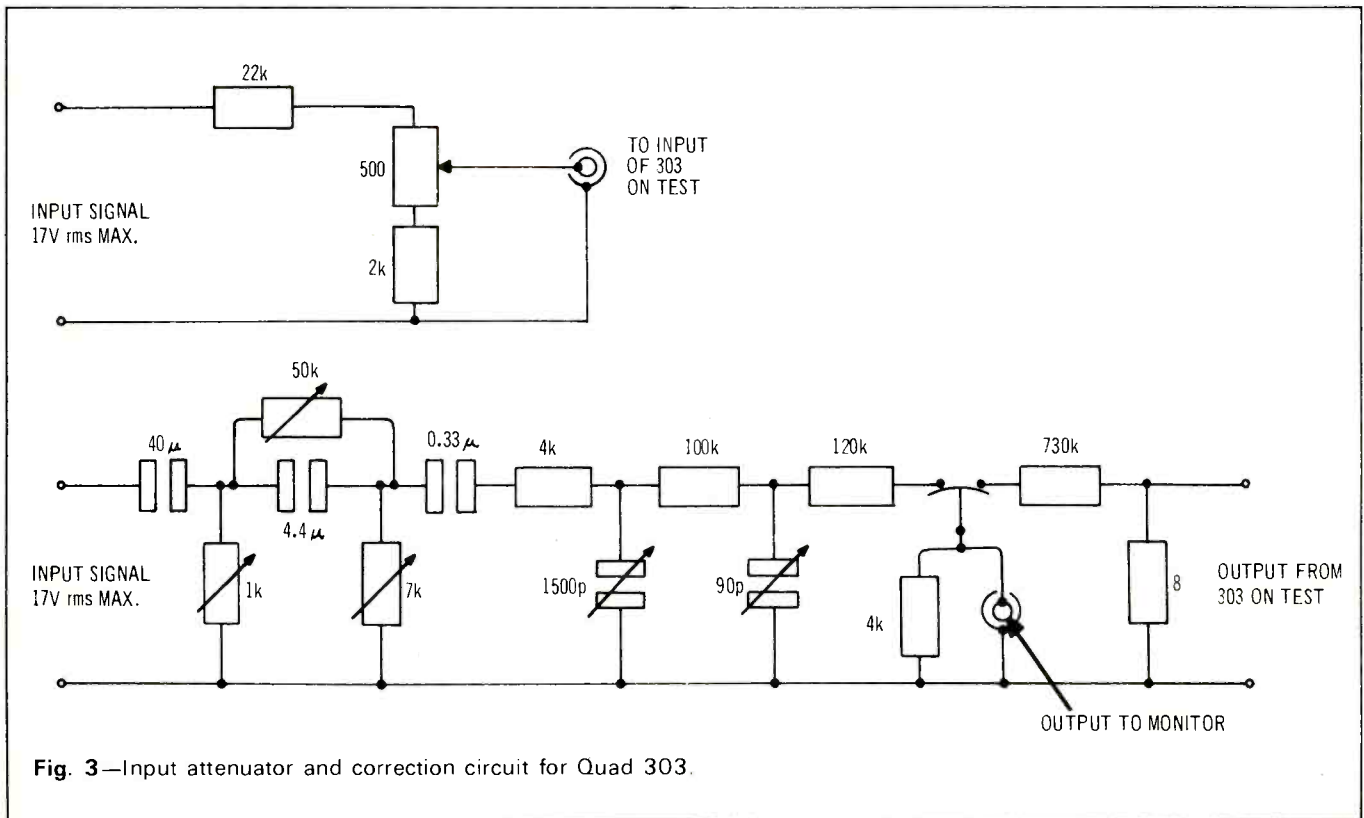
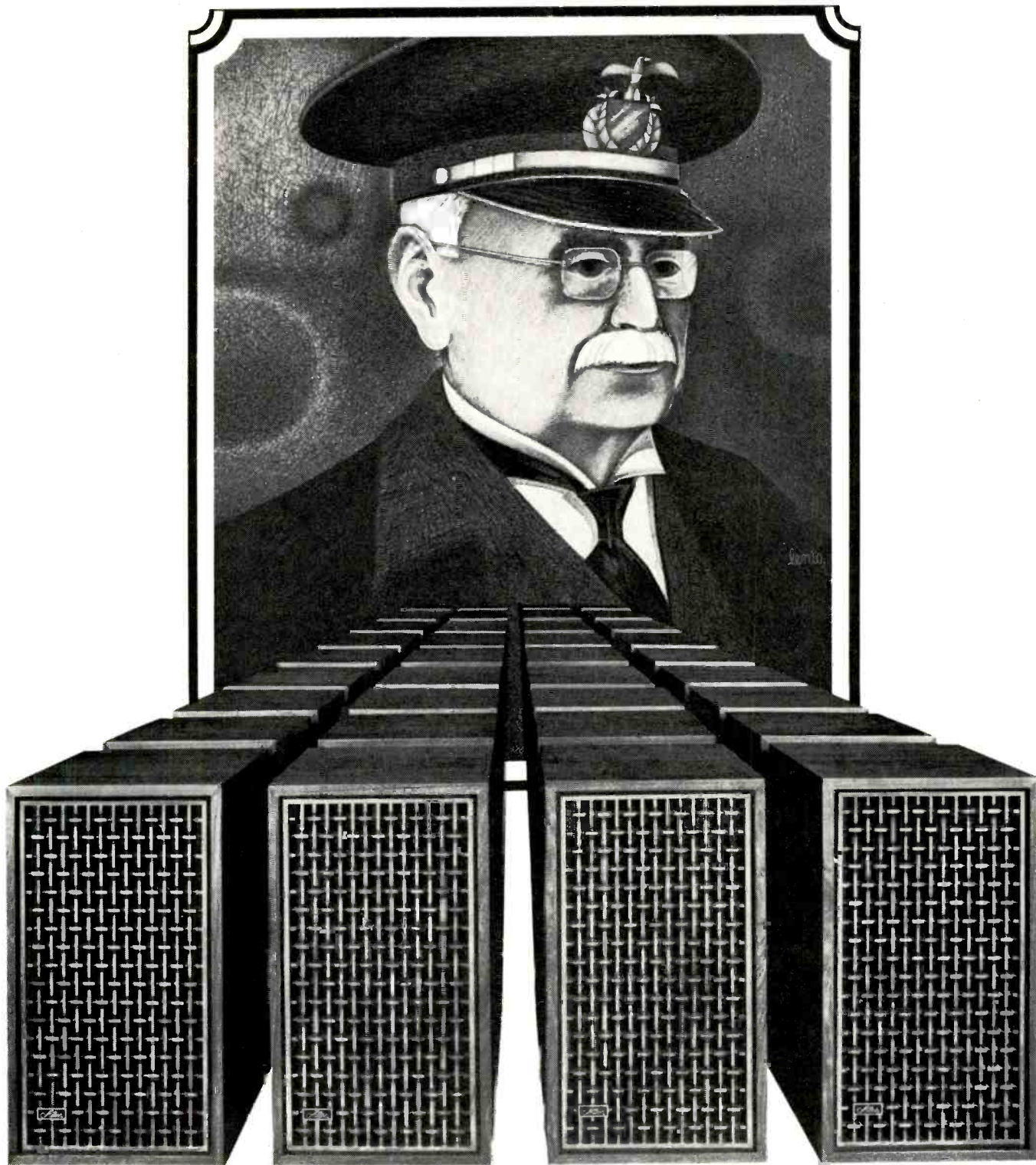

Fig. 3—Input attenuator and correction circuit for Quad 303.



# Sousa lives in the new Altec Segovia



If you're going to listen to Sousa, it should sound like Sousa. Oom-pa, oom-pa, oom-pa-pa. It should be so real that you can reach over and nudge the tuba player when he gets out of step.

The new Altec Segovia is the first bookshelf speaker system that lets you hear every sound clearly and distinctly and naturally. Oom-pa. From bass drum to triangle. There's nothing added and there's nothing taken out. Oom-pa. All you hear is what Sousa wanted you to hear. Oom-pa-pa.

Ask your dealer to put on some Sousa when you listen to the new Altec Segovia speaker system. You've never heard him so good.



The new Altec Dynamic Force Segovia sells for \$250.00. It's the culmination of years of building professional sound equipment and working with room acoustics and equalization while developing the proven Altec Acousta-Voicette Stereo Equalizer. Hear it at your local Altec dealer today. He's in the Yellow Pages under "High Fidelity & Stereo Sound Equipment" under Altec Lansing.

Check No. 31 on Reader Service Card

then the phase response of the network must match the phase response of the amplifier within one minute of arc at all audible frequencies. Similarly the amplitude response of the network must match the amplifier within 0.003 dB at all frequencies. After adjusting the network, a steady signal is applied to the input terminals and its level adjusted to produce an output of 5 volts or so across the load resistor. The monitor switch is set to the "amplifier output" position and the gain of the calibrated preamplifier adjusted so that the voltage delivered to the monitor loudspeaker is also 5 volts. A music signal applied to the input terminals will naturally be reproduced on the monitor loudspeaker at the same level as if this loudspeaker were connected to the output of the Quad 303 on test. The input signal level is adjusted to reproduce the program at a realistic level. If the monitor switch is now moved to the center position, to listen to the amplifier distortion, the monitor loudspeaker becomes completely silent. The input level can now be increased to the point where the amplifier overloads and the noises now produced by the monitor loudspeaker are most objectionable.

With the input level set so that the amplifier is just on the verge of over-

load on the loudest passages, the distortion is still inaudible and it becomes necessary to introduce more gain in the monitor chain. With up to 20 dB extra gain, the loudspeaker is quite silent; with 30 dB gain a signal becomes audible. Listening closely, it is apparent that this is mostly clean program present due to inaccuracies in the R-C compensating network, and it is still relatively undistorted. If the R-C network is patiently adjusted, it is possible to introduce 60 dB of gain in the monitor preamplifier before the signal from the monitor loudspeaker is comparable in loudness to the original signal with no extra gain. The amplifier distortion will now be audible and may still be just detectable with the gain reduced to 40 or 50 dB. Even so, this shows without ambiguity that the distortion introduced by the Quad 303 at any level up to the onset of clipping is 40 dB below audibility. Indeed, if perfection were achieved and the amplifier introduced no distortion whatever, it would sound no different. Looking at the results in another way, by increasing the distortion of a 45 watt amplifier by 40 dB, we are in effect listening to the distortion produced by a similar 450 kW amplifier at its true level.

By altering component values in the R-C network, the test can be ap-

plied to any amplifier and has been repeated with the Quad II power amplifier, a tube design which was tried, tested, and accepted by private and professional users during its 15-year production run. This proved to have a distortion content 20 to 30 dB greater than the Quad 303. This background noise level of the Quad II is also higher than the Quad 303 and with no extra gain in the monitor chain, the residual output is just audible.

As the technique is usable regardless of the nature of the input program, it is possible to carry out conventional harmonic distortion measurements using a sine wave generator with a high distortion content. For this application the monitor loudspeaker is replaced with a voltmeter and the "set 100%" function performed by switching the monitor switch to the "amplifier output" position. In the same way the amplifier distortion can be measured on square waves, white noise, and on a swept tone without the need for a tracking filter.

Having shown that one can produce an amplifier that does not produce audible distortion of the program, it may well be realistic at this time to devote some energy to reducing inaccuracies elsewhere in the reproducing chain. AE

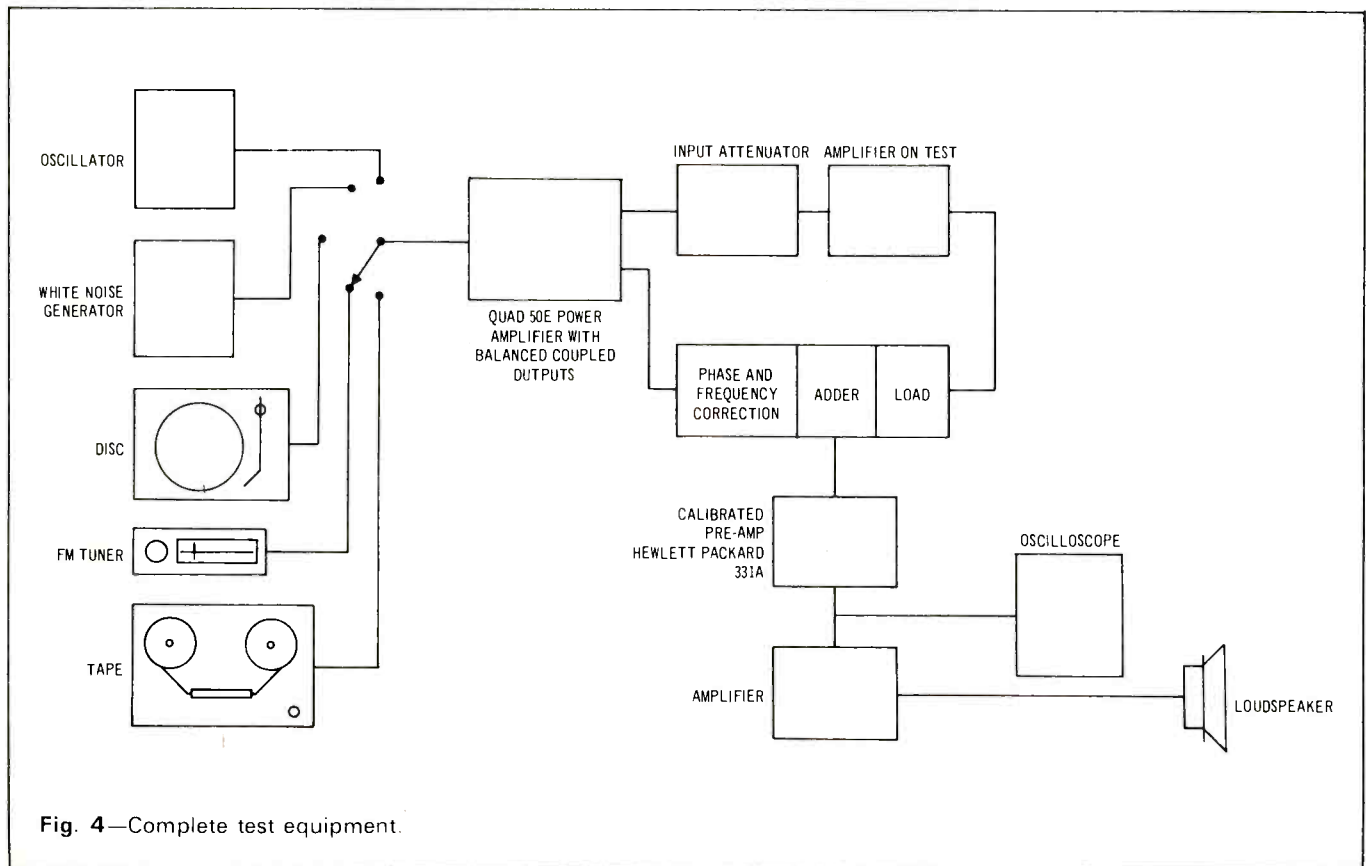

Fig. 4—Complete test equipment.



# Crown

## PROFESSIONAL STUDIO EQUIPMENT

Specs	15ips	7½ips
w. & fl.	0.06%	0.09%
f. resp. +2dB	40Hz to 30kHz	20Hz to 20kHz
S/N	-60dB	-60dB

3 speeds - 15, 7½ & 3½ips; hysteresis synchronous drive motor

torque reel motors

"capable of providing the most faithful reproduction of sound through the magnetic recording medium... to date" - Audio magazine, 4/68

optional Trac-Sync

individual channel equalizers

third head monitor with A/B switch; meter monitoring of source, tape, output and source+tape; sound-with-sound, sound-on-sound and echo

2 mixing inputs per channel

individual channel bias adjust

"construction rugged enough to withstand parachute drops" - Audio magazine, 4/68

\$1790 for basic rack-mount half-track stereo deck, about \$2300 with typical accessories; Formica floor console \$295, rugged portable case - \$69

computer logic controls for safe, rapid tape handling and editing; full remote control optional

modular construction with easy access to all 10 moving parts and plug-in circuit boards; deck rotates 360° in console, locks at any angle

### RECORDERS & REPRODUCERS



**SX711** Claimed by its pro audio owners to be the finest professional tape recorder value on the market today - price versus performance  
 ■ Frequency response at 7½ips ±2dB 20Hz-20kHz, at 3½ips ±2dB 20Hz-10kHz  
 ■ Wow & flutter at 7½ips 0.09%, at 3½ips 0.18%  
 ■ S/N at 7½ips -60dB, at 3½ips -55dB  
 ■ Facilities: bias metering and adjustment, third head monitor with A/B switch, sound-with-sound, two mic or line inputs, meter monitoring same as CX822, 600Ω output  
 ■ Remote start/stop optional, automatic stop in play mode  
 ■ \$895 for full-track mono deck as shown, \$995 for half-track stereo deck

**SP722** Ideal reproducer for automation systems  
 ■ Meets or exceeds all NAB standards  
 ■ Remote start/stop optional, automatic stop in play mode  
 ■ \$595 for half-track stereo reproducer

### CX822

**Crown tape recorders** and reproducers are available in 42 models with almost any head configuration, including 4 channels in-line. Patented electro-magnetic brakes maintain ultra-light tape tension and never need adjusting. They are made by American craftsmen to professional quality standards, with industrial-grade construction for years of heavy use.

**All Crown amplifiers** are warranted three years for parts and labor. They are 100% American-made to professional quality standards. All are fully protected against shorts, mismatch and open circuits. Construction is industrial-grade for years of continuous operation.

For more information, write CROWN, Box 1000, Elkhart, Indiana 46514

### STUDIO MONITOR AMPLIFIERS



#### D60

Delivers 30 watts RMS per channel at 8Ω  
 ■ Takes only 1¼" rack space, weighs 8½ lbs.  
 ■ IM distortion less than 0.05% from 1/10w to 30w at 8Ω  
 ■ S/N 106dB below 30w output  
 ■ \$229 rack mount



#### D150

Delivers 75 watts RMS per channel at 8Ω  
 ■ IM distortion less than 0.05% from 0.01w to 75w at 8Ω  
 ■ S/N 110dB below 75w output  
 ■ Takes 5¼" rack space, weighs 20 lbs.  
 ■ \$429 rack mount



#### DC300

Delivers 150 watts RMS per channel at 8Ω  
 ■ IM distortion less than 0.05% from 0.01 w-150w at 8Ω  
 ■ S/N 110dB below 150w output at 8Ω  
 ■ Lab Standard performance and reliability  
 ■ "As close to absolute perfection as any amplifier we have ever seen" - Audio magazine, 10/69  
 ■ \$685 rack mount

Check No. 33 on Reader Service Card

# Crossover Network Design



Edward M. Long \*

OVER THE YEARS, many articles, chapters of books and whole books have been written on the subject of crossover network design. While a practical crossover network is obviously intended for use with real loudspeaker drivers (woofers, tweeters, etc.), the design information usually treats such drivers as purely resistive load terminations. Often, very little, if any, attention is paid to the ultimate end use of the network: the blending and phasing of the acoustical output of the various drivers to produce a smooth total acoustical output from the loudspeaker system. This is not to say that such discussions are worthless, but they must be treated as only a good starting point. Many loudspeaker systems, in the past, were made up using only the simplest theoretical approach. For example, an 8 ohm woofer was matched to an 8 ohm tweeter, and, of course, both were connected to an 8 ohm crossover network. Asking a question like "When is an 8 ohm woofer really like an 8 ohm woofer?" would immediately stamp one as a trouble maker! In recent years however, this and other interesting questions have been raised with regard to one of the most important aspects of loudspeaker system design: the crossover network.

The proper design of a crossover network should proceed through three stages of development. The first stage treats the various loudspeaker driver impedances as if they were pure resistances, i.e. 4, 8, 16 ohms, etc. This is usually the only stage of development presented in almost all the available literature devoted to crossover network design. Since so much has been written elsewhere concerning this stage of crossover design, including various possible configurations and formulas for determining component values, we will pass on to the next stage of development.

In this second stage we must consider that the loudspeaker drivers are not pure resistances but complex and varying impedances. One author, while acknowledging this fact, continues his discussion of crossover networks using the convenient assumption that the terminating impedance is constant, with the admonition that a fair proficiency with computers is required to do otherwise.<sup>1</sup> There is a simple way out of this predicament. Assuming that a practical problem consists of designing the right crossover for a given set of loudspeaker drivers, one can use part of the problem in finding the solution! This is shown in Fig. 1. An audio signal generator acts as the function generator and a meter is used as the readout device. In essence we have an analog computer in which the loudspeaker drivers and their associated network components act as their own analog.

Using the setup shown in Fig. 1, one can plot the voltage appearing at the outputs of the high frequency and low frequency sections of the crossover network, both into the resistive load terminations and into the reactive load presented by the actual tweeter and woofer impedances. The impedance of the tweeter and woofer can also be plotted as well as the

\* Manager of Acoustics, Quadraflex Industries, Inc.

impedance of the network with resistive loading and the reactive loading presented to the network by the actual loudspeaker drivers.

The accompanying table shows the switch positions for the various tests. A simple, first order, constant resistance network is shown but higher order networks can easily be substituted. Figure 2 shows the results of crossover network electrical input and output measurements with both resistive and reactive (woofer and tweeter) loads. The actual system consists of a 10 in. woofer and a 3½ in. tweeter. It can be easily seen that the varying impedances of the woofer and tweeter do have a very definite effect upon the output of the crossover network. The rising impedance of the woofer, with increasing frequency, causes the voltage across the woofer to be higher than that obtained when a resistive load is substituted. Of course the actual power delivered to the woofer at

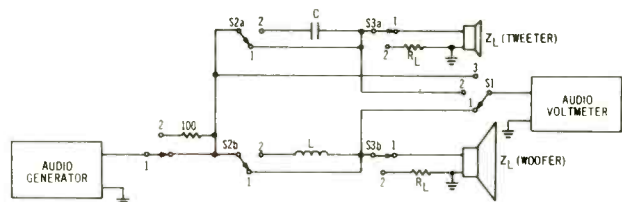

	TEST 1	TEST 2	TEST 3	TEST 4	TEST 5	TEST 6	TEST 7	TEST 8
	Impedance of Woofer	Impedance of Tweeter	Output of Low Freq. Section R Load	Output of Hi Freq. Section R Load	Output of Low Freq. Section Z Load	Output of Hi Freq. Section Z Load	Impedance of Network R Load	Impedance of Network Z Load
S1	1	2	1	2	1	2	3	3
S2	1	1	2	2	2	2	2	2
S3	1	1	2	2	1	1	2	1
S4	2	2	1	1	1	1	2	2

Fig. 1—Test set-up for making crossover network measurements.

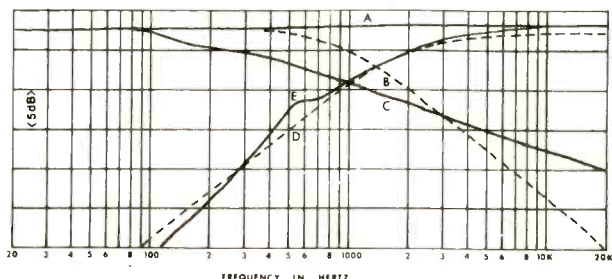

Fig. 2—Crossover network voltage measurements. A, input to network; B, output of low-pass section with 8-ohm resistive load; C, with woofer load; D, output of high-pass section with 8-ohm resistive load, and E, with tweeter load.



any frequency is the result of the square of the voltage across the woofer divided by its impedance.

The previous two stages of development have allowed the preliminary crossover component values to be chosen and their effects to be measured, with both resistive and reactive loads. It is the final stage of development which is the most important, however. In this final stage, the acoustical output is measured. The microphone was placed 18 in. from the loudspeaker system and was located on a line between the woofer and tweeter. The woofer and tweeter were mounted flush to the face of the enclosure and as closely together as possible.

Figure 3 shows the acoustical output of the two-way system measured before and after changes made in the crossover network values. The dashed frequency response curve of Fig. 3A was obtained using the crossover network values calculated by assuming that the impedances of the woofer and tweeter were constant. The acoustical outputs of the woofer and tweeter were also assumed to be constant. Of course, practical loudspeakers do not exhibit perfectly flat frequency response characteristics. In this case, the frequency

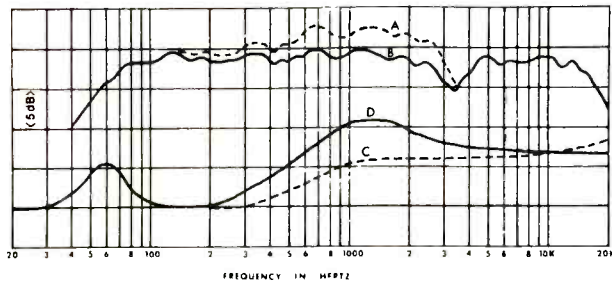

Fig. 3—A, frequency response of loudspeaker system with mathematically designed crossover network; B, modified network; C, impedance of system A, and D, impedance of modified system B.

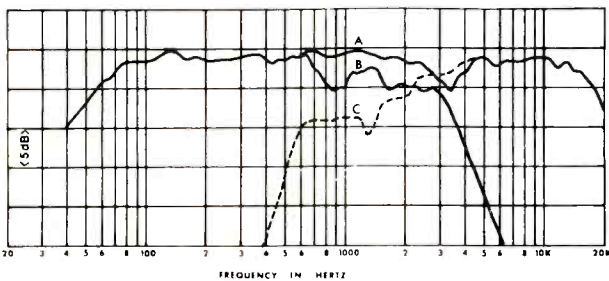

Fig. 4—A, frequency response of system; B, response of woofer; C, response of tweeter. All curves are with crossover network of Fig. 3D.

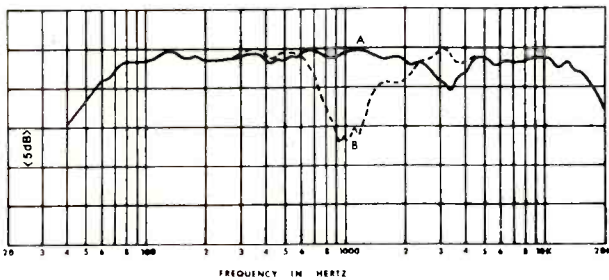

Fig. 5—Result of network-driver phasing. A, woofer and tweeter connected out of phase to d.c.; B, woofer and tweeter connected in phase to d.c.

response of the system shows an excess of output through the midrange. By treating the crossover network and loudspeaker drivers as an electrical input, acoustical output combination, adjustments may be made to obtain the desired results. This may appear a bit facetious at first. Many times however, one will see a designer trying to correct an unsatisfactory speaker system design by selecting a different theoretical crossover frequency. Often, the desired results can be obtained by merely adjusting the network values selected initially, instead of redesigning the network for a new crossover frequency. The solid curve of Fig. 3B was obtained in this manner. Figure 3 also shows the loudspeaker system impedance characteristics with the modified (3D) and unmodified (3C) crossover networks into both resistive and reactive loads. The modified version might, more correctly, be called a low pass-high pass filter, since it is not truly a crossover network in the classical sense. Besides keeping the high frequencies from reaching the woofer and the low frequencies from reaching the tweeter, the modified network also acts to shape the response, thus achieving a flat acoustical output.<sup>2</sup> The midrange hump in the impedance curve of Fig. 3D is the result of this response shaping function of the crossover network. This hump causes a rejection of electrical input power by the network in the midrange and results in the solid frequency response curve of Fig. 3B. It should be mentioned here that the curves shown in Figure 2 were made after the modification of the crossover network and result in the acoustical output shown by the solid curve of Fig. 3B.

Figure 4 shows the acoustical output of the woofer and the tweeter and the resulting combined acoustical output. There appears to be a small dip in the acoustical output at about 3kHz. Inspection of the frequency response curve of the tweeter output does not show any dip in the acoustical output at this frequency. The woofer is falling off rapidly at this frequency but since its output is at a much lower level than that of the tweeter, one would not expect such a dip to be the result of strictly amplitude effects. It has been determined that, as in the upper cutoff frequency region of a loudspeaker, the phase of its acoustical output begins to change and this will result in the acoustical output being 90° out of phase with the electrical input in the crossover region.<sup>3</sup> The first order network used in this design will cause the voltages across the woofer and tweeter to be 90° out of phase. By reversing the leads to the woofer and tweeter so that they are out of phase with respect to a d.c. voltage applied across their respective terminals, the acoustical output can be made to add properly.<sup>5</sup> This will be true throughout most of the overlap range of the woofer and tweeter. At about twice the crossover frequency there will be a small phase cancellation which is difficult to avoid completely. The spacing of the drivers will effect both the frequency and severity of this dip.

Figure 5 shows the effect of reversing the connections to the woofer and tweeter upon the acoustical output. The choice of connections is quite obvious. There are some who contend that such attention to phasing the acoustical output of the drivers has no real practical value since under reverberant conditions the total power output of the loudspeaker system will be the same regardless of phase. It is also contended that measurements made with a microphone, placed closely to a loudspeaker system usually show these effects of improper attention to phase and therefore the measurements should be made at a distance. It is the author's contention that a design which results in a loudspeaker system that produces a homogeneous plane wave radiation, without wierd phasing effects, as close to the face of the baffle as possible, is very desirable.

Most discussions about what we can measure and what we can hear do not take into consideration a very basic distinc-

tion between the two processes. Measurements are usually made with a single microphone occupying a single point in space at any one time. The human listener has two ears which occupy two points in space with a finite distance between them. (Hopefully this distance is filled with more than space!)

Figure 6 shows a human head and three ear-to-ear dimensions. Each of these dimensions is also plotted in terms of maximum addition and cancellation of sound waves. The velocity of sound used in 1129 feet per second which yields a transit time for sound waves of 0.886 milliseconds per foot. When the sound enters one ear slightly before it enters the other ear, and this slight difference in arrival time represents one half wavelength at a particular frequency, then the listener can sense an out of phase condition. As the arrival time differential increases to one full wavelength, the listener will sense everything as being normal and comfortable. Of course, we are considering here only steady state and not transient conditions. To get an idea of the effects being discussed, one can connect a simple phase reversing switch to a pair of headphones. Although this is not an exact equivalent of what one experiences when listening to a loudspeaker system which exhibits phasing defects, it will give clues regarding how to listen for phasing effects between the drivers of a loudspeaker system. The interesting thing about the plots of frequency vs. addition and cancellation shown in Fig. 6, is the way the three ear-to-ear dimensions cause the additions to cluster in the 2100Hz - 2600Hz region (A) and the cancellations to cluster from 2850Hz to 3250Hz (B). Another cluster of additions and cancellations occurs in the 6300Hz - 6900Hz (C) and 7100Hz - 7400Hz (D) regions, respectively. The most critical for crossover phasing, based upon actual listening experiences, would appear to be the

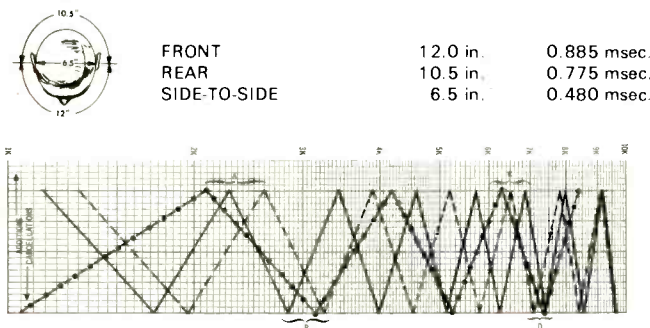

Fig. 6—Ear-to-ear dimensions plotted to show frequencies for which maximum cancellation and addition can occur. A and B show sensitivity to phasing effects can be expected. Ranges C and D do not seem to be as critical.

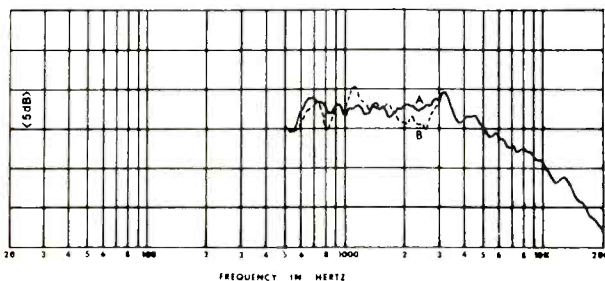

Fig. 7—Frequency response of loudspeaker system showing results of phasing. A, woofers and tweeters out of phase to d.c.; B, woofers and tweeters in phase to d.c. See text for details of measurement.

2000 - 3500 Hz region. The frequencies of addition and cancellation for the shortest ear-to-ear dimension, through the head, is plotted for reference only since, hopefully, very little sound will pass directly through the head!

A well-phased system can be listened to at close range as well as at a distance. A poorly phased system must be listened to at a distance and preferably in a fairly reverberent environment.

Figure 7 is an example of how even a measurement using a single microphone, under listening room conditions, can detect phase differences in a loudspeaker system. The microphone was placed 12 feet from the loudspeaker system. The loudspeaker system was placed with its back to the microphone and facing a wall! The reverberation (RT60) time measured under the same conditions was about 0.3 seconds through the 1000 to 3000 Hz range. The curves indicate that the microphone could measure the effect of reversing the phasing of the woofer and tweeter under these extreme conditions. Listeners could easily detect this phase reversing process.

In conclusion it must be mentioned that most loudspeaker systems designers are paying more attention to the acoustical phasing of various drivers than in the past.

1. Ashley, J.R. & Kaminsky, A.L., "Active and Passive Filters as Loudspeaker Crossover Networks," *Jour. Aud. Eng. Soc.*, Vol. 19, No.6, pp. 494-501, (June, 1971).
2. Augspurger, G.L., "Electrical vs. Acoustical Parameters in the Design of Loudspeaker Crossover Networks," *Jour. Aud. Eng. Soc.*, Vol. 19, No.6, pp.509-511, (June, 1971)
3. J.R. Ashley, "Phase Shift in Audio Systems," *I.E.E.E. Trans. on Aud. and Electroacoustics*, Mar., 1966, p.50.
4. Corrington, M.S. & Kidd, M.C., "Amplitude and Phase Measurements on Loudspeaker Cones," *Proc. I.E.E.E.*, Vol. 39, pp.1021-1026, (Sept., 1951).
5. Long, E.M., "Design Parameters of a Dual Woofer Loudspeaker System," *Jour. Aud. Eng. Soc.*, Vol. 17, No.5, pp.515-524, (Oct., 1969).
6. Briggs, Gilbert A., *Loudspeakers*, 5th Ed.; Yorkshire, England: Wharfedale Wireless Works, 1958, Ch.22, pp.250-256.
7. Jordan, E.J., *Loudspeakers*: London: Focal Press, 1963, Ch.8, pp.112-118.
8. Tremaine, H.T., *Passive Audio Network Design*, (AHT-1), Indianapolis: Howard W. Sams & Co., Inc., Ch.10, pp. 219-263.
9. Ashley, J.R., "On the Transient Response of Ideal Crossover Networks," *Jour. Aud. Eng. Soc.*, Vol. 10, No.3, pp.241-244, (Jul., 1962).
10. Ashley, J.R. & Henne, L.M., "Operational Amplifier Implementation of Ideal Electronic Crossover Networks," *Jour. Aud. Eng. Soc.*, Vol. 19, No.1, pp.7-11, (Jan., 1971)
11. Crowhurst, N.H., "Loudspeaker Crossover Design," *Radio-Electronics*, Vol.23, No.7, p.43, (July, 1952).
12. "The Basic Design of Constant Resistance Crossovers," *Audio Engineering*, Vol.37, No.10, pp.21-22, 108, (Oct., 1953).
13. "The R-C Crossover Compromise," *Audio*, Vol.41, No.7, pp.17-19, 53, (July, 1957).
14. Ewaskio, C.A. & Mawardi, O.K., "Electroacoustic Phase Shift in Loudspeakers," *Jour. Acous. Soc. Am.*, Vol.22, p.444, (1950).
15. Foster, E.J., "Active Low Pass Filter Design," *I.E.E.E. Trans. Audio*, Vol. AU-12, p.104, (1965).
16. Heyser, R.C., "Loudspeaker Phase Characteristics and Time Delay Distortion," Part 1., *Jour. Aud. Eng. Soc.*, Vol.17, No.1, pp.30-41, (Jan., 1969).
17. Hilliard, J.K., "Loudspeaker Dividing Networks," *Electronics*, Vol.14, No.1, pp.26-28, (Jan., 1941).
18. Klipsch, P.W., "Low Distortion Crossover Network," *Electronics*, Vol. 21, pp.98-99, (Nov., 1948).
19. Mitchell, R.M., "Transient Performance of Loudspeaker Dividing Networks," *Audio*, Vol.48, p.24, (Jan., 1964)
20. Small, R.H., "Constant-Voltage Crossover Network Design," *Jour. Aud. Eng. Soc.*, Vol.19, No.1, pp.12-19 (Jan., 1971).
21. Stroh, W.R., "Phase Shift in Loudspeakers," *I.R.E. Trans. on Aud.*, Vol. AU-7, p.120, (1959)
22. Tappan, P.W., "Phase Distortion," *I.E.E.E. Trans. on Aud.*, (Editor's Corner), Vol. AU-12, p.21, (1964).



# it really comes alive...

It would be silly to ask if you dig real live sound. Of course you do. The same holds true for **quality** — for things that are **really** made, and **really** perform.

Our objective in developing the B-301 (**Tempo 1**) was to give you the best, most lifelike sound obtainable, in a well-engineered, well-constructed bookshelf system. The fact that performance fully met expectations, and that we could furnish full-fledged BOZAK construction quality for a modest price, were the real measures of its success.

The BOZAK B-301 is a three-way system based on a long-throw, high-compliance bass driver with a solid low-bass response. The high-compliance midrange unit with its well-damped aluminum cone was developed especially for this loudspeaker system: its clear definition, or transient response, is remarkable and we know of no other that can equal it. The latest version of the BOZAK high-frequency driver, originally introduced over twenty years ago, is highly regarded for its wide dispersion and silky-smooth response. All three drivers are of standard BOZAK quality — sturdily constructed, with generous magnet structures and unique BOZAK-made cones assembled on solid cast frames.

You will have to compare this speaker system to really appreciate it. And its price is very modest — especially for a real BOZAK!

## the facts:

**Bass Speaker:** 12" high-compliance, long-throw/**Midrange:** 4½", with 2⅝" damped aluminum cone on high-compliance suspension/**Treble:** 2", with foam-damped diaphragm and wide dispersion/**Crossovers:** 1200 and 3600 Hz  
**Frequency Response:** 40-20,000 Hz

**Impedance:** 8 Ohms/**Power Handling:** 40 Watts  
Program average/**Acoustical-Environmental Switch:**

3-position/**Enclosure:** oiled walnut, 14½" x 23⅛" x 11½" deep  
**Grille:** snap-out/**Weight:** 40 pounds.

Bozak, Darien, Connecticut, 06820  
Overseas Export by Elpa Marketing Industries Inc.,  
New Hyde Park, New York, 11040, USA

Check No. 37 on Reader Service Card



# LOUDSPEAKERS

The following are not all the speakers of the manufacturers listed; some were eliminated for lack of space, others because information was not supplied. The data included are not the result of tests by this magazine but were supplied by the manufacturers.



AKAI SW-175



Advent



ADC 303



AR LST

MANUFACTURER	MODEL	WOOFER						MID-RANGE		TWEETER		Overall Freq. Resp., Hz to kHz	Ampl. Pow., for Avg. Room W	Crossover Capacity (RMS W)	Impedance, Ohms	Enclosure Dimensions, * D x H, In.	Wood Finish	Grille Material Color	Weight, Lbs.	Price	SPECIAL FEATURES
		Diameter, In.	Resonance (in system), Hz	Envelope Type	Diameter, In.	Type	Diameter, In.	Type	Diameter, In.	Type											
ACOUSTIC FIBER	Nirvana BK 300	12	50	Acous. Susp.	(2) 3 1/2 x 6	Cone	(2) 4	Cone	20-20K ± 1.5	6	30	1,000 5,000	8	26 1/2 x 16 1/2 x 15 1/2	*	Blk.	25 1/2	180.00	Vinyls, leathers, furs, corks, and fabrics.		
	Kriket 950-A	8**	70	Bass Reflex	-	-	-	-	30-20K ± 1.5	6	15	-	8	18 x 11 x 9	*	Blk.	6	45.00	**Full range.		
	Kriket 850	8**	70	Acous. Susp.	-	-	-	-	30-20K ± 1.5	6	15	-	8	10 cube	*	Blk.	5	33.00			
	Kriket 750	5**	105	Acous. Susp.	-	-	-	-	65-17K ± 1.5	6	10	-	8	7 1/2 cube	*	Blk.	3	27.00			
ACOUSTIC RESEARCH	AR-4x	8	65	Acous. Susp.	-	-	2 1/2	Cone	*	15	**	1,200	8	19 x 9 x 10	Wal., unf.	Cloth beige	18 1/2	63.00	*Complete data available from AR on request.		
	AR-6	8	56	Acous. Susp.	-	-	1 1/2	Cone	*	20	**	1,500	8	19 1/2 x 12 x 7	Wal., unf.	Cloth beige	20	81.00	**Depends on various factors; data available on request.		
	AR-2ax	10	56	Acous. Susp.	3 1/2	Cone	1/4	Dome	*	20	**	1,400	8	24 x 11 1/2 x 13 1/2	***	Cloth beige	36 1/2	128.00	***Wal., ch., teak, mah., bir., unf.		
	AR-5	10	56	Acous. Susp.	1 1/2	Hem. dome	1/4	Dome	*	20	**	625 5,000	8	24 x 11 1/2 x 13 1/2	***	Cloth beige	39	175.00			
	AR-3a	12	42	Acous. Susp.	1 1/2	Hem. dome	1/4	Dome	*	25	**	575 5,000	4	25 x 11 1/2 x 14	***	Cloth beige	53	250.00			
†	LST	12		Acous. Susp.	(4) 1 1/2	Hem. Dome	(4) 1/2	Hem. Dome	30-15K ± 2			575 5,000	4	27 1/2 x 9 1/2 x 20	Wal. Beige	Cloth Beige	90	600.00	6-pos. bal. sw.; prof. applications.		
AOC	450A	12	-	-	-	-	1/2	Dome	30-20K ± 3	15	60	-	8	14 x 12 1/2 x 25	Wal.	Blk.	50	165.00	2-way sys. w. 12" rubber surround woofer.		
	303AX	10	-	Acous. Susp.	-	-	1 1/2	Dome	37-20K ± 3	15	60	-	8	23 1/2 x 13 x 11 1/2	Wal.	Blk.	37	110.00	2-way; wide dispersion super tweeter; removable frame. 303B, same less controls, \$90.00.		
	404A	6	-	Acous. Susp.	-	-	1 1/2	Dome	45-20K ± 3	15	50	-	8	11 1/2 x 7 1/2 x 8 1/2	Wal.	White	11	55.00	2-way; hi accuracy, wide dispersion tweeter.		
ADVENT	-	10	43	Acous. susp.	-	-	1 1/2	Dome	30-20K ± 4	20	*	1,000	8	25 1/2 x 11 1/2 x 14 1/2	Oil wal.	Cloth light	44	120.00	Also available in walnut vinyl cabinet @ \$105.00. *Detailed info. available.		
	-	9 1/2	43	Acous. susp.	-	-	1 1/2	Dome	30-20K ± 4	15	*	1,400	4	20 x 9 1/2 x 11 1/2	Wal. vinyl	Cloth light	30	69.95			
AKAI	SW-155	12		Reflex	5	Cone	2 1/2 2	Horn Super Horn.	25-21K	50		1,200 5,000 15,000	8	25 x 16 x 11 1/2	Orn. finished	Black	38.9				
	†	NDS-70	(6) 3	-	-	-	-	-	70-18K	15	30	-	6	-	-	Metal	8.8		*Omnidirectional, hexagonal		
	SW-35	5 1/4		Acous. Lab.	-	-	-	-	40-18K	15	-	8	6 1/2 x 10 1/4 x 17 1/4	Wal.	Cloth	9 1/4					
	SW-125	10		Multi-pipe-ducted reflex	5	Horn	2	Horn	40-20K	-	30	1,200 5,000	8	21 x 13 7/8 x 11 1/2	Oil, Wood	Grille	24 1/4		Hi range level cont.		
	SW-131A	10	25	-	5	Cone	2 1/2	Cone	40-20K	-	30	1,200 6,000	8	13 1/4 x 10 1/4 x 21 1/4	Wal.	Cloth Beige	18 1/2		Bal. selector switch, jack and push button terminals. SW-135 similar.		
SW-175	15		-	2 1/2 x 2 1/4	Horn	3 (2)	Dome Super-dome	20-23K	80		600 5K 10K 15K	8	17 x 11 1/4 x 24 1/2	Wal.	Grille	49		Hi and mid level controls, jack and push button terminals.			



From any place in the room, the versatile Achromatic W35 is a top performer... built to take power and give it all back... with ease! The unique shape permits shelf use in two ways: either straight-on; or at the acoustically desirable but frequently wasted corners. And, with an optional corner mounting bracket, *suspension* in room corners becomes both simple and decorative.

The robust, extraordinary performance of the W35, despite its modest size (15" x 15" x 8" deep), is a result of its being a full 3-way speaker system and of its professional quality components. The 8" woofer is a heavy duty, long-throw assembly with oversized, four layer-wound voice coil for maximum heat dissipation and fully controlled transient response. A 3 1/4" acoustically isolated midrange unit

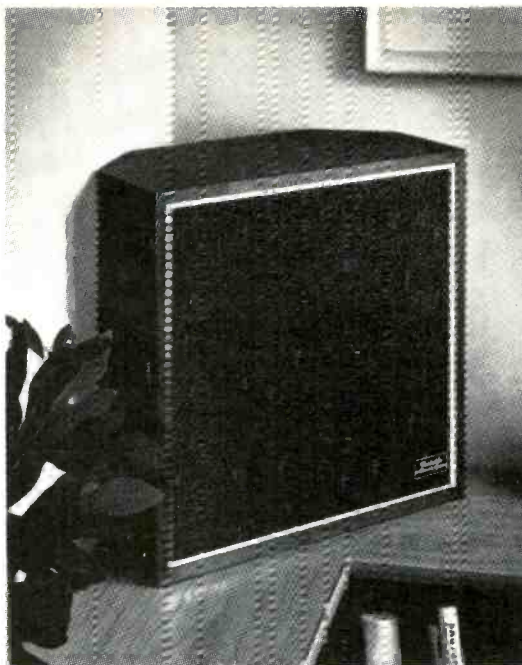

covers this important spectrum with clarity and definition; while a 2 1/2" ultra-curvilinear tweeter with low mass aluminum voice coil provides treble tones that faithfully image the original. A multi-element LCR network reduces electrical and acoustical distortion. Cabinet buzzes and resonances are avoided by sturdy, "unitized" construction.

One of six Wharfedale speaker systems engineered to satisfy every budget, space and performance requirement, the W35 is compellingly priced at \$82.00 list.

For catalog, write Wharfedale Division, British Industries Co., Dept. O-12, Westbury, New York 11590.

# Wharfedale

ACHROMATIC SPEAKER SYSTEMS

Check No. 39 on Reader Service Card

## The new W35 is built for power... and takes corners with ease.



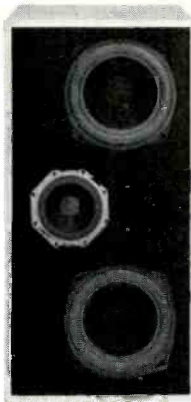

B&O 4700



B&W 70-CA



Allied Nova 9

MANUFACTURER	MODEL	WOOFER		MID-RANGE		TWEETER		Overall Freq. Resp., Hz to kHz	Impedance, Ohms	Enclosure Dimensions, W x D x H, in.	Wood Finish	Grille Material/Color	Weight, Lbs.	Price	SPECIAL FEATURES				
		Diameter, in.	Resonance (in system), Hz	Type	Diameter, in.	Type	Diameter, in.									Type			
ALLIED RADIO SHACK	Optimus 5	12	-	Acous. Susp.	-	-	4	-	-	20-20K +3	-	-	8	25 x 14 x 11 1/2	Wal.	Metal	35	99.95	3 tweeters.
	Nova-0mm	8	-	Acous. Susp.	-	-	-	Dome	45-20K	-	50	-	8	19 1/2 x 11 1/2 x 11 1/2	Wal.	Metal	25	69.95	360° dispersion.
	Nova 9	15	-	Acous. Susp.	4	Cone	-	Dome	20-25K +3	50	300 3,000	8	27 x 20 1/2 x 13 1/2	Wal.	Neutral	47	159.95	2 attenuator conts., tuned port.	
	MC-500	5	-	Acous. Susp.	-	-	2	-	75-20K +3	25	-	8	11 1/4 x 9 x 15 1/2	Wal.	Neutral	10	30.00		
ALTEC LANSING	Barcelona 2873A	15	-	Acous. Susp.	25	Sec. Horn	-	-	20-20K	-	60	500	-	29 1/2 x 38 1/2 x 24	Wal.	Fretwork	160	750.00	Includes 60 watts rms amp for bass; 30 watts ms for mids & highs.
	Santana 879A	15	-	Acous. Susp.	-	-	-	Dir. Rad.	35-18K	-	45	2,500	8	25 3/4 x 20 1/2 x 17	Wal.	Beige Cloth	-	195.00	Simulated slate top.
	Bolero 890C	10	-	Acous. Susp.	10	-	-	-	40-20K	-	50	2,000	8	14 1/2 x 25 1/2 x 12	Wal.	Fretwork	-	179.00	
	Segovia 874A	12	-	Acous. Susp.	4	-	-	Dome	20-20K	-	60	500 4,000	4	25 1/2 x 14 1/2 x 11 1/2	Wal.	Fretwork	58	250.00	
AZTEC	Gauguin III	12	25	Contr. duct.	3 x 9	Horn	2 x 6	Horn	25-20K +3	10	20	2,000 10,000	8	20 x 27 1/2 x 15 1/2	Wal.	Wood	65	249.95	
	Petite 1,000	8	50	Acous. Susp.	-	-	3 1/2	Cone	50-15K +3	15	30	2,000	8	20 x 10 x 9 1/2	Wal.	Tweed white	30	69.95	
B & W ELECTRONICS	70-CA	13	30	Inf.	Eleven-segment electrostatic			-	25-18K +3	50	400 18dB/oct.	8	26 1/2 x 32 1/2 x 15 1/2	Oil. wal. or white lacquer	Brn. or white	80	660.00	Triple suspens on woofer.	
BANG & OLUFSEN	3000	10	24	Acous. Susp.	-	-	2	Dome	28-20K +5	-	60	2,000	4	25 x 12 x 11	Teak or Rose wood	Cloth Charcoal	27	100.00	
	3700	8	30	Acous. Susp.	-	-	1 1/2	Dome	40-20K +5	-	40	2,000	40	9 1/2 x 9 1/2 x 19 1/2	Teak or Rose wood	Cloth Black	18	100.00	
	4700	(2) 7 1/2	30	Acous. Susp.	5	Cone	1 1/2	Dome	35-20K +5	15	50	500 3,000	4	13 x 11 1/2 x 11 1/2	"	Cloth blk.	30	175.00	*Brazilian rosewood or Burmese teak.
BELL & HOWELL	610	6.5	-	Seated	6	Cone	2	Cone (Concentric)	50-15K +5	5	25	2.5 kHz	8	8 1/2 x 15 1/2 x 6 1/2	Wal.	Cloth Brown	12	33.00	Polymer coated walnut veneer finish.
	620	8	90	Sealed Acous. Susp.	-	-	3	Cone	70-20K +6	5	30	3,000	8	11 1/2 x 7 1/2 x 17 1/2	Sim. wal.	Cloth blk.	10		Vetro-attached grille.
BENJAMIN	MS-5	8	62	Acous. Susp.	-	-	2 1/2	Cone	45-22K	10	25	2,000	8	10 1/2 x 8 x 19	Wal.	Cloth	13	55.00	
	MS-7	(2) 8 1/2	58	Acous. Susp.	-	-	2 1/2	Cone	40-25K	10	35	2,000	8	11 1/2 x 10 x 23	Wal.	Cloth	30	75.00	
	MS-10	(2) 8 1/2	50	Acous. Susp.	4	Cone	2 1/2	Cone	35-25K	10	40	800 3,000	8	13 1/2 x 11 x 24	Wal.	Cloth	38	100.00	
	MS-14	(2) 8 1/2; (2) 7 1/2	45	Acous. Susp.	4	Cone	2 1/2	Cone	30-18K	10	50	800 3,000	8	14 1/2 x 13 x 25 1/2	Wal.	Cloth	44	145.00	
BOGEN	LSX	4	-	Port	-	-	-	-	100-15K +5 dB	5	10	-	8	12 x 5 1/2 x 8 1/2	Wal.	Black	6	60.00 for pr.	Sold only as a pair.
	LS20A	8	-	Acous. Susp.	-	-	2 1/2	Cone	60-20K +5 dB	10	40	5,000	8	19 x 10 1/2 x 9	Wal.	Black	16 1/2	59.95	
	LS30A	10	-	Acous. Susp.	5	Cone	2 1/2	Cone	40-20K +5	10	50	600 5000	8	22 x 11 x 14	Wal.	Black	32	99.95	
	LS50	12	-	Acous. Susp.	2	Dome	-	Dome	25-20K +5	10	60	600 5,000	3	18 x 13 x 20	Wal.	Black	22	200.00	Woofer enclosure separate from tweeter/midrange.



We doubt that anyone will be overly surprised to learn that our newest loudspeaker sounds terrific. Most people really expect KLH to make terrific sounding things. But at \$62.50<sup>†</sup> a piece, our new Model Thirty-Eight delivers an amount and quality of sound that we think will astonish even our most avid fans. The bass response is absolutely staggering; the transient response is flawless; and the Thirty-Eight's overall smoothness matches anything we've ever heard. Most important, you can use a pair of Thirty-Eights with virtually any mod-

estly priced receiver. (What good is an inexpensive pair of loudspeakers that need a \$400 receiver to effectively drive them?)

The Thirty-Eights are at your KLH dealer now. After hearing them, we think you'd pay \$125 for just one. But \$125 buys you two. Which has got to make the Thirty-Eights the biggest stereo bargain since ears.

For more information, visit your KLH dealer or write to KLH Research and Development, 30 Cross Street, Cambridge, Mass. 02139.

## The New KLH Model Thirty-Eight. Two for \$125.<sup>†</sup>

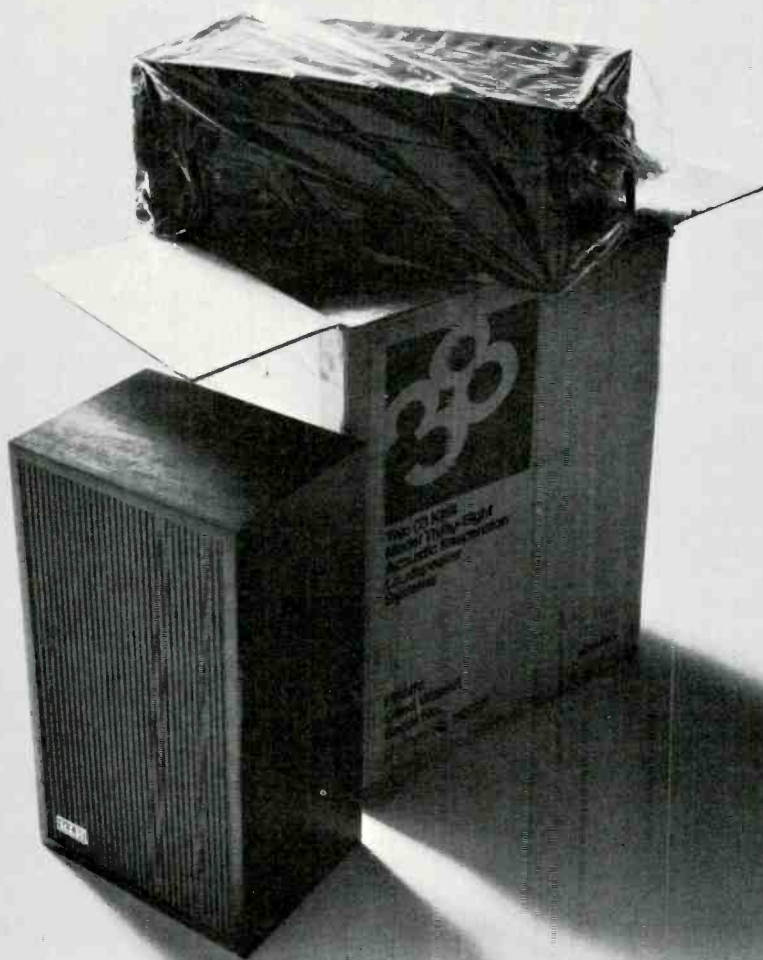

KLH RESEARCH AND DEVELOPMENT  
A Division of the Singer Company

<sup>†</sup>Suggested east coast retail price. Slightly higher in the south and west. \*A trademark of The Singer Company.

Check No. 41 on Reader Service Card



Eastman Crescendo



Bozak Tempo IB-301



Bose 901

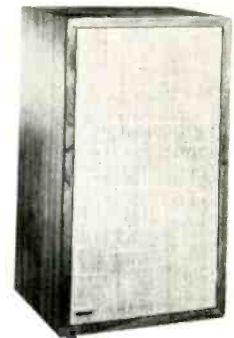

Dynaco A-25

MANUFACTURER	MODEL	WOOFER					MID-RANGE		TWEETER		Overall Freq. Resp., Hz to kHz	Ampl. Pow. for Avg. Room, W	Crossover Capacity (RMS W)	Impedance, Ohms	Enclosure Dimensions, W x D x H, in.	Wood Finish	Grille Material Color	Weight, Lbs.	Price	SPECIAL FEATURES
		Diameter, in.	Resonance (in system), Hz	Enclosure Type	Diameter, in.	Type	Diameter, in.	Type	20-20K ±5	20-20K										
BOSE	901	Nine full-range 4 1/2 inch drivers					-	-	-	25	270	-	8	20 1/2 x 12 1/2 x 12 1/2	Wal.	White Dk. Bm.	33	476.00 pair*	Direct reflecting, dk. brn. grille or wal. facings opt. Bl. or Wh. ped. opt. *Incl. act. Eq'lzr.	
	501	Integrated woofer-tweeter combination, balanced for direct and reflected sound.					-	-	-	15	100	-	4	14 1/2 x 14 1/2 x 24	Wal.	Dark Brown	35	124.80 each	Direct reflecting.	
BOZAK	B-301 Tempo I	12	40	Infin.	4 1/2	Cone	2	Cone	40-20K ±5	20	50	1,200 3,600	8	23 1/2 x 11 1/2 x 14 1/2	Wal.	Cloth Brown	49	149.50	3 position hi and mid environmental control.	
	B-302A Century	12	35	Infin.	6	Cone	2	Cone	40-20K	6	50	800 2,500	8	24 x 20 x 27 1/2	Wal.	Cloth brn. & blk.	-	316.25		
	B-4000A Modern	12	35	Infin.	6	Cone	2	Cone	35-20K	6	100	400 2,500	8	26 1/2 x 15 1/2 x 44 1/2	Wal.	Cloth brn. & Blk.	165	549.50	Line array tweeter; especially suitable for bi or tri amp operation.	
	B-1000 Bard	8	55	Infin.	-	-	-	-	50-10K	4	25	-	8	18 x 12 x 21	-	-	25	98.45	Weather proof, featuring aluminum cone & housing.	
BSR McDONALD	SS-2	8	45	Air Susp.	-	-	2 1/2	Cone	20-20K	4	18	-	8	14 x 8 x 7	Wal.	Cloth Brown	16*	70.00 *	*Pair.	
CRISMAN	Hefalump	15	30	Acous. laby.	10 x 7	Horn	2 x 5	Horn	30-18K	10	30	1,000 3,500	8	35 x 21 1/2 x 18 1/2	Wal.	Cloth Brown	90	193.00		
	Incredible Hulk	12	25	Acous. laby.	12 x 6	Horn	2 x 5	Horn	20-18K	10	50	800 3,500	8	35 x 21 1/2 x 18 1/2	Wal.	Cloth Gold	90	356.00		
	Bookbinder	8	55	Acous. laby.	-	-	2 x 5	Horn	40-18K	7	65	3,500	8	21 x 12 1/2 x 11 1/2	Wal.	Cloth, choice	35	98.00	Contin. adj. x-over.	
	Glendenning	12	40	Acous. laby.	10 x 4	Horn	2 x 5	Horn	30-18K	7	75	1,000 3,500	8	15 1/2 x 15 1/2 x 29	Wal.	Cloth, choice	72	165.00	2 cont. adj. x-overs.	
DAYTON WRIGHT †	XGBU/MT	Full range electrostatic, hermetically sealed.					-	-	35-14K ±3	20	350	-	8	40 x 11 x 49	Wal.	Option	54 ea.	1,832.00 pr.	XGBU, utility; MT = matching transformer-XGB1, with screen, \$200 additional; SA (stereo amp) model \$167 addl.	
DENON	VS-260	10	-	Bass Reflex	4 1/2	Cone	2	Horn	40-20K	-	30	600 3,500	8	14 1/2 x 25 3/4 x 10 1/2	Wal.	Cloth Brn. & white	35 1/2	360.00 a pair	Variable level cont. for high & mid-range; multi. ch. selector.	
	VS-160	8	-	Bass Reflex	4	Cone	2	Horn	40-20K	-	25	2,500 7,500	8	13 1/2 x 20 1/4 x 9 1/2	Wal.	Cloth Brn. & white	22	239.00 a pair	Variable level cont. for high & mid-range; multi. ch. selector.	
DELTA RET	500	(2)8	60	Acous. Susp.	-	-	(2)3	Cone	35-22K ±3	10	50	3,000	4	24 x 12 x 14	Wal.	Cloth Blk. & Beige	35	399.95	Separate equalizer; 20" angled spkr. mount gives flat resp. over 120° spread.	
DYNACO	A-25	10	-	Aperi-odic	-	-	1 1/2	Dome	-	20	30	1,500	8	20 x 11 1/2 x 10	Wal.	Linen Natl.	22	79.95	Teak & rosewood, \$10.00 additional.	
	A-50	(2)10	-	Aperi-odic	-	-	1 1/2	Dome	-	25	40	1,200	8	28 x 21 1/2 x 10	Wal.	Linen Natl.	47	179.95		
	† A-10	6 1/2	-	Aperi-odic	-	-	1 1/2	Dome	-	15	50	2,500	8	8 1/2 x 8 x 15	Orl. Wal.	Linen natl.	30 pr.	99.95 pr.	Sold in pairs with matched wood grain.	
EASTMAN (MARTIN)	120 Super Max	10	50	Acous. Susp.	-	-	3	Cone	36-18K ±7	8	35	1,700	-	10 x 12 x 21	Wal.	Cloth Brown	30	89.95		
	430 Crescendo	12	40	Acous. Susp.	4	Cone	2	Dome	30-18K ±5	7	36	1,000 5,000	8	12 x 13 x 25	Wal.	Cloth Brown	50	169.95	Mid & Hi controls.	
	830 Magnificat	(2)12	38	Acous. Susp.	7	Acous. Susp.	(2)2	Dome	28-20K ±5	10	60	750 4,000	4	14 x 8 x 38	Wal.	Cloth Brown	90	319.95		





EPI 400 Minitower



Empire 7500M



E-V 4A

MANUFACTURER	MODEL	WOOFER		MID-RANGE		TWEETER		Overall Freq. Resp., Hz to kHz ± 2 dB	Ampl. Pwr., for Avk. Room, W	Pwr. Handling Capacity (RMS W)	Impedance, Ohms	Crossover Frequency (Hz), Hz	Enclosure Dimensions, W x D x H, in.	Wood Finish	Grille Material Color	Weight, Lbs.	Price	SPECIAL FEATURES	
		Diameter, in.	Resonance (in system), Hz	Enclosure Type	Diameter, in.	Type	Diameter, in.												Type
ELECTROSTATIC SOUND	TS-Monitor	(2) 9x12	15	Trans. Line	Electrostatic	(9) 6x6	Electrostatic	25-20K ±2.5	60	150	550	4	19 x 19 x 60	Wal. Rosewd.	Fiber, blk.	180	1,035.00		
	TS-I	9 x 12	15	Trans. Line	Cone	(3) 3x6	Electrostatic	25-20K ±2.5	60	150	275, 1,475	8	18 x 15 x 40	Wal. Rosewd.	Fiber, blk.	135	579.00		
	TL-II	9x12	20	Trans. Line	Cone	(2) 2"	Dome	30-20K ±2.5	30	100	485, 1,485	8	14 x 13 x 40	Wal. Rosewd.	Fiber, blk.	80	299.00		
	ESS VII	9x12	20	Resistive Loading	Cone	2"	Dome	35-20K ±2.5	20	100	485, 1,485	8	14 x 13 x 27	Wal. Rosewd.	Fiber, blk.	60	189.00		
ELECTRO-VOICE	Four A	12	47	Acous. Susp.	Cone	2 1/2	Cone	30-20K	10	35	400, 1,500	8	25 x 13 1/2 x 14	Wal.	Cloth, Dk. Brn.	45	199.95		
	Nine	10	50	Acous. Susp.	Cone	3 1/2	Cone	30-20K	10	35	400, 1,000	8	22 1/2 x 12 x 13 1/2	Wal.	Cloth Dk. Brn.	30	139.95		
	Patrician 800	30	-	-	-	-	-	15-23K	20	70	100, 800, 5,000	16	33 x 26 1/2 x 51	Wal., Fruit-wood	Cloth Brown	315	1,400.00		
	Eight A	6	-	Acous. Susp.	-	2 1/2	Cone with Dome	60-20K	-	60 peak	-	8	15 1/2 x 6 1/2 x 8 1/2	Wal.	Cloth Brown	13	49.95		
	Seven-B	8	75	Acous. Susp.	-	3 1/2	Cone	40-20K	10	35	1,500	8	19 x 9 x 10	Wal.	Cloth, dk. brn.	19	64.95	Symmetrical cone damping.	
EMPIRE	9000 M II	15	20	Inf. Baff.	5	Dome	1	Dome	20-20K ±3	10	100	450, 5,000	8	22 dia. x 29	Wal.	None	120	329.95	Includes imported marble top.
	7500 M	15	25	Inf. baff.	5	Dome	1	Dome	20-20K ±3	10	100	450, 5,000	8	20 dia. x 27	Wal. Oak	None	75	184.95	Includes imported marble top.
	7000 M II	12	30	Reflex	5	Dome	1	Dome	25-20K ±3	10	100	450, 5,000	8	19 dia. x 26	Wal.	None	90	229.95	Includes imported marble top.
	6000 M	10	40	Reflex	4	Cone	2	Cone	30-18k ±3	10	75	500, 5,000	8	18 dia. x 24	Wal. Oak	None	60	119.95	Includes imported marble top.
EPI	100	8	43	Acous. Susp.	-	-	1	Invert. dome	43-18K ±1.5	20	50	1,800	8	9 x 11 x 21	Wal.	Black	25	89.00	
	601	(2) 18 (1) 6	35	Acous. Susp.	-	-	(3) 1	Invert. dome	35-18K ±3	35	150	1,800	4	15 x 24 x 16	Wal.	Black	60	249.00	Reflective system.
	201A	(2) 8	40	Acous. Susp.	-	-	(2) 1	Invert. dome	-	25	75	1,800	8-16	11 x 18 x 28	Wal.	Black	40	199.00	Dispersion up and forward with two modules.
	400	(4) 6	30	Acous. Susp.	-	-	(4) 1	Dome	30-18K	35	200	1,800	8	14 x 14 x 38	Wal.	Blk.	90	389.00	Omnidirectional.
FAIRFAX	F2A	8	-	Ducted port	-	-	3	Cone	35-20K	8	25	8	12 x 9 x 18	Oil. Wal.	Cloth Black	22	59.95	3/4 in. board construction.	
	FX100A	8	-	Ducted port	-	-	3	Cone	32-20K	8	30	8	12 x 7 1/2 x 21	Oil. Wal.	Cloth Black	22	79.95	3/4 in. board construction.	
	FX200C	(2) 8	-	Acous. Susp.	-	-	1	Dome	30-20K	10	40	8	21 x 7 1/2 x 12	Oil. Wal.	Cloth Black	26	99.95	3/4 in. board construction.	
	FTA2	(2) 8	-	Acous. Susp.	3 1/2	Cone	4	Cone	24-20K	10	50	8	14 x 12 x 24	Oil. Wal.	Cloth Black	44	139.95	1 in. board construction.	
	L34A	(2) 8	-	Laby.	5	Cone	1	Dome	20-20K	12	50	8	14 x 12 x 24	Oil. Wal.	Cloth Black	48	189.95	1 in. board construction.	
	FE8A	(4) 8	-	Acous. Susp.	(2) 5	Cone	(2) 3; (2) 1	Cone; Dome	20-20K	15	60	8	20 x 12 x 28 1/2	Oil. Wal.	Cloth Black	64	279.95	1 in. board construction.	
	Wall of Sound	(6) 8	-	Laby.	(2) 5	Cone	(2) 3; (2) 1	Cone Dome	20-22K	20	100	6 1/2	30 x 6 1/2 x 52	Oil. Wal.	Cloth Black	125	399.95	1 in. board construction.	

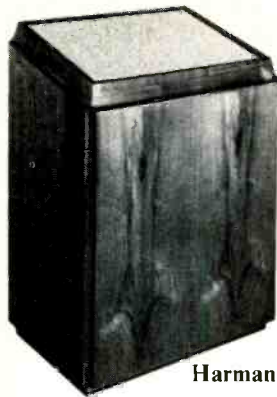

Harman-Kardon Citation 13



Fisher XP-7B

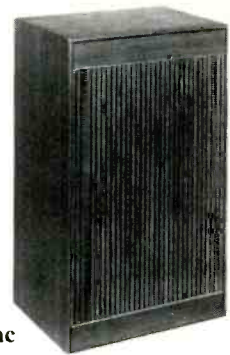

Hartley Zodiac

MANUFACTURER	MODEL	Diameter, in.		Resonance (in system) Hz	Enclosure Type	WOOFER		MID-RANGE		TWEETER		Overall Freq. Resp., Hz to kHz	Ampl. Pwr., for Av. Room, W	Crossover Capacity (RMS W)	Crossover Frequency (Hz), Hz	Impedance, Ohms	Enclosure Dimensions, W x D x H, in.	Wood Finish	Grille Material Color	Weight, Lbs.	Price	SPECIAL FEATURES
		Diameter, in.	Type			Diameter, in.	Type	Diameter, in.	Type													
FISHER	XP-9C	15	10	Acous. Susp.	(2)5	Cone	(2)1½	Dome	28-22K	20	30	500 1,200 5,000	8	27½ x 16½ x 13	Wal.	Cloth Brown	55	219.95	4-way with dome super tweeter.			
	† XP-7C	12	15	Acous. Susp.	(2) 5¼	Cone	(2) 3	Cone	30-20K	20	25	350 800 3,500	8	24½ x 14 x 11¾	Wal.	Cloth Brown	40	169.95	4-way, lattice-work grille. XP-7B, similar, \$159.95.			
	XP-66C	12	20	Acous. Susp.	5¼	Cone	3	Cone	32-20K	15	25	400 1,500	8	24½ x 13½ x 12	Wal.	Cloth Brown	33	129.95	3-way, lattice-work grille. XP-65k, similar, \$109.95.			
	† XP-56	8	38	Acous. Susp.	-	-	3	Cone	35-20K	10	15	1,500	8	21 x 11½ x 9	Wal.	Cloth Brown	20	79.95	2-way, fretwork grille opt. at \$89.95. XP-55B similar \$49.95.			
	XP-18	18		Acous. Susp.	8, 5¼	Cone	(2) 2	Dome	30-22K		60	150 1,500 3,000	8	30½ x 16½ x 29½	Wal.	Cloth, brn.	105		3-step-adj. mid and hi cont.			
	WS-80	8		Omn.	5¼	Cone	3	Dome	35-20K		30	400 1,500	8	18 x 11 x 18½	Wal.		24					
	101	8		Acous. Susp.	-	-	3	Cone	37-20K		30	1,500	8	20 x 7½ x 10½	Wal.	Fret-work	18					
	105	12		Acous. Susp.	5¼	Cone	3	Cone	32-30K		50	400 1,500	8	24½ x 12 x 13½	Wal.	Fret-work	33					
FRAZIER	Mark VI	12	25	Mod. Helmholtz	8	Cone	3 x 7	Horn	25-14K ±5	5	50	800 3,300	8	25½ x 16½ x 29	Wal.	Brown & gold	90	295.00	Cone or dome tweeter opt.; 3-way adjust. network.			
	Mark V	12	25	Acous. Susp.	(2)4	Cone	3 x 7	Horn	30-14K ±5	5	30	800 3,300	8	14 x 12 x 25½	Wal.	Brown	50	189.95	Bal. controls for Hi & mid freq. In black, \$159.95.			
	Capsule	10	50	Acous. Susp.	-	-	2 x 3	Cone	30-15K ±5	5	25	1,500	8	16 x 16 x 19	Black	-	35	75.00				
	Mark IV	10	60	Helmholtz	-	-	3 x 7	Horn	60-13K ±5	5	25	2,000	8	14 x 12 x 24	Wal.	Linen natl.	41	99.95				
	Manhattan Deluxe	8	38	Tuned port	-	-	3	Cone	40-15K ±5	1	30	3,000	8	24 x 12 x 19	Oil, Wal.	Org.	37	125.10	With base \$129.90.			
	Black Box II Deluxe	8	38	Tuned port	-	-	3 x 7	Comp. Horn	40-15K ±5	1	30	3,000	8	19 x 12 x 24	Black	-	33	106.00	Brilliance cont.			
	Black Box I Deluxe	8	38	Tuned port	-	-	3	Cone	40-15K ±5	1	30	3,000	8	19 x 12 x 24	Black	-	33	87.00	6 dB per octave network.			
	Monte Carlo IV	8	100	Tuned port	-	-	3	Cone	40-12K ±5	5	20	3,000	8	19 x 11½ x 10¼	Wal.	Linen natl.	24½	69.00				
	Super Midget	4		Tuned enc.	-	-	-	-	100-12K ±5	5	15	-	8	15½ x 9½ x 7½	Wal.	Black	10	32.95				
HARMAN-KARDON	Citation 13	(3)7	32	Doab. Chamb. reflex	1½	Dome	1	Dome	27-22K ±3	15	60	1,500 6,000	6-8	20½ x 14½ x 29½	Wal.	Brown, Blue, Orange, Black	80	295.00	Omnidirectional type.			
HARTLEY	Concertmaster VI	24	13	Semi. Inf.	10	Cone	7	Cone with dome	16-25K ±3	20	50	250 3,000	12	39 x 29 x 18	Wal.	Cloth Gold Brown	150	795.00	Mag. susp.; cast alum. frames; cones of iden. matl.; x-overs, 12dB/oct.			
	Holton A	10	28	Inf.	-	-	1	Dome	30-25K ±4	15	30	2,000	6	30 x 24 x 14	Wal.	Cloth, brn. & gld.	85	300.00				
	Holton Jr.	10	30	Inf.	-	-	1	Dome	35-25K ±4	15	30	2,000	6	30 x 15 x 13	Wal.	Cloth, brn. & gld.	50	250.00				
	Zodiac II	8	30	Inf.	-	-	2	Cone	40-18K	10	20	2,000	5	18 x 11½ x 8½	*	Black mesh	16	90.00	*Rosewood, wal. teak, white.			
	Zodiac III	8	30	Inf.	4	Cone	2	Cone	38-20K	10	20	2,000 8,000	5	20 x 12 x 8½	*	Black mesh	23	135.00	*As above.			





Hitachi HS-500



Infinity Hologonic I

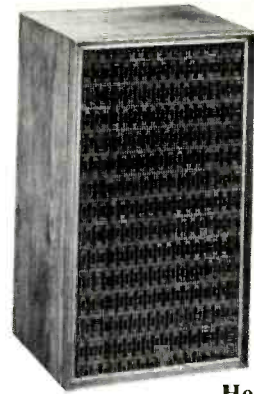

Heath AS-105

MANUFACTURER	MODEL	WOOFER		MID-RANGE		TWEETER		Overall Free Resp. Hz to MHz	Impedance, Ohms	Enclosure Dimensions, W x D x H, In.	Wood Finish	Grille Material Color	Weight, Lbs.	Price	SPECIAL FEATURES				
		Diameter, In.	Resonance (in system), Hz	Diameter, In.	Type	Diameter, In.	Type									Ampl. Pwr. for Av. Room, W	Crossover Frequency (Hz), Hz		
HEATH	AS-48	14	—	Duct. port	—	2	Cone	40-20K	8	50	2,000	8	23 1/2 x 12 x 14	Pecan	Cloth Brown-Black	42	184.95	Kit, JBL components.	
	AS-103	12	42	Acous. Susp.	1.5	Dome	0.75	Dome	30-20K	25	—	575	4	14 x 11 1/2 x 25	Wal.	Cloth Brn.-Blk.	53	189.95	Kit, AR components.
	AS-101	15	—	Bass reflex	—	—	—	Compl. driver	35-20K	—	50	800	8	27 1/2 x 19 1/2 x 29 1/2	Pecan	Cloth Gold-Blk.	101	259.95	Kit, ALTEC components.
	AS-102	12	—	Inf. Baffle	6	Cone	(2)2 1/2	Cone	40-20K	—	50	800	8	27 1/2 x 19 1/2 x 25 1/2	Pecan	Cloth Gold-Blk.	92	239.95	Kit, BOZAK components
	AS-104	10	46	Acous. Susp.	4 1/2	Cone	3 1/2	Cone	30-18K ± 5	10	30	500	8	24 x 13 1/2 x 11 1/2	Oil, wal.	Cloth Brown	36	89.95	
	AS-105	10	46	Acous. Susp.	—	—	3 1/2	Cone	30-18K ± 5	10	30	1,000	8	24 x 13 1/2 x 11 1/2	Oil, wal.	Cloth gld. & brn.	34	69.95	Unfin., \$64.95.
HEATH	AS-106	4 1/2	100	Acous. Susp.	—	—	—	100-10K ± 5	4	20	—	8	12 x 7 x 6	Oil, wal.	Cloth Black	6	19.95		
HEGEMAN	—	8	—	Col.	—	—	1	Dome	30-20K	15	25	5,000	8	10 1/2 x 8 1/2 x 25	Teak Vinyl	Black	20	199.00*	*Pair.
HILL	D200	12	—	Air susp.	3 1/2	—	1	Dome	35-19K	10	40	1,000	8	—	Wal.	Cloth Brn. or Blk.	40	100.00	
	500	8 1/2	50	Sealed	—	—	1 1/2	Dome	40-16K ± 5	20	60	1,500	8	—	—	—	—	79.00	*Woofer had butyl rubber surround; built-in fusing.
HITACHI	HS-201	8	—	Reflex	—	—	—	Horn	40-20K	—	20	4,000	8	21 1/2 x 11 1/2 x 12 1/2	Wal.	Cloth Brown	26 1/2	95.00	Detachable grille.
	HS-250	10	—	Reflex	5	Cone	—	Horn	35-20K	—	40	500	8	25 1/2 x 11 1/2 x 14 1/2	Wal.	Cloth Brown	37 1/2	155.00	Detachable grille.
	HS-300	8	—	Reflex	—	—	—	Horn	40-20K	—	50	3,500	8	14 1/2 x 9 1/2 x 23 1/2	Wal.	Cloth Beige	33	—	Woofer has gathered edge suspension.
	HS-500	8	—	Reflex	—	—	—	Horn	40-20K	—	20	3,000	8	14 1/2 x 13 1/2 x 24	Wal.	Cloth Brown	—	315.00	Woofer has gathered edge suspension.
IMF	Studio	8	24	Dual trans. line	4	Lam. cone	2 1/2	Dome	25-20K ± 3	30-60	25	375	8	15 x 14 x 35 1/2	Wal.	Cloth Black	70	300.00	Dual transmission line, laminated plastic, 4-way drive system.
	Monitor II	—	14	Dual trans. line	5	Lam. cone	2 1/2	Dome	20-25K ± 2	30-60	30	375	8	20 x 17 x 43	Formica, Grey or Wal.	Cloth Black	125	800.00	*9 x 12 in. rectangular.
	Studio MK II	8	24	Dual Trans. Line	5	Cone	1 1/2	Dome	24-20K ± 5	30	25	375	8	15 x 14 x 35 1/2	Wal.	Cloth Black	70	320.00	4-way plastic laminate drive system
INFINITY	2000A	12	—	Trans. line	4.5	Cone	Strid	Electro.	28-30K ± 3	35	100	275	6	26 x 18 x 12	Wal., Rosewood	Cloth Black	60	289.00	Electrostatic tweeters above 17K radiate from rear.
	Servo Static I	18	—	Servo system	—	Electro.	—	Electro.	15-30K ± 2.5	60	100	100	—	—	Wal., Rosewood	Cloth Black	140	1,995.00	2 electrostatic screens w. bass amp and bass comode. Includes electronic crossover.
	1001	12	—	Trans. Line	—	—	2	Cone	31-21K ± 4.5	20	75	1,300	6	25 x 14 1/2 x 12 1/2	Wal.	Black	50	139.00	
	Holographic I	12	—	Trans. Line	—	—	(5) 2	Cone	27-21K ± 3.5	20	75	1,300	6	39 x 13 1/2 x 12 1/2	Wal.	Black	65	210.00	

# Wednesday for piano. Thursday for horns.

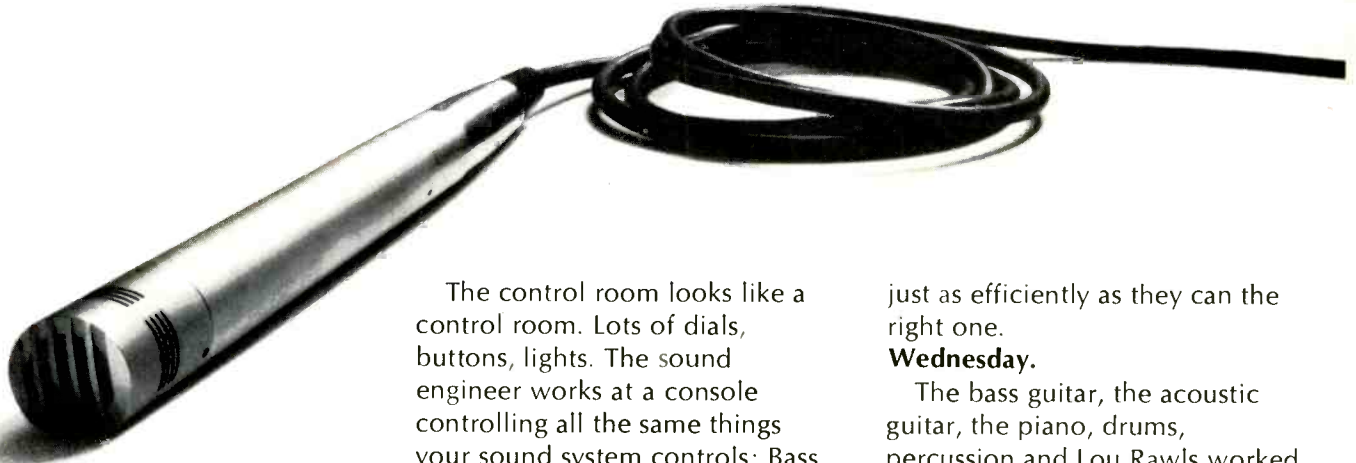

► **Close your eyes.**  
**Lou Rawls is singing. He says, "Believe in me." And you do.**  
**An acoustic guitar, way off to the left somewhere, scratches the back of your ear. Trap drums hug the bass guitar in the center of the sound. Strings, woodwinds, percussion, trombones, fourteen different pieces of pure sound come together.**

**And you're there with them— hearing, sharing, capturing a moment that never happened.**

They don't make records like they used to.

Until very, very recently the goal of any musical recording was to recreate an event that had happened somewhere. The "live" performance was perfection; the only purpose of recording was to record.

It's not that way any more. Not with the new music.

The last album you bought, the one with fifteen or twenty artists performing together, likely took a month to record, another month to mix. Many of the musicians performed as soloists, the rest in small groups. Only three people were there from the first day to the last: The arranger, the producer and the sound engineer.

The control room looks like a control room. Lots of dials, buttons, lights. The sound engineer works at a console controlling all the same things your sound system controls: Bass, treble, volume, balance, etcetera. The only difference between your system and this one is a little more sensitivity, capacity, precision and maybe two or three hundred thousand dollars.



The control room and the studio are acoustically isolated. Very important. The only way sound can come out of that studio is through a speaker in the control room. See those beauties all in a row? JBL speakers, thank you.

Out in the studio, there are yards and yards of cloth hung here and there between musicians, over instruments and next to microphones. The cloth dampens sound. It keeps each instrument's sound near the microphone assigned to it. That's important. Musical instrument microphones are very precise and very literal and can pick up the wrong sound

just as efficiently as they can the right one.

## Wednesday.

The bass guitar, the acoustic guitar, the piano, drums, percussion and Lou Rawls worked the same session.

The tambourines start in the big studio but are banished to the isolation booth because their sound is leaking into other microphones.

Look at the five microphones on the drums; three for the traps and two for the bass drums. Each is there to retrieve a particular tonal quality.

See the mike inside the piano, under the top, over the sound? If you really want to hear good piano, that's the place.

## Thursday.

Horns, woodwinds, strings— each takes his turn until all have had their say.

Finally, fourteen channels are filled, each with a component of the total sound, ready to be blended.

## Monday.

The mix-down begins. Fourteen tracks heading toward two.

Each monitor speaker holds a separate sound. And now each is heard in turn, solo and then in unison.

The sound engineer steps to the podium and brings up the bass guitar for rhythm. It goes in the center of the stereo perspective. He tightens it slightly, adding equalization at 50 Hz.







**L100 CENTURY**

A runaway best seller. The beautiful twin of JBL's compact professional studio monitor. Now the mightiest bookshelf ever produced. Easily handles 50 watts of continuous program material, although it takes only 1 watt to produce 78db sound pressure level at 15 feet. Oiled walnut enclosure and a new dimensional grille that's more acoustically transparent than cloth and happens in colors like Ultra Blue, Burnt Orange or Russet Brown. 14"x24"x14". \$273.

**L200 STUDIO MASTER**

Just like JBL's professional studio monitor only more so. High acoustic output, uniform spatial distribution, smooth frequency response and the extraordinary capability of handling a full 100 watts of continuous program material, yet produces 80db sound pressure level at 15 feet with only 1 watt input. Graceful tapered form, oiled walnut enclosure and sculptured Crenelex grille in Smoke or Raven or Aegean or Burgundy. 33"x24"x21". \$597.



**Guitars over there. Woodwinds here. How do they do that?** Besides the left-channel and right-channel placements, the sound engineer uses tiny delays in sound and drops in volume to place the sound "away" from you or "near" you. Your brain does the rest, putting each sound in stereo perspective.

Traps left and traps right. A little equalization to brighten them; some echo to give them depth.

Now the bass drum; then the acoustic guitar on the left with the piano on the right to balance it.

**Wednesday, again.**

The tambourine comes into the

center with a bit of echo to make it fuller. French horns left and right and the sweetening process: Bass trombones for resonance. An oboe solo for delicacy and a room full of strings — violins, cello, viola — to make the whole thing smooth and round.

And, finally, all monitor speakers are in agreement. One last button is pushed, and the master recording is made.

That's all there is to it.

**The art of recording is changing. The business is changing. More creative scope, more ideas, more discipline. A whole new incredibly complex art form has emerged.**

**We're glad to be a part of it. In fact, most major recording studios in the world produce their records mastered on JBL monitors.**

James B. Lansing Sound, Inc.  
3249 Casitas Avenue  
Los Angeles 90039  
A subsidiary of Jervis Corporation



Check No. 47 on Reader Service Card

Our thanks to Lou Rawls and MGM Records for allowing us to document the recording, mixing and mastering of the title song from the MGM movie, Believe in Me.

Jensen Model 5

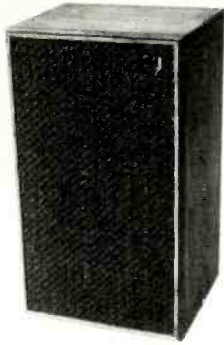

JBL L-200



JansZen Z-412



MANUFACTURER	MODEL	Diameter, in.		Resonance (in system), Hz	Enclosure Type	WOOFER		MID-RANGE		TWEETER		Overall Pres. Resp., Hz to kHz	Ampl. Pwr. for Avg. Room, W	Crossover Capacity (RMS) W	Impedance, Ohms	Enclosure Frequency (res), Hz	W x D x H, in.	Wood Finish	Grille Material Color	Weight, Lbs.	Price	SPECIAL FEATURES
		W	D			Type	Diameter, in.	Type	Type													
JBL	† L55 Lancer 55	14	25	Bass Reflex	-	2	Cone	-	2	35	2,000	8	18 x 13 x 25	Oil Wal.	Cloth, Choice	65	276.00					
	† S109 Aquarius 4	8	40	Bass Reflex	-	2	Cone	-	3	35	3,000-8,000*	8	10 x 10 x 40	Oil Wal.	Matte Brown	52	186.00	*Broad band.				
	L100 Century	12	27	Bass reflex	5	Cone	2	Cone	2		2,500	8	24 x 14 x 14	Wal.	Foam	54	276.00	Acous. identical with JBL monitor.				
	L200 Studio Master	15	55	Bass reflex	-	-	Compression	1	100	1,200	8	24 x 14 x 14	Wal.	Foam	125	597.00						
JVC	5351	15	27	Acous. Susp.	6 1/2	Horn	2 2	Cone Horn	20-20K ± 2.5	8	50	400 1,000 5,000	8	17 1/2 x 15 1/2 x 29 1/2	Wal.	Cloth, Brown	57 1/2	299.95	Provision for elect. crossover, 2 level controls.			
	5306	12	28	Acous. Susp.	5	Dome	2 2	Dome Horn	20-20K + 3	20	30	600 4,000 8,000	8	14 1/2 x 12 1/2 x 26	Wal.	Cloth, Brn. & White	40 1/2	249.95	Provision for elect. crossover; 2 level controls.			
	5321	8	28	Air susp.	3 1/2	Cone	2	Cone	37-20K ± 5	5	30	5,000 10,000	8	13 x 9 1/2 x 21 1/2	Wal.	Brown	21 1/2	89.95	Detachable grille.			
	5305	4 x 5	28	Acous. Susp.	-	-	4 x 2	Cone	20-20K + 5	12	40	5,000	8	13 1/2	Metal Black	Metal Black	26 1/2	169.95	Omnidirectional; includes stands.			
JANSZEN	Z-108	8	55	-	-	-	-	Electrostatic	35-20K + 3	20	100	2K	4	10 1/2 x 20 x 10 1/2	Wal. & Vinyl	-	-	99.95				
	Z-110	10	43	-	-	-	-	Electrostatic	25-20K + 3	20	100	2K	4	12 1/2 x 23 1/2 x 11 1/2	Wal. & Vinyl	-	-	129.95				
	JanKit 41	11	50	Acous. Susp.	-	-	(2)	Electro	46-20K + 3 dB	20	75	1,500	4	-	-	-	15	139.95	2 electrostatic elements and 11" woofer mounted on baffle board for custom installations.			
	Z-210	10	44	Acous. Susp.	-	-	(2)	Electro	35-20K + 3	20	75	2,000	4	21 x 14 x 21	Wal.	-	41	169.95	2 electrostatic elements and 2 acoustical refraction lenses.			
	Z-412	12	39	Acous. Susp.	-	-	(4)	Electro	31-20K + 3	20	100	800	4	14 1/2 x 14 x 26 1/2	Oil Wal.	-	50	279.95	4 electrostatic elements and omnidirectional acoustical refraction lens.			
	Z-600A	10	37	Acous. Susp.	-	-	-	Electro	32-20K + 3 dB	20	75	2,000	8	20 x 13 x 26 1/2	Oil Wal.	Brown or Brown	50	249.95	2 electrostatic elements.			
	Z-900A	(2) 10	35	Acous. Susp.	-	-	-	Electro.	30-20K - 3 dB	20	100	700	4	31 1/2 x 15 1/2 x 26	Oil Wal.	Brown or Black	80	398.00	4 electrostatic elements, 2 10 in. dynamic woofers.			
	130	-	-	-	-	-	-	Electro.	700-20K + 3 dB	20	100	700	4	22 x 13 x 7 1/2	Oil Wal. or Util.	Beige	13	199.95	120° dispersion 4 element, electrostatic mid/high array.			
	65	-	-	-	-	-	-	Electro.	1500-20K + 3 dB	20	50	1,500	4	11 1/2 x 7 1/2 x 6 1/2	Oil or Util.	Beige	8	119.95	2 element electrostatic mid/high array.			
JENSEN	1	8	-	Closed Baffle	-	-	-	40-18K	5	-	6,000	11	14 1/2 x 10 x 8 1/2	Vinyl	Cloth Beige	14	30.00					
	2	8	-	Closed Baffle	-	-	3 1/2	Cone	38-20K	5	-	1,200	11	18 1/2 x 11 x 8 1/2	Wal.	Cloth Beige	22	48.00	Removable grille.			
	3	10	-	Closed Baffle	-	-	3 1/2	Cone	36-20K	5	-	800	4	22 1/2 x 12 1/2 x 10 1/2	Wal.	Cloth Beige	31	75.00	Removable grille.			
	4	10	-	Closed baffle	5	Cone	-	Dome	36-20K	5	-	500 4K	8	24 x 13 x 12	Wal.	Cloth Char. Brown	46	99.00	Removable grille.			
	5	12	-	Closed baffle	Two 5	Cone	-	Dome	32-30K	5	-	500 4K	4	26 x 15 x 13	Wal.	Cloth Blk. & Brown	52	147.00	Removable grille.			
	6	15	-	Closed baffle	8	Cone	5	Cone & dome	27-30K	5	-	300 1,000 4K	4	27 x 20 1/2 x 15	Wal.	Cloth Black	74	198.00	Removable grille.			
KARLSON	X-15	15	22	Spec.	-	-	-	Comp. ± 3.5	20-16K	2	100	2,000	16	28 x 19 x 14	Wal.	Black	90	300.00	*Compression tweeter w. special Karlson X-over.			





Kenwood KL-5060

Belle Klipsch

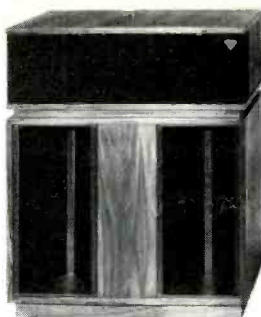

KLH 38



MANUFACTURER	MODEL	Diameter, in.		Resonance (in system), Hz	WOOFER		MID-RANGE		TWEETER		Overall Freq. Resp., Hz to MHz	7 dB	Ampl. Pwr. for Avg. Room, W	Pwr. Handling Capacity (RMS W)	Crossover Frequency (Hz), Hz	Impedance, Ohms	Enclosure Dimensions, W x D x H, in.	Wood Finish	Grille Material Color	Weight, Lbs.	Price	SPECIAL FEATURES
		Diaphragm	Diaphragm		Type	Type	Type	Type														
KENWOOD	KL-5060	12	45	Ducted Reflex	6 1/2	Cone		2 Horns	40-20K	10	40	600 6,000	8	15 x 11 1/2 x 25 1/2	Wal.	Metal Dk. Brn.	48	279.95 Pair	2 level controls; free-edge woofer; 2 horn tweeter.			
	KL-3080	10	55	Ducted Reflex	5	Cone	1 1/2	Cone	45-20K	8	25	800 5,000	8	13 x 11 1/2 x 22 1/2	Wal.	Metal Dk. Brn.	31	199.95 Pair	Free-edge woofer.			
KLEIN & HUMMEL	OY	10	20	Acous. Susp.	(2) 4	Cone	-	Horn	40-16K +2	-	-	500 8,000	4,700	19 x 9 x 12	Wal.	Metal Silver	44	566.50	Contains 2 30-watt amps & x-over; takes input direct from preamp.			
	SL-35	10	14	Acous. Susp.	3	Cone	-	Horn	30-20K	6	40	500 6,000	6	19 x 9 x 12	Wal.	Cloth Gray	-	235.00*	*Plus 7% surcharge.			
KLH	5	12	44	Acous.	(2) 3	Cone	1 1/4	Cone	-	25	-	600 2500	8	26 x 11 1/2 x 13 1/4	Oil Wal.	Cloth, lt. brn.	54	189.95	2 3-pos level contrs; fin on 4 sides; changeable grille cloth.			
	33	10	56	CAC*	-	-	1 3/4	Dir. rad.	-	15	-	1500	8	23 1/2 x 10 1/8 x 12 1/4	Oil Wal.	Cloth, lt. brn.	33	99.95	*Contr. acous. compliance 3-pos h.f. level contr; fin 4 sides; changeable grille.			
	17	10	60	Acous. Susp.	-	-	1 3/4	Cone	-	12	-	1500	8	23 1/2 x 9 x 11 1/4	Oil Wal.	Cloth, off white	27	74.95	3-pos tweeter level contr; fin 4 sides; changeable grille.			
	32	8	59	Acous. Susp.	-	-	2	Cone	-	12	-	1800	8	19 1/2 x 7 1/2 x 10 1/8	Oil Wal.	Brown	16 ea.	93.00 pr.	Available only in double pack.			
	38	10	50	Acous. Susp.	-	-	1 3/4	Cone/ Dome	-	12- 15	-	1,750	8	12 1/2 x 8 1/2 x 21 1/2	Oil Wal.	Brown Boncle	25	62.50	Packed two a carton, \$125.00 the pair.			
	12	12	35	Acous. Susp.	(2) 3	Cone	1 1/4	Cone	-	30	-	600 2,500	8	22 1/2 x 15 x 29	Oil Wal.	Boucle Off-White	114	275.00	4 3-pos. level controls- changeable grille cloth.			
KLIPSCH	Klipschorn K-437	15	-	Horn	2	Horn	1	Horn	35-17K	10	100	400 6000	8	52 x 31 x 28	Wal., Mah., others	Several	180	471.00 1,026.00				
	Belle Klipsch	15	-	Horn	2	Horn	1	Horn	40-17.5K	10	100	400 6000	8	30 x 18 x 36	Wal.	Several	145	841.00				
	La Scala K447	15	-	Horn	2	Horn	1	Horn	45-17.5K	10	100	406 6000	8	34 x 24 x 24	Fir	None	126	576.00				
	Cornwall	15	-	Ducted port	2	Horn	1	Horn	38-17K	10	60	600 6000	8	25 x 36 x 15	Wal., Mah., others	Several	55	460.00 342.00				
	Heresy	12	-	Total encl.	2	Horn	1	Horn	45-17K	10	40	700 6000	8	22 x 15 x 13	Wal., Mah., others	Several	45	252.00 209.00				
LAFAYETTE	Criterion 5XB	12		Acous. Susp.	6 1/2	Cone	3 1 1/2	Cone Cone	18-25K	5	75	800 4,000 10,000	8	23 1/2 x 14 1/2 x 11 1/2	Oil Wal.	Cloth, dk. brn.	46	129.95	4-way, 4 speaker system - 2 level controls.			
	ES85	8	45	Acous. Susp.	-	-	-	Elec- tro.*	45-25K	12	45	5,000	8	21 1/2 x 8 1/2 x 11 1/2	Wal.	Cloth Brown	20	64.95	4-element tweeter with control. *Single side.			
	88	10	20	Acous. Susp.	3	Cone	1 1/2	Cone	20-20K	15	40	6,500 16,000	8	15 x 9 1/2 x 24 1/2	Wal.	Cloth Brown	32	89.95	Brilliance control.			
	90	12	18	Acous. Susp.	6 1/2, 3	Cone	1 1/2	Cone	18-15K	20	90	650 3,500 5,000	8	18 x 12 x 30	Wal.	Cloth Brown	67	159.95	Mid & Hi controls.			
LWE	I-A	15		Acous. Susp.	6	Cone	5	Horn	20-20K ±5	20	40	2,000 4,500	4	25 x 17 x 12	Wal. or kit	Cloth, dk. brn.	61	290.00 250.00 (kit)	Electronic suspension; inverse feedback.			
	II	Two 15		Acous. Susp.	Two 6	Cone	5	Horn	20-20K ±5	40	80	2,000 4,500	4 or 8	34 x 24 x 16	Wal. or kit	Cloth, dk. brn.	141	500.00 400.00 (kit)	Electronic suspension.			
	VI	8	85	Acous. Susp.	-	-	3 1/2	Cone	30-15K ±5	10	20	3,000	8	19 x 10 x 9	Wal. or kit	Cloth, dk. brn.	23	94.50 74.50 (kit)	Electronic suspension.			
	III	12	-	-	6	Cone	3 1/2	Cone	25-17K ±5	15	40	-	4	22 1/2 x 15 x 9 1/2	Oil Wal.	Cloth Brown	-	185.00	Mid & Hi controls.			
	IV	(4) 15	-	-	(4)8; (4)6	-	(2)5	Horn	16-20K ±5	100	200	-	4	48 1/2 x 36 1/2 x 20	Oil, Wal.	Fretwork grille	-	1250.00				
	VII	10	-	-	-	-	3 1/2	Cone	28-18K ±5	15	35	-	4	22 1/2 x 15 x 9 1/2	Oil Wal.	Cloth Brown	-	135.00				
	VIII	(8) 15	-	-	(8)8; (8)6	-	(3)5	Horn	16-20K ±5	200	400	-	4	90 x 49 1/2 x 23	Oil Wal.	Fretwork grille	-	2300.00				



*Special Offer to*  
**Audio Readers & Subscribers**

# EXECUTIVE SHOPPING

Wants you to TRY THIS REMARKABLE  
 IN THE COMFORT OF YOUR HOME OR

**ABSOLUT**



*The beauty of con-  
 temporary design. . . .*

*The Comfort of 2½" of  
 luxurious foam-filling . . .*

*The durability of heavy  
 gauge chrome-plated  
 steel and fine quality  
 Naugahyde makes the  
 "SWINGER" Chair and  
 Ottoman a beautiful  
 addition to any room, at a  
 price you can afford.*

You'll marvel at the "Swinger's"  
 unique reclining action.  
 It tilts and reclines, utilizing  
 only gravity. No moving  
 parts to wear out and no effort  
 on your part, to recline  
 to any position.



Burnt Orange

Tar

Avocado

Oxblood

Black



# DISCOUNT SERVICE



HAIR & MATCHING OTTOMAN,  
OFFICE FOR THE NEXT 15 DAYS—  
**FREE!**

**TRY IT FREE FOR 15 DAYS AND IF YOU LIKE IT . . .**  
Pay only \$119.50 plus a small shipping and handling charge, or charge it to your credit card.

### AT HOME . . . AT WORK . . .

- Read in your Swinger while your body relaxes.
- Rest in your "Swinger." Take a break out of your daily routine and "recharge" yourself.
- Unwind from the office in your "Swinger!"
- Watch television in your "Swinger." Its unique design reduces body fatigue.
- Make good music, great music in your "Swinger."

### THE SWINGER FITS INTO EVERY ROOM!

It's perfect for a waiting room . . . a den . . . in front of the fireplace . . . in the living room . . . the family room . . . the office . . . library or study.

And, the Swinger and matching Ottoman are available in your choice of vibrant decorator colors. The luxurious swinger looks rich, feels rich . . . yet costs very little!

But, before you even think about purchasing this remarkable new chair and ottoman, we would like you to try it for yourself.

*Use it for 15 days and then decide if this fantastic chair and matching ottoman is worth the special Executive Discount Shopping Service price of only \$119.50 plus shipping and handling.*

**YOU SAVE VALUABLE DOLLARS!** (The Swinger and matching ottoman is now being sold in stores across the country for more than \$149.50).

**IF YOU DECIDE TO KEEP THE SWINGER (AND WE KNOW YOU WILL)**

### Pay Cash & Save!

1. Pay the full cash price of only \$119.50 by check or money order, and we'll pay all shipping and handling charges.

or . . .

2. Charge your "Swinger" to your Credit Card. Executive Discount Shopping Service is authorized to accept the following cards for payment.

- Diners Club
- American Express
- Carte Blanche
- Mastercharge

If you decide to return the Swinger for any reason at all, just slip into the original shipping carton and send it back to us. It's that simple! But, no matter what you decide, NOW's the time to take advantage of this great opportunity to examine the Swinger and matching Ottoman absolutely FREE with NO OBLIGATION TO PURCHASE!

**MAIL THIS COUPON TODAY . . .** We'll ship you a brand new Swinger in your choice of color immediately. Satisfaction guaranteed.

*P.S. If you like the bearskin rug in the photo under the "Swinger", you can order that too! It's another great bargain from Executive Discount Shopping Service at only \$98.50 plus nominal shipping charges and sales tax where applicable.*

### EXECUTIVE DISCOUNT SHOPPING SERVICE

1309 Cherry Street, Philadelphia, Pa. 19107  
Please send me the "Swinger" Recliner with Ottoman for a 15 day free trial. I understand that if I am not completely satisfied, I may return the Swinger and Ottoman in 15 days and my money will be fully and promptly refunded.

**Plan 1 . . . Save Money—Pay Cash**, and we'll pay the costs of shipping and handling.  
 I prefer to pay cash. I am enclosing my check or money order for \$119.50 for each chair & hassock ordered.

**Plan 2**  
 Please bill my credit card \$119.50 plus \$9.95 shipping and handling.

#  
 American Express  Diners Club  Carte Blanche  Master Charge

**Choice of Color**  
 #3B3 Burnt Orange  #3T8 Tan  #3F8 Black  
 #3A8 Avocado  #3X8 Oxblood

**P.S.** I like the "Big As Life" Animal Skin Rugs. Please ship me the following products and charge my account only \$98.50 ea. plus a slight additional shipping and handling charge.

Bear Rug (5' x 7')  white  brown  black  
 Leopard (5' x 9')  Tiger (5' x 9')

Please ship my order to:  Home  Office

Name \_\_\_\_\_

Title \_\_\_\_\_

Company \_\_\_\_\_

Street \_\_\_\_\_ Tel. \_\_\_\_\_

City \_\_\_\_\_ State \_\_\_\_\_ Zip \_\_\_\_\_ (area code)

Signature \_\_\_\_\_

(Order must be signed)

Local Sales Tax where applicable will be added. Sorry, no merchandise can be shipped to a P.O. box.

I prefer to pay cash. I am enclosing my check or money order for \$98.50. (Ship prepaid)

Please bill my credit card \$98.50 plus \$3.50 freight and handling. (Fill in credit card info on the left)

AU-3



Marantz Imperial VI

Nikko SS-83



Panasonic SB-400

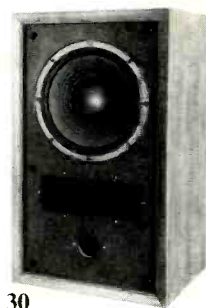

Onkyo 30

MANUFACTURER	MODEL	WOOFER			MID-RANGE		TWEETER		Overall Freq. Resp., Hz to kHz -1 dB	Ampl. Pwr. for Avg. Room W	Power Handling Capacity (RMS #)	Crossover Frequency (dB) Hz	Impedance, Ohms	Enclosure Dimensions W x D x H, in.	Wood Finish	Grille Material Color	Weight, Lbs.	Price	SPECIAL FEATURES
		Diameter, in.	Resonance (in system) Hz	Enclosure Type	Diameter, in.	Type	Diameter, in.	Type											
MARANTZ	Imperial 4A	8	-	Acous. Susp.	-	-	2	Cone	60-18K	-	30	2000	8	10 1/4 x 7 1/2 x 18 1/2	Wal.	Cloth brn.	14	69.00	
	Imperial 5	8	-	Ducted port	-	-	2	Dome	35-20K	5	40	2000	8	12 x 9 1/2 x 23	Wal.	Cloth brn.	-	89.00	
	Imperial 6	10	-	Ducted port	-	-	2	Cone	40-18K ±5	-	100	3000	8	14 1/4 x 11 1/2 x 25 1/2	Wal.	Cloth brn.	-	129.00	
MAXIMUS	1	5	55	Acous. Susp.	-	-	1	Dome	45-20K ±5	-	-	1900	8	7 1/2 x 5 1/2 x 10 1/2	Wal.	-	10	87.50	
	5	12	40	Acous. Susp.	6/3	-	1	Dome	20-35K ±5	-	-	1000 5K 8K	8	14 x 12 x 30	Wal.	-	52	187.50	
	44	18	45	Acous. Susp.	-	-	3	-	30-18K ±5	-	-	2000	8	12 1/4 x 9 1/2 x 22	Wal.	-	28	105.95	
	55	12	45	Acous. Susp.	6	-	3 1/2	Cone	20-20K ±5	-	-	2,000 5,000	8	24 x 14 x 12	Wal.	-	30	137.50	
	† Hallmark I	6	100	Acous. Susp.	-	-	2	Acous.	50-17K	5	10	5,000	8	15 x 8 x 8	Wal.	Brown Black	5	32.95	*Hallmark speakers may carry an additional product name.
	† Hallmark II	8	45	Acous. Susp.	-	-	3	Acous.	40-18K	10	15	1,500	8	17 1/2 x 9 1/2 x 8 1/2	Wal.	Brown Black	7 1/2	52.95	
	† Hallmark III	10	35	Acous. Susp.	-	-	3	Acous.	30-18K	10	30	5,000	8	22 x 12 1/2 x 9 1/2	Wal.	Brown Black	25	75.95	
† Hallmark IV	12	40	Acous. Susp.	3	-	3	Acous.	30-20K	10	50	2,000 5,000	8	24 x 14 x 12	Wal.	Brown Black	35	94.95		
MICRO ACOUSTICS							Two 1 1/2; Two 1 1/2	Dyn.	3.5-18K -2	10	60	3.5K & 7K*	16	9 1/4 x 5 1/2 x 3 1/4	Wal.	Cloth, beige	2 1/4	57.00	*Switchable. For use with full range system.
NIKKO	SS-83	8	-	Acous. Susp.	-	-	2 1/4	Cone	40-21K	15	4,000	8	9 x 9 x 14 1/2	Wal.	Cloth, blk.	10 1/4	-	Constant RLF network (12 dB oct); High compl. woofer; interchang. grille.	
	† SS-85	8	-	Bass Reflex	5	-	2	Horn	40-21K ±5	-	25	1,000 5,000	8	9 x 14 1/2 x 18 1/2	Oil Wal.	Cloth Brown	15.5	-	
	† SS-88	12	-	Bass Reflex	5	-	2 1/4	Horn	35-21K ±5	-	35	600 6,000	8	11 x 16 x 26 1/2	Oil Wal.	Wood Lattice	38 1/2	-	3-step tone control.
OHM	B	12	32	Acous. Susp.	5 1/2	-	1	Cone	30-20K ±5	20	60	250 5,000	8	26 x 15 x 10 1/2	Wal.	Cloth, brn.	-	240.00	Quasi 18 dB oct. phase linear cross-over.
	C	10	32	Acous. Susp.	-	-	1	Cone	34-20K ±5	20	50	1,750	8	25 x 14 x 9 1/2	Wal.	Cloth, brn.	-	115.00	Quasi 18 dB oct. phase linear cross-over.
ONKYO	† 20	12	60	Cone	2	-	1	Dome	35-20K	10	25	700 7,000	8	23 1/2 x 13 1/2 x 11 1/2	Wal.	Cloth Beige	40	199.95	12 dB/oct. network 2 dB steps ± 5 pos. cont. for mid & hi.; removable grille.
	† 25	14	53	Cone	2	-	1	Dome	30-20K	10	30	700 7,000	8	25 1/2 x 14 1/2 x 11 1/2	Wal.	Cloth Beige	54 1/2	249.95	As above.
	† 30	12	45	Cone	3 1/2 x 10 1/2	Horn	2 1/4	Horn	20-20K	15	30	700 5,000	8	28 1/2 x 16 1/2 x 15 1/2	Wal.	Cloth Beige	51	299.95	As above.
PANASONIC	SB-750	12	50	Acous. Susp.	(2) 6	-	(2) 4	Dome	20-20K	60	600 5,000	8	19 1/2 x 11 1/2 x 29 1/2	Wal.	Wood Lattice	55.1	239.95	Front level controls; provision for electronic crossover.	
	SB-550	12	60	Acous. Susp.	6	-	4	Dome	30-20K	45	500 5,000	8	15 1/2 x 11 1/2 x 25 1/2	Wal.	Wood Lattice	41.9	189.95	Front level controls; provision for electronic crossover.	
	SB-300	10	75	Acous. Susp.	5	-	3 1/2 1 1/2	Dome Dome	35-20K	30	800 5,000 10,000	8	13 1/2 x 11 1/2 x 22 1/2	Wal.	Cloth, Black	22 lb. 13 oz.	119.95	4-sprk., 4-way; provision for electronic crossover.	
	SB-400	10	65	Acous. Susp.	8-cell	-	6-cell	-	35-20K	-	38	650	8	12 1/2 x 11 1/2 x 25 1/2	Wal.	Cloth Black	26 1/2	149.95	Front level controls; provision for electronic x-over.





Quad

Retilinear III



Pioneer CS-A700

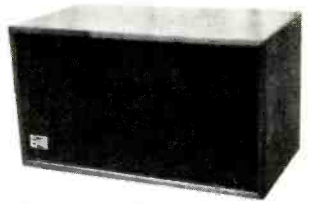
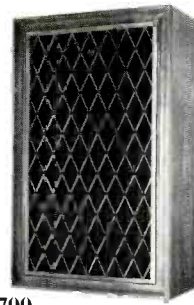

Rogersound 28

MANUFACTURER	MODEL	Diameter, in.		Acous. Susp.	Resonance (in system), Hz	Enclosure Type	WOOFER		MID-RANGE		TWEETER		Overall Freq. Resp., Hz to kHz	Ampl. Pow. for Avg. Room, W	Part. Handling Capacity (RMS W)	Crossover Frequency (Hz), Hz	Impedance, Ohms	Enclosure Dimensions, W x D x H, in.	Wood Finish	Grille Material Color	Weight, Lbs.	Price	SPECIAL FEATURES
		Diameter, in.	Type				Diameter, in.	Type	Diameter, in.	Type													
PIONEER	† CS-99A	15	55	Acous. Susp.	(1)4; (1)5	Cone	2x2; 4x4	Horn	25-22K	10	40	800 2,000 5,000 10K	8	16 1/2 x 11 1/2 x 24 1/4	Wal.	Wood Lattice	52	229.95	Hi & mid control.				
	† CS-E400	8	50	Acous. Susp.	-	-	1 1/2	Dome	35-20K	10	12	2,800	8	11 1/2 x 7 1/2 x 20 1/2	Wal.	Cloth	23	79.95	Level control, removable grille.				
	† CS-E350	8	60	Acous. Susp.	-	-	3	Cone	40-20K	8	12	2,200	8	10 1/2 x 8 1/2 x 18 1/2	Wal.	Cloth	13	64.95					
	CS-A700	12	60	Acous. Susp.	4 1/2	Cone	1	Multi-cell Horn	35-20K	10	25	500 4,500	8	12 1/2 x 15 x 26	Wal.	Wood Lattice	37	189.00	Level control for mid range and high range; provision for elect. crossover.				
	CS-A500	10	60	Acous. Susp.	4 1/2	Cone	2 1/2	Cone	42-20K	10	15	800 6,000	8	13 x 12 1/2 x 22 1/2	Wal.	Wood Lattice	32	149.00	As above.				
QUAD (HARMONY HOUSE)									45-18K	30	60					34 1/2 x 31 x 10 1/2	Wal.	Anod. al., bronze		260.00	Full-range doublet; electrostatic; dispersion 70 deg. hor., 15 deg. vert.		
QUADRAFLEX (PACIFIC)	† 66	12	45	Air Susp.	6	Cone	3	Cone	35-20K ±5	20*	40	500 5,000	8	16 x 13 1/2 x 25 1/2	Wal.	Cloth Brn.	42	139.95	*20 w/1000 ft <sup>3</sup> room vol. for 103 dB SPL.				
	† 55	10	52	Air Susp.	4	Cone	3	Cone	45-20K ±5	14*	25	650 6,000	8	15 x 11 1/2 x 24	Wal.	Cloth Brn.	37	99.95	*14 w/1000 ft <sup>3</sup> room vol. for 101 dB SPL.				
	† 44	10	48	Air Susp.	-	-	3 1/2	Cone	50-20K ±5	12*	25	750	8	13 1/2 x 11 x 23	Wal.	Cloth Brn.	32	69.95	*12 w/1000 ft <sup>3</sup> room vol. for 100 dB SPL.				
	33	8	64	Air Susp.	-	-	3	Cone	60-20K ±5	10*	20	1,400	8	11 1/2 x 9 1/2 x 20	Wal.	Cloth Brn.	26	54.95	*10 w/1000 ft <sup>3</sup> room vol. for 98 dB SPL.				
	22	6	68	Air Susp.	-	-	3	Cone	65-20K ±5	6.2*	10	1,200	8	10 1/2 x 7 1/2 x 18	Wal.	Cloth Brn.	20	39.95	*6.2 w/1000 ft <sup>3</sup> room vol. for 95 dB SPL.				
	11	6	98	Air Susp.	-	-	-	-	90-8000 ±5	2.4*	10	-	8	9 x 7 1/2 x 14	Wal.	Cloth Brn.	16	24.95	*2.4 w/1000 ft <sup>3</sup> room vol. for 95 dB SPL.				
RADFORD (AUDIOHICS)	Trident Three	12	55	Air Sus.	5	Cone	1	Dome	50-20K ±3	5	60	500 4,500	8	22 x 13 x 10	Wal.	Dark	45	170.00					
	† 360S	(2) 12		Trans. line	(4) 4	Cone	(4) 1/2	Dome	25-25K ±5	10	100	500 5,000	8	45 x 18 1/2 x 15	Wal.		110	600.00	Omnidirectional.				
RECTILINEAR	III	12	40	Bass Reflex	5	Cone	(2)2 1/2 (2)2	Cone	22-18.5K ±5	20	100	500 3K, 11K	8	18 x 12 x 35	Wal.	Cloth, brn.	70	279.00	Low-mass drivers.				
	XII	10	45	Bass Reflex	5	Cone	3	Cone	45-17K ±3	10	70	350 4,000	8	25 x 14 x 10 1/2	Wal.	Cloth, brn.	44	139.00	High efficiency phase-linear X-over.				
	Mini III	8	50	Acous. Susp.	5	Cone	2	Cone	50-18.5K ±4	20	75	400 8,000	4	19 x 12 x 9 1/2	Wal.	Cloth, brn.	25	99.50	Low-mass driver, e/c. bass resp.				
	XI	10	50	Bass Reflex	-	-	3	Cone	45-17K ±3	10	40	1,800	8	23 x 12 x 10 1/2	Oil. Wal.	Fret-work	32	79.50					
	Xa	10	30	Acous. Susp.	5	Cone	2 1/2	Cone	30-18.5K ±4	35	75	100 800	4	25 x 14 x 10 1/2	Oil. Wal.	Cloth Brn.	65	199.00					
	† Low Boy III	12	40	Bass Reflex	5	Cone	(2)2, (2)2 1/2	Cone	20-18.5K ±5	20	100	500 3,000 11,000	8	28 x 22 x 12 1/2	Oil. Wal.	Fret-work	75	299.00					
ROGERSOUND	† RSL 28	8	64	Acous. Susp.	-	-	2 1/2	Cone	48-17.5 ±5	13	30	1,600	8	18 x 9 1/2 x 8 1/2	Wal.	Black	15	39.95					
	† RSL Studio Monitor	12	52	Bass Reflex	5	Cone	2 x 6	Horn	40-16K ±5	6	65	800 5,000	8	25 x 14 1/2 x 12	Blk.	Blk.	45	95.00	Utility cab.; wal. \$20.00 extra.				
ROLECOR	ROTEL RS-900	10	-	Acous. Susp.	6 1/2	Cone	1.5	Dome	30-20K	-	25	700 4,000	8	15 1/2 x 10 1/2 x 22 1/2	Wal.	Cloth, black or white	31	129.95	Mid-high range level control.				
	Rotel RS-1000	12		Acous. Susp.	6 1/2	Cone	2 x 2	Horn	20-22K	30		550 7,000	8	16 1/2 x 12 1/2 x 26 1/2	Wal.	Cloth blk. or wht.	47 1/2	179.95	Bass reflex pipe-ducted port; mid-hi range level control.				

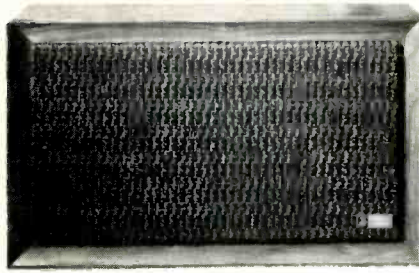

Soundcraftsmen SC-6

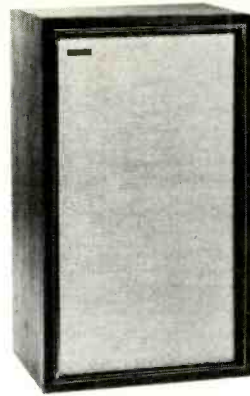

Scott S-11



Sansui AS-300

MANUFACTURER	MODEL	WOOFER			MID-RANGE		TWEETER			Overall Frq. Resp., Hz to kHz ± 1 dB	Amdt. Pwr. for Avg. Room W	Pwr. Handling Capacity (RMS W)	Crossover Frequency (Hz), Hz	Impedance, Ohms	Enclosure Dimensions, W x D x H, in.	Wood Finish	Grille Material Color	Weight, Lbs.	Price	SPECIAL FEATURES
		Diameter, in.	Resonance (in system), Hz	Enclosure Type	Diameter, in.	Type	Diameter, in.	Type	Diaphragm											
RTR	1200E			(6) 8		(9)	Elec.	200-30K	30	100	200 1,750		16½ x 16½ x x 27	Wal.		65	360.00	Rosewood, \$375.00, Magnum 12 and 15 woofers, resp. to 30 or 25 Hz, \$160 or \$240.00.		
SAE	Mark XII	12	39	Acous. Susp.	5; Cone Electrostatic*		Electrostatic			60	150	120, 240 or 480**; 1,250	8	17 x 12¼ x 27	Wal.	Blk; Beige	150 pr.	850.00 pr.	Elec. overload & oscil. prot.; mid & hi level cont. *3 panel, mid & hi range; **adj.	
SANSUI	AS-10C	10		Air Susp.	-	-	3	Dome	45-20K ± 5		28	2,000	8	11½ x 20½ x 9½	Wal.	Cloth, Beige	29½	89.95	Level-balance cont. for tweeter.	
	AS-20C	10		Air Susp.	6½	Cone	3	Cone	40-20K ± 5		35	2,000 7,000	8	12 x 12½ x 23½	Wal.	Cloth, Beige	40	119.95	Level-balance cont. for tweeter and midrange.	
	AS-300	12		Air Susp.	6	Dome	1	Dome	35-20K ± 5		42		8	14¼ x 12 x 26½	Wal.	Cloth, Beige	48	149.95	Level-balance cont. for tweeter and midrange.	
SCHOBER	LSS-100	(2) 12	30	Reflex	8	Cone	(2)	Horns	30-18K ± 5	1	100	150 1,000 3,500	8	32 x 16 x 54	Wal.	Cane Beige	180	544.00	4-way system.	
	LSS-10A	12	32	Reflex	8	Cone	1	horn	30-18K	2	40	250 3,500	8	24 x 16 x 34	Wal.	Cane Beige	105	196.00	Tweeter horn opt., kit.	
SCOTT	S-41	8	52	Acous. Susp.			3½	Cone	35-20K	10	35	1700	8	10½ x 9½ x 19	Wal.	Cloth, gray	25	69.90		
	S-51	10	37	Acous. Susp.			3½	Cone	30-20K	18	60	1200	8	14½ x 11½ x 24	Wal.	Cloth, gray	45	89.90		
	S-11C	10		Acous. Susp.	3½	Cone	3	Cone	35-20K	10	50	900 3,500	8	14½ x 11½ x 24	Wal.	Cloth, Bnn.	40	99.90		
SHERWOOD	Woodstock	8		Acous. Susp.	-	-	3½	Cone	40-18K	5	25	4,000	8	18 x 9 x 11	Wal.	Cloth, brn.	18	59.95	Tweeter control.	
	Berkshire III	12	21	Acous. Susp.	5	Cone	3½	Cone	28-22K	10	60	600 5,000	8	24 x 9 x 19	Wal.	Cloth, brn.	40	129.95	Removeable grille, midrange and tweeter controls.	
	Ravinia III	15	19	Acous. Susp.	5	Cone	3½	Cone	24-22K	10	70	600 5,000	8	25 x 11½ x 17	Wal.	Cloth, brn.	54	169.95	As above.	
SDNY	SS-4200	8	85	Acous. Susp.	8	Cone	3	Cone	50-20K ± 5	6	30	500 10K	8	13½ x 11½ x 23½	Wal.	Cloth, Black	30½	97.50	*Subject to increase.	
	SS-9500			Omni- dir.					50-18K	5	30	-	6	16 dia., 23" high	Wal.	Cloth, Bnn.	30½	149.50	Uses six full range 4-in. cone type speakers. *Subject to increase.	
SOUND INDUSTRIES	Quatre 8000	8		Ducted Port	5	Cone	2½	Cone	35-20K ± 5	10	50	400 2,500	8	14½ x 11½ x 29¼	Veneers	Various	48	85.00		
SOUNDCRAFTSMEN	Lancer SC-6	12	-	Bass energ. Tri-ax.	-	Diffuser	-	Flared Horn	18-22K	10	60	1,000 3,000	8	27 x 16 x 14½	Oil Wal.	Cloth, dk. red, consumer changeable	57	249.50	4-way system, aerodynamic bass- energized; 12-in. passive radiator; cont. var. h.f. level control.	
	Lancer SC-3X	12	-	Reflex res. loaded Tri-ax.	-	Diffuser	-	Flared Horn	26-22K	10	60	1,000 3,000	8	23½ x 15½ x 12½	Oil Wal.	Cloth, dk. red, consumer changeable	45	199.50	3-way system; ducted-port reflex, resistance loaded.	
	Lancer SC-5	12	-	Reflex Tri-ax.	-	Diffuser	-	Flared Horn	28-20K	5	40	1,000 3,500	8	23½ x 15¼ x 12½	Oil Wal.	Cloth, Beige	38	149.50	3-way system; dual ducted port reflex; tuned ports.	
TANNOY	† Granada	10	55	Ducted bass reflex	-	-	2½	Horn	48-20K ± 4	15	30	1,200	8	23½ x 14" x 11½	Oil. Wal.	Wht. cloth & carv. wd.	50	185.00	HF dyn. and bal. cont.	
	† Stuart	12	40	Ducted bass reflex	-	-	2½	Horn	40-20K ± 4	15	40	1,000	8	25½ x 24½ x 16½	Oil. Wal.	Wht. cloth & carv. wd.	60	294.00	HF dyn. and bal. cont.	
	Orbitus I	12	40	Omni.	-	-	2½	Horn	35-20K	20	30	1,000	8	17 x 17 x 29	Wal.		50	245.00	Omni, Dyn. and freq. bal. control.	



# After the monthly breakthroughs and revolutions in speaker design, how come the Rectilinear III still sounds better?

Figure it out for yourself.

More than five years ago, without much fanfare, we came out with a very carefully engineered but basically quite straightforward floor-standing speaker system. It consisted of six cone speakers and a cross-over network in a tuned enclosure; its dimensions were 35" by 18" by 12" deep; its oiled walnut cabinet was handsome but quite simple.

That was the original **Rectilinear III**, which we are still selling, to this day, for \$279.

Within a year, virtually every hi-fi editor and equipment re-

viewer went on record to the effect that the **Rectilinear III** was unsurpassed by any other speaker system, regardless of type, size or price. (Reprints still available.)

Then came about forty-seven different breakthroughs and revolutions in the course of the years, while we kept the **Rectilinear III** unchanged. We thought it sounded a lot more natural than the breakthrough stuff, but of course we were prejudiced.

Finally, last year, we started to make a **lowboy** version of the **Rectilinear III**. It was purely a cosmetic change, since the two versions are electrically and acoustically identical. But the

new **lowboy** is wider, lower and more sumptuous, with a very impressive fretwork grille. It measures 28" by 22" by 12 $\frac{1}{4}$ " deep (same internal volume) and is priced \$20 higher at \$299.

The new version gave *Stereo Review* the opportunity to test the **Rectilinear III** again after a lapse of almost five years. And, lo and behold, the test report said that "the system did an essentially perfect job of duplicating our "live music" and that both the original and the **lowboy** version "are among the best-sounding and most 'natural' speakers we have heard." (Reprints on request.)

So, what we would like you to figure out is this:

What was the real breakthrough and who made it?

For more information, including detailed literature see your audio dealer or write to Rectilinear Research Corp., 107 Bruckner Blvd., Bronx, N. Y. 10454.

## Rectilinear III

Check No. 55 on Reader Service Card

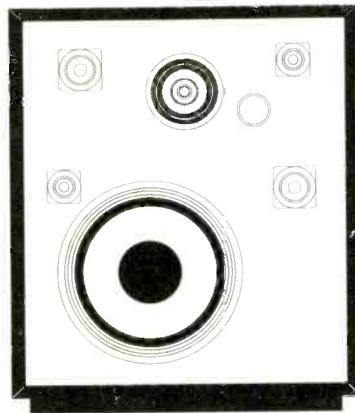

V-M Model 93



Wharfedale W80A



University Presidio



MANUFACTURER	MODEL	WOOFER		MID-RANGE		TWEETER		SPECIAL FEATURES											
		Diameter, In.	Resonance (for system), Hz	Enclosure Type	Diameter, In.	Type	Diameter, In.	Type	Overall Freq. Resp., Hz to kHz	Ampl. Pwr., for Av. Room, W	Pwr. Handling Capacity (RMS W)	Crossover Frequency (RMS W)	Impedance, Ohms	Enclosure Dimensions, W x D x H, In.	Wood Finish	Grille Material Color	Weight, Lbs.	Price	SPECIAL FEATURES
TEAC	LS-350	12	35	Acous. Susp.	4	Cone	2	Com-pression	50-20K +5	25	30	700 5,000	8	16 x 11 1/4 x 25 1/2	Oil Wal.	Cloth	41	134.50	Brightness control for mid and hi range; LC crossover.
	LS-400	12	30	Ducted Reflex	4	Cone	2	Com-pression	50-20K +5	25	40	500 5,000	8	17 1/2 x 14 1/4 x 27 1/4	Oil Wal.	Cloth	58	179.50	Separate mid and hi balance controls; LC crossover.
	LC-80M	12	40	Acous. Susp.	5	Cone	2	Com-pression	50-20K +5	25	40	450 5,000	8	16 x 11 1/4 x 26 1/4	Oil Wal.	Sculptured Rhombic pattern	42	199.50	Built-in crossover, or for tri-amp use.
SM. WOLLENSAK	A1000	4	100	Acous. Susp.					80-12K	10	14		8	8 x 9 x 13	Wal.	Cloth, Beige		49.95 (pr.)	
	A1050	4	100	Acous. Susp.					80-12K	10	14		8	7 1/4 cube	Wal.	Cloth, Beige		79.95 (pr.)	
ULTRA-TONE	Ultra I	Nine 4 1/2 in. full range.							20-20K	5	200	-	8	23 1/2 x 11 1/2 x 13	Wal.		35	399.95 pr.	
UNIVERSITY	Presidio	12		Acous. Susp.		Cone		Cone	20-40K	5	40	1,000 3,000	8	24 x 15 x 23	Wal.	Cloth, Brn.	70	199.95	
	Project M	11		Acous. Susp.			2 1/2	Cone	30-20K	5	60	1,000	8	12 1/4 x 11 1/4 x 23 1/2	Wal.	Cloth, Beige	30	109.95	
	Ultra D	10		Acous. Susp.	4	Cone	3 1/2	Cone	30-30K	3	32	1,000 5,000	8	11 1/4 x 9 3/4 x 23	Wal.	Cloth, Beige	24	89.95	
	Laredo	12	-	Acous. Susp.	8 2-way	Cone		Cone	30-30K	5	40	600 1,500 3,000	8	15 1/4 x 12 1/4 x 24	Wal.	Cloth, Beige	47 1/2	129.95	
V-M	85	8		Acous. Susp.	-	-	3 1/2	Cone	35-20K	-	40	2,000	8	20 1/4 x 26 x 26	Pecan	Cloth, gold	65	210.00	
	84	8		Acous. Susp.	-	-	3 1/2	Cone	35-20K	-	40	2,000	8	20 x 19 1/2 x 19 1/2	Pecan	Cloth, brn.	41	145.00	
	93	10		Acous. Susp.	4 1/2	Cone	1	Dome	37-22K +5	4	40	1,000 5,000	8	13 1/2 x 23 x 11 1/4	Wal.	Cloth Black	41	128.00	Hi and mid conts.
	91	8		Acous. Susp.	-	-	3	Cone	40-18.5K +5	5	25	1,850	8	11 1/4 x 20 x 10	Wal.	Cloth Black	20	63.00	Tweeter cont.
	† 39	8		Bass Reflex	-	-	3 1/2	Cone	55-15K +5	5	25	2,000	8	9 1/2 x 17 1/4 x 8 1/4	Blk. w. wal.	Cloth Black	12	99.95 pr.	
WHARFEDALE	W80A	12	40	Acous. Susp.	5	Cone	1 3	Dome Dome	20-1naud.	30	100	500 1,500 6,000	8	17 1/4 x 28 x 17	Oil Wal.	Cloth, Brn.	85	317.60	
	W70E	15	40	Acous. Susp.	5	Cone	1	Dome	25-20K	15	75	600 5,000	8	22 1/4 x 24 x 13 1/4	Oil Wal.	Cloth, Brn./gold	66	223.00	Cont. var. treble and midrange contr.; vert. or horiz. mtng.
	W60E	12	45	Acous. Susp.	6	Cone	1	Dome	30-20K	15	60	750 5,000	8	24 x 15 x 12	Oil Wal.	Cloth, Brn.	55	153.00	Cont. var. treble and midrange contr.
	W 25	8	65	Acous. Susp.	-	-	2 1/2	Cone	35-18.5K	10	35	1,500	8	15 1/2 x 10 x 8	Wal.	Brown	15	58.75	Cont. var. cont.; removable grille.
	W 35	8	60	Acous. Susp.	3/4	Cone	2 1/2	Cone	35-18.5K	10	40	1,200 5,000	8	15 x 15 x 8	Wal.	Brown	19	82.00	Mid and Hi conts.
	W45	10	56	Acous. Susp.	3/4	Cone	2 1/2	Cone	30-18.5K	10	45	1,000 4,000	8	12 x 22 x 10	Oil Wal.	Cloth, Brn.	35	117.00	As above.
YAMAHA	NS-230E	12 1/2 x 18	50	-	-	-	2	Cone	40-18K +5	-	10	5,000	8	16 1/2 x 7 x 20	Wal.	Cloth	15 1/2	61.50	Piano shaped woofer.
	NS-20B	20 x 27	60	-	8	Cone	2 1/2	Horn	30-20K	-	20	200 6,000	8	36 x 13 1/4 x 26	Wal.	Cloth	62	199.50	As above.
	NS-30B	25 x 35	50	-	12	Cone	2 1/2	Horn	30-20K +5	-	30	200 6,000	8	42 1/2 x 13 1/4 x 29 1/4	Wal.	Cloth	81	299.50	As above.
	† NS-570	15 x 20	60	Closed	-	-	3/4	Horn	60-20K	*	15	5,000	8	17 x 13 x 43	White	Cloth Black	88		*93 dB with 0.25 W.
	† NS-550	12 1/4 x 17 1/4	65	Closed	-	-	2 1/4	Cone	65-18K	*	12	5,000	8	16 x 12 x 40	AW	Cloth Black	71 1/2		*91 dB with 0.25 W.
	NS-410	8	85	Closed	-	-	2 1/4	Cone	85-18K	*	10	5,000	8	12 x 7 x 19	AW	Cloth gray	13 1/2	49.00	*94 dB with 1 W.



# before you select a speaker look into all the Fax.

**WALL OF SOUND**—12 individual high efficiency drivers; 6½" deep; unique integrated cyclone labyrinth. \$399.95

**FE-8A**—8 individual drivers for high-efficiency, concert hall sound; low distortion over full frequency range. \$279.95

**FTA-2**—3-way system with four power-packed drivers. Unheard of at \$139.95

**FX-100A**—2-way speaker system with our own crossover design cuts "hole-in-the-middle" effect. \$79.95

**F-2A**—High power handling capacity and flat frequency response at a super-low price. \$59.95

**L-34A**—Bookshelf-type front loaded folded horn 4-way system outperforms many floor-standing models. \$189.95

**FX-200C**—Newly redesigned with twin 8" drivers and super-dome tweeter for big-speaker sound. \$99.95

Model for model, we put more into them. So you get more out of them. See and hear for yourself how true pitch and zero overlap engineering are incorporated into our entire line. Check out the advanced electronics responsible for distortion-free reproduction of the widest possible range of sound. See the special sound chambers. Even bigger-and-better baffles for improved sound dispersion. You won't see the quality control testing we give every component in every speaker. But you'll hear the super-sound results.

**INSIST ON A FREE COMPARATIVE LISTENING DEMONSTRATION**

If your dealer doesn't stock Fairfax, we'll send him a pair of speakers pre-paid for evaluation... (we pay the shipping charges both ways). If he doesn't believe you, show him this ad.

**FREE COMPARATIVE TEST REPORT**

Find out how experts test and rate our speakers in comparison to other leading speaker systems. Send for your free copy of a highly informative Test Report. A "must" before purchase.

**FAIRFAX, of course.**  
the *SUPERSOUND* line

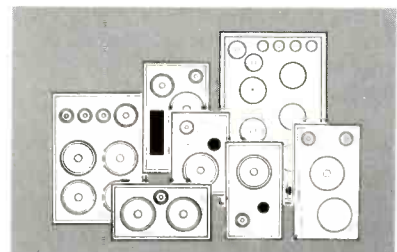

**FAIRFAX**

INDUSTRIES INC.  
900 PASSAIC AVE. EAST NEWARK, N.J. 07029

Check No. 57 on Reader Service Card

# Speaker Q's and A's

## Mainly for Beginners



IMF Studio uses the transmission line principle.

**Q.** What are the advantages of omnidirectional speaker systems, if any?

**A.** The advantages are a diffused sound, a wide stereo image, and a certain smoothness in the treble, as peaks in the response are "ironed out." Compared with more directional systems, the disadvantages are an imprecise, confused stereo image, inferior transient response, and greater dependence on room acoustics. Some systems like the Bose 901 attempt to combine the virtues of both methods by having a front speaker for direct sound in addition to the rear speakers which use the walls as a reflector.

**Q.** Are electrostatic speakers that much better than dynamics?

**A.** ESL's have a smooth transparent sound which is only equalled by the very best dynamic systems. This is partly due to inherent virtues and partly because there are no cabinet resonances. No cabinet—no resonances! On the other hand, full range ESL's have a restricted low frequency because of cancellation effects (all those presently available are doublets, that is they

radiate in two directions) and to the electrode spacing limitations. The diaphragm has to be close to the plate or plates to obtain reasonable sensitivity and spacing must be large enough to permit the large movements necessary at low frequencies. Thus, a compromise has to be accepted.

**Q.** I bought a pair of loudspeakers after hearing them at a dealer's, but when I connected them up at home, the bass response seems much less. I am using an amplifier similar to the one at the dealer's. What could be wrong? I have checked the phasing according to the instruction book.

**A.** The listening room must be considered acoustically as an extension of the loudspeaker, and as room sizes and characteristics vary, so will the actual sound. Best position for maximum bass is usually in the corners but this will not necessarily give the best overall balance. So do not be afraid to experiment (domestic conditions permitting). Assuming the speakers check out all right and the bass loss is due to the room, it is perfectly permissible to use a little bass lift on the amplifier—that's what tone controls are for. However, too much lift may cause distortion and give a "chesty sound" to speech. An equalizer, such as the Amplidyne SE-111 or the Soundcraftsmen 20-12, might be worth considering. These units can lift the extreme bass without affecting frequencies in the 200 Hz region.

**Q.** What is a labyrinth system?

**A.** It basically consists of a long tunnel or pipe at the rear of the loudspeaker. Its purpose is to provide an effective termination for the cone and increase the path length of the rear wave so that any radiation will not cancel the output from the front. Output from the tunnel can be positioned at the front or the back of the enclosure—or even at the sides. Figure 1 shows a typical arrangement. The cross-section of the tunnel should be at least equal to the cone area and the length is usually equal to the quarter wavelength of the speaker cone resonance. Thus, a loaded

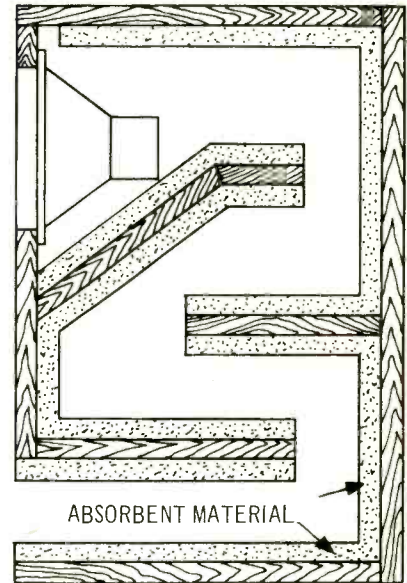

Fig. 1—Typical labyrinth system.

speaker resonance of 40 Hz would need a path of about nine feet. Since the loudspeaker sees a high impedance when the tunnel length is quarter wave, the cone excursions and distortion are reduced to a minimum. At frequencies below this mode, the port and diaphragm radiation is out of phase so radiation falls off steeply. At higher frequencies, the port radiation would be in or out of phase with the diaphragm output so the tuner has to be heavily damped with acoustic material.

**Q.** What is a transmission line system?

**A.** A labyrinth is really a transmission line, but recently the term has been applied to a variation developed by Dr. Bailey. Instead of lining the tunnel, it is completely filled with absorbent material (usually long-hair wool). This obviously reduces output above 150 Hz or so, provided a higher resistance loading for the cone and increases the effective length of the tube! Speakers using this system include the IMF, Trans-Static, Electrostatic Sound, Radford, and Infinity. Some of these use  $\frac{1}{8}$ th wave length tunnels instead of  $\frac{1}{4}$ .



We enjoy telling you how each aspect of the 12 year basic research program on sound reproduction contributed to the unconventional features found in the Bose 901 and 501 DIRECT/REFLECTING® loudspeakers.\* We also take pride in quoting from the unprecedented series of rave reviews because to us they are like awards won for the best design.†

However, it is important to realize that the research and the reviews are of only academic interest unless the speakers really are audibly superior. It is equally important to realize that YOU are in every sense the ultimate judge, for you are the one who lives with the sound you choose.

So—forget the rave reviews and the research and sit in judgement of two fascinating experiments. Take your most exacting records to any franchised BOSE dealer and:

1. Place the BOSE 901's directly on top of any other speakers, regardless of their size or price, and

make an A-B listening test with your records.

2. Place the BOSE 501's beside (with at least 2 feet clearance) any other speaker using woofers, tweeters and crossovers and perform the A-B listening test. (Don't ask the price of the 501 before the test)

Then, just enjoy your records. When you finish you will know why we get much more satisfaction from our work than could ever be derived from profits alone.

P.S. If you already own expensive speakers, many dealers will lend you a pair of BOSE 901's for an A-B in your living room, where the acoustics are generally far superior to those of the speaker-lined showroom.

\* Copies of the Audio Engineering Society paper, 'ON THE DESIGN, MEASUREMENT AND EVALUATION OF LOUDSPEAKERS', by Dr. A. G. Bose, are available from the Bose Corp. for fifty cents.

† For copies of the reviews, circle our number on your reader service card.

You can hear the difference now. **BOSE**®

## Unless they're audibly superior it's all academic.

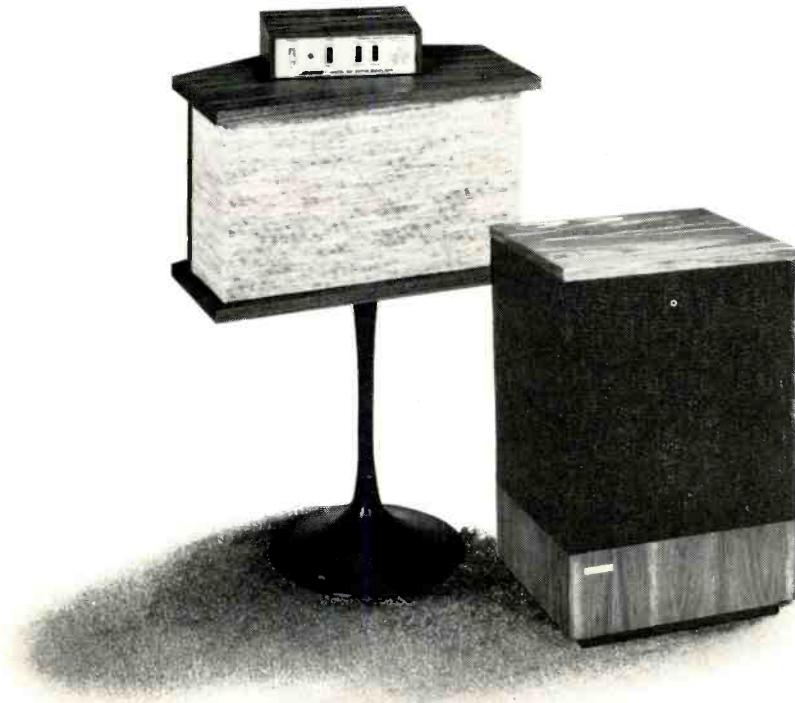

The BOSE 901 and BOSE 501 are covered by patent rights, issued and pending.

Check No. 59 on Reader Service Card

# Equipment Profiles

TEAC AS-201 Integrated Amplifier	60	Beyer D-480 Stereo Headphones	66
Foster (Ercona) RDF-224 Stereo Headphones	64	Telex Studio I Stereo Headphones	68
Sharpe 770 Stereo Headphones	64	Wharfedale W70E Speaker System	69



TEAC AS-201 Integrated Amplifier

## MANUFACTURER'S SPECIFICATIONS

**Power Output:** 50 watts per chan., 8 ohm load. **Distortion:** Less than 0.5% THD at 50 watts; less than 0.5% IM at 40 watts. **Frequency Response:** 20 to 80,000 Hz +0 -1 dB, main amp roll-off at 30 Hz in preamp. **Power Bandwidth:** 20 to 30,000 Hz. **Sensitivity:** PHONO 1 and 2, 2 mV; AUX 1 and 2, TUNER, TAPE, 130 mv. **Dimensions:** 16½ in. W by 11¾ in. D by 6½ in. H. **Price:** \$349.50.

The TEAC AS-201 is an integrated amplifier having most of the usual facilities plus extra features for the tape recording enthusiast. As this company has built up its reputation in the tape recorder field, this is not really surprising! As can be seen from the photograph, the front panel looks unusually clean and uncluttered because most of the controls are hidden away behind the hinged lower section. The push buttons on the left are for TUNER, PHONO, and AUXILIARY inputs and the group of three is designated TAPE MONITOR. These permit two tape recorders to be used with monitoring of the signal source and from the tape (if the recorder has independent heads). When dubbing from one recorder to another, the tape recorder for playback of the original tape is connected to one of the auxiliary inputs.

The two main controls are VOLUME and BALANCE, and on the extreme right is the ON/OFF switch and indicator. Behind the lower panel, the controls are as follows: slide switch for two PHONO inputs, stereo mode, bass, treble, tone control cancel, high and low filters, loudness, and then the speaker switch. A socket for headphones is located on the right. On the rear panel are three power receptacles (one switched, two unswitched), thermal circuit-breakers, and the various input and output sockets, which include a DIN socket for tape recorders. A little crowded, this panel! The speaker terminals are heavy-duty spring connectors, and there is an output socket for center channel. Note in Fig. 2 that under the circuit-breaker reset buttons are sockets for main amplifier and preamplifier with removable connecting links. This is a useful point for the insertion of a decoder, electronic crossover, or equalizer, if so desired. I did, in fact, use a Soundcraftsmen 20-12 here and no detectable increase in noise or distortion was noticed. Figure 1 shows the view inside.

## Circuit Description

The first stage is fairly conventional, using three transistors in an NPN, PNP, NPN configuration, as shown in Fig. 4. Phono equalization is performed by the feedback loop at E1. The low impedance output from this stage is taken to another three-stage amplifier. The first transistor is an FET and high level inputs are taken from this stage. After this three-transistor amplifier comes the tone-control amplifier which uses

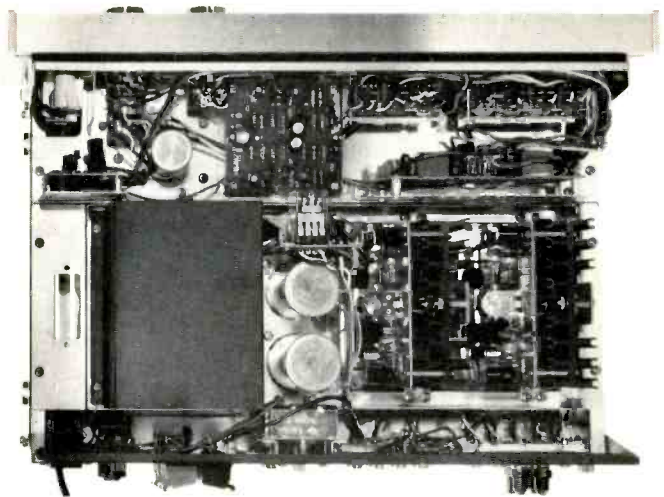

Fig. 1—Showing inside view.

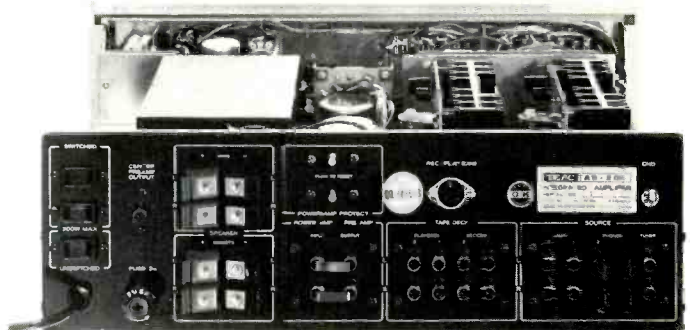

Fig. 2—Rear panel.

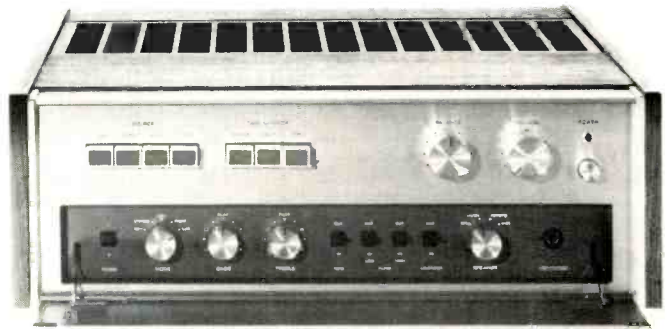

Fig. 3—Showing control knobs behind lower panel.

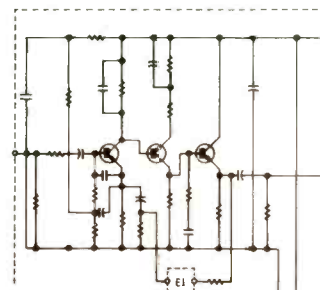
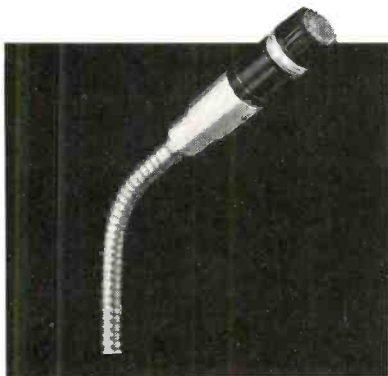

Fig. 4—Phono preamplifier section.





## Con-Con to Congress



Nowadays, history isn't written, it's spoken . . . and verbal clarity is essential wherever people meet to discuss the issues of the day. From coast to coast, from town halls to the halls of Congress, you'll find Shure microphones in the really critical, prestigious sound reinforcement installations. Case in point: when the Illinois Constitutional Convention ("Con-Con"—see photo above) met to create the first new state constitution since 1870, a total of 65 Shure Unidyne III microphones were at hand to assure a clear, intelligible voice for each delegate. The Unidyne III was right for Con-Con, and there's a Shure problem-solving microphone right for every installation.

Write:

Shure Brothers Inc.  
222 Hartrey Ave., Evanston, Ill. 60204



Check No. 61 on Reader Service Card

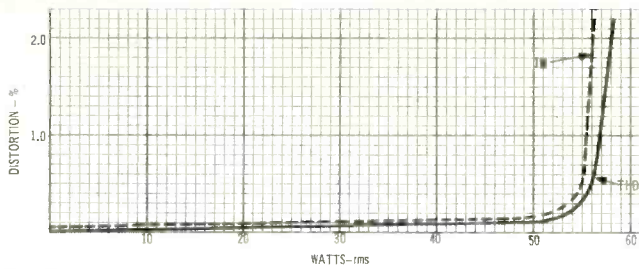

Fig. 5—THD and IM distortion.

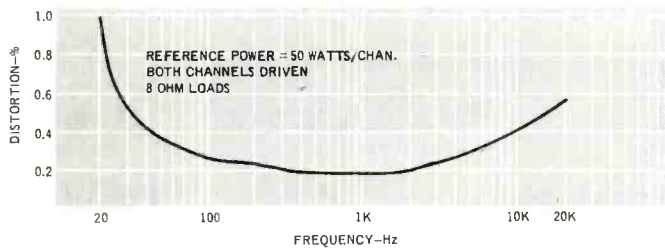

Fig. 6—Distortion versus frequency.



Fig. 7—Power bandwidth.

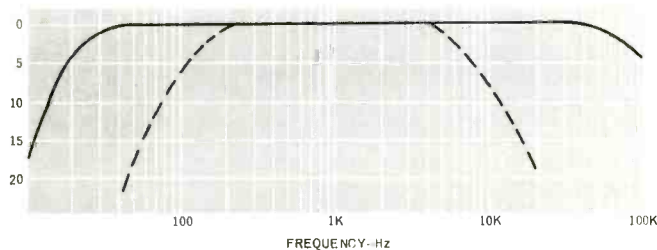

Fig. 8—Frequency response and filters.

three more transistors plus an emitter-follower that feeds the power amplifier section. A differential input stage is used here—an arrangement which is now becoming standard practice. The two silicon NPN output transistors are driven by a complementary pair and output is taken to the speaker terminals via a four-transistor circuit which operates the cutouts. A muting circuit prevents current reaching the speakers for about three seconds after switching on. Not only does this minimize the possibility of damaging fragile tweeters, but it stops that annoying switching thump too. The stabilized power supply uses two transistors and the unstabilized voltage for the output stage is just over 40.

### Performance

Power output came out at 55 watts per channel with half-power points at 17 and 32,000 Hz. (See Figs. 5 and 7). The distortion versus frequency curve is shown in Fig. 6. Frequency response is shown in Fig. 8 (taken at the tuner input), and square wave performance at 60, 1000, and 10,000 Hz is shown in Fig. 9. The low frequency waveform shows the effect of 30 Hz roll-off. High frequency square-wave characteristics were checked with the tone controls in and out of circuit but there was no detectable difference (with the controls set flat) apart from a complete phase reversal. Neither, for that matter, was there a measurable change in distortion. Stability was checked with an electrostatic speaker and found to be completely satisfactory. Filter characteristics are shown in Fig. 8, and tone control curves in Fig. 10. These are both step-type controls giving about 2 dB change per step at 40

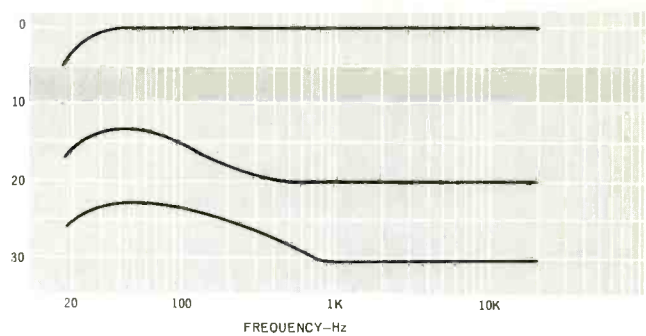

Fig. 11—Loudness control characteristics.



Fig. 9—Square-wave performance at A, 60; B, 1000, and C, 10,000 Hz.

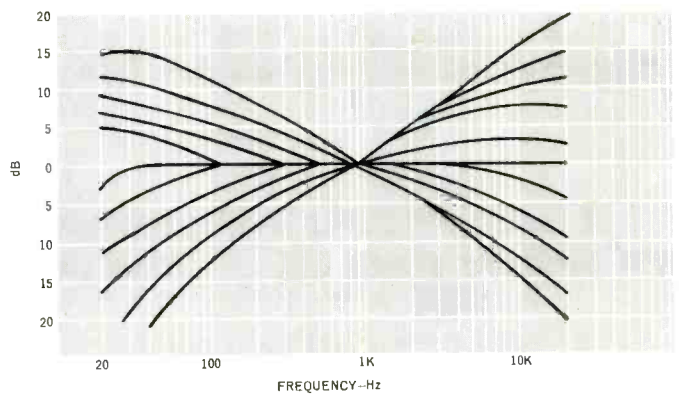

Fig. 10—Tone control curves.

Hz and 10,000 Hz. The effect of the loudness control (Fig. 11) was much less drastic than most, giving a maximum lift of 7 dB at the low end with 30 dB overall attenuation. Hum and noise measured 71 dB, unweighted at the PHONO inputs (grounded) and 84 dB for AUX, TUNER, and TAPE positions. Residual noise (volume control set at minimum) was -89 dB referred to full rated output. Phono sensitivity measured 2.1 mV with overload at 145 mV—very satisfactory. TUNER and AUX sensitivity was 140 mV. Crosstalk was -55 dB at 1000 Hz and 49 dB at 10,000 Hz.

These days, an amplifier with an output of some 50 watts per channel is rated as a medium power unit, but a total of 100 watts is certainly ample for most people! A Shure V-15 Mk II was used for most of the listening tests and the PHONO 1 input was used. The second phono input has a stated impedance of 80 kohms—too high for the majority of cartridges in common use and a parallel 100 kohms resistor would be needed for accurate matching. This should be mounted inside the amplifier and a low-noise type ought to be used. A tape recorder was also used with the AS-201 and recordings were made simultaneously on a cassette machine—a TEAC A-24. An interesting comparison greatly facilitated by the provision for two recorders mentioned earlier. The protection circuits worked very well; in fact, great care had to be taken when testing with full sine wave power because of the operation of the circuit breakers! Summing up, the AS-201 is a fine medium-power amplifier, specially recommended for the tape enthusiast.

T.A.

Check No. 62 on Reader Service Card



# New Heathkit AR-1500 stereo receiver... the critics say it all:

"...the most powerful and sensitive receiver we have ever measured..." — JULIAN HIRSCH — *Stereo Review*

"...a stereo receiver easily worth twice the cost (or perhaps even more)..." — *Audio Magazine*

"Great new solid-state stereo receiver kit matches the demands of the most golden of golden ears..."  
— *Radio Electronics*

Mr. Hirsch goes on to say: "The FM tuner section of the AR-1500 was outstandingly sensitive. We measured the IHF sensitivity at 1.4 microvolts, and the limiting curve was the steepest we have ever measured... The FM frequency response was literally perfectly flat from 30 to 15,000 Hz... Image rejection was over 100 dB (our measurement limit)..."



The Heathkit AR-1500 AM/FM/FM-Stereo Receiver... 379.95\* (Kit, less Cabinet)

"The AM tuner was a pleasant surprise... It sounded very much like the FM tuner, with distinct sibilants and a quiet background, and was easily the best-sounding AM tuner we have had the pleasure of using..."

"...all input levels can be matched and set for the most effective use of the loudness compensation. This valuable feature is rarely found on high-fidelity receivers and amplifiers..."

"The phono equalization was perfectly accurate (within our measuring tolerances)... The magnetic phono-input sensitivity was adjustable from 0.62 millivolt to about 4.5 millivolts, with a noise level of -66 dB, which is very low... When properly set up, it would be impossible to overload the phono inputs of the AR-1500 with any magnetic cartridge..."

"...it significantly bettered Heath's conservative specifications. Into 8-ohm loads, with both channels driven, the continuous power at clipping level was 81.5 watts per channel. Into 4 ohms it was 133 watts per channel, and even with 16-ohm loads the receiver delivered 46.5 watts per channel. Needless to say, the AR-1500 can drive any speaker we know of, and with power to spare..."

"At 1,000 Hz, harmonic distortion was well under 0.05 per cent from 1 to 75 watts per channel... The IM distortion was under 0.05 per cent at a level of a couple of watts or less, and gradually increased from 0.09 per cent at 10 watts to 0.16 per cent at 75 watts... The heavy power transformer is evidence that there was no skimping in the power supply of the AR-1500, and its performance at the low-frequency extremes clearly sets it apart from most receivers..."

"Virtually all the circuit boards plug into sockets, which are hinged so that boards can be swung out for testing or servicing without shutting off the receiver. An 'extender' cable permits any part of the receiver to be operated 'in the clear' — even the entire power-transistor and heat-sink assembly! The 245-page manual has extensive tests charts that show all voltage and resistance measurements in key circuits as they should appear on the receiver's built-in test meter..."

"With their well-known thoroughness, Heath has left little to the builder's imagination, and has assumed no electronic training or knowledge on his part. The separate packaging of all parts for each circuit board subassembly is a major boon..."

"In sound quality and ease of operation, and in overall suitability for its intended use, one could not expect more from any high-fidelity component."

From the pages of *Audio Magazine*: "... the AR-1500 outperforms the near-perfect AR-15 in almost every important specification..."

"The FM front end features six tuned circuits and utilizes three FETs, while the AM RF section has two dual-gate MOSFETs (for RF and mixer stages) and an FET oscillator stage. The AM IF section features a 12-pole LC filter and a broad band detector. The FM IF section is worthy of special comment. Three IC stages are used and there are two 5-pole LC filters..."

"... IHF FM sensitivity... turned out to be 1.5 uV as opposed to the 1.8 uV claimed. Furthermore, it was identical at 90 MHz and 106 MHz (the IHF spec requires a statement only for IHF sensitivity at 98 MHz but we always measure this important spec at

three points on the dial). Notice that at just over 2 microvolts of input signal S/N has already reached 50 dB. Ultimate S/N measured was 66 dB and consisted of small hum components rather than any residual noise. THD in mono measured 0.25%, exactly twice as good as claimed! Stereo THD was identical, at 0.25% which is quite a feat..."

"... the separation of the multiplex section of the AR-1500 reaches about 45 dB at mid-band and is still 32 dB at 50 Hz and 25 dB at 10 kHz (Can your phono cartridge do as well?)..."

"The real surprise came when we spent some time listening to AM... This new AM design is superb. We still have one classical music station that has some simultaneous broadcasting on its AM and FM outlets and that gave us a good opportunity to A-B between the AM and FM performance of the AR-1500. There was some high-frequency roll-off to be sure, but BOTH signals were virtually noise-free and we were hard pressed to detect more THD from the AM than from the FM equivalent. Given AM circuits like this (and a bit of care on the part of broadcasters), AM may not be as dead as FM advocates would have us believe!..."

"Rated distortion [0.24%] is reached at a [continuous] power output of 77.5 watts per channel with 8 ohm loads (both channels driven). At rated output (60 watts per channel) THD was a mere 0.1% and at lower power levels there was never a tendency for the THD to 'creep up' again, which indicates the virtually complete absence of any 'crossover distortion' components. No so-called 'transistor sound' from this receiver, you can be sure. We tried to measure IM distortion but kept getting readings of 0.05% no matter what we did. Since that happens to be the 'limit' of our test equipment and since the rated IM stated by Heath is 'less than 0.1% at all power levels up to rated power output' there isn't much more we can say except that, again, the unit is better than the specification — we just don't know how much better..."

"As for the amplifiers and preamplifier sections, we just couldn't hear them — and that's a commendation. All we heard was program material (plus some speaker coloration, regrettably) unencumbered by audible distortion, noise, hum or any other of the multitude of afflictions which beset some high fidelity stereo installations..."

"As always, construction instructions are lucid enough for the inexperienced kit-builder and there is enough technical and theoretical information to satisfy even the most knowledgeable audio/RF engineer."

The Heathkit AR-1500...its performance speaks louder than words. Order yours now.

Kit AR-1500, less cabinet, 53 lbs. 379.95\*

ARA-1500-1, walnut cabinet, 8 lbs. 24.95\*

See and hear the new AR-1500 at your nearest Heathkit Electronic Center...order direct from the coupon below...or send for your free Heathkit catalog.

	HEATHKIT Schlumberger
	<p>HEATH COMPANY, Dept. 41-3 Benton Harbor, Michigan 49022</p> <p><input type="checkbox"/> Please rush my free Heathkit Catalog.</p> <p><input type="checkbox"/> Enclosed is \$_____ plus shipping. Please send my AR-1500 by return mail.</p> <p><input type="checkbox"/> Enclosed is \$_____ plus shipping for ARA-1500-1 walnut cabinet.</p> <p>Name _____</p> <p>Address _____</p> <p>City _____ State _____ Zip _____</p> <p>Prices &amp; specifications subject to change without notice. *Mail Order Prices; F.O.B. Factory. HF-256</p>
<p>FREE CATALOG... describes AR-1500, plus over 350 other fun-to-build home and hobby kits.</p>	

Check No. 60 on Reader Service Card



### Sharpe Model 770 Dynamic Stereo Headphones

#### MANUFACTURER'S SPECIFICATIONS

**Type:** Dynamic. **Frequency Range:** 20-20,000 Hz,  $\pm 3$  dB. **Source Impedance:** 4-16 ohms. **Output:** 100 dB SPL for 0.82 mW input. **Maximum Input:** 1000 mW. **Cord Length:** 14 ft., coiled. **Weight:** 19 oz. **Price:** \$100.00. Lifetime guarantee, each channel fused, independent volume controls. seven models intended for high fidelity use. The molded housings are in a walnut finish with gold finished metal parts, giving a luxurious appearance. The retracted length of the light brown coiled cord is 36 in., and the cord extends to 15 ft.—adequate for listeners who do not want to be limited in their seating position while enjoying their music. Each phone has a removable liquid-filled ear cushion, and the left phone is faced on the inside with a blue velvet-like material, the right one with a red lining. The cord is wired with the tip of the stereo phone plug to the right unit, and the ring to the left one to which the cord is connected. The ear cushions measure  $3\frac{1}{4} \times 4\frac{1}{4}$  in. and are very comfortable, even with glasses on, during long listening periods. These pads provide the highest isolation we have so far measured—in excess of 30 dB—making them easily usable

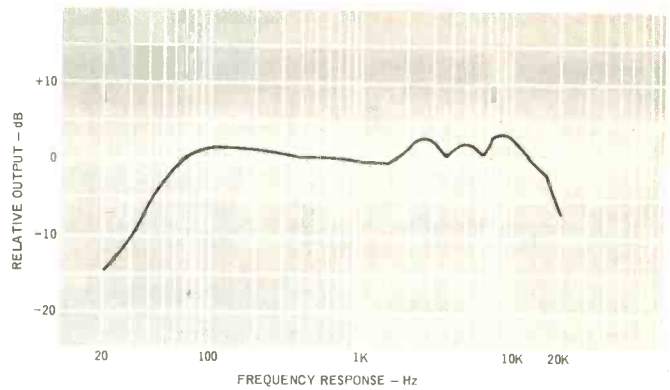

while recording in the same area as the performers, since very little external sound reaches the ears while the phones are on. Sensitivity was slightly lower than average when measured with an artificial ear and a signal of 3.0 volts applied through 100-ohm resistors, produced an SPL of 82 dB. However, we might also add that this represents an input of far below the maximum for which the phones are rated.

As to frequency response, the curve shown is one of the best we have ever encountered with dynamic phones, being well within the claimed  $\pm 3$  dB from 50 to 18,000 Hz. Measurements above and below these frequencies are likely to vary considerably from absolute. The curves for the two phones differed by no more than 2 dB over the entire range and are essentially flat from 80 to 2000 Hz, followed by some undulations of not more than 3 dB up to 18,000. On our measuring setup, there was still output up to 20,000 Hz, and the rolloff below 70 Hz should normally be expected from small driver units such as are used in headphones.

For high-quality listening, we can heartily recommend the Sharpe 770 headphones, and the comfort in wearing is not exceeded by any.

Check No. 64 on Reader Service Card



### Foster (Ercona) RDF-224 Stereo Headphones

#### MANUFACTURER'S SPECIFICATIONS

**Type:** Dynamic. **Frequency Response:** 20-18,000 Hz. **Source Impedance:** 8-16 ohms. **Sensitivity:** 1.0 mW input for 100 dB SPL. **Maximum Input:** 100 mW. **Cord Length:** 8 ft. **Weight:** 12 oz. **Price:** \$24.95.

For the first time in our varied examination of stereo headphones, we have encountered one pair which incorporates a miniature slide switch within the three-way stereo plug to parallel the two earphones for mono listening when desired. In the other position, the two phones are connected as usual for stereo. Thus the Foster RDF-224 can well serve for a number of applications other than for pure stereo listening.

The phone housings are molded black plastic supported on a dual spring wire headband, also covered in black plastic. Attractive chrome caps accentuate the transducer units, and a solid cord strain relief is a part of one of the phones. The tip of the phone plug is wired to the phone into which the cord enters, but the two phones are not identified as to which is right and which is left. The vinyl-covered foam-filled pads are smaller than average, measuring  $3 \times 3\frac{3}{4}$  in. The black cord measures 24 in. when retracted and extends to 8 ft.



# HIRSCH-HOUCK LABS TELLS IT LIKE IT IS

in January STEREO REVIEW



## KENWOOD KT-7001

3-FET, 4-IC,  
XTAL FILTER, FM/AM STEREO TUNER

"We are unreservedly enthusiastic about the Kenwood KT-7001. There are a number of very fine tuners on the market, but if there is a better one than the KT-7001, we haven't seen it."

"The measurement data show that the Kenwood KT-7001 is one of the most sensitive FM tuners on the market, with exceptional capture ratio, stereo separation, and freedom from spurious responses."

"The stereo separation was an exceptional 41 dB between 400 and 1,000 Hz, decreasing smoothly to 22 dB at 30 Hz and 21 dB at 15,000 Hz. The mid-range separation, in particular, was as great as we have ever measured."

"The complete 'capture' of the tuner by the stronger of two signals on the same channel took place with such a small difference in signal level that we couldn't read the change on the signal-generator's output attenuator! All we can say with certainty is that the KT-7001 has a capture ratio better than 1 dB, and it is far superior in this respect to any other tuner we have tested."

— Excerpts from Hirsch-Houck Laboratories'  
"Equipment Test Reports," January STEREO REVIEW

For the complete Hirsch-Houck Lab Report and full specifications on the KT-7001 FM/AM Stereo Tuner, write . . .



The sound approach to quality

**KENWOOD**

15777 So. Broadway, Gardena, Calif. 90248  
72-02 Fifty-first Ave., Woodside, N.Y. 11377  
In Canada: Magnasonic Canada, Ltd., Toronto,  
Ontario; Montreal, Quebec; Vancouver, B.C.

Check No. 65 on Reader Service Card

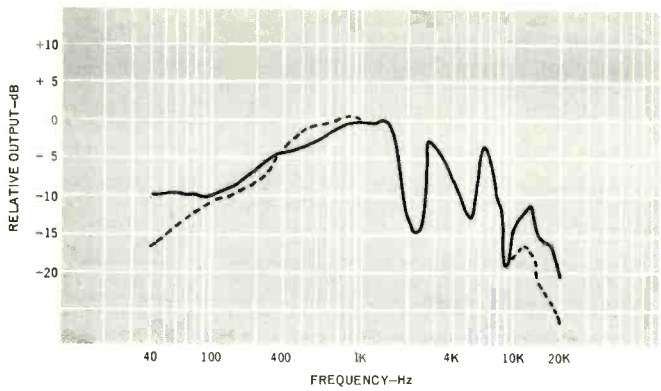

**Beyer DT-480  
Dynamic Stereo  
Headphones**



We measured an SPL of 110 dB when connected to a terminated signal of 3.0 volts and fed to the phones through a 100-ohm resistor. The d.c. resistance of each phone was measured at 15 ohms, and when placed on the artificial ear, sound isolation was measured at 19 dB, which is a little above average.

The RDF-224 phones were found to be quite comfortable to wear, even with glasses on, and for long periods of listening. The two phones measured quite alike in frequency response, perhaps somewhat deficient in bass, but the response showed a good middle range, and very similar characteristics throughout the mid- and upper-mid ranges. For the price, these phones should provide good service and comfortable listening.

Check No. 66 on Reader Service Card

#### MANUFACTURER'S SPECIFICATIONS

**Type:** Dynamic. **Frequency Response:** 30-18,000 Hz. **Impedance:** 5, 25, or 200 ohms. **Sensitivity:** 155 dB/mW over  $2 \times 10^4 \mu\text{bar}$ . **Maximum Input:** 200 mW. **Distortion:** 0.1%. **Cord Length:** 7 ft. **Weight:** 16 oz. **Price:** \$75.00.

The phones we tested were the 25-ohm variety, but designed to work across the usual 8- or 16-ohm output from a stereo amplifier equipped with the series resistor of about 100 ohms as is the usual practice. This headset is a handsome device, with attractive removable foam-filled vinyl pads measuring  $3\frac{1}{4} \times 4\frac{1}{4}$  in. The individual units are carried on a flat steel band, which is plastic covered and equipped with a foam-filled head pad for comfortable wearing. The phone housings are molded

**Wow and flutter 0.1%, lowest of any stereo cassette deck at any price.**

Sony's exclusive closed loop dual capstan tape drive system solves a major cassette problem—pronounced wow and flutter. This system (shown here) helps make the Sony 160 and 165 stereo cassette decks perform better than any other. Why? Because it drives the tape at a constant speed, exerting the *same amount of tape-to-head pressure from one end of the tape to the other.* (Not only a steady pressure but the correct amount of pressure to reduce modulation distortion drastically.)

In addition, both Sony decks are equipped with a built-in Peak Limiter. A unique first, it automatically monitors the recording level preventing tape saturation and distortion without audibly altering the dynamic range while you're recording.

There is also a tape select switch that enables you to change the record equalization for either standard or the new chromium dioxide cassette tapes.

## Sony keeps the

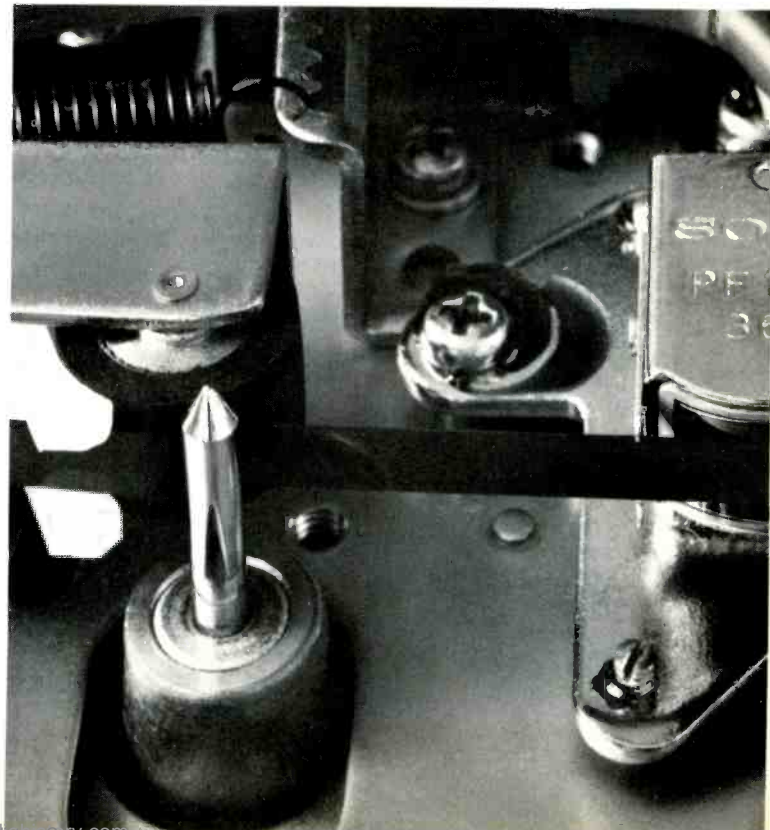



of dark gray plastic, with the letters "L" and "R" molded in the shells. The right phone is fitted with a 6-terminal polarized socket into which is plugged the mating receptacle molded onto the 10-foot dual cord, which is terminated on the other end by the usual three-circuit stereo plug.

The phones were exceptionally easy to wear, even over glasses, and produced no fatigue after a continuous hour of listening. Wiring of the stereo plug was with the tip feeding the right phone and the ring feeding the left phone which would appear to be the standard, although this observer has never seen any indication that there was such a standard. We have observed other phones in which the tip fed the left phone, even though it really shouldn't make much difference to the average user.

Our method of measuring sensitivity is to feed a signal from an amplifier, properly terminated, at a level of 3 volts at 500 Hz, and then to measure the sound output from each of the phones, averaging the measured value. This level is compared with the output of a known set of headphones. The measurement is made with an artificial ear using an AKG C-451E condenser microphone slightly modified to feed into an unbalanced measuring circuit instead of the phantom circuit usually employed with the C-451E. The same setup is used to measure frequency response, feeding a swept audio signal from a phonograph record through the amplifier at the same level. The curves shown for frequency response are the average of the two phones, in which the variation was within  $\pm 3$  dB over the entire spectrum. Using this method, a sound pressure level of 92 dB was measured from a 3-volt signal (500 Hz) fed through 100 ohms.

Isolation of external sound was measured by feeding a 1000-Hz signal from a loudspeaker to the condenser microphone in the artificial ear and noting the level of the micro-

phone output. Then the phones were placed over the artificial ear and the level read again. The difference in the two levels is the amount of isolation, and in this instance measured 28 dB, which is very good.

Frequency response curves made on the artificial ear show a rapid falling off below 100 Hz, relative smoothness from 100 to 2000 Hz, and the usual peaks and valleys encountered with practically all dynamic phones. These variations in level—of the order of  $\pm 5$  dB—are not much different than those which would be encountered from measurement of loudspeaker measurements in a room. In actual listening—which is what counts, anyway—these are not noticed.

On the whole, the Beyer DT-480 phones will give satisfaction to the average listener, and the overall sound quality is excellent.

Check No. 67 on Reader Service Card

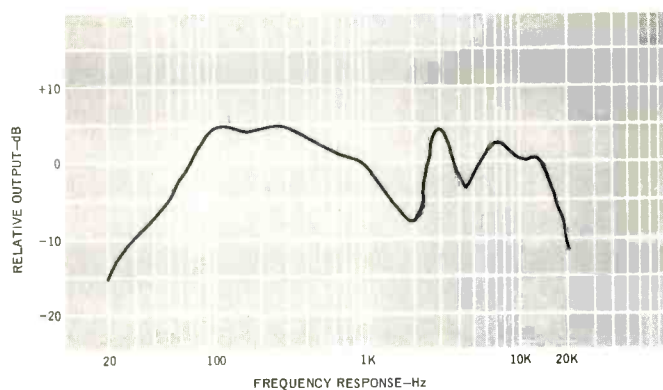

© 1972 Superscope, Inc., 8142 Vineland Ave., San Valley, Calif. 91352. Prices subject to change without notice.

# pressure on!

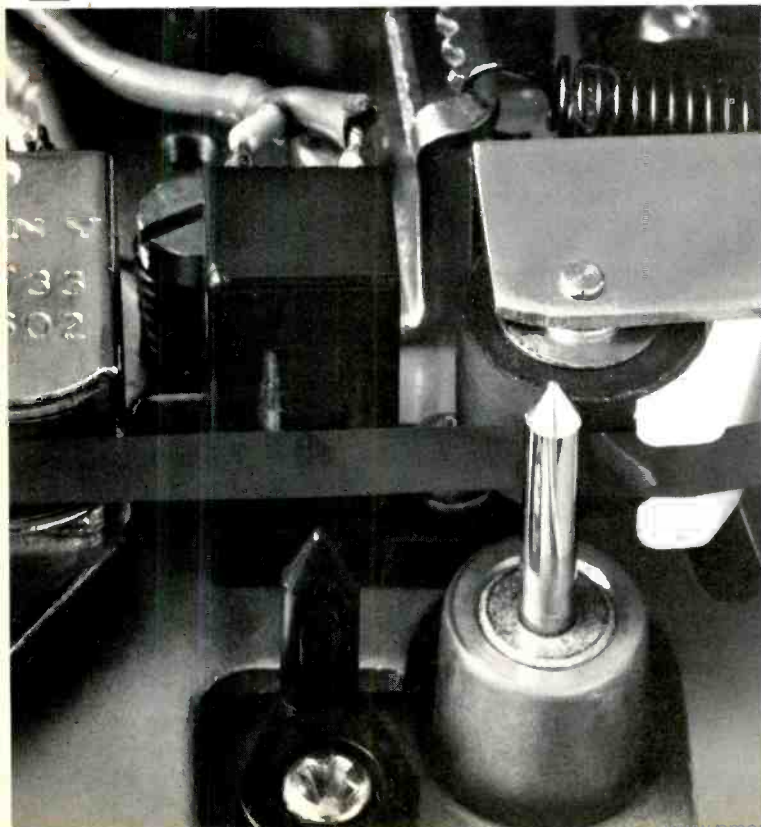

Brilliant Sony engineering and outstanding reliability guaranteed by Superscope make these two stereo cassette decks the best buy bar none. Choose the Sony model 160 for just \$199.95. Or own the Sony model 165 with automatic reverse. It permits both sides of a cassette to be recorded or played back without turning the cassette over, then shuts off automatically; or it can be programmed for continuous play. The price—\$259.95.

At your Sony/Superscope dealer you'll see the full line of superior Sony stereo cassette decks from Superscope starting as low as \$99.95.



**SONY SUPERSCOPE**  
You never heard it so good.®  
Check No. 63 on Reader Service Card



### Telex "Studio 1" Stereo Headphones

#### MANUFACTURER'S SPECIFICATIONS

**Type:** Dynamic. **Frequency Range:** 20-22,000 Hz. **Source Impedance:** 3-16 ohms. **Output:** 105 dB SPL/mW. **Maximum Input Power:** 1 watt. **Cord:** 25 feet, coiled. **Weight:** 24 oz. **Price:** \$99.95.

The Studio 1 stereo headphones are apparently designed for the professional user (considering their price), and they provide most of the facilities required for satisfactory listening.

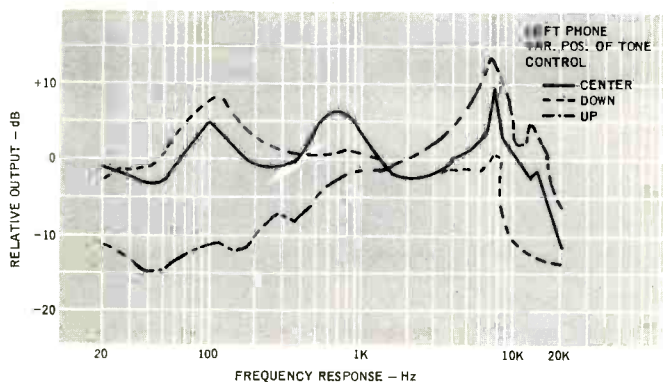
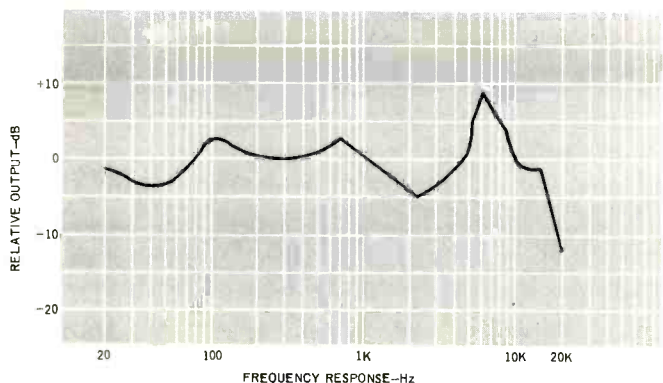

The headband is covered with an "off-white" plastic housing with a goodly sized head pad of the same plastic as viewed from front or back, and with a walnut-figured plastic insert on the top for a luxurious finish. Each phone is similarly treated and is also equipped with slide volume and tone controls. Volume is maximum with the control at the top position, and when the tone controls are in the center position the response is essentially flat. The down position of the tone control results in a droop of the high frequencies by as much as 10 dB without appreciably affecting the mid- and low-frequency responses. In the up position of the controls, the bass is rolled off some 10 dB and the highs are boosted some 3 dB above the center position. Since these controls are separate for each phone, it is possible to obtain a "pseudo-stereo" effect from even mono material by setting the two controls at different ends of their range. Most listeners will undoubtedly prefer an adjustment somewhere near the center positions of the tone controls, however, which in actual use is the most pleasing.

The fairly large circumaural ear pads, as well as the head pad, are made of a black surgical silicone rubber compound and are fairly firm—sufficiently so that wearing with glasses for extended periods can become slightly uncomfortable, but their isolation to external sounds is good, being approximately 17 dB. The four-ft. coiled cord extends to 25 ft., making it possible for the listener to sit across the room from his equipment, rather than having to stay within six or eight ft., as is the case with many headsets. Another advantage of the long cord is that both volume and tone controls are accessible to the user so the proximity to the amplifier or receiver is not at all necessary.

Using an artificial ear and a level of 3 volts applied to the phones through 100-ohm resistors, a sound pressure level of 85 dB was measured from each phone. Response was noticeably good down to 20 Hz, which is unusual in most phones, so it is likely that recordings made while monitoring with the Studio 1 headphones should sound very much in the playback as what the recordist heard while he was recording.

The two major peaks in the response appeared at 100 and 700 Hz, and another of less importance because of its narrow nature was noted at about 7500 Hz. On the whole, however, the listening reaction to these phones was most favorable, probably due largely to the ability of the individual listener to adjust response to suit his own preferences—which always helps in getting a pleased expression on the faces of the people doing the listening, as we had in the case of the Studio 1 phones.

Not everyone uses his stereo headphones continually, and most households have more or less stringent rules about accessories with their attendant cords lying about the living room while they are not in use. Thus, an additional advantage of the Studio 1 phones is the attractive molded plastic case in which they may be stored—or even carried from one listener's home to another for comparison purposes or for just plain listening—not a likely occupation, since two people sitting in a room with phones on are not particularly companionable. However, the case is convenient, even if only while storing the phones in a nearby closet. Since the phones are fairly large, the case must be big enough to accommodate them easily, and this one measures 10 x 13½ x 4¾ in. deep. It is a solid black plastic, with a molded latch which holds it securely closed. Inside is a fitted foam padding for the phones, properly cut out to accommodate them adequately, together with a slot into which the long cord fits neatly. Truly a delightful accessory for a fine pair of phones. *C. G. McProud*

Check No. 68 on Reader Service Card



**Wharfedale W70E  
Speaker System**



**MANUFACTURER'S SPECIFICATIONS**

**Frequency Response:** 25 to 20,000 Hz. **Min. Input Power:** 15 watts, IHF per channel. **Max. Input Power:** 60 watts, IHF per channel. **System Impedance:** 8 ohms. **Speaker Components:** 15 in. woofer, 5 in. acoustically isolated midrange, 1 in. omnidirectional mylar dome tweeter. **Enclosure Type:** Acoustic suspension. **Size:** 24 in. x 22<sup>3</sup>/<sub>4</sub> in. x 13<sup>5</sup>/<sub>8</sub> in. (includes table tops). **Finish:** Oiled walnut. **Weight:** 72 lbs. **Price:** \$223.00.

The Wharfedale W70E is a high quality, moderately priced floor-standing speaker system, which uses the infinite baffle principle without being unduly large. According to British Industries Co., which distributes the Wharfedale line in this country, the W70E can be used either as a high-boy, by standing the speaker on its end, or as a low-boy, by placing it on its side.

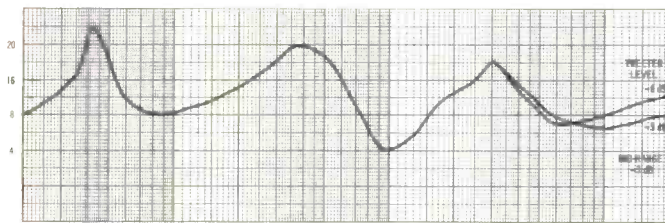

**Fig. 1**—Impedance curve at two positions of the tweeter level control.

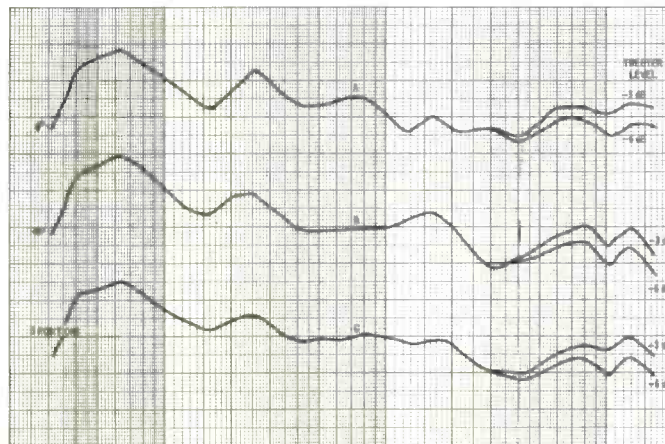

**Fig. 2**—Overall frequency response: **A**, on axis; **B**, off axis, and **C**, averaged of five combined readings to 1/3 octave pink noise taken at various angles and distances.

Within the relatively small confines of this enclosure are housed a 15 in. woofer, a 5 in. midrange unit and a 1 in. domed treble radiator. The woofer incorporates a heavy cast chassis, a large 10<sup>1</sup>/<sub>2</sub> lb. magnet assembly, and a long-throw rubber suspension. The midrange speaker is housed in a separate cylindrical sub-enclosure, thus preventing modulation of the midrange by the back pressure of the woofer. Crossover to the midrange unit is specified at 500 Hz. The 1 in. tweeter comes in at 5000 Hz, overlapping the midrange and carrying on to the limits of audibility.

Screw terminals for the amplifier output leads, as well as midrange and high frequency level controls, are provided on the back panel in a recessed area. The attractively finished walnut cabinet has a removable grille, and the entire system weighs in at 72 lbs.

**Performance**

For our tests, we set the midrange and the tweeter controls to minus 3 and minus 6 dB, respectively, from their wide open positions. These settings were chosen after listening to a variety of program material. The relative amount of high frequency energy that one uses depends on the acoustical environment and the listener's preference in concert hall seating location. Figure 2 shows the speaker system's frequency response on axis, off axis, and averaged. Note the smooth transition when using either 3 or 6 dB tweeter cut.

The system impedance varied quite a bit across the frequency spectrum, but that really shouldn't present any problems. Sensitivity is somewhat above average, being 87 dB for 1 watt input. From the distortion figures of Fig. 4 and the frequency response graphs, it is clear that the system can be considered good down to 40 Hz and usable down to 30 Hz.

The higher than average efficiency of the Wharfedale W70E permits some savings in amplifier power. A good 30 watt rms amp will drive this system very nicely. To sum up, this loudspeaker from British Industries is a well-made product which will fit into most decors and won't put a strain on amplifier or pocketbook.

*Alex Rosner*

Check No. 131 on Reader Service Card

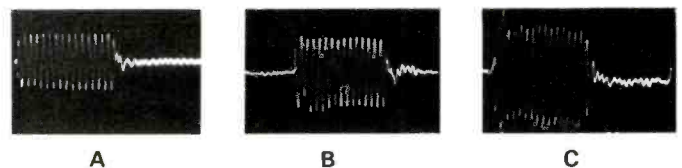

**Fig. 3**—Tone burst response at **A**, 500; **B**, 2000, and **C**, 10,000 Hz.

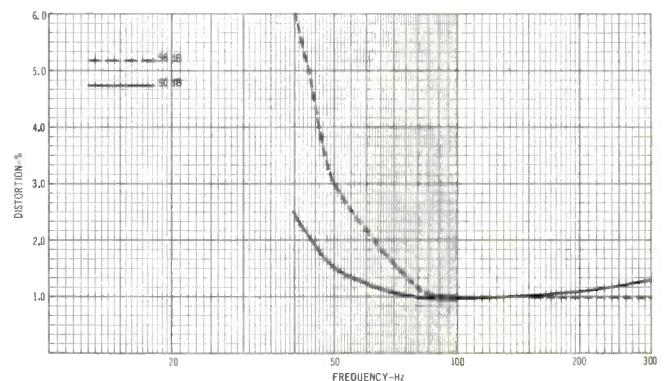

**Fig. 4**—Harmonic Distortion.

## The Corporate Block: International Trade



**A**ND WHAT has this young Leap Year of 1972 brought us in its first months? Mainly impasse. The biggest, most gristly set of deadlocks we have ever experienced. The Corporate Block. It's a trend, alas, and I do not like it. (Does anybody?) Bad for you and me and for the corporations too. Bottles up everything. Stops trade, strangles sales, kills initiative, ruins dispositions. Ugh. No good. But what can be done?

It happens more and more often as corporations get bigger and technology grows ever more complex and expensive. Really frightening. No movement. Just a war of attrition. Is this the be-all and end-all of our Great System, a kind of vast capitalist constipation? Awful idea. But here it is. We are in the middle of it. And I don't expect enough change to make my words out of date when this appears in print. Though it would be nice if I am proved wrong, at least in part.

The trouble is that our business, our art, like a thousand others, can only survive in *motion*—production, sales. A fluid, give-and-take competition, like the old fashioned war of movement, as it used to be called in the military manuals. But here we are holed up like 1914, in the trenches. Stuck. Millions thrown into the contests, dollars and people. Vast super-

powers, giving their all, out to win. And what happens? Nothing. Impasse. So—toss in more millions. Or withdraw with staggering losses. It's an ugly pattern, and I'll bet the corporations would like to get out just as much as we want them to get out (so long as each of them is the winner, of course). It took four years to untangle the mess of 1914. And look at our little old war right now, over there beyond. Are corporate wars the mirror image of "real" wars?

I am not thinking of merely one obvious instance of the corporate block today. I have in mind two and a half, to be exact (though there are plenty more), and it'll take me a couple of installments to cover them. Let's look at the half, this month, if only because it shows signs of being an exception to the rule. A prime example of *fluidity*, if in an unexpected quarter. International trade.

In audio—that insufficient term which now expands to cover all sorts of aspects in the media, arts, communications—we exist by virtue of a powerful triangle of forces. Engineering, science, audio itself, is just one strong leg. On its own, it is meaningless. Another leg is art. Software, as the Educators put it. What good is audio without a signal? What good is a signal without a message, useful and/or

entertaining, practical and/or beautiful? Third, as you can guess, is the all-embracing link, that binding force for practicality, business. An immense array of talent, and knowhow, and organization, that spreads all the way from mass-production manufacturing out to sales and distribution. Business without product is a vacuum. Our business leg depends equally on the other two, our engineering hardware and our signal software. Out at the sharp point of the whole danged triangle stands—lo!—the customer! What a superb idea. The customer is **IT**. Keeps the whole thing going. But now we have the corporate block. And we aren't even getting to him. The product gets talked about. But not sold. Conception, gestation—and then, no birth. It's awful. And dangerous. One way or another, movement is essential.

The one good thing, you see, about all the fuss over international trade in our area (which is very heavily affected as we all know) is that this business *remains fluid*. There are no serious impasses, however deadly the arguments. Vast pressures, heated fights, violent opinions; but movement continues. The rest, in a way, is normal. We can take the fight. Strictly part of life, after all. What we can't take is a freeze.

Thanks to the shrinking of the mighty dollar, it is dawning on us—even if our pride has dropped 8 percent—that now we can sell, over there, for less; and they have to sell, over here, for more. Realistic, and it undoubtedly reflects actual technological and economic balances more accurately than did the old puffed-up dollar. Only the tourists (ours) suffer. Even so, I remain marginally uneasy myself. We can so easily slide on into another kind of impasse, the kind that chokes off impetus for new development and profit and the competitive instinct that takes all comers and is constructive. I do not like to see any cherished American technology giving way to foreign competition, for any reason at all. I can't help feeling that the legitimate complaints about lower foreign costs, wages, etc., though true, are an excuse that we cannot afford to live with. It is the old story—production, or else. If we can no longer build our own products, if we must turn ourselves into mere salesmen and consumers (while the cash lasts), for other peoples' products, then we are on the downslide. We have always been a nation of innovators, designers, producers, carriers-out, organizers, distributors—the whole bit. We still are. But are we slipping, in a few areas (especially in our own, right here), into second-hand dealers?



# Radio Shack puts more into its speakers by leaving a few things out!

Things like distributors and their profits . . . and costly (to you!) trade shows, factory salesmen, promotional programs, and more. We leave those things out because we design our own Realistic® speakers . . . and build them in our own plants . . . and sell them factory-to-you in our own 1300 stores. We put in more quality, more special features, more beauty per \$ because we leave out costs other brands are forced to "pass on." Now you know our secret. Visit our nearest store and see how it pays off for you in superior sound at Real(istic) savings!

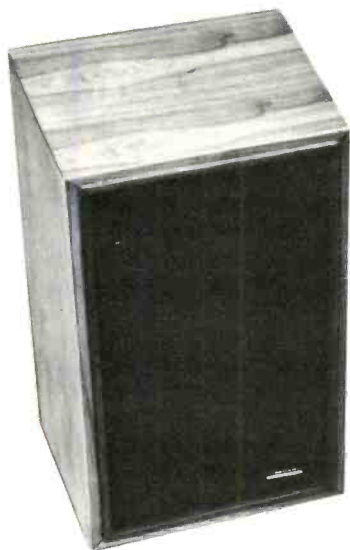

**Realistic Optimus-5.**  
Our deluxe bookshelf model. 12" acoustic-suspension woofer, 3 tweeters, unique crossover, tonal balance controls. 11 1/2 x 14 x 25" 99.95



**Realistic Minimus-0.5.**  
Tiny add-on "beefs up" sound of portable radios, recorders. Ideal extension too. 10.95

**Realistic Nova-9.** Our floor model with bass so deep you can feel it. 15" acoustic-suspension woofer, midrange, tweeter. Our best. 13 1/2 x 20 1/2 x 27" 159.95

**Nova-Omni.**  
Solves those placement problems with 360° dispersion - put a pair anywhere for great stereo. 8" top-firing woofer, side tweeter. Ornamental iron grille. 11 1/2 x 11 1/2 x 19 1/2" 69.95



**Realistic Optimus-1.**  
Over 50,000 sold. 10" acoustic-suspension woofer, 2 tweeters. 11 1/2 x 12 x 23" 79.95



**RADIO SHACK**

AND  
**ALLIED RADIO STORES**  
A TANDY CORPORATION COMPANY

Dept. A-11 2725 W. 7th St. Ft. Worth, Texas 76107

**Realistic MC-500.**  
BIG-sounding 5" acoustic-suspension woofer, 2" tweeter. 9 x 11-3/4 x 15 1/2" 30.00



**Realistic MC-1000.**  
Compact for serious music lovers 8" acoustic-suspension woofer, 3" tweeter. 8 1/4 x 11 1/4 x 17 1/4" 50.00



Check No. 71 on Reader Service Card

Are we, for business reasons, shutting down on our own on-going native know-how, in favor of somebody else's? It seems so, and I hate to see it. The beginning of the end. The Roman Empire. *We are there*, if we don't look out. The Greeks put it well, as they did. *Look to our laurels*.

Like a pianist who doesn't practice every day, we'll soon go rusty, selling other's products, and then slide implacably, over the long run, down into ignorance. Not yet. It's just a possi-

bility. But watch out. Practice makes perfect. Neglect leads to—well, you name it.

Are we to hide behind protection? Such an easy way out that most business people have the sense to avoid it, like a drug. Just slap on an import quota and/or a good stiff tariff for the imports, and then sit back to make cash, hand over fist. Ostrich like. We cannot ever hope to stay in planetary business on that basis. And to live that way inside our own walls is just an

illusory hope. No longer, Not on *this* planet. Again, we must keep fluid, keep up with the international Joneses. Anything else is an invitation to deterioration.

It isn't a matter, you see, as to whether we "approve" somebody else's system, of labor, finance, government interference and support. It is the result that counts. If they produce a better product, we won't make it worse by talking. Nor by keeping it out of our fair country. What matters is—do we still want our leadership, or don't we? We can't count on it any more, as we used to. To mix a metaphor, if you think we can rest on our laurels, you're going to find they're made of hawthorne branches, with big, fat thorns, an inch long. Ouch!

Actually, it would seem that the dollar devaluation will work out to a lessening of the trouble that has been so bad of late, too many imports and not enough exports. And so we may hope, not for more protection, but for a more realistic competition between our goods and theirs. OK! Nothing could be more heartening for our own future *and* our profits, and I am sure that most of us can take the deflation in our national pride with a bit of good philosophy. After all, we've been the fat king of the roost now for a long time. Do us good to work off some fat, get back into condition.

You see how my theme of fluidity comes in. In a free and easy competitive situation, things balance out and genuine trade is the end result. *You* have something I can use, I have another thing *you* can use. I do so-and-so best, you do such-and-such best. Trade for trade. It works inside our country. It must work outside too. It has to. No—I don't mean that trade is a bed of roses. It seldom is, as anybody knows, however polite the exterior. But what matters is, however ruthless the details, that the whole thing be fluid and in movement. No impasses. No deadlocks.

Yes, of course there must be head-on competition. I didn't mean to exclude *that!* Our hi-fi receivers vs. theirs, both aiming at the selfsame niche in the market place. Absolutely a part of all trade, along with the give and take, the you-have-something and I-have-something. Maybe the Japanese can make the best three-inch color TV, and maybe we can edge them out in the large-size models—but in between, it's cheek to jowl, model for model, GE, Zenith, RCA against Sony, Sansui and so on. No quarter. But, please, *no artificial restraints* either, no short-sighted, wishful-thinking arguments that reduce

# Ask a cynic... if you want the facts about speaker quality!

Scratch below the surface of an audio dealer and you'll find a cynical, opinionated, always skeptical expert. He's got to be... his continued existence depends on his ability to pick and choose. When he coordinates a receiver, a record player and a couple of speaker systems, he is practicing the art and science of his craft in an attempt to produce great sound at competitive prices in a trouble-free music system.

The *Creative Dealer* conjures up systems with a mix of brands — often marrying a top receiver and record player with a speaker bearing his own name. This is partly pride, but also a striving for the best sound value and so he works with top designers and manufacturers in creating *his signature* system.

Maximus is the acknowledged master in this field and has come up with all the great "Private Label", signature systems. The signature designs carry the dealers name, but all the great ones show the Maximus *Hallmark* — either printed label or evident by the sound alone.

MAXIMUS SOUND CORP. 809 Stewart Avenue, Garden City, N. Y. 11530  
MAXIMUS WEST 1900 West 135th Street, Gardena, Calif. 90249

## MAXIMUS



All Maximus™ and Maximus made systems are warranted by Maximus and may be recognized by their superior sound qualities and (if pride permits on signature models) our Hallmark.



You probably think it's impossible to get the big sound of a 12-inch woofer and a mid-range tweeter from an enclosure measuring only 7¼x10½x5½ inches... that is, until you hear the mini-MAXIMUS!

Check No. 72 on Reader Service Card



pure competition.

Yes, I know that the idea isn't pleasant for those on the competitive line. It's easy for *me* to talk. It is so easy to go for the argument that the other side's system isn't fair, our law, our principles, our set-up, doesn't allow us to complete. True, the differences exist. We must cope with them, or else.

Somehow, our traditional ingenuity must be forced into new channels, to find the means to meet the "enemy" not on his own ground but on ours, not via his system but via our own. A thousand little bits of that sort of ingenuity are already turning up among our still-ingenious industrial designers, whereby we are learning to meet the foreign competition as we have to, directly, in, so to speak, hand to hand combat.

I was heartened, for instance, by a recent visit to Advent's new factory in Cambridge, Mass. They gave me the grand tour after some kind words I dropped awhile back concerning their espousal of the hi-fi cassette. Advent's first cassette machine, the 200 deck, was, as might be expected, Japanese. An import ("to our specifications," of course). But in the newer Model 201, Advent has switched back to all-American product. That switch, I was given to understand, was possible because of purely technical ingenuity in getting around the low cost of production inherent in the imported product. (This was before the 8 percent jump.) Part of it is to the credit of 3M, which makes the basic and very American "chassis," typically solid, with the big flywheel and the record-changer-like mechanical controls, the clanky, springy sort that go *zing* when you shift gears. Feels exactly like a record changer.

Advent's contribution, or rather, one contribution that I can remember, is an extension of that very idea. Quick thinking. Now, it seems that wiring is one of the big costs of circuit-board production. Suppose, instead of building the boards and what-not so they wire out to the compound switches on the control panel, let's build *for the least wiring*, and then put in the switches one by one, where they fall, at the most economical point.

How to hook them up? There you are! Just extend the familiar mechanics of the record changer sort, so that a single outside control simultaneously shifts three of four different switches *in different places*. Advent's mechanical assemblies for this purpose, lowered into the chassis on jigs to fit onto the circuit board lay-out, had me absolutely cross-eyed. All I know is, you push a lever here, and switches pop all over

for complete record & tape  
information you need both . . .

## Schwann 1

*The Schwann everybody  
knows*

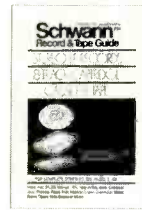

It takes frequent revision to keep up with the many new releases in records and 8-track cartridge and cassette tapes. The monthly Schwann Record & Tape Guide contains nearly 45,000 listings in classical, recent popular, rock, jazz, folk, musical shows, quadrasonic, etc. Special new listing section lists this month's releases in all categories.

Latest Monthly Issue

**75¢**

## Schwann 2

SEMI-ANNUAL SUPPLEMENT

*The Schwann everybody  
needs to know*

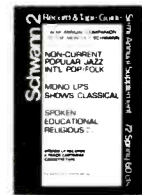

Necessary companion to the monthly Schwann. Contains pop records more than two years old, classic jazz, older and re-released mono classical recordings, classical on lesser-known labels, international pop & folk on domestic labels, spoken, educational, etc., on records and tapes.

Latest Semi-Annual Issue

**60¢**

Keep Schwann Catalogs at home for reference and to help you decide on additions to your music library. Ask your record dealer for the latest editions.

### SAMPLE OFFER

If your dealer does not have the Schwann publications you want, we will help you to become acquainted.

- SCHWANN SAMPLER consisting of one each, Schwann 1 (monthly) and Schwann 2 (semi-annual Supplement). SPECIAL PRICE Postpaid \$1.25.
- Latest monthly Schwann 1 Postpaid \$1.00
- Latest Semi-annual Schwann 2 Supplement Postpaid 75¢

Amount enclosed \$ \_\_\_\_\_ for items checked above.

Name \_\_\_\_\_

Address \_\_\_\_\_

City \_\_\_\_\_ State \_\_\_\_\_ Zip \_\_\_\_\_

Dealer's Name & Address \_\_\_\_\_

**Schwann Record & Tape Guide**

137 Newbury Street, Boston, Mass. 02116.

AU

the place, as neatly as you please. Rube Goldberg, brought up to date! Everything is taken care of in this way, from Dolby and Chrome circuits to RECORD and PLAY. So, you see, U.S. ingenuity meets the competition, not directly but around the flank. That's the way, boys. If it's wiring that costs too much, then don't have wiring. The mountain goes to Mohamet, the steel arms go out to the switches and flip 'em, right in place. Crazy, man. You see what I mean.

And so we get into real competition, fluid and full of movement. I keep thinking of Westminster's old trade mark, out of context, "natural balance." Free competition, however ruthless, has always tended to align things for the best, or if you wish, for better and better. The on-going fight is healthy, for it tends to call bluffs, puncture pretences, show up faults, shoot down overblown public relations claims, and generally to get us all down to reality and may the best man *really* win. It has worked that way remarkably well in the good old U.S. all things considered. And it has done so right up until recently. Take the LP vs. the 45, the famed "record war" of years back. See how beautifully that all-out war of movement steered

the varying competitive new types of disc, each to its proper useful sphere. That was healthy competition, it was *fluid*, and in spite of all our squawks, it worked out well. Because there were products on the market, there was business.

Even as recently as 1958 when the big fight over stereo disc came to a head, the results were healthy. And that in spite of the long, painful period when mono and stereo discs were both offered. Technology got ahead of itself there, but gradually caught up in a hundred ways, until the mono record (a) faded out and (b) became compatible via improved stereo cartridges and better stereo cutting (for less wear via the mono players still remaining). Nobody says it was a period of halcyon rejoicing. The stereo fights were plenty bitter. But things did remain fluid, products appeared, both discs and playing equipment, and it was bought by consumers. There was movement. And enough compatibility so that the big triangle of engineering, software, and business could stay together. Production and consumption went on. And so all was well in the end. It was even like that back in 1901, when the 78 disc was compounded out of a vast pooling of patents that in fact had brought

business to a complete standstill, each of a number of systems implacably out to kill and win. They knew, back then. Do they know now? Yes—but how? How to compromise, but not disastrously, is the name of the game, and in international trade we seem to be finding the constructive way to do it. Good.

But in the two major areas that round out my 2½, the picture is very bad. Maybe by the time I continue this it will be better. In both, there is deadlock. Implacably competing systems, incompatible, and nobody willing to give an inch. Will the so-called video-cassette (including the video disc) suddenly start moving? A dozen systems and not even the magnetic tapes have been able to get together very far, let alone the big new systems like EVR and SelectaVision.

And the four-channel disc? On a smaller scale, the same story. Monkey wrenches. (Spanners to our British editor, in case he doesn't get me.) Millions of bucks lined up back of incompatible systems. Products announced but unlaunched. Products launched but unavailable. Products barely available, but unsold. The corporate block for fair. Trench warfare. How long will it last? **Æ**

# Unclipping Power. 700 Watts.

(High fidelity. The concept isn't new—but the power you need to hear it is)

High fidelity means low distortion. A good amp will give you low distortion — when it's not clipping. But your typical 150 watt per channel number is going to clip. Even with the best and most modern speaker systems, there's just not enough power to avoid overload during low frequency passages. And on musical peaks. You need unclipping power to prevent overload — and distortion. *Phase Linear* is unclipping power. 700 watts. It's the untypical solid state amplifier with the three year guarantee — on parts *and* labor. 700 watts of high fidelity power at \$779 suggested retail price.

That's not typical either.

The Phase Linear power sound is at your dealer's.  
Or write Phase Linear, 405 Howell Way, Edmonds, Wa. 98020 for information.

Check No. 70 on Reader Service Card

## Phase Linear

**POWER** — Better than 350 watts/channel R.M.S., both channels driven into 8 ohms, 0 to 20 kHz.  
**HARMONIC or I.M. DISTORTION** — less than .25%; typically .01%.

**POWER at CLIPPING** — 450 watts per channel R.M.S. at 8 ohms. 720 watts per channel R.M.S. at 4 ohms. 270 watts per channel R.M.S. at 16 ohms.  
**FREQUENCY RESPONSE** — 0 to .25 mHz.  
**DAMPING RATIO** — 1,000 to 1, @ 20 Hz.  
**HUM & NOISE** — Better than 100 dB below 350 watts; typically 110 dB.





# Classical Record Reviews

Edward  
Tatnall  
Canby



## AUDIO SWEEP GENERATOR



Continuously sweeps  
the entire audio range  
**ELECTRONICALLY!!**

### SPECIFICATIONS & FEATURES

- Functions: sine, square, triangle, positive and negative sawtooth with variable slope control
- Controls: range, frequency, functions, attenuator, sweep speed (VCO frequency), VCO amplitude
- Frequency Range: 0.02 Hz. to 20 KHz. - all functions
- Dial Accuracy: better than 2% linear
- Power: 115 vac, 50/60 Hz.
- Output Impedance: 50 OHMS
- Output Voltage: 0-10 volts, peak-peak
- Sweep Speed: variable 1/25 sec. - 10 sec.
- Sweep Width: continuously variable maximum; 20Hz. - 20KHz. minimum; zero!
- Waveform Distortion: less than 1% (sine, square, triangle)
- Frequency Response: 20Hz - 20KHz  $\pm$  1db
- Frequency Stability: 0.1% per °C (0-50°C)
- Square Wave Rise Time: less than 80 ns.
- Triangle Linearity Error: less than 0.5%
- VCO Access: use the ASG-200 to trigger other equipment, or use other outputs to trigger the ASG-200!
- Added Features: smooth continuous sweep, no external inputs needed, short-circuit proof!
- Dimensions: 4-3/4 in. high, 8-1/4 in. wide, 6-1/2 in. deep
- Weight: 48 ounces

The low price of \$108.09

includes factory assembly  
and testing, a two year  
warranty, and a ten day  
money-back guarantee  
if not satisfied for any  
reason!

Also available as kit: \$84.85

PHASE CORPORATION Dept. 884  
315A Boston Ave., Medford, Mass. 02155

### German Opera

**Wagner: Die Meistersinger.** Donath, Hesse, Adam, Kollo, Schreier, *et al.*, Dresden State Opera and Leipzig Radio Chorus, State Opera Orch., von Karajan. **Angel SEL 3776**, 5 discs, \$29.90.

The latest von Karajan Wagner is on Angel, instead of DGG, but the qualities that have distinguished his earlier recordings carry over to the new label and new locale—Dresden, in East Germany. My long-time Wagnerian ear says Von Karajan is *it* for our time in terms of Wagner in the living room. He has it exactly right.

Recorded Wagner hasn't done too well in these years since the great days of Flagstad and Melchior in the 1930's. Individual great performances, stars galore, brilliant conductors, encouraging experiments in stereo sound—but very seldom a real, all-over *show*, a unified, all-of-a-piece performance, with one aim: the opera itself. Of all the operas, *Meistersinger* most needs it. And here, at last, it gets it. Fantastically good, I say.

It is indeed a show, full of enthusiasm, tight, economical, dramatic, without an inch of excess fat and yet relaxed where it ought to be. The voices, beautifully recorded, are matched to perfection in both singing style and ability, down to the smallest parts; it is a true *German* performance, even if the lead lady is from Texas. She sings the purest German-Austrian style. The pair of tenors, René Kollo and Peter Schreier, are matched like a pair of the Queen's gray horses, the bevy of basses, who are the imposing Master Singers, are like a row of solid Germanic peasantry, every one of them good—even Beckmesser, the dupe and foil, who was born Welch. And the chorus, representing the lively Apprentices, etc., is astonishingly full of verve and excitement, on its feet every second. The near-impeccable orchestra fills out the sonic picture, full of feeling, yet never too tense and always plastic.

This is no stage-distance recording—far from it. The singers are quite close, though blending musically with the orchestra and chorus. They perform out of individual half-isolation booths, each with his mic, and they are unobtrusively exact in their spacing around a stereo half-circle. To tell the truth, though I agree that for recorded Wagner the voices must take on a new sonic relationship to the musical surround, and *not* that of the stage, I felt that this time they are a trace too close and too loud. In the long pull—10 sides—they tire the ear; and yet the recording is so big, so clear, so good in its ambience, that you are bound to want full volume. Also, I detect a bit of "cavity" sound in each, which is undoubtedly the space in the isolation booth. Minor quibble.

The big booklet gives complete, easily followed text and translation, and it is worth following, straight through the 10 sides. (Though if you are wise you will suffer a few moments, hours, maybe days, of silence between acts. At such close range, there's just too much to take in). You will never really catch on to Wagner until you can follow the immediate drift of the running conversation which is the main operatic content. In *Meistersinger*, note well, it moves very fast and colloquially; whereas in the other operas the pace of discussion is unendurably slow, until you adjust your own musical pace to fit it.

Very nice on four-channel set-ups, with almost any kind of decoder. Mine was the E-V, with two power amps. Right in the big opera house, which is all around you. Best seat in the house? Of course! You are on the stage itself, at the conductor's podium—or where he would be if the orchestra, too, were on the stage and all around you. That's the way it sounds and that's exactly as things should be. For records, I mean.

Performance: A-                      Sound: A-



# Quadrasizer™ IV

## Exhilarating quadraphonic sound from any 2-channel source

### Insurance against stereo tape and disc obsolescence.

**Present Coverage** — You won't believe the difference! With ambient material being reproduced by rear speakers, you'll wonder why you always haven't listened to music this way... totally encircled by sound as if in a concert hall. That's what the SSI QUADRASIZER IV will do for your system now.

**Future Protection** — When discrete 4-channel sound becomes commonplace, the SSI QUADRASIZER IV will still be an important part of your system. It will enhance all the stereo tapes or discs you own by providing "synthesized" quadraphonic reproduction. So don't worry about obsolescence. Cover your-

self against the loss of present and future enjoyment.

**Specifications and Features:** Channel separation — Front, Left to Right greater than 55 db. Front to Corresponding Rear 4.5 db. Front to Opposite Rear 9.5 db. Center, Front to Rear greater than 25 db.

Does not diminish frequency response of any system to which it is connected. Operates with one or two stereo amplifiers. Matrix system closely simulates studio or "live" recording conditions. Passive matrixing adds NO distortion, hum or hiss.

*SSI components are available at selected audio dealers everywhere.*

### QUADRASIZER IV



Suggested Retail Price **\$29<sup>95</sup>**

Also available from Sound Systems International: **The QUADRASIZER 8.** A 4-channel playback adapter for use in automobiles. Same specifications and features as Quadrasizer IV.



Suggested Retail Price **\$19<sup>95</sup>**



Super Components® from: **Sound Systems International**  
53 East Oakland Avenue, Salt Lake City, Utah 84115

Check No. 23 on Reader Service Card

**The Comic Beethoven.** Anneliese Rothenberger, Nicolai Gedda, Walter Berry; Munich Convivium Musicum; Consortium Musicum, Chorus Bavarian State Opera, Vienna Akademie Kammerchor, et al. **Seraphim S 60180**, stereo, \$2.98.

A slightly delayed holdover from the Beethoven Year (1970), this is a very pleasant and well put together disc of Beethoven trifles, vocal and instrumental, not a one of which, however, does not display Beethoven's professional sense of craftsmanship. The mixture is tastefully distributed between songs, with three different soloists, instrumental dances of three kinds—

Country Dances, German Dances and Viennese Dances—and an occasional choral intrusion. Several of Beethoven's more famous canons are included, notably the one about Mälzel's metronome invention, which was incorporated into the Symphony No. 8. Another familiar symphony, the "Eroica," is represented in the Country Dance (or Contra Dance) in E flat, original for the familiar tune in the Symphony's last movement.

Most of the singing is spirited and lively, in broadly relished dialect Austrian, especially the excellent basso songs with Walter Berry. Anneliese Rothenberger, a seasoned pro, almost

splits herself, however, trying to sing a Tyrolese yodel song straight, minus falsetto! She makes it, but Swiss and Tyrolese yodelers would turn gray at the sound. Some of the songs are evidently from that new mass of "WoO" (works without opus) numbers that were resurrected at the time of the Beethoven Year for recording, the ones with the higher (i.e. later-catalogued) WoO numbers. Others fit in between the familiar works, as late as 1819, when the Viennese Dances were composed. All the ribald texts are included, with translations.

Performances: B+

Sound: B



# ASTONISHING\*

That is how people who have heard it describe the Transparency of  
*The TRANS-STATIC I by ESS*



## SPECIFICATIONS — TRANS-STATIC I

FREQUENCY RESPONSE	Below 15 hz to above 32 khz 25 hz to 20 khz $\pm$ 2.5 db
DISTORTION DISPERSION	Less than 1% at 90 db. 80 hz to 20 khz. Controlled dispersion pattern to provide 160° dispersion as well as center fill
POWER REQUIREMENT	30 Watts RMS
POWER CAPABILITY	FUSED DRIVERS accept the new generation of high power space-age amplifiers to cre- ate the ultimate in bass
DESIGN PRINCIPLE	Transmission line bass-electrostatic tweet- ers, non-resonant, open enclosure design incorporating the augmentation principles (back wave propagation reinforces front wave radiation)
DIMENSIONS	20W x 15D x 42H
WARRANTY	5 years — parts and labor
WEST COAST PRICE	Under \$600.00 in Oiled Walnut Slightly higher in Rosewood

\*To overwhelm with wonder and surprise; amaze, confound. **Amaze, surprise, astonish** mean to fill with wonder or incredulity by confronting something unexpected. We are **amazed** at what seems impossible, highly improbable, extremely difficult, or otherwise beyond normal experience. That which is merely unexpected **surprises** us; we are **astonished** when the surprise is great enough to silence or daze us.

The TRANS-STATIC I speaker system is something new and exciting — a high reliability electrostatic speaker system capable of high power handling and of concert size sound in a small handsome enclosure that blends with living room decor instead of dominating it. The TRANS-STATIC I is a superb uncompromised state-of-the-art speaker system that has a delicate transparent top and electrifying thunderous bass — not the flattened sweet treble that rolls off at 12 khz or the piercing shrillness of many an extended dome tweeter, but the delicate sheen of an electrostatic top flat to 30 khz; not muddy, fat, boomy bass, but crisp bass, lean and taut enough to reproduce guitar accompaniment faithfully, and yet deep and dramatic enough to propagate the enormous room shattering energy of timpani or fundamental 20 hz organ tones, in short, a speaker which sounds superb, playing Madrigals or Montavani, chamber music or The Chambers Brothers.

## SPECIFICATIONS — ESS VII



*“Great music is a psychical storm, agitating to fathomless depths the mystery of the past within us.”*

— LAFCADIO HEARN

The ESS VII — The Bookshelf size speaker that lifts the veil and lets the music speak for itself.

FREQUENCY RESPONSE	30 to 20 khz $\pm$ 3 db
DISTORTION	Less than 1% at 90 db
POWER REQUIREMENTS	20 Watts RMS
DIMENSIONS	16W x 14D x 27H in Oiled Walnut in Rosewood

## ESS ELECTROSTATIC SOUND SYSTEMS, INC.

4503 E. Railroad Street, (916) 452-5532 Sacramento, California 95826

# Canby's Capsules

Edward Tatnall Canby

**Mephisto Waltz & Other Satanic Piano Music of Liszt.** John Ogdon. Seraphim S-60170, stereo, \$2.98.

**Bartók: Suite for Two Pianos, Op. 4b (1907/1941); 14 Pieces from "Microcosmos,"** arr. Bartók. Richard and John Contiguglia. Connoisseur CS 2033, stereo, \$5.98.

**Tchaikovsky: 1812. Borodin: Prince Igor, Polovtsian Dances. Stravinsky: Pastorale.** John Aldis Chorus, Welch Nat. Opera Chorus, Band of Grenadier Guards, Royal Philharmonic, Stokowski. London Phase 4 SPC 21041, stereo, \$5.98.

**The Well-Tempered Saw.** Jim Turner. Owl ORLP 22, E-V Stereo-4, \$4.98.

**Shankar: Concerto for Sitar and Orch.** Ravi Shankar; London Symphony, Previn. Angel SFO 36806, stereo, \$5.98.

**Spike Jones is Murdering the Classics.** RCA LSC 3235(e), sim. stereo, \$5.98.

**Tchaikovsky: Francesca da Rimini; Hamlet.** U.S.S.R. Symph. Orch., Svetlanov. Melodiya/Angel SR 40167  
**Tchaikovsky: Romeo and Juliet; The Tempest.** (Same) Mel./Angel SR 40166, \$5.98 ea.

**The Best of the Virtuoso Instrumentalists.** Vanguard VSD 709/10. The Best of Mozart. Vanguard VSD 705/6, 2 discs each, \$5.98 each.

**Delius & Elgar: Songs for Chorus.** Louis Halsey Singers. Argo ZRG 607, stereo, (\$5.98).

Powerhouse Ogdon from England has more than the necessary technique to whirl off these fantastic finger-twisters; but Liszt is not well served. Ogdon seems to miss the whole import of Liszt's strange-harmonied "satanic" music, forerunner of so much later atonality. Definitely not recommended, unless for technique.

The Contiguglias join the very top 2-piano teams of today, and in their impeccable musicality and sense of style they surpass many more famous duos. See also their superb Schubert-Brahms disc. This is a very early Bartók work, for orch. in 1905-7, set for pianos by Bartók in 1941. Heartening "reminiscences," before the fact, of his later music, mixed with Brahms and Debussy! Nice. Bartók arranged and re-composed the 14 "Microcosmos" etudes into bigger works.

What—another . . . ? Just so! Big Phase 4 spread, glorious, enthusiastic, if somewhat unrehearsed, performance with true Stokowski drama, all-out. Chorus, in unison, only at the very end. (The Ormandy-Phila. version puts it at the beginning, effectively.) The Polovtsian Choruses are similar, full of verve but a bit incoherent in detail. Stravinsky fills out a few extra minutes. Phase 4 at its most unbuttoned.

Nothing like finding your own niche in this big world! Jim Turner has, and he is backed by a lot of power, including the Boulder Philharmonic, not to mention everything from cowbells to harpsichord. If you can stand the banshee wail of the high-soprano saw, you can have Vivaldi, Gershwin, Frère Jacques, Careless Love, etc. And in compatible E-V Stereo-4.

East has been trying to meet West in musical terms for so long—from "Scheherazade" to the Beatles. Mostly, the mix is either all one-sided, faked up, or dismally incompatible. Ravi Shankar's Concerto is astonishingly good, a 50-50 work that does not demean or falsify either element, a series of near-Ragas, with the orch. playing easily along behind the solo. Excellent—for East *or* West listening.

Wow, is this delightfully dated! Cleverly simulated stereo and hi fi recording give a totally modern sonics—but oh, those murders. Out of another world, already. Mostly blats, gargles, tweets, explosions, cowbells, etc., with zany comment ("FEETLEbaum!!"). Grossly corny yet astonishingly disciplined. Idiotic "Carmen," act by act, is the crowning topperoffer. I almost died, as we useter say. Bizet already twittering in grave.

The famed tone poem "Romeo and Juliet," one of T.'s very best works, is quite early. He wrote others in the same general formula; here are three more: They rant, roar, croon, sound *very* much like Tchaikovsky—but not one, today, can really catch the modern ear. And so long, so loud! "Romeo" was a sort of lucky freak with its ultra-clear shape and impressively dramatic themes. Good solid Russian playing.

Just to call attention to Vanguard's continuing "Twofer" series, 2 discs for the (list) price of 1. The company's reissues are always strong because Vanguard engineering and recording technique have been excellent since 'way back. The Virtuosi here include small-orch. works of many sorts by Vivaldi, Mozart, Cimarosa, Weber. The Mozart discs offer good cross-section, from "Kleine Nachtmusik" to the "Jupiter" Symphony.

If you're American, you probably hate Delius & Elgar. If not, you'll find this a superb rendition of lush Romantic music, beautifully understood and projected. I ate it up.



(Continued from page 14)

small consequence when playing quadrasonic records with ambience only on the rear channels. Unfortunately, the new version was not available for these brief tests, but it can be assumed that it is fully compatible with the CBS SQ. Again, the CBS logic or gain riding decoder was not tested. Obviously, this will give much greater separation between all channels but whether the extra cost is justified is doubtful.



Here is a brief report on some CBS SQ records which were also used in the above tests.

Barbra Streisand in extracts from *Funny Girl*, SQ 30992.

This is taken from the original soundtrack and has some interesting effects particularly in the duet between Barbra and Omar Sharif. It puts you right in the middle of the front row!

Ray Stevens' *Greatest Hits*, ZQ 30770.

Here the listener finds himself between the violinist and the orchestra—at least that's the way it sounded in my room. Exciting, though.

Al Kooper, Steve Stills, Mike Bloomfield: *Super Session*, CQ 30991.

Now you are right in the middle of the players—you can almost reach out and touch that bass player. Excellent recording.

Morton Subotnick with the Buchla Synthesizer in *Touch*, MQ 31019.

Mort says "to live without a quadrasonic set-up may be possible but is not advisable." I won't comment on that but unquestionably this medium is ideal for electronic music. Might be even better with four discrete channels, but the sense of location is pretty good anyway.

Bernstein and the LSO: *Verdi Requiem*, M2Q 30060.

The singers, Martina Arroyo, Josephine Veasey, Placido Domingo, and Ruggero Raimondi, are not recorded too well. Just a slight touch of edginess easily removed by a filter, but the orchestral climaxes are tremendous with a most realistic ambience.

Ray Conniff: *Love Story*, CQ 30498.

A very pleasant surround sound, this one. Nicely recorded.

Finally, a word of praise to Dr. Takeo Shiga of the Nippon Columbia Company who, I believe, was responsible for the UMX demonstration record. The selections ranged from electronic to chamber music and were beautifully recorded. So, incidentally, is the Sansui record which features part of the Dvorak *New World Symphony* by the Tokyo Symphony Orchestra. There is a very real sense of actually being there in the concert hall.

The finest speaker in the world costs \$660. You need two.

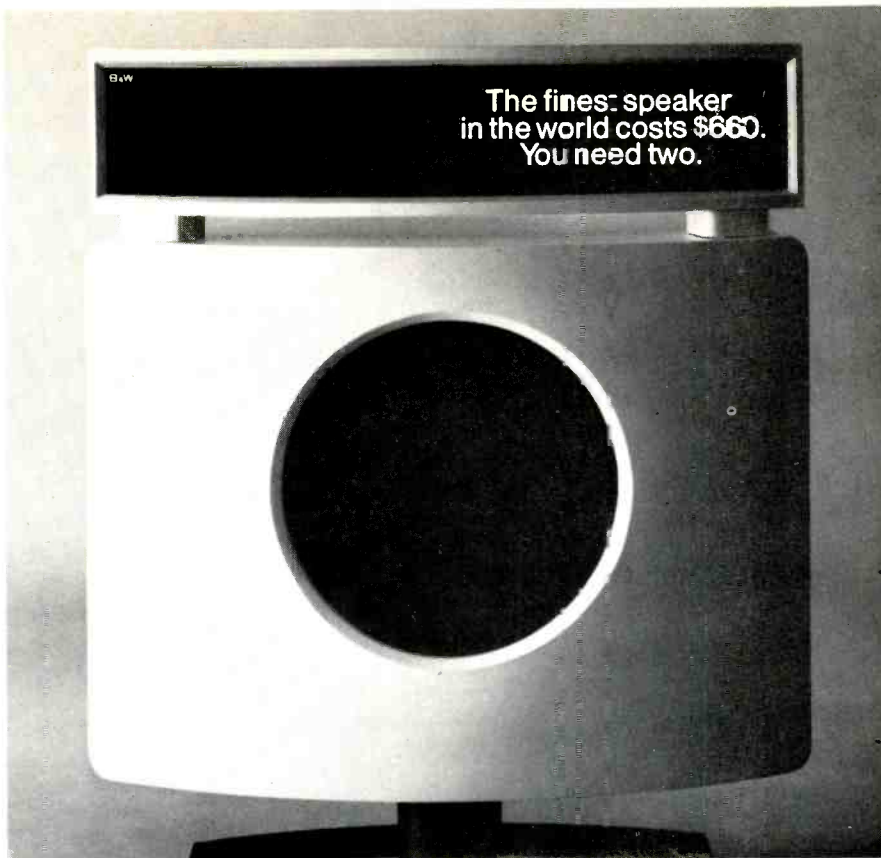

B&W 70CA specifications: Frequency response 25 Hz to 18 KHz  $\pm$  3 db.  Axial response 90° arc horizontal in the order of  $\pm$  2 db of on axis response at all frequencies up to 15 KHz.  Distortion: difficult parameter to state simply but audibly lower than any other speaker.  Power handling: 50 Watts RMS continuous.  Impedance: 8 Ohms nominal.  Electrostatic mid and high frequency unit from 400 Hz up.  13 inch triple suspension dynamic from 400 Hz down.  Crossover slope 18 db per octave. LINEAR DEVICES INC., 148 French St., New Brunswick N.J. 08901. For more information call (201) 846.7777.

FREE

## McIntosh CATALOG and FM DIRECTORY

Get all the newest and latest information on the new McIntosh Solid State equipment in the McIntosh catalog. In addition you will receive an FM station directory that covers all of North America



### MX112 FM STEREO/AM TUNER PREAMPLIFIER — ALL SOLID STATE

SEND TODAY!

McIntosh Laboratory Inc.  
2 Chambers St., Dept. AE11  
Binghamton, N.Y. 13903

NAME \_\_\_\_\_

ADDRESS \_\_\_\_\_

CITY \_\_\_\_\_ STATE \_\_\_\_\_ ZIP \_\_\_\_\_

# Weingarten Looks At Neil Diamond

Sherwood L. Weingarten

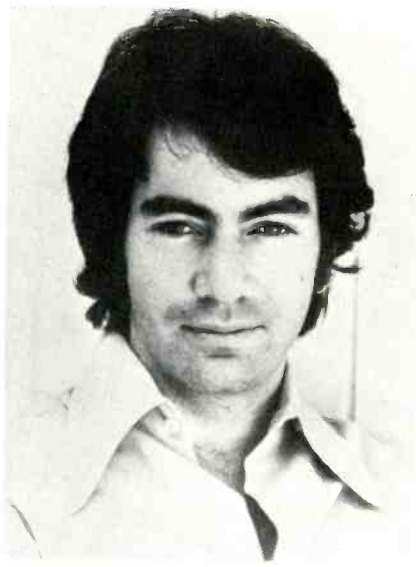

**T**HE DAY of the singer is dead; long live the day of the *writer-singer*.

Once upon a time vocalists were content to perform material conceived by others, material penned by tunesmiths who had spent years honing their skills with words and music. Today, however, is the time of future shock, of looking inward, of identity crisis. And out of the traumas come entertainers who insist on being modern Renaissance men, partially to find themselves, partially to express themselves, and partially to make an extra buck via corporate tax loopholes.

Much like the little girl in the doggerel, when they're good, they're very, very good, but when they're bad, they're horrid. Most fall in the latter category. One who *does* seem to be a one-man amalgamation of talent, however, is Neil Diamond, a guy who, like vintage wine, improves with age.

**STONES** (Uni, 93106), his most recent album, easily proves the point, for it's his best LP yet. It definitely is a professional product, ultra-smooth, slick as the dew on freshly cut grass, and thus outstanding in a time when amateur recordings are a proverbial glut on the market.

The package begins and ends with his own composition, "I Am . . . I Said," a year-old chartbuster that is having a second go-round on the airwaves. The song, autobiographical and introspective in nature and yet universal in scope, has the excitement of reality and the power of illusion. It is simultaneously musical and visual, its images penetrating the armor of young and old alike.

That, undoubtedly, is the reason for Diamond's success. He makes a 40-year-old remember what it was like a long yesterday ago, a 20-year-old think about what it's like now.

Sandwiched between the two versions of "I Am . . . I Said" are two other Diamond originals, the hit title tune and "Crunchy Granola Suite," the latter an eclectic, electric simple bouncer, the kind of thing you go

away from humming, despite its tricky Latin-rock beat.

But Diamond recognizes that he's not the only multi-faceted artist around. So he borrows from seven other writer-vocalists, each a star in his own right. There's "The Last Thing On My Mind," a slow ballad from the genius of folksinger Tom Paxton, for instance. And Roger Miller's "Husbands and Wives," originally a count-rified piece but in Diamond's rendition almost a music box melody. And Joni Mitchell's zestful "Chelsea Morning."

Want more? Try the schmaltzy yet poignant "If You Go Away," a collaborative effort by Jacques Brel and Rod McKuen. Or "Leonard Cohen's Suzanne," or Randy Newman's "I Think It's Gonna Rain Today."

All, of course, are modern classics, yet Diamond puts his own deep-voiced, slightly-drawled individual stamp on them, sticking, mostly, to folk or contemporary art stylings.

Diamond, not incidentally, traces his musical beginnings to a childhood in which he changed schools many times because his parents moved frequently. "Making and keeping friends was difficult under those circumstances and I was for the most part an outsider in each new school," he says. "Yet I was sustained by two things: a fantasy world I created and the sounds of music which filled my house."

He received a used guitar as a birth-day present from his parents at 16,

and composed his first song that day. Compulsively, he then wrote on anything he could find, "envelopes, the back of receipts, paper bags. There was never enough paper to write on in the beginning."

Success came initially with Bang Records, a small independent label that produced three Diamond-penned hit singles, "Solitary Man," "Cherry, Cherry," and "I Got the Feeling." Shifting to Uni, he has delivered four gold albums, signifying more than a million dollars in sales per LP. **STONES** should be the fifth, for *the* Diamond has more polish, more sheen than ever.

**LOVE IS STRONGER** (RCA Victor, LSP-4535) focuses on a new trio, Love, Peace & Happiness, a group which provides soul with a huge gospel overtone. Unhappily, lyrics too often get muddled, perhaps because the arrangements are super-glossy. The trio (consisting of two brothers, Melvin and Leslie Wilson, and an ex-Marvelette, Ann Bogan) composed eight of the nine songs with producer Harvey Fuqua. Better luck next time.

**COOL 'N SAXY** (Hi-London, SHL 32060) puts Ace Cannon in the lime-light for a dozen cool, though not soft, raspy sax successes. Every tune's tempo seems heightened just a bit, making the gig more inviting. Highlights are Tony Joe White's "Rainy Day in Georgia," Lennon-McCartney's "Let It Be," Joe South's "Don't It Make You want to go Home," and Fred Neil's "Everybody's Talking." Above them all, however, is Cannon's own "Chicken Fried Soul," a particularly bouncy instrumental.

**FRANCIS LAI PLAYS FRANCIS LAI** (United Artists, UAS-5515) has the Frenchman, who once was piano accompanist for Edith Piaf, performing 11 of his own creations. Best are "Love Story" (he won an Academy Award for the film's original score), "Live for Life," and "A Man and a Woman."

**TAKE HEART** (A&M, SP 4310) joins singer-songwriter-guitarist and sister of Joan Baez, Mimi Farina, with



Tom Jans for an album of almost all original material in the folk-rock genre. There's pleasant harmony and a good soft now-sound not far removed from that of The Carpenters. Mimi penned four of the 10 tracks herself; Jans did two, and three were written in collaboration by the pair (including the one instrumental, "After the Sugar Harvest"). Highlights are a poignant solo by Miss Farina, "Charlotte," and "Letter to Jesus," replete with gospel aura.

**FOR ALL WE KNOW** (Columbia, G 30622) is a two-disc package by Charlie Byrd with 21 cuts (ranging from "Tea For Two" to "Superstar," "House of the Rising Sun," "I Want to be Happy" and "Venezuelan Waltz No. 2." Says the jazz-pop guitarist, a one-time student of Segovia, "I think this album has a little bit of everything on it. It's got some solos, classical kind of things. And it's working with a minimum of background for the guitar." It's a groove.

**JERRY KENNEDY PLAYS: WITH ALL DUE RESPECT TO KRIS KRISTOFFERSON** (Mercury, SR 61339) is a tribute to the tunesmith, a pleasant country-pop sound augmented by heavy use of strings. All 11 cuts, three of which use background chorus, were penned by Kristofferson. Kennedy, who also produced the vinyl, plays electric, classical, and flat-top acoustical guitars, gut string guitar with resonator, dobro, and electric sitar. Best tunes are "Sunday Mornin' Comin' Down," "Help Me Make it Through the Night," and "When I Loved Her."

**FOUR TOPS GREATEST HITS, VOL. 2** (Motown, M 740L) is a look backward to yesterday's charts. The dozen familiar items, all offering good harmony and a pleasant soul sound, include "In These Changing Times," with its superimposed carnival noises and the sound of clocks at the opening; "It's all in the Game," a good combination of the old and the new, and Tim Hardin's "If I Were A Carpenter."

**COUNTRY LOVIN' FOLK** (Philips, PHS 600-351) features the Mystic Moods Orchestra, a surprisingly good ensemble that has its talent hidden by the superimposed sound effects. The 10 songs here, one of the orchestra's best outings, all are from the minds of the top modern tunesmiths. Such as Fred Neil's "Everybody's Talkin'," Nilsen's "I Guess the Lord Must be in New York City," Donovan's "Catch the Wind," Bob Darin's "Simple Song of Freedom," Bob Dylan's "She Belongs to Me," and Joe South's "Don't it Make You Want to go Home." Instrumentals that might even be better without the gimmickry.



## Soundcraftsmen presents the new RP10-12 PROFESSIONAL EQUALIZER for RECORDING and PLAYBACK

PERFECT tailoring of octave-wide bands... Infinitely variable adjustment flexibility  
... Special Effects programming ... Instant re-setting  
via Computone-Charts

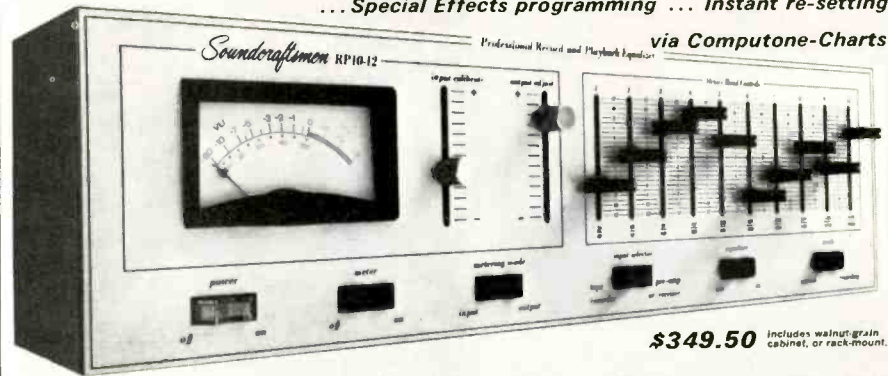

\$349.50 includes walnut grain cabinet, or rack-mount.

Recording Studios • Audiophiles • Night Clubs • Performers • Theatres  
Churches • Gyms • Auditoriums • Hi-Speed Duplicating • Musical Groups

### SPECIFICATIONS

FREQUENCY RESPONSE:  $\pm 1/2$  dB from 20-20,480 Hz, 1 dB down @ 10KHz, 1/2 dB down @ 100 KHz.  
HARMONIC DISTORTION: Less than .08% @ 2V, .05% @ 1V, Typ. .01% @ 1V.  
IM DISTORTION: Less than .08% @ 2V, .05% @ 1V, Typ. .01% @ 1V.  
SIGNAL-TO-NOISE RATIO: Better than 90 dB below 2V output, Typ. 95 dB.  
INPUT IMPEDANCE: 100K ohms - (Operable from any source up to 100K ohms; any Mixer, Hi-Fi Preamp, Receiver or Tape Recorder).  
OUTPUT IMPEDANCE: 600 ohms - (Operable into any Mixer, Hi-Fi Amp, Receiver or Tape Recorder).  
INSERTION LOSS: Zero (slide controls centered, and "OUTPUT ADJUST" control set so that "input" equals "Output").  
MAXIMUM OUTPUT: 7 V into hi-impedance, 3.5 V into 600 ohms - (13 dBm).

VU METER: Precision  $\pm .5\%$  meter movement provides an accurate visual display, to enable exact unity-gain input-output matching.  
INDUCTORS: Toroidal and shielded ferrite-core.  
CIRCUIT BOARDS: Military grade G-10 glass epoxy.  
RESISTORS: Low-noise selected carbon-film throughout.  
SWITCH CONTACTS: Gold-plated to assure low noise and reliability.  
OFEAT SWITCH: Electrically removes the Equalizer from the circuit.  
OUTPUT ADJUST: Controls a continuously variable 18 dB range, from -12 dB to +6 dB, to match output to input.  
RANGE: 12 dB boost and 12 dB cut, each octave centered at 30, 60, 120, 240, 480, 960, 1920, 3840, 7680 and 15,360 Hz.  
SIZE: Walnut-grained wood case  $5\frac{1}{2} \times 18 \times 11$ , Rack-panel  $5\frac{1}{2} \times 19$ .



Soundcraftsmen: 1310 E. Wakeham Ave., Santa Ana, Cal. 92705 Ph: 714-836-6375

NEW 1972 **STEREO 20-12** .... \$299.50

MASTER OUTPUT LEVEL: "Frequency-spectrum-level" controls for left and right channels, continuously variable 18 dB range, for unity gain.  
HARMONIC DISTORTION: Less than .1%, THD @ 2 v., Typ. .05% @ 1 v.  
IM DISTORTION: Less than .1% @ 2 v., Typ. .05% @ 1 v.  
SIGNAL-TO-NOISE RATIO: Better than 90 dB below 2V output.  
INPUT IMPEDANCE: Operable from any source 100K ohms or less - (any Hi-Fi Pre-amp, Receiver or Tape Recorder.)  
OUTPUT IMPEDANCE: Operable into 3K ohms or greater - (any Hi-Fi Amp, Receiver or Tape Recorder.)  
SIZE: Walnut-grained wood case  $5\frac{1}{2} \times 18 \times 11$ , or rack-mount

ALSO AVAILABLE, the **20-12-600** .. \$349.50  
SAME AS 20-12 ABOVE, EXCEPT HAS 600 OHM OUTPUT

Check No. 80 on Reader Service Card

## WE CAN SELL FOR LESS

### Nationally Advertised Brands

- Hi-Fi Stereo Components
- Tape Recorders
- Record Changers
- Home & Car Stereo Tapes
- Speaker Systems
- Radio & TV Sets
- Electronic Equipment

BRAND NEW AND FULLY GUARANTEED

## WE CAN SAVE YOU MONEY

SEND: for FREE Listing  
of 1000's of items ...

LOWEST PRICES ANYWHERE!

• Factory Sealed Units • Fast Service

## AUDIO Sales

2745 ERIE BLVD. EAST  
SYRACUSE, NEW YORK 13224

Check No. 81 on Reader Service Card

## HEAR HERE

FOR THE UTMOST IN

## DISCOUNTS

ON NATIONALLY  
ADVERTISED

## HI-FI STEREO COMPONENTS

WRITE FOR OUR QUOTE

All Merchandise Shipped  
Promptly Fully Insured From  
Our Warehouse.

## DOWNTOWN AUDIO, INC.

17 WARREN ST.  
NEW YORK, N.Y. 10007  
267-3670-1-2  
DEPT. A

Check No. 88 on Reader Service Card

Where O' Where  
has your  
HIGH FIDELITY  
gone?



Without regular maintenance, it's probably buried under layers of dirt, which can reduce the listening quality of even the best machine. But there is an answer—

## NORTRONICS QM SERIES quality maintenance accessories

Designed to preserve reproduction quality from virtually every cassette, cartridge and reel-to-reel recorder/player and also to protect expensive pre-recorded tapes through years of playing. The new QM-SERIES is the *only* safe, effective line of professional recording accessories that will keep machines and tapes sounding like they did when they were new.

Our new RECORDING EQUIPMENT MAINTENANCE MANUAL thoroughly discusses the importance of regular maintenance and the advantages of using Nortronics' QM-SERIES accessories in your personal maintenance program. If you want to keep getting the most out of your player and tapes, it should be *must* reading. Available FREE at nationwide Nortronics distributors, or write:



**NORTRONICS  
COMPANY, INC.**

6140 Wayzata Blvd.  
Minneapolis, Minnesota 55416

World's leader in magnetic heads and professional recording accessories

Check No. 82 on Reader Service Card

# Jazz & Blues

Martha Sanders Gilmore



## Miles Davis: Tribute to Jack Johnson

**Musicians:** Miles Davis, trumpet; Steve Grossman, sax; Michael Henderson, bass; Billy Cobham, drums; Herbie Hancock, keyboard, and John McLaughlin, guitar.

**Songs:** Right Off, Yesternow.

**Columbia KC-30455**, stereo, \$5.98

The music from the film "Jack Johnson" walks as tall and free as did Jack Johnson, 1908 heavyweight champion of the world, musically portraying his bold, libertarian dance through life.

Here, Miles Davis' genius soars starward in mind-blowing new directions, paying court to the jazz-rock fusion but leaping far beyond it in a totally fitting tribute to his subject. Davis himself becomes a Jack Johnson, as innovative, heraldic, and futuristic a musician as was Johnson a fighter and social mover.

Davis' group is taut and tight as a space capsule in the two gloriously marathon bands, sectioned off within themselves by drum tempo changes and interspersed with ethereal dream interludes. Each part blends theme and variations which build and subside via adventurous dynamics and flawless phrasings as the individual instruments comment upon Johnson.

Michael Henderson endorses it generously with lead-bellied ballast on bass but always remains punctual, precise, and discreet of note, seeking the high ones to bring out the grain. Billy Cobham on drums does what is required and more, while John McLaughlin on guitar is a kind of co-feature artist, executing stringent running lines, distorting, and trading bars with Henderson's bass. It moves along like a rhythm machine, surrealistic, Salvador Dali-esque, and of the computer age in its wiriness.

Steve Grossman plays a saucy, sardonic soprano sax, and Herbie Hancock on organ delivers clusters of notes

and uses his stops to great advantage. Then there is Miles, the pied piper walking on egg shells, using space as a painter would, creating a perspective and sight-line in his sound. One imagines Miles as Jack Johnson, walking his pet leopard in Europe while drinking champagne with crowds following.

"Right Off" is right on, setting an unrelenting pace, strutting and striding through life with the heavyweight. Davis makes a vivid opening statement on trumpet, combining crystal-clear tones with note bending knee-bends and spraying rapidly repeated notes about his musical universe. McLaughlin's wa-wa guitar encircles Davis' horn in moments of refreshing rapport, McLaughlin making lovely utterances and comments on his instrument.

Building in impact, gaining momentum, the music suddenly fades away in the distance as in a flashback or dream sequence, Miles' muted trumpet appropriate, the echo machine used to perfection. Then Grossman bops in on soprano sax, turgid, suggestive of Coltrane, his intonation at times approaching the timbre of an oboe. Sax, bass, and drums intertwine as the music becomes increasingly complex, sounding as though it all just happens at random—but the pieces fit *so* well.

Hancock crashes in on organ with a cord of doom against the guitar's do-ing-doiing, drowning his keyboard in a water bed of sound. Miles bites notes, Cobham implements chorus girl cymbals and clip-clopping chomps, Henderson clucks his bass and away it goes.

"Yesternow" begins slowly over a seven-note motif in the bass, mystical as a tone poem with the wind blowing through it, exposing the grey-green backs of the leaves. Davis is at once terse and concise, breathy and dreamy, holding notes for interminable lengths of time, McLaughlin's guitar simulating the wind. As the drum enters, the music assumes a more definite beat,



Linear, abstract, and near chamber-like in its demand for perfection. One can hear a pin drop.

Finally, Hancock comes in faintly, holding church chords, providing a stable influence, bringing order out of chaos. Grossman bolsters up the tempo on sax, nudging it along while Davis' muted trumpet swirls and twirls over the percussive drum, becoming more and more frantic. McLaughlin alternates hip-smacking guitar chords with telephone frequency lines of notes.

These vignettes of Jack Johnson's life end with a majestic passage and Johnson's voice: "I'm Jack Johnson, heavyweight champion of the world. I'm black. They never let me forget it. I'm black all right. I'll never let them forget it."

The sound is good—it has to be. The music, excellent!

Even fans who are turned off completely by rock and the electronic syndrome will admire these two long bands of uninterrupted artistry. Their intensity is shattering; their hypnotic quality will haunt you.

Listen anew to the magic of Miles Davis, brilliant technician, artist of cosmic dimensions, in a musical moon-struck eclipse of the first order.

Performance: A+                      Sound: A

**The World's Greatest Jazzband:**  
What's New.

**Musicians:** Yank Lawson and Billy Butterfield, trumpets; Bob Wilbur, clarinet and soprano sax; Bud Freeman, tenor sax; Vic Dickenson and Eddie Hubble, trombones; Ralph Sutton, piano, Bob Haggart, bass, and Gus Johnson, Jr., drums.

**Songs:** Bourbon Street Parade; Smile; The Eel; What's New; Mercy, Mercy, Mercy; Root Dog; Walk Him Up The Stairs, and four more.

**Atlantic SD 1582**, stereo, \$5.98.

Since its inception in 1968, the WGJB has been sponsored and financed by jazz fan Dick Gibson, a personal friend of many of the individuals in the band who saw to it that they finally stood up on those economically uncertain surf boards. In addition, he gave the band its name, not immodestly but with great aspirations.

With this LP, we believe the WGJB is well on its way, and with leverage that could sink a leviathan, how can they miss? Picture Yank Lawson and Bob Haggart, both alumnae of the Bob Crosby Band; drummer Gus Johnson, one of the most formidable drummers Basie ever had; Bob Wilbur, who studied at Juilliard, the Eastman School of Music, and with Sidney Bechet. And then there's Vic Dickenson, Bud Free-

# Do Something Nice for a Friend Today

## Introduce him to Audio Magazine at our expense!



We'll send your friends a copy of Audio Magazine at absolutely **NO COST**, so they can get a glimpse of one of the best read, well written magazines about hi-fi, stereo . . . **AUDIO MAGAZINE**, of course! We want to show your friends what they're missing every month. And, we want to tell them how valuable Audio is for stereo enthusiasts, do-it-yourselfers, music lovers and even audio engineers and professionals.

Each and every month Audio carries dozens of stories and columns devoted to new products, record reviews and new equipment—practically everything new and exciting that's happening in the audio spectrum.

**So, do something nice for a friend today!**

Let us send him a **FREE** copy of Audio. I guarantee you he'll be grateful for your thoughtfulness.

Please list the names and addresses of friends you think would enjoy Audio Magazine. We'll send them **FREE** copies of Audio and a gift card inscribed with your name.

My name is \_\_\_\_\_  
 Address \_\_\_\_\_  
 City \_\_\_\_\_ State \_\_\_\_\_ Zip \_\_\_\_\_  
(tear-out or attach subscription label from cover)

Please send **FREE** copies of Audio to my friends listed below.

Name \_\_\_\_\_  
 Address \_\_\_\_\_  
 City \_\_\_\_\_ State \_\_\_\_\_ Zip \_\_\_\_\_

Name \_\_\_\_\_  
 Address \_\_\_\_\_  
 City \_\_\_\_\_ State \_\_\_\_\_ Zip \_\_\_\_\_

check with the  
East-Coast Stereo  
Discounters...  
...then BUY from

MIDWEST  
HI-FI  
WHOLESALE

4N270 Mill Rd. (Box 182)  
Addison, Illinois 60101

Write for our new  
WHOLESALE price list  
& catalog. You'll  
be glad you did!

OVER 50 NAME BRANDS  
FACTORY - SEALED CARTONS  
WHOLESALE PRICES  
• SAVE ON TIME  
& FREIGHT CHARGES

Check No. 83 on Reader Service Card

## The World's Greatest Speakers?

Every week some  
manufacturer claims that  
his speakers are the best.  
Where then do Rogersound  
Labs come in?

We make truly great  
speakers like other people  
do, only our bag is price. We  
sell for 50% less because you  
buy direct from the factory.

Columbia Records, Warner Bros., Reprise,  
Vanguard and loads of other professionals  
use RSL studio monitors.

For full information on how you can get  
more speaker per dollar than you'd ever  
dream could exist, write or call:



**Rogersound Laboratories**

5706 Lankershim Boulevard  
North Hollywood, California 91601  
Phone: (213) 763-0855 • 877-1420

Check No. 84 on Reader Service Card

man, Billy Butterfield, Eddie Hubble,  
and Ralph Sutton.

Composer-arranger-bassist Bob Haggart charts the course of the band in frisky arrangements that alternately enchant, swing, and instill joy. To my mind, the arrangements are one of the band's major assets, imbuing it with a happy-go-lucky catholic sound that would ensnare even the most cynical newcomer to the art. It is a happy music with room for expansion for both ensemble and individual.

Nonetheless, being a greedy sponge-like listener, I find the tracks all too brief—jewels by their very contrivance but perhaps too contrived and with a lack of spontaneity and abandonment. The charts are flawlessly executed but don't go far enough, merely whetting this reviewer's appetite for more. Verdict: Catch this band in person if you can. But in the meantime, you can garner a more than generous introduction from its records.

The opener is a sure winner, a militaristic and slap-happy "Bourbon Street Parade" featuring Johnson on a rock-bottom rat-tat-tat snare coupled with Sutton's rather supple pianistics. Sutton appears to simulate the snare underneath brass and reeds, giving vent to a coursing filligree of notes, dashing off rippling arpeggios which, alongside Johnson's drum murmur under it all, are the very warp and woof of the tune! We'd like to see pianist Sutton receive more solo space.

The rhythm section in this band is all important, providing ballast brimfull of texture and empathy. Soloists Bob Wilbur and Yank Lawson are thoroughly professional as are their colleagues Bud Freeman and Vic Dickenson. Each is allotted a score of bars to spin a yarn.

The Charlie Chaplin standard "Smile" is given a most unusual treatment by trumpet and bass but unfortunately emerges as a tour de force. Yank Lawson on a muted trumpet which evokes images of Clyde McCoy's "Sugar Blues" combines his talents with bassist Bob Haggart whose tone is robust and resonant, his notes to the point. However, the total effect is ponderous and somewhat labored. It would be easy to fail on this one.

One of the most delightful tracks is Bud Freeman's "Eel" which made its debut back in 1933. Totally Freeman, it is a pleasure to drop in on the tenor saxophonist, who dips in and out of the water dolphin-like, skimming and wriggling along the slippery bottom surface, darting in and about like the sea squirt, plummeting the dusky depths of his range. Freeman is indeed only—facile and free as his name would indi-

cate, horsing around with dynamics, displacing accents, toying with the timbre, and doing it all in a tawny, twilight tone. This is a showcase of big band writing to boot!

Bob Haggart's "What's New?" proves once again that it has withstood the test of time, betraying the feeling of a band at a summer dance. Butterfield's tone is as wide open and fresh as the sun rising and Wilbur's Gershwin-esque clarinet simmers under it like fireflies on a June night. The ending, however, is a bit drawn out.

Bob Wilbur carries on the lyrical tradition of the soprano sax in "Root Dog" and "Girl on the Beach," the latter of which is taken at a loping gait and imparts a willowy quality.

"Dogtown Blues" stands tall as one of the most developed stretches in the set, chugging like a locomotive on the Long Island Railroad at a choo-choo pace. Be it Douglaston, Long Island (Haggart's boyhood home), Denver, Chicago or Crescent City, it has all the elements of the city and of a success story.

The ensemble writing in "Doodle Doo Doo" is full of lovely harmonies and winsome sonorities in which the band builds through successive modulations and crescendos. They explore the various components competently and with dash and verve, wringing all they can out of the tune. And it's nice to hear newcomer Ed Hubble at the mast on a growling trombone.

"My Inspiration" is the closing theme and it is rare that the band has an opportunity to complete it. In a minor key, it is a hauntingly lovely ballad with the chamber music intimacy of a string quartet. Once more, Wilbur's clarinet wails, causing wonder as to why the clarinet is not employed more often as a solo instrument. We find ourselves in a vintage ballroom. The entire piece has a conclusive aura, ending atypically, unpredictably, and arrestingly.

The engineering on this LP is unequivocally excellent thanks to Dave Wiechman and George Piros. This listener could find absolutely nothing to gripe about.

So, if you dig a contemporary big band sound, well-seasoned soloists, a venture into Dixieland, or just plain infectiously happy music, this LP should be in your collection.

Incidentally, the WGJB was due in Europe spring of '71. We wish them even further success both at home and abroad. This is a rousing ragout which would tempt the tastebuds of gourmets from New England to Ireland!

Performance: B- B+      Sound: A+



# Tape Reviews

Bert Whyte

**The Ted Heath Orchestra Plays Beatles, Bach, and Bacharach.** Ampex/London M74148, open reel, 7 1/2 ips, \$6.95.

You know, unless you are some sort of fantastic devotee of pop and mood music background music, the enormous output of this kind of music by the various record companies can be absolutely stultifying. The sameness and the monotony of these recordings can drive you up a wall. Thus, it is very refreshing when you encounter a recording of this type that from the opening notes grabs your attention by the sheer high quality of sound and its musical felicities.

This London "Phase Four" recording is one of the most outstanding examples of this genre in a long time. It has everything going for it: Good tunes such as "Norwegian Wood," "I'll Never Fall in Love Again," "Hey, Jude," "Raindrops Keep Falling on My Head." The Bach numbers are the "Minuet in G" and the "Air on the G String." All are accoutered in clever arrangements and intelligent orchestrations. The sound is absolutely "hound's tooth" clean, not a smidgen of distortion even at high levels. Great brazen brass sounds, explosive transients of percussion . . . it has them and to spare, along with excellent overall balances, stereo directionality which is positive but not overdone, and just the right amount of reverb for maximum presence. Even at high playback levels, tape hiss was quite low, there was no print-through, and while there was some occasional crosstalk, it would probably be undetectable in most speakers. If you like really good "big band" sound, this recording is sure to please.

**Tchaikovsky, Symphony No. 1 (Winter Dreams).** Michael Tilson Thomas conducting the Boston Symphony Orch. Ampex/DGGL3078, open reel, 7 1/2 ips, \$7.95.

Tchaikovsky's early symphonies are finally getting their just due. We have had several fine recordings of the second symphony, the "Little Russian," now this splendid realization of his first symphony, and it is to be hoped that we shall soon have a modern recording of the third, the "Polish" symphony. This is an immediately ingratiating work, cast in the traditional four movement pattern and with the unmistakable

stamp of Tchaikovsky, with its drama and lyricism.

Michael Tilson Thomas, the young associate conductor of the Boston Symphony Orchestra, has fared well in the hands of critics and this fine performance gives ample evidence why he has been so well received. Here he shows us a nicely paced, cohesive reading, notable for its excellent balances and sense of scale and proportion. He eschews conductorial "gimmickry" and does not indulge in radical alterations of tempi and phrasing. The Boston players respond to his disciplined approach and produce some really ravishing sounds, especially in the strings and horns.

All of this is captured in a top notch recording. As is their wont, DGG engineers have cast the work in a broadly spacious acoustic perspective, which is proper with this kind of music, providing you can still maintain good orchestral definition. For the most part they have succeeded with good integral balances and moderate directional qualities, though there were several times when more weight and articulation in the tympani would have been desirable. But this is a minor point, and with the wide frequency and dynamic range and the exceptional cleanness of the overall sound, this is a lovely recording. While tape hiss was fairly low at room-filling levels, Dolbyizing the tape would have given us that final fillip of realism. In fact, this recording and all of the recordings DGG has made with the Boston Symphony Orch. thus far have been recorded with Dolby and in four-channel stereo! Ah, well! Some happy day, perhaps sooner than we think, we will be able to get these fine performances in that ultimate sonic format . . . open reel, four-channel, "B" Dolby. Are you listening, DGG friends in Hamburg?

**Follies, Original Broadway Cast.** Ampex/Capitol L761, open reel, 7 1/2 ips, \$9.95.

Quite frankly, I expected this current Broadway musical to be one of those corn-ball bows to nostalgia which seems to be the rage these days. A look at the cast appeared to support this idea, what with the "Hit Parade" gal, Dorothy Collins, and cool type Alexis Smith, the poor thing who was always the "loser" in Errol Flynn movies, to say

Hear it like it is:

**REDWOOD  
STEREO  
COMPANY**

Western High Fidelity Wholesalers

**DISCOUNTS**

ON NATIONALLY ADVERTISED

**HI-FI STEREO  
COMPONENTS**

ONLY RSC OFFERS:

- Low Eastern Prices
- Lowest Shipping Costs
- Fastest Delivery

FOR A RUSH QUOTE WRITE:

**RSC**

P. O. BOX 2794

SAN RAFAEL, CA. 94902

Telephone (415) 472-3447

RSC — Best in the West

**IT'S EASY TO ASSEMBLE  
A SCHOBER ORGAN!**

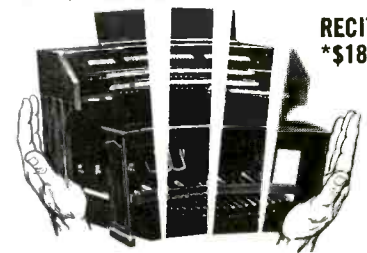

RECITAL  
\*\$1850

\*Includes easy to assemble walnut console kit. (Only \$1575 if you build your own console.) Amplifier, speaker system, optional accessories extra.

You couldn't touch an organ like this in a store for less than \$4,000—and there never has been an electronic instrument with this vast variety of genuine pipe-organ voices that you can add to and change any time you like! If you've dreamed of the sound of a large pipe organ in your own home, if you're looking for an organ for your church, you'll be more thrilled and happy with a Schober Recital Organ than you could possibly imagine — kit or no kit.

You can learn to play it—and a full-size, full-facility instrument is easier to learn on than any cut-down "home" model. And you can build it, from Schober Kits, world famous for ease of assembly without the slightest knowledge of electronics or music. Highest praise from musicians everywhere.

Send right now for the full-color Schober catalog, containing specifications of all five Schober Organ models, beginning at \$499.50.

The Schober Organ Corp., Dept. AE-41  
43 West 61st Street, New York, N.Y. 10023

- Please send me Schober Organ Catalog and free 7-inch "sampler" record.
- Enclosed please find \$1.00 for 12-inch L.P. record of Schober Organ music.

NAME \_\_\_\_\_

ADDRESS \_\_\_\_\_

CITY \_\_\_\_\_ STATE \_\_\_\_\_ ZIP \_\_\_\_\_

Check No. 86 on Reader Service Card

nothing of some real old-timers like Fifi D'Orsay and Ethel Shutta. While the nostalgia element is strongly in evidence, I was pleasantly surprised by the excellent music, which has very little "ricky-tick" to it, and the amusing and intelligent lyrics. Moreover, the arrangements are quite a cut above the usual Broadway variety. My wife and I found the entire production so tuneful and enjoyable that we then had to go and see the darn thing!

The engineering here is very good indeed. The acoustic perspective is just

right and is so good that it is hard to determine whether the reverb is from EMT chambers or a good recording hall. The balance between orchestral and vocal elements is such that rarely does one swamp the other. I should add that the articulation is good with high intelligibility. There is some "stage" movement which adds to the verity of the production. Overall sound is bright and clean, and all stereo attributes properly maintained. All in all, not a monumental musical, but certainly a pleasant diversion.

**Flight of the Doves, Original Picture Sound Track.** Ampex/London M57184, Dolbyized cassette, \$6.95.

I haven't seen this picture advertised in the New York press, so I'm assuming it is as yet unreleased. From the material, it is a story obviously set in Ireland. The music and the lyrics are nothing earthshaking by pleasant withal. What is quite extraordinary is the overall quality of the cassette sound. This is the first cassette I have heard with every sound parameter up to the standards of even the most persnickety audiophile. The frequency response is very wide with a big, solid bass end and highs out to beyond 10-11 kHz. Furthermore, the high frequencies are exceptionally clean, with hardly a trace of the distortion that mars many cassettes duplicated at high speed. Dynamic range is wide too, and with playback level set for 100 dB peaks, only the tiniest whisper of residual tape noise can be heard. Transients were crisp and clean. Drop-outs and scrape flutter, the main cause of modulation noise which produces the familiar "bubbling" sound in flutes, oboes, and clarinets in exposed passages, were so reduced that this is the first cassette recording in which I could not detect this unpleasant phenomenon. This is also the first time I feel that in a comparison of the same music on a disc, an audiophile would be likely to choose the cassette because of the overall quality and superior signal-to-noise ratio. Of course, Dolbyized open reel tape should be the ultimate step; there are areas in which narrow tracks and 1 7/8 ips cannot compete with wider tracks and 7 1/2 ips. But equating cost and convenience of both mediums, a cassette of this quality would satisfy a great many people.

**Summer of '42 and Picasso Suite, Original Motion Picture Sound Tracks.** Composed and conducted by Michel Legrand. Ampex/Warner Bros. M81925, 8-track cartridge, \$6.95.

More motion picture background music, both of more than passing interest. I haven't seen the movie, but from the way the music is presented on this cartridge, I would assume that both scores are interrelated. Legrand furnishes an attractive, somewhat haunting theme, and then proceeds to give us some exceptionally good variations, running the gamut of instruments. The orchestration is facile, colorful, and quite engaging. Add expert playing by the un-named orchestra and a generally clean sound, with minimal print-through and crosstalk, and it makes for pleasant listening in the car or at home.



**NEW  
POWER  
SPEAKER BY**

*FRAZIER*

**MANHATTAN DELUXE**  
Model F8-3MD-B

Here's a NEW improved FRAZIER Speaker with the same high efficiency but with a new heavy duty driver and a 6 db network for double power handling capacity. The clean sound of the Manhattan Deluxe is unbelievable. Ask your Frazier dealer for a demonstration of this deluxe sound.

Pick up a Frazier color folder or write Frazier for the complete line of speakers in your price range and application.

*FRAZIER*  
INCORPORATED

1930 Valley View Lane  
Dallas, Texas 75234  
Phone 214-241-3441



# Classified

Rates: 25¢ per word per insertion for noncommercial advertisements; 50¢ per word for commercial advertisements. Frequency discounts as follows: 2 times, less 15%; 6 times, less 20%; 12 times, less 30%. Closing date is the FIRST of the second month preceding the date of issue. Payment must accompany all orders under \$10.00. Use the handy self-addressed, postage paid card at the back of this issue. When replying to AUDIO box number ads. send letters c/o AUDIO, 134 No. 13th St., Phila., Pa. 19107.



## FOR SALE

**CASSETTES**—Unique titles including old time radio, educational, language. Send 10¢ for new 16-page 1972 catalog covering 8-track and cassette blanks plus hard-to-find accessories. Cassettes Unlimited, P.O. Box 13119A, Pittsburgh, Pennsylvania 15243

**PROTECT YOUR LPS.** Poly Sleeves for jackets 5¢ Inner sleeves 4¢ Poly lined paper sleeves 10¢ White jackets 25¢ Postage \$1.00 House of Records, Hillburn, N.Y. 10931

**OPERA TAPES**—Great performances of past 35 years. Free catalog. Ed Rosen, P.O. Box 97, Freeport, N.Y. 11520

**STEREO HI-FI SALE.** Nationally advertised amplifiers, tuners, speakers, tape decks, etc. Discounting of 40% since 1959. Arkay National, 1028-05 Commonwealth, Boston, Mass 02215

**BRAINWAVE FEEDBACK.** Electroencephalophone teaches alphawave control. J & J Enterprises, 24120-A 3rd West, Bothell, Wash. 98011.

**STEREO SYSTEMS LOW PRICES!** Write or call: Purchase Radio Co., 747 Main St., Buffalo, N.Y. 14203 (716) 854-2124

**WIRED, SELF-POWERED** background music adaptor to use with your present FM—\$25.00. Thieves Warehouse, P.O. Box 8057, Pensacola, Florida 32505

**SCULLY** Professional Tape Recorders, from 1 to 24 tracks, complete recording studio packages designed to order featuring W.A.L. console systems and other leading professional audio products: Wiegand Audio Laboratories, R.D.3, Middlesburg, Pa. 17842—(717) 837-1444.

**DISC RECORDING EQUIPMENT:** Complete mono, and stereo cutting systems featuring rebuilt Scully, Neumann, Van Eps, and Fairchild lathes and new W.A.L. amplifiers. Priced from \$2500.00 Wiegand Audio Laboratories, R.D.3, Middlesburg, Pa. 17842—(717) 837-1444

**OVER 20 YEARS SUCCESSFUL DISCOUNTING OF AUDIO EQUIPMENT** insures best value and service. Specialize in Stereo Components. Tape Recorders, Cassettes, Magnetic Cartridges, Sleep Learn Equipment, etc. **LOW QUOTES, FREE CATALOG, DRESSNER,** 1523A, Jericho Turnpike, New Hyde Park, New York 11040

**FIRST BREAKTHROUGH IN RECORDING TAPE.** Originally made by America's leading tape manufacturer 2400' mylar, 7" reel, \$2.29, 1800' mylar, 7" reel, \$1.69, 1200' acetate, 7" reel, \$.79. Write for quantity prices, AAE, 218 Columbia St., Utica, N.Y. 13502

**AUDIO RESEARCH DUAL 100C** amplifier. Finest available 6 months old, mint condition, list \$1600, sell for \$850. Larry Dupon, 2704 W. Argyle, Chicago, Ill. 60625. 312-728-9625.

## FOR SALE

**KLIPSCH, TANNOY, BOZAK, MARANTZ, THORENS, RABCO.** No discounting. Superior Sound, 1801 Brewerton Rd. (Rt. 11) Syracuse, N.Y. 13211.

**INFINITY,** Audio Research Corp amplifiers, SAE, Phase Linear, Quad, Decca Controlled multi-directional dispersion; electrostatic, transmission-line Trans-static 1 speakers. Brochures available, other components. Paul Heath, 81 Big Tree St., Livonia, N.Y.

**WORLD'S FINEST SPEAKERS**—on demonstration—Audio Research 4 x 6 panels. Infinity SS1 (improved version), 8 Quad system, B&W 70's, trans static speakers, inquiries invited Paul Heath, 81 Big Tree St., Livonia, N.Y. 14487. (716) 346-5630.

**RECORDING TAPE 2400'** reel \$15.00 dozen, 1800' reel \$12.00 dozen, 1200' reel \$9.00 dozen Postpaid guaranteed. Mitchell, Box 444A, Flushing, N.Y. 11367

**JBL HARTSFIELDS (2)** \$1100.00 Exec. Cond. Heathkit AJ-15 tuner w/cabinet \$150.00 Advent Model 101 Dolby NRU \$100.00 (2) Shure M63 control mixers \$70.00 ea (2) Shure M62 Level LOC \$35.00 ea. Ron Shagula 1627 North 20th St., Abilene, Texas 79601

**AUDIO RESEARCH,** Infinity, SAE, Decca, Transcriptors, Stax, Quad, and many others. The Stereo Set, 1737 Wisconsin Ave., Washington, D.C. 20007 (202) 338-1493

**ALTEC, JANSZEN, THORENS, Revox, Tandberg, Beyer, Citation, Dual, JVC, Pioneer,** others at LS PX prices. No catalog, quotes only on immediate domestic delivery. Audiofax Unlimited, Box 7961, Atlanta, Ga. 30309

**DAYTON WRIGHT, B&W, Radford, IMF, Sinclair,** Phase Linear, Quad, Transcriptors, Decca, Braun, Ampex, SS1 Turntable Transcendental Audio, 1214 Walden Ave., Buffalo, N.Y. 14043

**SAVE UP TO 45% ON MAGNETIC CARTRIDGES** Shure, Empire, Pickering, etc. Send cartridge name, model number and stamped self addressed envelope for prices to PARTS, P.O. Box 587, Englewood, N.J. 07631

**BIG BAND SOUNDS** of the 20's, 30's and 40's—swing and dixieland jazz. 5,000 performances from original recordings and broadcasts available reel to reel or cassette. Ed Jones, 5127 Bauman Ave., Omaha, Nebr. 68152.

**GET "MUSIC ONLY" FM Programs.** SCA Adaptor fits any FM tuner or receiver. Free list of Stations with order. Kit \$14.50 (with Squelch \$19.50) Wired and Tested \$25.00 (with Squelch \$29.95) All plus postage & insurance. Thousands Sold SWTPC, Box 32040A, San Antonio, Texas 78216.

**SCOTCH MAGNETIC TAPE,** discount Box 167A, Onwingsburg, Pa.

## FOR SALE

**ALTEC** horns and drivers in like new condition. Models: 311-60, 311-90, 203B, 1005B, 288C, 291-16A, 290E. Celebration, 161 Gray Road, Ithaca, N.Y. (607) 272-8964, 273-3348.

**INTEGRATED CIRCUIT KITS** Free Catalog FRAZER & ASSOCIATES, 3809 Surfwood Road, Malibu, California 90265

**ON DEMONSTRATION**—Trans-static electrostatic transmissionline monitors, Super Quad speaker system, Audio Research Corp D-75 amplifier, Phase Linear 700 and 400 amplifiers, Sound System International arm-turntable combination. Paul Heath, 81 Big Tree St., Livonia, N.Y. 14487 (716) 346-5630.

**MARANTZ SLT—12U** turntable, new factory sealed carton. Also one used, best offer. Michael Stiuso, 69 High St., Eatontown, N.J. 07724 (201) 542-6705

**JBL HARTSFIELDS (2),** Walnut \$1500.00 or best offer. Exec. condition. Bob Berthiaume, 16371 Oleander, Los Gatos, Calif. 95030.

**PSYCHEDELIC LIGHT** Box Kits—From \$5.00! CarrCraft, Dept. 150, P.O. Box 1165, Yucaipa, Calif. 92399

**FCC "TESTS-ANSWERS"** Original exam manual for F.C.C. First and Second Class License. —plus— "Self-Study Ability Test" Proven! \$9.95. Satisfaction Guaranteed. Command, Box 26348-L, San Francisco 94126.

**FREE** literature and quotes on Hitachi stereo equipment. Write: Disco Electronics, Inc., P.O. Box 146, Springfield, New Jersey 07081.

**ORGANS:** Save 25 to 50% on five famous makes. Delivered to your door in factory sealed cartons. Fully guaranteed. Greenwich Music Center, Greenwich, N.J.

**RUBBER STAMPS.** One line \$1.00. Each additional line 50¢. Good quality. Prompt service. MOYERS, 3037 Montrose, Chicago, Ill. 60618.

**STEREO CORNER** will sell most major Audio Products at 20% off the advertised list price—Freight pre-paid. Send order with check to: Stereo Corner, 339 Park Ave. So., Winter Park, Fla. 32789. Check will be refunded by return mail if we are unable to fill order.

**QUAD,** Radford, Bang & Olufsen Audio components of superb quality for the connoisseur. Audio Imports, 5557 Versaille Dr., Indianapolis, Ind. 06227.

**STEREO TAPES** (reels) 30-70% discount. Sokol, 3237 South Manor, Lansing, Ill. 60438.

**REVOX A77 MKIII DECK** \$489 factory new. A. R. amp \$185. Also Marantz, Thorens, Quad, Dual, Sony. Write for details. CUSTOMCRAFT SOUND, 202 W. Fayette St., Baltimore, Md. 21201 (301) 727-1134.

## FOR SALE

**BUY DIRECT FROM ENGLAND'S HI-FI MAIL-ORDER SPECIALIST!** Save on SME, Iak, Acoustical, Goldring, Decca, Bowers & Wilkens, Thorens, Tandberg, Revox, Gold Speakers, Garrard, BSR Dual, Lowther, Wharfedale, KEF, Celestion, Transcriptors, Radford, etc. Insured shipping quotes free or send \$2 bills for catalog (\$3 airpost). Goodwin Ltd., 7 Broadway, Wood Green, London N22. Visitors welcome to show-rooms.

**FREE 64 PAGE CATALOG** offers hundreds of recordings of rare renaissance, baroque and classical music. Some records priced as low as \$1.00 each! All late recordings. In stereo only. Musical Heritage Society, Box 932-AU, New York, N.Y. 10023.

**AMPEX MODIFICATIONS AND REBUILDS**—2 track to 8 track—Conversion Transistor Electronics—Studio Accessories—Mixdown Panels—BKM Associates, Box 22, Wilmington, Mass. 01887.

**SHURE V15-11** improved, \$47 and old cartridge, shipped prepaid. STEREO Shop, 1209 1st Ave. SE, Cedar Rapids, Iowa 52402.

**LOW, LOW PRICES**, on Audio Equipment, L.P. Records, and Tapes. All factory fresh, 1st quality items. Trained personnel at your disposal for audio consultation. We accept Master Charge. Write for FREE CATALOGS to Mr. A, Dept. AMO at SMG DISTRIBUTORS, INC., 46-35 54th Road, Maspeth, N.Y. 11378, or call (212) 786-3337.

**HARPSICHORDS AND CLAVICHORDS**—New Flemish Harpsichord, curved bentside, uncompromising classic construction and detail, \$295. Other kits from \$100. Send for free brochure. Zuckermann Harpsichords Inc., Dept. R, 160 Sixth Avenue, New York 10013.

**HI-FI DISCOUNTS**. Free catalog—Western Electronics, 7121 Rich Ave., Newark, Calif. 94560

**HEAVY DUTY 12" ANTI-STATIC TURNTABLE MAT**. \$4.95 postpaid. Creighton Audio labs, 740 Haven Pl., Linden, N.J. 07036

**SOUND SYSTEM INTERNATIONAL** presents a revolutionary radial track tone arm and turntable. Brochures available. Paul Heath, 81 Big Tree St., Livonia, N.Y. 14487 (716) 346-5630.

**DISCOUNTS—STEREO COMPONENTS & SYSTEMS**. Lowest possible prices on quality brands. For fastest service, Lowest cost—get our quote! Redwood Stereo Co., P.O. Box 2794, San Rafael, Calif. 94902 (415) 472-3447

**AUDIO RESEARCH** components and speaker system; also Infinity Systems, Revox, and Thorens. D S Audio, 410 East Evergreen Road, Lebanon, Penna. 17042. (717) 273-6314.

**DIAMOND NEEDLES** and Stereo Cartridges at Discount prices for Shure, Pickering, Stanton, Empire, Grado and ADC. Send for free catalog. All merchandise brand new and factory sealed. LYLE CARTRIDGES, Dept. A, P.O. Box 69, Kensington Station, Brooklyn, New York 11218.

**HI-FI FURNITURE?** See toujy designs at S.E.E. 70's High Fidelity exhibit 443 Park Ave. S., N.Y.C. 10016, Tues. to Fri. 10-6, Sat. 10-4. Full line brochure 25¢.

**OPERA TAPES**—Records "live" performances, broadcasts. Free Catalog. Hathaway, 49 Merbrook Lane, Merion, Pa. 19066.

**DO-IT-YOURSELF, PROFESSIONAL ELECTRONICS PROJECTS**—\$1.00 up, Catalog 25¢. PARKS, Box 25665E, Seattle, Wash. 98125.

**BASF RECORDING TAPE** . . . prerecorded stereo tapes, postpaid. Stereotone-Tapes, Box 657, Sterling, Illinois 61081.

## FOR SALE

**FREE CONSULTATION AND TECHNICAL ASSISTANCE** with purchase of individually hand picked, guaranteed lab tested and aligned custom components from Audio Research Corp., Crown, Decca, Frazier, I.M.F., Infinity, SAE, JBL PROFESSIONAL, Quad, Rabco, Revox, Stax, Tandberg, Trans-static. We save you \$ \$ with **FACSIMILE REPRODUCTION** at Music and Sound Ltd., 413 Johnson Street, Jenkintown, Penna. 19046 (215) 885-4214.

**REVOX 1224** (portable model w/power amps., speakers) + Advent 100 Dolby System, both in prime condition. \$675.00. S. Sarper, Prescott House, 3-C, Greenwich, CT 06830.

**SAE TUNER**, preamps, amplifiers, Infinity, Bose, Revox, LWE, Rabco, B&O, Demonstration by appointment, only with John Vogt of Stereo Exchange, Manhasset, Long Island, N.Y. 516—365-8585.

**LOUDSPEAKER KITS**, complete or cabinet only, original and published designs. Amplifier kits. Factory direct at great savings. Catalog 25¢. R.C.S. Co., P.O. Box 30312, Santa Barbara, Cal. 93105.

**LOW, LOW QUOTES** on stereo components, recorders for home, boat, auto. Nationally advertised, factory sealed, warranted; Write: C & S Electronics, 9743 Larsen, Overland Park, Kansas 66214.

**AMPEX**: 602-2 stereo \$650.00. Pair 2010 speaker-amplifiers \$135.00 ea. 860 stereo deck \$125.00. 861 stereo with speakers \$150.00. **SONY**: 255 stereo deck \$75.00. C-37A condenser mike system \$150.00. **ROBERTS** 192-FT full track \$150.00. **WOLLENSAK**: 5725 stereo with speakers \$125.00. 5280 stereo with speakers \$75.00. **CONCERTONE** 800 stereo with speakers \$175.00. All in excellent condition and meet specs. R. Beery, 178 W. 15th, Holland, Mich. 49423.

**JAPAN HONG KONG DIRECTORY**. World products information. \$1.00 today. Sekai Shogyo Annai, Hillyard, Washington 99207.

**LOWEST Prices Electronics Parts**. Confidential Catalog Free. Knaco, 3174 8th Ave. S.W., Largo, Fla. 33540.

**COUNTRY RECORDS** and tape cartridges—fiddle tunes, blue grass, polkas. Free circular. Write Jim O'Neal, Box A50, Arcadia, Calif. 91006.

**SAE, PREAMP**, brand new, plus Phase Linear 700 watt amplifier. Bose 901's. Army got me! Ken Levine, Apt. 1606, Westgate, Cambridge, Mass. 02139.

**EICO 460 5" DC-10 Mhz Oscilloscope**. Perfect condition. \$140.00. Scott Stevens, Clark, S.D. (605)—532-3931)

**Used Mylar Tapes**. 1800'. 50 reels for \$35.00 postpaid. Send check with order to Fremerman, 4041 Central, Kansas City, Mo 64111.

**ALTEC MULTICELL HORNS** 1505, 1003's. W.E. 26A Fairchild 531 turntable. Keith Steinberg, P.O. Box 35121, Chicago, Ill. 60635 (312) 889-5611.

**ALL ADVENT PRODUCTS IN STOCK**. Including Dolby. Also Audiocoustic loudspeakers, Revox, Crown, Tandberg, Stax, and many others. Professional advice and booklet, "The Stereo Buying Guide," given free to all inquiries. SoundPro, P.O. Box 2417; West Lafayette, Indiana 47906.

**JBL PARAGON**, KLH-9s, Infinity SS2, Mac C-28, C-26, 2100. Crown DC-300, D-40, Marantz 33, Sony 777-4, Sony TC-440, Thorens 125B, Rabco, Paul Heath, 81 Big Tree St., Livonia, N.Y. 14487 (716) 346-5630.

## FOR SALE

**Record Cleaning Machine**. See page 58 AUDIO November issue \$425.00 CIF destination send check WORO, P.O. Box 415, Hato Rey, Puerto Rico 00919.

**IMF STUDIOS AND MONITOR MARK III's THE INCOMPARABLE SPEAKERS**; TEAC audio-ophile quality automobile stereo cassette players, C/M Laboratories, Mattes-Martin, Phase Linear, and SAE "State-of-the-Art" electronic equipment; Decca "reference standard" cartridges in stock. Mint equipment as follows: Fisher Professional X-100-C control stereo amplifier \$135.00; pair Brooks mono amplifiers true collectors-connoisseur quality the pair for just \$145.00; B & O SP-12 cartridge new \$65.00. We take trade-ins. Audiocraft, South Rockwood, Michigan 48179. Telephone (313) 379-9945.

**FM BACKGROUND MUSIC** without commercials available on many FM stations! MUSICON Adaptor plugs into your FM Tuner, delivers continuous music thru your amplifier and speakers. Line cord operated. No adjustments or tuning, ever. New design breakthrough guarantees optimum performance (15-day refund for any reason). Lowest price ever—\$39 postpaid to K-LAB, Box 572A, S. Norwalk, Conn. 06856.

**TV & RADIO TUBES** 36¢ EA. Free 48 page Color Catalog. Cornell 4215 A University, San Diego, California 92105.

**McINTOSH 2505 VERSUS MARANTZ 32**, Citation Twelve, and Dynaco Stereo 120. The winner? Send \$1 today for test report, refundable with \$7.50 yearly subscription. THE HI-FI NEWS-LETTER, Box 593, Hialeah, Fla. 33011.

"**HI-FI FREAKS**" and discerning people can now get the amplifier that's "wiping out" all other amplifiers at test clinics across the country and is better than test equipment! Kit only \$60. Send for Free Catalog SWTPC, Box 32040B, San Antonio, Texas 78216.

**MARANTZ** model 19 receiver less than 6 months old with case \$795. MARANTZ 7T and model 250 (one month old) \$645. McIntosh 2105 perfect \$495. C. M. Santmire, 1340 S. 20th St. Lincoln, Nebraska 68502. (402) 477-8469.

**SCOTCH RECORDING TAPE**, lowest prices. TAPE CENTER, Box 4305B, Washington, D.C. 20012.

**B&W 70CA, PHASE LINEAR, THE WORLD'S FINEST SPEAKER AMPLIFIER COMBINATION**. JVC 5011 super preamp, Transcriptor, EPI Tower, Quad, Electrostatic specialists. Finest, best equipped laboratory in the country. Formerly supplying to professionals only. Now you can benefit from the unique services of THE AUDIO-LAB, 146 French St., New Brunswick, N.J. 08901 (201) 249-9191.

**BASIC AMPLIFIERS—DREADNAUGHT 1600**—800 watts RMS per channel into 4 $\Omega$ , 550 watts/channel into 8 $\Omega$  at .075% THD 20-20 KHZ \$1049.95 includes meters. DREADNAUGHT 800—400 watts RMS per channel in 4 $\Omega$ , 200 watts/channel into 8 $\Omega$  at .075% THD 20-20 KHZ \$499.95 meters optional, extra. DREADNAUGHT 400—200 watts RMS per channel into 4 $\Omega$ , 125 watts/channel into 8 $\Omega$  at .075% THD 20-20 KHZ \$399.95 meters optional, extra. Dunlap Clarke Electronics, 44 River St., Framingham, Mass. 01701 (617) 879-1026.

**ALPHAPHONE** headset—brainwave trainer. Free literature. Aquarius Electronics, Box 627-S, Mendocino, Ca. 95460.

**PLATTER PEDESTAL**, oiled solid walnut. Stack discs safely, dust-free after preening, before placing on changer. \$5.00. Discrafters, 150-10 Arnold Drive, West Lafayette, Indiana 47906.



## FOR SALE

**DBX 117 EXPANDS DYNAMIC RANGE.** Records, tapes, broadcasts come alive. Linear decibel expansion reduces background noise 10 dB or more. Stereo compressor-expander continuously adjustable to 2:1. 20 dB noise reduction for tape recording. 10 day trial. Send check \$145. Your check returned if unit returned promptly. Inquiries invited. dbx inc., Harvard, Mass., 01451 (617) 456-3930.

**RECORDING TAPE:** Cassettes, 8-track, Reel. Brand names. Wholesale prices. Save \$\$\$\$. Write NNA, Box 721E, Rye, New York 10580.

## RECORDS

**OLDIES—45 RPM** original labels and represses over 5,000 from personal collection for sale. Reasonable prices. Try me for the ones you've given up hope in finding. Call or write, Robert Fenster, 1503 Ave. J, Brooklyn, N.Y. (212) 258-5121.

**COLLECTORS JOURNAL—VALUABLE DATA, RECORD MART** 12 issues \$3.00—Record Research, 65 Grand Ave., Brooklyn, New York, 11205.

**SHOW ALBUMS—Rare, Out-Of-Print LP's.** Free large list. Broadway/Hollywood Recordings, Georgetown, Connecticut 06829.

**OLDIES—45 RPM.** Original hits. Catalog 50¢. C&S Record Sales, Box J97, Wampsville, N.Y. 13163.

**CATALOGS.** Broadcasts, soundtracks. Personalities of Thirties, Forties. Box 225, New York, N.Y. 10028.

**SYMPHONION MUSIC BOX** concert 50 minute stereo LP \$4.98 postpaid Music Box, 685 South Roys Ave., Columbus, Ohio 43204.

**ORIGINAL HIT RECORDINGS.** Popular entertainers 1920's, 1930's, 1940's New LP's. Low Prices. Fast Reply. DIBS-AD, Box 388, San Pedro, Calif. 90733.

## INVENTIONS WANTED

**FREE "DIRECTORY OF 500 CORPORATIONS** Seeking New Products." For information regarding development, sale, licensing of your patented/unpatented invention. Write: Raymond Lee Organization 230-AM Park Avenue, New York City 10017.

## TAPE RECORDINGS

**RENT 4-TRACK** open reel tapes—all major labels, 3,000 different. Free brochure. Stereo-Parti, 55 St. James Drive, Santa Rosa, Cal. 95401

**MEMOREX** recording tape, audio & video lowest prices, write for free information BERGETZ SYSTEMS CO., Box 1181, Melrose Park, Ill. 60161.

**AUDIOPHILES** stamped self-addressed envelope brings free valuable splicing tips acquired making 10,000 splices while developing improved line splicers. Nagy Research Products, Box 289, McLean, Va. 22101.

## SCHOOLS

**EARN** College degrees at home. Many subjects. Ministerial studies, High School Equivalency Diploma. Florida State Christian College, Post Office Box 1674, Fort Lauderdale, Florida 33302.

## HELP WANTED

**Serious recordists** to make records for five companies. We train, equip and provide protected franchised territories. Modest investment required. Send resume to Mr. Bloch, 418 N. Main St., Englewood, Ohio 45322.

**EUROPEAN-FOREIGN EMPLOYMENT.** Detailed report on currently available jobs, Europe, Africa, Australia. Numerous technical and teaching positions. \$3.00. Eurojob Report, Box 52643-E, Lafayette, Louisiana, 70501.

## SITUATION WANTED

**BLACK ELECTRONIC ENGINEER** with BSEE, MSEE—12 years experience in engineering, would like to gain experience in recording industry. Have desire to own studio in near future. Reply to Box AF2-2.

**Serious young man** looking for a job in the Audio field, would prefer sound reinforcement or studio recording job. Bob Miller, 246 Crestwood Dr., Milltown, New Jersey 08850.

## GOVERNMENT SURPLUS

**JEEPS** Typically From \$53.90 . . . Trucks From \$78.40 . . . Boats, Typewriters, Knives, Airplanes, Clothing, Multimeters, Oscilloscopes, Transceivers, Photographic, Electronics Equipment. Wide Variety, Condition 100,000 Bid Bargains Direct from Government Nationwide. Complete Sales Directory and Surplus Categories Catalog \$1.00 (Deductible On Orders From Separate Included Catalog). Surplus Service, Box 820-AUD, Holland, Michigan 49423.

## RADIO PROGRAMS

**RADIO RERUNS.** Complete broadcasts of old favorites. Catalog free. Box 724, Redmond, Wash. 98052.

**OLD RADIO PROGRAMS.** Catalog \$1.00 (refundable) The Radio Vault, Box 9032, Wyoming, Michigan 49509.

**OLD RADIO PROGRAMS** on Cassettes or Reels high quality, low prices thousands of your favorites live again, priced as low as \$8.00 for 6 hours. Catalog 50¢. Remember Radio Inc., Box 2513, Norman, Okla. 73069.

**OLD RADIO PROGRAMS.** Reels or cassettes. Free catalog. Fred Berney, 5931 S.W. 8 Street, Miami, Fla. 33144.

**OLD RADIO PROGRAMS** at low prices yet a large selection. Catalog 50¢. The Best of Radio, P.O. Box 1692, F.D.R. Sta., New York, N.Y. 10022.

**MOST AMAZING SHOW** ever produced for Radio; Ken Nordine, narrator, network cast. Introductory notes by show's creator-producer. Complete series, 19 Cassettes. Volume One, \$3.98; subsequent releases, 3 for \$10.00. Postpaid. Guaranteed. "Incredible, But, True!", Sawyer, Michigan 49125.

**WAR OF THE WORLDS** and other full length old radio programs on LP records. RADIO, Dept. AM; Box 844; Orange, Conn. 06477.

## EQUIPMENT WANTED

**CASH FOR YOUR** unwanted LP's and pre-recorded tapes. Record House, Hillburn, New York 10931.

**WANTED: STEPHENS 206AXA SPEAKER.** Farber, 871 Grandview, Lancaster, Pa. 17601.

**WANTED: REK-O-KUT 150** or 240 Ipi lead-screws for M-12S cutting lathe on a TR-43H turntable. Eduardo L. Lozano, Urdiales 307-A, Monterrey, N.L.—México.

**MARANTZ** model 9 power amplifiers and 7 T preamp. Bill Schoening, P.O. Box 4130, Tucson, Ariz 85717.

**WANTED—**one JBL 537-509 hornlens assembly, reasonable. Dave Turner, 494 South Atlantic, Cocoa Beach, Fla. (305) 783-7374.

**STELLAVOX SP7 RECORDERS,** Accessories, also Sennheiser MKH 405, MKH 404 microphones. Jerry Hyde, 301 Springdale Ave., Wintersville, Ohio 43952 Phone 614-264-4987.

**WANTED: McINTOSH** components. Include Price. Ray Cendroski, Box 64, Negley, Ohio 44441.

**INFINITY SPC PREAMPLIFIER.** Donald S. Konicoff, 49 S.E. 3rd St., Boca Raton, Fla. 33432.

## STEREOS

**Automatic Radio, Blaupunkt, Boman Auto radios-Tape** players Dual, Garrard, PE Record Changers, Sony Superscope, Roberts Norelco, Craig Tape recorders, Bogen, Grundig, Telefunken, Shure, Pickering, Grado, Cartridges, Auto and Home Accessories. Unbeatable prices. Write: MARTY'S, 2414 University Blvd. West, Wheaton, Maryland 20902.

### COMPLETE LIST OF PRICES

FOR top manufacturers of stereo equipment. Write for quotations on all major brands of stereos.

### STEREO COMPONENT CENTER

465 High St.,

Morgantown, West Virginia 26505

Check No. 89 on Reader Service Card

## BOOKS

Any out of print book located. Free search service. Write: Spinelli, 32 Elmwood, Pgh, Pa. 15205.



**Complete catalog!**  
**6,000**  
**STEREO**  
**TAPES**

• Pop • Rock • Jazz • Folk • Country and Western • Classical • Complete new entertainment guide. A must for every owner of an open reel, 8-track cartridge, or cassette player/recorder. Send 25¢ in coin, check, or money order to AmpeX, 2201 Lunt, Elk Grove Village, Ill. 60007. ATTN: Dept. 114

**AMPEX**  
STEREO TAPES

# FREE! New '72 Edition Radio Shack Electronic Accessories & Parts Catalog

1000's of  
Products  
100's of  
Exclusives

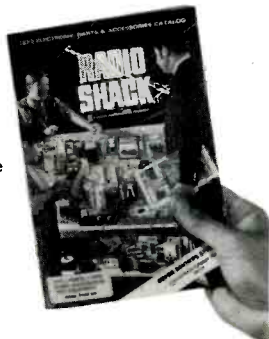

THE buying guide for kit builders, CB'ers, installers, experimenters, hobbyists, electricians—anyone in electronics in any way!

Electronics from A to Z—Antennas, Batteries, Capacitors, Diodes, Educational Kits, Fiber Optics, Grille Cloth, Hi-Fi Speakers, IC's, Jacks, Knobs, L-Pads, Mikes, Needles, Oscillators, P-Boxes, Quad-racs, Resistors, Semiconductors, Telephones, Ultrasonic Alarms, VHF Antennas, Wire, Xenon Strobe, Y Adapters, Zener Diodes plus our Science Fair kits and Knight-Kits—and much more!

Get your FREE copy at our nearby store—or mail in coupon today!

**ALLIED RADIO SHACK** Dept. A-10  
A TANDY CORPORATION COMPANY

2725 W. 7th St. Fort Worth, Texas 76107  
Send me your FREE 1972 Catalog #215

Please PRINT Clearly

Name \_\_\_\_\_ Apt. # \_\_\_\_\_

Street or Rte. & Box \_\_\_\_\_

City \_\_\_\_\_

State \_\_\_\_\_ Zip \_\_\_\_\_

Check No. 76 on Reader Service Card

## HELP!

Anytime you have a question about your Audio subscription, please include a mailing label to insure prompt service on your inquiry.

### CHANGE OF ADDRESS

If you're about to move, please let us know approximately four weeks before the move comes about. Or, if there is anything wrong with your current mailing label, please let us know on this form also. Simply affix your present label here, and carefully print the updated information below.

PLEASE HELP US TO SERVE YOU BETTER

AUDIO MAGAZINE

134 N. 13th Street • Phila., Pa. 19107

Name \_\_\_\_\_  
(Please Print)

Company \_\_\_\_\_

Address \_\_\_\_\_

City \_\_\_\_\_ State \_\_\_\_\_ Zip \_\_\_\_\_

AFFIX  
LABEL  
HERE

## SERVICES

**DON'T PAY** the high mail order prices. Theives Warehouse is coming to your area. Franchises available. Thieves Warehouse, P.O. Box 8057, Pensacola, Florida 32505.

**RENT STEREO TAPES** \$1.50 week. Catalog 25¢ Tape Library, Box 8126, Washington, D.C. 20024.

**CUSTOM STYLUS** and cartridge re-tipping, repairing (Weathers, Ortofon, Edison, Shure, etc.) Box 322A, Tuckahoe, N.Y. 10707, (914) SP 9-1297.

**CUSTOM RECORDING SERVICE.** Tape and disc. Stereo and mono. Live and copies. Editing. Masters and pressings. High quality at reasonable rates. Joseph Giovanelli, Audio-Tech Laboratories, 2819 Newkirk Ave., Brooklyn, N.Y. IN 9-7134.

**LEARN** Electronic Organ Servicing at home. All makes including transistors. Experimental kit—trouble-shooting Accredited NHSC. Free Booklet. Niles Bryant School, 3631 Stockton, Dept. 1D, Sacramento, Calif. 95820.

**TRADE STEREO TAPES,** \$1.25 each postpaid. Minimum three. Tapetrade, Box 2181, La Jolla, Calif. 92073.

**HIGH FIDELITY SPEAKERS REPAIRED**  
AMPRITE SPEAKER SERVICE  
655 Sixth Avenue, New York 10, N.Y.

**NEW YORK AUDIO SOCIETY** offers you a comprehensive program and numerous benefits. For details write: N.Y. AUDIO Society, Dept. A, 215 Adams St., Brooklyn, N.Y. 11201.

**AUDIO MIXERS** engineered to your specifications. Input flexibility including equalization, gain, pan and switching Modular construction with plug-in cards for easy changes. Nueva Engineering, Box 161, Glen Burnie, Md. 21061.

**MAKE FRIENDS.** Write Worldwide Tapespondence, P.O. Box 85, Philadelphia, Pa. 19105.

**RECORDS MADE FROM YOUR TAPES.** Also, editing and mastering. Send for free brochure. Nashville Record Productions, Inc., Dept. AM, 204 19th Ave., So., Nashville, Tennessee 37203

**COMMERCIAL SOUND SYSTEMS** Sales and service. For fast repairs contact Mr. Lawrence, Erie TV & Sound. 215—BA 3-3778, Philadelphia.

**CUSTOM AUDIO CONSOLES.** Mixers, control systems, modular-equalization, slide gain, pan, compression. G & K Studios, 7316 E. Vernon, Scottsdale, Arizona 85257. Individual specs. provided.

## TRAVEL RESORTS

**MONT TREMBLANT LODGE & Ski Area,** Mont Tremblant, P.Q. Best skiing in Eastern America. Ski Weeks, weekends & group rates. For information and reservations Tel. (819) 425-2711 or Mtl. 861-6165. For snow reports Mtl. 861-1925.

## BUSINESS OPPORTUNITIES

**MAILORDER**—Carry no stock. Companies will pack, ship under your label. One-man operation capable of \$10,000-\$20,000 year. Details Free. Distributors, Box 9-M, East Rockaway, New York 11518.

**MAILORDER MILLIONAIRE** helps beginners make \$500 weekly. Free report reveals secret plan! Executive (1Q2), 333 North Michigan, Chicago 60601.

# Advertising Index

Acoustic Research, Inc.	21
Advent Corp.	25
Allied Radio Shack	71, 90
Altec Lansing Div.	31
Ampex Stereo Tapes	89
Audio Dynamics Corp.	27
Audio Sales	81
B & W speakers	79
Benjamin Electronic Sound Corp.	8
Bose Corp.	59
Bozak Mfg. Co., R. T.	37
British Industries Corp.	3, 39
Classified Advertising	87
Continental Audio	84
Crown International	33
Downtown Audio	81
Dual turntables	13
Dynaco, Inc.	7
Eastman Sound Mfg. Co.	12
Electro-Voice	11
Electrostatic Industries	77
Elpa Marketing Industries	26
Empire Scientific Corp.	9
Executive Shopping Discount Service	50, 51
Fairfax Industries, Inc.	57
Frazier, Inc.	86
Garrard turntables	3
Heath Co.	63
JBL	46, 47
KLH Research & Development Corp.	41
Kenwood Electronics	65
James B. Lansing Sound, Inc.	46, 47
Linear Devices, Inc.	79
Marantz Co.	Cover IV
Martin speakers	12
Matsushita Electric	5
Maximus Sound Corp.	72
McIntosh Laboratory, Inc.	79
Metrotec Industries	Cover III
Nortronics Co., Inc.	82
Panasonic	5
Phase Corp.	75
Phase Linear	74
Pickering & Co.	17
Pioneer Electronics Corp.	23
Rectilinear Research Corp.	55
Redwood Stereo	85
Rogersound Laboratories	84
Sansui Electronics	15
Schober Organ Corp.	85
Schwann Record & Tape Guide	73
H. H. Scott, Inc.	Cover II
Sharpe Audio, Div. of Scintrex	2
Sherwood Electronic Labs	29
Shure Bros. Inc.	61
Sony Corp. of America	19
Sony/Superscope, Inc.	66, 67
Sound Systems International	76
Soundcraftsmen	81
Stereo Component Center	89
TEAC Corp. of America	1
Thorens turntables	26
United Audio Products	13
Wharfedale speakers	39



# READER INQUIRY CARD

MARCH 1972 ISSUE

THIS CARD EXPIRES MAY 31, 1972

Name \_\_\_\_\_

Firm \_\_\_\_\_

Address \_\_\_\_\_

Office  
 Residence

City \_\_\_\_\_ State \_\_\_\_\_ Zip \_\_\_\_\_

Are you a subscriber to AUDIO Magazine?  Yes  No

### OPTIONAL INFORMATION:

I am a:

1 <input type="checkbox"/> High Fidelity Enthusiast	4 <input type="checkbox"/> Broadcast Engineer/Manager
2 <input type="checkbox"/> Home Recordist	5 <input type="checkbox"/> Audio Service Technician
3 <input type="checkbox"/> Professional Recordist	6 <input type="checkbox"/> Audio Manufacturer or Dealer
7 <input type="checkbox"/> Other	

I would like to see more:  Technical articles  Articles for beginners  
 Construction projects  Articles on music  
 Music reviews:  Classical  Jazz  Rock  
 Other

I buy an average of \_\_\_\_\_ records a year. Age \_\_\_\_\_

I have purchased the following equipment after seeing it advertised in AUDIO Magazine. \_\_\_\_\_

I am planning to purchase the following equipment in the next year. \_\_\_\_\_

Use this FREE Post Paid Card for more facts on the products described and advertised in this issue.

### CHECK BOX A or B beside each coupon number

A to help me make an immediate decision to purchase.  
 B to explore a new method or to keep my files on the subject up to date.

#	A	B	#	A	B	#	A	B	#	A	B	#	A	B	#	A	B	#	A	B						
1			16			31			46			61			76			91			106			121		
2			17			32			47			62			77			92			107			122		
3			18			33			48			63			78			93			108			123		
4			19			34			49			64			79			94			109			124		
5			20			35			50			65			80			95			110			125		
6			21			36			51			66			81			96			111			126		
7			22			37			52			67			82			97			112			127		
8			23			38			53			68			83			98			113			128		
9			24			39			54			69			84			99			114			129		
10			25			40			55			70			85			100			115			130		
11			26			41			56			71			86			101			116			131		
12			27			42			57			72			87			102			117			132		
13			28			43			58			73			88			103			118			133		
14			29			44			59			74			89			104			119			134		
15			30			45			60			75			90			105			120			135		

My Comments On This Issue \_\_\_\_\_

FIRST CLASS  
Permit No. 22,489  
Philadelphia, Pa.

BUSINESS REPLY MAIL

No Postage Necessary if Mailed in the United States

POSTAGE WILL BE PAID BY:

# AUDIO

134 North Thirteenth St.  
Philadelphia, Pa. 19107

CLASSIFIED ORDER CARD Fill in other side to order a classified ad

# SUBSCRIPTION ORDER CARD

Don't wait until your subscription runs out. Renew now and insure uninterrupted service. The remaining issues on your current subscription will be added.

GENTLEMEN: PLEASE ENTER MY SUBSCRIPTION TO AUDIO

Name \_\_\_\_\_

Address \_\_\_\_\_  Office  New Subscription  
 Residence  Renewal

City \_\_\_\_\_ State \_\_\_\_\_ Zip \_\_\_\_\_

1 YEAR—\$5  
  
(Foreign - \$8)

2 YEARS—\$9  
  
(Foreign - \$13)

3 YEARS—\$12  
  
(Foreign - \$17)

BILL ME   
PAYMENT  
ENCLOSED

FOR OFFICE USE

FIRST CLASS  
Permit No. 22,489  
Philadelphia, Pa.

**BUSINESS REPLY MAIL**  
No Postage Necessary if Mailed in the United States

**POSTAGE WILL BE PAID BY:**

# AUDIO

**P.O. BOX 8671  
PHILADELPHIA, PA. 19101**

**READER INQUIRY CARD**

Fill in other side to get more information on advertised products

## CLASSIFIED ORDER CARD

Want to buy, trade or sell components? Looking for a rare piece of equipment? Want to offer or buy a service? Want a job in the audio field? If your answer is "yes" to any of these questions, your ad belongs in Audio Classified. Rates are comfortably low—readership is astoundingly high. Use this handy order form to include your message in the next issue.

**PLEASE CHECK ONE:**

- |   |   |
|---|---|
| <input type="checkbox"/> For Sale               | <input type="checkbox"/> Insert in next issue     |
| <input type="checkbox"/> Wanted to Buy or Trade | <input type="checkbox"/> Insert in next 2 issues  |
| <input type="checkbox"/> Situation Wanted       | <input type="checkbox"/> Insert in next 6 issues  |
| <input type="checkbox"/> Help Wanted            | <input type="checkbox"/> Insert in next 12 issues |
| <input type="checkbox"/> Services               | <input type="checkbox"/> Assign box number        |
- Other \_\_\_\_\_ (additional cost \$1)

**RATES:** Commercial, 50¢ per word; situation wanted or non-commercial, 25¢ per word. We reserve the right to determine classification as commercial or non-commercial. **Payment must accompany all orders under \$10.00.**

**COPY FOR YOUR AD**

\_\_\_\_\_  
\_\_\_\_\_  
\_\_\_\_\_  
\_\_\_\_\_  
\_\_\_\_\_

Name \_\_\_\_\_  
Address \_\_\_\_\_  
City \_\_\_\_\_  Office  
 Residence  
State \_\_\_\_\_ Zip \_\_\_\_\_

FIRST CLASS  
Permit No. 22,489  
Philadelphia, Pa.

**BUSINESS REPLY MAIL**  
No Postage Necessary if Mailed in the United States

**POSTAGE WILL BE PAID BY:**

# AUDIO

**134 North Thirteenth St.  
Philadelphia, Pa. 19107**

**SUBSCRIPTION ORDER CARD** Fill in other side to order a new subscription



# 4 channel sound.

**Metrotec makes it easy!  
Just add 2 speakers.**

Universal Decoder/Rear Channel Amplifier  
Model SD4A-Q wired only, \$149.95



**Universal matrix system decodes all the new 4 channel records and FM broadcasts plus synthesizes quad sound from any 2 channel source.**

Metrotec engineers have designed matrix/phase shift decoding circuits which will decode all types of the new 4 channel records and FM broadcasts. Just a flick of a switch gives the exact phase shifts and coefficients to match the program material. Featured are . . . a front to back balance control which eliminates the need to adjust the volume controls on separate amplifiers . . . a master volume control which adjusts the volume on all 4 channels simultaneously . . . tape monitor switch . . . and a source selector switch. In addition to precisely reproducing the 4 channels as they appear on the new 4 channel records, synthesized quad sound can be generated from any 2 channel source. This unique circuit separates the ambience information that would otherwise be lost and mixes it into the rear channels.

The Model SD4A-Q includes a powerful 30 watt rear channel amplifier with all controls on a single panel. All you add are the two rear speakers.

Most major record companies are producing 4 channel records. Columbia, Project 3, and Ovation to mention a few already have over 50 selections with many more on their way. 4 channel is here to stay. Look into it.



Model SDW-Q wired \$69.95  
Model SDK-Q kit \$54.95

If your equipment consists of separate preamp/basic combination, all you need is another basic amplifier and a Metrotec SDW-Q.

The heart of the Metrotec 4 channel system is a new universal 4 channel matrix/phase shift decoder. This amazing break thru in electronics and recording allows 4 channels of information to be put on records, tapes and FM broadcasting. No special turntables, cartridges or FM tuners are required. The matrix decoder analyzes the information and separates it into 4 separate channels. Recordings are made using as many as 16 microphones. This allows for reproduction of all separate, direct, indirect, complex phase and reflected acoustic signals. The startling 4 channel sound is far more dramatic than anything you have ever heard. The sense of special distribution adds a new and important dimension to realism.

A great deal of this complex information already exists on many stereo records. It goes undetected because the standard 2 speaker stereo system cannot reproduce multi-dimensional signals. Your entire 2 channel collection has sound that you have never heard before. Try it.

The matrix coefficients have been designed and constructed in such a way that they can be modified should changes be required at a future date. This special care in engineering will make these products valuable for many years.

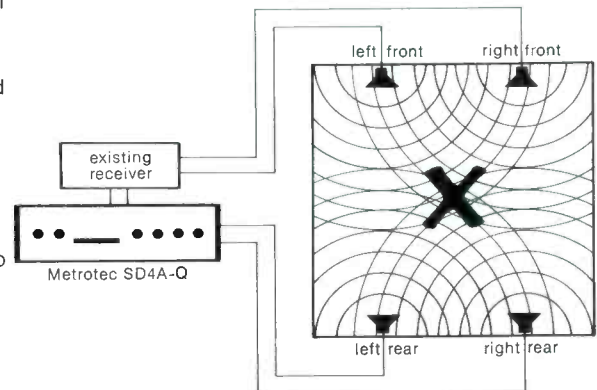

## Frequency Equalizer

Be sure to look into the Metrotec Stereo Frequency Equalizer. Match the speakers to your room. Guaranteed to improve any stereo system. You've got to hear it to believe it.

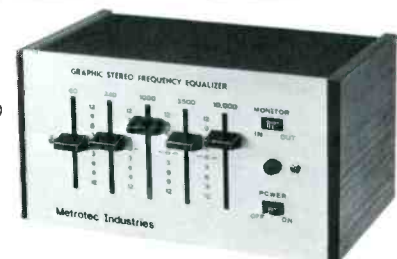

Model FEW-1 wired \$99.95  
Model FEK-1 kit \$79.95

# Metrotec Electronics, Inc.

33 Cain Drive, Plainview, N.Y. 11803 • Telephone: (516) 293-2520  
in Canada: GOULD MARKETING CO., LTD.

9429 Côte de Liesse Road • Montréal 760, Que. • (514) 636-0220 TELEX: 01-255 79

Check No. 78 on Reader Service Card





## A Marantz speaker system breaks up that old gang of yours.

Separation of sound is a true test of a speaker system. And to put Marantz—or any speaker—to the test you should listen to something you are already familiar with so you'll be able to hear for yourself that it's the speaker and not the recording that makes the difference. Oh, what a difference Marantz makes! What you thought were two oboes are now clearly an oboe and a flute and that barbershop quartet... well, they're really a quintet.

Let's face it: most speakers look the same, most speakers have an impressive list of specifications and ALL—ALL—ALL speakers claim to be the very A-1 HOT SHOT MOSTEST BEST.

But the proof is in the listening. And that's where the Marantz Imperial 5 comes in. The Imperial 5 is engineered to handle a plethora of continuous RMS power and has an acoustic

suspension woofer and tweeter with a fantastic off-axis response and a 3-position high frequency control and costs just \$89 and gives you true stereo separation anywhere in the room and is, for the money, truly the very A-1 HOT SHOT MOSTEST BEST.

But on paper so is theirs.

However keep this in mind. Marantz speaker systems are built by the makers of the most expensive stereo equipment in the world. And exactly the same quality that goes into Marantz receivers and Marantz amplifiers goes into the Marantz Imperial 5 speaker system.

To find out how much better it sounds, listen. That's all we ask. Listen. Then ask about the big savings on a complete Marantz system.

**marantz®**  
We sound better.

