

**BEETHOVEN
AT 200-Camby**

The Authoritative Magazine About High Fidelity

AUDIO

MARCH
1970
60¢



Special

Loudspeaker
Directory

Loudspeaker

& Questions
Answers on
Loudspeakers

Issue

How to choose a Loudspeaker

Bass Response
& Enclosure Size
by Victor Brociner

Damping
Factor *by*
Paul Klipsch

Plus: All Regular Features



Now... Scott Quadrant Speakers

(That deliver perfect stereo in any room . . . regardless of size or shape.)

Come in a choice of 3 new sizes and shapes



Scott Quadrant Q-102

This is Scott's lowest-priced Quadrant system, designed for use with one side directly against a wall. There is one woofer on the front capable of better than 180° dispersion and three tweeters arranged on the three exposed sides, each radiating more than 90°. 10" x 19" x 10½". \$89.95.

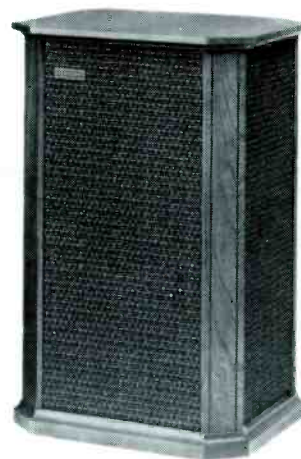

Scott Quadrant Q-100 Speaker System

This is the original Scott Quadrant . . . the one that set the critics on their ears! It includes two woofers radiating more than 180° each on opposite sides, and four midrange/tweeters each radiating better than 90°, placed one on each side. The Q-100 can be placed anywhere in the room, and provides a more heightened bass response than the Q-102. Dimensions, 14½" x 14¼" x 22". Price \$149.95.



Scott Quadrant Q-101 Speaker System

This is our finest Quadrant. The Q-101 incorporates two over-sized woofers, four midranges, and four tweeters. It's a match to our most costly conventional speakers in sound quality and range . . . in terms of stereo presence and depth, it is incomparable! Dimensions, 17½" x 17½" x 22". Price, \$249.95.

Long-shaped, L-shaped, and odd-shaped rooms used to be a hang-up for stereo speaker placement, but not any more. Scott now offers three Quadrant speaker systems* to fill every nook and cranny of any shaped room with perfect stereo.

The incredible Scott Quadrants project full-frequency 3-dimensional sound in a complete circle. Sound is radiated directly at you, and in all directions, using the reflective qualities of your walls to heighten the live stereo effect. You can go anywhere in the room, stand in a corner . . . even sit on a speaker . . . you're surrounded by rich, full-range stereo sound!

Scott Quadrants can be placed in virtually any convenient spot . . . quite helpful from a decorating point of view . . . particularly important if you're planning ahead toward 4-channel stereo.

Words can only hint at the dramatic difference between Scott Quadrant stereo and conventional speaker stereo. Hear for yourself, at your Scott dealer's.

*Patent applied for.

Write for complete information

SCOTT

H. H. Scott, Inc., Dept. 35-03
Maynard, Mass. 01754
Export: Scott International,
Maynard, Mass. 01754.

Prices and specifications subject to change without notice.

© 1970. H. H. Scott, Inc.

TANDBERG

NEW 6000X STEREO DECK

*A Dynamic New Thrust In Recording Capability
Featuring Our Unique CROSSFIELD Design*

The 6000X challenges the most precise professional instruments that sell for \$1,100 or more. At 3¾ ips, this new stereo deck surpasses the 7½ ips performance of our world famous, *top rated Model 64!* It offers the truest high fidelity you've ever heard, even at 3¾ ips (40-18,000Hz $\pm 2\frac{1}{2}$ db). And, it incorporates a completely new design for the 70's...fresh, interesting —inviting use!

Convince yourself. Would you believe...

- Signal-to-noise ratio at 62db
- 70db dynamic range, plus
- An additional 24db overload protection
- Peak reading instruments

And would you believe...

- 4 hyperbolic, mumetal screened, precision-gapped heads
- Mixing, cueing, source vs. tape monitor, sound-on-sound, add-a-track, remote control
- Independent mike/line recording controls and stereo mixing

Although we hesitate to say that this is the world's best tape recorder, we have yet to find its equal! Try the new 6000X. Record any material at 3¾. Play it back. Compare with others at 7½. You'll see that *you now* can make professional quality recordings. Your franchised dealer has it now ... **\$499.00**



TANDBERG SERIES 6000X

Available in quarter or half-track models, 3 speeds. Solid state, 57 silicon planar and FET transistors. May be used horizontally or vertically. Low-noise, high output tape recommended. Hand-rubbed walnut cabinet.

Tandberg
OF AMERICA, INC.

P.O. Box 171, 8 Third Ave., Pelham, N.Y. 10803
Tel.: (914) 738-0772 • N.Y.C. (212) 892-7010

In Canada: Clifco Electronics, 5522 Cambie St., Vancouver, B.C.
Engineered Sound Systems, 169 Kipling Ave., So., Toronto, Ontario



A NEW ARRAY

FRED NICHOLS
Marketing Manager,
High Fidelity Products

The creation of the new E-V LANDMARK 100* integrated compact system afforded an opportunity to review every aspect of compact system design. And the inclusion of the Servo-Linear* motional feedback circuit permitted even greater design freedom than usual.

An analysis of compact system usage indicated the need for greater versatility in sound distribution to accommodate less-than-ideal speaker placement. Since current designs are generally restrictive in placement, a new concept was needed. The development, Acoust-Array* speakers (patent applied for), utilizes reflected sound in a manner designed to solve many of the problems raised by either reflected or conventional speaker systems.

Three full-range radiators plus a tweeter are employed. One full-range speaker faces forward, while the other two speakers and the tweeter radiate from angled planes at the rear of the truncated cube enclosure. The entire system is slightly less than a one foot cube.

Each cube is asymmetrical, and a stereo pair of cubes are mirror images of each other. One rear speaker of each cube faces either vertically or horizontally at a 45° angle to the wall. The other speaker and tweeter are also angled to the wall and are tilted either left or right at 45°. Thus by turning or interchanging the two cubes a total of 8 different patterns of reflected sound may be achieved.

By radiating in several planes, a number of basic advantages accrue. Speakers may be located directly against a wall without muffling the reflected sound or negating the subjective advantages of a reflective system. Location of the speakers is less critical and wider variations in effective sound distribution are possible. By simply orienting the cubes, apparent speaker location can be widened, narrowed, or even shifted left or right.

A combination of direct and reflected sound was chosen that best defines stereo separation, while creating a "far field" condition of uniform sound distribution as close to the speaker systems as possible. The use of motional feedback permitted the choice of small enclosures without unduly restricting bass response or increasing low frequency distortion. This provides greater convenience for the user, with the added advantage of minimum restriction of wide-angle radiation patterns that would result from a larger enclosure.

While the Acoust-Array concept is currently available only in the integrated LANDMARK 100 system, plans are being developed to incorporate the basic design into speakers suited for use with conventional high fidelity components.

*Electro-Voice trademark

For reprints of other discussions in this series,
or technical data on any E-V product, write:
ELECTRO-VOICE, INC., Dept. 303A
602 Cecil St., Buchanan, Michigan 49107



AUDIO

March 1970 Vol. 54, No. 2

Successor to **RADIO**, Est 1917

GEORGE W. TILLET
Editor

C. G. MCPROUD
Publisher

JAY L. BUTLER
Associate Publisher

EDWARD TATNALL CANBY
Associate Editor

RICHARD CLIFF
Design

SANFORD L. CAHN
Marketing Director

NATE ROSENBLATT
Promotion Director

R. KENNETH BAXTER
Production Manager

RUTH E. NAPP
Advertising Manager

MARY CLAFFEY
Subscription Manager

Contributing Editors

HERMAN BURSTEIN

JOSEPH GIOVANELLI

LEONARD FELDMAN

ALEXANDER ROSNER

BERTRAM STANLEIGH

S. L. WEINGARTEN

BERT WHYTE

FEATURE ARTICLES

- Bass Response vs. Cabinet Size 20 *Victor Brociner*
 Choosing a Loudspeaker 24
 Adding a Woofer to an Electrostatic Speaker 26 *Nathan M. Garfinkle*
 Another Look at Damping Factors 30 *Paul W. Klipsch*
SPEAKER SYSTEMS DIRECTORY 32
 Speaker Systems Manufacturers 45
 Q's & A's on Loudspeakers 48
 Beethoven is 200! 76 *Edward Tatnall Canby*

EQUIPMENT PROFILES

- Nikko Stereo FM Receiver 50 *STA-501S*
 Garrard Automatic Turntable 52 *SL-95B*
 Shure "Stereo" Phono Cartridge 54 *V-15 Mark II Improved*
 Pioneer Auto-Reverse Tape Deck 58 *T-600*

RECORD/TAPE REVIEWS

- Classical 62 *Edward Tatnall Canby*
 Light Listening 70 *Sherwood L. Weingarten*
 Jazz 74 *Bertram Stanleigh*
 Tape Reviews 78 *Bert Whyte*

AUDIO IN GENERAL

- What's New in Audio 6
 Industry News 8
 Audioclinic 10 *Joseph Giovanelli*
 Behind the Scenes 12 *Bert Whyte*
 Dear Editor 14
 Tape Guide 16 *Herman Burstein*
 Editor's Review 18
 Classified 80
 Advertising Index 82



AUDIO (title registered U.S. Pat. Off.) is published monthly by North American Publishing Co., I. J. Borowsky, President; Frank Nemeyer, C. G. McProud, and Roger Damio, Vice Presidents. Subscription rates—U.S. Possessions, Canada, and Mexico, \$5.00 for one year; \$9.00 for two years; all other countries, \$8.00 per year. Printed in U.S.A. at Philadelphia, Pa. All rights reserved. Entire contents copyrighted 1970 by North American Publishing Co. Second class postage paid at Phila., Pa.

REGIONAL SALES OFFICES: Jay L. Butler and Sanford L. Cahn, 41 East 42nd St., New York, N.Y. 10017; Telephone (212) 687-8924. Jay Martin, 15010 Ventura Blvd., Sherman Oaks, Calif. 91405; (213) 981-7852.

REPRESENTATIVES: United Kingdom: H. A. Mackenzie and Peter E. Holloway, 4a Bloomsbury Square, London W.C.1. Tel. HOL-3779. Continental Europe: John Ashcraft, 12 Bear St., Leicester Square, London W.C.2. England. Tel. 930.0525. For Benelux & Germany: W. J. M. Sanders, Mgr., Herengracht 365, Amsterdam, Holland. Tel. 24.09.08. Japan: Matsushita Inc., 709 Kitano Arms, Hirakawa-Cho, Chiyoda-Ku, Tokyo.

AUDIO Editorial and Publishing Offices, 134 N. 13th St., Philadelphia, Pa. 19107
 Postmaster: Send Form 3579 to the above address

Citation is back.



Minimum resale prices—
(Kit) \$225. (Wired) \$295.

TECHNICAL SPECIFICATIONS AND FEATURES FOR CITATION TWELVE POWER AMPLIFIER

- Continuous Power Output:** • 120 watts, RMS, both channels driven simultaneously @ less than 0.2% THD, 20-20,000 Hertz @ 8 ohms.
- Intermodulation Distortion:** • Less than 0.15% at all power levels, 60 and 6,000 Hertz.
- Hum and Noise:** • Better than 100 db below 60 watts.
- Damping Factor:** • 40:1.
- Frequency Response:** • 1-70KHZ, ± 0.5 db @ normal power level. Less than $\frac{1}{2}$ Hertz—100KHZ, ± 1 db @ normal listening level.
- Power Bandwidth:** • 5-35,000 Hertz.
- Phase Shift:** • Less than 5 degrees at 20 Hertz.
- Rise Time:** • Better than 2 microseconds @ 20K Hertz.
- Dimensions:** • $5\frac{7}{16}$ " H x $12\frac{3}{16}$ " W x $12\frac{3}{8}$ " D (complete with metal cage).
- Weight:** • 30 pounds.
- Finish:** • Olive, black trim and gold escutcheon.
- Outstanding Features:** • Two individual power supplies deliver superb regulation for absolute stability and extended low frequency response. Handling of transients is effortless at any power level.

- Thermal cutouts remove power from output stage when heat build-up exceeds 80 degrees C. Series-type limiting relays protect amplifier from short circuits. Reset automatically once short is removed.

- Absolutely stable with any type of speaker system.

The Citation Twelve is available as a factory wired and tested amplifier or as a simple-to-construct kit. No special technical or mechanical skills are required. Instructions are complete and easy to follow. See and hear the Citation Twelve soon. We think you will agree it represents a remarkable breakthrough in high fidelity.

For complete technical information, write to Harman-Kardon, Inc., 55 Ames Court, Plainview, N.Y. 11803, Dept. A-3

harman kardon



A subsidiary of Jervis Corporation



W 80 Rear View

When our engineers told us what the new VARIFLEX® Speaker Systems could do...we didn't believe it.

After all when we were told that two speaker systems can be placed end-to-end as a console, or at various spacings apart, or any distance from the wall, or at almost any height between ceiling and floor, and still project flawless stereophonic reproduction to all areas of a room simultaneously... we were skeptical... but there are three ways to deal with a skeptic.

First, tell it like it is.

Engineers love to explain things, so that's what they did. Variflex Speaker Systems, we were told, are not like any

other speaker systems past or present. They are unique because they are the only reflective speaker systems that are completely adjustable. In the rear of each unit is a variplanular disc set in a universal swivel mount. This disc, they said, can be finger tip adjusted to any combination of vertical to horizontal positions. Once adjusted for correct acoustical reflection, the speaker systems would provide overall stereophonic reproduction as promised... and furthermore, we were told, we could move about the room freely and never lose that important sense of program source characteristic

of concert hall performance.

Second, put it to the test.

We watched as two W80's were adjusted. The engineer merely tipped the variplanular disc this way and that... and rotated the swivel mount a little to the left, a little to the right... and that was all there was to it. It seemed too easy to us. But after about two minutes, or maybe a shade less, they were ready. We were asked to stand anywhere in the room. Then we were treated to a fine performance of Tchaikovsky's Pathétique. "Walk about", they suggested. We

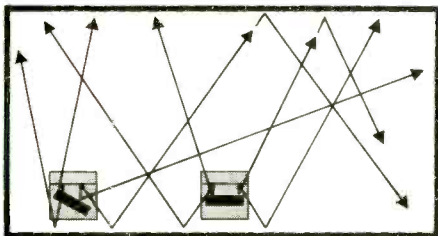

did and we were amazed. It was true stereo everywhere and anywhere. There was none of the splatter or surround effect associated with omnidirectional systems. We had to admit this was a "first" for all of us and we found it difficult to restrain our excitement.

Third, do it yourself.

"Now", they suggested, "you try it". It looked like fun. We each took a turn adjusting the speakers. Only one thing bothered us. The W80 makes everybody with finger tips an instant expert. Then they asked us questions.

What acoustical problem is solved?

A very important one. Since almost all rooms are acoustically unbalanced, fixed directional systems, conventionally placed, are too rigid to overcome this deficiency. Only the amazing flexibility of the new Variflex Speaker Systems can provide "all over" balanced stereo.

What will women say?

"It's about time", probably. W80's are a woman's dream. They are never unwelcome intruders. Since they are reflective systems, the front of the cabinets resemble fine pieces of furniture. Because they permit placement versatility, they can be inserted decoratively or unobtrusively into any room scheme... even as built-ins with an optional roll out base.

What about quality?

That was an unnecessary question. The W80's are Achromatic Speaker Systems — and therefore are critically engineered in the uncompromising tradition of excellence.

A suggestion to all skeptics.

Believe your own ears. Just visit a Wharfedale dealer, and ask for a dramatic demonstration. Start walking around as a disbeliever... you won't be one for long. You'll be as amazed as we were. Wherever you pause, you will be aware of distinct stereophonic separation... Variflex may well be the component speaker innovation of the 70's.

For full specifications on the W80 and all Wharfedale Systems write: Wharfedale, division British Industries Co., Dept. HC20, Westbury, N.Y. 11590

Wharfedale
Achromatic Speaker Systems

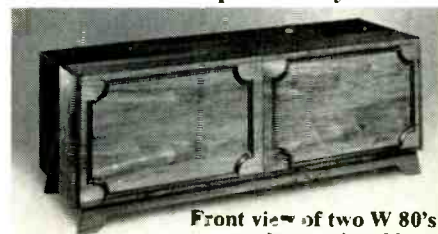

Front view of two W 80's mounted on optional base

Check No. 5 on Reader Service Card

What's New In Audio

Hegeman Line

Hegeman have announced a range of sophisticated stereo equipment which will be available in kit form or completely wired and assembled. Included are 3- and 4-channel amplifiers, electronic-crossover modules, remote-control units, loud-



speaker switching panels and a unit which is capable of monitoring any portion of a two-, three- or four-channel stereo system. Shown in the photograph is a Preamplifier and Control unit (HL-100) and a Power Amplifier (HL-200). Price, HL-100 \$490 wired, \$380 in kit form. HL-200 \$398 wired, \$342 as a kit.

Check No. 18 on Reader Service Card

FM Signal Generator

Model 188 is a new FM generator from Measurements designed for laboratory use and production line testing. Range is



from 86 to 108 MHz with 0.5% accuracy, and distortion is rated at less than 0.5% at 75 KHz. Provision is made to use the 188 with MPX modulators. Price \$700.

Check No. 20 on Reader Service Card

AM/FM receiver from Panasonic

This is model SA-70 and it is rated at 80 watts per channel (IHF, 8 ohms). Features of the SA70 are an overload protection circuit, ceramic multiplex filter, 3



FETS in the 'front end,' dual bass and treble controls, two switched filters and a thermometer-type tuning band instead of a dial pointer. Price \$349.95

Check No. 22 on Reader Service Card

Tandberg 6000X Tape Recorder

Model 6000X is the first in a new series designed as Tandberg says—"for the 70's." It uses 57 transistors, automatic overload protection circuitry and features independent level controls for each channel. Facilities available include stereo mixing,



cueing, source vs. tape monitor, sound on sound, add-a-track and remote control. Cross-Field bias design is used and response at 7½ ips is claimed to be 40-22,000 Hz within 2½ dB. Available in quarter-track or half-track versions. Price \$499.

Check No. 24 on Reader Service Card



Advanced Compact System

Electro-Voice have just introduced a Compact System called the Landmark 100 which has some unusual and interesting features. These include servo-motional feedback, speakers with controllable dispersion, a high-sensitivity tuner with FETS, a magnetic cartridge and a power output of some 60 watts IHF. Each speaker system comprises 3 full-range 4½-inch units plus a 2¼-inch tweeter. Price \$444. Dust cover \$14.95.

Check No. 26 on Reader Service Card



Solid State Energizer

The JBL SE460, a more powerful version of the 80-watt SE400S was introduced recently by JBL. It has all the features of the smaller unit with an increase in power up to 120 watts (rms).

Check No. 28 on Reader Service Card

Literature

"Sound of Excellence" This is the title of a two-color 10-page brochure describing the LWE range of "electronic suspension" speaker systems and kits.

Check No. 34 on Reader Service Card

"Melcor Equalizers" is a 6-page catalogue giving details of graphic equalizers for professional use.

Check No. 36 on Reader Service Card

"Caedmon 1970." Interested in recordings of the spoken word? This 80-page catalogue lists recordings of Shakespeare, plays by Shaw to Miller, traditional and modern poetry, great speeches by Churchill, Roosevelt, and so on.

Check No. 38 on Reader Service Card

JVC's paperwork pays off in bigger, better sound

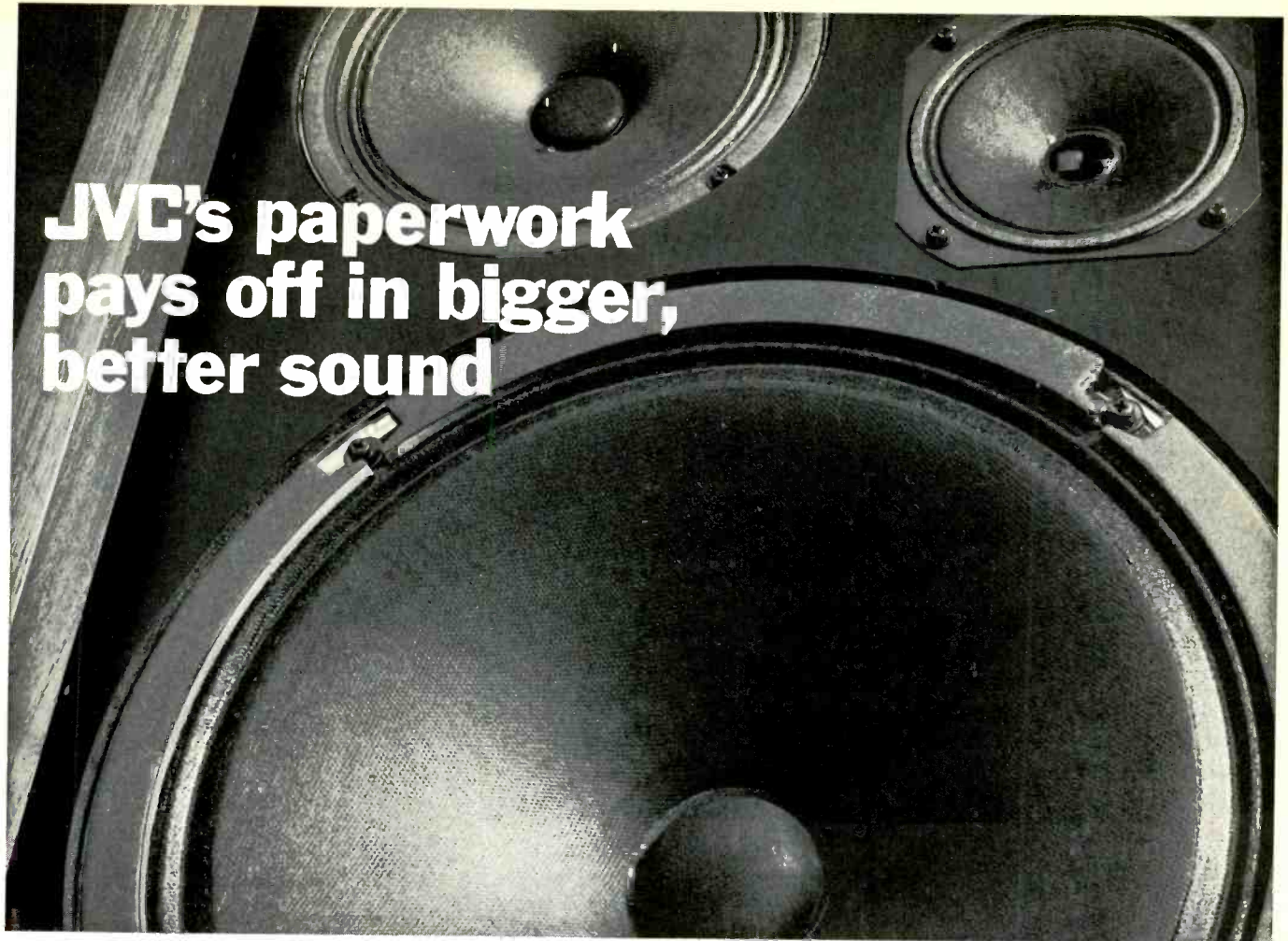

If you've been looking for a compact speaker system that would give you big sound reproduction from an ordinary amplifier, knock on wood.

Thanks to JVC's paperwork, they're here. We call them our new High Efficiency (HE) line, and they're specifically designed to exploit less powerful amplifiers with maximum effect.

The secret of the HE systems is in the cone paper, specially developed to give it exceptional air permeability, which in turn means a significant increase in the output sound pressure level.

In other words, by employing this special paper, JVC makes it possible for the HE systems to deliver the same sound volume as conventional systems while needing only one quarter as much power.

JVC does its paperwork. And this is just one example of how such research is passed on to you in the form of improved, more sophisticated audio products.



Model 5340. 4-way 4-speaker system. Handles up to 80W peak. Frequency response: 20-20,000Hz. Crossovers: 1,000, 7,000, 10,000Hz. Impedance: 8 ohms. Price: \$229.95.*
Model 5304. 4-way 4-speaker system. Handles 80W peak. Frequency response: 30-20,000Hz. Crossovers: 1,500, 7,000, 10,000Hz. Impedance: 8 ohms. Price: \$149.95.*
Model 5320. 3-way 3-speaker system. Easily handles 30W

peak. Frequency response: 35-20,000Hz. Crossovers: 5,000, 10,000Hz. Impedance: 8 ohms. Price: \$99.95.*
Model 5310. 3-way 3-speaker bookshelf system. Handles 25W peak. Frequency response: 40-20,000Hz. Crossovers: 7,000, 10,000Hz. Impedance: 8 ohms. Price: \$69.95.*
See the JVC dealer nearest you and let him show you how JVC's paperwork has made the difference in giving a big sound boost to compact speaker systems.
*Suggested list price

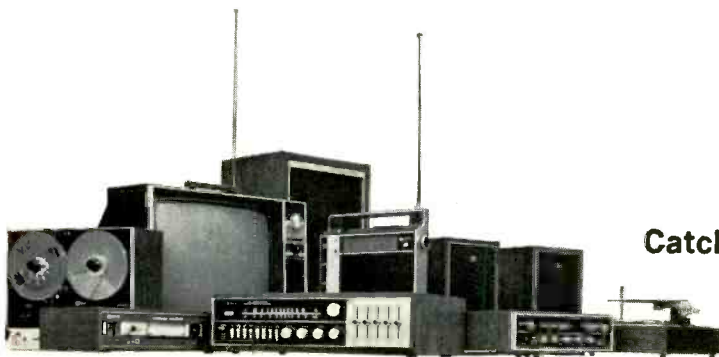

Catching On Fast

JVC

JVC America, Inc., 50-35, 56th Road, Maspeth, New York, N.Y. 11378 A Subsidiary of Victor Company of Japan, Limited, Tokyo, Japan

AUDIO • MARCH 1970

Check No. 7 on Reader Service Card

Coming in April

The Listening Room—E. T. Canby writes about the acoustics of the listening room, and what can be done with the new frequency balance control units.

Negative Feedback—Norman Crowhurst discusses some transistor circuits in the next article in this series.

Some Loudspeakers Past And Present—Bob Berkovitz describes some unusual designs in a controversial but interesting article.

Tape Transport Maintenance—by H. W. Hellyer. Part 5 deals with heads, guides and pressure pads.

EQUIPMENT PROFILES

include:

Ampex M52 Stereo Tape Recorder

Teac AS200-U Amplifier

Advent Frequency Balance Control Unit

PLUS

Record and Tape Reviews and all the regular features

DON'T MISS . . .

The AES
Meeting and
Exhibition
Los Angeles
May 4-7

NEWS FROM THE INDUSTRY

Advent-Dolby Noise Reduction System

The Advent Corporation of Cambridge, Mass. have announced that they are proposing to market a Dolby unit which can be used with any high-quality Tape Recorder—so bringing this useful device within the reach of the enthusiast. It is claimed that the Advent unit can make dramatic improvements in the noise level and dynamic-range capabilities of any good recorder and will allow good-quality recordings to be made at 3¾ ips, thus doubling the playing time. The price is not yet fixed but it is expected to be in the region of \$200.

Electronic Industries Corporation

A small midwest company that has been in operation less than four years has become an important company in the Hi-Fi world through several acquisitions. Peploe Inc., a Minneapolis based electronics firm founded in 1965 as a manufacturer of prototype printed-circuit boards entered the music field in 1968 with the acquisition of Electronic Industries, Inc.,

another Minneapolis company which produces high-quality amplifiers. This was followed by the acquisition of RTR Industries Inc., of California and the Janszen Speaker Division of Neshaminy Electronics Corporation.

Both RTR and Janszen are makers of electrostatic speakers and George Peploe said recently that "electrostatic speakers are the coming thing in the speaker field, Janszen was a pioneer in this development, and the key patent it held was included in our acquisition." He went on to say "We have no designs for capturing the mass market, but instead have been aiming for the quality-conscious market."

Electronic Industries now have a range of amplifiers and speaker systems in production and a tuner is scheduled for delivery early this year. 4-channel demonstrations were put on in Minneapolis recently and they attracted a great deal of interest. The vice-president of the new company for marketing, J. Weaver Welch, said that "4-channel sound had a large application which will extend beyond that of the home systems and has a great potential for theatres and auditoriums."



Left: George Peploe, founder of Peploe, Inc.
Right: J. Weaver Welch, President of Electronic Industries, Inc.

FOR THOSE WHO DEMAND

The Very Best

Some people can accept reduced quality in their audio components. For others — the recording engineer, the professional musician, the music connoisseur — there is only one quality — *the very best*. These are the uncompromising — the people who choose CROWN.

They know that behind each Crown product stands the teamwork of some of the nation's finest audio engineers and proudest American craftsmen. These are the designers whose innovations have led the tape industry with exclusive electro-magnetic braking, the first solid-state components, original computer logic tape control, the new industry standard power amplifier — DC300, and now an ultra-flexible, high-performance control center. These are the craftsmen who carefully hand-fabricate and test each unit, entering measurements on individual proof-of-performance records. This is the product line that is worthy the pride of both its makers and its owner.

To discover what you're missing — compare CROWN's Total Performance sound today. Write Crown, Box 1000, Elkhart, Indiana, 46514.

Crown 
MADE ONLY IN AMERICA



CX844 For the audio perfectionist or professional, the ultimate in live recording. 4 channels in-line, 3 speeds, computer logic tape control never breaks tapes, remote control optional, sound-on-sound, sound-with-sound, echo effects

All models shown feature total silicon solid-state design, non-mechanical brakes, precision micro-gap heads, 5" VU meters, 4 mic or line inputs, 3/16" panel with massive central casting, third head monitor with AB switch, rugged construction, 100 hours in-plant testing.



CX722 Superlative professional quality with outstanding flexibility for on-location recording. 2 channels, 3 speeds, pushbutton electric control, remote start/stop optional, sound-on-sound, sound-with-sound, echo effects, shown in studio console.

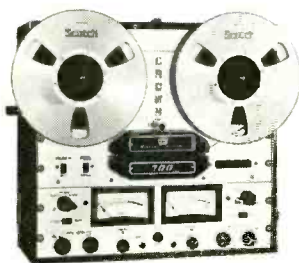

SX724 Professional performance at a minimum price. Essential for the finest component systems. 1/4-track stereo 2 speeds, push-button electric control, remote start/stop optional, sound-on-sound, shown in scuff-proof carrying case.

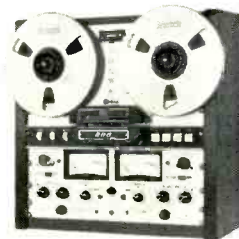

SX824 For the serious audiophile, the ultimate home recorder. 2 channels, 2 speeds, computer logic control never breaks tapes, remote control optional, sound-on-sound, shown in genuine walnut hard-wood cabinet.



DC300 Laboratory standard basic amplifier. 300 watts per channel RMS, complete output protection, extreme purity, shown in walnut cabinet. **D40** The ideal monitor amplifier. 40 watts per channel RMS, compact, low distortion, shown in walnut cabinet.

Check No. 9 on Reader Service Card

Audioclinic

JOSEPH GIOVANELLI

If you have a problem or question on audio, write to Mr. Joseph Giovanelli at AUDIO, 134 North Thirteenth Street, Philadelphia, Pa. 19107. All letters are answered. Please enclose a stamped, self-addressed envelope.

Product Selection

Q. We are thinking seriously of investing in stereo components consisting of receiver, tape deck with speakers to enable its use as a separate portable unit, turntable and two stereo speakers for the moment. Ultimately, we would like to extend the system to at least two more rooms in the house. For this reason, we would like enough power to operate six speakers. Although I presume that most of the time only two of these speakers would operate at once, probably some of the time four would operate. Only on rare occasions would six speakers be operated simultaneously.

I must admit that both my wife and I are confused by the vast array of equipment available. We feel that we should seek the advice of someone who has no equipment to sell and could thereby give us an unbiased opinion. Would you be kind enough to recommend the best combination of components by brand names and model numbers?—Ernest A. Bottke, Jr., Howell, Mich.

A. I regret to say that I do not deal with product selection and evaluation. This is a subjective matter. The ear is a peculiar device. What I like and would, therefore, tend to recommend can well be something which you do not like at all. Therefore, you would not think much of me after that. Therefore, I do not and will not get into the area of product selection.

When looking for a product, check the features it offers because some components may offer features which you may never use.

When it finally comes down to it, there is only one way to judge the performance of a product, especially speaker systems. You must listen to the equipment. This can take some doing if you are not near a good high fidelity showroom which features the various pieces of gear you are considering.

The kinds of questions I answer are those of a more general nature, i.e., your question about connecting six speakers to one amplifier.

You need to buy 16-ohm speakers. Remember that when all six speakers are operated simultaneously, you will have three speakers connected in parallel across each channel. This will decrease the combined speaker impedance to around five ohms, which is still within the safe impedance-tolerance limits of your amplifier, *whatever brand it may be.*

If the speakers you choose had impedances lower than 16 ohms, three speakers in parallel would produce an impedance which is lower than 4 ohms. Four ohms is the impedance below which it is unsafe to operate most amplifiers. The result of this is likely to be damage to the output stage of the amplifier.

It is not easy to make a selection from among a welter of equipment, but at least your choice of speakers is now narrowed to those having impedances of 16 ohms.

As for your selection of an amplifier, make sure that it will deliver at least 50 rms watts per channel. This is the only way to be reasonably sure that you will have sufficient power fed to all six speakers, even when really loud listening is contemplated.

Test Equipment for Servicing

Q. I have a shop in which I have been performing repairs on black and white TV sets, radios, tape recorders, and so on. I have not, however, taken on the high-quality audio equipment.

If you are at liberty to do so, I would appreciate your recommendations regarding a practical array of test equipment which can be used to service high-quality audio equipment.

My thinking is that I would use a triggered sweep 'scope and a good sine/square-wave generator in lieu of exotic distortion analyzers.—Carl C. O'Neal, Bellevue, Nebraska.

A. Before buying test equipment you must first be sure you have an understanding of general electronics and an understanding of what goes on under the cover of the various pieces of audio gear. I know you already have basic knowledge because you are successfully doing various kinds of service work. I made the previous statement, however, for the sake of completeness. There is no substitute for knowledge. A piece of test equipment can disclose a number of things, but the "sharp" technician can often find them without using a single piece of equipment, just because he recognizes certain problems and uses common sense in terms of how to localize the area in the equipment in which the trouble lies.

As for test gear, a good VTVM is vir-

tually a necessity. You are right about the possibility of using a square- and sine-wave generator. It is always a handy source of signal and an aid in checking frequency response and square-wave performance.

I do not believe that a 'scope will show distortion as well as will a good distortion analyzer. You do not have to be elaborate with the kind of distortion measuring gear you buy either. Good results can be obtained at very modest prices. I suggest that you consider both a harmonic and an intermodulation distortion analyzer.

Of course, the 'scope does help in identifying the character of square-waves, but it is useful in aligning FM tuners and it also can be used as a voltmeter.

If you plan to repair stereo tuners and receivers, you will need a stereo generator. There are some which are comparatively inexpensive. While they are quite useful, they are not as accurate as a really good one, made for topnotch performance.

In addition to this specialized piece of equipment, you will need a marker and sweep generator to perform basic r.f. alignment. You probably already own this gear, used in connection with your television service work.

You should have a capacitance checker and a capacitance bridge.

In your tool collection you doubtless already have various soldering aids which are useful for removing components from printed circuit boards. Various types of pliers, too, are useful, such as diagonal cutters, long-nose, and right-angle long nose. Fingertip wrenches, socket wrenches, and Allen and Bristo wrenches also come in handy from time to time.

A little while ago I mentioned the necessity for a good VTVM. Typically this piece of gear incorporates an ohmmeter together with a.c. and d.c. voltage capabilities. However, such a meter usually has a low-voltage scale of 1.5 volts full scale. This is not sufficient for all applications. You also should have an a.f. VTVM. This meter reads audio frequencies down to perhaps 10 millivolts full scale or in some cases to even 1 millivolt full scale. This is useful in measuring low signal levels which are encountered in the early stages of audio equipment, especially solid-state gear. This meter must have a wide frequency response, for it is likely to be called on to do such jobs as enable you to set prescribed bias levels on cassette decks, make frequency-response checks of low level stages, and so on.

When you have the foregoing test equipment, your shop will be adequately equipped. Æ

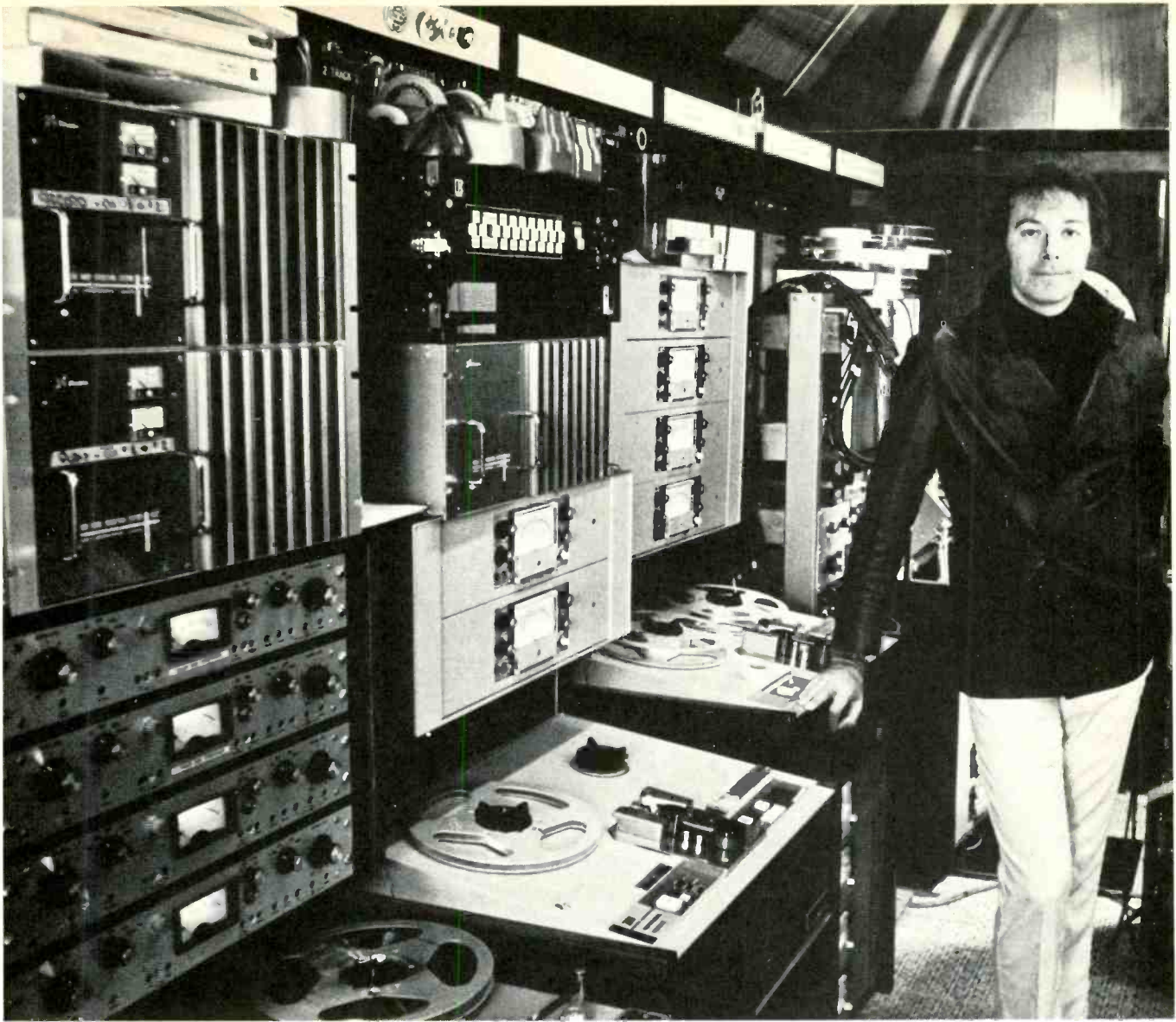

"Elektra was first in recognizing the value of the Dolby System for multi-track rock recording,"

says Jac Holzman, President of Elektra Records. "Since early 1967, we have used Dolby units on most of our recordings of The Doors, Judy Collins, Tim Buckley, Tom Paxton, The Incredible String Band, Roxy, and many others. The New Music can have a surprising dynamic range, and we find that the Dolby System not only gives a really low-noise background during quiet passages, but it helps to preserve the clarity and definition of complex musical textures. A related advantage is that the mixdown is faster and less tedious. In working out the final mix, we no longer have to resort to intricate equalization schemes to retain crucial nuances and subtleties of the performance."



DOLBY LABORATORIES INC

333 Avenue of the Americas New York N Y 10014
 telephone (212) 243-2525 cables Dolbylabs New York
 for international inquiries contact UK address:
 346 Clapham Road London S W 9 England
 telephone 01-720 1111 cables Dolbylabs London

S. Calif. Audio Industries Corp.
 1419 N. LaBrea Ave., Hollywood, Calif. 90028
 Tel. 213-HO 5-4111

N. Calif. Audio-Video Systems Engineering
 1525 Tennessee Street, San Francisco, Calif. 94107
 Tel. 415-647-2420

Midwest Expert Electronics, Inc.
 7201 S. Western Avenue, Chicago, Illinois 60636
 Tel. 312-HE 6-2700

Canada J-Mar Electronics, Ltd.
 6 Banigan Drive, Toronto 17, Ontario, Canada
 Tel. 416-421-9080

BEHIND THE SCENES

BERT WHYTE

SOME YEARS AGO I VISITED THE HOME of an audiophile friend of mine, who wanted to show me his new super-duper, "state-of-the-art" preamplifier. As I walked into his listening room my ears were assaulted by the over-bright shrill strings of a "mood" record he was playing. I winced, and asked him to roll off his treble control a little. He looked positively shocked at this suggestion and stated with great emphasis that he "always kept his tone controls perfectly flat." Is asked him if he enjoyed listening to shrill distorted strings. "Of course not, he bristled, but I don't believe in "diddling" with tone controls. This just confuses things and you never know when the balance is right." Now mind you, this lad lived in one of those fancy modern apartments with a glass "window wall," the furnishing was sparse, and what there was of it was mainly hard surfaces. In essence, a room with hard, over-bright acoustics. The room simply cried out for acoustic treatment via drapes, carpeting, and so on, but you would think that in the absence of such aids, the least he could do would be to utilize his tone controls! Here was a chap who had just laid out quite a sum for this fancy pre-amp, and somehow had become convinced that "purists" just don't use tone controls. In the years since that incident, I've run into similar situations and it is astonishing how this notion persists. But today, in addition to the "flat-tone-control fetish," we have a new whipping boy—equalization—which apparently is a "dirty word" to certain misguided hi-fi buffs.

The reason I mentioned this is that there appears to be the start of a trend towards the inclusion not merely of conventional tone controls in certain new playback equipment, but of bass and treble equalization control for the cut or boost of specific frequencies. It is strange that equalization should be viewed with such suspicion, when it is very much a part of the warp and woof of the fabric of audio, and has been a basic technique for many years. Where would we be without the standard RIAA equalization curve for disc recordings, or the NAB

equalization for tape recording, to say nothing of the special new equalization that permits wide response with a reasonable signal-to-noise ratio on 1½-ips cassettes? There are other applications of equalization too numerous to mention and it would be a very rare recording studio that didn't own a Pultec or graphic equalizer or far more elaborate equalization equipment. Not long ago the JVC company of Japan introduced a receiver which incorporated what they call a "Sound Effects Amplifier." This comprises five slide-type pots which afford up to 10 dB boost and 10 dB attenuation of frequencies of 60, 250, 1000, 5000, and 15000 Hz. This is a rather broad spectrum, nonetheless it offers a more versatile approach to sound control than conventional bass and treble controls. The idea has been well received and while the JVC has the field to itself at the moment, I understand there are similar equalization facilities on some competitive receivers waiting in the wings.

When I was at the Los Angeles Hi-Fi Show last year, I ran across a unique preamplifier made by a small Los Angeles-based firm called Scientific Audio Engineering. Their SAE Mark One preamp costs a whopping \$500, making it the most expensive in this country. For this kind of money however, they have built a unit which is finely crafted with much use of MIL/SPEC quality components, deposited carbon resistors, and other similar embellishments. Reliability should be quite high as they offer a five-year guarantee on the unit. This preamp has a fairly elaborate equalization facility in place of the usual tone controls. A rotary switch gives a choice of low-frequency equalization at 60, 120, 220 and 320 Hz. Another rotary switch handles high-frequency equalization at 2500, 5000, 10000 and 15000 Hz. The rate of slope from these frequencies is 12 dB per octave. Low- and a high-frequency step controls are provided for left and right channels. There are six steps of clockwise rotation for each control, each step giving 2.5 dB of boost at the selected frequencies for a total of 15 dB boost. Counter clockwise each of the first four steps gives 2.5 dB attenuation. The final step gives an additional 5 dB attenuation for use as a notch filter. The total attenuation is 15 dB. There are two toggle-type switches, one for low and one for high frequencies which in one position gives flat response and in the other position provides the equalization selected. Thus you can A-B between the flat response and the equalization on your program material. With such a flexible equalization set-up, you can handle virtually any situation which calls for frequency manipulation. Certain

phono cartridges have high-frequency peaks. A few seconds adjusting controls on this unit and the peak is no more. Some speakers accentuate the middle range and in certain rooms this can spell trouble. Switch in the desired amount of attenuation at 2500 Hz and you've solved that problem. Conversely, in certain rooms the sound from some speakers is on the dull side. A few minutes experimentation with mid and upper frequencies boosted a certain number of decibels affords the desired balance. These are some of the more obvious uses of equalization. The major use of the equalization facility is frequency modification of program sources, and this is what scares many people and makes them shy away from any such devices. Let us look at this concept for a moment. The most simple situation would be a record with excessive high frequencies and corrective equalization could be applied in seconds. Or we may have a recording which is weak in the mid-bass frequencies. This too, is easily corrected. The people who are afraid of equalization and who always set their tone controls to the flat position, would seem to have an almost blind faith in the omnipotence of the recording engineers and recording directors. They don't seem to realize that while there is plenty of the scientific method in making a recording, with much rigid adherence to certain electronic disciplines, there is also a good deal of "art" and personal judgment in recording. Naturally, much depends on the background of the personnel involved with the recording. For example, the recording director may have played the violin in a symphony orchestra. When this gentleman makes a classical recording, for one thing, he has perhaps an unconscious tendency to pay more attention to the string sound than he does to brass or woodwinds. He usually has very definite ideas of what kind of string sound *he* prefers. If he played for a numbers of years with the orchestra in the same hall, he has a certain degree of acoustic conditioning which influences his preferences in string sound. Or let us assume that for many years this recording director was an avid concert goer at Symphony Hall in Boston. Here he has been exposed to the overall sound of the orchestra from the listener's viewpoint. Again he has been conditioned to a degree, and while acoustic memory is supposed to be fallible, nonetheless he retains an image of the kind of orchestral sound he feels is ideal, and in his recording he strives to duplicate that sound. Quite apart from all this, there is always the possibility that our recording engineers and directors are faced with an entirely new hall in which they must

30 voice power



in a 30-man meeting...

Today, whether the meeting is a businessmen's seminar, a teachers' workshop, or a debate on the floor of a State House, *everybody* wants to be heard. They *will* be heard, if each participant has his own microphone. That's the Shure concept of Total Communications: Every man with something to say has a microphone close at hand . . . so he *can* be heard.

To meet these changing concepts of modern meeting

dynamics, Shure offers a broad range of specialized microphones, along with a selection of unique microphone mixers and associated circuitry products that let you connect those microphones through a single amplifier and loudspeaker set-up.

For you, they're easy to install. For your customers, they're easy to use. And for the people with things to say, they're a must!

SHURE

TOTAL COMMUNICATIONS

Shure Brothers Inc., 222 Hartrey Avenue, Evanston, Illinois 60204

record their symphony, simply because the hall they prefer is not available for some reason. I've had it happen to me. In London, I like to record in Walthamstow Town Hall, but there have been times when I had to use other halls, each with its own distinctive acoustics. You try to cope with the strange acoustics, but, it must be confessed, rarely with complete success. Another variable involved in the recording of classical music is the monitoring situation. Finding a room offstage where there will be no mutual sound interference is hard enough. Further, the acoustics of these rooms are usually just plain awful. If the room acoustics are not modified (as is frequently the case) monitoring is poor. The whole idea is of course, not to let the acoustics of the room which you are monitoring influence the sound you are hearing from the recording hall. To this end, many engineers heavily damp the monitoring room with fiberglass, burlap, or other suitable material.

The monitor speakers that are used can have a significant influence on the quality of the sound on the master tape. You would be astonished by what kind of speakers are used by certain recording engineers. I have seen them use 8-in. speakers in small portable baffles which are quite poor in general, and most specifically have little bass response below 150 Hz. Granted, when the master tapes are played back in their studios, their playback speakers are usually of considerably better quality than those they use for monitoring in the recording hall. This affords them an opportunity to apply corrective equalization which hopefully will improve the sound to the point where it can be issued commercially. As you can readily see, if nothing else, the use of a poor monitor speaker makes unlikely the chance of recording from the master tape directly into the cutter-head, thus forcing them to go to a second- and perhaps a third-generation equalized tape for the disc master. Of course, if the recording engineers were using the Dolby System, they could get away with the noise build-up engendered by the multiple generations of tape. My personal opinion is why use a sophisticated technique like the Dolby System without making certain the master tape is of high quality. Even if the recording engineers, used high-quality monitor speakers, the sound that is recorded is still to the individual taste and ideas of the recording director. Whether his ideas are consonant with yours is a moot point.

I am not suggesting you run out helter-skelter and buy yourself some means of home equalization. Recording companies in general furnish a well-balanced disc or

tape. Strictly speaking, in the home you don't really equalize a recording per se. With a unit of sufficient flexibility you use your ears to arrive at a balance which seems pleasing to you, which if you think about it encompasses your listening room, your speakers, amplifiers, phono cartridge, tape heads, and recording itself. In other words you are either pleased with what you hear in the total acoustic environment and chain of electronics, or you feel it needs modification. Up to now, such modification was restricted to bass and treble controls. With the JVC unit, or this SAE Mark One preamplifier-equalizer, or the Advent "Frequency Balance Control," the audiobuff has the means to effect the frequency modification. The SAE Mark One handles all of the other usual preamplifier functions, and does it with extremely flexible controls, wide-range response, vanishingly low distortion, and very low noise. It is my understanding several other preamplifier manufacturers are investigating this equalization concept, and it will be interesting to see if this becomes popular with audiobuffs. Æ

Dear Editor..

Cry of Anguish

• I was flipping through the January issue of *AUDIO*, when my eyes were caught by the headline "Simultaneous 4-channel stereo." Four-channel! Four not two! Two-channel has been causing me enough trouble over the years. Spare me, please, from four.

I have succumbed to the various phases of Audio right from the early stages. I've had a ton of bricks in the living room to help (?) with the solid sound of speakers. I've appeased neighbors for interference to their TV sets from experimental speakers, and so through various stages to two-channel stereo.

Two-channel brought enough problems to my living room. Every time we move and start house hunting, I'm eyeing the living room windows, deciding if the drapes will still fit, while my husband is jumping up and down on the floor to see if it has the minimum vibrations for sound reproduction, and that the corners of the room are in the right place for his speakers. My valuable antique corner cabinet is then pushed off to any odd corner that's left after the speakers have been placed. With *four* speakers there just won't be a corner left for *my* cabinet

—will probably have to sell it to pay for the new equipment. Then there's the seating arrangement, the number of rugs we have worn through swiveling the sofa back and forth. 'It has to be here for the hi-fi,' 'Yes, but it looks better against that wall.' All this upheaval for two-channel stereo, what am I going to do with *four* of everything? But I see the experts have solved the problem nicely, see Figs. 1 and 3, January *AUDIO*. To start with, the room shown doesn't have a door; that's great. Maybe all the stereo fanatics climb inside, block up the door and stay there. Also, it doesn't have a fireplace. Maybe one shouldn't, in case all the sound goes up the chimney? What about book shelves, end tables, and all the other paraphernalia one finds in a living room, where does that go?

So we've come to *four*-channel, what next? *Six*-channel, *eight*-channel, *ten*-, *twelve*-? the mind boggles at the possibilities. The sooner someone finds a pill for speaker systems the better.

Is it any wonder that my husband calls me 'Cloth Ears.'

JUST A HOUSEWIFE.
Danbury, Conn.

"Cloth ears" is a very distressing disease and it cannot be cured as easily as dandruff, for instance, because of the psychological factors involved. I once knew a young married lady with this affliction and I advised her to attend a course on Musical Appreciation at the local College. It worked out very well for a few weeks and she and her husband spent many happy hours discussing the merits of "The Vienna Octet" and so on. But it did not last—after three months of marital bliss she ran away with the music teacher.

About the room with no doors and windows, yes, I think you have put your fingers on a real problem here. I tried to call the designer, but his wife said she had not seen him since he built the room some weeks ago.

—Ed.

Bouquet

I want to sincerely thank you for the report on the AR-5 speaker in your January issue. Each issue has been eagerly awaited since January 1969 when I purchased a pair of AR-5's. Thereafter, two other reports in other magazines left me somewhat confused. A third report and AR's (prejudiced) rebuttal tied the score somewhat. . . . Your carefully worded report might well be an example of how a loud-speaker should be presented.

W. R. Rank
Madison, Wis.

" . . . the Dynaco PAT-4 is unsurpassed . . . a remarkable unit and unmatched at anywhere near its low price . . . "

(Stereo Review, January 1968)



DYNACO
PAT-4
\$89.95 kit
\$129.95 assembled

A separate preamplifier can offer superior performance and greater flexibility than available on any integrated control amplifier or receiver. How well did Dynaco succeed with its PAT-4? Here's what two of the most respected publications say.

The Stereophile, Vol. 2, No. 9, 1968

"With all of its tone controls and filters set to Flat, and feeding any high-level input, we were simply unable to tell whether we were listening to the original 'raw' signal or the output from the PAT-4. In this respect, we cannot see how any preamp, present or future, could surpass the PAT-4."

Julian Hirsch in Stereo Review, January, 1968

". . . (the PAT-4 has) an extraordinary degree of operating flexibility . . . (and) in sonic quality, we would unhesitatingly say that the Dynaco PAT-4 is unsurpassed by any preamplifier we have seen. It is a remarkable unit and unmatched at anywhere near its low price of \$89.95 in kit form or \$129.95 factory-wired."

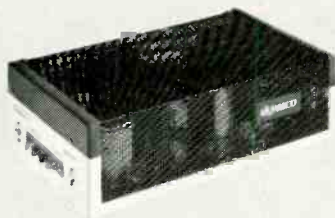

The Dynaco PAT-4 preamplifier can be used with any power amplifier, tube or transistor, like the Stereo 120 (60 watts rms per channel) or new Stereo 80 (40 watts rms per channel). Owners of Stereo 70's can also derive the full measure of enjoyment from the PAT-4.

Send for literature or pick some up at your dealer where you can see and hear Dynaco equipment

dynaco inc.

3060 JEFFERSON ST., PHILA., PA. 19121

IN EUROPE WRITE: DYNACO A/S, HUMLUM, STRUER, DENMARK

Tape Guide

If you have a problem or question on tape recording write to Mr. Herman Burstein at AUDIO, 134 North Thirteenth Street, Philadelphia, Pa. 19107.

HERMAN BURSTEIN

Tape Squeeeeeeal!

*Q. I would appreciate your advice on a perplexing and frustrating problem which has occurred in connection with my tape recorder. I have two tape decks: a * * * which I use primarily for recording and a * * * which is used almost entirely for playback of prerecorded tapes and my own tapes. Both machines are less than six months old. A month or two ago I noticed a loud squeal coming from the * * * when I played tapes which I had recorded on the * * *. This was audible not only as a mechanical noise which could be heard easily in the next room, but also through the two speaker systems of my stereo system. The music on the tape became harsh and distorted. When I cleaned the * * *'s heads, the squeal subsided for a short time, but soon came back. When I transferred the tape to the * * *, there was no squeal. Assuming that the fault lay with the * * *, I returned it to the audio dealer from whom I'd purchased it for repair. He loaned me a tape recorder of still another make to use while the * * * was being worked on. The serviceman was unable to find anything wrong with the * * *, and the squeal, needless to say did not occur while it was in the repair shop. In the meantime, it did plague me again, while playing my tapes on the third machine loaned to me. Aha, I thought! It's the tape! This argument sounds good, but has several holes. First, I am using 1 mil polyester low-noise tape made by a top company. Second, this tape is supposed to be permanently silicone lubricated. Third, why does the squeal occur only after the deck has been operating for some time? Fourth, why can't I hear it every time I play the same spot on a tape; sometimes I can play a tape through with no problem. Fifth, why is there no squeal when I play the same tape on the * * * or when I'm recording? Last,*

I can make the squeal stop by reversing the direction of play. As you can understand, this is the sort of problem which has me tearing my hair out. I would be most grateful for your help. — Stephen Sarper, Pittsburgh, Pa.

A. I do not have an explicit answer for you. I have heard, though, that certain tapes in combination with certain tape machines are apt to result in squeal. And not always; the squeal may come and go with temperature, humidity, how long the machine has been running (and therefore how much heat has been generated), how many times the tape has been used, when the heads and guides were last cleaned, etc. etc. The fact that a given tape may squeal on one machine and not on another may have to do with the tape tension system employed, the pressure pads used or not used, tape approach to the heads, location of tape guides, etc. It is difficult to get down to specific rules as to what does and what does not cause squeal. The best course is to try various kinds and brands of tape until you find the one that works best with your particular machine or machines.

Undistorted 'Rock'

Q. On occasion I have recorded a live "rock" group and have found it fairly difficult to get a clear undistorted tape. I have placed mikes among the performers and as far away as 20 feet without the hoped-for results. Does room size and sound intensity need to be taken into account? I recorded one group in a large, acoustically terrible auditorium and got better results than in a smaller ballroom, although there were unwanted echoes in the auditorium. I have used several different mikes with about the same results for all. Can the input of my tape recorder be overloaded and still allow the VU meter to read the correct level? Would volume controls between the mikes and tape recorder help the distortion, or would it merely provide different balances? Is there any way to connect directly to the performers' amplifiers, or is this undesirable? In short, is there any way to eliminate the unwanted distortion from my recordings? — Ben Miller, Barrington, Illinois.

A. My guess is that you are overloading your tape, particularly if there is a considerable amount of treble in your "rock" group attributable to female voice or instruments.

It is quite possible for a tape recorder meter, VU or otherwise, to understate the actual level of the signal reaching the tape by as much as 10 to 20 db. One reason might be miscalibration of the meter. More likely is the fact that the meter, because it is a mechanical rather than electronic device, cannot follow the rapid, high amplitude, brief sounds that we call transients. And this is even worse at high frequencies due to the large amount of treble boost supplied by the tape machine's record amplifier. I suggest that you back down on the record volume control of your tape machine, even though the VU meter is then reading considerably below 0 VU.

Of course, the possibility still remains that your tape recorder has a poorly designed first stage that overloads too readily. Finally, it is possible that you are using a poorly designed microphone that overloads too readily.

What Deck Shall I Buy?

Q. I want a tape deck for recording and playing music, and am willing to spend around \$500 if necessary. Do you have any recommendations? Despite many months of searching through equipment reports, the vast profusion of tape decks on the market today (most of which have not been tested by any of the high fidelity organizations) make a decision extremely hard.—Brian P. Cox, Philadelphia, Pa.

A. I repeat—and repeat and repeat—that the policy of AUDIO magazine strictly prohibits me from recommending specific items of audio equipment. Confusing as they may be, equipment reports are one of your very best guides to a tape recorder suitable to your requirements and purse. Although the specific model you see in a store may not have been reviewed, the chances are that similar models of the same manufacturer have been reviewed and you can be guided accordingly. Also, do not hesitate to trust the evidence of your own ears when you listen to a tape machine in a store. Æ



This is the A-6010U, top of the TEAC tape deck line. And these are just a couple of its supersonic breakthroughs: Unique **phase sensing auto reverse** operates electronically at any chosen point on the tape. Or it can take a sensing foil (if desired). But don't look for this system on anybody else's machine. Separate heads for record and playback allow **off-the-tape monitoring while recording**; most other machines in this price range can monitor the sound source only. What's the barrier to your complete sound enjoyment? Chances are, TEAC has broken that, too.

**Breaks
the sound
barrier.**

A-6010U • Exclusive symmetrical control system • Dual-speed hysteresis synchronous motor for capstan drive • 2 exclusive eddy-current outer rotor motors for reel drive • Pause control • Unique tape tension control • 4 heads, 4 solid-state amps, all-silicon transistors • Independent LINE and MIC input controls

TEAC® TEAC Corporation of America
2000 Colorado Avenue
Santa Monica, California 90404

EDITOR'S REVIEW

■ Looking through the list of loudspeaker systems in our current directory I find that they can be classified as follows: dynamic types, 162, electrostatic plus dynamic 3. If we include the two full range electrostatic units, that puts the dynamic types well out in front with over 96%. Not had for a speaker whose early demise was predicted when electrostatic units appeared a few years ago! Incidentally, the original dynamic or moving-coil speaker was invented as far back as 1878 by Siemens, and Sir Oliver Lodge patented an improved model in 1898. This one looks almost identical with present day speakers and when Rice and Kellogg looked through the specifications in 1921, they were reported as saying "the ancients have stolen our invention." And I imagine they were a mite disappointed at that.

Why is the dynamic speaker so popular? The answer is not hard to find, it is rugged, capable of a high standard of performance and it is reasonably easy to mass-produce. The availability of all kinds of plastics, resins, fiber-glass, and improved magnetic materials has allowed the speaker engineer (who has to be something of a chemist, too) to perform miracles of design not possible a few years ago.

How about the audio enthusiasts' dream of loudspeakers without diaphragms, of plates built into the walls? Well, there may be something like this in the laboratories but I am sure they will stop there for some years yet. I myself spent some time developing a MHD (Plasma) system—yes, with plates built into the walls, no diaphragms, no moving parts. It worked all right—but there were snags. First of all, it used enough energizing power to run a small factory and then it generated so much ozone that fans had to be used. There were other problems—like finding a room for the power supply—but apart from these minor irritations—it worked quite well!

"I am against the whole shebang of Romantics and Moderns, I despise Schumann, Wagner, Berlioz, Tchaikovsky, and Chopin." Who said that? None other than the irrepressible De Koven (he scorns the Mr.) who runs the Barococo Society. As the name implies, this society is mainly interested in music of the period from 1600 to 1800 which covers Bach, Mozart, Haydn, Vivaldi, Beethoven, Handel, and Schubert. Concerts are given on WNCN (104.3 MHz) FM of New York every Saturday night from 10:05 to 11:00, and Mr.—sorry, De Koven does occasionally play some music he likes from the Romantics and Moderns. So, if you get bored with the Guests on TV and their plugs for new books or Broadway shows—switch over to WNCN or other stations carrying the Barococo program—you might like it!

* * *

DX fans will be interested to know of the existence of the "World Wide TV-FM DX club. The address is Box 5001R, Harbor Station, Milwaukee, Wis. 53204.

* * *

The classical record market is declining and now accounts for less than 5% of the total compared with 20% some 10 years ago. In a very thought provoking, hard-hitting article in *Stereo Review*, James Goodfriend says that the record companies are to blame because they did not take the trouble to instill a love of music and educate the children of 15 years ago. He went on to say that this was also the responsibility of the parents and schools, but only the record companies had a commercial interest in the matter. Very true, but record sales are still skyrocketing with no sign of a recession and the industry (with some exceptions) confines its educational efforts to the support of a proliferation of semi-literate "underground" journals whose gullible readers feel are somehow Striking a Blow against the Establishment. At the same time, vast numbers of exotic high-pressure publicity experts are frantically thinking up new gimmicks, new promotional stunts to keep the cash registers ringing. The question is—are the record companies responsible for this depressing state of affairs, or does the blame really lie with the educational system?

G.W.T.

A new concept **100% MUSIC POWER[®]**

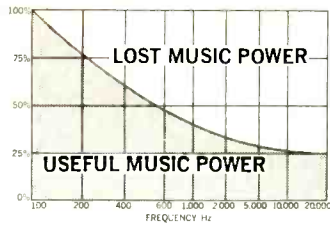

CARTRIDGE "C"
at 25% Music Power

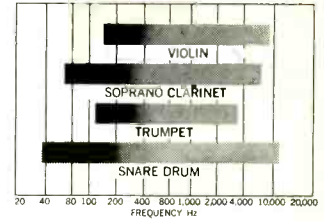

... a serious loss of definition occurs: because cartridge "C" has completely lost 75% of the Music Power at the higher frequencies.

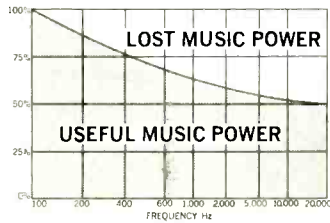

CARTRIDGE "B"
at 50% Music Power

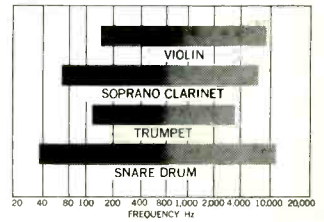

... in this case you lose definition of tone and instrument: because cartridge "B" loses as much as 50% at higher frequencies.

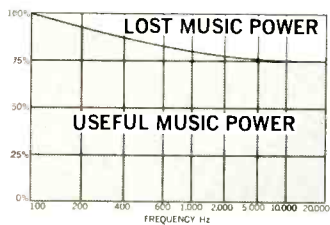

CARTRIDGE "A"
at 75% Music Power

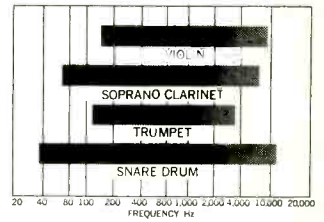

... the instruments seem a little faded in the upper frequencies: because cartridge "A" attenuates higher frequencies as much as 25%.

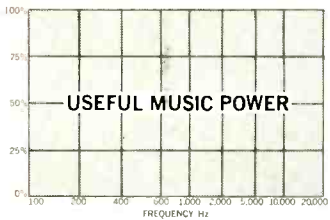

XV-15
at 100% Music Power

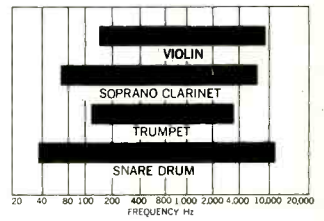

... the instruments, all of them, are distinct and clear throughout the entire fundamental frequency range.

With the Pickering XV-15 Cartridge You Get 100% Music Power — You Hear It All!

Only Pickering's XV-15 series of cartridges features 100% Music Power. With the Pickering, a harp sounds like a harp, a trumpet has the biting sound that you expect from a brass instrument, the flute has a rich romantic tone, the orchestra is the full-throated instrument the composer called for. So choose Pickering — and make the enjoyment of 100% Music Power a part of your life.

PICKERING



For those who can **HEAR** the difference

THE NEW PICKERING XV-15/750E. PREMIER MODEL OF THE XV-15 SERIES. TRACKS AT 1/2 TO 7 GRAM. DYNAMIC COUPLING FACTOR OF 750 FOR USE IN FINEST TONEARMS. \$60.00. OTHER XV-15 CARTRIDGES FROM \$29.95. PICKERING & CO., PLAINVIEW, L.I., N.Y.

Check No. 19 on Reader Service Card

SPEAKER SIZE AND PERFORMANCE

IN SMALL CABINETS

Victor Brociner

In speaker systems using closed and vented cabinets, low-frequency performance is predictable by calculation, which indicates an optimum relationship between speaker area and cabinet volume. This has been confirmed by experiment. Contrary to popular ideas on the subject, performance is not proportional to speaker size.

ASK A HI-FI ENTHUSIAST how to improve the bass performance of a speaker system of moderate size, and the chances are he will reply "Get a larger woofer." Surprisingly, when the recipient of this advice follows it, he will probably be disappointed. If he had asked a slightly more sophisticated advisor, he might have been told to use a woofer with greater compliance. In this case, he would be somewhat puzzled at not being able to hear much difference. Had he been advised to use a *smaller* speaker, there would be no need to discuss the result of the experiment because he would have concluded that the "expert" was joking, or crazy. But if he had taken the trouble to try it, and certain conditions had been met, he might have been agreeably surprised.

Is this affront to our customary worship of size supported by the facts? Fortunately, the low-frequency performance of speakers is fairly simple to calculate, so we can proceed to make a series of experiments—on paper—to explore this problem. Afterwards, it will be of interest to test our conclusions experimentally.

The Requirements

First, what do we mean by "moderate size?" Bookshelf-type speaker systems have internal volumes in the range of 0.5 to perhaps 3 cubic feet. This class of speaker is extremely popular, and warrants our primary attention.

Second, what is meant by "improving the bass response?" We assume that this comprises:

1. Extending the frequency response to a lower limit.
2. Maintaining a smooth response, without peaks and with a minimum amount of roll-off.
3. Keeping distortion within acceptable limits at reasonably high power levels.

Basic Theory

The acoustic output of a direct-radiator speaker is expressed by the formula:

$$P_A = R_A U^2$$

where P_A = acoustic power in watts
 R_A = radiation resistance in mks rays (acoustic ohms)
 U = rms volume velocity in m^3/sec

and $R_A = \frac{2\pi\rho f^2}{c}$ for low frequencies

where ρ = density of air in kg/m^3
 f = frequency in Hz
 c = velocity of sound in m/sec

Also U (volume velocity) = Av
 where A = area of the cone in m^2
 v = velocity of the cone in m/sec

Figure 1 shows that at low frequencies the radiation resistance slopes upward at the rate of 12 dB per octave. The dashed line shows

the high cone velocity at resonance, followed by a downward slope that becomes 6 dB per octave in the so-called mass-controlled region of operation. The power output, derived from these curves by the formula given above, is shown by the solid line. This is the frequency response of the speaker assuming piston action, that is, no cone break-up which is a valid assumption for the lower part of the curve at least.

The response at resonance relative to the flat section of the frequency-

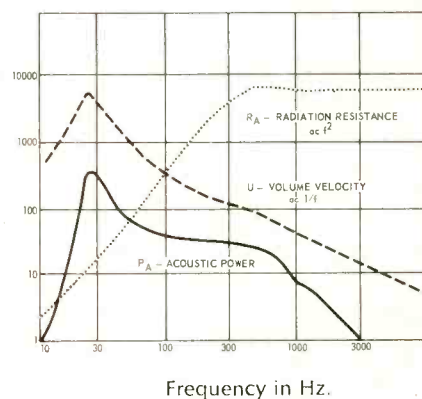

Fig. 1- Calculated performance of piston as a direct radiator.

response curve is determined by a single parameter: the Q of the speaker-amplifier combination. As in all resonant circuits, the higher the peak, the narrower it is. A family of response curves for different values of Q is shown in Fig. 2. Critical damping occurs for $Q=0.5$; for this condition, the curve has no rise above the flat portion of the curve. It is down 6 dB at resonance and drops off at 12 dB per octave below this point. For $Q=1$, there is a slight rise above resonance—about 1 dB—and response at resonance is equal to that in the flat range. As a matter of fact, the

ESP automatic tape reverse.

ESP automatic tape reverse.

ESP Automatic Tape Reverse. A special electronic sensory perception circuit indicates the absence of any recorded signal at the end of a tape and automatically reverses tape direction within ten seconds.

Non-Magnetizing Record Head. Head magnetization build-up—the most common cause of tape hiss—has been eliminated by an exclusive Sony circuit, preventing any transient surge of bias current to the record head.

ServoControl Motor. Automatically corrects for speed variations and maintains precise timing accuracy. Vari-speed feature of motor can be adjusted up or down to match musical pitch of tape playback to any piano.

Instant Tape Threading. Retractable pinch rollers permit simple one-hand threading. Other features: Four-track Stereophonic and Monophonic recording and playback. Also records in reverse direction. Three speeds. Two VU meters. Stereo headphone jack. And more.



Noise-Suppressor Switch. Special filter eliminates undesirable hiss that may exist on older prerecorded tapes.

Scrape Flutter Filter. Special precision idler mechanism located between erase and record/playback heads eliminates tape modulation distortion. This feature formerly found only on professional studio equipment.

FACTORY AUTHORIZED
NOW SAVE \$100 OR MORE
AT ANY SONY/SUPERSCOPE DEALER!

Sony Model 560D. Priced under \$349.50. **Also available:** The Sony Model 560 Tape System with stereo control center, stereo pre-amplifier and stereo amplifier, microphones, and lid-integrated full-range stereo extension speakers for less than \$449.50. For your free copy of our latest tape recorder catalog, please write to Mr. Phillips, Sony/Superscope, Inc., 8144 Vineland Avenue, Sun Valley, California 91352.

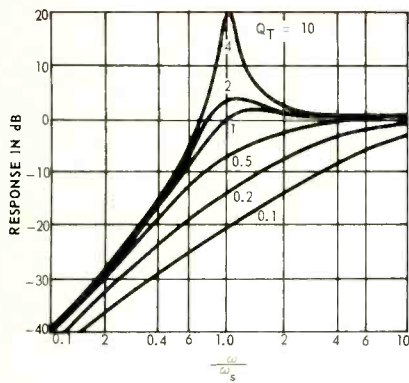

Fig. 2—Frequency-response vs. Q.

response at resonance is given by a simple expression:

$$20 \log_{10} Q$$

It is seen that for values of Q greater than one there is a peak at resonance; while for values less than one, response is down at resonance.

Closed Box

The curves apply to a speaker in a true infinite baffle, or in a closed box, radiating into a hemisphere. As is well known, placement of the speaker at a wall-floor junction or in a corner of a room tips the bass response upward.

The resonant frequency referred to above is that of the speaker-box combination and not just that of the speaker. When a speaker is mounted in a closed cabinet of moderate size, the air in the box behaves like a spring acting against the motion of the cone. The inverse of the stiffness of this air spring is the compliance of the box. It is proportional to the volume of the enclosure. The compliance of the speaker-box combination is less than that of the speaker alone, raising the resonant frequency. Figure 3 shows the direct analog circuit of a speaker mounted in a closed box. The moving mass of the speaker is represented by an inductance, while capacitances correspond to compliances. The box compliance is in series with the speaker compliance, resulting in a total compliance that is less than either of them.

$$C_{Total} = \frac{C_S C_B}{C_S + C_B}$$

Typically, C_B may be $1/8 C_S$. Then $C_{Total} = 1/9 C_S$

as

The resonant frequency $f_r = \frac{1}{2\pi\sqrt{mC}}$

where m = mass in kg

C = compliance in m/n (meters per Newton of force)

Since f_r is inversely proportional to \sqrt{C} , the result of decreasing the compliance to $1/9$ its original value is to raise the resonant frequency to three times its original value. A speaker with a free-air resonance of 20 Hz in the box used as an example would have a system resonance of 60 Hz.

When a speaker is connected to an amplifier, the Q of the combination is lower than that of the speaker alone. Typical hi-fi amplifiers have such high damping factors, or to put it another way, such low source resistances that they can be considered virtual short-circuits as far as speaker Q is concerned. Under these conditions, the amount of additional damping provided by the amplifier is almost completely determined by the voice-coil resistance. The Q of the amplifier-speaker combination is related to the speaker Q as follows:

$$Q_{Total} = Q_{Spkr} \frac{R_C}{R_R}$$

where R_C = resistance of the voice coil

R_R = resistance at the peak of the resonance curve

Suppose that the speaker taken as our example is critically damped ($Q=0.5$) when in its enclosure. Its frequency response is shown as curve 1 in Fig. 4. How can better bass be obtained? Obviously, by increasing the size of the enclosure. But we

have ruled this out. The problem is what to do about the speaker, not the box. The effect of the stiffness of the box can of course be reduced by making the speaker stiffness greater. It might be made equal to that of the box, that is, eight times as great as before. Then the box will only halve the original compliance, and the frequency of resonance will only increase by a factor of $\sqrt{2}$ instead of 9, as before. The trouble is that when the speaker stiffness is increased by a factor of 8, its free-air resonance is increased by $\sqrt{8}$, to 56 Hz. The box now raises this by only $\sqrt{2}$, to 78 Hz, resulting in Curve 2; obviously we are worse off than before. We might have known that nothing can be gained by increasing stiffness. But we can learn something interesting if we look at it in reverse: decreasing speaker stiffness gains very little as long as the box stiffness is the controlling factor and the mass of the speaker's moving system is not increased. "Low-resonance" woofers with light moving systems do not provide good bass response.

We might try to increase the stiffness by a smaller factor, say 4, and increase the moving mass by 4 (without changing the voice-coil driving system) so as to retain the original 20-Hz free-air resonance. Now the box increases the total stiffness by a factor of only 3, the ratio of system to speaker resonance is only $\sqrt{3}$, and the net resonant frequency becomes $20 \times \sqrt{3} = 35$ Hz. This looks good. What has it cost? The mid-frequency of a speaker is inversely proportional to the square of its moving mass. This has been multiplied by 4, so the efficiency is lowered by 12 dB. See Curve 3 of Fig. 4. Note that the

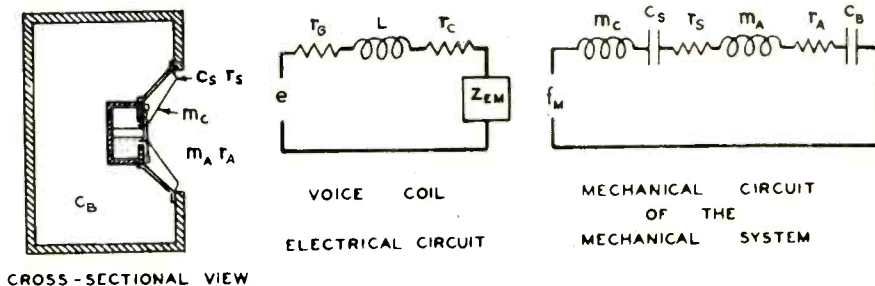

Fig. 3—Analog circuit of speaker mounted in a closed box.

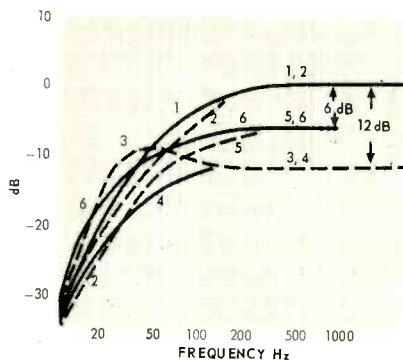

Fig. 4—Calculated frequency response of speakers of different parameters mounted in a closed box.

curve shape is different. Something has happened to the Q .

$$Q = \frac{2\pi f_r m}{R_M}$$

where f_r = resonant frequency
 m = moving mass
 R_M = total resistance

The mass m has been multiplied by 4, f_r has been divided by 60/35, so the new $Q = 4 \times 35 / 60 \times 0.5$ or about 1.2. The Q could be reduced to 0.5 by increasing the damping mechanically, acoustically, or electrically. Both damping and efficiency could be improved by using greater flux density; this is a fairly expensive expedient.

What else could be done? A more detailed examination of the box compliance is in order. If it is assumed that the box can be represented by a pure compliance, which is reasonably true at low frequencies for enclosures that are not disproportionately long or narrow,

$$C_A = \frac{V}{\rho c^2}$$

where V = volume of the box in m^3
 ρ = air density in kg/m^3
 c = velocity of sound in m/sec

This assumes that the box contains comparatively little sound absorbing material. The correct amount of appropriate material can increase the box compliance by a factor of 1.4. Dimensionally, C_A is in units of d^2/F where d =distance and F =force. We are used to stating compliance in terms of d/F or distance per unit force. Let this mechanical compliance be C_M .

$$\text{Then } C_A = d^2 \frac{d}{F} = d^2 C_M$$

Since d^2 represents an area squared we can write

$$C_A \text{ (acoustical compliance)} = A^2 C_M$$

where A =area

But what area? Well, what we want to know is the effect of the box on the speaker. So the area must be that of the speaker. Hence,

$$C_M \text{ (mechanical compliance)} = \frac{C_A}{A_s^2}$$

Intuitively, the result is obvious. If we apply the same hand pressure, first to a small piston and then to a large one when both are mounted in boxes of equal size; the box will feel much stiffer (less compliant) with the large piston than with the small one.

The compliances used in the analog circuit of Fig. 3 are mechanical compliances. Consequently we can make the box compliance look greater by reducing its area. Going back to the original example in which the box compliance was $1/8$ that of the speaker, suppose that the speaker diameter is reduced by a factor of 0.707 and all other parameters kept the same (including the mass). The new area is one-half that of the original speaker. The mechanical compliance (of the box) seen by the speaker is multiplied by the square of the compliance ratio (new to old) or 4. Instead of $1/8$, the box compliance is now $1/2$ that of the speaker, and the new system resonance is $20\sqrt{3}$ or 35 Hz.

What has been lost this time? Reducing the cone area by $1/2$ cuts the radiation resistance to $1/4$ of its former value. The efficiency is decreased by 6 dB. The frequency response is shown by Curve 5. The Q is reduced to about 0.3 and the frequency response is more nearly flat than that of the original speaker. Decreasing the damping to restore Q to 0.5 would result in Curve 6. The power handling capability of a speaker is proportional to the square of the area, so this has been reduced to $1/4$ the original value, assuming the permissible voice-coil excursion is as great as before.

The speaker designer can juggle many parameters to obtain the de-

sired compromise among frequency response, curve shape, efficiency, power handling capacity, and cost. The speaker purchaser cannot easily specify or even determine some of these factors. Most moderately-priced woofers of the "high-compliance" type are likely to be underdamped, so there is not too great a probability that system Q 's will be appreciably less than 0.5. If the box size is fixed, frequently the bass response can be most easily improved by using a smaller speaker, provided one is willing to sacrifice some power-handling capacity.

Vented Box

The vented, ported, or ducted box, or bass reflex cabinet is also capable of analysis in terms of analog circuits and families of curves. For a box tuned to the speaker free-air resonance, the equation is

$$\text{SPL} = 80 \log_{10} g - 10 \log_{10}$$

$$\left\{ \left[g^4 - \left(\frac{C_s}{C_b} + 2 \right) g^2 + 1 \right]^2 + \frac{g^2}{Q_s^2} [1 - g^2]^2 \right\}$$

where: C_b = compliance of box
 C_s = compliance of speaker
 $g = f/f_r$
 f_r = free-air resonant frequency of the speaker.
 Q_s = Q of the speaker in free air, connected to the amplifier.

It is now no longer possible to draw one family of response curves because there are two parameters—the speaker Q and the ratio C_s/C_b . Typical response curves have been published by James F. Novak of Jensen¹ and are reproduced here, slightly modified, in Figs. 5, 6, and 7.

These curves appear quite complicated to interpret, but a study of them reveals that some interesting generalizations can be made. The first is fairly obvious: for small cabinets—where the speaker compliance is several times the cabinet compliance, the speaker circuit Q must be between 0.3 and 0.4 for smooth response without peaks. Higher values can result in violent peaks, as in the case of the closed box. For boxes of moderate to

(Continued on page 69)

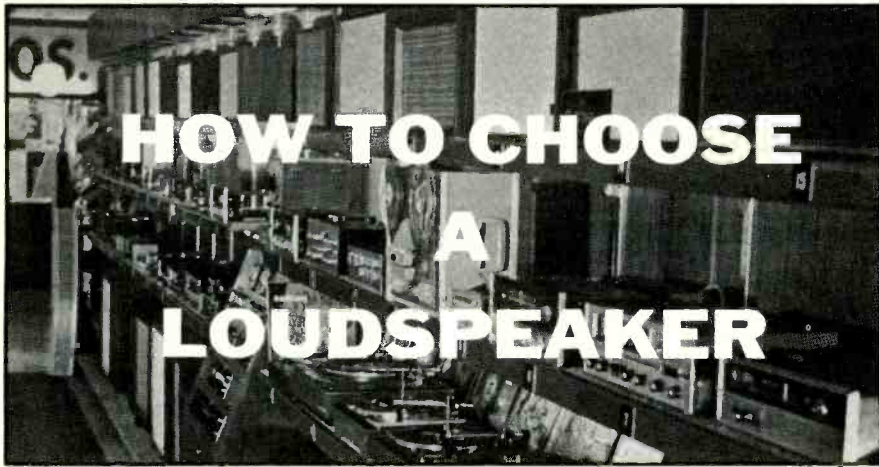

HOW TO CHOOSE A LOUDSPEAKER

Choosing a loudspeaker is easily the most difficult task in assembling a Hi-Fi system because so many subjective things are involved. The problem is complicated by the fact that the listening room-acoustically-forms part of the loudspeaker system, so ideally, loudspeakers should be evaluated in that room. True, Audio Shows can give *some* indication of performance but all too often demonstrators play gimmicky music at high volume levels and so a realistic judgment is very difficult. At some European Shows—notably the British and French, special demonstration records were given out so listeners would have some basis for comparison. However, this idea did not work out too well because by the time you had fought your way through milling crowds from room A to room B down the corridor—you had forgotten what the music really sounded like!

First of all, then—determine whether you want large or small floor standing systems or bookshelf types: this will mainly be a matter of space and cost—but do not forget that some of the bigger bookshelf models like the AR-3A, Fisher XP-9 and JBL “Aquarius” can set you back more than \$200 each! Having narrowed the choice down that far (and read the reviews) try and hear a selection at a local dealer. This is a lot easier than it was a few years ago when you had to listen on the shop floor out among the washing machines and refrigerators! Nowadays, most dealers boast a demonstration room of some kind and the specialist Hi-Fi dealers have very elaborate facilities with multi-switching arrangements for all imaginable permutation of speakers,

receivers and pick-ups. Now the big question is—what kind of music should be played and what to listen for? At one time all the pundits said—piano, of course, nothing like it! But, unless you are an expert who can tell the difference between a Steinway and a Bluthner—not a piano. Make your first A-B comparison with male speech, preferably from a local FM station. Switch from one system to another and listen for boxiness, that “chesty” sound or a hangover effect that would indicate coloration or resonances of some kind. In some very bad systems (fortunately not so common these days) the poor unfortunate speaker sounds as if he is in a cave or at the bottom of a barrel! One (and only one) of the causes of such coloration is vibration of the enclosure itself: this is why good ones are very solid in construction. If you can persuade the now anxious salesman to put on a record or tape of a soprano like Joan Sutherland, Renato Tabaldi, or Maria Callas, so much the better. Those top notes really show up bad loudspeakers with peaky treble-systems which would make a very impressive noise with jazz for instance. (A very good test of a phone cartridge too—but I am assuming that the dealer is using a good one!) Next, listen to some symphonic music, strings should be smooth with a silky sheen and not strident and wiry. Bass line should be smooth but well-defined, and not *too* prominent. You are not conscious of bass (or treble, for that matter) in a concert hall and if you are continually aware of the low frequencies in a loudspeaker, something must be wrong somewhere. Brass should have bite and the instru-

ments should sound clear and forward without tizz and distortion. Percussive sounds should be sharp and well defined. Most important, the high frequencies should not be too directional otherwise stereo will be too restricted. The stereo image ought to be central, without that “hole-in-the-middle effect. At this point, the best test is the use of “white noise.” What is white noise? Technically, it can be defined as a “random noise” covering all audible frequencies without any particular emphasis. It has been colorfully described as a gentle hiss, like that made by steam coming from water dropped on a hot brick or tire noise from a smooth, wet, road. It is a most useful tool for loudspeaker engineers who have available special noise generators with all kinds of refinement controllable outputs etc. However, the next best thing is interstation noise from a FM tuner—but make sure that the mute switch is off! Use one channel only for this test and turn the volume control up. Now the noise should be a smooth hiss that should not change very much as you move your head away from the axis or beam of the tweeter. Watch for sudden changes in sound quality which would indicate uneven dispersion. A loudspeaker with peaks in the 2 to 4kHz (upper mid-range) region will have a spurious brilliance that can be quite impressive and exciting with some kinds of music but will rapidly become very tiring. Such systems tend to emphasize tape hiss and record scratch and, as might be expected, they sound harsh and strident with a white noise signal. How about actual dips in the response? They will cause a hollow, pipe like effects which are quite easily recognized—especially if there is a first class loudspeaker available for comparison. Low frequency coloration can be detected too, and resonances will be heard as a rumbling or roaring sound. Finally, if your loudspeaker or loudspeakers have survived these quick tests (and your wife likes, or will accept the cabinets)! try a pair in stereo again, but *this* time find some music your wife likes and ask her to listen. The rest is easy.

G.W.T.



The Outperformer that fulfills the impossible dream

Here's the brilliant realization of sound, beyond your fondest dream. The new Pioneer SX-990 solid state AM-FM multiplex stereo receiver was designed with you in mind. Thoroughly flexible, you can plan a complete stereo system around it. Rated according to the Institute of High Fidelity standards (as all Pioneer units are), it contains top quality circuitry plus many refinements

found only in much more expensive units. Versatile, it offers: 2 phono, tape monitor, microphone, auxiliary and main amplifier inputs. Outputs for two pairs of speakers make it ideal as a power source for any fine stereo system. Elegantly styled in an oiled walnut cabinet, it's the perfect complement to the most discriminating decor. Hear it at your local Pioneer dealer. Only \$299.95

 **PIONEER**®

PIONEER ELECTRONICS U.S.A. CORPORATION, 140 Smith Street, Farmingdale, N. Y. 11735 • (516) 694-7720

West Coast: 1335 West 134th Street, Gardena, Calif. 90247 / (213) 323-2374 & 321-1076 • In Canada: S. H. Parker Co., Ontario

AUDIO • MARCH 1970

Check No. 25 on Reader Service Card



How to Add a WOOFER to a Electrostatic Speaker

Nate Garfinkle

MANY ARTICLES DESCRIBING how to add an electrostatic tweeter to a woofer have appeared in the literature but I wanted to reverse the procedure and add a woofer to an electrostatic speaker. The reason is simple: I have a pair of Quad full-range electrostatic units which have superb transient response and clarity but I wanted to extend the low end to get those elusive lower-register notes of the Organ, Cello, Double Bass and Drums. I have heard the KLH-9's and Acoustechs but still did not *feel* those very low notes as experienced at live organ recitals and concerts, especially in such items as Verdi's "Requiem," Messiaen's "Nativite du Seigneur" (where the 27.5-Hz pedal tone is sustained for twenty-five seconds), and the opening of "Also Sprach Zarathustra" with its sustained 32-Hz pedal.

In the early days of Hi-Fi (?), a Bass Coupler was developed and tried: it produced a great amplitude of bass but was resonant, boomy, and colored in sound. Another type of enclosure investigated was the *Paraline* which is a type of labyrinth or pipe system popular in England. It requires very careful design and internal damping but does not go low enough in frequency for my test. Joseph Marshall wrote about "Super Woofers" in the May 1963 issue of *Popular Electronics*, and offered some fine suggestions. He stated that speaker manufacturers have done a remarkable job in designing compact stereo speaker systems which stand up well to the larger bass-reflex, infinite-baffle, and even horn-loaded systems, but all too often fall short at the low end.

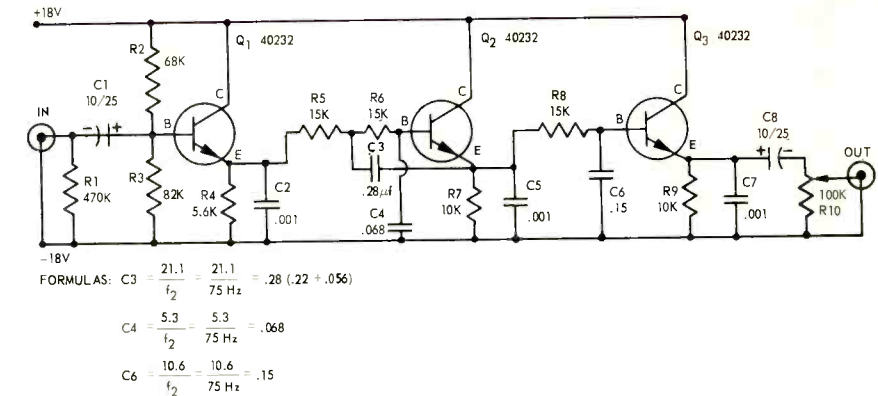

Fig. 1—Schematic of crossover and formulas used to determine values.

They cannot compare with the big speakers when it comes to reproducing the bass from real "live" drums, double basses and organ pedals. The drums do not sound as big or as "low down," the double basses do not roar, and the organ pedal tones rattle rather than rumble—the awesomeness is just not there! (*This is a 1963 judgment and compact systems have improved since then: however, big speakers are still better than small ones—certainly as far as that bottom end is concerned. As a matter of interest, the Quad units fall off below about 70Hz and in any case are not recommended for extremely high power levels or in very large rooms—Ed.*)

If all a system lacks is a good solid bass response, it can be improved by adding a bass speaker to cover the bottom two octaves. Sounds easy, but I have never heard it done without some resonances, doubling or coloration of one sort or another. Moreover,

conventional crossover networks add resistance to the amplifier degrading the damping factor or "brakes" on the speaker cone. Some time ago Paul Weathers came up with an idea which promised to overcome these defects. He mounted a 12-in. speaker in a small, folded coupler box and loaded the cone with fibrous material which added mass and reduced the resonant frequency. He used an electronic crossover ahead of the main amplifier to combine the low frequencies of both channels and feed them through the amplifier to the woofer. The crossover frequency was about 75 Hz and the system worked quite well but is not marketed any more. However, using some of Paul's ideas led us to look for a bass enclosure small enough to use in an average room in addition to the normal stereo speakers (Quads in my case). The electronic crossover should be designed to roll off at 18 dB per octave and here *AUDIO* maga-

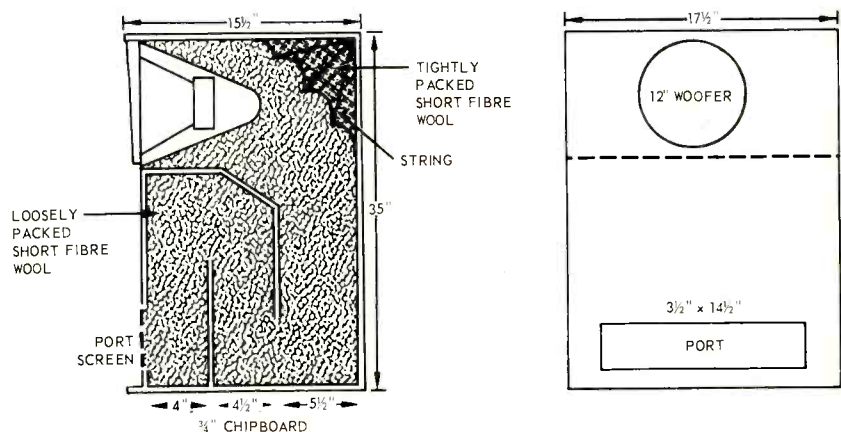

Fig. 2—Details of woofer enclosure.

zine solved the problem with the solid-state circuit published in the July 1968 issue. All formulas were given and I used a cut-off of 75 Hz, like the Weathers system. Figure 1 shows the circuit and formulas.

Next, I looked back at a "Non-Resonant" enclosure described in the October 1965 issue of the *British Wireless World*. This was developed, after much research, by Dr. Arthur Bailey for Radford, who hold the patents. A similar enclosure with a tapered line has been developed by IMF here and is being made in England. This was demonstrated at the recent Audio Fair in London and was apparently very impressive. Dr. Bailey's experiments showed that an acoustic line filled loosely with pure long-fibered wool to be practically non-resonant and could produce 84 dB at 22 Hz in a 20-by-40-foot room. Cone movement is restricted thus minimizing intermodulation and Doppler effects. Here, I thought, is something that should meet my requirements and so I got to work.

Figure 2 shows the suggested dimensions. A low-resonant woofer works best here. Dr. Bailey used a KEF rectangular woofer, model B139. As this was not readily available here, I used a Jensen W12 LF, a 12-in. unit with a free-air resonance of 20 Hz. This was tried with a derived signal from two amplifiers and it worked very well. Next, in a burst of enthusiasm, I bought another speaker and built a second enclosure so I now had two Super Woofers in full Super Stereo, flanking the two Quad speakers (I also added another 303 Quad amplifier). This produced bass closer to "live" than I have heard from any system. On a recent 4-channel demonstration here put on by two local FM stations, I added two ADC 404 speakers for the rear channels. This brought us right into the Symphony Hall: the bass from Berlioz "Requiem" and some of the electronic music was so real and *felt*—it was startling!

The system was set up using a Vega condenser microphone and a test record with the results shown in Fig. 3. The room is 15 by 24 feet with a cement floor, rugs, and normal furnishings. Level control for the woofers is mounted next to the preamps so adjustments can be made to suit special

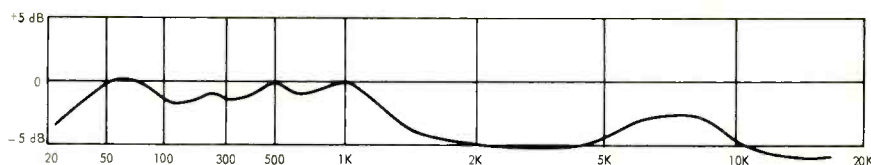

Fig. 3—Frequency-response curves from warble-tone source measured at 12 feet from the woofer enclosure.

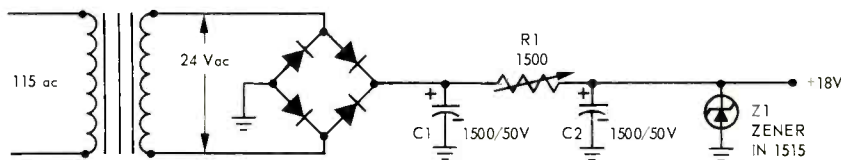

Fig. 4—Schematic of power supply.

music or compensate for program deficiencies and so on. As for power—there is plenty to spare—even for the young crowd! The power supply circuit is shown in Fig. 4.

All parts are readily available: wool can be obtained from Wool Grower's Associations at approximately \$3.50 per lb. It takes one pound to fill 2.3

cubic feet and you will need 3 lbs. for the enclosures described.

Incidentally, this article was published in a much less detailed version in the *British Hi-Fi News* but so many letters were received from American readers asking for further information that I prevailed on *AUDIO* to publish this piece. *AE*

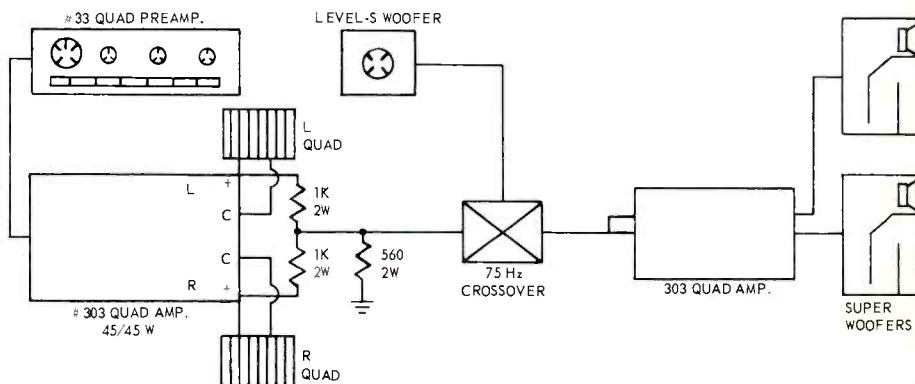

Fig. 5—Finalized system. Note that common-bass arrangement is used.

Crossover

Transistors	Q1,2,3
R10	100k linear
C1,8	10/25v miniature
C2,5,7	.001
C3	{ 0.22
	{ .056
C4	.068
C6	0.15

Power Supply

T1	transformer, 24v
D1,2,3,4	diodes
Z1	Zener diode, 18v
C1,2	1500 μ f, 50v
R1	1500 w.w

PARTS LIST

RCA 40232	
Mallory U39	
Sprague	192P10292
Sprague	192P22492
Sprague	192P56392
Sprague	192P68392
Sprague	192P15492
UTC, FT-10	
IN537	
IN1515	
Sprague	TUL 1341
Mallory	VW 1P5K

SONY CITY[®]

(where leading high fidelity dealers offer the finest stereo receiver values)

Stop in at your Sony high fidelity component dealer. Audition any of these magnificent stereo receivers.

At \$699.50, the Sony STR-6120 FM Stereo/FM Receiver. "The set logged no less than 55 stations...43 were deemed suitable for long-term listening or off-the-air taping (the others were mostly stations that many lower-quality sets don't even hint at receiving)." That's what High Fidelity said about the 6120.

At \$399.50, the Sony STR-6060 FM Stereo/FM-AM Receiver. Try the famous Sony FM station countdown test. Tune along the dial and hear the stations pop in one after the other, sharp and clear. Audio Magazine said: "Such excellent receiver performance at \$400 list price is not so very common these days."

At \$279.50, Sony STR-6050 FM Stereo/FM-AM Receiver. Hirsch-Houck Laboratories tells it all in the May, 1969 issue of STEREO REVIEW: "When we received the Sony STR-6050 Stereo receiver for testing, we did not know its price. We listened to it and estimated its price from its general performance. Our guess was about \$120 higher than its actual price."

At \$199.50, the Sony STR-6040 FM Stereo/FM-AM Receiver. First receiver to break the \$200 price barrier without putting the slightest dent in quality. Eliminates the unessentials. Just delivers pure superior performance. In your city, visit Sony City. It's at your local stereo component dealer.

Sony Corporation of America, 47-47 Van Dam St., Long Island City, N.Y. 11101.

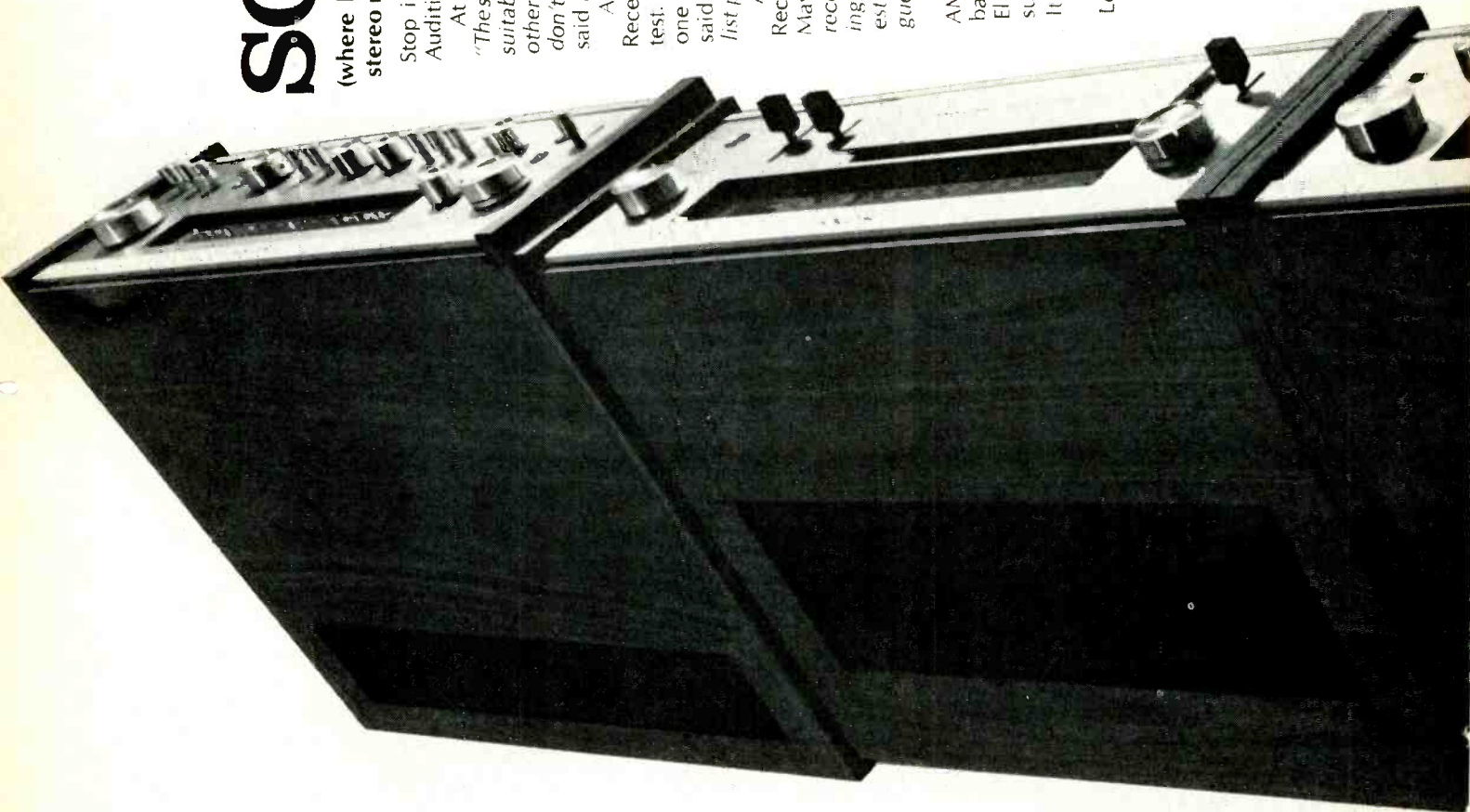

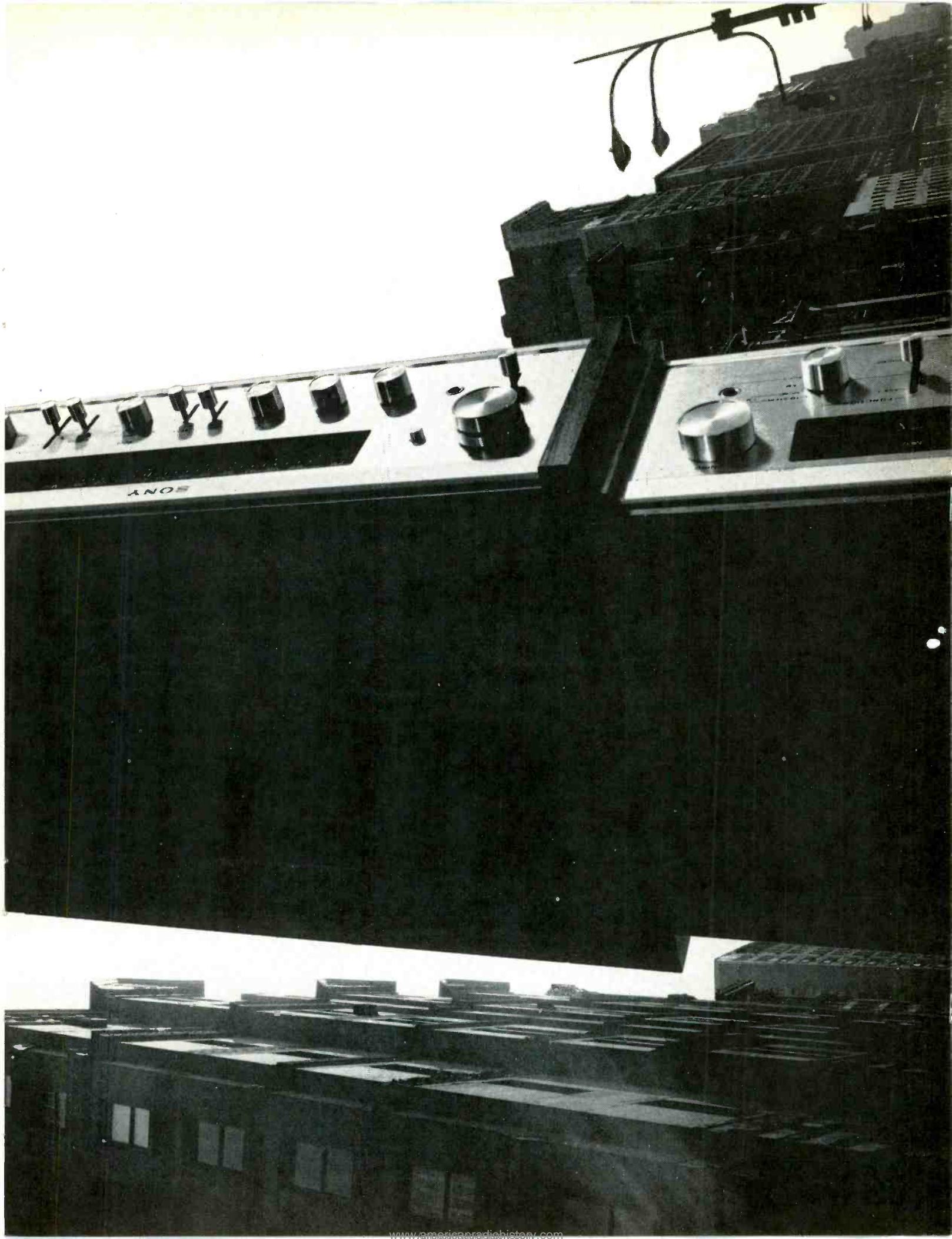

SONY

THAT DAMPING FACTOR

Paul W. Klipsch

THE TERM "DAMPING FACTOR" (DF) is supposed to mean some sort of relation between the internal impedance of an amplifier and the impedance of the nominal load. If we use this as a definition, and then define "nominal load" as what ideally would be connected, then an amplifier with 0.8 ohms internal impedance with an 8-ohm load rating would have a "damping factor" of $DF=8 \div 0.8=10$. If the actual connected load were 16 or 32 ohms, the so-called damping factor would be 20 or 40.

There is a fallacy in this concept. The actual load on an amplifier, the loudspeaker, consists of the ohmic or d.c. resistance of the voice coil plus some "impedance," part of which is "motional," that is, due to motion of the coil in its magnetic field. The true damping effect is the absorption of unwanted motion or overshoot by the resistance in the circuit which includes acoustic damping and the d.c. resistance of the voice coil. Typically an 8-ohm loudspeaker might have 6 ohms resistance. The minimum impedance of an amplifier might approach zero, (except for special feedback systems which have fallen into disrepute due to instability and other objectionable manifestations. When the impedance becomes less than zero by positive feedback, one has a potential oscillator) but the 6 ohms in the voice coil is still there. Thus the true damping factor of the amplifier could hardly exceed $8 \div 6 = 1.33$ even if the DF of the amplifier were "infinite" (internal impedance equal to zero).

Practically, many loudspeakers are tested on a "constant-voltage basis" and to achieve performance equal to the tests would call for an amplifier to have a flat response relative to a reasonable range of load impedances,

that is to say the amplifier would desirably have a low internal impedance. Most amplifiers worthy of connecting to good loudspeakers exhibit an internal impedance of a fraction of one ohm.

We ran a response curve on one of our horn-loaded loudspeakers using a McIntosh MC 30 (a tube amplifier which has been discontinued) and another curve using a one-of-a-kind solid-state amplifier of very low internal impedance. The curves differed by less than one decibel over the 20-20,000 Hz range.

Generally speaking we like the new solid-state amplifiers with their low internal impedance because they exhibit low distortion and are "constant-voltage sources"—that is, with a constant-voltage input we get a constant-voltage output even with wide variations of load impedance which all speakers exhibit. But as far as "damping" is concerned, this should be a function of the "speaker, not the amplifier. We are proponents of horn loading as this makes the "damping" take the form of useful output (sound), the efficiency is high and the speaker distortion low. But as far as the amplifier contributing to the damping, this is apt to be a delusion. If the speaker resistance is 6 ohms, what matters if the amplifier impedance is 0.6 or 0.06 or 0.006 ohms? The resistance in the circuit to produce electrical damping is still 6 ohms, plus whatever tiny bit the amplifier puts in series with the 6 ohms.

So forget "damping factor" as such. Get any good amplifier that exhibits low amplifier distortion (harmonic and modulation) and has a low internal impedance—anything under 0.2 ohms should offer substantially a "constant-voltage source"—and if you have to

find this internal impedance by using the maker's "damping factor," just remember that any number over about 20 would be good and anything over 100 is sales propaganda except inasmuch as the feedback to produce low internal impedance may contribute to reduced distortion. After all, low distortion should be the criterion, not "damping factor."

I hope I haven't stepped on any amplifier maker's toes. Among amplifiers we have used are McIntosh and Marantz, both tube and solid-state.

Finally, recall the words of the sage, J. Figby Blotz, who wrote, "The aural differences between \$200 and \$500 amplifiers is almost negligible; the comparison between speakers exhibiting the same price ratio is startling."

Additional and Remotely Related Notes

We have run sound-pressure frequency-response curves on several loudspeakers driven by different amplifiers with speakers connected to different nominal-impedance taps. The response curves differed by less than 1/2 dB over the 20-20,000 Hz range. The Marantz Model 9 was fed to a KLIPSCHORN and curves run using 1-ohm and 16-ohm taps, adjusting input to produce 4 volts at 1000 Hz. The two curves superpose "exactly" or well within the resolution of our X-Y recorder.

Another curve was run using a low-internal-impedance solid-state amplifier which curve compares within 1/2 dB of the curves run using the Marantz Model 9.

It was said "Forget damping factor as such." However this number may be used to compute the internal impedance of the amplifier.

(Continued on page 75)

Products and guarantees:

AR's viewpoint.

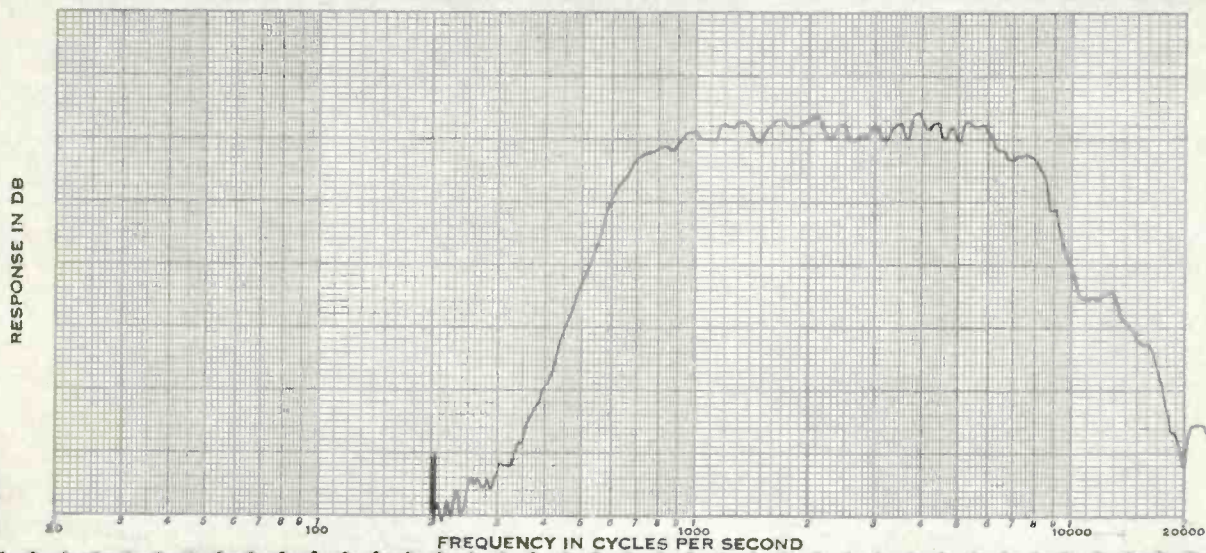

On-axis frequency response of the mid-range unit in the AR-5

The goal of high-fidelity reproduction is the truthful, accurate reproduction of the broadcast or recording chosen by the listener. Writers and reviewers may speculate about their preferences in equipment appearance, cabinet size or eccentricity of design, but accuracy is a measurable, objective quantity. It is the quality for which the consumer pays when he buys high-fidelity equipment. Degradation of this quality is as offensive in the cartridge as in the tuner, as unacceptable in a speaker system as in an amplifier, for the end result as heard by the music listener is the same.

Acoustic Research publishes comprehensive performance data for every one of its products. The data given is measured in accordance with standards established by recognized government and technical organizations. The specifications for the AR receiver, for example, include 29 curves, carefully plotted on graphs which allow the interested reader to compare the performance we state to that actually measured on typical receivers. Claims are the language of advertising; data is the substance of science.

The accuracy and validity of the data published by AR and its reliability, even after the products have been used, is assured by a guarantee which to our knowledge is without precedent or counterpart in the audio field:

The workmanship and performance in normal use of AR products are guaranteed from the date of purchase: 5 years for speaker systems, 3 years for turntables, 2 years for electronics. These guarantees cover parts, repair labor, and freight costs to and from the factory or nearest authorized service station. New packaging if needed is also free.

The AR catalog and complete technical data on any AR product are available free upon request.



Acoustic Research, Inc.

24 Thorndike Street, Cambridge, Massachusetts 02141

AUDIO's 1970 Speaker System Buying Guide



ADC 303AX



Altec 846A "Valencia"

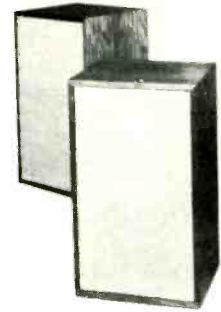

Air-Coustic PC-12

MANUFACTURER (Circled numbers indicate adv. page)	Model	WOOFER			MID-RANGE			TWEETER		Overall Freq. Response, Hz to kHz ± 2 dB	Ampl. Pwr. for Avg. Room, W	Pwr. Handling Capacity (RMS Cont)	Crossover Frequency (fcs), Hz	Impedance, Ohms	Enclosure Dimensions, W x D x H, in.	Wood Finish	Grille Material & Color	Weight, Lbs.	Price	SPECIAL FEATURES
		Diameter, In.	Resonance (in System), Hz	Enclosure Type	Diameter, In.	Type	Diameter, In.	Type												
ACOUSTIC RESEARCH 31	AR-3a	12	43	Acous.	1½	Dome	¾	Dome	*	25	**	575 5,000	4	25 x 11½ x 14	Wal. Chry. teak, mah, birch, unf.	Cloth, Beige	53	250.00	*Complete frequency response and distortion data available from AR on request. **Depends on various factors; available on request.	
	AR-5	10	55	Acous.	1½	Dome	¾	Dome	*	20	**	625 5,000	8	24 x 13½ x 11½	Wal. Chry. teak, mah, birch, unf.	Cloth, Beige	39	175.00		
	AR-2a ^x	10	55	Acous.	3½	Cone	¾	Dome	*	20	**	2,000 7,000	8	24 x 13½ x 11½	Wal. Chry. teak, mah, birch, unf.	Cloth, Beige	36½	128.00		
	AR-2 ^x	10	56	Acous.	2½	Cone	-	-	*	20	**	1,200	8	24 x 11½ x 13½	Oil Wal. and 6 others	Burlap, Beige	33	102.00		
	AR-4 ^x	8	65	Acous.	-	-	2½	Cone	*	15	**	1,200	8	19 x 10 x 9	Wal. unf.	Cloth, Beige	18½	57.00		
ADVENT	Loudspeaker	10	43	Acous.	-	-	1½	Dome	30-20K ± 4	15	100	1,000	8	25½ x 11½ x 14½	Oil Wal.	Cloth, Light	44	112.00	Three-position, high-frequency level control.	
AIR-COUSTIC	PC-12	12	40	PC*	5 x 7	Cone	1	Dome	30-15K ± 4	20	35	400 5,000	4	15½ x 13½ x 27	Wal.	Brown	51	239.00	*12-inch woofer is pneumatically coupled to a 12 x 17 Bass diaphragm.	
	PC-8	8	51	PC*	-	-	4	Cone	40-15K ± 5	10	20	500	4	11 x 9 x 19	Wal.	Brown	20	119.00	*8-inch woofer is pneumatically coupled to an 11 x 9 bass diaphragm.	
ALLIED	2385	15	-	Reflex	-	Compr. Horn	-	Dome	20-aud.	10	50	1,000 8,000	8	20½ x 14 x 30½	Wal.	Cloth Olive	70	149.95	VHF tweeter; 2 level contrs.; tuned ducted port; with floor base.	
	2370	12	-	Acous.	-	Compr. Horn	-	Compr. Horn	20-aud.	15	35	1,000 5,000	8	25 x 13 x 14	Wal.	Cloth Brown	50	129.95	2 level contrs. Kit - \$99.95.	
	2300C	12	-	Acous.	-	Compr. Horn	-	Compr. Horn	20-aud.	15	30	1,000 10K	8	25 x 13½ x 14	Wal.	Cloth Beige	49	99.95	2 level contrs.; Kit - \$74.95.	
	3030B	12	-	Reflex	6	Horn	3½	Cone	35-17k	10	30	400 5,000	8	24 x 9 x 14½	Wal.	Cane	28	64.95	Fiberglass insulated; Kit - \$44.95	
ALTEC LANSING	846A	15	25	Reflex	-	-	18" sectional Horn	Compr. Driver	35-20,000	15	50	800	8/16	27½ x 19 x 29½	Wal.	Fretwork, Brown	100	339.00	A7 "Voice-of-the-Theatre" Components.	
	847A	12	30	Reflex	-	-	4.3" Horn	Compr. Driver	40-20,000	15	35	3,000	8	26 x 19 x 14	Wal.	Fretwork, brown	60	249.00	Attractive design with multicell horn tweeter.	
	890C	10	28	Inf.	-	-	7" Horn	Compr. Driver	35-20,000	25	50	2,000	8	29½ x 12¼ x 14½	Wal.	Fretwork, brown	52	179.00	Contemporary styled grille fretwork. 10" free-suspension phase inverter.	
	893A	10	-	Inf.	-	-	3	Direct Rad.	50-18,000	25	40	2,500	8	22 x 9½ x 12¼	Wal.	Cloth, neutral	22	85.50		
AMPEX	715	(2) 6	68	Air Susp.	-	-	3½	Wide Dis- persion Air damped	50- 20,000 Hz ± 3	6	40 80**	1,400	8	19 x 13 x 9¼	Wal.	Dark brown	45	129.95 pr.	*Typical response. Mutually coupled woofers. Cup-chamber tweeter. **Rec. max. ampl. pwr/chan.	
	516	6 x 9 Duo Cone	-	Dist. Port.	-	-	-	-	130- 15,000 Hz ± 6	2	12 30**	-	8	9 x 14½ x 7¼	Wal.	Dark brown	22	59.95 pr.	High efficiency design. **Rec. max ampl. pwr/chan.	
	414	4½	140	Air Susp.	-	-	-	-	90- 15,000 Hz ± 6	5	20 40**	-	8	6 x 6 x 6	Wal.	Dark brown	6	49.95 pr.	*Response with 10-lb boost at 90 Hz. Special high comp. annulus. **Rec. max. ampl. pwr/chan.	
ADC	450	12	42	Acous.	1½	Dome	¾	Dome	18-22K ± 3	-	-	-	8	14½ x 12½ x 25	Oil Wal.	Cloth dark	50	225.00	Sep. mid. and tweeter level contrs., interchangeable grille.	
	410	12	47	Acous.	-	-	1½	Dome	22-20K ± 3	-	-	-	8	14½ x 12½ x 25	Oil Wal.	Cloth dark	39	130.00	Sep. mid. and tweeter level contrs., interchangeable grille.	
	303AX	10	50	Acous.	-	-	1½	Dome	30-20K ± 3	-	-	-	8	23¼ x 13 x 11	Oil Wal.	Cloth dark	37	100.00	Sep. mid. and tweeter level contrs., interchangeable grille.	
	404	6	70	Acous.	-	-	1½	Dome	45-20K ± 3	-	-	-	8	11" x 7¼ x 8¼	Oil Wal.	Cloth Beige	22*	55.00 pr.	*Twin pack.	

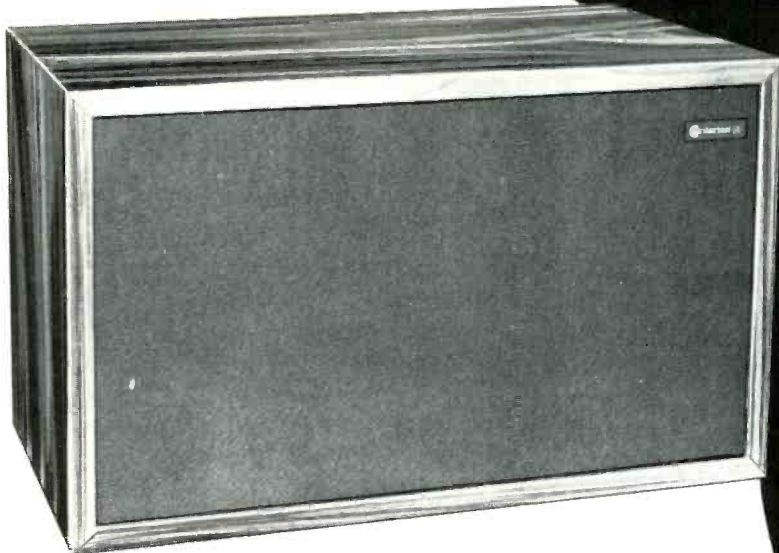

**For Those Who Seek
Sheer Listening Pleasure!**

Here is the bookshelf speaker system that we think will really "turn you on" to a new dimension in audio pleasure without the expense of a more costly speaker system.

Admittedly, the Criterion "VI" isn't the biggest size (24 W x 14½ H x 12" D), nor the most expensive system available today. Yet, we know, whether your listening pleasure is a summer pop musical festival, classical concert, or, the new mod-compositions filled with all sorts of "electronic thingies," that you'll discover and enjoy a renewed experience in more natural sound without boom or shrill.

Perhaps, just as important is the resplendent beauty of its hand-rubbed, oiled walnut wood finish and subdued dark brown tweed grill.

Lafayette has been in this business 49 years and we know a good speaker when we hear one, but you needn't take our word for it—*"make a sound investment"*—SEE and HEAR a pair of Criterion "VI's" in person at your local Lafayette Dealer now. It's the least expensive trip to a new dimension in sound you'll ever find! Only \$74.95 each.

**P.S. Other Lafayette
Criterion Speaker systems are available
from \$19.95 to
\$159.95.**

**For
Those Who
Are Technically
Oriented**

The Criterion "VI" features a 4-way system utilizing six matched drivers; 12" woofer with 4½ pound magnet structure and 2" voice coil, 5" midrange unit, two 3" high frequency units, and two 1½" super high frequency units.

Solid, ¾" wood enclosure is a renowned bass reflex design, incorporating a ducted port which is acoustically tuned to provide a special path for the sound waves radiated from the rear of the woofer. Rigid internal bracing and use of a sound absorbent lining prevents undesirable resonance.

5" midrange unit, housed in its own acoustic chamber provides more precise contouring of musical balance throughout the system.

The high frequency (5kHz to 12kHz) and the super high frequency speakers (12kHz to beyond audibility) reproduce the highs with discernible definition, providing a spacious sound quality free from many of the usual room-acoustic limitations.

A 6 db/octave LC network operates electrically at 800 and 5,000 Hz; mechanically at 12,000 Hz.

There are continuously variable midrange and high frequency level controls and speaker phasing is assured by the use of polarized terminals. Efficiency of the system is well within the limits of both high and low power amplifiers, and it will easily handle up to 50 watts of power. Impedance is 8 ohms.

make
a sound
investment...



LAFAYETTE®

FREE!

1970 Catalog 700

496 Pages



Featuring Everything in Electronics for

- HOME
- INDUSTRY
- LABORATORY

LAFAYETTE RADIO ELECTRONICS
Dept. 27030 P.O. Box 10
Syosset, L.I., N.Y. 11791

Send me the FREE 1970 Lafayette Catalog 700 27030

Name

Address

City

State Zip

Check No. 33 on Reader Service Card

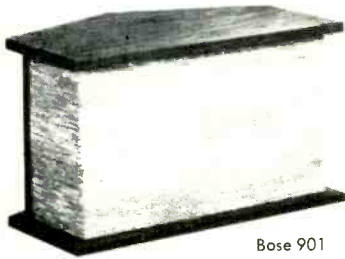

Bose 901



Dynaco A-25



Epicure 100



Bozak "Tempo I"

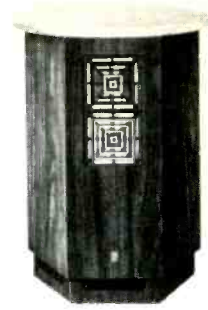

Empire 6000M

MANUFACTURER (Circled numbers indicate adv. page)	Model	WOOFER			MID-RANGE			TWEETER			Overall Freq. Response, Hz to kHz ± 7 dB	Ampl. Pwr. for Avg. Room, W	Pwr. Handling Capacity (RMS Cont)	Crossover Frequency (est), Hz	Impedance, Ohms	Enclosure Dimensions, W x D x H, in.	Wood Finish	Grille Material & Color	Weight, Lbs.	Price	SPECIAL FEATURES
		Diameter, in.	Resonance (In System), Hz	Enclosure Type	Diameter, in.	Type	Diameter, in.	Type													
AZTEC	Rembrandt I	10	43	Ducted Reflex	-	-	2 x 6	Horn	40-16K ± 5	6	30	2,000	8	23 3/8 x 11 1/2 x 13 3/8	Wal.	Cloth brown	38	135.50	6 lb. woofer magnet; 12 db/Oct. LRC adj. x-over network.		
	Cezanne II	10	70	Acous. Susp.	-	-	(2) 3 1/2	Cone	45-18K ± 5	6	20	2,000	8	22 x 9 1/2 x 12 1/2	Wal.	Cloth Gold	26	99.50	Column array tweeters for wide dispersion.		
BENJAMIN (37)	105	14 1/4 8 3/4	62	Acous.	5	Cone	3 3/4	Cone	35-20K ± 5	15	80	1,000 4,000	8	13 3/2 x 12 1/4 x 24 1/2	Wal.	Brown	50	169.50	Special fibre glass elliptical cone.		
	62	10 x 6 3/4	91	Acous.	-	-	3 1/8	Cone	60-20K ± 5	10	35	5,000	8	11 1/4 x 10 x 20 1/2	Wal.	Black	28	79.95	Special fibre glass elliptical cone.		
BOGEN	LS30	10	-	Acous.	5	Cone	3	Cone	40-20K ± 5	10	50	600 5,000	8	22 x 11 x 14	Wal.	Cloth green-blue tweed	32	99.95			
	LS20-W	8	-	Acous.	-	-	3	Cone	50-20K ± 5	10	40	1,100	8	19 x 9 x 10	White	Cloth Tangerine	18	69.95			
	LS20	8	-	Acous.	-	-	3	Cone	50-20K ± 5	10	40	1,100	8	19 x 9 x 10	Wal.	Cloth green-blue tweed	18	59.95			
	LS10	6	-	Acous.	-	-	3	Cone	60-20K ± 5	10	30	1,100	8	15 x 7 x 8	Wal.	Cloth green-blue tweed	15	49.95			
BOSE (37)	901	9 full-range, high-compliance long-throw spkrs. in each enclosure									20	270	None	8	20 3/8 x 12 3/8 x 12 3/4	Oil Wal.	Linen Berge	33	476.00 pr.	Ebony brown grille cloth, add \$15.00. Walnut facing, add \$39.90. Pedestal-black or white, add \$39.90.	
BOZAK (39)	B-410 Moorish	(4) 12	40	Inf.	(2) 6	Metal Cone	(8) 2 1/2	Metal Cone	28-20K	50	100	400 2,500	8	36 x 19 x 52	Wal.	Cloth white, met. grill	229	897.00	Replaceable grille cloth.		
	B-4000A Classic	(2) 12	40	Inf.	6	Metal Cone	(8) 2 1/2	Metal Cone	35-20K	40	80	400 2,500	8	26 x 15 1/2 x 44 1/2	Wal.	Cloth white, met. grille	190	575.00	As above.		
	B-302A Mediterranean	12	40	Inf.	6	Metal Cone	(2) 2 1/2	Metal Cone	40-20K	20	35	800 2,500	8	27 1/2 x 20 7/8 x 28 1/2	Oak	Cloth Burgundy	120	347.50	As above.		
	B-301 Tempo I	12	30	Inf.	4 1/2	Metal Cone	2 1/2	Metal Cone	40-20K	15	40	1,200 3,600	8	23 3/8 x 14 x 11 1/8	Wal.	Cloth brown weave	40	149.50	Acoustical contour sw.; snap out grille cloth.		
DYNACO (15) (35)	A-25	10	58	Friction Loaded	-	-	1 1/2	Dome	47-20K	15	35	15	8	20 x 10 x 11 1/2	Oil Wal.	Linen Natural	20	79.95	Oiled walnut std. Also available in teak and rosewood for \$89.95.		
ELECTRO-VOICE (2) COVER IV	Aries	12	42	Acous.	6	Cone	2 1/2	Cone	25-20K	10	35	400 1,500	8	27 1/2 x 16 1/2 x 22 1/4	see note	Various	60	275.00	Deluxe furn. cab. avail. in cont./pecan, trad./cherry and Spanish Oak.		
	E-V Four-A	12	47	Acous.	6	Cone	2 1/2	Cone	30-20K	10	35	400 1,500	8	25 x 13 1/2 x 14	Wal.	Cloth, dk. brn.	45	199.95	Ultra-linear 12-inch foam susp. woofer.		
	E-V Nine	10	50	Acous.	5	Cone	3 1/2	Cone	30-20K	10	35	400 1,000	8	22 1/2 x 12 x 13 1/2	Wal.	Cloth, dk. brn.	30	144.00	Smooth 5-inch mid-range fills out treble range.		
	E-V Five-C	10	50	Acous.	-	-	2 1/2	Cone	30-20K	10	35	1,000	8	21 3/4 x 10 1/2 x 12 1/4	Wal.	Cloth, dk. brn.	22	99.95	Four-layer voice coil for efficiency at low freqs.		
	E-V Seven-B	8	75	Acous.	-	-	3 1/2	Cone	40-20K	10	35	1,500	8	19 x 9 x 10	Wal.	Cloth, dk. brn.	19	66.50	Symmetrical tone damping.		
	E-V Eleven	6	110	Reflex	-	-	-	-	80-15K	5	15	-	8	15 1/4 x 6 1/2 x 8 1/4	Wal.	Cloth, dk. brn.	9	37.00	Low cost dual-radiator system.		
ELITE	Magnum-K	12	40	Acous.	4	Cone	4	Cone	30-20K ± 5	6	25	1,500 +6,000	8	15 x 11 1/4 x 24	Wal.	Cloth, charc. & white	47	189.00	Vinyl cone susp. Tweeter control and mid-range control.		
	Mezzo-II	12	48	Acous.	-	-	4	Cone	40-20K ± 5	6	15	2,000	8	19 1/2 x 9 x 12	Wal.	Cloth, charc. & white	20	139.00	Vinyl cone susp. Tweeter control.		
	Maxim	4	60	Acous.	-	-	3 1/2	Cone	45-20K ± 5	8	12	2,000	8	5 1/2 x 7 1/4 x 10 1/2	Wal.	Cloth, brn., white	8	59.95	Vinyl cone susp. Extremely compact.		
EMPIRE	9000 M	15	20	Inf. baffle	4	Cone	1	Dome	20-20K	10	100	450 5,000	8	22 x 29	Satin Wal.	None	120	299.95	3-way sys.; w.a. lens, marble top.		
	7000 M	12	25	Reflex	4	Cone	1	Dome	25-20K	10	90	450 5,000	8	19 x 26 1/2	Satin Wal.	None	75	209.95	As above.		
	6000 M	10	30	Reflex	5	Cone	3	Cone w. lens	30-20K	10	75	450 2,500	8	18 x 24 1/4	Satin Wal.	None	60	109.95	Marble top. Model 6000 with walnut top, \$99.95.		
EPICURE	EPI 150	8	35	Acous.	-	-	1	Acous.	35-18K ± 3	17	40	1,800	8	11 x 15 x 24	Wal.	dk. brn.	35	129.00	Unique cabinet design.		
	EPI 100 Standard	8	43	Acous.	-	-	1	Acous.	40-18K ± 3	17	40	1,800	8	11 x 9 x 21	Wal.	Brown	22	89.00	Uniform dispersion ± 5 db. 40-13 kHz.		

"... (the Dynaco A-25's) are quite probably the best buy in high fidelity today."

The Stereophile Magazine.

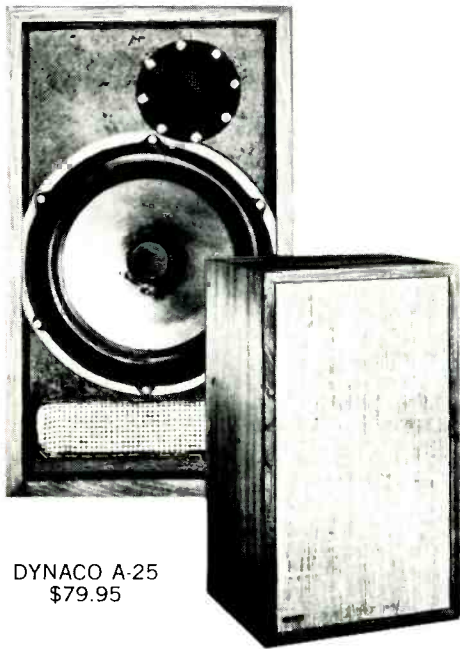

DYNACO A-25
\$79.95

Dynaco designed the A-25 loudspeaker system to have the most accurate reproduction of any speaker available, regardless of price, yet at a low cost to the consumer. Here's what two of the most respected publications say about the results of our efforts.

The Stereophile, Vol. 2, No. 9

"... (when) some really deep stuff came along . . . what came out of the A-25's simply defied belief, for they went **deeper** even than two of our standard systems . . . We were certainly **not** prepared to find these piddling little Dyna systems going **flat** down to 35 Hz and rattling windows at a hair below 30 Hz! . . . these A-25's are better than anything else we've ever encountered for less than \$200 each . . ."

Julian Hirsch in Stereo Review, June, 1969

"... the Dynaco had a remarkably neutral quality. Many speakers have response irregularities that . . . leave no doubt in the listener's mind that he is listening to a speaker. The A-25 had less of this coloration than most speakers we have heard, regardless of price . . . nothing we have tested had a better overall transient response . . . Not the least of the A-25's attraction is its low price of \$79.95.

“The excellent overall transient response of the Dynaco A-25 speaker system is shown by the tone-burst response photos at (left to right) 600, 2,000 and 10,000 Hz.” (Stereo Review)

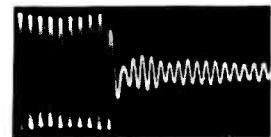
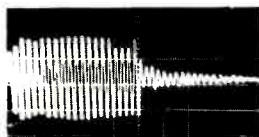

Send for literature or pick some up at your dealer where you can also hear the A-25

dynaco inc.

3060 JEFFERSON ST., PHILA., PA. 19121
IN EUROPE WRITE: DYNACO A/S, HUMLUM, STRUER, DENMARK

Check No. 15 on Reader Service Card



Harman-Kardon HK-50



Heath AS-37



Fisher XP-18



JVC 5901

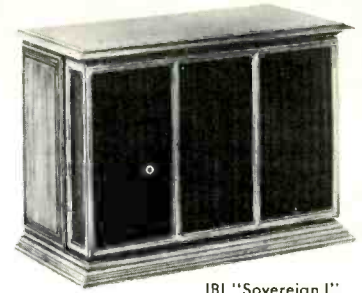

JBL "Sovereign I"

MANUFACTURER <small>(Circled numbers indicate adv. page)</small>	Model	WOOFER			MID-RANGE		TWEETER		Overall Freq. Response, Hz to kHz ± 1 dB	Ampl. Pwr. for Avg. Room, W	Pwr. Handling Capacity (RMS Cont)	Crossover Frequency (Hz), Hz	Impedance, Ohms	Enclosure Dimensions, W x D x H, In.	Wood Finish	Grille Material & Color	Weight, Lbs.	Price	SPECIAL FEATURES
		Diameter, In.	Resonance (In System), Hz	Enclosure Type	Diameter, In.	Type	Diameter, In.	Type											
FISHER	XP18	18	14	Acous.	8 low 5 1/2 up.	Cone	(2) 2	Mylar Dome	30-22K	10	50	150 1,500 3,000	8	30 1/2 x 29 1/2 x 16 1/2	Wal.	Cloth Brown	105	359.95	
	XP7B	12	15	Acous.	5 1/4 low 5 1/4 up.	Cone	(2) 3	Cone	30-20K	10	30	300 800 3,500	8	24 1/2 x 14 x 11 1/2	Wal.	Cloth Brown	40	149.95	
	XP66B	12	15	Acous.	5	Cone	3	Cone	30-20K	10	20	500 1,000	8	24 1/2 x 14 x 11 1/2	Wal.	Cloth Brown	40	99.95	
	XP55B	8	38	Acous.	-	-	3	Cone	37-20K	10	15	1,500	8	20 x 10 x 7 1/2	(vinyl) Wal.	Cloth Brown	18	49.95	
FRAZIER (71)	F-1023	10	36	Slit tuned	-	-	(2) 3	Cone	40-10K ± 3	0.5	25	2,000	8	11 1/2 x 9 1/2 x 23 7/8	Oil Wal. 4 sides	Cloth Brown	37	89.50	
	FS-6	6	48	Slit tuned	-	-	-	-	80-12K ± 3	1.0	15	-	8	10 1/2 x 8 x 19	Oil Wal. 4 sides	Linen off wht.	16	44.95	
GOTHAM	OY	10	20	Acous.	2 x 4	Cone	-	Horn	40-16K ± 2	-	-	500 8,000	4700	19 x 9 x 12	Wal.	Metal Silver	44	550.00	Low-level input; contains 2 30-w amps; elect. x-over; separate level conts. and equalizers.
GROMMES	GS-310	10	37	Acous.	6	Cone	3 1/2	Cone	25-20K	20	50	600 3,500	8	23 x 13 1/4 x 10 1/2	Wal.	Tan	30	119.75	Mid and hi-freq. level controls.
HARMAN-KARDON (3)	HK 50	8	35	Acous.	-	-	2 1/4	Cone	35-20K ± 4	20	45	1,500	8	11 1/2 sq. x 18	Wal.	Dr. Brn.	22	99.95	Omnidirectional 360° dispersion.
	HK 25	6	40	Acous.	-	-	2 1/4	Cone	42-20K ± 4	20	40	2,000	8	12 1/2 dia. x 16 1/2	Wal.	None	15	69.95	Tweeter level control. Removable front grille.
	HK 40	10	32	Acous.	-	-	3	Cone	30-20K ± 4	20	45	2,000	8	13 1/2 x 10 1/2 x 22 7/8	Wal.	White	35	89.95	Omnidirectional 360° dispersion.
	HK 20	8	40	Acous.	-	-	3	Cone	38-20K ± 4	12	20	2,500	8	11 1/2 x 8 1/4 x 17 1/4	Wal.	Brown	20	55.00	
	HK 12	6	43	Acous.	-	-	-	-	40-18K ± 4	5	10	-	8	9 1/2 dia. x 13 3/4	Wal.	Black	2	44.95	360° dispersion.
HARTLEY	Concertmaster V & VI (3 spkr.)	24	13	Semi-Inf.	10	Poly Cone	7	5 1/2 cone 2 1/2 dome	16-25K ± 3	20	50	300 3,000	16	39 x 29 x 18	Wal.	Cloth, brn. & gold	150	730.00 760.00	Mag. susp.; cones of identical material, x-over 12 dB/oct. cast alum. fr.
	Holton Jr.	10	28	Inf.	-	-	3	Cone & Dome	35-20K ± 4	15	30	2,500	8	30 x 15 x 13	Wal.	Cloth, brn. & gold	45	195.00	CO-AXIAL speaker w/pat. moisture proof polymer cones; mag. susp.; dual cones and v.c.'s.
HEATH	AS-38	12	-	Tube ported	-	-	2	piston type dir. rad.	45-20K	7	40 program	2,500	8	23 1/2 x 11 1/4 x 14	Wal.	Cloth Brown	37	129.95	Kit.
	AS-10W	10	-	Acous.	-	-	Two 3 1/2	Cone	30-15 ± 5	10	40 RMS	2,250	16	24 x 11 1/2 x 13 1/2	Wal.	Cloth Cane	28	64.95	Kit.
	AS-16	8	-	Acous.	-	-	3 1/2	Cone	45-20K ± 5	25	50	1,500	8	19 x 8 1/4 x 10	Wal. Vinyl	Cane	15	49.95	Kit.
	AS-37A	8	-	Ducted port	-	-	-	Horn	50-12K	5	25	1,600	8	23 x 11 1/2 x 11 1/2	Wal. Polyester	Cloth Brown	22	41.95	Kit.
JBL	Aquarius** III	10"	-	Radial diffraction line	5	Radial Horn Driver	1.7	Direct Radiator	-	15	45	1,000 3,000	8	20 x 20 x 14	Oil Wal.	None	51	270.00	Bkshlf.-type; mult. diffraction rad. sys. independent of room; dir. rad. tweeter.
	Aquarius* II	12"	-	Radial diffraction line	5	Radial Horn Driver	1.7	Direct Radiator	-	15	50	400 2,500	8	21 x 30 x 15	Oil Wal.	None	88	385.00	As above. *Specs. and prices subj. to change.
	Alpha 570 WX	12" w 12" passive radiator	28**	Passive Radiator	5	Direct Radiator	1.7	Direct Radiator	-	15	50	1,200 7,000	8	26 1/2 x 35 x 17 1/2	Oil Wal.	text. blk. mtl. w/wal. ribs	115	336.00	Augmented 2-way sys. w/passive radiator. **Freq. of pass. rad. tuning.
JVC (7)	5303	(4) 5	35	Acous.	-	-	(4) 2	Horn	20-20K ± 6	25	40	5,000	8	Spherical 13 1/2 dia.	-	Metal Black	26.4	199.95	Omni-directional radiation. Spherical shape.
	5304	12	45	Acous.	6 1/2	Cone	3 1/2 2	Cone Horn	30-20K ± 6	20	40	1,500 7,000 10,000	8	12 1/2 x 15 x 24 1/2	Wal.	Cloth Brown	35.2	149.95	2 level controls. Multi channel input terminals.

Why BOSE eliminates woofers, tweeters and CROSSOVERS

If you have heard the BOSE 901 Direct/Reflecting™ speaker system or if you have read the unprecedented series of rave reviews in the high fidelity publications, you already know that the 901 is the longest step forward in speaker design in perhaps two decades. Since the superiority of the 901 (covered by patents issued and pending) derives from an interrelated group of advances, each depending on the others for its full potential, we hope you will be interested in a fuller explanation than is possible in a single issue. This discussion is one of a series on the technical basis of the performance of the BOSE 901.

In other issues we describe how a multiplicity of same-size, acoustically coupled speakers eliminates audible resonances and, in addition, makes possible the unprecedented bass performance of the BOSE 901 Direct/Reflecting speaker system. But there is yet another vital benefit from this advance — the elimination of crossovers.

The best answer which had previously been found, for reproducing the full audio spectrum with dynamic speakers, was the use of a large speaker for the bass frequencies and smaller speakers for the higher frequencies, with crossover networks routing the appropriate frequencies to the appropriate speakers. (see fig.) Crossover networks, whether they are passive in the speakers or electronic in amplifiers, are generally designed so that the sum of the voltages at 'B' and 'C' is proportional to the speaker input signal at 'A'. This would be adequate only if the speakers were themselves perfect for then we might have an acoustical signal at 'D' which bore a close relation to the speaker input 'A'. However, woofers and tweeters are far from ideal. They exhibit both phase and amplitude irregularities in the crossover region. Phase differences between the woofer and tweeter, for example, can cause the cone of the woofer to advance while the cone of the tweeter is retreating. The result is sound coloration caused by the fact that the sum of the output of the woofers and tweeters is widely varying in the region of the crossover frequencies.

Equally important, the directionality (dispersion) of a speaker varies with its diameter. Therefore, the spatial characteristics of the sound can change sharply in the crossover region as the radiation shifts from the large woofer to the small tweeter. "This spatial property of the sound incident upon a listener is a parameter ranking in importance with the frequency spectrum . . . for the subjective appreciation of music."^{*}

The principal reason which had been put forth in favor of the use of crossovers was the reduction of possible doppler distortion. (When a high frequency note is emitted from a speaker cone which is 'slowly' moving toward or away from the listener while it is also reproducing a bass note, is the frequency of the higher note affected audibly?) Measurements and computations in support of this hypothesis have been based on sine waves, on one axis, in an anechoic environment. No correlation has been established between these numbers and what we hear with music and speech signals, in a room. In another issue, on the subject of DISTORTION, we shall explain how we were able to prove (in an experiment which is reproducible by

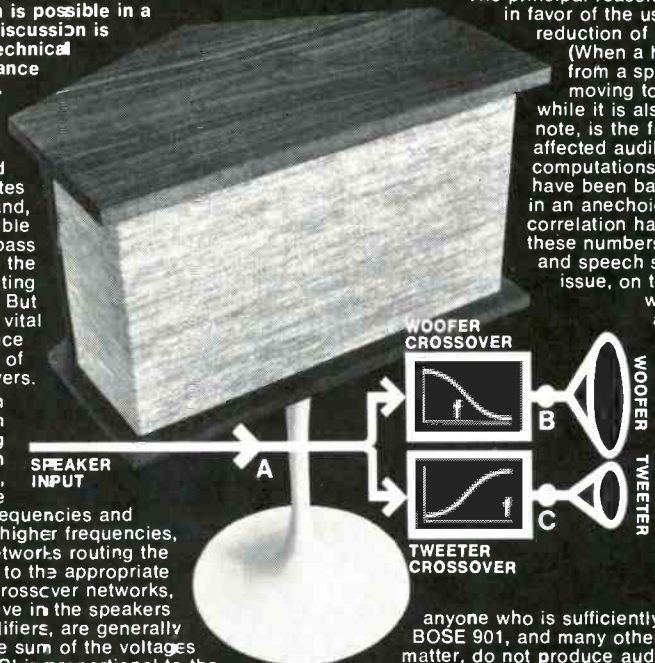

D LISTENER
Block Diagram of Conventional Speaker System Employing Woofers, Tweeters and Crossovers.

anyone who is sufficiently interested) that the BOSE 901, and many other good speakers, for that matter, do not produce audible doppler distortion on music or speech.

If you would like to hear the performance of a speaker with no woofers, tweeters or crossovers (and several other major advances), ask your franchised BOSE dealer for an A - B comparison of the BOSE 901 with the best conventional speakers he carries— *regardless of their size or price.*

^{*}From 'ON THE DESIGN, MEASUREMENT AND EVALUATION OF LOUDSPEAKERS', Dr. A. G. Bose, a paper presented at the 1968 convention of the Audio Engineering Society. Copies of the complete paper are available from the Bose Corp. for fifty cents.

You can hear the difference now.

THE **BOSE** CORP.®

East Natick Industrial Park, Natick, Massachusetts 01760



Jensen TF-25

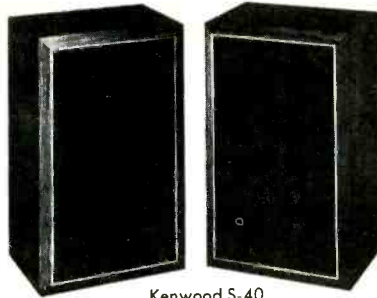

Kenwood S-40



JansZen Z-960



KLH 33

MANUFACTURER (Circled numbers Indicate adv. page)	Model	WOOFER			MID-RANGE		TWEETER		Overall Freq. Response, Hz to dB ± 1 dB	Appr. Pwr. for Avg. Room, W	Pwr. Handling Capacity (RMS Cont)	Crossover Frequency (fs), Hz	Impedance, Ohms	Enclosure Dimensions, W x D x H, in.	Wood Finish	Grille Material & Color	Weight, Lbs.	Price	SPECIAL FEATURES	
		Diameter, in.	Resonance (in System), Hz	Enclosure Type	Diameter, in.	Type	Diameter, in.	Type												
JVC (Cont'd)	5320	8	45	Acous.	3½	Cone	2	Cone	37-20K ± 6	15	30	5,000 10,000	8	13 x 9¼ x 21½	Wal.	Cloth Brown	19.8	99.95	Level controls.	
	5310	6½	90	Acous.	-	-	2	Cone Horn	40-20K ± 6	5	18	7,000 10,000	8	11 x 7¼ x 17¼	Wal.	Cloth Brown	12.1	69.95	Bookshelf type.	
JANSZEN	Z-960	11	42	Inf. Baffle	3 Electrostatic Elements				30-30K	20	100	800 2,000	8	26¼ x 8½ x 27½ x 14½	Oil Wal.	Cloth Beige	67	259.95	High-frequency switch.	
	Z-600	11	46	Inf. Baffle	2 Electrostatic Elements				30-30K	20	100	800 2,000	8	26 5/8 x 20 x 13	Oil Wal.	Cloth Beige	65	208.95		
JENSEN	700-XLW	12	20	Acous.	-	Horn	-	Horn Loaded Dome	20-25K	10	40	600 4,000 10,000	8	25½ x 12 x 16¼	Wal.	Cloth, Brown	60	275.00	4 way system, hor. or vert. opt. floor stand Flexair® woofer.	
	TF-3C	10	25	Acous.	3½	Cone	-	Dome	25-20K	10	25	2,000 10,000	8	23¼ x 11½ x 13½	Dura-syn. Wal. Ven.	Cloth, Brown	40	128.00	Superflex® enclosure. Sonodome® tweeter, Flexair® woofer.	
	TF-25	10	25	Acous.	-	-	2 x 6	Horn	25-19K	10	25	2,000	8	22½ x 8 5/8 x 14	Dura-syn. Wal. Ven.	Cloth, Brown	27	89.50	2-way air suspension, Flexair® woofer, horn- loaded tweeter.	
	X-45	8	35	Acous.	-	-	2 x 6	Horn	30-18K	10	25	2,000	8	19½ x 9 x 10½	Wal.	Cloth, Brown	24½	69.50	Flexair® woofer, horn-loaded tweeter.	
KLH	12	12	35	Acous.	(2) 3	Stiff paper cone	1¼	Stiff paper cone				30	600 2,500	8	22¼ x 15 x 29	Oil Wal.	Boucle off white	101	275.00	Contour control w/four 3-pos. level controls for matching to room. Can be used remotely. Changeable grille cloth.
	5	12	44	Acous.	(2) 3	Stiff paper cone	1¼	Stiff paper cone		25	-	600 2,500	8	26 x 11½ x 13¼	Oil Wal.	Cloth, light brn.	51	179.95	Two 3-pos. level control. Finished on 4 sides. Changeable grille cloth.	
	6	12	55	Acous.	-	-	1¼	Stiff paper cone		20	-	1,500	8	23½ x 11½ x 12 5/8	Several	Boucle off white	34	122.00 to 124.00	3-pos. tweeter level control unf. birch, cherry, oil walnut; fin. 4 sides. *Depending on finish.	
	33	10	54	CAC*	-	-	1¼	plastic impreg. paper		12W	-	1,500	8	28 1/8 x 10 1/8 x 12 1/8	Oil Wal.	Cloth, light brn.	33	99.95	*Controlled acoustic compl.; 3-pos. tweeter freq. control; fin. on 4 sides. Changeable grille cloth.	
	17	10	60	Acous.	-	-	1¼	Stiff paper cone		12	-	1,500	8	23½ x 9 x 11¼	Oil Wal.	Cloth, off white	27	69.95	3-pos. tweeter level control; finished on 4 sides. Changeable grille cloth.	
KARLSON	X-15	15	40	Spec.	-	-	2½	Spec.	20-18K ± 4	2	100	4,000	16	20 x 14 x 28	Wal.	Woven plastic	90	299.00	Sep. conn for woofer for organ or instrument use. Avail. utility and other finishes.	
KENWOOD (57)	S-44	6½	-	Acous.	-	-	2¼	Cone	50-20K	-	20	2,000	8	10 x 8 x 16 1/8	Wal.	Cloth, brn.	13	79.95 pr.		
	S-33	6½	-	Acous.	-	-	2¼	Cone	50-20K	-	20	2,000	8	8¼ x 7 7/8 x 14 1/8	Wal.	Cloth, brn.	11	69.95 pr.		
KLIPSCH	Klipschorn K-347	15	-	Horn	2	Horn	1	Horn	32-17.5K ± 3	30	100	400 6,000	16	52 x 31 x 28	Wal. Mah. others	Several	180	571.00 1,020.00		
	La Scala K-447	15	-	Horn	2	Horn	1	Horn	45-17.5K ± 3	30	100	400 6,000	16	34 x 24 x 24	Fir.	None	120	550.00		
	Cornwall II	15	-	Ducted port	2	Horn	1	Horn	32-17.5K ± 4	30	60	600 6,000	16	36 x 24 x 15	Wal. Mah. others	Several	105	469.00 342.00		
	Klipsch's Heresy	12	-	Total encl.	2	Horn	1	Horn	45-17.5K ± 4	25	50	700 6,000	16	21 x 15 x 13	Wal. Mah. others	Several	55	258.00 209.00		
LAFAYETTE (33)	Criterion 80	12	25	Acous.	6½	Cone	2 (3) 2 (1½)	paper cone Alum. cone	18-25K ± 5	10	75	800 4,500 10,000	8	18 x 12 x 38	Oiled Walnut	Cloth, dk. brn.	66	159.95	Mid and high freq. level controls; 5 yr. warranty.	
	Criterion 3X	12	-	Acous.	6½	Cone	3	Dome	20-25K	10	60	1,200 6,000	8	23 x 11¼ x 13½	Oil Wal.	Cloth, Beige	32	89.95	Mid and high freq. level controls; 5 yr. warranty.	
	Criterion VI	12	-	ported	5	Cone	2 (3) 2 (1½)	Paper	20-20K	10	50	800 5,000 12,000	8	24 x 12 x 14½	Oil Wal.	Cloth, dk. brn.	45	74.95	Mid and high freq. level controls; 5 yr. warranty.	
	Criterion 100 B	10	-	ported	3½	Cone	1½	Paper	30-19K	5	40	3,500 10,000	8	21½ x 9¼ x 11¼	Oil Wal.	Cloth, Beige	31	44.95	High freq. control; 5 yr. warranty.	

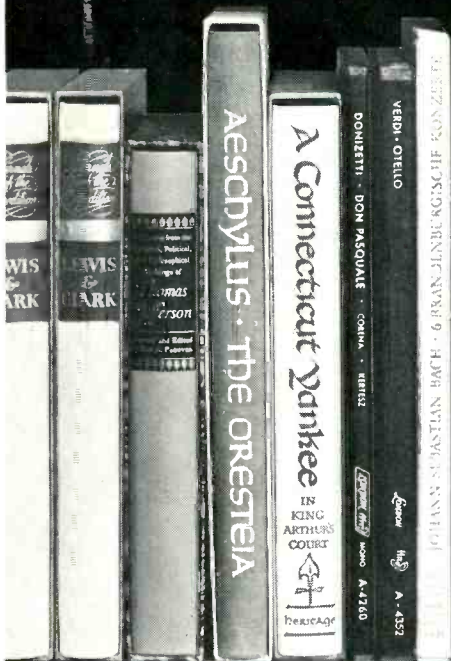

Tempo 1

The Bookshelf Speaker
with a heritage of quality.

It's all there . . . all the care and skill that make *Concert Grand* and *Symphony* household words wherever the ultimate in music re-creation is desired and appreciated.

Now we proudly present the newest Bozak — the astonishing Tempo 1 Bookshelf Speaker System. This is a genuine 3-way system — with a special high compliance driver for true bass without coloration, a 4½" mid-range driver with exceptional transient capabilities and the famous B-200 treble for sparkling crystal highs — plus much more.

Tempo 1 is yet another example of Bozak's long-standing tradition of quality. See it at your nearest dealer, ask for it, listen to it. You'll find that there's suddenly a new standard in bookshelf speakers.

It's called Tempo 1.

By Bozak, of course.



Tempo 1 literature available on request.



P.O. Box 1166 • Darien, Connecticut 06820

Overseas Export: Elpa Marketing Industries, Inc.
New Hyde Park, New York 11040 U.S.A.



LWE II



Maximus 55



Marantz "Imperial II"

Rectilinear X



Pioneer CS-88



Pioneer CS-61

MANUFACTURER (Circled numbers indicate adv. page)	Model	WOOFER				MID-RANGE		TWEETER		Overall Freq. Response, Hz to kHz ± dB	Amp. Pwr. for Avg. Room, W	Pwr. Handling Capacity (RMS Cont)	Crossover Frequency (ies), Hz	Impedance, Ohms	Enclosure Dimensions, W x D x H, in.	Wood Finish	Grille Material & Color	Weight, Lbs.	Price	SPECIAL FEATURES
		Diameter, In.	Resonance (in System), Hz	Enclosure Type	Diameter, In.	Type	Diameter, In.	Type												
LWE	I	15	Non Res	Sealed	6	Cone	2 x 5	Horn	22-20K ±5	25	50	1,000 5,000	4	25 x 17 x 12	Wal.	Linen Beige	61	250.00	Elec. susp. feedback; unif. kit \$75.00.	
	II	(2) 15	Non Res	Sealed	(2) 6	Cone	2 x 5	Horn	20-20K ±5	40	100	1,000 5,000	4-8	34 x 24 x 16	Wal.	Brown strip	141	550.00	Unf. kit \$330.00.	
	III	12	Non Res	Sealed	6	Cone	3½	Cone Dome	25-17K ±5	20	40	1,000 5,000	4	22½ x 15 x 9½	Wal.	Linen Beige	35	175.00	Unf. kit \$105.00.	
	VI	8	Non Res	Sealed	6	1	3½	Cone Dome	29-13K ±5	20	25	1,500	8	19 x 10 x 9	Wal.	Linen Beige	23	100.00	Elec. susp. feedback; unif. kit \$75.00.	
LEAK	Mark III	13	19	Acous.	-	-	5	Alum. sandwich	30-20K ±5	4	70	900	8 or 15	26 x 15 x 12	Wal. or teak	Cloth Tan	50	199.00	Piston action sandwich cone in both woofer and tweeter.	
MARANTZ (42) (43)	Imperial II	12	-	Inf. baffle	(2) 4	Cone	(2) 2	Cone	20-20K	-	40	700 6,000	8	22 x 15 x 26	Lacq. Wal.	Carved Grille	60	369.00	Separate brilliance and presence controls.	
	Imperial I	12	-	Inf. baffle	(2) 4	Cone	(2) 2	Cone	20-20K	-	40	700 6,000	8	22 x 15 x 26	Lacq. Wal.	Cloth, Brown	60	299.00	As above.	
	Imperial III	12	-	Inf. baffle	2	Dome	1	Dome	30-20K	-	100	1,500 6,000	8	13½ x 12 x 23	Lacq. Wal.	Cloth, Brown	42	199.00	As above.	
MAXIMUS (79)	Maximus 33	8	55	Air Susp.	-	-	3½	Cone	35-18K ±5	15	*	2,000	8	11 x 9 x 18	Wal.	Cloth, Brown	25	56.00	*Use with any com. amp. designed for music at home. All controls are up front for easy access behind cloth or panel.	
	Maximus 55	12	45	Air Susp.	6	Cone	3½	Cone	30-20K ±5	15	*	2,000 5,000	8	14 x 12 x 24	Wal.	Cloth, Brown	39	99.50	Same as above.	
	Maximus 1	4	70	Air Susp.	-	-	3	Cone	45-20K ±5	25	*	1,900	8	7½ x 5½ x 10½	Wal.	Cloth, Brown	12	64.50	Same as above.	
	Maximus 7	12	45	Air Susp.	2 ea. 5"	Cone	3½	Dome	20-35K ±5	15	*	1,000 8,000	8	14 x 12 x 24	Wal.	Cloth, Brown	58	189.00	Same as above.	
NIKKO	SS-83	8	-	Acous.	-	-	3	Cone	30-20K	10	25	4,000	8	9 x 14½ x 9	Dil Wal.	Cloth, Black	10	89.95 pr.	High-compliance woofer.	
PANASONIC	SB-88	12	50	Acous.	(2) 5	Cone	(2) 2	Horn	24-22K	10	-	800 6,000	8	15½ x 13½ x 26½	Oil Wal.	Cloth, Beige	48.5	249.95	3-pos. treble and mid-range control.	
	SB-77	10	60	Acous.	5	Cone	2	Horn	28-21K	10	-	800 6,000	8	13½ x 11½ x 23½	Oil Wal.	Cloth, Beige	32	179.95	As above	
	SB-33	10	60	Acous.	3½	Cone	2	Cone	30-20K	10	-	1,300 6,000	8	11½ x 11½ x 22½	Oil Wal.	Cloth, Black	20	125.00	3-pos. treble control.	
	SB-22	8	75	Acous.	-	-	3	Cone	38-19K	10	-	2,500	8	10½ x 9½ x 20½	Wal.	Cloth, Black	14.3	79.95		
PIONEER (25) (61)	CS-63DX	15	-	Acous.	5 x 2	Cone		horn, cone, (2) domes	20-22K	4	80	700 3,000 12,000	8	19 x 13 x 29	Wal.	Cloth, Brown	80	259.00	4-way, 6 spkrs; lattice wood grille.	
	CS-99	15	-	Acous.	5	Cone		horn, cone, (2) domes	25-22K	4	80	600 4,000 7,500 14,000	8	16 x 12 x 25	Wal.	Cloth, Brown	53	215.00	5-way, 6 spkrs.; lattice wood grille.	
	CS-66	10	-	Acous.	6½	Cone	1	Cone	35-20K	16	40	1,850 6,850	8	13 x 12 x 22	Wal.	Cloth, Brown	29	109.00	Lattice wood grille.	
	CS-44	8	-	Acous.	-	-	2½	Cone	35-20K	16	25	2,500	8	12 x 10 x 20	Wal.	Cloth, Brown	18	67.50	Lattice wood grille.	
	CS-5	8	-	Acous.	-	-	2½	Cone	35-20K	16	25	2,500	8	12 x 10 x 20	Wal.	Cloth, Brown	18	59.00	As above but without lattice wood grille.	
RECTILINEAR (41)	III	12	40	Duct port	5	Cone	(2) 2½ (2) 2	Cone	22-18.5K ±4	20	60	500 8,000 11,000	8	18 x 12 x 34	Oil Wal.	Polyester	70	279.00	Very low mass mid & twtrs. for opt. transient resp.	
	X	10	45	Acous.	5	Cone	2	Cone	40-18.5K ±5	30	80	100 5,000	4	24 x 12 x 14	Oil Wal.	Polyester	50	199.00	As above.	
	Min I	8	58	Acous.	5	Cone	2	Cone	50-18.5K ±5	20	60	400 8,000	4	19 x 19½ x 12	Oil Wal.	Polyester	25	89.50	As above.	

"The finest loudspeakers I've ever listened to, regardless of size, type or price."

That's how Ronald M. Benrey, electronics editor of *Popular Science*, described a pair of **Rectilinear III** speaker systems in the May 1968 issue of his magazine, in an article on "The Stereo System I Wish I Owned."

Mr. Benrey went on to justify his ranking of the **Rectilinear III**'s:

"They produce beautiful bass tones without boom, accurate midrange tones without a trace of coloration, and crystal-clear treble tones without a hint of harshness. And they do it at any volume, including 'window-rattling' sound levels."

Of course, one expert's opinion may differ considerably from another's. But here's what Julian D. Hirsch wrote in the "Equipment Test Reports" of *Stereo Review*, December 1967:

"The **Rectilinear III** ranks as one of the most natural-sounding speaker systems I have ever used in my home. Over a period of several months, we have had the opportunity to compare it with a number of other speakers. We have found speakers that can outpoint the **Rectilinear III** on any individual characteristics—frequency range, smoothness, distortion, efficiency, dispersion, or transient response. However... none of the speakers combine *all* of these properties in such desirable proportions as the **Rectilinear III**."

Summing up his test report, Mr. Hirsch concluded: "In our opinion, we have never heard better sound reproduction in our home, from any speaker of any size or price."

Of course, both Mr. Benrey and Mr. Hirsch write for the readers of popular,

large-circulation magazines. But here's what Larry Zide wrote for the more specialized audience of *The American Record Guide* ("Sound Ideas" column, October 1968):

"The transient response of the speaker is superb... the overall quality is extreme in its fidelity to 'live' music. The bass is solid and firm, the midrange is clear and neutral, and highs are bell-like in their cleanliness.

"It all comes down to this: there are only a handful of speakers that I find completely satisfactory... I have had these **Rectilinear III** units for a month

now. Lately I have found myself listening to them just for the pleasure of it. They are among the very best speakers on the market today."

Of course, all of the opinions above appeared in publications that accept advertising. But here's what *Buyer's Guide* magazine wrote in their August 1968 issue, just in case you're more inclined to trust a consumer review without ads:

"**Rectilinear III**... has had tremendous impact on the hi-fi industry... This speaker's virtue is the fact that it is the first and only full-range dynamic speaker system that possesses sound quality which is directly comparable to electrostatic speakers.

"... Flute and violin concertos as well as string quartet were reproduced with honest clarity... Piano and organ music were effortlessly reproduced in a manner that suggested the instruments were being performed live. Jazz and rock music were unpretentious and true sounding..."

To such unanimity from such varied sources we need only add the dimensions and price of the **Rectilinear III**: 35" by 18" by 12" deep, \$279.00 in oiled walnut.

(For further information, see your audio dealer or write to Rectilinear Research Corp., 107 Bruckner Blvd., Bronx, N. Y. 10454. Canada: H. Roy Gray Co. Ltd., 14 Laidlaw Blvd., Markham, Ont. Overseas: Royal Sound Co., 409 N. Main St., Freeport, N. Y. 11520.)

Rectilinear III

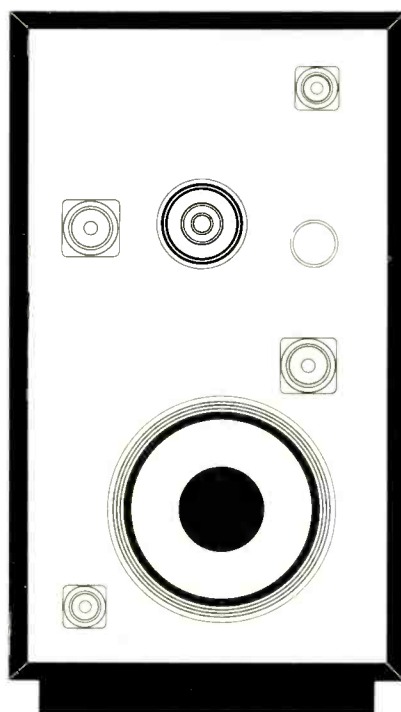

Check No. 41 on Reader Service Card

Only Marantz Has Gyro-

What's a Marantz?

Any audio engineer or stereo hobbyist will tell you. Marantz builds the world's finest high-fidelity components. And has for fifteen years.

This message, therefore, is not to engineers but to professional musicians, serious music-lovers, and beginning stereo hobbyists. We'd like to introduce you to Marantz.

Never Heard Of Marantz?

Until this year, the least-expensive Marantz stereo component you could buy cost \$300.00. And our FM tuner alone cost \$750.00! To own a Marantz, you either had to be moderately wealthy or willing to put beans on the table for awhile. But it was worth it. And a lot of experts thought so, too, because the word soon got around, and the products sold themselves.

What The Competition Said

The chief design engineer of a major competitor once said that no one even tries to compete with many of Marantz' sophisticated features; it would be just too expensive. Marantz designs its circuits the same way the aerospace industry designs missiles and jet planes—for utmost performance and reliability.

Gyro-Touch Tuning

Marantz even offers a different tuning experience because you rotate the actual tuning flywheel. This results in the

smoothest, most precise tuning possible. And this Marantz-exclusive design requires considerably fewer moving parts than conventional systems used by other manufacturers. The benefits: reduced friction, wear and service problems. We call this patented pleasure "Gyro-Touch Tuning."

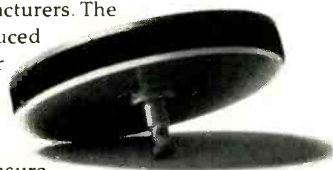

Features, Not Gimmicks

The unique features of a Marantz component are there for only one purpose: to make possible the highest level of listening enjoyment.

That's why we put an oscilloscope in our best components.

An oscilloscope is kind of a TV tube. But instead of the Wednesday Night Movie, it shows you a green wavy line. An electronic picture of the incoming FM radio signal, telling you exactly how to rotate your antenna for minimum multi-path distortion (ghost signals) and maximum signal strength (clarity) even from the weakest stations.



The "scope" also shows correct stereo phasing: that is, if the broadcasting transmitter or your equipment is out of phase. And it lets you set up optimum stereo performance and reception to

create a solid "wall" of sound.

Butterworth Filters

You've probably never heard of Butterworth filters because practically no one else uses them besides Marantz. And the U.S. Military. Other manufacturers feel they can get by without them. And they can. Because their standards don't have to measure up to Marantz' Butterworth filters let

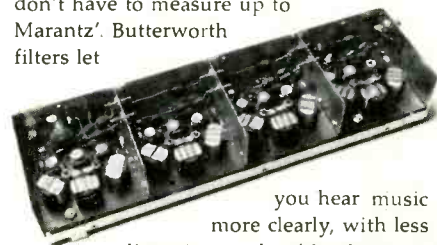

you hear music more clearly, with less distortion; and unlike their conventional I.F. coil or filter counterparts, they never need realignment. They help pull in distant FM stations and separate those right next to each other on the dial. Although Butterworths cost more, Marantz designed not one but four of them into their Model 18 receiver.

Built To Last

Marantz stereo components aren't built in the ordinary way. For example, instead of just soldering connections together with a soldering iron, Marantz uses a highly sophisticated waveflow soldering machine—the type demanded by the Military. The result: perfect, fail-

Touch Tuning!

proof connections every time.

Even our printed circuit boards are a special type—glass epoxy—built to rigid



military specifications, ensuring ruggedness and dependability.

Marantz Power Ratings Are True

When someone tells you he has a "100-watt amplifier," ask him how the power was rated. Chances are his 100 watts will shrink to about 75 or 50 or perhaps even as few as 25. The reason is that most manufacturers of stereo amplifiers measure power by an inflated "peak power" or "IHF music/dynamic power."

Marantz states its power as "RMS continuous power" because Marantz believes this is the only method of measurement that is a true, absolute, scientific indication of how much power your amplifier can put out continuously over the entire audible frequency range.

But if Marantz *were* to use the unscientific conventional method, our Model Sixteen 100-RMS-100 power amplifier could be rated as high as 300 watts.

Moreover, you can depend on Marantz to perform. For example, the Marantz

Model Sixteen can be run all day at its full power rating without distortion (except for neighbors pounding on your wall). That's power. And that's Marantz.

Marantz Speaks Louder Than Words

In a way, it's a shame we have to get even semitechnical to explain in words what is best described in the medium of sound. For, after all, Marantz is for the listener. No matter what your choice in music, you want to hear it as closely as possible to the way it was performed.

In spite of what the ads say, you can't really "bring the concert hall into your home." For one thing, your listening room is too small. Its acoustics are different. And a true concert-hall sound level (in decibels) at home would deafen you.

What Marantz does, however, is create components that most closely recreate the sounds exactly as they were played by the musical performers. Components that consistently represent "where it's at" in stereo design. No one gives you as much—in any price range—as Marantz.

Every Marantz Is Built The Same Way

Every Marantz component, regardless of price, is built with the same painstaking

craftsmanship and quality materials. That's why Marantz guarantees every instrument for three full years, parts and labor.

Now In All Price Ranges

Today, there is a demand for Marantz-quality components in other than very-high price ranges. A demand made by music-lovers who want the very best but must consider their budgets. Though you can easily invest more than \$2000.00 in Marantz components, we now have units starting as low as \$209. True, these lower-priced models don't have all of the same features, but the quality of *every* Marantz is exactly the same. Marantz quality.

And quality is what Marantz is all about.

Hear For Yourself

So now that you *know* what makes a Marantz a Marantz, *hear* for yourself. Then let your ears make up your mind.



marantz®
Components • Speaker Systems • Receivers

©Marantz Co., Inc. 1970. A subsidiary of Superscope, Inc., P.O. Box 99A, Sun Valley, Calif. 91352. Send for free catalog. Illustrated above, Model 26. Price \$209.



Sony SS-3300



Tannoy "Mallorcan"



Scott S-20

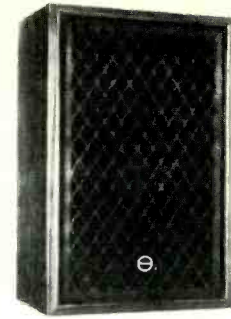

Sansui SP-30

MANUFACTURER (Circled numbers Indicate adv. page)	Model	WOOFER				MID-RANGE		TWEETER		Overall Freq. Response, Hz to kHz ± 7 dB	Ampl. Pwr. for Avg. Room, W	Pwr. Handling Capacity (RMS Cont)	Crossover Frequency (Hz)	Impedance, Ohms	Enclosure Dimensions, W x D x H, In.	Wood Finish	Grille Material & Color	Weight, Lbs.	Price	SPECIAL FEATURES
		Diameter, In.	Resonance (In System), Hz	Enclosure Type	Diameter, In.	Type	Diameter, In.	Type												
SANSUI (46) (47)	SP 2002	12	-	-	5 6½	Cone Cone	(2) 1	Dome	35-20K	-	50	600 5,000	8	15 x 12¼ x 25½	Wal.	hand-carved fret-work	46	179.95	Elec. x-over terms; mid & hi conts; baffle damped with acetate acous. mat'l.	
	SP 1001	10	-	-	6½	Cone	1	Dome	35-20K	-	40	600 5,000	8	14 x 12 x 24½	Wal.	hand-carved fret-work	38½	139.95	As above.	
	SP-50	8	-	-	-	-	2	Horn	50-20K	-	25	7,000	8	12¼ x 19¾ x 9¾	Wal.	hand-carved fret-work	19¾	79.95	Baffle damped with acetate acous. mat'l.	
	SP-30	6½	-	-	-	-	2	sq. horn	50-20K	-	20	7,000	8	10¾ x 7¾ x 16¾	Wal.	hand-carved fret-work	10	119.95 pr.	As above.	
SCHÖBER	LSS-100	two 12's	30	Reflex	8	Cone	2 horn 1 horn		30-18K ±	1	100	150 1,000 3,500	8	32 x 16 x 54	Wal.	Tan Cane	150	499.50 kit	Highest efficiency, extremely low distortion, high power handling auditorium system.	
	LSS-10A	12	32	Reflex	8	Cone	Optional 1 horn		30-13K ±	2	40	250 3,500	8	24 x 16 x 34	Wal.	Tan Cane	60	180.00 kit	Optional tweeter to 18KC. High efficiency, extremely low distortion.	
SCOTT COVER II	Q-100	(2) 8	70	Acous.	-	-	(4) 3	Cone	38-20K	10	80	2,000	8	14¼ x 14¼ x 22	Wal.	Cloth, Dark Brown	37	149.95	Quadrant 360° full range. (Controlled Impedance)	
	Q-101	(2) 10	60	Acous.	(4) 4½	Cone	(4) 3	Cone	35-20K	10	100	800 4,000	8	17¾ x 17¾ x 22	Wal.	Cloth, Dark Brown	45	239.95	Quadrant 360° full range. (Controlled Impedance)	
	S-20	10"	60	Acous.	-	-	3½"	Cone	40-20K	7	50	1,200	8	20 x 11¾ x 11	Antq. Pecan	Cloth Red	21	109.95	Traditional scrollwork grille. (Controlled impedance).	
	S-15	10"	60	Acous.	4¼"	Cone	3"	Cone	35-20K	10	50	750 3,800	8	23¾ x 11¾ x 9	Wal.	Cloth dk. brn.	24½	119.95	(Controlled impedance).	
SHERWOOD	SR 4 Tanglewood	(2) 10	19	Air susp.	8 5	Cone Cone	¾"	Inverted Cone	22-22K	12	75	200 600 3,500	8	24 x 31½ x 13	Oil Wal.	Plas. Cane Nat.	73	219.50		
	SR 6 Ravonia II	15	19	Air susp.	5	Cone	¾"	Inverted Cone	24-22K	10	70	600 5,000	8	25 x 17 x 11½	Oil Wal.	Dark Wal. Tone	53	159.50		
	SR-5 Berkshire II	12	21	Air susp.	5	Cone	¾"	Inverted Cone	28-22K	8	60	600 5,000	8	24 x 14 x 9	Oil Wal.	Dark Wal. Tone	40	119.50		
SONY (28) (29)	SS-3100	12	25	Reflex	6½	Cone	2	Horn	30-20K	-	30	400 5,000	8	15¾ x 11¾ x 26¾	Wal.	Cloth, Black	55	229.50	Sep. sw. for multi-channel use.	
	SS-2800	10	30	Reflex	6½	Cone	2	Horn	40-20K	-	20	600 6,000	8	13¾ x 9¾ x 23¾	Wal.	Cloth, Black	35	124.50		
SOUND CRAFTSMEN	Lancer SC-6	12	-	Bass energ.	-	Diffuser	-	Flared Horn	18-22K	10	60	1,000 3,000	8	27 x 16 x 14¾	Oil Wal.	Cloth, Dark Red Consumer Changeable	57	219.50	Aerodynamic bass energized. 12" passive radiator, cont. var. h.f. contr.	
	Lancer SC-3x	12	-	Reflex res. loaded	-	Diffuser	-	Flared Horn	26-22K	10	60	1,000 3,000	8	23½ x 15¼ x 12½	Oil Wal.	Cloth, Dark Red Consumer Changeable	45	179.50	Cont. var. h.f. contr.	
	Lancer SC-5	12	-	Reflex	-	Diffuser	-	Flared Horn	28-20K	5	40	1,000 3,500	8	23¾ x 15¾ x 12½	Oil Wal.	Cloth, Beige	38	139.50	Cont. var. h.f. contr.	
	Lancer 9535-2	12	-	Reflex	-	-	2 x 6	Cone	30-20K	5	35	3,000	8	25 x 14¼ x 11¾	Oil Wal.	Cloth, Beige	34	89.50	Ducted port.	
TANNOY	Windsor GRF	15	Cut-off 35	Rear Horn Loaded	-	-	2½	Exp. Horn	35-20K ±4	15	50	1,000	8	23¾ x 17 x 42	Oil Wal.	Dec. carved wood; White cloth	120	477.00	Dyn. and freq. bal. control. Non-dec. model (GRF) \$420.00	
	Belvedere	15	54	Reflex	-	-	2½	Exp. Horn	38-20K ±5	15	40	1,000	8	23¾ x 16 x 33½	Oil Wal.	Cloth, Beige Neutral	80	307.00	Dyn. and freq. bal. control. Dec. model (Lancaster) \$366.00	



Wollensak A-200



University "Mediterranean"



Telex "Energized Stereo 70"



Wharfedale W90D

MANUFACTURER (Circled numbers Indicate adv. page)	Model	WOOFER		MID-RANGE		TWEETER		Overall Freq. Response, Hz to kHz ± 7 dB	Ampl. Pwr. for Avg. Room, W	Pwr. Handling Capacity (RMS Cont)	Crossover Frequency (fcs), Hz	Impedance, Ohms	Enclosure Dimensions, W x D x H, in.	Wood Finish	Grille Material & Color	Weight, Lbs.	Price	SPECIAL FEATURES	
		Diameter, in.	Resonance (in System), Hz	Enclosure Type	Diameter, in.	Type	Diameter, in.												Type
TANNOY (Cont'd)	Stuart	12	58	Reflex	—	2½	Exp. Horn	40-20K ±5	15	30	1,000	8	24¼ x 16¼ x 25½	Oil Wal.	Dec. carved wood; white cloth	55	294.00	Dyn. and freq. bal. control.	
	Mallorcan	12	68	Reflex	—	2½	Exp. Horn	45-20K ±5	20	30	1,000	8	23½ x 14¼ x 11½	Oil Wal.	Dec. carved wood; white cloth	45	219.00	Dyn. and freq. bal. control.	
TEAC (17)	LS-350	12	—	Inf. baffle	4	Cone	2	Horn	35-20K	—	40	700 5,000	8	16 x 25½ x 11½	—	—	41	—	
TELEX	4400	8	—	Acous.	—	—	3½	Cone	20-20K ±2	—	30	2,500	8	16 x 14 x 5	Wal.	Cloth. Brown	22 pr.	149.95	Two speaker cabinets with built-in 60W stereo power amp; phone jack.
	ES-70	—	—	—	6	Cone	—	—	40-15K	12 built-in	—	—	8	11½ x 11¼ x 5 ea.	Wal.	Cloth. Black	10 pr.	69.95	Built-in stereo pwr. amp; tone and vol. contrs.; phone jack; pilot lt.; low-and hi-Z inputs ea.
TRUSONIC	T112 FR	12	—	—	—	—	—	—	—	—	—	—	—	14 x 12 x 23¼	Oil Wal.	—	—	177.00	Incls. 12-in coaxial. Avail. with 12-in. extended-range spkr, 135.00
UNIVERSITY (67)	Mediterranean	12	—	RRL	8	Cone	4 x 2	Horn	20-Beyond Audibility	5	50	800 5,000	8	24¼ Dia. x 22½	Butternut	Cloth Beige	74	285.00	
	Laredo	12	—	RRL	8	Cone	2	Dome	30-30,000	5	40	600 1,500 3,000	8	24 x 15¼ x 12¾	Wal.	Cloth Brown	47½	119.95	
	Project M	11	—	RRL	—	—	2½	Cone	30-20,000	5	60	1,000	8	23½ x 12¾ x 11¾	Wal.	Cloth Beige	30	99.95	
	Ultra D	10	—	RRL	8	Cone	3½	Cone	30-Beyond Audibility	5	32	1,000 5,000	8	23¼ x 11¾ x 9¾	Wal.	Cloth Beige	24	79.95	
UTAH	AS-8	12	25	Acous.	4 x 10	Horn	1¾	Horn	35-20K	20	30	2,200 5,000	8	30 x 25½ x 12¾	Wal.	Cloth. Brown	60	189.00	Credenza; mid and h.f. controls.
	AS-6	12	25	Acous.	4 x 10	Horn	1¾	Horn	35-20K	20	30	2,200 5,000	8	25 x 14 x 13½	Oil Wal.	Cloth. Gold	49	120.00	As above.
	HS-4	12	45	Ducted Port	2 x 6	Horn	3½	Cone	30-18.5K	10	20	2,500 5,000	8	25¼ x 14 x 15	Wal.	Cloth Gold	46	94.50	Hi-freq. contr.; solid walnut frame.
	AS-1	10	25	Acous.	—	—	3½	Cone	32-18.5K	10	20	3,500	8	24 x 12 x 12	Oil Wal.	Cloth. Gold	41	79.95	h.f. cont.
WHARFEDALE (4) (5)	W90D	12	40	Acous.	5	Cone	3	Dome Dome	20 to inaud.	10	50	125 1,000 4,000	4-8	23¼ x 13½ x 30	Wal.	Cloth. Brn. pattern	100	340.00	6-spkr., 4-way sys.; sand-filled; div. bass. range.
	W80 Variflex	12	40	Acous.	5	Cone	3	Dome Dome	20 to inaud.	15	60	800 2,500 6,000	4-8	17¼ x 17 x 29	Wal.	All wood Front	85	289.95	Reflective sys.; var. acoustic dev.; use singly or as console.
	W70D Mark II	12	42	Acous.	8	Cone Cone	3	Dome	25 to 20K	10	40	175 1,250 5,000	4-8	22 x 13¼ x 24	Wal.	Cloth. Brn. Gold	73	211.00	Use hi or lo-boy; 4-way sys.; sand filled.
	W60D Mark II	12	45	Acous.	5	Cone	3	Dome	30 to 20K	8	40	1,000 3,500	4-8	14¼ x 13 x 24	Wal.	Cloth. Bk. Brn.	56	153.00	3-way sys.; sand-filled removable grille.
	W40 D	10	50	Acous.	5	Cone	3	Dome	35 to 20 K	8	35	1,250 3,500	4-8	12½ x 10¼ x 23½	Wal.	Cloth. Mix	37	111.25	Indiv. mid and treble contrs.; phase-comp. tweeter-diffuser contr.
	W30D Mark II	8	54	Acous.	—	—	3	Dome	40 to 18,500	10	35	2,000	4-8	10 x 9¼ x 19	Wal.	Cloth. Mix	22	69.95	Var. tweeter contr.; Replaceable grille.
	W20D	8	62	Acous.	—	—	3	Dome	45 to 18K	10	35	1,600	4-8	9¼ x 8½ x 14	Wal.	Cloth. Brn. Gold	14	52.95	Var. tweeter contr.; Replaceable grille.
3M/WOLLENSAK	A-2000	8	55	Acous.	—	—	1	Dome	40-18K	20	—	1,500	5	23 x 10¼ x 13¾	Wal.	Cloth Black	35	Under 150.00 Each	2 controls to voice the woofer in addition to the tweeter control; low/IM distortion.
	A-1000	4	100	Acous.	—	—	—	—	80-12K	10	14	—	8	8 x 5 x 13	Wal.	Cloth Black	4½	49.95	Pair
	A-1050	4	100	Acous.	—	—	—	—	80-12K	10	14	—	8	7¼ Cube on 5 High Pedestal	Wal.	Cloth Black	4½	79.95	Pair

180 WATTS *of* SANSUI POWER



SANSUI 5000A

180 watts of Sansui power are built into the 5000A—an AM/FM stereo receiver that has been created for the connoisseur who demands the ultimate in tonal magnificence and clarity of sound. The Sansui 5000A *features a new FM Pack with linear tuning for greater selectivity and pin-point station selection . . . All-Silicon AM tuner for maximum stability . . . inputs for three separate sets of speaker systems . . . records up to 4 tape decks simultaneously . . . just a few of the features which will make the Sansui 5000A the nucleus of your most comprehensive hi-fi music system for years to come. At your Sansui Audio Dealer. \$449.95*

Sansui® SANSUI ELECTRONICS CORP.

Woodside, New York, 11377 • Los Angeles, California 90007

SANSUI ELECTRIC CO., LTD., Tokyo, Japan • Frankfurt a.M., West Germany • Electronic Distributors (Canada), British Columbia

Q's and A's on LOUDSPEAKERS

Selected for general interest from enquiries received recently.

Q. What is meant by the efficiency of a loudspeaker system?

A. The efficiency of a loudspeaker system is the ratio of acoustic power to the electrical input. It is expressed as a percentage and it ranges from around 25% for large corner horns right down to 4% or even less for small bookshelf systems. (Not that bad when you consider that the efficiency of the human voice is only about 2%) Loudspeaker efficiency is directly related to amplifier power and in a room of average size you would need a minimum of 20 watts per channel for a low-efficiency system but only 10 watts per channel for a speaker of 8 to 10% efficiency.

Q. I have a pair of speakers that are too directional and I find I only get good stereo from one position in the room. Is there anything I can do to improve matters?

A. That stereo seat was all too common in the early days of stereo (Just listen to this record, no not in that chair—sit over here!) before the dispersion requirements were fully appreciated. If your speakers are fairly old, the best advice is to buy new ones. You could replace the treble units but many systems are difficult to disembowel without causing damage and then again—who knows what the frequency response will be like when you have finished? Much easier to add an external speaker, but before you try that why not angle the systems inward as shown in Fig. 1. This is called the "Hugh Brittain" arrangement and it works like this: a listener in the center of the shaded area will get good stereo as might be expected, but as he moves towards the left speaker he will also move into the axis of the right speaker. Thus the tendency of the nearer left speaker to sound louder will be offset by the increased intensity of the right speaker—and vice

versa. So, according to the theory, the stereo image will be central over a wide area. I have found that this arrangement can work very well indeed, especially with some of the more directional horn systems. Incidentally, Hugh Brittain was the designer of the first successful loudspeaker to use a metal cone—the British GEC model 1851.

Fig. 1—The "Hugh Brittain" arrangement.

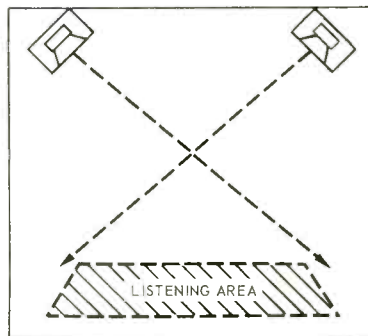

Q. I have often read that the transient response of a small bass speaker system is superior to that of a large one. How much truth is there in this?

A. First let us define the question and see what is involved. A loudspeaker in a closed box will have a natural resonant frequency, that is the frequency at which it will tend to vibrate if excited by an electrical signal or mechanical impulse. If the box is vented, then there probably will be two such resonances, the upper one (usually in the 80- to 150-Hz range) being the most prominent. If these resonances are not damped sufficiently the result would be that "one-note-bass effect" or a kind of hangover°. Damping is applied acoustically by the stiffness of the enclosed air in the box and electrically by the loudspeaker's magnetic system and to a lesser extent by the low output re-

*Also referred to as "overhang"—probably by writers more familiar with another context for "hangover."

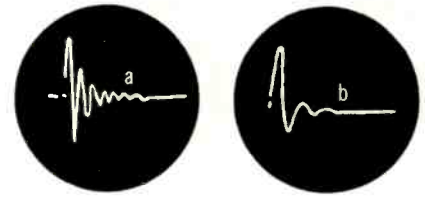

Fig. 2—Pulse waveforms.

sistance of the amplifier acting as a "brake." One way of testing the transient response is to apply a sharp electrical pulse to the loudspeaker and monitor the output with a microphone connected to an oscilloscope which gives a visual indication. Figure 2a shows what happens when a pulse is applied to a loudspeaker with hangover and it can be seen that the cone still keeps moving after the pulse has been switched off. Contrast this with Fig. 2b which shows the response from a well-damped system; as soon as the pulse is switched off, the cone comes to rest.

Now we will consider two bass systems, one with a big 15-inch woofer and the other using an 8-inch unit. A glance at the chart (Fig. 3) will show that the 8-inch speaker cone has to travel nearly 5 times the distance of the larger one to produce the same amount of sound (or move the same amount of air) at 30 Hz. This means that the magnetic field has to be much longer to accommodate the long excursions of the voice coil. However, providing this is done and the acoustic damping requirements are met then there should be no significant difference between the two systems as far as low-frequency transient performance is concerned. The small system will of course need more power to drive it and the long voice-coil traverse brings other problems. For instance, both the centering spider and cone surround have

(Continued on page 73)

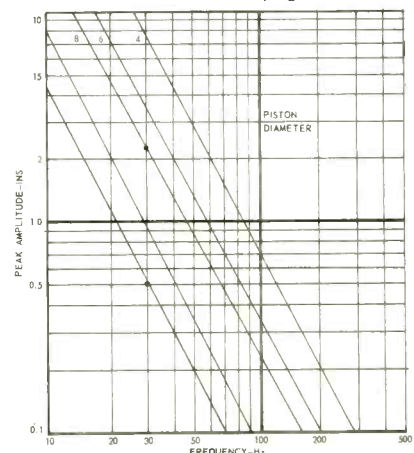

Fig. 3—Peak cone excursions vs. frequency (for 1 acoustic watt).



When you're #1 in tape recorders, you don't make the #2 tape.

If you've got a few hundred bucks tied up in a first-quality tape recorder, you're not going to want to gum up the works with second-rate tape. Especially when just a few extra pennies buy the finest Sony professional-quality recording tape.

Not only will Sony tape make any recorder sound its best, but it'll keep it sounding that way. Because our tape won't shed or cover tape heads with a performance-deteriorating oxide coating. Head-wear, too, is minimized, thanks to Sony's exclusive Lubri-Cushion process, which impregnates the tape with long-lasting lubricants.

Sony tape comes in all configurations: Open reel. Eight-track. Cassettes.

Open-reel tape is available in 3¼", 5", and 7" sizes. The new Sony SLH-180 low-noise, high-output tape is available on 7" reels only. And "Easy-Threader" tabs make every Sony open reel self-threading.

Our professional-quality tape is also available in eight-track stereo cartridges plus new Easy-Matic cassettes for both functional and stereo units, with 60, 90, or 120 minutes' recording time.

To hear the best, play the best. Sony Professional-Quality Recording Tape. From the people who offer the number-one line of tape recorders—Sony/Superscope.

SONY SUPERSCOPE

You never heard it so good.®

Equipment Profiles

This Month:

- Nikko Stereo FM/AM Receiver STA-501S
- Garrard SL-95B Automatic Turntable
- Shure V-15 Mark II Improved Phono Cartridge
- Pioneer T-600 Auto-Reverse Tape Deck

Nikko Sta-5015 stereo FM/AM Receiver



Fig. 1—

MANUFACTURER'S SPECIFICATIONS:

Tuner Section: IHF Sensitivity: 1.8 μ V. Image Rejection: over 45 dB Stereo FM Separation: over 38 dB @ 1 kHz. AM Sensitivity: 10 μ V for 20 dB S/N.

Amplifier Section: Power Output: 50 watts total IHF Music Power, 8-ohm load. Power Bandwidth: 20 to 20,000 Hz. Frequency Response: 15 to 50,000 Hz \pm 1 dB. Tone-Control Range: \pm 15 dB at 50 Hz (Bass) and 10 kHz (Treble). THD: Less than 0.8% at rated output; less than 0.3% at 10 watts, less than 0.2% at 0.5 watts. Input Sensitivity: Mag Phono: 2.8 mV; Tape Head: 1.8 mV; AUX: 1.2V into 250K-ohm load. Hum and Noise: Tape Head: -55 dB; Mag Phono: -60 dB; AUX: -65 dB.

General: Dimensions: 15 $\frac{1}{4}$ " W x 12 $\frac{3}{4}$ " D x 4 $\frac{3}{4}$ " H. Weight: 17.7 lbs. Price: \$189.95.

For an integrated receiver in the "under \$200.00" price class, this Nikko receiver offers a full measure of amplifier power and specifications, but somewhat less performance and quality in the FM tuner section. Getting away from the traditional brass or gold look of so many of its competitors, Nikko offers a front panel in matte black and silver trim, with highly legible white control markings. The dial-scale area offers only about five inches of actual calibration for AM

and FM frequencies, the rest of the opening being devoted to a large tuning meter surmounted by a long red stereo-indicator lamp. No logging scale is provided. The balance of the upper half of the panel consists of two huge knobs—one for tuning (coupled to a very minimal flywheel which, however worked very well), the other for signal-source selection.

The lower portion of the panel contains, starting at the left, a mode switch for listening to right or left channels through both speakers and for stereo or stereo-reverse operation. Next come two slide switches for tape monitor and loudness-contour insertion. Volume and balance controls are next, followed by scratch- and rumble-filter slide switches. Bass and treble

controls are of the dual-clutch-action type, enabling individual channel tonal compensation, if desired. A remote-speaker switch is next, so arranged that the main speakers are always operative unless a pair of headphones is plugged into the adjacent headphone jack. The power on-off switch is of the push-push type and becomes illuminated in bright red when power is applied to the receiver. A photo of the front of the receiver is shown in Fig. 1 and, although there seem to be no more controls than on similar products, the panel does tend to look a little crowded although this is a purely personal view.

Surprisingly, the rear panel, shown pictorially in Fig. 2, is a model of thoughtful organization. No less than three circuit-breaker buttons are provided, for instant re-set in the event of power-supply or speaker-line overload. One switched and one unswitched a.c. receptacle are followed by spring-loaded speaker-connection terminals. These terminals accept the stripped ends of speaker leads with no wrapping or tightening of screws required. When the terminal head is depressed, a small hole appears into which the end of the exposed wire is inserted. Releasing the terminal head results in a tight and permanent connection with virtually no possibility of shorted speaker leads from then on. FM and AM antenna terminals are similarly constructed, although for some reason the remote-speaker connection is made by means of phonotip plugs, which would have to be soldered to the speaker cables in question. A DIN tape-recorder socket in addition to the usual input jacks and a ground terminal completes the rear panel layout. The built-in AM antenna can be pivoted 90 degrees for best AM reception, a very welcome innovation for those who *must* position the equipment on the "wrong" wall.

(Continued on page 50)



Fig. 2. Rear Panel View

(Continued from page 48)

Removal of the metal cabinet in which the STA-5018 is supplied discloses a rather crowded parts layout, with most components mounted on p.c. boards of varying size and description. Interestingly, the metal cabinet has a permanent inter-lock power cord attached to it, which detaches from the unit whenever the cabinet is removed to prevent accidental shock when servicing the unit. This technique is often used with "hot chassis" designs, in which one side of the line voltage is electrically connected to the chassis itself. This is definitely *not* the case here, but because of exposed a.c. voltage points within the set, the designers thought best to provide this protection. An "inner" view of the chassis layout is shown in Fig. 3.

Measurements

The significant FM performance measurements of the STA-501S are shown graphically in Fig. 4. Note that the IHF sensitivity which we measured was $7 \mu\text{V}$. Ultimate signal to noise ratio was 58 dB, while THD in mono was 2.3% for full modulation, measured at $1000 \mu\text{V}$. In stereo, this figure increased to 2.8%. Signal strength meter readings were found to be quite meaningful on this set, unlike most such meters which reach full scale at only a few microvolts of input signal and are therefore of little use in gauging signal strength. In the case of this unit, a reading of 80% of full scale was reached with $1000 \mu\text{V}$ signal input.

Stereo FM separation is plotted in Fig. 5 and is considered acceptable at low and mid frequencies, though it does fall off rather sharply above 5 kHz.

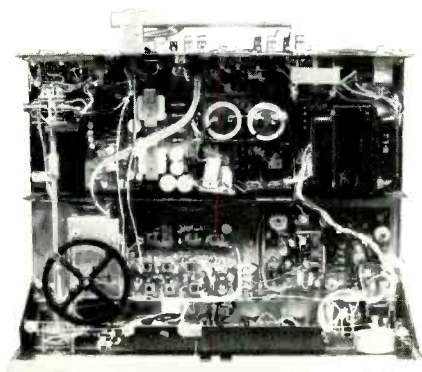

Fig. 3—Internal component layout.

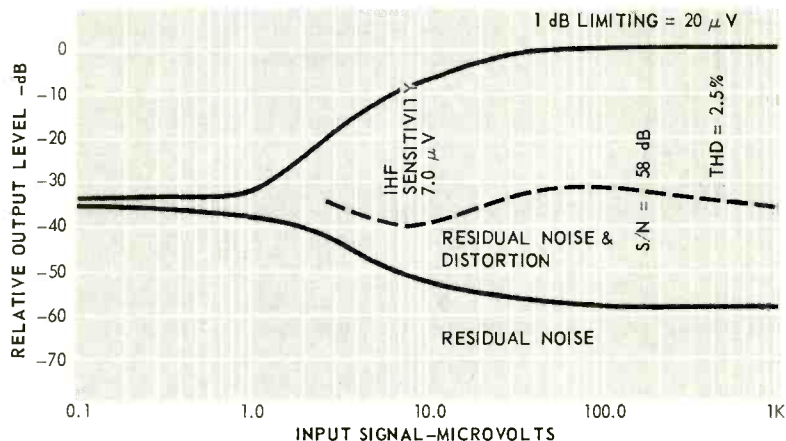

Fig. 4—FM characteristics.

Although no statement is made by the manufacturer regarding rms power output capability, we measured 1% THD at an output of 20 watts rms per channel with both channels driven. This seems reasonable in view of the music power figure of 25 watts per channel listed by the manufacturer. Of greater significance than the high power-output figures is the fact that there is little tendency for the distortion to rise at low power outputs either—a malady often found in today's less expensive equipment. At no power output below 15 watts did the THD exceed 0.2%. Results of these measurements are plotted in Fig. 6, along with IM distortion measurements which reached 1.0% at an output power of 17.5 watts, rms. Power bandwidth, based upon an rms power output of 20 watts, was found to agree nicely with manufacturer's claims, as shown in Fig. 7. Figure 8 is a graphic plot of tone-control action, loudness compensation and high- and low-frequency filters. The loudness-compensation curve was plotted at -30 dB from full volume settings and conforms well to accepted

practice in this feature. The filters, on the other hand, are very gentle, since they are of the 6-dB-per-octave type and do not significantly cut response within the passband desired. Hum and noise in the phono position was -60 dB , as claimed, while hum and noise in tape head and aux positions exceeded published ratings, measuring 60 and 72 dB respectively.

Listening Tests

As might be expected, the FM portion of this receiver did not quite come up to the more expensive models, this fact was confirmed when we tried to use the dipole supplied with the receiver. Whereas we normally are able to get between 35 and 40 acceptable signals in our near-city suburban location, this receiver picked up some 32 signals, of which about 12 were in acceptably noise-free stereo. With the application of a good outdoor antenna, the number of acceptable stations was increased to 40, of which 15 were broadcasting in stereo FM. One obvious deficiency noted was the rather poor limiting exhibited by this unit. "1 dB" limiting, as noted in Fig. 4, is

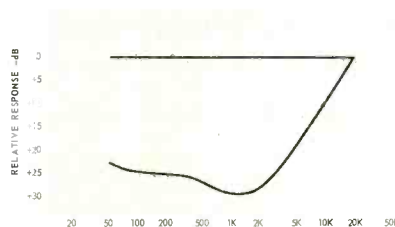

Fig. 5—Stereo separation.

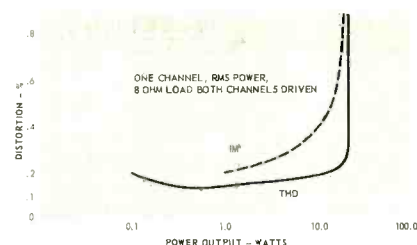

Fig. 6—THD and IM characteristics.

achieved at a signal input level of about $30 \mu\text{V}$. As a result, weak stations were received at considerably lower audio level than stronger stations, necessitating constant readjustment of the volume control when tuning from station to station. With the outdoor antenna in use, however, this condition was minimized, since nearly every signal received was greater than $30 \mu\text{V}$.

Gain and power output of the amplifier are such that the unit was capable of delivering ample power to a pair of inefficient air-suspension speakers in our medium-sized listening area. The addition of a second pair of speaker systems of similar construction, however, resulted in noticeable distortion when we tried to push the sound levels to what we consider "concert hall levels." If medium- or high-efficiency speaker systems were to be used, however, the STA-501 would be able to provide more than enough sound for just about anyone's listening tastes. Control action was

smooth and effective and transient response was good. Levels, too, were correctly set, so that switching from phono to FM resulted in almost equal levels. AM, however, was a bit "heavy" sounding, and seemed constricted in bandwidth even beyond that normally expected of the AM section of a receiver. Sensitivity of AM was excellent, however, considering the minimal circuitry employed.

When one considers this receiver in terms of price, one cannot overlook the fact that not too long ago an integrated amplifier, at 20 watts per channel, used to cost as much as this entire receiver. For metropolitan-area installations where reasonably efficient speakers are to be used, the Nikko STA-501S represents very good value for the price. Extended use did not disclose any undue heating of components, so that trouble-free service can be anticipated from this model. As for the aesthetics, they are, after all, a matter of taste.

Check No. 52 on Reader Service Card

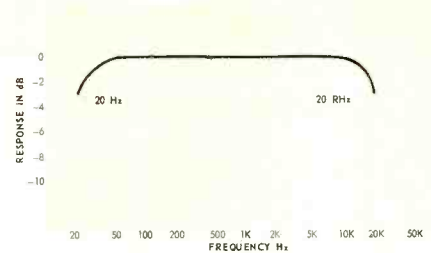

Fig. 7—Power-bandwidth curves.

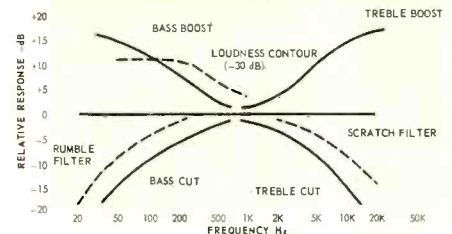

Fig. 8—Tone-control range and filter response.

Product Information

Simply complete the Reader Service Card (back of issue), noting the reader service number on advertisements and editorial material. We'll handle the rest.



Garrard Synchro-Lab 95B Auto Transcription Turntable

MANUFACTURER'S SPECIFICATIONS:

Speeds: Three— $33\frac{1}{3}$, 45, and 78 rpm. **Motor:** Synchro-lab (combination synchronous and induction to reach operating speed quickly and then maintaining exact speed). **Platter Diameter:** $11\frac{1}{2}$ in. **Wow & Flutter:** .07%. **Dimensions:** $13\frac{3}{8}$ x $12\frac{1}{2}$ in. (chassis alone). On base with dust

cover: $16\frac{1}{2}$ x $14\text{-}9/16$ x $8\frac{1}{4}$ in. **Weight:** 11 lbs. **Price:** \$129.50.

The SL-95B represents a gradual improvement over the SL-95, as is the usual custom of Garrard. To the eye, the principal change is the addition of a cueing control in the front right corner. This control is in the form of a vertical tab which raises and lowers the arm on command—forward to lift,

and a return to the vertical position to lower. Mounted on its new plastic base and fitted with the new "smoky" plastic dust cover, it is an elegant piece of equipment—one which could improve the appearance of practically any music center.

At the front left corner of the motor board is the speed control with its five positions—from left to right, the speeds are combined with record diameter settings as follows: 78, 12 in., 45, 7 in., 33, 12 in., 33, 10 in., and 33, 7 in. Since the 10-in. LP record has become obsolete, the need for automatic selection of record diameters has diminished, and is really only necessary if the user has a large collection of the older 10-in. LP's which he wishes to play intermixed with the current 12-in. disks. At the right front corner are the three-tabs which control the operation of the unit. From left to right, they are: Auto start and stop, with the start position serving as a reject control; Manual, off and on; and the previously mentioned cueing control which raises the arm or lowers it without moving it laterally.

The arm itself is an aluminum channel damped with a strip of wood. It is

We put a little more feature into each feature.

The Miracord 50H not only offers more features than any top quality automatic turntable on the market, but each feature offers more. Here's what we mean.

■ Two worthy competitors offer a kind of synchronous motor. Neither motor, however, can qualify as a hysteresis synchronous motor. And, neither is a Papst hysteresis synchronous motor. The Papst is the one used in professional studio record-playing equipment. The Miracord 50H uses the Papst hysteresis synchronous motor with outer rotor for unvarying speed accuracy, regardless of the voltage or load fluctuation.

■ When examining the cueing feature, be sure to ask whether cueing works in both automatic and manual modes. Because, in automatic, where one leading automatic turntable doesn't work, cueing represents the ideal device to interrupt play for just a moment when there are a stack of records on the spindle. The Miracord 50H provides silicone-damped cueing in both modes.

■ Stylus overhang adjustment is essential for optimum tracking. Another automatic turntable does feature this adjustment, but it's internal and difficult to set. The Miracord 50H offers external overhang adjustment with built-in gauge — no shifting, no guess work, no templates. You can line up your stylus in seconds accurately.

■ Now here's the feature no one has. Those light touch pushbuttons that make it so easy for you to enjoy all of those other wonderful Miracord 50H features. The pushbuttons provide sim-

ple, foolproof operation. For example, the 50H is the only automatic changer that can go from manual to automatic or vice versa without re-setting.

■ Over the past few years, Miracord 50H has proven its reliability and enhanced its position of leadership by its superb performance in thousands of home music systems. The finest automatic turntable available today costs \$169.50. At leading hi-fi dealers.

Benjamin Electronic Sound Corp., Farmingdale, N.Y. 11735, a division of Instrument Systems Corporation.

Miracord 50H



mounted at an angle in a metal ring which is, in turn, is pivoted vertically. The arm, with the cartridge mounted, is balanced with a counterweight at its rear—sliding for large adjustments, and using the knurled knob at the back for final accurate balancing with the stylus-force control set at “0” grams. The proper stylus force is then dialed in with a thumb-wheel under the arm to the desired force as indicated by a line against a scale calibrated directly in grams. The range of force is from 0 to 5½ grams, with click stops indicating quarter-gram intervals, and is provided by a spring under the arm. A sliding weight is then moved along the anti-skating-force arm at the right of the arm base to the same indicating number as the stylus force.

Three additional adjustments are provided on the arm, and while rarely used, their presence indicates good design, since these adjustments are important, even though rarely changed. One of them adjusts the height of the arm in the lifted position so the stylus will clear the top record on a stack of played disks (maximum of six). A second adjustment sets the maximum height the arm will reach, and this is set so the top of the arm will not touch the bottom of the lowest record on the automatic changer spindle when the machine is used as a changer. The third adjustment sets the radius at which the stylus lowers to the record surface. Once this is set for the 12-in. position, the other two positions will be correct.

The high-impact plastic base is attractive in itself. Besides being perfectly fitted to the motor board, it provides two compartments for extra spindles. Both have hinged covers, and the forward compartment accommodates the automatic and single-play spindles, while the rear one is designed to hold the 45-rpm adapter. In case the user plans to mount the unit on a base of his own construction or in an existing cabinet, spring clips are provided, along with mounting screws, to hold the 45 adapter, and to hold the automatic and single-play spindles. The base is fitted with cork-compound pads to protect the surface on which it is placed as well as to provide some high-frequency isolation.

The dust cover is strikingly attractive and provides for two ways to

permit access to the platter to load the machine or to change records. If the unit is installed in shelves, the cover is simply pulled forward in the molded troughs in the base and removed. If used on a table top or if sufficient space above the turntable is available, the cover is lifted upward to gain access to the mechanism. It remains tilted upward at an angle of about 45 deg. until released by a gentle push forward. The dust cover, and the back plate which fits into slots in the molded base, represent a unique design, since there are no hinges, no holding arms or levers—only the single spring which holds the cover in the raised position.

Performance

The SL-95B performed about as we expected from our earlier experience with the Garrard line. Speed was exact when driven by a 60-Hz source, and varied with frequency when driven by a variable-frequency source, as would be indicated when a synchronous motor is used. There was *no* speed variation, however, from 85 to 135 volts, and since the only likely variation in supply parameters is voltage, the unit's constancy is all that anyone would want.

Wow-and-flutter measured .07 per cent in the range from 6 to 250 Hz, which is right up to specifications. In the range from 0.5 to 6 Hz, the figure was 0.12 per cent which is reflected in the overall flutter figure—0.5 to 250 Hz—with the same measured value. The rumble figure was somewhat better than the previous models of the SL-95, and well above average for automatic turntables of conventional drive. This value measured 41 dB below a peak stylus velocity of 5 cm/sec at 1000 Hz, unweighted, and a comfortable -59 dB with the “A” weighting network. The turntable performance was measured using a Shure V15 Type II improved cartridge, and arm resonance with this cartridge measured 8 Hz. Cycling time at 33 rpm was measured at 10 seconds from the time of cycle activation until music started on the next record, which is remarkably fast for a high-quality turntable.

The new Garrard SL-95B is undoubtedly the best turntable that has been produced in this line so far. It is extremely attractive with its base and

dust cover, both of which are optional accessories, and it performs superbly. In over twenty hours of use, the unit performed flawlessly, with never a fault in its changing operations during that time. Naturally, we cannot test any equipment to destruction and still produce a number of profiles each month. However, Garrard's reputation practically guarantees continued high-quality performance for years, and any user should be completely satisfied with this model, which represents the culmination of many years of turntable manufacture.

Check No. 54 on Reader Service Card

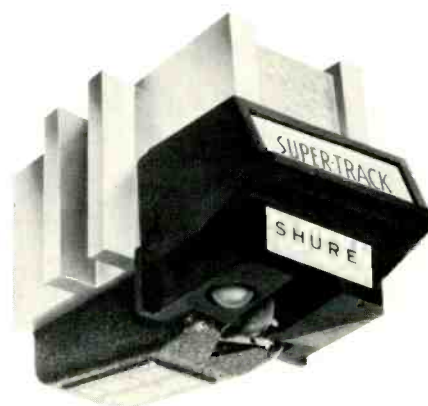

Shure V-15 Type II (Improved) Stereo Phono Cartridge

MANUFACTURER'S SPECIFICATIONS:

Frequency Response: 20 to 25,000 Hz. **Output Voltage:** 3.5 mV per channel at 1000 Hz. **Channel Balance:** Within 2 dB. **Tracking Force:** ¾ to 1½ grams. **Input Impedance:** 47,000 ohms (nominal); can be used up to 70,000 ohms without audible change in response. **Inductance:** 720 mH. **D.C. Resistance:** 630 ohms. **Typical Trackability at 1 gram:** 400 Hz—28 cm/sec; 1000 Hz—35 cm/sec; 5000 Hz—30 cm/sec; 10,000 Hz—22 cm/sec. **Stylus:** Elliptical diamond, .0002 x .0007 in. radii. (.0007 spherical stylus available on V-15 Type II-7). **Weight:** 6.8 grams. **Price:** \$67.50.

The Shure line of cartridges has improved and improved over the years since its introduction of the monophonic “Dynetic” which was introduced in 1957. The “V-15” of a year or so ago was a big step forward, to be followed by the Type II, which has been a standard for some time. Now they have introduced the “Improved” V-15 Type II, and it does exhibit a

PE
E PE PE
PE PE P
E PE PE
PE PE PE
E PE PE PE
PE PE

PE
E PE PE
PE PE P
E PE PE
PE PE PE
E PE PE PE
PE PE

PERfection
in
PERformance



The one automatic turntable that stands out — feature for feature PE automatic turntables stand alone: Dial-a-Matic vertical tracking angle adjustment . . . Gentlest, fingertip cueing action . . . One-Lever Control . . . Fail safe stylus protector . . . Automatic record scanner. Awarded "DIN" Seal of Excellence for PERfection in PERformance. Get a demonstration on the world's gentlest automatic turntable at your PE dealer, or send for details: Elpa Marketing Industries, Inc., New Hyde Park, N.Y. 11040. 



PERfection in PERformance

number of improvements, primarily to the ear rather than to measuring instruments. To the eye, the only apparent difference is the possibly shinier housing and the red lettering of "Shure" and "Super-Track" instead of the black on the earlier model. But then, the principal use to which we put phono cartridges is to *listen* to them rather than to *measure* them—a procedure which is complicated, even if you already have the equipment.

Before doing any listening, however, we first went through the usual measuring procedures, comparing an original "unimproved" V-15 Type II with the "improved" model. Let it be said here and now that both channels of each cartridge came within less than 0.5 dB throughout the entire range from 20 to 20,000 Hz when playing a CBS Labs STR-100 test record. And from 20 to 8000 Hz, both cartridges measured alike within 1 dB. The "improved" cartridge followed the same general curve shape above 8000 Hz as did the original Type II, but reached some 4 dB higher in response at 20,000 Hz. Both models showed a dip starting from 1000 Hz and reaching a maximum of 4 dB at 8000 Hz, which is not at all unusual with cartridges. To obtain the curves shown in Fig. 2, the cartridge outputs were fed singly through an equalized preamp consisting of an N5709T Signetics integrated circuit with suitable equalization so as to follow the RIAA curve throughout the spectrum, except that there is no "rolloff" above 1000 Hz as would be required for a phono pre-

amp. This test amplifier deviates a maximum of 0.8 dB from the RIAA curve at frequencies below 50 Hz. Thus it should provide a curve which is essentially a straight line from 20 to 20,000 Hz when playing the STR-100 test record with one exception. The record is cut with a curve represented by two straight lines which intersect at 500 Hz—below that frequency the record drops off at 6 dB per octave, while above it is flat. Thus the output cannot be flat when played through an amplifier which is compensated—as is the usual case—with RC networks, since they invariably cause a curvature at the intersection, resulting in a "bump" in the output of about 3 dB at 500 Hz. A shunt resonant circuit across the output of the test preamp was used to eliminate this bump. This circuit consisted of an inductance of 100 mH, a capacitance of 1.1 μ F, and a resistor of 68 ohms. This was placed across the output of the equalized preamp after its output resistor of 100 ohms, and before feeding into the a.f. voltmeter level-setting network of 10,000 ohms. All of this circuitry is shown in Fig. 3. The net result is to provide a flat response across the range of the "bump" caused by the recording curve in the STR-100 record.

Channel separation is also shown on Fig. 2, and ranges from 13 dB at 20 Hz to 25 dB at 50 Hz, and then remains around 25 to 2000 Hz, at which point it decreases gradually to 15.5 at 18,000 Hz, then increases slightly to 19 dB at 20,000 Hz. Since

a level change of 6 dB is completely adequate to move the apparent source of the sound from one speaker to the other, this separation (which is the result of measurement rather than specification) is excellent. Output measured 0.93 mV for a stylus velocity of 1 cm/sec at 1000 Hz.

Listening Tests

After several hours of comparative listening between the "improved" and normal V-15 Type II cartridges, we are convinced that the new one is easily capable of handling higher stylus velocities than were possible heretofore. This is noticeable most readily in the type of music of which this observer is not likely to be in the habit of playing. Most classical music is recorded with a reasonable level, and in fact, we have rarely measured any classical recordings which exceeded a maximum stylus velocity of 20 cm/sec. On the other hand, we have measured velocities as high as 44 cm/sec on some of the louder "rock" records, and on these, the improved V-15 sounded much cleaner than did the older cartridge, and this was with a stylus force of 1 gram, which is sort of a median between the manufacturer's recommended "3/4 to 1 1/2 grams" of stylus force. Thus the V-15 Type II Improved cartridge is strongly recommended to all who are likely to play those recordings which are likely to be cut at the maximum stylus velocities.

Check No. 56 on Reader Service Card

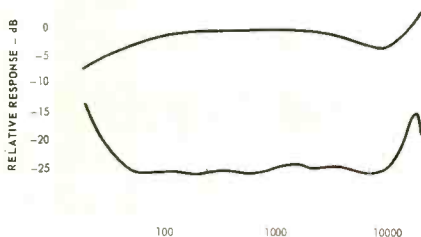

Fig. 2—Frequency response.

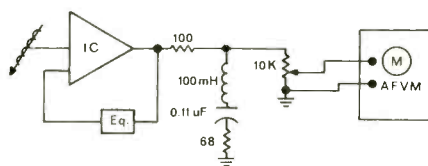

Fig. 3—Network used.

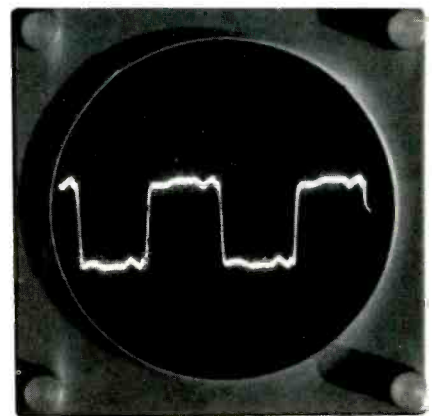

Fig. 4—Square-wave performance.

Introducing...

A NEW PINNACLE OF PERFECTION in stereo listening

KENWOOD

KR-7070

FM/AM STEREO RECEIVER



Featuring... **NEW 3-WAY FM/AM TUNING CONVENIENCE:**

Automatic Station Selector; Remote Automatic Control and Manual Tuning; Exclusive Automatic Tuning Circuit selects only FM stereo station

NEW OUTSTANDING TUNER SECTION:

4 ICs and Crystal Filter FM IF Stages deliver superb selectivity and 1.5 dB capture ratio; 3 FETs, 4-gang Tuning Condenser FM Front-end provides superior sensitivity and spurious response ratio

NEW DYNAMIC AMPLIFIER SECTION:

300 watts (IHF) power output to drive any low efficiency speakers; 2 dB Step-Type Tone Control and Presence Control for best sound

OTHER FEATURES include:

- FET, Mechanical Filter AM Tuner Section
- Interstation Muting Circuit to suppress interstation noise
- 2 pairs of PHONO Input Jacks for 2 sets of record players
- Front Panel Tape Dubbing and Headphone Jacks
- 20 dB Muting Switch for temporary quietness
- Exclusive low level Phono Inputs for low level Output Cartridges, the output of 2mV, .6mV, .06mV
- Separate Pre-amplifier Outputs and Main Amplifier Inputs
- 2 pairs of stereo speaker Output Terminals for 2 sets of stereo speakers and Front Panel Speaker Selector Switch
- Exclusive Power Transistor Protection Circuit (U.S. Pat.)

the sound approach to quality

For complete specifications write to:



15711 So. Broadway, Gardena, California 90247
69-41 Calamus Avenue, Woodside, N.Y. 11377



PIONEER Model T-600 Stereo Tape Deck

MANUFACTURER'S SPECIFICATIONS:

Drive and Control: Center-capstan drive mechanism with automatic reverse in record and playback by sensing foil, or manual operation. **Motor:** Hysteresis synchronous motor. **Reel Size:** 7 inch, maximum. **Heads:** 2 4-Track 2-channel heads for recording and playback, 2 heads for erase. **Tape Speeds:** 7-1/2 and 3-3/4 ips. **Fast Winding Speed:** Approx. 110 seconds for 1200 feet of tape. **Wow and Flutter:** Less than 0.12% rms at 7-1/2 ips; less than 0.20% rms at 3-3/4 ips. **Frequency Response:** 30-20,000 Hz (50-15,000 Hz \pm 3dB) at 7-1/2 ips; 30-13,000 Hz at 3-3/4 ips. **Signal to Noise Ratio:** 50 dB. **Transistor Complement:** 18 Transistors and 8 diodes. **Power Source:** 110, 117, 130, 220, 240 volts a.c. **Maximum Power Consumption:** 80 VA, 73 watts. **Overall Dimensions:** 17-1/4" W \times 17-1/8"D \times 7-7/16"H. **Weight, Unpacked:** 31 1/4 pounds. **Price:** \$300.00.

From Pioneer comes a useful and easy to use 4-track self-reversing deck in the medium price class, which meets its fine specifications without a hitch. The most significant feature of this machine is its quick reversing capability which assures a minimal loss during the change cycle while recording. Many decks have automatic reverse during playback, but so far, relatively few provide for doing it in record too. The advantage of auto reverse during recording is that we won't ruin a recording nor run out of

tape because the automatic reversing takes place faster than anyone can manually flip the reels round for a second pass.

The Model T-600 is a one-motor machine, reliably engineered to drive both turntables, capstan/flywheel, and tape counter—all at the right time with the proper force. The motion is transmitted via neoprene rubber belts, as shown in Fig. 1. A stepped pulley, driven by a hysteresis synchronous motor, simultaneously drives a capstan/flywheel and both turntables. The turntables are driven by the belts via clutches. Speed change is accomplished by shifting the capstan belt to

a different portion of the pulley. A spare 50-Hz pulley is supplied with the deck, should the user wish to use it in parts of the world where the line frequency is 50 Hz. Input voltages are also selectable, so this machine can be used with any kind of a.c. power. The four-digit tape index counter is driven by the supply turntable via neoprene belts.

The head arrangement shown in Fig. 1, is uncluttered and cleverly designed. Four heads and associated guides are mounted on a solid 3/32 metal plate, two on each side of the capstan. The outer two are erase heads, working one in each direction when recording. The same goes for the remaining record/reproduce heads. The pressure roller, two stationary guides and a protective cover swing completely away for threading. The two small guides, one on each side of the pressure roller, ensure good head contact and minimize flutter. A spring-loaded, counter-balanced and damped pin-guide, which swings at the incoming stationary guide and another at the outgoing side also act as the sensing posts for reversal. One advantage of the centrally mounted capstan pressure roller assembly is that regardless of which direction the tape is traveling, it is being pulled across the recording/reproduce head and not pushed along as on some other reversing machines. Thus, a more even tape motion and better head-to-tape contact is likely. Another nice feature is the way in which the direction of tape travel is reversed manually. See Fig. 1. Simply press one of the arrows and that's all there is to it! Tape direction

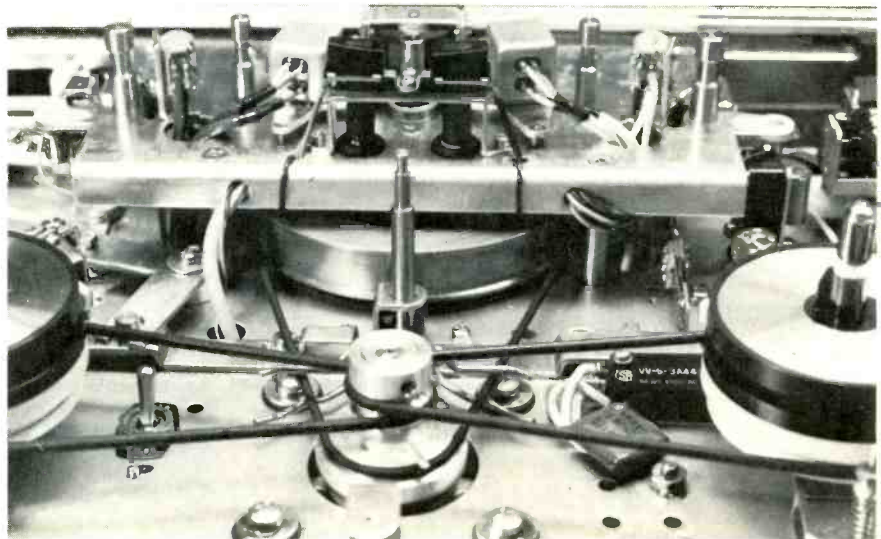

Fig. 1—Rear view, showing drive arrangement.

You Hear 3 More Octaves In The Sound Of KOSS



MODEL ESP-7 ELECTROSTATIC STEREOPHONES at \$79.00

Now get the thrilling reproduction of super-wide range, fatigue-free music at even lower cost than some conventional dynamic headphones. The latest addition to the breakthrough development of electrostatics by Koss is the lightweight Model ESP-7 at only \$79.00. Better than any speaker system, you feel, as well as hear, the thunder of the 64 foot pipes of an organ. You experience the living, breathing reality of your favorite vocalist, the sparkle and tinkle of the celesta, crystal-like clear, with veritably measureless distortion.

MODEL ESP-7

Electrostatic Stereophones complete with SE-7 energizer and individual machine-run response curve.
\$79.00

The ESP-7 connects to the speaker terminals of any good amplifier easily, quickly. It is self-powered by a small energizer in line with the cord containing convenient switch to mute the speakers, containing the matching transformers, and provision for a second headset (Model ESP-A, \$59.00) for simultaneous listening by two people.

As with all Koss Electrostatic Stereophones, the frequency response is so outstanding that each headset comes with its own individual, machine-run response curve. Write today for catalog of Electrostatic Stereophones containing full information on the new ESP-7, ESP-6, and astounding new ESP-9 Studio Monitor Stereophones. Or better yet, visit your hi fi dealer and ask for a demonstration of The Sound of Koss.

SPECIFICATIONS

Frequency Response Range, Typical: 35-13,000 Hz \pm 6 db (8½ octaves) 30-15,000 Hz \pm 8 db. An individual machine-run response curve accompanies each headset attesting to subscription to specifications.

Sensitivity: 90 db SPL at 1 kHz referred to 0.0002 dynes/cm² with one volt at the input. Total Harmonic Distortion: Less than ¼ of 1% of 110 db SPL. Isolation From External Noise: 40 db average through the audible range. Source Impedance: Designed to work from 4-16 ohm amplifier outputs. Power Handling Capability: Maximum continuous program material should not exceed 10 volts (12 watts). External Power Requirements: None.



KOSS

KOSS ELECTRONICS INC.
2227 North 31st Street
Milwaukee, Wisconsin 53208
KOSS ELECTRONICS S. r. l.
Via Bellini 7/Nova Milanese, Italia



is indicated by one of the two illuminated arrows. It's interesting to note that regardless of which direction the machine is set, when shut off, it re-sets to go to the right whenever power is first applied. So much for reversing.

Electronically, the deck is produced in the fine construction tradition of Japanese manufacturers. See Figs. 2 and 3. The electronic components are well laid out, fastened, and neatly interconnected, adding to the compactness of the deck. One gets the distinct feeling of un-crowding, however, with lots of space inside and all around. The reason for the deck's size seems to be the spread of the controls rather than the need for component space.

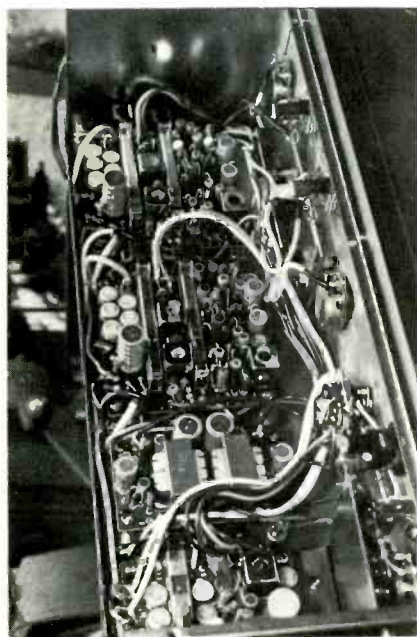

Fig. 2—View of electronics chassis showing the four printed boards.

Considering the reversing capability of the unit, we were pleasantly surprised at its overall simplicity of operation. Aside from the convenient and effective reversing controls, the deck has only five more knobs and two VU meters, all intuitively placed and positive acting. It was a pleasure to operate this unit.

We tested the T-600 using Scotch 150 tape, on which it seems to work best as adjusted from the factory. The playback frequency-response curves are shown for both directions (therefore, both heads) at 7½ ips, in Fig. 5, averaging 50-15,000 Hz ± 2 dB. The playback signal-to-noise ratio, referred to 0 VU of the standard Ampex

alignment tape, was measured at 61 dB forward and 55 dB in reverse. 55 dB is excellent and 61 dB is phenomenal.

In record/reproduce the signal-to-noise ratio, again referred to 0 VU, was 50 dB, just as specified. The frequency response is shown in Fig. 6 and 7 for the two speeds, and they are within 0.5 dB in both directions. It averages out as follows: 50-15,000 Hz ± 2 dB at 7½ ips and 50-9,000 Hz ± 2 dB at 3¾ ips. Both heads are very similar, insuring uniform good response in both directions. Wow-and-flutter was also well within specifications, at 0.08 and 0.175% rms at 7½ and 3¾ ips, respectively. We measured the distortion of the 80-kHz bias oscillator at 0.08%, which is pretty good in this class. Third-harmonic distortion at 0 VU measured 0.8% at 7½ ips and 1.5% at 3¾ ips, which is average. Fast forward and rewind of a 7" reel of 1200 feet of tape was accomplished in 120 seconds, which is slow but even. The machine is relatively quiet while operating. The fixed output yielded 0.65 volts out at 0 VU, 700 Hz, while the maximum available signal out of the variable output is 1.5 volts. The deck was fun to use and came up with nice recordings off the air, from records, and using microphones. It was never temperamental and the tape never once got away from us. It's the sort of machine we wouldn't mind getting stranded in the dark with. We think it's a fine value and recommend it highly for 4-track use in medium priced systems.



Fig. 3—Close-up of a record/replay circuit board.

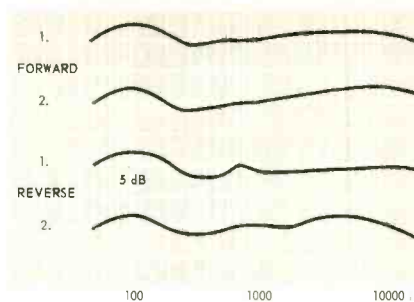

Fig. 5—Frequency-response curves at 7½ ips.

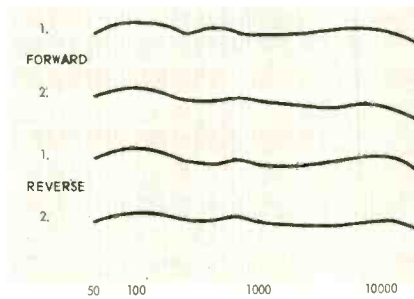

Fig. 6—Frequency-response curves at 3¾ ips.

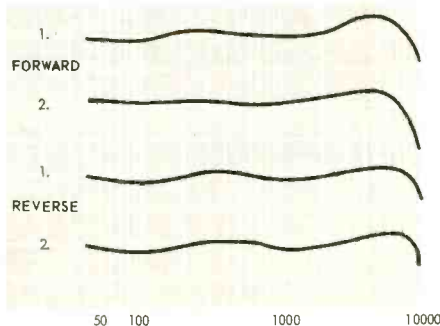

Fig. 7—Frequency response curves at 1¾ ips.

Check No. 60 on Reader Service Card



*On a
clear day
you can hear
forever*

CS-63DX



CS-99



To hear forever is to hear it like it is. Exactly. Uncolored. Unadulterated. It's simple to say, but not quite so simple to achieve. Nevertheless, it has been achieved by Pioneer. Meticulous design and coordination of speakers, crossover networks and cabinets result in two superb speaker systems of unrivaled capability and sound reproduction. Further, they're designed with you in mind. Since no two rooms are acoustically identical, these systems incorporate a compensating tone control to match the units to your specific environment. Twin 3-step controls can be adjusted for both middle and high

frequencies. Combine this refinement with an air suspension enclosure lined with resonance-free, sound-absorbing material, plus advance design speakers in a handsome oiled walnut cabinet with a contemporary latticework grille and you realize instantly why these systems are called the Outerformers.

Both the CS-63DX (4-way, 6-speakers) and the CS-99 (5 way, 6-speakers) are the culmination of three decades of brilliant audio research on the part of Pioneer—the world's largest producer of quality speakers. Here them today at your Pioneer dealer.

CS-63DX

CS-99

	CS-63DX	CS-99
System	4-way, 6-speaker	5-way, 6-speaker
Speakers	15" woofer; (2) 5" mid-range; horn tweeter; (2) super horn tweeter	15" woofer; 5" mid-range; horn tweeter; cone super tweeter; (2) dome super tweeter
Frequency Response	20-22,000 Hz	25-22,000 Hz
Crossover Frequency	770 Hz, 3300 Hz, 12,000 Hz	600 Hz, 4,000 Hz, 7,500 Hz, 14,000 Hz
Dimensions	18 $\frac{7}{8}$ " (W) x 28 $\frac{3}{8}$ " (H) x 13-1/16" (D)	16" (W) x 25" (H) x 11-2/5" (D)
Price	\$259.00	\$215.00

Specifications in common: Enclosure: Infinite baffle; Impedance: 8 ohms; Maximum Input: 20 watts (1HF)

PIONEER[®]

PIONEER ELECTRONICS U.S.A. CORPORATION, 140 Smith Street, Farmingdale, New York 11735 • (516) 694-7720
West Coast: 1335 West 134th Street, Gardena, Calif. 90247 / (213) 323-2374 & 321-1076 • In Canada: S. H. Parker Co., Province of Ontario



Check No. 61 on Reader Service Card

Classical	62
Light Listening	70
Jazz	74
Tape Reviews	78

Classical Record Reviews

EDWARD TATNALL CANBY

E. Power Biggs. The Organ in Sight and Sound. With book. Columbia KS 7263 stereo (\$6.98.)

Eleven years ago, that dashing organist and commentator E. Power Biggs put out a monumentally breathless Columbia album called "The Organ" in which, via his own spoken commentary and musical examples (played by himself) from organs all over Europe, he traced the history and importance of the classic instrument and made clear his very definite feelings about the desecrations perpetrated by nineteenth century organ designers of the Romantic school. As we all know, the Biggs enthusiasm did much to spark the present popularity of the classic, or Baroque, organ. Hundreds of recordings have made it known everywhere. Hundreds of churches know all about it too—they have had to spend thousands on new organs, or extensive rebuildings, in order to give their instruments the current "Baroque" sound.

Now the ever-indefatigable Mr. Biggs has done it all over again. Outwardly it is the same album, covering approximately the same ground in the same way. But I got out my copy of the earlier release and was astonished to find how thoroughly the work has been revised, word for word, example for example. Virtually all of the music is now offered in stereo recordings, though a few useful items out of the old mono set have been included here and there, or perhaps replayed in stereo sound. The big book, too, is extensively revised, using much of the original exhaustive material and illus-

trative matter but recast in every detail. D. A. Flentrop, the contemporary Dutch organ builder, writes an expanded text here, and some of the lesser earlier material is dropped out. Good. (Mr. Biggs' "home" organ in Cambridge, Mass. is, needless to say, a Flentrop.)

In this new album E. Power is just a shade less voluble and effusive than in the earlier opus, which moved at such a pace that one was soon out of breath merely listening. I remember objecting heatedly to the fading out of one musical example after another; perhaps I am more resigned to the technique by now, for it did not bother me as much as before though from a musical viewpoint the excerpts are still outrageously short. Often no more than a few seconds long. At Mr. Biggs' pace, and with his coverage, longer examples could never suffice! If you want to hear more, then go out and buy organ records, he would surely say. His records. There are plenty of them.

Record and book are well coordinated, each doing for the whole what is best for the medium, sound or the printed page. The record gives a bird's eye view, the book goes into panoramic detail on visible principles of organ construction. Invaluable, I'd say.

Performances: B- *Sound:* B

Historic Organs of Italy. E. Power Biggs. Columbia MS 7379 stereo (\$5.98.)

Mr. Biggs' assorted *safari* into organ territory continue unabated. He has long since done up the prime organ country, North Germany and surrounding lands including Holland. Here, he turns to slightly alien ground (from the organ viewpoint) to show us that even the Italians could build nice little classic organs when they put their minds to it. Just like the Spaniards (bigger, more complex instruments), whose products he has recently been

sampling.

There are five organs here, one of them dating from unmentionable 1857, about which Mr. Biggs says nary a word. The oldest has a much more distinguished dating, 1471-75; it is one of a pair located on opposite sides of the chancel in the huge Basilica at Bologna. This pair has been extensively recorded before on another label, both playing together in music for two organs. Mr. Biggs samples each separately. Then there is a splendid instrument at Brescia (where Italian motor traffic made the going difficult) and another at Ravenna. The unmentionable "modern" instrument is at Bergamo. It plays only a minute or so.

The music is mostly pre-Baroque, or very early Baroque, such composers as Gabrieli (both), Frescobaldi, Banchieri, Gesualdo (of the strange madrigals), all Italians of the region. Mr. Biggs' playing is of his familiar somewhat nervous sort, often beautiful but often rather pounding and unphrased. He is better at imaginative registration than in the shaping and phrasing of musical lines. The organ sounds are recorded with felicity except the sound of the pair at Bologna where the enormous reverberation lasts seven or eight seconds or more. Perhaps because of this, the Columbia recording is done close-up, the grand effect of that long "echo" barely audible in the background in favor of too much clarity of detail. The double-organ recordings of the same sound on the other label—Westminster, if memory serves—hit it off much more successfully to my way of thinking. There, you can hear both the organs *and* the reverb. The other Biggs organs sound just fine.

Performance: B- *Sound:* B

The Glory of Gabrieli, Vol. III. Choral Music. Gregg Smith Singers, Texas Boys Choir, Smith, Bragg. Columbia MS 7334 stereo (\$5.98.)

Volume III of the recordings made awhile back in Saint Mark's Cathedral, where Gabrieli (Giovanni) wrote the music around 1600, supplements the first two volumes. Vol. I combined choirs and instruments, Vol. II was all-instrumental, Vol. III is for voices alone. All, of course, featuring music for multiple groups of performers, that

being the Gabrieli specialty as of the Cathedral itself, where performers were isolated on balconies surrounding the great pillars that hold the building up. Most of the original music did not specify instruments or voices; the choice was according to taste and circumstance and still is. Some of the definitely instrumental works are included in Vol. II.

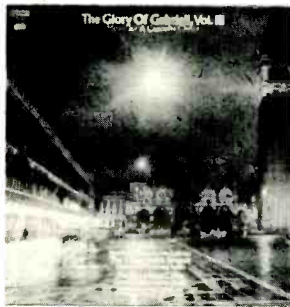

The combined choirs, Americans flown over to Venice in grand style for the occasion (the Italians ignore their own heritage in true provincial fashion!) produce here, as in the earlier Vol. I, a somewhat American sound though a suitable one for the music, a bit on the brash and loud side, confident, well-trained, rather muscular and not very subtle in the shaping of words and phrases, the virtuoso boys (and girls too, if I remember) matching the professional sound of the men. There are no performance indications in the old scores. Gregg Smith says that his best guide was Saint Mark's cathedral itself, that vast space of distances and reverberation, where the best interpretation is the one that gets through! A good practical solution though hardly an all-embracing guide; composers often write more complex music than their local acoustics can take—witness old Bach, for one. You will enjoy these performances, then, even if some other conductors, in other locations, might well do the same music twice as fast, or maybe only one-third as fast. Interpretations of such music, minus any living tradition, very wildly. (One of these works is in the repertory of my own Canby Singers. We do it *entirely* differently, needless to say.)

This whole fly-over project, incidentally, was at least in part realized because of the typical enthusiasm of E. Power Biggs of Columbia, who plays

the (imported) organ whenever there is a need for an organ, though not in this Volume. It would take a Biggs to conceive the idea of an American musical invasion of Saint Marks by chartered plane!

Note a final oddity. Gregg Smith is listed as conducting his own Singers. George Bragg, it says, conducts *his*, the Texas Boys Choir out of Fort Worth. But who conducts the music on this record, especially where there are two or more choirs involved? It doesn't say. Equal billing?

Performance: B+ *Sound:* B

Beethoven: Ninth Symphony. Soloists, Chorus, Berlin Philharmonic, Furtwängler. Everest 3241 sim. stereo (\$4.98.)

Beethoven: Symphony No. 3 ("Eroica"). Recorded 1944. Berlin Philharmonic, Furtwängler. Turnabout TV 4343 mono \$(2.98.)

Beethoven: Ninth Symphony. Yeend, Lipton, Lloyd, Harrell, Westminster Choir, New York Philharmonic, Bruno Walter. Odyssey 32 16 0322 (sim. stereo) (\$2.98.)

Budapest Quartet—Beethoven, the Six Quartets Op. 18 The Classic 1951 Recordings. Odyssey 32 36 0023 mono, (\$8.94.)

Curious. The coming Beethoven 200th year has evidently sparked a number of companies to look into their own archives, or the floating availabilities on the out-of-date masters market, for classic reissue material. They have found plenty, and perhaps significantly. Is the best of 20th century Beethoven playing already in the past? Quite possibly.

The legendary Furtwängler, a conductor of the old school who failed to keep up with those other old men in the longevity race, died before he had a chance to become a Venerated Elder along with Toscanini, Walter, Klemperer et al. His conducting genius was considered eccentric—you may try for yourself in these two Beethoven symphonies, both made far back in the war-time years (though Everest carefully avoids saying when the Ninth was produced, or how—except that it is a concert recording. Coughs).

My thought is that his is not only one of the most moving Ninths I've ever heard but—considering the eccentricities in the piece itself—it rates

as definitely *uneccentric*. The tempi are not always the accustomed ones, there are some slightly prominent ritards, here and there. But to my mind these are no more than evidence of an older way of thinking, which Furtwängler inherited from the age of William Mengelberg, a time when "liberties" were still taken for granted and unabashed outward sentiment was quite proper, even in orchestral playing.

There are more oddities in the "Eroica," definitely. Some very odd ritards in the scherzo, almost to a dead standstill. They should not bother you to extremes—the rest is superb. And so much of interest in brought alive in the details, music which is mostly just played, so many notes, in a zillion other performances, that there will be more to learn on every repeat as your ear adapts itself to the old recording and acoustics.

The "Eroica" is plainly dated 1944, and its sound is utterly unlike the undated Ninth. Which came first? The "Eroica" was perhaps made on early Magnetophon tape; it is clean, wide-range, with a prominent and quite tubby bass. The Ninth, however, is not only limited in tonal range but lacks any bass at all, though it is not a distorted sound by any means. The energetic kettledrum in the Ninth sounds like a large dishpan being whacked with a ladling spoon! Presumably the very same drummer (same orchestra, anyhow) in the "Eroica" thumps a fat, ponderous elephant drum set, soft and soggy. Quirks of recording technology.

Furtwängler



Beethoven
Symphony No. 3
"Eroica"

Whence this superb and heartfelt Ninth, such a movingly sincere portrayal of the Beethovenian brotherhood-of-man sentiments? Most probably it was a fine "Nazi" chorus, and

BASF

BASF the "more" tape

Every time you choose BASF, you get more for your money . . . more than you get with any other quality tape.

First, you get superlative recording quality. BASF is made with a special formulation that creates superb sound reproduction with extra-low tape noise.

and there's more . . .

BASF tape is ageless. Your recordings will last a lifetime, unaffected by temperature, humidity or time.

and there's more . . .

BASF tape reels are packaged in the exclusive plastic "Perma-Store" box—the one that makes your tape library look as good as it sounds.

and there's more . . .

BASF tape reels come with color-coded leads and switching foils at both ends.

and there's more . . .

Now BASF cassettes, with the same superior tape quality, come in handsome mini versions of the Perma-Store Box, for looks, convenience and protection.

and there's more . . .

BASF tape reels and cassettes cost *no more* than other quality recording tapes. Ask to see BASF tape at your favorite dealer's today.

BASF SYSTEMS INC

Crosby Drive

Bedford, Massachusetts 01730

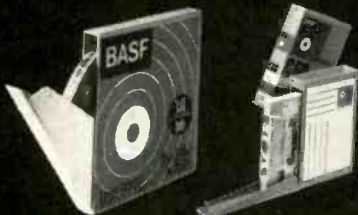

very probably the Berlin audience included, if not Herr Hitler himself, then some of his well-known henchmen. Strange! One can only suggest that music in its all-embracing emotions carries men with it, the misguided along with the wise. We may discreetly avoid wondering just what Herr H. was thinking, if he did in fact attend that concert—no matter. What matters is the music that was produced, and it is superb, even if the recording is marginal.



As for Bruno Walter's Ninth, that elderly gentleman embodied a more classic restraint, another aspect of Germanic performance that we also inherit in the piano playing of Artur Schnabel (all the Beethoven piano sonatas and concerti). Chaste, dignified, ineffable, marvelously sincere, sometimes, though, a bit on the ponderous side—that's Bruno Walter. His Ninth is now available in two incarnations, this being the older mono set; the newer one is in stereo with the California-based Columbia Symphony. To have both of these on hand (and any others you may wish to try for comparison) is a fine thing, I'd say. Nobody has ever had the sole rights to the meaning of this big work.

As for the classic 1951 Budapest Beethoven Quartets, they are all that the ecstatic reviewers said of them in 1952, and more too. The Budapest set Beethoven standards for these last 25 years of performance—which is about as long as any performing concept is likely to remain valid and current. The Budapest also, I should add, has certain mildly irascible playing idiosyncracies that tell against them now and then (and in favor of other less-high-voltage but smoother playings); their performances are so intense that the sound is often scratchy and wiry, or bumpy and

thumpy, for extra-strong accents. Definitive—yes (and there are 1951 recordings of all sixteen quartets). But I remind youngsters that before Columbia got hold of the Budapest, RCA Victor released some of the most gorgeously youthful Beethoven and Mozart performances you can imagine, by a smoother, more polished youthful Budapest Quartet. Those 78s I have always thought were musically superior to all later counterparts. I have only a couple of albums—that's enough to tell the story. They were pre-war recordings. The Budapest goes that far back.

Joseph Woelfl: Three Sonatas. Vladimir Pleshakov, piano. **Orion SFM 6901 stereo** (\$5.00.)

Rediscovered composers are a dime a hundred these days, but here's a good one, and from an unusual period—the time of Beethoven. Many parts of the big C Minor Sonata on this first LP side could be mistaken for Beethoven himself. Moreover, the interpreting pianist here is a splendid musician and a highly communicative artist. Perhaps Woelfl wouldn't seem quite as good without Vladimir Pleshakov's sympathetic playing.

Woelfl was born in 1773, three years after Beethoven, and died in 1812, at the height of Beethoven's years of composing fame. His background is interesting—study with Leopold Mozart, Mozart's pedagogue father, and with Michael Haydn, younger brother of *the* Haydn, both of these gents in residence at Salsburg, where Woelfl came out of musical background very much like Mozart's. No wonder his piano works are in good taste and well made! He evidently went so far as a pianist as to compete with Beethoven himself in one of those ever-popular virtuoso contests that happened all the time.

Woelfl wrote prolifically, some 125 sonatas. Evidently one must pick and choose—a good deal of his music is said to rate nearer the insipid salon level than that of Ludwig van B. These three are a good choice, then. The big one is really a most congenial work of the Beethoven period, and not at all un-modern for the time. I'd say, here at least, Woelfl easily stands up to such as Spohr, Hummel, Dussek, Clementi, others of that musical background. The two sonatas on the second side are somewhat lesser works,

one of them clearly an earlier opus, the other again fully up to early middle Beethoven in its new Romantic styling. If you love the "Appassionata" and the "Moonlight" sonatas or any of the others of that vintage, you'll be enthralled to hear what another and unknown composer of the time could do with similar material.

Performance: A- *Sound:* B-

Rameau: Ballet Suite from Les Indes Galantes. Collegium Aureum. RCA Victrola VICS 1456 stereo (\$2.98).

C. P. E. Bach: Harpsichord Concerto in D Minor; Oboe Concerto in E Flat. Gustav Leonhardt, hps., Helmut Hücke, Baroque oboe, Collegium Aureum. RCA Victrola VICS 1463 stereo (\$2.98).

I trust I'll be pardoned for allowing my personal enthusiasm to get into these columns—it's bound to happen one way or another! Here is one—the current output of RCA's low-price division on the Victrola label, the music licensed from the incomparable Harmonia Mundi label in Germany. This conductor-less Collegium Aureum is far and away the best Baroque group I have ever heard in its playing of the late Baroque and the still later music that led on into the "classical" school of Mozart and Haydn.

Authentic performance, of course, is a German specialty just as is the whole science of musicology, which was born and bred out of a Germanic attitude towards musical research. But too often extreme scholarship has meant extreme unmusicality. Scholarship can so easily be correct—and stodgy. The really sensitive artist deplores such slothfully accurate music making, all science and no art. But the easily reached conclusion is nevertheless wrong, that a real artist of temperament is above such things. The Collegium Aureum, thus, combines the impossible. Systematic German scholarship in every detail. Imaginative, lively, artistic performance. It can be done!

The Rameau recording, music by that arch-French antithesis of the Germanic approach, is here a model of correctness in the all-important ornamentation—natch, the Germans wouldn't flub that important element in French style. But unlike many an earlier German performance of French music, this one is no heavyweight, plodding travesty of all that is French!

AUDIO • MARCH 1970

Instead, it has the true French *elan*, ornaments and all, as lively and stylish as you can imagine. In that respect, these new German players are astonishingly un-Teutonic. (Some of them, by the way, would seem to have Dutch connections, perhaps via Gustav Leonhardt, the harpsichordist.)

The Collegium Aureum is in the *avant garde* of super-authenticism, carrying that principle beyond any former conception. Their instruments as a matter of course are "authentic" for each period, either actual old instruments or newly made replicas. The oboist plays a Baroque oboe in the C. P. E. Bach concerto, again as a matter of course. No fancy keys and mechanical cross-finger links, as in the modern oboe. Just a row of holes, like a recorder, and a double reed of obstinately penetrating quality. Only a few years ago, this instrument would have been thought unplayable in any seriously artistic fashion. Just listen, now!

Thank the Lord that C. P. E. Bach, the middle Bach son and patron saint of Hamburg music and, earlier, of Frederic the Great's Potsdam circle, is now coming back into performance. He is not a "great" composer but he was enormously influential in a period of transition, and more important, a deep thinker whose music is never frivolous, often extraordinary. The two concerti on the Collegium Aureum record are worlds apart, one from Potsdam in 1748 (two years before old Bach died), the other from 1765. In both we hear the outward Baroque format, solo and *tutti* passages all on one complex of themes, marvelously transformed into proto-Mozart in the details of melody and expression.

Keep tabs on RCA Victrola. It is the top label in the "low price" category as far as older music is concerned.

Performances: A- *Sound:* B+

Mozart: Lucio Silla, K. 135. Soloists, Angelicum Orch. and Polyphonic Chorus of Milan, Cillario. RCA Victrola VICS 6117 stereo (\$8.94).

RCA's Victrola label, via its European affiliate, has been exploring some marvelous little-known music by big composers, offered in marvelous performances—Vivaldi, Handel, now more Mozart.

THE LITTLE PERFECTIONIST. ONLY \$100.

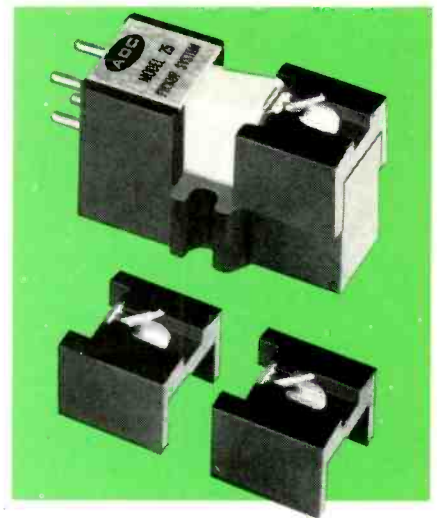

Not all records are created equal. And now Audio Dynamics has done something about it. We've hand-crafted the world's only 3 stylus cartridge. It allows you to custom match the cartridge to each record in your collection, simply by selecting the optimum stylus assembly.

The ADC 25 represents the "state of the art"—the ultimate refinement of Audio Dynamics' induced magnet principle.

With all this, the ADC 25 naturally costs a little more than most other cartridges, but for audiophiles \$100.00 is a small price to pay for perfection.

If money is an object, buy the ADC 26. It is the same cartridge, but with one elliptical stylus. You can always add one or both of the other 2 styli later.

SPECIFICATIONS

ADC 25 STEREO PICKUP SYSTEM with GRAIN ORIENTED DIAMOND STYLUS*

Type . . . Induced magnet
Sensitivity . . . 4 mv at 5.5 cms/sec. recorded velocity
Tracking force range . . . 1/2 gram to 1 1/4 grams
Frequency response . . . 10 Hz to 24,000 Hz \pm 2 db
Channel separation . . . 30 db from 50 Hz to 10 KC
20 db from 12,000 Hz to 24,000 Hz
Compliance . . . 40 x 10⁻⁶ cms/dyne
Vertical tracking angle . . . 15 degrees
Recommended load impedance . . . 47,000 nominal ohms
Price . . . \$100.00 suggested resale
Replacement Styli . . . #251, #252, #253

*For substantially increased stylus life



AUDIO FOR AUDIOPHILES

Check No. 65 on Reader Service Card

This stylized Italian opera of the classic sort, all formal recitatives and arias laid out in the timeless symmetry of the late Baroque age, was composed, all in a fever, by a seventeen-year-old Mozart, out to impress the Italian bigwigs. He did. And the opera itself, outwardly derivative to the last note (that was Mozart's intention, to write the Italians a better Italian opera than they could manage themselves) is nevertheless delightful, and astonishingly Mozart. You'll spot him in seconds if you are a Mozart fan. Classical or no, the music is full of youthful verve and enthusiasm, yet, as always in Mozart, it is disciplined and expressive, professional to the nth degree, technically masterful.

Of course you will not find the extreme concentration of late Mozart, nor the very modern characterization of the late operas, the depths or meaning, the tragedy and humor mixed together. This is easygoing, sprightly music for the most part, its tragedy mostly of a formal sort. You'll let it slide easily past the ears, all melody and sparkle, without strain. But it is *Mozart*—no less. Which means that on second and third and nth playing it will continue to grow upon you.

Where do they find such imaginative and musical singers as these, all out of Italy, all of a sort and the same tradition, blending together in a team as *very* few opera companies now bother to do, what with the international star system. This is extraordinary singing (and much of the music is technically beyond most of the great stars—too taxing).

An extraordinary performance, even to the excellent and lively orchestra. I wouldn't take a dozen big-name expensive opera albums for this single inexpensive box. See others in the same RCA Victrola series, both operas and oratorios.

Performance: A- *Sound:* B+

Szell/Wagner. Great Orchestral Highlights from the Ring of the Nibelungs. Cleveland Orchestra, Szell. Columbia MS 7291 stereo (\$5.98).

George Szell is becoming more and more a sort of second Fritz Reiner. Utterly different in personality (and in shape, one pudgy, the other thin-

nish), they share a number of conductorial characteristics. First, a fanatical perfectionism as to orchestral technique, the art of precise, perfect professional ensemble. Second, a tendency towards high tension in the playing, and to high speeds, especially in the more popular standard items of the conventional symphonic repertory.

Thus there are many passages in these excerpts from the Ring which are pushed hell for leather at speeds I've never heard before. Don't know what old Richard W. would think of them, but they surely make for a "different" sound, as compared to the leisurely, almost torpid pace of much Wagnerian unfolding a generation or so ago.

My reactions were, in fact, quite mixed. I like the old slow-motion style—provided I don't have to listen to it for too many hours. (Like, say, five, at the usual complete opera performance.) For my generation Wagner, the once-revolutionary, was already comfortable and almost old fashioned; no point in trying to make him modern at the expense of expansiveness. On the other hand, Wagner today is old fashioned, far more so even than Brahms. At this point he must be restyled for relevance, the music as well as the Wagnerian staging, which has been wholly modernized since the last War. And so—to sum it up—I enjoyed listening to Szell, though occasionally I squirmed in discomfort.

A good selection here, well thought out. The first side is all from the last late music of the Ring, *Götterdämmerung*, and the latter part of *Siegfried*, where the language is grown extraordinarily concentrated and even astringent, though built largely on the themes of the early operas. Side 2 is entirely from those first operas, composed many years earlier, where the same themes are first heard in much looser, simpler formations full of youthful confidence. A very interesting contrast.

Performance: B+ *Sound:* B+

Stokowski—Khachaturian: Symphony No. 3 with Organ and 15 Trumpets; Rimsky-Korsakoff: Russian Easter Overture. Chicago Symphony. RCA Victor LSC 3067 stereo (\$5.98).

For its first five minutes and more, this heady Khachaturian Symphony

same composer as the famous *Gayne Suite*, all-time hi-fi noisemaker of a decade or so ago—makes an impressively novel and enormous sonic impact, worthy of the best equipment you can muster on which to play it. *Fifteen trumpets!* They play fanfares against the orchestra, and their number allows Mr. K. to write some brilliantly dissonant chords that amount to a grand New Sound in trumpetry.

But after that things rapidly deteriorate. The organ comes in with a long, frantic, and somewhat Baroque solo. The introductions over, so to speak, what next? Plenty of noise but the corniest, most derivative noise you can imagine. Watered-down, hepped-up Rimsky Korsakoff in semi-modern dress. I found it so dreary I forgot to listen to the fi for the last half.

Next to this brilliantly contrived *tour de force* of nothing very much, the old and familiar Russian Easter celebration by Rimsky himself sounds clean and classical. But its sounds are in themselves so familiar that once again I waxed absent minded and sort of gave up halfway through.

You don't have to expect the same reaction, and if you are likely to enjoy RCA's brilliant recording on your own fancy equipment, you will find ancient Maestro Stokowski at his incredible best—nobody puts on a better show in this kind of music.

Performances: A- *Sound:* A-

Carl Nielsen—Piano Music. Arne Skjold Rasmussen. Vox SVBX 5449 (3 discs) stereo (\$9.95).

Carl Nielsen: Flute Concerto; Clarinet Concerto, Op. 57. Paul Pazmandi, fl., Joseph Deak, Cl., Philharmonia Hungarica, Maga. Vox Turnabout TV 34261 stereo (\$2.98).

Just as there are plenty of people who buy up Bruckner with passion, or Scriabine, or Harry Patch, so there are Nielsenites all over the place these days. As for me, I'd prefer that old Swede Berwald any time to this more recent Dane (d. 1931) but that isn't to say I don't find Nielsen interesting. He is one of those odd twentieth-century Romanticists, along with Sibelius and Rachmaninoff, Howard Hansen, and Samuel Barber and, for that matter, Richard Strauss himself in old age, who carried on in a nineteenth-century manner right through the age of

jazz and twelve tones as though nothing (well . . . hardly anything) had changed.

For my ear the trouble with Nielsen is that he tried obstinately and too often to work into atonality and dissonance—but fell back again and again to the old familiar consonance. He is better on the older ground. That dichotomy of style is a thing only Sibelius could really do with a flare. The Nielsen dissonance and non-tonality just wanders, awkward, insecure, until it finds itself back, say, in a safe D major.

I sampled through the Complete Piano Music—six sides of the same—and was defeated by just this aspect. Work after work in the general sound-era of Grieg, out of Chopin, yet full of harmonic aberrations that don't fit Grieg or Chopin. Not new enough, for my ear, yet not comfortably old either. However, if you are likely to hear the music in a different way you will find that the Danish pianist Arne Skjold Rasmussen is a first rate artist who is dedicated to this music, a fine choice for the job. The Vox recording, too, does justice to a splendid piano sound.

The pair of solo concerti on Turnabout make a more interesting buy for the general listener. The Clarinet Concerto, the last of Nielsen's major works, at long last finds a really congenial idiom that combines the older Romantic approach with a perky, somewhat astringent touch of dissonance, stylishly consistent and musically secure. This work I really liked and so will you. Especially with such excellent clarinet playing, and such top-drawer recording too. You do not have to be a Nielsenite (nor belong to the Carl Nielsen Society of America) to enjoy such music!

The Flute Concerto on the other side is equally well recorded and played, but a slightly earlier work, it still suffers from that harmonic double vision described above, never quite one thing or another but somehow uneasily flitting from this to that, neither modern nor old. It is, of course, the more typical Nielsen. Too bad that he did not live another decade, to turn out a definitive cycle of works following the Clarinet Concerto. To my way of thinking, he had at last found himself there, at the end of his career.

Performances: A— Sound: A—

They laughed when I started hooking up my own public address system,



But oh, when it started to play!

"And ouch, when they heard how much money I saved installing it myself. With just pliers and screwdriver."



"University Sound supplied everything — all pre-matched and pre-engineered. Speakers, amplifier, cables, wires, microphone, turntable — all I did was hang the speakers and hook 'em up. And it all worked perfectly the first time."

"It's called 'TCS'. Totally Coordinated Sound. University makes it available for thousands of applications, from churches to restaurants, office buildings to lumberyards."

Just walk in to your University dealer, tell him what you need it for, and walk out with the world's finest public address system.

Only University Sound — the world's largest manufacturer of public address equipment — could do it. They've got a system for every situation, including yours. If you need a public address system, or you know someone who does, write for our free

booklet: "How to Install Your Own Public Address System with Pliers and Screwdriver".



UNIVERSITY SOUND
A quality company of LTV Ling Altec, Inc.
P.O. Box 26105 • Oklahoma City, Oklahoma 73126

Bass Response

(Continued from page 23)

Calculated frequency response of speakers in vented boxes.

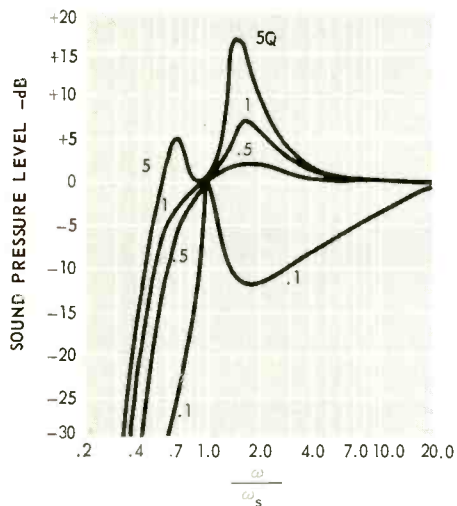

Fig. 5—Large vented box.

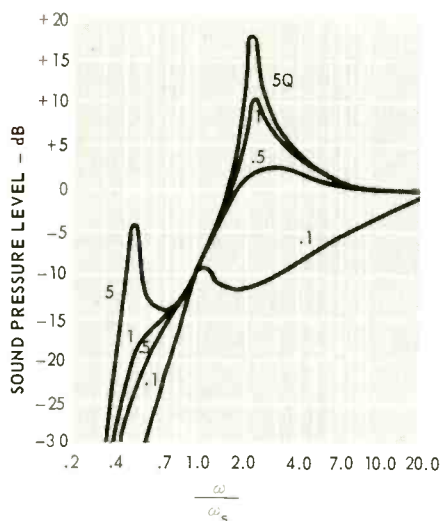

Fig. 6—Medium size vented box.

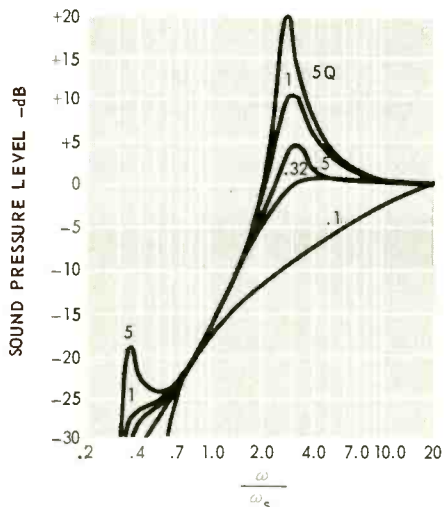

Fig. 7—Small vented box.

small size, the peak is given approximately by:

$$\text{SPL} = 10 + 20 \log Q_s$$

for low values of Q. For example, a Q of 1 produces a 10 dB peak which is accurately given by the formula.

This peak occurs at the upper resonance mode of the system, corresponding to the upper peak in the well-known impedance curve. For practical boxes this occurs at 2 to 3 times the resonant frequency of the system with the vent closed. The peak thus can easily be in the vicinity

of 90-100 cps, where it causes an extremely annoying booming effect, with a great deal of hangover. This is a cogent reason for maintaining values of Q down to the previously mentioned values of 0.3 and 0.4.

How far down can one expect the bass response to go? At the speaker resonance, the sound pressure level referred to mid-frequency response is:

$$\Delta \text{SPL} = 20 \log_{10} \frac{C_s}{C_B}$$

(Continued on page 79)

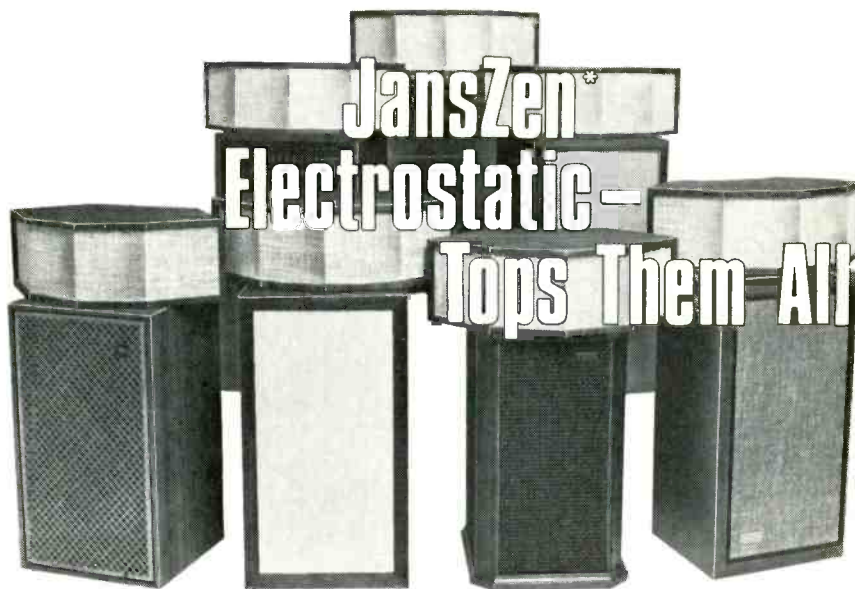

The JansZen model 130 speaker makes fast friends with any of today's fine speaker systems and enhances the sound with true electrostatic realism. A quartet of electrostatic elements arranged for maximum dispersion, can add a spectrum of frequency responses from 500 Hz. to beyond 30,000 Hz.

This speaker companion demands no special wiring or adapters for hook up to your present system. The model 130's size, 7-1/4" x 22" x 13" allows it to fit in nicely with bookshelf or floor standing speaker systems, finished in hand rubbed oiled walnut.

Other JansZen systems include:



The Z-960, Oiled walnut cabinet, 26-3/4"H x 27-1/2" W x 14-1/2"D.



The Z-600, Oiled walnut cabinet, 26-5/8"H x 20"W x 13"D. Same components available in JanKit 41 for custom installation.



The Z-700, Oiled walnut cabinet, 15"H x 26-1/4"W x 13-1/4"D.

*JansZen speakers incorporate designs by Arthur A. Janszen and are made exclusively in the United States by

ELECTRONIC INDUSTRIES, INC., 7516 42nd Ave No., Minneapolis, Minn. 55427

Check No. 69 on Reader Service Card

Light Listening

Sherwood L. Weingarten

America is plunging headlong into the Seventies with the hope that this will be *the* decade of problem-solving, peace and innovation. Musically, however it's anybody's guess: no-one 10 years ago would have predicted the impact of acid rock; today, only the foolish are forecasting pop's direction.

One thing is certain though . . . early indications are meaningless, for what's been released thus far is merely a shadow of last year. There are no new trends, no valuable experiments—merely business as usual, carbon copies of previous winners. The emphasis, of course, is still on blues and rock plus a combination of the two. Witness. . .

The Chambers Brothers' latest album is a two-disc package that capitalizes on the theme for our time, LOVE, PEACE AND HAPPINESS (Columbia, KGP20). Unfortunately, it is just a selection of what was . . . exciting and strong in parts, it's true but basically more of the kind of "roots" material on which they climbed the ladder to cash-register success.

The first vinyl, a studio product that offers better sound quality than the second (recorded live at Bill Graham's teenybopper-filled Fillmore East) spotlights a 16-minute-16-second pop suite. The piece, which encompasses the entire second side, is listed as being three movements but actually runs together in what appears to be a paean to commercial mediocrity. The composition, a bit removed from the norm offered by the four black Chambers and their white drummer, starts too slowly and ends at an equal pace. Sandwiched between are flashes of fire, but not enough of them erupt to really warm things up. If there is musical meaning to the lengthy potpourri, it is lost somewhere along the way. All that seems to happen is that the tempos frequently change and the intensity varies not at all haphazardly, but not with any apparent goal either.

After the easy beginning that metamorphoses into soft soul-rock, the quintet, consisting of George, Lester, Joseph, and Willie Chambers — plus drummer Brian Keenan introduces a vocal that includes Neil Armstrong's first words upon landing on the moon. Shoutin' soul follows, with a redundant yet passionate screaming of the word "higher" (indicative of the levels man *can* achieve should he devote his energies to them?). Next is a soft interlude that is almost classical in orientation, spiced by a touch of Eastern influence. A jazzy instrumental segment follows, then a chant-like vocal portion, a percussion extravaganza, another vocal section, and then a guitar interlude that leads to the choir-like conclusion.

The whole thing seems too much in line with the trade notion that modern LP's must have a "concept"—usually an elongated piece that is something more than just good music to be bought in bunches by mop-toppers. The trouble is it just doesn't work.

More successful are the five straight tracks on the first side, especially the gospel-soul of "Have a Little Faith" (Keep the Faith, baby), they declare emphatically), the ultra-smooth, slow-tempoed "To Love Somebody," the happy rocker "If You Want Me To," and the spirited though brief (2:18) "Wake Up." Overall, however, the second disc is better. Spotting the heavy, steady beat that allows dancers to know where they're at, the live recording offers nine cuts that generate enthusiasm-plus. Any audiophile who digs this type of music will bask in the excitement, despite the technical flaws and the more occasional interference by a raucous audience.

The first concert side by the Brothers Chambers is high-lighted by a 10:20 rendition of "Wade in the Water," marred slightly by spectator's applause, cheers, and whistles. Still, it cooks . . . from the instrumental intro (punctuated by grunts from the combo) to the rock-gospel crescendo that builds, and through the drum interlude that is squeezed in. Another winner is "I Can't Turn You Loose," a driving tune with a fantastic rhythm. On the flip side, "People Get Ready" features harmony not unlike the antiquated strains of the Ink Spots, an immersion in the rock-'n'-roll of old;

"Bang Bang," with its novelty approach utilizing all sorts of vocal trills, noises, and gimmicks plus audience participation, and the medley consisting of "Love! Love! Love" and "Undecoded," the latter a throwback to the Mills Brothers type of polyphonics. Bulls will squeal with delight, others will probably muse that it all sounds familiar.

. . .

It's a shame that the one different album released recently is almost a total failure—from the listener's standpoint, that is. Artistically, the performers not only seem satisfied but rave about their efforts. Nonetheless, Sonny Sharrock's "BLACK WOMEN" (Vortex, 2014) comes off as an avant-garde melange that should be served only with psychedelic lighting and mind-expansion. To me, though, it's a musical bummer.

The album consists of five "melodies" all written by guitarist Sharrock except for the French traditional "Bialero" which he re-arranged. The cacophony starts with the title tune, on which Gary Sharrock tinkles with bells. High-pitched chanting by Linda Sharrock (begin to sound like a nest of nepotism?) is stressed, but to a trained ear there is an impression of having heard the agonies of childbirth or some similar torture.

"Peanut," the second piece, and the longest at 9:14, contrasts solo guitar with a wild choral effect (apparently via overdubbing). It's a musical canvas reminiscent of Shostakovich composing in the midst of a de Sade orgy with an African tribal ritual being performed simultaneously. The 'daymere' is compounded by use of percussion (drums and piano both carry the burden) that reminds one of early Charlie Mingus, experimenting before he knew where he was headed.

On the flip side, "Bialero" shows that Sharrock's guitar skills are extraordinary but used in poor frameworks. "Blind Willy" stands out because of its Eastern-flavored intro and the blues feel on which a simulated bagpipes sound is superimposed. (Are you listening, Mac?) The most fascinating work is the lengthy "Portrait of Linda in Three Colors, All Black," a duet by Sharrocks (a wordless Afro theme) dissipates quickly as Linda starts flying alone, screeching to the accom-

paniment of Sonny's guitar and drums by Milford Graves. A staccato trumpet (by Teddy Daniel) that seems hell-bent for an accident interceded and makes matters worse. Joining at this point is virtually everybody, each apparently going his own way, to complete the mayhem as the vocal becomes even more piercing. Why the musicians (the others are Dave Burrell, pianist; Norris Jones and Richard Pierce, bassists) would desire credit for the gig is a mystery I've yet to unravel.

Oh, yes, there's one other item Linda Sharrock, in those few instances when she's not inclined to imitate an operatic soprano being dismembered, proves she probably *could* sing well straight. Here's hoping!

Richie Havens who combines pop and soul in such a glossy manner they're inseparable, adds a dash of progressive rock and a pinch of multi-track gimmickry to his latest outing, "STONEHENGE," (Stormy Forest SFS-60001). The singer-guitarist (who also dabbles with percussion) offers songs aimed at those who prefer understanding what they're hearing. Most of it is, sad to say, bland.

Havens, who is adequate on both electric and acoustic rhythm guitars, is best on his own compositions (he had a hand in writing seven of the ten tracks). But he too falls into the "concept" trap. Hear, for confirmation, "Shouldn't All the World be Dancing," a 7:58 band replete with jazz riffs, echo effects and vocal narration by Havens and Mark Roth who designed and photographed the dust jacket as well as helping Havens to produce the LP. Although the cut is the most innovative, Sgt. Pepper needn't worry. The album, not incidentally, opens with Havens' deep voice in a plea for peace, via "Open Our Eyes." "Ring Around the Moon" has the vocalist singing counterpoint with himself, and "Baby Blue" is a fair mirror of Dylan singing Dylan. Side two has the star multiplying himself into a group—(the overdubbing gimmick again, a favorite device of the artist) on "Prayer," which is what the title indicates it is. Oddly, for what is basically an album of vocals, the best number is "Tiny Little Blues," the

lone instrumental, a heavy blues that showcases Dave Bronberg's style on what is termed "forward and backward dobro guitar." The LP may sell, but we've all been there before.

B. B. King, who learned his pluckin' trade he says "from his cousin Bukka White and jazz greats Charlie Christian and Django Reinhardt," plays blues guitar as well as anyone in or out of vogue. Aptly called "King of the Blues," he continues to come up with

album after album of superior fare. No surprise then is "COMPLETELY WELL" (BluesWay-ABC, BLS-6037). And, aye, there's the rub: it's basically the same as the last (and probably the next). The mold is magnificent, but even an audiophile can tire of too consistent a musical diet. King, whose vocal style has its foundation in the lyrical meanderings of Jimmy Rushing and Al Hibbler, mostly presents blues that make you feel good because of

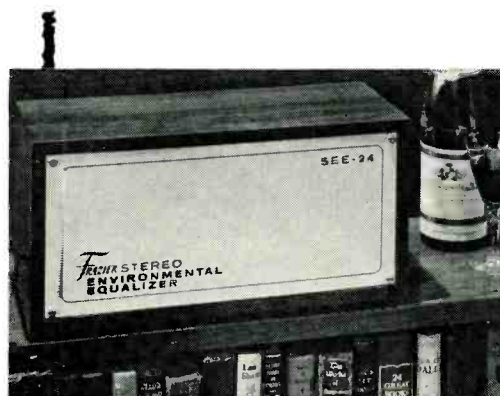

Hear* How It Improves Even The Finest Stereo System!

The new Frazier Stereo Environmental Equalizer—a totally new concept in electronic instrumentation—employs twelve 2/3-octave tuned circuits for each of

two channels, to reduce acoustical peaks either in the loudspeakers or room acoustics by a factor of 15 decibels maximum. Flattens the response curve for new balance in sound reproduction never before available.

FRAZIER STEREO ENVIRONMENTAL EQUALIZER

*Provides Exciting New Balance
In Home Sound Reproduction*

FLATTENS
RESPONSE
CURVE

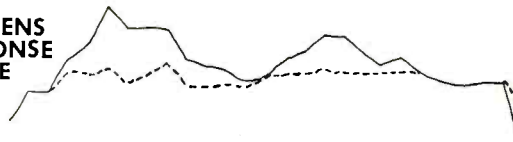

EMPLOYS THIS PATENTED CIRCUITRY

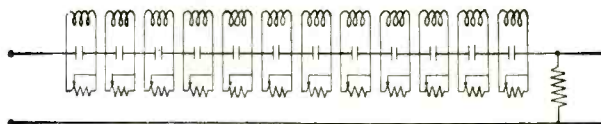

*Get demonstration of
ENVIRONMENTAL EQUALIZER
at your dealer's . . . or . . .
WRITE for literature and name
of Frazier dealer nearest you.

FRAZIER
INCORPORATED

1930 VALLEY VIEW LANE
DALLAS, TEXAS 75234.
PHONE 214-241-3441

the bright tempo, blues that make you want to dance. Although it is difficult to describe the man's technique because he is an original despite his leaning on legends, suffice to say he plays in a style that has been aped by many stars and shouts soul and blues that he penned himself or helped to write (six of the nine tunes on the vinyl).

Aided by four other musicians (the most noteworthy being Paul Harris, who shifts from piano to organ to electric piano) King's best are "What Happened," a gem that brings the listener back to the golden area of rhythm and blues, a time when he was bouncing around the black circuit; "Confessin' the Blues," a boogie-based melody written in the late '30s, and "Key to My Kingdom," which opens with a gospel aura but moves into straight blues (with life pumped into it by the bass of Gerald "fingers" Jemmott).

• • •

Mabel Mercer has been described by one youthful wag in my family as "a low-keyed Mrs. Miller." Though I wouldn't go *that* far, she's not exactly my cup of antique-tea either. And Bobby Short falls so far short in my estimation of what a singer should be, the only needle I enjoy giving him is in a column (as opposed to on the turntable).

In deference to the many fans of the two (the flacks tell me there *are* many) I listened to their latest discs "Second Town Hall Concert" (SD2-605). Same reaction: Ugggh! Maybe the whole thing is from an era in which I wasn't, or because it's too cutesy, or because I don't find Cole Porter or Vernon Duke relevant anymore. At any rate, I suffered (no crying towels necessary, thank you). The package is neatly divided: disc one contains Short (who accompanies himself on piano) doing such current items as "Isn't It a Pity," (The Gershwins wrote that one for a forgettable film entitled "Pardon My English") and a full side of Duke ditties (would you believe "I Like the Likes of You," from the Ziegfeld Follies of 1934?). Disc Two includes Mabel's hair-raising rendition of Porter's "Down in the Depths" (write your own dig here) and some con-

temporary tunes such as Joni Mitchell's "Both Sides Now," and the once-breezy "Love is Blue." There's a smashing finish too: Miss Mercer and Short join to demolish the Lennon-McCartney closer, "Good-Night." But it wasn't that for me—perhaps the Rocking-Chair Set will enjoy it.

• • •

Another "supergroup" merged members of dissolved ensembles that momentarily stole the pop-rock spotlight. David Crosby, a refugee from the Byrds; Steve Stills, of the Buffalo Springfield, and Graham Nash, an escapee from the Hollies, stress blended vocals and comparatively soft material on CROSBY, STILLS & NASH (Atlantic, SD-8229).

All three utilize talents as writers, singers and guitarists, and the 10-track LP was a combined production of the trio. The material is varied and fresh (the best example being the bluesy lead number, a 7:22 opus entitled "Suite: Judy Blue Eyes," a Stills original that combines love songs to three women and ends with another love song, to Cuba, complete with Latin tempo and Spanish vocal).

"Marrakesh Express," a Nash tune with heavy exotic rhythms, crashed through the hit barrier as a single; "Guinnevere," written and sung by Crosby, is as lovely a ballad as produced anywhere; "Lady of the Island," a Nash composition, is reminiscent of Donovan's poetry and ethereal melodic lines; "Helplessly Hoping," penned by Stills, is a zippy countrified winner, and "Long Time Gone" has a heavy blues element, due in part to the fact that it was written by Crosby shortly after the assassination of Sen. Robert F. Kennedy.

There is some gimmicky mixing on "Pre-Road Downs," but as a totality the trio (aided by Dallas Taylor on drums) offers as pleasant an excursion into rockland as can be found on vinyl.

The trio's first album may be its last, however; like so many of the rock groups, changes seem as inevitable as the rising sun, and Crosby, Stills and Nash have now added a fourth singer-songwriter-guitarist, Neil Young, also an ex-Buffalo Springfielder. Does that make it a "super-supergroup"?

Although much of rock is impossible

to pigeonhole, a designation of country-rock is easy to place on THE FLYING BURRITO BROS. (A&M, SP4175), who in the age of group offspring might be considered an omelet created by the Byrds.

Guitarists Chris Hillman and Gram Parsons, who handle most of the vocals, both were members of that high-flying combo (the former having started playing grassroots music with something stuck with the moniker Scottsville Squirrelbarkers, the latter dishing out country and blues with the ill-fated, one-record-producing International Submarine Band). Joining them are Chris Ethridge, who began as Judy Collins' concert group bassist, and Sneaky Pete (no kidding!), a steel guitarist who guested with the Byrds.

The tunes on the LP have a twangy flavor, but the emphasis is shared equally by words and music (note especially the draft-evasion plea on "My Uncle," as devastating a social commentary as anything written by Tom Paxton, Phil Ochs or "Country Joe"). All but two of the 11 melodies were written by members of the quartet, and each of the songs has impact—and a unique, immediately recognizable sound.

Best tunes are the originals, "Sin City" and "Do You Know How It Feels," but "Hippie Boy," which features narration by Hillman over an organ-ized rhythm, is most interesting. "Christine's Tune," with its recurrent theme of "devil in disguise," is easily the one that jumps the most and lends itself to theft by whistlers.

Adding to the instrumentation are Hillman's toying with a mandolin on one tune, Ethridge playing piano on a pair, and Parsons tinkering with keyboard instruments on several. But the overwhelming feeling is simplicity, what they call "white soul." Parsons sums it up thusly: "We are involved in music of the spirit, or if you will, goose bump music. When the music is honest those bumps are usually the end result. Listen to the simplicity of gospel, country, and blues. That's where we're at."

A minor annoyance is Junior's repeated references (four times) to the fact that MGM was cutting the LP on the scene. Æ

(Continued from page 48)

to allow for large movements without distortion. Linearity is not too easy to achieve with the spider and the wide, flexible surround causes more headaches for the designer. Figure 5 is a side view of a dynamic loudspeaker and it shows how the surround can move the opposite way to the cone at some frequencies. This uncooperative behavior causes a phase cancellation dip in the frequency response as shown in Fig. 4. Various methods are used to overcome or minimize this fault—usually treating the surround with resinous “gooey” materials or the adoption of special concertina configurations. The 15-inch job does not have these problems, instead the emphasis is on cone rigidity to prevent break-up, nodes, and so on—plus the complications of choosing the right strength-weight factor. In other words, it's all a question of proper design, both systems have their merits and their own particular problems.

Q. What are the advantages of electrostatic speakers?

A. If you are referring to the push-pull models as opposed to the inexpensive single-element types, the advantages are as follows: low distortion (partly due to the push-pull cancellation), good transient response, and low coloration. Full-range models have no enclosure resonances simply because they have no enclosure (there's logic for you!) Disadvantages, —to be fair we must mention those—are the necessity of providing an energizing voltage and the fact that full-range models are a little restricted in power output at the extreme bass. Increasing this would mean wider plate spacing with a higher polarizing voltage, a larger diaphragm, or both. Acoustically, electrostatic speakers are subject to the same laws as dynamic types, e.g. they still have diaphragm break-up and nodes to contend with. Because of the large size-to-mass ratio of the diaphragm they have a very low acoustical output impedance, consequently bass output is highest when they are placed in the center of a room—quite unlike dynamic speakers in that respect. Commercial systems are designed to give a balanced output when placed one to three feet from a wall. The figure-8, or doublet radiation pattern may not always be desirable although in some rooms it does make for a more spacious sound. Laboratory models with suppressed back radiation have been made (and demonstrated) but so far none has reached the market.

AUDIO • MARCH 1970

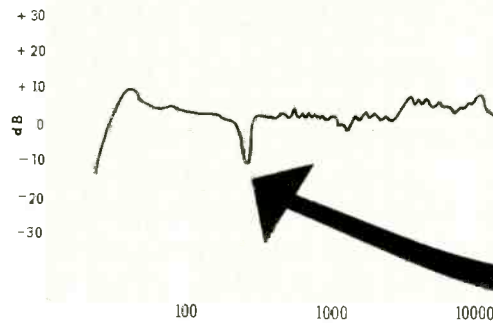

Fig. 4—Frequency response, showing dip.

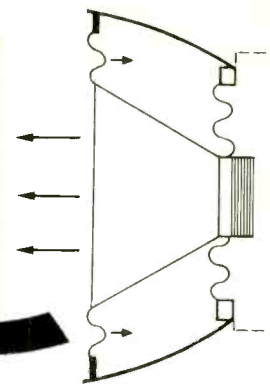

Fig. 5—Side view of dynamic speaker.

**WANT
SOMETHING
FRESH...
EXCITING?**

new
SUPEREX...
it's beautiful

Beautiful all the way! In design — a triumph of newest state-of-the-art concepts. In response — a spectacular bass; sweet, clear highs; exciting mid-range. And the experts say that overall performance is better than some expensive speaker systems. It's all made possible by our exclusive woofer/tweeter design that puts a 2-way speaker system at each ear. The name is PROB-V... and the all-new extras include “con-form” ear cushions, tuned port ear shells, retractable cord and soft, tropical green finish.

\$59.95 — at dealers everywhere

SUPEREX ELECTRONICS CORP.
151 Ludlow Street, Yonkers, N.Y. 10705

Check No. 73 on Reader Service Card

Jazz

BERTRAM STANLEIGH

Jose Feliciano: Alive Alive-O!

RCA Victor Stereo LSP-6021

Recorded at a concert in London's Palladium, this set is replete with announcements and applause but there is a total absence of the anticipated background noise that so often afflicts such concert recordings. Feliciano's instrumental performance of Lecuona's *Malaguena* is not only an impressive sample of this popular artist's technical resources, it's the kind of crisp, close-up recording that is generally only encountered under ideal studio conditions. Most of the balance of the recording is on the same high technical level, and Feliciano turns in one fine performance right after another in his familiar blues style and in such unanticipated items as the previously mentioned *Malaguena* and a 12-minute medley of bossa nova favorites from *Black Orpheus*. This 2-disc package is filled with fine performances, and much as I deplore the extensive applause, it must be admitted that he earns every bit of it. One minor complaint—the charming, descriptive battle piece for solo guitar is mislabeled *La Entrade de Bilbao* and mis-translated the *Battle of Entrada*. It is, of course, the *Entry into Bilbao*.

Performance: A Sound: A

Art Heatlie: Soul Hits Sax Style

Fontana Stereo SRF 67595

The sound that Fontana seems to be producing in its British studios is the most exciting to be encountered on any of the sound labels. Like the recent *The Sophisticated Johnnie Dankworth*, this disc has sound of exceptional brilliance and presence, with bright percussion transients and widely separated stereo effects. The

Dankworth platter carried a special "Living Presence Stereo" symbol that is absent from the present set, but the sound is obviously derived from the same engineering techniques. The music includes Otis Redding's *Fa-Fa-Fa-Fa-Fa*, *Sittin' on the Dock of the Bay*, and *Respect*, other qualified soul items such as *Soul Man*, *Don't Fight It*, and *Soul Finger*, and a few somewhat marginal items like *Chain Gang*, *Mustang Sally*, and Henry Mancini's *Peter Gunn*. But it hardly matters what the origins of the music may be in this collection. The focus is on the brilliant sound of Heatlie's electronic sax and the bright brass and driving rhythm of his splendidly recorded group.

Performance: A Sound: A+

Melvin Jackson: Funky Skull

Limelight Stereo LS 86071

Bassist Melvin Jackson plays an acoustical bass connected at various times to a Maestro G-2 filter box for guitar, Boomerang, Echo-Plex, and Ampeg amplifier. With eight or ten assorted brass, reed, and percussion men backing up his fanciful flights on eight master channels, he produces some extraordinary sounds and utilizes group and solo voices for special effects. Jackson, who has often been heard with electronic saxophonist Eddie Harris, has his first opportunity to front a group of his own on discs, and he takes the opportunity to say many highly unusual things. No matter how wild the experiment, Jackson manages to keep the result within acceptable loudness levels and inside a comfortable harmonic framework. The sound is splendid, and this disc will have strong appeal to sound lovers who want their modern jazz in a comfortable framework.

Performance: A Sound: A

The Brothers and Sisters: Dylan's Gospel Ode Stereo ZIZ 44018

Ten of Bob Dylan's songs, arranged and conducted by Gene Page, are presented in traditional gospel format by a group of top-flight West Coast professional singers with an accompaniment of organ, piano, bass, drums, and percussion. Included are *The Times are Changing*, *I Shall Be Released*, *Lay Lady Lay*, *Mr. Tambou-*

rine Man, *All Along the Watchtower*, *The Mighty Quinn*, *Chimes of Freedom*, *I'll Be Your Baby Tonight*, *My Back Pages*, and *Just Like a Woman*. The songs stand up well to gospel treatment, and the vocal group here could hardly be improved upon. Its style is impeccable, and its enunciation is remarkably clear. It rocks and swings, soars, and rumbles, and the music benefits. Only an excess of reverberation on some of the bands keeps this from being a perfect recording.

Performance: A Sound: A-

The New Don Ellis Band Goes Underground

Columbia Stereo CS 9889

The new Don Ellis Band is different from the earlier group not only in personnel, (only Ellis and fellow trumpeter Glenn Stuart seem to have survived), but also in instrumentation. Ellis' original hit set was an album called *Electric Bath*, but it's the new band that is really plugged in. Electrophonic trumpets, Fender-Rhodes piano, clavinet, and ring modulator all play an important part in creating the characteristic sound of this hard-driving band. The recorded sound is not sufficiently open to show off the group to full advantage, but on a good sound system, at high level, this disc can produce an awesome amount of impact. The music, mostly original pieces by Ellis, is hardly memorable at best, and cornball "message pieces" like *Black Baby* are well worth missing.

Performance: A- Sound: B+



"I didn't mind when the judge awarded her all of the diamonds, but she even had the gall to ask for my elliptical stylus."

(Continued from page 30)

$$R_{amp} = Z/DF$$

where R_{amp} is the internal impedance of the amplifier, Z is the nominal load impedance and DF is the stated damping factor. This is valid only at the frequency for which the damping factor is stated, usually 1000 Hz. From the value of R_{amp} one can get an approximation for the change in amplifier voltage for different load impedances. Usually the lower R_{amp} the better the amplifier because of the larger feedback which tends to reduce distortion, provided that the high feedback does not induce instability under certain load conditions.

The load impedance (impedance of the speaker) consists of a dissipative part (the actual ohmic resistance of the voice coil), and a complex impedance consisting of various electrical and acoustic reactances and the radiation resistance, the latter contributing to the acoustic damping. Really this is the most significant part of the damping system; the *higher* the radiation resistance the more energy is absorbed by the air and the better (more natural) the damping. This is not a conflict; the lower the dissipative resistance the better; the higher the radiation resistance the better.

In typical horn-type loudspeakers, the radiation resistance is usually close to the maximum attainable and the natural damping nearly optimum. In direct-radiator speakers the radiation resistance is a very small fraction of the total system resistance, the efficiency is low, and dependence is on amplifier damping. Even when viscous semifluids are applied to speaker outer suspensions (surrounds) and enclosures completely stuffed with fiberglass, amplifier damping is significant, but actually the amplifier damping factors higher than about 5 or 10 fail to contribute much because there is always the ohmic resistance of the voice coil in series with the low amplifier internal impedance.

Back in 1934, when an "all time high" in audio may have been achieved, Wente and Thurax of The Bell Telephone Laboratories concluded that the loudspeaker should have an impedance about 2.25 times the amplifier impedance—a damping factor of only 2.25, corresponding to an amplifier impedance of about 7 ohms for driv-

ing a 16-ohm speaker. This does not mean that modern amplifiers with 0.7 or 0.07 ohms are wrong but rather that speaker designers are working on designs that work better out of a constant voltage source.

CONCLUSIONS

"Damping factor" is more significant in terms of amplifier internal impedance and the implication of lower distortion than it is relative to damping of transients in the loudspeaker.

Amplifiers with recommended loads of 4 or 8 ohms may be operated with higher impedance loads with a probable reduction in distortion. While the amplifier power output may be reduced one decibel, it may be that the acoustic power will be increased by several dB because of the higher efficiency.

Specifically in the case of Klipsch speakers, the nominal impedance is 16 ohms, arrived at by taking the square root of the product of the impedances at the first peak and first

trough. (We may be the only ones using this computed impedance). However, our Klipschorn exhibits about 9 ohms impedance at 400 Hz and presents an ideal load to an amplifier of "nominally 8 ohms" and would cause a slightly reduced amplifier distortion if connected to a 4-ohm amplifier. For years we have recommended the use of the 4-ohm tap on certain tube amplifiers as a simple and effective way of achieving a bridged center speaker for stereo from two amplifiers.

Maybe this is a complicated way to say "use the 4- or 8-ohm amplifiers with our speakers" and don't worry about the "impedance mismatch." It usually (if not generally) is permissible to connect a higher-impedance load to a given amplifier, but it is *generally* ill advised to connect a lower-impedance load. Simply stated, it is permissible to connect a 16-ohm load to a 4-ohm amplifier but not acceptable practice to connect a 4-ohm load to a 16-ohm amplifier—or a one ohm load to a 4-ohm amplifier.

FREE McIntosh CATALOG and FM DIRECTORY

Get all the newest and latest information on the new McIntosh Solid State equipment in the McIntosh catalog. In addition you will receive an FM station directory that covers all of North America.



MX112
FM STEREO/AM TUNER PREAMPLIFIER
— ALL SOLID STATE

SEND TODAY!

McIntosh Laboratory Inc.
2 Chambers St., Dept. AE11
Binghamton, N.Y. 13903

NAME _____

ADDRESS _____

CITY _____ STATE _____ ZIP _____



Beethoven at 200

So Beethoven is 200! He will be soon, at any rate. He was born December 16, 1770 and survived until March 26, 1827, which means that in seven years we will have another Beethoven milestone, the sesquicentennial of his death. (The occasion of the centennial in 1927 was the beginning of Beethoven recordings.) With so much number magic on hand, the old curmudgeon is likely to have a lot of his music played between now and 1977. And yet the continuing road to fame—which must be renewed for every generation of listeners—will not be easy. Beethoven is in transition (if we may speak relatively, as though he were moving away from us); what will the younger generations make of this rough, exalted, obstinate early Romantic?

It is easy to say that Beethoven is eternal, his music imperishable. It's been said for a long time. But in these days of larger crisis, is music itself as we know it in any sense imperishable? More likely, we feel, it hangs by a musical thread. We are merely repeating the comfortable language of the nineteenth century and the eighteenth before it when we speak of "eternal" art. The ages of Reason and Science were confident that the world's (i.e. man's) problems were at last near solution and what man had wrought well nobody was likely to tear down unless for a very good reason. Tear down *Beethoven*? Things then moved onward and upward, each day's new miracles routinely surpassing those of the day before, just as expected. Of course Beethoven would live forever, in an ever more enlightened future.

After all, Beethoven was the man who freed music, as one writer, Rob-

ert Haven Schauffler, put it for his generation. Freed it from what? Well, from tyranny. Tyranny, first (they always said) in the old aristocratic world, where musicians had been mere servants in livery. And yet Haydn (in gorgeous livery) lived to a mellow old age and world fame as a servant of that same appreciative aristocracy, which was knowledgeable in music as few groups have been since. Some of its members voluntarily contributed to Beethoven's upkeep. Beethoven's own freedom, too, was scarcely better than wretched, to put it mildly. Things are not as simple as they used to seem in the century of utter confidence.

Nor did Beethoven free music from the supposed rigid restraints of the older Mozart-Haydn music, a thought that was dinned into me in my musical youth and is still taught today in Music Appreciation classes. On the contrary, he was formed and disciplined by that very admirable school of composition and now is considered a part of it—the Viennese Classic school.

Moreover, in the face of freedom the key to Beethoven's greatness lay in sheer musical self-discipline, a regard for shape and form and musical logic that knew no bounds in terms of man-hours of self-imposed work. He was, to be sure, the first big popular Romantic composer and he did free music from one set of expressive conventions simply by indicating another and more currently relevant set in his music, more forceful in sound, more outward and literal in emotion, more democratic in that it was a language newly easy for the masses to understand. But this was an updating, not a kind of freedom! Mozart and

Haydn were unaware of the "restraints" from which, said the nineteenth century, Beethoven had freed music. Freedom, as we ought to know by now, is only a higher state of self discipline.

Beethoven's music has a different importance for us. His sound structure expresses above all the sense of his own times—and not so very differently from our own "multi media" expressions today.

It was the dynamic new age of industry and machinery, the time of revolutionary democracy, the downfall of kings and the rising of the people. William Blake's "dark satanic mills" sprawled hideously on the landscape, the beginnings of modern industrial expansion. For the first time in 700 years Notre Dame in Paris and Westminster Abbey in London turned dark, smudged with soot. Coal, steam, dirt and sweat began their rule in the midst of the glorious bloody wars of Napoleon, old-style wars, yet fought on a frightening new scale of enormity, the first global conflict. After centuries, European man was exploding like a supernova and the excitement was felt in every aspect of life. Beethoven "free" of all this? Of course not. The opposite.

The railroads were only a few short years ahead. Already in Beethoven we sense their kind of power; it was, so to speak, in the air and we may hear it loudly in his driving orchestral momentum. *Not* literally, of course. Even more importantly, though, for being such an accurate expression of the ground-feeling of that time, the sense of enormous things to come. And how like Napoleon's *Arche de Triomphe* in Paris is the great arch of the Eroica

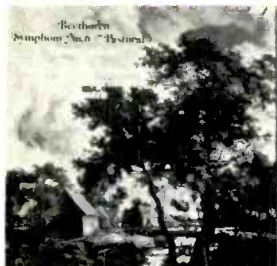

Symphony, enormous beyond precedent yet so ineffably classical in structure!

We can forgive those who followed Beethoven for their wishful misinterpretations of him—they were speaking for themselves and he was their embodiment. Bigger and better! That was the cry. Expand, expand! Down with restraints and formalities, on to the wild blue yonder. Freedom from everything! But if other composers, taking up Beethoven's new and exciting musical language, used much less discipline and inner shaping than he himself did, it was not Beethoven's doing. His was the freedom of discipline—exactly the same sort that brought the industrial age forward so astoundingly in the next hundred years. Without the heady concept of freedom, it would not have happened.

Today, of course, we still expand, and we talk Progress with every breath. But how differently. We are afraid to believe ourselves, beyond the day after tomorrow. That dazzling explosion of future glory that the nineteenth century anticipated with such confidence is no longer in our future. We're expecting a more dire explosion and we feel helpless before it. The promised land is no longer achieved and then regularly achieved again, except maybe, on the moon.

In art, in music, we are bifurcated, the two halves expressing us equally. One part blasts away at the old institutions, as they must be blasted at if we are ever to pull out and away: pop art, electronic music, aleatoric (chance) sound configurations, the Moog and the RCA Synthesizer. *What is music?* Who knows any more; but we'll find out for ourselves even if we

must invent our own new music.

The other half of us finds blessings in musical hindsight—and why not? If people in the past did an enviably good job, should we ignore them? And so we revive old music (95 per cent of it *not* from the Romantic nineteenth century) and restore such obsolete mechanisms as the Baroque oboe, ancestor of the “modern” oboe. Perverse, but logical. A rediscovery of former real and solid human values, in our time of need. It's worth learning to play the Baroque oboe, if only to experience the feeling of how it was, back in that golden age of confidence. It's all in the human family, and that family is in a bad way right now.

So Beethoven, writing in the buoyant first enthusiasms of an age now rushing to ruin (relatively, at least—it'll last awhile yet) is no longer an easy composer to understand and may well become much more difficult. Not only in his way of thinking, so unlike ours, but because his very language is increasingly unfamiliar among the young, who go easily for Bartok, Mahler, Stravinsky, Rock, or the massive Baroque of Vivaldi and Telemann.

In Beethoven's day, Bach was at his lowest ebb. Will Beethoven, perhaps, have to ebb too, before we rediscover his ebullient message of hope? Maybe another 50 years will help. How about his 250th for Rediscovery Day. That would be December 16, 2020, a good deal less than a lifetime away. Less than Beethoven's own. About then, I expect, we'll really be needing Beethoven, perhaps to herald the dawn of planetary expansion. Good luck! is all I can say. He'll need it and so will we.

DON'T MISS ...
 AUDIO
 ENGINEERING
 SOCIETY'S
 38th TECHNICAL
 MEETING
 AND
 EXHIBITION OF
 PROFESSIONAL
 EQUIPMENT
 AT THE
 LOS ANGELES
 HILTON
 MAY 4-7



Recorded Tape Reviews

BERT WHYTE

DEBUT!—Henry Mancini conducting the Philadelphia Orchestra Pops RCA TR3-1006, open reel, 3 $\frac{3}{4}$ ips, (\$6.95)

As you are probably aware, RCA has either lost or given up (take your choice) the Boston Symphony to Deutsche Grammophon, and naturally this also means no more Fiedler and the Boston Pops on this label. Having acquired the Philadelphia Orchestra, it would seem that the popular Henry Mancini has been chosen as Fiedler's replacement and it is certainly easy enough to label the orchestra as a "Pops" group. This tape is presumably the first in a Pops series with Mancini, although one imagines that this is sort of a "look see" venture to sample public reaction. All the music on this tape was composed and arranged by Mr. Mancini. On the first sequence of the tape are six "musical vignettes," fancifully titled such as "Strings On Fire" and "Drummers' Delight," and so on, which are designed to show off the virtuosity of the various sections of the orchestra and the lushness of the "Philadelphia Sound." The second sequence is an autobiographical suite entitled "Beaver Valley—'37." Mr. Mancini has a deservedly high reputation for writing some of the more interesting pop and mood music of today, but on this tape he hasn't given us anything that is very memorable. The music designed to show off the orchestra is pleasant enough and the arrangements facile, slick and professional. The "Beaver Valley—'37" suite is in three sections—the first two rather rambling and without much flesh on the musical bones. The third section subtitled "The Sons of Italy" is a rousing affair with a few "catchy" moments reminiscent of some of this composer's better work. Certainly it is the best music on this tape. In matters of sound we have a mixed bag. This recording was made in the Academy of Music in Philadelphia, where the orchestra

usually performs. This has musical advantages of course, but the hall is very dry acoustically and Columbia eschewed using it when they were recording the Philadelphians. RCA has been using a controversial method of adding reverb to the original sound, involving feeding the signals into another room and remixing. Apparently it is complicated and problematic and the overall reception of the first few RCA/Philadelphia recordings has not been favorable. I understand that as a result, recording in the Academy of Music will be abandoned. On this tape there are sections where the sound is quite good, with especially clean and articulate percussion. But unfortunately, there is an unpleasant shrillness in high-register ensemble string passages and frequent instances where the acoustic perspective and orchestral balance are decidedly at variance with good stereo recording. In summation, this impressionistic-type music isn't vintage Mancini, and the best that can be said for it is that it can serve as a somewhat different kind of background music. Mr. Mancini and RCA can do much better and the new recording location should certainly help.

Chicago Transit Authority (Vol. 1)—Columbia 8-track cartridge. 18-10-0726 (\$6.95)

First off in this review let me confess that a fan of rock music—"hard," "acid" or otherwise—I ain't. Oh, I've listened to the Beatles (but admire them mostly for their compositional efforts) and to a few other of the "better" groups that exhibit a certain interesting "creativity." But by and large most of the stuff sounds like sheer cacophony to me. A great deal of it sounds like a big "put-on," and an affront even to the permissive tastes of the young. I especially decry the absurd "intellectualizing" of much of this puerile pap by certain critics who are afraid the young will label them as "squares," if they don't react properly to this "new music." Okay, I'm not worried about my image. I'm a square—so be it. But I'm a curious square. That is why every now and then I'll play something with these outlandish titles. Chicago Transit Authority! That stops me. I figger maybe this group has incorporated the sound of a Chicago subway into their music. Typical square thinking, right? Well, I set my pre-amp at the usual level, inserted the cartridge . . . and was nearly blown off my feet! How Columbia managed to put such a level on an 8-track cartridge without distortion would be interesting to know. I mean this thing is *loud!* The musical content has plenty of what I abhor. It also has the redeeming values of a certain originality and I sup-

pose what you might call structural interest, rather than clever arrangements. The members of the group really know how to play their instruments well, a marked and refreshing contrast from most rock groups. The vocal aspects of this production can be dismissed as pure caterwauling, a situation which is distressingly common with the vast majority of rock albums I have heard. There is little question that the group in this recording is a few cuts above average. I consulted with a few of my "under thirty" experts, who were unanimous in their opinion that the CTA was a "real groovy crew." Certainly the relentless hard driving beat generated a lot of excitement among my young friends. Good clean sound throughout the tape.

Classical Cassettes

Tchaikovsky—Piano Concerto #1—Van Cliburn, piano Kiril Kondrashin, cond. RCA RK1002, \$6.95

Rimsky-Korsakov—"Le Coq d'Or" Suite
Stravinsky—"Firebird Suite"

Erich Leinsdorf conducting the Boston Symphony Orch. RCA RK1031, \$6.95

Tchaikovsky—Violin Concerto, Pinchas Zukerman, violin, Bernstein/NY Phil.

Mendelssohn—Violin Concerto, Pinchas Zukerman, violin, Dorati, London Sym. Columbia 16110162, \$6.95

In the early days of pre-recorded cassettes, very little classical product was issued. And just as well, for the medium just wasn't ready for the demands of classical music. Very obtrusive tape hiss, hum, distortion, restricted dynamics and frequency response, poor transient response—it all added up to a pretty dismal picture. Today, there still is not a great number of classical cassettes released, but the situation has improved and is rapidly getting better. The three cassettes listed above are typical of what is being released presently. As you can see, for the most part it is duplicating the tried and true "pot-boilers" to be found on disc and open-reel tape. Nothing much need be said about the performances which have received their share of accolades over the past few years. The improvement in sound quality has been dramatic. Of course there is still too much hiss, extraneous noises and drop-outs, and occasional overload distortion. But a comparison with the early product shows how much reduction has been effected in these areas. What really makes the difference, is the broader dynamics, better transients and better frequency response both at the high end and in the bass. A good example is in the Firebird

(Continued on page 81)

(Continued from page 69)

Fig. 8 if one considers Curve 2 the original response and Curve 1 the curve resulting from a lower resonant frequency. The responses at 40 Hz are nearly identical. (It is assumed that the box is always tuned to resonate at the free-air resonant frequency of the speaker.)

As with the closed box, increasing mass reduces efficiency and raises the Q, requiring more damping, and lowering output by 12 dB, as illustrated by Curves 3 and 4.

The last alternative illustrated comprises improving the box/speaker compliance ratio by increasing the box compliance—not by making the box larger, but by using a smaller speaker. Curve 5 is for a speaker of half the original cone area. The frequency response is the same (Curve 4) but the loss of output is only 6 dB.

Comparing the closed and vented boxes, it is apparent that the latter provides flat response to a somewhat lower frequency, with a sharper low-frequency cut-off. The vented enclosure has three parameters in place of the two of the closed box, affording the designer more flexibility in optimizing bass response. On the other hand, it can be seen from the curves of Fig. 8 that a relatively small deviation from the correct values of the parameters of the vented box can result in large deviations from flat response, which is not the case for the closed box.

Experimental Results

In order to test the theoretical conclusions by experiment, a woofer was constructed² with a 3 3/4-inch diameter cone and a free-air resonance of 34 Hz. This required a very large surround; since a part of the surround moved so as to radiate an appreciable amount of sound, the effective cone diameter was actually about 4 1/4 inches. This woofer was mounted in a 0.6 cubic foot cabinet tuned to 34 Hz by means of a port with a cylindrical duct. It was realized, of course, that the small power-handling capacity of this speaker would make it an impractical design; the extreme conditions were imposed to make the comparison with a large speaker more striking.

The frequency response up to 1000

Hz was measured and compared with that of a heavy 15-inch woofer in a 4 cubic foot vented enclosure. In Fig. 9 the dashed lines depict the response in an anechoic chamber and the solid lines show the performance in a typical living room. Listening tests were conducted with the speakers concealed behind a sound-permeable curtain, with signal levels adjusted for equal acoustic outputs. At moderate sound levels below the overload point of the small woofer, it was not possible to distinguish its bass response from the large system.

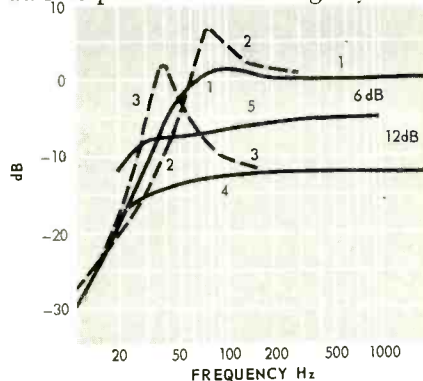

Fig. 8—Calculated frequency response of speakers with different parameters in a vented box.

The author wishes to thank Daniel von Recklinghausen, Technical Director of H. H. Scott, Inc., for his invaluable assistance in providing the necessary computer calculations of the data plotted in Figs. 4 and 8. Æ

FOOTNOTES

1. Performance of Enclosures for Low-Resonance High-Compliance Loudspeakers—James F. Novak—IRE Transactions on Audio—Jan-Feb 1959.
2. This experimental speaker was constructed and measured while the author was Engineering Manager at University Loudspeakers, Inc.

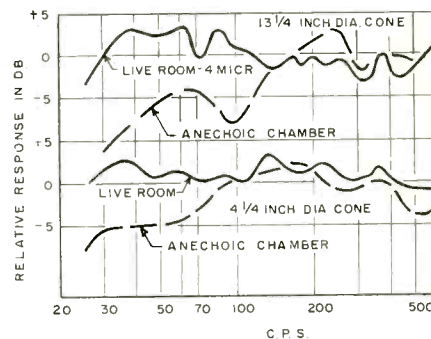

Fig. 9—Relative response curves of a small and a large speaker.

You've **SEEN** the Mini- now **HEAR** the MAXIMUS!

You probably think it's impossible to get the big sound of a 12-inch woofer and a midrange-tweeter from an enclosure measuring only 7 1/4 x 10 1/2 x 5 1/2 inches... that is, until you hear the MAXIMUS 1!

Be sure it's the MAXIMUS because today we've got imitators. Better still—let your ears compare... you'll be able to choose THE sound imaginative technology makes possible!

Your MAXIMUS dealer has seven superb systems from compacts to a magnificent 4-speaker 3-way system—from \$39.95. Only MAXIMUS makes the original mini-MAXIMUS!



MAXIMUS SOUND CORP. 809 Stewart Ave., Garden City, N.Y. 11530, (516) CH 8-6404

CLASSIFIED

Rates: 25¢ per word per insertion for noncommercial advertisements; 50¢ per word for commercial advertisements. Frequency discounts as follows: 2 times, less 15%; 6 times, less 20%; 12 times, less 30%. Closing date is the FIRST of the second month preceding the date of issue. *Payment must accompany all orders under \$10.00.*

SERVICES

HIGH FIDELITY SPEAKERS REPAIRED AMPRITE SPEAKER SERVICE

168 W. 23rd St., New York, N.Y. 10011
CH 3-4812

DON'T THROW YOUR OLD CARTRIDGES AWAY. Send us \$50.00 and any old used cartridge and we will ship you via air prepaid anywhere any one of the following Top Stereo Cartridges: Shure V-15 Type II, Empire 999VE, Stanton 681-EE. These are **NEW** and include diamond stylus. Write for lowest quotations on all stereo components. Send \$1.00 for our discount catalogue. **Defa Electronics**, 2207 Broadway, New York, N. Y. 10024.

PROTECT YOUR LPS—Heavy poly sleeves for jackets 5¢, Round bottom for records 3½¢ ea. New LP jackets, White 20¢. Min. order \$5.00. House of Records, Box 323A, Hillburn, N. Y. 10931.

ACOUSTIC RESEARCH, Dyna, Koss, Shure discount specialists. Write for free catalogue. SCS Corp., 95 Vassar St., Cambridge, Mass. 02139.

RENT STEREO tapes \$1.00 week. Catalog 25¢. Tape Library, Box 8126, Washington, D. C. 20024.

SERVICES

FREE — FREE — FREE — FREE — FREE
Send in for your FREE one year subscription to Olson Electronics' fantastic value-packed catalog—unheard of low, low prices on brand-name speakers, changers, tubes, tools, stereo amplifiers, tuners, CB, and other values. Credit plan available. If you have a friend interested in electronics, send his name and address for a FREE subscription also. Olson Electronics, Dept. AC, 260 S. Forge St., Akron, Ohio 44308.

RECORDING for radio producers, agencies, musicians. Mono. & Stereo. Evening and weekend sessions available. **DEMOVOX SOUND STUDIO**, 1038 Bay Ridge Avenue, Brooklyn, N.Y. (212) DE 1-3954.

EARN MORE at home. Details \$1.00. R. Grossman, Box 51, Winsted, Conn. 06098.

CUSTOM RECORDING SERVICE. Tape and disc. Stereo and mono. Live and copies. Editing. Masters and pressings. High quality at reasonable rates. Joseph Giovanelli, Audio-Tech Laboratories, 2819 Newkirk Ave., Brooklyn, N.Y. IN 9-7134.

FREE LITERATURE: Address labels, business cards, printing, rubber stamps. Jordan's 552 W. O'Connor, Lima, O. 45801.

FOR SALE

FREE 40-PAGE CATALOG offers hundreds of recordings of rare Renaissance, Baroque and Classical music. Some records priced as low as \$1.00 each! All late recordings in stereo only. **MHS RECORDS**, Box 932-AU, New York, New York 10023.

AMAZING DISCOUNTS on famous brand high fidelity stereo components. No small wonder that we have set new sales records each year since 1959. Write. Arkay Electronics, 1028-05 Commonwealth, Boston, Mass. 02215.

DISC RECORDING EQUIPMENT: Complete mono and stereo cutting systems featuring rebuilt Scully, Neumann, Van Eps, and Fairchild lathes and new W.A.L. amplifiers. Priced from \$2500.00 Wiegand Audio Laboratories, 3402 Windsor Road, Wall, N. J. 07719.

HARPSICHORD: Same as owned by Philadelphia Orchestra and RCA Victor. In kit form for home workshop assembly, \$150. Clavichord kit, \$100. Free brochure. Write: Zuckermann Harpsichords, Dept. R., 115 Christopher St., New York, N. Y. 10014.

ELECTRONIC CROSSOVERS featuring high reliability, integrated circuits, output level controls, 12 dB/octave rolloff. Specify crossover frequencies and/or speaker system. Stereo: 2-way \$75, 3-way \$110, 2-way 6 dB/oct. \$45. Development Engineering Services, P.O. Box 693, Pacoima, Calif. 91331.

Ampex 934 Tape Player, extra Nortronics Playback Head, Walnut Base—\$99. Citation B Amplifier—\$190. Box 1482, Arlington, Texas 76010.

ROBERTS 770X—\$195.00. 4902 Panorama, Huntsville, Alabama 35801.

McINTOSH 250 Amp, Fisher TRM 1000 Tuner, AR 3's—All New. Long, 79 Chittick Rd., Hyde Park, Mass. 02136.

AMPEX 755, Perfect Condition, Used 30 Hours, \$165.00. Norman Tetenman, 20 Whitebirch Lane, Commack, N.Y. 11725.

FAIRCHILD F-22 Condenser Mike. Built-in power supply. Dual Z. Like new, in case. \$125.00, Art White, 5904 Gordon Ave., Tampa, Fla. 33611.

2 Auto-Reverse Ampex 2070 tape recorders, used, with accessories. \$175.00 each. G. W. Bailey, 148 King William St., Newark, Delaware 19711. Tel. (302) 368-0768.

PAT-4, FM-3, wired, new, warranty, Stereo 120, 10 hours, cost \$490+, Dealer's personal system, \$299.00. Kane, 3801 Finley, Irving, Texas 75060.

FOR SALE

FM BACKGROUND MUSIC—Miniaturized SCA Adapter Module connects to any FM Tuner. Operates on 12 volts. \$29 postpaid. Performance guaranteed. K-LAB, Dept. A1, Box 572, S. Norwalk, Conn. 06856.

REVOX RECORDERS, Box 499, Maywood, Ill. 60153.

BIG BAND RADIO THEMES — Quarter-Track Tape Orrin Tucker, Clyde McCoy, Xavier Cugat, Shep Fields, Etc. SOHNNY, 1311 Painter Street, Streator, Ill. 61364.

Midwesterners, Westerners — New York Prices in Indiana. Acoustic Research a specialty. Write for lowest system quotes on fine AR speakers with Dyna, Dual, Fisher, Scott, Shure, Thorens, Rabco. Factory-authorized dealers; personal replies. HOME HIGH FIDELITY, 1233 So. 8th St., Terre Haute, Indiana 47802.

FILIGREE WOODWORK used by top quality hi-fi manufacturers available for handi-crafters. Send \$0.50 for sample and literature. Empire, Box 937, Pacific Palisades, Calif. 90272.

OLDIES—45 RPM. Original hits. Over 4000 available. Catalog 25¢. C & S Record Sales, Box 197, Wampsville, N. Y. 13163.

CATALOGS Broadcasts, Soundtracks, Personalities of Thirties, Forties. Box 225, New York, N. Y. 10028.

SCULLY Professional Tape Recorders, from 1 to 24 tracks, complete recording studio package designed to order featuring W.A.L. console systems and other leading professional audio products. Phone (201) 681-6443, Weigand Audio Laboratories, 3402 Windsor Road, Wall, N.J. 07719.

SAVE OVER 33 1/3 on a pair of one of the world's best speaker systems shipped direct to you from factory. Try them in your home for thirty days. Write KGLL, Inc., Water St., Lewiston, Maine 04240.

QUOTES: STEREO COMPONENTS, Box 18026, Seattle, Washington 98118.

IMPROVED SHURE V15-II, \$50 and your old cartridge, shipped prepaid. The Stereo Shop, 1201 Ellis, Cedar Rapids, Iowa 52405.

SYLVANIA TV'S, stereos, components—model number. Furniture, 933 W. 7th Street, St. Paul, Minn. 55102.

ORGANS, KITS, PARTS & ACCESSORIES. new and used. Write for free brochure: Newport Organs, Dept. A, 1593 Monrovia Ave., Newport Beach, Calif. 92660.

FREE Catalog: Low-priced, high-performance subminiature listening devices direct from manufacturer. Dealers welcome. Audiotronix Adm. 5, 156 Fifth Avenue, New York, N. Y. 10010.

AUDIO • MARCH 1970

FOR SALE

MARANTZ 18 Receiver; perfect condition; orig. fact. carton available for shipping; \$350.00. Box AM-O-1

TWO HARTLEY 207 MS 7 speakers \$65.00 each. Used 9 months. G. Foster, 2065 Overlook Ave., Willow Grove, Pa. 19090.

MARANTZ 7-T Solid-State Amp and Mattes SST-200 Solid-State 200-watt Amplifier. 2 AR-3's. All in perfect condition. \$800.00 Joe Dobbs, 2977 Dale Drive, NE Atlanta, Ga. 30305. (404) 233-6581.

THORENS TD-124, has Series II motor mounts, knobs; 16" WB-309/SW Base; 12" and 16" tone arm boards. Excellent condition, \$75.00. James Ebbert, 827 South Pine Street, York, Pennsylvania, 17403.

AKG CONDENSER MICROPHONE SYSTEM, M250/M250 E. New, never used. \$185. Auerbach, 6 Horizon Rd., Fort Lee, N.J. 07024.

EQUIPMENT WANTED

CASH FOR YOUR unwanted LP's and pre-recorded tapes. Record House, Hillburn, New York 10931.

WANTED: One pair of Neumann or Telefunken U-47, U-48, or M-49. Good condition and complete. D. C. Smith, 942 Post Lane, Clarkson, WA. 99403.

WANTED, two Jensen G 600 Triaxial loudspeakers with crossover units. In good condition. C. Carollo, 189 West Side Ave., Freeport, N.Y. 11520.

JBL Speakers; 075, D130, and N2400 crossover. G. M. Hoffsommer, 3501 Croco Rd., Topeka, Kansas 66605.

WANTED: Heathkit Legato Speaker System. 1956-1959. Has 2 15-inch Altec Speakers and Multicell Horn. Fairchild LP, 78 Mono Cartridges. David Rodger, 469 NE 130 St., N. Miami, Fla. 33161.

SITUATION WANTED

WOULD LIKE TO WORK as a record distributor assistant. Call (215) KI 6-0220.

INSTRUCTION

LEARN Electronic Organ Servicing at home. All makes including transistors. Experimental kit—trouble-shooting. Accredited NHSC. Free Booklet. Niles Bryant School, 3631 Stockton, Dept. 1D, Sacramento, Calif. 95820.

BUSINESS OPPORTUNITIES

MAKE BIG MONEY raising chinchillas, rabbits, guinea pigs for us. Catalog—25¢. Keeney Brothers, New Freedom, Pa. 17349.

NEW FINCO® Home entertainment distribution wiring system for do-it- yourselfers



MODELS;
HWK-75
75 ohm
HWK-300
300 ohm

• For Color TV—
UHF/VHF

Everything needed
to wire your home
for multiple set
reception—in
easy-to-handle kit
form.

• FM/FM
Stereo

Turn your whole house into a home entertainment center. Operate up to four sets, or be able to move your entertainment equipment from room to room. Kit includes all necessary parts, fittings and instructions.



**THE FINNEY
COMPANY**

34 W. Interstate St., Dept. AM-3 Bedford, Ohio 44146

Check No. 78 on Reader Service Card

Recorded Tape Reviews

(Continued from page 78)

Suite. At the beginning of the "Infernal Dance" and throughout this section, there is a tremendous bass drum, which on the disc and open-reel tape was often used to demonstrate loudspeakers. This drum has great power and projection and has a fundamental of about 35-40 hertz. On the cassette tape, with the benefit of about 2.5 dB of bass boost, the drum is reproduced amazingly well. The piano transients in the Tchaikovsky Concerto are nice and clean with no blurring or "fuzzing." In the violin concertos, the string tone is brilliant with overtones, yet smooth and clean. On many lesser stereo systems, played at "apartment level," these cassettes would be perfectly acceptable to many people. For the audiophile, in spite of recent improvements, the classical cassettes cannot compete with his disc or open-reel tape. However, the immediate future is very bright for high-quality cassettes, with some startling developments I cannot reveal to you at this moment.

*A Major
Breakthrough
In Sound
Reproduction...*

**THE RABCO
SL-8**



ACCLAIMED BY EXPERTS...

"Without question, the Rabco arm does what it is supposed to do, and does it nicely. ...minimized record and stylus wear, superb reproduction."

Audio Magazine

"Extremely well engineered...unprecedented low tracking force, no skating effects, minimum groove wear, and minimum stylus wear. ...ruggedly constructed: after months of continuous use the SL-8 remains as responsive and foolproof as when first installed."

Hi Fidelity Magazine

**THE ONLY STRAIGHT LINE
SERVO TONE ARM**

RABCO

11937 TECH ROAD,
SILVER SPRING, MARYLAND 20904
Check No. 82 on Reader Service Card

Advertising
Index

Acoustic Research, Inc.	31
Audio Dynamics Corp.	65
Audio Engineering Society	77
Benjamin Electronic Sound Corp.	53
Bose Co., The	37
Bozak	39
British Industries Corp.	4-5
Classified	80
Computron	64
Crown International	9
Dolby Laboratories, Inc.	11
Dynaco, Inc.	15, 35
Electro-Voice, Inc.	Cover IV, 2
Electronic Industries, Inc.	69
Elpa Marketing Industries	55
Finney Company, The	81, 82
Frazier, Inc.	71
Harmon-Kardon	3
Hi-Fidelity Center	82
JVC America, Ind.	7
Kenwood Electronics, Inc.	57
Koss Electronics, Inc.	59
Lafayette Radio	33
Marantz Company	42-43
Maximus Sound, Inc.	79
McIntosh Laboratory, Inc.	75
Pickering & Company, Inc.	19
Pioneer Electronic (USA) Corp.	25, 61
Rabco	82
Rectilinear Research Corp.	41
Sansui Electric Co., Ltd.	46-47
Scott, H. H., Inc.	Cover II
Shure Brothers, Inc.	11
Sony Corporation of America	28-29
Sony/Superscope	21, 49
Stanton Magnetics	Cover III
Superex Electronics Corp.	73
Tandberg of America, Inc.	1
TEAC Corp. of America	17
University Sound	67
Wharfedale	4-5

**FM Stereo
WINDOW
ANTENNA**
by **FINCO**®

**Outperforms any
indoor antenna!**

List Price
\$17.80

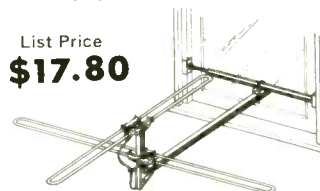

- All directional receiving pattern.
- Aluminum construction with gold-corroded corrosion-proof finish on antenna.
- Fits horizontally or vertically in windows up to 42" wide or high.
- Extension bars available for larger windows.

Write for Catalogue 20-462 Dept. AM-3



**THE FINNEY
COMPANY**

34 West Interstate St., Bedford, Ohio 44146

Check No. 83 on Reader Service Card

*We Own The
Sharpest Pencils
In Town!*



**YOU SAVE MORE
ON HI-FI COMPONENTS
& TAPE RECORDERS**

- We invite your test of our "We Will Not Be Undersold Policy."
 - 15-day money-back guarantee.
 - 2-yr. unconditional guarantee parts & labor no charge, at local warranty station or factory.
 - Trade-ins—highest allow. Send your list.
 - Most items shipped promptly from our \$250,000 inventory, fully insured.
 - Our specialty—APO & Export.
 - 23rd yr. dependable service—world wide.
- Rated #1 service—satisfaction according to nationwide survey.

Write for Our Price First!
You'll Be Glad You Did!

HI-FIDELITY

CENTER

"The House of Low Low Prices"

239-V East 149th St.
New York, N.Y. 10451

Check No. 84 on Reader Service Card

AUDIO • MARCH 1970

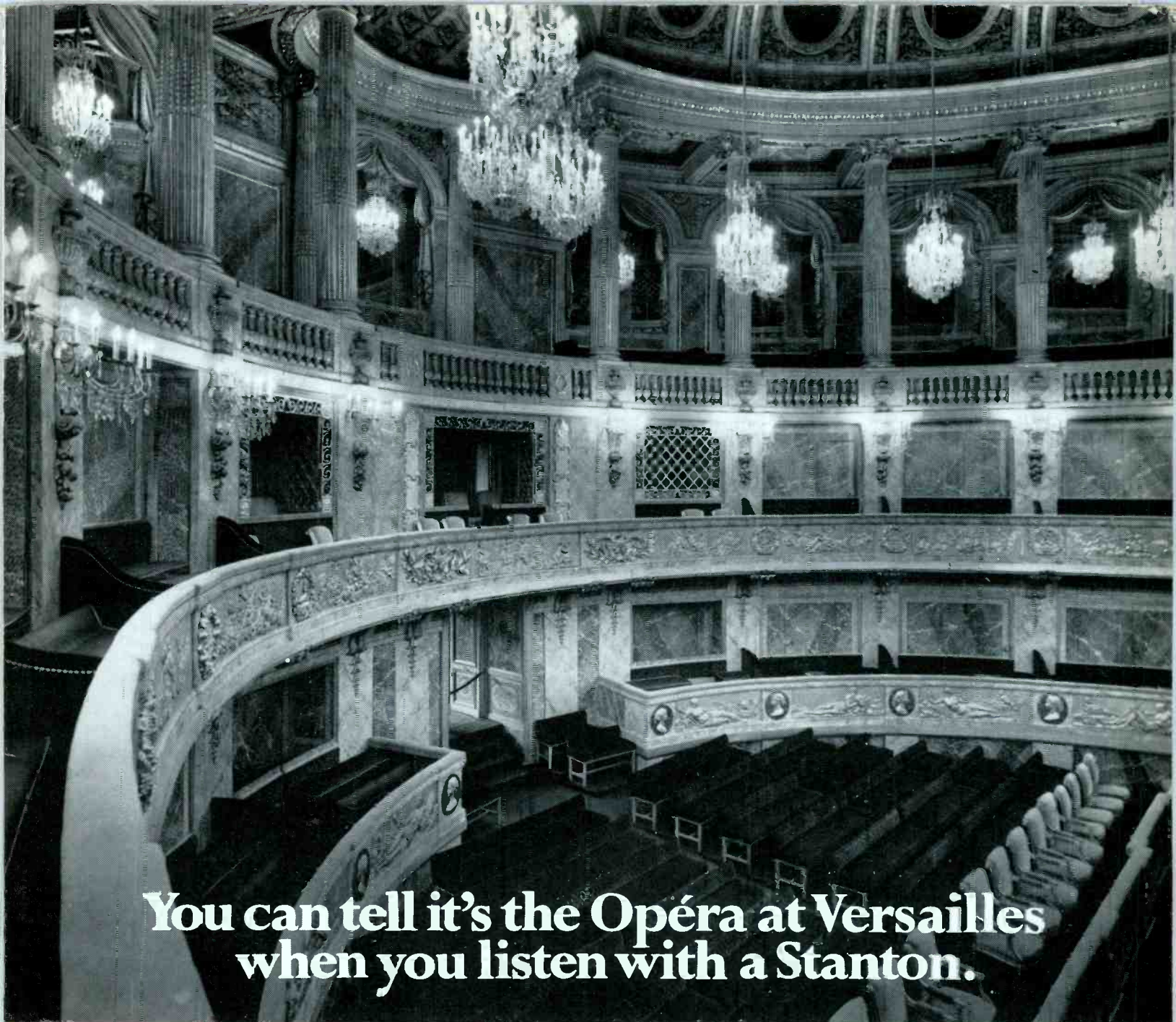

You can tell it's the Opéra at Versailles when you listen with a Stanton.

The Opéra at Versailles, completed 1770, scene of the first performances of Jean Baptiste Lully's operas and ballets. (Lully was court composer to Louis XIV.)

PHOTOGRAPH BY FRANZ EDSON

The ultimate test of a stereo cartridge isn't the sound of the music.

It's the sound of the hall.

Many of today's smoother, better-tracking cartridges can reproduce instrumental and vocal timbres with considerable naturalism. But something is often missing. That nice, undistorted sound seems to be coming from the speakers, or from nowhere in particular, rather than from the concert hall or opera stage.

It's easy to blame the recording, but often it's the cartridge.

The acoustical characteristics that distinguish one hall from another, or any hall from your listening room, represent the subtlest frequency and phase components of the recorded waveform. They end up as extremely fine undulations of the record groove, even finer than the higher harmonics of most instruments.

When a cartridge reproduces these undulations with the utmost precision, you can hear the specific acoustics of the Opéra at Versailles, or of any other hall. If it doesn't you can't.

The Stanton does.



Stanton

The specifications.* Frequency response from 10 Hz to 10kHz, $\pm 1/2$ dB. From 10kHz to 20kHz, individually calibrated. Nominal output, 0.7mV/cm/sec. Nominal channel separation, 35dB. Load resistance, 47K ohms. Cable capacitance, 275 pF. DC resistance, 1K ohms. Inductance, 500mH. Stylus tip, .0002" x .0009" elliptical. Tracking force, $3/4$ to $1 1/2$ gm. Cartridge weight, 5.5 gm. Brush weight (self-supporting), 1 gm.* Each Stanton 681 is tested and measured against the laboratory standard for frequency response, channel separation, output, etc. The results are written by hand on the specifications enclosed with every cartridge. The 681EE, with elliptical stylus and the "Longhair" brush that cleans record grooves before they reach the stylus, costs \$60. The 681T, identical but with interchangeable elliptical and conical styli both included, costs \$75.

For free literature, write to Stanton Magnetics, Inc., Plainview, L.I., N.Y. 11803.

Check No. 103 on Reader Service Card



E-V 1382 150-watt AM/FM stereo receiver \$299.95 Suggested Retail. Shown with optional CWR3 walnut finished case, \$27.00.

Flexibility. It's written all over the face of this new 150-watt E-V 1382 receiver.

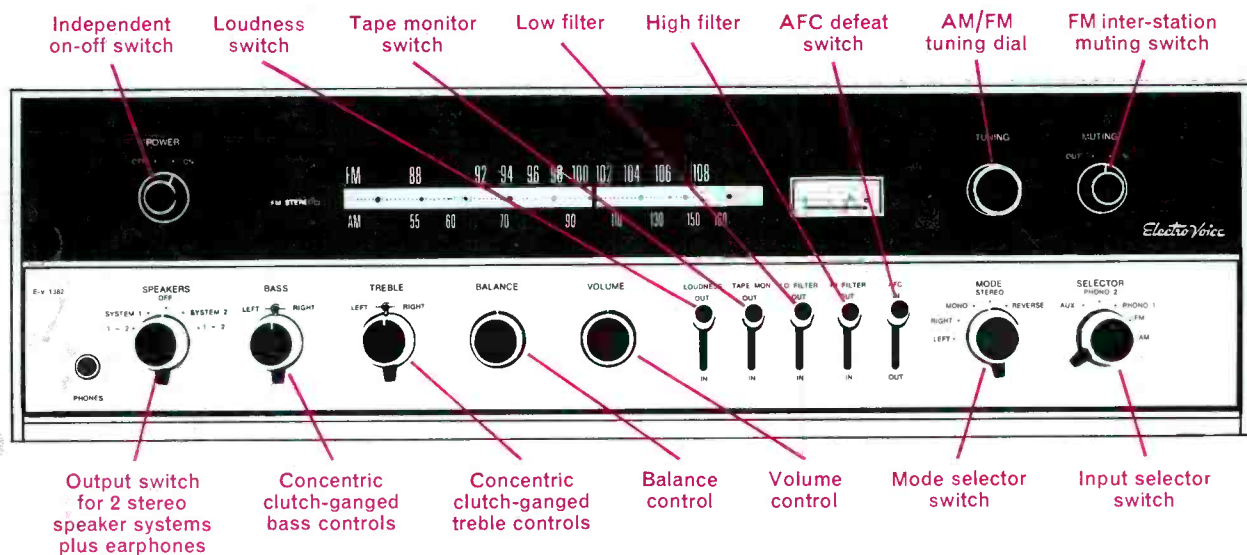

E-V Study the front panel of the handsome new E-V 1382 receiver. Note the controls: 17 of them. Look at what they can do for you today . . . and in the future if you expand your system.

We've obviously gone beyond the basics to provide you some very helpful options. Like reverse stereo (you can put the violins on the other side of the room anytime). Or TWO stereo magnetic phono inputs (for both a turntable and a changer). And you can channel a mono signal into one or both outputs at the flip of a switch. Plus an output control that makes it easier to switch sound anywhere in your home.

But what of performance? Behind the

volume control is 150 watts* of clean power. Total harmonic distortion is an inaudible 0.8% or less at full-rated output. And our power bandwidth is 15-45,000 Hz for full range performance, even at concert levels. The tuning dial controls a solid-state FET front end that provides 2.0 uV sensitivity for stereo FM signals. And a 4-stage IF circuit insures excellent selectivity and stereo separation.

Stereo-mono switching is automatic, of course. And the signal strength meter simplifies precise tuning of AM or FM. Speaking of AM, this new circuitry is just as carefully designed — and just as up-to-date. Sensitivity, for example, is far better than most other present day

hi-fi receivers.

In sum, we've combined 42 transistors, 31 diodes and 17 logical, easy-to-use controls to help you get the most from your high fidelity investment today . . . and tomorrow.

Listen soon to the new E-V 1382. Compare it feature-for-feature, dollar-for-dollar. It's now on display at E-V soundrooms all across the country. Or ask for our latest literature. Your free copy is waiting.

*Music power \pm 1db. Equal to 120 watts (IHF) at 4 ohms, or 80 watts (RMS) continuous sine wave at 8 ohms.

ELECTRO-VOICE, INC., Dept. 304A, 602 Cecil Street, Buchanan, Michigan 49107

high fidelity systems and speakers • tuners, amplifiers, receivers • public address loudspeakers • microphones • phono needles and cartridges • aerospace and defense electronics

Electro-Voice®

A SUBSIDIARY OF GULTON INDUSTRIES, INC.

Check No. 104 on Reader Service Card