

the authoritative magazine about high fidelity

AUDIO

Eng.

JULY

1968 60¢

ENGINEERING
LIBRARY

* Exotic Loudspeakers *
The Ultimate Charles Ives
* Audio Test Equipment *

CHARLES IVES
INSTITUTE OF
TECHNOLOGY

CALIF INST OF TECHNOLGY
LIBRARY
ENGINEERING FUND 91109
PASADENA CAL
DEC 68 7L-14

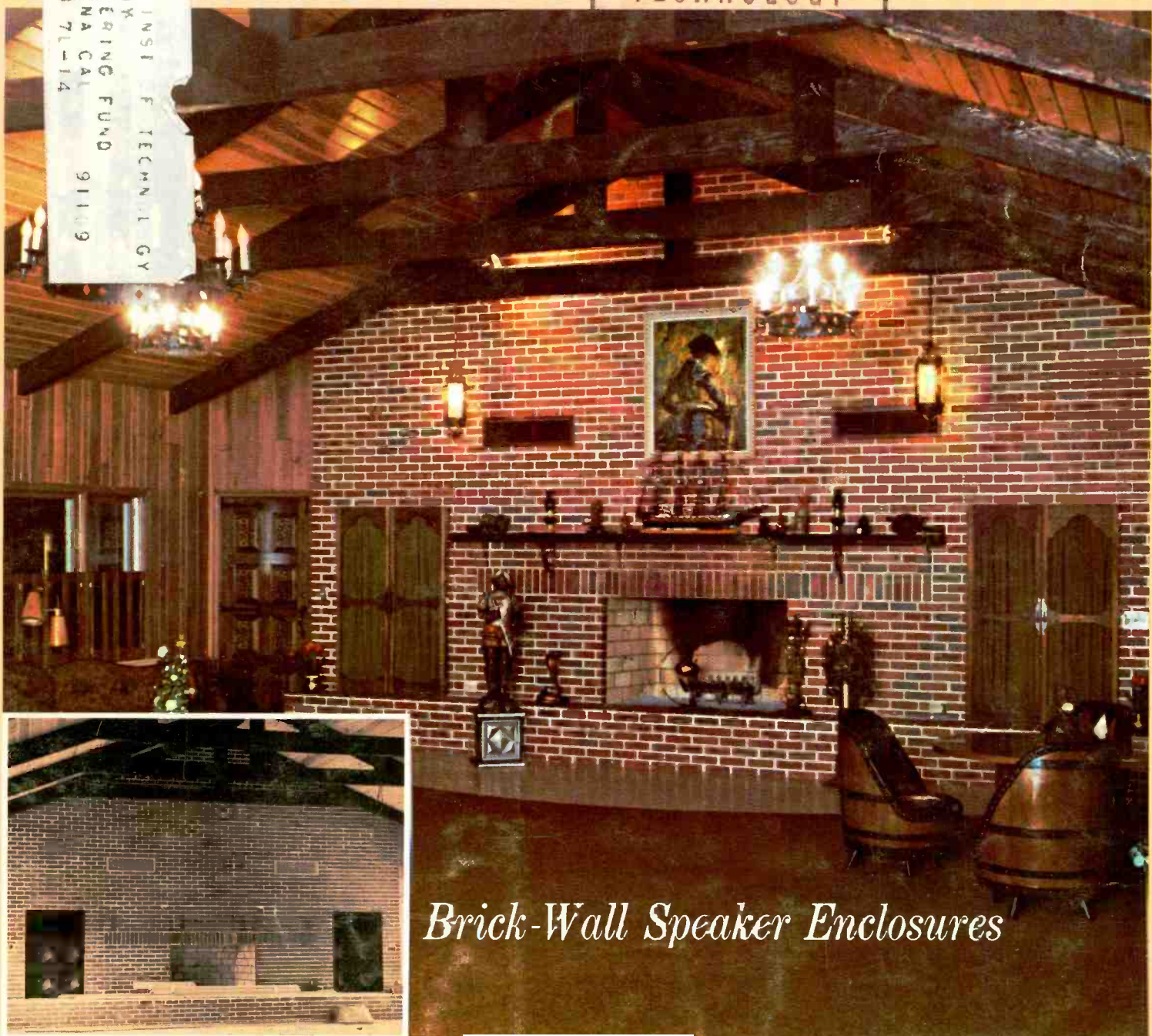

Brick-Wall Speaker Enclosures



If you could look through your speakers, is this what you'd see?

Listen carefully. Chances are your speakers add their own distorting coloration to the music. Maybe it's a boomy bass, or an overemphasis on treble. Most speakers do it, and some are designed to do it. You may not even mind the effect. But is this really the absolutely faithful reproduction you paid for?

If you enjoy adding emphasis to selected parts of the music, that's your prerogative. But don't let your speakers do it for you! There are controls on your receiver or amplifier that do the job much more predictably and pleasingly.

The best speaker is still the one with absolutely even response; with no coloration of the highs or the lows. This is the kind of speaker that Scott makes.

Scott engineers design every component part of Scott speaker systems. It's far more difficult than using ready-made components, but Scott won't accept the bias built into "off-the-shelf" parts. Scott's Controlled Impedance speakers are

designed specially for use with today's solid-state equipment. Custom-designed woofers, tweeters, midranges, and cross-over circuitry are carefully matched in solid, air-tight enclosures. And each individual speaker system must survive the scrutiny of both electronic instruments and trained ears before it's allowed to leave the Scott factory.

As a result, Scott speaker systems are completely honest; what goes into them is what comes out of them. They won't cover up for a poor receiver or turntable. Neither will they distort the perfection of a good component system. And that's what Scott believes great speakers are all about.

Choose from five Scott Controlled Impedance speaker systems, priced from \$49.95 to \$274.95, at your dealer's.

SCOTT®

H. H. Scott, Inc., Dept. 35-07
Maynard, Massachusetts 01754

Improve your listening with Scott 20/20 Speakers.



AUDIO

July 1968

Vol. 52, No. 7

Successor to **RADIO**, Est. 1917

Number 58 in a series of discussions
by Electro-Voice engineers

ARTHUR P. SALSBERG, *Editor*

EDWARD TATNALL CANBY, *Associate Editor*

PETER RENICH
Art Director

RICHARD CLIFF
Design

C. G. MCPROUD, *Publisher*

SANFORD L. CAHN

Marketing Director

R. KENNETH BAXTER

Production Manager

MARY CLAFFEY

Subscription Manager

Contributing Editors

HERMAN BURSTEIN

JOSEPH GIOVANELLI

LEONARD FELDMAN

ALEXANDER ROSNER

BERTRAM STANLEIGH

STUART TRIFF

BERT WHYTE

FEATURE ARTICLES

- | | | |
|---|----|-----------------------------|
| Electronic Crossover Networks Revisited | 21 | <i>C. G. McProud</i> |
| Exotic Speakers | 22 | <i>Al Fanning</i> |
| Audio Noise Reduction, Part 2 | 26 | <i>Ray M. Dolby</i> |
| Sound & Decor Styles | 32 | |
| Audio/FM Test Equipment Sampler | 34 | |
| The Ultimate Charles Ives | 47 | <i>Edward Tatnall Canby</i> |
| ABZ's of FM—"Front Ends" | 52 | <i>Leonard Feldman</i> |

MUSIC REVIEWS

- | | | |
|-----------------|----|-----------------------------|
| Classical | 46 | <i>Edward Tatnall Canby</i> |
| Light Listening | 48 | <i>Stuart Triff</i> |
| Jazz | 49 | <i>Bertram Stanleigh</i> |
| Tape Reviews | 50 | <i>Bert Whyte</i> |

AUDIO PROFILES

- | | | |
|---------------------------|----|----------|
| Fisher FM/Stereo Receiver | 36 | 200-T |
| KLH Loudspeaker System | 39 | Twelve |
| AKG Stereo Headphones | 40 | K-60 |
| Heathkit Organ "Bandbox" | 42 | TOA-67-1 |

AUDIO IN GENERAL

- | | | |
|---------------------------|----|-----------------------------|
| Audioclinic | 2 | <i>Joseph Giovanelli</i> |
| What's New in Audio | 6 | |
| Audio, Etc. | 8 | <i>Edward Tatnall Canby</i> |
| Tape Guide | 14 | <i>Herman Burstein</i> |
| Letters | 16 | |
| Editor's Review | 18 | |
| Audio News | 44 | |
| AES West Coast Convention | 45 | |
| Classified | 56 | |
| Advertising Index | 58 | |



AUDIO (title registered U. S. Pat. Off.) is published monthly by North American Publishing Co., I. J. Borowsky, President; Frank Nemeyer, C. G. McProud, and Arthur Sitner, Vice Presidents. Subscription rates—U. S. Possessions, Canada, and Mexico, \$6.00 for one year; \$11.00 for two years; all other countries, \$7.00 per year. Printed in U.S.A. at Philadelphia, Pa. All rights reserved. Entire contents copyrighted 1968 by North American Publishing Co. Second class postage paid at Philadelphia, Pa.

REGIONAL SALES OFFICES: Sanford L. Cahn, 663 Fifth Ave., New York, N. Y. 10022; (212) 753-8824. Louis Weber, 5201 N. Harlem Ave., Chicago, Ill. 60656; (312) 775-0755. Jay Martin, 9350 Wilshire Blvd., Beverly Hills, Calif.; (213) 273-1495.

REPRESENTATIVE: Warren Birkenhead, Inc., No. 25, 2-chome, Shiba Hamamatsu-cho, Minato-ku, Tokyo, Japan.

AUDIO Editorial and Publishing Offices, 134 N. 13th St., Philadelphia, Pa. 19107

Postmaster: Send Form 3579 to the above address.

← Check No. 100 on Reader Service Card



THE HEATED COIL

JOHN R. GILLIOM
Chief Engineer,
Loudspeakers

In many ways, the Electro-Voice Model 30W is an impressive loudspeaker. Its size alone sets it apart: 30" in diameter and over 13" deep. The 30W weighs 34 lbs., and employs 9 lbs., 4 oz. of ceramic magnet.

While the 30W was originally intended for high fidelity music reproduction, its unusual bass capability has earned it a place in other applications. It is used by major pipe organ constructors as an electronic substitute for bulky and expensive 32' pipes needed for the lowest range of the pipe organ. In addition it is used extensively as a bass speaker in non-pipe organs.

Recently the popular music field has taken note of the unusual sonic characteristics of the 30W. Its extreme low range and high efficiency is of interest to musicians seeking new sounds and higher volume levels. In addition they are attracted by the high power handling capacity of the 30W. Nominal peak power rating is 240 watts, and 70 watts continuous sine wave.

This high power handling capacity results from the achievement of several design goals. These include: high mechanical strength of moving parts, the reduction of excessive localized stresses, and the control of heat generated as a by-product of the conversion of electrical energy into cone movement.

The 30W has several natural advantages that help to improve heat dissipation at high power levels. It uses a massive magnetic structure totalling 23 pounds. This conducts away much of the heat generated in the voice coil gap. In addition, the voice coil itself weighs 20 grams, and this relatively massive edgewise-wound copper coil can absorb more heat than smaller coils. The coil is mounted to a 2-ply fiberglass form, impregnated with high-temperature polyester to further reduce the effects of high heat.

It might be pointed out that air convection cooling is of little consequence as relative air motion is slight in a well-designed speaker structure. In experiments with extremely high power, temperatures as high as 300°F have been measured in the gap of speakers that successfully survived the tests. In one test, however, a 30W literally burst into flames at the end of a popular music concert. Its failure was understandable since the guitar amplifier driving the speaker was providing as much as 300 watts of continuous sine wave power. Temperature in the gap was estimated at 600°F, the flash point for the materials involved!

Although study of methods to raise the temperature limit for high power speakers is continuing, there is a practical limit to advances in this direction. As temperature rises, speaker efficiency drops. This is a direct result of higher magnet temperature as well as increased resistance in the voice coil wire. The resultant lower efficiency encourages the use of multiple drivers in order to maintain effective use of amplifier power. Nevertheless, better thermal stability will result in greater reliability when high power operation is attempted.

For reprints of other discussions in this series,
or technical data on any E-V product, write:
ELECTRO-VOICE, INC., Dept. 783A
602 Cecil St., Buchanan, Michigan 49107

Electro-Voice®

A SUBSIDIARY OF GULTON INDUSTRIES, INC.

Check No. 101 on Reader Service Card

Coming in August

Audio's Annual 1968-1969 Directory of Hi-Fi Stereo Component Equipment

Here, in one issue, you get a truly comprehensive view of what's available in the latest hi-fi component models:

- Amplifiers Preamplifier Tuners Receivers
- Modular Systems Record Changers Turntables & Tone Arms Phono Cartridges Loudspeaker Mechanisms Loudspeaker Systems Tape Recorders Video Tape Recorders Microphones Headphones and a host of allied products plus a directory of manufacturers.

In addition to this authoritative, year-long equipment buying guide, the August issue of AUDIO Magazine will include regular features and departments.

ABOUT THE COVER

Read about the "brick wall" speaker system installation on page 32 of this issue. Installation photos show how it was accomplished, while the text explains why this approach was undertaken.

Audioclinic

JOSEPH GIOVANELLI

If you have a problem or question on audio, write to Mr. Joseph Giovanelli at AUDIO, 134 North Thirteenth Street, Philadelphia, Pa. 19107. All letters are answered. Please enclose a stamped, self-addressed envelope.

TV sound: Multiple headphone listening

Q. I am currently in the process of upgrading my high fidelity equipment, providing a more attractive housing for it, and (hopefully) integrating into the system a good quality color television receiver. Because the objective of the whole project is to create an integrated wall of entertainment with a high overall standard of quality, two special considerations have arisen on which I would appreciate your comments.

1) The audio output of today's finest television receivers in the 800 dollar to 1,000 dollar range is unsatisfactory. Hence, I wish to bring the audio signals, unamplified, from the TV tuner to an auxiliary input on my preamplifier. Which commercial sets, if any, provide for this? How much of a job is it, in your opinion, to modify a commercial set in accordance with the requirement that the set be restorable at trade-in time to its original state? How is the modification made?

2) What is the best way to provide for multiple headphone jacks, such that each individual head set has its own level control? In answering this, you may wish to note that I use the Dyna PAT-4 and Stereo 120. The PAT-4 provides but one headphone jack, and the Stereo 120 has restrictions concerning hookups to headphone junction boxes requiring common ground connections.

Your comments and advice on these matters will be greatly appreciated.—Michael Bernstein, San Francisco, Calif.

A. 1) I know of no ready-built TV receiver which has provisions for audio taken off from a cathode or emitter follower. Such features are built into the Heath color receiver, I understand, if you are interested in kit building.

If you are going to modify a commercially-built set, you will need to do a small amount of work. The external

modifications are so slight that there will be little need to restore the receiver, come trade-in time. Because of problems associated with color convergence, I would suggest that you have these modifications made by someone who can restore the balance after the audio work has been accomplished. You will, of course, have to remove the receiver from its chassis. This is sufficient to cause trouble in the convergence in most sets.

Now to the modifications themselves. The audio signal is usually available across the audio gain control. A small connector is mounted on the rear apron of the TV set's chassis. I suppose you could use the type found in normal, high fidelity equipment. Signal is fed from the volume control to this connector. That might be all there is to the project.

However, it sometimes happens that the de-emphasis network is placed in the circuit after the volume control.

Fig. 1—De-emphasis network.

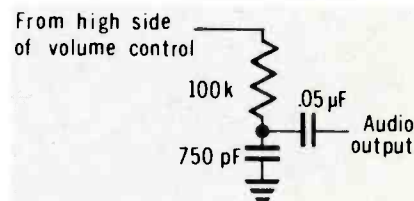

What this means is that the signal you hear will contain too many high frequencies. (You probably know that TV stations boost the highs when transmitting, just as FM stations do. They are reduced again during the receiving process. This high-frequency cut is accomplished in a simple circuit known as a de-emphasis network.) You might

Fig. 2—Cathode follower.

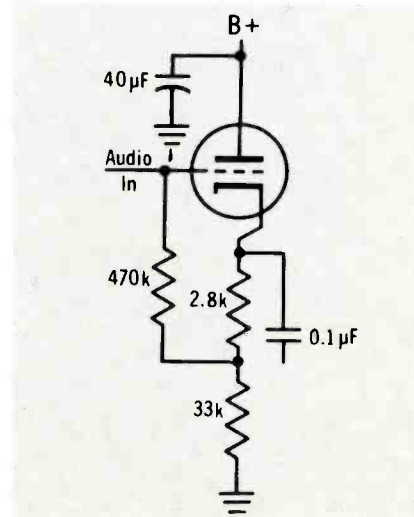



Feature by feature, the SL 95 is today's most advanced automatic turntable

An investment of \$129.50 in an automatic turntable cannot be taken lightly. When you're ready to buy, compare carefully—feature by feature. You will find that Garrard's SL 95 meets your every requirement since it offers all the innovations that distinguish a superlative instrument plus the assurance of years of flawless performance. Here's why:

Synchronous motor: Look for a synchronous motor, the only type which can really guarantee constant speed regardless of voltage, record load, warm up and other variables. By locking in, to the fixed 60 cycle current (rather than varying voltage), this type of motor guarantees the unwavering pitch and distortion-free record reproduction you should insist upon in a top-notch record playing unit. Garrard's revolutionary new Synchro-Lab Motor™, which powers the SL 95, is not only synchronous...it also offers the advantages of the induction type motor—instant starting, high driving torque and freedom from rumble.

Light, kinetically matched turntable: The SL 95's synchronous motor has obsoleted the heavy turntable which was developed because of the need to override fluctuation in the speed of induction motors, through fly-wheel action. The relatively light (3 pounds), but magnificently balanced turntable, precision matched to the kinetic energy of the

motor, now relieves weight on the all-important center bearing and reduces wear and rumble in this most critical area. Furthermore, its full-sized 11½" diameter gives your records maximum edge support.

Low-mass tonearm: Look for tracking capabilities which can only be obtained through light weight and low resonance damping, combined with rigidity and advanced pivoting. The SL 95's distinctive, dynamically balanced one-piece arm of Afrormosia wood and aluminum is mounted within a gyroscopically gimbaled assembly which permits it to float virtually friction-free on jewel-like needle pivots. The need for plug-in shells is eliminated by a new cartridge clip which insures flawless alignment. It is compatible with the latest, most compliant pick ups and the arm will track them perfectly down to the smallest fraction of a gram specified.

Permanently accurate anti-skating control: Look for a control that relies on a counterweight and is not affected by wear or temperature. The SL 95's patented control, which neutralizes side pressure on the stylus, is adjusted by a simple sliding weight rather than springs.

Convenient, gentle, cueing control: The SL 95 features single action cueing—one control is used to start the motor and lift and lower the tonearm. Its location at the

front of the unit plate facilitates the safeguarding of your records in manual and automatic play.

Accurate audible/visible stylus force adjustment: The SL 95 combines accurately calibrated visual positions with detents for positive ¼ gram settings.

Two-point support for automatic play: It has been found vital to have positive support of records at center and edge. The SL 95's center spindle dropping mechanism guarantees perfect operation at all times, regardless of the condition of center hole or size or thickness of records. A unique support platform telescopes into the unit plate when the SL 95 is used as a manual player. Patented automatic spindle handles up to six records safely; manual spindle rotates with record, has durable, friction-free Delrin® tip.

We urge you to send for a complimentary Comparator Guide with full, feature by feature descriptions. Write Garrard, Dept. AG1-8, Westbury, N.Y. 11590.

Garrard®
World's Finest

Some mikes have to take a beating



But your worries are over if it's an RCA STARMAKER. They're designed for whispers or shouts. A mike for every broadcast or recording application. From \$8.00 to \$50.00.* For complete information on RCA STARMAKER mikes, call RCA, Microphone Merchandising at 201-485-3900, Ext. 2678. Or write RCA Electronic Components, Microphone Department, Section G-91MC, Harrison, N.J. 07029. *Optional User Price

RCA

want to add such a network. The de-emphasis network, together with its connection to the volume control, is shown in Fig. 1.

You will notice that if you wish to allow the television receiver to work in its normal manner, all you need to do is to turn its volume control up. If it is plugged into the amplifier and no sound comes from the speaker of the TV set even when you do turn up the volume, you probably have the selector switch on your amplifier set to the wrong position. This selector switch will not only prevent the signal from the TV set from reaching the high fidelity system, but will prevent its being heard through the set's own loudspeaker. This is because the selector switch shorts all unusued positions to ground.

If it happens that you have to add a de-emphasis network to your television receiver as described, you might notice that the sound heard from the set's own speaker is muffled. Remember that you now have two de-emphasis networks in the circuit. You will have to locate the original one and remove it. Of course, at trade-in time you will have to remember to restore it.

Should you need to remove the connector which feeds the signal from your set to the amplifier, a small, metal plug can be obtained for the purpose of filling the hole. Thus, the chassis will remain neat looking. If you buy the type of connector which mounts similar to a standard phone jack, you will not even

Fig. 3—Emitter follower.

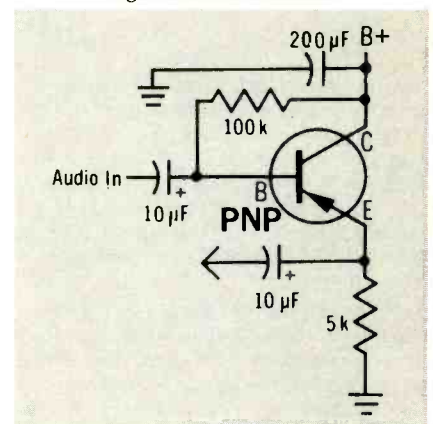

need to drill mounting screw holes, thereby saving you time and making a neater job.

I am assuming that the TV receiver and the amplifier will be mounted close together, making for a short, interconnecting cable. If the cable is too long, you will lose "highs." You might be able to get away with several feet of cable. This is a matter of the impedance of the detector circuit. Should you find that you are losing high fre-

(Continued on page 55)

You just can't compromise good design. It can't be rushed. You're both patient. We've been patient. Now we're both going to be rewarded. The new Sony 6060 receiver is a superb performer on FM stereo, FM and AM broadcasts; records and tapes.

On FM, even the weakest, fuzziest stations sound like the strong ones. And they don't get clobbered by the strong ones. Stations you never knew existed suddenly appear.

FM stereo? Superb. All the separation necessary for full, rich stereo sound. And the 6060 automatically switches to stereo operation.

Sony engineering innovations made this possible: the front end combines three newly developed Sony field-effect transistors with a 5-gang variable capacitor to provide an unprecedented combination of low internal noise, high sensitivity (1.8 μ V) and low cross-modulation. The IF section uses six solid-state filters instead of conventional tuned

circuits. Even FM broadcasts are better, because of the special care devoted to this portion of our receiver.

The powerful amplifier section delivers 110 watts IHF into 8 ohms without the slightest trace of distortion (0.2% at rated output). Plenty of power to drive any speaker system with plenty in reserve for difficult passages. A unique heat-sensing circuit protects the 6060 from overload.

Not only is the 6060 a pleasure to hear, but it is also a pleasure to use. It has a full complement of controls and conveniences: zero-center tuning meter; front-panel headphone jack; switches for tape monitoring, muting, speaker selection, tape head or Aux. input, loudness—the works.

At \$399.50 (suggested list), it outperforms receivers selling for as much as \$500. But don't take our word, hear for yourself at your hi-fi dealer.

Sony Corporation of America, 47-47 Van Dam St., L.I.C., N.Y. 11101.

Now, aren't you glad you waited?



SONY®

What's New In Audio

Sherwood FM Tuner Uses Microcircuits

Sherwood introduces its first FM stereo tuner with integrated circuits, the new model S-3300. According to the manufacturer, this design reduces FM distortion to 0.15% at 100% modulation, as well as improving noise rejection. Field-effect transistors are used



in both r.f. and mixer stages to suppress spurious responses in strong-signal areas.

The S-3300 tuner's specifications include: 1.8 μ V FM sensitivity (IHF), 2 dB capture ratio, -95 dB crossmodulation rejection; FM stereo separation, 35 dB; FM stereo frequency response, 20 to 15,000 Hz \pm 0.5 dB; hum and noise level, -70 dB.

Among the S-3300's features are: automatic FM stereo/mono switching, D'Arsonval zero-center tuning meter, interchannel hush, front-panel output level control, and a stereo noise filter. Dimensions are 14" x 4" x 10 $\frac{1}{4}$ " deep. Price is \$197.50. Optional are a walnut-grained leatherette-covered case at \$7.50 and an oiled-walnut wood case at \$28.00.

Check No. 2 on Reader Service Card

Fairchild Integrated Control Module



Fairchild Recording Equipment Corp. has introduced a packaged mike line-channel integrated control module. The module encompasses a plug-in strip with equipment needed to process a mike signal from a microphone's output to the mixing buss line. The same strip can be used as a channel strip with 18-dBm output to a recording machine, or to the line for further distribution.

The integrated control module contains input level selector switches and pads, input preamplifier, input fader, echo feed control, echo feed selector, compressor, full spectrum program equalizer, output amplifier, and metering and channel-selector switch.

The strip may be unplugged quickly. And it may be used singly or as a "building block" for multi-channel consoles. Dimensions are 2" W x 18 $\frac{1}{2}$ " L x 5" D. \$525.00.

Check No. 6 on Reader Service Card

University Sound Bass Energizer

A 12-in. bass energizer, which is a non-electrical woofer designed to be driven by the rear radiation of high-compliance 12-in. woofers, is being made available as a component speaker by University Sound. The Bass Energizer is the same unit being used in the company's Estoril speaker system to increase the latter's bass output.

The Bass Energizer is designed to be mounted in a suitable enclosure measuring 2 $\frac{1}{2}$ to 4 cu. ft. (internally), along with a 12-in. full-range speaker.

The expanding and contracting air resulting from the conventional woofer's cone motion drives the freely suspended cone of the energizer. This, according to the manufacturer, doubles the effective woofer radiating surface, adding up to 8 dB of bass in the lowest octave of music. Frequencies below 15 Hz are said to be cancelled.

Free-air resonance of the energizer is 15 Hz. Dimensions are 13" diameter, 4-11/16" depth. Mounting holes are for a standard 12" speaker opening.

Check No. 8 on Reader Service Card

Kenwood AM/FM Stereo Receiver System

Kenwood's latest addition to its line is an AM-FM stereo receiver system, model KS-33, which includes two compact speaker systems, an FM antenna, speaker cables and walnut-finish receiver cabinet.

The solid-state, 30-watt receiver includes an FET transistor in its front



end. FM sensitivity is 2.5 μ V; FM harmonic distortion, 0.6%.

Features includes automatic switching from FM stereo to mono modes, transistor protection circuit, automatic stereo indicator light, and an illuminated tuning meter. Each bookshelf-size speaker system includes a 6 $\frac{1}{2}$ " air-suspension woofer and a 2 $\frac{3}{4}$ " cone-type tweeter. \$199.95.

Check No. 10 on Reader Service Card

Tape Cartridge Innovations

Cartridge-type FM tuners have been placed on the market recently. These "cartridges" fit into the cartridge slots of 4- or 8-track playback tape units, converting them into radios. One such device, called Stereo-Magic FM cartridge Tuner, claims a 10- μ V output and a signal-to-noise ratio of 23 dB. The unit sells for \$39.95. And GW Elec-



tronics, California firm, plans to have an under-\$50.00 AM-FM cartridge tuner in the fall.

Sylvania Electric has introduced a combination color TV-cassette tape recorder (Norelco)-slide projector (Kodak), combining in one unit a few popular forms of home entertainment. The cassette tape recorder can be synchronized to operate with slides, using a built-in Kodak tape sync device. The color slides are projected directly on the color TV screen through use of a novel projection system.

Superex Stereophones

Superex's improved version of its Model ST-PRO-B stereo headphones uses a dynamic woofer for low-frequency response, interconnected by a crossover network. The combination is coaxially mounted in unbreakable ear cups. The ear cups incorporate soft, re-



movable vinyl cushions filled with urethane foam to provide a tight ear seal. A fully adjustable spring-steel headband makes the phones adaptable to all head sizes.

The ST-PRO-B has a frequency response of 18 to 22,000 Hz, according to the manufacturer. Impedances available are 8 to 16 ohms, 600 ohms, 2000 ohms, and 15,000 ohms. \$50.00.

Check No. 14 on Reader Service Card

You get what you pay for.

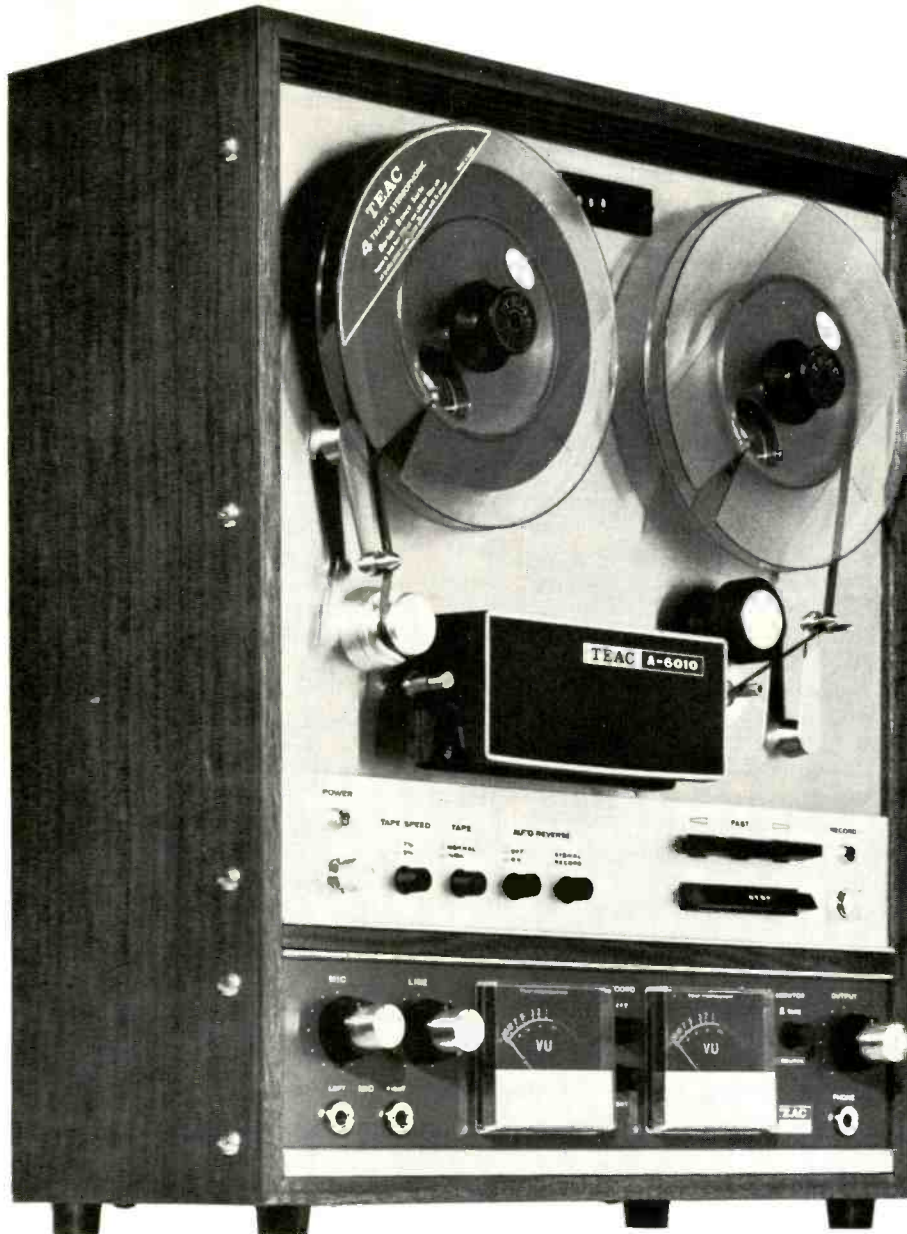

Four heads, 4 track, 2 channel. A 7" maximum reel size. Tape speeds $7\frac{1}{2}$ and $3\frac{3}{4}$ ips (0.5%). A dual speed hysteresis synchronous motor for capstan drive and a pair of eddy current outer-rotor motors for reel drive. Exclusive Phase Sensing Auto Reverse (so you'll never need sensing foil for automatic reverse play). Exclusive Symmetrical Control System, a soft-touch control operation for fast-winding in both tape directions, plus playback and stop.

Four TEAC-built tape heads in a removable unit. Tape tension control switch. Independent LINE and MIC input controls. 100 KHz bias frequency. A pair of jumbo VU meters. An optional remote control unit.

An optional repeat play unit. Polished walnut cabinet.

And these tested performance specifications:

Wow and flutter: $7\frac{1}{2}$ ips: 0.08%; $3\frac{3}{4}$ ips: 0.12%.

Frequency Response: $7\frac{1}{2}$ ips: 30 to 20,000 Hz (2 dB 45 to 15,000 Hz). $3\frac{3}{4}$ ips: 40 to 14,000 Hz (2 dB 50 to 10,000 Hz). **SN Ratio:** 55 dB. **Crosstalk:** 50 dB channel to channel at 1,000 Hz. 40 dB between adjacent tracks at 100 Hz. **Input:** (microphone): 10,000 ohms—0.5 mV minimum. (line): 300,000 ohms—0.1 mV minimum.

Output: 1 volt for load impedance 10,000 ohms or more.

At the price of \$664.50, the **A-6010** might be a little too rich for your taste. Unless your taste just happens to run to extraordinary tape performance.

TEAC

TEAC CORPORATION OF AMERICA 1547 18th St. Santa Monica, Calif. 90404
Available in Canada through American General Supply of Canada Ltd., 5500 Fullum St., Montreal

AUDIO, ETC.

EDWARD TATNALL CANBY

Testing the Test Record

I haven't reviewed any test records in this issue because none has come my way lately.

Maybe they've got tired of making them. Or just lost my address. They shouldn't. Because test records do serve a lot of useful purposes. Even though test tapes are likely to be more to the professional taste, except when it comes to testing phono playback.

I have a shelf full of lovely old test discs, some going back to the very earliest LP days, a few in ten-inch and even seven-inch format; mono, stereo, compatible, and all at once. Great variety. No use reviewing *them*. Instead, I'm thinking out loud as to how a new test record should be laid out today, in view of all the faults (and some of the virtues) I've found on these old ones. Since I'm not likely ever to see a test record of my own devising appear in genuine vinyl flesh, I'll call my theoretical offering the Canby ultraviolet test record. Invisible, and likely to stay that way.

First of all—for whom do we produce test records? Ah, what a cogent question! The crux. On that score there are no doubts at all in the minds of those who produce a different test breed, test tapes of the sort that recording engineers busily run off on their big machines before they begin each recording session. Those tapes are strictly pro and strictly practical. But discs? For whom are they intended?

Will the real pro, for instance, actually use a test disc to obtain, say, a 1 kHz tone? Not likely if he has a tone generator handy. Or at least a test tape. Will he use a test disc to measure dis-

tortions in his signal? Don't be silly—he has much better ways of doing that. Professional test equipment. How about such minor items as the phasing of his playback speakers? Don't insult your pro—his speakers are *always* in phase. (And if not, he knows it instantly via his super-sensitive ears—yes?)

The test disc for the pro is thus rather more a convenient “instant.” type, than a basic testing tool; at least in most respects. It is undeniably useful but also undeniably a sort of stop-gap device. So we shouldn't aim our test discs at the professional.

As you already may have thought, there is one notable exception. After a start with an “audiophile” test record in its STR 100, CBS Labs issued a number of genuine pro test discs in its Technical Series, each ones specifically labeled “professional test record” and directly intended for precision use with associated professional test equipment. STR 120, for example, ties in neatly with the General Radio 1521A Recorder to produce automatic frequency response graphs of a pickup cartridge, mono, or channel-by-channel stereo including “wrong-channel” cross talk. Purely professional and highly useful too. But I'm concerned here with the more generalized test records, those which do not demand associated test equipment and are suitable for the consumer—a class which includes CBS's later “Seven Steps to Better Listening,” STR 101.

A Happy Medium

The test record, then, must aim away from the pro—but how far? The disc makers have never quite settled their collective minds about it, nor how they should best accommodate those of us who own and operate our own millions of component home systems.

Thus some test records are not only overly complex and technical but often, also, too professional in tone—in the tone of voice, so to speak. They tend to chill the most courageous home user; and yet they are watered-down from the truly professional viewpoint. Other test records not only oversimplify things but tend to smear their happy pronouncements with unctuous consumer-type goo, sounding like so many commercials for bubble gum or Wheaties! Gives any reasonable audiophile acid indigestion, just to listen to the stuff. Please—a reasonably happy medium.

Just because we aren't all professional engineers, doesn't mean we are hi-fi idiots. That's the great American

weakness, to assume that everybody outside our own field is a dope when he sticks his head *into* our field. The fact is, we should assume—speaking again of test records—that all those who practice componentry, even componentry in the mildest degree (the kind you just turn on and away it goes) are people of better than average intelligence, maturity and intellectual curiosity. They are, anyhow, if they go out and buy your test record. And don't forget to include that most famous of all prize dopes (from the engineering viewpoint), the Little Lady. Maybe *you* don't respect your wife's innate intelligence, in respect to hi-fi, but I do. And I'll bet the IQ figures are on my side.

So—my ultraviolet theoretical test record must combine two basic approaches to usefulness. First, it is aimed NOT at the pro but at the “home user.” This is the person who is ready to buy a test record and go to work with it for really constructive purposes (and maybe a bit of entertainment along the way), who has the twin urge to improve things and to gain reassurance. Improve things if something is faulty. Be assured, if all proves to be OK.

The test record, then, is neither advertising nor soft soap. It has a job to do, simply but yet honestly. It must of course be simplified. But constructively, not misleadingly.

My Ultraviolet parameters, you see, are being laid out in reverse. First, the over-all approach, the aims and intended audience, the situations envisioned. Next, the general shape and sound, accordingly. Then last of all—the actual tests.

Music and Test Tones

Let's get on to the general shape and sound. There are many approaches to the test-record procedure, but they all center upon three aspects. First, a decision: will it be synthetic test tones and sounds? or musical (and speech) sounds?

There have been all-music test records, without a single synthetic tone. The prototype was perhaps the Popular Science-Urania “True Sound of Musical Tones” of 1957, all music, which nevertheless featured stylus and other pickup tests, low- and high-frequency response, dynamic range, not to mention something called “A Musical Guessing Game” that purported to test fidelity of sound by your ability to tell one musical instrument from another. (I'd say it tested *you*, not your system.) Other discs are all test tones, with never a trace of music,



CLOSE THE TRACKABILITY GAP (AND YOU'LL HEAR THE DIFFERENCE)

The photomicrograph above portrays an errant, hard-to-track castanet sound in an otherwise conservatively modulated recording. The somewhat more heavily modulated grooves shown below are an exhilarating combination of flutes and maracas with a low frequency rhythm complement from a recording cut at sufficiently high velocity to deliver precise and definitive intonation, full dynamic range, and optimum signal-to-noise ratio. Neither situation is a rarity, far from it. They are the very essence of today's highest fidelity recordings. But when played with an ordinary "good" quality cartridge, the stylus invariably loses contact with these demanding grooves—the casta-

nets sound raspy, while the flute and maracas sound fuzzy, leaden, and "torn apart." Increasing tracking weight to force the stylus to stay in the groove will literally shave off the groove walls. Only the High Trackability V-15 Type II Super-Track® cartridge will consistently and effectively track all the grooves in today's recordings at record-saving less-than-one-gram force . . . even with cymbals, orchestral bells, and other difficult to track instruments. It will preserve the fidelity and reduce distortion from all your records, old and new. Not so surprisingly, every independent expert and authority who tested the Super Track agrees.

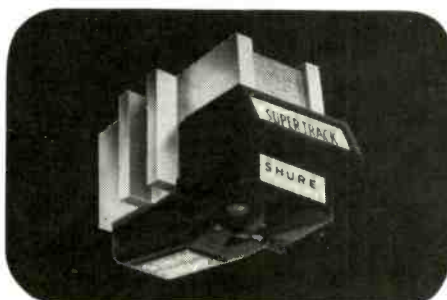
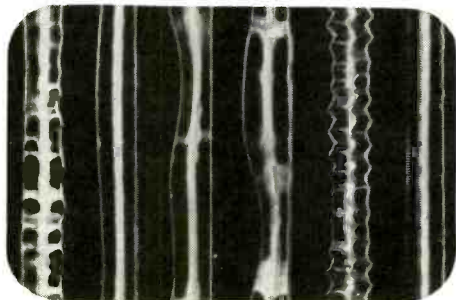

SHURE V-15 TYPE II

SUPER TRACKABILITY PHONO CARTRIDGE

At \$67.50, your best investment in upgrading your entire music system.

Send for a list of Difficult-to-Track records, and detailed Trackability story: Shure Brothers, Inc., 222 Hartrey Ave., Evanston, Illinois 60204

© 1967 Shure Brothers Inc.

Check No. 9 on Reader Service Card

and the variety and ingenuity of sound on them is remarkable, if not always useful.

Frankly, my thought is that music belongs on musical records. Music is a composite sound, a summation. It can indeed be usefully dissected while being heard—"listen to the triangle; does it sound like breaking glass?"—but it is not normally in itself analytic. Whereas test sounds are deliberately created to measure a single parameter of performance in optimum fashion.

There is a temptation, of course, to round out your test record with music as a sort of hi-fi demonstration. Good, if you have nothing more useful to fill up the space. Advertising of your wares, however, has no place on a test record, no matter how sensational your sound. Some such musical "tests" come perilously close to being mere hi-fi sales

downright infuriating, depending upon the ineptitude of the record's producers. It is highly annoying to have to start a band all over and play through interminable unwanted material in order at last to arrive at the specific sound desired. No test disc, however ingenious, is going to persist with this sort of location-fault built into the playing.

OK—then let's have spoken explanations, right on the record and at the proper test point. In general there is no better procedure. But with important qualifications.

The "tone" of your test record is instantly set up for the listener by the type of speaking voice, not to mention the speech content. Entirely too many spoken test-record instructions are given out in that dismal, institutional language of deadpan that seems to go automatically with scientific explana-

normal speaking voice. I'd spend a lot of time on this if I were really putting out my Ultraviolet Test Record.

OK—so there's speech on the record.

The listener gets the directions audibly along with the tests, and knows where he is, by ear. What, then, do we do with the printed part—the liner text or booklet?

One serious mistake is merely to print the full "libretto," the exact spoken words as heard on the disc. If your spoken material is any good, after all, it should speak for itself, without qualification as to intelligibility. Let it do so.

Take full advantage of the fact that you have not one but *two* media by which to convey explanatory material, each with its own differing attributes. Spoken speech is direct and persuasive, it comes precisely at the right and immediate place, next to the things it describes. "The next tone is 100 cycles," and bzzz—you hear 100 cycles. But speech is slow. The reading mind can move much faster, the printed text can get over much more to the roving eye.

Write your printed text to supplement the spoken text, with a larger background, a fuller explanation, more detail, so that the speaker on the disc can be brief and concise.

But dovetail the two! Some misguided test records fail to coordinate written and spoken material, so that, for instance, you'll be floundering through the printed text about Band 3 while the record moves on into Band 4—and utter confusion. Tailor the one to match the other. Much of the printed material should be read without the record, anyhow. The distinction must be made clear on the printed page, even if you must say "Read this first—before you play the record." But good typography can make it clear enough which parts are to be read as the record turns and which are for reading ahead of time.

Sounds obvious, all this, doesn't it? You'd be surprised how often such things are ignored.

So now you have spoken speech, printed text, plus tests. How about the record itself? What about banding?

Banding

Banding takes up valuable space. (Some people find it valuable, anyhow.) Too often, test records play on and on without any distinguishing bands for identification. Even with speech helpfully included, specific tests are hard to locate in mid-disc. With no speech, the

"Looking for a particular tone? You may have to play through a dozen . . . and still not be sure you have the right one."

puffs, testing nothing but your sonic sales resistance.

Second—another fundamental division occurs between those test records which involve spoken explanations and those which are tests alone, and no speech. A triangulation occurs here due to a third factor, the printed annotations or booklet.

Spoken and Written

If there is no speech on the record, then the printed material must bear the whole weight of the necessary explanations. Quite feasible, but consider some practicalities. The ultimate consumer in his living room must sit with his eyes buried in the instructions; a moment's lapse of attention and he loses his place in the sometimes involved sonic sequences heard from the disc. Looking for a particular tone? You may have to play through a dozen, counting carefully, and still not be sure you have the right one.

Moreover, each operational action concerning the playing equipment itself involves putting the booklet aside and, usually, moving over to the machine. Then back to the listening place and back into the booklet, to resume reading and following. Not at all easy. This sort of audio-visual approach can range from slightly inconvenient to

tions to the layman—an announcer-type voice that speaks slow—ly and disTINCT—ly, pronouncing every syllable with painful precision as though the listener's ears were wrapped in cotton batting. Yes, mister, we know that "violin" has three syllables—VI-O-LIN—but do you hafta say it as though it were 3 separate words? Not in my living room! And please, just talk at a normal speed and cut out the fancy diction. I can hear you *quite* well; I have a hi-fi system, after all, don't I?

But by all means let's not go to the other extreme and get cute and cuddly. That's even worse, though it has been done.

"Now folks, here's what you gotta do—just twist those li'l tone knobs, boy are they toney—hahaha!—until they point straight up, you know, like they're reaching for the heavens . . ."

I'm not quoting literally. But I have heard as bad, and maybe you have. Let's steer clear of *this* sort of thing too, decidedly.

Speech on the test record, then, is as vital in its impact as the tests themselves. Speech can make or break your record, all on its own. So give it much thought, in the content, but also in style and in presentation, before you get down to your recording date. Your aim is only reasonable, to convey concise information in a natural, neutral,

"we love you, dear Dyna..."

March 11, 1968
Furugränd 6
Umeå 5, Sweden

Dear Sirs:

I thought I ought to drop you a line to tell you about our adventures with your excellent amplifier Mark III. Having read the specifications and the test results of the Mark III, we (a very unknown and inexperienced pop-group) bought two amplifiers to use them as singing-amps. The very first thing that struck us after having connected the loudspeakers was the absence of distortion, though we didn't understand it at first, so we thought something was wrong and turned on the volume control to the maximum position, switched on a microphone and shouted something. Having bought new loudspeakers and ear-drums, we learned how to operate it. On our way to a performance, our trailer was practically crushed by an irritated truck which didn't approve of pop-music. We got out of the car and looked at the mess. One of the Mark III's was lying under a 100-pound loudspeaker and I pulled it out with my head turned away to be spared from the sight of my dear late lamented amplifier. However, the only visible damage was a dent on the cover, but I was sure no electronic device could work after such a violent treatment. I started looking for the other one but in vain, until our lead guitarist went out into the forest beside the road (why, he doesn't want me to say) and found the amp in a pine tree, nicely seated between two branches after a flight of about 100 feet. We loaded the equipment on the truck which took us the remaining way to the town where we were to play. Putting the things up on the stage our road manager somehow managed to drop the airplane-Mark III from the 3 feet high stage on to the floor. The last fragments of hope that at least one amp would be fit for fight disappeared. However, we plugged in both of them just for fun. They both worked, our bass guitarist fainted and our drummer promised never to touch another glass of whiskey. Well, I hope you are flattered, you ought to be, I mean having turned our drummer a tetotaller and all. All bad joking apart, we love you, dear Dyna Company, your Mark III is the best amplifier on earth. I'm willing to bet my last cent on that. We wish you all luck and want you to know that we really appreciate your products.

Best wishes,

Lars Back
Lars Back

The Mark III hasn't changed since it was introduced 11 years ago. Even the price is the same—\$79.95. Your high fidelity specialist will be pleased to demonstrate Dynaco amplifiers, preamps, and FM tuners. They have achieved world-wide recognition for unsurpassed excellence at prices to fit every budget. Complete specifications are available on request.



DYNACO INC.

3060 JEFFERSON STREET, PHILADELPHIA, PA. 19121
IN EUROPE WRITE: DYNACO A/S, HUMLUM, STRUER, DENMARK

Be an expert on how to select the best automatic turntable.

A true hi-fidelity automatic turntable is a precision built mechanism with many many parts, each of which has a very special function to perform. Very often, to save money in manufacturing, some companies either compromise on the quality of these parts, or leave certain of them out. The turntable will still operate of course but forget about getting maximum high-fidelity. How can you tell when a turntable has everything? Use our BSR McDonald 600 as an example of perfection. It has all of these essential features that a professional quality automatic turntable must have to insure peak performance.

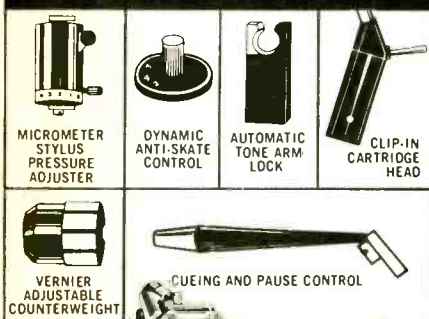

Please send FREE detailed literature on all BSR McDonald automatic turntables.

Name _____
 Address _____
 City _____ State _____ Zip _____



PRECISION CRAFTED IN GREAT BRITAIN
 BSR (USA) LTD., BLAUVELT, N.Y. 10913

Check No. 12 on Reader Service Card

AUDIO, ETC.

(Continued from page 10)

situation is hopeless. Might as well junk the record. The one unique advantage that the test disc has over a test tape is quick and easy locating. Therefore, divvy up your record surface into clear, easily visible bandings. And not too many—none of those dreadful hair-thin separations, either, please! Nor the skimpy proliferation of many bands, whereby you may laboriously count up to band 27, eyes squinting and neck craning, only to find you're on band 29. Wrong number, dial again. Some test!

Don't think this isn't important. Your test effectiveness is nullified if the consumer-listener can't figure where he's at, or locate the test he wants to use, or get through the required printed material before the test itself is all over.

Test Length

Which leads me to one final generalization. (I'm still working in reverse, from the general towards the specific.) An absolutely vital consideration on any test record is the *duration* of each test. *How long* should each test tone last for optimum usefulness? How short? How long should the pauses be, where pauses are useful? There have been more sad mistakes made here than in any other aspect of the test recording business—on records or on tape.

"One-thousand cycles — SET LEVEL," says one tape. Then a brief pause, followed by the tone. Just as you start to set your level, the tone ceases. *Stupid!!* So you rewind, and you get "GRRWWK — ND cycles — SET LEVEL," all over again, and still not enough tone to get yourself organized. It may take five or six tries before you're all set.

Oppositely, some overly high-minded test recordings drive you nuts in the opposite fashion—endlessly long tones, when brief bursts would do precisely as well. I can hear them now, in exasperating slow motion. You want, say four-thousand cycles (test records mostly antedate the great shift to Hz terminology), and you fire away: "TEN . . . THOUSAND . . . CYCLES," says the voice, like an ultra-slow crack of doom, and then "wheeeee" . . . for an eternity. Followed by silence. Then, at long leisure, NINE . . . thousand . . . cycles, and another "wheeeee" for another eternity. By the time you get down to four thousand, your eyes are popping.

Of course, there may be an excellent reason for very long test tones in a

given type of test. And good reason for mercifully short ones in another. I remember one broadcast of mine in which, merely to demonstrate the sequence of sounds at varying musical frequencies, I edited down each tone to a short minimum, fading each up and down, up from the background and back down under, as I spoke. It was a very efficient sequence, brief and to the point, but it took me a whole day of work for maybe thirty seconds of effect. Well worth it.

So, above all, TEST your test record for its timing and pace. And for confusions, possible misunderstandings, redundancies and inadequate explanations. I would surely test mine in this fashion, and test it until I was blue in the face before I let it out on the market. No matter how good your actual testing material is, your record is doomed to uselessness (and few sales) if you do not organize it rightly in all these ways, with an acute ear and a sharp eye out for specific consumer needs. Intelligent consumer needs, remember.

What tests? O boy—now you're asking me! I have my preferences, but that's another story. My reversed procedure just didn't get that far this time. For your info, however, here are a few notable test records of the hi-fi past, all designed for the audiophile and phonophile consumer. Some of them are still extant, and worth it.

Elektra Playback System Calibration Record (10-inch). Elektra EKL-35. 1956.

Popular Science Hi-Fi Test Record, Vol. 2—"True Sound of Musical Tones." Urania UPS 2. 1957.

London Microgroove Frequency Test Record. London 5343. 1957.

***Audio Fidelity Stereo Test Record** (First Component Series). Audio Fidelity FCS 50,000. 1959.

Stereo Hi-Fi Test Record. Components Corp., Denville, N. J. 1959.

***Vanguard Stereolab Test Record.** Vanguard VSD-100. 1960.

***Stereophonic Frequency Test Record.** CBS Labs STR 100. 1961.

The Chromatic Scale Test Record. Cook Series 60. 1962.

***Seven Steps to Better Listening.** CBS Labs STR 101. 1964.

KSC Stereo/Mono Speaker Adjustment and Test Record. (7-inch 45 rpm single-side). KSC Systems, Inc. ZTSP 96455. 1964.

An Audio Obstacle Course. Shure Brothers, Inc. 1966.

* The Schwann Catalogue lists updated versions of the above as currently available. Also: **How to Use Your Tape Recorder** (Golden Crest 4001); **Sounds of Frequency** (Folkways 6100); **Stereo Check-Out** (Command CSC-100); **Test Record** (stereo/mono) (Concert-Disc PTX 10); **Testing, Testing, Testing** (Westminster SRX).

Build a world of your own on "Scotch" Brand Dynarange® Tape.



Great moments in music . . . happy times at home and away—capture whatever sound you want to save on "Scotch" Brand "Dynarange" Recording Tape. "Dynarange" delivers true, clear, faithful reproduction across the entire sound range. Makes all music come clearer . . . cuts background noise . . . gives you fidelity you didn't know your recorder had.

And "Dynarange" saves you money, too! Delivers the same full fidelity at a slow 3 3/4



speed that you ordinarily expect only at 7 1/2 ips. The result: You record twice the music per foot . . . use half as much tape . . . save 25% or more in tape costs! Lifetime silicone lubrication protects against head wear, assures smooth tape travel and extends tape life. Isn't it time you built your own private world of sound on "Scotch" Brand "Dynarange" Recording Tape?

Magnetic Products Division **3M** COMPANY

"SCOTCH", "DYNARANGE" AND THE PLAID DESIGN ARE REGISTERED TRADEMARKS OF 3M CO

Check No. 13 on Reader Service Card

Tape Guide

HERMAN BURSTEIN

If you have a problem or question on tape recording write to Mr. Herman Burstein at AUDIO, 134 North Thirtieth Street, Philadelphia, Pa. 19107. Please enclose a stamped, self-addressed envelope.

Syndicated Discs

Q. Syndicators of 5-minute radio shows (actual running time: 3 min., 15 sec.) make their masters on tape and then transfer the shows to transcriptions for broadcast on radio stations. My question is this: Are these shows transcribed on both sides of the disc, and how many shows can they get on one 33 $\frac{1}{3}$ LP? If several shows are on a transcription, how does the station keep from making a mistake, and perhaps even duplicating a show over the air which they already have run before on the station?—Richard M. Hanlon, Indianapolis, Indiana

A. I will pass along information given me by a radio station, but cannot vouch for its accuracy. Some syndicators use only one side, but many use two sides. The reason for using only one side is that, when the disc is played, the other side tends to pick up dust from the turntable. The studio personnel usually are not careful about tending to dusty records, so that the two-sided disc is apt to present more of a dust problem, with adverse effect on sound. The number of "shows" per side of a disc might be on the order of 3 to 5, but there is a lot of variation because different syndicators set themselves different standards of sound quality. The closer one goes to the center of a disc, the more deterioration in quality. Thus a high-quality syndicator, trying to keep well away from the center might limit a side to 3 "shows." Before a "show" is run, the operator listens to the material on the disc (without running it on the air), then manually backtracks to the quiet portion preceding this material; thus he is cued-in and ready to go on the air. Since he has listened to the start of the material, the operator, in theory, should not make mistakes in his presentation. Nevertheless, as one who listens knows, mistakes do happen.

D.C. Braking

Some time ago (March 1967) we had a question involving the use of direct current to brake reel motors. Mr. Joseph Killian (Claremont, Calif.) provides further insight into the matter:

"I own an EICO RP-100 tape deck which uses d.c. braking (one of the few that does). Enclosed is a simplified circuit (switching omitted) as used in this machine. The applied voltage in my unit measures 33V under load. The currents through the motors I calculate to be 0.4 amperes for M1 and 0.16 amperes for M2. The power dissipated by them is 15.5W for M1 and 5.75W for M2. The motor winding resistances are calculated as about 37 ohms.

"The machine is, of course, 3-motor. The reel motors are ordinary four-pole a.c. motors. With the amount of braking supplied, the machine stops from full speed in about $\frac{2}{3}$ sec. The 50-ohm resistor provides 'differential' braking; with M1 being the unwinding reel motor, greater braking is applied to this reel in order to avoid tape slack or spillage. The 50-ohm resistor is switched between reel motors as necessary, according to tape direction. Tape does

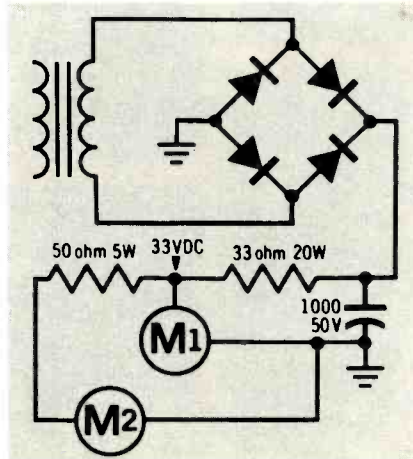

not spill at any speed for any combination of 7- and 5-in. reels, although it will become slack with a full 7-in. reel winding at full speed into a three-in. reel. During fast winds, 33V through 1,000 ohms is applied to the unwinding reel to avoid slack. During play, 33V through 235 ohms is applied to the unwinding reel for the same reason. Take-up power during play is applied through 250 ohms to reduce tension on the takeup reel (this deck uses no pressure pads, although it does have a felt-material drag wheel on the rewind side of the heads). With 15W dissipated, the motor does get warm, but of course it does not burn up. I have not tried the system without the 33-ohm resistor long enough to ascertain the heat problem involved.

"Although I do not use $\frac{1}{2}$ -mil tape,

I have tried it on this machine and have had no difficulty. The method of braking employed appears to be one of the gentlest I have seen in tape machines. I think that the d.c. method of braking should get more attention than it does. It is mechanically simpler than other systems, without the expense of excessive electrical complication."

Distortion and Noise

Q. My tape recorder plays well with pre-recorded tapes, but I am having difficulty — distortion and noise — recording from my receiver. Also, when I play back the tapes I have recorded, I get nothing approaching high fidelity. What is the cause of my problems?—Bernard Flam, Williamsport, Pa.

A. Among the possible causes of your problem are insufficient bias (causing excessive distortion), distorted bias waveform (causing noise), and a defective capacitor, resistor, or other component in the tape recording electronics (causing distortion or noise).

Reader Feedback

Reader Jon Black, Elmhurst, New York, offers the following thoughts on the problem of the individual who obtained distortion and no gain when using a Wollensak 1290 tape recorder with a Scott 348 amplifier (March 1968 issue).

"I own a T-1515-4 (a relative antique) and a friend owns a 5700 series Wollensak. While I am not specifically familiar with the 1290, it may have the same peculiarity as the other models mentioned. I have found on these machines that the volume control (which also controls the inboard speaker volume) must be opened to deliver any signal from the preamp output jacks as well as from the extension speaker jacks. In order to overcome the nuisance of having the inboard speakers blasting away, I have inserted plugs with terminating resistors (near the value of the speaker impedance) into the extension speaker jacks. I have obtained best results with the volume control set so that the neon indicator indicates as it would when making a recording at proper level. This gives me a level roughly equal to other high-level sources into the tape-amp input jacks of my amplifier."

Mr. Daniel R. von Recklinghausen of H. H. Scott suggests that the problem is perhaps "... one of using the improper connections such as, for example, interchanging the tape-out and tape-in jacks or, perhaps, making some other error in connection of equipment."

Æ

How to recognize a stacked deck.

The Choice of Experts. This is the improved successor to the famous Sony Model 350 which was picked as "a best buy" by the nation's leading consumer reporting service!

Professional 3-Head Design. The ultimate in versatility. Such wanted features as Tape and Source Monitoring, Sound-on-Sound, Sound-with-Sound, and other special effects!

Instant Tape Threading. Exclusive Sony Retractable pinch roller permits simple one-hand tape threading. An automatic tape lifter protects heads from wear during fast forward and reverse!

Vibration-Free Motor. An important new Sony development utilizing "floating" shock absorber action to completely isolate any motor vibration from the tape mechanism!

Sony Model 355. Priced under \$229.50. For your free copy of our latest tape recorder catalog, please write to Mr. Phillips, Sony/Superscope, Inc., 8142 Vineland Avenue, Sun Valley, California 91352.



Scrape Flutter Filter. Special precision idler mechanism located between erase and record/playback heads eliminates tape modulation distortion. This feature formerly found only on professional studio equipment!

Non-Magnetizing Heads. Head magnetization buildup—the most common cause of tape hiss—has been eliminated by an exclusive Sony circuit which prevents any transient surge of bias current to the heads!

Unprecedented Frequency Response. Achieves true high fidelity performance even at slower speeds!

20-22,000 Hz @ 7½ ips
20-17,000 Hz @ 3¾ ips
20- 9,000 Hz @ 1⅞ ips

Noise Suppressor Switch. Special filter eliminates undesirable hiss that may exist on older recorded tapes. Filter does not affect the quality of sound reproduction!

Three Speeds. 7½, 3¾ and 1⅞ ips. Additional features include: Four-track Stereophonic and Monophonic recording and playback. Seven-inch reel capacity. Stereo Headphone Jack. Automatic Sentinel Shut-off. Two VU Meters. Pause Control. Four-Digit Tape Counter. Record Interlock. Vertical or Horizontal Operation. And more!

You never heard it so good.

SONY SUPERSCOPE The Tapeway to Stereo

©SUPERSCOPE INC., 1968

Check No. 15 on Reader Service Card

Letters

Confirmation

• I enjoyed your article on power amps in the April 1968 AUDIO. One might note that the transistors do, however, dissipate more power with 40% square waves.

I would like to call your attention to my article in June 1966 AUDIO in which tests are outlined to demonstrate and evaluate precisely the phenomena you discuss in your article.

R. A. GREINER
Professor, University of Wisconsin
Madison, Wisc.

Testing . . . One, Two

• Your equipment review on the Crown CX822 in the April issue of AUDIO was excellent, but I must differ with one of your tests. I own a new Crown SS822, the exact same machine, except for the computer logic transport. My own tests of the frequency response revealed that I am getting 20 to 25 kHz \pm 1.2 dB at 7½ ips. This was using either Scotch 201 or RCA 15 ALN. Also, response was better at 15 ips than you indicated. And yes, the S/N ratio is slightly better at 7½ than at 15.

I use this machine for remote recording sessions constantly, and I have found that I actually like the performance at 7½ ips better than at 15 ips. Response is as smooth, with no loss of audible highs, and with slightly better bass response. In fact, for me, the only advantage of 15 ips is that editing is easier, and I am hardly ever faced with editing work that critical.

Perhaps your test machine was not checked for response at 20 dB below 0 VU, or perhaps it needed rebiasing or equalization adjustments.

THOMAS P. WITHERSPOON
Witherspoon Sound Recordings
Jacksonville, Fla.

The difference in frequency response between your measurements and ours is easily accounted for by a slight shift in bias adjustment. As you are prob-

ably aware, just a slight drop in bias would increase the frequency response. Unfortunately, distortion also rises (you don't say at what distortion figure you obtained your measurements). Also, we performed our frequency-response tests at the standard -10 VU, not at -20 VU. Our initial tests showed a response down only 2 dB at around 30 kHz, but the bias was set too low. So we can't disagree with your findings.

Aside from easier editing, which you mention, the difference between the two speeds is measurable at the high end. Whether or not this difference is audible depends on the system through which one is listening. And since hearing is subjective, depends also on who's listening.—Ed.

Echo Chamber

• You published a letter inquiring about building an "echo" chamber recently. The text reflects a common misuse of the word.

The ear requires approximately 1/5 sec. delay before it can clearly separate two inputs. This means that a sound originating at the listener must travel a round trip of 220 ft. or to a point of reflection 110 ft. away before a clear echo is discerned. Sounds which arrive back at the ear in less than 1/5 sec. mix with the original stimulation to produce reverberant sound. This type of delay may be produced in a large hall or artificially by a number of devices available commercially. The only way to artificially produce an authentic echo is by using a multihead tape recorder designed with the record and playback heads spaced such that the tape speed and head spacing yield the desired delay.

In addition, a box built as described would have strong nodes which would cause the resultant sound to be dominated by the tones enforced by the box dimensions. This effect may be experimentally verified by using two tape recorders and playing a broad-band sound on one while recording the resultant sound in the room with the other. If this process is repeated sequentially about five times, the final sound will contain only those tones reinforced by the room nodes and will not sound anything like the original input.

Reverberant chambers designed to avoid this effect have non-parallel sides, of which the simplest to build is a five-sided polygon with a slanted roof. There will be little effect at frequencies below where $560/\text{freq.} = \text{largest dimension of chamber}$. This tends to discourage most people from building a chamber because to have a reverbera-

tory effect at 50 Hz requires a dimension of 11 feet. The wasted space and the cost of construction cause the other spring-type delays to be used in most applications aimed at producing musical effects.

One further comment: If a chamber is used, both the source and the mike should be placed at the intersection of as many surfaces as possible to attain maximum efficiency.

J. R. ARRINGTON
Wilmington, Del.

Tape Recording

• In reading your ["Tape Guide"] column for Feb. '68 on the question posed on "Cross Field" biasing, the following information was passed on to me while in Tokyo at the Akai factory.

I had experienced about the same problem with an Akai M-7 tape recorder which is equivalent to the Roberts 770. Both machines use "Cross Field" biasing. An engineer at the Akai factory stated that tape thickness unfortunately had a great bearing on recording level that appears on the tape. Namely, the thicker the tape, the less recorded level that appears on the tape for a set bias voltage. This is mainly the reason for giving the brand and type of tape that is used at the factory to align the machine.

By its application, "Cross Field" biasing is applied to the back side of the tape. So, the greater the thickness of the tape, the greater the attenuation of bias. In my opinion, the advantages of "Cross Field" biasing at slow tape speeds more than makes up for this one slight disadvantage.

VIRGIL S. HOWARTH
San Francisco, Calif.

• Concerning "TV Sound Again" in the April issue ["Tape Guide"], I would like to make this suggestion to your readers.

I recommend a simple, inexpensive method of "taping sound from the TV. Use a telephone pick-up (e.g., Sony TP4S) placed near the TV's speaker. I find that this approach gives very satisfactory results. Worry of wiring errors, isolating transformers and the like is eliminated.

Permanent installation may be achieved by gluing the suction cup of the TP4S to the speaker frame. I feel this is a very practical and safe method for those who are not electronically oriented, but mainly concerned about making a recording.

WILLIAM C. McQUISTON
Folsom, Pa.

AR-2a^x speakers and AR^{INC.} turntables are used as laboratory measurement standards—

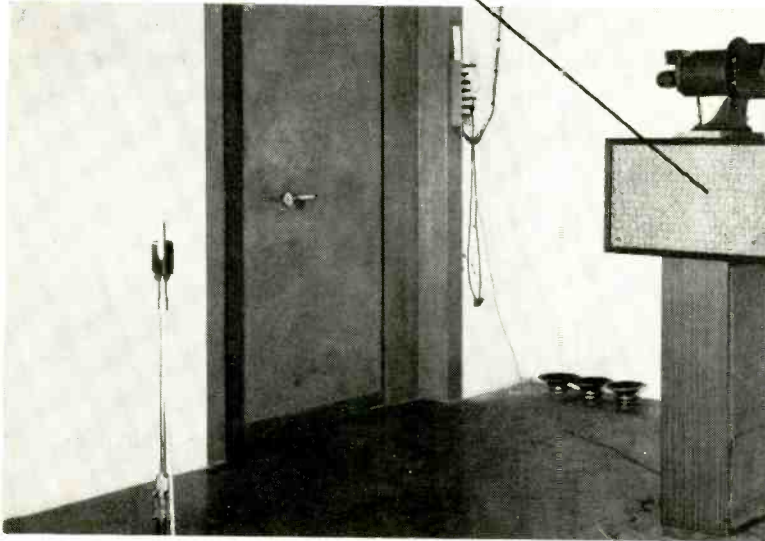

COURTESY PERMA-POWER CO.

Reverberant test chamber and associated laboratory test bench of the Perma-Power Company of Chicago, manufacturer of instrument amplifiers and sound-reinforcement systems. The AR-2a^x speaker on the pedestal is used as a distortion standard to calibrate chamber characteristics. This test facility, described in a recent paper by Daniel Queen in the *Journal of the AES*, employs only laboratory-grade equipment. (Note the AR turntable on the test bench.)

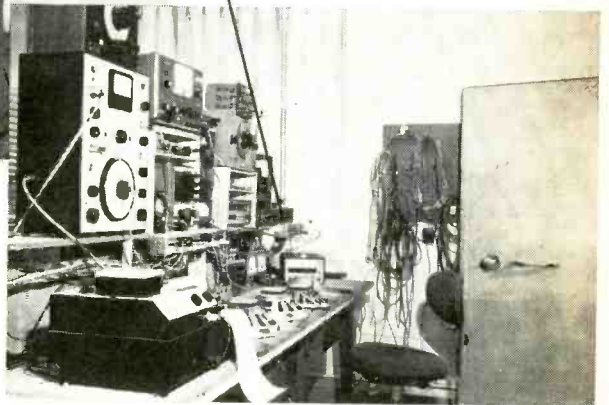

***but they
were designed
for music.***



COURTESY WABC-FM



Offices of the Vice President and General Manager, and of the Program Director of radio station WABC-FM in New York City. AR-2a^x speakers and AR turntables are used throughout WABC's offices to monitor broadcasts and to check records. WABC executives must hear an accurate version of their broadcast signal; they cannot afford to use reproducing equipment that adds coloration of its own.

EDITOR'S REVIEW

Up Again, Down Again

AUDIO reported here many months ago that a federal court decision upheld Crosby as patent holder for FM stereo, though another system was adopted by the Federal Communications Commission. The appeals court, however, reversed the decision. Now, General Electric and Zenith Radio—it was the General Electric/Zenith Radio FM stereo system that was accepted by the FCC—are both savoring the possibility of receiving royalties from other manufacturers.

More Stereo-Hi-Fi Models

Based on preliminary findings in compiling AUDIO's annual August equipment preview directory, hi-fi equipment models have grown in number by about ten per cent over last year. So next month's directory will be packed with specifications and features of over 800 models. The choices are wider than ever before.

Electronic Video Recording

Murmurings continue about CBS's Electronic Video Recording (EVR) system, the latest being that the cost of the system will be around \$400, with recorded tape cartridges pegged at \$10 each. The system, spearheaded by Dr. Peter Goldmark, CBS Laboratories president who developed the long-playing record 20 years ago, is simply attached to the antenna terminals of a conventional TV receiver. Playing an EVR video tape cartridge, visual and aural information will be received. Rumors have it that there's even a chance that recorded commercials will be used, keeping the video tape cartridge's price down.

Dr. Goldmark, holder of more than 150 patents, recently received the George Washington Award for contributions to scientific research and human knowledge. Past recipients of the Award, pre-

sented annually by the American Hungarian Studies Foundation since 1961, include Dr. Edward Teller, Dr. Theodore von Karman, Admiral Lewis S. Strauss, and Dr. Fritz Reiner.

The Logical Bassoon

The electronic organ, electric guitar, and other instruments dependent upon electrons for operation, have been joined by the bassoon. A British psychologist designed the new type of bassoon to make fingering of the instrument, notorious for its difficulty, much simpler. The player's fingers operate keys which incorporate micro-switches, the signals (on-off) of which are fed to diode-transistor logic circuits which control solenoids. The solenoids raise and lower pads over holes in the bassoon's acoustic column. The timbre of the instrument is said to be somewhat akin to that of a saxophone.

Canadian Hi-Fi Show

Canada residents will have an opportunity to attend a showing of high-fidelity equipment in their neck of the woods at the Lord Simcoe Hotel, Toronto, November 20 through 23.

Favorite Performers and Recordings

In a poll conducted among readers of the January and February issues of the Schwann LP Catalog to determine favorite performers and recordings (a new LP-record listing in Schwann during 1967 was a qualification), the following were named winners:

Most Popular Classical Artist: Leonard Bernstein.

Favorite Popular Artists: The Beatles.

Most Popular Classical Records (three):

- (1) Mahler—Symphony No. 8—Leonard Bernstein and the London Symphony Orchestra, Columbia;
- (2) Prima Donna, Vol. 2—Leontyne Price, RCA;
- (3) Handel—Julius Caesar, Treigle, Sills—Rudel and the New York City Opera, RCA.

Favorite Popular Record: Sgt. Pepper's Lonely Hearts Club Band—The Beatles—Capitol.

Most Popular Show Record: Cabaret, Columbia.

Most Popular Folk Record: In My Life—Judy Collins, Elektra.

Most Popular Jazz Record: A Day in the Life—Wes Montgomery—A&M. A.P.S.

The X factor in the new Pickering XV-15.

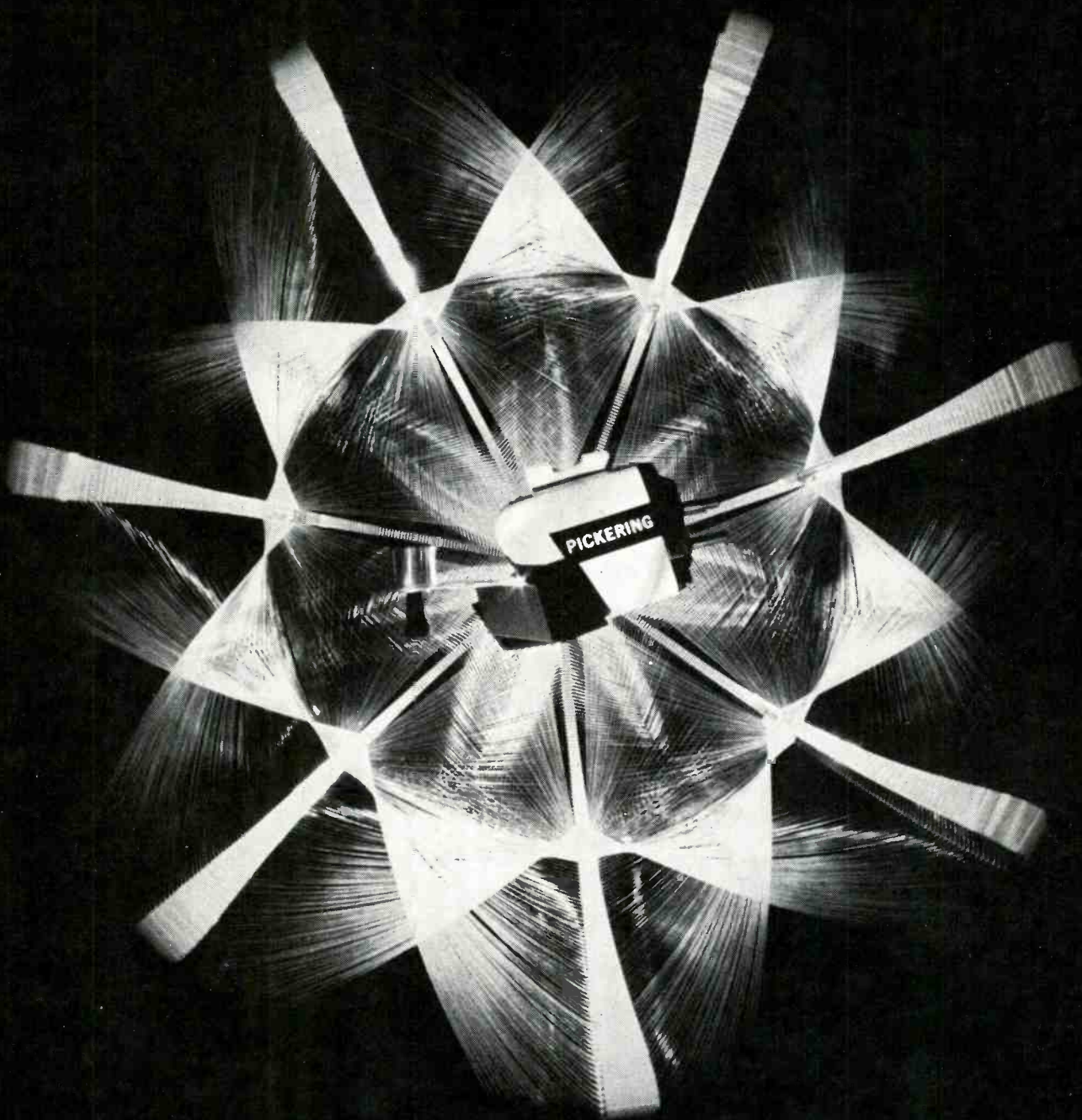

The X in the new Pickering XV-15 stands for the numerical solution for correct "Engineered Application." We call it the Dynamic Coupling Factor (DCF).SM

DCF is an index of maximum stylus performance when a cartridge is related to a particular type of playback equipment. This resultant number is derived from a Dimensional Analysis of all the parameters involved.

For an ordinary record changer, the DCF is 100. For a transcription quality tonearm the DCF is 400. Like other complex engineering problems, such as

the egg, the end result can be presented quite simply. So can the superior performance of the XV-15 series. Its linear response assures 100% music power at all frequencies.

Lab measurements aside, this means all your favorite records, not just test records, will sound much cleaner and more open than ever before.



All five DCF-rated XV-15 models include the patented V-Guard stylus assembly and the Dustamatic brush.

For free literature, write to Pickering & Co., Plainview, L.I., N.Y.

SM Dynamic Coupling Factor and DCF are service marks of Pickering & Co.

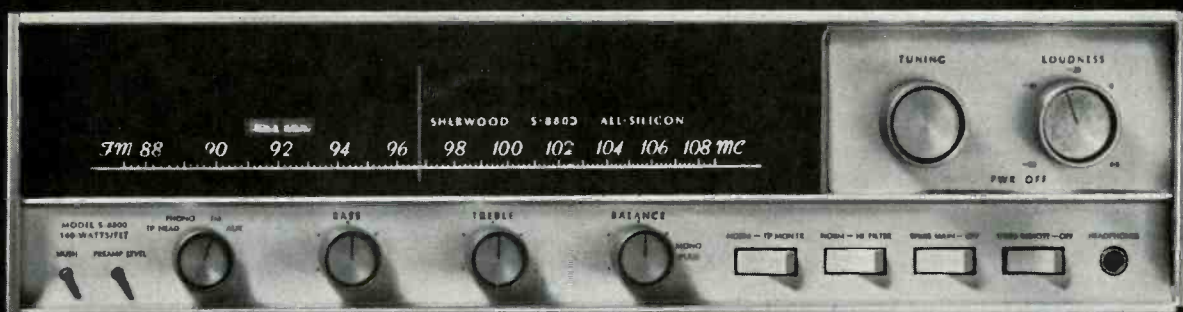
Our most-honored receiver



*Sherwood Electronic Laboratories
 proudly announces
 that its most-honored FM receiver,
 the Model S-8800, has been further enhanced
 with the addition of Field-Effect Transistors.*

The highly-rated Sherwood S-8800 now features Field Effect Transistors (FET's) in the RF and Mixer stages to prevent multiple responses when used with strong FM signals.

Among the Model S-8800's many useful features are two front-panel switches for independent or simultaneous operation of main and remote stereo speaker systems.

Visit your Sherwood dealer now for a demonstration of those features which make Sherwood's new Model S-8800-FET receiver so outstanding.

With Sherwood, you also get the industry's longest warranty—3 years, including transistors.

Compare these Model S-8800 specs: 140 watts music power (4 ohms) • Distortion: 0.1% (under 10W.)
 • FM sensitivity: 1.8 μ v (IHF) • Cross-modulation rejection: -95db • FM hum & noise -70db.

Model S-8800 custom mounting \$369.50
 Walnut leatherette case \$378.50
 Hand-rubbed walnut cabinet \$397.50

Sherwood

Sherwood Electronic Laboratories, Inc.,
 4300 North California Avenue,
 Chicago, Illinois 60618. Write Dept. A7

Electronic Crossover Networks Revisited

How to change parts values to obtain different crossover frequencies

C. G. McPROUD

READER INTEREST resulting from the author's article in the February issue was overwhelming, but the principal subject of many letters was the desire for information on how to change parts values to provide for other crossover frequencies. Second in importance to our readers was a redesign to accommodate only two channels instead of the three shown in the original article.

While our idea in presenting the article was to offer a construction project for our readers' "education," the article also served to elicit some education for ourselves. For instance, we were advised that there is another speaker system which uses the "bi-amplifier" principle in addition to the one we mentioned. Klein + Hummel of Stuttgart, West Germany, has a Model OY monitor speaker which uses two amplifiers—one for the woofer and one for the mid-range and tweeter—with an electronic crossover ahead of the amplifiers, providing separation at 500 Hz. The output of the mid- and high-range amplifier is fed through a conventional passive network which crosses over at 8000 Hz to feed the mid-range and tweeter separately. This speaker/amplifier system is marketed in the U.S. by Gotham Audio Corporation.

We were also reminded that H. H. Scott marketed an electronic crossover a number of years ago, and we received three reprints of articles by Masami Yamane, an assistant professor at Waseda University in Tokyo, all dealing with the electronic crossover.

We never claimed to have originated the idea, of course—we only reduced it to a simplified device which could be constructed by the

average hi-fi buff. But because of the interest shown by readers, we offer this additional material: first, a series of formulas which enable anyone to calculate the required capacitors for different crossover frequencies, and second, a design for a two-channel network.

Calculations

In order to change the crossover frequencies without otherwise disturbing the circuit, it is only necessary to change certain of the capacitors, assuming that the remainder of the components remain as originally specified.

As mentioned on page 66 of the February issue, the slopes of the crossovers are determined by the number of RC circuits in each of the sections. For a slope of 18 dB/octave, three RC circuits are used, with different frequencies for each to ensure a sharper cutoff and reasonable flatness to the cutoff point. For a slope of 12 dB/octave, two RC circuits are used, but both center at the same frequency.

Thus in the woofer section, the three RC circuits are R_5-C_3 , R_6-C_4 , and R_8-C_6 . The first is centered at twice the crossover frequency, the second at one half the crossover, and the third at the crossover frequency. Response is down 3 dB at the point where reactance of the capacitor equals the value of the resistor.

Since $X_c = \frac{1}{2\pi fC}$, the formula can be rearranged to the form $C = \frac{1}{2\pi fR}$, where f is the value of frequency actually used ($1\times$, $2\times$, or $\frac{1}{2}\times$) and R is the related resistance value.

Where two resistors are used to set the bias on transistors X_5 and X_6 , the resistance value used in the calculations is the resistance of the two in parallel, or one half the value of either.

Working through the entire circuit, one comes out with ten formulas, each of which requires some calculation to determine the capacitor values required. These formulas can be reduced to simpler form, requiring only one simple division to find out what size of capacitor is required for each location. All of this is based on the circuit which appeared first in the February issue, and again in corrected form in the April issue. The same circuit configuration and the same values of resistors must be used throughout the network for these formulas to be effective.

Woofer section, low-pass:

$$C_3 = 21.1/f_c$$

$$C_4 = 5.3/f_c$$

$$C_6 = 10.6/f_c$$

Mid-range section, high-pass:

$$C_{10} = 5.3/f_c$$

$$C_{11} = 8.5/f_c$$

$$C_{14} = 10.6/f_c$$

Mid-range section, low-pass:

$$C_9 = 10.6/f_c$$

$$C_{12} = 4.1/f_c$$

Tweeter section, high-pass:

$$C_{15} = 10.6/f_x$$

$$C_{16} = 4.25/f_x$$

where f_c is the crossover frequency between the woofer and mid-range, and f_x is that between the mid-range and the tweeter. All values are in microfarads. Minor shifts in capacitor values may be advisable to obtain exact compliance with the curves.

Thus for any desired change in crossover frequencies, it is only necessary to perform the individual cal-

culations, assemble the components, and you have the desired network. It is again suggested that 5% resistors be used throughout, as well as the Sprague 192P series of capacitors which are 10% values. The printed circuit boards were designed for these capacitors, which are comparatively small. Other types can be substituted, of course, but it is not likely that they will fit the circuit boards (construction of which was described in the February issue).

Two-channel crossover

Figure 1 is a modified schematic showing the result of eliminating the tweeter section from the three-channel circuit and removing the low-pass section from the mid-range network so it acts only as a high-pass filter. Therefore, signals are provided above the crossover frequency to the tweeter, filtering out those below the crossover.

The circuit as shown does not use C_9 , C_{12} and R_{14} of the original, nor does it use any of components of the original tweeter section. The circuit is drawn without any power supply components, since it is assumed that the builder will have some other source available that is well filtered and at approximately 28 V, as in the three-channel circuit.

The same printed circuit boards can be used for the two-channel circuit as for the three-channel configuration with the omission of the components mentioned. In place of R_{14} ,

a short length of hookup wire should be installed to provide circuit continuity.

The same formulas can be used to determine capacitor values for crossover frequencies as for the three-channel unit. However, since there is only one crossover frequency, f_x is equal to f_c .

We reiterate the suggestion offered by George Augspurger of James B. Lansing Sound in a Letters column about the desirability of providing some protection between the mid-range and tweeter amplifiers and the respective driver units. This protection can be provided by a series capacitor between amplifier and speaker. The value should be such that the reactance of the capacitor is equal to the impedance of the driver at about two octaves below the crossover frequency.

In the original article, we suggested a 6- μ F capacitor for a 16-ohm driver in the tweeter circuit when the 5000-Hz crossover frequency was used, and in a note in the Letters column in the April issue we suggested a 40- μ F motor-starting capacitor as protection for the mid-range driver for a 500-Hz crossover. Calculations for these capacitors are as follows:

$$C = \frac{1}{\pi f_c Z}$$

where Z is the impedance of the mid- or high-frequency driver and f_c is the crossover frequency. The formula takes into account the "octave below" the crossover frequency. AE

Fig. 1—Two-channel electronic crossover circuit derived from the original three-channel circuit and designed with components for a 500-Hz crossover. The text explains how to calculate component values for other crossover frequencies.

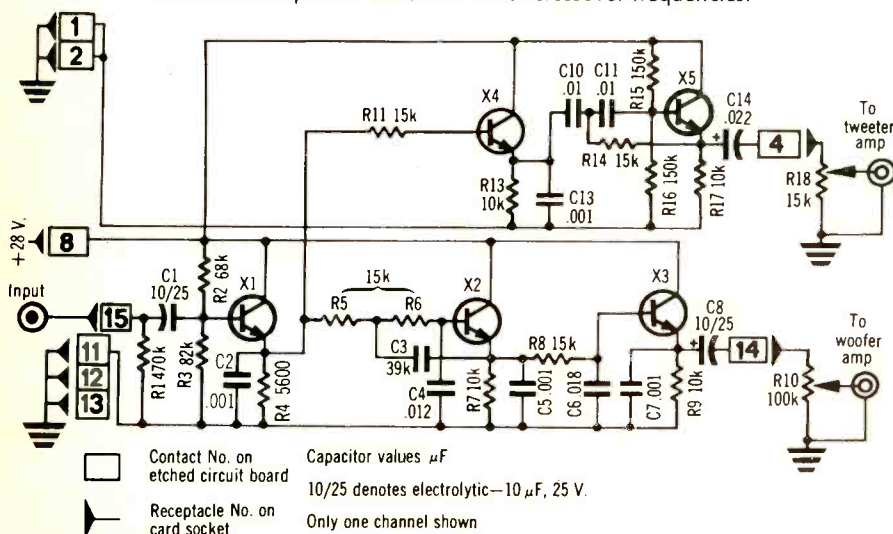

EXOTIC

Unorthodox speaker designs and how they compare to moving-coil speaker types

MOVING-COIL cone loudspeakers have been in the king-seat for some 40 years. But from time to time some different designs arouse the interest of audio fans. In recent years these have included the electrostatic speaker and ionic speaker to name a few.

Before we discuss these "exotic" speakers in detail, let us establish some reference points by first examining moving-coil loudspeakers.

The basic moving-coil loudspeaker consists of a voice coil wire (wound on a form), magnet, centering device, frame, and diaphragm (cone). A cross-section view of such a speaker is illustrated. The cone is attached to the voice coil at one end (actually to a flexible centering device which is attached to the voice coil). The other end of the cone, flaring out to a large diameter, is attached to a suspension material which connects to the speaker's frame.

When an electrical signal from an audio amplifier passes through the coil, which is positioned in the magnet's gap, a magnetic field is formed. This causes the coil to move back and forth, which, in turn, forces the cone to follow its motion. As the cone moves back and forth with the coil, it kicks the surrounding air into sound waves.

As every owner of a top-grade hi-fi speaker system knows, the moving coil speaker can be designed to do an excellent job of creating realistic sound—but it is not absolutely perfect.

And that's where the exotic speakers come in. Each one has appeared

SPEAKERS

AL FANNING

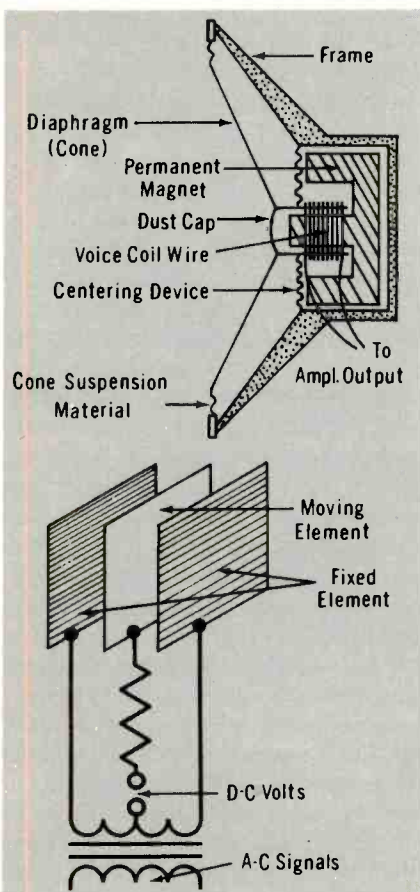

Fig. 1—Most loudspeakers made today are moving-coil types (top), operating in a fixed magnetic field. An electrostatic loudspeaker (three-element, push-pull type shown below) moves in response to an electrostatic force varied by audio signals. D.c. voltage maintains the moving element in a strained state.

as part of an attempt to solve some inherent limitation of the moving coil speaker, some slippage in its performance that keeps it from being perfect. This consciousness of perfection reflects the extraordinary improvements in tape machines, pickups, turntables and amplifiers of the last decade. Moving coil speakers have gone far ahead, too, of course.

Moving coil problems

Consider the way the cone behaves when it is pushed by the coil,

which is attached near the apex of the cone. Since the cone is pushed at one place and held at another, it tends to bend or ripple. Ideally, it should move as one piece. No cone does, completely. And that's a pity, because this rippling and bending, with the collective name of "break-up," is a main source of distortion in speakers. Naturally, if different parts of the cone move differently, it will produce different sounds at different points on its surface, not just the one sound it is supposed to produce.

In the best cone speakers, break-up has been reduced to a very low point. It is least troublesome over the range from the bass resonance of the speaker (described in a moment) up to several hundred hertz, in a 12-in. speaker. Higher up in the range, break-up becomes more intense.

Consider another complication of the cone speaker: the many resonances or "favored frequencies" of the vibrating parts. Anytime you have a mass connected to a spring (technically, a "compliance") there will be one frequency at which the two vibrate very strongly, almost without being pushed. A cone speaker is loaded with such resonances. There is the mass of the whole cone plus the voice coil, and the springiness of the whole suspension, which produces the main or bass resonance. This is usually somewhere between about 30 Hz and 100 Hz. There is the separate system of cone mass and surround compliance; voice coil mass and cone bending; various bending systems in the cone itself; etc. Any light material, forced to vibrate, will have one or more resonances.

Electrostatic speakers

The "exotic"-type speakers use a design principle other than the moving coil one in an effort to overcome some limitations. The most popular

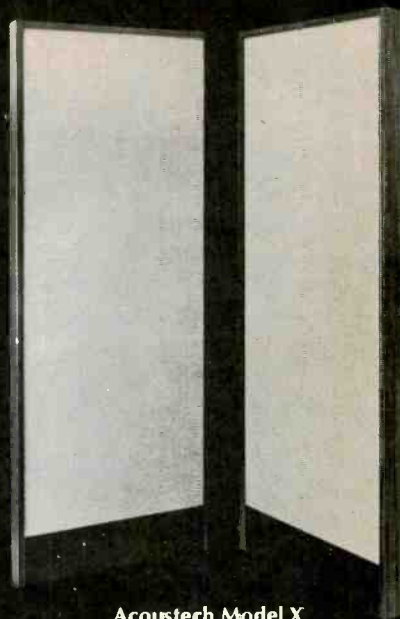

Acoustech Model X

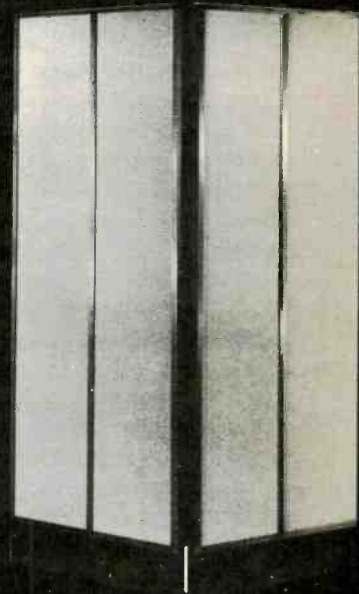

KLH Model Nine

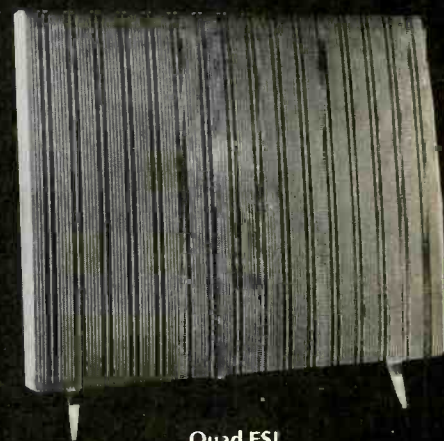

Quad ESL

of exotic speakers, the electrostatic speaker, has stirred up a sizeable response in audio ranks because it solved some problems of the cone speaker (though it introduces many of its own, too).

The electrostatic speaker, mind you, is not a startling new principle. It was, in fact, employed decades ago.

The principle upon which the electrostatic speaker operates is a simple one: "like" electrostatic forces repel, "unlike" electrostatic forces attract. Repelling or attracting force depends largely on the amount of static charge and the distance between the objects which are in a charged state.

To understand how an electrostatic speaker operates, consider it to be composed of two very thin, conductive screens. One of the screens is mounted in a fixed position, while the other screen is in a flexible position. If the screens are oppositely charged, the flexible one will move toward the fixed one, depending upon the strength of the charge and the distance between the screens. When the amount of static charge is varied by an audio signal, the flexible screen—the equivalent of a speaker's cone—will respond to changes in attraction force by moving back and forth in accordance with audio signals.

A decided drawback exists with two-element electrostatic speakers, however. Electrostatic force does not change in simple direct proportion to distance. As the flexible element gets closer to the fixed element, the attraction rapidly increases; the same concept (force varies inversely with the square of the distance) holds true as the flexible element is repelled. The distortion introduced in this manner becomes more apparent as frequency is lowered because the diaphragm must move a greater distance to push air for bass frequencies than for treble frequencies.

Development of push-pull electrostatic speakers overcome the foregoing problem. With a central diaphragm pushed from one side and pulled from the other, the above distortion is cancelled.

The electrostatic way of converting electrical forces into mechanical forces is extremely attractive for a

Fig. 2—Ion speaker uses pulsating air to produce sound waves.

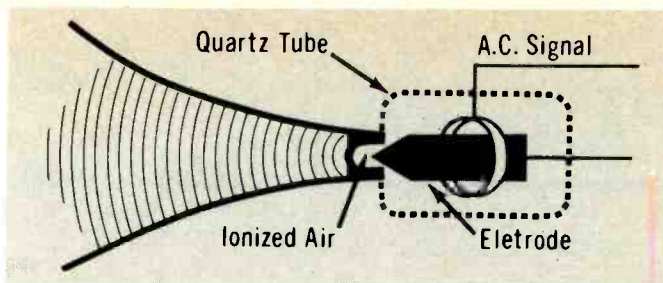

loudspeaker because every tiny part of the moving diaphragm is pushed at the same time. It is as though millions of little fingers were side by side, to push and pull the light material. This cuts break-up to virtually zero. So by putting an audio signal across the plates, the diaphragm can be alternately pushed and pulled in step with the signal.

Of high importance, transient response—how quickly the diaphragm responds to an electrical signal and how fast it stops when the signal is removed—is improved. Since the diaphragm is extremely light it can be driven at high frequencies; up into the ultrasonics above the range of hearing, in fact.

Sound wonderful? There are "buts" that, unfortunately, have kept moving-coil speakers on top.

For example, electrostatic forces do not work over much of a distance. The two plates have to be quite close together, and therefore there can't be much room for motion of the diaphragm—a very small fraction of an inch.

In the highs this is fine because a loud sound can be produced by tiny movements, vibrations over thousandths or even millionths of an inch, from a diaphragm less than a square foot in area. For the bass, though, we bump into a requirement for large area, or large diaphragm motion, or some combination of the two. Since we can't get large motion in a practical electrostatic design, the diaphragm has to be big, at least several feet on a side, for moderately good low-bass performance. Even so, the big electrostatic's can't equal the deep low *whump* put out by some moving-coil woofers. Its large size, like the large size of a conventional floor speaker, makes it impractical to use in some homes. Also it is quite expensive. And some hi-fi amplifiers become unstable when faced with the

ELS's large capacitance reactance. The net result of all this is that, at the present time, the full range electrostatic has not infringed heavily on moving coil speaker territory, even though it offers fine sound.

Another approach to obtaining a flat diaphragm is in the form of a flat induction speaker. This is actually a modification of the moving-coil speaker, which means that the forces will operate over a substantial distance. It uses a flat coil which is, in effect, distributed over the whole back side of the plate. It looks as though we would have the best of both worlds: an evenly-driven diaphragm that can move a good distance. But there are drawbacks.

For example, the diaphragm motion is not as great as that of a moving-coil speaker and, thus, requires a large diaphragm area for low bass. This means big speakers and, it turns out, fairly expensive ones. Though it emulates the flat diaphragm surface of an electrostatic, it shares other inherent limitations of mechanical transducers.

Then there's a transducer that attaches to a wall and uses all the walls in a home as a "diaphragm." But there's no claim for high-fidelity sound being made for it.

No-diaphragm speakers

Finally, there is another far-out speaker, the ionic. The idea is exciting. Instead of setting in motion a diaphragm of solid material with its critical mass, why not work on the air directly. We can do this if we *ionize* the air, that is, make it electrically active. An ion is a molecule that has lost one or more electrons, or gained one or more, so that it is no longer electrically neutral. It has a net plus or minus electrical charge. Brought near an electrode carrying a high voltage, that is, within an elec-

(Continued on page 54)

A Marantz stereo component isn't built for the mass market.

(That's what's so good about it!)

Marantz isn't the name that most people think of first when they think of components. It's understandable. The price of Marantz equipment is simply beyond them.

On the other hand, price is the very reason a Marantz component can be as good as it is. (Nobody can give you something for nothing.)

Quite frankly, our philosophy is to let our engineers design a piece of equipment as best as they know how. Not as cheaply. (There are enough other manufacturers doing that already.)

We believe that the four superb stereo components illustrated here are the finest

performing stereo components available anywhere in the world. The Marantz SLT-12U Straight-Line Tracking Turntable (\$295). The Marantz 7T Solid-State Stereo Preamplifier Console (\$325). The Marantz 15 Solid-State Stereo Power Amplifier (\$395). And the Marantz 10B Stereo FMTuner (\$750).

As soon as you examine these components, we know you will appreciate what goes into making a Marantz. That's why your local franchised Marantz dealer will be pleased to furnish you with complete details together with a demonstration. Then let your ears make up your mind.



marantz®

Designed to be number one in performance... not sales.

Audio Noise Reduction

PART 2 (Conclusion)

RAY M. DOLBY

More aspects of the Dolby professional noise reduction system and practical applications

Construction

THE A301 audio-noise-reduction system described last month is powered by an 18-volt regulated supply (the power supply module may be seen in position on the left in Fig. 1 and separately in Fig. 2). Having a total noise content of about 100 μ V peak-to-peak and an extremely low output impedance, the unit powers all circuits with a minimum of further decoupling. The power supply module also contains the input and output transformers for the system.

To obtain the full benefits of modular construction, the system has been designed to use a minimum number of different modules. The eight circuit modules in the A301 system comprise only three different types: amplifier, control, and compressor. This simplifies troubleshooting significantly.

Fiberglass printed circuits are used in the modules, component numbers being silk-screened with epoxy paint. All resistors are 5%, 2%, 1%, and 1/2% high-stability carbon film types. Electrolytic capacitors are used where necessary, but band-splitting filter capacitors, time-

constant capacitors, and critical coupling capacitors are of the polyester type, while tantalum capacitors are used in situations where high values and reliably low leakage currents are required. Tolerances are tightly controlled, with more than 200 components being bridged, matched, or specified to better than 1%.

The 99 transistors used in the system are of the high-gain silicon planar type, enabling large amounts of negative feedback to be used in the circuitry. The circuits are thus highly stable with regard to transistor spreads and ambient temperature variations. Wherever possible, the circuitry has been designed to be temperature independent. Where this is not possible or practical, temperature compensation is used (of the 163 germanium and silicon diodes in the system, 44 are used for temperature compensation).

System alignment

Because of the stability of its circuitry, the system does not require routine alignment. Nevertheless, an alignment procedure is useful for troubleshooting purposes or for giving the system a thorough check. The two signal processors are adjusted independently, following a standard procedure which ensures that all modules of a given type are fully interchangeable.

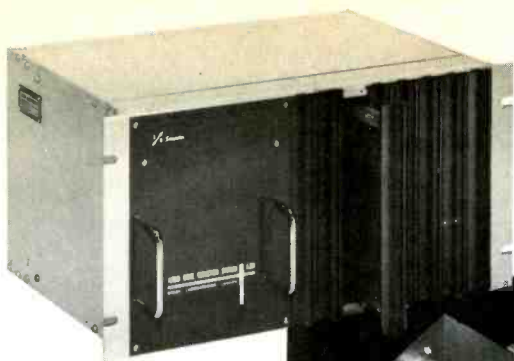
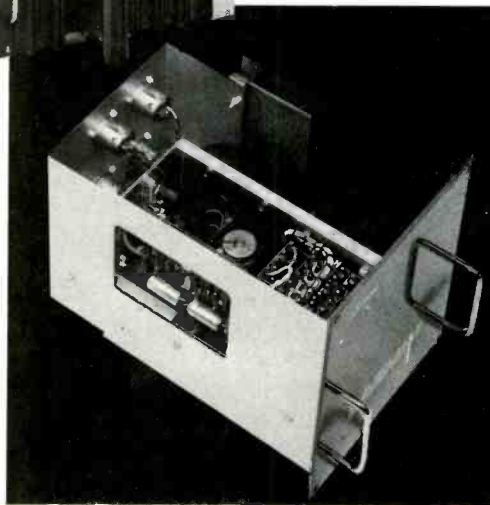

Fig. 1 (left) — Audio Noise Reduction System A301. Fig. 2 (below) — Power-supply module removed.



During alignment, a module is removed and a special alignment card, providing several switch-selected calibration and test functions, is inserted in its place; the module is then plugged into a connector on the alignment card.

Apart from the power supply voltage adjustment, the A301 has six different types of controls on it: input level, output level, record calibration, playback calibration, compressor gain, and compressor law. The first four controls are on the amplifier modules, the last two on the compressor modules. The control modules do not require adjustment.

Each amplifier module is adjusted by feeding a calibration tone into the system from an oscillator. The input level control accommodates the various signal standards encountered, giving standardized operating conditions within the system (100 mV at the amplifier test point). The output level control, being adjusted in a complementary way, yields an overall processor gain of unity. After the input and output level controls have been set, the record calibration and playback calibration controls are used to standardize the gain of the noise reduction amplifier Q105 and Q106. This procedure gives the required 10 dB of noise reduction at 1 kHz, which also automatically sets the 15 kHz value at 15 dB.

The alignment card is then shifted to a compressor module position and switched to the compressor gain mode, which bypasses the filters and inserts a precision 50 dB attenuator between the filter driver amplifier output and the compressor inputs. As the resulting level is below the compressor threshold, the compressor gain can be accurately set (10 mV at the compressor output). Then the alignment card is switched to the compressor law mode, which raises the input to the compressor by 20 dB. The law control is then adjusted to give a compression of 6 dB (that is, 50 mV at the compressor output).

The above compressor procedures are carried out on the two compressor modules (two compressors each), and finally the whole routine is repeated for the second processor.

Because of the international exchange of master tapes, it is necessary that the above alignment procedure should take into account

Shown here are several good reasons why Altec audio equipment is being used by more and more recording and broadcast studios and auditoriums. And for all sound reinforcement applications.

Altec microphones are engineered and manufactured to the same high standards of quality that have made "Voice of the Theatre"® speaker systems, Altec audio controls, monitors and other sound equipment the standard of the industry for so many years.

Take our Solid State Condenser Microphone Systems (M49 Series), for example. Extremely wide, smooth frequency response. Front-to-back discrimination of 20 dB. Omnidirectional or cardioid types. Battery or AC operated.

Lightweight but rugged, with power supplies to match. Altogether, these fine, precision-made instruments are the most advanced professional mikes on the market today.

The M49 is typical of the complete Altec mike line, which includes selectable pattern types, miniature lavaliers, close-talking models and other solid-state condenser types. Plus mounts, wind screens and accessories.

So go ahead and put Altec on. Why not start by asking your Altec Sound Contractor for complete technical data? He's listed in the Yellow Pages under "Sound Systems." Or, if you prefer, write direct to us at 1515 S. Manchester Ave., Anaheim, Calif. 92803.



Now we know why you're putting us on.

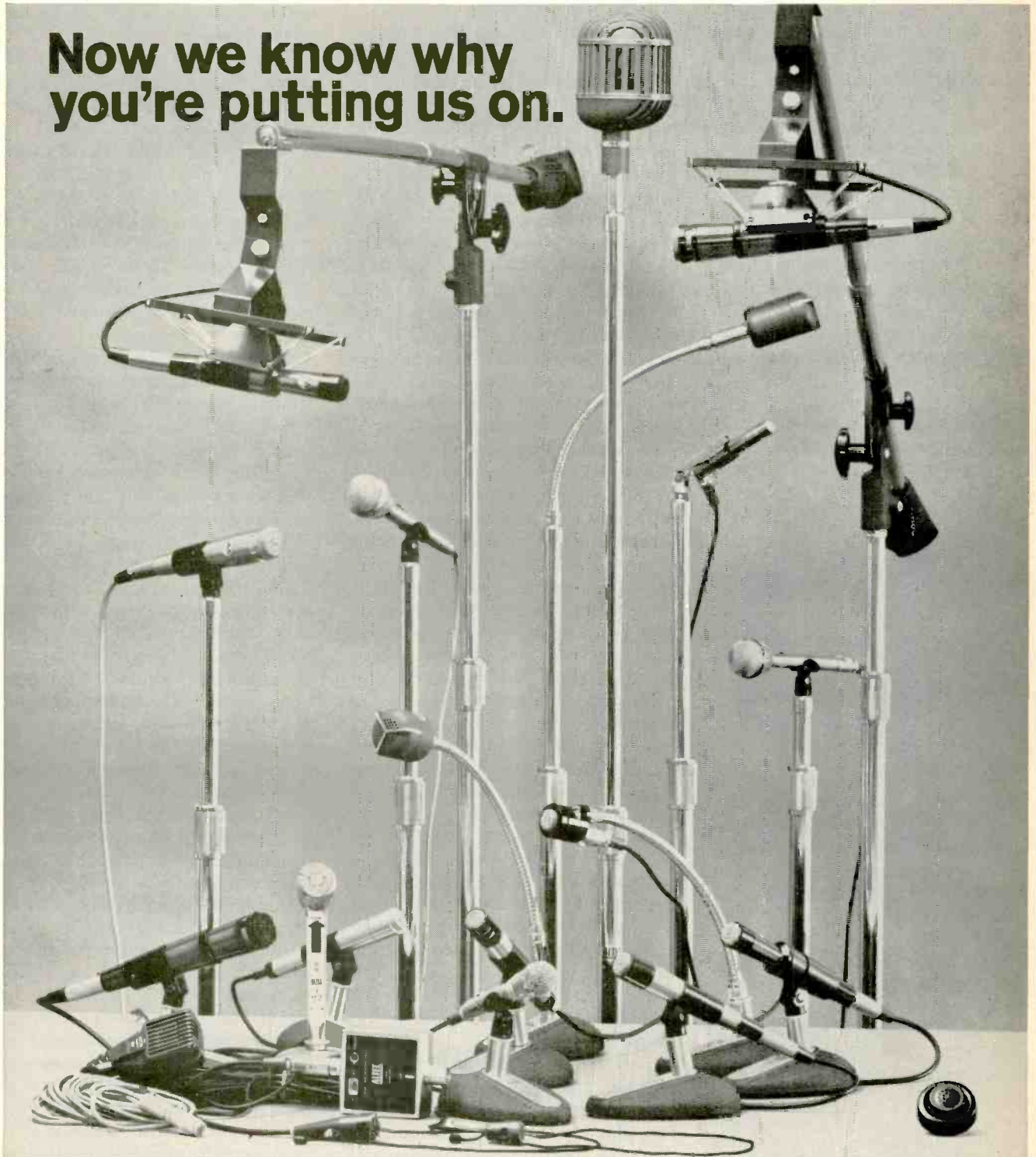

World's Largest Manufacturers of Sound Equipment Exclusively: Stereo Receivers, Speakers, Speaker Systems, Stereo Ensembles for the Home / Microphones, Control Consoles, Amplifiers, Speakers, Speaker Systems for Public Address Systems / Acousto-Voice Equalization / Audio Controls, Consoles, Amplifiers, Microphones, Monitors for Professional Broadcast, Recording & Motion Picture Studios & Theatre / Telephone Amplifiers & Associated Wire & Microwave Transmission Equipment / Power Supplies & Transformers / Doctors, Nurses & Hospital Call Systems.

the various signal standards used throughout the world. This is accomplished by means of the two main 15 i.p.s. alignment tapes in use, Ampex-NAB and DIN.¹ Unfortunately, these tapes employ different reference levels—the DIN level being approximately 4 dB higher—and it is necessary to allow for this fact when adjusting the input and output level controls of the A301 system.

For standardization purposes the system is adjusted with a calibration tone equal to the signal level produced by a DIN alignment tape (that is, recorded flux of 32 mM/mm at 1 kHz), each processor then being set for 100 mV at the amplifier module's test point, as explained previously. Thus, the Ampex-NAB tape, the most widely used reference in the U.S., should produce a voltage 4 dB below 100 mV at the test point; during adjustment of the system, it is therefore necessary to use an oscillator signal which is 4 dB higher than

Fig. 3—Changeover system. Added to the back of Model A301, the changeover facility enables one unit to be used for recording and non-simultaneous playback on two tracks. Both remote control and manual control are provided.



the level produced by the Ampex-NAB tape. This procedure correctly ties the two alignment tape standards together and also compensates for the many different line levels in use. The most common practice in U.S. studios is that the Ampex-NAB level corresponds to a 0 VU signal level of +4 dBm, 600 ohms, or 1.23 volts rms. The level which should be fed into the A301 system for alignment purposes is thus +8 dBm or 1.95 volts.

¹J. G. McKnight, "Absolute Flux and Frequency Response Characteristics in Magnetic Recordings: Measurements, Definitions, and Standardization," *J.A.E.S.*, 15, 254 (1967).

Although noise-reduction tapes will be recorded and reproduced under standardized level conditions on an international basis by use of the above procedures, it is still necessary to remember that there are several equalization curves in use throughout the world (NAB, CCIR, DIN, and others¹), and that these must be accommodated in the usual way.

Operational aspects

Since the A301 comprises two independent signal processors — each of which may be connected either in the recording mode or playback mode—one unit may be utilized for recording on two tracks, playback on two tracks, or recording and simultaneous playback on one track. The operating modes of the processors are normally determined by two toggle switches on the back of the unit.

Whenever weight, space, or economy are considerations, it is possible to exploit the dual mode facility. In many recording situations, particularly multi-track, it is not customary to monitor line-out during the "take" itself. Also, for remote sessions on two tracks, it is convenient to be able to get along with only one noise reduction unit. In such cases, line-in is monitored for setting balances, while line-out (the raw noise-reduction tape playback) can be checked with regard to dropouts and other tape or recorder defects. After listening awhile, it is possible to become somewhat accustomed to the bright, breathy, bigger-than-life sound of processed signals, thereby allowing at least some judgment of the artistic merits of the recording during the "take" itself. Of course, during a proper playback, the noise-reduction system is changed over to the playback mode.

While a switch is provided for determining the operation mode, it is necessary to remember that the unit must also be shifted appropriately to the input or output circuit of the tape recorder. In a simple setup a signal switchbox can be built or the XLR cables can be physically re-plugged.

For more sophisticated installations, a remote changeover system, (shown in Fig. 3) is used. This facility, added to the back of the unit, includes a 24-volt power supply and provides for relay-controlled change-

over of the processor mode and all signal connections. When connected to the record relay circuit of the tape recorder, the changeover system operates automatically.

The way in which the noise-reduction system is actually used in the studio chain will now be considered in more detail. While the arrangement is very simple (see Fig. 1 of Part I), it is necessary to observe the operational rules which are implicit in the figure.

Basically, the signal should not be operated upon by the normal studio facilities while it is in the processed condition (points II and III, between processors and recorder). But the signal may be manipulated as usual either before or after the system, at points I or IV. The tape recorder should have level frequency response and, as discussed previously, the absolute sensitivity of the recorder should be adjusted with a test tape.

If these requirements are not met, the output from the noise reduction system may contain low-level errors in frequency response and signal dynamics. In fact, however, the allowable tolerances are reasonable. A gain-error of 4 dB, for example, may produce barely discernible changes in high-frequency response on a direct A-B comparison.

An attempt should be made to keep overall gain-errors within 2 or 3 dB, which is normally not very difficult. But in a complex studio using many different kinds of equipment, even this fairly liberal requirement is met only with some degree of care. For example, a termination resistor left off a source having a true 600-ohm impedance will cause a voltage rise of 6 dB (which will result in a brighter sound than normal during playback). Nevertheless, such mistakes can usually be avoided. And if a studio uses standardized practices throughout, such as consistently terminating lines on either the sending end or the receiving end (as opposed to mixing the two methods), then use of the noise-reduction system is simply a matter of inserting the unit in the lines to and from the recorder.

It should be appreciated that the requirement for tape recorder standardization does not mean that the level actually recorded on the tape must be standard, only that the A301

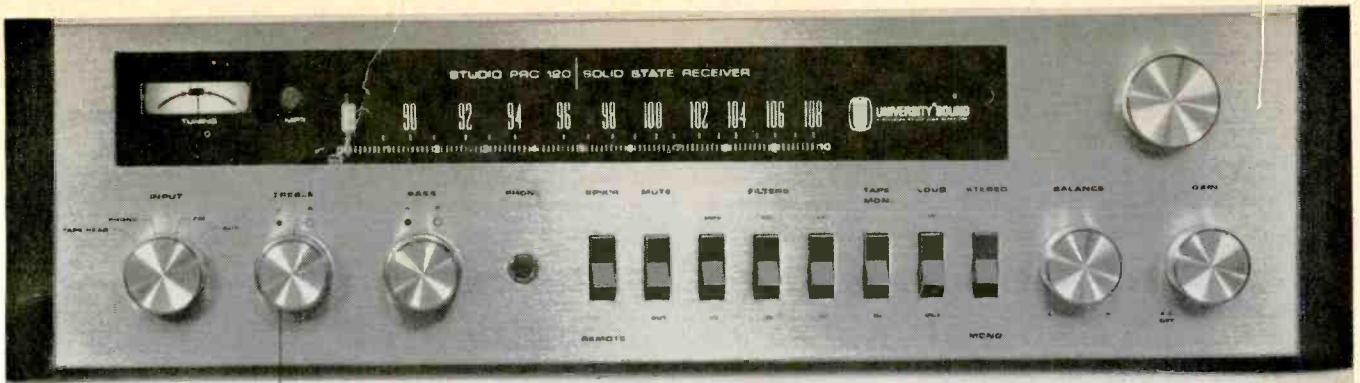

If you don't mind paying a lot less for a lot more, try the new University receiver

If we had priced our new Studio Pro-120 Solid-State FM/Stereo Receiver at half again more than its \$379.50, the whole thing would have been deceptively simple. Then no one, not even the most spend-thrifty status seeker, could question its modest price versus its immodest quality.

If the thought of paying a lot less to get a lot more bothers you, we'll tell you why the Studio Pro-120 is such a value. For over 35 years, we've built some of the world's finest speakers and sold them at prices lower than anything comparable. We're famous for that. But who ever heard of a University receiver?

The Studio Pro-120 is our first, so we put everything we could into it, including our many years of experience in designing sophisticated audio electronics for the military.

The results turned out to be so fantastic, we had every spec certified by a leading independent testing lab. That way, when you compare our middle-of-the-line price with quality that's quite comparable to the top-of-the-line of the Big 5, you'll know both are for real.

And if that isn't enough, how about asking your dealer for a re-print of the three-page article on the Studio Pro-120 from the January, 1968, issue of *Audio Magazine*.

Better yet, play with the Pro-120. Listen to it. And by all means compare it to any much higher-priced receiver in the store. We'll bet you'll wind up with our magnificent receiver, as long as you don't mind paying a lot less while getting a lot more.

 **UNIVERSITY SOUND**
A DIVISION OF LTV LING ALTEC, INC.
9500 West Reno • Oklahoma City, Oklahoma 73126

AMPLIFIER SECTION: IHF Power Output: 120 watts total, IHF Standard at 0.8% THD, 4 ohms (60 watts per channel). RMS Power Output: 8 ohms: 30 watts per channel at 0.3% THD. Frequency Response: ± 0.3 dB from 10 Hz to 100 kHz. Power Bandwidth: 10 Hz to 40 kHz, IHF Standard. Intermodulation Distortion: Less than 0.5% at any combination of frequencies up to rated output. Tone Control Range: ± 18 dB at 20 Hz and 20 kHz. Damping Factor: 50 to 1. Noise Level: (Below rated output) Tape monitor: -83 dB—Auxiliary: -80 dB—Phono: -60 dB—Tape Head: -63 dB. Input Sensitivity: (For rated output) Tape Monitor: 0.4 Volts—Auxiliary: 0.4 Volts—Tape Head: 1 mV at 500 Hz—Phono: 4 mV at 1 kHz. Input Impedance: Phono and Tape Head: 47,000 ohms—Tape Monitor: 250,000 ohms—Auxiliary: 10,000 ohms. Load Impedance: 4 to 16 ohms. **FM TUNER SECTION:** Sensitivity: 1.6 μ V for 20 dB of quieting, 2.3 μ V for 30 dB of quieting, IHF. Frequency Response: $\pm 1/2$ dB from 20 to 20,000 Hz. Capture Ratio: Less than 1 dB. Image Rejection: Greater than 90 dB. IF Rejection: Greater than 90 dB. Separation: 40 dB at 1 kHz. Selectivity, Alternate Channel: 55 dB. Drift: .01%. Distortion: Less than 0.5% at 100% modulation ± 75 kHz deviation. Multiplex Switching: Fully automatic logic circuit. **GENERAL:** Dimensions: 4 1/2" H x 16 3/8" W x 12" D (including knobs). Weight: 17 lbs. Amplifier Protection: Three 1-ampere circuit breakers. Complement: 31 Silicon & MOSFET transistors, 21 Diodes, 2 Integrated circuits (each containing 10 transistors, 7 diodes, 11 resistors).

UNIVERSITY saving money never sounded better

compression law should always correspond to standard magnetic conditions on the tape. After the noise-reduction system and recorder have been adjusted, the recording engineer is free to set the output of the mixing console to any level required for full modulation of the particular type of tape used. Note that compensation for tape sensitivity (for example, for high-output tape) should be accomplished in the above way, not by modifying the record and playback gain settings on the tape recorder, as is usually done.

While the foregoing standardized operating conditions are recommended, occasions sometimes arise in which, for one reason or another, it is necessary to use non-standard level conditions. In such cases a level-setting tone should be recorded on the beginning of the tape, the equivalent level used being indicated—i.e., whether the tone corresponds to the Ampex-NAB level or to the DIN level (4 dB higher).

Regarding the question of tape itself, engineers often have strong feelings about the best kind to use. Normal, low-noise, and high-output are the main types considered for conventional recordings. With noise reduction, however, the type of tape selected is not so important since hiss and print-through are reduced by the system, and the distortion situation can be alleviated simply by recording at a slightly lower level. Nevertheless, most engineers feel that low-noise tape is optimum with the system. The print-through tendency is corrected by the system, a very low noise level is obtained, and the overload properties are good, especially at high frequencies; a good balance between the various limiting factors is thereby obtained, resulting in excellent performance overall.

Regardless of the tape used, it sometimes takes a while to become accustomed to the latitude which a 10 dB increase in dynamic range provides. When first using the noise-reduction system, many recording engineers instinctively continue trying to record at as high a level as possible. This is a practice to be discouraged, since two or three dB of the increased signal-to-noise ratio

can well be sacrificed for a reduction in distortion.

Regarding the editing of noise-reduction tapes, most editors prefer working with the signal restored to normal. However, for certain passages the facility of monitoring the processed signal is used (the play-back-noise-reduction unit being switched out); in this way a kind of magnified view of the recording is obtained, whereby doubtful noises (such as the honking of a distant horn or musicians whispering) can be identified quickly. Moreover, if a splice sounds acceptable—in terms of differences in hall acoustics, for example—while the signal is in the processed condition, then the splice is sure to pass inspection after the signal has been restored to normal.

Under ideal conditions the original tape is edited and is used in the final tape-to-disc transfer, an operating procedure which is still often used for classical music. However, where tapes are bought or sold abroad, copies are usually involved. In such cases one-to-one copies of processed tapes are made for distribution on two ordinary recorders. Whether using an original or a copy, a noise reduction unit is used in the final tape-to-disc transfer.

Since the A301 system is a complementary one, it follows that it cannot be used to reduce the noise on old normally recorded material. If a normal tape is treated by a playback processor, the noise will be significantly reduced. But this will be at the expense of introducing errors in low-level signal dynamics and a loss of high-frequency response. However, if it is necessary to use old material, the system can successfully minimize any further degradation during re-recording; the noise level of the copy will then be substantially the same as that of the original (theoretically, 0.4 dB higher).

So far, the discussion has concerned use of the system in a standard way, whereby the rules are followed and one can be sure that the output signal will always be identical in all respects to the input signal. Situations arise, however, in which there is a strong temptation to use the system in a non-standard way for

the purpose of reducing the total number of units required. Unless an engineer has some understanding of the system and is of an experimental bent, such practices should be avoided. In principle, it is not permissible to operate on the signal without first restoring it to normal; the "control signal," which is contained in the processed signal itself, will be altered in the process. Nevertheless, some non-standard procedures, when used cautiously, often produce satisfactory results. For example, moderate amounts of equalization and filtering usually may be introduced in the processed signal without detrimental effects. Limiting can also be done, provided the gain control of the limiter is set to yield an overall gain of unity at all levels below the limiting threshold.

In the mixing-down of three-, four-, and eight-track recordings, a matter of even greater significance is that processed signals can often be mixed together with results which are indistinguishable, after de-processing, from those of the standard case in which the signals are de-processed before mixing. In such a procedure it is sometimes necessary to readjust the resultant level slightly (to the playback unit), to take into account the degree of correlation of the signals being mixed. In general, an experimental approach is required; as long as the rules are being broken, the only rule of any consequence is that *if it sounds right, it is right*.

It should be appreciated that the installation of a noise reduction system by no means marks the end of noise problems in a studio. On the contrary, the removal of tape as the limiting factor often uncovers a whole new layer of deficiencies which the meticulous engineer will wish to correct: microphone, pre-amplifier, and mixer noise; air-conditioning, fluorescent lights, creaking chairs. In addition, if the above factors are well under control, there will be further surprises. The soft puffing noises of the felt dampers on pianos will be revealed, and many other instruments (and their players) will be found to be unmistakable generators of wide-band noise. Æ

When Stanton engineers get together, they draw the line.

The frequency response curve of the new Stanton 681 Calibration Standard is virtually a straight line from 10-20,000 Hz.

That's a guarantee.

In addition, channel separation must be 35 dB or greater at 1,000 Hz. Output must be 0.8 mv/cm/sec minimum.

If a 681 doesn't match these specifications when first tested, it's meticulously adjusted until it does.

Each 681 includes hand-entered specifications that verify that your 681 matches the original laboratory standard in every respect.

Nothing less would meet the needs of the professional studio engineers who use Stanton cartridges as their ref-

erence to approve test pressings. They must hear exactly what has been cut into the grooves. No more. No less.

But you don't have to be a professional to hear the difference a Stanton 681 Calibration Standard will make, especially with the "Longhair" brush which provides the clean grooves so essential for clear reproduction. The improvement in performance is immediately audible, even to the unpracticed ear.

The 681 is completely new, from its slim-line configuration to the incredibly low-mass moving system. The 681A with conical stylus is \$55.00, the 681EE with elliptical stylus, \$60.00.

For free literature, write to Stanton Magnetics, Inc., Plainview, L. I., N. Y.

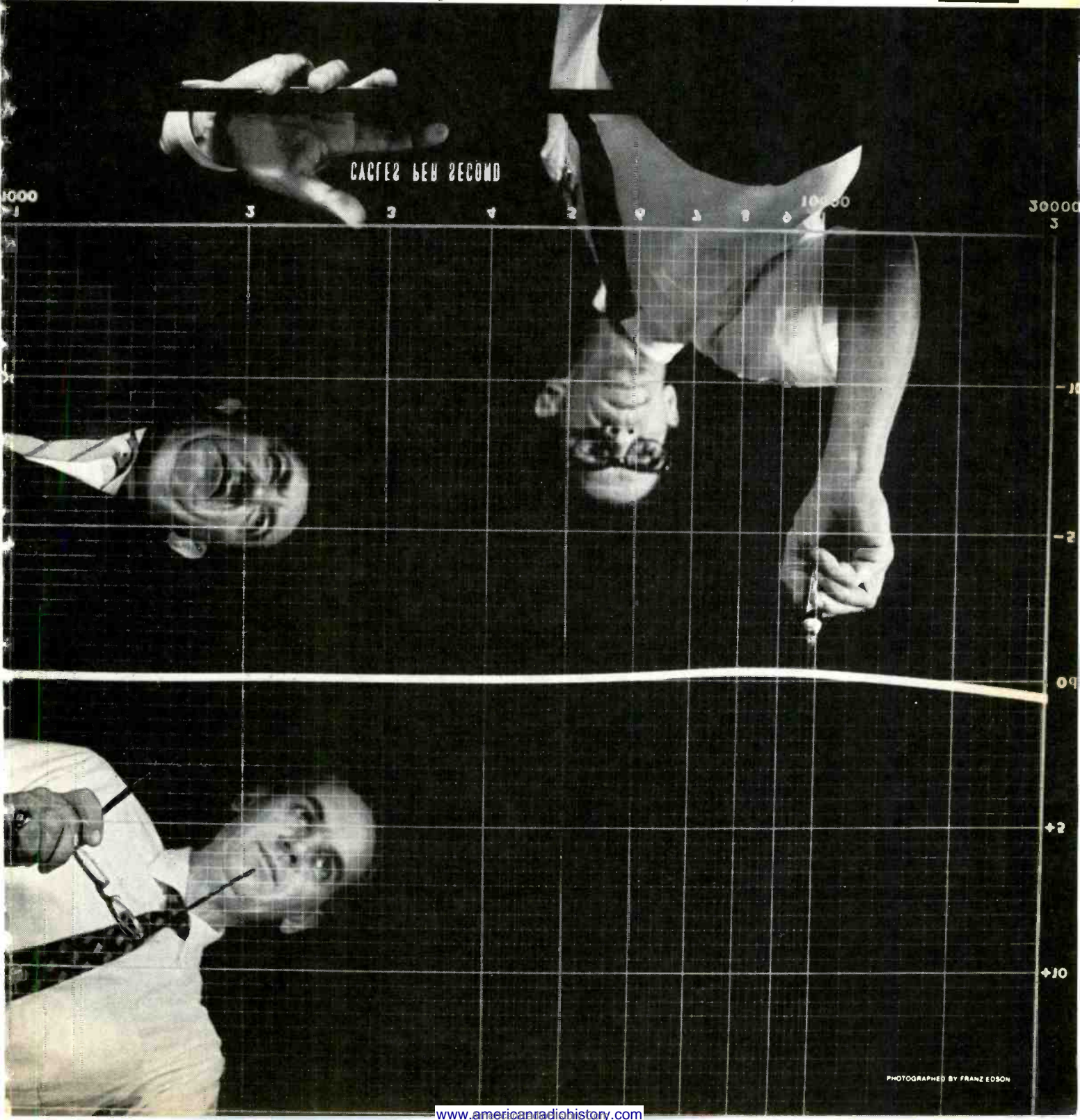

PHOTOGRAPHED BY FRANZ EDSON



AUDIO INVITES YOU TO SEND IN PHOTOS AND DETAILS ON YOUR HI-FI SYSTEM. PAYMENT WILL BE MADE FOR ALL PUBLISHED MATERIAL.

Brick-wall speaker system installation is shown at left. Various installation steps are shown below, before grille cloth covers enclosure openings.

Sound & Decor Styles

Brick-Wall Speaker Enclosures

Fred R. Hulen, Audio Mart, Kansas City, Mo.—“Build the room to do justice to the equipment” is a rare directive from a customer. This hi-fi stereo components dealer, however, found such a person in Dr. Frank Jones of Kansas City, Mo., who wanted to build a new family entertainment room in his home.

The decision was to use a “wall system” type of speaker installation in one end of a room that was to be built with the following dimensions: 31-ft. wide x 46-ft. long with a pitched-beam ceiling reaching 17 ft. in the center. The building contractor was instructed to provide the type of structure needed to house the speaker system(s) to be installed.

The contractor built a solid brick wall with 230 cu. ft. of space per side to accommodate the speaker systems. The cavities were covered with better than 200 sq. ft. of absorptive padding per side. Speakers consisted of eight Altec Lansing 515B woofers, two Altec 802D drivers, two 511B horns, and two N500G networks. Mounted on reinforced 1½-in. panels, each one weighed out at approximately 185 lbs. when ready for installa-

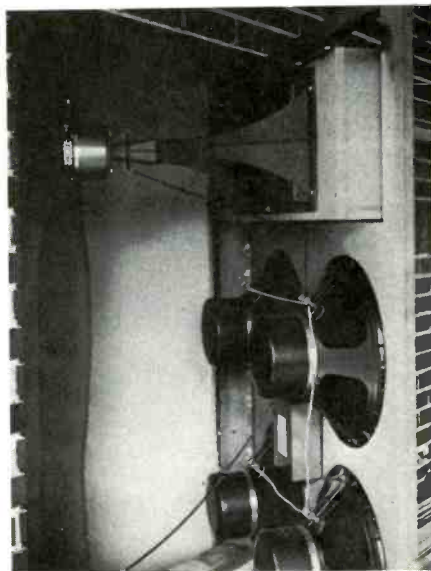

tion. The panels were installed within the cavity openings, held in place by wood screws on 5-in. centers. The brick wall provides perfect rigidity, with no possibility of resonances.

Complementing the system, at the other end of the room, are a Marantz 7T pre-amplifier, Marantz 15 power amplifier, Sherwood 3300 FM tuner and a Miracord 50H automatic turntable.



Back Power!

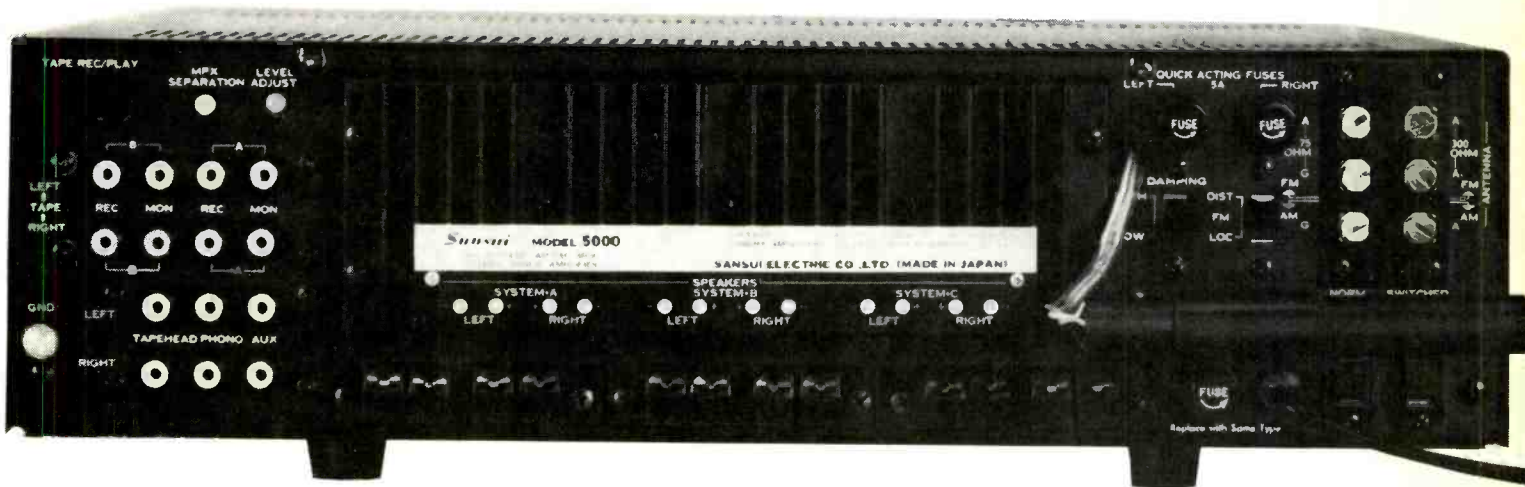

Take a close look at the back of the powerful, exciting, Sansui AM/FM Stereo 5000. You'll see the inputs for 3 pairs of stereo speaker systems that can be played individually or in pairs—engineered quick holding plugs that eliminate the need for cumbersome clips; selective monitoring for 2 tape decks so that you can monitor while you record. Even the inputs for phono, tape, and aux. are grouped for easier access and to reduce the chance of wires accidentally touching. □ The Model 5000 Receiver features FET FM front end and 4 Integrated Circuits, with a set of specifications that exceed Sansui's unusually high standards — 180 watts (IHF) music power; 75 watts per channel continuous power; FM tuner sensitivity of 1.8 μ V (IHF); selectivity greater than 50 db at 95 MHz; stereo separation greater than 35 db; amplifier flat frequency response from 10 to 50,000 Hz. □ The front of the Sansui 5000? See it at your franchised Sansui dealer. Price **\$449.95**

Sansui®

SANSUI ELECTRONICS CORPORATION • 34-43 56th STREET • WOODSIDE, N.Y. 11377
 Sansui Electric Company, Ltd., Tokyo, Japan • Electronic Distributors (Canada), British Columbia

Check No. 33 on Reader Service Card

Audio/FM Instrument Sampler

Several specialized pieces of equipment are used to measure characteristics of audio and FM equipment. Aside from the ubiquitous vacuum-tube voltmeter and oscilloscope, there are various signal generators, distortion meters, and a wow-and-flutter meter. A sampling of what's available in the latter categories for hobbyist, service, and laboratory applications are shown here. Specifications were supplied by manufacturers. For more information on any instrument shown, write in your request on the reader service card on page 59 of this issue.

SIGNAL GENERATORS

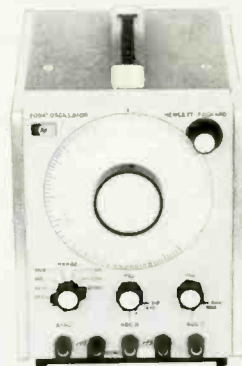

Hewlett Packard Model 209A—Sine/square wave. 4 Hz to 2 MHz. Under 50-ns rise time. \$320.00.

FM MULTIPLEX GENERATORS

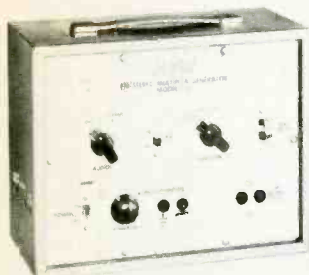

Hickok Model 727—Composite output, mono. SCA signal. Crystal-controlled 19 kHz pilot. Separation: 35 dB min. Battery-operated (opt. a.c. power supply). \$199.95.



Heathkit Model IG-37—Kit-form unit generates mono FM or composite stereo FM signals and audio. Crystal-controlled markers. SCA signal. \$79.95.



EICO Model 342—Generator provides both composite audio and FM r.f. outputs. External SCA. Separation: 30 dB min., 50 to 15 kHz. Crystal-controlled 19 kHz pilot. \$175.00 (wired only).



EICO Model 262 AC Volt/Watt meter—Voltage ranges: 10 mV to 1000 V rms; power range: 0.15 mW to 150 W. Incorporates tapped power resistor loads (4, 8, 16 and 600 ohms). \$59.95 (kit); \$89.95 (assembled).



Sencore Model MX129—Composite stereo signal. Crystal-controlled. SCA signal. Peak-to-peak and decibel-reading meter. \$169.50.



Karg Model MX-1G—Composite stereo or mono. External SCA. Separation: 40 dB min. Crystal-controlled 19 kHz pilot. \$255.00.

H. H. Scott Model 830—Features input, composite, and detected signal monitoring without disconnecting associated test equipment. Separation: exceeds 30 dB, 50 to 15 kHz. Switch-type controls. Crystal-controlled 19 kHz oscillator. SCA signal. Self-check circuitry. \$600.00.

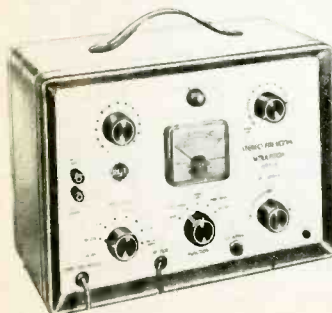

RCA Model WR-52A—Composite stereo, mono, r.f. sweep, and audio. SCA signal. Crystal-controlled 19 kHz pilot. R.F. deviation meter. \$248.00.



H. H. Scott Model 450 Sound Meter—Palm-sized sound level meter. Fully transistorized. Designed for ASA Standard S1.4-1961, A, B and C weightings. Range: 40 to 142 dB. Frequency range: 35 to 8000 Hz. Built-in crystal microphone. A.C. line calibration. \$182.00.



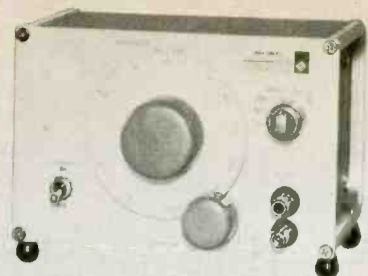

General Radio Model 1313-A—Sine/square wave. 10 Hz to 50 kHz. Typical rise time, 40 ns. \$325.00.



Heathkit Model IG-82 — Sine/square wave. 20 Hz to 1 MHz. Under 0.15 μ s rise time. \$53.95 (kit). Assembled Model IGW-47, \$94.00.



Lafayette Model 99H5014 — Sine/square-wave generator. Sine wave: 20 Hz to 240,000 Hz; square wave: 60 Hz to 30,000 Hz. \$35.95.



RCA Model WA-504A — Sine/square wave. 20 Hz to 200,000 Hz. Under 1- μ s rise time. \$95.00.

Knight Model K-687 — Sweep/marker generator. 3 Hz to 220 Hz with crystal marker. Up to 18 MHz wide sweep. Independent agc bias supplies. Kit: \$120; Assembled: \$185.00.



Heathkit Model IG-72—Audio generator. 10 Hz to 100 kHz. Under 0.1% distortion, 20 Hz to 20 kHz. Metered output voltage. Switch-selectable outputs. \$44.50 (kit); \$64.95 (assembled).

EICO Model 378 — Audio generator. 1 Hz to 110 kHz. Under 0.1% distortion, 20 Hz to 20 kHz. Metered output voltage. Switch selectable outputs. \$59.95 (kit); \$79.95 (assembled).



Amphenol Model 880 — Combination Tester—Seven test instruments are combined here: sine- and square-wave generator, FM multiplex generator, r.f. sweep generator, with 10.7 MHz marker, IM distortion analyzer (SMPTE standard), a.c. VTVM, and an impedance bridge. \$329.95.



Gotham Audio Models ME-101, ME-102 — Solid-state. Lowest readable flutter: ME-101, $\pm 0.02\%$; ME-102, $\pm 0.01\%$ (to 2.5% and 0.75% full-scale measuring range tolerance, respectively). Test frequency: 3150 Hz. Calibrating provisions. CCIR and DIN standards. ME-101, \$375.00; ME-102, \$395.00.



Amplifier Corp. of America Model 590-A—Lowest readable flutter: 0.01%. Test frequency: 3 kHz. \$495.00.

WOW & FLUTTER METERS

DISTORTION METERS

EICO Model 902—IM/harmonic distortion meter and a.c. VTVM. IM distortion measurement uses 7 kHz for high frequency and filtered line-frequency signal for low frequency. Harmonic distortion frequency range, 20 to kHz. 5% full-scale accuracy. \$250.00 (wired only).



Measurements Model 31 — IM distortion meter. Incorporates test signal generator, analyzer, voltmeter and power supply. 3000 Hz for high frequency, 60 Hz for low frequency. LF/HF voltage ratio: fixed 4/1. Accuracy: $\pm 10\%$ full scale. \$240.00.

MISCELLANEOUS

Gotham Audio Model EMT 160 Polarity Tester — For determining polarity of microphones, loudspeakers, cables or complete channels. Uses acoustic pulse sender. Indicators show polarity by means of green or red light. \$345.00.



Heathkit Model IM-12—Harmonic distortion meter. Measures as low as 1% full scale, $\pm 5\%$ full-scale accuracy, 20 to 20 kHz frequency range. \$60.00 (kit); \$115.00 (wired).



Equipment Profiles

This Month:

- Fisher Model 200-T Stereo FM Receiver
- KLH Model Twelve Speaker System
- AKG Model K-60 Stereo Headphones
- Heathkit Model TOA-67-1 Organ "Band Box"

Fisher Model 200-T Stereo FM Receiver



Fig. 1—Seventy-watt (IHF) stereo FM receiver.

MANUFACTURER'S SPECIFICATIONS—(FM TUNER SECTION) Usable Sensitivity (IHF): 2.0 μ V. Harmonic Distortion (400 Hz, 100% Mod.): 0.5%. Signal-to-Noise Ratio: 65 dB. Alternate Channel Selectivity: 40 dB. Spurious Response Rejection: 90 dB. Image Frequency Rejection: 60 dB. I.F. Frequency Rejection: 90 dB. FM Stereo Separation @ 1 kHz: greater than 35 dB. Capture Ratio (IHF): 2.5 dB.

(AMPLIFIER SECTION) Total Music Power (IHF): 50 watts (8 ohms). Total Harmonic Distortion (@ 1 kHz): 0.8%. IM Distortion: 1%. Power Bandwidth (8 ohms): 22 to 30,000 Hz. Hum & Noise: Volume (at min.): -80 dB; Phono low (6 mV ref.): -55 dB. Frequency Response (Aux.): 25 to 20,000 Hz +2 dB. Bass Control Range (@ 50 Hz): 17 dB. Treble Control Range (@ 10 kHz): 16 dB. Subsonic Filter: 12 dB/octave below 20 Hz. Dimensions: 15 $\frac{1}{8}$ in. W x 4-13/16 in. H. x 11 $\frac{1}{2}$ in. D. Weight: 22 lbs. Price: \$299.95. (Optional walnut cabinet, \$24.95.)

Fisher Radio's Model 200-T, a moderately priced (\$299.95) receiver, offers a measure of flexibility often associated with more costly units. As shown in Fig. 1, major controls located along the lower half of the front panel include

the usual selector switch (four position), a ganged bass control as well as a ganged treble control, a balance control and the volume control which, in its counter-clockwise position, turns off power to the receiver. There are, in addition, four "rocker" switches on this part of the panel as well as a stereo headphone jack at lower left.

The upper portion of the panel contains the very precisely calibrated dial scale, expanded to about six in. from 88 MHz to 108 MHz. There is also a complementing "logging scale" numbered from 0 to 100 for those people who just can't memorize their favorite station's actual frequency in megahertz. Overall calibration was found to be extremely accurate from one end of the band to the other. A peak-reading tuning meter and the familiar stereo indicator light are also located under the softly illuminated dial glass. While we generally take exception to "peak reading" tuning meters, in this case the meter proves to be effective as a center-of-channel type. The least de-tuning away from center-of-channel causes a decrease in the maximum reading. Insofar as its usefulness as a signal-strength meter however, its exponential action is such that all signals in excess of about 50 μ V cause almost full-scale deflection.

To the left of the dial scale is a speaker selector switch, enabling the listener to select main, remote or both sets of speakers, as well as an "off" position that would be used to disconnect all speaker systems while listening to stereo headphones, if desired. At the upper right of the panel is the tuning knob.

The rear connection panel is illustrated in Fig. 2. Pairs of input jacks are

provided for magnetic phono, low-level and high-level auxiliary sources, and tape recorder output and monitor inputs. The magnetic phono input is associated with a slide switch which varies magnetic input sensitivity, thus accommodating a greater range of magnetic cartridges than might otherwise be possible. There was no evidence of input overload or incompatibility of levels between phono and internal FM or FM Stereo gain. At the left are located the speaker terminal strips, the line fuse, and an auxiliary power receptacle. Speaker terminals are rather closely spaced. Therefore, we would recommend using spade lugs to ensure that frayed ends of speaker lead wires do not cause shorts.

Unlike many manufacturers who provide a "local" and "distant" antenna connection scheme by "padding" or attenuating the input signal resistively, the Fisher 200-T provides a "Local FM" position on the main selector switch for use when a very strong station causes interference with a desired,

Figs. 2 and 3—Rear-connection panel of Fisher 200-T. Tube socket at center is for test points. Bottom photo shows circuit-board construction.

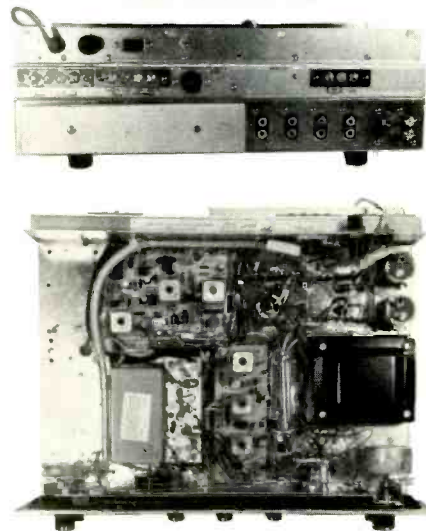

weaker station. This switch position alters the r.f. gain electronically, varying the gain of the first FET stage in the front end. This approach strikes us as a preferred one, since impedance match between antenna and input is always maintained.

Figure 3 shows the Model 200-T receiver's internal construction. In addition to the fully sealed front end, which employs two FET's and a 2N3588 local oscillator, there are six printed circuit

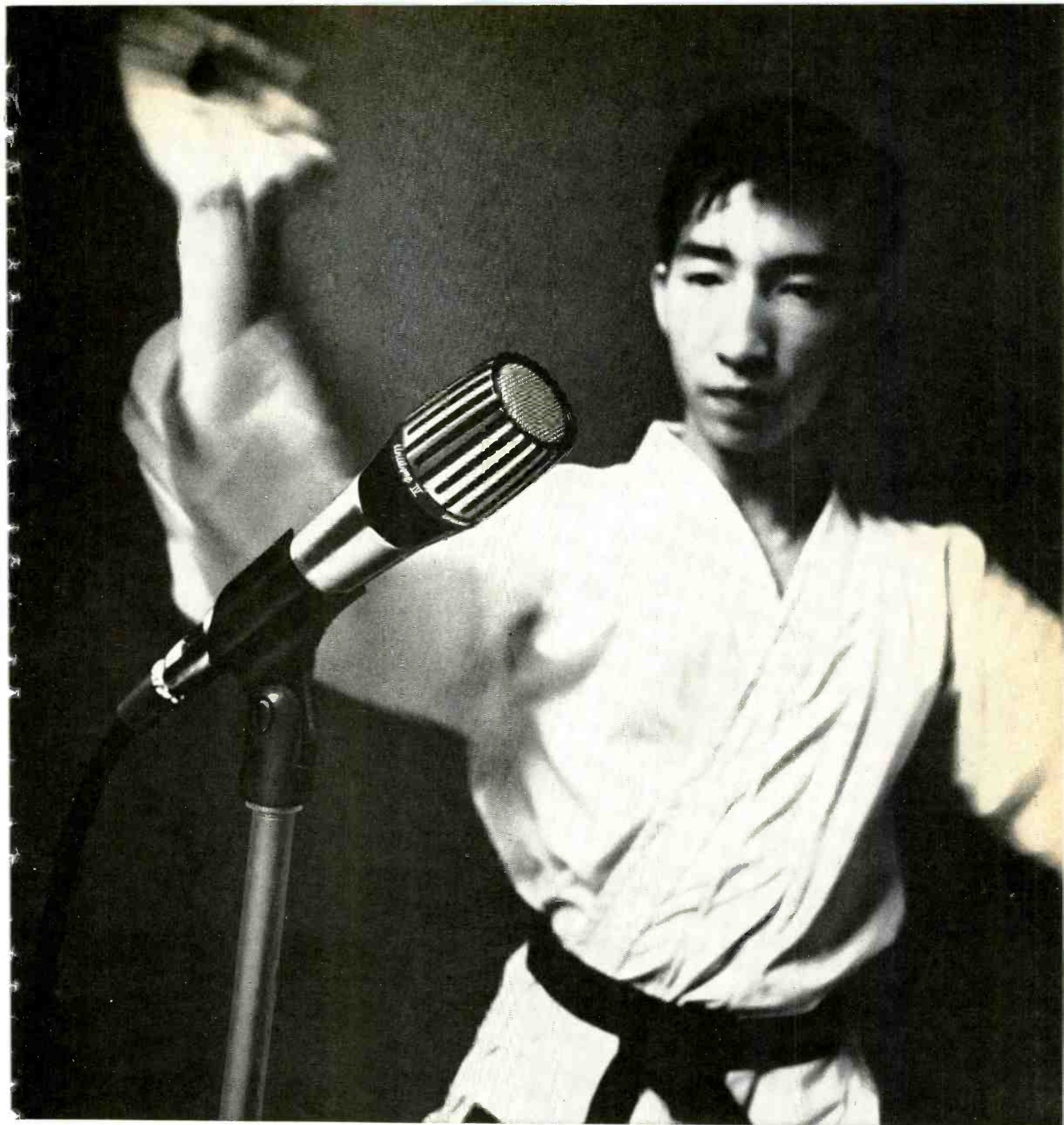

HAAAAH PROOF

THE SHURE UNIDYNE IV is the newest and premier member of the famed Unidyne family of true cardioid dynamic microphones which have pickup symmetrical about microphone axis at all frequencies . . . in all planes. The Unidyne IV is so rugged that it can withstand a Karate chop. Reinforced, cushioned cartridge withstands severe impacts and vibrations . . . the diaphragm can take the full force of a leather-lunged Karate yell! Trouble-free Cannon-type connector. Exceptionally easy to service in the field. The strongest, most durable Unidyne yet! Send for all the facts: Shure Brothers, Inc., 222 Hartrey Ave., Evanston, Ill. 60204.

Available in two models: Model 548 (hand-held), at \$100.00 list; Model 548S (with On-Off switch and swivel connector for stand use), at \$105.00 list.

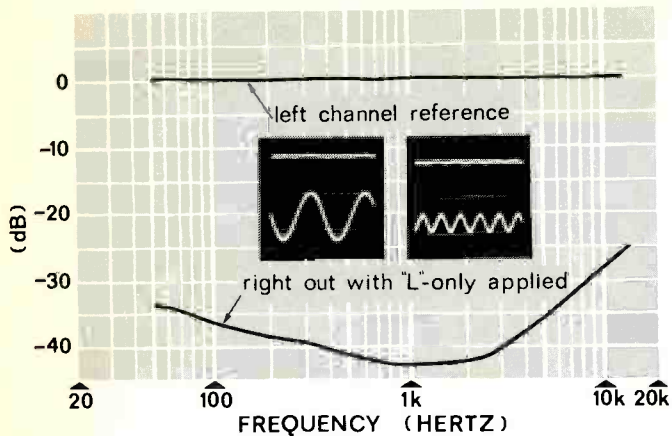

Fig. 4—Stereo FM separation of Fisher 200-T.

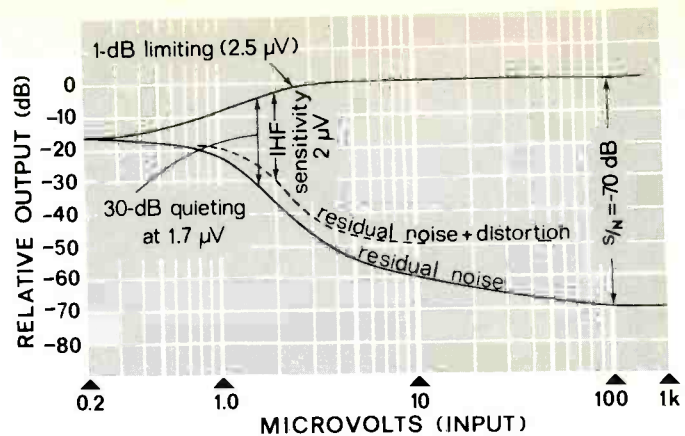

Fig. 5—FM quieting characteristics.

modules. The output transistors themselves are, of course, separately mounted on the rear of the chassis to provide adequate heat-sinking.

Measurements

Fisher specifications have long been noted for their conservatism, and the 200-T does not upset this tradition. IHF sensitivity was measured as 2.0 μV , as claimed by the manufacturer. Harmonic distortion on FM was a very low 0.3% at full modulation, bettering the 0.5% claimed. Ultimate signal-to-noise exceeded manufacturer's claims by fully 5 dB, measuring 70 dB. No evidence of spurious responses was observed during listening tests at any point on the dial. Capture ratio corresponded nicely to the 2.5 dB claimed, while stereo separation (see Fig. 4) exceeded claims at 1 kHz, measuring 38 dB on both channels. Figure 5 tells the story about limiting and FM quieting characteristics.

As for amplifier power output, we reached rated total harmonic distortion

(THD) at an output (per channel) of 21.8 watts as against the 20 watts claimed for 8-ohm load operation. At 20 watts (rated output), distortion was a mere 0.5%. THD and IM distortion curves are shown in Fig. 6. Power bandwidth is plotted in Fig. 7 and is seen to correspond very neatly with the manufacturer's specifications. All hum and noise figures exceeded published claims by anywhere from 3 dB (volume at minimum) to 8 dB ("Phono Low," with 6 mV reference).

Bass and treble control range, while not great (see Fig. 8), were certainly adequate for the moderate amounts of compensation that the average music listener might want.

As for frequency response, the design philosophy of the 200-T was obviously that of the school which believes that response should not extend much beyond the 20 and 20,000 Hz limits. This accounts for the somewhat more rounded square-wave response shown in Fig. 9 (at 10 kHz). Nevertheless, transient response is noted to be excellent, as there is no evidence of over-

shoot or "ringing" at either 100 or 10,000 Hz application of square-wave signals.

When we tried measuring the action of FM, with the muting circuit "in," it was realized that here was a really unique muting circuit. Not a trace of added distortion was detected with the introduction of "muting." The "threshold point" is absolute—either the signal is muted (below about 10 μV), or it comes "popping" in, fully listenable and free of distortion. Few, if any, muting circuits we have seen have performed so flawlessly.

This remarkable muting circuit was even more effective under actual listening tests. When "in-circuit," the mute maintains silence until the desired station is almost tuned in to the center of the channel. Then sound comes in, with no noticeable crash or transition—it is suddenly just *there*. Furthermore, we didn't sacrifice too many stations with the circuit in. In a close-to-New York location, 38 usable stations were received without muting; 36 with the muting "in." No less than 14 stations

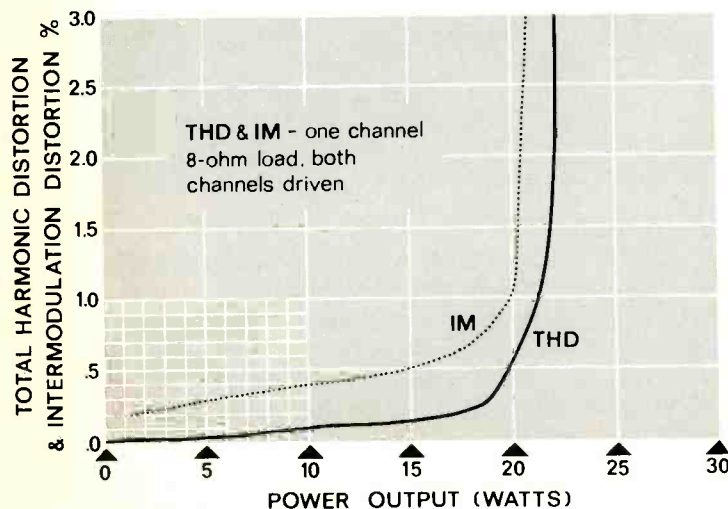

Fig. 6—Harmonic and IM-distortion curves.

Fig. 7—Power bandwidth with 8-ohm load.

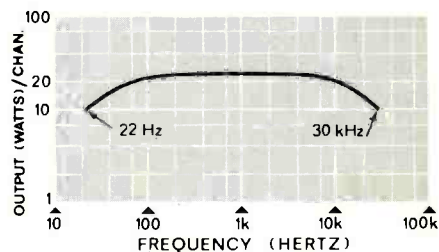
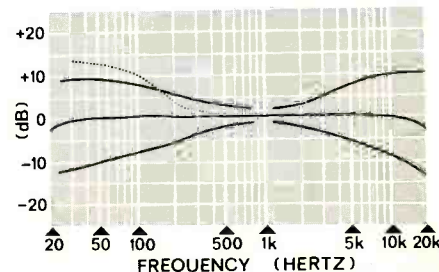

Fig. 8—Tone-control range. Dotted line shows loudness compensation for bass region at 1/4 rotation of volume control.



were received in stereo FM, with muting either "in" or "out." One of these was marginal, and now and again the "Stereo Beacon" would go on and off, but there was no accompanying "switching noise" associated with this periodic transition, simply a return to and from mono reception.

Sound quality on both FM and recordings was quite "transparent." The amplifier was able to handle the many percussive and wide dynamic musical passages to which it was subjected (for example, "Pictures At An Exhibition," Mussorgsky-Ravel, London Tape LCK-80054).

In view of a "modest" damping factor (around 10), this raised the old question as to how much importance damping factor really is in relation to

Fig. 9—Square-wave response of Fisher 200-T receiver at 10 kHz (left) and 100 Hz.

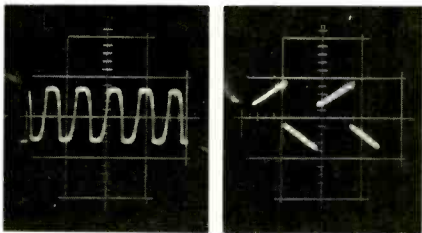

transient response. It should be noted, too, that low-efficiency type speaker systems were used and yet there was more than adequate volume in an average-size living room (around 15 by 20 ft.). As one audio wag put it years ago, "What this country needs is not more powerful amplifiers but an honest amplifier that can produce its rated output down to 20 cycles." (He said this before "cycle" was converted to "hertz".) The Fisher 200-T certainly fills that need and then some. If it lacks separate tone controls for each channel, consider that its ganged controls are tracked perfectly down to -50 dB (within 2 dB). If it doesn't have switchable hi- and lo-cut filters, consider how rarely these features are really used. If input level adjustments are absent it does take the trouble to provide alternate inputs (high and low) for both phono cartridges and auxiliary sources.

All in all, Fisher Radio's specifications for the Model 200-T FM stereo receiver tell it like it is. And though the receiver is not laden with various controls, it offers more than sufficient operating versatility for music lovers who are not enamoured with ultra control flexibility.

Check No. 36 on Reader Service Card

KLH Model Twelve Speaker System

MANUFACTURER'S DESCRIPTION: Type: Three-way, four-speaker system. Speaker Complement: One 12" woofer, two small-cone mid-range drivers, one 1 3/4" tweeter. Crossover Freq.: Nominally 600 & 2500 Hz. Controls: Four three-position switches. Housing: Floor-standing cabinet, oiled walnut. Dimensions: 29" H x 22 1/2" W x 15" D. Price: \$275.00.

The Model Twelve speaker system, which at \$275 is the most expensive unit in the KLH line of moving-coil systems, belies the small-enclosure image of acoustic-suspension speakers. The "Twelve" is a floor-standing unit as contrasted to the familiar bookshelf-sized systems which often employ the acoustic-suspension principle.

As readers know, until the adoption of acoustic-suspension designs, an enclosure had to be large in size to produce deep-bass frequencies. Acoustic-suspension speaker systems changed all that by making it possible to reproduce very low frequencies in a small enclosure. However, proponents of this type of system have long insisted that the principle of design does not necessarily require that a unit be small in size.

The Model Twelve's walnut console houses four direct-radiator, cone-type speakers. The woofer, designed to handle frequencies below 600 Hz, is a long-throw acoustic-suspension design with heavy cone and magnet assemblies. It works into four cubic feet of space. The manufacturer's intent here is to extend low-frequency coverage while retaining the acoustic-suspension principle of operation, which replaces conventional mechanical springiness of the speaker's outer suspension with spring action of the air trapped within a sealed enclosure. The two three-in. mid-range units operate in their own acoustic suspension sub-enclosures. These are the same speakers as wide-range units used in some of KLH's compact music systems. With the Model Twelve, they cover the range of frequencies between 600 and 2500 Hz. A 1 3/4-in. tweeter covers the range above 2500 Hz.

The unique feature of the Model Twelve is its frequency-contour control. This box, 12-in. x 9-in. x 2 1/2-in., can be attached to the back of the speaker with self-contained "Velcro" (a hook and pile fastener), or it can be positioned remotely at the listening station. It has four 3-position selector-type switches, is finished in walnut just like the



Fig. 1—KLH Twelve, including frequency contour control.

speaker, and contains circuitry for frequency shaping as well as for the speaker system's crossover network. The power amplifier's output is connected to the box. Either of two lengths of color-coded 4-conductor wire supplied are used to connect the control box to the speaker system. One length is short, mounted to the rear of the speaker, the other length, about 40 ft., is used if the unit is placed at a remote location. Each switch controls the specific range of frequencies described earlier. In center positions, we found that about a 3-dB boost in the center of the specific frequency range is accomplished. In the down positions, a 3-dB cut can be effected. We liked the flexibility afforded by the contour control—especially when used at the listening place. Since its controls are

Fig. 2—The KLH Twelve's contour control box, showing crossover, filter and attenuator components. The hefty attenuator resistor in the bass range (lower left) only became luke warm while listening to music at high levels.

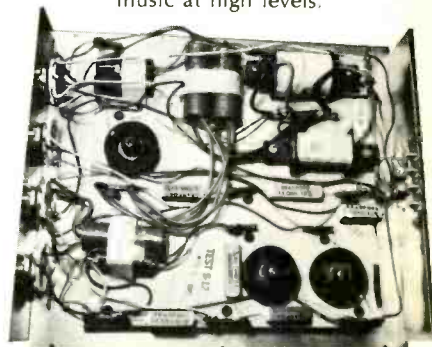

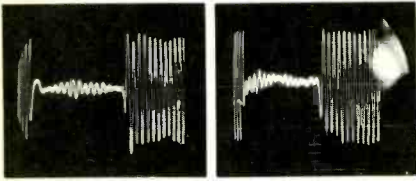

Fig. 3—Tone-burst traces of KLH Twelve speaker system at 300 Hz (left) and 5 kHz.

stepped rather than continuous, settings may be precisely duplicated. Additionally, the controls provide greater flexibility, over a limited range, than most amplifiers' tone controls can.

Providing listeners with limited frequency-shaping facilities presumes that

source material or some other part of the system (including the room) is not perfectly flat and, therefore, can use correction. This is a valid approach. The balance on certain records and tapes was improved, for instance, by adjusting the controls.

In testing the Model Twelve system (with controls set flat) we measured a smooth and wide frequency response between limits of 30 and 18,000 Hz. The bass is truly solid, starting to roll off slowly below 60 Hz. Driven very hard at 100 Hz, the speaker exhibited a remarkably low 5% harmonic distortion, and doubling in this extreme circumstance could be induced only below

50 Hz. High-frequency dispersion was excellent, with slight beaming above 13 kHz. Efficiency is low, though somewhat higher than KLH's Models Four and Six, and we recommend using an amplifier rated at least 30 watts rms/channel for use at loud listening levels in moderate-size rooms.

In listening to the speaker for weeks, we noted a full, open sound throughout the audio range. There were no significant peaks or dips in the response, and the resulting sound was smooth and natural. No doubt about it, the KLH Twelve rates high among systems in its price class and even above.

Check No. 39 on Reader Service Card

AKG K-60 600-ohm Stereo Headphones

MANUFACTURER'S SPECIFICATIONS—Frequency Range: 20-20,000 Hz, ± 3 dB. Distortion: 1% at 125 dB SPL (at 1000 Hz). Impedance: 600 ohms/channel. Weight: 11 oz. Furnished with 7-ft. cord, stereo phono plug, ear cushions. Price: \$39.50.

A number of months ago we commented on a pair of low-impedance phones with the suggestion that certain requirements of use demand a higher impedance—such as for monitoring a tape recording, or for professional monitor applications. And here we have one, with an impedance of 600 ohms, more than enough output for any listening use, and comfort achieved by two elements—light weight and foam-filled cushions.

Measurement of headphones is at best a difficult operation, particularly when the 6-cm³ standard coupler does not simulate the actual ear cavity above 600 Hz or thereabout. We have measured phones with 2-cm³ couplers with fairly acceptable results in the range

above 1000 Hz, but with somewhat erratic results in the range below that. And now we know why.

According to the descriptive literature which accompanies the K-60 phones, the 6-cm³ coupler which is standard for phones does not truly represent the impedance of the ear cavity, and reliable measurements can only be made by using a probe microphone with a probe diameter of only 1/16 in. This probe is inserted into the cavity while the phones are worn, and with such a measuring method it is claimed that results comparable to subjective tests can be reduced to objectivity.

The results of AKG's studies in this area has led to the development of its phone/ear "system," which provides what they call a "humanized" listening experience. In effect, the AKG phones do *not* shut out external sounds completely; some room sounds are transmitted through the ear shells. As a consequence, you might say that AKG's approach is contrary to what other headphone manufacturers have followed.

Evaluating the merits and demerits of a headphone set is a very subjective task, to say the least. Measurements do not indicate what is heard very accurately, of course. About the only virtue in making measurements is to prove what the response is likely to be above our upper hearing limit (which admittedly doesn't go much beyond 14,000 Hz).

Fig. 2—Measured and subjective frequency-response curves

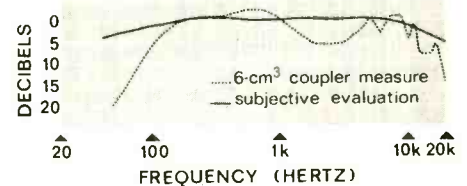

Listening to stereo music with the AKG phones provides what is rather more like normal listening to stereo loudspeakers. Thus, these phones present a more familiar sensation than others.

Even with the slight noise leak, however, low to middle frequencies were fine, deep bass was clearly present. High-frequency response appeared good, too, though at high-listening levels some harshness was evident. But good highs in this situation are the Achilles Heel of most headphones.

The result is a pair of phones which fill the need for a high quality unit combined with sufficient comfort in wearing that they may be left on the head and ears for hours with no discomfort. And all this at a price of \$39.50, which is somewhat under most other high-quality phones in the high-impedance range.

Check No. 40 on Reader Service Card



Fig. 1—North American Philips' AKG Model K-60 headphones.

How to build a better tape recorder.

ServoControl Motor. Automatically corrects for speed variations and maintains precise timing accuracy. Vari-speed feature of motor can be adjusted up or down to match musical pitch of tape playback to any piano!

ESP Automatic Tape Reverse. A special sensing head indicates the absence of any recorded signal at the end of a tape and automatically reverses the tape direction within ten seconds!

Non-Magnetizing Heads. Head magnetization buildup—the most common cause of tape hiss—has been eliminated by an exclusive Sony circuit, preventing any transient surge of bias current to the heads!



Noise Suppressor Switch. Special filter eliminates undesirable hiss that may exist on older recorded tapes. Filter does not affect the quality of sound reproduction!

Scrape Flutter Filter. Special precision idler mechanism located between erase and record/playback heads eliminates tape modulation distortion. This feature formerly found only on professional studio equipment!

Instant Tape Threading. Retractable pinch rollers permit simple one-hand threading. Other features: Four-track Stereophonic and Monophonic recording and playback. Also records in reverse direction. Three speeds. Two VU meters. Stereo Headphone Jack. And more!

Sony Model 560D. Priced under \$349.50. For your free copy of our latest tape recorder catalog, please write to Mr. Phillips, Sony/Superscope, Inc., 8142 Vineland Avenue, Sun Valley, California 91352.

You never heard it so good.

Heathkit "Band Box" Model TOA-67-1

MANUFACTURER'S SPECIFICATIONS—
Mounting: In Model TO-67, control head mounts in checkblock at right end of accompaniment manual. Circuit board mounts inside organ on accompaniment shelf rail. In Models GD-232, GD-232B, GD-325, and GD-983, control head installed in pull-out tray. Both tray and circuit-board assembly mount under lower keyboard shelf. Transistor Complement: Power supply circuit, 2 transistors. Voicing circuits, 15 transistors. Detector circuits, 8 transistors. Preamplifier circuit, 2 transistors. Net Weight: 8 lbs. Price: \$145.00.

Electronic organ enthusiasts, especially those who are more interested in the Theatre Organ than the classical types, invariably want a "Mighty Wurlitzer" sound from their instruments. The Wurlitzer was, of course, a pipe organ, with the various possibilities that are inherent with a wind instrument, and more specifically, with an instrument which has every one of its tones individually created and tuned separately (and painfully) pipe by pipe.

One of the important advantages of the Wurlitzer always was the ubiquitous "toy box," which usually included a number of sounds which cannot be obtained from an organ pipe, such as drums, wood blocks, castanets, and cymbals. The toy box also contained a number of other voices which were created by pneumatic action converted into mechanical action by a bellows-like device, and such instruments as xylophone, orchestra bells, glockenspiel, and so on could be produced.

Most electronic organs are not equipped with circuitry which will permit the creation of these sounds, although some of the latest models are and can simulate the theatre organ quite successfully.

The Thomas-by-Heathkit organs are among the ones not so equipped, but the new Band Box may be added to them to provide ten voices in the "toy-box" category. These voices are: crash cymbal, brush cymbal, bass drum, snare drum, snare drum roll, two different bongos, block, clave, and castanet. Any one or more of these voices may be produced by one of three ways—by a pushbutton on the control panel, by the action of a pedal, or by the action of a key on one of the manuals of the organ.

Designed originally for use with the Thomas or Thomas-by-Heathkit organs, we can see no reason why this unit could not be applied with equal

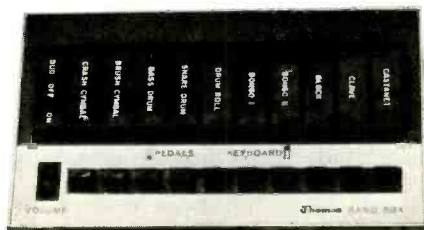

Fig. 1 (top)—The "chassis" of the Band Box. Three panels are used, but the one at the right is factory assembled and adjusted for the proper characteristics. The user assembles the remaining two, connects the cable which feeds the a.c. power in and carries all control and output signals.

Fig. 2—The Band Box control panel which is designed to mount in the Thomas-by-Heathkit organ. Electrical connections are by means of slip-on clips

success to any other electronic organ to provide the desired effect.

Circuitry

The Band Box is assembled in three printed circuit boards—the power supply and trigger circuit board, the Cymbal voicing circuit board, and the Drum voicing circuit board. Control is vested in a Control Head, which contains the tab switches, voice pushbuttons, and the volume control for the Band Box output which permits its level to be adjusted in suitable proportion to the normal organ voices. The arrangement of the circuitry is shown here in a block schematic.

The power supply and trigger circuit board provides a regulated 15-V. d.c. supply to the entire unit, and also accommodates a pedal-down detector and a key-down detector. These convert the impulses from the pedals or from the

lower manual into signals suitable for actuating the circuits of the other two circuit boards. The outputs of the two detectors are fed to the control head where they are routed to either the pedal bus or the keyboard bus, or to the "duo" position, in which case the voices are actuated by both pedal and keyboard. Provision is made for the pedal-down detector to be actuated by either a d.c. or an a.c. signal. This is to accommodate certain types of Thomas organs which are provided with "pedal sustain" and which use the d.c. signal, as contrasted to the models which do not have pedal sustain, and which are actuated by an a.c. signal. In addition to the ten rocker switches in the control head which select the desired voice(s), push buttons permit creating any voice without association with either pedal or manual keys. The action of the control head is to feed a +15-V. signal to the cymbal and drum boards to originate the desired voice.

The cymbal board has a brush-cymbal driver, which consists of two transistors that convert the keying signal to a pulse which is amplified and fed to one input of the noise generator, and thus furnishes the correct noise signal to the audio output bus. Formant circuits cause the noise for the brush cymbal to be centered around 8000 Hz, giving the desired "sizzle" to the voice. The crash cymbal is similarly resonated at around 2500 Hz, and the pulse timing is longer so as to provide the sound of a crash cymbal.

To produce the snare-drum voice, two signals are required—the "strike" tone, and noise—and these two signals are combined. The roll for the snare drum is provided by a multivibrator functioning at about 15 Hz which actuates both the strike-tone oscillator and the noise generator to furnish a snare drum roll which is most realistic.

The drum board consists of a number of similar phase-shift oscillators which

Fig. 3—Block diagram of the organ Band Box described in the text.

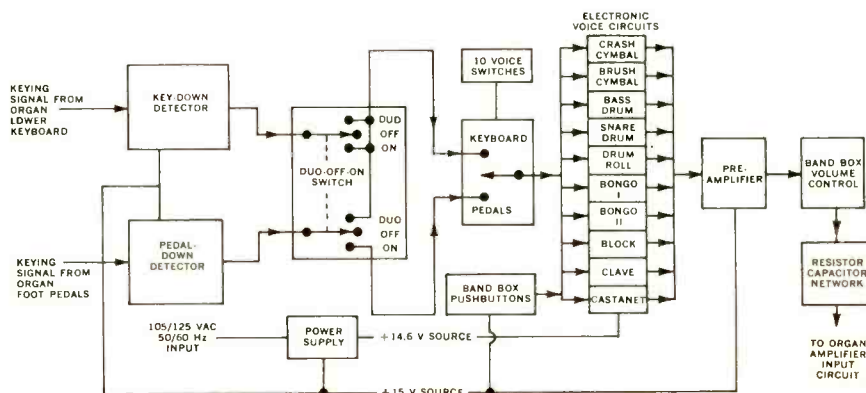

are pulsed to provide signals for the bass drum, block, bongo I, bongo II, clave, and castanet—the latter being repetitive so that the sound continues as long as the key or pushbutton is held down. The repetitive pulsing is provided by another multivibrator which functions at about the same frequency as the snare-roll multivibrator—and the latter is adjustable so that the two may be set to the same frequency.

With one exception, all Band Box voices may be played simultaneously. This exception results from the two modes for the snare drum. Since both basic sounds are provided by the same circuit, the keying is so arranged that the snare-drum tab will override the drum-roll tab, so both are not heard at once.

One further additional component is the power transformer which supplies 20 V. to the bridge rectifier, and which is external to the rest of the assembly.

One master harness interconnects the electronic chassis—all three of which are mounted in a wooden frame—with the control head and with the organ circuits for key and pedal signals, and to feed the audio output into the organ amplifiers. This harness is provided with two cable receptacles, one of which connects to the power transformer, and the other to the organ circuits. When completed, the electronic section is shielded by a foil-covered corrugated cardboard cover, which effectively eliminates external a.c. fields and coupling from other organ circuits, as well as protecting it physically from possible damage.

Construction

There is really not very much construction required to put this unit into operation. One of the three circuit boards (the drum board) is factory assembled and "tuned" for the proper voices, so there are only two circuit boards to be assembled. The control head is also factory assembled, and the master harness is equipped with clips which simply slip into slots on the circuit board which is the principal circuitry of the control head.

The three circuit boards in the electronic section are mounted in a wooden frame which accommodates them and provides a solid mounting. The cable harness is fitted with push-on clips which attach to pins on the three circuit boards. Actually, one is ready to install it in the organ within about 8 hours of unpacking the kit (the manufacturer's manual states "... 4 to 6 hours).

Considering the fact that there are 27 transistors in the Band Box, it is a

tribute to the designers that the entire electronic assembly, including the wood frame, is only 5 in. wide, 1½ in. high, and 20¼ in. long, while the control head measures 4½ x 7⅞ x 2 in. In the Thomas-by-Heathkit organ, the control head mounts to the right of the lower manual on the cheekblock. A cutout is already provided, and it is only necessary to cut through a thin layer of wood paneling to accommodate the control head, which clamps into place. The electronic assembly mounts on the rear of the accompaniment shelf support rail in a horizontal position.

Thorough and complete instructions are given in the kit manual for installation in the Heathkit "Paramount" organ, model TO-67. If the Band Box is to be installed in any of the "GD" series—GD-232, 232B, 325, or 983—it will be necessary to obtain the Band Box drawer and slides, Model TOA-67-2, which permits mounting the Band

Box control head on the console below the lower manual. This kit is available at a cost of \$35.00.

Performance

The addition of a Band Box to the Thomas-by-Heathkit (or any of the Thomas) models gives the player the additional advantage of voices which are not otherwise provided, and makes it possible to add some color to his music. All of the voices are convincing, and in various combinations will add new excitement to organ playing.

Again, while intended for use with the Thomas organs, we can see no reason why the Band Box could not be adapted to practically any other organ. One only needs to find a suitable keying signal to make it work, and especially in the case of kit models, it should be simple enough to find a source for these signals.

Check No. 42 on Reader Service Card



AUDIO NEWS

Plastic Acoustical Ceiling

An adjustable plastic ceiling that can be "tuned" to give a desired acoustical effect is a feature of the multi-million-dollar Fine Arts auditorium recently completed at Calvin College, Grand Rapids, Mich.

The movable ceiling consists of 104 pieces of black Kydex acrylic-PVC sheet, each measuring 3 ft. by 3 ft., giving a total sound reflecting surface of 936 ft. The panels, which are 3/16 in. thick, have cylindrical-shaped edges which snap over a framework of light aluminum conduit piping.

This acoustical ceiling hangs 10 ft. below the conventional roof and is 20 ft. above the auditorium floor. About 40 per cent of the tunable ceiling is situated directly above the stage area. The remainder covers the

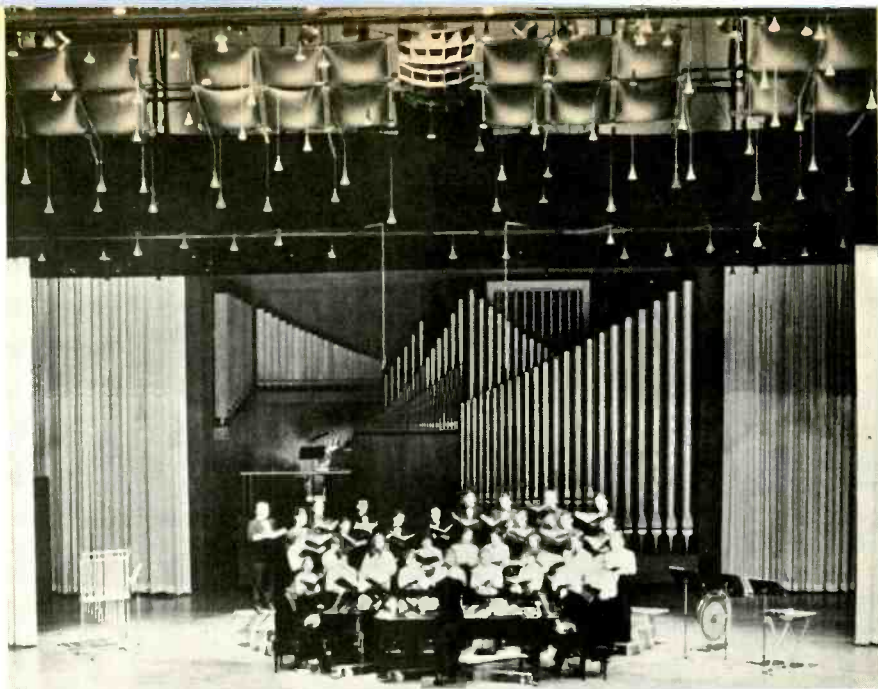

audience sitting in the front rows of the 1,000-seat auditorium. Steel cords and pulleys attached to the aluminum frame permit the ceiling to be raised or lowered to achieve the appropriate effect. The hall is equipped with a large pipe organ and recording equipment for tapings. Æ

Fig. 1—Adjustable plastic ceiling (installation design by Bolt Beranek & Newman Inc., New York City) can be raised or lowered to achieve desired acoustical effect.

Office Machines

TRAINING TIME FOR office machines repairmen has been reduced as much as 48 percent by a new audio tape-teaching system now being used by the National Training Center of Remington Office Machines Division, Sperry Rand Corporation. According to the company, time saved by using this method goes as high as 52 percent and expenses have been reduced about 30 percent.

The system, which combines taped instruction with books and drawings, is used for training new employees of the firm's dealers and its own Customer Engineers, as well as implementing other training programs.

The taped course, which under

Fig. 1—Audio tape-teaching system reduces training time for office machine repairmen.



"live" instruction required 26 weeks, is now completed in from 12 to 16 weeks without any appreciable change in average standings. With several months of taped instruction behind him, a sampling of the records of 13 trainees under each of the systems, the former classroom program and the present audio tape methods, revealed that those trained on Remington's Model 104 Printing Calculator with traditional classroom methods had required an average of eight weeks to learn how to repair it. Their final scores averaged 91.2. Those trained by taped instructions learned the same lessons in an average of three weeks and scored 91.1 on their finals. Furthermore, it was pointed out, it cost \$17,000 less to train the 13 men with tape than it did to train the other 13 men in the ordinary classroom.

Where instructors formerly stood before a class to demonstrate the repair procedures, there is now a series of six rooms containing 10 individual cubicles each. In these cubicles, students learn by listening to the tapes, doing as the taped voice directs them to do, and comparing notes with manuals and drawings. At the student's right is a drawer containing the tape recorder on

which he runs the instructional tapes. At his left is a drawer containing his training manual and tools. The desk space in front of him carries the machine—a typewriter, adding machine, calculator or cash register—which he is learning to repair.

The student listens to the taped lecture with an ear-set, avoiding distracting sounds, and watches his manual to observe the appropriate illustrations while the lecture is being given. As soon as he understands the mechanical function which is discussed on the tape, he selects the proper tool and works on that part of the machine. Progress is entirely at the individual's own pace—fast or slow.

One-and-a-half mil Mylar tapes are used throughout the system. With a recording speed of $3\frac{3}{4}$ inches per second, the Training Center uses 1,200 foot reels, giving two hours of lecture narration. Tests are recorded on three inch reels. Tapes, made in the Training Center's own recording studio, are produced from a master recording of the narrator's lecture. Presently, the Center has a library of some 150 recorded master tapes, covering instructions for repair of 10 of the company's products. Æ

The 34th AES Convention

NEARLY EVERYBODY who is anybody in the professional audio industry turned out for the 34th AES Convention held at the Hollywood Roosevelt Hotel April 29 to May 2. President Leo Beranek and Convention Chairman Don Davis should be pleased with the papers program, the exhibits, and the attendance.

It is becoming evident that the Society may soon have to run two parallel papers programs, since the 79 papers presented occupied morning, afternoon, and evening of each day except Wednesday, when the evening program was pre-empted by the Banquet. Phil T. Hanna, political writer for the L. A. Herald-Examiner, was the principal speaker. His subject was how to analyze political candidates in their bids for office. The Banquet was also the occasion for the presentation of fellowships to C. Paul Boner and Carl S. Nelson, and a Citation to Marvin R. Headrick, who was Exhibits Manager for the Convention.

The exhibit areas—because of the layout of the hotel there were two spaces divided into booths, and four separate rooms were utilized—were busy constantly, so that one wondered who was left to attend the papers sessions, while at the papers sessions, one wondered who could be visiting the exhibits.

In Electro-Voice's room, Lou Burroughs offered a two-hour discussion on the use of microphones on three separate mornings; Dolby Laboratories demonstrated in another room, and Ampex in a third, while Harman-Kardon showed its commercial sound line in a fourth. Gauss Electrophysics displayed its 240-ips tape transport with a flat bin for the 1-in. tape used in mass duplication. Gotham was represented by its line of Neumann and EMT equipment; B & K Instruments showed a full-range third-octave sound analyzer for adjustment of auditoriums. Altec Lansing made available three studios at Century City to show its Acousti-Voice principle in actual operation to prove that it really works. Practically every exhibitor who was in New York last fall was represented in L. A., along with a few new contenders.

The papers given at the eleven sessions were listed in the April issue of *AUDIO*, and preprints are available on most of them. For information about them, write the Audio Engineering Society, 60 East 42nd St., Room 428, New York, N. Y. 10017. Æ

Is price
the only
reason
you never
bought a
Neumann
microphone?

You just
ran out of
reasons.

microphone?

Now you can own a Neumann microphone for as little as \$237. Because we've reduced our prices by as much as 30%.

Using advanced transistor electronics, our new FET-80 Series Microphones give you the same superb acoustical quality for which Neumann has always been world-famous.

And—incredible as it may seem—by paying less, you get more features than ever before:

Central compatible powering, for example, that provides you with greater flexibility. By installing one power supply for just \$82.50, you can power upwards of 30 microphones.

Long life batteries may be used where there's no AC power available. These batteries give you approximately 10 days of continuous operation for less than 1¢ an hour.

And you get a two-year guarantee.

Neumann FET-80 Series Microphones are available in many different models, priced from only \$237 to \$417.90. Send today for our free illustrated brochure

Up till now, only the major recording studios of the world could afford to own a Neumann microphone. And every one of them did. Now you can, too.



Gotham Audio Corporation A-1
2 W. 46th Street, N.Y., N.Y. 10036
Please send me your free brochure and technical article describing Neumann's FET-80 Series Microphones.

Name _____
Company _____
Address _____
City _____ State _____ Zip _____

AUDIO MUSIC REVIEW

| | |
|-----------------------|----|
| Classical | 46 |
| Light Listening | 48 |
| Jazz | 49 |
| Recorded Tapes | 50 |

Classical Record Reviews

EDWARD TATNALL CANBY

Renaissance to Bach

Music of the Renaissance and Baroque for Brass Quintet. (G. Gabrieli, Pezel, Isaac, Scheidt, Finck, Tielman Susato, Dowland, Anon.) American Brass Quintet. Folkways FM 33652 stereo

Amazing how professionals can immerse themselves in their own business, ignoring the outside world so close to them. Here is a superb American brass group, flawless in technique and ensemble, powerful, dead-accurate, ready to blow the roof off or trip along as light as air. Fabulous.

But what one hears, in this recording, is not "What interesting music!" but "Boy, just listen to us play—we are good!"). And they are. But the composers come off second-best. The notes they wrote on paper are simply grist for the brass mill, something with which to show off technique. One detects very little interest in these different masters—if only in that they all sound alike. They weren't.

Nor did they write for this sort of modern brass, nor this snazzy modern style of playing, accurate but also arbitrarily high-powered (for no good reasons) and remarkably indifferent to melodic shaping and rhythmic phrasing.

Stereo recording, though my copy was mono. Rather dry acoustics, excellent tonal quality. Extensive booklet annotations—at least here the composers are differentiated!

Performance: B— Sound: B+

Harry Partch: *And on the Seventh Day Petals Fell in Petaluma*. Gate 5 Ensemble, under direction of the composer. Composers Recordings CRI 213 USD stereo (\$5.95)

Whoopee! (Well, Partch is of that generation...) Some sounds here.

Harry Partch, father of Vergil Partch, has been making music of the spheres, far-out and take-it-away, for as long as I can remember. He is maybe the last of the old Individualists in music, following after Ives and Ruggles and Varèse (an adopted American) and such. This is the current Partch operation and, clearly, after these many years, he hasn't finished work yet. Tape technique? He's taken it on in one fell swoop.

The Partch specialty is unique: he builds his own exotic instruments, gives them astro-space-type names, then makes music for them. He is as much of a visual artist, a kind of instrument sculptor, as he is a musician—perhaps even more so, if I may hazard an opinion. His things are beautiful to look at and marvels of craftsmanship. His music is all exotic tone color but not (to my ear) really very radical in terms of musical construction. All sorts of delicate jangles, tinklings, gongings, thumps, clanks, zooms—gorgeous sound, gorgeous tone color.

Yet, things being what they are today, I say all this with large grains of salt in my typewriter. As our interests change, so do the values put on "musical" sounds. Partch would seem to be coming straight into style in the happening and mixed-media age. He couldn't very well be more "now" than he is now, unless maybe tomorrow.

This large in-progress piece (I gather it isn't quite total yet) presents us with 34 "verses" of music, each short segment a different combo of exotic sounds. Verse 1 is for Zymo-Xyl and Crychord (I told you he uses astro-space names), Verse 2 for Surrogate Kithara and Bass Marimba, Verse 3 for Harmonic Canon I and Blue Rainbow. There are gourd trees and cone gongs and a Quadrangularis Rerver-

sum, not to mention something called a Spoils of War, a Castor & Pollux (twins—get it?) and a Gubagubi.

After 23 verses are played off, Mr. Partch doubles up via tape. The verses are played simultaneously in pairs, dubbed together, and eventually in triplets. How those engineers sweated! They did a good job. And so we get to Verse 34, which combines Verses 21, 22 and 23 for a grand finale.

Mr. Partch is 67 and has a fine, oriental, pointed, white beard. Might think, listening here, that he was all of 18. But no 18-year-old would have the persistence to carry through this monumental super-Californian extravaganza! Buy it, buy it, and enjoy (Composers Recordings, 170 West 74th St., New York, N. Y. 10023).

Performance: A Sound: A—

Virgil Fox in Concert. (Bach, Gigout, Reger). Command CC 11040 SD stereo (\$5.79)

It's all in your point of view. If you like a huge "old fashioned" (i.e., recent-modern) organ and lots of big-organ sound, here it is, and especially in the whopping bass. Rattle your hind teeth all right.

If you like Bach played as Bach ought to be played on the organ, and if you tend to dislike any sort of musical shop talk—that is, music the experts play for each other to show how good they are—then you'll walk away from this one, hi fi or no.

I played only the Bach—enough for me. This organ is wholly unsuitable for Bach. That is a very minor sin, and many good organists can get away with it convincingly, as good pianists do playing Bach on their unsuitable instrument. But this Bach is just hideously unmusical, a worse sin. Hard, pounding, the inner rhythms banked away relentlessly and without a trace of phrasing, not even in reasonable time, the registration crude and ugly. That's how it hit me.

Of course, Reger is hardly an organist's shop-talk composer, though he can be dreadfully complex and lengthy in a late-Romantic way. I didn't try him, nor Gigout, a student of Saint-Saëns who wrote 500 pieces for the organ. Perhaps Reger and Gigout will fill your hi-fi bill to perfection—you can always try.

Performance: C Sound: B+

The Ultimate Ives

IT IS BECOMING more and more clear why Charles Ives, after fifty years of obscurity, is suddenly popular. It is not because he is any easier to listen to (like Beethoven's, his music will never be mood music). It demands attention and it grabs at your ears with the roughest sort of impact. Nor is the Ives renaissance a matter of style, coming back into fashion. Far from it! The sound of Ives is more and more *old* fashioned, in spite of all the dissonance. He is very much of his time, the first two decades of the century, and the further we move away, the more unmistakably is he an out-and-out post-Romantic. Eccentric, to be sure.

What really gets us about Ives, now, is the extraordinary musical philosophy behind his work and, of course, its results in sonic terms. It was a viewpoint that until very recently was just plain incomprehensible to musicians and the lay public alike. What it amounts to—we now see—is a deliberate use of controlled chance, the interaction of totally disparate elements that are not supposed to “relate” in the usual artistic sense, nor resolve themselves into unity. They simply *are*.

This is much easier to hear—boy, is it!—than to describe. Ives will play an old-fashioned gospel hymn in one key and deliberately throw a violently swearing accompaniment at it in another key. It is the opposition, the *existence of two strong elements at once*, that interests him. Or he will set two, three, or even more independent “pieces” all going at the same time, deliberately unrelated, or rather, chance-oriented; often the resultant is never the same in any two performances.

It is this throwing-together of forces that, like the potent clashes of particle against particle in nuclear physics, produces the sonic “events” which make the Ives music move in such a dynamic fashion.

There's a splendid new *Vanguard Cardinal* recording out of the four Ives Symphonies which tells the whole story for you in the most dramatic terms you can imagine. Three records of integrated Ives, six long sides, and what a super-hi-fi sonic blast, Dolby-ized for the most sensational dynamic range of the cen-

tury! An exhausting experience to play all the way through this album, to put it mildly, but also an exciting and therefore enjoyable one, no matter how hard Ives lambastes your ears.

The four Symphonies, brought together here for the first time, range over Ives' creative life. The Second and Third, eccentric as they are in the characteristic Ives ways, are already moderately familiar. The First is a characteristic student piece if I ever heard one, all brash-



ness and overconfidence, much too long for its tortuous overweight and full of conventionalities (as of the 1890s), treated with impetuous brilliance and—alas—banality. Everybody who was anybody at the time gets in—Brahms, Berlioz, Saint-Saëns, César Franck, Wagner—with enthusiastic non-discrimination. What else, from a budding student with a big gift?

As for the Fourth, it carries the Ives Philosophy to the ultimate stage. (Maybe that's why he went no further, over many later years of a long life.) An enormous work, it calls for two orchestras (one back stage), a chorus, organ, three pianos (one of them solo), a percussion group (also offstage)—and a plurality of conductors to hold things more or less together. (This performance was managed with only one man at the helm, thanks to a revised set of directions worked out by Gunther

Schuller.) For the most part, these elements are independent and often set against each other, with deliberate intent to “overwhelm”—Ives' own word. Totally different, even to different time values and purely chance interactions. There is no resolution—there isn't supposed to be. But through the five long movements the poly-clashings and the contactings, both violent and gentle, are always exciting.

Harold Farberman is a totally dedicated Ives conductor and already a specialist in that difficult area. His persuasive enthusiasm—which shows to fine advantage in the very personal notes he has written for the album—has obviously carried the British performers with it. There isn't a trace of that skepticism which mars so many Ives performances, nor of that too-precious snobbery that also goes with many of Ives' modern appearances—not that the old man himself would have stood it for a moment. The New Philharmonia Orchestra has been conquered; it plays with the utmost seriousness and interest.

As for the recording, put it this way: never did a recording engineer have such a problem, nor such a challenge. The results here are fantastic. A marvelous presence and balance, combining clear separation of the numerous elements with a realistic sense of the whole space, plus the all-important feeling of *largeness*, of big-as-life impact. And listen to the low-level passages! The last movement of the Fourth opens with total silence, plus a few tiny, half-audible scratchings and scrapings, cymbals touched barely—as though the orchestra had been commanded into total silence but hadn't quite managed it. Then listen to the big climaxes and follow them down to pianissimo, down further, down, down—it is an experience I have never heard before on records. There's even one faint British bus to be heard. It must have been half-a-mile away.

E.T.C.

Ives: The Four Symphonies. New Philharmonia Orchestra of London, Ambrosian Singers, Harold Farberman. *Vanguard Cardinal* VCS 10032/3/4 (3) stereo (\$10.50)

Performance: A—

Sound: A

Light Listening

STUART TRIFF

Pops Magic

The Pops Goes Latin: Boston Pops Orchestra/Arthur Fiedler. RCA Victor LM/LSC-2988 (\$5.79)

This collection of tropically-flavored music proves once again what an incredibly versatile orchestra the Boston Pops is! The venerable Arthur Fiedler leads his men through a half-dozen Richard Hayman arrangements of bossa-nova tunes and Herb Alpert specialties with the skilled assurance of one who is an old hand at this sort of thing; the orchestra responds with ease to the often tricky rhythms and syncopations.

Four of the six selections were written by Americanos: "Tijuana Taxi"; "A Taste of Honey"; "Spanish Flea"; and Hayman's own "Dansero" (my own personal favorite). The remaining two, from Brazil, are Luis Bonfá's lovely "Carnival Morning" from the film "Black Orpheus," and Jobim's "Desafinado." Jack Mason's arrangement of the latter includes a beautiful trumpet solo, played with limpid sensuousness by Roger Voisin.

The second side is given over to Morton Gould's "Latin-American Symphonette." This deservedly popular work, inspired by dance rhythms from Cuba and Argentina, has been well-represented on records. First recorded for Victor in the early Forties by José Iturbi and the Rochester Philharmonic, there have been subsequent LP versions by Howard Hanson, Felix Slatkin, Maurice Abravanel and Gould. Fiedler enjoys the best sound of all, and his performance is rivaled only by the composer's (also on Victor).

The Dynagroove reproduction is excellent throughout, capturing every timbre of the wide variety of percussion instruments employed here. One sour note: an umpteenth version of Falla's "Ritual Fire Dance" (used as the second side filler) impresses me as a particularly unimaginative and inappropriate choice for inclusion in a collection of light music by American and Latin-American composers.

Performance: A

Sound: A

America's Favorites—Kate Smith, vocalist; with the Boston Pops Orchestra/Arthur Fiedler. RCA Victor LM/LSC-2991 (\$5.79)

Kate Smith is here accorded the unique distinction of being the first singer to appear on discs with Arthur Fiedler and the Boston Pops, since the Orchestra made its recording debut nearly 33 years ago. This mating is an altogether fitting one, above and beyond its commercial considerations. I can think of no two performing artists who have contributed more nobly or more consistently to the cause of good light music in America, over a period of almost four decades, midst the changing tastes and styles in the popular idiom.

Miss Smith's singing has lost amazingly little of its admirable qualities. Her voice, now with a noticeably darker coloration and less security in the upper register, is still a rich and powerful instrument. Every word of every lyric is delivered, as always, with crystalline clarity; an example most of our pop and legitimate singers could well profit from.

The program provides a generous dose of old-fashioned nostalgia (a tonic which we all can use a good swig of, now and again) showcased in lovely arrangements by versatile and always-reliable Richard Hayman. The songs include such Broadway oldies as "Kiss Me Again"; "April in Paris" and "Strange Music"; while Hollywood is represented by "Be My Love" and "All the Way." Among the standards, there's "Brazil" and "When Day Is Done"; and from the light concert repertoire, we have "Danny Boy"; "Because" and "For You Alone." All of these chestnuts are sung with impeccable musicianship by Kate Smith, with Arthur Fiedler providing sensitive and considerate accompaniments. Combined with RCA's top-notch engineering, this disc is an eloquent testimonial to the talents of two ever-bright beacons in the world of popular music.

Performance: A

Sound: A

Sound Tracks

How to Save a Marriage and Ruin Your Life (Soundtrack): composed & conducted by Michel Legrand. Columbia OS-3140, stereo only (\$5.79)

After more than forty scores for European films, including "The Umbrellas of Cherbourg" and "The Young Girls of Rochefort," Michel Legrand makes his bow as a Hollywood composer with the music for "How to Save a Marriage and Ruin Your Life." The movie's slim plot revolves around a man whose marriage is headed for the rocks

because of his extra-curricular activities with a certain young lady. A busy-body buddy intervenes, by attempting to prove that the mistress is unfaithful, in the hope that friend philanderer will see the error of his ways.

Fortunately, Legrand's score is a winner and reminds us that his is one of the freshest and most original minds in popular music today. The score for HTSAMARYL is punctuated with typical Legrand touches: felicitous and unusual scoring and orchestration that is economical and wonderfully transparent.

Mack David's lyric for the main theme, "Winds of Change," is sung behind the opening credits of the film by the Ray Conniff Singers and reprised during the end title, with the chorus used instrumentally. The theme is heard again in the breezy Overture, then as a straight instrumental, and finally, in a jazz version. And that, friends, is the way to get the most mileage for your money.

A much lovelier tune, "The Sunnyside," arranged as a dialogue between piano and harp, is heard only once. There is also the "Punch and Judy Waltz," with a sly wink at Stravinsky; and a piece called "Thinking Voices," featuring flutes and piccolo chattering over muted strings—both grand Legrand.

Although labeled an original soundtrack recording, the liner notes point out that the themes and motifs are recorded in a fuller development than the fragmentary form in which they occur on the soundtrack. The statement is true, and all to the good for home listening purposes. The reproduction is excellent; clear and full with a natural stereo spread.

Performance: A

Sound: A

Billion Dollar Brain (Soundtrack): Orchestra conducted by Marcus Dods. United Artists UAL-4174/UAS-5174 (\$5.79)

Richard Rodney Bennett, the composer with the three first names and the dual (musical) personality, has become increasingly familiar to American audiences of late. One of the more prominent of England's younger generation of composers, Bennett writes in a conservative serial style for the concert hall, while composing tonal background scores for the cinema. Recently, New Yorkers heard the world premiere of his Second Symphony, under Leonard Bernstein; and witnessed the first American performance of his opera, "The Mines of Sulphur."

Bennett's music for "Far from the Madding Crowd" was the first of his

film scores ever to be recorded. It was released on M-G-M in December of last year. Now, in quite a different mood, we have his score for "Billion Dollar Brain," the movie version of Len Deighton's entertaining, but far-fetched novel about an electronic monster with delusions of grandeur.

The music is somewhat dissonant at times, but always highly-effective and nicely-varied. Electronic effects are used with restraint to create an appropriately eerie atmosphere. The title theme is excellent, as is a romantic little piece called "Anya." Also enjoyable is the "Ambush" sequence—an amusing bit of pomposity in the Russian manner.

As is necessarily the case with most original soundtrack recordings, the listener is subjected to track after track of music that fades out in mid-air. Without the visual aid of the film, this makes no sense whatever as a purely aural experience, and actually undermines the composer's efforts. For home consumption, it would be so much more enjoyable if these scores could be arranged into suites or condensations. Perhaps then, recordings of movie music would sell better and wouldn't

go out of print so quickly. The stereo quality is good, but the recording lacks reverberance.

Performance: B+ *Sound:* B

Jazz, etc.

BERTRAM STANLEIGH

The Total J. J. Johnson
RCA Victor Stereo LSP-3833 (\$4.79)

Trombonist J. J. Johnson provides a swinging disc consisting of nine of his own compositions. They are performed by a batch of top studio musicians, including: Benny Powell, Tony Studd, Paul Faulse, Art Farmer, Snooky Young, Phil Bodner, Hank Jones, Ron Carter, and Grady Tate. Clean recording and nicely balanced stereo add much to the atmosphere of this fine set.

Performance: A *Sound:* A

Bill Dixon Orchestra: Intents and Purposes
RCA Victor Stereo LSP-3844 (\$4.79)

Three compositions in the jazz idiom written to be performed in conjunction with the dance. The music leans heavily on a sustained, bowed doubled-bass line with percussion accents, intermittent ascending trumpet and fluegelhorn riffs, and in the case of *Metamorphis*, which occupies all of side 1, frenetic reed climaxes. The effect, without choreographic counterpart, is a bit unsettling.

Performance: A *Sound:* A

Reissues

Fats Waller: Smashing Thirds. RCA Victor LPV-550

A fourth collection of Waller high jinks. This group includes his famous 12-inch version of *Honeysuckle Rose* as well as his take off on *Boo Hoo*. Three of these numbers date from 1929, the balance were all cut in 1937.

Performance: A
Sound: A (for a reissue)

(Continued on following page)

THE DOLBY A301 AUDIO NOISE REDUCTION SYSTEM



Making the
Master
Recordings
of the
Future

DOLBY LABORATORIES INC.

Already in use in eighteen countries, the Dolby system is making master recordings which will withstand the test of time.

The system provides a full 10 dB reduction of print-through and a 10-15 dB reduction of hiss. These improvements, of breakthrough magnitude, are valid at any time—even after years of tape storage. This is why record companies with an eye to the future are now adopting this new revolutionary recording technique.

A301 features: Easy, plug-in installation · solid state circuitry · modular, printed circuit construction · high reliability, hands-off operation. Performance parameters such as distortion, frequency response, transient response, and noise level meet highest quality professional standards.
Price \$1,950 f.o.b. New York.

NEW optional half-speed adaptor modules for premium quality tape to disc transfers.

NEW Remote Changeover option cuts costs, enables one A301 unit to do the work of two.

333 Avenue of the Americas · New York · N.Y. 10014
(212) 243-2525. · Cables: Dolbylabs New York

Check No. 49 on Reader Service Card

Jazz, etc. (continued)

The Original Dixieland Jazz Band, RCA Victor Mono LPV-547

This is the group that started it all, or at least that drew New York's attention to what had previously been called ragtime. Not only are the original versions of *Livery Stable*, *Tiger Rag*, and *Clarinet Marmalade* included, but 1936 remakes by the re-organized band are also here. Rudi Blesh, who confesses to having heard the group at Reisenweber's in 1917, contributes an exceptionally fine set of notes.

Performance: A *Sound: C*

Rock, etc.

Van Dyke Parks: Song Cycle. Warner Bros. Stereo WS 1727 (\$4.79)

An ambitious, musically attractive attempt to blend folk-rock and pop-rock with advanced tape effects, this unique disc employs an orchestra and chorus of approximately fifty. Composer-singer Parks has written most of the material himself, and it has both message and style. What keeps this experiment from being a real success is the strong over-emphasis of multitrack tape gimmickry and a too-distant, low-presence sound quality.

Performance: A *Sound: C*

Hair. RCA Victor Stereo LSO-1143 (\$5.79)

An original cast recording of what is described as "an American tribal love-rock musical," *Hair* turns out to be a rather deft bit of musical comedy with a few hippy allusions. Under its bells, beads, flowers, incense, and strange attire, there beats the heart of a Broadway box office. Maybe, as the liner says, the story renounces "the harsh compulsions and competitiveness of the establishment," but in its conventional music making, this is a very commendable product of commercial theatre.

Performance: B *Sound: B*

Butterfield Blues Band: The Resurrection of Pigboy Crabshaw. Elektra Stereo EKS 74015 (\$5.79)

A soaring, wailing, rocking triumph that is not only the finest achievement of the Butterfield Band on records, it is also one of the most successful and rewarding synthesis of the blues and rock media. Not for an instant does this disc fail to get its message across. Sound is just as exciting as the content.

Performance: A *Sound: A*

Recorded Tapes

BERT WHYTE

Schonberg: Verklarte Nacht (Opus 4). **Scriabin:** The Poem of Ecstasy. Zubin Mehta cond. the Los Angeles Philharmonic. London/Ampex LCL80202, open-reel 4 tr. stereo, 7 1/2 ips (\$7.95)

Zubin Mehta is one of London Records' most important conductors these days, and his desire to record with his own Los Angeles Philharmonic is probably the reason they made the long, arduous and expensive journey from foggy London to smoggy Los Angeles. Such an undertaking is almost without precedent. As one who has made recordings in this country and in London, I can assure you that at the very least, it is twice as expensive to record in the States as it is in the "tight little isle."

Have the results justified all the trouble and expense? London made four recordings in Los Angeles and on the evidence of the three that I have heard, I can cast an affirmative vote... with some reservations. These reservations are confined mainly to Mehta's readings of "Petrouchka" and the "Tchaikovsky 4th Symphony." There is little to fault in this altogether splendid taping of Verklarte Nacht and the Poem of Ecstasy.

Mehta's way with the Schonberg work is utterly convincing. A very cohesive performance, yet quite passionate and intense. Mehta elicits some splendid sonorities from his magnificent strings. The first violins are particularly lush and smooth in tone and they play with great precision. Purportedly, the Los Angeles Philharmonic has the most highly valued string instruments of any orchestra in the world, including four Stradivarius, one of which is a cello. Good as the "Verklarte Nacht" is, it is the Scriabin work which is the prize on this tape. On the basis of this performance alone, Mehta and the Los Angeles orchestra are clearly established as an outstanding, top-rank team.

Scriabin was something of a mystic and the psychedelic nut of his day. If I remember correctly, he employed devices like a "color organ" to project colored flashing lights and even used various scents so that the audience would "participate" in the "totality of realism" during performances of his Poem of Fire. Scriabin ascribed all sorts of quasi-mystical significance to his Poem of Ecstasy. In spite of all this mumbo-jumbo, he has given us a

highly interesting and exciting work.

Mehta is in his element here, giving us an eloquent performance; sensuous, tremendously intense. He builds slowly, commanding his forces with great authority, lingering a little on detail, but never overly fussy. His climaxes are enormous and piled on one another until the final shattering outpouring of sound in the long-held C major chord, which ends the work.

The overall sound quality is very good. The frequency range is wide; great dynamic range. Lateral directionality was fairly pronounced, but a good central channel fill restored the proper balance. Acoustic perspective is one of spaciousness, but not as much as I suspect the London engineers would have preferred. With medium-close miking, the presence is very good with nice definition. Here again, strings are outstanding in their smoothness, and the first strings play with positively searing intensity in the great climaxes. Superb playing and impressive sound from the french horns. The important trumpet solo is played in virtuoso fashion, but I would have liked more projection and a brighter, more brazen sound. For those who have the speaker systems and the power to do it justice, there is a bass drum with a really low 30 to 35 Hz response and an impact of awesome proportions.

Most of the sound is very clean, with just a smidgin of overload on one climax. Hiss was moderate, but more than I expected with the EX-Plus processing and the possibility the master was made with the Dolby A-301. Crosstalk was almost non-existent, but there was some "pre" and "post" print-through apparent. There are some occasional low-frequency "thuds," which I suspect may be maestro Mehta stomping his foot for emphasis. Play this music at a big room-filling level and you will have a sonic feast of huge proportions.

8 Tracker

Without Her: Jack Jones. RCA Victor P851289, Stereo 8-Tr. cartridge (\$6.95)

This is Jack Jones' first recording for RCA after his fabulously successful tenure at Kapp Records. Here transferred to an 8-track cartridge, this album gives further evidence of Jack Jones' continuing development as one of the top male vocalists on the pop scene. The purity of his voice is a joy to hear, his facile phrasing in the league with Sinatra, his control most impressive.

Although he has been doing more of the "swinging," up-beat type of song than formerly, his forte was and is the romantic ballad. Jack imbues this kind

of song with a warmth and intimacy of projection that has a remarkable effect on the female, I've observed. This is further enhanced by the usually excellent recording afforded Jack, and this album is no exception.

His program on this cartridge is the usual mixed bag of old and new tunes. Jack essays such standards as "Isn't It Romantic," "I Can't Get Started" and "For All We Know," and such recent items as "The Look Of Love," "Without Her" and "Live For Life." On this latter tune he accompanies himself by an effective overdub.

As noted, the technical quality is excellent. The voice is well-centered in the phantom center channel and has beautiful projection. The vocal/orchestral balance is nigh perfect with just the right amount of reverb that affords good presence and lots of warmth. As played in my home at a room-filling level, the hiss was quite moderate, there was virtually no crosstalk (you see . . . it can be done with a separate bias supply on the 4 pairs of stereo tracks and scrupulous quality control) and there was a slight amount of print-through. With the ambient noise in my car, even this moderate conglomerate of noise could not be heard. This one is a winner!

Open Reel, 3³/₄ ips

Nancy Wilson: Welcome to My Love (arranged and conducted by Oliver Nelson. Capitol Y1T2844, 4 tr.-3³/₄ ips open reel (\$4.95))

Nancy Wilson has a good voice, true and steady, and unlike many of today's female vocalists she knows how to use it effectively without recourse to excessive "gimmickry." Her phrasing is particularly good and well disciplined. Most of all she knows how to put over a song with the right kind of emotional involvement, whether it is a ballad or a "swinger." The program she sings on this tape is attractive and well balanced. It includes items such as the title song "Welcome To My Love," "Angel Eyes," "It Never Entered My Mind," "For Once In My Life," and the ubiquitous "Ode To Billy Joe."

Technically, the recording is quite good, with the voice well-placed in the center phantom channel, good lateral directivity; vocal/orchestral balance could have been slightly improved, as at times the voice lacks projection and is covered. The moderately heavy reverb doesn't blunt the definition of the orchestra and presence is good. Tape hiss, crosstalk and print-through were all pleasingly low in level. For Nancy Wilson admirers, an enjoyable addition to their library.

One-finger exercise for the music lover



The gentlest touch of a pushbutton is all that is needed to put the Miracord 50H into automatic play: single records, once over or continuously, or stacks of up to 10 in automatic sequence. Or you can ignore the push buttons and play single records manually by simply placing the arm on the record. That's how easy it is to operate and enjoy the Miracord 50H. Other features include: Papst hysteresis

synchronous motor; leadscrew adjustment of stylus overhang; cueing facilities; anti-skate compensation and direct dialing stylus force adjustment to as low as 1/2 gram. Less cartridge and base, \$149.50. Visit your high fidelity dealer and see a complete line of Miracords starting at \$89.50. Benjamin Electronic Sound Corp., Farmingdale, N.Y. 11735 **Miracord 50H**

Check No. 50 on Reader Service Card

NEW WATTS BOOK IS HERE!

PROFESSIONAL METHODS FOR RECORD CARE AND USE — The tremendous potential of today's advanced record playing equipment — more sensitive tonearms, higher compliance cartridges, elliptical styli, reduced tracking forces — all require more sophisticated methods of maintenance. If you've read the basic Cecil E. Watts book and/or your equipment is the finest and the undistorted sound of music is important to you, this long awaited book is "must" reading. Price: 50¢

HOW TO CLEAN, MAINTAIN AND PROTECT RECORDS by Cecil E. Watts—The basic book on record care, this has been a guideline for thousands on the essential care of every record collection. Subject matter includes a discussion of dust, static, static behavior, handling records, how to use record changers properly, and how to rejuvenate records. Excellent as a starter course in record care or, with the book above, an "insurance policy" for all the records you'll ever own. Price: 25¢

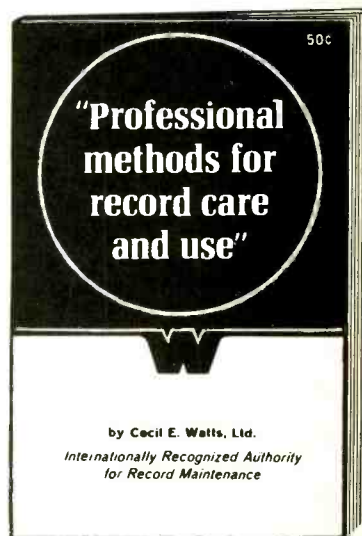

Get your copy at any hi-fi dealer, or mail coupon to order direct.

| | | |
|---|--|--|
| ELPA MARKETING INDUSTRIES, INC. New Hyde Park, N. Y. 11040 | | 57 |
| Dear Sirs: Please send the following book(s) on record care | | Enclosed is _____ |
| <input type="checkbox"/> Professional Methods for Record Care and Use. Price: 50¢ | | Name _____ |
| <input type="checkbox"/> How to Clean, Maintain and Protect Records. Price: 25¢ | | Address _____ |
| | | City/State/Zip _____ |
| | | Please do not send stamps. No C.O.D.'s |

ABZs of FM

LEONARD FELDMAN

R.F. Front Ends Go "Solid State"

IT IS SAD but true that early attempts at r.f. front-end transistorization resulted in performance that was measurably inferior to tube designs displaced. While I do not wish to belabor the industry's over-enthusiasm in rushing into solid-state front-end designs, a brief discussion of why these first designs fell short of the mark will help in understanding some vital FM r.f. design considerations.

There are several things that an r.f. stage is expected to do, in terms of overall FM performance. For one, it is expected to establish a suitably low noise figure. Since the r.f. incoming signal is at its lowest level at the input to this critical first stage, it is this first r.f. stage which ultimately determines overall noise figure. Another characteristic expected of an r.f. stage is satisfactory selectivity. In general, the r.f. stage will be tuned (either "double tuned" at input and output, or single tuned at output) to provide as much selectivity as possible without restricting necessary channel bandwidth. An r.f. stage may be expected to encounter signal input levels ranging from a few microvolts to a volt or more. In other words, a dynamic range approaching

one million! If the stage is to handle this range without overload, some means must be provided to vary the gain of the active device, be it tube, Nuvistor, transistor, or FET (Field Effect Transistor). Such variation, as mentioned earlier, is accomplished by means of an Automatic-gain-control (A.g.c.) voltage. Finally, a good r.f. stage should produce a minimum of spurious responses of its own and be subject to a minimum of interference brought about by certain combinations of multiple frequencies related to but not identified with the desired signal frequency.

With all of the above in mind, let us examine a "typical" early r.f. stage attempting to use high-frequency germanium transistors for an r.f. amplifying circuit. The circuit is shown schematically in Fig. 1. The first big problem here is that in the common base configuration, input impedance of a bi-polar germanium transistor is quite low. If the input is pre-tuned with a parallel tank circuit, one of two detrimental things will happen: 1) If we just slap the tank circuit across the input, it will "load it down," reducing circuit "Q" and selectivity; 2) If we compensate for the basic impedance mismatch, and "tap down" on the tank circuit, we will be "tapping down" on the signal voltage, or reducing gain capability.

To make matters worse, a.g.c., while present in the circuit of Fig. 1, is limited in its action by the gain-changing characteristics of the typical bi-polar transistor. These devices were limited in dynamic range and, therefore, could be subjected to overload even in the presence of carefully worked out a.g.c. schemes.

With operating points established along the non-linear characteristics of the transistor (to enable gain control), several forms of spurious response were often present. The two most important spurious responses that plagued early

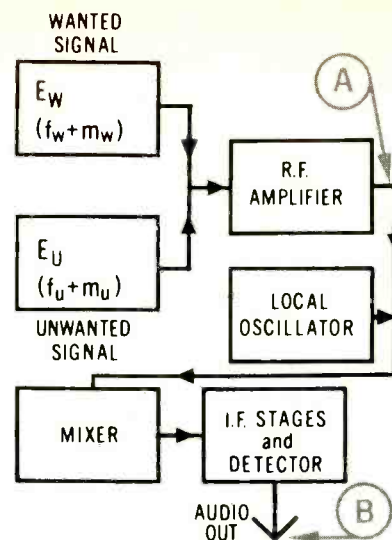

Fig. 2—The amplified signal at (A) may contain the desired carrier plus modulation of both desired and undesired carriers if a strong unwanted signal is close in frequency to a weak, wanted signal. Elements of both may appear at (B) if the FM receiver has poor AM rejection and/or poor i.f. limiting.

transistorized front-end designs were cross-modulation and intermodulation distortions. Cross-modulation distortion can occur when a receiver is tuned to a small, wanted signal (E_w), while a large, unwanted signal (E_u) causes interference. With poor selectivity, the large signal is usually within the range of selectivity of the r.f. stage.

Figure 2 shows the wanted and unwanted signals as inputs to the r.f. amplifier. E_w consists of carrier frequency f_w and modulation frequency m_w . E_u consists of carrier frequency f_u and modulating frequency m_u . When E_u is very large with respect to E_w , an actual transfer of modulation, m_u from f_u to f_w , is accomplished because of the non-linear input of the r.f. amplifier stage. The output waveform contains $f_w + m_w + m_u$ instead of the desired $f_w + m_w$ only.

Intermodulation distortion occurs when two or more frequencies, related in a particular way (so far as frequency only is concerned) are applied to the non-linear transfer characteristic of such an r.f. amplifier. The resultant frequencies present after the intermodulation process must be related harmonically to the center frequency of the tuner and the local oscillator frequency to produce a measurable amount of i.f. frequency or its sub-harmonics; or the resultant frequencies must be sub-harmonically related to the i.f. frequency.

Fig. 1—Typical FM r.f. stage employing an ordinary bipolar PNP transistor.

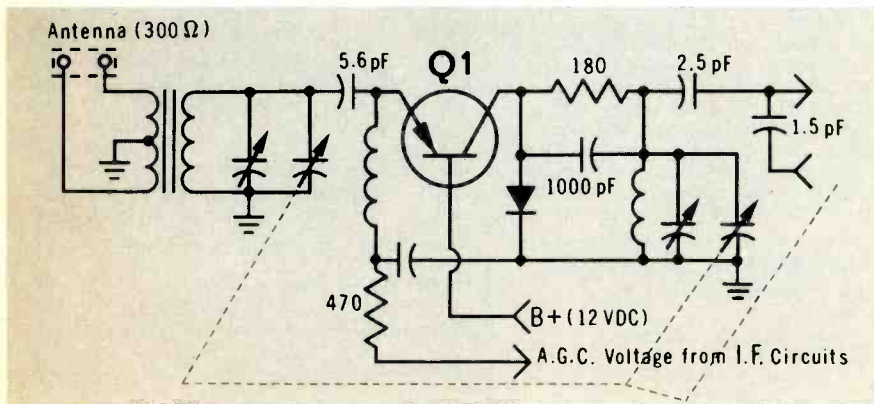

When we speak of non-linearity of the input characteristic of early r.f. transistors, we must quickly add that this non-linearity enabled the control of gain so vital in preventing severe overload and allowing for the dynamic range necessary in an FM r.f. stage. Non-linearity, by itself, is not a bad thing, providing the non-linearity follows the curve of a square-law device. Such a device, in effect, will produce second harmonic distortion in its output, but practically no third- or higher-order harmonics. In the case of intermodulation distortion, second-harmonic distortion corresponds to first order (or sum and difference) intermodulation products. Thus, if one signal is 103 MHz and the other is 104 MHz, the sum will be 207 MHz and the difference will be 1 MHz. Neither of these products is anywhere near the selective range of the mixer or i.f. stages which follows. Consequently there is no problem. Still, gain control is made possible because of the non-linear characteristic still present.

The up-to-date circuit of Fig. 3 illustrates the use of a field-effect transistor (FET) in the critical r.f. stage. This device fills the "square law" requirement, and does a lot more, too. Unlike the bi-polar transistor, the input impedance at the "gate" element is very high—higher, in fact, than was the grid input impedance of the old triode vacuum tube. (Incidentally, the elements of the FET are called "gate," "drain" and "source." The "gate" is the controlling element, similar in function to the grid of a vacuum tube. Sometimes the "drain" and "source," equivalent to a tube's plate and cathode, may be physically interchanged with no difference in performance of the device. Many forms of FET are appearing on the market, and it is beyond the scope of this series to detail differences between the various types.)

This high input impedance enables us to resort to classical high-impedance

resonant circuit coupling at the input, improving selectivity while at the same time permitting full, useful gain of the device to be realized. The improved selectivity, coupled with the square-law action of the FET's, has resulted in cross-modulation rejection of nearly 100 dB! Such superior rejection exceeds rejection figures typical of tube circuits, which generally ran about 80 or 85 dB. Certainly, it surpasses anything that was possible with conventional bi-polar transistors, where typical cross-modulation figures ran 60 to 70 dB!

You may recall that we spoke of equivalent thermal noise in early tube or transistor stages of an FM receiver (AUDIO, March 1967, p. 26). The equivalent noise resistance is, in effect, a fictitious resistor connected in series with the input of the r.f. amplifier. This equivalent resistance determines ultimate "noise figure" of the front end. In the case of a typical triode, the equivalent noise resistance (simplified from a more complex formula) boils down to $2.5/G_m$, where G_m is the transconductance of the tube. Thus, a triode having a G_m of 8,000 micromhos would have an "equivalent noise resistance" of approximately 310 ohms. The 2.5 figure comes about because a triode operates at a temperature which is about 2.5 times as high as room temperature, when both are expressed in absolute degrees (Kelvin Scale). In absolute degrees, room temperature is about 300°, whereas tube operation is at about 750° (K). The ratio of the two is, therefore, 2.5.

Since a transistor (and that includes an FET) operates at just about room temperature, the equivalent noise resistance becomes $1/G_m$, rather than $2.5/G_m$, so that an FET having a transconductance of 8000 micromhos would represent an equivalent noise resistance of only about 125 ohms, and the lower the equivalent noise resistance, the better the noise figure! Æ

Fig. 3—A modern r.f. amplifier design using an FET device. Note circuit's similarity to that of a "triode" amplifier's.

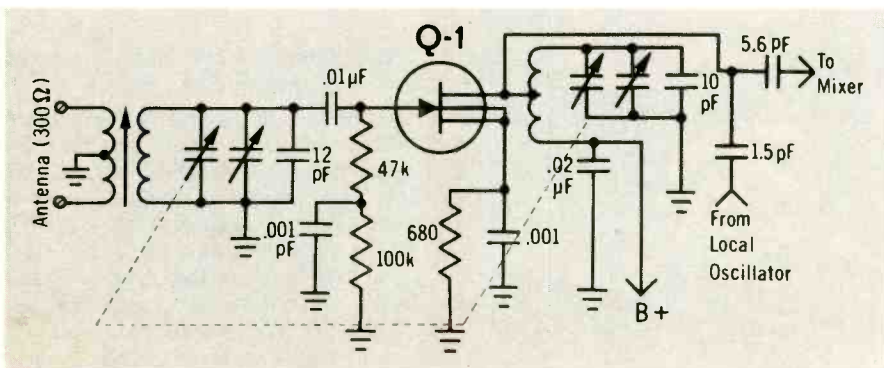

get the
**NEWS
FREE!**



**MAC
1700**

Solid State Stereo Receiver

The new McIntosh 36 page catalog gives you all the details on the new McIntosh solid state equipment. In addition, you'll receive absolutely free a complete up-to-date FM Station Directory.

SEND TODAY

McIntosh

McIntosh Audio Company
2 Chambers St. Dept. C 5
Binghamton, N. Y. 13903

Send **FREE CATALOG** and **DIRECTORY**

NAME _____

ADDRESS _____

CITY _____

STATE _____ ZIP _____

Check No. 53 on Reader Service Card

... REPRODUCTION
 WAS SCARCELY
 DISTINGUISHABLE
 FROM THE SOURCE. *



*Equipment Profile
 AUDIO, Jan. 1968



**The Hammond M-100
 Condenser Microphone**

- Nuvistor Preamplifier
- Variable Low-End Rolloff
- Transistorized Power Supply
- Cable Extensions to 200 Feet

The price of this sound idea:
Stereo Model: \$229.50
Mono Model: \$149.50
 with a unique extended warranty
 May we send you a brochure?

**THE
 MICROSOUND
 COMPANY**

Box 4591 L
 Colorado Springs, Colo. 80909
 Check No. 54 on Reader Service Card

EXOTIC SPEAKERS

(Continued from page 24)

trical field or magnetic field, the ion will be forced to move. Therefore, an audio signal applied to an electrode or a coil near a cloud of ions will vibrate the whole cloud back and forth—producing sound!

There are great difficulties, though, in getting a broad cloud of ions into the air: in most known schemes it takes extremely high voltages. The difficulties of ionic design are reduced by ionizing a tiny volume of air in a small cylinder. In early designs a strong radio-frequency current was applied to an electrode to heat it to a point where ions bubble off into the air. Adding audio signals to the ionizing current agitates air particles, causing compression and rarefaction of air to produce sound waves.

These expansions and contractions are fed out one end of the little cylinder into a horn. Without the horn, the sound waves coming out the end of the cylinder could not push much of the air in the room. The horn "couples" the cylinder to

the outside air with a high degree of efficiency.

This type speaker has been marketed as a tweeter only. The sound quality is said to be very pure. But there's a fly or two in the ointment. The need for a radio-frequency amplifier which is supplied with the speaker is disquieting, to say the least. Also, the quartz tube "wears out" and must be replaced after a time.

Also in the no-diaphragm category are "flame" loudspeakers (see "Audio ETC," AUDIO, May 1968). There are a few types—all in the experimental stage—that use a torch's flame. One problem here is that bass frequencies cannot be reproduced unless the flame is very large. Other problems for home use are obvious.

This sends us right back to the moving coil speaker for reasonable cost, complete variety of size and appearance, and trouble-free speaker systems, not to mention excellent performance. If you want to sacrifice some of these considerations to possibly improve the last one, however, an "exotic" speaker system is available to you. Æ

Authors Update Articles

Ref. "Protect Your Loudspeakers with Relays," AUDIO, May 1967.

I wish to correct the circuit drawing for the article I wrote that appeared in May. While the Motorola rectifier specified is a packaged unit and the diode configuration shown will confuse very few people, the rectifier has polarity markings which could cause experimenters with little experience to run into trouble. The rectifier polarities should be used as shown here.—

John R. Kissinger, Chicago, Ill.

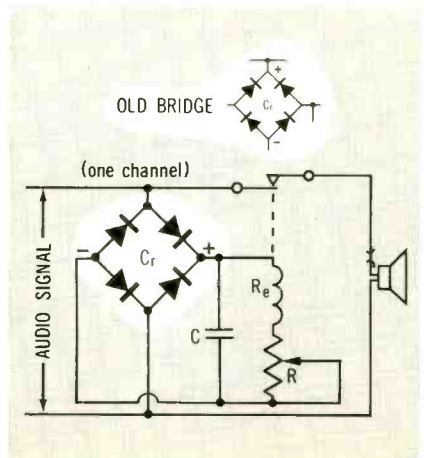

(Reader George E. Chamberlain, State College, Miss., observes that better protection for output transistors can be effected if the circuit was modified as follows: Using a normally-open relay instead of a normally-closed one, parallel the relay switch contacts across the speaker instead of placing it in series (as shown) so that the switch contacts are open during normal operation. Insert a high-wattage, low-value resistor (say, equivalent to the speaker's impedance) in series with the contact so that when the relay is activated, closing the circuit, the resistor acts as an additional load on the amplifier. Speaker volume would drop when the relay operates, warning the user that volume should be reduced or the amplifier should be shut off.)

Ref. "Convert Your Audio Analyzer to Stereo," AUDIO, Nov. 1967.

In the last paragraph of my article, a warning is given not to use the converted Heathkit analyzer with solid-state amplifiers in which speaker ground is not chassis ground.

This type of amplifier is gaining popularity because the speaker is included in a feedback loop, thereby tending to stabilize speaker impedance throughout its frequency range. A simplified output circuit of such an ampli-

AUDIO CLINIC

(Continued from page 4)

quencies, you will have to add a cathode or emitter follower to the set. Your choice of circuitry will depend upon the nature of the receiver. These circuits are shown in Figs. 2 and 3. In either case, the components can be secured to the chassis by small brackets which can easily be removed when needed. Power to operate this circuit is obtainable from the TV set's power supply at some suitable point. No other directions can be given about this because of the wide variety of television sets which are available, each having different circuit arrangements. First, try the set without adding the cathode or emitter follower. If you don't need it, don't build it.

2) Your preamplifier probably does not have sufficient power to drive several sets of headphones. Therefore, the only source having sufficient power to do so is your power amplifier. As you have indicated, because of the transistor circuitry involved, the use of this amplifier is restricted in terms of headphone junction boxes employing common ground techniques. Because such grounding makes the wiring in which you are interested considerably easier, I suggest that you arrange your ampli-

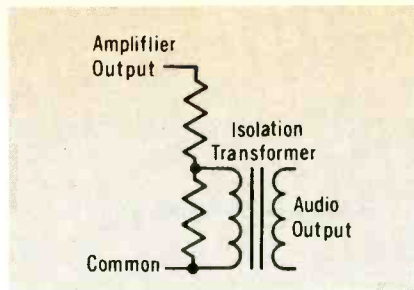

Fig. 4—Voltage divider and isolation transformer.

fier in such a way that this type of wiring still may be accomplished.

Because of this problem, you will need to isolate one amplifier channel from the other, and this is done by a one-to-one isolation transformer for each channel. The impedance of the transformer will be equal to that of the power amplifier. These transformers will not need to handle much power. It is possible to connect a voltage divider on each channel, with the primary of the isolation transformer connected to its mid-tap. This is shown in Fig. 4. The purpose of this divider network is to reduce the voltage which can be fed into the phones. This reduces background hiss. The likelihood of damage to the phones as a result of being over-driven is minimized. Further, there is less of

a chance that your own ears can be damaged by excessive sound levels.

Inside the headphone junction box, you will need a pad for each set of phones, a jack for each set of phones, and all necessary wiring. I hope that you can locate ganged "T" pads. Remember that your phones are stereo, so that one normal "T" pad will be satisfactory for one channel only. By a ganged pad, I refer to one which is actually two pads which are adjusted by a common shaft. Each pad controls the headphone fed from each channel. If you are unable to locate such pads, you may find it wise to improvise a mechanical arrangement whereby the shafts of two, separate "T" pads may be rotated simultaneously.

The inputs for all pads for a given channel are paralleled and their outputs are connected to the phone jacks in the manner indicated in the instructions found with each pad.

There is so much power available from an amplifier that we do not need to be concerned about impedance matching.

If you do not wish to construct your own headphone junction box, there are some commercially available units. I have not investigated to see whether or not they might contain all of the features that you wish to have. Æ

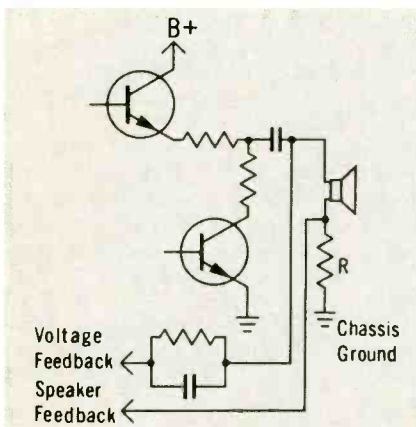

fier is shown here. Note that there are two feedback loops. Typically, R is a very small resistor—perhaps 0.15 ohms—so when a purely resistive test load is used, the speaker feedback loop contributes only about 1/4- to 1-dB feedback, compared to the 15 dB or more furnished by the voltage feedback loop.

This being the case, the grounds of analyzer inputs #1 and #2 may be connected directly to the amplifier chassis instead of the common terminal provided by the manufacturer. Of course, the speaker feedback loop is then inoperative, increasing both gain and distortion, but the changes are so slight as to be hardly measurable.—*William B. Fraser, San Francisco, Calif.*

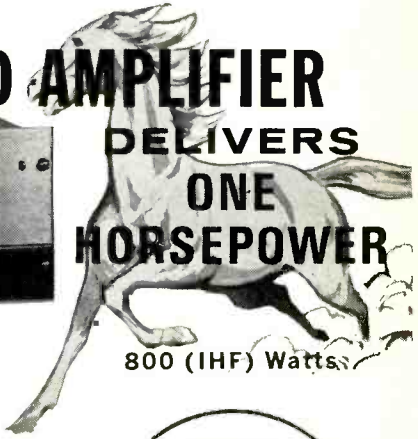

LAB STANDARD AMPLIFIER

DELIVERS
ONE
HORSEPOWER

800 (IHF) Watts

MODEL
DC 300
DUAL CHANNEL
ONLY
\$575

WRITE NOW
FOR FULL DETAILS TO
DEPT.



Box 1000, Elkhart, Indiana 46514

a special
report...



Switchcraft ends the mix- up over Sound Mixers

Confused as to what a sound mixer should do for your sound system? Or wondered why some mixers cost only a few dollars while others run into the hundreds?

Get all the facts from Report 307TR direct from Switchcraft's Research Dep't. Find out why you should have a pre-amp mixer... why equalization for magnetic phono cartridges is a must... the advantages of a stereo/monaural mixer, plus many other searching questions that will help you decide on the equipment that's best for your sound system.

The report is free. So is a look at Switchcraft's Studio Mix MASTER 4-channel, stereo/monaural sound mixer at your local dealer.



MIXER SPECIFICATIONS:

- * Portable, battery powered, with completely solid state circuitry.
- * Four channels, accepts 1 to 4 monaural inputs or up to 2 stereo inputs. Separate volume control per channel plus master volume control.
- * Two channels equalized for monaural or stereo magnetic phono cartridges. Auxiliary inputs for high level input signals.
- * Distortion 1% max. at 1.5 v. output. Frequency response 20Hz to 20KHz. Signal to noise ratio 60 db referred to 1 my. input. Up to 2 v. R.M.S. output.

GET AN INDEPENDENT PERFORMANCE REPORT ON SWITCHCRAFT'S MIX MASTER PUBLISHED BY AUDIO MAGAZINE. WE'LL GLADLY SEND IT ALONG WITH OUR REPORT 307TR.

SWITCHCRAFT
INC.

5585 N. ELSTON AVE.
CHICAGO, ILLINOIS 60630

Check No. 56 on Reader Service Card

CLASSIFIED

Rates: 25¢ per word per insertion for noncommercial advertisements; 50¢ per word for commercial advertisements. Frequency discounts as follows: 2 times, less 15%; 6 times, less 20%; 12 times, less 30%. Closing date is the FIRST of the second month preceding the date of issue.

SERVICES

12" LP's MADE from any half-hour tape —\$4.50—ARG, 341 Cooper Station, NYC 10003.

HIGH FIDELITY SPEAKERS REPAIRED
AMPRITE SPEAKER SERVICE
168 W. 23rd St., New York, N. Y. 10011
CH 3-4812

PROTECT YOUR LPS—Heavy poly sleeves for jackets 5¢, Round bottom for records 3 1/2¢ ea. New LP jackets, White 20¢, Colors 25¢. Min. order \$5.00. LP Supplies, Hillburn, P.O. New York.

CUSTOM RECORDING SERVICE—Tape or disc recordings made from live or recorded material. High quality. Reasonable rates. Audio-Tech Laboratories, 2819 Newkirk Avenue, Brooklyn, N. Y. IN 9-7134.

M. RETTINGER, Consultant on Acoustics. Analysis. Room Design. Noise Reduction. 5007 Haskell Ave., Encino, Calif. Tel: (213) 784-3985.

RENT STEREO TAPES—75¢ week. Catalog. Art's 1613 1/2 N. Mariposa Ave., Hollywood, Calif. 90027.

ELECTRONIC CROSSOVER Networks. Custom made. Paul Lambidakis, 7213 Cedar Ave., Takoma Park, Md. 20012, JU 7-7965.

CASH for used audio components—describe and price. Ask for free list—Marco Electronics, Box 336A, Winter Park, Fla. 32789.

FOR SALE

HARPSICHORD: Same as owned by Philadelphia Orchestra and RCA Victor. In kit form for home workshop assembly, \$150. Clavichord kit, \$100. Free brochure. Write: Zuckermann Harpsichords, Dept. R. 115 Christopher St., New York, N. Y. 10014.

RECORDS. 40 different new 45's, many recent hits. \$3.95 postpaid. Jack Armstrong, 52724 Francis Rd., So. Bend, Ind. 46637.

DISPOSAL—\$80,000.00 hi-fidelity retail store inventory. New/used equipment: Ampex, Marantz, Fisher, others. Hewlett Packard test equipment. Free list—Marco Electronics, Box 336A, Winter Park, Fla. 32789.

FOR SALE

MUSIC LOVERS, background music, continuous, uninterrupted, from your FM radio, using new inexpensive adaptor. Free literature. R. Clifton, 11500-E N.W. 7th Ave., Miami, Florida 33168.

DISC RECORDING EQUIPMENT: Cutterheads, Recording Amplifiers, and Lathes. New and used. From Rek-O-Kut to Scully. Send requirements. Wiegand Audio Labs, 221 Carton, Neptune, N. J. 07753.

SCULLY Professional Tape Recorders, from 1 to 12 tracks, complete recording studios available in prewired console cabinets starting at \$8,000.00. 70% financing. WIEGAND AUDIO LABORATORIES, 221 Carton, Neptune, N. J. 07753.

FREE! Send for money saving stereo catalog AM and lowest quotations on your individual component, tape recorder, or system requirements. Electronic Values, Inc., 200 West 20th St., New York, N. Y. 10011.

JAPANESE PRODUCTS CATALOG by air mail \$5, sea \$3. Intercontinental, CPO 1717, Tokyo, Japan.

MAGNECORD 1024, 1/4 track, 3 3/4 and 7 1/2 in./sec. Tape Deck. New Sept. '67. Excellent Condition. 36 8 1/4 reels in boxes. Best offer. Steve Shepard, Box 4302, State College, Miss. 39762. Phone 601-323-2756.

AMPEX AG-350-2 Stereo Recorders. Both unmounted. Like New condition. One machine has standard track heads, \$1,550.00. Second machine has additional quarter-track playback, \$1,600.00. J. M. Edelman, M.D., 4550 North Boulevard, Baton Rouge, Louisiana, Phone 504-927-3553.

AUDIO: July 1950 thru August 1960 and No. 1 Anthology, \$75 complete. If not sold after 30 days, will divide at \$10/year; priority based on size of purchase. Russell Spielman, 7031 Foster, Morton Grove, Ill. 60053.

FREE CATALOGS Broadcasts, Sound Tracks of Thirties. ARG, 341 Cooper Station, New York City 10003.

TAPE RECORDING MAGAZINE—Enthusiasts monthly magazine for amateurs and professionals. Send \$3.75 for 1 year subscription to 14-18 Holborn, London, E. C. 1, England.

FOR SALE

AMPEX PR10-2 stereo recorders (2) in complete custom recording system. Altec compressor, McIntosh amps., Ampex mixers, Grampian/Gotham cutting system, mikes, earphones & E.V. & EMI speaker systems. Complete flexibility. **MUST SELL**. J. Bernard, 189 Main St., Hempstead, L. I., N. Y. 11550.

ARTISAN ORGAN. 2-Manual, 32 Pedal, 40 Stops, Perf. cond. \$3750 complete with bells and sound system. Robert Eby, Box 1731, Newport Beach, Calif. 92663.

CHET ATKINS: Read the fascinating story of "Mr. Guitar." Rush Today! \$2.98 ppd. Stephenson, 3600 Hillsboro—C5, Nashville, Tennessee, 37215.

MARANTZ 7T & 15. Both near new. \$575. Capt. Robert W. Wempe, 14-13 Englewood Drive., Bellevue, Neb. 68005.

TAPE RECORDER SALE. Brand new nationally advertised brands, \$10 above cost. Amazing discounts on stereo components. Arkay Electronics, 1028-H Commonwealth Avenue, Boston, Mass. 02215.

MAGNACORD P75 Recorder, Mono, Half Track, 7 1/2 ips & 15 ips, \$295.00. Audio Associates, 4802 Camp Bowie, Fort Worth, Texas 76107.

ORTOFON Cartridges SPU/T, SPET/. Never Unpacked. One each only. (Will take \$45 for Both.) 1—only GRADO LAB ARM, like new, very little use. \$7. 1—only MODEL 275 McINTOSH Amplifier, like new, \$300. J. A. D., 3635 Parkway Blvd., Allentown, Pa.

KLIPSCH CORNWALL or Heresy. Marantz 7T & 15. Jamszen 350 woofers. Sony electronic cover. Tom Groom, 324 North Spring, Murfreesboro, Tenn.

AMPEX PR10-2 RECORDERS (2) in complete two track recording system built by Grumman Engineers. McIntosh, Altec Compressors, Custom switching panel, etc. Sold **only** as complete system. J. Bernard, 189 Main St., Hempstead, N. Y. 11550.

KLIPSCHORN, Tannoy, Altec, Rectilinear AR, Inc., Wharfedale, Dynaco, Sherwood, Kenwood, Teac, Uher, Garrard, Benjamin, Superior Sound, 621 S. Main St., N. Syracuse, N. Y. 13212.

AUDIO: 52-66, \$10/year. Box AJ8-1.

ACOUSTIC RESEARCH, Dynaco, Koss, Shure specialists; free listing. Stereo Component Systems, 95 Vassar St., Cambridge, Mass. 02134.

COMPLETE AUDIO, HIGH FIDELITY, HI-FI/STEREO, TAPE RECORDING or will contribute for T/L. Box AL8-1 AUDIO.

SCOTCH RECORDING TAPE, lowest prices. Tape Center, Box 4305, Washington, D. C. 20012.

EQUIPMENT WANTED

MAGNACORD P-75 record or play head mount needed. Please state mounting method. Reply to: Richard McCleary, 4534 Blount Ave., Jacksonville, Florida 32210.

MARANTZ Model 9 amplifiers. G. R. Bowen, 5496 Hugh Howell Rd., Stone Mountain, Ga. 30083.

REBEL IV Speaker cabinet by Cabinart. F. W. Scholl, Box 193, Lancaster, Ohio 43130.

KLIPSCH selected SAHF, \$16; Ampex 601, \$190; RCA 44BX mike, \$39; Marantz pre-amp 7, \$110; Scott 121 preamp (mono), \$65. Tom Groom, 324 N. Spring, Murfreesboro, Tenn.

HELP WANTED

EXPERIENCED HI-FI, HAM, CB salesmen wanted. J. S. Draper, Lafayette Radio Electronics, All Cape Shoppers Bazaar, Rt. 132, Hyannis, Mass. 02601.

BUSINESS OPPORTUNITIES

MANUFACTURER sought for patented, revolutionary tone-arm design. Box AL8-2.

THE BIG ONE IS COMING!

AUDIO's 1968-69 Annual August Equipment Directory

A most important issue for you because:

- You'll get the inside story on the new stereo models
- It's arranged for easy comparisons of specifications
- It's an authoritative year-long buying guide

**LOOK FOR THE BIG ONE—
AUDIO'S AUGUST ISSUE**
(includes regular features & departments)

Bogen's new RX200 120-watt FM/AM receiver.

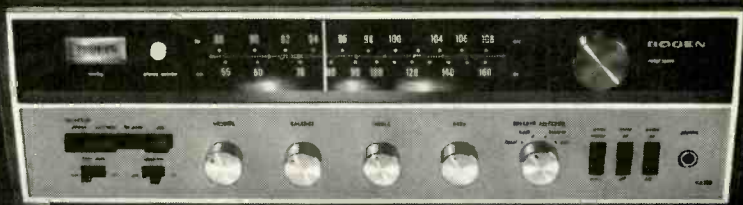

You buy a receiver for its sound. Which is why, at every stage in the RX200 receiver's design, we listened to it. Through speakers of every size, shape, price and quality. In our factory and in our homes. Until we were absolutely happy with its sound. Because its distortion is low: only 0.8% at full 120 watt output, only 0.2% at 110 watts or less. And its sound is clean and crisp at every frequency from 10 to 35,000 Hz. We're equally proud of its performance as a tuner. Our FET front end gives the RX200 excellent sensitivity (2.0 microvolts on FM, 75 microvolts per meter on AM), yet still has 80 db of cross-modula-

**WE
DESIGNED
IT BY
EAR**

tion rejection. Naturally, we've used Bogen's all-silicon modular design, and included push-button function selection and inter-station muting. And when our chief engineer took the RX200 home for a final listening test, his wife was happy, too. "I like it," she said. "But I haven't plugged it in yet," he answered. "I know. But it's so beautiful."

The RX200 AM/FM stereo receiver. 120 watts. Only \$369.95. At your Bogen dealer. Dept. 15-3-7

LEAR SIEGLER, INC. **BOGEN**
BOGEN COMMUNICATIONS DIVISION
PARAMUS, NEW JERSEY 07652

Check No. 57 on Reader Service Card

**HOW
A KLIPSCHORN®
REVEALS THE
TRUTH—
THE WHOLE
TRUTH—
NOTHING BUT
THE TRUTH.**

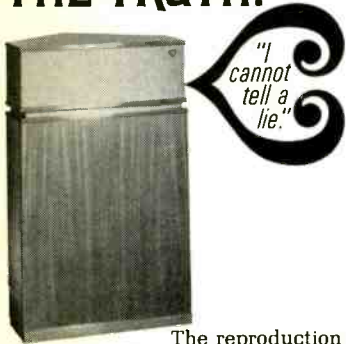

The reproduction of true sound is the sole purpose of a Klipschorn loudspeaker. You'll like the sounds you hear from a Klipschorn only if you like the sounds that were recorded. It has no sound of its own. If you're looking for exaggerated bass, sensational treble, or dramatic "hi-fi" effects, don't depend on your sound reproducing system, tell the recording artists. Strictly speaking, there is no such thing as "high fidelity" only "fidelity" or "infidelity". Our speakers are designed and built for but one purpose—fidelity. They're built in Hope, Arkansas, under the personal supervision of Paul W. Klipsch by a small group of dedicated craftsmen. They're sold by dealers who are concerned that you get a system with fidelity.

KLIPSCH & ASSOCIATES

**BOX 280 A-7
HOPE, ARKANSAS 71801**

Please send me the whole truth about the KLIPSCHORN loudspeaker system. Also include the name of my nearest Klipsch authorized audio expert.

Name.....
 Address.....
 City.....
 State..... Zip.....
 Occupation..... Age.....

Enclosed is \$3.50 for a complete set of 17 technical papers on sound reproduction and stereo.

Check No. 58 on Reader Service Card

**ADVERTISING
INDEX**

| | |
|--------------------------------------|-------------|
| Acoustic Research, Inc. | 17 |
| Altec Lansing | 27 |
| Benjamin Electronic Sound Corp. | 51 |
| Bogen Communications | 57 |
| British Industries Corp. | 3 |
| BSR (USA) Ltd. | 12 |
| Crown International | 53 |
| Dolby Laboratories | 49 |
| Dynaco, Inc. | 11 |
| Electro-Voice, Inc. | Cover IV, 1 |
| Elpa Marketing Industries | 51 |
| Garrard Sales Company | 3 |
| Gotham Audio Corporation | 45 |
| Hi-Fidelity Center | 58 |
| Klipsch & Associates..... | 58 |
| 3M Company | 13 |
| Marantz Company | 25 |
| Microsound Company | 54 |
| Multicore Sales Company | 58 |
| McIntosh Laboratory, Inc. | 55 |
| Pickering & Company, Inc. | 19 |
| Pioneer Electronic U.S.A. Corp. | Cover III |
| Radio Corporation of America | 4 |
| Sansui Electronics Corp. | 33 |
| Scott, H. H., Inc. | Cover II |
| Sherwood Electronic Labs, Inc. | 20 |
| Shure Brothers, Inc. | 9, 37 |
| Sony Corporation of America | 5 |
| Sony/Superscope | 15, 41 |
| Stanton Magnetics | 31 |
| Switchcraft, Inc. | 56 |
| TEAC Corporation | 7 |
| University Sound | 29 |

**WORLD'S
FINEST
5-CORE
SOLDER**



**ERSIN
MULTICORE**

**NEW EASY
DISPENSER
PAK ONLY 69¢**

BUY IT AT RADIO-TV PARTS STORES
 Check No. 48 on Reader Service Card

*We Own The
Sharpest Pencils
In Town!*



**YOU SAVE MORE
ON HI-FI
COMPONENTS & TAPE RECORDERS**

- We invite your test of our "We Will Not Be Undersold Policy."
- 15-day money-back guarantee.
- 2-yr. unconditional guarantee parts & labor no charge, at local warranty station or factory.
- We accept Diner's Club charges.
- Trade-ins—highest allow. Send your list..
- Most items shipped promptly from our 250,000 inventory, fully insured.
- Our specialty—APO & Export.
- 23rd yr. dependable service—world wide.

Rated #1 service—satisfaction according to nationwide survey.

Write for Our Price First!
You'll Be Glad You Did!

**HI-FIDELITY
CENTER**
 "The House of Low Low Prices"
 239-V East 149th St.
 New York, N.Y. 10451

Check No. 52 on Reader Service Card