

# AUDIO

FEBRUARY / 1966

60¢

...the original magazine about high fidelity!

In the year 1887, the idea occurred to me that it was possible to devise

an instrument which should do for the eye what the phonograph does for the ear, and that by a combination of the two all motion and sound could be recorded and reproduced simultaneously. This

idea, the germ of which came from the little toy called the Zoetrope, and the work of Muybridge, Marec, and others has

now been accomplished, so that every change of facial expression can be recorded and reproduced life size. The Kinetoscope is

only a small model illustrating the present stage of progress but with each succeeding month new possibilities are brought into view. I believe that in coming years by my

own work and that of Dickson, Muybridge, Marec, and others who will doubtless enter the field, that grand

opera can be given at the Metropolitan Opera House at New York without any material change from the original,

and with artists and musicians long since dead.

The following article which gives an able and reliable account of the invention has my entire endorsement.

The authors are peculiarly well qualified for their task from a literary standpoint and the

opportunities which Mr. Dickson has had in

of his work

Thomas A. Edison

AL BROWDY  
1962 SO STEARNS DRIVE  
LOS ANGELES 34 CALIF  
SEPT 64 3C-11

# Amazing tower test proves superiority of Scott FET design!

New 342 receiver has greater sensitivity, better selectivity, less drift, and exceptional freedom from cross modulation.

The toughest place to test a solid-state FM tuner is *right at* a strong transmitter site. Being this close to the overpowering signal of the station causes ordinary tuners to "cross modulate." Powerful stations will appear at many points on the dial, obliterating other FM signals listeners want to receive.

To prove the superior cross modulation rejection of Scott's new Field Effect circuitry, the 342 FM Stereo Receiver was tested *right at* Boston's WHDH-FM transmitter tower. Here the radiated energy from the multi-kilowatt transmitter is at maximum level, and any susceptibility of a receiver to cross modulation would be drastically evident. Not only did the Scott 342 reject cross modulation exceptionally well, but, equipped only with the normal FM dipole antenna supplied with the unit, the 342 picked up 37 stations loud and clear in spite of impossible reception conditions. Until development of Field-Effect circuitry by Scott engineers, it was impossible for an all-solid-state FM receiver to provide the listener with *both* high sensitivity *and* freedom from annoying cross modulation. This test strikingly demonstrates achievement of *both* desired results. Cross modulation rejection is at least 20 db better than conventional designs . . . and there is *no* sacrifice of sensitivity.

## Outstanding Specifications of New 342

Controls include tape monitor, speaker switching, stereo balance, bass, treble, and volume, automatic stereo switching, and front panel stereo headphone output. Specifications: Usable sensitivity, 2.5  $\mu$ v; Frequency Response, 18-25,000 cps  $\pm$ 1 db; Cross Modulation Rejection 85 db; Music Power Rating (4 ohm output), 32.5 watts per channel; Stereo Separation, 35 db; Capture Ratio, 6.0 db, price \$299.95



ANOTHER FIRST FROM SCOTT  
FIELD-EFFECT TRANSISTOR CIRCUITRY

Write for Scott's informative new booklet on field-effect transistors.

Scott... where innovation is a tradition

**SCOTT®**

H. H. Scott, Inc., Dept. 35-02, 111 Powdermill Road, Maynard, Massachusetts  
Export: Scott International, Maynard, Mass. Prices and specifications subject to change without notice. Prices slightly higher west of Rockies.

Circle 100 on Reader Service Card

# AUDIO

February, 1966 Vol. 50, No. 2

Successor to **RADIO**, Est. 1917

LARRY ZIDE  
Associate Editor

HAROLD D. WEILER  
Roving Editor

JANET M. DURGIN  
Production Manager

Contributing Editors  
EDWARD TATNALL CANBY  
JOSEPH GIOVANELLI  
HAROLD LAWRENCE  
CHESTER SANTON  
HERMAN BURSTEIN  
BERTRAM STANLEIGH

## AUDIO Articles

Herman Burstein

Account of the Invention

George S. Lehsten

Norman H. Crowhurst  
C. G. McProud

## AUDIO Reviews

Chester Santon  
Edward Tatnall Canby  
Bertram Stanleigh

## AUDIO Profiles

Model IG-112  
G-36  
220MS Holton Sr.

## AUDIO in General

Joseph Giovanelli  
Harold Lawrence  
Edward Tatnall Canby  
Harold D. Weiler  
Herman Burstein

C. G. McPROUD  
Editor and Publisher

SANFORD L. CAHN  
Advertising Director

EDGAR E. NEWMAN  
Circulation Director

### Representatives

Bill Patis & Associates,  
4761 West Touhy Ave.,  
Lincolnwood, Ill. 60466

James C. Galloway,  
9220 Sunset Blvd.,  
Los Angeles, Calif. 90069

Warren Birkenhead, Inc.,  
No. 25, 2-chome, Shiba Hama-  
matsu-cho,  
Minato-ku, Tokyo, Japan

Test Instruments and the Audio Buff	23
Audio Test Equipment Compendium	27
Edison's Invention of the Kineto-Phonograph	32
Evaluation of Artificial Reverberation to Conventional Sound Installations	44
Audio Measurements Course—In Five Parts, Part 2	54
Test Tape for Checking Head Position	46

Light Listening	8
Record Revue	16
Jazz and All That	72

Heathkit FM Stereo Generator	48
Revox Tape Recorder	50
Hartlev Speaker System	52

Audioclinic	2
Letters	6
About Music	10
Audio ETC	12
Editor's Review	20
Sound & Sight	39
Tape Guide	42
New Products	66
New Literature	74
Industry Notes	78
Advertising Index	80

AUDIO (title registered U. S. Pat. Off.) is published monthly by Radio Magazines, Inc., C. G. McProud, President; Henry A. Schober, Secretary. Executive and Editorial Offices, 204 Front St., Mineola, N. Y. Subscription rates—U. S., Possessions, Canada, and Mexico, \$5.00 for one year, \$9.00 for two years; all other countries \$9.00 per year. Single copies 60c. Printed in U.S.A. at The Orchard Press, Inc., Garden City, N. Y. All rights reserved. Entire contents copyrighted 1966 by Radio Magazines, Inc. Second Class postage paid at Mineola, N. Y. and additional mailing offices.

RADIO MAGAZINES, INC., P.O. Box 629, MINEOLA, N.Y., 11501  
Postmaster: Send Form 3579 to AUDIO, P.O. Box 629, Mineola, N.Y., 11501

Number 30 in a series of discussions  
by Electro-Voice engineers



## TIPS ON TIPPING

RONALD HAHN  
Cartridge Engineer

There is no room in today's small, light, stereo ceramic cartridges for sloppy tolerances or poor assembly. And as the design trend continues toward even smaller models, the need for improved uniformity and tighter tolerances increases.

Of course, entirely new designs often will give the desired improvements in performance and uniformity. More often, however, the greatest progress can be seen in improvements of existing products by the application of new techniques and methods.

Such is the case with a popular 2-element plug-in stereo cartridge now being produced by Electro-Voice. Even with the highest standards of manufacture and assembly, it became clear that improvements were necessary to optimize performance and reduce rejects. A study revealed that the primary problem centered about the proper orientation of the two ceramic elements with respect to the needle cap and the cartridge shell.

The original design called for a plastic molded needle cap, to be cemented to the elements using conventional cartridge assembly techniques. Despite great care in assembly, however, the desired level of uniformity could not be satisfactorily maintained in production. Another approach was needed.

At this point, a new assembly technique was developed. The two ceramic elements are introduced directly into the cavity of the mold used to produce the plastic needle cap. Location of the elements is precise, and the additive effect of cumulative tolerances needed for cementing the separate parts is eliminated. An excellent bond between the elements and the needle cap is achieved, using normal thermoplastic materials in standard plastics molding equipment.

The mold itself is unique only in that it includes a removable holder for the elements, precisely machined to locate two close-tolerance ceramic elements so that the tips of the elements extend a specific distance into the mold cavity, and at a specified angular relationship.

The benefits of this new technique have been dramatic. Rejects have dropped to 1/3 their former level, and a larger percentage of completed cartridges fall close to the design center when tested for both mechanical and electrical specifications. Improvements have been noted in more uniform lateral tip location, reduced tip lean, and more uniform needle set-down on turnover models. The improved angular orientation and more uniform parallelism of the elements has increased isolation of stereo signals, lowered distortion, and lessened differences in channel level. The net result has been a significant improvement in performance for the consumer without an increase in the cost of production.

For technical data on any E-V product, write:  
ELECTRO-VOICE, INC., Dept. 263A  
602 Cecil St., Buchanan, Michigan 49107

**ElectroVoice**<sup>®</sup>

SETTING NEW STANDARDS IN SOUND

Circle 104 on Reader Service Card

# COMING

## Articles

**A Solid-State Flutter Meter**, by Arthur Gladfelter. A home-construction project resulting in an instrument useful to all tape recording enthusiasts, and resulting in measurements in three frequency bands. In Two Parts — Part 1 in March.

**Warning for Wives in Stereophonic Sound**, by Carolyn Howard Johnson. Amusingly written by a typical Hi-Fi Widow.

**High Input Resistance with Stability** by L. D. Smithey. The theory behind methods employed to get a desired result. Plus all of the regular features and a section on the U.S. Department of Commerce Hi-Fi Show in London.

## Profiles

ADC Six Hundred Receiver

Uher 9000 Tape Recorder

Grado Type "B" Cartridge

Heathkit AR-14 Receiver Kit

In the March Issue

On the newsstands, at your favorite audio dealer's, or in your own mailbox.

# AUDIO CLINIC

Joseph Giovanelli



Send questions to:

Joseph Giovanelli  
2819 Newkirk Ave.  
Brooklyn, N. Y.

Include stamped, self-addressed envelope.

### Unbalance in a Stereo System

*Q. I have a problem with my equipment which apparently defies logic and which may soon deprive me of mine. I hope that you can offer some help.*

*I have a complete music system (stereo) consisting of two monophonic preamps, a stereo adaptor and two power amplifiers. The two preamps are operated from a common power supply.*

*I recently had the preamps and the power supply serviced and subsequently discovered that the left channel had decidedly weaker output. By a process of substitution, I determined that the problem lay in the left-channel preamp, which I returned for re-servicing. The service agency checked it out, told me it was fine and met factory specs. But when I got home, the same problem existed. The output was so low that I had to turn the volume up to achieve a normal listening level.*

*Again I brought the preamp back to the repair shop. They very kindly connected them up to another amplifier, phonograph, and speaker system. They worked fine, and had all the output I'd ever want. But again, on my return home, the output was as low as before.*

*Thinking it might be caused by a problem in the power supply, I switched the connections between the preamps and power supply several times, without any change in performance of one preamp over the other. The left channel always remained as weak in output as has been described above.*

*If this, per se, were the only problem, I would not mind. I could simply set the two preamp gain controls at different settings, so that the output from each would be the same. However, the fact that I have to turn the volume up to maximum means that a great deal of hum and hiss appear this level. Can you think of any possible reasons for this problem? Max Prola, Jackson Heights, New York.*

A. I really cannot give you a complete answer to this problem until I have more information.

First of all, I wonder if the trouble is really in the preamps. Maybe it is in the power amplifier feeding the left speaker.

To prove this, reverse the leads feeding the two power amplifiers. If the trouble is the preamp, the right channel will not have as much output as the left channel, the reverse of the condition of which you are now writing. If the condition does not change, that is to say, the left channel is still lower in output than the right channel, the trouble would appear to be in the left channel power amplifier or its associated leads.

If the condition does not change, perhaps the trouble is in the preamp after all. Does this trouble occur on all input sources or just in the phono position?

Maybe your cartridge is to blame. You can determine this by the same procedure, reversing the leads from the phonograph to see whether the cartridge's two channels are indeed equal in output.

### Follow-Up

*Q. Before writing to you the first time, I checked out the possibility of the source of the unequal outputs as being in other components. However, since then, by careful checking over a period of time, I have come to the following conclusions.*

*You may recall that the preamps functioned normally at the repair shop, but not at home. I have since discovered that at times, the output from this preamp is extremely low. It is comfortably audible at full output on the volume control. At other times it is louder, so that it becomes possible to balance the two channels by means of the balance control on the adaptor.*

*From this, I concluded that there is reduced output in one channel and that the degree of reduced output can vary from one extreme which required maximum gain to achieve normal listening levels, to another, though still lower than the other channel, is within tolerable limits. The problem is, therefore, an intermittent one.*

*I checked the role of inputs and the reduced output was evident on both phonograph and tuner.*

*I then decided to investigate the possibility that the volume control in the pre-amplifier might be at fault. I hooked up the stereo control with the preamp so that the tape output of the preamp was fed to the stereo control and then to the amplifier. In this way, the volume control and the tone controls of the preamps were rendered inoperative: the signal from tuner or cartridge bypassed these controls.*

*With the equipment hooked up this way, I find that the volume in the problem preamp was still lower, but it is at a level which can be matched with the other preamp; it never gets as low as it did previously. It would seem, then, that the*

*This is the Lab 80. Add up the galaxy of innovations which Garrard has developed and engineered into it...including built-in cueing... variable anti-skating compensation...ultra-sensitive magnetic tripping... and you will begin to visualize why this superbly performing automatic has revolutionized the turntable industry.*

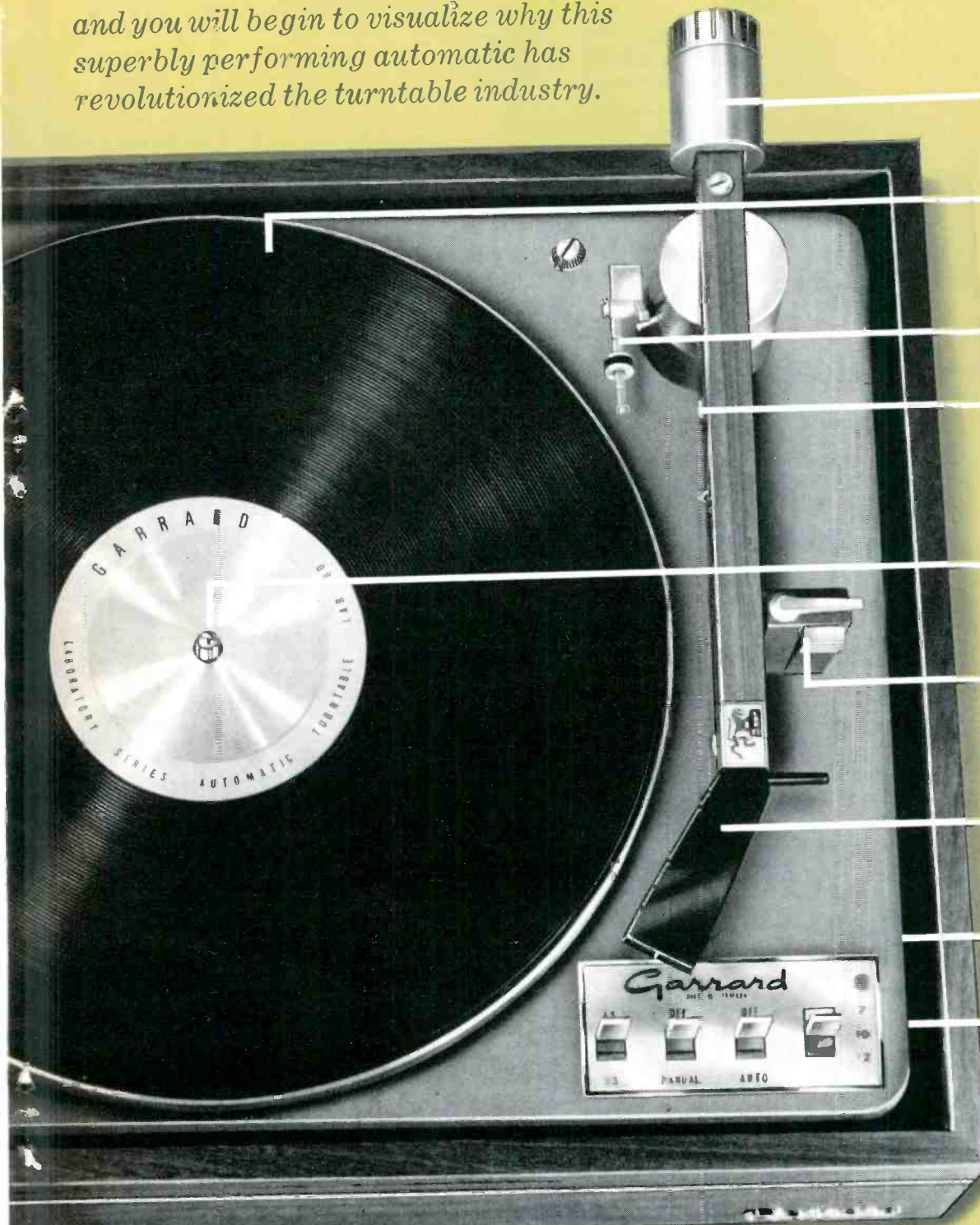

Dynamically balanced, counterweight-adjusted tone arm, built of Afrormosia wood for light weight, low resonance.

Full 12" anti-magnetic turntable—heavy and dynamically balanced for perfect speed. Anti-static mat.

Anti-skating control—with patented foolproof sliding weight design—does not use springs. The natural side pressure on the stylus which frequently causes distortion and rapid record wear is eliminated.

Calibrated stylus pressure gauge with precision 1/4 gram click adjustments for accurate audible/visible settings.

Two spindles—one for manual play, the other for automatic operation. Convenient short spindle interchanges with revolutionary center drop spindle, which handles 8 records fully automatically when desired. Exclusive... spindles remove for safety and convenience when taking records off the turntable.

Built-in cueing control eliminates all danger of accidental damage to records or stylus through manual handling. A great operating feature and a tremendous convenience which permits selecting any band of the record with complete safety.

Low mass cut-away shell—with extended finger lift—compatible with the most advanced cartridge designs.

Exclusive super-sensitive magnetic trip, with Dupont Delrin® to offset friction... performs perfectly with highest compliance pickups at correct minimal tracking force.

Silent Laboratory Series® 4-pole shaded motor with vibration-proof total isolation suspension.

Important reading: 32-page Comparator Guide detailing all Garrard models. Write for complimentary copy to Garrard, Dept. GB-16, Westbury, New York 11591.

*Only Garrard could have created the Lab 80. Only Garrard could have produced it to sell for \$99.50. This results from more than 50 years of leadership, supported by the great advantages of substantial international volume, vast manufacturing facilities, and truly exceptional engineering resources.*

CIRCLE NO. 103 ON READER SERVICE CARD

**Garrard**<sup>®</sup>  
WORLD'S FINEST

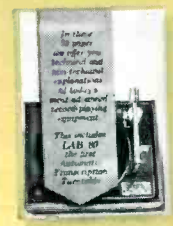

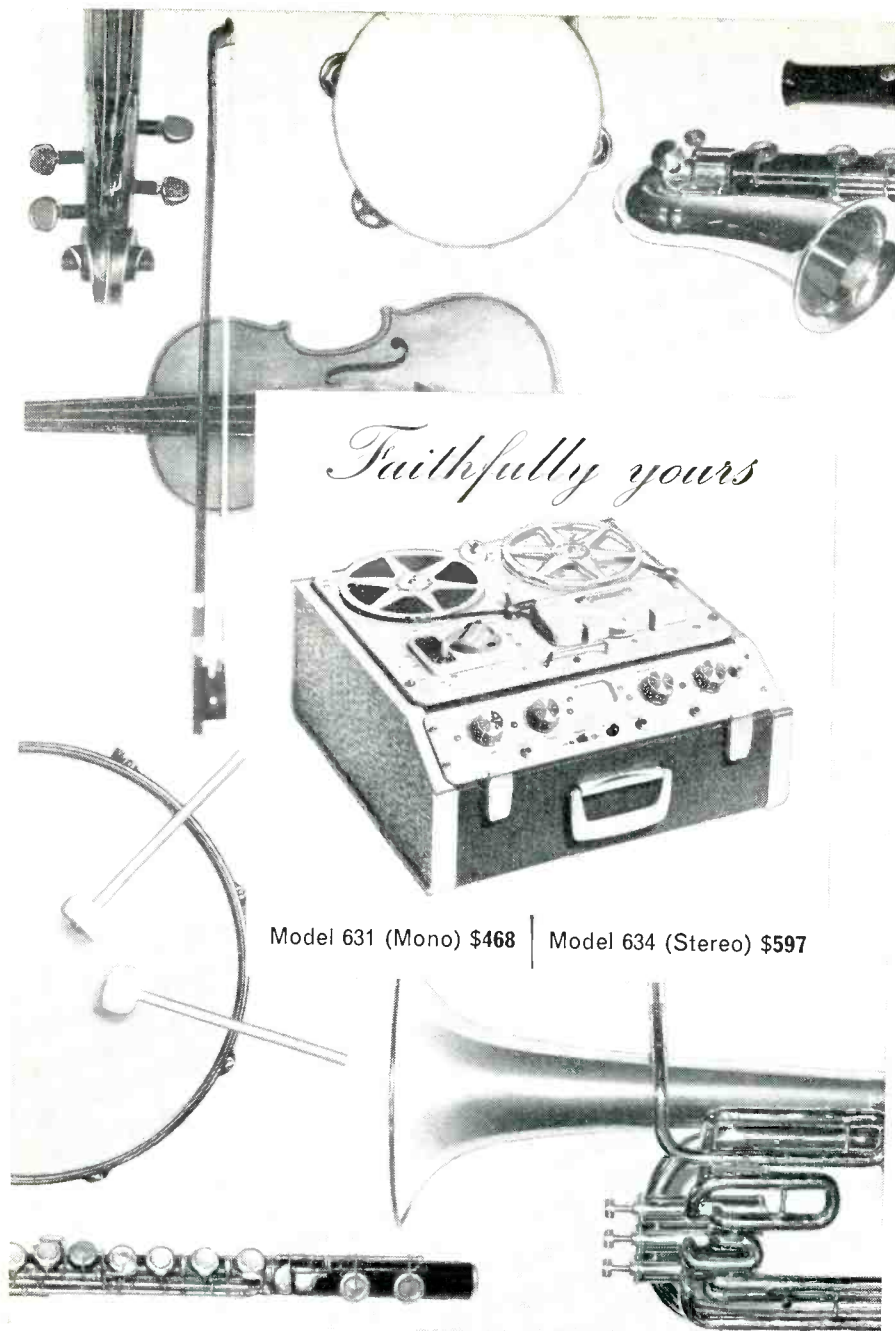

*Faithfully yours*

Model 631 (Mono) \$468 | Model 634 (Stereo) \$597

If you want chromium trim, light weight, eye-catching colours and built-in obsolescence—if you read exciting specifications and pretend they are true—if you acquire a recorder solely to keep up with the Joneses—the Ferroglyph is not for you.

Ferroglyph tape recorders are built in a tradition of engineering that believes the weight of the instrument, within reason, to be of small moment—that you cannot have quality without amply designed components—that there is no easy way to achieve quality.

The Ferroglyph is designed for the man who wants a tape recorder to perform as well some years hence as it does when first delivered to him. He is concerned with the pleasure—the enduring pleasure—a quality instrument adequately designed and well engineered will give him. He is a discerning character who is able to appreciate quality when he hears it, recognize engineering skill when he sees it—in a word, he is a connoisseur.

*The Manual of the Ferroglyph, a sixty-four page illustrated volume, bound in cloth, and containing full operational and technical data, is supplied to every Ferroglyph owner. You can obtain this manual in advance however by sending \$3 with the coupon below to us in London. (Indicate Stereo or Mono).*

Please send me a copy of the Ferroglyph leaflet.

Please send me a copy of the "Manual of the Ferroglyph" for which I enclose \$3.  Stereo or Mono

NAME .....

ADDRESS .....

**The Enduring *Ferroglyph***

THE FERROGRAPH CO. LTD. 84, Blackfriars Road, London, S.E.1. England

Circle 105 on Reader Service Card

*fault is an intermittent problem with the volume control of the preamp.*

*Does this sound sensible?*

*How can I correct it? Max Prola, Jackson Heights, New York*

A. When you checked your preamp to see if the volume control might be at fault, you were on the track in terms of the method by which the checks were made. However, what you were checking was not the volume control alone, but also the remainder of the preamp's circuitry following the selector switch. The trouble in your preamp lies anywhere from the input of the volume control onward.

You also indicated that you observed some difference in level between the two preamps at the tape output. If a tuner were connected to the inputs of both preamps and fed to the tape-output terminals, there would be no loss of level because there is no circuitry there except the selector switch—at least that is true for the majority of preamps. If you did not make your check in that way, you really do not know as yet just why the output from your two tape outputs differ from one another.

If you used a recording, you can find several factors coming into play there. First of all, the cartridge may not have equal output from one channel to the other. This is a common occurrence. Secondly, the phono stages in the preamp may have differing amounts of gain. Only a test signal from an oscillator can be used to determine this.

In fact, the oscillator is the best method for feeding signals into a circuit when checking balance. Feed the oscillator into both inputs at once and then trace through the preamps with a VTVM till you find the place or places where one preamp has less gain than the other. You then can check that particular stage for other troubles.

Mistracking of the gain control in your stereo adaptor can result in an apparent unbalance between channels. To check this, feed a signal simultaneously into the two inputs of the stereo adaptor. Measure the voltage at the output of each channel with various settings of the volume control. If the pot is tracking properly, the two channels will be within a dB of each other at all settings of the pot.

If the stereo adaptor shows channel unbalance even with the pots open, then you should check into the remainder of the circuitry of the unit. Perhaps there is a dirty switch or oxidation in a connector somewhere in the adaptor or anywhere in your preamp chain for that matter.

Check all audio cables for partial shorts or opens.

Check to see if the two power amplifiers have equal gain by feeding equal signal into both and measuring their respective output voltages. They should be very nearly the same. (When making this check, be sure to have a load across the speaker terminals of the amplifiers and to disconnect the speakers.  $\text{\AA}$ )

## RECENT PROFESSIONAL INSTALLATIONS OF AR SPEAKERS

### AR-2<sup>x</sup>

(\$89-\$102, depending on finish)

Aeolian-Skinner reverberation system corrects excessively dead acoustics in the chapel of Choate School, Wallingford, Connecticut. Duncan Phyfe, musical director of the school, describes the effect on live pipe organ and chorus as "so natural one is not aware of an electronic reverberation system."

Similar Aeolian-Skinner installations are operating in Christ Church, Cambridge, Massachusetts, and in St. John's Episcopal Church, Washington, D.C. AR speakers were chosen because of their lack of coloration, their undistorted, full-range bass, and their reliability.



### AR-2ax

(\$109-\$128)

Sound reinforcement system for the summer jazz concerts in the sculpture garden of New York's Museum of Modern Art. Live music had to be amplified without giving the sound an unnatural, "electronic" quality; AR speakers were chosen after testing many brands.



©1965, LINCOLN CENTER FOR THE PERFORMING ARTS

### AR-3

(\$203-\$225)

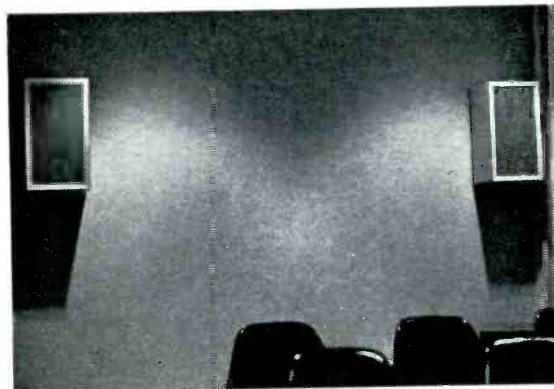

One of the listening rooms in the Library & Museum of the Performing Arts at Lincoln Center in New York City. AR-3's were chosen for these rooms to achieve an absolute minimum of artificial coloration.

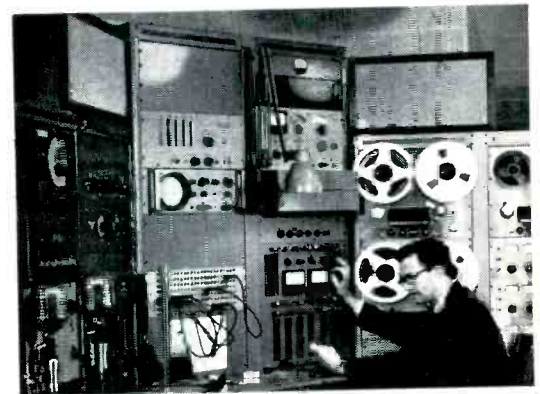

Experimental Music Studio of the University of Illinois. Dr. Hiller (seated) writes about the AR-3's, used as monitor speakers: "I wish all our equipment were as trouble free."

AR speakers and turntables are often used professionally, but they are primarily designed for natural reproduction of music in the home. Literature is available for the asking.

**ACOUSTIC RESEARCH, INC.,**

**24 Thorndike Street,  
Circle 106 on Reader Service Card**

**Cambridge, Massachusetts 02141**

# SOUNDMEN GET SOUND ANSWERS FROM FAIRCHILD!



## NEW! FAIRCHILD COMPATILIZER

An automatic approach to the production of compatible stereo records. Unit rejects low frequency information automatically above a predetermined level. COMPATILIZER also permits increase in high level recording time on discs and provides maximum separation on stereo records above 100 cycles.

## NEW! FAIRCHILD BASS-X

A dynamic low frequency roll-off filter — that can roll off high level low frequency information, starting at 500 cycles, with a maximum obtainable attenuation of 12 db at 30 cycles. Device is automatic, is in use only when needed — therefore it does not alter overall apparent low end response to the ear. THE FAIRCHILD BASS-X allows higher levels to be maintained in disc recording, and particularly assists AM stations in increasing their effective signal by automatically controlling the often troublesome low end response.



## FAIRCHILD CONAX

The world-accepted way to control high frequency spillovers in FM due to pre-emphasis. Lets your station maintain real high levels even with brass and crashing cymbals and still avoid FCC citations.

## THE REVERBERTRON

The new compact reverberation system which gives your station that real big voice. With the Reverbertron you can have that Carnegie Hall effect as close as the gain control on the Reverbertron. And there's the added plus of an increase in apparent loudness of your station sound due to reverberation, as originally described by Dr. Maxfield.



Write to FAIRCHILD — the pacemaker in professional audio products — for complete details.

# FAIRCHILD

RECORDING EQUIPMENT CORPORATION  
10-40 45th Ave., Long Island City 1, N. Y.

Circle 197 on Reader Service Card

# LETTERS

## Three-Speaker Stereo Hookup

SIR:  
In the past several months I have seen in some magazine devoted to audio or hi-fi an article showing how to connect three speakers for stereo. Was this in *AUDIO*: I can't seem to locate it anywhere? If so, would you please send me a copy of the article.

RAYMOND B. BOTTOMI, JR.,  
Vice President, WGH,  
P. O. Box 98,  
New Port News, Va. 23607

(David Halfter — Dynaco, Inc., 3912 Powelton Ave., Philadelphia, Pa. 19104, has done considerable work on this subject, and I believe he had an article in a British magazine. He also has distributed a single sheet describing the suggested hookup, which is simple and effective. Basically, the center speaker is connected between the common return from the two stereo speakers and the common on the amplifier. While this introduces some L signal into the right channel and vice versa, it can be cancelled out by connecting a resistor between the two channels in the manner of a blend control, adjusting for minimum crosstalk. Theoretically and practically, it works. Suggest you write him for the data sheet, which is entitled "Dynaco Derived Center-Channel System." Ed.)

## A Well Deserved Rebuke

SIR:  
I have been a subscriber since the first issue of *AUDIO*, so I feel that this and previous criticism of "my" magazine is a friendly and constructive effort.

*AUDIO* has suffered along with about the sorriest proofreading for too long, and this should be corrected. Not an issue is printed without numerous typos, grammatical errors, and technical mistakes. Sometimes, even "continued on" references list the wrong pages if they appear at all, and this is less tolerable than misspelling and errors of grammar.

I was wryly amused by the first LETTER in the December issue in which you admitted the problem, then printed "a impedance" in the reply. On page 24, you refer to "an hysteresis synchronous motor." This printed h-dropping never fails to irritate me, even when used by would-be snobs in the context of "humble," "historical," and the like. Significantly, even those who use this aberration never employ it in speech.

However, even if *AUDIO* never reforms, I still like the magazine and just about everything in it, including Mr. Canby, the verbose, non-technical Yankee, whose comments and technical dabbling liven up *AUDIO* quite pleasantly.

JOHN RUSSELL OWEN  
6063 Selma Ave.,  
Hollywood, Calif. 90028

(We were on the verge of making a firm resolution about always using "a" in front of all words beginning with "h," like hysteresis and even humble and historian, but a hour later we decided it would not be a honorable thing to do. Ed.)

# AR INC. books et al

## HIGH FIDELITY SYSTEMS—

A User's Guide by Roy F. Allison

AR Library Vol. 1 70 pp., illus., paper \$1.00

A layman's practical guide to high fidelity installation. We think that it will become a classic work for novices (and perhaps be consulted secretly by professionals). From the *Bergen Evening Record*: "completely basic . . . If this doesn't give you a roadmap into the field of hi-fi, nothing will." From *The American Record Guide*: "really expert guidance . . . I would strongly urge this book as prerequisite reading for anyone contemplating hi-fi purchases." From *High Fidelity*: "welcome addition to the small but growing body of serious literature on home music systems." From *Electronics Illustrated*: "To my mind, this is the best basic book now available on high fidelity."

## REPRODUCTION OF SOUND

by Edgar Villchur

AR Library Vol. 2 93 pp., illus., paper \$2.00

Vol. 2 explains how components work rather than how to use them, but it presupposes no technical or mathematical background. Martin Mayer writes in *Esquire*: "far and away the best introduction to the subject ever written—literate, intelligent and, of course, immensely knowledgeable." From *HiFi/Stereo Review*: "just the books to satisfy that intellectual itch for deeper understanding."

## RADIO MAGAZINES, INC.

P. O. Box 629, Mineola, N. Y.

Please send me the following:

- Roy Allison's "High Fidelity Systems — A User's Guide" at \$1
- Edgar Villchur's "Reproduction of Sound" at \$2

I enclose \$\_\_\_\_\_ in bills, money order, or check only. (All prices post-paid.)

NAME \_\_\_\_\_

ADDRESS \_\_\_\_\_



# IS THIS ~~WAS~~ THE WORLD'S FINEST PREAMPLIFIER



**PAS-3X**  
Kit \$69.95  
Assembled \$109.95

For years since its introduction, the Dynaco preamplifier design has been generally accepted as one in which the noise and distortion are so low and the quality so high that attempts to improve it would be laboratory exercises rather than commercial enterprises. Yet we have always been questioned as to why we did not gild this lily by adding step type tone controls. The enthusiastic audiophiles who ask this tell us that they want to be sure that their tone controls are out of the circuit when not being used. Our answer has always been that continuous controls give a range of flexibility which cannot be attained with step type controls, and that the "neutral" position of our con-

trols produces a flat response characteristic adequate for the most critical need.

However, our avowed philosophy of perfectionism has kept us working on the possibility of some improvement in the circuit—and this work has now led to the first major change in our preamplifier design since it was initiated. This development (on which patents are pending) is applicable to all continuous tone control systems and immediately makes them superior to the far more expensive step type controls. What we have accomplished is to keep the infinite resolution capability of the continuous control, but to remove all frequency and phase discriminating networks from the circuit when the control is rotated to its mechanical center. This new design is incorporated in the PAS-3X (PAS-2X, too) which is now at your dealer's at the same low price.

Further, for the nominal charge of \$10.00, a conversion kit TC-3X is available to update any Dyna PAS-2 or PAS-3.

Can you hear the difference? We doubt it. The preamp was amazingly good in the past. We have improved it for the sake of improvement, not because we think it needed it. It has always surpassed every other preamp without regard to cost. And, it is superior on more than measurements—listening tests prove that the Dyna preamp adds no coloration to the sound and that its inclusion in the hi fi chain is undetectable. Partially diagrammed below is the performance you can expect from the PAS-3X—why you can never get better overall quality regardless of how much money you spend.

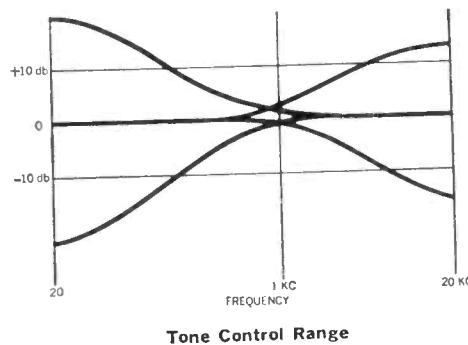
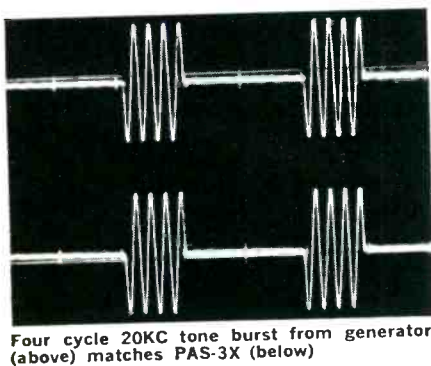
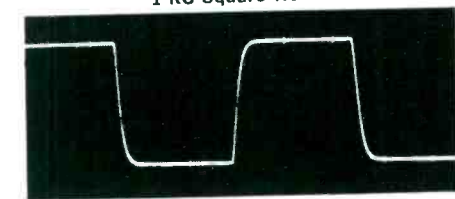
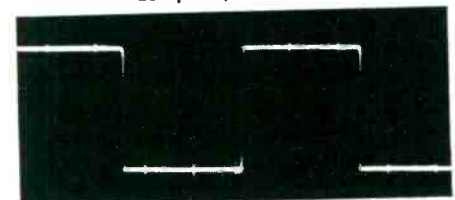
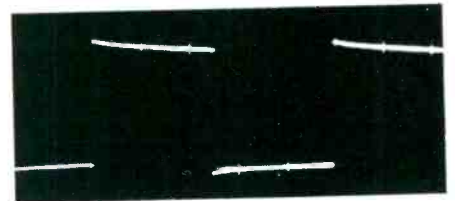
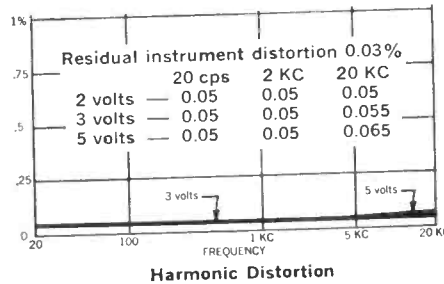
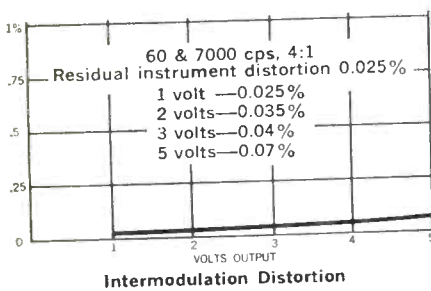

There are Dynakit amplifiers in all power brackets which will do justice to the perfectionist's preamplifier. All are rated for continuous power.



Complete specifications and impartial test reports are available on request. In Europe write Audiodyne a/s Christian X's vej 42, Aarhus, Denmark.

**DYNACO INC.** 3912 POWELTON AVENUE, PHILADELPHIA 4, PA.

Circle 109 on Reader Service Card

## HOW TENDER IS A HUNK OF STEEL? EXCEEDINGLY...

*When you are dealing with high-permeability core laminations.*

In the original state, no. You can punch it, draw it, form it, shear it, or bend it and it's only thin sheet steel. But once formed into laminations and hydrogen annealed to bring out their peculiar magnetic properties, these laminations are delicate beyond belief. Drop them three inches to a hard surface, grind them ever so lightly, or merely bend them slightly and the magic is lost... you're back to bits of sheet steel again.

MHI performance begins with unique, sintered brass core holders so stable and precise that core laminations can be formed to the final contour *before heat treatment*. No grinding is necessary, ever. The ultra thin laminars are hand-inserted and loosely stacked. (Pinch them ever so lightly and you'd have a mediocre head.)

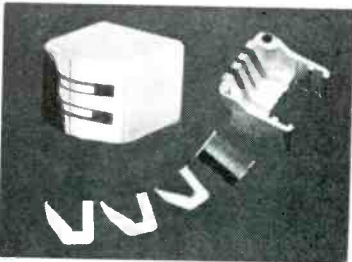

After inductance balancing, the assembled heads are cased, epoxied and bake-cured at 250° F. — your assurance that gaps and inductance will hold at any normal environmental temperatures. A final lapping and polishing of the head face is accomplished (again with-out grinding techniques) to provide a finished head with more inherent, built-in performance than other heads of so-called premium quality.

MHI heads provide high-end performance second to none, a superb low end, and long trouble free service life.

All of this is our way of saying: When you buy a high fidelity tape player or recorder, MHI heads as factory equipment are not exactly cause for disappointment.

Or, when buying a replacement head for your present tape equipment, you or your dealer can obtain an MHI replacement in just about five days. We make only one quality. *Standard* MHI replacement heads in the four-track stereo type retail at only \$24.50. *That's less than ordinary premium heads.*

If you are concerned with the manufacture or engineering of teaching equipment, tape players of any type, or instrumentation systems, write or call for details on full track, half-track and quarter track heads suited to your needs.



MacALLISTER / HOGAN, INC.  
5710 W. 36th St.  
Minneapolis, Minn. 55416

Circle 110 on Reader Service Card



## LIGHT LISTENING

Chester Santon

### "Welcome to the LBJ Ranch"

Capitol W 2423

One of the hazards of White House occupancy nowadays is the appearance of at least one finger-pointing comedy album during one's term in office. The Kennedy's got the treatment in the disc titled "The First Family" which flabbergasted the record industry with its phenomenal sales and brought a certain prominence to writer Earle Doud. Doud, once known only in the inner circles of the comedy business, had supplied material for Jack Paar, Jackie Gleason, Jonathan Winters, and Jack Carson before hitting upon the idea of a disc spoof of the colorful Kennedy clan. In this release Doud has teamed with another Carson writer, a Mr. Robin who uses an "e" to spell his first name Alen instead of Alan. Their object? To draw a few laughs at the expense of the Johnson administration. As anyone who reads the papers could have told the Messrs. Doud and Robin, the Johnson entourage is a duller source of "copy" for comedy writers than the Kennedy regime was. This fact apparently became evident early in this project because it was expanded to include a scattering of contemporary political personalities other than the Johnsons.

The basic idea of the album looks quite simple on paper. The actual voices of the political figures to be kidded were taken from tapes that had been made over a period of years in the course of public speeches, private interviews, or what have you. Miles of these tapes were searched for phrases that could produce a funny answer if preceded by the right question. These questions were then put to each politician by a panel of live interviewers seated in a recording studio. With them was an audience able to hear both the question and the "answer" as played back from the tape made by the unsuspecting figure on an entirely different occasion. Anyone familiar with the mechanics of such a procedure need not be told that the real star of this bit of entertainment is the man in charge of the tape splicing. Bob Prescott, the sound effects supervisor, and the staff of Fine Recording Studios in New York are entitled to the ungrudging admiration of everyone who has ever "rocked" a tape past a playback head with a crayon in his hand. Quite apart from the physical drudgery of processing miles of tapes for a "clean quote," there still remained the herculean task of equalizing the various taped excerpts originally made under a bewildering variety of recording conditions. The original wish of the record's producers may have been no more than a disc of diverting comedy. They have ended with one of the year's technical triumphs.

12 Forest Avenue, Hastings-on-Hudson, N.Y. 10706

### Nero Goes "Pops"

RCA Victor LSC 2821

Pianist Peter Nero joins the roster of RCA pop artists making the pilgrimage to the sanctuary of the Boston Pops Orchestra presided over by the sprightly Arthur Fiedler. With the help of jazzmen George Duvivier (bass) and Bobby Rosengarden (drums). Peter Nero enlivens a fine Gershwin program in this modified-Dynagroove release. Nero's extensive musical background stands him in good stead in the "Rhapsody in Blue" which here receives the lighthearted jazz treatment it so seldom gets in the concert hall or on records. The members of the Boston Pops play like men possessed in the collection of Gershwin tunes that forms the rest of the record. They catch their breath in some of the quieter songs but the six minute arrangement of "I Got Rhythm" closing the album is about the wildest thing I've ever heard the Pops do on discs. Get this one for your own amazement. The range of the Dynagroove sound is adequate for the most part with only the lowest notes of the piano the real sufferers. On my setup, the cleanest sound was heard at a playback level of only medium intensity.

### Trio Los Panchos: Music of Lecuona

Columbia ES 1845

You don't have to sample a reviewer's typical monthly pile of records to appreciate a welcome change of pace in recorded material. The next time you find yourself speculating that your disc library is beginning to reach a certain amount of sameness in some departments, try some of the byways available even on the most familiar labels. Of all the majors, Columbia Records has maintained about the most consistent contact with current doings in Latin American music. Its "EX" series ("ES" for stereo) contributes something interesting to the catalog every month. Admittedly, much of the stuff is aimed at a specialized market but an item does crop up occasionally that makes very refreshing listening. Just such a release is this latest album, one of many, by the Trio Los Panchos. Its appeal stems from the new light it throws on the singularly attractive music of Ernesto Lecuona. With "Siboney," "Always in My Heart," and "Malaguena" now part of our musical currency, no one has to be told Lecuona had an uncommonly high batting average. These favorites receive their share of vocal attention by Los Panchos. The major surprise in the album will come for listeners who had read somewhere or other that Lecuona spread his great gift for melody over a total of three hundred songs. For the first time, I'm fully prepared to believe that statement after listening to the "unknown" Lecuona numbers that make up the greater part of this album. The man had a remarkable talent and this trio with classy guitar and percussion ac-

(Continued on page 70)

AUDIO • FEBRUARY, 1966

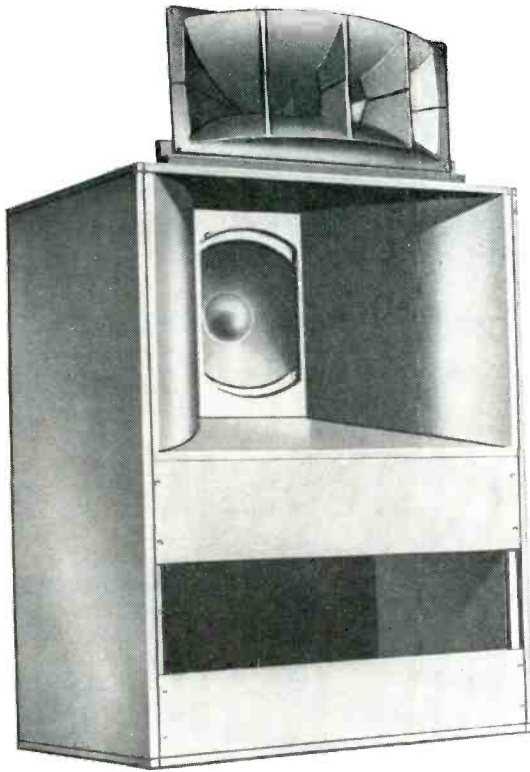

## ***Some Sound!***

At left, the gigantic Altec A7-500 "Voice of the Theatre"® speaker system, whose massive perfection in sound thunders forth in the nation's recording and broadcast studios. (Studios don't have wives concerned with room décor, but they do have a strict requirement for the best speaker system anywhere!)

At right, the new, Magnificent A7-500W-1. Same components, same cubic volume, same sound. Different exterior design. (Designed for wives and room

Altec's **PLAYBACK** A7-500, as used in recording and broadcast studios, and in its new, A7-500W-1 decorator model, is a high-efficiency system with an unusually wide, smooth frequency range of 35-22,000 Hz (cps). A large cast-aluminum sectoral horn accurately reproduces frequencies above 500 Hz. Altec's famous high-efficiency 802D high-frequency driver coupled to the 511B horn achieves the cleanest, distortion-free midrange of any h.f. speaker. Low frequencies are reproduced by our 15" Model 416A bass speaker combined with a front-loaded exponential horn and full-size rear-loading reflex baffle.

Designed to operate on 8 or 16 ohms, the Magnificent A7-500W-1 has a 30-watt power-handling capacity. Dimensions: 44" H x 32" W x 25" D. Consumer net: A7-500 (the brute at left) \$327; A7-500W-1 (the beauty at right) \$498. Same sound! Write for complete Altec catalog, Dept. A-2.



## ***Same Sound!***

décor and husbands who won't settle for less than the best speaker system anywhere!)

Hand-fitted sculptured walnut hardwood cabinet, elegantly patterned in natural wood grain. Delicate, Spanish-inspired fret-work grille, curving gently. A gracefully rounded facade for a massively rounded sound.

The Magnificent Altec A7-500W-1. For the man who won't compromise sound...and the woman who won't compromise beauty.

Besides the glorification of style, you will be aware of something new in the sound from the A7-500W-1 which transcends even that which placed the earlier A7-500's at the summit of loudspeakers. Listen to the new Magnificent; or if you're French, the new Magnifique; or if you're Spanish; the new Magnifico!



©1965 AL  
**ALTEC LANSING**  
A Division of **LTV** Ling Altec, Inc.  
ANAHEIM, CALIFORNIA

# problem solving micro-phones

by

**SHURE**



**PROBLEM:**  
Feedback

**SOLUTION:**  
Unidyne III

ULTRA-COMPACT UNIDIRECTIONAL MICROPHONE

Shure's true cardioid microphones with pick-up pattern symmetrical about the axis in all planes, at all frequencies! Solves more common P.A. system problems than any other microphone made: effectively controls feedback caused by sound reflections or spurious frequencies. Also suppresses reverberant "boom." Uniform pattern without "hot spots" or "dead" areas; ideal for distant pick-up, group coverage with one microphone, or multiple microphone set-ups. Model 545S with Switch—List \$89.95.

*budget a problem too?*

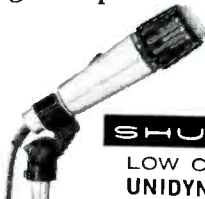

**SHURE**  
LOW COST  
UNIDYNE A

In the quality tradition of the famed Unidyne family. Gives unidirectional problem solving ability at an omnidirectional price . . . makes it possible to effectively control feedback even in low budget P.A. systems. Choice of impedances. Low Impedance model 580 SB only \$52.00 List.

write for data sheets:

**SHURE BROTHERS, INC.**  
222 Hartrey Ave.  
Evanston, Illinois

Circle 113 on Reader Service Card



## ABOUT MUSIC

Harold Lawrence

### The Dubious Art of Dubbing

**T**HE CAMERAS are rolling. Fill-in lights play over the principal actors to compensate for the gloomy weather. Spread out over the countryside is an army of extras dressed in boots and armor, carrying spears and crossbows. The hero is making a speech. All listen in rapt attention. There are no mishaps and the scene is chalked down as a master take. But to the uninitiated observer, quite a few things would seem to have gone wrong. While the scene was being acted, a truck had roared down a highway nearby; a plane had droned overhead; an overseas jet, invisible above the clouds had screamed in the distance; one could hear music from a transistor radio dangling from the handlebar of a passing bicycle; all this to the obbligato sound of the wind agitating the trees. The sound engineers were on hand with their microphones, but they appeared unconcerned; they and everyone connected with this film about medieval England knew that the speech would be re-recorded out of range of twentieth-century noises and obtrusive nature-made sounds.

In a studio remote from the scene of the shooting, the actor will repeat his lines as he watches himself on the screen. Later a film editor will lay in the newly recorded track hoping to achieve near-perfect lip-synchronism. When the final mix is made, every syllable will be in its proper place. But for some reason the dubbed scene will be as disturbingly unreal as if the truck, the jet plane, and the transistor radio were still there; and despite sonic montage, it will fail to convince us that the words we are hearing actually were spoken by the actor. For example, we observe the wind swaying the branches of the trees, but we don't hear the leaves rustle; we see the actor move along the rocky hillside, but his feet make no sound, as if he were floating in space. What we are hearing is a voice recorded in a dry studio where every sibilant and every breath intake can be heard clearly. The illusion which the technicians attempted to preserve with such painstaking care has been shattered.

Dubbing has become a permanent feature of cinematic life. Because it is a process that demands a high degree of taste and sensitivity, we can expect to see increasingly more movies produced with the kind of visual-sonic incongruities described above. In fact, films that possess true integrity of sound and image are in danger of flickering into extinction.

In itself, dubbing is not the villain of this piece. In this sound-polluted world of ours, few outdoor scenes can be shot free of extraneous noises. Even remote lands are not immune to the jet plane. But noise is not the only actor that calls for lip-synchronism and background dubbing. The economics of movie-making require it. Unlike stage actors, many film stars have trouble memorizing their lines. Obviously it is cheaper to re-record dialogue in a studio than out of doors with a film crew and throngs of extras standing by getting paid by the hour.

The exodus from Hollywood and the growth of international co-productions have witnessed an increase in the number of films produced with casts made up of actors of different nationalities, many of whom speak little or no English. In these cases all dialogue in and out of doors is dubbed. Language dubbing of other films of international appeal has become a major industry, with hundreds of actors who are never seen by the public speaking the lines of Marcello Mastroianni, Audrey Hepburn, Cary Grant, and so on, in everything from Finnish to Japanese.

Many movie producers take the easy way out and dub films in their entirety. I often hear the claim that the Italians, for example, have developed this technique to an amazing degree. Perhaps I haven't seen enough Italian films, but I have yet to be convinced.

Is the public aware of faulty dubbing? Hard to tell. But we do know that the great majority of movie critics are not, or else don't write about it. Only one issue aroused controversy in recent years: the use of English sub-titles versus dubbed dialogue. It was a debate of limited scope that failed to grapple with the principle of dubbing, only its application to the dialogue of foreign-language films.

It took a critic outside of the ranks of screen reviewers to cope with the basic issue. In an article for the *New York* supplement of the *Sunday Herald Tribune* (September 20, 1964), Walter Kerr wrote of the introductory scenes of the film *The Night of the Iguana* in which "clergyman Richard Burton chases his congregation out of the church. We begin to see him coming down the aisle, shouting and hearing his stunned flock toward the doorway, head-on. We see his face, throat, and shoulders all at work as he shouts. The film then cuts to a rear view of Mr. Burton as he pushes the throng

(Continued on page 79)

Circle 114 on Reader Service Card

**AUDIO** • FEBRUARY, 1966



Leave it to us.  
The new, integrated  
Miracord 40A

comes  with its own  
cartridge.

Factory cartridge installation insures correct installation — optimum playback quality and lowest record wear. Distortion and tracking problems due to incorrect positioning and angling are eliminated.

It is natural that the manufacturer who built the first turntable-quality changer, and the first moving magnet stereo cartridge, should be the first to combine the two in an integrated unit.

The new Miracord 40A plays records manually or automatically, singly or in sequence, at all speeds. Its features include: heavy, one-piece, dynamically balanced 12" turntable; dynamically balanced tone arm; calibrated stylus-force dial; high-torque, 4-pole induction motor; and the famous feathertouch push buttons which help make the Miracord the most gentle of all turntables.

The new Elac 240 mono/stereo cartridge in the Miracord 40A has an 0.7 mil diamond stylus. It is distinguished by clean channel separation, low distortion and smooth, flat response. Its performance is comparable to many highly reputed, stereo-only cartridges available today.

The new Miracord 40A is priced at \$89.50, complete with Elac 240 cartridge, but less base. See and hear it at your hi-fi dealer. For further details, write: Benjamin Electronic Sound Corp., Farmingdale, N.Y. 11736

new Miracord 40A

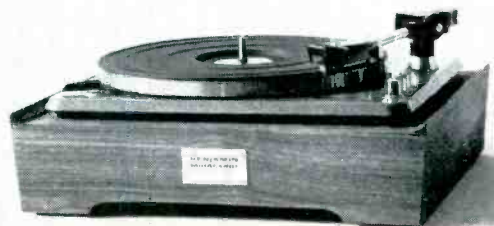

# AUDIO ETC.

Edward Tatnall Canby



## DX-ing

Sometimes I get the strangest anonymous packages through the mail. Like one that came in a few months back, without the slightest warning—not even any advance publicity.

It was the size of a ladies' shoebox and it came from Norelco. Hum, says I, must be something to do with hi fi. Or maybe records. Or tape. So I unpacked it, not noticing the label on one end of the box, and found inside a slick-looking but moderately unidentifiable object, sort of like an elongated electric shaver, or maybe a small hair dryer, made out of plastic with sort of slats for air, up at one end, and a batch of little knobs and things on the side. Controls. Not a word printed on the thing itself.

One little slider switch showed a red streak when I pushed it up. ON, I guessed. I turned it on and nothing happened. An arrow on the bottom indicated a door of some sort into the inside—I finally managed to get it opened (the arrow was slightly misleading) and—there was a battery. 9-volt, transistor energizer. Hmm, says I once more. What do we have here? Mysteriouser and mysteriouser. There was a cord, too. Bare wires. No plug on the end.

Well, I went back to the wastebasket and retrieved the box, which I had thrown out in my usual rapid fashion. Lo and behold—it said PROFESSIONAL MICROPHONE, modestly, on one end. And out of the inside fell a comic book.

Looked a bit like one, anyhow. But it was, instead, an all-language (i.e. no-language) instruction booklet. Pictures only. And also, out fell two sheets. One was labeled *Ersatzteilbestellung*, a mouthful that was happily translated as Parts Order. Lotta diagrams of insides, with parts numbers. The other sheet said "Microphone Specification DX11, Technical data." The entire sheet was blank. No technical data! HMMMMM, says I. This isn't going to be so easy. (It's an AKG mike, from Austria.)

## Pictures Only

So I dove into the no-language instruction book. It was like none you've ever seen. About 2 x 10 inches, and on the cover it says DX11DX11DX11. Picture—drawing, that is—of a silly wench with big you-know-whats and a huge double-bouffant hairdo, smiling gaily. She has a DX11 in one hand.

Page 2. Ye gal is doing a dance step. Mike is diagrammed into a box with three knobs and then to a sort of 1925 klaxon-type auto horn. Hmm—loudspeaker. Maybe. Yep. At the other end of the page, a dizzy

old gent with walrus moustaches sits on a bar stool with champagne in one hand and looks lecherously at ye gal. Love-interest begins.

He's *listening* (one can guess) as well as looking. Aha! Public address. The box is an amplifier. That's it.

Page 3. She's doing another dance twist, to the left of the page, and the mike now runs into an obvious tape recorder. Reels. Oversimplified, but I bet it's a Norelco. Old man is in dressing gown now, in a plush chair, with cigar, looking benevolent. I mean *listening* benevolently. His eyes are closed. Natch. This isn't videotape.

Page 4. Complications. This is really baffling. Ah! I get it! The lady dances a step with mike in one hand, in one picture. Then she does the same no-hands in another picture. Mike is on a stand. Big, fat arrow runs to diagram of an octagonal collar arrangement, with measurements. Part Sa 13. Little man (in white smock and thick black glasses—why?) points to it, looking pleased through his walruses.

Page 5. Connections. Fat cable, enlarged in diagram. One wire is HI, another is 200 ohms, and a third is common to both. Then there is the shield. Three kinds of plugs, with words (at last) attached. Nouns, though. Not verbs. Little man is now a carpenter type, with lots of pockets on overalls, black skull cap. He looks peeved. He's examining a plug. I'd be peeved too. I hate connecting plugs.

Page 6. Now we come to the pay-off. Little lady is reduced to the you-know-whats and the bouffant hairdo. She's lost her lower anatomy. Next to her—two of her—is a big, black picture-diagram of the controls on the mike and next to that, beside the rotating knurled thing that works like a volume control, it says "LAAaa" and then, "La, la". Across the page is a picture of the openable box for the battery, with an arrow, and 9V written inside.

Get it? What—you don't?? Now, come, come! You, an expert audio man, can't figure that one out?

## Instant—

Well, I couldn't either. And that battery had me flummoxed. As well as the funny shape of the mike; for its plastic case, tapered a bit towards the bottom, was tall, not far from ten inches, and something had to be in all that extra space, along with the battery. So I tossed the whole thing to my assistant and came back later, to find the 200-ohm wire (white) hooked into a shielded cable with a phone plug on it, ready to try, to see what would happen.—But I've forgotten to tell you about page 7.

Page 7. Pure guesswork on my part, yet

I figured maybe the transistor circuit on this last page might have something to do with that battery and mysterious other parts inside the mike. Little man with the moustaches has now persuaded the gal (who has her whole body back again) to come over to his side of the page and the two of them are making eyes in what looks like a flowery meadow. Flowers, anyhow. No mike in sight. Love conquers all, irrelevantly. Some instructions!

The diagram looks like this, anyhow.

Needless to say, *you* know what the DX11 is by now, but I still didn't. So I plugged it into my Ampex 350 system, one of the mike inputs on my mixer (tailored to my broadcast and specially built for me 'way back)—and I talked, and recorded.

Well, it sounded like a mike all right. I compared it with my regular broadcast mike, a real oldie but a beaut for its age (Western Electric cardioid) and found that it compared favorably enough. As with speakers, of course, all good mikes should sound exactly alike. These two were certainly very close first cousins.

Then I turned that little knurled volume control on the mike all the way, just to see what would happen. *You* know what happened. Of course! On one position, I said "La" and it came out "La" on the recording tape. On the other, I said "La" again (copying the comic book instructions) and the tape said back to me "LAAAAaaaaaa." Yep, it's an instant reverb mike. Built-in doorspring system.

Now what on God's earth would I do with a *reverb* mike, right in my own home? I'm no night club pro, and the only recordings I make are informational, broadcast, speech only. (Via the mike, that is. I don't tape records through a mike, thank you.)

I felt like a perfect idiot—all I could think of was to say "La, La, La" a dozen times, and then "Wump, WOOF-WOOF" and the inevitable "TESTING, TESTING"—all of which came out duly scrambled and reverberated to a fairtheewell, WWWWU-MMMPPP, WOOFWFVFWFW, TSTN-TTSTNGTESTNGGG. Interesting, if true, I mumbled to myself. And wondered what I was supposed to do next.

No question about it, this ingenious microphone can make hash of any and all speech with the greatest of transistorized ease, in case that's what's on your mind.

Now I suppose that a reverb mike is real useful—once the somewhat limited stunt value is run through (and the kiddies have tried saying WUMP, WUMP into it until they're tired)—for those who actually sing and dance on a stage, home-type or otherwise, pro or amateur. And for all who want to add reverberated singing to their own home-style tapes, whether to home accompaniment, records or taped radio music. Fine, even if it isn't my dish. (No point in recording with a reverberated mike for professional work. There, the reverb is added afterwards—or via a fancy built-in studio reverb system.)

I can even imagine trying this mike for such serious efforts as the recording of home-style "live" music, or a chorus, or chamber group, in the too-dead acoustics of the average home or meeting room.



## PROFESSIONAL PLAYMATES



The new Sony Solid State 350 adds professional performance to home entertainment systems

Selecting the brilliant new Sony Solid State 350 to fulfill the stereo tape recording and playback functions of your professional component music system will also enduringly compliment your impeccable taste and passion for music at its finest. With an instant connection to your other stereo components, the versatile two-speed Sony 350 places at your pleasure a full array of professional features, including: 3 heads for tape and source monitoring. Vertical or horizontal operation. Belt-free, true capstan drive. Stereo recording amplifiers and playback

pre-amps. Dual V U meters. Automatic sentinel switch. Frequency response 50-15,000 cps  $\pm$  2db. S.N. ratio plus 50db. Flutter and wow under 0.15%. Richly handsome gold and black decor with luxurious walnut grained low profile base. This remarkable instrument is yours at the equally remarkable price of less than \$199.50. Should you want to add portability to all this, there's the Model 350C, mounted in handsome dark gray and satin-chrome carrying case, at less than \$219.50. For information write Superscope, Inc., Sun Valley, Calif.

**SONY** **SUPERSCOPE** *The Tapeway to Stereo* <sup>®</sup>



*Portable Model 350C*

Circle 115 on Reader Service Card

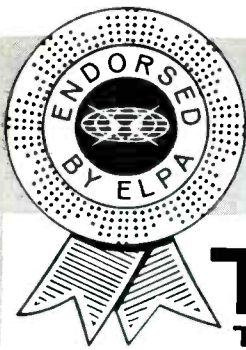

World-Wide Products of Distinction

# THORENS TURNTABLES



## NEW THORENS TD-150 AB

A superb turntable in the world-famous Thorens quality tradition. Features silent, two-speed operation (33 1/3 and 45 rpm), plus integrated tone arm that incorporates latest safety lowering device with pneumatic damping action. You get everything you ever wanted in an integrated turntable, including the Thorens reputation for precision craftsmanship.

Only \$99.50

### OTHER FEATURES INCLUDE:

- Extra-light, low-mass aluminum plug-in shell with exclusive adjustable vertical tracking angle. Adjusts to optimum playback stylus angle for any cartridge.
- Handsome slim-line chassis.
- 12-inch, 7 1/2 lb. precision balanced, non-magnetic platter.
- Spring-loaded suspension system to minimize vibrations.



## THORENS TD-124 Series II

The Finest Transcription Turntable on the market today.

A brilliant example of Swiss craftsmanship acclaimed throughout the

world. Unmatched for mono- or stereo-performance. Has more outstanding features, more built-in extras, than any transcription turntable in its price range. No other instrument like it available.

Illustrated with the Ortofon RMG-212 Tone Arm and Hi-Jack cueing device. Only \$125

### IMPORTANT 15° STYLUS OWNERS

It is an ignored fact, that in any record changer or automatic turntable that stacks records on a turntable, the 15° stylus will have its greatest tracking error when used for single play because of the compromising angle of its tone arm.

Therefore, for correct tracking and optimum playback performance, any stylus including the 15° stylus should be used with a non-automatic turntable.

### A "MUST" FOR RECORD LOVERS!

Want to get more out of your records? Reduce surface noise? Get longer record life? Learn professional secrets of record care? Get a copy of HOW TO CLEAN, MAINTAIN and PROTECT RECORDS by Cecil E. Watts, noted record care expert. Only 25¢.

Available from your hi-fi dealer or order directly.



ELPA MARKETING INDUSTRIES, INC. • Dept. 110A2 • New Hyde Park, N.Y.

Available in Canada

Circle 116 on Reader Service Card

Might work. Might help the sound, if used with discretion.

Beyond that, I'm afraid my imagination runs to negative values. Like reverbing a dull lecturer, glamorizing his sounds into unintelligibility. (College students, I dare you . . .) Or doing recorded dictation for the office secretary with added reverb to keep her awake in the transcribing. (That's roughly like pouring perfume on her typewriter.) What else? I dunno. Go ask Norelco.

How does the reverb sound? Well, I've had a Fisher reverb unit for some time and it sounds like that—more or less. But the Fisher Space Expander unit has two doorsprings, and longer ones, too. This mike has one, shorter and fatter. It still sounds like a doorspring. It tends to twang. And, as mounted inside a movable, bumpable mike, it is easily twanged, at that. Gotta be careful.

Used in moderation, a spring-driven reverb system can be very helpful in certain situations, such as for a singer in a club, for example. Especially when it is set low, just barely to take the edge off a too-dry sound. But when you turn it up too far, it sounds faked. (Even the fancy pro Fairchild model can do that, if used with too free a hand.) So, all in all, I have some doubts about this DX11 Norelco for my uses or for recording—though I'm happy to admit that my opinion is sort of limited. May be just the thing for your needs whatever they are.

### Dead Battery

All this was some months back. I took the mike out again, just now, to re-check it, and found the little red warning streak showing. O-oh! I'd left it on. Dead battery. Well, then, no reverb this trip. But I plugged it in, anyhow, just to try the mike itself again, minus reverb.

No go. Dead as a doornail. Not a sound could I get.

Now wait a minute . . . A dynamic mike that runs on a battery?? You mean . . . ??

Well, I guess so. At press time, I was still trying to figure this one out (never looking, of course, at the circuit diagram—I never do) and was coming to the sad conclusion that this mike must feed through the reverb solid-state circuit in such a fashion that when the battery is dead, so is the mike. Sort of silly, I was thinking—there ought to be some way or other, in an emergency . . . just to use the dynamic unit, minus reverb. Better straight sound than none at all.

The little gal in the picture instruction book isn't telling me. She wouldn't know. Nor the man with the walrus moustaches.

P.S. I got a bill from Norelco the other day, one of those memo bills. It said \$130. So that's what you'll pay for your portable instant reverb. Probably well worth it—if, for you, instant reverb in the hand is worth two in the bush. Even with dead batteries.

### DEMONSTRATION

I can't resist writing this—because I had such a good time. I always do, every year.

You see, one of the mainstays of the entire hi fi business, one of its Vital Factors, its crucial cruxes, essential to keep  
(continued on page 68)



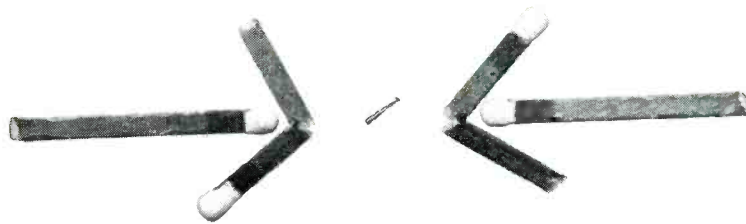

# This is all that moves in the new ADC 10/E cartridge

We figure it costs you roughly \$49,000 a lb.

You'll probably never buy anything man-made as costly by weight as this tiny, incredibly rugged moving stylus of the new ADC 10/E cartridge.

It reduces "moving mass" to about *one-third* that of the best magnetic cartridges.

Moving mass (the weight or inertia of the total moving system as felt at the stylus tip) is what your record has to push around. The groove must move it in one direction, stop it, then push it another direction—thousands of times a second.

Even a few milligrams of moving mass set up such tremendous forces that the record groove *yields* as the stylus passes. . . . So even on the very first play, you hear a distorted groove, not the groove that was pressed in. Now, by a major jump forward in de-

sign, the ADC 10/E reduces moving mass well *below* the critical point of groove yield. Result: for the first time ever, you can hear the actual record you bought . . . on the first play, or the 500th. (Wear is negligible.) Listen to a complex passage, piano, operatic or choral selection, and you hear the difference. You get clarity,

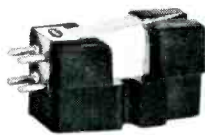

brilliance, reality and definition never obtained before. At long last, true "clean-ness"!

How good is the new ADC 10/E? By any test, lab or listening, it is so perfect that any improvement would be pointless. For the first time it can be said: no one will ever make a cartridge that performs perceptibly better.

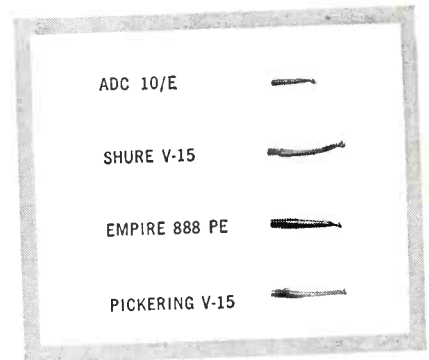

This actual photo of the moving parts of these popular cartridges contrasts dramatically the much lower "moving mass" of the new ADC 10/E.

## SPECIFICATIONS — ADC 10/E

Type	Induced magnet
Sensitivity	4 mv at 5.5 cms/sec recorded velocity
Channel separation	30 db, 50 to 10,000 cps
Frequency response	10 to 20,000 cps. $\pm 2$ db
Stylus tip	Elliptical Stylus Contact radius — .0003" Lateral radius — .0007"
Vertical tracking angle	15°
Tracking force range	1/2 to 1 1/4 grams
I.M. distortion	Less than 1% — 400 & 4,000 cps at 14.3 cms/sec velocity
Compliance	35 x 10 <sup>-6</sup> cms/dyne
Price	\$59.50

## AUDIO DYNAMICS CORPORATION

Pickett District Rd., New Milford, Conn. 

Circle 117 on Reader Service Card

# RECORD REVUE

Edward Tatnall Canby \*

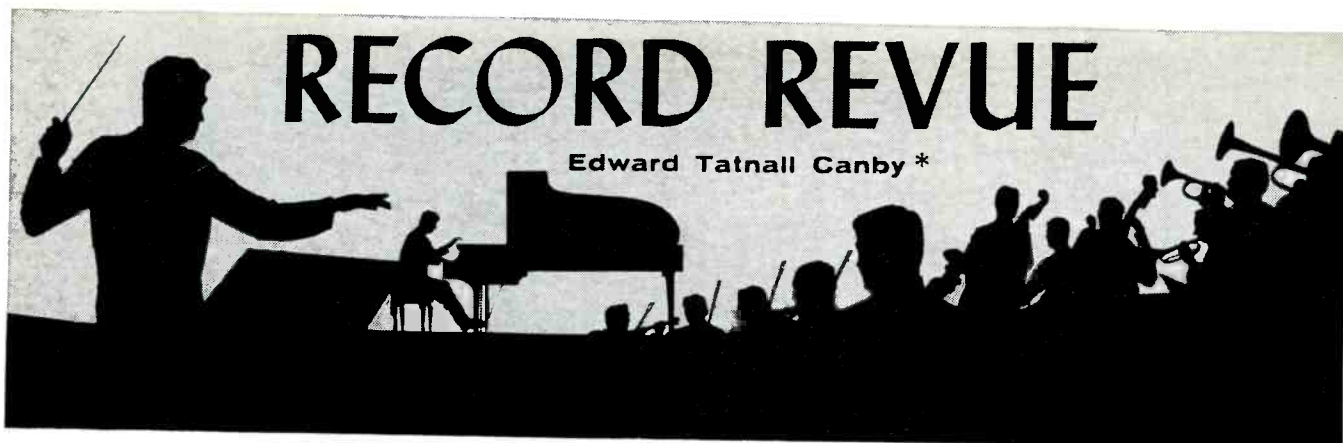

## CLASSICAL BEATLES

**The Baroque Beatles Book.** Baroque Ensemble of the Merseyside Kammermusikgesellschaft, The Canby Singers, Harold Brienes, helpentenor, dir. Joshua Rifkin. Elektra EKL-7306 stereo

Just in case you missed this pre-Xmas satire, here it is. Beatle tunes (most people know them, or have kids who do!) converted most ingeniously into "authentic" Bach-Telemann-Handel Baroque by Joshua Rifkin, who once played in a jug band and is now a budding musicologist of a very authentic sort. It takes a bit of expertise on your part—whether Beatlish or Baroque—but most people will find this pretty amazing as a sheer musical feat; for the Baroque music is excellent in its own right. It could "very well pass for" (Gilbert & Sullivan) the real thing in any company.

There is, first, the *Royal Beethoven Works Musick*, a splendid Baroque suite with trumpets, the overture based trickily on "I Want to Hold Your Hand," the succeeding dance movements based on other such tunes, including the recent "Ticket to Ride" (From "HELP!") Then the *Epstein Variations* for harpsichord solo, out of "Hold Me Tight." On Side 2 is the full-scale cantata for "the Third Saturday after Shea Stadium," on "Last Night I said," in which my own Canby Singers do the choral parts, rather heavily frustrated by a 19-mike pops set-up which drowned out the choral voices with too much trumpet *et al.* Also the delightful recitative and aria "When I was Younger" straight out of the movie "HELP!"—it's even in the same key as the Beatle version. Finally (at too-high a level on the record, after the Cantata) comes a trio sonata, *Das Käferlein* (transl. The Little Beetle).

An interesting example, by the way, of all-out multimix "pops" studio technique on four tracks applied to Baroque-style classical music. In spite of some technical weaknesses, as above, the over-all effect is surprisingly good for the music.

## A TURN ABOUT TURNABOUT

(Note. Vox's Turnabout label was a quick follower after Nonesuch—with the new low-cost, well packaged imported recordings, \$2.50 list, or less, mono or stereo. Turnabout's repertory centers so far on the Mozart-Haydn period and

later, where Nonesuch has largely Baroque and earlier though they do overlap. E. T. C.)

**Vivaldi: IV Concerti** (Piccolo, Viola d'Amore, V. d'Amore and Lute). Württemberg Chamber Orch., Faerber.

Turnabout TV 34009 stereo

There's not nearly as much Baroque in the Turnabout line as on Nonesuch, but here's a good sample. Nonesuch also has the two piccolo concerti. The other two here are typical of the "new" Vivaldi—the many works for all sorts of odd-ball combinations, doubtless composed for his lady students at the Venetian Pietà orphanage-music-conservatory where he worked for many years, which have been newly uncovered since World War II, in terms of musical performance.

Good soloists here; the Württemberg orchestra is just a bit soggy and its sound is enhanced by a blurry liveness.

**Dittersdorf: Concerti for Double-Bass, Harp; Sinfonia Concertante for Double-Bass and Viola.** Württemberg Ch. Orch., Faerber.

Turnabout TV 340055 stereo

This genial Mozart-period composer with the jittery name (Properly Karl Ditters von Dittersdorf) wrote expertly Mozartean music, for odd-ball combinations even odder than those of Vivaldi a half century earlier. Here are two concerti with double bass, plus one for harp, and all of the music flows along most easily, if wholly minus the deeper tension that kept getting into Mozart's music. It makes a very pleasant record for casual listening.

**Haydn: Four Flute Quartets.** Camillo Wanausek; members of the Europa quartet.

Turnabout TV 340075 stereo

Here's similar music—but from a master, in his earlier period. The flute enjoyed a terrific popularity in the middle to late Eighteenth century and many a work of this sort was turned out to meet the big demand. The sound, one flute and three strings, is a bit thin for our ears today and the early-Haydn style, as of about 1767, a quarter-century before the familiar Haydn symphonies, is very *galant* and polished, taking a bit of listening before our ears adjust properly to its values. Still, a fine record for anyone with a liking for the "Mozart-Haydn" period.

**Mozart: Haffner Serenade, K. 250.** Württemberg State Orchestra, Leitner. Susanne Lautenbacher, vl.

Turnabout TV 340135 stereo

The famed wedding serenade, written for the same Haffner family as the later "Haffner" Symphony (which appears to have been made out of another serenade

by dropping some of the movements) gets a vigorous if slightly flowery treatment here, in what seems to be the official Württemberg manner, authoritative, very strong, but a bit unblended in ensemble, with rather wobbly string tone. I like it. And the violin concerto within the serenade (typical of the serenade form—and probably played by Mozart himself originally) is nicely put forth in the same somewhat florid style by Susanne Lautenbacher.

**Mozart: Three Early Symphonies.** No. 25 in G minor (K. 183), No. 23 in D (K. 181), No. 20 in D (K. 133). Mainz Chamber Orch., Kehr.

Turnabout TV 340025 stereo

Here's a splendid record—for of these three closely related early symphonies only the "little G Minor," K. 183, is commonly played. The others are very seldom heard, which is a shame. From a lad of some sixteen years of age they are extraordinary miracles. The sound is much like that of the Württemberg players, but more intimately recorded, more suitable for these works. A florid sound with a good deal of violin-section vibrato, but strong and musical even so.

It's always a sobering experience, and conducive to thought, to listen to Mozart—even youthful Mozart—after a goodly dose of his contemporaries. He goes so very much further, even at sixteen. This one is highly recommended if you are a Mozart fan.

**Hoffman: Mandolin Quartet in F. Guilian; Mandolin Quartet in A.** Elfriede Kunschak, Edith Bauer-Slais, mandolins.

Turnabout TV 340165 stereo

Like the flute, the mandolin became widely popular towards the end of the Eighteenth century and much "popular" music was written including it. Here are two works, a good cross section of the mandolin music of the time—so different from ours.

The Hoffman work is a very competent piece, late classical, out of the period of early Beethoven and late Haydn, not profound but well written and showing off the mandolin's silvery plucked tones to surprisingly good advantage. Present-day guitar buffs should find it interesting. As for the Guiliani, though it purports (according to the notes) to date from the early Nineteenth century, its sound is that of the early classical time, the 1760's or 70's, and it is surely the emptiest example of that sort of music presently on records! Dishwater stuff. I'd buy the record for the Hoffman, any time.

(P.S. There's a lute somewhere in the ensemble; I suspect it is "arranged" into the music. The Hoffman piece is listed as arranged, from what it does not say, by the lute player, Vinzenz Hladky.)

The new Empire Grenadier is the world's most perfect speaker system. If there is any doubt in your mind, take a seat and listen...



 **EMPIRE**

CIRCLE NUMBER 108 ON READER SERVICE CARD

[www.AmericanRadioHistory.com](http://www.AmericanRadioHistory.com)

You're on the threshold of an entirely new concept in sound, a voyage into startling reality, a sense of presence never before achieved in speaker systems.

Close your eyes, think performance only. Hear the penetrating thunder of the kettle drums... resounding clamor of the cymbals, and the soft, sweet brilliance of the reed section. This is the Empire Grenadier, the only speaker that lets you sit anywhere—hear everything. Now open your eyes. Take a close look at some of its amazing features:

A revolutionary die-cast divergent acoustic lens assures fuller frequency and separation, plus broader sound propagation (over 50% more sound dispersion of its highs and mids than conventional speakers).

Exclusive dynamic reflex stop system allows you to adjust the bass and treble response to suit your individual acoustics.

A 12" woofer faces downward, close to the reflecting floor surface, feeds through a front loaded horn with full circle aperture throat. This provides 360 degree sound dispersion and prevents standing waves from developing in the room.

The world's largest (18 lbs.) speaker ceramic magnet structure, an ultra-sonic domed tweeter, full presence mid-range radiator, and complete symmetry of design with terminals concealed underneath... and the most classic looking, elegantly styled chassis 'round.

Out of sight but never out of sound—the Empire Grenadier—world's most perfect speaker system.

No less perfect than the Grenadiers are the incomparable Troubadors — complete playback systems.

The famous Empire 398 and the Empire console 498.

The Troubadors consist of the Empire 3-speed professional "silent" turntable... 980 dynamically balanced arm with sensational dyna-lift... and the new Empire "Living cartridge", featuring the exclusive magnetic cone stylus. Empire has built its home around a family of quality products, years ahead in design and performance. For complete color brochure write to Empire—for a sound demo go 'round to your local Hi Fi showroom.

**EMPIRE** SCIENTIFIC CORP.  
845 STEWART AVE., GARDEN CITY, N.Y.



**MODEL 8000P**

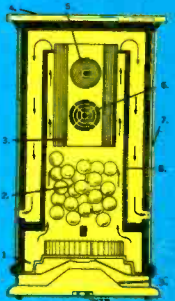

- OUTSTANDING FEATURES**
1. 12 inch mass loaded woofer with floating suspension, four inch voice coil and world's largest (18 lbs.) speaker ceramic magnet structure.
  2. Sound absorbent rear loading
  3. Die-cast acoustic lens
  4. Imported marble top.
  5. Ultra-Sonic domed tweeter
  6. Full presence mid range radiator.
  7. Damped enclosure
  8. Dynamic Reflex Stop System.
  9. Front loaded Horn.
  10. Complete symmetry of design with terminals concealed underneath.

CIRCLE NUMBER 108 ON READER SERVICE CARD

Medieval and Renaissance Music for the Irish and Medieval Harps, Vièle, Recorder, and Tambourin. Elena Polonska, Guy Durant, Roger Cotte.

Turnabout TV 40195 stereo

The convolutions of international recordings diplomacy these days are incredibly involved. These players belong to the same "Groupe d'instruments anciens de Paris" which Capitol imports on the Pathé-EMI label. Capitol is owned by British EMI, of course. Here, they are reissued on Turnabout, American arm of Vox . . .

Anyhow, no spoken French here, but some interesting performances, on a bevy of relatively unusual old instruments. No singing, and this disc is a rather intimate one, for the "soft," indoor-type instruments of old. No brass. Excellent, in its field, and very nice in hi-fi sound, too. Ranges from the 1200's through as late as the early 17th century.

Schubert: Waltzes, Op. 9; Deutsche Tänze, Op. 33; Valses Nobles, Op. 77. Walter Hautzig.

Turnabout TV 340065 stereo

Vox's Walter Hautzig, from Vienna himself (via the Curtis Institute in Phila.) plays these many fluent and waltzy Schubert dances with unmistakable Viennese styling. They are lovely, never thumpy or rigid, always varied, for good contrast, and my only reservation is the rather pronounced *rubato* throughout (hesitations, slowings-up), which makes some of the music rather difficult to follow. It is good *rubato*, though, and always musical.

Schubert improvised dozens of these on end for actual dancing at the famous "Schubertiades," and wrote down only those for which he could find time. They are all but waltzes, though somewhat before the waltz period.

Bach Cantatas No. 56, "Ich will den Kreuzstab," No. 82, "Ich habe genug." Herman Prey, bar., Leipsic Gewandhaus Orch., Thomanerchor, Kurt Thomas.

Turnabout TV 340205 stereo

Here, Vox-Turnabout has the Ultimate Bach Source—out of Bach's own home town of Leipsic. The "Thomanerchor" is the choir of Bach's own church, St. Thomas. Doesn't prove anything necessarily—but fact is that these are lovely performances of two solo cantatas, for baritone and orchestra. The choir merely sings the chorale at the end of the first cantata. (Was there no room for a chorale at the end of Side 2? Could be.) If you love Bach's usual lengthiness and weight, and if you can take one good singer for two whole sides, you'll find this first rate. He wears very well on the ear. So does the orchestra.

## DIRECT IMPORTS

(Note. Lately, to add to the enormous numbers of domestic releases, direct imports have been coming in thick and fast, often imported by U.S. labels with foreign affiliations. Here are some samples. E. T. C.)

Orfeo Catalá. Homenaje al Mtro. Don Luis Millet. (Catalonian Choir.)

Odéon LALP 525 mono  
(via Capital)

This was an extraordinary boys' and mens' choir of Spain which made recordings, and a world-wide reputation, back before the Spanish Civil War. For "classical" collectors, its remarkable recordings of two Bach cantatas, No. 140, *Wachet auf* and No. 4, *Christ lag*, issued

on 78 in Europe and then again by Victor in the U.S.A., will bring this choir back poignantly to mind—many of us learned what a Bach Cantata was like through those two magnificent albums! I still have both of them.

Here, the famous choir sings a peculiar kind of semi-popular Spanish music in a sort of high-Romantic classical disguise. It is amazing. Nobody sings like this today anymore. Nor this kind of music. Each piece is a long, unbroken work—maybe two 12-inch sides in the original or even more. Six of them fill up the LP. Each is kind of Romantic choral symphony of trick effects, and the style of singing must be heard to be believed—such sighings and gaspings, such unctuous harmonies, such extraordinary instrumental effects! It is all terribly, terribly emotional, every note a tearing at the heartstrings and one wonders how such little boys could ever learn the stuff; but, then, little boys can learn anything, They sob and weep here like real troupers. Some of the choral tricks are so remarkable that I had to re-play one piece to be sure there wasn't a big orchestra of instruments with it. Nope. Only voices. Weird. In another piece, the voices seems to be imitating a flock of sheep, like the orchestra in Strauss's *Don Quixote*. No explanation on the imported jacket, so I can't vouch for the sheep.

Nevertheless, this is impressive music of its sort. Perhaps younger listeners should stay away, unless they love icky late-Romantic stuff. But older chorus fanciers, the sort who go for the Icelandic Singers, or the Welch, or Russian, or what-not, will find this record superb. Also, out of sheer curiosity, those who remember the Orfeo Catalá Bach recordings. I've often wondered whether any of these kids ever survived the Revolution, which came so soon afterwards. They were on the losing side.

Frühe Musik in Italien, Frankreich, und Burgund. Studio der Frühen Musik.

Telefunken SWAT 9466 stereo

(via London)

What a terrific disc! The finest of its sort I have ever heard. "Early Music of Italy, France, and Burgundy," it belongs in the "Pro Musica" category of old-music recordings, led so far hereabouts by the mass-production N.Y. Pro Musica, plus the older Belgian Pro Musica and, on recent Dover issues, the Ambrosian Singers under Denis Stevens. Like these and others, this one features very old music for solo voices and instruments, done up with impeccable musicological research.

But where the other records tend to be dull, or brassy-hard, as in the New York Pro Musica offerings, and the voices are often much less communicative than the old instruments, here the voices are—I can only use one term—electric! Stunning. So are the instruments. These people have the musical sincerity and feeling of the Belgian Pro Musica (Safford Cape) but, where the Belgians tends towards almost too much gentleness, these performers are as brilliant as the New York Pro Musica group with an enormously greater musical feeling to back it up. Their voices do not wobble, they are always beautifully blended, phrased, on pitch, and their dexterity in rapid passages, especially the mezzo-soprano Andrea von Ramm, is astonishing. So is the French and Italian diction—coming apparently from English and German singers.

Whatever they touch, with their weird instruments or their electrically alive voices, these people bring to vivid dramatic life. And this though the music, ranging from the 1300's to near 1600, is largely before the "real" music we have all been brought up on. (How wrong we were.) Whether Italian, Burgundian, or French, it's all exciting and often most persuasive—or really funny. Nothing stodgy here!

The performers are a bit of a mystery. The "Studio for Early Music" is otherwise unidentified but it includes such names as Karl Heinz Klein, Johannes Fink, as well as Don Smithers and Sterling Jones. Wonder where they hang out? Wherever it may be, DON'T MISS Andrea von Ramm, in particular. She's a Medieval Anna Russell, a superb musical actor.

Even the stereo sound is tops. It would be, from Germany.

Schütz: Cantiones Sacrae 1625. Dresdner Kreuzchor, Mauersberger.

Telefunken SAWT 9468/70 (3) stereo

(via London)

Schütz: Motets from "Cantiones Sacrae." Niedersächsischer Singkreis, Hannover, Träder.

Nonesuch H-71062 stereo

Here's a complete imported version of all 40 of these splendid short choral pieces, competing with a Nonesuch import also from Germany. Nonesuch, on one disc has eighteen of the forty, which takes three records on Telefunken.

German choral singing today is fantastically good, and especially in the all-male church choirs and singing clubs. The style is remarkably uniform, too—intense, accurate, minus vibrato, the boys pure and earnest, the men somewhat guttural in tone, the harmony-ensemble, as clean as a barbershop quartet.

These two are thus much alike, though Nonesuch has some of the works unaccompanied (an optional choice in such music). But the Telefunken group, from Dresden, turns in an inferior performance on a number of scores. Muddier, over-live and distant sound, for one thing. And a tendency in the singers towards plodding, or jouncing rhythm, not well phrased. Nonesuch's Hannover group sings with more musical tension, a long, live phrase, better diction, and in a much clearer, cleaner acoustic surround.

Telemann: Tafelmusik III, Teil (Musique de Table, Third Production). Soloists, Concerto Amsterdam.

Telefunken SAWT 9453/54 stereo

(via London)

If you like Baroque and want an all-in-one cross section of Baroque instrumental music à la Telemann, try this! You'll find, too, why Telemann was the most respected and most original composer of his time, as per his own contemporaries.

He published three "productions"—collections—of his so-called "Table Music," music for entertainment, (perhaps fancifully at banquets), each with a novel arrangement of varied works. A full-size orchestral suite (with all sorts of interesting modifications in detail, quite startling to a Bach listener), a quartet, here for flute, violin, cello, and continuo, a concerto, for two horns and orchestra, a trio, for two flutes and continuo, a solo sonata, for oboe and continuo—and a "conclusion," a brief, snappy orchestral movement for all the instruments. All these appear on these two

(Continued on page 75)

# EDITOR'S REVIEW

---

**B**ACK IN THE PALMY days of early hi-fi, it used to be accepted that there was one industry show during the year—the BIG one in New York. Now there are hi-fi shows practically everywhere. The next one on the calendar is at Philadelphia—in the Benjamin Franklin Hotel—February 18, 19, and 20. This is one of the better locations in the country from the standpoint of room sizes and over-all accessibility.

Then the REAL BIG show hits the boards on March 27 at the Ambassador Hotel in Los Angeles. This is always one of the greatest shows in the U.S. in our opinion, because of the facilities. The rooms are easily accessible, rather larger than average, and being in what might be likened to a garden apartment complex, are not jammed together as to create a hodge-podge of sound. We recall one L.A. Show where you could hear the Scott equipment just as well in the Electro-Voice exhibit as you could in the Fisher room. But if every hi-fi show were as well situated as the Los Angeles show is, hi fi exhibits would hit a new peak in attendance and resultant business.

Comes next the San Francisco show, held for the first time in the new Civic Auditorium building. This one opens on April 18th, and lasts through the 25th, but not having yet attended a show in these surroundings we are unable to assess the location and facilities. However, having seen and heard shows practically everywhere in the U.S., we will wager that it will turn out to the satisfaction of exhibitors and attendees alike. They always seem to.

## U.S. DEPARTMENT OF COMMERCE SHOW

In the furtherance of International Trade, the Government has got-

ten into the hi-fi-show business. Beginning with Frankfurt in 1964, and following with Milan in 1965, the U.S. Department of Commerce has staged hi-fi shows in West Germany and Italy, and with rather spectacular results in terms of sales. Consequently, since there is a large and almost untapped hi-fi market in England for U.S. products, London has been chosen for this year's U.S.D.C. show, and the location is the U.S. Trade Center, 57 St. James Street, which is just off Piccadilly.

For a hi-fi show outside of the U.S., there is quite an impressive list of exhibitors—32 in all, as of this writing, in addition to Audio. The list must of necessity be limited to those manufacturers whose products are actually made in the U.S., of course, which means that some of the products which are well known and well accepted in this country but which are imported from elsewhere will not be represented. However, anyone who "happens" to be in London in that month will have an opportunity to see all the British products, as well as some of the European ones, at the International Audio Fair at the Russell Hotel in London from April 14 to 17, while the U.S.D.C. show is to be held from April 14 to 22, nearly co-incident with the San Francisco Show. Oh, well, we guess we just can't make 'em all. We've already given up on the Festival du Son in Paris, March 10-15. We're waiting for shows in Cairo, Capetown, and Canberra, to say nothing of Buenos Aires.

## LATEST INTEREST FOR THE AUDIO BUFF

And now we are thinking about a natural step-up for the confirmed audio recordist, who may have ex-

hausted *his* horizons on ¼-in. tape and who is now looking forward to experimenting with the ½-in. version in Video Recording. We are inclined to predict that this will be the next big boom in home entertainment equipment. Wherever they have been available so far, they have sold out, so it is not as easy to buy a VTR as a loaf of bread or a fifth of milk, but manufacture is beginning to catch up to where it can keep in step with the demand.

While admittedly—so far—not as portable as an 8-mm movie camera, the results are comparable, and portability will come. We can well remember when a personal portable radio was rarely as small as a college dictionary, but now they are smaller than a package of cigarettes. So we are fairly certain that one will be able to take his VTR anywhere an automobile can go, and still take pictures to his heart's content—and see them within minutes.

Our SOUND & SIGHT column is busily engaged in researching all the possibilities and techniques, and will keep readers continually—and reliably—informed about this new art.

## OMISSIONS

Readers who scan the "COMING" column on page 2 will note that the contents of this issue do not include everything we had anticipated. It appears that we sometimes get over-ambitious, and then space does not materialize, or the article was not completed to our satisfaction, or some similar unforeseen occurrence militated against our fulfilling our projected "Comings." In other words, we sometimes bite off more than we can chew. Anyhow, these same items will crop up again in a month or so, you may be sure.

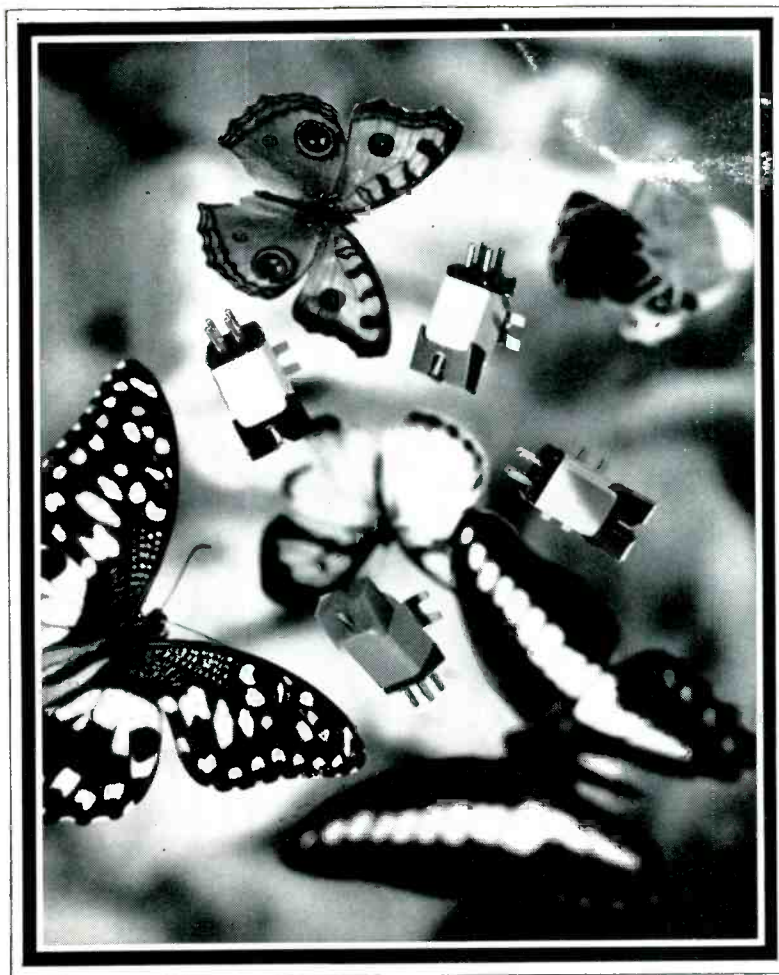

## Capture natural sound with Pickering.

From the softest flutter of the woodwinds to the floor-shaking boom of the bass drum, natural sound begins with Pickering. Right where the stylus meets the groove.

Any of the new Pickering V-15 stereo cartridges will reproduce the groove, the whole groove and nothing but the groove. That's why a Pickering can't help sounding natural if the record and the rest of the equipment are of equally high quality.

To assure compatibility with your stereo equipment, there are four different Pickering V-15 pickups, each designed for a specific application. The new V-15AC-2 is for conventional record changers where high output and heavier tracking forces are required. The new V-15AT-2 is for lighter tracking in high-quality automatic turntables. The even more compliant V-15AM-1 is ideal for professional-type manual turntables. And the V-15AME-1 with elliptical stylus is the choice of the technical sophisticate who demands the last word in tracking ability.

No other pickup design is quite like the Pickering V-15. The cartridge weighs next to nothing (5 grams) in order to take full advantage of low-mass tone arm systems. Pickering's exclusive Floating Stylus and patented replaceable V-Guard stylus assembly protect both the record and the diamond. But the final payoff is in the sound. You will hear the difference.

PICKERING—for those who can  the difference.

Pickering & Co., Plainview, L.I., N.Y.  
Circle 118 on Reader Service Card

Compare these Sherwood features and specs! *ALL-SILICON* reliability. Noise-threshold-gated automatic FM Stereo/mono switching, FM stereo light, zero-center tuning meter, FM interchannel hush adjustment, front-panel stereo headphone jack, rocker-action switches for tape monitor, mono/stereo, noise filter, speaker disconnect and loudness contour. 100 watts music power (8 ohms) @ 0.3% harm distortion. IM distortion 0.1% @ 10 watts or less. Power bandwidth 12-35,000 cps. Phono sens. 1.8 mv. Hum and noise (phono) -70 db. FM sens. (IHF) 1.6  $\mu$ v for 30 db quieting. FM signal-to-noise: 70 db. Capture ratio: 2.4 db. Drift  $\pm$ .01%. 40 silicon transistors plus 14 silicon diodes and rectifiers. Size: 16½ x 4½ x 14 in. dp.

Model	Vacuum Tube S-ALL-SILICON T-Germanium Transistor	Power (RHF) 2 channels 8 ohms Watts	Max. IM Distortion Below 10 watts	FM Sensitivity Microvolts	Price	Dollars/ Watt
Sherwood S-8800	S	100	0.10%	1.6	\$ 359.50	3.60
Altec 711	S	100	0.15%	2.2	378.00	3.78
Bogen RT 8000	T	70 (4W)	0.3%	2.5	319.95	4.57
Dyna FM-3, PAS-3, & 3-70	V	90	0.1%	4.0	394.85	4.38
Fisher 600 T	V & T	120	1.6%*	1.8*	459.50	3.82
Harman-Kardon SR-900	T	75 (4W)	0.9%*	3.3*	429.00	5.61
McIntosh MR71 & MA230	V & T	88	0.25%*	1.8*	748.00	8.50
Marantz 8B, 7, & 10B	V	75*	0.2%*	2.0	1170.00	15.60
Scott 348	V & T	100	0.5%	1.9	479.95	4.79

Reference "T" (above) may include some silicon transistors. Figures above are manufacturers' published specifications except (\*) which are published test findings.

# SHERWOOD SPECS SPEAK FOR THEMSELVES



S-8800 100-watt FM *ALL-SILICON* Receiver  
 \$359.50 for custom mounting  
 \$368.50 in walnut leatherette ca-e  
 \$387.50 in hand-rubbed walnut cabinet



*Sherwood*

Sherwood Electronic Laboratories, Inc., 4300 North California Avenue, Chicago, Illinois 60618 Write Dept. A2

Circle 119 on Reader Service Card



# Test Instruments and the Audio Buff

• HERMAN BURSTEIN\*

While the entire subject of audio measurements is a complex one, there are a number of uses to which even the most inexperienced audio enthusiast can put simple test equipment to make sure his "rig" is performing properly and to keep it in top condition throughout its life.

TO THE ARDENT AUDIO BUFF the love of equipment and the love of music are inseparable. No matter how much time and money and effort he has put into his audio system, he is never quite satisfied and never quite done. He is ever window-shopping for a better phono cartridge, better speakers, a better amplifier, a better whatnot. He revisits the audio salons and avidly reads the equipment reviews. And every so often he replaces one component with another.

Considering the audio buff's travail in choosing, acquiring, and improving a system, and how he suffers when aught goes wrong, it is surprising how little if anything he spends on test instruments to ensure maximum performance. It is surprising because even without technical skill the audio buff can make valuable use of these instruments. It is further surprising because such helpful items as meters, signal generators, and capacitor checkers can be purchased, at least in kit form, for about the price of a good magnetic cartridge, and even such items as distortion meters can be had for no more than the cost of a top-quality cartridge.

Perhaps the audio buff's reluctance to acquire instruments is less a question of cost than a baseless fear he is incompetent to use them. Perhaps, like the person who won't make a will because he can't contemplate death, he wants no visible evidence that anything

might ail his system. All the same, a few relatively inexpensive instruments whose use is easily learned can help the audio buff get the best out of his system and can save him unnecessary woe. How much fun is it to lug a heavy amplifier to and from a service shop and wait several weeks in between, only to find the fault was in a cable back home that could have been checked with an inexpensive meter?

## Basic Uses

Instruments are of course essential to the expert for basic research, equipment design, modification of equipment, sophisticated alignment procedures, and solving deep audio troubles. But instruments in the hands of the amateur can also perform useful, though simpler tasks. They can be useful in the following basic ways.

1. Checking the performance of new components to make sure they come up to the manufacturer's specifications.
2. Checking the performance of old components to make sure they perform as they originally did.
3. Finding the source of trouble in equipment not working properly.
4. Aligning equipment—not everything, but at least the simpler things.
5. Checking the elements of a kit to make certain all parts are of proper value and quality.
6. Checking a kit for accurate construction.

These basic uses could easily fill several articles or books. However, we shall limit the discussion to what the

audio buff might do with test instruments.

## Checking Performance of Components (New or Old)

There are many aspects of performance in audio, but the dominant triumvirate are frequency response, distortion, and signal-to-noise ratio.

**Frequency Response.** To check the response of a single component or the assembled system, you need an audio generator to feed signals in, and a meter to measure the signals coming out, as in Fig. 1. The generator is connected to the item under test, say an amplifier, just as a tuner would be connected to the amplifier. The meter is connected to the output of the item (amplifier) under test. Feed in a series of signals covering the audio range and perhaps beyond, and measure their relative level at the output. The input signals must be "flat"—all of equal magnitude. Some audio generators have a built-in meter for this purpose; you can adjust the level of the input signal in accordance with the meter indication. If the generator has no meter, use the setup of Fig. 2 to ensure flat input signals. Then the one meter is switched to read input and output signals alternately. These readings are in dB (decibels) rather than absolute voltage. The meter must have flat response over the frequency range used for the test.

Some special precautions are in order when checking the record-playback response of a tape recorder. To avoid saturating the tape at high frequencies and thus producing an erroneous indication of treble loss, the test signals must be at least 20 dB below maximum permissible recording level. That is, they must be 20 dB below the recording level that at 1000 Hz causes a magic eye to close or a neon lamp to ignite; or they must be 14 dB below the recording level that at 1000 Hz causes a VU meter to indicate 0 VU (a properly calibrated VU meter indicates 0 VU at a level about 6 dB below maximum permissible recording level). Before checking frequency response, clean and demagnetize the heads to

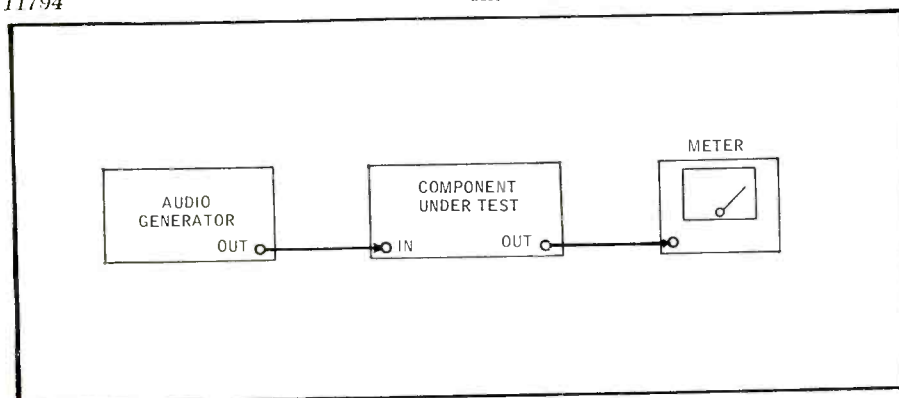

Fig. 1. Checking an audio component for frequency response.

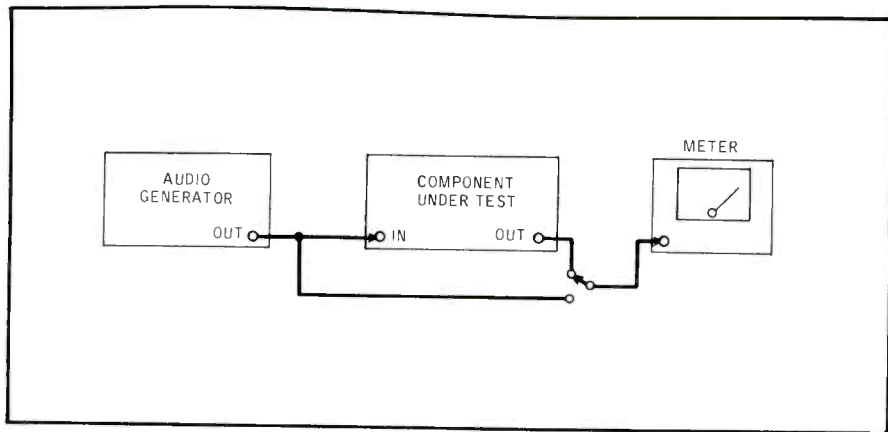

Fig. 2. Checking an audio component for frequency response, using the meter to adjust the generator for "flat" (uniform) output over the frequency spectrum.

eliminate treble loss due to dirty or magnetized heads. It should be added that it is common practice to check playback response independent of the recording function; then the source of input signals is a test tape.

Quite-adequate audio generators are available for about \$40 or less in kit form, and perhaps 50 per cent more in wired form. The kits present no special construction problems. These generators start at about 10 or 20 Hz and go up to about 100,000 or 200,000 Hz, so they can check the high-end performance of almost any audio component.

The meter can be a VOM (volt-ohm-milliammeter) or a VTVM (vacuum-tube voltmeter). Good meters are available for about \$25 or \$30 in kit form, and for about 60 per cent more in wired form. Compared with a VTVM, the VOM has the advantage of portability (because it is not powered by house current) and of being able to measure current directly (whereas a VTVM requires you to measure current indirectly by finding the voltage across a known resistance and dividing the voltage by the resistance). But a VTVM is generally preferable for measuring frequency response because of its wider and more uniform response, and because it presents a higher load resistance to the item being measured, so that it is less likely to upset the performance of this item. If you are measuring very small input and output voltages, as might be the case when making tests involving magnetic-phono pickups, tape heads, and amplifier inputs for these devices, you may need an a.c. VTVM, which can indicate differences in magnitude clearly and accurately for signals of a only a few millivolts. The a.c. VTVM in kit form might cost about \$35, compared with \$25 or \$30 for a VTVM.

**Distortion.** Checking harmonic distortion requires an audio generator to

supply signals to the item under test, and a distortion meter connected to the output, as in Fig. 3. To check intermodulation distortion, only a single instrument is needed, as in Fig. 4; this supplies the special input signals (customarily a combination of 60 Hz and 6000 Hz in 4:1 ratio), and also measures the output distortion.

A bonus of distortion meters is that they incorporate a sensitive a.c. VTVM. This can be used independent of the distortion-checking function if desired, eliminating the need to buy a separate a.c. VTVM. In kit form, distortion checkers are available for as little as approximately \$55.

A special note applies to measurement of harmonic distortion in a tape recorder. This measurement is customarily made at a mid-frequency, usually 400 Hz, and not at treble frequencies. And it is made at the maximum permissible recording level as indicated by the magic eye, neon lamp, or VU meter. (In the case of a machine with a properly calibrated VU meter, the recording level should be about 6 dB above that which causes the meter to indicate 0 VU.) At this level, the great amount of treble boost employed in recording would emphasize a high-frequency input signal (for example, 10,000 Hz) to a degree that produces appreciable tape distortion. But this would offer a misleading indication of the performance of the tape recorder. In practice, the treble boost is offset by the fact that the high-frequency content of most sounds is of substantially lower level than the mid-range.

**Signal-To-Noise Ratio (S/N).** To check S/N, again you need an audio generator to supply an input signal, and a meter to measure output. The input signal is usually 1000 Hz.

The first step in measuring S/N is to drive the component under test to a reference level. Ordinarily this is stated

as so many volts output or so many watts output, with the component's gain control (if any) full on. Thus in the case of a power amplifier rated at 30 watts, you would feed in enough signal at 1000 Hz to drive it to 30 watts. In the case of a preamp rated at 3 volts, you would feed in enough signal at 1000 Hz to drive it to 3 volts output (with the gain control full on). In the case of a tape recorder, you would feed in enough signal at 400 Hz to drive the machine to maximum permissible recording level as indicated by the magic eye, neon lamp, or VU meter. In the case of the magnetic phono input or tape head input of an amplifier, the reference level is properly stated as a certain number of millivolts *input* at 1000 Hz. Customarily this is 10 mV for magnetic phono input; it might—or might not—be about 3 to 5 mV for tape head.

When the reference level has been established (that is, while feeding in a signal of required magnitude or one that produces an output signal of required magnitude), the output of the component under test is measured. Then the input signal is removed, the input terminals shorted, and the output of the component is again measured; now the output consists only of noise. The difference between the outputs expressed in dB, is the S/N ratio. The meter employed (VOM, VTVM, or wattmeter) customarily has a dB scale.

When measuring S/N of a power amplifier and establishing the reference level, you are dealing with wattage rather than voltage output, and it is desirable but not necessary to have a wattmeter (which may be incorporated in a distortion checker). But you can just as well read wattage with a VOM or VTVM. Load the power amplifier with a resistor equal in value to the stated output impedance of the amplifier, for example, an 8-ohm resistor connected to 8-ohm output taps. The wattage rating of the resistor (ability to dissipate heat) should be at least as great as the rated output of the amplifier, for example 40 or 50 watts. Using a VOM or VTVM, read the voltage across the load resistor, and calculate wattage by this form of Ohm's Law:  $P = E^2/R$ , where P (power) is watts, E is volts, and R is resistance.

**Other Tests.** In addition to the basic performance checks we have described, a number of other significant tests can be performed easily, with a minimum of equipment, and inexpensive equipment at that. You might want to check sensitivity, that is, the amount of signal input required for a stated signal output. You might want to check stereo separation: how much signal appears in one channel when you feed a signal

into the other channel. You might want to check an amplifier's equalization characteristic on magnetic-phonograph input or on tape-head input: feed in low-level signals of equal magnitude, and measure the variation in output response. You might want to check how many volts your preamp can deliver before it reaches, say, 1 per cent intermodulation distortion. You might want to check how many millivolts signal you can feed into your amplifier's magnetic-phonograph input before there is appreciable distortion at the amplifier output. You might want to check the speed of your phonograph or tape recorder, in this case requiring that you equip yourself with a stroboscope disk (for phono), or a stroboscopic tape wheel or stroboscopic tape.

### Trouble Shooting

If there is trouble in your system and the system has separate components (such as separate tuner, preamp, and power amplifier), the first step is to identify the defective component. This can almost always be done by intelligent deduction. For example, if the sound is fine on phono but ragged on FM, this suggests the tuner is at fault. If phono and FM are both ragged, but FM sounds fine when plugged directly into the power amplifier (bypassing the preamp), the preamp is probably the culprit. And so forth. With stereo equipment, where it is often possible to substitute a known good channel for a suspected bad one, the detection process tends to be all the easier.

In any event, when the defective component has been identified, test instruments can help narrow the search for the cause of difficulty. If you have a schematic for the faulty component and can read it just well enough to find your way from point to point, you can try injecting a signal (from an audio generator) at various points in the component, starting at the output and working back to the input. So long as the output signal "appears good," there is no trouble between the test point and the output. You can judge whether the output signal "appears good" by listening to it, by measuring it on a VOM or VTVM, or by looking at it on an oscilloscope. (Oscilloscopes satisfactory for audio are available for as little as \$55 in kit form.) When you have moved the input signal to a point in the component where the output signal is no longer satisfactory (distorted, too low, excessively noisy, intermittent, and so on), the trouble lies between the point where the signal is applied and the prior test point. Then the parts in that area—tube or transistor, capacitors, resistors, and the like—are suspect.

Tubes can be checked readily by substitution. Transistors are another mat-

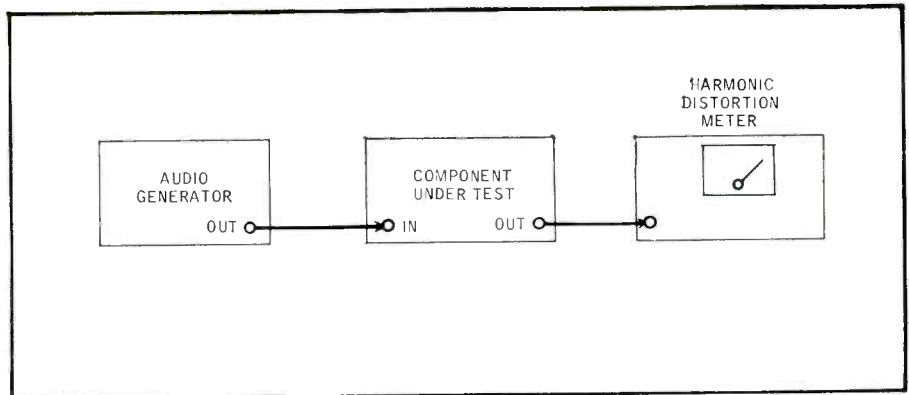

Fig. 3. Measuring harmonic distortion.

ter, perhaps even if located in sockets instead of wired into the circuit. Resistors can be checked for correct value by either VOM or VTVM. A capacitor checker is needed to test capacitors for correct value, opens, shorts, or excessive leakage. This instrument can be obtained for about \$25 in kit form, and for about 25 per cent more in wired form. It is often necessary to disconnect one end of a capacitor from the circuit in order to make a satisfactory check, unless you use a special type of capacitor checker that permits "in-circuit" testing.

A supplementary procedure for locating the trouble area is to measure voltages and resistances at test points specified by the manufacturer of the component. These test points are usually at the tubes and transistors, and are easily identified. Either the VOM or VTVM may be used to check resistances (with the component disconnected from the power line of course). While the VOM may be satisfactory for checking voltages, depending on the quality of the particular instrument used, it is wiser as a rule to use a VTVM, particularly when measuring relatively small voltages; the lower resistance of the VOM may affect the voltage being measured. If a voltage or resistance is considerably different from what the manufacturer says it should be, say more than 20 per cent off, the

resistors, capacitors, and other parts associated with that test point are suspect and should be checked.

Don't overlook the possibility of the trouble being in a cable that connects components. A faulty cable or one insecurely connected to the components can account for hum, noise, distortion, intermittent operation, or no operation at all. Excessive flexing or poor construction can produce an open or short in the cable. Age can build up dirt or oxidation that causes a high-resistance instead of low-resistance contact between the cable plugs and the components' jacks. On its resistance ranges, the VOM or VTVM serves as a continuity checker that enables you to identify whether a cable has an open, short, near short (finite instead of virtually infinite resistance between hot and ground leads), or near open (finite instead of virtually zero resistance between opposite ends of the same lead). We should mention that instruments for measuring capacitance can often measure resistance as well, and therefore are able to check continuity. Between the two "hot" terminals at either end of a cable, one should measure virtually zero resistance, as illustrated in Fig. 5. Similarly, there should be no noticeable resistance between the two ground terminals. But there should be virtually infinite resistance between the hot terminal and ground terminal (when

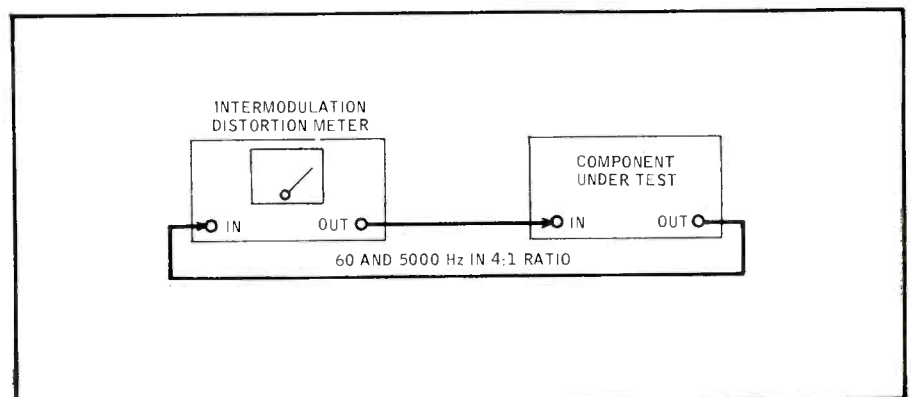

Fig. 4. Measuring intermodulation distortion.

the cable is disconnected from the components).

The VOM or VTVM (or capacitor checker used as a resistance-measuring device) can serve in additional useful ways as a continuity checker. For example, a cable leading from the amplifier to a speaker may be partly hidden from view (perhaps under a rug), and you may have forgotten which lead is which—important information in order to assure correct polarity in a stereo installation. If you can get at opposite ends of each lead, the resistance check can tell you which ends belong to the same lead. Suppose that the cable goes to extension speakers in another room. You can connect a flashlight battery to the leads in one room, and you can measure d. c. voltage with your VOM or VTVM in the other room. The connection between the meter and the speaker leads will give either a positive or negative reading. If a negative reading, reverse the connections between the meter and the leads. Now identify the lead connected to the positive terminal of your meter: tie a knot in the lead or mark it with fingernail polish. Similarly identify the lead connected to the positive (center) terminal of the flashlight battery. Thus you have identified opposite ends of the same lead.

To take one more example, you might verify that you have a continuous lead to your FM or TV antenna by temporarily shorting the leads at the far end and using your meter at the near end to see whether you then have a continuous electrical path between the two leads; due to the length of the antenna lead-in, the meter reading may be a few ohms. Removing the short at the far end, you should then get a reading of virtually infinite resistance, indicating no short in the lead-in.

#### Aligning Components

While there are alignment procedures too technical for the average audio buff, others are simple enough provided the necessary instruments are at hand. For example, some tube amplifiers incorporate a bias adjustment which merely requires connecting a d.c. voltmeter at a clearly designated and readily available point, and adjusting a control so that the meter (VOM or VTVM) gives a specified indication. Then the amplifier yields optimum performance. When output tubes are replaced, this adjustment must be remade. Even if they are not replaced, the adjustment should be checked occasionally.

In balancing the two channels of a stereo system, it may be helpful to use the signal from an audio generator instead of program material (tuner, phono, or tape), and to use the evi-

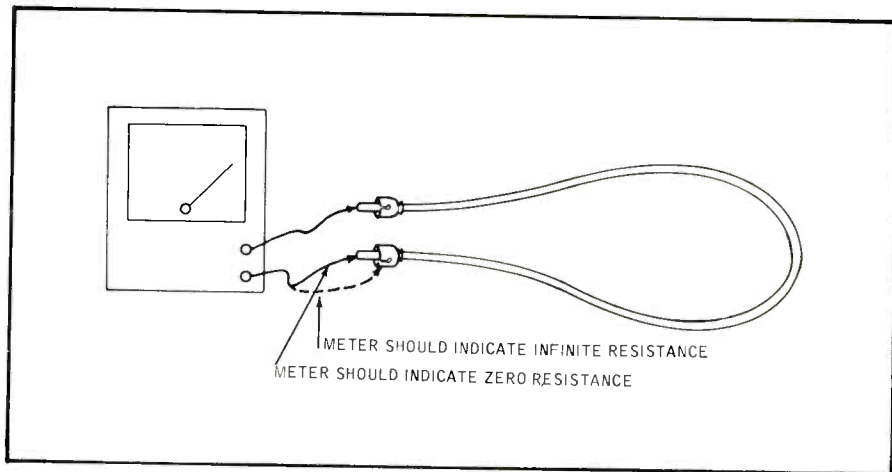

Fig. 5. Using a resistance-indicating meter (ohmmeter) to check cable continuity.

dence of a meter instead of one's ears. Equality between channels is achieved by adjusting input level-sets, gain controls, and balance controls.

Alignment of most FM tuners is far too technical a task for the average person. But some tuners in kit form are designed for alignment by the layman with even no instruments at all. On the other hand, a meter may facilitate the task, and perhaps make alignment somewhat more accurate than it would otherwise be.

In adjusting a tape playback head for correct azimuth, it is possible to play a recorded tape and align the head by ear for maximum treble response. But you can be more certain of best results by playing a test tape carrying a prolonged high-frequency tone, and adjusting the playback-head azimuth for maximum response as indicated by a meter connected to the output of the tape machine.

The better tape recorders include controls for adjustment of bias (which affects output level, distortion, and treble response), and the adjustments can be done in various ways. An audio generator and/or meter will generally be needed. For example, some manufacturers recommend adjusting bias by recording and playing a specified tone (such as 1000 Hz) and adjusting bias for maximum output of this tone. What is sometimes done is to consider this a preliminary adjustment and make a fine adjustment (a *slight* increase or decrease in bias) that improves record-playback frequency response. In other cases, the manufacturer specifies a certain voltage to be measured at a given point: or a certain amount of current flowing through the record head (measured by measuring voltage across a known resistance in series with the head). Similarly, a tape recorder, particularly a high-quality one, may include internal adjustments for record and playback level, and for calibrating the

record-level indicator; these call for a signal source, a meter to measure output, and a harmonic-distortion meter—the last for the purpose of calibrating the record-level indicator.

#### Kit Building

A VOM (or VTVM) and a capacitor checker can be of great aid in the accurate construction of an audio kit. To begin, it is wise to check each resistor for proper value. For proper operation of the kit, resistors must be within a designated percentage of design value, ranging from 20 per cent down to 1 per cent. Sometimes a pair of resistors must be virtually identical in value. Similarly, capacitors should be checked for proper value, for possible shorts or opens, and for excessive leakage. More than one kit has failed to work through no fault of the builder, but because of a defective part. Yet it is hard to blame the kit manufacturer, because it would add appreciably to the cost of the kit if the manufacturer had to check every last part. His quality control procedures are such that generally, but not always, all parts are okay.

During construction it is wise to check periodically the steps taken. For example, if you have snaked a rather long lead from one point to another, use the VOM (or VTVM) to check continuity between these points; this not only makes sure there is no break in the lead, but checks your soldering for a good electrical connection. If you have had to apply considerable heat to solder a resistor to a particular point, it is a good idea to make sure the resistor has not appreciably changed value owing to the applied heat. If you have something like three or four leads coming to a common tie point, there is always the possibility that one of these leads is floating free within the solder blob and not making good electrical connection.

(Continued on page 75)

# Audio Test Equipment Compendium

On the following pages are presented several of the more useful items of audio testing equipment that the serious audio buff will want to scan thoroughly when he begins to assemble an embryonic "test lab." There are many other similar items available, but the ones listed here are offered by the manufacturers with which AUDIO readers are most familiar.

## VOLTOHMMETERS

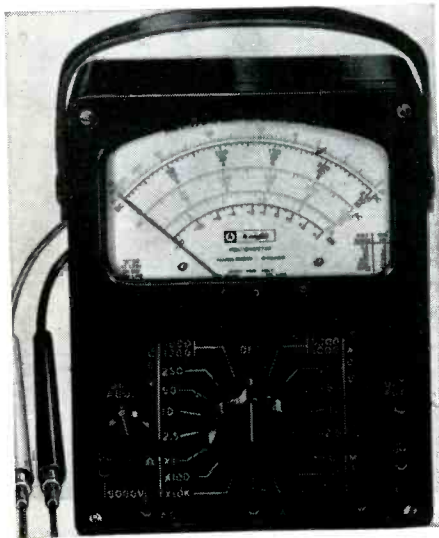

KNIGHT 83U972 MW

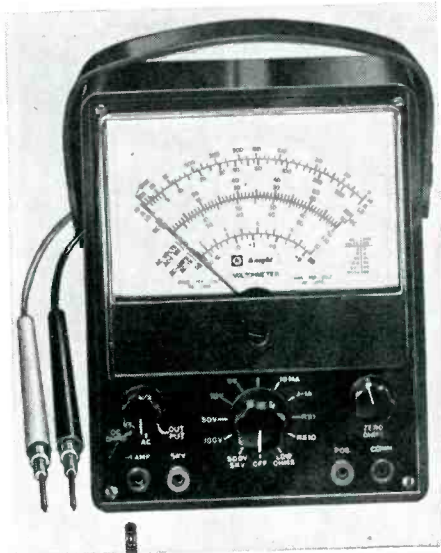

KNIGHT KG 645



HEATH MM-1

MAKE and MODEL	SENSITIVITY	RANGES	COMMENTS	PRICE	
				KIT	WIRED
EICO 536	d.c. - 1000 OHMS/VOLT	0-1, 5, 10, 50, 100, 500, and 5000 volts	3-in. meter. Measures a.c.V., d.c.V., d.c. amps, ohms	\$14.95	\$18.95
EICO 566	d.c. - 1000 OHMS/VOLT	0-1, 5, 10, 50, 100, 500, and 5000 volts	4 1/2-in. meter. Measures a.c.V., d.c.V., d.c. amps, ohms	\$16.95	\$22.95
EICO 565	d.c. - 20,00 OHMS/VOLT	0-2.5, 10, 50, 250, 1000 and 5000 volts	4 1/2-in. meter. Measures a.c.V., d.c.V., d.c. amps, ohms	\$24.95	\$29.95
HEATH MM-1	d.c. - 20,000 OHMS/VOLT a.c. - 5000 OHMS/VOLT	0-1, 5, 50, 150, 500, 1500, and 5000	4 1/2-in. meter. 1% resistors used throughout for maximum accuracy. Measures a.c.V., d.c.V., d.c. amps, ohms. 150 μA full scale	\$29.95	—
KNIGHT KG-645	d.c. - 1000 OHMS/VOLT	0-1, 5, 10, 50, 100, 500, and 5000 volts	4 1/2-in. meter. 1% resistors used for maximum accuracy. Overload protectors. Measures a.c.V., d.c.V., d.c. amps, ohms	\$17.95	—
KNIGHT 83U972MW	d.c. - 20,000 OHMS/VOLT a.c. - 5000 OHMS/VOLT	0-1, 5, 10, 50, 250, 1000 and 5000 volts.	4 1/2-in. meter. 1% resistors used for maximum accuracy. Overload protection. Measures a.c.V., d.c.V., d.c. amps, ohms. 100 μA full scale	\$29.95	—
LAFAYETTE 99R-5010	d.c. - 1000 OHMS/VOLT	0-15, 150, 1000 volts	Pocket-sized; measures a.c.V., d.c.V., d.c. amps, ohms	—	\$4.95
LAFAYETTE 99R-5004	d.c. - 30,000 OHMS/VOLT a.c. - 15,000 OHMS/VOLT	0-2.5, 10, 25, 100, 250, 500, and 1000 volts	Has buzzer short test; uses 1% resistors. Measures a.c.V., d.c.V., d.c. amps, ohms	—	\$16.88
LAFAYETTE 99R-5013	d.c. - 20,000 OHMS/VOLT a.c. - 5000 OHMS/VOLT	0-2.5, 10, 50, 250, 1000, and 5000 volts	6-in. meter; 1% resistors used. Measures a.c.V., d.c.V., d.c. amps, ohms. 50 μA full scale	—	\$26.95

# VACUUM-TUBE VOLTMETERS



**EICO 222** A general purpose ac-dc-ohms unit with a low-scale sensitivity of 3 volts full scale. A zero-center-scale feature is provided for null-type readings. A single multi-purpose probe is supplied for use with all measurements. Frequency response is 30 Hz to 3 mHz. Price is \$27.95 as a kit and \$42.95 wired.

**EICO 232** A general purpose ac-dc-ohms unit with a low-scale sensitivity of 1.5 volts. A zero-center-scale feature is provided. This VTVM is calibrated for direct readings of peak-to-peak a.c. voltages. A single multi-purpose probe is supplied for use with all measurements. Frequency response is 30 Hz to 3 mHz. Price is \$29.95 as a kit and \$49.95 wired.

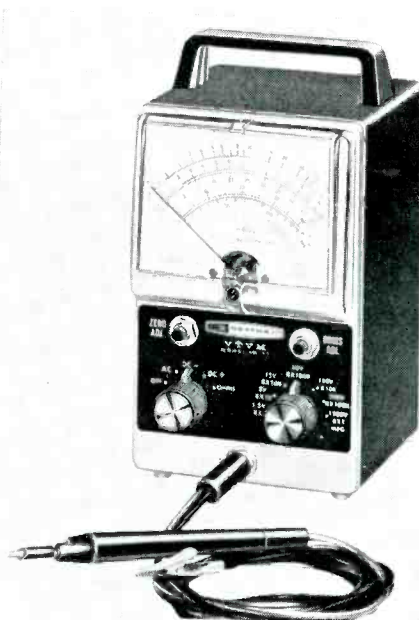

**Knight KG-620** A general purpose ac-dc-ohms VTVM with a maximum full-scale range of 1.5 volts. Separate probes are provided for a.c. and ohms or d.c. volts. The meter may be set for center-scale measurements. Rms or peak-to-peak measurements may be made. Frequency response is 30 Hz to 5 mHz  $\pm$  3dB. Price as a kit is \$24.95; \$39.95 is the wired price.

**Heath IM-11** A general purpose ac-dc-ohms VTVM with a maximum full-scale sensitivity of 1.5 volts. A single multi-use probe is employed. A zero-center-scale feature is provided. Rms or peak-to-peak measurements may be made. Price is \$24.95 as a kit and \$39.95 wired.

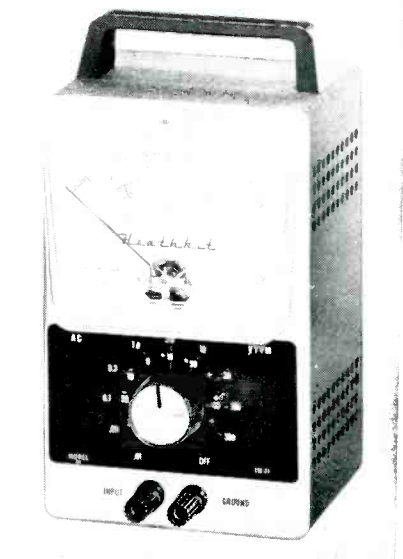

**Heath IM-21** An a.c. VTVM for audio work. Frequency response is 10 Hz to 500 kHz  $\pm$  1dB. Maximum sensitivity is 10 mV full scale. Decibel ranges are -40 to +52 dB in 10-dB increments. Price as a kit is \$33.95 and \$52.95 wired.

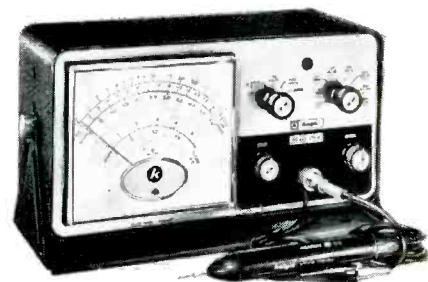

**Knight KG-625** A deluxe general purpose ac-dc-ohms VTVM. Maximum a.c. sensitivity full scale is 1.5 volts, d.c. measurements may be made down to 0.5 volts full scale. The meter has a 6" face and is equipped with a combination probe for all measurements. Rms or peak-to-peak measurements may be made, as well as a center-scale zero set. Price is \$36.95 as a kit and \$53.95 wired.

**Lafayette 38R 0101** A general purpose ac-dc-ohms VTVM. Maximum sensitivity, full scale, is 3 volts. The meter has a 6 1/2" face. A pilot light indicates the unit is powered. A.c. peak-to-peak or rms measurements may be made from the a.c.-ohms probe. A separate probe is used for d.c. The pointer may be set for a zero center. Price is \$26.95 wired only.



**EICO 250** An a.c. VTVM designed particularly for audio measurement work. Maximum sensitivity is 1 mV full scale. Decibel range is -80 to +52 dB in 10-dB increments. Frequency response is  $\pm$  0 dB from 10 Hz to 600 kHz. A switch converts the instrument to a high-gain amplifier with a maximum voltage output of 5 volts rms. Price is \$49.95 as a kit and \$79.95 wired. The same unit is available without the amplifier feature at \$44.95 or \$72.95. Also available is a reduced sensitivity VTVM that is also calibrated as a wattmeter. Price is \$49.95 as a kit and \$79.95 wired.

# AUDIO GENERATORS



**Knight KG-653**



**Heathkit IG-72**



**Heathkit IG-82**

MAKE and MODEL	SINE-WAVE RANGE	SQUARE-WAVE RANGE	CALIBRATION ACCURACY	DISTORTION	OUTPUT HI Z	ATTENUATOR TYPE	PRICE	
							KIT	WIRED
BARKER & WILLIAMSON 210	10 Hz-100 kHz	none	not given	0.2%	5 volts	single continuous	—	—
EICO 377	20 Hz-200 kHz	60 Hz-50 kHz	±3%	1%	14 volts	single continuous	\$37.95	\$54.95
KNIGHT KG-653	20 Hz-1 MHz	none	not given	0.3%	10 volts	step-type and continuous	\$39.95	—
HEATH IG-72*	10 Hz-100 kHz	none	±5%*	0.1%	10 volts	6-position step-type and continuous	\$41.95	\$64.95
HEATH IG-82**	20 Hz-1 MHz	same	not given	0.25%	sin-10V rms square-10V p-to-p	step-type and continuous	\$51.95	\$94.00
LAFAYETTE 99R-5014	20 Hz-200 kHz	20 Hz-25 kHz	±3%	2%	7 volts	single continuous	—	\$35.95

\* This unit has step-type frequency selectors for accurate resetability. It also has a volt- and dB-calibrated output meter.  
\*\* This unit offers simultaneous sine- and square-wave outputs.

# OSCILLOSCOPES



**EICO 430** A general purpose scope with a vertical response from 2 Hz to 500 kHz +1, -3 dB. Has a three-inch face. Sweep range is from 10 Hz to 100 kHz and sync is automatic. Sensitivity in the vertical channel is 25 mV/cm., rms. Price is \$69.95 as a kit and \$99.95 wired.



**EICO 427** A highly sensitive d.c. scope with a five-inch face, well suited to audio measurements. Vertical sensitivity is 3.5 mV/cm, rms, and frequency response is d.c. to 500 kHz +1, -3 dB. Sweep is from 10 Hz to 100 kHz and sync is automatic. Price is \$69.95 as a kit and \$109.95 wired.

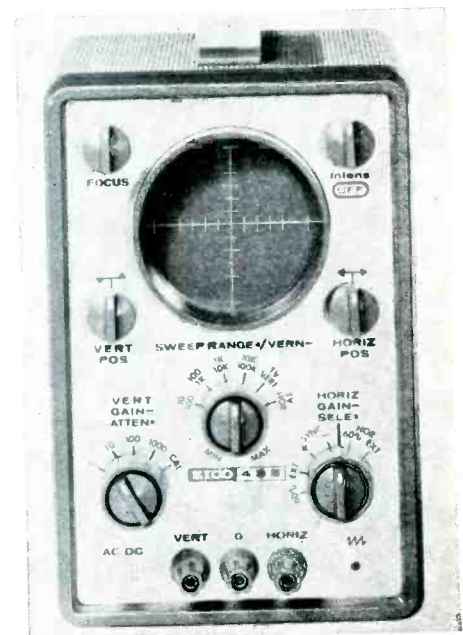

**EICO 435** A wideband d.c. scope with a three-inch face. Vertical response is from d.c. to 4.5 MHz +1, -3 dB. Sweep range is from 10 Hz to 100 kHz plus a TV vertical and TV horizontal. Sensitivity is 18 mV/cm, rms. Price is \$99.95 as a kit and \$149.95 wired.

# OSCILLOSCOPES—Continued



**HEATHKIT 10-21** A general purpose compact scope. Has a 3" tube face. Features identical vertical and horizontal amplifiers with 2 Hz to 200 kHz  $\pm 2$  dB response. Sweep generator range is 20 Hz to 100 kHz and sensitivity is 0.25 vol'ts/inch, rms. Price is \$54.95 as a kit only.

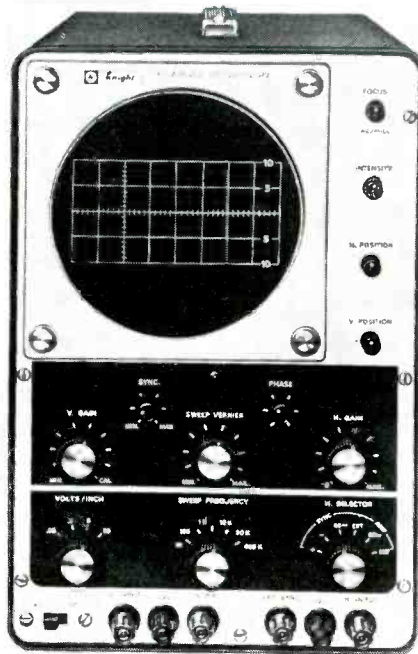

**Knight KG-635** A wideband d.c. scope with a 5" face. Vertical frequency response is d.c. to 5.2 MHz  $\pm 1.5$  dB. Rise time is 70 nanoseconds. Sweep is available from 10 Hz to 400 kHz and is semi-automatic with a level control. Vertical sensitivity is 17 mV/inch, rms. Price as a kit is \$99.95 and wired at \$149.95.



**Heathkit 10-10 A** 3" a.c.-d.c. scope specifically suited to audio measurements. Features identical vertical and horizontal amplifiers with a d.c. to 200 kHz response at the -2 dB point. Sweep is available from 5 Hz (lower with an external capacitor) to 50 kHz. Sensitivity is 0.1 V/inch, peak-to-peak. The phase shift between channels is less than 5 deg. Price is \$89.95 as a kit only.

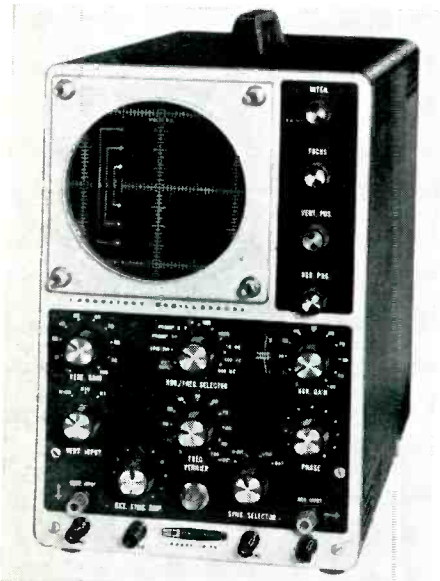

**Heathkit 10-12** A lab-type scope suited to a wide range of uses. Has a 5" face with standard camera-mount connectors. A.c. range of the vertical amplifier is from 3 Hz to 5 MHz  $\pm 1.5$ , -5 dB. 10 Hz to 500 kHz sweep range. Sensitivity is 0.025 volts/inch, rms, and rise time is 0.08 microseconds. Synchronizing is automatic. Price is \$76.95 as a kit; \$126.95 factory wired.

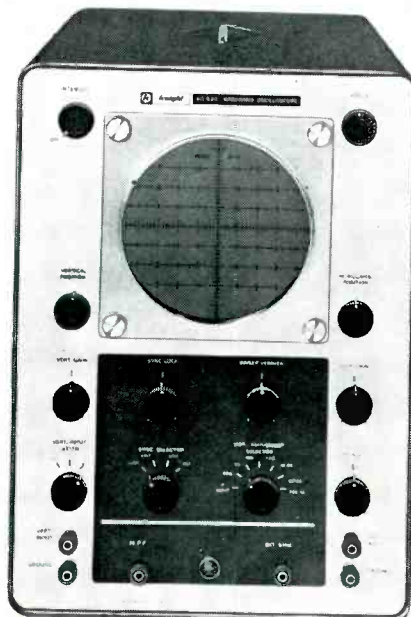

**Knight KG-630** A wideband scope with a 5" face. Response is 5 Hz to 5 MHz,  $\pm 3$  dB. Vertical sensitivity is 20 mV/in., rms./inch. Sweep is from 15 Hz to 600 kHz. Synchronizing can be locked in as high as 9 MHz. Price is \$74.95 as a kit, \$99.95 wired.

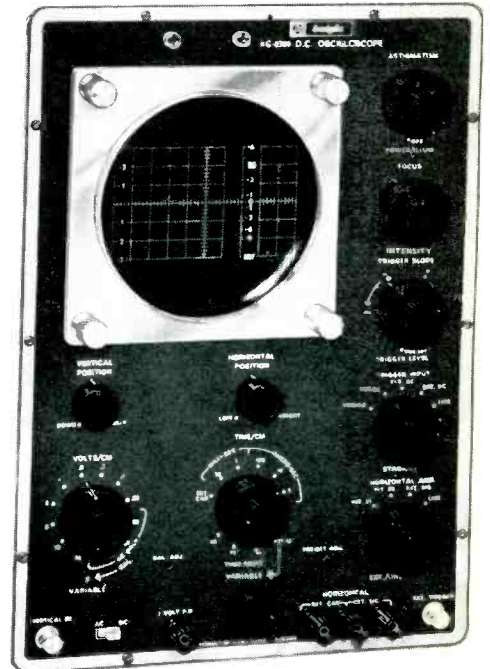

**Knight KG-2000** A wideband 5" d.c. scope that easily exhibits the greatest versatility of all scopes listed. Vertical bandwidth is d.c. to 5 MHz, -3 dB. Vertical sensitivity is 0.05 volts/cm, p-p, d.c. coupled, and 0.005 volts/cm, p-p, a.c. coupled with a d.c. rise time of 85 nanoseconds. Time-base sweep ranges are from 0.05 sec/cm to 200 nsec/cm in 16 ranges. Sweep timing accuracy is within 3 per cent, and is fully automatic. Vertical input is by a shielded BNC connector, camera mount studs are provided and a 5X horizontal expansion position is provided. Price is \$199.50 as a kit and \$249.95 wired.

(Continued on page 73)



# If the Electro-Voice Model 664 picks up sound here...

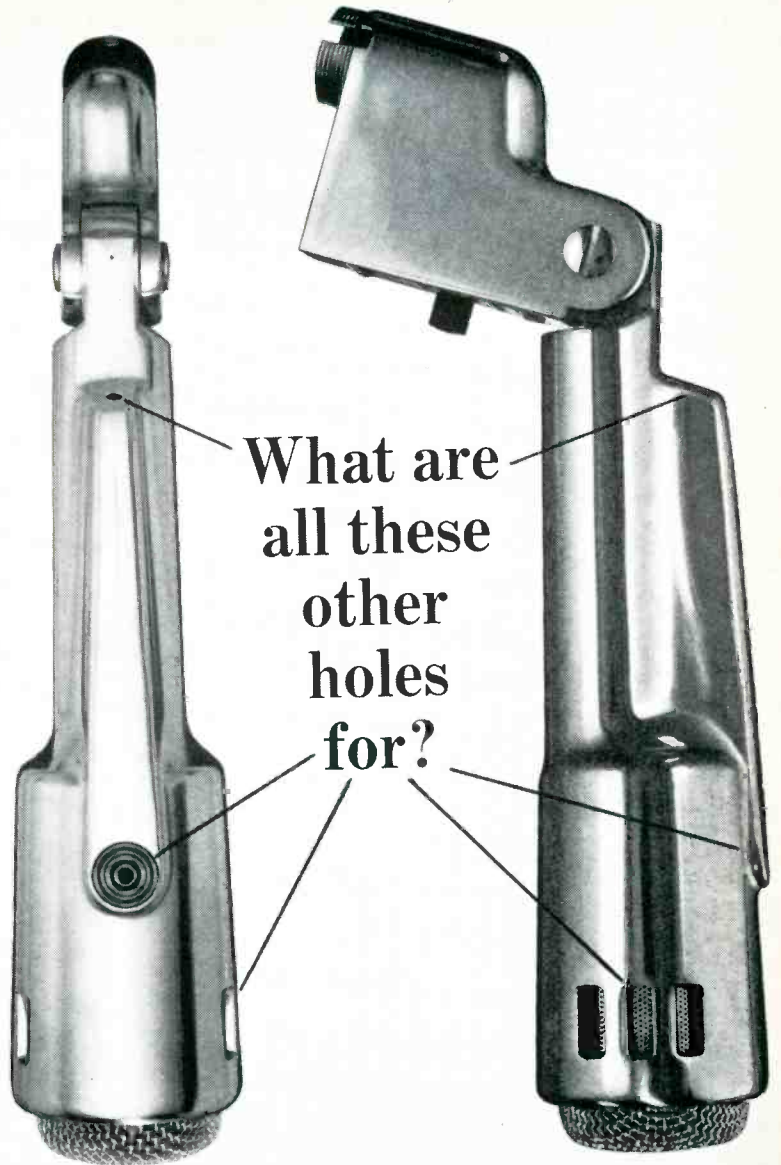

What are  
all these  
other  
holes  
for?

Ⓔ The holes in the top, sides and rear of the Electro-Voice Model 664 make it one of the finest dynamic cardioid microphones you can buy. These holes reduce sound pickup at the sides, and practically cancel sound arriving from the rear. Only an Electro-Voice Variable-D® microphone has them.

Behind the slots on each side is a tiny acoustic "window" that leads directly to the back of the 664 Acoustalloy® diaphragm. The route is short, small, and designed to let only highs get through. The path is so arranged that when highs from the back of the 664 arrive, they are cut in loudness by almost 20 db. Highs arriving from the front aren't affected. Why two "windows"? So that sound rejection is uniform and symmetrical regardless of microphone placement.

The hole on top is for the mid-range. It works the same, but with a longer path and added filters to affect only the mid-frequencies. And near the rear is another hole for the lows,

with an even longer path and more filtering that delays only the bass sounds, again providing almost 20 db of cancellation of sounds arriving from the rear. This "three-way" system of ports insures that the cancellation of sound from the back is just as uniform as the pickup of sound from the front—without any loss of sensitivity. The result is uniform cardioid effectiveness at every frequency for outstanding noise and feedback control.

Most other cardioid-type microphones have a single cancellation port for all frequencies. At best, this is a compromise, and indeed, many of these "single-hole" cardioids are actually omnidirectional at one frequency or another!

In addition to high sensitivity to shock and wind noises, single-port cardioid microphones also suffer from proximity effect. As you get ultra-close, bass response rises. There's nothing you can do about this varying bass response — except use a Variable-D

microphone with multi-port design\* that eliminates this problem completely.

Because it works better, the E-V 664 Dynamic Cardioid is one of the most popular directional microphones on the market. It has both high and low impedance outputs available at the plug. Frequency range is peak-free from 40 to 15,000 Hz (cps). Output is -58 db. To learn more about Variable-D microphones, write for our free booklet, "The Directional Microphone Story." Then see and try the E-V 664 at your nearby Electro-Voice microphone headquarters. Just \$85.00 in satin chrome or non-reflecting gray, or \$90.00 in gold finish (list prices less normal trade discounts).

\*Pat. No. 3,115,207

**ELECTRO-VOICE, INC.**, Dept. 262A  
602 Cecil Street, Buchanan, Michigan 49107

**Electro-Voice**  
SETTING NEW STANDARDS IN SOUND

Circle 121 on Reader Service Card

# Edison's Invention of the Kineto-Phonograph

## Account of the Invention

We reprint this rare article from the June, 1894, issue of *Century Magazine* describing Thomas A. Edison's invention of motion pictures. It was one of the best contemporary accounts of Edison's invention and as such should be of interest to anyone concerned with the modern version of this invention—the Video Tape Recorder.

**T**HE SYNCHRONOUS ATTACHMENT of photography to the phonograph was early contemplated by Mr. Edison, in order to record and give back the impressions to the eye as well as to the ear.

The comprehensive term for this invention is the kineto-phonograph. The dual "talking-machine" is the phono-kinetograph, and the reproducing-machine the phono-kinetoscope, in contradistinction to the kinetograph and the kinetoscope, which relate respectively to the taking and reproduction of moving but *soundless* objects.

The initial experiments took the form of microscopic pin-point photographs, placed on a cylindrical shell, corresponding in size to the ordinary phonograph cylinder. These two cylinders were then placed side by side on a shaft, and the sound record was taken as nearly as possible in synchronism with the photographic image impressed on the sensitive surface of the shell. The photographic portion of the undertaking was seriously hampered by the defects of the materials at hand, which, however excellent in themselves, offered no substance sufficiently sensitive. How to secure clear-cut outlines, or indeed any outlines at all together with phenomenal speed, was the problem which puzzled the experimenters. The Daguerre, albumen, and kindred processes met the first requirements, but failed when subjected to the test of speed. These methods were therefore regretfully

abandoned, a certain precipitate of knowledge being retained, and a bold leap was made to the Maddox gelatine bromide-of-silver emulsion, with which the cylinders were coated. This process gave rise to a new and serious difficulty. The bromide-of-silver haloids, held in suspension with the emulsion, showed themselves in an exaggerated coarseness when it became a question of enlarging the pin-point photographs to the dignity of one eighth of an inch, projecting them upon a screen, or viewing them through a binocular microscope. Each accession of size augmented the difficulty, and it was resolved to abandon that line of experiment, and to revolutionize the whole nature of the proceedings by discarding these small photographs and substituting a series of larger impressions affixed to the outer edge of a swiftly rotating wheel, or disk, and supplied with a number of pins, so arranged as to project under the center of each picture. On the rear of the disk, upon a stand, was placed a Geissler tube, connected with an induction coil, the primary wire of which, operated by the pins, produced a rupture of primary current, which, in turn, through the medium of the secondary current, lighted up the Geissler tube at the precise moment when a picture crossed its range of view. This electrical discharge was performed in such an inappreciable fraction of time, the succession of pictures was so rapid, and the whole mechanism so nearly perfect,

that the goal of the inventor seemed almost reached.

Then followed some experiments with drums, over which sheets of sensitized celluloid film were drawn, the edges being pressed into a narrow slot in the surface, similar in construction to the old tin-foil phonograph. A starting-and-stopping device very similar to the one now in use was also applied. The pictures were then taken spirally to the number of two hundred or so, but were limited in size, owing to the rotundity of surface, which brought only the center of the picture into focus. The sheet of celluloid was then developed, fixed, etc., and placed upon a transparent drum bristling at its outer edge with brass pins. When the drum was turned rapidly, these came in contact with the primary current of an induction coil, and each image was lighted up in the same manner as described in the previous disk experiment, with this difference only, that the inside of the drum was illuminated.

The next step was the adoption of a highly sensitized strip of half-inch-wide celluloid, which proved unsatisfactory because of inadequate size. One-inch pictures on a band one and-a-half-inches wide were next substituted, the additional width being required for the perforations on the outer edge. These perforations occur at close and regular intervals, in order to enable the teeth of a locking-device to hold the film steady for nine tenths of 1/46 of a second, when a shutter opens rapidly and admits a beam of light, causing an image or phase in the movement of the subject. The film is then jerked forward in the remaining tenth of 1/46 second, and held at rest while the shutter has again made it round, admitting another circle of light, and so on until forty-six impressions are taken per a second, or 2760 a minute. This speed yields 165,600 pictures in an hour, an amount amply sufficient for an evening's entertainment, when unreeled before the

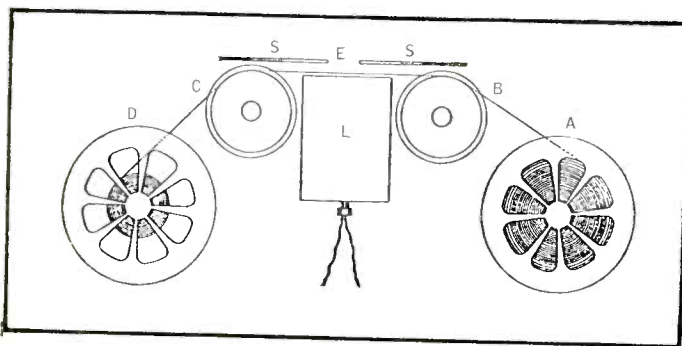

Fig. 1 An overhead view of one of the earliest Edison Kinetographs taken from a contemporary article which appeared in *Harpers Weekly*, June 13, 1891.

eye. By connecting the two ends of the strip, and thus forming a continuous band, the pictures can be indefinitely multiplied. In this connection it is interesting to note that were the spasmodic motions added up by themselves, exclusive of arrests, on the same principle that a train record is computed independent of stoppages, the incredible speed of twenty-six miles an hour would be shown.

The advantage of this system over a continuous band, and of a slotted shutter forging widely ahead of the film, would be that in the latter only the fractional degree of light comprised in the 1/2720 part of a second is allowed to penetrate to the film at a complete sacrifice of all detail, whereas, in the present system of stopping and starting, each picture gets one hundredth part of a second's exposure, with a lens but slightly stopped down—time amply sufficient, as any photographer knows, for the attainment of excellent detail even in an ordinarily good light. It must be understood that only one camera is used for taking these strips, and not a battery of cameras, as in Mr. Muybridge's photographs of "The Horse in Motion."

The next step, after making the negative band, is to form a positive or finished series of reproductions from the negative, which is passed through a machine for the purpose, in conjunction with a blank strip of film, which, after development and general treatment, is replaced in the kinetoscope or phonokinetoscope, as the case may be. When a phonograph record has been taken simultaneously with such a strip, the two are started together by the use of a simple but effective device, and kept so all through, the phonograph record being in perfect accord with the strip. In this conjunction, the tiny holes with which the edge of the celluloid film is perforated correspond exactly with the phonographic records, and the several devices of the camera, such as the shifting of the film and the operations of the shutter, are so regulated as to keep pace with the indentation made by the stylus upon the phonographic wax cylinder, one motor serving as a source of common energy to camera and phonograph, when they are electrically and mechanically linked together.

#### Synchronization

The establishment of harmonious relations between kinetoscope and phonograph was a harrowing task, and would have broken the spirit of inventors less inured to hardship and discouragement than Edison's veterans. The experiments have borne their legitimate fruit, and the most scrupulous nicety of adjustment has been achieved, with the resultant effects of realistic life, audibly and visually expressed.

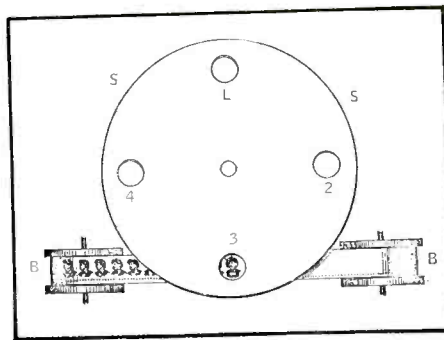

Fig. 2 A front view of the Kinetograph taken from the same article and illustrating the film strip and shutter arrangement employed. Both drawings were made from sketches furnished the authors by Mr. Edison.

The process of "taking" is variously performed: by artificial light in the photographic department, or by daylight under the improved conditions of the new theater, of which we shall speak. The actors, when more than one in number, are kept as close together as possible, and exposed either to the glare of the sun, to the blinding light of four parabolic magnesium lamps, or to the light of twenty arc-lamps, provided with highly actinic carbons and supplied with powerful reflectors equal to about 50,000 candlepower. This radiance is concentrated upon the performers while the kinetograph and phonograph are hard at work storing up records and impressions for future reproduction.

A popular and inexpensive adaptation of kinetoscopic methods is in the form of the well-known nickel-in-the-slot, a machine consisting of a cabinet containing an electrical motor and batteries for operating the mechanism which acts as the impelling power to the film. The film is in the shape of an endless band fifty feet in length, which is passed through the field of a magnifying-glass perpendicularly placed. The photographic impressions pass before the eye at the rate of forty-six per second, through the medium of a rotating, slotted disc, the slot exposing a picture at each revolution, and separating the fractional gradations of pose. Projected against a screen, or viewed through a magnifying-glass, the pictures are eminently lifelike, for the reason that the enlargement need not be more than ten times the original size. On exhibition evenings the projecting-room, which is situated in the upper story of the photographic department, is hung with black, in order to prevent any reflection from the circle of light emanating from the screen at the other end, the projector being placed behind a curtain, also of black, and provided with a single peephole for the accommodation of the lens. The effect of these somber draperies, and the weird accompanying monotone

of the electric motor attached to the projector are horribly impressive, and one's sense of the supernatural is heightened when a figure suddenly springs into his path, acting and talking with a vigor which leaves him totally unprepared for its mysterious vanishing. Projected stereoscopically, the results are even more realistic, as those acquainted with that class of phenomena may imagine, and a pleasing rotundity is apparent, which, in ordinary photographic displays, is conspicuous by its absence.

Nothing more vivid or more natural could be imagined than these breathing, audible forms, with their tricks of familiar gesture and speech. The inconceivable swiftness of the photographic successions, and the exquisite synchronism of the phonographic attachment, have removed the last trace of automatic action, and the illusion is complete. The organ-grinder's monkey jumps upon his shoulder to the accompaniment of a strain from "Norma." The rich strains of a tenor or soprano are heard, set in their appropriate dramatic action; the blacksmith is seen swinging his ponderous hammer, exactly as in life, and the clang of the anvil keeps pace with his symmetrical movements; along with the rhythmical measures of the dancer go her soft-sounding footfalls; the wrestlers and fencers ply their intricate game, guarding, parrying, attacking, thrusting, and throwing, while the quick flash of the eye, the tension of the mouth, the dilated nostrils, and the strong, deep breathing give evidence of the potentialities within.

The photographic rooms, with their singular completeness of appointment, have been the birthplace and nursery of this invention; and the more important processes connected with the preparation and development of the film, together with other mechanical and scientific devices, are still carried on in this department. The exigencies of natural lighting incident to the better "taking" of the subjects, and the lack of a suitable theatrical stage, however, necessitated the construction of a special building which stands in the center of that cluster of auxiliary houses which forms the suburbs of the laboratory, and which is of so peculiar an appearance as to challenge the attention of the most superficial observer. It obeys no architectural rules, embraces no conventional materials, and follows no accepted scheme of color. Its shape is an irregular oblong, rising abruptly in the center, at which point a movable roof is attached, which is easily raised or lowered at the will of a single manipulator. Its color is a grim and forbidding black, enlivened by the dull luster of many hundred metallic points; its material is paper, covered with pitch and profusely studded with tin nails. With its flapping

sail-like roof and ebon hue, it has a weird and semi-nautical appearance, and the uncanny effect is not lessened when, at an imperceptible signal, the great building swings slowly around upon a graphited center, presenting any given angle to the rays of the sun, and rendering the operators independent of diurnal variations. The movable principle of this building is identical with that of our river swinging bridges, the ends being suspended by iron rods from raised center-posts. This building is known as the Kinetographic Theatre, otherwise the "Black Maria." Entering, we are confronted by a system of lights and shades so sharply differentiated as to pain the eye, accustomed to the uniform radiance of the outer air. Later we find that the contrasts are effected by the total exclusion of light from the lower end of the hall, heightened by draperies of impenetrable black, against which stands out in sharp relief the central stage, on which are placed the kinetographic subjects, bathed in the full power of the solar rays pouring down from the movable roof. This distribution of light and shade is productive of the happiest effects in the films, as the different figures are thrown into the broadest relief against the black background, and a distinctness of outline is achieved that would be impossible under ordinary conditions.

At the other end of the hall is a cell, indicated by an ordinary door and an extraordinary window, glazed in panes of lurid hue, which gives the finishing touch to the Rembrandtesque character of the picture. The compartment is devoted to the purpose of changing the film from the dark box to the kinetographic camera, being provided with a special track, running from the mysterious recesses at the back of the stage to its own special precincts, where fresh films are substituted for the ones already employed. The processes of development, etc., are performed in the main photographic building.

The *dramatis personae* of this stage are recruited from every characteristic section of social, artistic, and industrial life, and from many a phase of animal existence. One day chronicled the engagement of a troupe of trained bears and their Hungarian leaders. The bears were divided between surly discontent and a comfortable desire to follow the bent of their own inclinations. It was only after much persuasion that they could be induced to subserve the interests of science. One furry monster waddled up a telegraph-pole, to the soliloquy of his own indignant growls; another settled himself comfortably in a deep arm-chair, with the air of a post-graduate in social science; a third rose solemnly on his hind legs and described the measures of some dance, to the weird strains of his keeper's music. Another licked his master's swarthy face, another accepted his keeper's challenge, and engaged with him in a wrestling-match, struggling, hugging, and rolling on the ground.

Of human subjects we have a superfluity, although the utmost discrimination is essential in the selection of themes. The records embrace pugilistic encounters, trapeze and cane exercises, dancing, wrestling, fencing, singing, the playing of instruments, speech-making, the motions involved in the different crafts, horseshoeing, equestrianism, gardening, and many others.

We have yet to speak of the microscopic subjects, a class of special interest, as lying outside of the unaided vision of man. In the treatment of these infinitesimal types, much difficulty was experienced in obtaining a perfect adjustment so as to reproduce the breathing of insects, the circulation of blood in a frog's leg, and other similar processes of nature. The enlargement of animalcules in a drop of stagnant water proved a most exacting task, but by the aid of a powerful lime-light, concentrated on the water, by the interposition of alum cells for the interception of most of

the heat rays, and by the use of a quick shutter and kindred contrivances, the obstacles were overcome, and the final results were such as fully to compensate for the expenditure of time and trouble. We will suppose that the operator has at last been successful in imprisoning the trickey water-goblins on the sensitive film, in developing the positive strip, and placing it in the projector. A series of inch-large shapes then springs into view, magnified stereoptically to nearly three feet each, gruesome beyond power of expression, and exhibiting an indescribable celerity and rage. Monsters close upon one another in a blind and indiscriminate attack, limbs are dismembered, gory globules are tapped, whole battalions disappear from view. Before the ruthless completeness of these martial tactics the Kilkenny cats fade into insignificance. A curious feature of the performance is the passing of these creatures in and out of focus, appearing sometimes as huge and distorted shadows, then springing into the reality of their own size and proportions.

Hitherto we have limited ourselves to the delineation of detached subjects, but we shall now touch very briefly upon one of our most ambitious schemes, of which these scattered impersonations are but the heralds. Preparations have long been on foot to extend the number of actors and to increase the stage facilities, with a view to the presentation of an entire play, set in its appropriate frame.

This line of thought may be indefinitely pursued with application to any given phase of outdoor or indoor life which it is desired to reproduce. Our methods point to ultimate success, and every day adds to the security and the celerity of the undertaking. No scene, however animated and extensive, but will eventually be within reproductive power. Martial evolutions, naval exercises, processions, and countless kindred exhibitions will be recorded for the leisurely gratification of those who are debarred from attendance, or who desire to recall them. The invalid, the isolated country recluse, and the harassed business man can indulge in needed recreation, without undue expenditure, without fear of weather, and without the sacrifice of health or important engagements. Not only our own resources but those of the entire world will be at our command. The advantages to students and historians will be immeasurable. Instead of dry and misleading accounts tinged with the exaggerations of the chroniclers' minds, our archives will be enriched by the vitalized pictures of great national scenes, instinct with all the glowing personalities which characterized them. (*Antonia and W. K. L. Dickson*)

Fig. 3. The first motion picture studio was known as the "Black Maria" because of its resemblance to the police patrol wagons of the period. A reproduction of this building is part of the Edison National Historic Site at Orange, N.J. The building rotates on the circular track to obtain the maximum amount of sun light at any time of the day

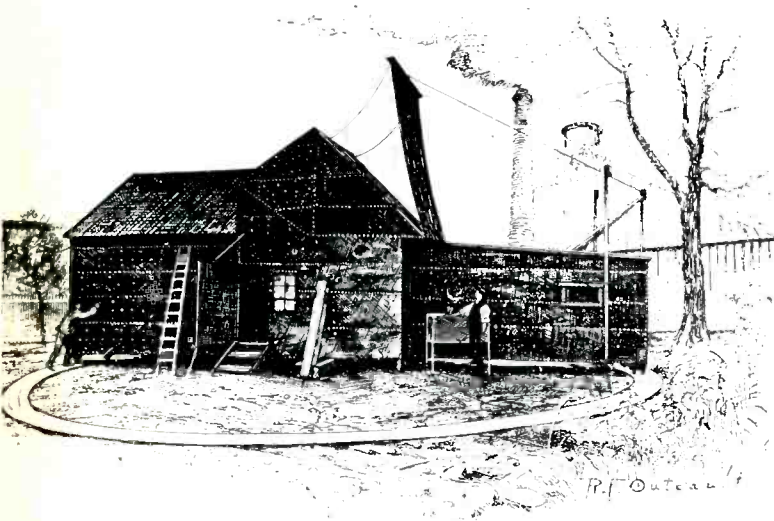

**SONY<sup>®</sup>**  
**for home**  
**video tape**  
**recording**

**VIDEORECORDER<sup>®</sup>**

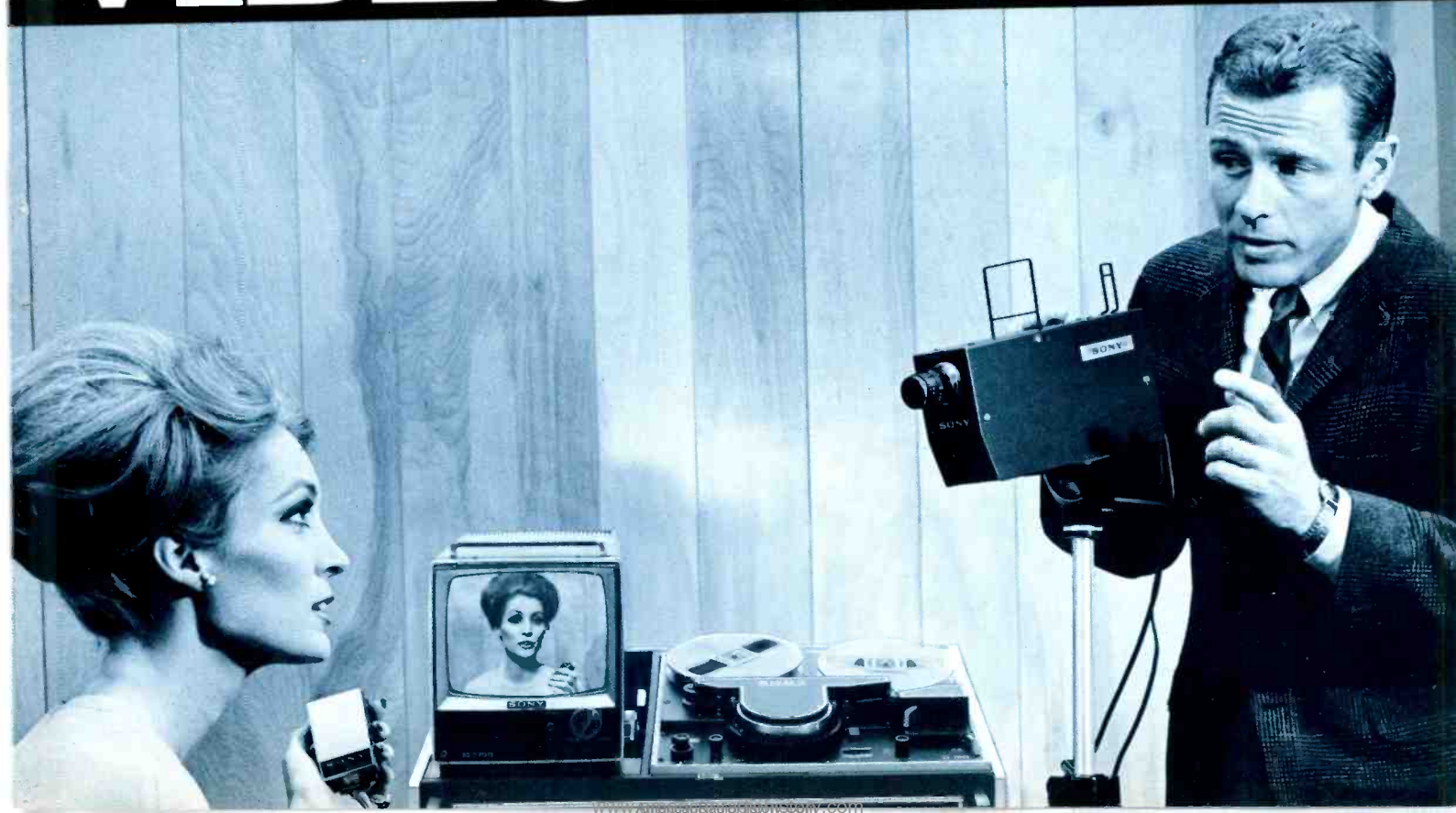

# SONY's Home Videocorder®

*Important programs may be seen time and time again.*



**What is the Videocorder?** The Videocorder is an instrument which records both picture and sound on tape, much in the same manner as an ordinary tape recorder records sound only. Professional video tape recorders have been in use for several years in many fields, notably television, where programs are recorded on tape for later broadcasting.

Now, SONY becomes the leader with a low priced home video tape recorder, called the SONY Videocorder®. Its operation is similar to that of an ordinary tape recorder. With the flip of a switch, you may either transcribe an uncopyrighted television program on tape for later viewing or play back a recorded tape. By the use of the Videocorder, important programs can be recorded on tape in your absence. Also, if two important programs are telecast simultaneously, one may

be taped on the Videocorder while the other is viewed on a second TV set.

With the use of SONY's Video Camera Kit, a new era of enriched home entertainment has truly begun. Using the simple-to-operate SONY Video Camera and Microphone, anyone may easily record family events, or even their own sports activities for study and improvement. It is easy to see the tremendous advantages of video tape recording. Any recording may be viewed immediately without waiting for developing or processing. You may build a home tape library of these events for later viewing.

Sony's home use Videocorder, the newest major breakthrough in magnetic recording techniques, compact in size and low in cost, makes it possible for all to enjoy the excitement of video recording in their own home!

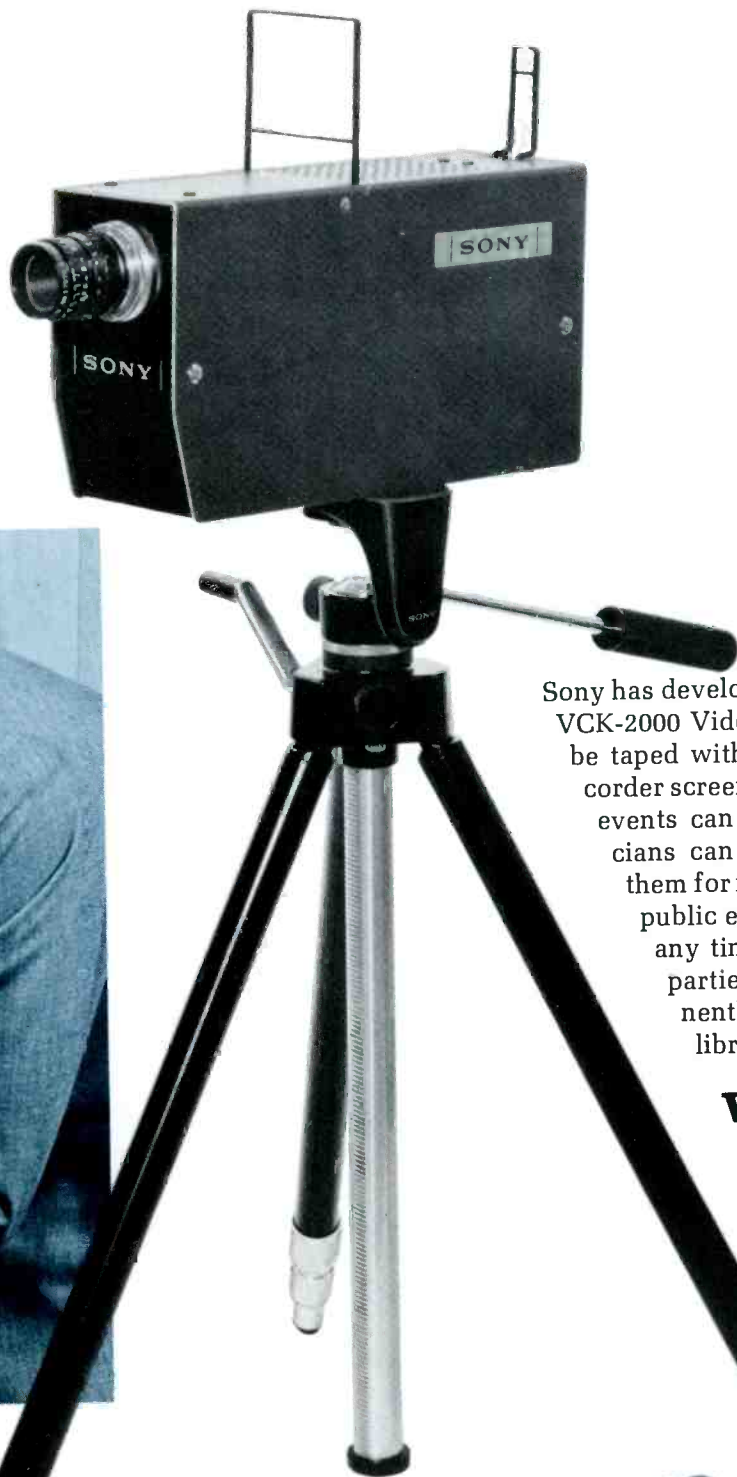

For more versatile usage of the Videocorder, Sony has developed its video camera which is included in the VCK-2000 Video Camera Kit. Using this Kit, any event can be taped with sound for immediate replay on the Videocorder screen. Therefore, a home tape library of important events can be built; Athletes, actors, singers or musicians can record their own performances and study them for improvement. Parades, celebrations and other public events can be recorded on tape for showing at any time in the home. Any family activity such as parties, anniversaries, or weddings can be permanently recorded and stored in the home tape library.

### **Video Camera Kit**

- Comes complete with camera, standard lens, camera cable, microphone, tripod, AC cord and extension cord—all in one portable case.
- Operation of the camera is simple.
- Camera is compact in size.
- Telephoto and wide angle lenses can be used.
- Videocorder screen can be used as a monitor when recording.
- Camera is solid state—maintenance free.
- Operates on regular household AC current.

Complete Camera Kit  
VCK-2000, \$350.00

**Video Camera  
gives you an easy  
way to record  
family events  
for immediate  
playback**



The Videocorder is not to be used to record copyrighted works.



### Videocorder TCV-2010 features

- Simple operation, similar to ordinary tape recorders.
- Slow speed recording—Sony's special feature
  - Tape speed is only 7½ inches per second.
  - Tape is only ½" wide.
  - Uses only 7" reels for one full hour of continuous recording.
  - Tape consumption is low.
  - Tape breakage is minimal.
  - Mechanical durability is assured.
- Solid state circuitry further assures durability.
- Tapes can be erased for new recordings.
- Videocorder screen can be used as a normal TV receiver.
- Operates on regular household AC current.
- Has carrying handles for easy portability.

Videocorder Model TCV-2010, \$995.00



### Videocorder TCV-2020 features

The Videocorder model TCV-2020 has all the features of the TCV-2010 except for the carrying handles. In addition:

- Housed in a beautiful walnut cabinet.
- Has timing device which may be preset to record programs while you are away from home.

Videocorder Model TCV-2020, \$1250.00



### SONY VIDEO TAPE

Comes in unique plastic case for convenient storage.

Type	Reel Size	Length	Playing Time	Price
V-32	7"	2370 ft.	one hour	39.95
V-31	7"	1240 ft.	½ hour	21.95



# Sound & Sight

HAROLD D. WEILER

The art of video recording and its pioneers. The introduction of a low-priced home video recorder and some of its unusual applications.

**V**IDEO TAPE RECORDING caused a major revolution in television broadcasting! We believe the recent introduction of a video recorder for less than one thousand dollars will greatly expand the use of this medium and that it will create the same impact in many other fields.

It was in 1951 that Crosby Enterprises, now the Min-com Division of 3M Company, amazed the television industry by announcing that they had perfected a method of recording both sound and pictures on magnetic tape and demonstrated the first video recorder. This was shortly followed by RCA's announcement of their video tape recorder. Both units operated on essentially the same principle and employed the longitudinal technique of recording. This method is similar to that used in modern audio tape recorders. As illustrated at (A) in Fig. 1, the tape moved across the record/playback heads, which were stationary. The signals were recorded parallel to the tape path, as shown. The one-inch tape in the Crosby recorder moved at a speed of 100 inches per second and provided a bandwidth of 2.5 megacycles. The video signal was separated into eleven different components which were recorded on as many parallel tracks. A fourteen-inch reel of tape was required to obtain a 15-minute video recording. While this bandwidth did not provide any great improvement in quality over the Kinescope (film) recording process then in use (motion pictures were photographed from the screen of the station monitor), the Crosby video tape recorder did offer many other advantages. Most important at the time was the fact that the Kinescope recordings were expensive; the cost of raw film and developing alone was about \$1000 for a one hour show.

The RCA system, with its one-half-inch tape moved over three times as fast (360 inches per second) and recorded the video signal on a single track and required a seventeen-inch reel of tape for four minutes of programming.

◀ Circle 120 on Reader Service Card

However, this system provided a greater bandwidth and in consequence a picture superior to the Kinescope recordings.

Meanwhile another company, Ampex, had perfected a video recorder which operated on a different principle. It was not until April, 1956, when the television industry was gathered at a convention in Chicago, that their first video tape recorder was demonstrated and became available.

Instead of moving the tape across a single stationary record/playback head, as in the earlier systems, the four record/playback heads employed, as well as the tape, were moved. A drum incorporating the four heads rotated crosswise to the tape motion, as illustrated at (B) in Fig 1; as the four record/playback heads revolved each recorded a single track. While the forward motion of the two-inch tape was only fifteen inches per second, the effective tape-to-head speed was 1500 inches per second. This technique, called transverse recording, provided a still greater bandwidth and a picture demonstrably superior to the Kinescope recordings. In addition, a 12½-in. reel of video tape would provide a one-hour recording.

In November, 1956, CBS began the

first regularly scheduled video tape news program with "Douglas Edwards and the News." Before video tape, programs of this nature were repeated four times each evening, once for each time zone. Kinescope recordings were impractical because of the time required for film processing, and their prohibitive cost.

As deliveries of video recorders increased and they were put into use, other advantages soon became apparent. The quality of the video tape telecasts was now such that they could not be distinguished from the "live" broadcasts by the viewers. This is quite simple to understand when we stop to realize that when video tape is employed there are only three transfer stages. The electronic signals are converted to magnetic impulses and stored on tape. Upon playback the stored magnetic impulses are simply converted back to video signals. Conversely, a Kinescope recording must pass through twelve transfer stages losing some quality at each as it is transferred from the electronic to the optical, to chemicals, to optical and back to electronic again.

Perhaps the most important advantage to the early users of video tape recording was the fact that the cost for a one-hour show was only a few dollars as opposed to the thousand or more for

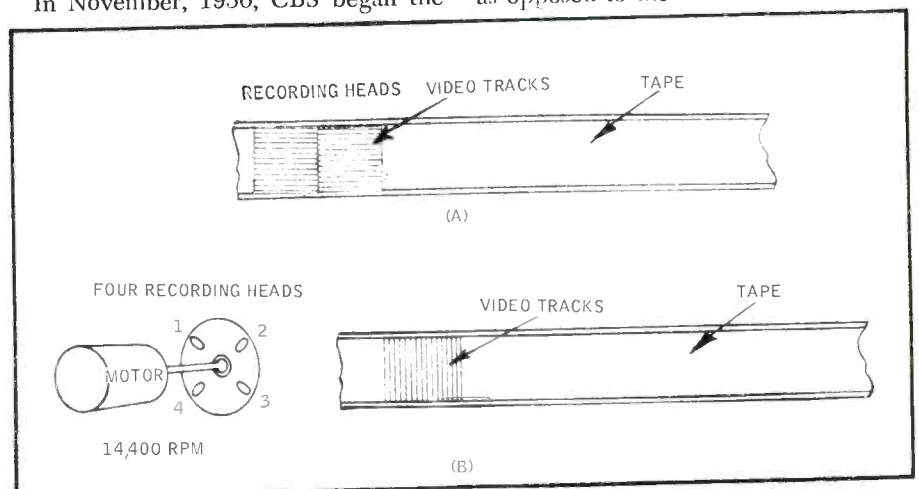

Fig. 1. (A) The longitudinal method of video recording employed by Crosby enterprises. (B) The transverse method of video recording later developed by Ampex.

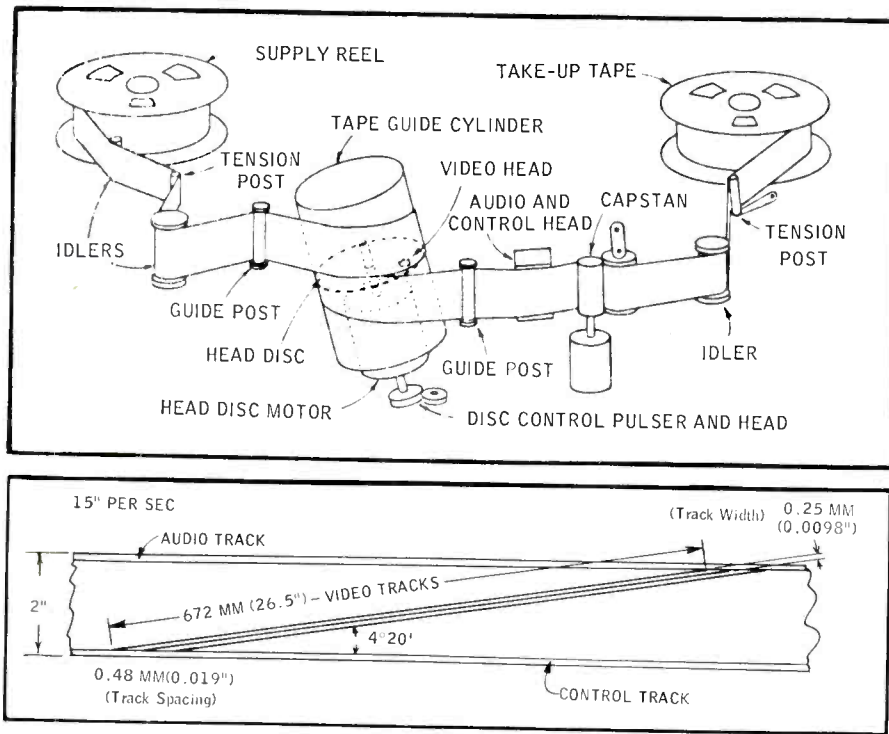

Figure 2 The single-head, helical-scan system of video recording invented by Tokyo Shibaura Electric Co. Ltd. (Toshiba).

a kinescope recording, since the video tape could be erased after use and re-used many times. As word of the new medium spread, the government and educators quickly realized its tremendous potential as a teaching and training aid. The use of video recorders was, of course, still limited by their high cost (\$50,000 each). Initially, only larger universities, the TV networks, and the government could afford them.

In September, 1959, the Japanese firm of Toshiba announced and demonstrated a single-head video recorder employing a radically new concept. The helical scan technique of video recording, as it came to be called, employed a single record/playback head mounted on a disc within a cylinder, as illustrated in Fig. 2. The two-inch tape was wound and moved in a helical loop around the cylinder at the broadcast standard speed of fifteen inches per second. As the record/playback head revolved it recorded a long slanting track. The track started at the bottom of the tape and rose diagonally to the top as the head revolved inside the helical loop. The head then immediately contacted the bottom of the tape again; however, due to the forward motion of the tape, the following track was recorded a fraction of an inch further along the tape, as illustrated.

The helical scan technique, by eliminating three record/playback heads, the head switching system, and three amplifiers (four were required with the transverse system), was able to provide excellent quality at a price substantially less than others available at the time.

In November, 1959, a grant from the

Ford Foundation permitted the National Educational Television Network (which is to educational television stations what national commercial networks are to their member stations) to install video tape recorders in its duplicating center at Ann Arbor, Michigan. The hope was that these recordings would provide a means of copying tapes and erasing them for re-use eliminating the necessity of making copies of kinescope films which had been found to lose value after the initial showing at a station. Video tape would make it possible, it was hoped, to distribute to schools and colleges programs of current events, or special "one-shot" programs which previously had been prohibitively costly to duplicate on film. The Foundation's fondest expectations were realized; the video recorders were highly successful. In consequence the Ford Foundation made a second grant to NET in 1960 permitting twenty-five additional stations to be equipped for video tape. By 1961 NET numbered 58 affiliates, all with video tape facilities.

In the spring of 1961, Ampex demonstrated a single-head recorder which operated on essentially the same principle as Toshiba's. The tape was moved at a speed of 7½ ips, which was to become the standard for non-broadcast applications, instead of the 15 ips employed by Toshiba.

In October of 1962, a helical scan recorder priced at the \$10,000 level—a substantial reduction from the previous prices—was introduced by the Japanese Sony Corporation. This company had started in 1948 by build-

ing audio tape recorders for educational purposes. In 1955 they manufactured the world's first miniaturized transistor radio. In 1960 they had begun the manufacture of the world's first miniature transistorized television receivers. Little did Mr. Ibuka and Mr. Morita, the founders of Sony, realize that each of these developments, noteworthy by itself, was merely another step toward an end which would be as important as the invention by Gutenberg of movable type. This comparatively low price further expanded the use of video recording.

Smaller schools, colleges, and universities could now afford them. Video tape recorders were quickly incorporated into many closed-circuit educational TV systems. Now specialists in various fields could be recorded when they were available and events could be recorded as they occurred, and shown when a particular phase of a course called for the information. The smaller TV stations also expand their use of video tape recorders.

Soon Hollywood became interested in the new medium and the possibilities of combining the video recorder with a motion picture camera. It was discovered that the video recorder could provide many advantages in this field too! Rehearsal time could be greatly reduced. The director could now view the scene on the monitor without the film camera operating. There was no longer any guesswork about composition, and possible omissions. The number of "takes" could be reduced; the director could now follow the scene on the video monitor as it was being shot. There was no longer any problem as to whether or not a given "take" was satisfactory. The video tape preview was found to be of tremendous value in rehearsing the cast. The fact that the actors and crew could see the take as it was played back was found to be extremely valuable in shooting. The combination of the video camera and recorder and the motion picture camera had streamlined production procedures, provided economies, and increased the quality of the ultimate film. In 1964, the Mitchell Camera Corporation, who had been working with the Sony Corporation introduced their "System 35," and created a new film making tool. This was the first commercially available combination of the video camera and recorder with the motion picture camera, as illustrated in Fig. 3. It was subsequently discovered that when this combination system was properly employed it could cut the cost of filming by at least 25 per cent, and it also permitted a substantial saving in time.

During this time North American Philips, RCA, and others had also developed a number of excellent video recorders at competitive prices. Video

recording, because of the consequent price reductions again expanded from its earlier applications to new ones in science, commerce, medicine, research, and religion.

During the year 1965 video recorders in the three-thousand-dollar price category were introduced and thereby began the same revolution in other fields which video tape had caused in television broadcasting.

It was also during this year that Sony Corporation's long experience with precision motors, miniaturized electronic components, television receivers and monitors, and video recorders were combined to create a major breakthrough in the art of video recording by introducing the first instrument to sell for under \$1000, thus removing the one limitation which had precluded the use of video recording by many prospective buyers. It is now well within the budgets of even the smallest organizations. Almost complete automation in recording and viewing make it possible for anyone to produce excellent video tape recordings.

The combination of moving pictures and sound is today recognized by business, science, education, government, industry, and religion as the most effective means of transmitting information. The effectiveness of video recording in any of the varied tasks which were assigned to it had been proven. It could be employed to analyze, to report, to educate, to persuade, and to sell.

There is a tremendous number of applications in which video recording permits the user to accomplish his ends more efficiently and less expensively than any other medium. There are even more in which video recording opens up entirely new possibilities. We will attempt to outline a few in the hope that they will stimulate the imagination of the reader into suggesting others applicable to his particular field of endeavor.

The video recorder can be of tremendous advantage in the pre-production testing of prototype machinery, aircraft, ships, and automobiles. The video camera can be attached to, or close by, any point of interest where the use of a direct observer is impossible because of safety, space, or other considerations. The effectiveness of test runs can be greatly increased since a video recording can provide more accurate and detailed information than the memory of any observer. A video recording can be played back as often as required by the engineering, or any other, department.

In the medical field, video recording has many valuable applications. The study of X-ray pictures can be greatly facilitated since the image from a video recording can be made much brighter

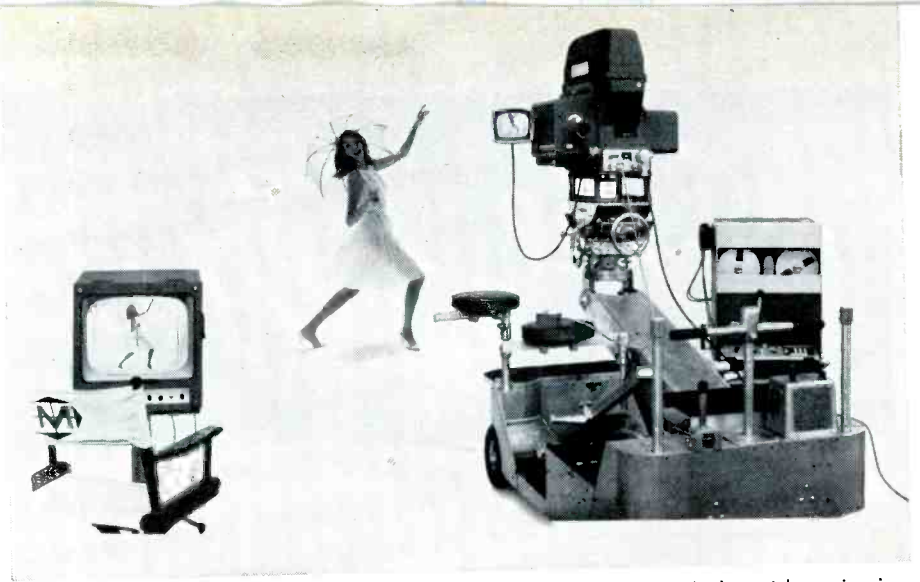

Fig. 3. The Mitchell Camera Corp's new System 35 which includes video viewing and previewing.

than the same image would appear on an X-ray screen, thus providing improved detail recognition.

Video recordings may be made of the behavior of mentally disturbed patients, then played back and studied at the convenience of the staff psychiatrist eliminating the necessity of calling him for personal observation while he may be otherwise occupied.

For biological research the microscope may be combined with a video camera and recorder to create a research tool of fantastic power—an "electronic-recording microscope." This new scientific instrument will greatly facilitate study by reducing the viewing fatigue commonly experienced when looking at the microscope field directly through the eyepiece for prolonged periods. Perhaps the most important contribution the "electronic-recording microscope" makes to biological research or any field where a microscope is employed, is its ability to repeat the original observations as often as required to check a particularly important or interesting stage. There is no processing delay encountered as when film is employed—the cost of the record is considerably less since when the observation is unsatisfactory or has served its purpose, the video tape may be instantly erased and reused. The addition of ultra-violet and infrared illumination and/or the substitution of the vidicon tubes now available for these wavelengths can further extend the application of the "electronic-recording microscope" in many fields.

While on the subject of infrared light, we should mention that a video recording will prove extremely valuable to naturalists and zoologists. Both amateur and professional can greatly extend the areas of their research by employing a video camera and recorder fitted with an infrared sensitive vidicon tube to observe nocturnal birds, insects,

and small mammals when the eye could not see them at all. The phenomena can be recorded for later and more convenient study and analysis.

A video camera and recorder combined with a telescope can provide many advantages to the amateur or professional astronomer. The video chain can increase the basic sensitivity of the telescope almost six times. Phenomena of particular interest may be recorded and instantly played back as often as required to a group audience.

We could continue with many other applications for the video recorder, however, the lack of space permits only one. The field of home entertainment will benefit greatly by its introduction.

We believe one of its most interesting applications will be the creation of "home video movies" which can compare favorably with the professional travelogues and documentaries shown on commercial television such as the fascinating NBC release "Spanish Armada" produced by George Vicas. In this documentary, "live" action, slides, film clips, and "stills" taken from books and paintings were combined to create a superb television program. With a video recorder, vacation pictures can be combined with purchased slides of the same area, "the shots you missed" for one reason or another. Interesting facts from books or travel folders can be employed as the "script" for your narration. A complete sound and sight "video movie" can be created in your home.

We have mentioned only a few of the possible applications of video recording in order to acquaint our readers with the tremendous potential of this medium.

In future "Sound and Sight" articles we will cite actual examples of the various applications and provide detailed information on the techniques employed—the "tricks of the trade" so to speak. Æ



# The Tape Guide

## Some Comments on the RIAA Tape Standard

HERMAN BURSTEIN

Send questions to:

Herman Burstein

280 Twin Lane E.

Wantagh, N. Y.

Include stamped, self-addressed envelope.

THE RECORD INDUSTRY OF AMERICA, Inc. recently issued Bulletin No. E5, "Standards for Magnetic Tape Records." It is gratifying to note the existence of these standards and to read them. They are clearly and succinctly expressed, and appear a sagacious combination of what is desirable and what is practical. In the case of equalization, RIAA's standards, to my knowledge, are the first ones *officially* promulgated for 7.5 and 3.75 ips operation. Previously there were only *suggested* standards, such as those of MRIA (Magnetic Recording Industry Association); and there were "common practices" which lacked a desirable degree of universality. By implication the RIAA standards have home use in mind inasmuch as they deal with 7.5- and 3.75-ips operation, whereas the professional speed is usually 15 ips.

I am not going to try to discuss the entire contents of Bulletin E 5 even though its text fills less than three printed pages. The interested reader can write to RIAA (1 E. 57th St., New York, N. Y. 10019). What I would like to discuss are the standards concerning equalization and disposition of the tracks in quarter-track operation. First, however, here is a relevant excerpt from a letter sent me by RIAA:

\*280 Twin Lane E., Wantagh, N.Y. 11794

"With regard to our standards generally, I think you ought to be aware that the Association does not arbitrarily legislate standards and exact mandatory compliance on the part of members of the industry. Adherence to these standards is completely voluntary and in order to win as much compliance as possible the standards endeavor to cover not only the theoretical aspects of the question but also its practical applications. At times, this involves a compromise between conflicting points of view and between theoretical desirability and practical attainment."

### Equalization

Figure 1 shows the playback equalization curves recommended by RIAA for 7.5 and 3.75 ips. Standard 9.1 states, "This is exclusive of any modifications to the characteristics required to correct for head losses." In other words the playback equalization in Fig. 1 can be altered (less treble cut and/or additional bass boost) to compensate for frequency losses of the playback head. Because the above quotation appears in a section titled "Reproducing Characteristic," it must be interpreted as applying only to the playback head.

The RIAA standard says nothing about record equalization. But logic and precedent (such as the NAB standard for 15 ips) tell us that record equalization shall be such that, in conjunction with standard playback equalization, it achieves record-playback response which is flat within desirable and practical limits (determined in large part by tape speed).

Happily the RIAA playback curve for 7.5 ips is the same as NAB equalization. The NAB curve has long been official for

15 ips, and in the past 10 years has come into increasing use for 7.5 ips as well. For a number of years all or nearly all 7.5-ips recorded tapes have incorporated NAB equalization; that is, they produce flat response when played back with the 7.5-ips curve in Fig. 1. It is to be hoped that those tape recorder manufacturers who do not yet provide RIAA (same as NAB) equalization at 7.5 ips will be prompted by the new standard to fall in line.

On the other hand, the RIAA 3.75 ips curve gives us cause for reflection. In net it appears a good choice, but there are problems; no matter what other choice might have been made, there still would have been problems.

To approach these problems, it is first necessary to appreciate that the whole question of tape equalization doesn't really revolve about frequency *per se* but about recorded wavelength. Within the audio range of 20 to 20,000 Hz, modern, well-constructed tape heads exhibit insignificant frequency losses. What we are up against essentially are losses on the tape, which increase as recorded wavelength decreases. At a given tape speed, recorded wavelength decreases with rising frequency. At a given frequency, recorded wavelength decreases in proportion to a decrease in tape speed. A playback equalization characteristic is chosen to achieve optimum performance in view of tape losses at various wavelengths. Optimum performance means the best combination of extended treble response, low distortion, and high signal-to-noise ratio. When we translate a wavelength characteristic into frequency, we must take tape speed into account. If the optimum playback equalization thus translated gives us a bass-boost curve with 50- $\mu$ sec equalization (3180-Hz turnover) at 7.5 ips, then it gives us 100- $\mu$ sec equalization (1590-Hz turnover) at 3.75 ips.

In short, if 50  $\mu$ sec equalization is satisfactory at 7.5 ips, 100  $\mu$ sec equalization should be equally satisfactory at 3.75 ips. The RIAA (or NAB) curve for 7.5 ips is a 50- $\mu$ sec curve. But the RIAA curve for 3.75 ips is 90 instead of 100  $\mu$ sec. Why 90  $\mu$ sec? I don't know, but here are two guesses.

1. Ninety  $\mu$ sec may be closer to optimum than 100  $\mu$ sec at 3.75 ips. (If so, by the same token 45  $\mu$ sec is closer to optimum than 50  $\mu$ sec at 7.5 ips. But since 50- $\mu$ sec equalization is in widespread use at 7.5 ips, RIAA wisely decided to make the 50- $\mu$ sec curve standard.) Although 100  $\mu$ sec might have been closest to optimum until recently, continued improvements in tape heads, tape machine electronics, and tapes (better treble response, less noise, and more head room—ability to withstand more applied signal before saturating) have probably made it feasible to go somewhat below 100- $\mu$ sec equalization, say to 90  $\mu$ sec. It should be understood that reducing playback equalization in terms of the time constant (or increasing it in terms of the turnover frequency means a larger amount of bass boost and, conversely, a greater amount of treble cut in playback. More treble cut in playback is feasible if the tape's treble performance has been improved and if it is possible to apply increased treble boost to the tape before

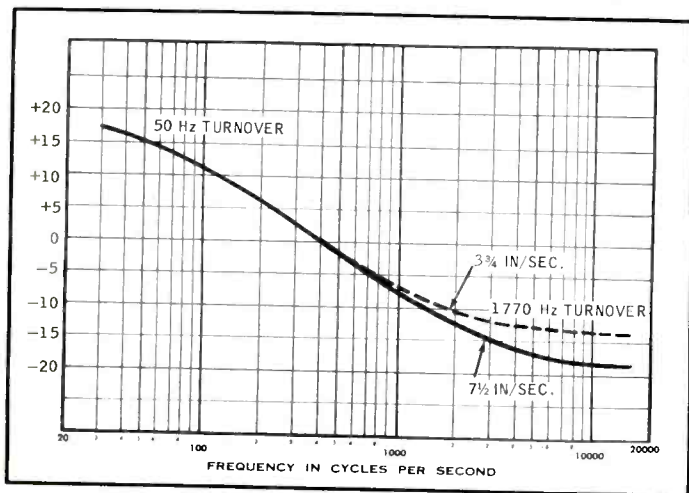

Fig. 1. Reproducing characteristics for magnetic tape records as provided by the RIAA Tape Standards. Reference frequency, 400 Hz; Tolerance:  $\pm 2$  dB

excessive distortion sets in. Altogether, if the RIAA found 90- $\mu$ sec equalization optimum for 3.75 ips, and if it were not confronted by some other prevailing equalization practice at this speed, it had good reason to designate 90  $\mu$ sec as the standard.

2. If you study Fig. 1, you'll see that the curves for 7.5 and 3.75 ips are at most 5 dB apart at the high end. An intermediate curve, with 70- $\mu$ sec turnover, would be within 2.5 dB of being correct for either 7.5 or 3.75 ips. Hence a moderately priced tape machine could save money by providing only one playback characteristic for both 7.5 and 3.75 ips, and yet be within 2.5 dB of correct equalization at each speed. A 2.5-dB error is barely, if at all, audible, and easily corrected by a slight touchup of the treble control in one's audio system. It should be noted in Fig. 1 that the standard permits 2 dB tolerance for the playback curve. A deviation of 2.5 dB instead of 2 dB from the nominal curve is not unforgivable.

Thus in itself the RIAA 3.75-ips curve makes sense. But it does raise a problem in view of playback equalization practices at this speed on the part of some tape recorder manufacturers. In the previous absence of a standard applicable to this speed, various equalization practices have sprung up. Some machines employ as high as 200- $\mu$ sec equalization.<sup>1</sup> Others use 100  $\mu$ sec—observing the wavelength relationship, which calls for 100  $\mu$ sec at 3.75 ips if 50  $\mu$ sec is right for 7.5 ips. Still others may be using 120  $\mu$ sec equalization, as suggested by MRIA several years ago. The difference between 90- and 100- $\mu$ sec equalization is insignificant, involving not quite 1 dB of treble exaggeration if 100  $\mu$ sec is used when playing a tape calling for 90  $\mu$ sec. The difference between 90 and 120  $\mu$ sec is on the border of significance, involving about 2.5 dB treble exaggeration. But the difference between 90 and 200  $\mu$ sec equalization is serious, involving almost 7 dB of treble exaggeration. Recorded tapes operating at 3.75 ips are coming into vogue, and if they require a 90- $\mu$ sec playback curve, a machine with a 200- $\mu$ sec playback curve will produce noticeable treble emphasis.

The owner of such a machine might make the effort to have its playback equalization network changed; and this will require a corresponding change (more treble boost) in the record equalization. But what then of the tapes he has previously recorded at 3.75 ips? It appears his best course is to leave the equalization network alone, and use the treble control of his audio system to supply the required treble cut if and when he plays recorded 3.75-ips tapes requiring 90  $\mu$ sec equalization.

#### Tape Tracks

Until now we have understood that the quarter-track format is essentially that of

<sup>1</sup>Use of 200  $\mu$ sec playback equalization may have two explanations. In the United States, at one time 50  $\mu$ sec was considered suitable only for 15 ips. Proportionately, therefore, 200  $\mu$ sec was considered appropriate for 3.75 ips. In Europe, the CCIR curve uses 100  $\mu$ sec equalization at 7.5 ips. Proportionately therefore, 200  $\mu$ sec is called for at 3.75 ips.

Fig. 2. Basic quarter-track tape format.

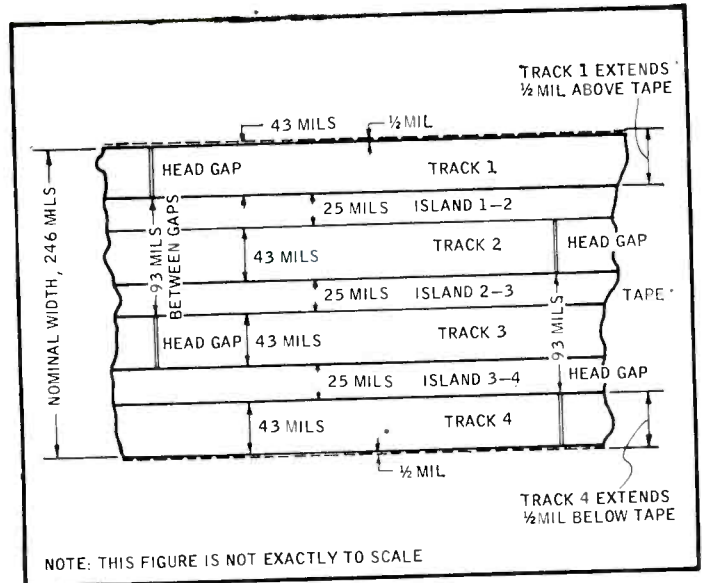

Fig. 2, whether used for four-way mono or two-way stereo. Each of the four tracks is shown as 43 mils wide, and each of the three islands is shown as 25 mils wide, adding to a total of 247 mils (thousandths of an inch). The nominal width of so-called "quarter-inch" tape is actually 246 mils (instead of 250 mils, which would exactly equal one-quarter inch), with a plus and minus tolerance of 2 mils. In brief, the tape may be between 244 and 248 mils wide. If it is less than 247 mils, a very slight amount of the upper gap of a stereo tape head may project above the tape, resulting in tracks 1 and 4 being slightly too narrow. But the loss in recorded signal on tracks 1 and 4 is inconsequential. At most, when the tape is 244 mils wide, 1 1/2 mils out of 43 mils would be lost on each track, reducing the signal by only 0.3 dB.

Alternatively, a stereo tape head can be aligned with reference to the tape so there is no track loss. What happens then is that the middle island (between tracks 2 and 3) is slightly wider than 25 mils, while the other two islands are slightly narrower than 25 mils. This is illustrated in Fig. 3, which shows how the gaps might be positioned with reference to a tape 244 mils wide. Note that each gap

has the same height (43 mils) as in Fig. 2, and the distance between the two gaps (93 mils) is the same as in Fig. 2. If we think of tracks 1 and 3 as remaining stationary, what has happened is that tracks 2 and 4 have been moved up 3 mils with respect to tracks 1 and 3.

With this background, we can turn to the RIAA standard, which basically conforms to Fig. 2 but makes the tracks fit the tape and the tape heads in use. Standard 8.2.3 states:

"The four tracks shall each have a recorded track width of  $.043 + .000, - .004$  in. and be equally disposed across the width of the tape so that the distance between the center lines of tracks 1 and 3, and 2 and 4 will be 0.134 inches to 0.136 inches. Tracks 1 and 4 should be positioned so that the distance between their outer edges does not exceed the minimum tape width of 0.244 inches."

Spelled out, this says:

1. The total space occupied by the tracks and the islands between them shall not exceed 244 mils, thereby fitting onto a tape of minimum standard width.
2. All four tracks shall be equally wide.

(Continued on page 77)

Fig. 3. Accommodating four tracks within a tape 244 mils wide.

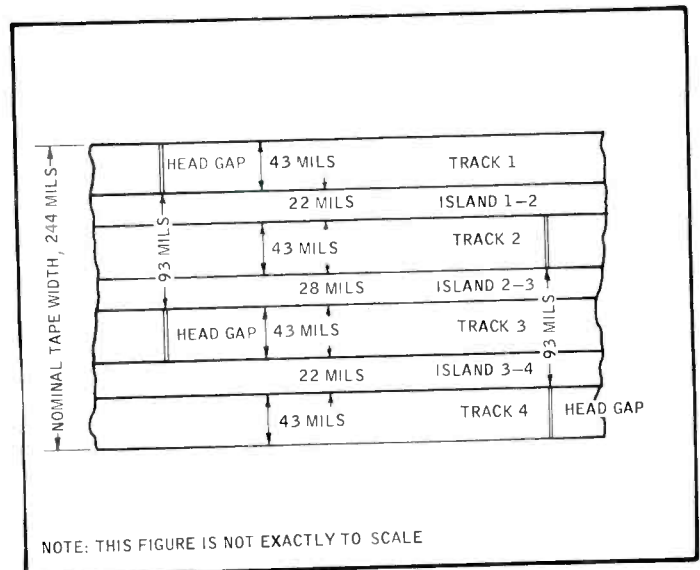

# Evaluation of Artificial Reverberation to Conventional Sound Installations

GEORGE S. LEHSTEN\*

While artificial reverberation is far from being a cure-all for recordings made originally in a "dead" hall, it does have some advantages and if the user understands the limitations, he can often improve the over-all result. The author calls attention to some salient features.

**D**URING THE PAST SEVERAL YEARS, the introduction of several different types of equipment for the purpose of providing artificial reverberation to existing recordings has been made. With few exceptions the majority of these ventures proved unacceptable chiefly because of a lack of experience in the proper use of such equipment. Admittedly, some units also added undesirable amount of distortion.

Extensive evaluation of a large percentage of these designs has led to the belief that improper use constituted the biggest source of distortion rather than the equipment itself. Specifically, four major types of reverberation equipment have been evaluated for their individual usefulness both for the purpose of adding a reverberation signal to a properly set up reproducing system and adding reverberation signals to existing recordings.

To evaluate the apparent quality of such equipment a reference must be at hand for a comparison. Consequently, a rather extensive study of various music studios and halls was made. While the results obtained did not point out any superior hall qualifications, they did point out that an "average" reverberation characteristic would not yield an acceptable pattern for the design of such a device. To this end, a more detailed study of Carnegie Hall in New York was made. It is based on the results of this study that the specifications for the application of a reverberation signal to existing stereophonic systems has been attempted. This is not meant to be an endorsement of the acoustical properties of Carnegie Hall or any other hall for that matter, but rather a basis for the development of an effective system

for the application of such signals to existing equipment.

## Types of Equipment

Of the general classes of equipment for this purpose, four main types are available—(1), the electro-mechanical systems employing electronic assemblies for the necessary amplifying considerations and mechanical devices such as springs or rods for the delay networks; (2), the electro-acoustical systems which are similar to the first type except that they employ acoustic chambers for the necessary delay qualifications; (3), the electronic recording techniques of recording the signal on an endless tape and combining, by rather intricate means, the signals from a number of reproduce heads spaced at varying increasing distance from the record head; and (4), the all-electronic systems employing electronic logic circuits to provide the necessary delay characteristics. To evaluate which of these systems could be considered the better design approach to the task at hand requires a highly imaginative line of reasoning to the desired end result.

The chief disadvantage with all of these systems, in varying degrees, is that the signal that controls or initiates the reverberation signal is the same that the listener hears from the main channels of the existing system. In actual practice however, it has been found that a certain percentage of the reverberation in the original hall presentation is derived from acoustical effects that are not picked up by normal microphone placement procedures. In some specific cases of intentionally recording the reverberation signal on a separate track the best over-all signal was captured when the reverberation microphones were located to the rear of the hall. When these tapes are compared on a point-to-point basis, by means of a sound spectrograph, to the

tapes made for the normal A and B channels, discrepancies as to the original notes and sounds are apparent.

## Applications

In setting up a system employing artificial reverberation the first approach is to in part remove by means of a series of sharp filters a frequency spectrum that is representative of the acoustic dimensions of the original recording hall. The differential level of this bandwidth has to be maintained, however, so that the listener does not become aware that a portion of the reproduced signal is missing from his "A" and "B" channels. The actual level of the resultant of the reverberated signal added acoustically to the remaining level of sound from the "A" and "B" channel has to be exactly the same as before the removal of the reverberation signals. As an example, if the original program material had, during one specific passage, a note of 1000 Hz at an acoustical level of 0.5 watts when reproduced, we would remove the equivalent of 0.1 watts of this 1000-Hz signal from the A and B channels, process it by way of our delay networks and subsequently reproduce it by another speaker at such a level that the listener is still aware of the 1000-Hz note at a level of 0.5 acoustical watts.<sup>1</sup> It should be apparent at this point that the application of any device that merely takes a portion of the A and B signals, delays it by some figure and reproduces it without any form of compensation of the original A- and B-channel levels, is adding to the acoustical level of the listening area this small bandwidth of frequencies placing them out of perspective with the original program material. (Continued on page 71)

<sup>1</sup>The actual level of course would depend on the amount of reverberation required. The figures given are for the purpose of explanation only.

\*480 Teaneck Road, Teaneck, N.J. 07666  
President, Perfectone Sound Laboratories  
Chief Engineer, Alpine Geophysical Associates, Inc.

**90-WATT OF AMPLE POWER!  
AUTOMATIC STEREO SWITCHING!  
AMAZING VERSATILITY!**



**MODEL SX-1000T**

**NEW 90-WATT SOLID STATE FM MULTIPLEX STEREO RECEIVER  
MODEL SX-1000T**

The above-mentioned are but a few of the superb features of PIONEER'S handsome new stereo receiver, the SX-1000T, a feature-packed receiver for the discerning listener who wants true professional performance at a practical price.

- Large power by 2SD-45 transistors
- Sensitive protective transistorized switch and relay for protecting transistorized circuits
- FM circuitry: cascode front-end using 4 nuvistors, 4 dual-tuning IF stages, with muting circuit
- Tuning range: 88~108 Mc
- FM sensitivity (IHF): 2 microvolts
- Multiplex circuitry: time-switching circuit, with automatic mono/stereo switch
- Audio circuitry:

- single-ended pushpull circuits using silicon power transistors, direct-coupled output to loudspeakers
- Frequency response:  $\pm 2$  db, from 20 to 20,000 cps (overall)
- Protection circuit: electronic switching
- Line requirements: 115/230 volts, 50/60 cycles AC
- Music power output: 90 watts (IHF), with 16 ohms loads
- Dimensions: 17-1/2" (W) x 5-7/8" (H) x 15-1/8" (D).

**NEW 40-WATT SOLID STATE AM/FM MULTIPLEX STEREO RECEIVER  
MODEL SX-600T**

- AM frequency range: 535~1605 kc
- AM sensitivity (IHF): 16 microvolts
- AM antenna input: built-in ferrite loopstick with terminal for external antenna
- Music pow-

- er output: 40 watts (IHF), with 16 ohms loads
- Dimensions: 17-1/2" (W) x 5-7/8" (H) x 16-15/16" (D). All other specifications are the same as for Model SX-1000T.

**MAIN PRODUCTS:**  Hi-Fi Speakers  Stereo Hi-Fi Amplifiers  Hi-Fi Speaker Systems  Stereo Hi-Fi Turntables & Record players.



**PIONEER ELECTRONIC CORPORATION**  
15-5, Nishi 4-chome, Omori, Ota-ku, Tokyo, Japan  
Cable Address: PIONEER TOKYO  
NEW YORK OFFICE: 350 Fifth Ave., New York, N.Y. 10001  
Telephone: (212) LA4-1757/8

Circle 122 on Reader Service Card

# Test Tape for Checking Head Position

C. G. McPROUD

Changing heads, replacing one type with another, or any other activity involving the moving of the heads on a tape recorder points up a need for a test tape to ensure proper positioning.

A FEW MONTHS AGO, the author had occasion to change a head on an Uher 4000-S tape recorder (AUDIO, October, 1965) and needed some sort of alignment-indicating tape to make sure that the new head, a Nortronic 1202, was in the correct location. Such a tape is commercially available from RCA under the designation 12-5-64T, and can be obtained from RCA Victor Record Division, 6800 E. 30th St., Indianapolis, Ind., we have since learned, but at the time we were unaware of it.

However, in talks with our associate, Larry Zide, we came up with a tape which most anyone with two properly head-positioned tape recorders can make for himself, provided one of the recorders is full-track and the other quarter track, with three heads.

The whole idea is borrowed from movie practice, in which an optical track was used for the same purpose. This track consisted of an area which was unmodulated in the proper position for the sound projector light slit, and the remainder of the track was modulated with a "buzz," essentially a low-frequency square wave. When the film was played on a properly aligned projector, nothing was heard. If there was any misalignment, you heard the buzz.

We decided upon a track which would have 1000-Hz modulation on the proper track positions, and a 150-Hz square wave on the balance of the tape. To produce such a tape, we first recorded the 150-Hz square wave on a full-track machine, thus giving us the "buzz"-track background. The next step was to record 1000 Hz on both channels of a four-track stereo recorder, with the normal erase head "cleaning off" the 150-Hz square wave prior to the recording of the 1000 Hz.

While this did exactly what we thought it would, we had overlooked the fact that the erase-head track is about 8 mils wider than the recorded track, so it left a clear space on each side of the 1000 Hz, as shown in Fig. 1, which is a simulated representation of the final result. This resulted in a playback of the 1000 Hz in a satisfac-

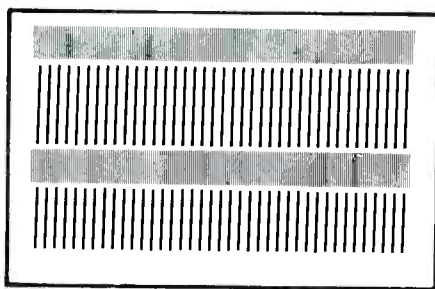

Fig. 1. First attempt to prepare the test tape resulted in tracks of 1000 Hz with a small clear space between them and the "background" of the 150-Hz square wave pattern.

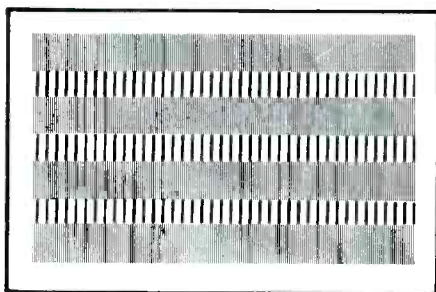

Fig. 2. By using the record head as an erase head for one pass, and then actually recording 1000 Hz with the same head on the second pass, the spaces between the tone and the buzz are eliminated. Needless to say, the erase head was not energized to make this recording. Then, reversing the reels and repeating the performance gave a four-track 1000-Hz tone, with the buzz background occupying only the island spaces.

tory manner, but permitted a slight deviation from the correct position before the error became noticeable. Obviously, the tape could weave some 4 mils either way before the background buzz was heard.

The next step, logically, was to disconnect the erase head and connect the record head to the erase oscillator, using the record head as the erase head and thus cleaning off *only* the area properly occupied by the desired track position. A second pass through the machine with the record head connected in the normal manner and the erase head still disconnected gave a

similar result to that in Fig. 1 but without the spaces between the 1000 Hz and the 150-Hz buzz.

Reversing the tape and making two more passes through the machine, repeating the last two steps, will provide the result shown in Fig. 2.

Thus we have a test tape which will reproduce only 1000 Hz when the heads are in the correct position, but any deviation will show up as a buzz superimposed over the 1000 Hz.

## Modifications

While it may be argued that for the single purpose of track positioning the test tape could have accomplished the same objective if we had only erased the 150-Hz buzz track, with the record head serving as the erase head, and leaving the track position completely blank. This would undoubtedly have been preferable since it would be easier to hear the buzz in the absence of the 1000-Hz tone. However, this would have eliminated a second benefit of the test tape—that of checking the balance between the two tracks and the associated amplifiers.

The tape described offers the experimenter a simple and workable means of checking the head position after a change, and can be made on any standard four-track recorder in which the erase head may be disconnected and the record head used temporarily as the erase head.

In this latter connection, it is likely that the erase/bias oscillator may not furnish sufficient bias to the record head to erase the buzz without some adjustment, but some recorders have this facility. It is usual for the record head to have higher inductance than the erase head, and more erase current may be required than the erase oscillator can furnish. This can be remedied by interposing an amplifier between the oscillator and the record head. Then monitor on the play head and gradually increase the erase current until the track is silent. This does require a machine with three heads, but the typically ingenious tape enthusiast should have no trouble in obtaining the desired result. Æ



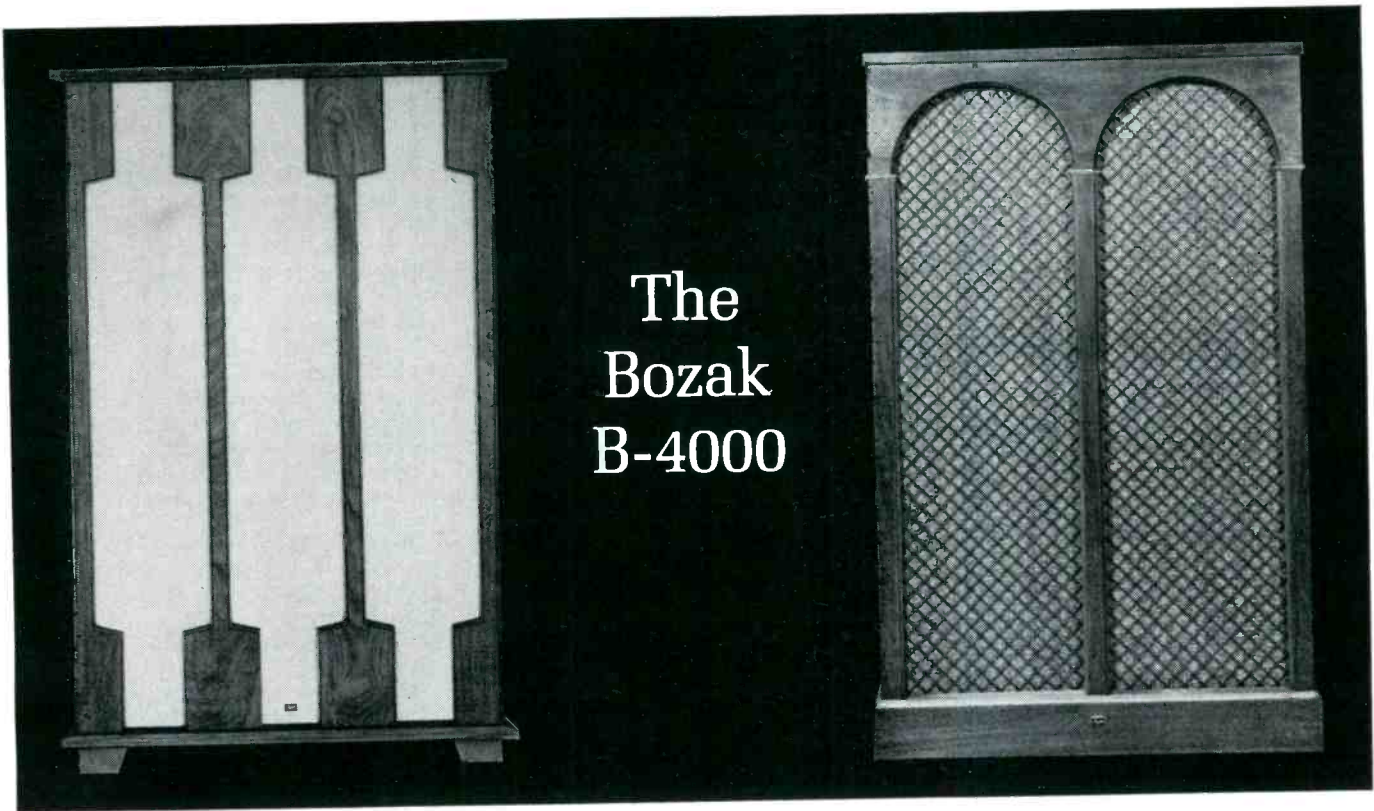

## The Bozak B-4000

**“Well Articulated...Musically Balanced...Eminently Honest”  
—High Fidelity**

What makes Bozak's Symphony No. 1, Model B-4000, the largest selling full-sized, full-voiced speaker system in the world?

For one thing, it is specifically designed for stereo. To achieve the broad, uniform distribution of high frequencies needed for stereo realism, the eight treble speakers in the B-4000 are arranged in a loaded vertical column array. That's the same arrangement we designed for the outdoor sound reinforcement systems used by the New York Philharmonic and the Metropolitan Opera.

Even though we designed and build the Symphony No. 1 to provide the utmost in stereo realism, we were gratified to have added rec-

ognition for the results of our efforts from the authoritative magazine *High Fidelity* in its December issue.

Such phrases as “outstandingly smooth and uniform”, “top performing speaker system” and “satisfying combination of breadth and depth” also reaffirm your judgement in making the B-4000 the popular speaker that it is.

If there's a certain indefinable something missing from your own music at home, perhaps you should listen to the Bozak Symphony No. 1. Your dealer will gladly demonstrate.

Or, if you'd like the opinion of an unbiased expert, we'll gladly send you a reprint of *High Fidelity's* review.



Box 1166, Darien, Connecticut  
Circle 123 on Reader Service Card

# EQUIPMENT

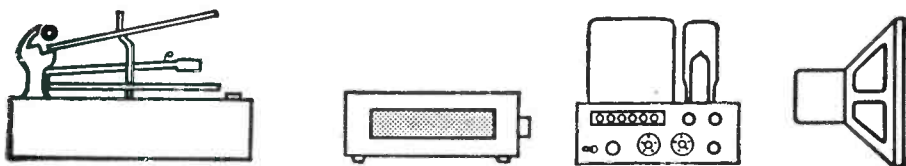

# PROFILE

## HEATHKIT MODEL IG-112 FM STEREO GENERATOR

It is particularly appropriate that we report on this piece of test gear in this issue, centered as it is upon useful audio test equipment. The FM Stereo generator is, in fact, a new comer to the test field. There are, at this writing, few enough service agencies that possess one. Part of the reason is that FM Stereo generators have been expensive. \$500 is the figure quoted for several of the *lower* priced ones. So, how can Heath deliver a unit of quality at \$100 (admittedly as a kit)? We shall see.

It might be logical to ask, first off, if this is the sort of instrument that is needed by the average audio buff. Certainly it is not the *first* instrument that a budding lab requires. But if you take your FM Stereo seriously and want to maintain your tuner in best possible operating condition, this generator will pave the way toward that goal.

This is a good alignment tool for *any* FM tuner, mono or multiplex. In a single package of compact dimensions is con-

tained a multi-frequency audio generator, a multiplex signal generator, and a 100-mHz FM signal generator. Three in one, as it were.

The IG-112 thus provides an audio modulated FM Stereo signal that can feed directly either a multiplex adapter (or the input to the multiplex section of a tuner or receiver) or the antenna terminals of a tuner.

The FM output is centered at 100 MHz with an adjustment for  $\pm 2$  MHz. Deviation is continuously adjustable to a maximum of 75 kHz with a sweep rate of 60 Hz. For 'scope alignment of a tuner, the sweep width is adjustable to 750 kHz. Output is moderately high, certainly enough for the most insensitive tuner. Conversely, there are three step-switches that each give the FM signal 20 dB of attenuation.

Audio modulation is switch selectable at 400, 1000, or 5000 Hz. In addition, you may elect 19 kHz, 38 kHz, and SCA (65 or 67 kHz). Output is selectable at the composite-signal output for left- or right-in phase. You can also pick any of the

available audio frequencies directly if you wish.

If it is a complete tuner to be aligned, the IG-112 will also provide FM markers (crystal generated) at 10.7 MHz, 90.95 MHz, 96.3 MHz, 101.65 MHz, and 107 MHz. A 5.35-MHz crystal is employed.

The controls are self-explanatory regarding function of the unit. There are five front-panel knobs. In the center is the function switch. This places the mode of operation at R. F. Sweep/I. F. Marker; Audio and Mono FM, Phase Test (Left plus Right in Phase); Left Channel; Right Channel. To the left of this switch is the 19-kHz pilot-level control that also includes the power on/off switch. To the right is a control with the wordy label: Deviation - Sweep Width - Composite Level-Audio Level. Obviously, it doesn't do that all at once but depends rather on the mode of operation.

Along the lower portion of the front are to be found the Frequency Selector, Composite Signal/Audio-Output connector, I. F. Marker Output connector, the three R. F. attenuators, (slide switches), and the Center R. F. Frequency control.

On the rear apron is the only additional operating control: a slide-switch selector for the SCA signal of 65 or 67 kHz.

## Construction

Heath stoutly maintains itself as the leader of the paper-bag-pack concept of kit packaging. There is nothing fancy about the way the kit comes. All the resistors are in one bag, all the capacitors in another. Once everything is sorted out, you set to.

One thing we discovered pretty quickly was that good quality parts are used throughout. Heath has not stinted on hardware, either. There were left-overs in all screw sizes.

A bit over ten hours had the job done. Heath's book is magnificent. Illustrations are excellent and sufficiently detailed. Frankly, we expected that there would be several errors along the way since no addendum sheet came with the kit. And we did find two: on page 23 the book has you threading a wire from a lug of tube  $V_6$  through the center post and out to another terminal. The special ceramic socket provided for that position has no center post. Then in the alignment instructions (this procedure takes another hour or more) we spent a bit of time looking for  $L_6$  to adjust. There was none. A check of the schematic revealed that what was screened  $L_6$  on the chassis is, in fact,  $L_{10}$ . Those were the errors. Frankly, we have found less perfect books when there *have* been addenda.

Well, it was finished and we plugged it in. Tubes lit, nothing smoked, so we went on to the alignment. It wasn't long ere we discovered that all was not right in the multiplex section. Audio was fine, but no multiplex generation. It was a couple of hours later before we uncovered the joint that solder hadn't quite reached. (Not Heath's fault—ours.) Alignment incidentally requires both a scope and an a. c. VTVM.

Once alignment was finished we had on hand a worthwhile tool. Scope observa-



Fig. 1. Heathkit IG-112 FM-Stereo Multiplex Generator.

*New from Garrard  
Model SP 20  
at only \$37.50*

*an excellent 4-speed manual  
record playing unit with  
high fidelity features. This  
compact, efficient player  
is recommended for  
basic music systems  
and quality audio-  
visual applications.*



Semi-counter-  
balanced arm  
with adjustable  
stylus pressure

Full size  
weighted  
turntable

Trip of DuPont  
Delrin®... track  
as light as  
2 grams

Size—Compact  
14 $\frac{3}{8}$ " left to  
right, 12 $\frac{1}{2}$ "  
front to rear,  
3 $\frac{1}{2}$ " above and  
2 $\frac{1}{8}$ " below  
motor board.  
Fits Garrard B10  
series bases.

Interchangeable  
plug-in head, for  
any cartridge

Automatic return  
of arm to rest,  
and shut-off  
after play

Motor designed  
and built entirely  
by Garrard

**Garrard**  
WORLD'S FINEST

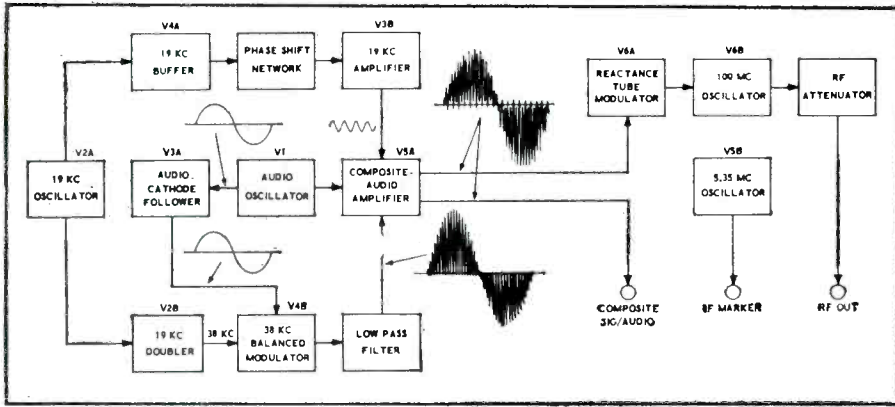

Fig. 2. Block schematic of Heathkit Multiplex Generator.

tions showed as good a signal as one could want. We used it to check the alignment of a tuner that had just had a going over with equipment listing at ten times the cost. The results were the same.

We are not running the usual circuit description (it is given in considerable detail in the construction manual) relying instead on publication of the block diagram, Fig. 2. The only comment necessary is that both the 19-kHz and 5.35-mHz oscillators are Pierce crystal-controlled circuits for maximum stability and accuracy at these critical points.

This generator is a tool of considerable merit for its qualities and versatility. If we feel that it could be further improved by the addition of an input for an audio oscillator or music signal and a position that provided only 19 kHz (instead of including signal) at the level it is mixed with signal (10 per cent) then we are lint picking. This is a fine instrument; one that does a thoroughly professional job at considerably less than a professional price. For this, even had there been nothing else, Heath is to be congratulated.

Circle 210

### REVOX G-36 TAPE RECORDER

Tape recording has come a long way in the last few years. It seems only yesterday that it was an extraordinary machine indeed that could break the 12-kHz barrier. (And, not much earlier, it was a rule of thumb that top frequency response equalled the speed in inches-per-second multiplied by one kHz.)

Now it is commonplace for a recorder to provide 20,000-Hz response at 7½ ips. And, at low distortion. Where standard 0 VU was often specified at a 2- or 3-per-cent point, 0 VU now is expected to be under 1 per cent. And it is often half a per cent or less.

This ReVox G-36 is a prime example of what we mean. Although a recent arrival in this country, the Swiss firm has been on the European scene for a while. The G-36 is identical to the ReVox 736 that has been described in recent British periodicals, with one important difference—the equalization standard in Europe is the CCIR curve, materially different from our NAB curve. The G-36 is, of course, supplied with NAB equalization. The accuracy of that curve reproduced is shown in Fig. 4. This is derived from Ampex Test Tape 31321-01. The bass rise shown is, for the most part, the tape and not the ReVox.

At \$500, the G-36 is the lowest-priced unit we know that has the capability of handling 10½-inch reels. And, it is admirably qualified to handle these reels, too.

By way of explanation, the G-36 is a three-motor machine. Capstan drive is from an oversized Papst hysteresis-synchronous motor. Each reel hub is an extension of a shaft from a separate Papst motor. Hold-back tension for tape transport is achieved by applying reverse torque to the supply motor. Since the 10½-inch reels have an average circumference (with tape) that is larger than the usual 7-inch reel, greater pull is required for these large reels.

This is achieved by a cleverly arranged knurled ring switch located at the apex of the head cover. In the small-reel position, an arm is extended from the cover and prevents the placement of large reels until a tension change is made by pushing the arm back into the cover.

It is hard to imagine that controls could be placed more logically and practically than they are here. The four knobs shown are actually all coaxials. The two on the left are for the play circuits; the two on the right for record. The coax rings on the two left knobs control power on/off and playback mode respectively. The two on the right are identical. Each selects one of three possible inputs for each channel. This pair also allows sound-on-sound with an extra position each that transfers sound from one stereo channel to the other.

The small knobs are all control pots. On

the right, they control respective channel record volume. On the left, one is for play volume through the built-in mono speaker; the other applies bass boost to playback through that speaker.

A pair of standard-ballistic VU meters are provided for record monitoring. They are stilled in playback. Playback, incidentally, is either through a single built-in monitor speaker and six-watt amplifier or, via fixed-output cathode followers (to a stereo amplifier).

Since there are three separate quarter-track heads and separate record and play preamplifiers, off-the-tape record monitoring is possible. This may be done on the machine, affecting only the sound that comes from the internal speaker. Or, it can be achieved on any standard amplifier/control that has a tape monitor facility.

All tape motion is controlled by four of the five piano-type keys. These are electric-keyed to the operation they control. The capstan pinch-roller, assembled on a heavy casting that is part of the over-all head assembly, is solenoid controlled as are the mechanical brakes. These brakes, incidentally, are of fail-safe operation. That is, when power is removed, the brakes are applied. Thus, a plug pulled while in high-speed rewind will safely stop the tape with nary a loose turn. If the tape should run out or break, thus releasing a pressure switch, the brakes will also be applied and the capstan roller released.

### The Circuit

The entire electronics section is reached by removing the bottom cover of the unit. Layout is exemplary—all straight line and lovely-to-look-at (and to service if needed). Circuitry is straightforward enough using the common varieties of twin-triode tube. In all, twelve tubes, three silicon diodes, and three selenium rectifiers are used.

Each of the stages is notably single purpose. Relatively unusual in a recorder is the use of completely passive frequency compensation and equalization. Less unusual perhaps, but equally desirable, is the d. c. heating of all early preamp stages. Each record stage has a total of five triode stages. Each pair employs feedback to reduce distortion and noise. Three triode



Fig. 3. View of the Revox G-36 tape recorder.

# As of now, practically everything you've heard about solid-state receivers is out of date – including how much you should pay

## The new ADC *Six Hundred* all solid-state 60 watt stereo receiver

From the people who scored that astonishing breakthrough in phono cartridges . . .

*The ADC 10/E dropped critical "moving mass" to one-third that of other leading make cartridges, to become the first of which it can be said: No one will ever make a cartridge that performs perceptibly better.*

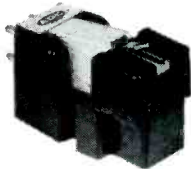

And got that independent top rating for a major advance in speakers . . .

*The ADC Brentwood 303A Speaker solves the old problem of "cone break-up" not with complicating capacitors or inductors, but by a simplifying design and production advance. In the independent ratings that count most, the 303A scored top!*



A receiver like this is the heart of your music system. It has to perform very, very well. This one does. And truth to tell, so do several other fine American makes, priced from about \$285 on up.

From there on out, this ADC Six Hundred is so different it starts a new generation. ADC never made tube units. This is no adaptation of a tube circuit, or tube parts, or tube assembly line. It's pure solid-state from the concept on.

As we did in cartridges and speakers, we created this advanced receiver with an approach we call Integrated Production Design. The usual method in the industry is to design the unit, then figure out how to produce it. Instead, we work out design and production together. Good ideas flow both ways. So when we go into production, no compromises are necessary—and we have a simpler, sturdier, better functioning piece of equipment. And a lot of the old "rules" are apt to go out the window.

For example, you may have heard that each transistor needs a big, complicated "heat sink". Nonsense! We use a simple aluminum extrusion that dissipates the heat through the chassis. It's more efficient and less costly. You've been warned that turning on the unit with a speaker lead loose could blow the transistors? Stop worrying; this one can't. No special protectors, just better design. You've been told all transistors have to be silicon? That's from the past. We use two types, each where it functions best, each totally damage-proof.

Our Integrated Production Design also makes this a "permanent" unit you can probably hand down to your son, and maybe grandchild. The electronics is wholly free of wires and tube-styled assembly. The rugged etched circuit boards

and solid, bonded modules could go on a moon-trip. And note the size (a tip-off to newness) —yet inside it is strikingly uncrowded and uncluttered. Peek in and admire.

Now as to price. As you know, transistor unit prices have crept down year by year as technology advanced. With this ADC development, they really crack. Compare. This beautiful, trouble-free, foolproof, soul-satisfying unit leaves from about \$60 to \$150 more in your pocket. Should you buy a semi-obsolete model and pay more for it? Silly question! See the new ADC Six Hundred (and the companion ADC Sixty Amplifier) at your dealer.

**SPECIFICATIONS—ADC Six Hundred RECEIVER**  
List price, \$248.00.

**TUNER SECTION:** Sensitivity (IHF Standard), 2.0 uv. Stereo separation, 35 db. ■ Automatic stereo switching ■ Tuning meter ■ Visual stereo indicator.

**AMPLIFIER SECTION:** Power output (IHF), 60 watts at 8 ohms. (Provides full output with any conventional speakers regardless of impedance) ■ Power per channel, 22 watts RMS ■ Full, independent control on front panel for 2 pairs of speakers ■ Separate fuses for each channel prevent shorting ■ Headphone jack ■ Full tape and monitoring provisions ■ Automatic contour ■ Total harmonic distortion at rated power, 0.5%; intermodulation distortion, 0.8% ■ Power band width at rated distortion, 20-20,000 cps. ■ Frequency response,  $\pm 2$  db., 10-100,000 cps. ■ True bookshelf size, only 8½" deep in finely crafted walnut cabinet (extra, optional).

THE ADC Sixty AMPLIFIER has identical power (60 watts at all impedances) and same features as Amplifier Section of the Six Hundred Receiver. Also available in walnut cabinet (extra, optional). List price, \$149.50.



**AUDIO DYNAMICS CORPORATION**   
Pickett District Road, New Milford, Conn.



Circle 125 on Reader Service Card

www.americandisbistro.com

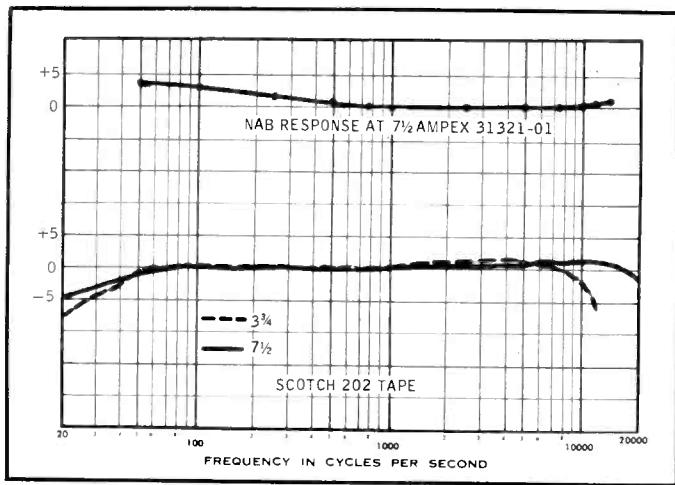

Figure 4. NAB playback and overall record/playback response of the ReVox G-36.

stages, two amplifiers, and a cathode-follower output form the play circuits. These stages just quoted do not count the push-pull oscillator (70 kHz) or the cathode-follower isolators between the record amplifiers and the VU meters.

The built-in mono power amplifier is of a completely standard three-stage push-pull design. It will deliver a legitimate 6 watts into an 8-ohm load.

#### Test Results

Figure 4 shows the over-all frequency response measured on Scotch 202 tape. Levels were run at 10 dB below indicated 0 VU. Between 18 and 20 kHz we detected some audible beat tones between the input signal and the bias. However, it should be noted that the normal energy content of music at these frequencies is well below the 10-dB mark, so this will never be an audible problem in recording.

0 VU as indicated on the meters was within one dB of standard 0 VU. In fact each channel was within one dB of its mate at all times so our graph has only one channel shown.

Input dynamic range capacity is enormous. In the microphone input, sensitivity is 1.2 mV for 0 VU. Strange, however, was the fact that distinctly non-standard back-panel RCA-type phono jacks were provided.

Tuner input sensitivity is 0.018 volts. Aux (labeled with the British radio term *Diode*) has a 2.7 mV sensitivity. There are a pair of input attenuators in this function that reduce voltage before the first stage so that the volume control can be used at a convenient middle position. Otherwise, it would be hardly needed. With that 2.7 mV input sensitivity it takes 0.8 volt before overload distortion sets in.

Signal-to-noise measurements were arrived at by erasing a 0-VU signal from the tape and measuring the residue. It was a respectable -45 dB left and -43 dB right channel. These are unweighted figures.

That big drive motor and careful attention to tape-handling details resulted in exceptionally low flutter and wow. At the 7 1/2-inch speed our meter needle just hung a bit over the zero mark. This is below 0.05 per cent total flutter and wow; extraordinary performance! At 3 3/4 ips we could, at least, reliably measure flutter. Total combined wow and flutter was 0.12 per cent; still better than we have measured on some units at 7 1/2!

Finally, if you are in a hurry to rewind

a tape, the ReVox will zip 1200 feet through in 45 seconds. With a tight, smooth wind.

We can't close without stating something about the plastic cover that comes with the recorder. It is of flexible Tenite-like plastic. Granted it is strong enough to support my 190-odd pounds without so much as a shudder, but its appearance isn't up to the rest of the machine.

So you see, nothing is perfect. (Oh, would that *everything* was so imperfect.) Some where along the line we trust that you have reached the conclusion that we are enamored of this machine. Because we are.

Circle 211

#### HARTLEY 220MS HOLTON SR. SPEAKER SYSTEM

Recently arrived is the latest in a series of 220 speaker systems from Hartley Products. These share the commonness of being full-range single ten-inch drivers. The Holton Sr. designation is indicative of the type of enclosure provided—a floor standing unit of modest but larger than "bookshelf" size.

The MS designation stands for Magnetic Suspension, a device consisting of a ferrous ring beyond the voice coil that acts as a movement damper on the cone. The result is a crisp clarity indicative of excellent transient response capabilities.

This latest version has removed the "whizzer" dome that graces earlier 220-MS's. In its place is a separate coaxial cone connected to the main cone only by a flexible surround. The manufacturer states that separate voice coils drive each section; this cannot be seen by visual inspection.

This, then is a coaxial system employing a ten-inch, long-throw woofer and, at its apex, a small tweeter sub-assembly. The mechanism is sold separately (no cabinet) for \$135. In the cabinet, which is fully loaded with a roll of kimsul-type insulation, it is \$245. From which price a quality product should be deduced. And, that is indeed what this is.

This is a full-range system. If you want to hear what 20 Hz sounds like, listen to this system. It is capable of bass response that needs take a back seat to nothing.

Actually, it is a lack of bass that is most impressive at first hearing. There

is no doubling at any normal levels. The solid transients reveal a driver that will not make bass when the music has none.

But one cannot eat of bass alone. This unit will do equal justice to the rest of the model, this 220MS delivers a mid-range that is both easy to listen to and full and rich.

Highs in appropriate abundance are here, too. Response extends smoothly up to the limits of audibility. Microphone checks indicate that those limits are beyond the average range of human hearing.

So it is a safe bet to deduce that musical balance is secure with this speaker. And so it is. Still, extensive listening tests do reveal a characteristic color. This is not a neutral speaker. (What speaker is?) The best adjective is "warmth." Or, to juxtapose, there is no sterile coldness to the sound of this system. Warmth must not be interpreted to mean muddiness. That is certainly not the case. The bass transient capability already alluded to extends over the entire spectrum of sound. Instrumental separation is good. (Don't confuse *instrumental* separation with stereo separation. We mean the ability of the speaker to separate the voices of the orchestra or chorus.)

Human voice is served well by these qualities. There is only a handful of speakers that share this ability to make a male voice *not* sound as if it comes from a barrel.

All of these qualities are bought, apparently, at the cost of efficiency. While this is not the lowest-efficiency system around by any means, it is one that will do best with a moderate to high-powered amplifier. Certainly, 20 watts per channel is a minimum needed.

This system will not prove to be everyone's cup of tea. Perhaps no speaker is or will ever be. But if you want a speaker to complement top-grade components, one that sounds musically valid and has more than adequate dispersion so that highs do not hit you between the eyes, then by all means audition this Hartley.

Circle 212



Figure 5. The Hartley Holton Sr. speaker system.

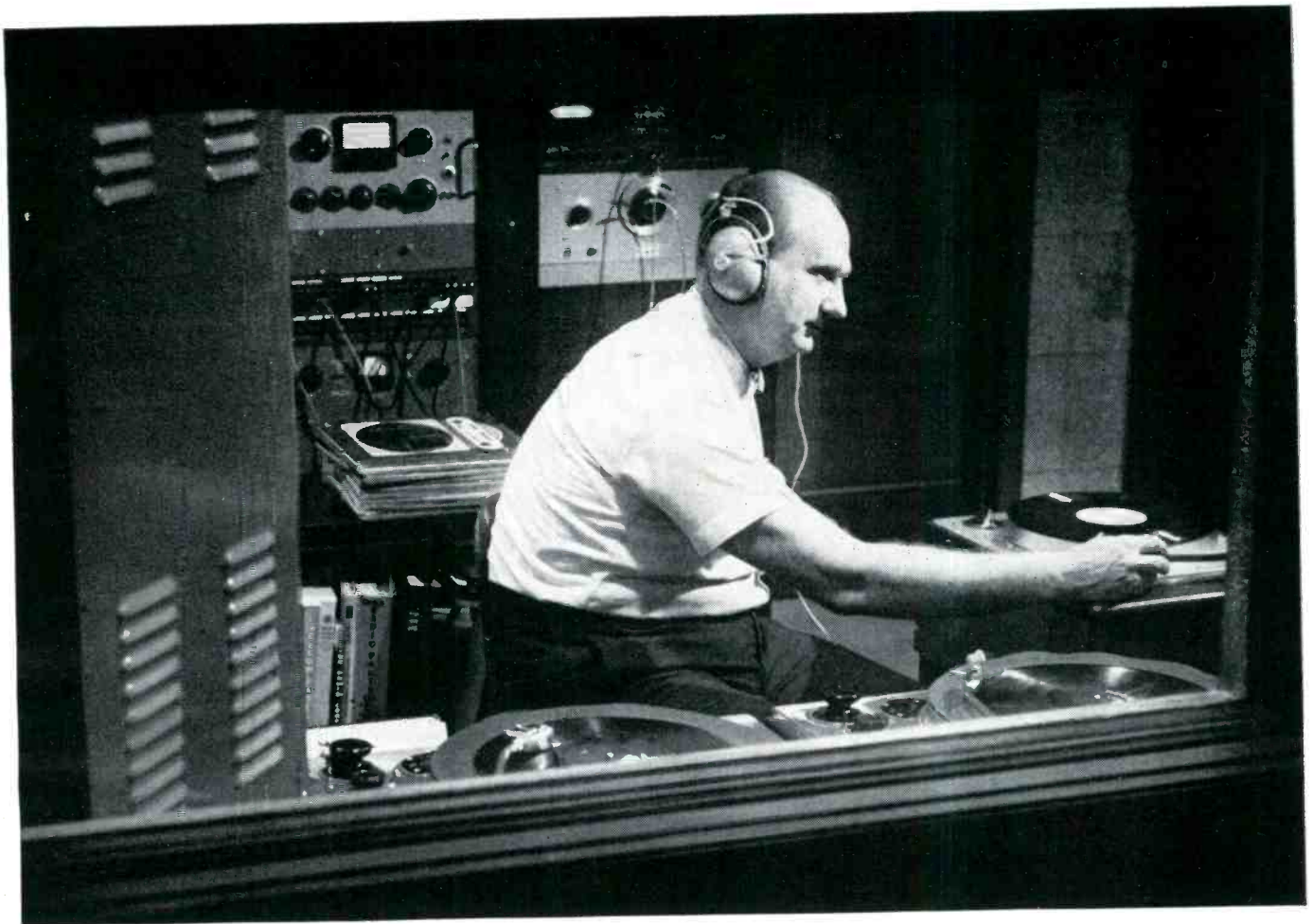

# ♥♥♥ RADIO STATION WFOX LOVES REK-O-KUT

Engineer Edward Wille depends on Rek-O-Kut turntables, as he has for over a decade to deliver the finest in recorded sound for his disc jockey shows. Hundreds of radio stations use Rek-O-Kut turntables. They operate with the same clock-like precision for many years. Owning a Rek-O-Kut is a long-term love affair.

## ALMOST EVERYONE LOVES REK-O-KUT



**REK-O-KUT B-12H TURNTABLE \$165.00**

Three speed. Noise level: 59 db below average recording level. Wow and flutter: 0.085% RMS. Custom-built, heavy duty Hysteresis Synchronous motor for constant speed and "hush" performance. On-off signal indicator. Less tone arm and base.



**KOSS**

**REK-O-KUT**

2227 N. 31st STREET • MILWAUKEE, WISCONSIN 53208  
Circle 126 on Reader Service Card

# Audio Measurements Course

NORMAN H. CROWHURST\*

## In Five Parts, Part 2

In this installment we learn why it is important to make sure that the signal we are measuring is actually the one we want, and we learn the relation of impedance to gain measurements if our results are to be accurate and repeatable.

**B**EFORE STARTING TO ANSWER the questions we left open at the end of the first installment, we want to emphasize a procedure that should always be used in making audio measurements, in one way or another: *look at what you are measuring*; one thing we said might have alerted you to the value of doing this—the piece about possibly overloading on hum or noise. By looking at what you're reading, with a 'scope as well as a meter, you won't be misled by a false answer of this kind. But don't feel bad if the idea didn't occur to you; many audio men have made the same mistake!

A vital piece of equipment for audio measurements is an oscilloscope. Without checking to see *what* you are looking at, your measurements may be absolutely meaningless, because the figures you read on meters may not be what you think they are at all! Meters are usually preferred for obtaining the final information, because they give numbers convenient to write down. But

\*Box 651, Gold Beach, Ore. 97444

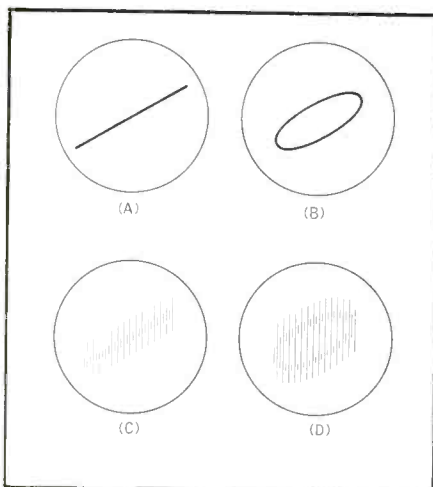

Fig. 2-1. Traces seen on a 'scope, using line sweep, when there is a component of line frequency present: (A) and (B), pure line frequency; (C) and (D), with noise or some other signal component.

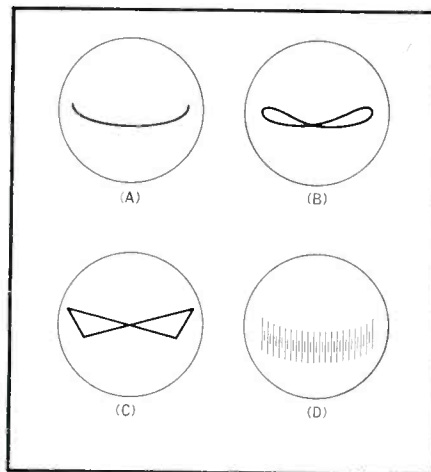

Fig. 2-2. Traces due to 120 Hz, also using line sweep, introduced from supply ripple: (A), (B), and (C), different forms of ripple; (D), with noise or other signal.

these numbers may be anything but the quantity you think the meter is indicating, if you don't also look at the quantity with a 'scope.

### Using a Scope

As we proceed, we will give more details on the proper use of a 'scope for various measurements and the way to interpret what it displays, but at the outset we will briefly describe how to identify an "unknown" reading with it. Suppose you have found that the reading isn't what you thought it was and you want to find out what it is.

Assume that you have checked the input waveform with a 'scope to be a sine wave, and now, when you connect the 'scope to the output, it is just a mass of traces that don't mean anything: how do you identify what it is? You may have some ideas, so you check accordingly, until you know.

If it is a high-frequency oscillation, you may find the frequency by changing the time-base frequency, until you get a trace of the ultrasonic frequency on the screen. If this doesn't work, then

you have something else.

Is it hum, or something hum-related? Switch to the line sweep. If it is 60 Hz, or if 60 Hz is present with something else, the trace will be either a sloping line or a loop, or one of these with something superimposed on it [Fig. 2-1, (A) through (D).] If it is a multiple of 60 Hz, such as inadequately smoothed full-wave rectification, or a radiated hum field with dominant third harmonic, then an appropriate multiple loop or curved line will appear, possibly with something else superimposed (Fig. 2-2).

Then perhaps it may be signal-related. For example, a heavy oscillation could be triggered at some certain point on the waveform, so the 'scope does not sync properly on the signal, as it did with the pure sine wave. Connect the input to horizontal input and the output to vertical input of the 'scope and switch to external sweep. Now the trace (when you've adjusted amplitude to get it "on screen") should be a straight line at an angle (which can conveniently be adjusted, by means of horizontal and vertical gain controls, to a 45-deg. angle). If it has bursts superimposed on it (Fig. 2-3), you know what the trouble is.

So much in general for using a 'scope with audio measurements, now get to the specifics.

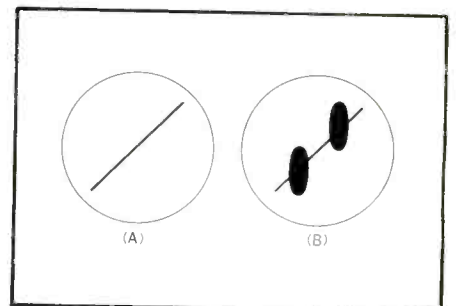

Fig. 2-3. Vertical/horizontal display of output vs. input sometimes helps: a, where both have the same waveform; b, where output has bursts of high frequency oscillation at parts of its waveform.



*Introducing*

**S-10**

**SYNCRØN**

**SOLID STATE / CONDENSER MICROPHONE**

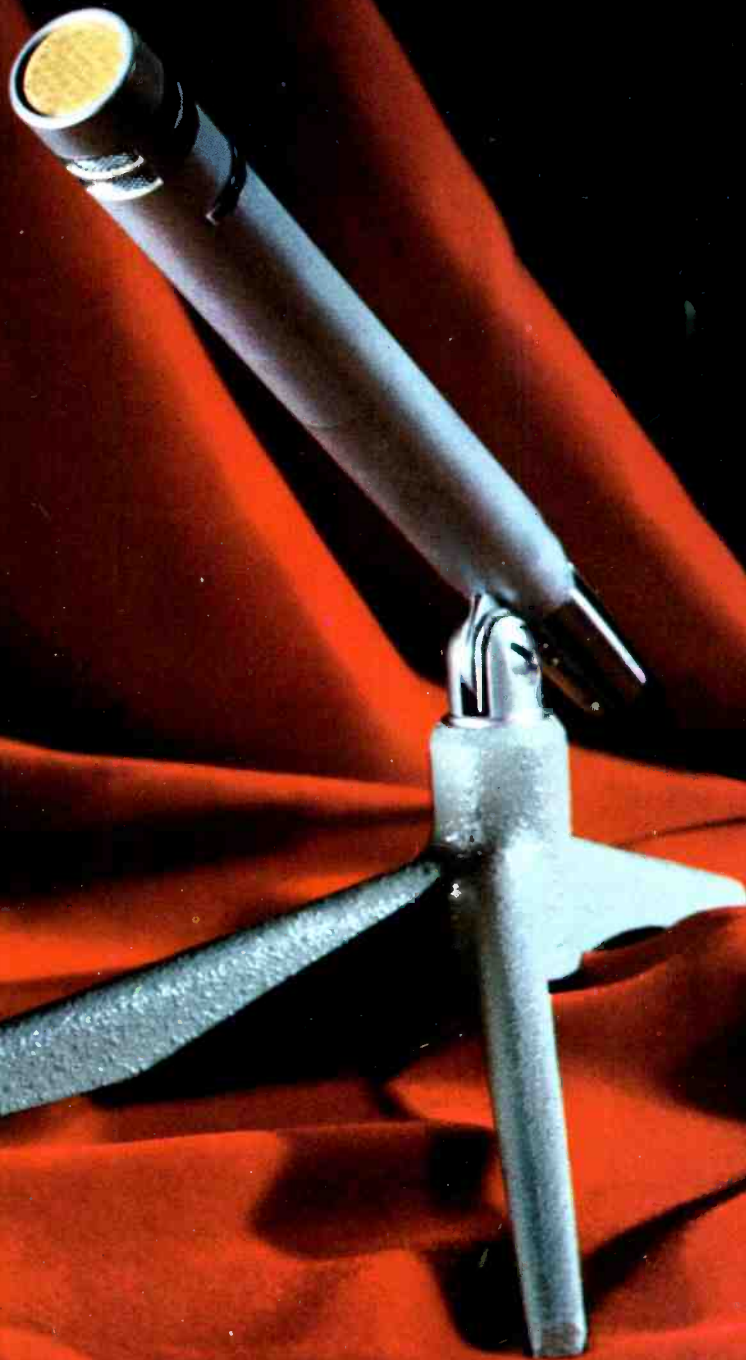

Cardioid Pattern / Self Contained with Lifetime Polarization

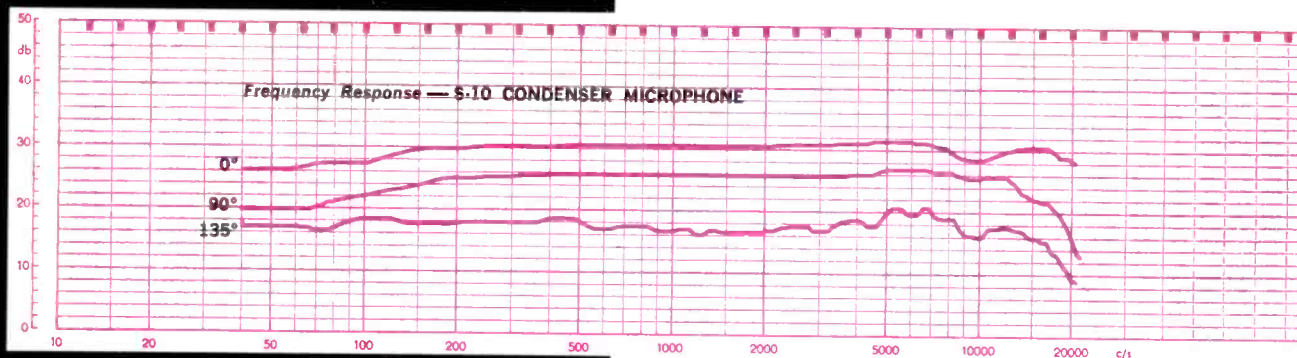

## WHY CONDENSER ... ?

Many dynamic microphones entering the market in recent years appear to have all the qualities of condensers. In some cases their frequency curves show linear responses from 30 to 18,000 Hz. They also claim performance comparable to condensers due to new diaphragm materials. Why is it then that professional recording studios are filled with condenser microphones? Why is it that the condenser microphone is used as a standard measuring tool against which all other types are compared? Why is there such a startling difference between the condenser and other types in A-B comparisons?

Much of the answer lies in the microphone's response to *transients* — the attack of a bow on a string, the strike of a drum, the nuances of a human voice.

A dynamic microphone diaphragm must be massive in order to achieve a low enough resonant frequency to reproduce the lower end of the audio range. This is true for all magnetically operated microphones, including ribbons. The ribbon type achieves its low resonant frequency by its great compliance which results in a fragility too great for many applications.

Condenser types, on the other hand, have resonant frequencies well above the audio spectrum, permitting the lowest possible diaphragm mass. The condenser's diaphragm is not required to move a voice coil as in the dynamic nor is it surrounded by a large magnetic structure as in the ribbon, *it is free to follow the sharpest audio transients.*

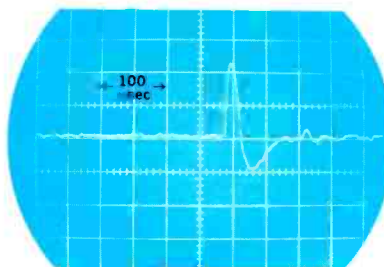
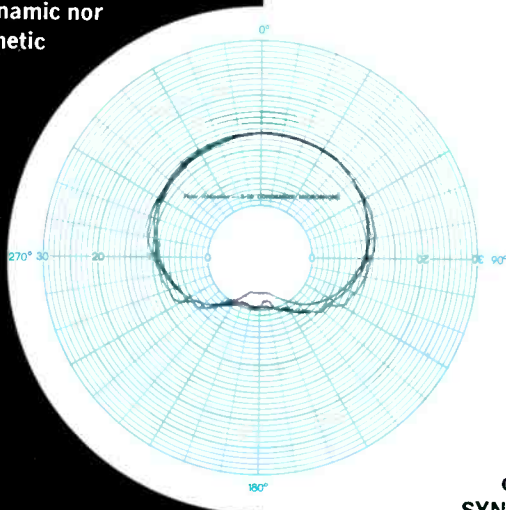

FIGURE 1

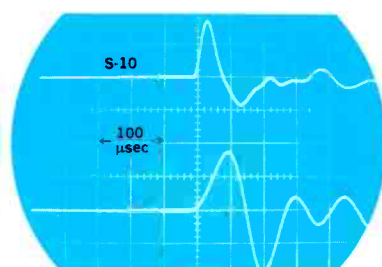

FIGURE 2

## THE DIFFERENCE

In order to measure the transient response of a microphone, it is necessary to subject it to the severest of all acoustic transients — the shock wave, in this case produced by an electrical discharge. The acoustic transient produced has a risetime of less than one micro-second. By observing the output of a microphone subjected to such a shock wave, its transient response can be determined.

In order to portray this shock wave as accurately as possible a special pressure condenser microphone was built using an extremely small, light diaphragm with linear frequency response well beyond 200,000 Hz. Figure 1 shows the characteristics of the shock wave as measured by this special microphone in an anechoic chamber. Figure 2 is a dual beam presentation of the response of two microphones to the same shock wave at the same instant. The upper trace shows the response of the new SYNCRON S-10 condenser microphone. It shows a risetime of 15 micro-seconds and an insignificant amount of ringing and overshoot. The lower trace shows the response of a leading cardioid dynamic microphone at the same instant. The risetime is 40 micro-seconds and a significant amount of ringing and overshoot is evident.

Comparisons of the S-10 with virtually all leading dynamic microphones have produced essentially the same results as shown here — graphic proof that frequency response curves do not tell the whole story . . .

## UNIPOLAR RESPONSE

The S-10's on-axis frequency response shows all the smoothness and wide range expected of condenser microphones. Just as important, the frequency response for off-axis sounds is very linear. The polar pattern pictured here indicates a deviation of no more than 2 dB. from the on-axis response for frequencies of up to 10 kHz. These curves were produced by an actual S-10 microphone in an anechoic chamber and are not artists' conceptions. Each S-10 microphone produced is tested under identical conditions and an individual response curve is furnished with it. For a nominal charge, S-10 owners may return their microphones to SYNCRON at any time for verification of this performance

## SELF-CONTAINED

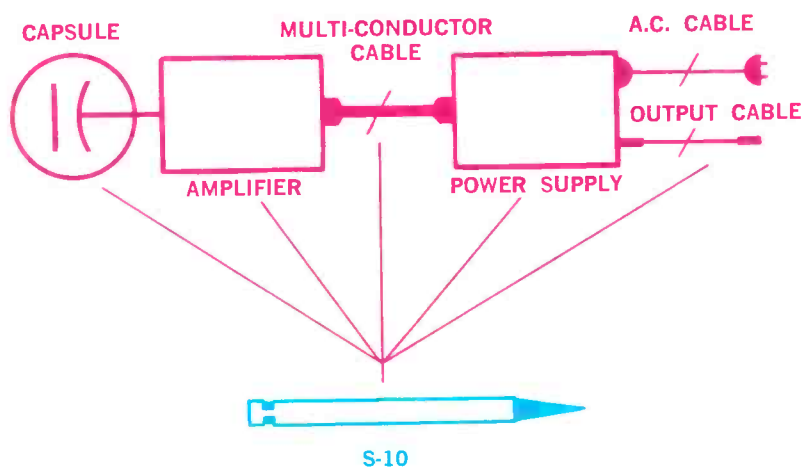

SYNCRØN's employment of the latest semiconductor and battery technology obsoletes elaborate condenser microphone "systems". The external power supply is eliminated, enabling the S-10 to be used with the ease of a dynamic microphone. The condenser element is permanently polarized at a potential of 62 volts. Electronic circuitry is powered by a single inexpensive mercury battery encased in the microphone body. Battery life is 1,000 hours minimum with simple insert replacement. The S-10 can be used with assurance on critical "no second chance" pickups. There's no tube filament to suddenly burn out. The end of battery life is signaled by a slight increase in distortion, giving the user several hours advance warning at replacement time.



## THE SOUND

The first and final analysis of microphone quality concerns *sound*. The clear superiority of condensers has been proven through the years with their universal use by recording centers, film studios, broadcast operations, orchestras, vocalists, and everyone sensitive to highest fidelity. The S-10 fulfills the really important requirements: superiority in the lab and superiority in the studio.

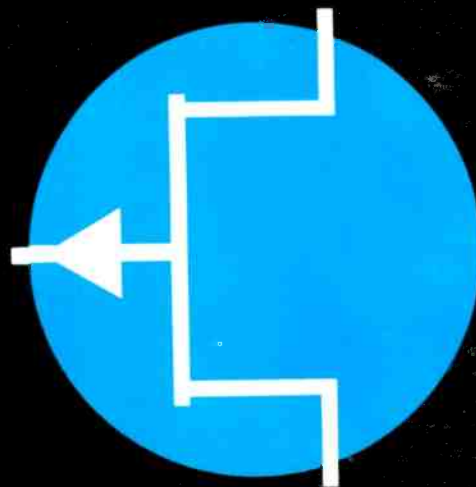

## SOLID STATE

The S-10 Field Effect Transistor circuitry has noise performance superior to tubes — and the obvious solid state advantages of longevity, small size, and low power consumption without the necessity of resorting to complicated RF circuits. Microphonics and heat generation are entirely eliminated. In addition, the inherent linearity of the FET makes possible a dynamic range unequalled by tubes or transistorized RF circuits, thus eliminating the need for costly overload protection devices. The S-10 is not encumbered by over-design or trick circuits. The emphasis is on simplicity, quality, and reliability.

## CONVENIENCE

Battery replacement is accomplished easily in a matter of seconds without the use of tools. The single mercury battery — Mallory TR-126 or equivalent — is easily obtained locally. Substitution of a three-wire shielded cable adapts the S-10 for remote on-off switching, and the addition of an S-104 battery bypass enables operation via an external source of 8-9 volts when inaccessibility or continuous service are factors.



## S-10 Microphone SPECIFICATIONS

Type:	Pressure gradient, condenser
Frequency Response:	40 — 20,000 Hz $\pm$ 3db
Capsule Capacitance:	60 pf
Diaphragm:	Mylar
Directional Characteristic:	Cardioid at all frequencies, 20 db front-to-back ratio
Overload Protection:	None needed
Total harmonic distortion:	Less than 0.5% to 124 db SPL at all frequencies
Output Level, 200 ohm load:	— 53 dbm re 10 dyne/cm <sup>2</sup>
Noise:	Less than 27 phon, (DIN 45405) Less than 23 db SPL (DIN 5045)
Output Impedance:	200 ohms nominal, characteristics unaffected by any load from 30 ohms to $\infty$
Amplifier:	Field Effect Transistor
Microphone Connector:	4 pin XLR type (serves as on-off switch)
Cable:	2 wire shielded, stripped and tinned, 20 feet
Power Supply:	Single TR126 mercury battery, life — 1000 hours
Mount:	5/8" — 27 swivel stand mount
Finish:	Satin nickel
Dimensions:	7/8" diameter x 7 3/8" long
Weight:	9 oz. with battery
Price:	\$240.00 complete with battery, carrying case, swivel mount, and cable

## S-101 WINDSCREEN

Prevents wind noise and effectively reduces plosive speech sounds without affecting microphone characteristics. 100% nylon construction. Weight: 1/5 oz. Diameter: 2 inches.

Price: \$14.95



## S-102 DESK STAND

A heavy brass casting provides maximum stability on three padded legs. Unique swivel band permits finger-tip positioning — 360° horizontally, 150° vertically. Rich textured vinyl finish. 4 1/4" high, 10 1/2" long, 7 1/4" wide. Weight: 1 3/4 lbs.

Price: \$19.95.

## S-103 SUSPENSION

Eliminates vibration and shock problems. Used on floor stands, booms, and desk stands. Construction: brass. 4" diameter. Equipped with swivel mount 5/8" — 27 thread. Weight: 8 oz.

Price: \$29.95



## SYNCRØN AND THE FIELD EFFECT TRANSISTOR

Synchrøn Corporation was formed by a group of young engineers from broadcasting, recording, and acoustical instrumentation fields with a common primary interest — quality condenser microphones. With all the fast-breaking developments of the space age, somewhere they felt, in the melange of power supplies, tubes, fuses, cables, expensive foreign connectors and high price tags, there must be a better way. With the United States' active leadership in Field Effect Transistor technology it was only natural that an American company would be the first to use the Field Effect Transistor successfully in a condenser microphone. Upon the introduction of commercial FETs

in early 1963, Synchrøn built the first condenser microphones to use such devices. The cost of the FETs that would meet Synchrøn's rigid requirements was extremely high, so the microphones remained in the laboratory where they were subjected to nearly a year of intensive field-testing. The inevitable price break came in 1964 whereupon Synchrøn introduced its FET condenser microphone — the first commercial product to employ a Field Effect Transistor in any form. Synchrøn engineers have continually worked to perfect the use of the Field Effect Transistor in condenser microphones. The Synchrøn S-10 is the result of this clear leadership in modern condenser microphone development.

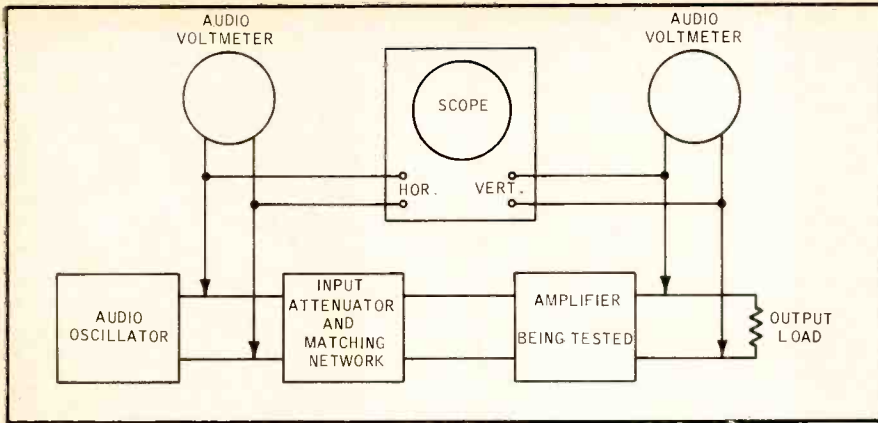

Fig. 2-4. Complete input/output method, using attenuator to match levels and calculate gain.

### Amplification

A complete set-up for taking frequency response is shown at Fig. 2-4. This differs from Fig. 1-11 for reasons we will discuss shortly. You could switch the 'scope to external sweep and set it for a 45-deg. line at a mid-frequency and then interpret the result for other frequencies by the way the line deviates from 45 deg. This is a good method, provided you know (a) that the 'scope amplifiers are accurate throughout the frequency range used and (b) that connecting the 'scope to the input does not produce some cross-coupling that could influence particularly the high-frequency response.

The best method is to use the 'scope with its conventional time base, merely to verify that you are measuring what you think you are. Use the same meter to measure input and output (Fig. 2-5) by switching and preferably use it at the same setting. This means that the gain measurement will be independent of the meter's accuracy. If it has a slight high-frequency loss, or inaccuracy in calibration, using the same setting eliminates both forms of error from the measurement.

To do this, you need a calibrated attenuator. These come in various forms, either rotary or key type, and at various impedances. The procedure is to adjust the attenuator setting at each frequency of measurement, so input and output indications on the meter are both the same. Use the 'scope to verify that the output reading is in fact amplified input. With the attenuation, it will have the same amplitude as output, so both traces should be sensibly identical.

If you intend to make use of the connection from 'scope horizontal to the input metering point, verify that connecting it does not make any more difference to higher frequencies than it does at low frequencies. The effect of connecting the 'scope horizontal input should be negligible at all frequencies. If it isn't, disconnect this link, except

for when you need it for the check described in the previous section.

So taking a frequency response involves making connections and adjusting at each frequency to get the same reading at input and output when the meter is switched. Then the setting of the attenuator is noted as being the amplifier gain at that frequency.

### Terminating Impedances

We hinted at the end of the first installment that input and output impedances must be correct. The output load impedance must be of the correct value, and capable of dissipating whatever power level is used for making the test, without materially changing in value. This means the wattage rating of the output load resistors needs to be several times the maximum power they will receive, so they run relatively cool at all times, and also their value should be checked, preferably on a resistance bridge. An ohmmeter does not give a sufficiently precise reading for checking output load values.

Input source impedance is another quantity about which there is often mis-

understanding as to correct use. Looking back from the amplifier input, the impedance "seen" must be correct. With modern feedback amplifiers, this is sometimes important to ensure the stability of the amplifier. But in almost every amplifier, changing the source impedance affects either gain or frequency response in some way. More sophisticated tests will explore this in detail. A simple frequency-response measurement should be made with the correct value connected.

### Gain

Now comes the question of where the input should be metered. Gain is usually defined, somewhat vaguely, as the increase in level from the input terminals to the output terminals of the amplifier. A "standard" definition used for a long while was designated "insertion gain," which was described as the amount by which level is raised or lowered (in the latter case, it is a loss, not a gain) by inserting the amplifier between the input and output terminals.

A difficulty about that definition is that input and output impedances are seldom identical. The only case where they are is in a line amplifier. In all other cases, connecting the input directly to the output will result in a mismatch and its corresponding loss. If the input is other than the vague "high impedance" which, in tube amplifiers, means it connects directly to the grid of the first stage, then a realistic reference for insertion gain can be the substitution of a hypothetically perfect transformer to match input and output impedances.

In short, the gain relates output power to input power. But this vague "high impedance" does not readily lend itself to expression of input level in terms of power. In this case, input is essentially a voltage. So we must refer to voltage gain, or else hybrid the

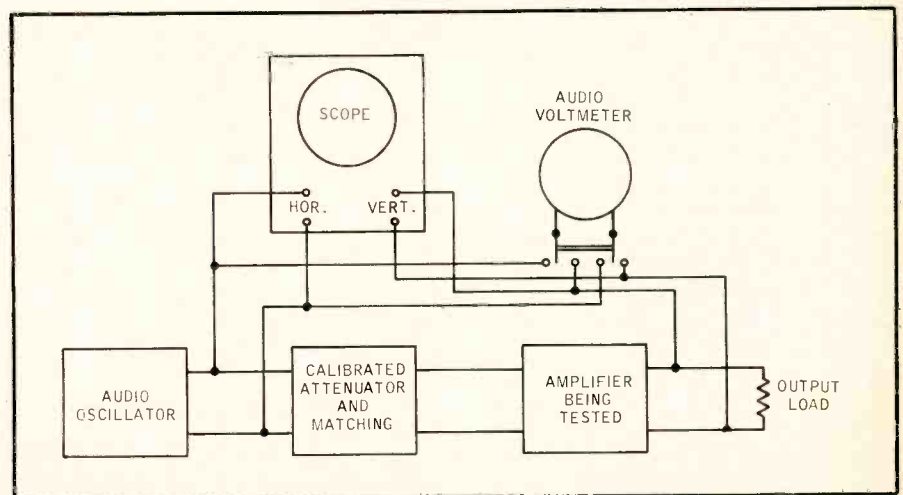

Fig. 2-5. Using a single audio voltmeter to eliminate possible errors due to voltmeter calibration error or response deficiency.

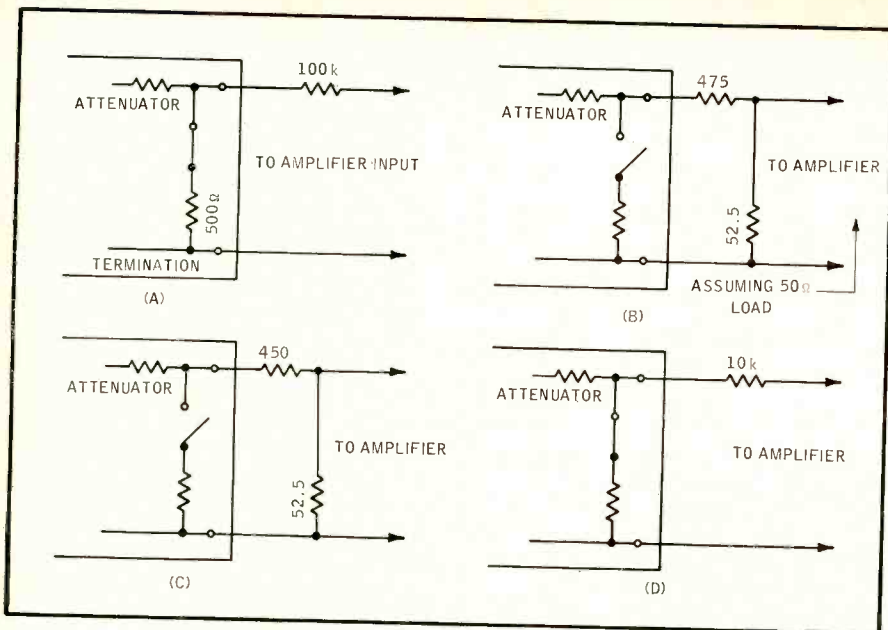

Fig. 2-6. A variety of input matching arrangements, discussed in the text.

measurement by referring to power out for voltage in.

Regardless of whether voltage or power is used as reference for calculating expressed results, the voltage measured to determine input level must be at the input end of the source resistance. If, as is the usual method, attenuation is used so the same meter indication can be applied at both ends, then the attenuator also comes between the input measurement point and the amplifier input.

The input source resistance, if different from the working impedance of the attenuator, must be achieved in such a way as to terminate the attenuator correctly, while presenting the correct source impedance to the amplifier. An appropriate calculation can include the effect of this matching procedure into the gain figures. A few examples will illustrate.

First suppose that the input is "high impedance" and the recommended maximum source resistance is 100,000 ohms, and that the attenuator is 500 ohms. The attenuator should be terminated with 500 ohms (usually there is a key to provide this termination internally) and a resistance of 100,000 ohms should be inserted between the attenuator termination and the amplifier input (Fig. 2-6). As gain will always be referred to voltage in these circumstances, merely read the attenuator setting when input and output readings are the same.

Now suppose the input impedance is 50 ohms: you need two resistors as termination for the attenuator, such that the attenuator is correctly terminated with 500 ohms, while the amplifier gets

its source resistance of 50 ohms. It is well to check whether the amplifier is supposed to provide a load approximating 50 ohms, or what, although with a 10:1 impedance-matching ratio this is not as important as it would be with closer ratios.

If the amplifier is supposed also to present a load of 50 ohms, than a series resistor of about 475 ohms with a shunt resistor of 52.5 ohms will present a load of 500 ohms to the attenuator (including the 50-ohm amplifier input) and a source of 50 ohms to the amplifier. This conclusion is arrived at by paralleling the 52.5 ohms and 50 ohms in series with 475 ohms, to make very close to 500 ohms, while 975 ohms (don't forget the attenuator's source, as well as the external 475 ohms) in parallel with 52.5 ohms makes 50 ohms.

Now to calculate gain. First there is the setting of the attenuator, which will deliver the input power, divided by the attenuator setting, into the total 500-ohm termination. Of this, only about

25/500 appears across the amplifier input, which represents a power loss of 13dB (current is not changed, but voltage is).

Now the current is divided between the 52.5-ohm shunt resistor and the amplifier input, which is a further 3-dB power loss (same voltage, half current). But this is part of the normal transfer loss between equal, matched impedances. In effect, omitting this from the calculation does the same thing as measuring the voltage at the "front end" of the input resistor, except that here we are using current dividing, instead of voltage division, for matching, as a matter of convenience. So you merely add 13 dB to the attenuator setting to get the insertion gain of the amplifier.

Now suppose the input is rated for 50 ohms source, but the amplifier's own internal input impedance is higher—say 2000 ohms. Here a series resistor of 450 ohms, with a shunt of 52.2 ohms will come close. The 2000 ohms in parallel with 52.5 ohms produces about 51 ohms, which added to 450 ohms makes up the required 500 ohms, within an ohm, to terminate the attenuator. And 950 ohms in parallel with 52.5 ohms produces the required 50 ohms source for the amplifier.

Now the voltage division is 50/500, or 1/10th. So you need to add only 10 dB to the attenuator setting. There will be less than 3 dB loss due to the shunting effect of the amplifier, but this is because the usual mismatch does not occur. The amplifier is working more like a bridging amplifier.

If the output impedance of the amplifier is 16 ohms, you have another correction to make for the change from 50 ohms (input) to 16 ohms (output). As the same voltage across 16 ohms represents a little more than 3 times the current it does in 50 ohms, this is a further gain increase of 5 dB, so the total to be added to the attenuator setting is 18 dB or 15 dB, as the case may be, to get the insertion gain figure.

Now suppose the output is 500 ohms, still with a 50-ohm input, using the

Fig. 2-7. A typical recorder chart, showing approximation to logarithmic frequency scale, and linear dB scale.

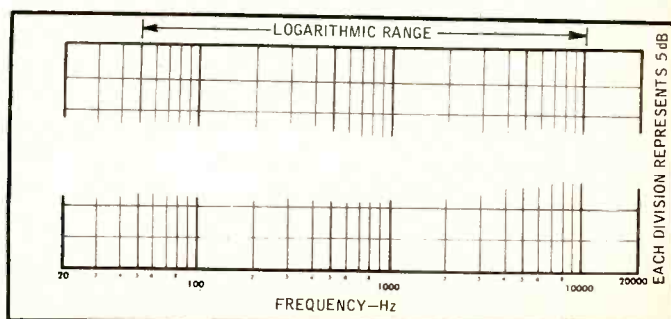

FIG. 2-7. AUTHOR: [unreadable]

AUDIO

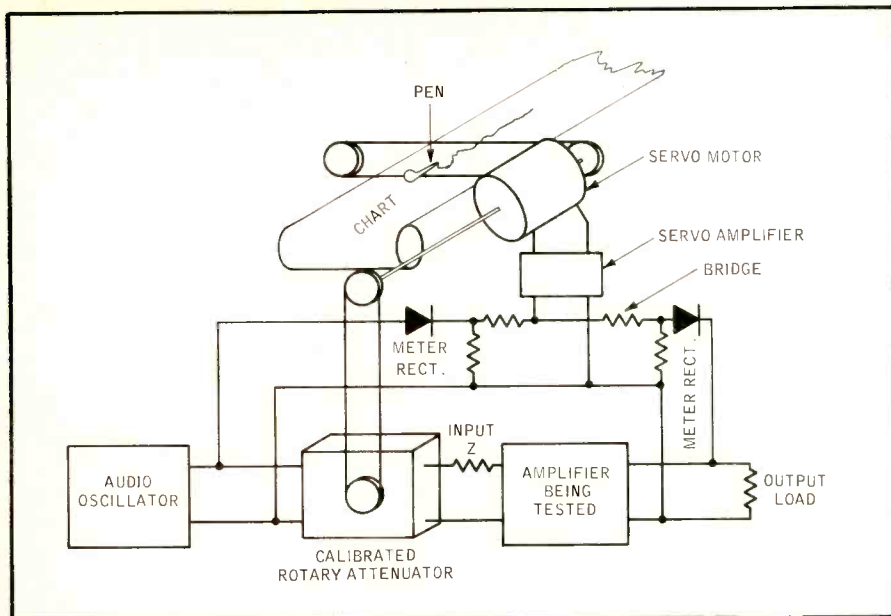

Fig. 2-8. Simplified schematic of an automated frequency-response plotter.

same input matching method. As a voltage across 500 ohms is accompanied by only 1/10th the current it will produce in 50 ohms, this represents a 10-dB loss for the impedance change. So the net amount to add to the attenuator setting would be 3 dB for the first case or no change for the second.

Next suppose the input impedance is 10,000 ohms. The result will be close enough if you terminate the attenuator of 500 ohms and then put a series resistor of 10,000 ohms. With the amplifier presenting another 10,000 ohms (we assume) there will be an additional shunt on the attenuator of 20,000 ohms, which makes the actual termination for the attenuator about 487 ohms instead of 500 ohms, which is a small fraction of a dB mismatch. Now you divide the current between 500 ohms and 20,000 ohms, which is a ratio of 40:1 or 16 dB, to add to the attenuator setting.

That assumes the output is also 10,000 ohms. If it is actually 500 ohms, for example, the same voltage will pro-

duce 20 times the current, requiring another addition of 13 dB, to make a total of 29 dB to add to the attenuator setting, so the result is insertion gain.

These are just typical examples to illustrate a method of calculating. Practical possibilities are virtually unlimited, but can be as readily calculated by following the same principles through.

#### Frequency Response

So much for determining gain according to recognized procedure. Now we proceed to take frequency response, which is merely making the same gain measurement at lots of frequencies and plotting the results out. If you don't have any better way to do it, you'll have to do just that. The usual way to express the result is to extract the mid-band gain as a constant factor, usually at 1000 Hz, and then plot the response in dB + or - from this mid-band gain.

If you have much frequency-response taking to do, it is obviously desirable to

automate the procedure a bit. Not only will this speed up the process, it will enable virtually all frequencies to be read, from 20 to 20,000 Hz, if those are the limits used.

Earlier attempts at automatic curve-plotting equipment used a very carefully compensated input circuit, adjusted to hold the input voltage as close to constant as ingenuity could achieve, and then used a recording voltmeter to read the output. The output meter often used a logarithmic rectifier, or a rectifier with a logarithmic shunt, to produce a record chart calibrated directly in a reasonable facsimile of dB. By also carefully engineering an audio oscillator with a frequency dial close to logarithmic, a suitable frequency scale could be used as well (Fig. 2-7).

But logarithmic rectifiers have a habit of changing with age, and the old type of oscillator with logarithmic frequency scale used a beatnote type, which needed careful zero adjustment to stay in calibration, particularly at the low frequency end. Hewlett-Packard changed the latter situation by developing an R/C oscillator (their type 207-A) that covers the whole audio range in one turn of the frequency dial, and that has an extension shaft at the rear to facilitate coupling to a recorder. Its scale is also close to logarithmic.

The automated method can incorporate all the accuracies of the adjustable attenuator method of spot plotting, by using a recorder with a servo drive mechanism (Fig. 2-8). In this arrangement, the input and output are each fed to identical rectifiers and the outputs are balanced one against the other. The difference is d.c.-amplified to drive a servo motor that moves two things at once: the setting of the calibrated rotary attenuator, so as to make the two voltages equal before the motor stops; and the recording pen, which thus automatically records the position of the attenuator at which balance is achieved.

The rotary attenuator is usually a plug-in unit, so different attenuation ranges can be inserted, with corresponding changes in the density of the dB scale on the chart. With this set-up, automated response taking is achieved with all the accuracy of the basic method, in a fraction of the time and with full-frequency coverage.

Now suppose you want a rough check, and you don't have the calibrated attenuator, or the automated recording system, at hand. The same basic method is good (Fig. 2-9). Calculate the input network to attenuate by a known factor, so the input and output voltages are as near the same as possible, and so correct matching is

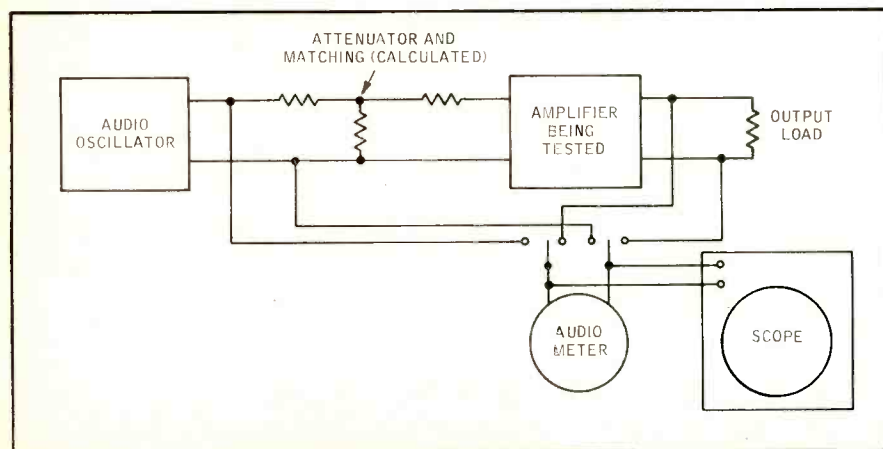

Fig. 2-9. Taking frequency response with improvised equipment.

# ASSEMBLE YOUR OWN ALL-TRANSISTOR *Schober* ELECTRONIC ORGAN



3 NEW MODELS  
 Recital \$1500  
 Console II 850  
 Spinet 550

This is the new, all-transistor Schober Console II...the most luxurious

"home-size" organ available today.

Full 61-note manuals, 17 pedals, 22 stops and coupler, 3 pitch registers, and authentic theatre voicing leave little to be desired. Comparable to ready-built organs selling from \$1800 to \$2500.

The pride and satisfaction of building one of these most pipe-like of electronic organs can now be yours...starting for as low as \$550. The Schober Spinet, only 38 inches wide, fits into the smallest living room. The all-new, all-transistor Schober Recital Model actually sounds like the finest pipe organ; its 32 voices, 6 couplers, 5 pitch registers delight professional musicians...making learning easy for beginners.

AND YOU SAVE 50% OR MORE BECAUSE YOU'RE BUYING DIRECTLY FROM THE MANUFACTURER AND PAYING ONLY FOR THE PARTS, NOT COSTLY LABOR.

It's easy to assemble a Schober Organ. No special skills or experience needed. No technical or musical knowledge either. Everything you need is furnished, including the know-how. You supply only simple hand tools and the time.

You can buy the organ section by section...so you needn't spend the whole amount at once. You can begin playing in an hour, even if you've never played before—with the ingenious Pointer System, available from Schober.

Thousands of men and women—teen-agers, too—have already assembled Schober Organs. We're proud to say that many who could afford to buy any organ have chosen Schober because they preferred it musically.

Send for our free Schober Booklet, describing in detail the exciting Schober Organs and optional accessories; it includes a free 7-inch "sampler" record so you can hear before you buy.

IN OUR 10TH YEAR

THE *Schober Organ* CORPORATION

43 West 61st Street, New York, N. Y. 10023  
 Also available in Canada, Australia, Hong Kong, Mexico, Puerto Rico, and the United Kingdom

THE SCHOBER ORGAN CORP., DEPT. AE-1B

43 West 61st Street, New York, N. Y. 10023

Please send me FREE Schober Booklet and FREE 7-inch "sampler" record.

Enclosed find \$2.00 for 10-inch quality LP record of Schober Organ music. (\$2.00 refunded with purchase of first kit.)

Name \_\_\_\_\_

Address \_\_\_\_\_

City \_\_\_\_\_ State \_\_\_\_\_ Zip. No. \_\_\_\_\_

Circle 128 on Reader Service Card

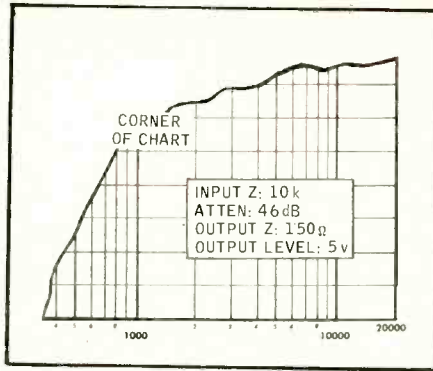

Fig. 2-10. Always enter full data on your response plots.

achieved. Always use non-inductive resistors for an improvised attenuator, and keep values in a reasonable range, where capacitive and inductive effects are less likely to invalidate—say between 10 ohms and 100,000 ohms.

In getting correct matching, make sure the resistors get the value you need, as described earlier. But where precision work needs a resistance bridge, for this purpose an ohmmeter will have to do, as the next best thing.

As you might expect, there is no universal "best." The measurement with the distortion meter is the simplest to make, but the analyzer can sometimes tell more. However, use of the distortion meter with a scope on the residue when fundamental is balanced out can tell more, in some respects, than the analyzer. But there is a third method, using simpler equipment, that is also easier to use and of greater potential accuracy, which we will describe fully in the next installment.

## Is the Result Valid?

Whichever method you use, always check what you are doing, over on the scope the whole frequency range before you start making measurements, either by hand or by recorder. In particular, check that distortion does not occur (in measurable or noticeable degree) at any frequency, and that noise does not invalidate the result at any frequency. If either occurs, you have to adjust your method, or the level, to improve matters.

In any event, always make, right on the chart, a record of the level and other details at which you made the response measurement (Fig. 2-10). Frequency response often changes with different levels, quite apart from the introduction of non-linear distortion, so the ability to reproduce your results, or to recheck them, may depend on knowing at what level they were taken.

If you want to get really sophisticated, a further test is to check response at different levels for comparison, and make comparative plots, to show how level affects response (Fig. 2-11).

That's enough about frequency response for the time being, as applied to basic amplifiers. Next we'll turn to distortion and power measurements. For these we have a choice of instrumentation: the so-called harmonic-distortion meter eliminates fundamental and measures everything left, as distortion; the wave-analyzer type of instrument measures each component frequency in the output individually, from which the total distortion can be computed. Which is better, or is there another way that might have some advantages? When you've thought about this, see what our answer in the panel says. *Æ*

(To Be Continued)

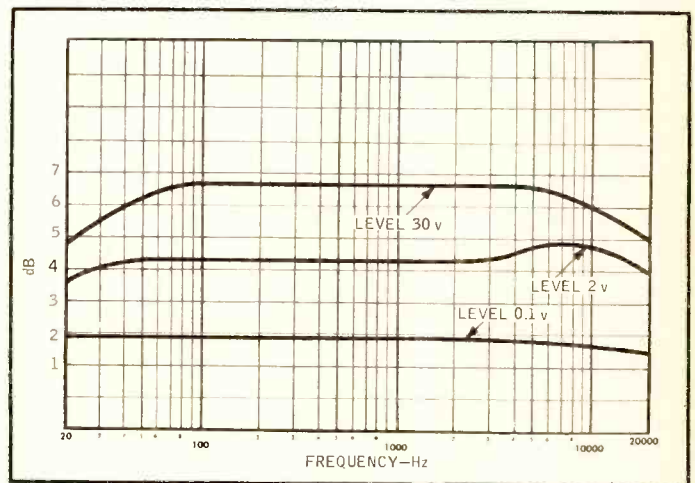

Fig. 2-11. A response taken at different levels, to show changes with level.

Give...so more will live  
**HEART FUND**







**EXPLORE** The Exciting  
World Of Electronic Kits  
With This New **FREE**  
1966 **HEATHKIT®** Catalog!

Heathkit ... world's largest electronic  
kit line — now bigger and better than  
ever!

- bigger selection - over 250 kits!
- greater savings - up to 50%!
- unmatched quality!

**MAIL  
TODAY!**

**PLEASE SEND MY FREE  
1966 HEATHKIT® CATALOG**

Name

(Please Print)

Address

City

State

Zip

41-2

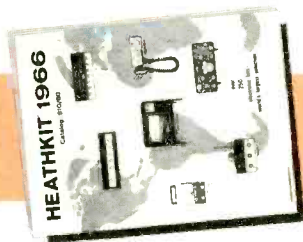

**HEATH COMPANY**  
Benton Harbor, Michigan 49023

PLACE  
5c  
STAMP  
HERE

There's something for everyone  
in the new  
**HEATHKIT® CATALOG**  
— truly the finest selection and  
savings ever offered kit builders!



**STEREO/HI-FI EQUIPMENT...**  
Changers, tuners, amplifiers and speakers — tube type or all-transistor — mix or match for the finest in stereo listening at savings of up to 50%!



**FOR THE ENTIRE FAMILY ...**  
Color TV, B & W TV, AM FM Short-wave portable and table model radios, intercoms, garage door opener, citizen's band radios, electronic organs, automotive equipment at big kit savings.



**HAM RADIO EQUIPMENT ...**  
Choose from a complete selection of transmitters, receivers and accessories recognized by hams the world over for quality.



**ELECTRONIC TEST EQUIPMENT ...** For work or workshop, engineers & technicians rely on quality-design, economical Heathkit test gear.



**MARINE GEAR ...** Direction finders, depth sounders, tachometers, power converters and radiotelephones to outfit your boat for safe cruising — economically!

Send for your **FREE** Heathkit Catalog now!

# FREE CATALOG

World's Largest Selection Of Stereo/Hi-Fi Kits At Up To 50% Savings

**Why Build Heathkit Electronics?** A desire for top-quality products at 50% savings, to be sure. But it goes beyond that. The reason people choose Heathkit is pride. Not just the pride of owning something new, but something a bit better that you have created yourself! From watching your Heathkit grow and take shape from your own efforts. It's a labor of love and a lot of fun. The large pictorial diagrams and simple, step-by-step instructions make it easy. And when you finish and turn it on you'll know that unique self-satisfaction that comes with "do-it-yourself". You will have joined the millions of people, from ages 11 to 79, people with no special electronic skills or knowledge, who successfully build Heathkits. People like you! Give it a try. Your FREE Heathkit catalog is waiting for you now.

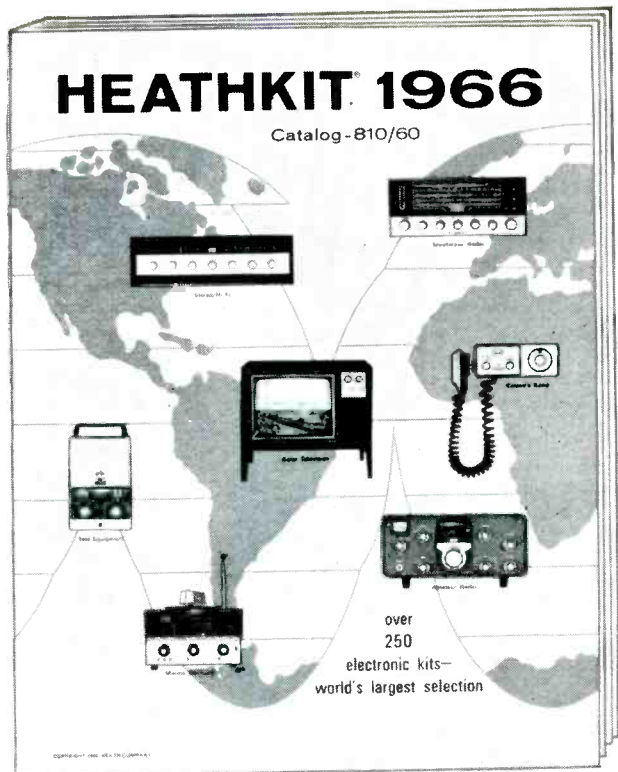

## Contains Many New Low Prices . . . New Kits



**NEW** Transistor FM Stereo Tuner That Assembles In 6 Hours Or Less. . . . . Only \$49.95



**NEW** Low Price On Heathkit Transistor Stereo Receiver with AM/FM/FM Stereo Tuning and 66 Watts Music Power. . . . . Now Only \$184.00



**NEW** Low Prices On Many Other Heathkit Stereo/Hi-Fi Components.

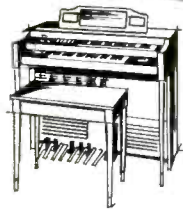

**NEW** Low Prices On Heathkit®/Thomas Transistor Organs . . . Deluxe "Coronado" (illustr.) . . . Now Only \$799. Low Cost "Artiste" . . . Now Only \$332

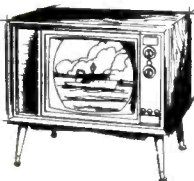

**NEW** Low Price On Heathkit 21" Color TV. . . Now Only \$375 Walnut cabinet. . . . . Only \$108 Economy cabinet. . . Only \$46.50

- See All Heathkit Stereo/ Hi-Fi Components . . . Tuners, Amplifiers, Speakers, Turntables, Cartridges, Furniture
- See the Unique Heathkit Stereo/Hi-Fi System Planning Guide
- See the Famous Heathkit®/Thomas Transistor Electronic Organs
- See the Vast Selection Of Portable And Table Model AM, FM and Shortwave Radios
- See A Complete Selection Of Home & Hobby Items . . . Intercoms, Color TV Sets, Garage Door Opener, Automotive Kits, Tools
- See The Full Complement Of Heath Marine Electronics
- See A Total Of 108 Pages . . . Many In Full Color . . . Describe & Illustrate These And Complete Lines Of Educational, Amateur Radio, Test & Lab Instrument, And Citizen's Band Radio Kits

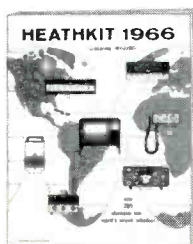

Mail Card Or Coupon For Your **FREE** Copy

Heath Company, Dept. 41-2  
Benton Harbor, Michigan 49023  
In Canada: Daystrom, Ltd.,

Please send FREE 1966 Heathkit Catalog.

Name \_\_\_\_\_

Address \_\_\_\_\_

City \_\_\_\_\_ State \_\_\_\_\_ Zip \_\_\_\_\_

Prices & specifications subject to change without notice.

CL-217



# NEW PRODUCTS

● **Amplifier Kit.** Latest in the "Superba" series of Knight-Kit components is a 120-watt solid-state amplifier. The illuminated selection-indicator feature of earlier units is retained. Full control versatility is offered. In addition to those controls common to all integrated units—tone, volume balance, and selection—there are remote/local speaker selection, speaker on/off (for the earphone jack operation), separate high- and low-cut filters, and an adjustable loudness compensation knob. Important specifications include: 8-ohm average sine-wave power 40 watts per channel, 60 watts IHF



power per channel; 18 to 30,000 Hz,  $\pm 1$  dB response at full-rated output; distortion: harmonic is less than 0.7 per cent at full-rated output, IM is less than 1 per cent; hum and noise is  $-75$  dB at AUX and  $-65$  dB in phono; input sensitivity for phono is 2.5 mV and 0.25 volts for the high-level inputs. Full output-device protection is offered by automatic self-resetting thermal circuit breakers. The model number is KG-895 and the list price FOB Chicago is \$149.95. An optional wooden enclosure is \$19.95.

Circle 200

● **Professional Dynamic Microphone.** An effective, built-in windscreen which virtually eliminates wind noise and explosive breath sounds is a primary feature of this dynamic microphone of omnidirectional characteristics. Called the Model SM50, the unit is a probe type of rugged construction, yet is lightweight and thus suited to hand-held use as well as stand operation. Shure Brothers' Professional Products Division is the manufacturer. Important specifications include: a smooth response from 40 to 15,000 Hz with slight tailoring to provide



an increase in the speech intelligibility range. Output is either 30-50 ohms or 150-250 ohms. Level at either impedance is  $-58.0$  dB (0 dB equals 1 milliwatt with 10 microbars). Artists that prefer to work close into a microphone will find that this unit is designed to suppress "P" popping at such distances. Finish is an inconspicuous textured dark grey enamel. A twenty-foot two-conductor shielded cable fitted with a Cannon XLR-3-11C connector is supplied. Also supplied is a 90-degree swivel slip-in mount that fits any stand equipped with  $\frac{5}{8}$ "-27 threads. List price is \$125.00.

Circle 201

● **Nutdriver Sets.** Constructors and kit hobbyists will want to know about these new Excelite nut driver sets. Set No. 77 contains seven solid-shaft nut drivers with hex openings from  $\frac{3}{16}$ " through  $\frac{3}{8}$ ". Sockets are all case-hardened with polished and plated shafts. The handles are shockproof (UL) and breakproof

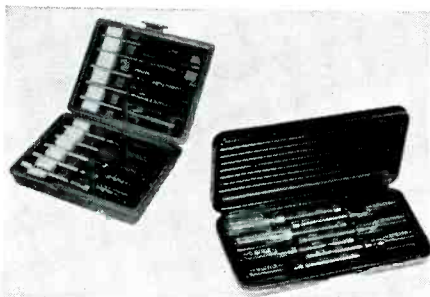

plastic. Set Number HS6-18 contains ten hollow-shaft nut drivers with hex openings from  $\frac{3}{16}$ " through  $\frac{9}{16}$ ", otherwise specifications remain the same. Either kit is packed in a snap-lock-lid case of compact dimension.

Circle 202

● **Public Address Amplifier.** Model PA-645 from Lafayette Radio Electronics is a 45-watt-average unit. Ideal for medium-sized applications such as dance halls or ice rinks. Power output is to 4-, 8-, 16-ohm speakers, or to lines of 25 or 70.7 volts. Frequency response is 30 to 20,000 Hz  $\pm 2$  dB. Inputs are provided for two microphone and two high-level

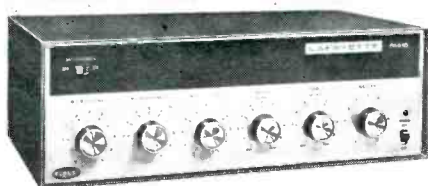

sources. Mixing of microphones with one auxiliary input is possible. All inputs are under the control of a master gain pot. Connections are by Amphenol 75 MC1F connectors and phone plugs. Weight is 30 lbs; power consumption is 110 watts. The tube complement includes 2-12AX7, 1-6V6, 2-6L6GC, and a 5AR4 rectifier. List price is \$54.95.

Circle 203

● **Solid-State Tuner.** A new stereo tuner featuring an all-silicon IF section has been announced by H. H. Scott. Designated the Model 312B the unit sells for a suggested list of less than \$250.00. FM, mono or stereo, with the latter being



automatically switched, is offered. In the stereo mode a panel light indicates that the unit is switched. An unusual tuner feature is the combination of signal strength and center tuning in a single meter—a front-panel switch selects the needed function. Maximum sensitivity is 1.9  $\mu$ V; signal-to-noise ratio is 65 dB; distortion, under 0.8 per cent; drift, less than 0.02 per cent; stereo frequency response,  $\pm 1$  dB, 30 to 15,000 Hz; capture

ratio is 4 dB; selectivity is 45 dB; cross-modulation rejection is 80 dB; and stereo separation is 35 dB. The silver-plated four-nuvistor front end feature of Scott tuners is retained.

Circle 204

● **Compact Speaker.** This latest unit in a long line of Wharfedales is the W-30. It is a true bookshelf speaker measuring 19" by 10" by 9 $\frac{1}{4}$ ". This is a two-way system with a high-compliance eight-inch woofer and separate small cone tweeter. A unique feature of this system is its Acoustic Compensation Circuit. This is a two-position switch that is unlike the usual tweeter control usually found on two-way systems. The switch

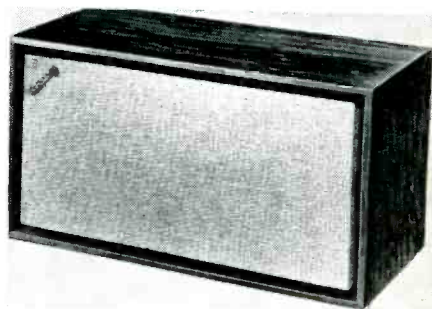

serves to alter the normal response by reducing the presence range together with a controlled amount of tweeter. The result is a change in the character of sound from full-bodied to mellow. This can be used to advantage for both room and personal-taste compensation. Efficiency of the system is high; a 10 to 15-watt amplifier is suggested. List price in walnut is \$69.95.

Circle 205

● **RCA's Lightest and Smallest Microphone.** A new subminiature, lavalier dynamic microphone has recently been unveiled by RCA Electronic Components and Devices. The RCA BK-12A weighs less than  $\frac{1}{4}$  of an ounce and measures 1 $\frac{1}{2}$  inches in length and  $\frac{3}{8}$  of an inch in diameter. This microphone has been designed for excellent speech balance for use in TV interviews and public address applications. Frequency response covers the range of 60 to 18,000 Hz. Pickup characteristics are non-directional. The microphone comes equipped with lavalier and tie-clip holders. Other features

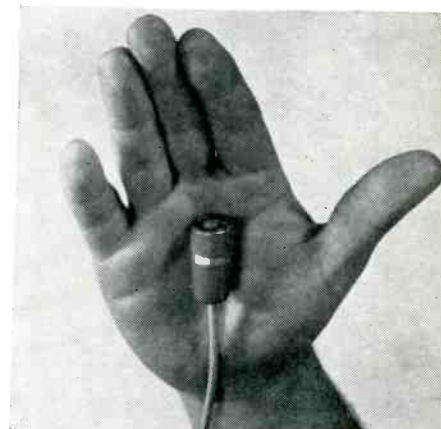

include: a line-impedance voice coil that permits its use with any system in the range of 30 to 250 ohms, gold plating on accessories, and a micron-sized, stainless steel meshed acoustic screen that effectively filters out dirt and moisture. On the spot repairs may be made by the use of available complete replacement cartridges. Installation can be made in less than five minutes. The cable is also readily replaceable. List price is \$95.00

Circle 206

*Feel it.*



The lively sound of music!

Feel it . . . the dynamic, electrifying sensation of music as it was played and meant to be!

Feel it . . . the total sound of music!

Listen to the Mediterranean, University's newest and liveliest reproducer for all the sound.

Styled to be seen . . . and used . . . in the finest Mediterranean tradition. Genuine Butternut . . . in a fine antique patina . . . velvet smooth, rich in color and proportioned for extra use as an occasional or lamp table. Matching pieces available at better department stores and furniture shops.

FACTS FREE. We'll send you the full story of the "Mediterranean" and include University's newest catalog of the largest and liveliest selection of speakers and systems in the world. PLUS University's "Guide To Component Stereo High Fidelity". Write today to Desk B63S.

Listen—University Sounds Better



**UNIVERSITY SOUND**  
A DIVISION OF LTV LING ALTEC, INC.

9500 W. Reno Oklahoma City, Oklahoma 73101

Circle 131 on Reader Service Card



**MEDITERRANEAN SPECIFICATIONS.** The Cabinet: Exclusive RRL acoustic enclosure in antique butternut or antique white commode table 22 1/4" high, 26" across top. The System: 12" long-throw, high-compliance woofer; acoustically isolated 8" mid-range; patented reciprocal flare horn-loaded wide range tweeter. Overall response, 25 to 20,000 cps. Selling Price: Butternut \$312, White \$360.

## AUDIO ETC.

(from page 14)

our vast system going, is the yearly dealer wingding that each of our major companies must put on to keep its regional dealership happy and well informed. Well, er . . . happy, anyhow. Some of these wingdings, oh-so-happily, are open to select members of the press.

Now I don't get to many of these affairs—I'd never get any work done if I did. But I always grab at the chance when one comes my way, because I like to be happy too. It's all one big happy hi fi family for me. And the one I grab at most quickly is Jensen's, from Chicago. That is, the New York Jensen wingding. It's something.

(I have also hugely enjoyed some of the others, including several by General Electric, one of which beat any repast I ever ate for sheer gourmandizing.)

### Parts Show

First, of course, these dealer get-togethers must be equipped properly. There must, naturally, be a one-company Parts Show, like at the Hi-Fi Shows but three times as big. And so first of all, the Company picks a big room at some hotel and laboriously sets up an enormous display of Company Products, all around the edges. Switching panels, colored lights, piles of

literature, music galore. Very instructive, to put it mildly. A lot of work goes into that sort of display, I tell you.

Well, finally, comes the Great Day. All the Company Brass is in attendance, the bugs have been got out of the Display, to the tune of hours of tuning-up (we hope they're out) and all is ready. An exhausting ordeal for those involved, but the guests, quite naturally, will be oblivious of all that and couldn't care less, which is as it should be.

So you arrive. But before you even see the Display you are likely to encounter a real live bunny. Or a more modest equivalent (Jensen). She checks you in, nuzzles your coat and hat away from you, pins on your badge and then, with a big smile, presents you with a GIFT. Good one, too. Off to a splendid start! Jensen's to me was a lovely blue ball point pen, fixed up so that each time you click it in and out a different Jensen ad appears in a magnifying window. I didn't catch onto this until halfway through the banquet. . .

But first, as I say, there is the Display, which is to be seen in all its glory as you enter the party room. It occupies everybody's mind for at least ten full seconds. What comes next, needless to say, is the

bar, where things are being dispensed with a fine freedom and a total absence of cash, to the delight of all including yours truly. In no time at all, the cocktail party is buzzing at its liveliest—you never saw such an Old Home Week! The display now serves handily for leaning against, in animated conversation, or putting down a drink for a moment, or for cigarette trays.

Nothing rowdy—far from it. Just, to coin a new word, loudy. Such a roar of pleased conversation you never heard. (This was a big party, mind you.) A rousing good time, as friends meet friends, circles form and dissolve, dealers whoop to dealers over other peoples' shoulders. Terrific. And the only sufferers are those unlucky minor officials who are stuck with running the exhibits in the Display. They did a thriving business at Jensen, as a matter of fact, but it had to be carried on in a hoarse shout, mouth to ear. Wearing. With one accord, most of the guests ignored them. They were much too busy having fun.

### Moment of Truth

But sooner or later, must come the Moment of Truth. The official Demonstration. No company can throw an affair like this without at least a gesture towards audible



## "NEUMANN CONDENSER MICROPHONES COMPLETE OUR SUCCESS FORMULA..."

... reports Vincent J. Liebler, Director of Technical Operations at Columbia Records, N. Y. "... our top rank talent and control room engineers achieve total rapport through NEUMANN mikes. It's a winning combination!" NEUMANN Microphones inspire confidence, command professional respect for their predictable, consistently reliable performance. And above all...artist, producer and technician admire them for that exclusive NEUMANN sound... the sound of success! Proven at Columbia and innumerable studios the world over.

That's why we find a forest of U-67s and M-49s in this

studio...why all who depend on recording for a living need NEUMANN. Got a particular problem? There is a NEUMANN Condenser Microphone suitable for any inside or outside application. GOTHAM is always ready to help you make the right decision. For more information write:

**GOTHAM**  
AUDIO CORPORATION

2 WEST 46 STREET, NEW YORK, N. Y., 10036 • 212-CO-5-4111  
In Canada: J-Mar Electronics Ltd.,



© 1965 GOTHAM  
AUDIO CORPORATION

Circle 132 on Reader Service Card

presentation of the very stuff upon which the party, the Company and the entire dealership depends.

And so, along about a half hour behind schedule, at the very height of the noise, the Vice President (or somebody) walks up to a mike with a very determined smile on his face and begins, "Gentlemen . . . may I have your attention."

I really wonder whether he ever expects to get it. For the job is not easy. Indeed, anybody in his right mind would call it wholly impossible. Our attention, at Jensen, was *very* hard to come by right then, even via a lusty overhead P.A. system, beamed straight down on our defenseless heads.

P.A. or no, nothing observably changed. The party went beaming along, better than ever. The boys were having their good time and why bother them, I thought to myself. That's the whole idea, isn't it? Now, Mister V.P., you don't *really* think you're going to get our undivided interest for your Demonstration *now*, at such a happy moment as this??

Nevertheless, the Vice President (or whoever he was) kept at it, mildly, calling for our attention. And after awhile, a good long while, there occurred a sort of half-lull, a slightly detectible lowering of the conversational dB. Some of the dealers, probably old hands, pretended not to notice. Others, slightly more dutiful to Mother Jensen's command, turned half away from their conversations and canapes—not giving them up, mind you, just revolving their persons a bit in the general direction of where things were to happen.

And so the Annual Demonstration began, and wended its way, still gently persuasive, all smiles, through a gradually rising tide of renewed cheerful noise until it finally just plain disappeared, completely engulfed, without an audible trace! It had to be seen to be believed. Seen, because you really couldn't hear it. Not much, anyhow.

I figured, myself, that most of the Jensen dealers already knew a lot about the models on display and so could afford to lend their ears to other matters more convivial. Jensen must have known it too. The amiable gent who ran the Demonstration, straight through the barrage of noise, didn't seem to be a bit annoyed. If he was, he manfully didn't show it. He beamed vocally through the mike, right in tune with the rest of us. We *all* made noise, all at once.

I tried to take a few notes on him (with the blue Jensen ball point), as the proceedings went on and as each of the Company's splendid stereo speaker systems was played in turn, via the switchings and the colored lights. But my second martini kept getting in the way, and all I can make out now of what I wrote down, on a program book, is a cryptic statement that says "replacements—I though it was replacement *ink*." I'm afraid I can't interpret that to you at this late date. But I did, with my unerring musical ear, recognize a very familiar tune, over and over again, which my accompanying lady friend, with her unerring memory, instantly identified as "Jealousy," a tango. We heard "Jealousy" through each of Jensen's systems, but I'm

# NEW! ROBERTS 400X 60 WATT STEREO SOLID STATE TAPE RECORDER with EXCLUSIVE 22,000 CPS CROSS FIELD



featuring

**REVERSE PLAY** automatically  
**SELECT PLAY** automatically  
**REPEAT PLAY** automatically

- |  |   |                                      |
|--|---|--------------------------------------|
| <input type="checkbox"/> 4 Heads, 3 Motors       | <input type="checkbox"/> 2 Speakers                 | <input type="checkbox"/> 2 VU Meters |
| <input type="checkbox"/> Timed or Signal Reverse | <input type="checkbox"/> Echo Chamber Effect        |                                      |
| <input type="checkbox"/> Sound-on-Sound          | <input type="checkbox"/> Remote Controllable        |                                      |
| <input type="checkbox"/> Sound-with-Sound        | <input type="checkbox"/> 10½" Reel Adaptable        |                                      |
| <input type="checkbox"/> Sound-over-Sound        | <input type="checkbox"/> 3 Speeds (15 ips optional) |                                      |
| <input type="checkbox"/> Push Button Controls    | <input type="checkbox"/> 4 Digit Index Counter      |                                      |

Roberts 400X—the ultimate in a tape recorder.

**\$799.95**



## ROBERTS

5922 Bowcroft St., Los Angeles, Calif. 90016

A DIVISION OF RHEEM MANUFACTURING COMPANY WITH 75 PLANTS AROUND THE WORLD

Circle 133 on Reader Service Card

afraid I couldn't really tell the difference I could just barely hear the music at all.

At that point some unreasonably in-polite Jensen dealer asked in a loud voice, "Are there Jensen speakers in this P.A. system?" a question which the microphone up front did not bother to answer. (It was built in, and has been built-in for many, many years I suspect.) And so the party resumed as before, more energetically than ever.

I might interject, in case you're inclined to get me wrong, that I have been to press parties which were just plain binges and very unpleasant. I walked out of one, last year, where there was actual fighting at the bar, with whiskey spilled all over everything. That sort of thing is outrageous in any business, including ours. The Jensen affair, though, was a genuine, like-

able party and always has been—that's why I'm plugging it.

I do enjoy this total American irreverence, this tolerance, which allows such a friendly disregard by the company employees of a company's own official demonstration, put on by the Big Shots themselves! Jensen's was simply dissolved in a babble of happiness and, if you ask me, Jensen came out the winner on points.

#### Banquet

That was far from all. Presently, the dinner gong sounded and we entered the grand ballroom, for a feast of noble proportions, replete with thick, juicy roast beef. Yum! My good will soared mightily. Some of the Jensen officials were attired in bright red coats, for easy identification

(I'm a dope—at first I thought they were the hotel's waiters) but a few were exempt, including one who sat at my table, the well known Ben Pinz. When, later on, Mr. Pinz rose for a few remarks, there was an enormous "boo!" from the crowd—which immediately made it plain to me that Mr. Pinz was one of the most beloved and respected of Jensen's official family. (What crazy people we are—where else in the world would a boo get over as an instantaneous compliment!)

And finally, there was the entertainment. Jensen is so wise—no further demonstrations at this point. Not after that superb roast beef. There's always something really unusual at Jensen's, to cap the total informality of the entire affair. Last year, if I remember rightly, it was a man who imitated EVERYTHING—steam engines, jet planes, people, birds, autos trying to start on a cold morning, simply by making noises into a close-up mike. This year it was a guy who talked double-talk. He spoke for at least a half hour, and not one word he said made the slightest sense. It was marvelous!

And so—back to work (at Jensen) for another long year. It is at times like these that I honestly think we Americans, for all our hard-boiled, high-power toughness, do have certain laudable Arts of Living equal to anything in the fabled Old World, if maybe not quite so sophisticated. Ours is the Art of Irreverent Nonsense. Like putting on formal Demonstrations, in the middle of cocktail parties, which nobody is expected to listen to, and nobody minds in the least—if I may turn utterly ungrammatical in my enthusiasm.

I was most grateful to Jensen for its inaudible Demo, then, and I think it was absolutely worth all their trouble, in hauling such enormous quantities of equipment to New York and setting it all up in such a compact fashion.

Think how much less happy we would have been if we hadn't had a Demonstration to talk down.

**What makes it different?  
It's got both AM and FM stereo - ultra-wide power bandwidth - tape input and output - radically new wide-dispersion air-suspension speakers, matched to the electronics - superb sculptured look...**



**harman kardon**  
**COMPACT MUSIC SYSTEM**

What other compact offers all the features of the Stratophonic SC-440? All-transistor AM/FM stereo receiver with extraordinary frequency response and power bandwidth; stereo indicator light; D'Arsonval tuning meter; stereo headphone jack; and—new from Harman-Kardon—air-suspension speaker systems assuring perfect stereo sound at any point in any room

without critical speaker placement.

All this, plus the incomparable good looks of the Stratophonic SC-440, for only \$399\*. Hear it at your Harman-Kardon dealer's. You'll like it on sight... buy it on sound. Harman-Kardon, Inc., 15th & Lehigh Ave., Philadelphia, Pa. 19132. A subsidiary of The Jerrold Corporation.

\*Slightly higher in the West. Dust cover optional.

Circle 134 on Reader Service Card

## LIGHT LISTENING

(from page 8)

companiment captures it in definitive performances and richly-detailed sound.

**Laurindo Almeida:** New Broadway-Hollywood Hits

**Capitol ST 2419**

One of today's more popular guitarists strikes out in new directions in this program with the help of a group called "San Fernando Guitars." This is quite a departure for Almeida, who has attained his present pinnacle pretty much as a solo act. Not content with the usual form of accompanying ensemble, Laurindo Almeida has applied as much showmanship in selecting the group's instruments as he has shown in his solo albums devoted to bossa nova, jazz, pop, and classical idioms. In this rundown of recent Hollywood and Broadway tunes,



Almeida plays a lead instrument of some sort in each selection, three of which happen to be his own compositions. In the themes from "The Reward" and "Zorba the Greek," his lead instrument is the tiple. This small item has four sets of double strings and is similar to the mandolin in appearance. Other instruments involved in the background: a cavaquinho, a treble Brazilian guitar about the size of a ukelele and, to complete the ensemble, there is a twelve string guitar, a Fender bass guitar, a variety of more conventional guitars, drums, and percussion. Not exactly a group you'd expect to meet coming down the street every day in the week but one capable of lending sonic variety to show music that can certainly use it. **Æ**

## REVERBERATION

(from page 44)

An interesting parallel occurs in geophysical echo-sounding techniques. In these applications the desired signal for recording is the bandwidth that is removed from the original. The remaining full bandwidth is not used except for reference purposes. In later applications the removed signals are again combined with the original data. In this manner, one is able, to a marked degree, to salvage a much weaker echo that is located under a multiple bottom reflection.<sup>2</sup>

### Conclusion

While the addition of artificial reverberation to an existing sound system does not make a great hall out of a small listening room, it does aid in establishing the proper depth to the program. It aids materially in acoustically removing the speakers from the room and in adding the much needed feeling of size. If these signals are correctly applied to the original program material, the affect is one step closer to the ideal of high fidelity: that of reproduction as close as possible to the original. **Æ**

<sup>2</sup>Echo sounding techniques make use of the fact that different layers of material such as water, sand, rock, clay, and so on, reflect signals of different frequencies in the audio-frequency range. Thus, if a reflected signal from additional layers below the ocean floor is received, the frequency containing the largest energy level would be different from the signal reflected from the ocean floor itself. Suitable filters enable the operator of such equipment to reject to varying degrees the multiple bottom echo and yet retain the reflected signal from these additional layers below the bottom even though this signal is considerably more attenuated.

this leprechaun will charm you



Try recording just one reel of Irish tape. You'll be enchanted by the clarity and crispness of response. Friends will call you a "pro"—but you'll know that the Leprechaun was working for you. Ask for Irish at better stores. Happily, at popular prices.

WITH  
ferro-sheen®  
PROCESS



Write for catalog describing complete Irish line sizes and technical specifications.



## IRISH MAGNETIC RECORDING TAPE

458 Broadway, New York, N. Y. 10013

Circle 135 on Reader Service Card

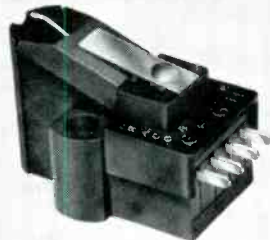

# GRADO

## MODEL B SOLID-STATE STEREO CARTRIDGE

"THE FINEST CARTRIDGE I HAVE EVER HEARD REGARDLESS OF PRICE, NOTHING CAN APPROACH IT FOR SOUND QUALITY."

The Model "B" solid state cartridge is a tremendous advance in cartridge design. It requires no power supplies, equalizers or transformers. It does not contain any coils, wires, magnets or solder joints, yet it produces voltage exactly like a moving coil cartridge and plugs directly into the low level magnetic input.

The Model "B" uses gem quality hand polished diamond stylus, 24K solid gold ribbon connectors and ultra miniature laminated solid state strain generators.

Frequency response is 10 CPS to well beyond 50 KC. Semi-automated production techniques keep the list price of this quality cartridge to an amazingly low . . .

### \$19.95

For complete information write to:

**Grado Laboratories Inc., 4614-Seventh Ave., Brooklyn, N. Y. 11220**

Circle 136 on Reader Service Card

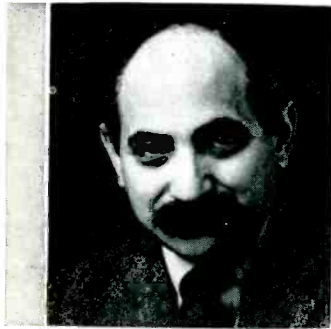

# JAZZ and all that

Bertram Stanleigh

Two new releases on two different American jazz labels have a common and somewhat extraordinary purpose. They serve to commemorate overseas visits by two German jazz groups. Both visits were sponsored by the German Goethe Institute, and if one can judge from the product on these two platters, we can anticipate the same kind of competition in the jazz field that we have encountered with our manufactured goods in overseas markets. It has been our smug habit to assume that we had one cultural export with which no other nation could compete. Whenever the State Department wanted to put on a goodwill tour that was uniquely American, all it had to do was get Louis Armstrong or Benny Goodman to pack a bag. It was our own patented technique for winning friends and overcoming language barriers. Now it looks as if the patent rights have expired. In the future it would be wise for us to recognize that we will be obliged to engage in vigorous competition if we don't want to find ourselves frozen out by high-quality foreign imitations.

It's particularly serious because we're up against a very interesting gimmick shrewdly designed to cement even closer friendships than can be stuck together by a simple concert tour. The gimmick may not be particularly new, but it is effective: combine your own jazz style with the music of the countries you're visiting. Dave Brubeck has clumsily attempted to employ this technique after visits to Germany and Japan, but the framework has been too large for his talents. Either these two Germans are less self-conscious than Mr. Brubeck or they are more skillful in merging their own personalities into their music. In any event, they have found an effective technique for blending European jazz with the music of other continents.

**Albert Mangelsdorff: Now, Jazz Ramwong**  
Pacific Jazz Stereo ST-20095

The ramwong is a popular Siamese folk dance, and according to the liner notes on this platter, the new version from which this disc derives its title received acclaim from press and public when it was presented in Bangkok in January, 1964. The disc was recorded at Waldorf Tonstudio, Frankfurt-am-Main, for CBS Records of Holland after

the Mangelsdorff Quintet returned from a 10-week Asian tour that stretched from Turkey to Japan and was commissioned by the Goethe Institute. The group gave 50 concerts in 65 days, and they were accorded what must by now be considered the traditional welcome for all jazz musicians in Thailand—a jam session at the royal palace in which King Bumiphol participated. The quintet is composed of Albert Mangelsdorff, trombone, Günter Kronberg, alto, Heinz Sauer, tenor, Günter Lenz, bass, and Ralf Hübner, drums. They turn in polished performances throughout, but it is the title tune and *Three Jazz Moods on 'Theme from Pather Panchali'* that provide the most interest and originality. Indefatigable travelers, the group has appeared at the important European jazz festivals in France, Poland, Switzerland, and Yugoslavia, and Mangelsdorff was a soloist at the Newport Festival in 1965.

**Klaus Doldinger Quartet: Doldinger in South America**

Emercy Stereo SRE 66009

This recording is an impressive document of the strong impact that South America made on one of Europe's leading jazz quartets. Following a 37-concert tour from Rio to Mexico that made a big impression on the Latin Americans, Doldinger's group returned to Europe and discovered that the Latins had also made quite an impression on them. Together with guitarist Atilla Zoller, they have recorded their impressions in a sophisticated collection of atmospheric jazz with pronounced bossa nova inflections. Control, rather than freedom, is at the core of these performances, and there is just a bit of conscious contrivance in some of the arrangements, but it's all handled with impeccable taste, and the results make for easy, satisfying listening.

**J. J. Johnson: Goodies**

RCA Victor Stereo LSP-3458

Good sound, a large orchestra, and a chorus have all been lavished on this production, and as might be expected, the results are inflated and a trifle vulgar. Jay Jay is given ample opportunity to solo, but he has no serious competition to play against. Consequently he doesn't rise to the heights of which he is so capable when the sides are more evenly matched. Osie Johnson sings a couple of tunes with lots of energy, and Marlene Ver Planck scats through another pair of numbers. The sound is great; lots of spread, contrasting rhythms from left and right speakers, a solid center. The only thing missing is the kind of music we expect from a musician of the calibre of J. J. Johnson.

**Gerry Mulligan: If You Can't Beat 'Em, Join 'Em**  
Limelight Stereo LS 86021

With the assistance of Pete Jolly, piano, Johnny Gray, guitar, Jimmy Bond, bass, and Hal Blaine, drums, Mulligan makes a conscientious obeisance to nine of the great hit tunes of the last three years. *King of the Road*, *Engine, Engine No. 9*, *Hush, Hush Sweet Charlotte*, *I Know a Place*, *Can't Buy Me Love*, *A Hard Day's Night*, *If I Fell*, *Downtown*, and *Mr. Tambourine Man* all receive agreeable performances that are planned to retain the melodic interest of these pop favorites intact. It's well below Mulligan's creative standard, but it is a deft rendition of music that can benefit from a more low-keyed treatment than is found in the classic versions. The album in which Limelight presents this set is a graphic triumph. Designed by Daniel Czubak, it features a pop-up center and a handsome booklet written by Gene Lees.

**Paul Butterfield Blues Band**

Elektra Stereo EKS-7294

"We suggest that you play this record at the highest possible volume in order to fully appreciate the sound of the Paul Butterfield Blues Band." That's the legend carried in a box on the jacket liner of this potential lease breaker. Anyone whose sound system is capable of more than moderate volume should approach this disc with caution for Elektra has managed to engrave a fantastic amount of clean, high-level sound on the grooves of this lively swaggering collection by a 23-year-old white Chicagoan with a direct, highly personal blues style. Butterfield sings, plays the harmonica, and creates much of his own material. Accompanied by a rocking band consisting of two electric guitars, electric bass, electric organ, and drums, he presents a vigorous, almost violent, approach to the blues that is very different from the usual introspective blues manner but one which is just as valid. This is a remarkably fine record, even when played at normal listening levels. At full output you had better chain yourself to the speakers, or you'll be blasted right through your walls. If your walls are thin and your neighbors are touchy, it also sounds great on earphones.

**Mr. 12 String Guitar**

World Pacific Stereo 21835

Having explored the sound of the twelve-string guitar in more traditional material in previous albums, World Pacific now offers us a disc of folk-rock. Seven of the platter's dozen tunes are from the pen of Bob Dylan, and only three guitars are used. They are augmented by two harmonicas, electric organ, drums, bass, and fender bass. The remarkably clear recording that has been a feature of this series is present once again, but for me, there is more of a detached, perfunctory quality to these performances than to the earlier records in the series. In any event, such considerations are not likely to affect seriously the popularity of this new release. Dylan is the reigning king of the folk-rock movement, and these tastefully arranged versions of some of his most popular songs include *Blowin' in the Wind*, *Mr. Tambourine Man*, *Like a Rolling Stone*, and *It Ain't Me Babe*.

70 Irving Place, New York, N.Y., 10003.

## TEST EQUIPMENT

(from page 30)

### DISTORTION ANALYZERS

**EICO 902** A combination harmonic and intermodulation distortion analyzer, this unit also functions as a high sensitivity a.c. VTVM. Measures distortion over frequency range from 20-20,000 Hz with a minimum input of 0.7 volts. Scale ranges of 0.3, 1, 3, 10, 30, and 100 per cent are available for either THD or IM analysis. As an a.c. VTVM full scale settings of

.01, .03, 0.1, 0.3, 1, 3, 10, 30, 100, and 300 volts are usable. Frequency response is 10-100,000 Hz  $\pm$  0 dB. A test signal of 60 and 7000 Hz at either 4:1 or 1:1 ratios is available for IM use or external signals may be substituted. Price is \$250, wired only.

**Heath IM 12** A harmonic distortion analyzer that will show THD over a range of 20-20,000 Hz. Full-scale ranges of 1, 3, 10, 30, and 100 per cent distortion. Minimum input voltage for distortion measure-



←  
**EICO 902**

ments is 0.3 volts. This unit also serves as an a.c. VTVM with a maximum sensitivity of 1 volt full-scale. It will measure noise levels down to 60 dBm. Price in kit form is \$54.95.

**Heath IM-22** Audio Analyzer. This instrument is for measurement of inter-modulation distortion in accordance with SMPTE standards. It provides its own signals of 60 and 6000 Hz which may be mixed as required. Other

←  
**HEATH IM-22**

frequencies may be applied externally if desired. Built-in 25-watt loads of 4, 8, 16 or 600 ohms may be used in terminations. The IM-22 also functions as a directly calibrated watt-meter and high-sensitivity a.c. VTVM with a maximum full-scale sensitivity of 10 MV. Full-scale distortion ranges are 1, 3, 10, 30, and 100 per cent. There is an input level set. Frequency response as an a.c.

←  
**HEATH IM-12**

VTVM is 10 to 100,000 Hz  $\pm$  1dB. Decibel calibration in dBm is from -65 to +52 dBm. Price in kit form is \$56.95.

# ONLY OKI

gives you such quality sound and weighs so little—at so quiet a price.

Only OKI 300 sounds so magnificent, and costs so little. It's a compact concert hall, lighter than 16 lbs., spectacular solid-state 4 track stereo. And it dresses up any room it's in. Hear it today — the matchless sound of OKI 300. Only \$219.95\*. 1 year warranty.\*\* See and hear it at your OKI dealer.



# ONLY OKI 300

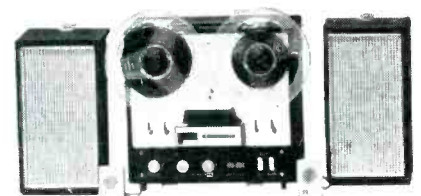

\*Manufacturer's suggested list price.  
\*\*1 year parts, 6 mos. labor.



Chancellor Electronics, Inc.  
457 Chancellor Avenue, Newark, New Jersey 07112  
Circle 173 on Reader Service Card



**The 5th AUDIO Anthology**

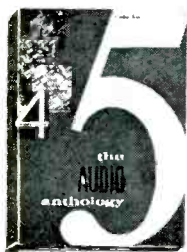

No. 125 \$3.50

Edited by C. G. McProud, publisher of AUDIO. An anthology of the most significant articles covering: stereo recording and reproduction; stereo multiplex; measurements; stereo technology, construction and theory—which appeared in AUDIO during 1958 and 1959. The 5th is truly a collector's item and a valuable reference for the professional engineer, teacher, student, hobbyist and hi-fi fan. 144 pages.

**The 6th AUDIO Anthology**

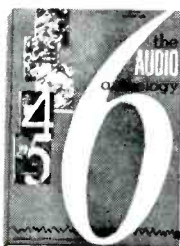

No. 130 \$3.95

Edited by C. G. McProud, publisher of AUDIO. Includes articles on the two most significant milestones in the field of high fidelity: FM STEREO and TRANSISTORS IN AUDIO EQUIPMENT. A meaningful reference for everyone in the fields of audio engineering, recording, broadcasting, manufacturing and servicing of components and equipment. A necessary book for the high fidelity enthusiast. 144 pages.

**The 7th AUDIO Anthology**



Edited by C. G. McProud. A compendium of articles relative to the art of high fidelity reprinted from AUDIO Magazine. A valuable reference tool for the audio hobbyist, the latest edition of this great series. 144 pages.

No. 135 \$3.50

**SPECIAL**

**Order all three  
SAVE \$3.00  
Circle S567  
YOUR COST \$7.95**

**NEW LITERATURE**

• **Audio Cable Adapters.** Users of foreign miniaturized radios, recorders, and television sets who are unable to interconnect them with standard American audio connectors will want to know about four new Switchcraft accessory plugs. Part Number 374 adapts standard 1/4 inch phone plugs to a tiny (9/64ths) jack. List price is \$1.70. Part Number 375 is an adapter with an 0.097-inch finger that goes from the standard 1/4-inch phone plug to a micro jack. List price is \$1.50. Part Number 376 has a 0.097-inch finger. It adapts a tiny plug to a micro jack. List price is \$1.50. Finally there is Part Number 377. This adapter has a 9/64ths-inch diameter finger and adapts a micro plug to a tiny jack. List is \$1.50. All adapters are two conductor and have shielded nickel-plated brass handles. **Circle 220**

• **Colorful Stereo Guide.** H. H. Scott is offering the latest edition of its Guide to Custom Stereo. This 20-page brochure, illustrated in full color, features photographs, descriptions, and specifications of all Scott components, kits and speakers. But it is also a valuable source of information. In simple language it explains how stereo works, and how to choose the components most suited to individual acoustic and budgetary requirements. Many of the color photos show the components in room decor conditions. The brochure is free of charge. **Circle 221**

• **PA Literature.** This latest catalog describes the Commander series of Harman-Kardon components. When fully opened, the catalog doubles as a wall chart and ready reference of complete, easy-to-read specifications. Two handy tables indicate which accessories are used with each amplifier, booster, or receiver. A new guide to the POWRCOM intercom system makes it easy to understand how this most valuable unit may be integrated into any PA installation. A basic "two-channel/two-amplifier" system block diagram further illustrates the flexibility of this product. List prices are included in this free catalog. **Circle 222**

• **Hobby Manual.** Kit and do-it-from-scratch constructors will enjoy this new book from General Electric. It is a 200-page digest of projects for car, entertainment, home, camp and workshop. Included are a light that dims gradually at a pre-determined time, an electronic organ the size of a typewriter that plugs into your music system, an airport receiver that lets you eavesdrop on conversations between pilot and control tower and an electronic car ignition system. Forty-five pages of the manual are devoted to a layman's explanation of the fundamental operation of the wide range of components used in these systems. All in all, there are thirty-five projects, none of them requiring deep electronic experience. Cost is \$1.50 and the Hobby Manual is available through GE electronic components dealers or direct from. **Circle 223**

• **Piezoelectric Data Book.** Electronic-device, circuit, and system designers will find value in this 45-page technical manual on piezoelectric technology. The book progresses from general descriptions of characteristics and principal applications of piezoelectric materials and elements to coverage of piezoelectric constants and specific properties of ceramics. There is also a brief discussion of equivalent circuits and their application to flexing, sandwich-type piezoelectric elements known as "Bimorphs" and "Multimorphs" as well as an outline of the properties of special ceramic shapes and tubes. The book, entitled "Piezoelectric Technology," is published by the Clevite Corporation. It contains forty figures and seven tables. Eight pages are devoted to conversion charts designed to facilitate converting published piezoelectric measures between U.S. and metric units. **Circle 224**

**AUDIO Bookshelf—AUDIO MAGAZINES, INC.**  
P. O. Box 629, Mineola, New York 11502

\*All U.S.A. and Canadian orders shipped postpaid.

Please send me the books I have circled below. I am enclosing the full remittance of \$..... (No C.O.D. or billing.)

125      130      135      S567

NAME \_\_\_\_\_  
ADDRESS \_\_\_\_\_  
CITY \_\_\_\_\_ STATE \_\_\_\_\_ ZIP \_\_\_\_\_

**FREE STEREO INFORMATION**

FM station directory . . . covers FM stations in U. S. and Canada. Factual equipment test reports. Test reports on tuners, preamps, poweramp/preamps. Find out what the experts think. A complete 36 page catalog tells about tuners, power amplifiers, preamplifiers, preamp/power amp combinations, and tuner preamp.

**ALL FREE—  
JUST WRITE  
TO:**

McIntosh Lab. Inc. 6 Chambers St.  
Binghamton, N. Y. 13903

NAME \_\_\_\_\_  
STREET \_\_\_\_\_  
CITY \_\_\_\_\_  
STATE \_\_\_\_\_ ZIP \_\_\_\_\_

Circle 138 on Reader Service Card

**ADVANCE ORDERS  
BOUND VOLUMES**

1965 Issues  
Audio Magazine

Order Now\*

LIMITED NUMBER  
AVAILABLE

\$10.00 EACH POSTPAID  
U. S. DELIVERY ONLY

Send Order  
and Remittance Today

Book Division

Radio Magazines, Inc.

P.O. Box 629  
Mineola, N. Y. 11502

\*Delivery January 20, 1966

## TEST INSTRUMENTS FOR THE AUDIO BUFF

(from page 29)

When you have completed an audio kit, the instructions may call for you to make certain resistance checks (for example at the d.c. power supply) before turning the component on. If the component doesn't work properly, the kit manufacturer will have a number of trouble-shooting suggestions, some of which call for measuring resistances and voltages.

### Conclusion

If you want your audio components to yield full potential performance and stay that way, you may well give serious thought to acquiring a few basic test instruments at relatively low cost. No one thinks it strange for a car owner to delve deep under the hood of his automobile. Why shouldn't the audio buff have similar technical familiarity with his audio equipment?

Getting started in something new is always a problem. Start in a simple way. A good VOM might be your best initial acquisition. It is really quite inexpensive, yet very useful. As you gain familiarity with your first piece of test equipment, you'll find that the notion

of using instruments is not so foreign as once seemed, and you'll be emboldened to go on to such things as a capacitor checker, audio generator, distortion meter, etc.

At the same time, recognize your limitations. There are service problems and alignments that require the skill and experience of the expert, and quite possibly require test instruments better than those sold at popular prices. When you probe inside a component, be careful not to disturb the arrangement of parts and leads. If you have to disconnect a part (for example a capacitor) in order to check it, first make a drawing that shows where the leads go, so that you'll be sure to reconnect this part or its replacement properly. If you are testing inside a component with the power on, keep in mind that small amounts of current passing through your body can hurt badly or can even kill. The rule is one hand for the test and one for yourself (behind your back). This is not meant to frighten you from using test instruments. It is simply meant to put you on respectful terms with them and their use. Æ

## RECORD REVUE

(from page 19)

records, enough to keep you in solid Baroque for weeks.

Performance is crisp and vigorous, through with a peculiar lunging quality that is a bit confusing at first (It could be partly the recording—which is called "Royalsound" and is calculated by computer, like Dynagroove.) The performers are Dutch, their playing subtly different from the standard German Baroque styling. English notes included.

Les anciens vous presentent leurs instruments de musique. Le Groupe d'Instruments Anciens de Paris.

Pathé EMI DTX 335 stereo  
(via Capitol)

Gotta know some French for this one. If you do, you'll find it a good sonic exposition of old musical instruments, with excellent examples and spoken comment (French) by two voices, in stereo, plus an excellent illustrated booklet (French). Even without French you might enjoy it.

Tricky procedure. The main narrator, in one stereo speaker, carries on the informative line of thought. (Excellent diction, slow enough to follow easily.)

A second voice, in the other speaker and a bit in background (probably for contrast in the mono version) quotes from contemporary accounts concerning the various instruments. The musical illustrations are very nicely managed, never rudely brief nor cut off unmusically, and well played, too. There's the expected emphasis on French musical history, natch—the French have the naive idea that most important things originate in France (as we do of our own self-centered country!) and they don't mind saying so (nor do we). Won't bother you a bit here.

You'll listen to several types of old harp, old flutes, oboes, recorders, serpent, cromorne (Krummhorn)—perhaps the original for our word "crummy"—the rackett, a handful of wooden bottle with a blowing-tube and a crackly bass voice, plus harpischords, clavichords, and a brief sampling of very early piano sound. Like to have heard more of that. And lots of fiddles, viols, vièles—a real musical zoo. Every instrument, though, is played with musical feeling and reasonable skill, as well as respect. All in all a model for this sort of recording.

### IF YOU ARE MOVING

Please notify our Circulation Department at least 5 weeks in advance. The Post Office does not forward magazines sent to wrong destinations unless you pay additional postage, and we can NOT duplicate copies sent to you once. To save yourself, us, and the Post Office a headache, won't you please cooperate? When notifying us, please give your old address and your new address.

Circulation Department  
RADIO MAGAZINES, INC., P.O. Box 629, Mineola, N.Y.

THIS  
BOOK  
IS  
FOR  
YOU!

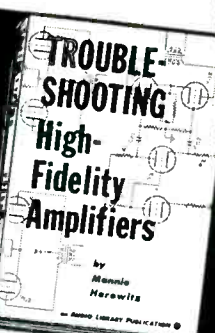

This book is for the hobbyist and technician who wants to know the plain and simple approach to **TROUBLESHOOTING HIGH FIDELITY AMPLIFIERS**.

Written by Mannie Horowitz, his fact-filled, illustrated chapters spell out the most direct approach to curing both, vacuum tube and transistorized amplifier ills. Everything from instruments and test procedures, to servicing transistorized stereo amplifiers, is covered in a writing style that makes it easy to read and absorb.

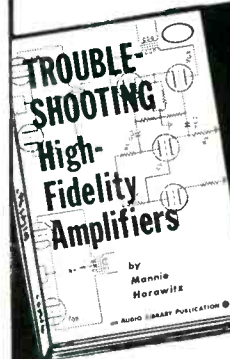

THIS  
BOOK  
IS  
FOR  
PROFIT!

**TROUBLESHOOTING HIGH FIDELITY AMPLIFIERS** was written specifically for the service technician and the audio hobbyist who specializes—or wants to specialize—in the growing and highly profitable field of audio and high fidelity service and repair.

A wealth of information  
—makes a perfect gift!

only \$2.95— Use convenient coupon below, just enclose your remittance—we pay the postage.

Radio Magazines, Inc., Dept. T62  
P.O. Box 629  
Mineola, New York, 11502

I am enclosing \$\_\_\_\_\_, please send me \_\_\_\_\_ copies of **TROUBLESHOOTING HIGH FIDELITY AMPLIFIERS\***, by Mannie Horowitz.

NAME \_\_\_\_\_

ADDRESS \_\_\_\_\_

CITY \_\_\_\_\_ ZONE \_\_\_\_\_ STATE \_\_\_\_\_

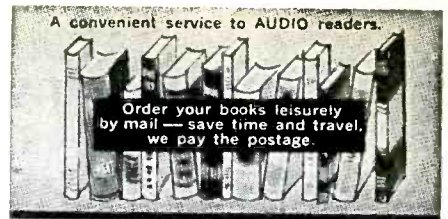

**Maintaining Hi-Fi Equipment**  
**Joseph Marshall**  
 A valuable reference for anyone whose living or hobby is servicing hi-fi equipment. Outlines the professional approach for servicing all types of hi-fi components. Covers trouble-shooting of electronic, mechanical and acoustic problems. 224 pages.  
**No. 58 Paperback \$2.90\***



**Designing and Building Hi-Fi Furniture**  
**Jeff Markel**  
 Written by a professional hi-fi furniture designer who has taught furniture design at leading colleges, this book is an authentic reference of value to the hi-fi fan and professional custom builder. Covers everything from types of woods to furniture finishing for the mechanically adept; design principles, styles and arrangements for the decor minded. 224 pages.  
**No. 79 Paperback \$2.90\***



**HI-FI TROUBLES**  
 By Herman Burstein  
**HOW YOU CAN AVOID THEM HOW YOU CAN CURE THEM**  
 Just published! At last, a book which deals directly with the problems you face in maintaining your audio system in peak condition. Tells you how to locate troubles, what to do about them and how to do it—and, just as important: what NOT to do. Helps you to achieve the best in listening pleasure from your equipment.  
**No. 120 \$3.95**

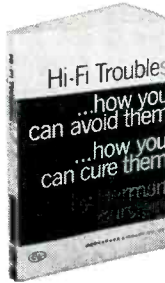

**McProud High Fidelity Omnibook**  
 Prepared and edited by C. G. McProud, publisher of Audio and noted authority and pioneer in the field of high fidelity. Contains a wealth of ideas, how to's, what to's, and when to's, written so plainly that both engineer and layman can appreciate its valuable content. Covers planning, problems with decoration, cabinets and building hi-fi furniture. A perfect guide.  
**No. 115 \$2.50\***



**The 5th AUDIO Anthology**  
 Edited by C. G. McProud, publisher of AUDIO. An anthology of the most significant articles covering: stereo recording and reproduction; stereo multiplex; measurements; stereo technology, construction and theory — which appeared in AUDIO during 1958 and 1959. The 5th is truly a collectors' item and a valuable reference for the professional engineer, teacher, student, hobbyist and hi-fi fan. 144 pages.  
**No. 125 \$3.50**



**"The AUDIO Cyclopaedia"**  
**Howard M. Tremaine**  
 Here is one single volume with the most comprehensive coverage of every phase of audio. Concise, accurate explanations of all audio and hi-fi subjects. More than 7 years in preparation—the most authoritative encyclopedic work with a unique quick reference system for instant answers to any question. A vital complete reference book for every audio engineer, technician, and serious audiophile.  
**No. 123 \$19.95\***

- 1280 pages
- 3400 topics
- 1600 illustrations



**Tape Recorders and Tape Recording\***  
**Harold D. Weiler**  
 A complete book on home recording by the author of *High Fidelity Simplified*. Easy to read and learn the techniques required for professional results with home recorders. Covers room acoustics, microphone techniques, sound effects, editing and splicing, etc. Invaluable to recording enthusiasts.  
**No. 112 Paper Cover \$2.95\***



**"the best of AUDIO"—**  
 edited by C. G. McProud  
 A new compendium of AUDIO knowledge. Here is a collection of the best of AUDIO — The AUDIO Clinic by Joseph Giovanelli . . . noted audio engineer and the original high fidelity answer-man — EQUIPMENT PROFILES edited by C. G. McProud . . . Editor of AUDIO. Here is a wealth of hi-fi and audio information. Answers to the most important issues in high fidelity and a valuable reference.  
**No. 124 Volume I \$2.00\***



**The 6th AUDIO Anthology**  
 Edited by C. G. McProud, publisher of AUDIO. Includes articles on the two most significant milestones in the field of high fidelity: FM STEREO and TRANSISTORS IN AUDIO EQUIPMENT. A meaningful reference for everyone in the fields of audio engineering, recording, broadcasting, manufacturing and servicing of components and equipment. A necessary book for the high fidelity enthusiast. 144 pages.  
**No. 130 \$3.95**

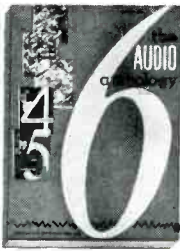

**MONTHLY SPECIAL! SAVE \$5.00**

Save almost 50% with this collection of AUDIO books.  
 "best of AUDIO" (\$2.00) 5th AUDIO ANTHOLOGY (\$3.50)  
 McProud High Fidelity Omnibook (\$2.50) and  
 Tape Recorders & Tape Recording (\$2.95)

**TOTAL VALUE ALL FOUR BOOKS . . . \$10.95**

**Your cost only . . . \$5.95 Postpaid**

**CIRCLE OS400**

This offer expires February 28, 1966, and is good only on direct order to the Publisher.

**High Fidelity Simplified**  
**Harold D. Weiler**  
**3rd Edition**  
 The complete hi-fi story — answers all questions about tuners, changers, amplifiers, tape recorders, speakers, record players, etc. Lots of ideas for custom installations. Tells how to achieve concert hall reception in your home. 216 pages.  
**No. 142 \$3.30**



**AUDIO Bookshelf—RADIO MAGAZINES, INC.**  
 P. O. Box 629, Mineola, New York 11501

\*All U.S.A. and Canadian orders shipped postpaid.

Please send me the books I have circled below. I am enclosing the full remittance of \$..... (No C.O.D. or billing.)

58	79	112	115	120	123
124	125	130	142	251	OS400

NAME \_\_\_\_\_

ADDRESS \_\_\_\_\_

CITY \_\_\_\_\_ STATE \_\_\_\_\_ ZIP \_\_\_\_\_

**Getting The Most Out Of Your Tape Recorder**  
**Herman Burstein**  
 Written in "plain talk" for the man who has, or wishes to buy, a tape recorder. It answers the myriad questions raised by tape recording enthusiasts. Its chapters cover every phase of operation and maintenance—from adding a tape recorder to the hi-fi system, to a thorough dissertation on microphones. Lots of practical information on how to buy. 176 pages.  
**No. 251 \$4.25**



## TAPE GUIDE

(from page 43)

The track width may vary between 39 and 43 mils.

3. The three islands between tracks shall be of equal width.

4. The tracks as a group shall be symmetrically positioned with respect to the tape, so that the top of track 1 and the bottom of track 4 are equidistant from the tape edges.

5. A track plus its adjacent island shall occupy between 67 and 68 mils, subject to the requirement that the total space occupied does not exceed 244 mils. (The distance between the center lines of tracks 1 and 3, or of 2 and 4, is given as 134 to 136 mil. Going from the center of track 1 to the center of track 3 sequentially covers half of track 1, island 1-2, all of track 2, island 2-3, and half of track 3—a total of two tracks and two islands. If 2 tracks plus 2 islands shall cover 134 to 136 mils, then 1 track plus 1 island shall cover half as much, namely 67 to 68 mils.)

If the minimum track width of 39 mils is used, then the islands must be between 28 and 29 mils in width, so that a track-plus-adjacent-island will cover between 67 and 68 mils. Then the total space occupied by tracks plus island is between 240 and 243 mils (4 tracks of 39 mils plus 3 islands of 28 mils add up to 240

necessarily to scale.) Note that whether the track width is 43 mils, 39 mils, or in between, each track's center line remains in the same place with respect to the tape, provided the distance between center lines of alternate tracks (of tracks 1 and 3, or 2 and 4) remains 135 mils. If the distance between center lines changes, the tracks shift position. But this shift can only be very slight, because the distance between center lines may vary only 1 mil above or below 135 mils. There is no danger that a tape recorded on one machine will play back improperly on another machine because their track widths (gap heights) are different or because their distances between center lines are different.

One may wonder why the track width is permitted to vary between 39 and 43 mils (producing a variation of about 1 dB in recorded signal) instead of being fixed at 43 mils as in Fig. 2. Similarly one may wonder why the distance between center lines is permitted to vary between 134 and 136 mils. Two reasons come to mind:

1. To avoid excessive manufacturing and processing costs, reasonable tolerances are

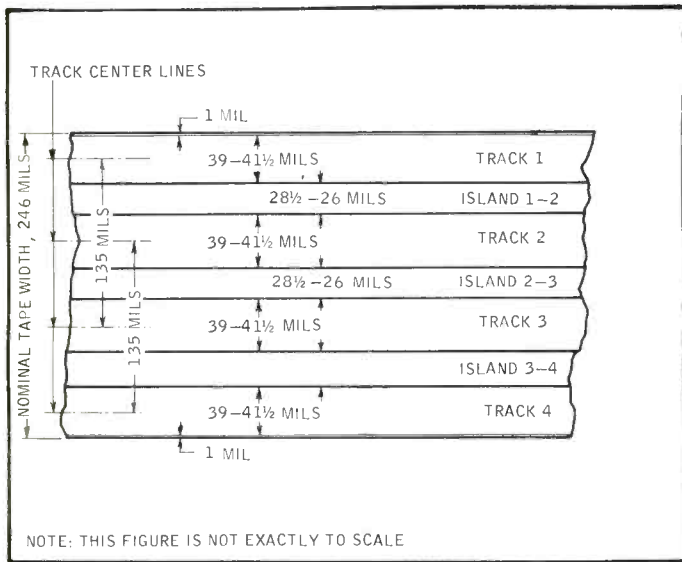

mils; 4 tracks of 39 mils plus 3 islands of 29 mils add up to 243 mils), At the other extreme, if the maximum track width of 43 mils is used, then the islands can only be 24 mils wide (instead of 25 mils as in Fig. 2). Four tracks of 43 mils plus 3 islands of 24 mils add up to the maximum permissible total width of 244 mils. If the tracks are of intermediate width, namely between 39 and 43 mils, the islands will range between 24 and 29 mils.

Assuming that a tape head manufacturer elects to use 135 mils as the distance between center lines of tracks 1 and 3 (and of tracks 2 and 4), Fig. 4 shows the maximum and minimum space covered by each track, and the corresponding island width, under the RIAA standard. (Figure 4 is not

necessary with respect to tape head gaps and therefore with respect to the width and disposition of recorded tracks. This is parallel to the situation for magnetic tape, which we have noted may vary 2 mils above or below the nominal width of 246 mils.

2. The RIAA standard may seek to accommodate both foreign and domestic stereo tape heads. I know there are U.S. heads with gaps 43 mils high and spaced apart so that the distance between center lines of alternate tracks is 136 mils. I also know there are foreign heads with gaps 1 mm (millimeter) high and spaced apart so that the distance between center lines is 3.4 mm.; this translates into a 39.4 mil gap, and a center line distance of 134 mils. The desirability of accommodating foreign heads is evident from the important role played by foreign tape machines in the U.S. market.

Fig. 4. Track widths per RIAA Standard if the distance between alternate center lines is 135 mils.

# for the SERIOUS RECORDIST

## NEWCOMB TX10

### PORTABLE PROFESSIONAL STEREOPHONIC RECORDER

Think of the many advantages the professional features of the Newcomb TX10 will provide for your recording activities...

**10½" REELS** give you long, editable recording time in one direction. To get the same time with smaller reels you are forced to use thinner tape or slower speed — both of which are undesirable when you want to make the best possible tape.

ADAPTABLE TO  
**LONG LOW IMPEDANCE  
MIKE LINES WITH PLUG-IN  
MATCHING TRANSFORMERS,  
BROADCAST TYPE MIKE CONNECTORS** — features seldom found in a portable recorder and yet most important in obtaining professional results — permit you to use top quality microphones, to place them properly, and to operate the recorder a convenient distance from the subject.

**SUPERIOR, SAFER TAPEHANDLING**



### A STUDIO IN A SUITCASE!

Here are a few of the studio features built into the TX10:

- 4-digit counter
- Choice of 2- or 4-track models
- Operates vertically or horizontally
- Mixing controls for both channels
- Differential braking on both reels
- Hysteresis synchronous motor
- Dynamically-balanced flywheel drive
- Three heads
- No pressure pads on heads

- Two illuminated vu meters arranged pointer-to-pointer
- Two speeds — 7½ or 3¾ IPS standard, 15 or 7½ IPS on special order
- Push-button speed change automatically provides speed-frequency correction
- 100 kc bias and erase oscillators with indicator lights
- Cybernetically engineered — the natural thing to do is the right thing to do — all tape movement controlled through a central joystick.
- \$750.00 less case — Carrying case, mounting hardware for rack or cabinet, portable 2-channel amplifier and reproducer systems are available.

For a complete description of the Newcomb TX10, write today —

**NEWCOMB AUDIO PRODUCTS CO., Dept. T-2**  
6824 Lexington Ave., Hollywood, Calif. 90038  
Circle 141 on Reader Service Card



**THE Turntable of the Tape-Age**  
**807**

Enjoy the superior quality of tapes with the convenience of phonograph records.

Connect a Viking 807 to your music system and play stereo or monaural tapes, half or quarter track at 3-3/4 or 7-1/2 ips. Automatic shut-off, cueing, fast forward and rewind features included for your pleasure.

807 complete with walnut base \$124.95

**MADE BY SKILLED AMERICAN CRAFTSMEN AT**  
**Viking** OF MINNEAPOLIS®  
9600 Aldrich Ave. So. Minneapolis, Minn. 55420

Circle 142 on Reader Service Card

**SAVE MOST ON stereo hi-fi**

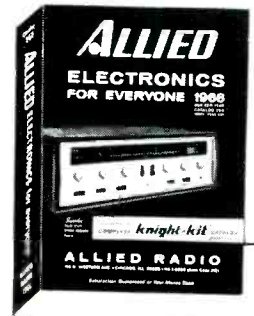

and Tape Recording  
**WORLD'S LARGEST SELECTION**

**free**

send today for your money-saving

**ALLIED 1966 CATALOG**

See what's new and best in stereo hi-fi—latest solid-state components... everything in tape recording. Save handsomely on famous build-your-own Knight-Kits®. For everything in Hi-Fi, for everything in Electronics, get the 1966 Allied Catalog.

**ALLIED RADIO free**

ALLIED RADIO, Dept. 11-B 508-PAGE CATALOG  
100 N. Western Ave., Chicago, Ill. 60680  
 Send FREE 1966 Allied Catalog.

NAME \_\_\_\_\_  
PLEASE PRINT  
ADDRESS \_\_\_\_\_  
CITY \_\_\_\_\_ STATE \_\_\_\_\_ ZIP \_\_\_\_\_

Circle 143 on Reader Service Card

## Industry Notes...

• **That Magnecord Contest.** Do you remember that contest that Magnecord ran recently to find the oldest living PT-6 recorder? They found one. Milliken University, Decatur, Illinois had it. Paul E. Wenger, speech and broadcasting professor turned in the winning information. The University had purchased the PT-6 in the late 1940's when they were setting up a radio studio. The recorder has been in continuous use since that time and was, at contest time, employed in the speech department. In accordance with the contest rules (revised per a suggestion that appeared in this column) the University was given a new PT-6 in exchange for their veteran unit. Professor Wenger received a new model 1028. Magnecord plans to overhaul the old unit completely and "gold plate" it for exhibition purposes.

• **JBL News.** No less than three JBL releases have crossed our desk recently. The first informs one and all that James B. Lansing Sound, Inc is the recipient of the Los Angeles Chamber of Commerce 1965 Industrial Design Award of Excellence. The product honored was the JBL 80-watt Stereo Power Energizer. This is the second consecutive year that JBL has received recognition in this contest. Last year the JBL SG520 Graphic Controller was awarded First Award.

Next release, **William H. Thomas**, president of James B. Lansing Sound, Inc., has been elected to the Board of Governors of the Audio Engineering Society. Mr. Thomas is associated with the Western Chapter of the AES in Los Angeles and has previously served the organization as Western Vice President in 1962. The final release announces that Mr. Eugene Hawkins, a staff artist at JBL, was recently named a John Hay Whitney Fellowship winner for 1965-1966. He was selected on the basis of his oils, lithographs, and drawings which were submitted to the Whitney judges earlier this year. **Eugene Hawkins** has been with JBL for several years. His posters saluting the 1963 Los Angeles High-Fidelity Show were selected by the IHF for promotion that year. He is also the recipient of the Foundation for Freedom Award. At JBL, Mr. Hawkins' work includes all graphic design for literature, including dealer aids, sales promotion collateral material and dealer advertisements.

• **News at Concertone.** Al Barsimanto has recently been appointed Vice President of Concertone, division of Astro-Science Corporation. He will be responsible for Concertone's product development and expansion program. In making the announcement, **J. E. Harting**, Concertone President, indicated that Al Barsimanto's background as a former National Sales Manager of Roberts and West Coast Sales Manager for Decca Records will serve him well in his new capacity. Mr. Barsimanto had more recently been active in marketing and product development projects as a consultant to the photographic and music fields prior to joining Concertone.

• **Connector Source.** Switchcraft, Inc. has been appointed as American distributors of the German Preh line. Preh is ranked as one of the largest manufacturers of high-quality audio and microphone connectors. Under terms of the agreement recently signed, Switchcraft will assemble and market Preh products under the Switchcraft/Preh name. Over 100 types of audio receptacles and connectors for use in such varied applications as public address, communications equipment, tape and phono equipment, dictation sets, and scientific test measurement devices, are now available under the combined brand.

• **Transistors on the Move.** At the NEREM Show in Boston, the 15th million audio output transistor manufactured by Bendix was presented, suitably mounted, to **Hermon H. Scott**, President of the company that bears his name. The presentation was made by James Harrison, Director of Marketing for Bendix's Semiconductor Division. The award was based on the fact that H. H. Scott, Inc. was the first manufacturer of stereo receivers to employ silicon transistors. More than one-quarter million of these devices have been used in H. H. Scott stereo components and consoles.

## CLASSIFIED

Rates: 10¢ per word per insertion for noncommercial advertisements; 25¢ per word for commercial advertisements. Rates are net, and no discounts will be allowed. Copy must be accompanied by remittance in first of the month preceding the date of issue.

**HIGH FIDELITY SPEAKERS REPAIRED**  
**AMPRITE SPEAKER SERVICE**  
168 W. 23rd St., New York, N. Y. 10011  
CH 3-4812

**HARPSICHORD:** Same as owned by Philadelphia Orchestra and RCA Victor. In kit form for home workshop assembly, \$150. Clavichord kit, \$100. Free brochure. Write: Zuckermann Harpsichords, Dept. R, 115 Christopher St., New York, N. Y. 10014.

**HI-FI SPEAKERS EXPERTLY REPAIRED**  
**USED SPEAKERS BOUGHT**  
**AUDIO SPEAKER TECHNICS**  
22 Astor Place, New York, N. Y. 10003  
AL 4-2140

**PRESSINGS FROM YOUR TAPES. WHOLESALE PRICES. SPECIALIZING IN SMALL QUANTITIES. DUBLE DUBLYU RECORDING COMPANY, 221 Carton Avenue, Neptune, N. J. 07753.**

**ANY RECORD PUT ON TAPE:** Single, LP, stereo. Quantity prices. Tapes duplicated: 1 or 100. Write John G. Ellis, Box 15852, Del Valle, Los Angeles, California 90015.

**STEREO REVERBERATORS** for experimental application, \$7. Mono, \$5. Cal's, Box 234, Dearborn, Michigan 48121.

**WANTED:** Bozak B-400 speaker system. Please state price, vintage, condition in first letter. David Ellis, 2016 O Street, N. W., Washington, D. C. 20036.

**SELL:** Dual 1009 auto/professional stereo turntable with Shure M7/N21D cartridge, \$65. Without cartridge, \$55. Eight months old. Fred Steele, 502 Homewood Drive, Huntsville, Alabama 35801.

**PROTECT YOUR LP'S. HEAVY POLY SLEEVES FOR JACKETS. 5c. MIN 50. LIGHT SLEEVES FOR RECORDS 3c. MIN 100. POLY CO., P.O. 323, HILLBURN, New York 10931.**

**WANTED:** Rek-O-Kut 16" overhead lathe model M58. IMPETUS S.A. 2 Via Berna, Lugano, Switzerland.

**CUSTOM RECORDS MADE.** Records of your tape. 10 minutes maximum, \$1.75. Price list on request. Al Zolnoski, 355 Richard Avenue, Hicksville, N. Y. 11801.

**WANTED:** James B. Lansing D-2002 speaker system. Please state price, condition, serial number. James Shapley, 1253 23rd East, Seattle, Washington 98102.

**FOR SALE:** Two Bozak B-500 bookshelf speaker systems in good shape. \$100 plus shipping charges. Dana L. Herr, R. R. #3, Columbus, Indiana 47201.

**NEW IN SOUND FOR "66."** Full fidelity bookshelf loudspeaker enclosures. Teak or walnut. Various styles, 8- and 16-ohm, kit or factory assembled. 1 year guarantee. Brochure. C.T. Acoustic Laboratories, Box 543, Newark, Calif. 94560.

**AUDIO/RF ENGINEER WANTED**  
A rapidly growing high fidelity manufacturer is looking for a talented circuit designer with experience in RF as well as amplifiers. Located in New England, the firm offers tremendous opportunity for the right man. Send resume to Dept. CB-1, c/o AUDIO, P.O. Box 629, Mincola, N.Y. 11501.

**WANTED:** Velocity microphones like RCA44B or 74B for church use. Don Spangler, 4557 Ridgebury, Dayton 40, Ohio.

**LANSING S-5 SYSTEMS.** new. Two each: LE10A, LE30, LX3-1, S270. Fair traded. All for \$179. Wendell Rice, 109A Twin Oaks Plaza, Belton, Missouri 64012.



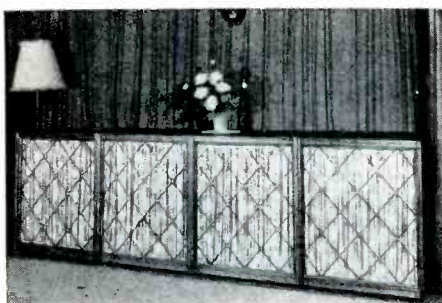

New MAESTRO, an all-horn-loaded, compression-operated uni-bass system, the world's first for home installation-, gives crisp, clean and clear bass unobtainable by any cone-type woofer.

Other models: Orchestra, Concert, Symphonia and Symphonietta.

For further details, contact:

**Provo High Fidelity**  
**P.O. Box 204, Batavia,**  
**N.Y. 14021**



**YL ACOUSTIC CO., LTD.**

No. 34-6, 2-chome, Nishi-Shimbashi  
 Minatoku, Tokyo, Japan.

Circle 146 on Reader Service Card

**SAVE over 40% on hi-fi**

**COMPONENTS & TAPE RECORDERS**

- Easy-Pay-Plan—Up to 24 mos. to pay.
  - 15 day money-back guarantee.
  - Franchised all lines, assuring you up to 5 yr. Mfr. Warranty.
  - Most items shipped promptly from our \$250,000.00 inventory.
  - Trade-Ins—Highest allow—Send your list.
  - Shipments double packed & fully insured.
  - Special consideration—Export & APD inquiries.
  - 21st yr. dependable service—World Wide.
- Write for our price first. You'll be glad you did.

"We own the sharpest pencils in the U.S.A."

**HI-FIDELITY**

CENTER  
 "The House of Low Low Prices"

239 U East 149 St.,  
 New York, N.Y. 10451

Circle 147 on Reader Service Card

**CANADA**  
**High Fidelity Equipment**

Complete Lines • Complete Service

Hi-Fi Records — Components  
 and Accessories

**ELECTRO-VOICE**  
**SOUND SYSTEMS**

126 DUNDAS ST. WEST, TORONTO, CANADA

Circle 148 on Reader Service Card

• New Building. Fisher Radio Corporation continues to grow. Latest news announces their new executive and administrative building, a few blocks from the original Long Island City facility. This building is the fourth in the growing Fisher complex. It is a two-story structure with over 60,000 square feet of floor space. It occupies a block-through site, at 11-40 45th Road in Long Island City, New York. Executive offices, sales, purchasing, engineering, customer-relations and service departments are all accommodated nicely. Three-channel shipping and receiving docks are off the street and can handle the longest trailers. Part of the building is used as a warehouse facility to service New York metropolitan area dealers.

## ABOUT MUSIC

(from page 10)

along, and his voice continues to harangue the congregation at precisely the same level. But nothing is going on in his shoulders or in the musculature at the base of his neck.

"We are instantly aware that this is not only an inserted shot—photographing pieces of a scene separately is of course legitimate film-making, provided it does not give its own secret away—but that the insert was shot silently, with sound added later. Mr. Burton's body is not engaged in the emotion announced on the sound track. It is 'walking through' the sequence, uninvolved. The discrepancy between the two mismatched pieces of film is at once obvious; illusion jars to a stop as though someone had pulled the emergency cord on a subway train."

(To director John Huston's credit, it should be stated that most of this film seemed to have been recorded live—to the extent that a microphone boom was seen being lowered momentarily into camera view during a Burton monologue. The scene was retained presumably because the director preferred the take over others.)

Even with expert post-recording of dialogue, however, illusion crumbles when other "seen" sounds cannot be heard. In an attempt to reconstruct a scene in aural terms, sound engineers usually isolate one effect and underscore the dialogue with it. A night scene, for instance, may feature the creaking of crickets. In interior scenes, we will hear obvious sounds such as the shutting of a door, the clicking of a cigarette lighter, the chatter of conversation in the background. What is missing in most dubbed scenes are random sounds that have no specific dramatic significance, as well as a reasonable acoustical recreation of the place we see. It is the absence of these sounds and the mismatch of acoustical properties that produce what Walter Kerr calls a "spooky" feeling.

Movies will continue to be spooky, or disembodied, as long as film directors and their mixers and dubbers remain insensitive to the need to make sound correspond to sight. Æ

**"Which microphone should I use for tape recording?"**



**micro phones '66**

UNIVERSITY SOUND

**Free!**

Microphones '66 — a book every owner of a tape recorder should have. Send coupon today!



**UNIVERSITY SOUND**

A DIVISION OF LTV-LING-ALTEC, INC.

Dept. B63M, P.O. Box 1056, Oklahoma City, Okla.

Name \_\_\_\_\_

Address \_\_\_\_\_

City \_\_\_\_\_

State \_\_\_\_\_ Zip \_\_\_\_\_

Circle 144 on Reader Service Card

**40 DB LIMITING**

Less Than 1/2% Distortion



**TELETRONIX**  
**LEVELING AMPLIFIER**

Using Revolutionary Optical Control

- NO LAG
- FLAT RESPONSE
- REPLACES EXISTING LINE AMPLIFIERS
- LOW NOISE LEVEL

OVER 500 IN USE BY MAJOR NETWORKS  
 INDEPENDENT STATIONS & RECORDING  
 STUDIOS

Our 8th Year Of Service To Industry

**TELETRONIX ENGINEERING CO.**

manufacturers of

FM Broadcast Transmitters and RF Amplifiers  
 Audio Relays. Solid State Remote Station Controls  
 Volume Levelers. FM Broadcast Antennae

308 Monterey Road, South Pasadena, Calif.

Circle 145 on Reader Service Card

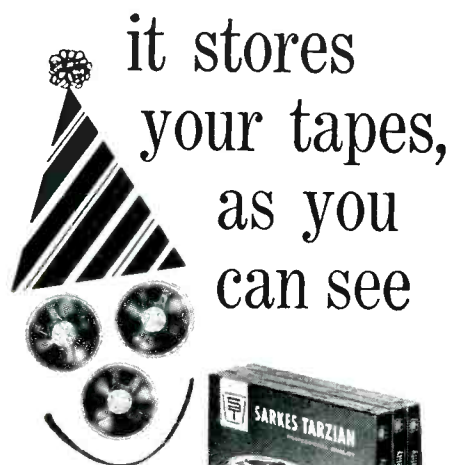

it stores  
your tapes,  
as you  
can see



and  
best of all  
the rack is  
free!

## -TARZIAN

Your tape dealer is joining us in this special offer to introduce you to Tarzian Tape. He'll give you the handy brass-plated tape storage rack *free* with your purchase of three reels of Tarzian Tape.

We hope you'll fill the other nine slots in the rack with additional recordings made on Tarzian Tape. You'll be pleased with the performance and quality of Tarzian Tapes, both acetate and polyester, Standard Play, Long Play, Extra Long Play, and Triple Play.

This offer continues only while our current supply of racks lasts. See your dealer now to get your tape rack free!



Ask your dealer for a free copy of our 24-page brochure, *Everybody's Tape Recording Handbook*, or write directly to us to receive one!

### SARKES TARZIAN, Inc.

World's Leading Manufacturers of TV and FM Tuners  
• Closed Circuit TV Systems • Broadcast Equipment  
• Air Trimmers • Semiconductor Devices  
MAGNETIC TAPE DIVISION • BLOOMINGTON, INDIANA  
Export: Ad Auriema, Inc., N.Y.

Circle 149 on Reader Service Card

## ADVERTISING INDEX

Acoustic Research, Inc. ....	5
Allied Radio .....	78
Altec Lansing Corporation .....	9
Audio Bookshelf .....	76
Audio Dynamics Corporation .....	15, 51
Benjamin Electronic Sound Corporation .....	11
Bozak .....	47
British Industries Corporation .....	3, 49
Chancellor Electronics, Inc. ....	73
Classified .....	78
Dynaco, Inc. ....	7
Electro-Voice, Inc. ....	Cov. IV, I, 31
Electro-Voice Sound Systems .....	79
Elpa Marketing Industries, Inc. ....	14
Empire Scientific Corporation .....	17, 18
Fairchild Recording Equipment Corporation .....	6
Ferroglyph Co., Ltd. ....	4
Garrard Sales Corporation .....	3
Gotham Audio Corporation .....	68
Grado Laboratories .....	71
Harman-Kardon, Inc. ....	70
Heath Company .....	63, 64, 65
Hi Fidelity Center .....	79
Irish Tape .....	71
Koss/Rek-O-Kut .....	53
MacAllister/Hogan, Inc. ....	8
McIntosh Laboratory, Inc. ....	74
Newcomb Audio Products Co. ....	77
Pickering & Company, Inc. ....	21
Pioneer Electronic Corporation .....	45
Roberts Electronics .....	69
Sarkes Tarzian, Inc. ....	80
Schober Organ Corporation .....	62
Scott, H. H., Inc. ....	Cov. II
Sherwood Electronic Laboratories, Inc. ....	22
Shure Brothers, Inc. ....	10
Sony Corporation of America .....	35-38
Stanton .....	Cov. III
Superscope, Inc. ....	13
Syncon Corporation .....	55-58
Teletronix Engineering Co. ....	79
University Sound .....	67, 79
Viking of Minneapolis .....	78
YL Acoustic Co., Ltd. ....	79

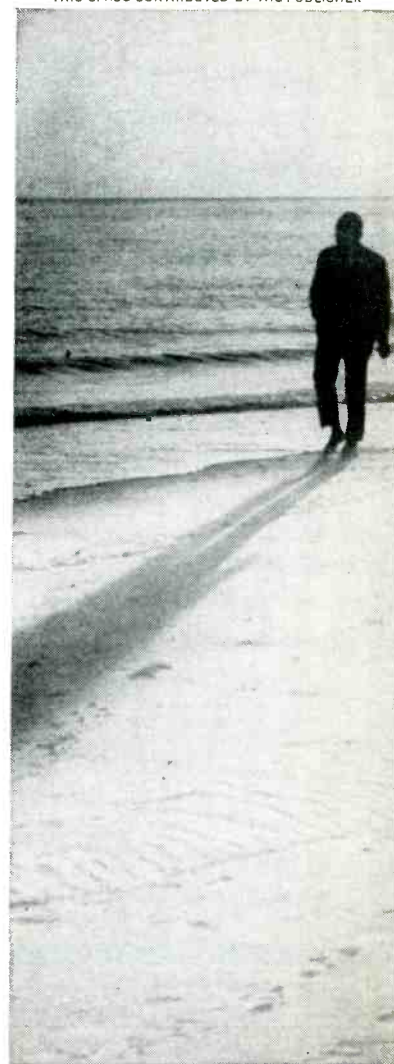

**His lifetime gets longer every minute**

It's a good deal longer than it used to be, ten or twenty or thirty years ago. And it gets longer every day, thanks in large part to medical research. Over a million men and women are alive today, cured of cancer. Research helped find the answers that saved their lives. Research takes time. And money. The American Cancer Society spent over \$12,000,000 last year alone, to find still more of the answers. Yet \$2,000,000 in research applications, approved by the Society, *could not be financed for lack of funds.* Your dollars are desperately needed to help speed the day of victory over this dread disease. Send your check today to **CANCER**, c/o Postmaster.



**AMERICAN CANCER SOCIETY**

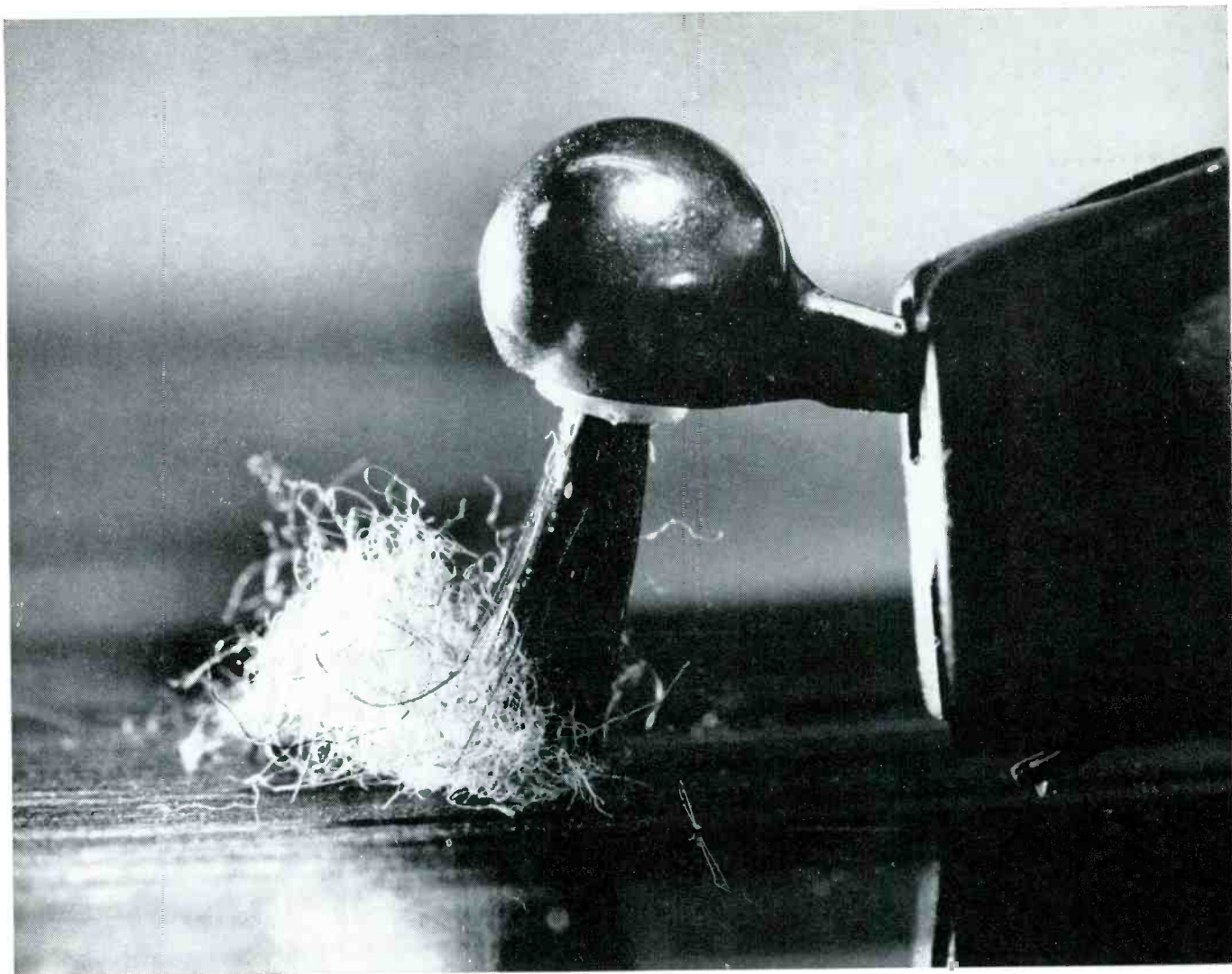

You are looking at the world's only true **longhair** cartridge.

In this unretouched photograph, the long, black hair of the brush built into the new Stanton 581 is shown in action on a rather dusty record. Note that all the loose lint, fuzz and dust are kept out of the groove and away from the stylus. That's why the Longhair is the ideal stereo cartridge for your Gesualdo madrigals and Frescobaldi toccatas. Its protective action is completely automatic, every time you play the record, without extra gadgets or accessories.

The stem of the brush is ingeniously hinged on an off-center pivot, so that, regardless of the stylus force, the bristles never exert a pressure greater than 1 gram and always stay the right number of grooves ahead of the stylus point. The bristles provide just the right amount

of resistance to skating, too.

But even without the brush, the Stanton 581 Longhair is today's most desirable stereo cartridge. Like its predecessors in the Stanton Calibration Standard series, it is built to the uniquely stringent tolerances of Stanton professional audio products. Its amazingly small size and light weight (only 5 grams!) make it possible to take full advantage of the new low-mass tone arms. And its frequency response is factory calibrated within 1 db from 20 to 10,000 cps and within 2 db from 10,000 to 20,000 cps. Available with 0.5-mil diamond (581AA) or elliptical diamond (581EL); price \$49.50.

For free literature, write to Stanton Magnetics, Inc., Plainview, L.I., N.Y.

# Stanton

Circle 101 on Reader Service Card

## New E-V Model 668 Dynamic Cardioid Boom Microphone

with built-in  
programming panel!

**Ey** It's just like having 36 microphones in one, at the end of your boom! Simply match the computer-style programming pins to the color-coded jack field inside the new E-V668. You'll get any combination of flat response (40 to 12,000 cps), bass and/or treble rolloff, treble rise, and 80 or 8,000 cps cutoff. The 668 built-in passive equalizer matches response to need precisely without loss in output level—mixes perfectly with any other microphone.

The 668 cardioid pattern is symmetrical in every plane with excellent rear cancellation at every program setting. Two independent Continuously Variable-D\* systems provide this uniformity, yet permit high output (-51 dbm) for distant pickup without added equipment or special cables.

Light in weight and small in size, the 668 with integral Acoustifoam™ wind-screen and shock mount minimizes shadow problems while allowing noise-free fast panning, indoors and out. Its 1 lb., 11 oz. weight eliminates "fishpole fatigue" and counterbalancing problems.

The 668 is guaranteed **UNCONDITIONALLY** against malfunction of any kind—even if caused by accident or abuse—for two years. And, like all E-V Professional microphones, it's guaranteed for life against failure of materials or workmanship.

The E-V 668 is the result of a three year intensive field testing program in movie and TV studios from coast to coast. It has proved itself superior to every other boom microphone available. Find out why with a no cost, no obligation trial in your studio. Call your E-V Professional microphone distributor today, or write us direct for complete specifications.

NEW! MODEL 667 identical to Model 668 except sharp cutoff filters and HF-rolloff eliminated. List price: Model 667, \$345.00; Model 668, \$495.00 (less normal trade discounts).

\* Patent No. 3115207 covers the exclusive E-V Continuously Variable-D design.

**ELECTRO-VOICE, INC.** Dept. 264A  
602 Cecil Street, Buchanan, Michigan 49107

**Electro-Voice**<sup>®</sup>  
SETTING NEW STANDARDS IN SOUND.

Circle 102 on Reader Service Card

**BRAIN  
ON A  
BOOM!**