

# AUDIO

CDC

JUNE, 1964

60¢

*...the original magazine about high fidelity!*



ANOTHER CLOSET FULL OF HI FI page 14

Distributed Loudspeaker Systems Page 19

Telstar Shaped Electrostatic Page 28

4 OF 12 TWEETER IN PARALLEL

# NEW SCOTT TRANSISTOR TUNER BRINGS MAJOR IMPROVEMENT TO FM LISTENING

... AND YOU CAN OWN ONE FOR ONLY \$259.95

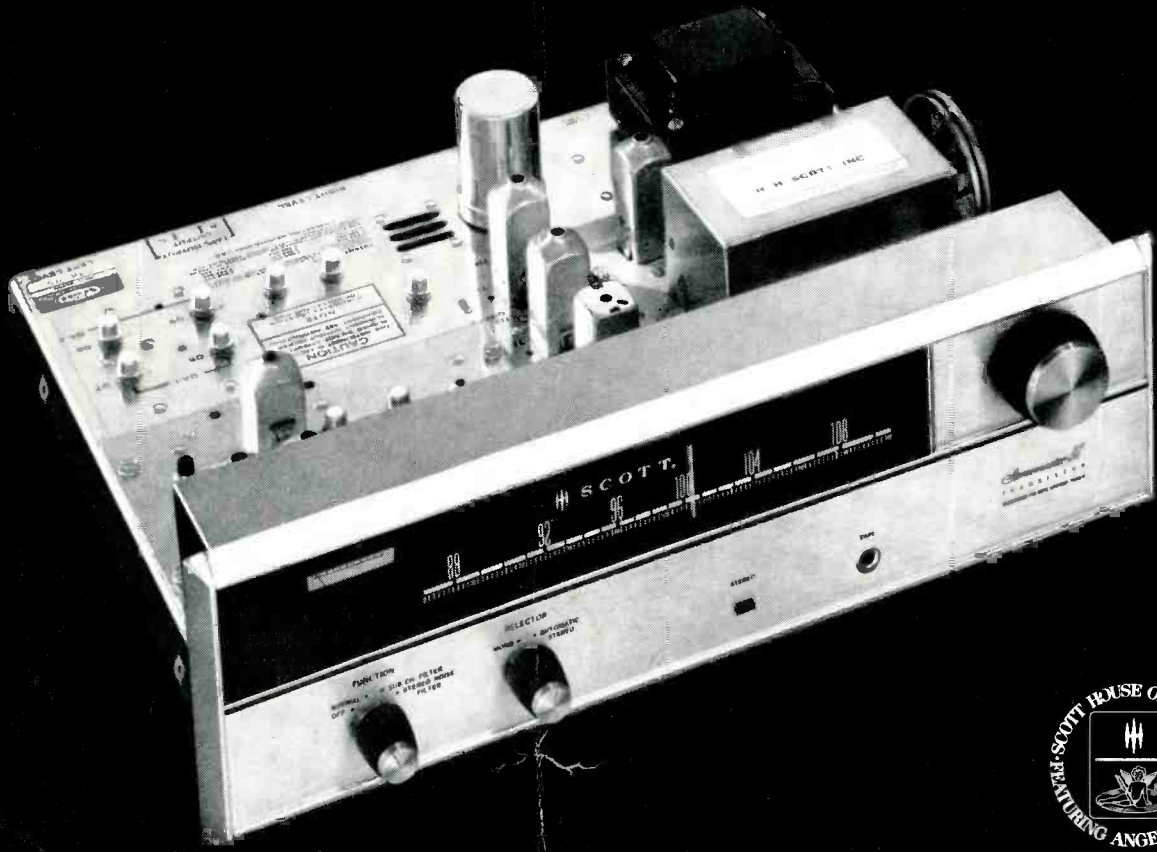

Great news! Scott announces a top-performing solid-state FM stereo tuner at a modest price . . . a no-compromise tuner that exceeds the performance of conventional tube units, and is factory guaranteed for two full years. ■ The superb per-

formance of the new Scott 312 required an entirely new approach to tuner circuit design . . . not just a simple substitution of transistors for tubes . . . it meant not just one, but six major engineering innovations. A few of these are shown below:

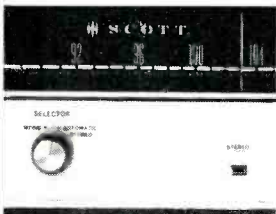

Exclusive "Comparatron" provides foolproof silent automatic stereo switching. Momentary changes in signal strength will not cause stereo to switch in and out as do ordinary automatic devices.

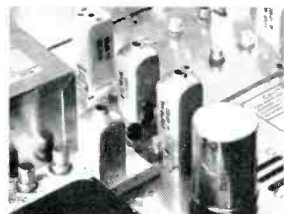

"Flat Line Limiting" circuits assure quiet noise-free FM reception, impervious to pulses caused by automobile ignitions, refrigerators, apartment house elevators, and other electrical noises.

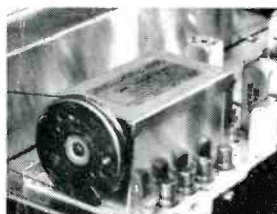

New Scott silver-plated four-nuvistors front end outperforms even the best conventional vacuum tube front ends. Nuvistors provide greater reliability, longer life, and guaranteed stability over years of use.

**SPECIFICATIONS:** IHFM usable sensitivity (minimum) 2.2  $\mu$ v; signal-to-noise ratio: 65 db; distortion: under 0.8%; drift: less than 0.02"; frequency response (in stereo):  $\pm$  1 db, 30-15,000 cycles; capture ratio: 4 db; selectivity: 30 db; cross modulation rejection: 80 db; AM suppression: 55 db; accuracy of calibration: 0.5%; separation: 35 db, an outstanding design accomplishment. Dimensions 15 1/2" w x 5 1/2" h x 13 1/4" d in optional accessory case.

\*These are the limits prescribed by the FCC. All Scott tuners will exceed these frequencies.

Export: Scott International, 111 Powdermill Road, Maynard, Massachusetts, Canada: Atlas Radio Corp., 50 Winrold Avenue, Toronto, Cable HIFI

## IMPORTANT FREE OFFER FROM SCOTT

• H. H. SCOTT, INC.  
• 111 Powdermill Rd.  
• Department  
• Maynard, Mass.

Please rush me your free booklet, "A New Era in FM" explaining how you can get better FM reception with these new solid state circuits, and complete specifications on the Scott 312 solid state FM Stereo tuner.

Name.....  
Address.....  
City.....  
State..... Zip Code.....

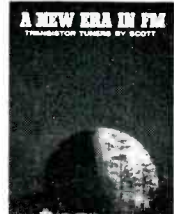

**SCOTT®**



# AUDIO

JUNE, 1964 VOL. 48, No. 6

Successor to **RADIO**, Est. 1917

C. G. McPROUD • *Publisher*

DAVID SASLAW • *Editor*

JANET M. DURGIN  
*Production Manager*

## Contributing Editors

EDWARD TATNALL CANBY

JOSEPH GIOVANELLI

HAROLD LAWRENCE

CHESTER SANTON

HERMAN BURSTEIN

BERTRAM STANLEIGH

HENRY A. SCHOBER  
*Business Manager*

SANFORD L. CAHN  
*Advertising Director*

EDGAR E. NEWMAN  
*Circulation Director*

## Representatives

Bill Pattis & Associates,  
4761 West Touhy Ave.,  
Lincolnwood 46, Ill.

James C. Galloway,  
6535 Wilshire Blvd.,  
Los Angeles 48, Calif.

Warren Birkenhead, Inc.,  
No. 25, 2-chome, Shiba Hama-  
matsu-cho,  
Minato-ku, Tokyo, Japan

Central-versus-Distributed Loudspeaker Systems Class-D for Efficiency—	<b>19</b>
In Three Parts—Part 1	<b>23</b>
Telstar-Shaped Electrostatic Speaker—	
In Two Parts—Part 2	<b>28</b>
A Basic Course in Commercial Sound, Chapter 3	<b>33</b>
Hi Fi and the British	<b>53</b>

Light Listening	<b>8</b>
Record Revue	<b>40</b>
Jazz and All That	<b>50</b>

James B. Lansing "Olympus" Speaker System	<b>37</b>
Dynaco-B&O Stereo Ribbon Microphone	<b>37</b>
Harman-Kardon 1000 Series Tuner and Amplifier	<b>37</b>

Audioclinic	<b>2</b>
About Music	<b>4</b>
Letters	<b>6</b>
Audio ETC	<b>12</b>
Cover Installation	<b>14</b>
Editor's Review	<b>16</b>
New Products	<b>42</b>
Tape Guide	<b>46</b>
Industry Notes	<b>55</b>
New Literature	<b>55</b>
Advertising Index	<b>56</b>

## AUDIO Articles

David L. Klepper

Peter A. Stark

R. J. Matthys

Norman Crouhurst

Alan Walling

## AUDIO Reviews

Chester Santon

Edward Tatnall Canby

Bertram Stanleigh

## AUDIO Profiles

Model C-50

Model 200

F1000T, A1000T

## AUDIO in General

Joseph Giovanelli

Harold Lawrence

Norman Pickering

Number 10 in a series of discussions  
by Electro-Voice engineers

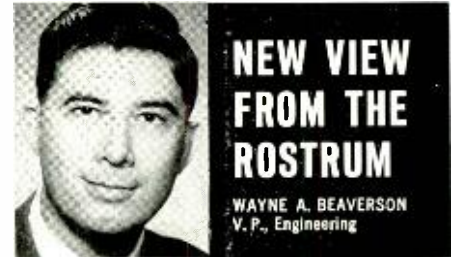

Many fixed rostrum microphone installations are compromises forced by the problems of acoustics, limited available speaker locations, and high mobility of speech makers who do not appreciate the problems created by their movement away from the microphone.

The simplest installations are based on a single omnidirectional microphone mounted on the rostrum. This is an ideal solution if the acoustic conditions are nearly perfect and the performer maintains a uniform distance from the microphone.

Greater working distance and/or higher sound levels can be achieved by substituting a cardioid microphone. By rejecting noise and lowering feedback sensitivity to the rear, the cardioid minimizes effects of the acoustical environment. Unfortunately, it also restricts lateral movement of the performer to about a 90° angle relative to the face of the microphone.

A common solution to the latter problem has been the use of two cardioid microphones, one on each side of the rostrum and angled in toward the center. While this does give a greater degree of freedom to the performer, erratic sound levels result as the performer approaches first one microphone, then the other. Even more serious degradation occurs due to phase difference caused by spatial differences as the subject moves relative to the two microphones.

One solution to these objections, employing two cardioid microphones, has recently been introduced. Basically, the two units are placed close together at the center of the rostrum, and angled out (from 15° to 25°). Optimum separation seems to be about 6 to 20 inches. This relocation reduces both phasing and amplitude differences to a minimum, while offering the performer the widest possible area of effective sound pickup. It is essential that both microphones be electrically in-phase and well matched.

While slightly greater feedback sensitivity may occasionally result from this arrangement, overall results are generally superior. A full discussion of this suggested technique, with diagrams, is included in the February, 1964 issue of *Microphone Facts* (pp. 97-101). It is available free on request from the address listed below.

For technical data on any E-V product, write:  
ELECTRO-VOICE, INC., Dept. 643A  
Buchanan, Michigan 49107



AUDIO (title registered U. S. Pat. Off.) is published monthly by Radio Magazines, Inc., Henry A. Schober, President; C. G. McProud, Secretary, Executive and Editorial Offices, 204 Front St., Mineola, N. Y. Subscription rates—U. S., Possessions, Canada, and Mexico, 5.00 for one year, \$9.00 for two years; all other countries \$6.00 per year. Single copies 60¢. Printed in U.S.A. at 10 McGovern Ave., Lancaster, Pa. All rights reserved. Entire contents copyrighted 1964 by Radio Magazines, Inc. Second Class postage paid at Lancaster, Pa.



RADIO MAGAZINES, INC., P. O. Box 629, MINEOLA, N. Y.  
Postmaster: Send Form 3579 to AUDIO, P. O. Box 629, Mineola, N. Y.

# Coming

## Theory and Construction

- **Class-D for Efficiency.** Peter Stark. This part will discuss the reasons for selecting the type of circuits he ends up with.

- **A New Triode Amplifier.** Robert M. Voss. Tube amplifiers may be going out of style but this one may still find use in the system of an audiofan undaunted by "styles." Construction details are provided.

## Servicing

- **Tuner Alignment for Quality FM Reception.** Arthur L. Boynton. How to do it, step-by-step.

## Sound Reinforcement

- **A Basic Course in Commercial Sound.** Chapter IV. Norman Crowhurst.

## Profiles

- **B&W Harmonic Distortion Meter, Model 410.**

- **RCA Ribbon Microphone, Model SK-46.**

## In the July Issue

On the newsstands, at your favorite audio dealer's, or in your own mailbox.

# AUDIO CLINIC

Joseph Giovanelli



Send questions to:

Joseph Giovanelli  
2819 Newkirk Ave  
Brooklyn 26, N Y

Include stamped, self-addressed envelope.

### Tuning Speaker Systems

*Q. How can I tune my speaker system?*  
A. J. Benoit, Concord, New Hampshire.

A. I am assuming that your question refers to a bass reflex enclosure. Tuning such an enclosure means that the main low-frequency resonances are to be smoothed out. It is difficult to measure the resonance of such a system at home because people do not have anechoic chambers in their living rooms. (Such chambers allow the observer to test a speaker system as though it were in free space, whereas the average listening room contains standing waves which will result in the introduction of resonances other than those possessed by the speaker system.)

Regardless of the difficulty, determine the resonances you have and then adjust the port of the enclosure until the resonances are damped out. When the cabinet is properly adjusted, there will be two resonant points, one on each side of the original resonant frequency. These points will have smaller amplitude than the main, or original, resonant peak of the cabinet and speaker combination.

How to do this is the question. If you have a good microphone, connect it to the input terminals of an ac VTVM. The microphone and meter must be adjusted so that when a signal is fed into the speaker at a convenient listening level, the meter reading will be at midscale. The resonant frequency will cause the meter reading to increase sharply.

If you wish to have a visual display of this process, the output of the microphone can be connected to the input of a good oscilloscope. By good, I mean that the scope should have sufficient sensitivity to enable the weak signal from the microphone to give you a usable trace. Resonance will be indicated by a larger trace.

It is possible also to find the resonance of the system by means of an impedance curve. This curve is obtained by plotting the impedance of the speaker over the frequency range. Resonance is indicated by a sharp increase in impedance at one particular frequency or one small band of frequencies. This impedance can be measured by connecting a variable resistor in series with the speaker and connecting a source of variable frequencies across this series

combination. You then adjust the resistor so that the voltage developed across it and the voltage developed across the speaker are equal. Next, measure the value of the resistance at that particular setting. This resistance value is equal to the impedance of the speaker.

It is also possible to calibrate the variable resistance in terms of impedance. Once this has been done you can eliminate that extra, annoying step of measuring the resistance at each point in your plot.

The impedance curve seems to me to be the most practical solution for the home experimenter because the effects of the listening room are almost completely eliminated. Schemes employing a microphone are, of course, greatly subject to room resonance effects.

### Impedance Matching in Voltage Amplifiers

*Q. In a monophonic music system, should networks, resistors, or transformers be used to match the following? ESL monophonic cartridge (40 ohms) and magnetic input on a preamplifier, (5-8 mv sensitivity—68 k ohms), Eico AM tuner (cathode follower—8 k ohms) and low-level radio input on preamplifier (100 k ohms). Leo Filion, Quebec, Canada.*

A. Assuming that your cartridge is giving you sufficient volume and that the signal-to-noise ratio is good, you need not worry about matching impedances between it and the preamplifier. It is true that certain cartridges do require a load resistor of a given value, but this is because the resistor is needed to lower the Q of a resonant circuit within the cartridge and tone-arm wiring, rather than impedance matching.

If you are not getting sufficient output from the stage driven by the cartridge or that the signal-to-noise ratio is poor, you can increase the voltage input to that stage by using a transformer to step up the voltage. I would avoid the transformer if possible because of the chance that it may degrade the sound.

If you find that a transformer is needed, use a good one, well shielded, and one which has provisions for the case to be grounded. At one time ESL had some fine transformers, but they may be hard to find now. The transformer should be one which has impedances of 50 ohms and 10 k ohms.

In equipment such as described in your letter, you are not interested in transferring maximum power from one circuit to another. Rather, you are interested in transferring maximum voltage from one circuit to another. Therefore, it is best that the im-

(Continued on page 54)



TYPE A  
Automatic Turntable  
\$64.50



AT6  
Automatic Turntable  
\$59.50



AUTOSLIM  
Intermix Changer  
\$44.50



Consider this...more people have purchased these 3  
Garrard models than all other record playing components combined

## To help find the Garrard which is best for you— let us send you the new Comparator Guide.

Clearly and concisely it describes the important Garrard advances—all of which play a vital part in insuring top performance and longer life for your records. Every Garrard model is pictured in full color... with detailed photographs, descriptions of its features and explanations of how they contribute to your enjoyment. The coupon below will bring you a copy of the Garrard Comparator Guide—without charge.

**COMPARATOR**

**Garrard**

**AUTOMATIC TURNTABLES**

**GARRARD** Division of British Industries Corp., Port Washington, N. Y.  
 Canadian inquiries to Chas. W. Pointon, Ltd., 66 Racine Road, Rexdale, Ontario  
 Other territories to Garrard Engineering & Mfg. Co., Ltd., Swindon, Wilts., England

Garrard, Dept. CF-14  
 Port Washington, N.Y.

Please send a Garrard Comparator Guide

Name \_\_\_\_\_  
 Address \_\_\_\_\_  
 City \_\_\_\_\_  
 State \_\_\_\_\_





## ABOUT MUSIC

Harold Lawrence

### A Visit to BBN (Part 1)

**O**VERHEARD DURING INTERMISSION in the lobby of one of our new concert halls: "How does it sound from your seat?"—"Well, the winds were weak and the trombones seemed to blot out the strings in the loud passages, but the piano was clear enough, though a bit dry."—"That's odd. From my row, the piano sounded muddy and wooden, very thin on the bass end. And, speaking of bass, I could hardly hear the cellos in the second movement." And so it goes. Acoustics has become a favorite topic of conversation among audiences attending concerts in the nation's new music auditoriums. The question is no longer: What did you think of the performance? but rather: How did it *sound* in the hall?

It all started in 1951. When London's Royal Festival Hall opened its doors, it sparked a controversy that continues to flame in musical circles. Since then, new music rooms, theatres and opera houses have sprung up all over the world, with varying degrees of acoustical success. The completion of New York's Philharmonic Hall brought to a climax the layman's interest in acoustics. All of this has catapulted the acoustician into new prominence. He is in the public eye as never before, having emerged from the position of a shadowy technical consultant, to that of an active and often publicized collaborator of the architect.

Few activities have succeeded more in bringing the acoustician to the attention of the general public than his participation in centers for the performing arts. Architects refer to these centers as "culture complexes" (no psychological overtones intended), and they seem to have caught the imagination of city planners throughout North America. In Canada, for example, twelve major concert halls have been built during the past ten years, or are in the process of construction. And each year we read of the openings of new music rooms, multi-purpose auditoriums and playhouses in the United States. If we paid special attention to the names of those (acoustically) responsible of these spanking new projects, we would have run across the firm of Bolt, Beranek & Newman repeatedly. One informed estimate credits BBN with about 90 per cent of the acoustical consulting business in the United States where it involves concert halls, large auditoriums and churches. The firm's most recent jobs include Clowes Memorial Hall (Indianapolis), the Grande Salle in the Place

des Arts (Montreal), and Philharmonic Hall in Lincoln Center.

Acoustics has become big business. Nowadays no self-respecting architect would think of embarking on a new building without engaging an acoustical consultant. Robert B. Newman, of BBN, puts it another way: "No self-respecting architect *should* build without the help of an acoustical consultant." Even in these acoustically enlightened days, architects and builders still employ a haphazard approach to "sound" problems. "More often than not," reports Newman, "the construction is well under way when the owner or the architect will say: 'We ought to do something about the acoustics.' At that point an acoustical firm is brought in, and it does the best it can under the circumstances."

Ideally, the acoustician participates in the early stages of the building's design. He confers with the owner and the architect, each of whom has a clear idea of the functions the building will perform. Most often, reports Newman, the owner assigns total responsibility to the architect, who may reject the acoustician's recommendations without notifying the owner. This can result in acoustical mishaps. A case in point involved the architect of a music school who placed the school's director in an office directly above the rehearsal room. The day the director moved into his new quarters, he was shocked to hear the very clear and loud sound of the piano. He phoned the architect: "Why didn't you isolate my office?" The architect replied: "It would have cost an additional \$1,000." To which the director said: "You should have told me: I would have approved the expenditure had I known how bad it was going to be. Besides, your fee would have been higher."

As the foregoing indicates, the acoustician must not only get *to* the architect with his suggestions, he must sometimes get *past* him (diplomatically, of course). Under the circumstances, he has to be a very articulate fellow. It was therefore no surprise to learn that the three men who guide the destinies of BBN are lecturers on acoustics, among other things. Their headquarters are located in Cambridge, Massachusetts, in a complex of low-lying buildings on Moulton Street. We arrived in Cambridge on a sunny Saturday morning and were invited into Newman's office. A painting on the wall caught our attention. "Oh, that was one of the original sketches Sandy [Alexander] Calder drew for the Great Hall of the University of Caracas, the Aula Magna." Newman explained. What we

saw was a stunning array of multi-colored stabiles which were designed to hang from the ceiling as sound reflectors. Calder gave the sketch to Newman who eventually found the right frame for it and hung it in his office.

Ever since *l'affaire* Philharmonic Hall, BBN has been in the eye of a hurricane of controversy. Has it affected its business? We asked. "Not at all. If anything, our activities have increased. We have 285 employees, and, in addition to our Cambridge plant, we maintain offices in Chicago, Los Angeles and New York." Newman was quick to point out that the acoustical design of music rooms constitutes only twenty per cent of BBN's work. The rest of its business is devoted to other types of buildings, and to noise studies for manned machine systems. BBN has worked on vibration experiments for every important missile launched by the government in its space program.

How old is BBN and how did it come into being? In 1947, the architect Wallace Harrison, who had been commissioned to build the entire United Nations complex in New York City, asked the dean of the School of Architecture at M. I. T. to recommend an acoustical consultant. The dean suggested two members of the faculty: Richard H. Bolt, a physics professor with a background in music and architecture; and Leo L. Beranek, a professor of communications engineering who once played the kettle-drums. During World War II, Beranek had supervised the nation's largest acoustics laboratory for the Office of Scientific Research and Development. Harrison took the dean's advice. With the U.N. contract in their pocket, the young acousticians went into business for themselves in 1948. Newman joined the firm a year later. Today, in addition to its extensive North American business, BBN owns half-interest in Europe's largest firm of acoustical consultants, Müller-BBN.

How does one become an acoustician? "There is no curriculum in acoustics," Newman revealed. "Students in architecture may study acoustics at a certain point in their five-year training. There are 76 accredited collegiate schools of architecture in the United States, but only about five per cent of these colleges give their students a true grounding in acoustics. In the majority of colleges, acoustics is given as part of a catchall course, including sewage, heating and ventilation. And it's usually taught as a piece of drudgery."

Beranek pointed out that at only seven colleges and universities (including M. I. T. and Harvard) are budding architects given a more intensive course in acoustics, usually in their fourth year. "We can't expect them to become acousticians during this semester," Newman warned. "The best we can hope for is that they will be more sophisticated about acoustics, that they will learn what *not* to use in the way of building materials, and that they will absorb fundamental principles of acoustics."

(to be continued)

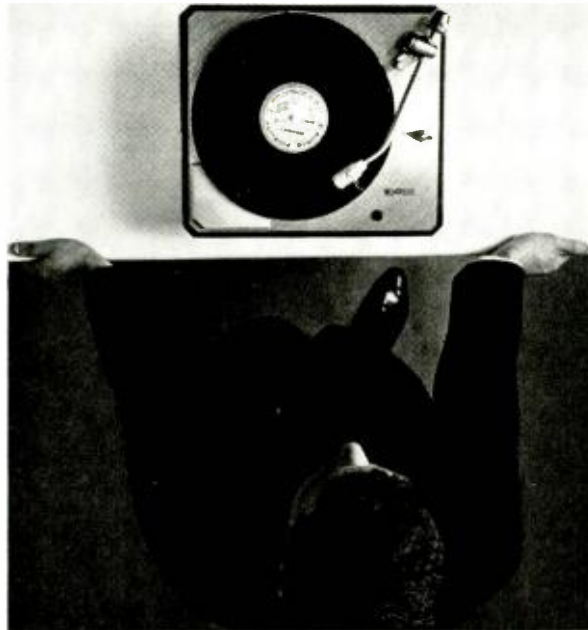

**You can listen and compare...listen and compare...and listen again...and you'll always come back to the Empire Troubador.**

**Why? Simple! Because it's the world's most perfect record playback system. Every Empire component was designed and built for maximum performance within the Troubador system... Be it the 398 or the new console model 488.**

**High Fidelity magazine reported "A precision-engineered product of the highest quality...each component, taken separately, first rate. Taken together, they form one of the finest and handsomest record players available."**

Here's how the Empire Troubador achieves that rating... There are only two moving parts in the belt-driven, 3-speed "silent" turntable — the heavy-duty hysteresis-synchronous motor and the turntable platter. Both are individually adjusted to perfect dynamic balance. Complete rumble isolation is provided by the motor suspension, flexible belt drive and the resilient nylon "seat" which supports and cushions the thrust of the main bearing.

Rumble better than -65db. Wow and flutter less than .05%. The American Record Guide (Larry Zide) says: *"I found speed variations — that is, flutter and wow — to be inaudible."* Don Hambly, Station Manager of KRE AM/FM, Berkeley, Calif. said "... the Empire tables, have all the basic requirements of design and simplicity of operation and maintenance that we have sought."

The Empire 980 dynamically balanced playback arm achieves the unique distinction of having rock-like stability and balance in all planes — which allows for perfect tracking at any angle — even upside down.

American Record Guide said "... One of the best available ... substantial reduction in vertical mass ... a cartridge of any dimension can be aligned in the head for minimum tracking error ... calibration is extremely accurate ... Dyna-lift most useful ... lateral and vertical friction is exceptionally low ... exceptionally stable ... steady even with shaky floors ..."

And now for the third member of the perfectly integrated record playback system — the 880 P cartridge — Stereophile Magazine reported — *"the Empire 880 P has as high channel separation as any pick up we have encountered ... needle talk exceedingly low ... inductive hum pick up well below limit of audibility. The 880 P appears to be one of the most rugged high-performance stereo cartridges we've encountered ... the best magnetic cartridge we have tested to-date."* Audio Magazine probably summed it up the best ... *"truly excellent."*

The above is only part of the Empire story. From its original concept, the Troubador was designed and built to please the most serious audiophile. Our most recent survey enlightened us to this fact — *"More Empire playback equipment is used by FM/Stereo stations than any other brand."*

We rest our case — listen and compare. It's the surest way.



For complete literature write:

"... World's Most Perfect Record Playback System"

**EMPIRE**

Empire Scientific Corp. • 845 Stewart Ave. Garden City, L. I., N. Y. Export EMEC, Plainview, L. I., N. Y. • Canada, Empire Scientific Corp., Ltd., 1476 Eglinton West, Toronto



## DYNAMIC NEWS FROM ALTEC

# 2 New Microphones Expressly for Professional Use

Two new studio dynamics—Altec 688A Omnidirectional; Altec 689A Cardioid—have been developed by Altec specifically for broadcast, recording, and TV use. Part of the famed Altec Series 680, these microphones offer maximal characteristics to meet and exceed the strictest professional recording and broadcast standards. Each is equipped with the exclusive Altec "Golden Diaphragm" which is not only extremely rugged in use but which also contributes inherent low resonance qualities and peak-free response. These two new microphones plus Altec's famed M20 Omnidirectional Condenser Microphone System and M30 Cardioid Condenser Microphone System now offer the industry superb qualities and characteristics to meet any and all requirements that can be imagined.



**ALTEC 688A OMNIDIRECTIONAL DYNAMIC MICROPHONE**—\$90 net. Extremely uniform response from below 35 to over 20,000 cycles. Highly efficient. Low hum pickup. Shown in an Altec 181A Boom Mount. Output Impedance: 30/50, 150/250 and 20,000 ohms (selection by connections in microphone cable plug). Output Level: -55 dbm/10 dynes/cm<sup>2</sup>. Hum: -120 db (Ref.: 10<sup>-3</sup> Gauss). Dimensions: 1 1/8" diameter at top (1 1/2" largest diameter), 7 1/2" long not including plug. Weight: 8 ozs. (not including cable and plug).



**ALTEC 689A CARDIOID DYNAMIC MICROPHONE**—\$108 net. High front-to-back discrimination for an average of over 20 db from 40 to over 16,000 cycles. Virtually flat response throughout this frequency range. Output Impedance: 30/50, 150/250 and 20,000 ohms (selection by connections in microphone cable plug). Output Level: -54 dbm/10 dynes/cm<sup>2</sup>. Hum: -120 db (Ref.: 10<sup>-3</sup> Gauss). Dimensions: 1 1/2" diameter at top, 7 1/4" long not including plug. Weight: 11 ozs. (not including cable and plug).



Each 688A and 689A microphone comes with its own individual response curve made by a Bruel & Kjaer servo-driven recorder in conjunction with an Altec anechoic chamber. The curve serves as a permanent record of the unit's response characteristics for immediate reference at any time required.



**ALTEC M20 OMNIDIRECTIONAL CONDENSER MICROPHONE SYSTEM**—\$233 complete with base, stand attachment, and power supply. This is the famous "Lipstik"—so named for its miniature size—the only American-made condenser on the market. The M20 provides the wide, uniform frequency response of a laboratory standard—an exceptional microphone for broadcast and recording of highest quality.



**ALTEC M30 CARDIOID CONDENSER MICROPHONE SYSTEM**—\$280 complete. This directional microphone offers the superb response characteristics of the condenser with the ruggedness and small size available only from Altec. 20 to 20,000 cycle range with better than 10 db front-to-back discrimination at the extremes, better than 20 db in the mid-range.

### ANNOUNCING AN IMPORTANT NEW DIVISION AT ALTEC

The Audio Controls Division was recently organized at Altec Lansing Corp. The new division specializes in design and manufacture of precision attenuators, equalizers, filters, networks and switches, as well as custom consoles and associated products specifically for the recording and broadcast industries. It is headed by Arthur C. Davis, a Fellow of the AES and well-known in this field as a leading design engineer and manufacturer.

For specific engineering details and free demonstration, call your nearest Altec Distributor (see Yellow Pages) or write Dept. AM-6.

**ALTEC**  
LANSING CORPORATION

**ALTEC LANSING CORPORATION**  
A Subsidiary of Ling-Temco-Vought, Inc.  
ANAHEIM, CALIFORNIA

LTV  
© 1964 ALTEC LANSING CORPORATION

# LETTERS

## Dynagroove, Tracing Distortion, and the "Bi-Radial" Stylus

SIR:

In cutting a "Dynagroove" record, as I understand it, a piece of equipment called a Dynamic Recording Correlator offsets the positive tracing distortion normally introduced by a conically ground stylus by introducing a negative tracing distortion, electronically, which is cut into the record. Therefore, we now have a record with a negative tracing distortion cut into it, which when played with a conically ground stylus has low distortion because the two distortions cancel each other.

The "Bi-Radial" stylus introduces no positive tracing distortion. Thus the negative tracing distortion which has been cut into the "Dynagroove" record is not neutralized when played with a "Bi-Radial" stylus.

It would appear that if "Dynagroove" records are played with the regular conically-ground styli or the "Bi-Radial" stylus is used with regular cut records the problem does not arise. The trouble occurs when "Dynagroove" records are traced by Bi-Radial styli.

DONALD S. MEECH  
81 Washington Rd.  
Pittsford, N. Y.

## RCA Answers

SIR:

In the March 1964 issue of *AUDIO* I described the Dynamic Recording Correlator and the way it is used by RCA Victor for the reduction of tracing distortion in "Dynagroove" records. As presently used, the Correlator is adjusted to give maximum reduction of distortion for playback with a 0.7-mil stylus tip radius, this being the size most generally used in stereophonic phonograph systems. The effect of playing back with smaller styli was discussed, and it was pointed out that a beneficial reduction in distortion is obtained by means of the Correlator even for the smallest playback styli now available. However, since additional inquiries have been received, particularly with regard to the use of elliptical or bi-radial styli, it seems wise to reiterate and state in more detail the relationship between stylus tip radius and the cancellation of distortion by means of the Dynamic Recording Correlator (DRC).

First of all, the statements made in my article relating to the effects of stylus tip radius and the DRC apply equally to spherically-tipped styli and to styli of other shapes as long as we consider the tip radius effective in the region of the stylus-groove wall contact. Equations (1) and (2) in the article show that the magnitude of tracing distortion components is directly proportional to the stylus tip radius. It is probably not feasible to make or use a radius less than 0.2-mil in a pickup stylus, and I have not heard any claims made for radii smaller than this. Reducing the radius from 0.7 mil to 0.2 mil should, theoretically, reduce each distortion component to  $2/7 = 0.29$  of the values measured for a 0.7-mil stylus. Experimental data presented in the article for playback with a 0.7-mil stylus showed that, on the average, use of the DRC reduced tracing distortion at the innermost grooves on a record to 0.25 of the average value measured when the DRC was

(Continued on page 10)



# two questions:

1. I want the finest possible music system, and price is no object. What brand should I buy?

2. I want fine sound, but I have a limited budget. What brand should I buy?

# one answer:

**DYNA**

WHO SAYS SO? Editors and reviewers, test laboratories and independent consumer testing organizations.

**Popular Science Editors**, in choosing the PAS-2 and Stereo 70 for their finest music system, after two months of the most extensive listening tests ever made by a magazine, reported:

"It was the unanimous opinion of the panel that you could spend well over \$1,000 and not get any better sound . . .

**Hi Fi Tape Systems Annual**, in their **Editor's Choice of Hi Fi Systems**, unanimously recommends Dyna amplifiers and tuners for the top three categories (excluding only 'Poor-boy,' 'Compact,' and 'Rock Bottom') "which in their judgment will meet 90 percent of needs and budgets with a pretty high guarantee of performance," with the following:

**Maximum Fi:** The Dyna outfit (PAS-3, Mark III's, FM-3) with stacked AR-3s is the least expensive way to obtain state-of-the-art performance.

**Music Lovers:** The Dyna (PAS-3, Stereo 70, FM-3) plus AR-3s has been recommended by more experts, and their nephews, than any other hi fi system. We don't hesitate to join the parade knowing that we run no risk whatever that anyone will be unhappy with the expenditure.

**Most Fi per Dollar:** This makes it three in a row for Dyna but we won't apologize. The SCA-35 is the finest low powered amplifier on the market, delivers 16 watts from 20 to 20,000 cycles at less than 1% distortion, and below 3 or 4 watts the distortion is unmeasurable."

**High Fidelity Magazine**, in individual test reports on Dyna-kits, has reported:

"We feel that the Dynakit PAS-2 is the equal of any manufactured preamplifier we have used, including some selling for several times its price."

"(The Stereo 70's) components are operated more conservatively than those in any other commercial amplifier we have tested. Its power and distortion ratings are completely conservative. Its listening quality is unsurpassed."

"On our instrument tests, the completed Mark III exceeded all its specifications by a healthy margin . . . this amplifier is an excellent choice for the kit-building music listener who considers the best present-day sound reproduction to be not quite good enough."

"The Dynatuner proved to be an outstanding performer, with measurements that generally confirmed or surpassed Dynaco's own specifications, and a quality of clear reception and clean sound which bore out these measurements. This tuner . . . should satisfy the requirements of the most critical FM listener."

"In tests conducted at United States Testing Company, Inc., a kit-built version of the SCA-35 proved to be an outstanding performer among low power amplifiers. (It) offers performance that belies its cost, meets or exceeds its specifications, and is in general an excellent high fidelity component."



**SCA-35**—Combined stereo preamp-amplifier with low noise, lower distortion, and 35 watts continuous power output from 20 to 20,000 cycles below 1% distortion. Exclusive Dyna feedback circuitry and output transformers for distinctly superior sound.

**SCA-35 kit \$99.95; assembled \$139.95**



**FM-3—STEREO Matic** FM tuner featuring automatic stereo/mono switching with the visual Stereocator. Super-sensitive, drift-free design with less than 0.5% distortion. Four IF-limiters, wide-band balanced bridge discriminator, and time switching multiplex.

**FM-3 kit \$109.95; assembled \$169.95**

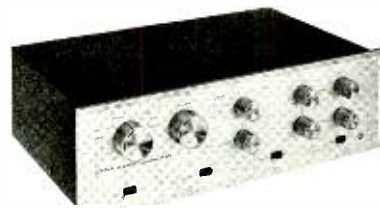

**PAS-3**—The famous "no distortion" PAS-2 stereo preamplifier with Dyna's new look. Wide band, lowest distortion, lowest noise, with every necessary feature for superb reproduction. Less than 0.1% harmonic or IM distortion at any frequency.

**PAS-3 kit \$69.95; assembled \$109.95**

Write for detailed specifications and descriptive literature

**DYNACO INC.** 3912 POWELTON AVENUE, PHILADELPHIA 4, PA.



## LIGHT LISTENING

Chester Santon

**Beyond the Fringe '64** (Original Broadway Cast)

Capitol SW 2072

The topical nature of its sketches tends to obscure the fact that "Beyond the Fringe" has been running on one continent or another since 1960. This four-man exercise in contemporary wit made its theatrical debut as a special added attraction at the Edinburgh Festival, then moved down to London's Fortune Theater on May 10, 1961. Featuring its original personnel, the show opened on Broadway October 27, 1962. The biting commentary on American and English foibles, changing with events on an almost adlib basis, has accounted for a good share of whatever hilarity the past few seasons have made available to the sophisticated theatergoer. Capitol Records lost little time in recording the first cast of "Beyond the Fringe" on album # SW 1792 back in the fall of 1962. This second album stars Alan Bennett, Peter Cook, Dudley Moore and Paxton Whitehead who brought the latest edition to Broadway last January. Here we find several new sketches, material taken from the original British production not previously used in New York and several items which originally had been considered a bit too insulting for inclusion during the American premiere engagement. Presumably our boiling pot has gone up during the intervening months.

The advantages of stereo are immediately brought into play in the opening sequence as the full cast, spread from speaker to speaker (loudspeaker, that is) proceeds to roast American feelings over a slow fire. Many of the quartet's softly voiced barbs would be far more difficult to sort out in mono. Domestic listeners who bruise easily under any form of railery will be relieved to learn that the rest of the record is pretty much given over to fun making at the expense of the quartet's fellow countrymen. The foibles exposed to a pitiless glare are the property of just about every class of English society. A certain amount of familiarity with English custom and far-out characters will help in fully appreciating some of the digs. Little is needed in the way of background knowledge to relish the broader sketches (a one legged actor applying for the role of Tarzan, the ribbing of Scotland Yard in "The Great Train Robbery" and the "interview" with Prince Phillip). Dudley Moore, the minstrel of the group, will probably steal the show for anyone with a reasonably wide knowledge of musical styles. His takeoff on Kurt Weill and Benjamin Britten are truly remarkable in both perception and execution.

**What Makes Sammy Run?** (Original Broadway Cast)

Columbia KOS 2440

Budd Schulberg's famous tale of a Hollywood heel has been raised a fraction of an inch in transfer to Broadway. Perhaps the most impressive (and surprising) feature of the show and the recording is the hard-as-nails music and lyrics created by Ervin Drake—a name probably as new to most Broadway fans as it is to me. Very little seems to be known about Drake over at Columbia Records. The person in charge of the elaborate album notes ignores him completely in the copy I've seen. The stars of the show—Steve Lawrence, Sally Ann Howes and Robert Alda—get the usual biographical sketches but no material whatever is forthcoming on the composer and lyricist.

The musical traces at some length the slippery career of Sammy Glick, played by

Steve Lawrence with an intensity his career as a pop singer did not prepare me to expect. Apparently his first acting experience in a stock company production of "Pal Joey"—an earlier stage heel—has really paid dividends. Robert Alda, the most seasoned player in the cast, is heard mostly in the earlier songs dealing with Sammy's newspaper days and his formative months in Hollywood. What soft sentiment there is in the music is expressed by Sally Ann Howes in *A Tender Spot* and *Something to Live For*. Most of the songs are too busy embellishing the chrome-plated plot to devote themselves to the usual human frailties. Steve Lawrence and Bernice Massi, playing the part of his Hollywood flame, come close to hitting the tenor of the show in their song, *You're No Good*, a sort of *You're the Top* in reverse. The brightest item is a Mexican-style ditty called *You Can Trust Me*. For all the youthfulness of the cast, the show has a dated quality because it deals with a period when Hollywood wasn't as uneventful as it is now.

**Barbra Streisand/ The Third Album**  
Columbia Tape CQ 624

Forgetting such factors as personality and talent, Miss Streisand's recordings certainly strike a fresh note in the matter of titles for her albums. How often do you find a record company so confident of an artist's acceptance that it labels the way Columbia does? The third Streisand release is somewhat different from earlier ones. This reel shows sign that producer Mike Berniker has taken into account a wider potential audience for each new album by the label's still rising young star. The songs recorded here—*Bewitched*, *Melancholy Baby* and *It Had to be You*—have a more general appeal in themselves than did some of the tunes in albums One and Two. The bittersweet quality of the Streisand voice, combined with almost phenomenal breath control, thrusts each of these old songs into a new light. Some inkling of Miss Streisand's importance in Columbia's plans may be gleaned from the number of arrangers engaged for this one release. Among such well-known names as Sid Ramin, Ray Ellis and Peter Matz may be found no less an arranger than Leonard Bernstein. Equal pains have gone into the selection of engineering talent in order to insure the best possible showcasing of this talent in audio terms.

**Patti Page: Love After Midnight**  
Columbia CL 2132

**Peggy Lee: In Love Again**  
Capitol T 1969

These mono releases, in addition to attractive cover photos of the ladies involved, represent much of the current style in solo vocalist single-channel recordings. Anyone who has remained loyal to a particular female thrush over the years is quite aware of the fact that stereo has made relatively slight inroads in the area of pop vocal recordings. This will probably remain true so long as a sizable group of record customers feels that stereo doesn't do enough for a solitary vocalist to warrant the extra money still being asked for most two-channel recordings. These days, I don't have too much occasion to consider the relative merits of stereo vs. mono in the case of a star vocalist because most releases arriving for review are in stereo. Were I faced with the delicate problem of counting pennies in a budget for recordings, I might well be tempted to stick to mono when purchasing a favorite

vocalist despite the unquestioned aura of realism that stereo imparts to the accompanying orchestra.

In neither of these albums does the orchestra play too important a role. Patti Page, following a long series of releases for Mercury Records, is now a fixture on the Columbia label. Her no-nonsense style is backed by a strong beat from the Robert Mersey Orchestra.

Peggy Lee, assisted by a capable group of sidemen directed by Max Bennett, relies on the ingratiating quality of her still discernible Southern drawl to put over a wide variety of tunes ranging from bossa nova to near-gospel swing. Use of a stereo system for playback of these recordings tends to emphasize the differences in the mono miking. Columbia has the orchestra much closer to the singer while Capitol delivers a pleasing illusion of depth through more distant miking of the band.

**The Very Best of Kate Smith**  
M-G-M SE 4220

I wonder how many record fans will purchase this disc under the impression that they are getting an up-to-date recording by Kate Smith. Most of these songs first saw the light of day decades ago yet the word Stereo (no mention of electronic reprocessing) is prominent on the jacket and record label. Another factor that is apt to confuse the browser is the fact that Miss Smith does have a 1964 stereo recording to her credit (Kate Smith at Carnegie Hall, RCA Victor LSP 2819). MGM evidently figures to cash in on the current revival of interest in Kate Smith with this release of antiquated material. This is not the first time someone has issued a "stereo" recording without bothering to mention electronic reprocessing. It is a bit of a surprise to see the stunt pulled by an outfit that likes to count itself one of the major labels. I'm not arguing against reissues per se. In many cases reissues have represented a distinct gain for the purchaser because of the reduced price and, equally important, an improvement in sound through the use of more modern mastering equipment. Most record companies, if only to protect the dealer against customer complaint, have taken the trouble to identify reissues—usually by means of a specially-named series or a clue of some sort on an individual jacket. In the meantime, if you'd like to refresh your recollection of how Kate Smith sounded on mono discs in her younger days, this "stereo" record is for you.

**Percy Faith: Great Folk Themes**  
Columbia Tape CQ 610

This reel finds Percy Faith fulfilling the clause in his contract wherein Columbia reserves the right to have him record anything it chooses. In this instance it happens to be currently-in-vogue folk themes arranged for fifty-piece orchestra and banjo. The brighter tunes (*Darlin' Corey*, *This Train*, etc.) will hardly satisfy those listeners who prefer words with the melody but the pretty tone colors of the gently rolling songs (*Blowing in the Wind* and *Fire Hundred Miles*) should make up for the loss.

**Bing Crosby: Return to Paradise Islands**  
Reprise RS 6106

One of the encouraging changes in the record industry has been the overhaul of the sound on Reprise Records since their merger with Warner Bros. When Frank Sinatra set up the Reprise label in 1961, the enterprise resembled a private lark more than it did a typical burgeoning corporation. With Frank's name leading a roster of personal friends, the label's main claim to a place on dealer's shelves was the value of his buddies' names. The day-to-day problems of the control room and pressing plant didn't seem to interest the Reprise executive echelon to any great extent. Now that the Warner Bros. label has taken over these responsibilities, Reprise is within hailing distance of the sound of the parent concern. This places it close to the top in the quality of its pressings. In these relaxed Hawaiian songs, Bing Crosby sounds better than he has in years. Allowing for an exceptionally salutary choice of soloist mike that favors the lower range of his voice, this disc gives the present-day Crosby pipes a new lease on life.



The Fisher XP-10, \$249.50



The following is *AUDIO* magazine's "Equipment Profile" on the Fisher XP-10 Console speaker system, reprinted in its entirety:

The Fisher XP-10 was introduced in the latter part of 1963 and represents the crowning achievement of the Fisher line of loudspeakers. It is a three-way system encompassing a 15-in. woofer, an 8-in. midrange speaker, and a "soft dome" hemispherical tweeter.

Before going forward with an explanation and description of this speaker system, it might be worthwhile to look back briefly. If our memory serves us correctly, Fisher has been making speaker systems for only a few years, and yet some trade sources indicate that they are amongst the top few in current popularity. A rather striking performance which has been largely unheralded. Undoubtedly part of this success was due to the fact that the Fisher name was on these speakers. Equally important, however, was the fact that the progression of systems have been excellent performers for their day and age, and have been consistently upgraded over the years. Thus we arrive at their best and most elaborate system to date.

The XP-10 is also the finest piece of speaker furniture produced by Fisher, which is only partially indicated in the illustration. Measuring 24 $\frac{3}{8}$ -in. wide, 30 $\frac{1}{2}$ -in. high, and 14 $\frac{3}{8}$ -in. deep, it makes an unusually handsome piece of furniture with its Scandinavian Walnut exterior. Now let us take a look at what lies beneath that exterior.

#### The Woofer

The 15-in. woofer features the eddy-current damped electrolytic-copper voice coil which was introduced in the Fisher XP-4A. This technique provides excellent damping, and thus excellent transient response. The open air resonance of this speaker is 18 cps, and in the enclosure provides good output in the 30-cps region. The crossover frequency of 200 cps permits the woofer to operate in its most effective range and avoids some of the phasing problems resulting from a higher crossover point. The low-frequency driver utilizes a 6-lb. magnet structure.

Altogether, the 15-in. cone, the powerful driver, the excellent damping, and the low crossover frequency combine to produce clean and tight bass.

#### The Midrange Speaker

Often, the importance of the midrange

**"The XP-10 is truly a step forward in smoothness, transient response and musical quality. It handled percussion, piano, strings, brass, and what have you, as cleanly and precisely as any speaker system we know."** — *AUDIO* magazine, March, 1964

speaker is overlooked, especially since it is usually the least expensive speaker in a decent-quality three-way system. In fact the mid-range does the lion's share of the work since it must carry the majority of the orchestral fundamentals. Just glance at one of those charts which show the frequency range of orchestral instruments if you want to be convinced.

In addition to doing all that work, it must also be a smooth bridge between the woofer and tweeter. We can't overstress the importance of properly bridging the high and low frequencies in a three-way system: a poor bridge can make even the best woofer and tweeter sound somewhat poor.

The preceding makes us well believe the statement by the manufacturer that he tried literally hundreds of different combinations of parameters before the right combination was found. The final result is a midrange which is flat within 1 $\frac{1}{2}$  db. It required an 8-in. speaker with a 5 $\frac{1}{2}$ -lb. magnet structure, 1 $\frac{1}{2}$ -in. voice coil, and its own separate-from-the-woofer loading. The upper crossover frequency of 2500 cps was chosen as a good compromise between the major orchestra fundamentals and the increasing importance of dispersion with increasing frequency.

#### The Tweeter

The major innovation introduced in the XP-10 is the "soft dome" hemispherical tweeter. Usually, hemispherical tweeters have domes made of molded phenolic or spun aluminum, both very stiff substances. The assumption behind these stiff domes is the same as one would have in making a cone tweeter: they require a stiff, light material because of the frequencies involved. Unfortunately, these stiff domes have certain resonances which tend to show up above 10 ke.

The designer of this system reasoned that the hemispherical tweeter is different than the cone tweeter in that it is driven at its periphery so that there is a certain amount of structural strength (like an arch) making it unnecessary to use materials such as aluminum or phenolics. Instead he used a rubber-impregnated cotton diaphragm and achieved the same excellent dispersion and transient properties of the stiffer materials, without the characteristic resonances of these materials. (A patent is pending on the idea.)

Of course, to take advantage of the excellent properties of this tweeter, and to match

it to the more efficient cone speakers, a 5 $\frac{1}{2}$ -lb. magnet structure with an air-gap flux density of 16,000 gauss was used. It is interesting to note that the magnetic circuit on this tweeter is more powerful than the circuit on many woofers—but of course this speaker is much, much less efficient.

#### Performance

In order to gauge the performance of the XP-10, we decided to go through extensive listening tests in addition to the usual microphone pickup tests.

First let us look at what the microphone revealed as far as frequency response and dispersion. The frequency-response curve was essentially flat (within 2 db) from 50 cps (our starting point) out to 16,000 cps. At 30 cps the curve was down 5 db and at 20,000 cps it was down 7 db. The dispersion was constant, within 3 db, over an angle of about 90 deg., which was as far as we measured. We noted that the high-frequency response was unusually smooth, thus corroborating the designer's contention concerning the soft dome. Indeed, our measurement of the midrange also agreed with his statements: it was well within the 1 $\frac{1}{2}$ -db variation he claimed. Beyond that, the unit we tested had a remarkably smooth response curve overall.

The listening tests were the best of all however. (They don't always agree with measurements, as you may well know.) We must report that the XP-10 is truly a step forward in smoothness, transient response, and musical quality. It handled percussion, piano, strings, brass, and what have you, as cleanly and precisely as any speaker system we know. We won't use that hackneyed term "best," because it is a meaningless term when applied to speakers, but we will say it pleased us immensely. You try it.

**FREE!** Mail this coupon for your free copy of the Fisher technical fact booklet on speakers plus the XP-10 technical fact sheet.

Fisher Radio Corporation  
21-40 44th Drive  
Long Island City, N. Y. 11101

FISHER SPEAKER SYSTEMS  
TECHNICAL FACT BOOKLET



03610

Name \_\_\_\_\_  
Address \_\_\_\_\_  
City \_\_\_\_\_ State \_\_\_\_\_

VERGAS RESIDENTS PLEASE WRITE TO FISHER RADIOL INTERNATIONAL, INC., LONG ISLAND CITY, N. Y. 11101; CANADIAN RESIDENTS WRITE TO THE TEL. ASSOCIATED, LTD., WILLOWDALE, ONT.

## The Fisher

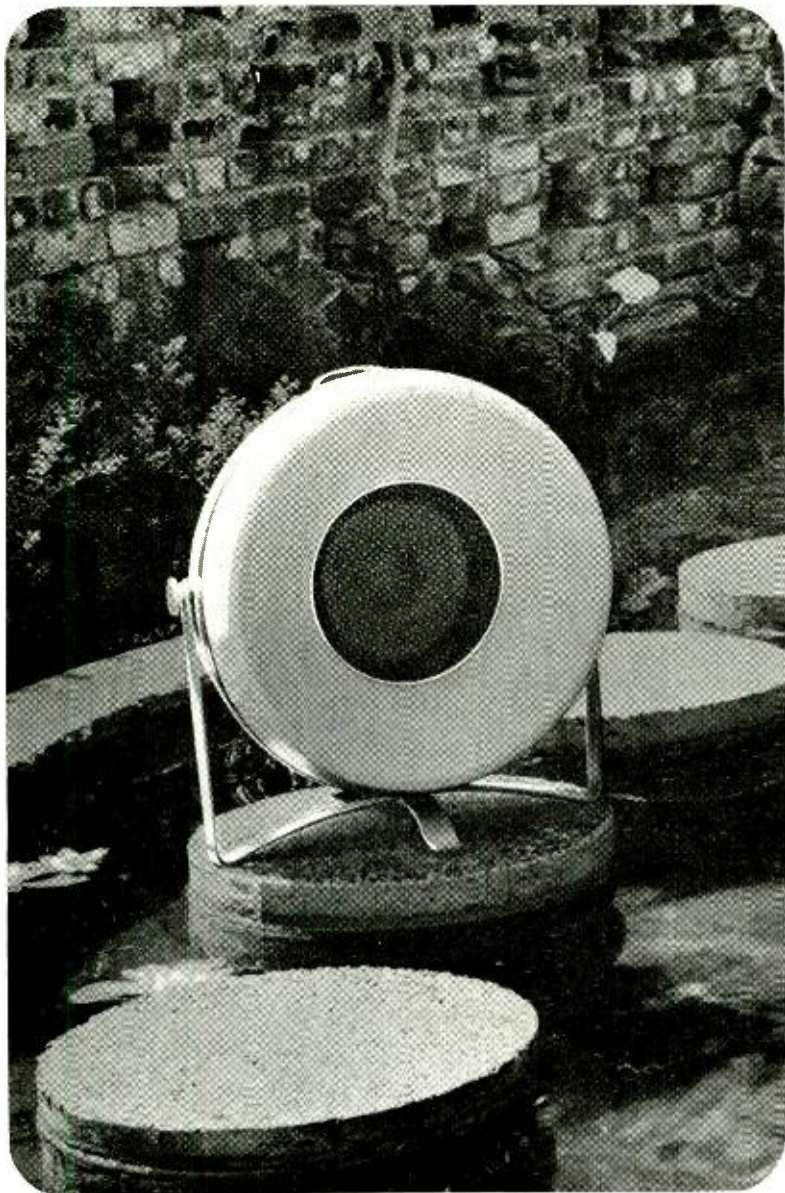

## FIESTA TIME GOES BEST WITH A BOZAK *bard*

In garden or patio, on the terrace or at the poolside — wherever you can run a wire from your main amplifier — the Bozak BARD brings your favorite music with remarkable fidelity. This weather-proof 20-pound wide-range speaker hangs or stands anywhere, never intrudes, never compromises on quality of sound. Modestly priced for such superb performance. Hear it at your Franchised Bozak Dealer.



DARIEN/CONN./06821

## LETTERS

(from page 6)

not used. Thus, the DRC reduces distortion more effectively than does any reasonable reduction in the stylus radius. However, the use of a smaller stylus in playing back DRC-recorded discs will not result in an increase in uncancelled tracing distortion unless a tip radius smaller than 0.2-mil is used. Laboratory measurements with 0.3-mil styli showed that the DRC reduced distortion even more than theory predicted for this stylus size. This anomalous result has led to an interesting and fruitful microscopic study of the modulation in the recorded grooves which will be reported at some future time.

In summary, we may assure the audiophile who is seeking the highest quality of sound from stereodiscs, and who is willing to pay the price, that a significant reduction in tracing distortion from conventional records can be achieved by using the smaller styli now being offered commercially by several pickup manufacturers and that he may expect a still further reduction in tracing distortion when using these small styli to play records made with DRC techniques. At the same time the DRC techniques provide a remarkable reduction in tracing distortion to listeners who continue to use the more conventional pickups having 0.7-mil styli.

J. G. WOODWARD  
RCA Laboratories  
Princeton, New Jersey

### Cutting Remarks from a Stylus Maker

SIR:

Mr. Woodward's article suggests several questions and observations:

(1) No mention was made of the possible effect of variations in the angle formed by the stylus axis and the record plane (as measured from the side). This angle must have varied through as wide a range as did the vertical tracking angle which was being measured with the special laboratory pickup on its circular rails. Thus, was not a variable factor being neglected? The argument is advanced in some quarters that the stylus-record angle should not have any significant effect because the business end of a stylus is ball-shaped, and a ball cannot have an orientation. Nevertheless it would seem to me that this theory should be subjected to actual test. If any such test or tests have been made and reported in the literature I would like to have the references.

(2) By now many others must have voiced their complaints against and dissatisfaction with RCA's unilateral action of using the Dynamic Recording Correlator in the Dynagroove process with a setting for 0.7-mil radius playback tips, which has the effect of freezing progress in the state of the stylus art at the 0.7-mil level! Perhaps it was in anticipation of such criticism that Mr. Woodward pointed out that "the reduction observed in the case of a 0.5-mil stylus was almost as great as that for the 0.7-mil stylus." Does it not follow that the converse should be true, and if it is, why does not RCA set its DRC for 0.5-mil so that progress in the stylus art will not be hampered—or wasted!

GERALD SHIRLEY, *President*  
International Audio Stylus Corp.  
107 Lake Avenue  
Tuckahoe, New York



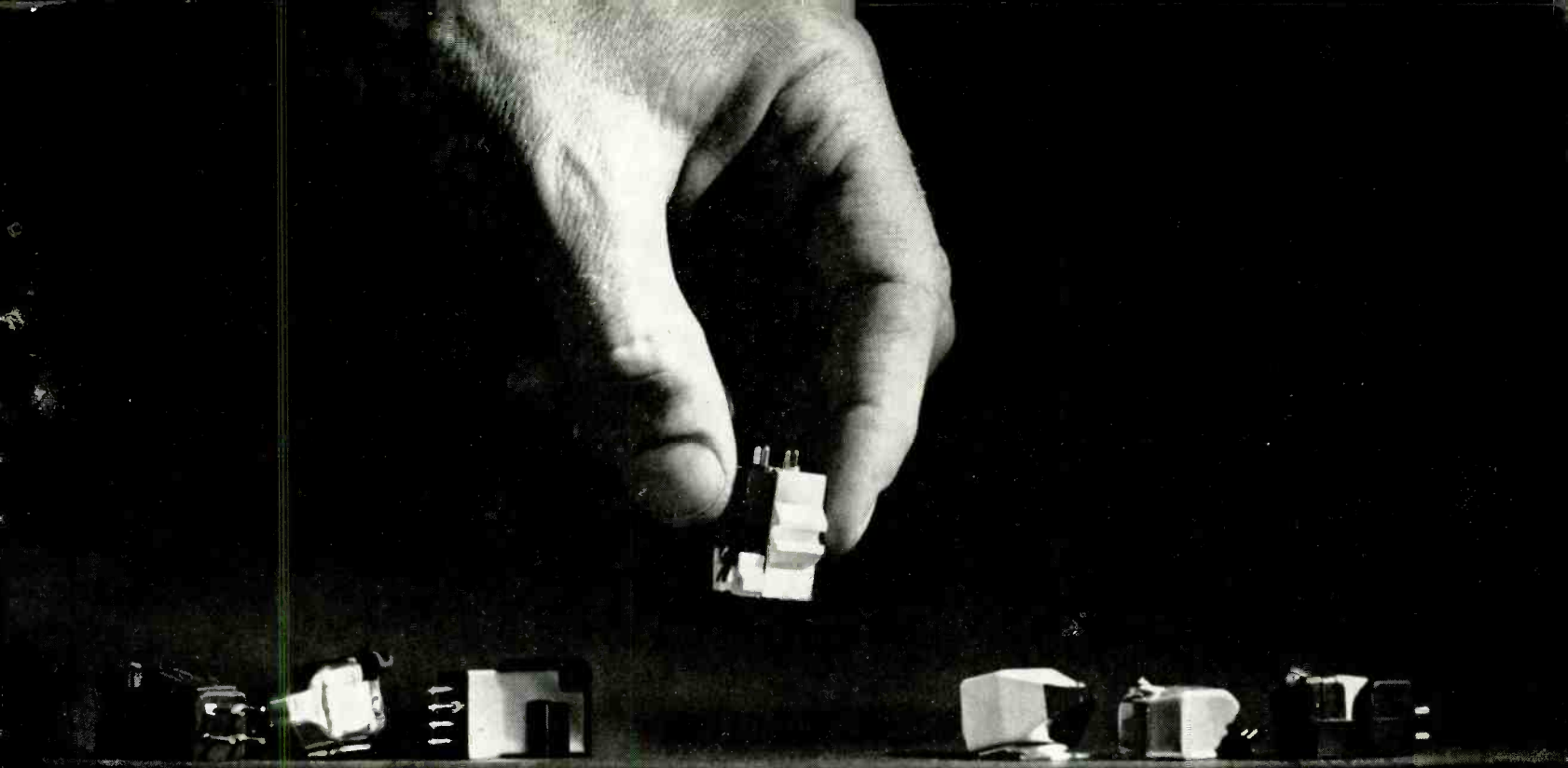

# Pick any cartridge you like.



## Of course!

This business about some cartridges not being suitable for record changers has nothing to do with your Miracord. There are automatics, and there are automatics.

Your Miracord will handle and track any cartridge available today at its recommended stylus force setting. And whether you play it manually or automatically, it will operate and perform gently and reliably.

Miracord has gone to great pains to give you quality. And you need not make any compromise in the choice of your cartridge. Pick the cartridge you like; install it in your Miracord; then sit back and enjoy really great record performance. In fact, may we suggest that you listen to the Miracord with the new Elac 322 stereo cartridge.

**BENJAMIN  
MIRACORD**

BENJAMIN ELECTRONIC SOUND CORP., 80 Swalm Street, Westbury, New York sole U. S. distributor for Miracord turntables, Elac cartridges, and other Electroacoustic® audio components

# AUDIO ETC.

Edward Tatnall Canby

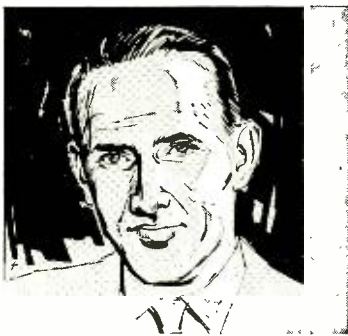

NORMAN PICKERING  
(GUEST CONDUCTOR I)  
FM = 50%. Why not 95%?

**R**ECENTLY, while recovering from a mild heart attack, I found myself for the first time in my adult life with large quantities of uncommitted time on my hands. Lying in bed with the controls of a good AM-FM (stereo, of course) receiver at hand, I was presented with a fine opportunity to re-acquaint myself with the state of the broadcasting art and to ponder present practice in that ubiquitous (and sometimes iniquitous) medium.

Although I am only in the not-so-late forties I find to my amazement that I can count up nearly forty years of intensive application to music as devoted student, perspiring professional, and happy amateur (in that order). I am also slightly shocked when I realize that the first violent pang in my love affair with audio occurred nearly thirty years ago. Like all true and lasting loves this one elicits the classic response to outrages inflicted upon the beloved, whether they are real or imagined. Sometimes the desire to swing the scimitar among the crowded ranks of the desecraters grows very strong indeed.

It had been many years since I last listened to records or radio for any extended period without some ulterior objective. Usually to test a piece of equipment for which I was responsible (hence non-objective), to evaluate a competitive device (humbling experience), to opine at the unveiling of friends' latest audio equipment (exercise in tact), to catch a performance by or of musician-friends or friends of friends (there's *always* something good to say), or to dissect a composition or performance for musical-study purposes (who cares about the quality?).

Fortunately for me, most of my recent confinement took place in a pleasant room which we had designed and built with acoustics very much in mind. It is isolated from outside noise and has turned out exactly as I planned with regard to "listening" acoustics. I will not attempt to defend or explain our taste in this regard (unless lightly urged to do so) except to say that we like the sound of our room very much indeed. When the program material is of good quality

the listening is sheer joy—but how rare these occasions are! Realizing that no two people will always agree on what constitutes first-class program material (by which I mean both subject matter and sound quality) I make no attempt to inflict my personal set of prejudices on you, gentle reader. This is by way of reporting what has occasionally induced sorrow and pain in this man's somewhat damaged breast, when the kindly operators of the radio stations in question must have had the opposite effect in mind.

First, as a general observation, I have concluded that almost any private citizen with respectable (but not necessarily expensive) modern audio equipment puts a cleaner, better-equalized signal from his records into his loudspeakers than most broadcast (AM or FM) stations put into their modulators most of the time. This is in sharp contrast to the post-war decade, when much superb sound from records broadcast from FM and small AM stations set a high standard for home music listeners. For a broadcast station to deliver first-class goods to the customer requires only three things, I believe: good equipment to start with (that's easy, these days); a rigorous maintenance schedule (not too bad, once it is started); and someone who cares on duty at all times while on the air (there's the rub!).

We live in eastern Long Island, and our happy hunting grounds for FM extend from New York City and vicinity to Boston (with a little bit of luck). With a good directional antenna on a tower we can pull in solid signals any old time within a 100-mile radius, which just barely includes New York. Our main fare emanates from Connecticut, which has a large number of powerful FM stations, but as yet not much stereo. With all this area in which to roam, we don't feel particularly limited as to sources of program material. Among the fifty or more stations regularly receivable, however, there are only about a dozen which always seem to expect to be listened to between commercials. Of course, the Great American Curse of audio is the omnipresent "background" music. When program material is intended merely to prevent silence between commercials and news it can-

not really be expected to be produced to high standards of quality. So let's forget about this class of operation and agree that although it fills a need felt by many, it is not the subject of this essay.

When we consider the remaining music outlets, there is a wide spread in quality among them and often in the output of a single station throughout the broadcasting day. The tedious job of programming for 12 to 24 hours every day while trying to keep sponsors and listeners happy must be one of the world's worst—but how wonderfully well it is done at some stations year after year! With the fantastic variety of serious and popular music (terrible designations—I'm sure some "popular" composers consider their output serious, and Lord knows some "serious" music has gotten a little too popular!) now on disc and tape there can hardly be need for endless repetition of the same few war horses. Blessings on the stations which air unusual or historic jazz, weird and awful experiments in electronic music, solid and beautiful performances of the "standards," a dash of the ancient in its original dress, occasional poems and plays, operas other than "Aida" (especially if they are uncut), chamber music of all types—and vocal music to infinity. If all of this is delivered substantially free of distortion, with some attention paid to balance between highs and lows and not too much restriction of dynamic range, my cup runneth over!

The best of this sort of thing seems to occur in the middle of the night. There are some wonderful announcers who actually seem to enjoy what they are putting out on the quiet air. They pronounce the names of composers and performers as though they were old friends, and present charming and unusual works as though they and we, the listeners, are sharing a delightful discovery. This, to my mind, is the happiest kind of experience available to radio listeners. For all the times I have felt like writing to these joy-giving stations and people—and haven't—I now express my belated gratitude.

On the other, more densely populated, side of the fence we have some strange combinations of technology and aesthetics. One of the funniest things I have heard (but not at all unusual) occurred the other night, when someone on a station which brags about its quality proclaimed that we were about to hear Debussy's "Afternoon of a Faun" after which the orchestra launched into the "Polovetsian Dances" of Borodin (without chorus). Then he announced the imminence of the "Polovetsian Dances," after which the same record was played over again. There was no other comment. Do you suppose they listen?



# WILL YOUR ULTIMATE PRECISION LOUDSPEAKER BE

## A JBL LINEAR-EFFICIENCY SYSTEM

?

To the concept of long linear cone excursion James B. Lansing Sound, Inc., adds JBL precision workmanship, extremely close tolerances, and the largest voice coils made anywhere. When Linear-Efficiency transducers are mounted in a compact enclosure, the full-range coverage they provide is miraculous indeed. And when the same principles are applied to a full size system, "ultimate" is a most apt description.

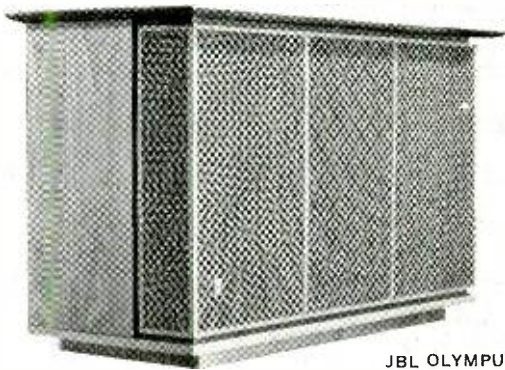

JBL OLYMPUS

## ...OR A JBL HIGH EFFICIENCY SYSTEM

?

JBL makes the most efficient loudspeakers in the world, the only transducers with four-inch voice coils. JBL efficiency is the result of advanced magnetic circuitry, tight tolerances, and the large amount of conductor in the gap provided by large voice coils made of wire ribbon wound on its narrow edge. This gives them a dynamic range, transient response, presence, and an evenness of coverage without equal.

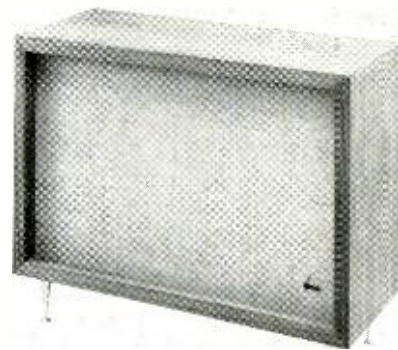

JBL C37

### ALL JBL SPEAKER SYSTEMS ARE AVAILABLE SELF-POWERED

In a JBL Energizer/Transducer, loudspeakers and power source are engineered as a unit, perfectly matched to reproduce a preamplified signal with a purity that has no precedent. All solid-state construction is used in the energizer. Generating negligible heat, non-microphonic, it can be mounted in and become a part of the acoustical enclosure.



It is without hum, and distortion in any form approaches the vanishing point. It is not subject to the creeping degeneration common in vacuum tube devices. With custom matching of energizer and transducers, exactly the right damping is provided at all frequencies. Transient response of an Energizer/Transducer has never been equalled.

### JBL OFFERS YOU MORE WAYS TO MAKE YOUR SYSTEM YOUR VERY OWN

JBL recognizes the fact that the serious participant in the art-science of high fidelity is an enthusiastic individual. He wants his very own system, one not quite like any other he has known. To serve the need of each individual, JBL offers two basic types of loudspeakers in many models. They can be used in large systems or small systems, built-in or free-standing. JBL provides enclosures for every taste—



infinite baffle, bass reflex, folded horn ... acoustically excellent, at the same time beautiful furniture. You will find that JBL makes equipment you will find nowhere else — acoustical lenses, a passive radiator, integrated stereo ... All have one thing in common: JBL products are precision built for the talented listener who is implacably determined to own the finest. Write for a free copy of the JBL complete catalog.

JAMES B. LANSING SOUND, INC. JBL LOS ANGELES, CALIFORNIA 90039



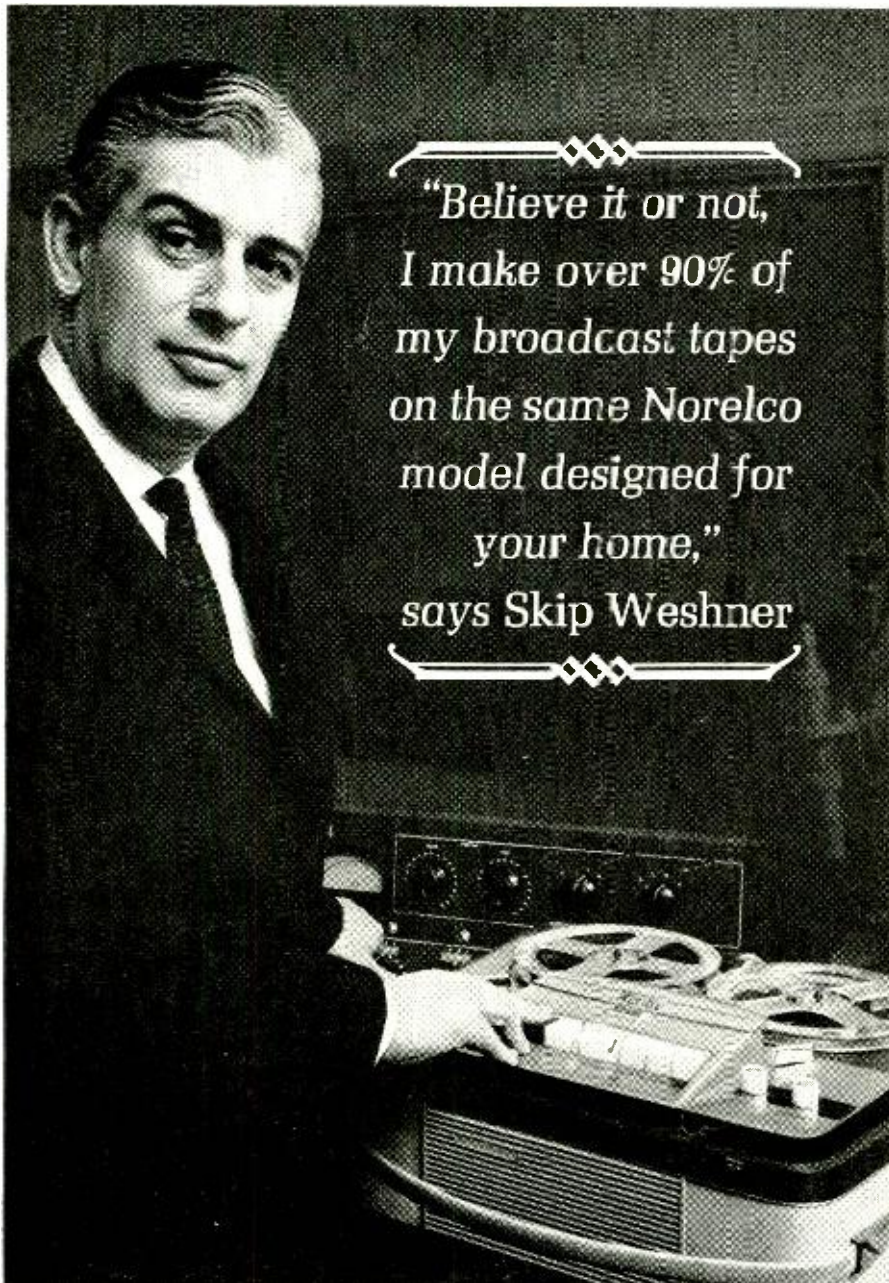

"Believe it or not,  
 I make over 90% of  
 my broadcast tapes  
 on the same Norelco  
 model designed for  
 your home,"  
 says Skip Weshner

"My tapes have to meet the broadcast standards of the leading FM stations around the country, whose other taped programs are normally recorded and played back on professional broadcast-studio consoles. My Norelco '401' gives me tapes that not only meet or exceed these standards, but on playback on the '401' I defy any listener to tell the difference between my live broadcasts and my taped ones!

"As to reliability, my Norelco has been on the firing line five nights a

week, month after month, year after year, and has required less maintenance than any other recorder I've ever used. It handles tape more gently, too: it doesn't break tape, it doesn't spill tape, it doesn't stretch tape—not even the half-mil stuff I'm forced to use to get an hour's broadcast on a 7" reel.

"Although the '401' was designed for the operating convenience and for the pocketbook of the home user, in my book it has proved itself as a thoroughly professional instrument."



**The Norelco Continental '401': 100% transistorized • 4-speed • 4-track stereo/mono, record/playback • completely self-contained with dual preamps, dual power amplifiers, two wide-range stereo-matched speakers and stereo dynamic microphone. (Two broadcast quality microphones can be used with simple adapter.)**

At your hi-fi dealer's—or write to Dept. A-6, North American Philips Company, Inc., High Fidelity Products Division, 100 East 42nd Street, New York, N. Y. 10017

**Norelco**

One of the more disturbing effects in broadcasting results from "riding the limiter." It occurs most, I find, on stations which duplicate their AM programs over FM. When a sustained chord in the upper voices is amplitude-modulated by pizzicato bass notes and drum beats it destroys whatever illusion of reality might have been achieved. In severe cases the background noise is about all that undergoes a change in level. Dynamic range in general seems quite curtailed as a matter of general practice on most FM stations, even when limiter abuse is not evident. While we are on that subject, the relative levels of voice announcements to music are still much too high in most cases, as they have been since broadcasting began. It is so very pleasant to listen to the announcements on the stations which make a practice of moderate voice levels. One gets the impression that there is a real human being at the other end instead of a grotesque caricature of one. In Europe I was impressed by the quantity and quality of (regular) female announcers on radio music and drama programs. The few stations in this country that use women's voices for regular announcements are a welcome change. I wish there were more—but how relatively few women in this country seem to have beautiful voices and good diction without affectation!

It is interesting to observe the varied treatment of voice announcements on FM stereo. Many stations put them through both channels, or in effect switch back to mono for voice. Others use either the right or the left channel alone. I still find myself listening most intently to announcements (including commercials) where two or more voices, cleanly sepa-

*(Continued on page 45)*

## COVER INSTALLATION

This installation is in the house of Mr. Lloyd Krause of New York City. The cabinet was installed in an existing closet. It accommodates an RCA color television set, McIntosh 240 amplifier, MR-65B stereo tuner, C11 preamplifier, Thorens TD-124 turntable with Pritchard arm and Shure M44-5 cartridge, and a Concertone 505CR tape recorder. All of the components are built in with complete access for repair and wiring. It also includes storage space for records and tapes, a large drawer and a pullout work table under the tape recorder. Perfect ventilation is achieved by a draft created through invisible openings at the bottom and top of the installation. The installation becomes part of a panelled wall section, the equipment being covered by hidden bi-folding doors. The cabinet is made of oiled black walnut with raised and matched panels. The designer-woodworker is Richard Lefebvre of New York.



**\$78.00\* TURNTABLE FOR A MILLIONAIRE:** An article in the Summer 1963 *Gentlemen's Quarterly* describes a "\$3,824 stereo system for those who demand the very best that can be purchased today." The system includes both a record changer and a turntable; the turntable is the AR.

**THE AR TURNTABLE** was also chosen in a study appearing in the September 1963 *Popular Science*. This article describes three stereo systems, each selected by a panel of experts as the best in its price category. The AR turntable was the choice for both the medium-priced and the luxury systems.

*The panel's choice*

REPRINTED COURTESY OF POPULAR SCIENCE MONTHLY  
© 1963 BY POPULAR SCIENCE PUBLISHING COMPANY, INC.

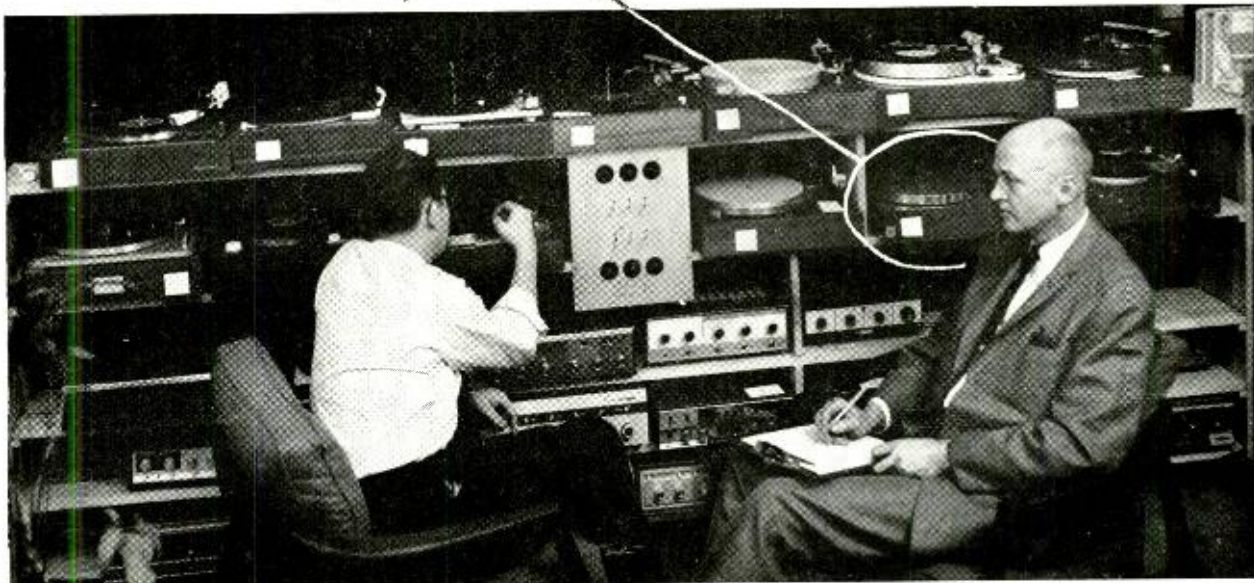

*Members of the Popular Science panel check turntables.*

A third study of high fidelity systems appears in the October 1963 *Bravo*. Components were chosen for optimum systems in three price categories—"bottom dollar", "middle-class" and "sky's the limit". The AR turntable was selected\*\* for all three systems, with this explanation:

"You may notice that the same inexpensive turntable appears in the following three systems. That is because its performance hasn't been bettered at any price."

**OTHER** equipment reviewers have reported the AR turntable to have the lowest wow, flutter, rumble, acoustic feedback, and speed error of any turntable they had tested.\*\*\*

*\*The price of the two-speed turntable has been increased from the original \$68 because of manufacturing costs.*

*\*\*AR speakers were also scattered through the systems selected in these three studies — AR-3's were chosen for the top systems both in *Popular Science* and *Bravo*, for the middle system (\$1,273) in *Gentlemen's Quarterly*.*

*\*\*\*Reprints on request. We will also be glad to send the complete component lists selected by each magazine.*

ACOUSTIC RESEARCH, INC.,

24 Thorndike Street,

Cambridge, Massachusetts 02141

# EDITOR'S REVIEW

## “. . . CONFIRMED BY LISTENING.”

**L**AST MONTH we attended several of the technical sessions of the ASA (Acoustical Society of America) concerned with the topic of architectural acoustics. We were especially interested because a Bell Labs contingent headed by Manfred Schroeder was slated to report the results of their measurements of the embattled Philharmonic Hall. In addition, the eminent acoustic expert Paul S. Veneklasen was presenting a paper on the acoustical behavior of segmented ceilings (long way of saying “clouds”). To top it all off, a sizable contingent from the acoustical firm of Bolt, Beranek, and Newman were presenting papers during the same session, in the same room, interleaved with the previously-mentioned paper. All the elements of a Greek drama.

In order to put this meeting into perspective, we will backtrack briefly. Philharmonic Hall, which opened in the Fall of 1962, was almost immediately the center of violent controversy. The major criticism was a deficiency of bass. As a result of the hue and cry, Philharmonic Hall was “rearranged” during the summer of 1963. Although the original acoustic consultant was Bolt, Beranek, and Newman, the “rearrangement” was effected by a committee of consultants, not including BB&N. It was obvious almost immediately following the “rearrangement” (some \$500,000 worth), that it had only been partially successful, although minor improvements had been effected, the major problem, bass deficiency, still remained. In fact, just prior to the ASA meeting, it was announced that another “rearrangement” is to take place this summer (another \$500,000 worth). This brings us roughly up to date.

The papers presented by the Bell Labs group centered about using a large digital computer as an analytical tool to measure concert-hall acoustics. We were quite impressed by the potential of this technique for gathering information *after the hall is built*. However, it was at the conclusion of one of these papers that the remark was made that the computer results were “confirmed by listening.” Clearly, that remark places the computer in its proper place, and, to us, was one of the significant statements made in that paper.

In any case, what they did report about Philharmonic Hall (measured before, during, and after “rearrangement”), was that there was still a deficiency of bass, a fact that the critics had perceived a long time ago. They did point out, however, that the rearrangement of the “clouds” has improved the bass somewhat.

Dr. Veneklasen’s paper was specifically aimed at the “clouds” in that he had built models simulating the “clouds” at Philharmonic Hall. His conclusions were that panel arrays were frequency discriminating in a complex manner, and especially in the mid-to-low frequencies. Before trying to connect this conclusion to Philharmonic Hall, we will add one more element to this drama.

Dr. Schultz of BB&N reported the results of some tests he and other members of his firm had conducted in a variety of concert halls, including several which have met with excellent critical and audience approval.

First of all they discovered that there is low-frequency absorption because of the seats in a concert hall, and that this effect exists in *all* halls. From this, and tests related to the ratio of “early” to “delayed” sound, he uncovered the fact that low-frequency sound is transmitted to the listener mainly by the “delayed” (or reverberant) sound. In effect his tests showed that the sense of bass and sound envelopment comes from the reverberant field, although clarity and definition come from the “early” sound. In another series of tests, confirming this point the Bell Labs group demonstrated that listeners did not notice the lack of low frequencies in direct sound if the low frequencies were contained in the reverberant sound.

Now to pull all the threads together and relate them to Philharmonic Hall. First of all, it is quite obvious now that all concert halls, good and bad, have quite irregular frequency response, such as low-frequency “dips.” In order to overcome these “dips” one must find the proper ratio of “early” to “delayed” sound. It therefore follows that Philharmonic Hall does not have the proper ratio, and that more “delayed” sound is required to overcome the apparent bass deficiency. Messing with “cloud” formation and perhaps seats may give some improvement, but really the “ratio” is the thing.

Two salient facts emerge from this rather involved report: (1) Concert halls should be built to provide a “certain sound” which is yet to be clearly defined, but whose broad outlines are fairly well known; (2) the well-trained ear is still the final measuring instrument.

Oh yes, that \$1,000,000 worth of “rearrangement” could have bought another concert hall.

## TOOLS FOR FREEDOM

It has been brought to our attention that a program exists wherein obsolete, but serviceable, tools may be donated to under-developed countries. It is felt, apparently, that by means of these donations the under-developed countries will be helped towards freedom. Here is part of a letter written by Vic Pomper, V. P. of H. H. Scott, soliciting contributions:

“. . . Tools for Freedom” solicits equipment, which may be used by schools in the under-developed lands for training students in scarce technical skills. Our free enterprise system is being tested throughout the world, and I can’t imagine a more effective contribution which American industry might make than to donate no longer needed tools and machinery to foreign technical schools. Truly, this program is aimed where real results may be expected, at improving individual skills on a grass-roots level.”

We agree. Write to Mr. Pomper and ask him how you can donate. It’s tax deductible.

## QUALITY CONTROL

We’ve received some letters recently complaining about a lowering of quality control (new equipment which is defective) in high fidelity components. We are not in a position to judge as to whether these were isolated cases or indicative of a trend. Certainly if the latter is true, we should all be quite concerned. Please let us know your experience in this matter.



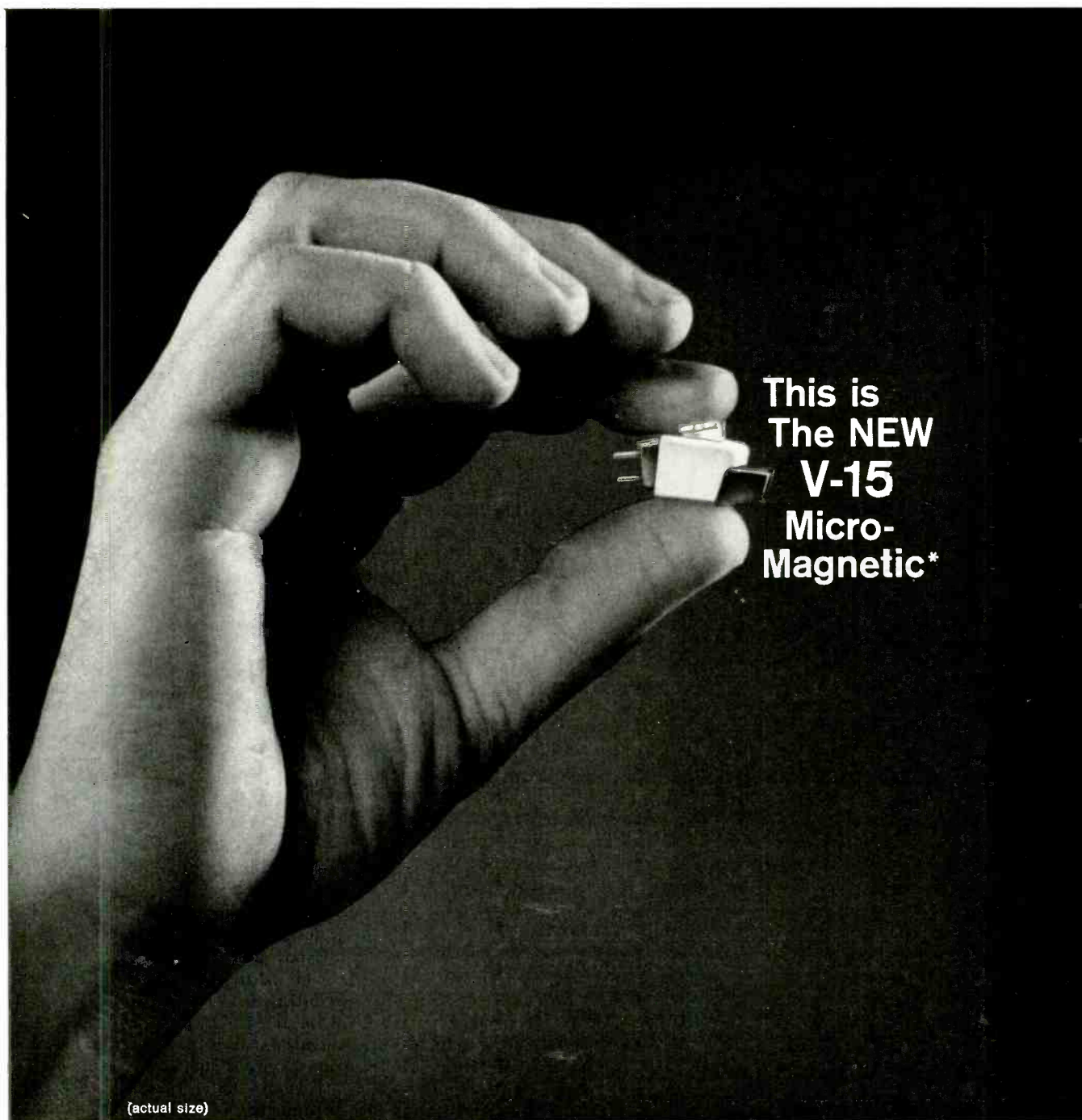

(actual size)

This is  
The **NEW**  
**V-15**  
Micro-  
Magnetic\*

## PICKERING'S NEW SUPER-LIGHTWEIGHT PICKUP

Here's a magnetic cartridge that's radically different. You can hear the difference. You can see the difference. Pick up the V-15. Note its lightness—only 5 grams. Perfect for low mass tone arm systems. The V-15, because of its high compliance, high output and rugged construction can be used in either manual turntables or record changers. Hear how it outperforms pickups two and three times its size. A revolutionary new magnetic structure provides an exceptionally flat response (20 cy to 20 KC), 7.5 mv per channel output at standard recording levels, low IM and harmonic distortion with 15° vertical tracking angle.

Now, take a close look. See how Pickering's exclusive "Floating Stylus" and patented replaceable V-Guard assembly protects your record and diamond as it plays.

See the V-15. Hear the V-15. Your local Pickering dealer has it.

FOR THOSE WHO CAN **HEAR** THE DIFFERENCE

Pickering and Company, Inc., Plainview, New York.

# Pickering

\* Trade Mark of Pickering and Co., Inc.

Are separate  
tuners and  
amplifiers passé ?



An outstanding new combined tuner/amplifier component . . . the S-7700II AM/FM/FM Stereo 80-watt Receiver.

Nothing duplicates the installation flexibility of separate components. This is one of many reasons why Sherwood sells so many of them. But for those who do not need this flexibility, Sherwood engineers have created an outstanding single component, which without compromise of fidelity, combines both functions.

The new S-7700II AM/FM/FM Stereo Receiver combines the 1.8 microvolt sensitivity and 2.4db capture effect of Sherwood's finest tuner with the 80-watt dual channel music power of Sherwood's highest-rated high fidelity amplifier. The size is a space-saving 16 $\frac{1}{4}$ " x 4" x 14". You enjoy all the tuning surety of Sherwood's D'Arsonval zero-center tuning meter and 8" long professionally calibrated dial scale. And, you have front panel control of all stereo amplifier functions for phono, tape—plus a stereo headset jack. As trim as the size, is the less-than-separate-components price of \$374.50 (slightly more on the West Coast).

**Sherwood low-distortion speaker systems  
for high fidelity music systems**

Ravinia: 3-way/48—17,500 cps/\$139.50 · Newport: 2-way/48—17,000 cps/\$79.50 · Berkshire: 3-way/53—17,500 cps/\$99.50 · Tanglewood: 4-way/29—17,500 cps/\$199.50

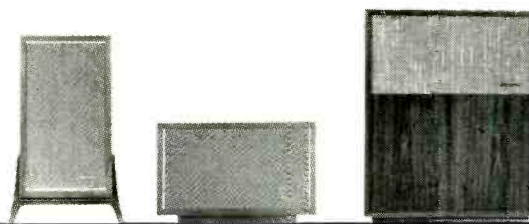

**FREE** . . . A \$1.00 VALUE  
INFORMATION KIT  
AT YOUR SHERWOOD DEALER

Take this coupon to your Sherwood dealer and receive:

- Time-Saver Shopping Guide—detailed comparative specifications on components offered by major manufacturers.
- 64-page book, *An Introduction to Hi-Fi & Stereo* published by the Institute of High Fidelity.

- FM & FM Stereo Station Finder—listing current and proposed stations.
- Photo file—a pictorial review of how different systems have been installed.
- Descriptive literature on Sherwood components.

If you prefer, send 25¢ in coin direct to Sherwood, together with your name and address. Your package will be sent by return mail.

Name \_\_\_\_\_

Street \_\_\_\_\_

City \_\_\_\_\_ State \_\_\_\_\_ Zip Code \_\_\_\_\_

Sherwood Electronic Laboratories, Inc., Dept. A-6  
4300 North California Avenue, Chicago, Illinois 60618

*Sherwood*  
**HIGH FIDELITY**

STEREO RECEIVERS ■ TUNERS ■ AMPLIFIERS  
■ STEREO INDICATOR LIGHTS ■ SPEAKER SYSTEMS ■ CONTEMPORARY CABINETRY



# Central—versus—Distributed Loudspeaker Systems

The initial step in the acoustical design of a sound amplification system is choosing between the two basic approaches in loudspeaker design: a central or a distributed system.

DAVID L. KLEPPER\*

**A** CENTRAL LOUDSPEAKER SYSTEM usually employs a single loudspeaker cluster, located near the live sound source requiring amplification. More clusters, three or five, are required for stereo or multi-channel operation, but each of these clusters must provide complete coverage of the hall. Distributed loudspeaker systems, on the other hand, employ a very large number of loudspeakers distributed throughout the listening area, each serving a limited area of coverage. The choice between the two basic types of loudspeakers should be based on the following factors:

- a. The location of the live or visual source (if any) with respect to the audience;
- b. The room-acoustic characteristics of the space;
- c. Expected background noise levels;
- d. Appearance considerations.

## Location of Live Source

Often the location of the live source cannot be pinned down to a defined area, and the system must be planned to accommodate any conceivable microphone location. In this case a central system becomes impractical and a distributed loudspeaker system is usually necessary. For example, the usual hotel ballroom sound system must be designed to provide microphone pick-up at any table throughout the room. The solution usually is a distributed loudspeaker system of ceiling-mounted loudspeakers, with loudspeaker cut-out switches permitting coverage to be switched off in the vicinity of live microphone locations. In attempting to cover a large ballroom floor with a single central loudspeaker cluster, we run two risks: 1. A microphone in the loudspeaker coverage pattern may present a feedback problem; 2. the person speaking at a distance from the loudspeaker location may hear his own voice returned from the loudspeaker with a sufficient

\* Bolt, Beranek, and Newman, Inc., 50 Moulton St., Cambridge, Mass.

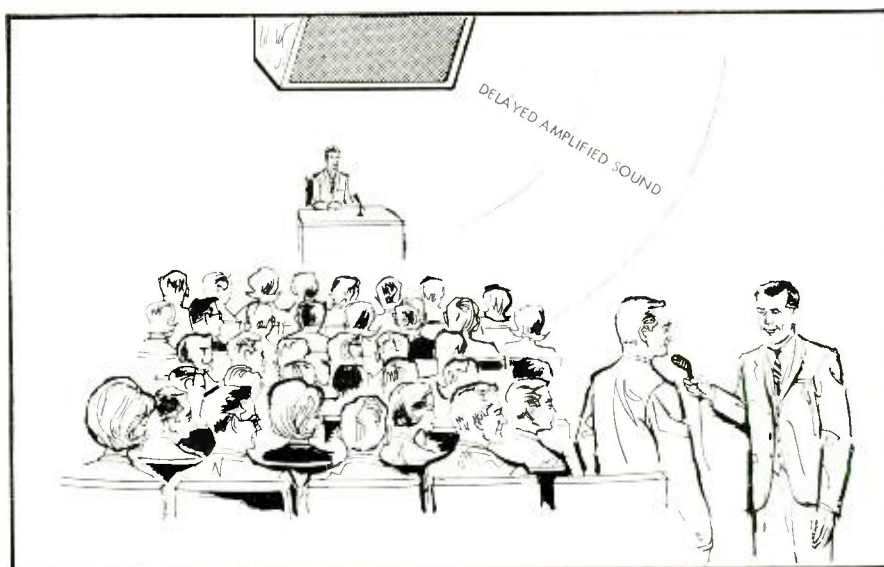

Fig. 1 Central loudspeaker systems should not be used in areas where the location of the live sound source is unknown.

time delay to cause difficulty in speaking, and nearby listeners may hear the loudspeaker sound as an echo to the natural voice. Distributed loudspeaker systems are, therefore, usually the best basic approach for stockholders meetings, exhibi-

tion areas, as well as ballrooms, and any other spaces where microphone pick-up is likely over a wide area.

A properly designed central loudspeaker system, however, provides a high degree of directional realism and intel-

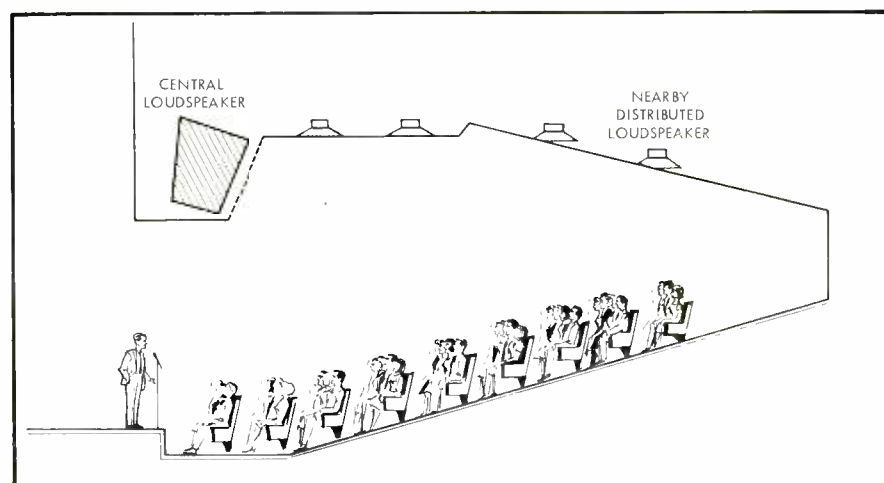

Fig. 2. In an auditorium where the live sound reaches all seats efficiently, central systems are preferred. Note the distance from the central loudspeaker cluster to the listener is roughly the same as from the lecturer to the listener, but sound arriving from a nearby distributed loudspeaker would cause live sound to be heard as an echo.

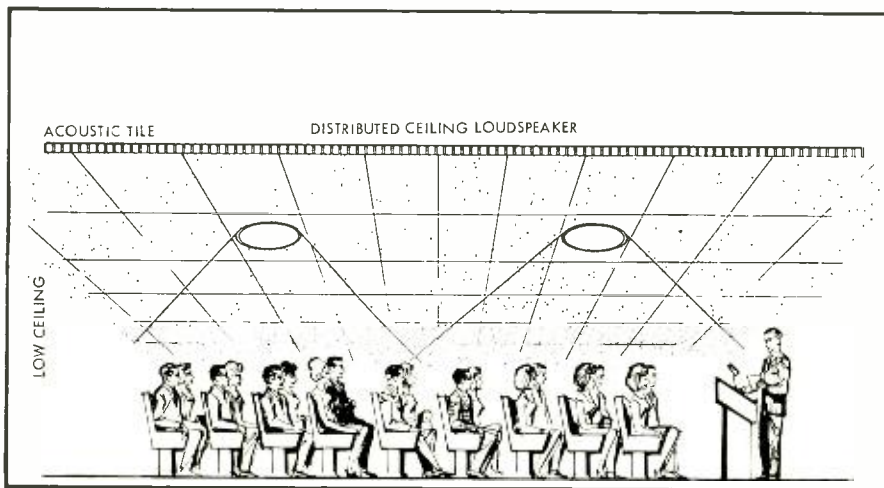

Fig. 3. A low-ceilinged large space with a sound-absorbing ceiling is a logical room for a distributed loudspeaker system. The ceiling-mounted loudspeakers should be chosen and located to assure even coverage.

ligibility when the loudspeakers are in the correct relationship to the live sound source. A proscenium style theater, for example, lends itself very well to the central loudspeaker system, because the live sound sources are confined to the stage, with a fixed spatial relationship to the audience. Most auditoriums are designed for the lecturer, actors, or musicians, to speak from a platform or stage, and a central system should be used, unless ruled out by other factors.

Occasionally a space can be best served by both types of system. A ballroom might have a central system for reinforcement of stage or spectator activities, and a distributed system for banquets and other events. Similarly, a large auditorium might employ a central system for reinforcement of lecturers, but a distributed system for amplification during audience-participation activities.

One acoustical advantage of a central loudspeaker cluster over a simple distributed system in a space that is appropriate for a central loudspeaker cluster is illustrated in Fig. 2. If the distributed loudspeaker system is employed, listeners at the rear of the auditorium will hear first the nearby amplified sound; then the live sound, both direct and reinforced by sound-reflecting surfaces from the

front of the stage. The live sound can arrive at the listener's ear with a great enough time delay following the amplified sound to be heard as an echo, or at least, if not observable as a distinct echo,



Fig. 5. A noisy space may be difficult to cover using a central loudspeaker system.

it may seriously interfere with speech intelligibility.

The use of time-delay equipment, such as tape loops and magnetic drums with distributed systems, often can overcome this difficulty and insure that live and amplified sound arrive at the listener's ear at the same time, especially using a distributed loudspeaker system.<sup>1</sup>

from a central loudspeaker system when its relationship to the live sound source is known and the loudspeaker system properly designed.

#### Room Acoustics Characteristics

In the auditorium illustrated in Fig. 2, the listener at the rear receives live sound both directly and reflected from the ceil-



Fig. 4. A low-ceilinged night club space where a distributed line source system employing time delay may be applicable.

<sup>1</sup> Examples of time-delay tape loop systems are Audio Instruments Company's models 300A and 301A. These provide a range of delays between 28 and 180 milliseconds, employing a tape speed of 30 ips. Magnetic tape delay equipment is also manufactured by Pamphonic, in England, and Telefunken, in Germany. Time delay of the amplified signal may sometimes be desirable with central systems, also, and the time delay equipment will usually be far less complex with central systems as compared with distributed systems.

<sup>2</sup> J. Wallach, E. B. Newman, and M. R. Rosensweig, "The precedence effect in sound localization," *American J. Psychiatry*, vol. 17, pp. 315-316; 1959.

<sup>3</sup> S. S. Stevens and E. B. Newman, "The localization of actual sources of sound," *American J. Psychology*, vol. 18, pp. 297-306; 1936.



ing surfaces. The reflected energy arrives a few milliseconds after the direct energy and provides reinforcement. Also, sound from a central loudspeaker cluster is directed to the audience with little attenuation beyond inverse square law, and even amplified sound receives some reinforcement from the hard, sound-reflecting ceiling surface. In this kind of situation the rear wall must be sound-absorbing and/or sufficiently "broken up" to scatter sound and minimize any possibility of disturbing echo at the front of the auditorium. In general we have found that auditoriums that are designed for efficient reinforcement of live sound from the stage area to the audience are the spaces where central loudspeaker systems are best used.

The space illustrated in *Fig. 3* provides a contrast. Here, a low, sound-absorbing ceiling provides little reinforcement of live sound energy, and the primary talker-to-listener sound transmission path has sound-absorbing material on both sides; the sound-absorbing ceiling above, and the sound-absorbing audience below. In this example live sound is very efficiently absorbed, very much like mechanical equipment noise is reduced in its travel along a lined, sound-attenuating duct.

A central loudspeaker system would not be a good solution for such a space. It can't be mounted high enough above the talker to provide sufficient gain without feedback. Further, if mounted to one side, directional realism would be lost for some listeners and then might even cause time-delay difficulties. Even with an ultra-directional column loudspeaker system it would be difficult to provide sufficient level at the rear of the seating area without "blasting" the front. Indeed, the application of a column loudspeaker system in such a space, while it may prove impressive in the empty space, would seriously suffer once the room were filled with people, because the added attenuation of the amplified sound over the audience is significant in this kind of situation.

A distributed loudspeaker system is obviously the answer to this application. Here the attenuation of live sound along the room would be sufficient to eliminate any problem of echo. A straightforward solution would be the use of cone-type loudspeakers mounted flush in the ceiling and spaced to provide even coverage. A listener equidistant from two or four loudspeakers hears the sound from these loudspeakers arriving at his ear within a few milliseconds and at approximately the same level, adding with regard to intelligibility. The system's operation would be relatively independent of occupancy, because sound reflected off the hard floor or seat surfaces would be absorbed by the ceiling treatment. The

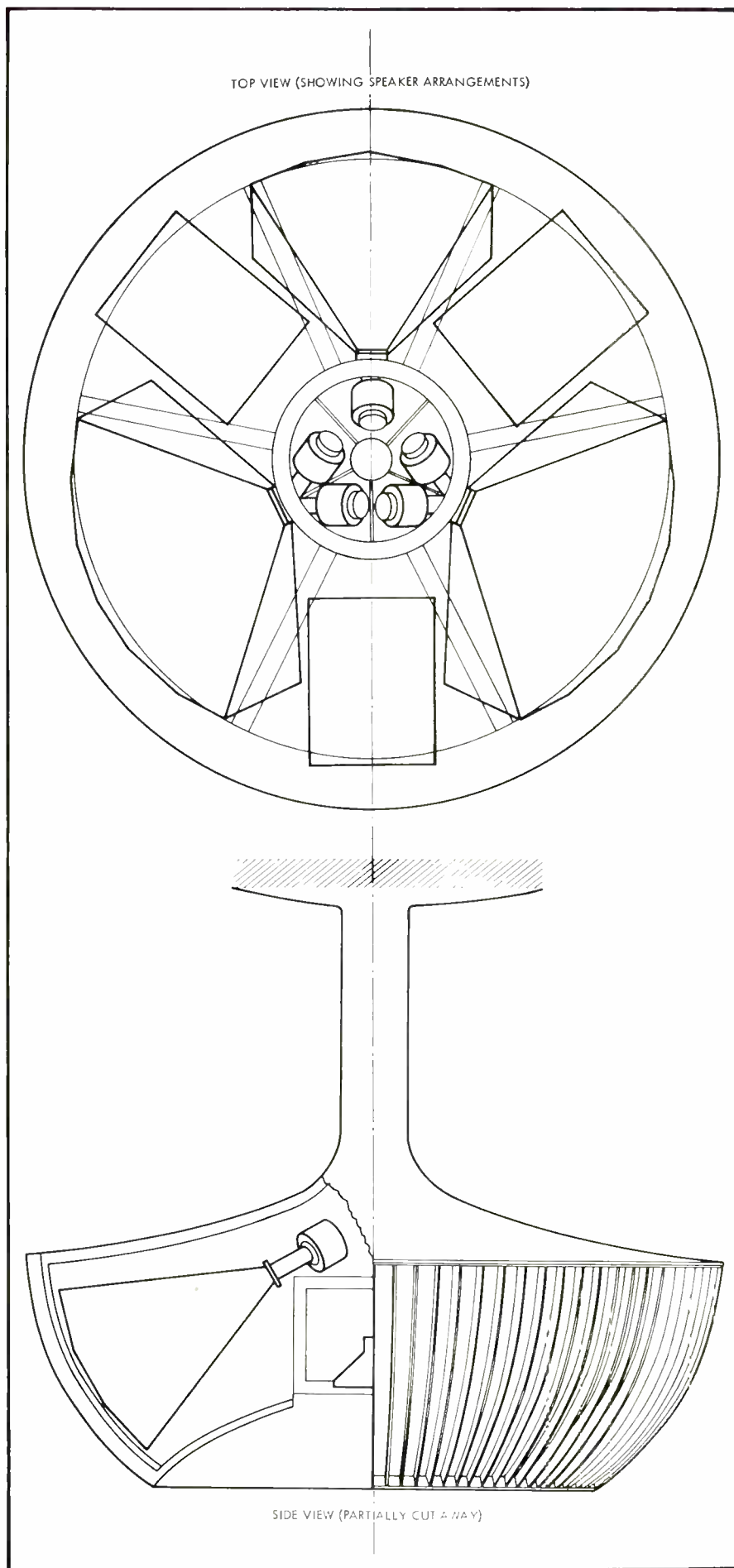

Fig. 6. A great architect can produce a piece of sculpture from an exposed loudspeaker system without impairing its acoustical efficiency: The central cluster at the TWA terminal, Idlewild, Eero Saarinen and Associates, Architects.

system would have one disadvantage: lack of directional realism.

A type of distributed loudspeaker system that is sometimes used in low-ceilinged night-clubs and similar spaces, where directional realism is desirable, is shown in Fig. 4. The time delay units insure that all amplified sound arrives at the listener's ear within a few milliseconds, insuring high intelligibility, and directional realism is retained for most listeners, because amplified sound comes from the same direction as the live source.

Distributed loudspeaker systems both with and without time delay have been used successfully for speech amplification in reverberant churches. Properly located loudspeakers can minimize the undesirable effects of reverberation by placing the source of amplified sound close to the listener. Such distributed loudspeaker systems simply do not "excite" the room reverberation. However, we should not assume a reverberant space automatically requires coverage by distributed loudspeaker systems. A central loudspeaker system may be employed, if the directional characteristics of the loudspeaker cluster is carefully controlled. The amplified sound energy is directed only to the audience or congregation, minimizing coverage of hard, sound-reflecting wall, ceiling, and floor surfaces. This procedure allows levels of direct sound energy 8 or 10 db over the reverberant "noise," and can assure high speech intelligibility with directional realism in a reverberant "music acoustics" space. The designer must recognize that the loudspeaker array may have to be quite large to produce the required directional control, unless the range of the system is restricted to high frequencies.

Generalizations that can be considered good workable rules of thumb are: 1. Use central systems when the room acoustics favor high intelligibility without a sound reinforcement system; 2. use distributed systems in low-ceilinged dead spaces; and 3. use either sophisticated directional central systems or low-level distributed systems in reverberant spaces. As always there are exceptions to these generalizations, based upon the other factors in this paper.

#### Background Noise Level

A high background noise level will usually complicate the design of any loudspeaker system and, particularly, a central loudspeaker system. The direct field from even a well-designed central loudspeaker system will usually show between 6 and 10-db variations over the audience area; such a variation may make the system uncomfortably loud in certain locations, while just barely over-riding background noise at others. Also,

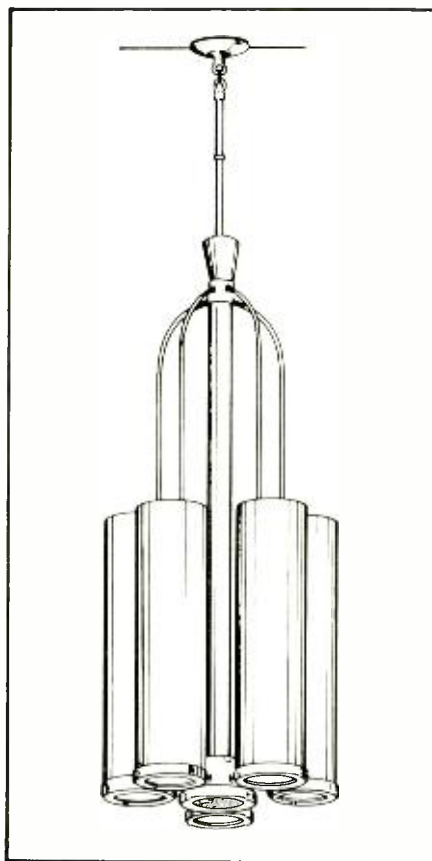

Fig. 7. Combination light fixture and loudspeaker enclosure by Soundolier, Inc.

the central loudspeaker system may not provide the gain required to over-ride a high background noise level without feedback difficulties or ringing. Finally, when a central system is operated at extremely high levels and gain settings, the quality of directional realism is usually lost; consequently central systems are less advantageous in situations where the background noise is high.

Unfortunately, simple "one-number" criteria stating background noise limits for central loudspeaker systems are not possible at this state of the art. Much will depend upon the character of the background noise spectrum, the particular central loudspeaker design that is feasible for a given situation, and the other interrelated factors discussed in this article. Generally, central systems can be successfully used in spaces with up to an NC-45 noise criteria curve,<sup>4</sup> but there are many exceptions. The author has heard a coliseum central loudspeaker system over-ride crowd noise, during sports events, where levels were in the range of 85-95 db (broadband). The background noise level may have more influence on the type of loud-

<sup>4</sup> Noise criteria curves were described briefly in "Controlling Sound Reinforcement Systems" in the December issue and are more fully covered in the chapter on sound control in the current ASHRAE Guide.

speakers used (cone-type or horn-type) then on the type of application.

#### Appearance Considerations

After considering the three preceding factors, there will remain a large number of spaces, perhaps even a majority, in which either a central loudspeaker solution or a distributed loudspeaker system can be used. Architectural considerations may ultimately resolve the decision between which of the two basic loudspeaker system classifications is best.

With either central or distributed systems the designer must carefully explore with the architect all possible loudspeaker locations that can insure an effective system. The author has seen central loudspeaker clusters successfully installed in church pulpit canopies, pulpit and lectern fronts, behind ceiling and wall grilles, and even completely exposed. Sound-transparent loudspeaker and enclosure grilles can be designed to blend with the surrounding room materials, may duplicate (visually) other items in the ceiling design (e.g. ventilating grilles), or may even form a decorative motif. Functional exposure of a large central loudspeaker cluster may be accomplished with only minor changes or non-functional additions to the loudspeaker equipment, making such clusters pieces of sculpture.

The central loudspeaker cluster at TWA's Idlewild Terminal illustrates a space where architectural considerations dictated the use of a central loudspeaker cluster. Airport terminals usually are best served with distributed loudspeaker systems, insuring the most even coverage and a match to the distributed characteristics of the noise they must over-ride. However, the architects, Eero Saarinen and Associates, wished to minimize ceiling projections. One suspended loudspeaker fixture could be tolerated, and the architects worked with system designers to produce a piece of sculpture that enclosed the necessary central loudspeaker equipment and provided the required sound-transparent openings. (See Fig. 6.)

Most architects have come to accept ceiling penetrations, especially in acoustic tile ceilings; and this accounts for the wide popularity of distributed ceiling-mounted loudspeaker systems. In high-ceilinged reverberant spaces, loudspeakers must be lowered well below the ceiling, usually to within twelve or fourteen feet of the audience, and some type of suspended loudspeaker fixture is usually necessary. Often the loudspeaker and lighting fixtures may be combined. Figure 7 shows such a fixture for a church distributed loudspeaker system.

As a last resort, when the architect

(Continued on page 47)



# Class-D For Efficiency

A summary of the operation and theory of Class-D audio amplifiers using switching techniques, with design information and several working circuits

PETER A. STARK

IN THREE PARTS—PART ONE

## What is Class D?

No, don't try to look it up. The phrase "Class D" is not commonly used, and so you won't find it listed unless you know where to look.<sup>1,2</sup> But the use of the term Class D to describe this type of operation is perfectly logical, and is in fact an outgrowth of the commonly-used Class A, Class B and so on, as we shall see.

The words Class A, Class B, and such date back many years and are used to describe the operating conditions of an amplifier, whether it be a tube or a transistor. But since most of the readers' knowledge about classes of amplifiers probably dates back to pre-transistor days, let's use the tube terminology in reviewing.

A Class-A tube amplifier is designed in such a way that we have plate current during the entire cycle of the signal; thus we have plate current all the time. Since there is a certain voltage drop across the tube at all times, there is also a power loss in the tube, and this power loss exists even when there is no signal being amplified, although it may not be the same as when a signal exists. Now, it turns out (and there is no reason to go through the derivations) that the theoretical maximum efficiency of a Class-A amplifier is 50 per cent, even though we rarely achieve this maximum. The remaining power applied to the circuit is absorbed by the tube and never reaches the load. The typical Class-A amplifier therefore has the following disadvantages: (1) The tube must be able to dissipate at least as much power as the circuit is rated to deliver to the load; (2) the tube gets very hot; and (3) the circuit needs a lot of power from the power supply. For this reason we rarely use Class-A amplifiers for power amplification, even though properly designed amplifiers using Class A have extremely low distortion. Instead, we try to use some other class of operation.

And so we come to Class B. In this class of operation, we bias the tube so that we have plate current during one half of the signal cycle. This sort of circuit produces a large amount of distortion, and so we usually use a push-pull amplifier where the other tube supplies the missing part of the signal cycle. The maximum theoretical efficiency of a Class-B audio amplifier is approxi-

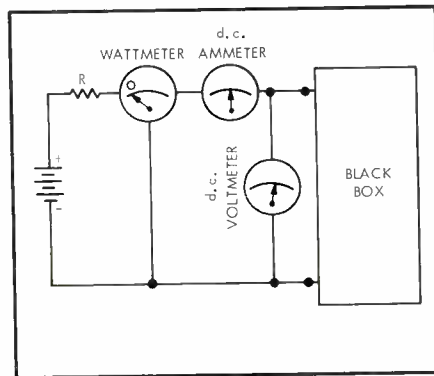

Fig. 1. A class-D black box.

mately 75 per cent. Since it is often difficult to produce a smooth transition between the two half-cycles supplied by the tubes in the push-pull circuit, most low distortion circuits use Class AB<sub>1</sub> or AB<sub>2</sub> amplification, which provides a combination of Class-A and Class-B characteristics: lower distortion than Class B, but better efficiency than Class A.

Then we have Class C. In this class of amplification we bias the tube so that there is plate current for less than half of the signal cycle. As a result, however, even two tubes in push-pull still can't supply a complete cycle, therefore the distortion is so high that Class C cannot be used in audio or in any other wide-band low-distortion application. But it is widely used in radio-frequency circuits, where tuned circuits reduce distortion (harmonics), and where efficiencies of more than 75 per cent are highly desirable.

Note that the maximum theoretical obtainable efficiency has been rising as we go from Class A to Class B and then to Class C. And so, if we should have an amplifier whose theoretical efficiency approaches 100 per cent it would be only natural to call it Class D, especially if its high efficiency could in some way be attributed to its biasing. As it turns out, this is indeed the case.

This type of Class-D amplifier can be made with either tubes or transistors, or even with other kinds of devices. But it isn't economical, or even practical, to use tubes or other vacuum or gaseous devices. And so, despite the fact that the

idea of a Class-D amplifier is almost a quarter of a century old (it was patented as early as 1931, I believe, though under a different name<sup>3</sup>), it has never caught on until the advent of transistors and other semiconductors. Even now, efficiencies of anywhere near 100 per cent are difficult to achieve using semiconductors within the price reach of the average audiofan unless he uses extremely complicated and sophisticated circuitry to get around the limitations of available semiconductors. But this situation is undoubtedly only temporary.

Having switched our thinking into semiconductor terms, let's now ask the following question: How can we connect a transistor either in series or in parallel with a load (such as a speaker) in such a way that the transistor can control the voltage and current in the load without itself dissipating any power? This seems to be impossible.

## A Class-D Black Box

The circuit of Fig. 1 is a "Black Box" puzzle which has appeared in various forms in many magazines and books, and it goes like this: The black box contains some sort of electrical device. When the black box is connected in series with a battery and resistor, there is some current through the black box, and some voltage drop exists across the box terminals. We measure these by inserting a voltmeter across the box and an ammeter in series. Let us also connect a wattmeter as shown. Now, if the wattmeter indicates zero watts, what is inside the black box?

This raises the problem of how can the voltmeter and the ammeter indicate some readings, implying that there is a power loss inside the box equal to the product of the voltage times the current, when the wattmeter reads zero? This is a contradiction.

The trick is to examine the wattmeter. A wattmeter is an electro-mechanical computer which calculates the power by multiplying the *instantaneous* voltage by *instantaneous* current. The wattmeter can read zero only when at every instant of time, either the current or the voltage is zero, or both. Yet neither the voltage nor the current can constantly be zero, since the corresponding meter would then read zero, and this is not so.

The only alternative is that the voltage

and the current alternate at being zero. This sort of behavior is possible if the black box contains a switch which is being rapidly opened and closed by a vibrator, a motor-driven cam, or some other device. When the switch is open, the current is zero and the product of current and voltage is zero. When the switch is closed the voltage is zero, so that the product of voltage and current is again zero. The wattmeter therefore reads zero. The voltmeter and the ammeter, on the other hand, read the average of the open-switch and closed-switch values of voltage and current. Regardless of how fast or how slow the switch operates, or even regardless of the ratio of the open-switch time to the closed-switch time, the wattmeter always indicates zero and the dissipation inside the black box is zero, although the voltmeter and ammeter readings may change.

But let's now look at resistor  $R$ . When the switch inside the black box is open, there is no current in the circuit and there is no power loss in the resistor. On the other hand, when the switch inside the black box is closed, the full battery voltage appears across the resistor. The current through the resistor is therefore equal to  $E/R$ , and the power loss in the resistor is  $E^2/R$ . When the switch alternately opens and closes, the average power loss in the resistor is somewhere between zero and  $E^2/R$  watts. The important thing to notice is that the average power loss in the resistor can be made any value between zero and  $E^2/R$  watts merely by varying the ratio of the open-switch to the closed-switch times.

For example, if the open-switch and closed-switch times are equal (i.e., each one is 50 per cent of the cycle), then the average power,  $P_{av}$ , dissipated in the resistor is

$$P_{av} = 0.5 (0) + 0.5 (E^2/R) = 0.5 (E^2/R).$$

On the other hand, if the open-switch time is 40 per cent of the cycle and the closed-switch time is 60 per cent of the cycle, then

$$P_{av} = 0.4 (0) + 0.6 (E^2/R) = 0.6 (E^2/R)$$

and so on. The black box is therefore a lossless device for controlling the average power applied to the resistor.

Note that the average power as defined above can exist only when measured over at least one cycle of switch operation. Any measurement of average power cannot change any faster than the time it takes to switch through one cycle. The switch operating speed must therefore be faster than the fastest desired change in the average power dissipated in the resistor, and should preferably be at least several times as fast.

The preceding paragraph is very important, because it leads to the conclusion that if we wish to change the average power loss in the resistor very rapidly, we must make the switch inside the black box operate even more rapidly. In fact, we can control the average power applied to the resistor at an audio frequency by making the switch operate in the ultrasonic frequency range. If we then substitute a loudspeaker for the resistor, and if we figure out some way

of controlling the behavior of the switch with an applied audio signal, we have devised a lossless audio amplifier.

Well, controlling the behavior of the switch with an audio signal isn't that easy. First of all, we obviously can't use a mechanical switch, but must use instead some device capable of operating at ultrasonic speeds. Transistors and other semiconductors fill the bill quite nicely. The opening and closing of the switch can therefore be easily represented by some sort of pulse signal, which in turn must be modulated in some way by an audio signal.

### Which Type of Modulation?

Having decided that some sort of modulation of a pulse signal is required, it's time to examine the kinds of modulation that are available.

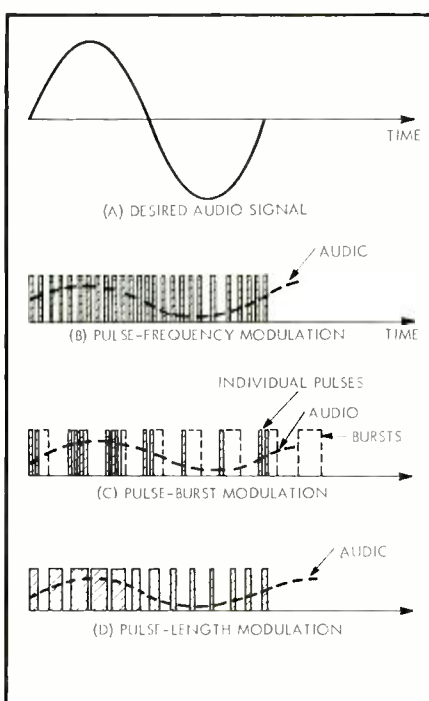

Fig. 2. Comparison of pulse-frequency, burst, and length modulations.

Modulating a pulse signal is in many ways similar to modulating a sine wave in a broadcast transmitter—that is, the signal must be changed in a systematic manner, where the changed signal is in some way related to the modulating signal. This includes changing the height (amplitude) of the pulses, changing their frequency (number of pulses per second), or changing their phase (with respect to some standard phase). As in the case of sine waves, we might consider sending the pulses in bursts, where the modulation determines the number of pulses in each burst. Or we might try varying the length of each pulse so that its length is proportional to the instantaneous value of the modulating signal (a technique which can't be used with sine waves). Or we might try some combination of the above methods.

To make a reasonable choice from the above, we must look at some desirable characteristics of our pulse signal. The method of modulation should be simple

to produce, should be compatible with the characteristics of the transistors in their switching mode, should require a relatively narrow bandwidth, and should be easy to convert back to the audio signal at the speaker. Based on these desirable characteristics, we can easily eliminate most of the modulating methods mentioned above.

In order to use the switching characteristics of the transistors as in our black box example, we must use them so that they are fully on or fully off at all times, with no intermediate states. When the transistor is fully on, it is said to be saturated. In this state it has what is called a saturation resistance on the order of several ohms or less, depending on the type of transistor, and a voltage drop from collector to emitter of about one volt or less, again depending on the type of transistor, even with relatively large collector currents. As a result of the low voltage drop, the power dissipated within the transistor is quite small.

When the transistor is turned fully off, it is said to be cut off. In this state it acts very much like a completely open circuit except that it has a very slight leakage (of the order of a few microamperes) from emitter to collector. As a result of the very small current, the power dissipated within the transistor is again quite small.

Any other operating point of the transistor, however, means an intermediate state—one where appreciable voltage and appreciable current both exist in the transistor, so that the power dissipated in the transistor is no longer negligible. This is what makes these intermediate states undesirable. As a result, these switching characteristics make it difficult to produce pulses with varying amplitudes. The amplitude modulation of pulses does not therefore provide the best use of the transistors (or most other semiconductors, for that matter).

We can also rule out phase modulation, since this type of modulation is not easy to recover at the speaker—it requires the use of a phase reference as well as other quite complicated circuitry. This signal recovery is not what we need. What we do need is a system of modulation which can be changed back to an audio signal simply by averaging, as in the black box example. This really involves the use of an integrator circuit which integrates (or sums) the pulses to provide an average signal. Such an integrator is really a low-pass filter.

The phase-modulated pulse signal can't be converted back into an audio signal by being passed through a low-pass filter. But the remaining types of modulation—the frequency-modulated pulses, the length-modulated pulses, and the pulse bursts—can be so recovered. We should therefore compare these with each other to see which might be best for our purpose.

Figure 2 shows a typical audio sine wave as it might be modulated using pulse frequency, pulse burst, and pulse length modulation. We immediately notice two characteristics: in pulse-frequency and pulse-burst modulation, all of the pulses are of the same length but



their spacing is different, and the number of pulses in a given length of time depends on the modulating signal. In this way these two modulation methods are very similar to each other, the only difference being the different grouping of the pulses in the burst modulation. The length modulation case is quite different, however, since the number of pulses in a given length of time is constant, but the length of each pulse varies with the modulation.

By looking at Fig. 2, we can also see that the audio signal is really proportional to the area under the pulses—the dashed areas. The same area is produced either by using many narrow pulses, or by using a few wide ones; this is really the difference between the kinds of modulation. The recovered audio signal, shown by dotted lines, is then proportional to the average area under the pulses. The low-pass filter or integrating network we mentioned a few paragraphs back is really nothing but an area measuring circuit—after all, integration is really nothing but a continuous measurement of areas under a curve.

If all three of the modulations are satisfactory in this respect and all of them have the audio signal as their average, which one do we pick? We can at this point return to some of the other criteria for a modulating system which we stated earlier: the modulation should be simple to produce, and should have a relatively narrow bandwidth. The criterion of simplicity eliminates pulse-burst modulation. This type of modulation is really inherently harder to produce than the others, because it requires two kinds of pulses: the wide ones which define the burst (the dashed pulses in Fig. 2C), and the narrow ones which are within the burst. These two pulses have to be produced together, which requires more equipment.

The final choice between pulse-frequency modulation and pulse-length modulation can be made quite easily on the basis of bandwidth. An old rule of thumb states that the more kinks a waveform has, the more high-frequency components it has. The pulse-frequency signal of Fig. 2B therefore would need a circuit which can respond to much higher frequencies than those required by the signal of 2D, whereas the lowest frequencies would still stay the same: more bandwidth.

As a result of the above reasoning, we have chosen pulse-length modulation as the best means of satisfying our requirements. But wait—we still aren't through: there are at least three important kinds of pulse-length modulation as shown in Fig. 3. There are the two kinds where only one edge of the pulse is modulated (either the trailing edge or the leading edge) to vary the length, and the case where both edges are modulated. Without going any further, we might immediately suspect that double-edge modulation might for some reason be preferable, merely because each edge only has to be modulated one half as much as in single-edge modulation to increase the area of a single pulse by a given amount.

And this turns out to be an interesting

point. One thing we still haven't looked into is the kind of spectrum, or frequency distribution, that such a series of modulated pulses might take up. Let's therefore digress for a moment and look into this side of the matter.

### Modulation Sidebands

In a standard amplitude-modulation broadcast transmitter with a broadcast frequency of, say, 1000 kc, the transmitter is actually transmitting frequencies other than just the simple 1000 kc carrier. As soon as a modulation is placed on the carrier, an entire series of other frequencies, called sidebands, is generated. In the case of amplitude modulation these sidebands are simple—they merely consist of the sum and difference frequencies between the carrier and the modulating signal.<sup>4</sup> For example, if the transmitter is transmitting a 1 kc test

frequencies—though the frequencies far removed from the carrier frequency have very low amplitudes.<sup>5, 6, 7</sup> After a certain point they are so small that they may be ignored without much loss, though this does result in a slight increase in distortion. A further irregularity in frequency modulation is that, at certain ratios of modulating frequency and amplitude, some of the sidebands (and sometimes even the carrier itself) disappear. To sum up, frequency modulation produces extremely wide sidebands which are spread out over a wide frequency range.

Now, how does all of this affect our modulated pulses? Well, it turns out that in many ways these length-modulated pulses behave like a complex type of frequency modulation; they also have sidebands extending far to both sides of the basic pulse repetition frequency.

Looking at Fig. 3B we see that the unmodulated pulses form a square wave. Such a square wave can be built up of harmonically related sine waves, with the lowest frequency sine wave having the same frequency as the square wave, and all other sine waves being odd harmonics of the first.<sup>8</sup> The amplitude of the sine waves falls as the frequency rises, so that although the spectrum theoretically extends infinitely high in frequency, after a while the harmonics have such a low amplitude that they can be neglected. The unmodulated pulse waveform therefore has many frequencies above the basic repetition frequency.

As soon as we modulate the basic square wave to produce one of the modulated pulse waveforms in Fig. 3 we complicate the picture further. We have now an entire collection of pulses whose lengths range from almost zero to some value about twice the length of the original unmodulated pulses. Each of these pulses has its own frequency distribution or spectrum, and each could almost be treated as though the others didn't exist.

But here is where we run into trouble. As long as we consider a continuous, symmetrical square wave, our only frequency components are sine waves with odd harmonics (including the first) of the pulse repetition frequency. But as soon as we start to consider a waveform consisting of non-equal pulses, we get a waveform which has a frequency spectrum consisting of frequencies both above and below the pulse repetition frequency. And this is in fact the case with the modulated pulse signals of Fig. 3.<sup>9-10</sup> One of the components of this frequency spectrum happens to be the audio signal which we will then recover by means of a low-pass filter. But it so happens that there are other low-frequency components which can lead to distortion.

Suppose we merely amplitude modulated an audio signal of 20-20,000 cps into a carrier frequency of, say, 50 kc. The spectrum of the modulated signal would then extend from 30 kc to 70 kc. If we then mixed the audio signal with the modulated signal, the highest frequency of the audio signal would still be below the lowest frequency of the modulated signal, and the two would not interfere with each other.

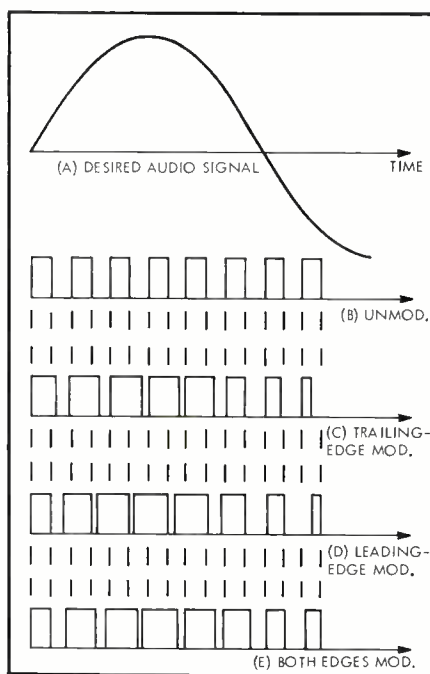

Fig. 3. Three types of pulse-length modulation.

tone, then the broadcast signal consists of the 1000 kc carrier, plus a difference frequency (called a lower sideband) of 999 kc, and a sum frequency (called an upper sideband) of 1001 kc. The total bandwidth required is therefore twice the modulating frequency, in this case from 999 to 1001 kc. For audio modulation to 10 kc, the bandwidth is 20 kc and extends from 990 to 1010 kc. A receiver tuned to receive this station must be able to receive these frequencies; a receiver tuned to another station must be able to reject them.

With other types of modulation the picture is less simple. For example, in frequency modulation the transmitter is also broadcasting a carrier and two sidebands. But, and here lies the difference, the sidebands consist of more than just the sum and difference frequencies. In fact, the sidebands are infinitely large since the sidebands consist of frequencies which extend infinitely far in both directions—towards higher and lower

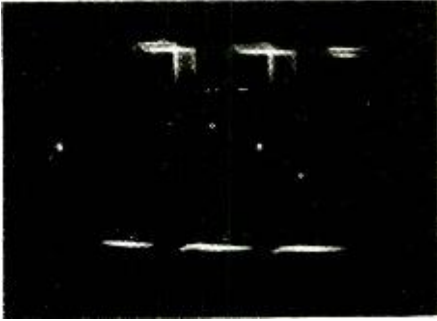

Fig. 4. Appearance of double-edge length-modulated pulses.

But suppose we try to modulate the same audio signal upon a 50 ke pulse signal using length modulation. Depending on the exact kind of modulation and the amount of modulation, we might easily get sidebands which extend 40 or 50 ke to either side of the 50 ke carrier. This means that the modulated spectrum will interfere with the audio signal. After we pass the signal through a low-pass filter and then through a loud-speaker, the part of the spectrum above some 17 ke is of little practical interest since we can't hear it (unless it causes other troubles), but the part below 17 ke can cause trouble. It is quite possible than an 8 ke audio note produces a sideband frequency at 10 ke. Since this is not a harmonic of the original 8 ke, it won't be hidden by the already-existing harmonics in the signal, but will stand out like a sore thumb.

And so we must try to reduce the undesirable effects of the modulation sidebands on the audible signal. There are two ways of doing this. One is to try to pick a type of modulation which has few lower sidebands, and the other is to raise the pulse repetition frequency of the pulses to the point where all (or most) of the undesirable sidebands fall above the audible region.

Though we won't go through the mathematical proof, it has been shown<sup>10</sup> that the double-edge modulation method of Fig. 3E has fewer lower sideband frequencies than the single-edge modulation methods of 3C and 3D. For this reason, double-edge modulation is preferable, especially since there is a limit to the maximum frequency we can make the pulse signal before we run into other difficulties.

When we look at individual modulated pulses with an oscilloscope, they look as shown in Fig. 4. The fuzziness on the vertical edges is caused by the continual shift of these edges by the modulation.

Having decided on the type of pulse modulation to use in our Class-D amplifier, the next problem is how to produce it.

#### Types of Modulators

There are several methods of producing pulse-length modulation. The most common is to start with a basic triangular or sawtooth wave and use this wave in combination with the applied audio signal to turn a voltage-sensitive stage on and off. This method has been described elsewhere,<sup>1, 2, 11</sup> but a quick review of it may prove helpful. (Anyone familiar with the Serrasoid method of

frequency modulation will quickly recognize the similarity!)

The waveforms involved in this method are shown in Fig. 5. In (A) of Fig. 5, we see the superimposed audio and triangular wave signals. This mixture has two basic characteristics. One is that there are clearly defined instants of time when the two signals have the same amplitude—that is, the two waveshapes cross. A circuit can be devised which switches back and forth between two states (say, *on* and *off*) whenever the two signals are equal. Such a circuit might be termed a coincidence circuit. The other characteristic is that, except at these crossover points, one signal is always larger than the other, and the order of their magnitudes changes at the crossover points. For example, at the beginning of the waveshapes shown (point A), the tri-

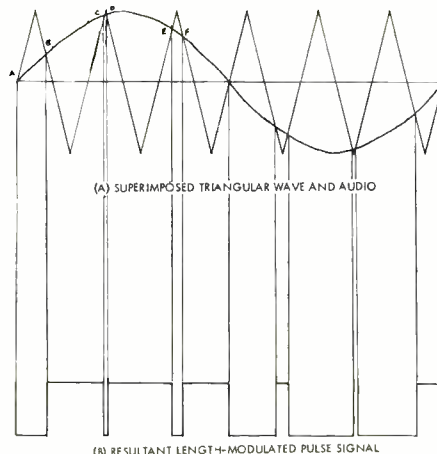

Fig. 5. Generating a pulse-length-modulated signal using a triangular wave.

angular wave has a greater amplitude, but at point B they reverse and the audio has a greater amplitude. Then at point C they switch again and the triangular wave is again larger, and so on. This characteristic can also be used to generate a modulated signal, by using a circuit which switches to one state when the audio signal is larger than the triangular signal, and switches to the other state when the triangular wave is larger than the audio signal. The resultant signal is shown in B of Fig. 5.

Now let's look at the type of modulation. Suppose that the audio signal were

zero—this corresponds to the horizontal line in 5A. By using the same process as before, we would get a modulated signal whose positive and negative halves would be equally long (a symmetrical square wave). But using an audio signal as shown in this figure results in uneven positive and negative portions of the pulse signal, with both the rising and the falling edges being shifted—this is therefore double-edge modulation. But obviously we can produce both types of single-edge modulation merely by using a sawtooth wave instead of a triangular wave in the modulator circuit. The difference is that in the triangular wave both the rising and the falling parts of the wave are slanted, whereas in the sawtooth wave one of the two is vertical. The result is that the sawtooth goes slowly in one direction and then rapidly snaps back. Only one edge of the resulting pulse signal is therefore modulated, since the other edge is the result of the intersection of the vertical edge with the audio signal, and this happens at the same time in every cycle, regardless of the audio voltage. Whether the modulated edge of the pulse is the leading or the falling edge depends on the polarity of the sawtooth wave. Similarly, note that an unsymmetrical triangular wave (one which takes longer to rise than to fall, or vice versa) will produce a combination of single-edge and double-edge modulation. This means that we can probably tolerate some unbalance in the triangular wave without undue degradation in audio quality.

Let's now examine some circuits which can be used to produce length modulation from audio and triangular waves, starting with the circuits which work on comparing the relative magnitudes of the two signals.

#### Long-Tailed Pair

The first circuit is shown in Fig. 6, and is called a long-tailed pair. Transistor  $Q_1$  is an emitter follower which accepts the triangular wave and applies it across resistor  $R_3$ . This is essentially a low-impedance output feeding the emitter of  $Q_2$ , and the signal here is almost a replica of the triangular wave except for its slightly lower amplitude, since the emitter follower amplifier has a voltage gain less than 1.

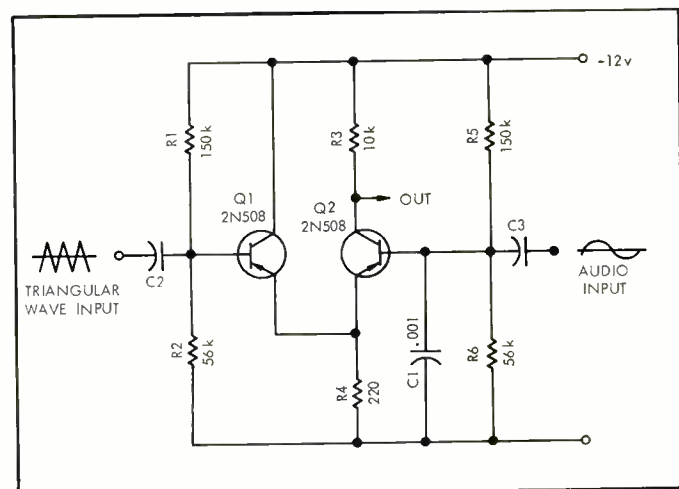

Fig. 6. Long-tailed pair pulse modulator.



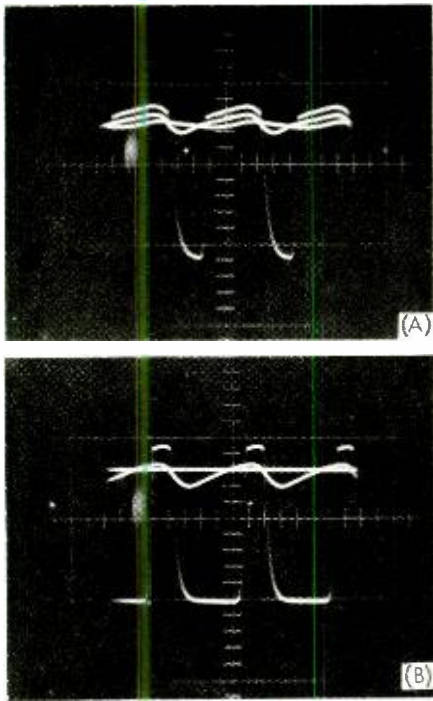

Fig. 7. Long-tailed pair modulator waveforms near modulation extremes.

Transistor  $Q_2$  is a pnp unit which conducts only if the base is negative with respect to the emitter (to be a little more exact, the base has to be about 0.5 volt more negative, and the exact value depends on the current through the transistor). As a result, the transistor is biased on only when the applied audio input signal to  $Q_2$  is more negative than the triangular input applied to the emitter through  $Q_1$ . When the transistor conducts the collector current is approximately 1 ma. and the collector voltage is therefore about -2 volts.

As soon as the triangular wave becomes more negative, the forward bias on  $Q_2$  decreases until the emitter is more negative than the base and  $Q_2$  cuts off. The collector current is therefore almost zero, and the collector voltage of  $Q_2$  is about -12 volts. The output of the circuit is therefore about -2 volts whenever the audio signal is more negative than the triangular wave, and is about -12 volts whenever the audio signal is more positive than the triangular wave. The length of the negative (-12 volt) portion of the pulse depends therefore on the length of time that the audio signal is more positive than the triangular wave. Except for a phase reversal, we have therefore generated the modulated pulse shown in Fig. 5.

But as it turns out, the circuit is relatively slow acting. This is due to several causes. For one, the region between full-on and full-off for transistor  $Q_2$  is rather wide, and there is a portion of the triangular wave when the wave is slowly changing through the transition region. The output pulses from the modulator do not therefore have the steep rise and steep fall of the wave shown in (B) of Fig. 5, but instead each pulse increases slowly and decreases slowly. Some waveshaping is therefore required at the output of the modulator, because these transition regions are undesirable.

There is also a further reason for the slow response of the circuit, and that is because the emitter currents of  $Q_1$  and  $Q_2$  both flow through resistor  $R_1$ . Suppose that the circuit is at the stage where  $Q_2$  is still off, but is about to come on due to the fact that the triangular wave input to the emitter of  $Q_2$  is just becoming positive. As  $Q_2$  slowly turns on, its emitter current will also flow through  $R_1$ . But this emitter current makes the emitter more negative—it actually opposes the effect of the triangular wave. This increases the response time of the circuit even more. This particular effect on the circuit can be minimized by making  $R_1$  large as in this circuit, but then the output current swing is not enough to drive the next stage without additional amplification.

One further disadvantage of the circuit is that the base current is dependent on the base-emitter voltage of both transistors. In the case of  $Q_2$ , the base-emitter voltage swings over both positive and negative values, with the result that there are large variations in the base current of  $Q_2$ . This means that the triangular wave appears at the base of  $Q_2$  and has to be filtered out to prevent even further slowing down of circuit operation. This is done by capacitor  $C_1$ , which filters out the high-frequency triangular wave. But the value of the capacitor must be chosen carefully to prevent filtering of the audio signal, and preferably, the audio signal should be applied through a low-impedance source.

Unfortunately, the slow response of the circuit also limits the maximum amount of modulation that can be achieved by the circuit; this can clearly be seen in Fig. 7, which shows the waveforms in the circuit at two values of audio input.

Figure 7A shows the waveforms when the audio input voltage is momentarily negative. The center, relatively straight, line is the instantaneous level of the audio signal. The triangular wave shown

(which is unsymmetrical and almost approaches a sawtooth in these particular photographs) is the wave present at the emitter of  $Q_2$ . The large pulse signal is the signal at the collector of  $Q_2$  with no load.

Several characteristics can be seen in the figure. For one, the tops of the pulse output signal follow very closely the shape of the triangular wave; this is due to the fact that the transistor is saturated and there exists an almost constant emitter-collector voltage, so that the collector voltage must follow the emitter voltage.

The second characteristic is that the fall time (time required for the output to fall) is relatively large, and that the output waveshape follows the exponential curve. This means that if the negative-going pulse is decreased much more in width, the negative pulse also isn't going to be as large. The circuit just doesn't have the time to drop all the way down. The waveforms shown are therefore quite close to the maximum amount of modulation permitted with a negative audio voltage before irregularities occur, resulting in distortion.

Pretty much the same thing occurs in B of Fig. 7, except that in this case the maximum modulation is limited by the need to produce complete saturation in  $Q_2$ . If the audio input voltage is made much more positive the base-emitter voltage of the transistor during the on time of  $Q_2$  (the positive or upward portions of the output wave) falls so low that the transistor starts to go out of saturation, and the amplitude of the output falls.

#### Diode Comparison

This disadvantage of the long-tailed pair circuit leads to a variation of it called the Schmidt trigger, but before we look into it let's examine yet another circuit which works on the comparison of the magnitudes of the audio and tri-

(Continued on page 44)

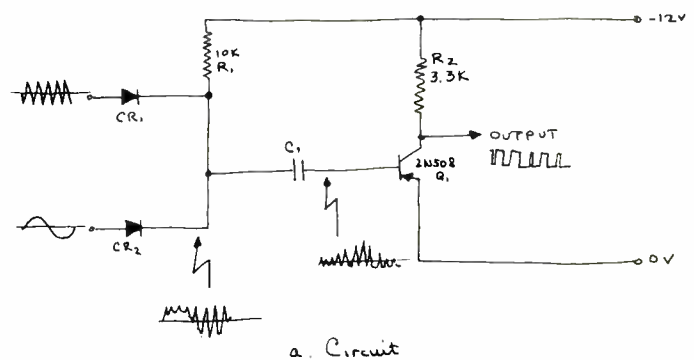
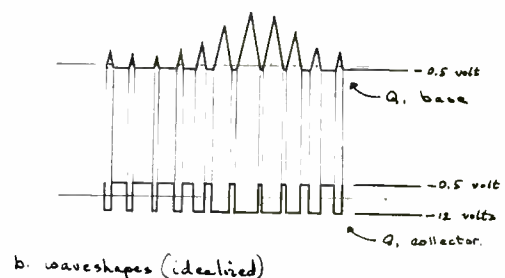

Fig. 8. Pulse modulator using diode comparison.



# Telstar-Shaped Electrostatic Speaker

Electrostatic speakers are best built in 3- or 4-way systems for best impedance matching and efficiency.

R. J. MATTHYS\*

## IN TWO PARTS—PART 2

### III. Speaker Construction

#### Speaker Units

Electrostatic speaker units are easy to make. The construction of the author's tweeter is shown in *Fig. 9* through 12. For convenience the tweeter units are made in groups of six. The dimensions of one group of six tweeters are shown in *Fig. 9*. Each diaphragm is rectangular, with a size of approximately 1.6 × 1.8-in. and a fundamental resonance of about 350 cps. The mechanical assembly of one group of six tweeters is shown in the cross-section views in *Fig. 10A* and *B*. *Figure 10C* and *D* shows the mechanical details of the grid spacers.

Each tweeter group consists of a stretched Saran Wrap diaphragm spaced midway between two grids of 1/16-in. diameter brass rods, using two pieces of 0.015-in. thick Cadco high-impact polystyrene as airgap spacers to maintain the two airgaps at precisely 0.015-in. each. The diaphragm, the airgap spacers, and the brass grids are held together between two stiff mounting frames of 1/8-in. thick epoxy-glass laminate. The assembly is held together with 4–40 screws. The input capacitance between the two push-pull plates is 122 pf for each group of six tweeters.

To put a graphite coating on the diaphragm, the diaphragm is stretched out on a sheet of masonite, and pulled semitaut with Scotch tape around the edges. A very thin layer of Dixon's Microfyne graphite is applied to the diaphragm and rubbed in vigorously using Kleenex. Graphite is added until the diaphragm resistance measures about 10 to 100 megohms with the ohmmeter probes about one-half to one inch apart on the diaphragm surface. The coating should be uniform, and this is checked by moving the two ohmmeter probes in parallel across the diaphragm surface in several

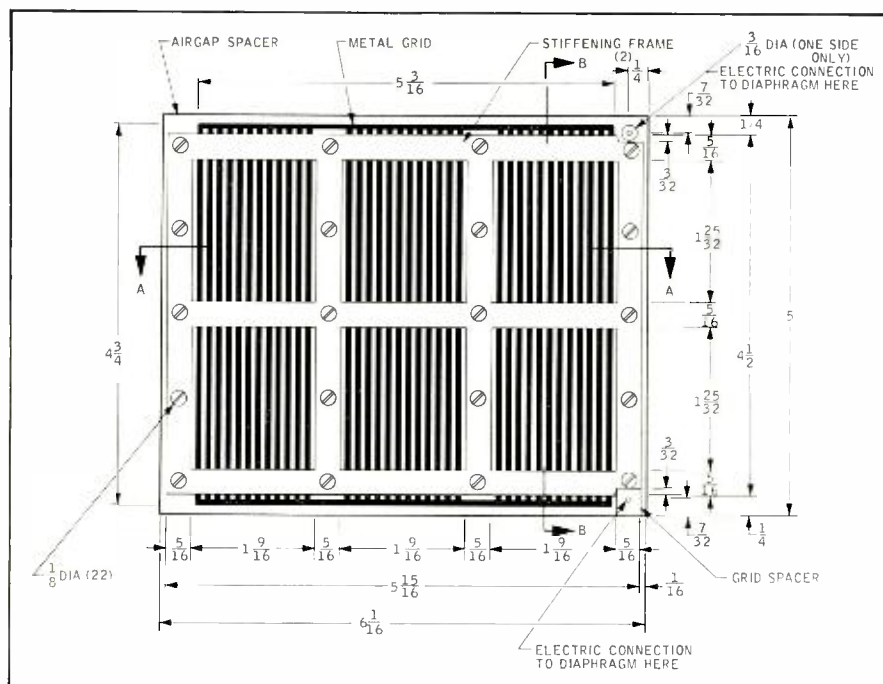

Fig. 9. Mechanical dimensions of a group of six electrostatic tweeters.

directions. If too much graphite is used the diaphragm resistance will be too low. Any excess graphite is removed by rubbing the diaphragm vigorously with Kleenex. In practice, the resistance of the diaphragm coating does not seem to be critical. When the resistance of the coating is satisfactory, the diaphragm is turned over and graphite is applied to the other side in the same manner.

To avoid shorting out the airgap spacers, the graphite operation should be performed in a separate area and your hands washed immediately afterwards, especially before handling the airgap spacers. One sweaty fingerprint loaded with graphite placed across the edge of one of the airgap spacers will provide a high resistance leakage path across the spacer and short out the dia-

phragm bias supply. It must be remembered that there is a very high resistance in series with the de bias supply, and a high leakage resistance across one of the airgap spacers will act as a partial short on the bias supply.

To keep the diaphragm tightly stretched in the speaker assembly, the diaphragm is cemented to one of the airgap spacers. The diaphragm, which is still stretched out on the masonite hardboard, is first pulled taut by applying more Scotch tape around the edges of the Saran. One of the airgap spacers is then laid on the stretched diaphragm and cement is applied around the outside edge of the airgap spacer. The location of the cement on the airgap spacer is important, and is shown in *Fig. 10A* and *B*. The cement must be kept off



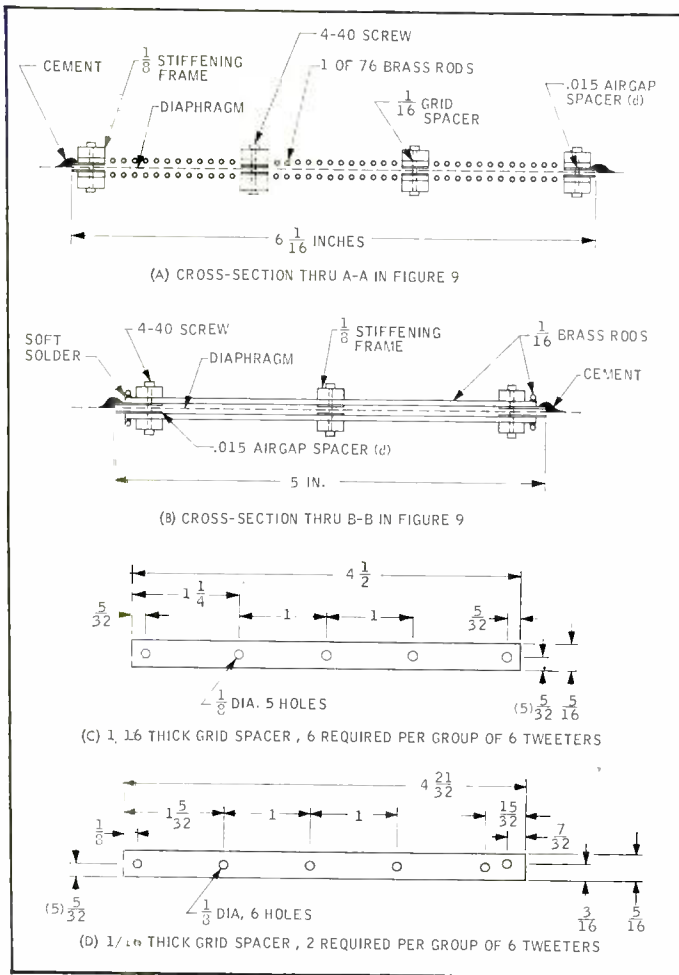

Fig. 10. (A) and (B) are cross-sections through the tweeter group shown in Fig. 9, and (C) and (D) give the mechanical dimensions of the grid spacers needed.

sure they are the correct size and uniform in thickness.

Electrical connections to the graphite coatings on the diaphragm are made by means of two screws in the upper right and lower right corners of the tweeter frame as shown in Fig. 9. An oversized hole is cut through the airgap spacer and the stiffening frame on one side in the corner of the frame, as shown in Fig. 9, so that the screw head contacts the graphite coating on the plastic diaphragm. In similar fashion a second screw makes contact to the graphite coating on the other side. The electrical diaphragm connections may be seen a little clearer in Fig. 12 where the two diaphragm connecting screws are shown with soldering lugs attached to them.

#### Crossover Network and Bias Supply

The tweeter crossover network is shown in Fig. 13. The 0.25-hy air core inductor was wound by hand, and its dimensions are given in Fig. 14. The high voltage bias supply is shown in Fig. 15. The crossover network and the bias supply were placed in a 6×11×13-in. wood box instead of a metal box so as not to affect the air core inductor. Connection to the amplifier was made by means of a socket on the rear of the amplifier chassis. The plates of the amplifier output tubes were connected to this socket. Disconnecting the crossover network at this socket makes the amplifier available for other purposes when desired.

#### Mounting the Tweeter

The electrostatic tweeter described here was designed for a two-way corner speaker system using two 15-inch moving coil woofers which the author had on hand. The complete tweeter array is shown in Fig. 16 and contains a total of 72 individual tweeters. To eliminate directional effects each group of six tweeters is mounted facing in a slightly different direction so as to form an approximately spherical surface covering

the spacer surfaces that determine the 0.015-in. airgap spacing, otherwise the airgap will not be uniform.

Each of the push-pull metal grids consists of a parallel array of 1/16-in. diameter brass rods spaced by 1/8-in. intervals. They are soldered together into a grid by means of two brass rods soldered across the two ends of the grid, as shown in Fig. 11. All of the rods in the array must be very straight and in the same plane to obtain a uniform airgap. If one of the rods should be closer than the others to the diaphragm, voltage breakdown will occur at that point. This will limit the bias voltage that can be applied to the speaker, and as a result the speaker's efficiency will be reduced.

Because straight brass rod is hard to find it is necessary to test each rod for straightness. An easy test is to roll them one by one across a flat surface, such as a piece of plate glass, and watch for "cracks of light" under the rods. Only 70 per cent of the rod material obtained by the author was usable. To insure that all of the grid rods lie in the same plane, they are clamped between two flat plates during the soldering operation as shown in Fig. 11. Although not necessary, the spacing between rods can be made uniform by placing short extra rods as spacers in the gaps between the rods during the soldering operation. The extra

rods are removed after the soldering operation.

The airgap spacers are cut from a sheet of plastic 0.015-in. thick with scissors and a razor blade. Burrs along the edges of the diaphragm openings are scraped off with a razor blade. The grid spacers are cut from sheets of epoxy-glass laminate 1/16-in. thick. They must be the same thickness as the brass rods. Because sheets of plastic vary in thickness, especially near the edges, the thickness of the airgap and grid spacers must be measured with a micrometer to make

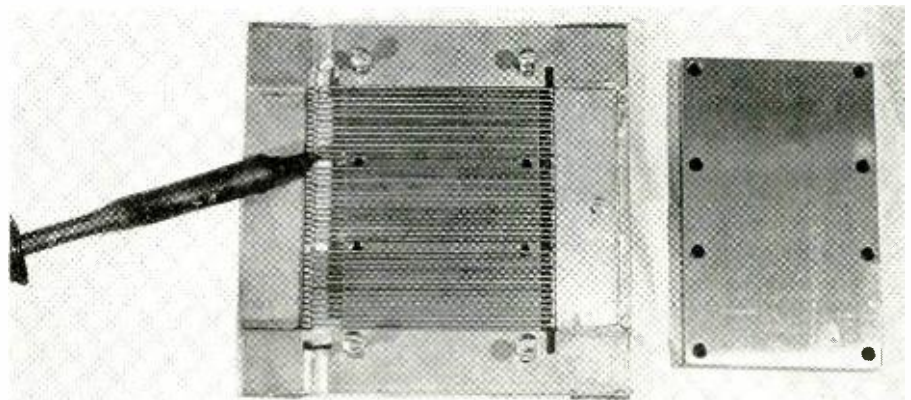

Fig. 11. The brass rods are clamped between two flat plates during the soldering operation. A thin brass frame encircles the brass rods between the two plates and holds them in position for soldering.

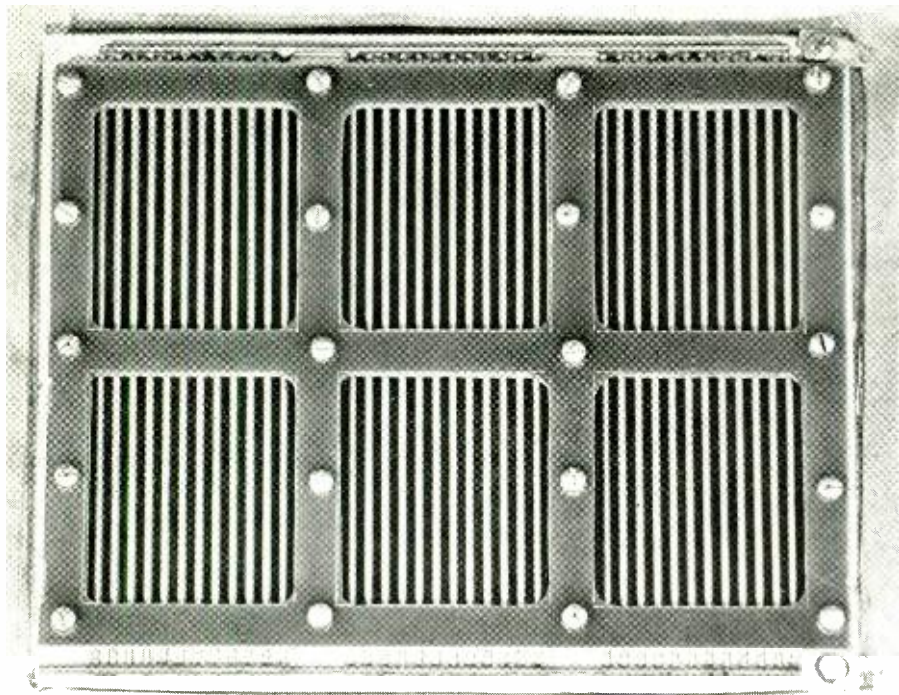

Fig. 12. A group of six electrostatic tweeters.

a solid angle of 90-deg. x 60-deg. To do this the tweeters are first attached to a flexible sheet of 3/64 phenolic-cloth laminate. Six V-shaped slits are made between the tweeters along the top and bottom edges of the sheet which is then bent backward and fastened to five vertical 3/4 inch dowels, as shown in Fig. 16. The dowels fasten the tweeter array into a recess in the front wall of a 50 cu. ft. bass reflex cabinet. The dimensions of the flexible mounting sheet are shown in Fig. 17. The tweeter recess is covered with a plastic grille cloth to make it more decorative.

#### Tools Needed

The 500-cps tweeter can be made by almost any hi-fi hobbyist in his basement workshop. The few tools needed are:

1. Coping saw or jig saw to cut out the stiffening frames.
2. Inexpensive 0-1 inch micrometer to

measure thickness of the airgap and grid spacers.

3. 100-watt soldering iron for soldering the brass rods into grids.
4. D.c. VTVM-ohmmeter to measure the resistance of the diaphragm coatings and the diaphragm bias voltage.
5. D.c. high voltage accessory probe for the above.
6. A homemade clamping jig (two flat plates) to hold the brass rods in a flat plane while being soldered into grids.
7. 1 ft. x 1 ft. piece of plate glass for testing the straightness of brass rods.
8. 2 ft. x 2 ft. piece of Masonite hard-board to hold each diaphragm stretched out flat while applying the graphite coating.

If you want to build a full range electrostatic or redesign the tweeter described here, an audio oscillator and an

a.c. VTVM will also be needed to measure the frequency response and input impedance of the crossover networks, the input capacitance of the speaker elements, the leakage inductance of the stepup transformer(s), and the fundamental resonant frequencies of the diaphragms.

#### Cost

The electrostatic speaker units, by themselves, cost very little to make. One 5 x 6-in. group of six tweeters cost the author \$2.50 each. Almost all of the cost is for the stiffening frames. Using phenolic-cotton laminate instead of epoxy-glass laminate for the stiffening frames would reduce cost to about \$1.50 per group of six tweeters, and if tempered masonite were used, the cost would drop to about \$0.75 per group of six tweeters.

Parts for the high-voltage power supply cost \$6 at the local surplus store.

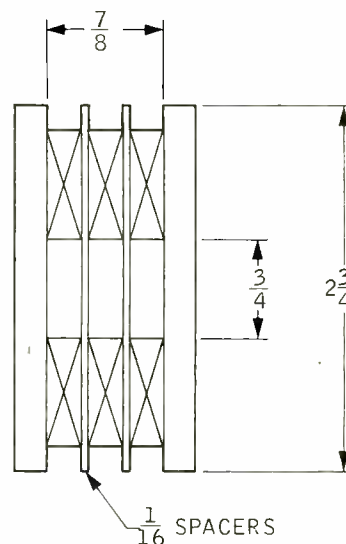

Fig. 14. The 0.25-hy air-core inductance shown here has 3600 turns of No. 32 wire (1/2 lb.), wound in three sections of 1200 turns each to reduce the winding capacitance.

Parts for the crossover network came from the junk box except for the air core inductor, the wire for which cost \$1. The only expensive item in the tweeter is the stepup transformer costing \$24.

This gives a total of \$40 for a 72-unit tweeter array, using tempered masonite for the stiffening frames. The cost of making a full range three-way system is estimated at \$120 to \$150. In comparing this cost to a moving-coil speaker system, remember that the full range electrostatic does not need a speaker cabinet.

#### Speaker Materials

The selection of the right plastic for the various parts of the speaker is im-

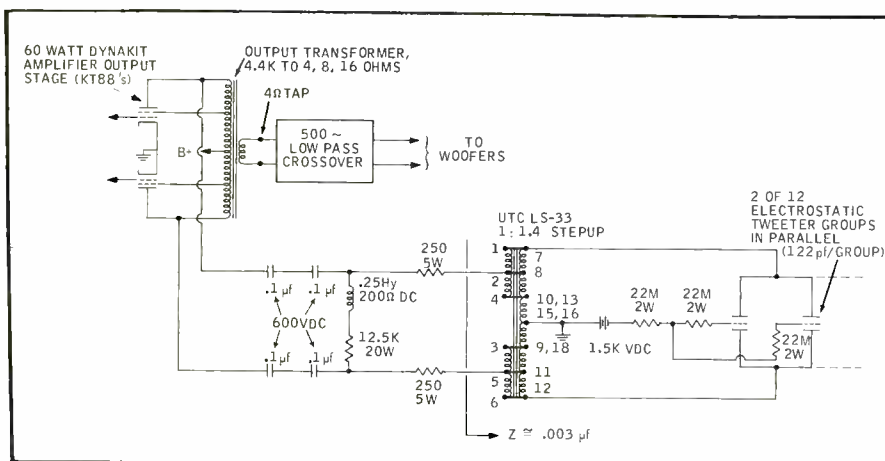

Fig. 13. Crossover network for the 500-cps electrostatic tweeter.



# A MAJOR BREAK-THROUGH IN SOUND PURITY

... BY **SHURE**

THE SOUND FROM THE NEW SHURE V-15 STEREO DYNETIC® CARTRIDGE WITH ITS REVOLUTIONARY BI-RADIAL ELLIPTICAL STYLUS HAS NEVER BEFORE BEEN HEARD OUTSIDE AUDIO LABORATORIES

by S. N. SHURE, President, Shure Brothers, Inc.

The sound from the new Shure V-15 Stereo Dynetic Cartridge is unique. The unit incorporates highly disciplined refinements in design and manufacture that were considered "beyond the state of the art" as recently as the late summer of 1963. The V-15 performance specifications and design considerations are heady stuff—even among engineers. They probably cannot be assimilated by anyone who is not a knowledgeable audiophile, yet the sound is such that the critical listener, with or without technical knowledge, can appreciate the significant nature of the V-15 music re-creation superiority. It is to be made in limited quantities, and because of the incredibly close tolerances and singularly rigid inspection techniques involved, it is not inexpensive. Perfection never is.

## THE BI-RADIAL ELLIPTICAL STYLUS

The outstanding characteristic is that the V-15 Stylus has two different radii . . . hence the designation Bi-Radial. One is a broad frontal plane radius of 22.5 microns (.0009 inch); while the actual contact radii on each side of the stylus are an incredibly fine 5 microns (.0002 inch). It would be impossible to reduce the contact radius of a conventional spherical/conical stylus to this micro-miniature dimension without subjecting the entire stylus to "bottoming" in the record grooves.

The Shure Bi-Radial elliptical stylus, because of its larger frontal radius of 22.5 microns (.0009 inch), cannot bottom . . . and as you know, bottoming reproduces the crackling noise of the grit and static dust that in practice cannot be eliminated from the canyons of record grooves.

## TRACING DISTORTION MINIMIZED

The prime objective in faithful sound re-creation is to have the playback stylus move in exactly the same way as the wedge-shaped cutting stylus moved when it produced the master record. This can't be accomplished with a spherical/conical stylus because the points of tangency (or points of contact between the record grooves and the stylus) are constantly changing. This effect manifests itself as tracing distortion (sometimes called "inner groove distortion"). Note in the illustration below how the points of tangency (arrows) of the Bi-Radial elliptical stylus remain relatively constant because of the very small 5 micron (.0002 inch) side contact radii:

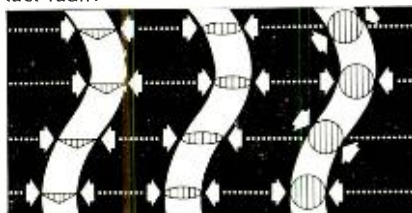

Cutter      Elliptical      Conical

The Shure Bi-Radial Stylus vastly reduces another problem in playback known as the "pinch effect." As experienced audiophiles know, the record grooves are wider wherever and whenever the flat, chisel-faced cutting stylus changes directions (which is 440 cycles per second at a pure middle "A" tone—up to 20,000 cycles per second in some of the high overtones). An ordinary spherical/conical stylus riding the upper portion of the groove walls tends to drop where the groove gets wider, and to rise as the groove narrows. Since stereo styli and cartridges have both vertical and horizontal functions, this unfortunate and unwanted up-and-down motion creates a second harmonic distortion. The new Shure Bi-Radial elliptical stylus, on the other hand, looks like this riding a record groove:



You'll note that even though it has a broad front face with a frontal plane radius of 22.5 microns (.0009 inch), and it measures 30 microns (.0012 inch) across at the point of contact with the groove, the small side or contact radii are only 5 microns (.0002 inch). This conforms to the configuration of the cutting stylus and hence is not as subject to the up-and-down vagaries of the so-called "pinch-effect."

## SYMMETRY, TOLERANCES AND POSITIONING ARE ULTRA-CRITICAL

Frankly, a Bi-Radial elliptical stylus, however desirable, is almost impossibly difficult to make CORRECTLY. Diamond, as you know, is the hardest material . . . with a rating of 10 on the Mohs hardness scale. It's one thing to make a simple diamond cone, altogether another to make a perfectly symmetrical Bi-Radial stylus with sufficiently close tolerances, actually within one ten thousandth of an inch! Shure has developed unprecedented controls, inspections and manufacturing techniques to assure precise positioning, configuration, dimensions and tolerances of the diamond tip. It is a singular and exacting procedure . . . unique in the high fidelity cartridge industry. And, unless these inspection techniques and safeguards are used, an imperfectly formed elliptical configuration can result and literally do more

harm than good to both record and sound.

## THE V-15 IS A 15° CARTRIDGE

The 15° effective tracking angle has recently been the subject of several Shure communications to the audiophile. It conforms to the effective record cutting angle of 15° proposed by the RIAA and EIA and now used by the major record producing companies and thereby minimizes tracking distortion.

The major features, then, of the V-15 are the Shure Bi-Radial Elliptical Stylus, the singular quality control techniques and standards devised to produce perfection of stylus symmetry, and the 15° tracking angle. They combine to reduce IM and harmonic distortion to a dramatic new low. In fact, the distortion (at normal record playing velocities) is lower than the inherent noise level of the finest test records and laboratory measurement instruments! In extensive listening tests, the V-15 proved most impressive in its "trackability." It consistently proved capable of tracking the most difficult, heavily modulated passages at a minimum force of 3/4 grams (in the Shure-SME tone arm). The entire V-15 is hand-crafted and subject to quality control and inspection measures that result in space-age reliability. Precision machined aluminum and a special ultra-stable plastic stylus grip. Exact alignment is assured in every internal detail—and in mounting. Mu-metal hum shield surrounds the sensitive coils. The V-15 is a patented moving-magnet device—a connoisseur's cartridge in every detail.

## SPECIFICATIONS

The basic specifications are what you'd expect the premier Shure cartridge to reflect: 20 to 20,000 cps., 6 mv output. Over 25 db separation.  $25 \times 10^{-6}$  cm. per dyne compliance. 3/4 gram tracking. 47,000 ohms impedance, 680 millihenries inductance per channel. 650 ohms resistance. Bi-Radial diamond stylus: 22.5 microns (.0009 inch) frontal radius, 5 microns (.0002 inch) side contact radii, 30 microns (.0012 inch) wide between record contact points.

But most important, it re-creates music with a transcendent purity that results in a deeply rewarding experience for the critical ear.

Manufactured under U.S. Patents 3,055,988; 3,077,521 and 3,077,522. Other Patents Pending.

V-15 Cartridge—\$62.50 net  
Replacement stylus VN-2E—\$25.00 net

SHURE BROTHERS, INC.  
222 Hartrey Avenue, Evanston, Illinois

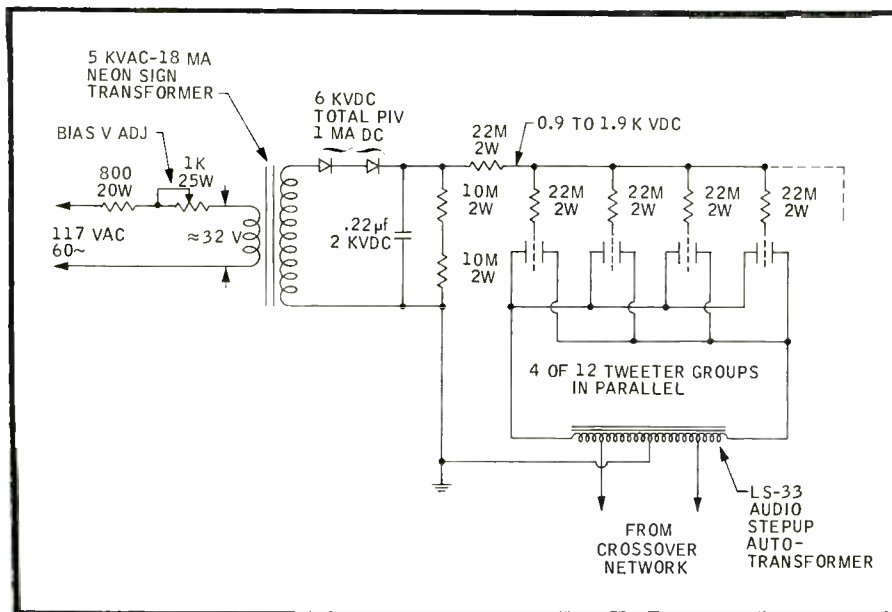

Fig. 15. High voltage bias supply.

portant. Many plastics were tested to determine which was best for the various parts of the speaker.

The diaphragm must be tough, tear resistant, and have a low mass-per-unit-area. Mylar and Saran Wrap are suitable diaphragm materials. The 1/4-mil (0.00025-in.) thick Mylar has less mass-per-unit-area, and consequently it has a slightly higher cutoff frequency than Saran Wrap, but the author was unable to get a uniform resistance coating on Mylar. Mylar also gave trouble with wrinkles and creases when graphite was applied to it. Saran Wrap, 0.4-mil (0.0004-in.) thick, is very cheap and is available from any grocery store. Saran shrinks when heat is applied, and this turns out to be useful in tightening the diaphragm to attain a specific resonant frequency. The writer has used both an electric hot plate and hot air from an electric hair dryer to shrink diaphragms. The key to successful shrinking seems

to be many "warm" passes over the heat source rather than one "hot" pass.

The airgap spacers should be a stiff low-creep material with a low dielectric constant, and it should not "track." Tracking means that the material will form a carbon track along the path of an arc over. If the speaker should happen to arc over, and a carbon track occurred, the track would make a high resistance leakage path across the airgap and short out the diaphragm bias supply.

The dielectric constant of the airgap spacers directly affects the amount of shunt capacitance in the speaker mounting frame, and hence affects the speaker's efficiency. Doubling the dielectric constant doubles the amplifier power wasted in the frame capacitance. Poly-

styrene, high-impact polystyrene, Lexan, Delrin, and epoxy-glass laminate are suitable materials for airgap spacers. Delrin is the best material if cost is no object because of its mechanical stiffness, stability, and (apparently) the lowest creep of any thermo-plastic. It has the disadvantage that its dielectric constant is a little high (3.7). Epoxy laminated with glass cloth also has the disadvantage of a high dielectric constant (5.8). Lexan is stiff and mechanically stable, but its edge "burrs over" when cut and this warps the diaphragm out of flat. Polystyrene is a very good material because of its low dielectric constant (2.6) and very high insulation resistance, but it is not available any thinner than 1/32 of an inch. The author used Cadeo high impact polystyrene, which is rather soft mechanically but has the advantages of a low dielectric constant (about 3.0) and low cost.

The grid spacers should have very high mechanical stiffness and be dimensionally stable. Either epoxy-glass laminate or phenolic-cloth laminate are good materials for grid spacers.

The stiffening frames should be the stiffest possible material at lowest cost. The stiffening frames should not be too thick or they will act as "tunnels" to the sound coming from the diaphragm. Although epoxy-glass laminate is the most rigid of any suitable material, it also is the most expensive and dulls cutting tools very rapidly. The best material for stiffening frames appears to be phenolic-cloth laminate. For a big speaker with several woofers, tempered masonite hardboard would be a good choice because of lower cost.

The adhesive used to fasten dia-  
(Continued on page 47)

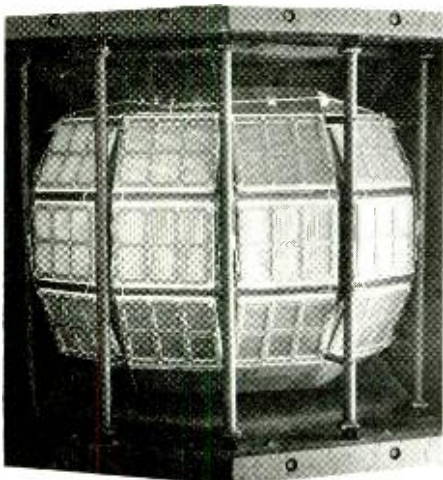

Fig. 16. Array of 72 electrostatic tweeters mounted in a recessed area in the front wall of a 50 cu. ft. bass reflex speaker cabinet.

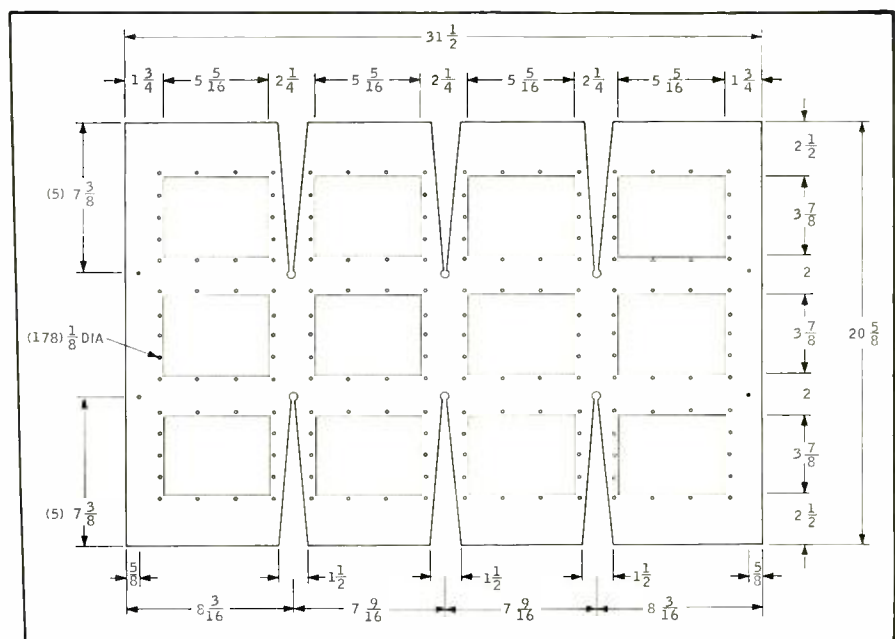

Fig. 17. Dimensions of the flexible tweeter mounting sheet. The linen bakelite sheet is 3/64-in. thick.



# A Basic Course In Commercial Sound

NORMAN H. CROWHURST

## CHAPTER III

### Using a Horn's Directivity

The commonest situation where directivity can help equalize level at different distances is with the simple re-entrant-horn type of speaker (*Fig. 3-1*). This

type has a strongly directional radiation pattern, concentrating most of the sound output close to the axis of the unit. By placing the unit as shown, members of the audience nearer the speaker receive a 'spillover' which leaves

the unit at considerably lower intensity than that directed toward the rear. The higher intensity directed back there is reduced by inverse-square law, so that the level is quite close to uniform throughout the area served. A

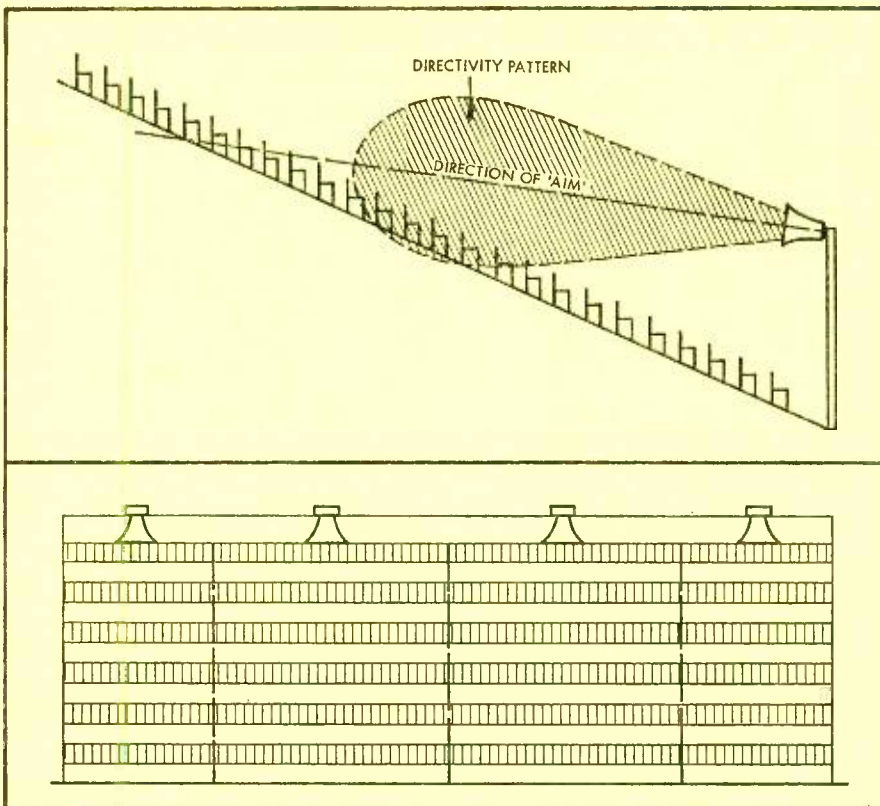

Fig. 3-1. Directing a re-entrant horn speaker so as to use its directivity to obtain uniformity of level over a maximum area.

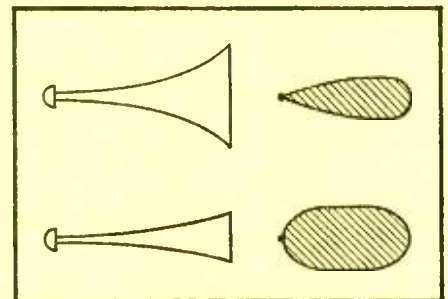

Fig. 3-2. Directivity patterns of the "older" flat rectangular horn.

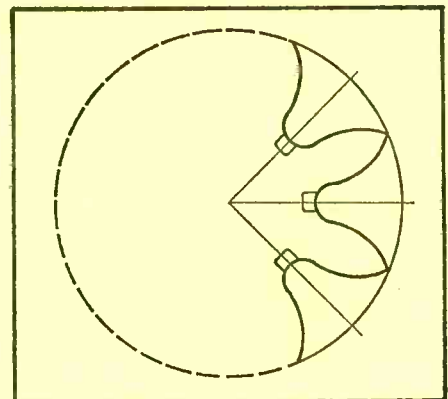

Fig. 3-3. Using the interlocking type re-entrant horns to achieve coverage over any desired angle, up to 360 deg.

succession of such units, arranged with suitable spacing, can serve a large arena, baseball park, stadium-type audience very effectively.

Rectangular horns are also available, but a word of caution here: the earlier type of unit does not radiate the kind of pattern the mouth shape would imply. At one time these units were popular for mounting on the roof of sound trucks—and some of them are still seen. The useful feature is that they reduce wind resistance. But the regular round type is much more efficient

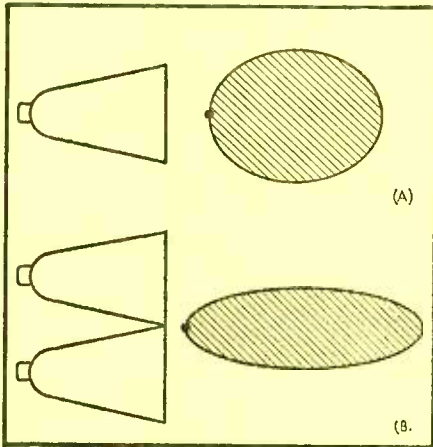

Fig. 3-4. Stacking these small directional horns will increase their directivity in the vertical plane, concentrating more of the sound in the horizontal plane.

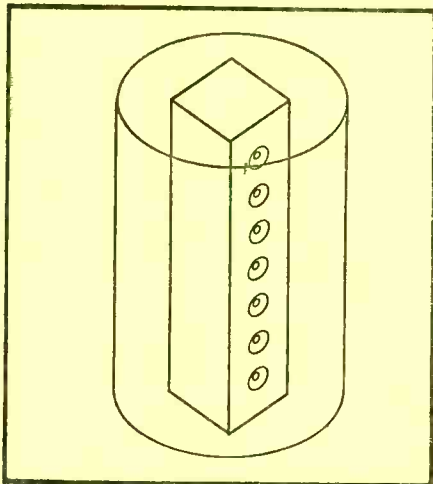

Fig. 3-5. A 'line radiator' array can be regarded as producing a cylindrical radiation pattern, rather than the spherical one produced by a simple unit (both in approximate terms).

for reaching an audience distributed on the ground around the truck, because the flat mounting results in the wrong directivity pattern.

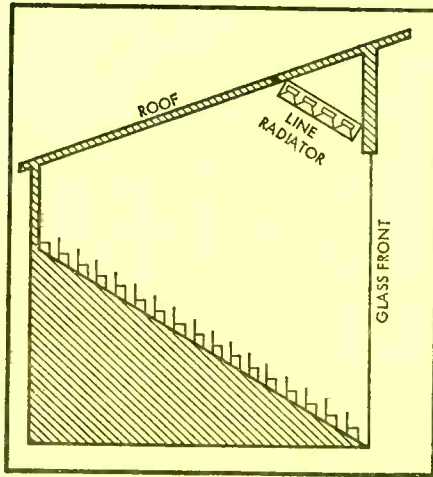

Fig. 3-6. One kind of installation where the line radiator array is very helpful, in avoiding unwanted reflections and echo effects.

A flat horn of this type behaves as a slot radiator, over the important, intelligence-conveying range of frequencies, with a narrow beam the long way of the slot, and a wide one crossways (Fig. 3-2). To be effective for reaching an audience distributed on ground level, it should be mounted with the mouth vertical, which rather destroys the convenience of its shape for roof mounting.

Some more modern units, including the rectangular interlocking type made by some manufacturers, serve a different purpose. Either the development changes 'flare rate' between the two dimensions (vertical and horizontal) before the wave reaches the mouth, or the basic horn is a simple re-entrant, which forms an adequately directional column before the mouth is reached, as well. Mounting the interlocking type together in clusters can build up any desired form of area coverage, up to 360 deg. (Fig 3-3,

where 135-deg. coverage is shown, by three units).

If maximum efficiency of coverage in a horizontal plane is wanted, improvement can be achieved by stacking (Fig. 3-4) which concentrates more of the radiated energy in a horizontal plane, as well as enabling a greater output to be obtained, if needed.

### Fabricated Directivity

For indoor use, directional speakers can be fabricated by use of a number of units in the same box. The so-called 'line radiators' are manufactured assemblies that do this. The easiest way to visualize the way these work is to think of the line as being the center line of a cylinder, the curved surface of which is served with sound (Fig. 3-5).

Places where such assemblies can be used are virtually endless, but a good example is the closed-front type of stadium stand, which is becoming more popular in new construction. The glass-paneled front may keep out the weather, but it also keeps in the sound, and the dimensions are large enough to cause trouble, in the form of multiple echo effects.

The roof reflects and so does the front glass. By directing these line radiator units at the audience (Fig. 3-6), sound does not strike either roof or front pane, until it's already fed the audience, which will absorb most of it. Here the function of the directional effect is as much to prevent sound going where it can cause trouble, as it is to put it where it's wanted.

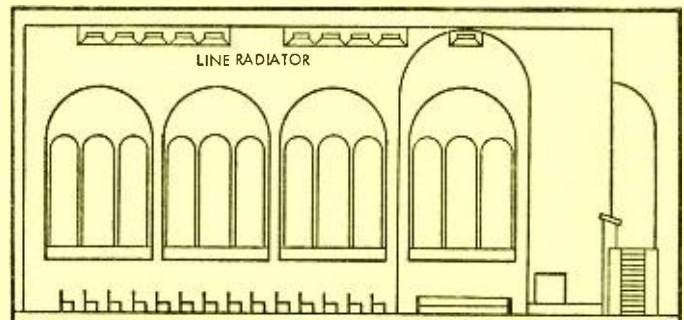

Fig. 3-7. Applying the idea of Fig. 3-6 to a traditional church building might lead to this, which while acoustically good, is psychologically poor.



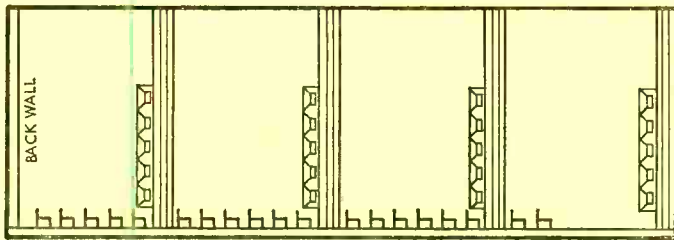

Fig. 3-8. The better way of treating the church installation of Fig. 3-7.

Churches, particularly the older, cathedral-like variety, are another problem for the sound man. Following the previous example, a logical notion might seem to be to put the speakers high in the roof (Fig. 3-7). While some men of the cloth might think it interesting to have their words seem to come directly from heaven, it's not a pleasant illusion from the listener's viewpoint!

Here line radiators can help keep the sound 'on the ground' (Fig. 3-8). An advantage of the line radiator is that it effectively changes the inverse-square law to a simple inverse law: the area of the curved surface of a cylinder is directly proportional to radius, not to radius squared, as with the surface of a sphere.

Viewed another way, the radiated energy comes from the whole length of the line, rather than from a single unit, or "point." Any point along the line radiates comparatively low intensity (only a fraction of the total from that unit) and the whole radiation is concentrated into a flat, expanding ring. If you listen close to a line radiator, it seems incredible that the sound level heard at a distance can be originating from speaker units all operating so quietly.

### Delay Systems

Even so, in large, highly vaulted churches, sound may still be a problem. The vertical walls at the 'back' act as an almost perfect sound mirror, and then the fact that diminution follows simple inverse, rather than inverse-square, becomes a disadvantage! Echo from the back walls becomes troublesome. A method that is quite effective, if rather

costly, is to introduce delay into the sound feed, enabling very low level distribution to be achieved, while retaining good audibility.

Sound starts from the front, close by the rostrum, with only sufficient level to reach part way back—little louder, if any, than natural voice. As sound attenuates with distance, it is reinforced, by making the sound reaching that point louder, not adding more of the original sound at this point. Suppose reinforcement is made every 30 feet: each successive speaker group will radiate the same sound, with successive delays of 30 milliseconds between each group, so 'new' sound is in phase with sound coming from units nearer the front (Fig. 3-9),

In this way a relatively quiet, quite audible sound reaches the back with insufficient energy to bounce back with serious echo effect. The reflected sound is attenuated in its travel, where the original 'forward' wave was artificially maintained. Where the reflected wave still has comparable intensity, the time difference

is small. Where the time difference is big enough to make an echo effect, the reflected wave is attenuated enough not to matter.

The problem with this kind of system is cost. As well as a fairly expensive delay system, which will usually be a tape deck using an endless loop of tape, running at a speed such that short delays can be represented by heads at reasonable spacing, each speaker group needs a separate amplifier to drive it. Little audio power is needed, but much more than the usual electronic input circuitry.

As mentioned in the first installment, a very important aspect of church installations is that they be unobtrusive. In a large church installation, of the type just described, a convenient disguise for the speaker assemblies may well be the support columns for the roof. These will often be of sculptured form and a modification of the design, with some 'thickening' at the base, can make room for a slim, line-radiator type assembly, at and slightly above audience ear level, in each column.

The direction from which the sound apparently comes, and the relative freedom from apparent echo, will lead the audience to a very good illusion that the sound comes directly from the officiating minister. There should be just enough echo to give the church its characteristic quality,

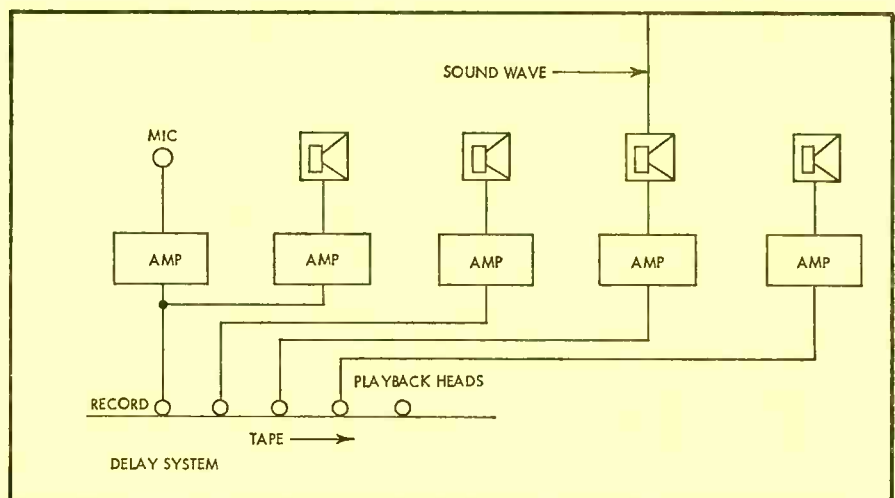

Fig. 3-9. The delay system to be used with the arrangement of Fig. 3-8, to achieve further, very considerable reduction in echo effect.

or 'tone,' without making listening arduous.

Without the delay system, the time difference between sounds from different speaker units, as the sound reaches any one audience position, actually aggravates the apparent natural echo acoustics of the building. Sound coming directly from further speaker units, without even reflecting from the walls, will sound to audience like an echo of that from nearer units. The delay prevents this effect, and also minimizes the actual reverberation effect, by keeping sound level to a minimum at all points.

As we implied in this example, the delay should be about a millisecond per foot, because sound travels at a little more than 1000 feet per second. Actually, the error resulting from this approximation assumes sound travels slightly more slowly than it actually does, and thus provides a slight margin to avoid a 'double image' effect. Hearing the more distant source only one or two milliseconds ahead of the local one, serves to enhance the illusion of true source and thus minimize the obtrusiveness of the reinforcement.

To get the delay, a tape deck will give the best quality. As an endless loop is used, being repeatedly demagnetized and recorded, use of low-speed tape transport is of no advantage, except maybe for reducing wear. If the transport speed is 30 inches per second, then each inch of space along the tape will represent  $1000/30$ , or 33 feet space for sound travel. If speaker spacing is at 30 foot intervals, the head spacing should be about 0.9", which is conveniently possible, with modern, small size heads. Speeds less than 30 inches per second are hardly practical.

### Question—Chapter III

It should be fairly obvious that correct phasing of individual units in a line radiator array is important: all the diaphragms should move back and forth in unison, to simulate a line sound source acting all at the same time. In systems where many speaker systems are used, is phasing important beyond this 'internal' aspect, or are the distances involved such

that precise phasing of one speaker unit relative to another is unimportant?

You may answer, yes, phasing is always important; no, phasing is never important, except between units in an individual assembly, such as the line radiator; or you may think that sometimes it is and sometimes it is not important. Try to formulate your own rules about this, then read the answer.

### Answer—Chapter III

How you answer this will quite likely depend to some extent on your experience, or on what you have read previously on this subject. The correct answer was the last one. Sometimes it is, and sometimes it is not important.

Let us assume that our system is the last one discussed—a church installation with a delay system—and that the columns on which speaker arrays are mounted are in pairs. Because of the symmetry of the column pairs, it is important for each pair of arrays to be in phase. Incorrect connection would result in cancellation and loss of apparent source direction (from the front), particularly in the area between the pairs of columns. But as

there is a 10 millisecond delay between sound signal fed to successive pairs, the precise phasing of one pair compared to the next can scarcely be critical like that between each unit of a pair.

Now, can we extend this argument to other kinds of system? Give the matter some thought, and see whether your deductions agree with the more detailed discussion in the next installment. Another question we shall consider, and about which you might like to devote thought meanwhile, is how to check for correct phasing in an installed system, apart from using the phase markings supplied by the manufacturer, or in those installations where electrical phasing proves to differ from correct acoustical phasing.

### WHAT DO YOU THINK?

Is this course useful to you?

Want it to continue?

Write: D. Saslaw, Editor



# EQUIPMENT

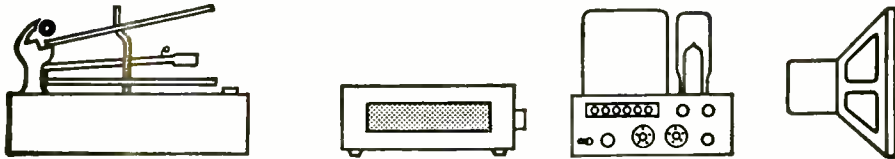

# PROFILE

## JBL "OLYMPUS" LOUDSPEAKER SYSTEM, MODEL C-50

The James B. Lansing "Olympus" is truly a thing of beauty to behold. Its carved-wood front grille and well-proportioned lines have that quality which enhances furnishings of almost any design persuasion.

The Olympus contains what JBL calls the S-7 Linear Efficiency System. The S-7 consists of an LE-15 15-in. woofer, an LE-85 high-frequency driver; which is used with an HL-91 exponentially-tapered cast-aluminum horn coupled to an acoustic lens. The crossover network, LX-5, crosses over at 500 cps.

For those who have forgotten about the acoustic lens, it is a device for diffracting and dispersing high frequencies in a manner similar to some optical lenses. Thus the sound waves are spread evenly instead of "beaming," as would be the case if the lens were not used. James B. Lansing has been making these acoustic lenses for a long time, and they work very well indeed. It certainly worked well on the Olympus we received.

Another note to explain what JBL means by "linear-efficiency." Simply, they mean a long-throw speaker with linear response. Obviously, a cone which undergoes a long excursion requires a voice coil which will do likewise, and stay in the linear part of the magnetic field all the while. If it went slightly beyond the magnetic field, it would produce non-linear movement since the field strength varies non-linearly at that point. Another source of non-linearity may be the voice-coil centering device (spider). Both factors make it very difficult to achieve a linear long-throw speaker.

Unquestionably James B. Lansing has succeeded if we judge by the Olympus. In listening tests we heard a remarkably rich bottom end, with nary a trace of overblown fullness. Clean and rich. The top end, as noted, is well dispersed and beautifully matched to the bottom. A fine speaker system with a beautiful appearance. **F15**



## DYNACO-B & O STEREO RIBBON MICROPHONE, MODEL 200

The Dynaco-B & O Model 200 is a dual-element velocity microphone intended for broadcast and recording applications. In a recent article by Madsen (Apr. 1964), the special value of ribbon microphones for FM-stereo broadcasting was described. The reason given was that FM-stereo broadcasting uses the M-S system of achieving stereo (sum of signals in one channel, and difference in the other).

But the B & O 200 is far more versatile than that; it is also easily usable as an A-B system microphone (separate left and right channels), or even as a monophonic microphone.

The construction of the B & O 200 is the reason for its versatility. From Fig. 2, we can see that the 200 consists of two microphones coaxially mounted, one on top of the other. The upper microphone can be unplugged to make a monophonic recording, or broadcast. In addition, the microphone elements can be switched from in-phase to out-of-phase output. Another switch permits selection of music (wide range), talk (restricted range), or "off." To top it all off, the upper element may be rotated so that the elements are at a 90-deg. angle to one another, or the angle may be reduced continuously to zero. Considering the rather modest price tag (about \$150), this microphone (really a set of microphones) is truly a versatile buy.

The pattern of each element, in common with most ribbon microphones, is a figure 8. Output level, in the music position, with the impedance 200 ohms, is -80 db referenced to 1 volt/ $\mu$ bar. In the talk position, response rolls off 3-db per octave below 2000 cps. Frequency response is within 2 db from 30 cps to 13,000 cps as the manufacturer claims. Indeed throughout most of the range it was within 1 db. Altogether the B & O 200 is a fine, versatile, and modestly-priced microphone. **F16**

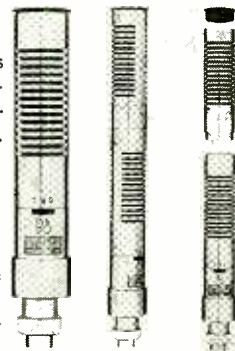

Fig. 1. (Left) James B. Lansing "Olympus" Speaker System, Model C-50.

Fig. 2. (Right) B & O stereo ribbon microphone, Model 200.

## HARMAN-KARDON 1000 SERIES AMPLIFIER, A1000T, AND TUNER, F1000T

### A1000T 70-Watt Stereo Amplifier

The A1000T is a solid-state amplifier featuring an output of 35 watts per channel at less than 1 per cent IM distortion. Another feature of the A1000T is the use of silicon output transistors.

Before discussing the inside workings of the A1000T we would like to take note of the excellent human engineering exhibited by this amplifier. First, and most obvious, is the way the front panel has been laid out to emphasize the most used controls (by size and placement), and deemphasize the less-used ones. For example, we see that the three most prominent control knobs are blend, balance, and gain. Next comes source selection, the bass and treble controls and finally several special-function switches are hidden out of sight behind a fold-down panel. Easy to use, and comfortable.

The circuit, although not unusual in basic configuration, is well worked out. The output stage is called a "totem-pole" con-



Fig. 3. Harman-Kardon 70-watt stereo amplifiers, Model A1000T.

figuration, which is in essence the well-known single-ended push pull. What is a little out of the ordinary is the use of silicon transistors to provide ruggedness, and the Class-A operation at low output levels, with the usual Class-B at high levels. The purpose of the Class-A operation is to eliminate "crossover" distortion from those levels where it would be most disturbing. Darling-ton-connected drivers are used, each driver being stabilized by means of a thermistor. The split-load phase inverter is driven by an emitter follower. A standard voltage-gain stage precedes the emitter follower, each preamplifier section contains 5 transistors and the usual complement of functions. Quite straightforward.

Performance is quite good as indicated by the following: IM distortion (60/7000 cps, 4/1, 8-ohm load less than 0.5 per cent out to 22 watts, then rising to 1 per cent at 36 watts and continuing up; power response at 35 watts, (8-ohm load) and 1 per cent harmonic distortion is within 1 db from 20 cps to 20,000 cps; frequency response is within 1 db from 20 cps to 30,000 cps; power output is within ratings at 4, 8, and 16 ohms; noise is 85-db below rated output; sensitivity, 1.3 mv phono input, 246 mv tuner input. **F17**

### F1000T Tuner

The F1000T is a completely solid-state FM-stereo tuner which seems to have tackled head on the serious problems this breed of animal has exhibited in the past.

In case you haven't heard, a solid-state r.f. stage has been far from successful in the past, especially with the FCC rules allowing more stations and increased power in some existing ones. The F1000T does not seem to exhibit those negative characteristics associated with strong signals, close in frequency.

(Continued on page 49)

# Some plain talk from Eastman Kodak about: oxide needles and sound brilliance

## What makes good tape good? How we push needles around has a lot to do with it.

As exotic as the many performance parameters of sound tape might be, it all still depends upon gamma oxide particles dispersed throughout a resin binder. Many of the tape's magnetic characteristics depend largely on the size, shape and orientation of these particles. Frequency response, signal-to-noise ratio and general sensitivity are all interrelated, not just to one another, but to how close to optimum these needles of gamma oxide are handled.

Let's see just what's involved.

### Visualize a basket filled with a few million needles.

They have all been magnetized so they are clinging together in disoriented clumps. The problem? Just take them all apart, lay them along parallel lines so they are all similarly oriented and their magnetic fields all reinforce one another. Oh, one more detail. These needles measure 1 micron by .2 microns; so, of course, they are somewhat delicate. One more point. Don't break any. The lengths are critical. For every broken or disoriented needle, H.F. response and signal-to-noise ratio will be affected. Every time one needle touches another, making electrical contact, sensitivity suffers.

Photographic emulsions are generally considered to be far more critical than sound tape in terms of physical characteristics. But we think that tape made to the gnat's-hair specifications of a photographic film is a better tape. And we proceed on just that basis. We separate the needles in a big-shouldered machine called a ball mill. Visualize a massive stainless steel drum that contains two million ball bearings. As the drum turns, the bearings tumble. Into the drum goes the binder which will act as a suspension for the oxide. Now add the oxide. Now the mill starts

turning, and the ball bearings tumble. As they tumble, they actually shear the honey-like suspension separating the individual needles, coating them with suspension so they can't make electrical contact with each other. This process really takes horsepower—and lots of it! It's like the world's biggest taffy-pull. Now comes the critical part. If you stop milling too soon, you'll have clumps of needles. If you mill too long, you'll start breaking up the individual needles.

We never cut milling time. And we can prove it.

Take any well-worn tape. Look at it so that light reflects off the surface. See those glossy spots surrounded by a dull



Nodules show up as polished "high points" on tape surface.

ring? These are nodules—high spots produced by clumping of the oxides. They were caused by too short a milling time.

In actual practice they cause accelerated head wear and degrade high-frequency response as well as show up on the tape as noise.

### Now check a well-worn Eastman tape

If you can't find a clumping immediately, check the entire roll. There must be one there, someplace. Or must there?

Milling too long is equally bad. Here's why. Best performance is to some extent dependent on the dimensions of the needles. That is the ratio of length to width. If you break the needles into smaller particles by milling too long, you'll get forms that are more cube-like than needle-like.

Cubes have pretty awful characteristics in terms of their magnetic parameters. Some of the very first magnetic tapes ever produced had cubes. These cubes do all sorts of other distressing things, such as change the bias requirements of the tape, and elongate the hysteresis curve, cutting sensitivity,

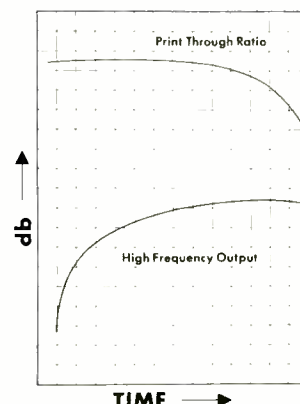

Notice how severely high frequencies suffer when milling time is too short; how print-through is degraded with prolonged milling.

and give pretty awful print-through characteristics.

Once the milling operation is complete, the suspension is filtered to remove any clumps that might have re-

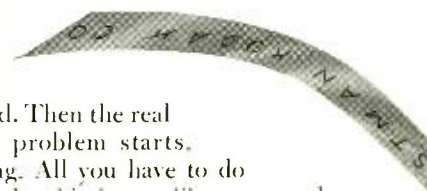

mained. Then the real tough problem starts. Coating. All you have to do is to take this honey-like mass and lay it along a base nice and evenly.

Problem is the needles try to re-clump after filtering. To prevent this, we developed our new "R-type" binder. It never re-clumps. And it always stays where it's put. No sagging, ever. And this means it can be handled with precision.

At Eastman Kodak, coating is uniform to within a few millionths of an inch. No, that's not a typographical error—we mean it. Six decimal places. This may be a new standard of precision for sound tape. But remember, we've been doing this sort of coating for years on film. While it's not exactly as easy as falling out of bed, it is a technique which we have down cold.

As one Eastman physicist puts it, "making tape is like being married to a redhead. But luckily, we know how to handle her." Next time, let's chat about base and surface characteristics.



ЭСТМАН КОДАК КО

Kodak

EASTMAN



Duroi Base  
NEW HIGH STRENGTH  
TRIACETATE

SOUND RECORDING TAPE

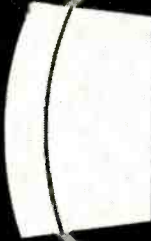

TYPE  
A303  
LOW PRINT

EASTMAN

SOUND RECORDING TAPE

TYPE  
A303  
LOW PRINT



Kodak  
TRADE MARK

EASTMAN KODAK COMPANY Rochester, N.Y.

AUDIO • JUNE, 1964

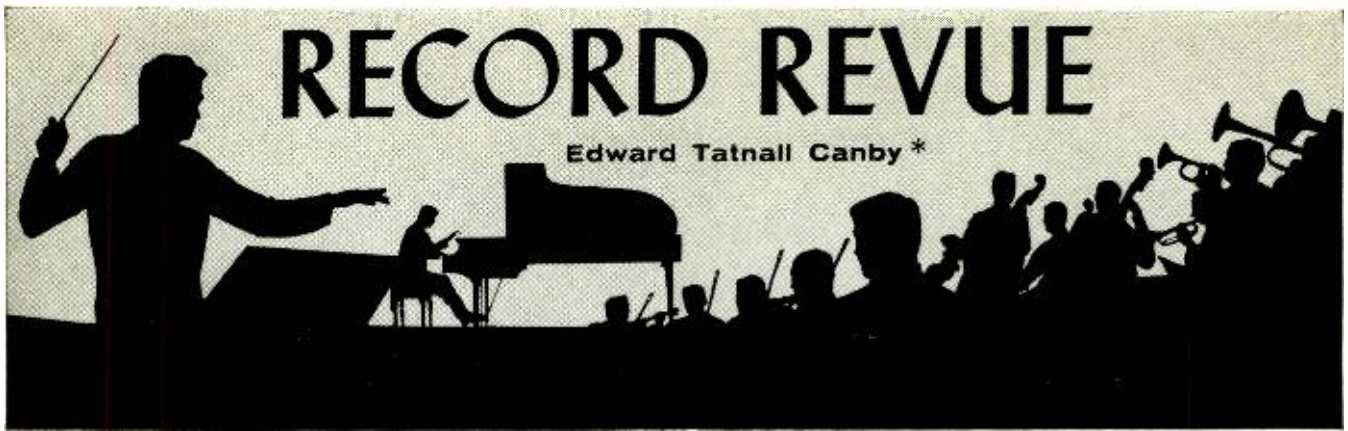

## BIG NAMES

**Bartok: Concerto for Orchestra.** London Symphony, Dorati.

Mercury SR 90378 stereo

Among the many recordings of this popular masterpiece this one surely pegs down a special place for itself, to complement the definitive but very different recordings by Fritz Reiner.

First, it is superbly miked in the new stereo manner, huge in effect but close and ultra-clear in detail, beautifully balanced over the whole big orchestra so that each instrument is as clear and sharp as chamber music.

We are accustomed now to this close-up technique and the uniquely good things it can do for music, whether via multi-mike or single-array techniques. The results are further and further removed from any conceivable "live" concert hall sound. But they are nevertheless more and more meaningful to us in musical terms, as stereo recording develops its own special virtues. For our present ears, at least (if not those of five years ago), this Mercury sound is musically superb, revealing and yet consistent in effect without unpleasantly noticeable exaggerations. Never has so much of the musical texture been projected for the ear.

And second, the British performance under Dorati is of a sort exactly to match the miking, carefully worked out in detail, intense and lyric but not high-strung (this we can credit to the solid British players), almost gentle in contrast to the driving over-all performances by Reiner. The white heat of the Reiner Bartok is missing, to be sure. But, on the other hand, many complex passages that in most recordings simply degenerate into a scramble of sonic confusion (like the *presto* at the very end) here come through with astonishing clarity, under perfect sonic and musical control.

I rate this as a great recording of its kind.

**Mozart: Così fan tutte.** Seefried, Merriman, Köth, Haefliger, Prey, Fischer-Dieskau; Berlin Philharmonic, Jochum.

Deutsche Gramm. 138 861/63 stereo

Fabulous big albums like this are both my delight and my despair—the bigger they are, the longer I have to wait to find time to do them justice. That means a lot of time in the case of one such as this.

Only six solid stereo LP sides, to be sure, and a foot-square book that is a mere 70 big pages long. All sorts of photos, comment, in assorted languages (four) and the entire libretto, word for word, in four languages arranged in parallel columns. One could skip along through in a couple of solid evenings but, really, that isn't properly enough. The album is good for weeks of pleasure and increasing amusement, as well as musical satisfaction of the profoundest sort.

What a satirist, what a razor-sharp commentator on the human scene, this wretch of a Mozart was! How artless, how disarming his music and how deadly his daggers! The more absurd becomes the mixed-up plot, the more life-like are the human weaknesses and strengths. And over all, is the perfect symmetry of structure that pairs off two silly, artful girls (sopranos) against their two raf-

fishly masculine lovers, (tenors) who return in disguise each to seduce the other's girl, with the balancing connivance of a worldly cynic, (baritone) and an even more worldly little servant girl (high soprano)—leading to every combination of pairs and pairs-of-pairs in music that paints each move, each thought, with devastating clearness.

I'm not up on all the other recordings. This one has a contrasted pair of soprano leads, the biggish American voice of Nan Merriman against the smaller, finer-edged soprano of German Irmgard Seefried, but a blended pair of magnificent near-twins in the tenors Haefliger and Prey. Fischer-D. is superb as the cynic and the little servant has exactly the proper cute, twittering voice in contrast to the bigger instruments of her two mistresses. Playing and singing under Eugen Jochum is superbly clean, relaxed sparkling, the nuances all there with gratifying communicativeness. And the stereo is just big enough to add lustre and immediacy, plus useful clarity in the big ensemble parts.

**Tchaikowsky: "1812" Overture; Nutcracker Suite.** London Festival Orch. and Band, Sharples.

London SPC 21001 stereo

I'm not physically capable of comparing one "1812" with another. Ears won't take it. Nor the mind, for that matter. So all I can say is that this London I'op Concert "Phase 4" version makes the d—muddest noise I ever heard and with the aid of 20-channel mixers (à l'Américaine) and twenty dozen cannon plus twenty thousand bells, is maybe the best technical job to date. Such a racket!

Of course, like a true hi-fi man, I skipped most of it, jumping straight into the furor about two-thirds through. Enough to suggest a reasonably eloquent playing of the mere musical parts, in a nicely big London-type liveness in spite of the 20 channels. (Maybe they were reserved for the end.)

Didn't get to the Nutcracker. I was deaf by that time.

**Brahms: Trio #2 in C.**

**Beethoven: "Kakadu" Variations.** Gary Graffman, pf., Berl Senofsky, vl., Shirley Trepel, cello.

RCA Victor LSC 2715 stereo

"Contrary to popular notion, there's nothing austere or forbidding about chamber music" says RCA in its liner notes for this album. There sure isn't!

This is one of the best "chamber" records RCA has put forth for some time. In musical effectiveness I'd rate it right up with the "Million Dollar Trio" reissues (Heifetz, Feuerman, Rubinstein) of recent and earlier release on the label though those artists probably cost a lot more. This one is, so to speak, Gary Graffman & Friends, Graffman being an RCA regular. But it isn't easy to say which of the three players leads, or trails; they make an excellent team, all three providing music of strong character with an ensemble sense that is always good.

This is grand recording, too. It projects a big, solid piano sound and a well-balanced violin and cello, separated in the stereo to make them shine as individuals in your living room but blended in the ensemble by the surrounding liveness. The Brahms is one of his

big best (not sombre, as some works); the Beethoven "Kakadu" Variations, on a silly tune, "I am the Tailor Kakadu" (out of an obscure opera called the "Sisters of Prague") is by no means a small piece—it ranks among those arresting sets of variations that include the famous "Diabelli" variations and the Variations in C Minor for piano as well as the "Eroica" piano Variations (out of which the "Eroica" Symphony was built). Beethoven greatly enjoyed taking petty musical material and making big things out of it. You'll not be disappointed by Kakadu!

**Vivaldi: Four Violin Concerti.** Nathan Milstein, strings.

Angel S 36004 stereo

Back in the early Eighteenth century Antonio Vivaldi must have averaged a concerto a day. His output was enormous. Now today, strangely, we are re-experiencing this vast output as the masses of Vivaldi works are at last systematically explored in manuscript, edited, published, played—and recorded. The man has always been a reasonably Big Name in music; but how little did we know of him until now!

This is the second volume of Milstein's current exploration of new Vivaldi (with a group of fourteen American string players and Robert Conant, harpsichord) and it is crackerjack. Superb. The Milstein playing is powerful, masculine, incredibly fleet and accurate in detail and utterly in the right style, almost without vibrato, blending into the quick harmonies, yet in melodic moments standing out powerfully. His string players perform crisply and with perfect discipline and imagination.

Again—how little we used to know of this towering musician! His few works were performed with huge orchestras in soggy, pseudo-archaic style, damning him with the faintest of praise. Here he is in his proper element and the music flies along, soars, hovers, the musical mind comes through entirely, alive with strength, brilliant with ideas, strong in the spare discipline of the harmonies, the thinly spaced chords, the toughened line of the violin and the bass, almost unsupported. Some of the music is almost fantasy, though disciplined; some is so original one wonders whether Vivaldi's contemporaries were aware of the astonishing range of his thinking. Since these works were unpublished, they were probably not known. What if J. S. Bach had heard these works, too? Might have changed the course of later music history, as well as the familiar sound of Bach-Vivaldi.

**Haydn: Symphonies Nos. 57, 17, 1.**

Vienna State Opera Orch., Max Goberman. (Miniature scores included in album).

Lib. Recorded Masterpieces HS 13 stereo  
(150 W. 82nd St., New York 10024)

The first nine of these remarkable recordings, as already chronicled, had me wowed for weeks. Such a superb wealth of eloquent music-making in these symphonies, most of which have been totally unknown in performance for nearly two centuries! Was ever a first-rank composer so neglected? (Well, plenty more are still neglected, of course.) Most of these records, with their bound-in complete scores and their very readable notes by the

(Continued on page 41)



Haydn authority H. C. Robbins Landon, contain two symphonies; the shorter early symphonies come three to a package, as here. After the first big batch, the series has continued. Here is no. 13 and we hope there are more unreleased. (Max Goberman died suddenly.)

Haydn wrote 104 symphonies, plus two that have been added lately (called, for lack of a better plan, A and B). The magic No. 1, the very first, is hereby revealed and should satisfy a lot of curiosity. From 1759—he was 27—it turns out to be a sprightly little item in three busy, bright movements, very much after the then prevalent “galant” style, full of little rushings hither and yon, gay little bits of melody, graceful turns and twists and not two seconds’ worth of tune or theme to remember—that was the way of things then. But, compared to the frothy music out of Mannheim, where much of this style originated, Haydn’s has a solid harmonic sturdiness, plenty to hold together the light-bodied up-works. A highly professional job, this, and no beginner’s bungle at all.

No. 17, only a few years later (the early symphonies are vague as to order), is similar in style but of a much more fluent and shapely texture, a splendid little work. And No. 57, fifteen years after No. 1, is already a first rate masterpiece.

**Haydn: Cello Concerto in C. Boccherini: Cello Concerto in B Flat. Milos Sadlo; Prague Radio Symphony, Klima.**

**Artia ALS 7206 stereo**

The Boccherini is just the same old cello warhorse (well performed), to fill out the second side of this disc—the big news here is the Haydn concerto, which is a brand “new” one, rediscovered in 1961 after almost 200 years of oblivion. It is a corker, an excellent piece of early Haydn, a much stronger work, I’d say, than the often-played Boccherini and a better piece, too, than the long-familiar Haydn cello concerto that usually accompanies Boccherini on records. Splendid find!

The theme of this appears in Haydn’s own catalogue, as one of two concerti both of which had vanished. The parts that have turned up were handed down in the library of a European noble family which, becoming less and less music-minded, had no idea it owned such a valuable piece in an only existing copy. A batch of old stuff, untitled, finally landed in a museum in Prague where, at last, some knowledgeable people got to work on the pile of music—and this piece was recognized.

The Prague performance is lively and beautiful, the cello soloist first rate, the recording in stereo (Supraphon) also first rate.

**Bach: Saint Matthew Passion; choruses and chorales. Philharmonia Choir and Orch., Klemperer.**

**Bach: Saint Matthew Passion: arias (soprano and mezzo). Elizabeth Schwartzkopf, Christa Ludwig; Philharmonia Choir and Orch., Klemperer.**

**Angel 36162, 36163 stereo**

Jack Sprat, style these two discs of excerpts from Angel’s complete Saint Matthew divvy up some of the music (there’s lots more, of course) into a platter for those who like solo voices (and hate choruses) and another for the people who love chorus music (and hate solos). Very neat. Take your choice.

Of course those who know the piece will not want any mere excerpts—you gotta hear the whole thing to get the dramatic impact. Agreed! Angel 3599 E/L gives you it all, on five LP’s, if you feel that way.

It remains merely to note that this is a very old fashioned styling, if a beautiful one, done up as of maybe 1930 or before. The sound is huge, the tempi ultra-slow, the chorales (hymns) sung slowly and—horrors!—with all those pauses at the ends of the lines. Nobody who’s modern does that any more. (Nowadays you sing them straight through and fast, with never a pause for breath.) Older people will find this lovely. Younger souls will find it slightly bewildering. Styles of performance have changed radically since old Klemperer learned his Bach. They don’t do it this way any more.

But it is a glorious performance of its kind, just the same.



## The THORENS TD-224 “Masterpiece”



**quality, convenience and performance  
...WITHOUT COMPROMISE!**

(as reviewed in May '64 AUDIO Magazine):

“In recent years we have come to know the term automatic turntable in connection with a breed of record changers whose individual parts are of turntable and separate tonearm quality, more or less. Still they suffer from the necessity of accommodating a stack of records so that the arm is set to track best at some compromise height, say four records worth. Although the amount of distortion introduced by this is relatively unimportant when balanced against the convenience, it is sufficient to eliminate this breed from the system of the purist who would not trade convenience for distortion.”

“Well, the purist can have both now!”

“The absolute precision of these parts must be seen to be believed.”

“In conjunction with the precision changing mechanism provided, we truly have the best of both worlds. Thus we can say unequivocally, that the Thorens TD-224 provides both the convenience of an automatic record changer and the uncompromised performance of a first-line turntable and arm.”

(Complete reprint of review available upon request) **\$250**



**TD-124**—A quality transcription turntable that remains the standard of the industry, regardless of price. Offers a host of exclusive features for the finest systems. **\$125**

For single speed performance, convertible as required, see the TD-121. Combines incomparable Thorens quality with economy. **\$85**



**TD-135** — A precision 4-speed transcription turntable with an integrated THORENS professional tone arm (BTD-125), for those who prefer a complete, compact unit. Outstanding adjustment flexibility, precision mounting and other quality Thorens features. No other integrated unit approaches the standards of the TD-135. **\$125**

# THORENS

A *sound REcreation* \* Product

If your dealer can not qualify for a Thorens Franchise—go to another one!  
ELPA MARKETING INDUSTRIES, INC., Dept. A6, New Hyde Park, New York.

\* *sound REcreation* — A Mark of Elpa Marketing Industries, Inc.

# NEW PRODUCTS

● **New Speaker System.** The Fisher XP-5, a new compact speaker system, measures 10" x 20" x 9" and has smooth response characteristics throughout the audible frequency range. This has been accomplished without changing the response of the amplifier or relying on bass boost. The 8" diameter woofer has a free-air resonance

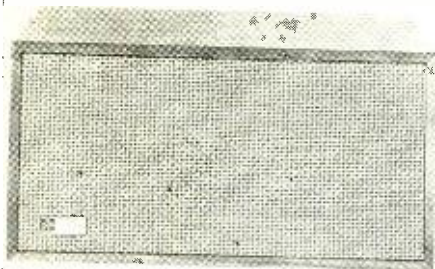

of 25 cps; the tweeter is a 2½-inch cone-type; crossover is at 2000 cps with a 12-db per octave rolloff; impedance is 8 ohms. Available in oiled walnut or unfinished birch. Fisher Radio Corp., Long Island City 1, N. Y. **F-1**

● **Microphone Desk Stand.** Atlas Sound announces the new model DS-14 microphone desk stand, specially designed to complement, both in appearance and function, the popular types of elongated microphones. This new model has a list price of \$4.50. It includes a fine-grain, gunmetal,

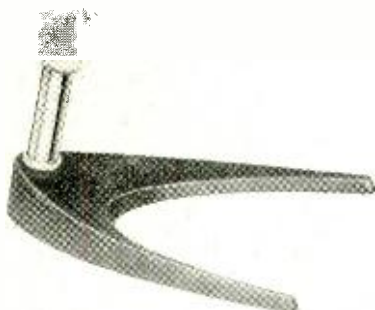

shrivel-finished base, styled in a contemporary motif, and a 3-in. polished-chrome upright which terminates in a standard thread. Protective felt base pads prevent damage to table or desk surfaces. Shipping weight is 2 lbs. Atlas Sound, New York. **F-2**

● **Transfer Set.** A "Meter and Dial Set" using "Instant Lettering" dry transfer marking system is now available through the Datak Corporation. Included are arcs, lines, arrows, and assorted rotary tape switch patterns covering all common angular detents. Featured are sheets of arcs and fine (12-mil) graduation lines for



marking special and prototype meter dials. Meter scales calibrated with these transfer sheets are indistinguishable from photographed production dials. Each set of twelve 5 x 7-inch sheets contains a complete assortment of patterns in black, white, and red arranged according to frequency of use. Meter and Dial sets are \$4.95 complete (Catalog #968). The Datak Corporation, Guttenberg, N. J. **F-3**

● **4-Track Tape Recorder.** Ampex Corporation has introduced a four-track version of the PR-10 professional audio tape recorder, previously available only in a two-track version. Called the PR-10-4, the recorder features all metal head shielding and narrow channel widths, permitting a 55-db signal-to-noise ratio. Areas of use for the PR-10-4 include broadcasting, education, and industry. The recorder has three four-track record-erase-playback heads, a two-track playback head and a head switch. It has tape speeds of 3¾ and



7½ ips. Available unmounted for rack or custom mounting and in portable carrying case. Specifications include: Frequency Response: ± 2 db, 40–12,000 cps at 7½ ips; ± 2 db, 40–6,000 cps at 3¾ ips. Down to no more than 4 db at 30 and 15,000 cps at 7½ ips. Flutter and Wow: Less than 0.18% rms at 7½ ips; 0.25% rms at 3¾ ips. Output: +4 dbm into 600 ohm balanced or unbalanced load. Inputs: One line input for each channel. Microphone preamps or line transformers may be used with line inputs. Ampex Corporation, Redwood City, Calif. **F-4**

● **Equalizer.** A new passive record equalizer for stereo and monophonic discs, flexibly designed to permit broadcast stations to install new stereo facilities, to convert existing monophonic facilities to stereo, or simply improve monophonic performance only, has been introduced by Gray Research and Development Co., Inc. Called the 604-M/S, the new equalizer takes the constant-velocity output of either stereo or monophonic magnetic cartridges and feeds their signal into the low-impedance microphone channels on a stereo mixing console, automatically compensating for



both cartridge output and recording characteristics. The 604-M/S operates effectively with either high-impedance magnetic stereo cartridges or low-impedance monophonic cartridges. It is mechanically interchangeable with the Gray Research 602-C Equalizer. The 604-M/S is priced at \$137.50. The 604-M, component for monophonic use only, is \$79.25; the 604-S, add-on component for stereo, is \$58.25. A kit to convert a 602-C to a 604-S is \$18.50. Gray Research and Development Co., Inc., Box 12, Elmwood, Connecticut. **F-5**

● **AM/FM Receiver.** Kenwood Electronics, Inc. has introduced an AM/FM multiplex stereo receiver, the KW-30. It incorporates a stereo FM tuner and a pair of 14-watt amplifiers in a single chassis. The FM tuner provides 2 microvolt IHF sensitivity for 20-db quieting, and more than 31-db channel separation at 400 cps. Image rejection exceeds 35 db; SCA rejection, 55 db. Audio response is less than ½ db from 20–20,000 cps (FM mono) and 50–15,000 cps (FM stereo). AM sensitivity is rated at 10 microvolts for 10-db quieting. Controls include: dual bass treble selectors; AM/FM stereo monitor, FM, stereo, phono and

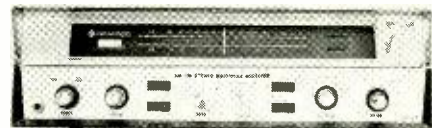

AUX; and, tuning hum balance. See-saw switches regulate power, loudness, noise filter, mode, speaker phase and speaker impedance. Unit accepts input from magnetic (1.5 mV) and crystal (20 mV) cartridges, tape recorders, AUX (100 mV) as well as from the built-in AM/FM tuner. Hum and noise levels are less than 60 db for phono and 69 db for AUX. Set includes left and right speakers, stereo phone jack and a.c. outlets. At 25-watt total music power, harmonic distortion measures less than 1% at 400 cps. Power consumption: a.c. 110–120 v, 60 cps, 200 watts. Dimensions: 16½" x 5½" x 14". Weight 23 lb. net. Complete except for speakers, \$189.95. Kenwood Electronics, Inc., Dept. P-364, 3700 S. Broadway Place, Los Angeles, Calif. **F-6**

● **4-Track Tape Recorder.** The newest addition to the Roberts tape recorder line is its new 4-track stereo Model 720. The Roberts 720 is designed to function as a complete sound system. It features a fan-cooled hysteresis-synchronous motor. It records at 1½, 3¾, and 7½ ips, with a 15-ips conversion kit available as an optional accessory. Spotlighting Roberts multiple-adjustment head, the 720 locates and aligns for 4-track stereo recording and playback, half-track stereo playback, and

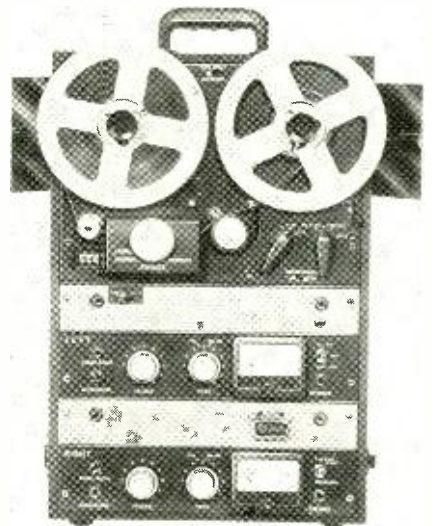

4-track monophonic recording and playback. Other features include a 3-digit index counter, dual head outputs, dual pre-amp outputs, and dual power amplifier speaker outputs. The tape recorder provides simplified sound-with-sound recording, speaker or stereophonic monitoring while recording, two low-impedance stereo outputs and an exclusive automatic "all-off" switch. Roberts Electronics, Inc., 5902 Bowcraft Ave., Los Angeles 16, Calif. **F-7**



# Now for MORE

## MUSICAL ENJOYMENT



### PROFESSIONAL CONTROL

The MA 230 gives complete control of listening pleasure. Select any one of six program sources. Adjust both bass and treble. Loudness control gives full rich sound even at low listening levels. High frequency filter to reduce objectionable noise from old records. Low frequency filter eliminates turntable or record changer noise. Two headphone jacks, and speaker switch give you private musical enjoyment. Tape monitor for checking recordings in progress. Two position record compensation adjust for earlier lp's. Phase control adds the final touch for full stereo enjoyment.

### POWER TO SPARE

The McIntosh MA 230 is the first combination preamplifier/power amplifier with less than  $\frac{1}{2}$  of 1%

distortion from 20 to 20,000 cps. This is RMS power with both channels operating. IHF music power rating is 44 watts per channel. Music is reproduced accurately. At 5 watts output distortion is less than  $\frac{7}{100}$  of 1%. No other combination unit gives this kind of performance. Music sounds alive and thrilling from a McIntosh MA 230.

### THREE YEAR PROTECTION

Your investment in the MA 230 is protected for three years. Parts and labor are guaranteed for three years. Only tubes and fuses are excepted.

### MONEY BACK GUARANTEE

You receive a full cash refund if your MA 230 does not meet its published specifications.

WRITE TODAY FOR THE COMPLETE DETAILS OF THE  
EXCITING MA 230.

# McIntosh

LABORATORY INC.

6 Chambers St., Binghamton, N. Y.

McINTOSH LABORATORY INC.  
6 Chambers St., Binghamton, N. Y.

Please send information on MA 230.

Name \_\_\_\_\_

Street \_\_\_\_\_

City \_\_\_\_\_

Zone \_\_\_\_\_

State \_\_\_\_\_

## CLASS-D

(from page 27)

angular wave inputs. This is the circuit of Fig. 8.

The circuit is essentially a diode comparison circuit, where diode  $CR_1$  applies the triangular input signal to resistor  $R_1$ , and diode  $CR_2$  applies the audio input to  $R_1$ . The circuit works like this:

In the absence of any audio signal (and the audio input open-circuited), the negative -12 volt power keeps diode  $CR_1$  conducting, so that the triangular wave input (which might vary from, let's say, -2 volts to +2 volts) appears at the junction of  $R_1$  and  $C_1$ . But when an audio input is applied to diode  $CR_2$ , then this diode clamps the signal applied through  $CR_2$  to some maximum negative value. For example, if the audio signal at a particular moment is -1 volt, then the voltage at the junction of  $R_1$  and  $C_1$  cannot go below -1 volt, because this makes  $CR_2$  conduct. The voltage across  $R_1$  is therefore either the audio voltage or the triangular wave, whichever is higher, and it looks like the audio input signal, except that it has a series of spikes superimposed on it. The tops of all of the spikes reach the same voltage as determined by the voltage of these tops on the input side of  $CR_1$ . But the bases of the spikes are of various widths, depending on whether the spikes are cut off near the top (where they are narrow)

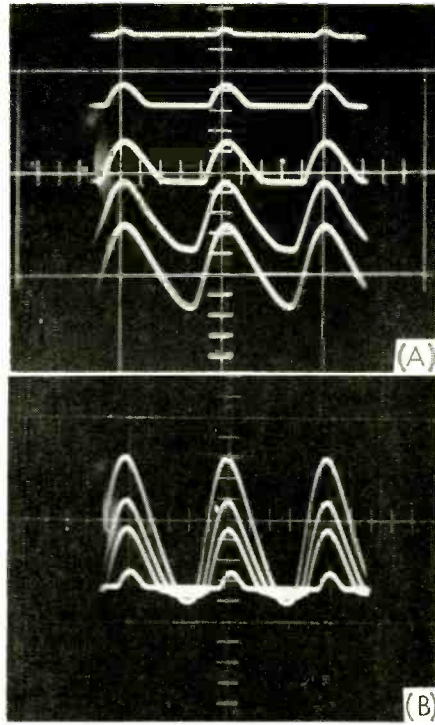

or near the bottom (where they are wide).

Capacitor  $C_1$  and the base-emitter junction of  $Q_1$  act as a high-pass filter which filters out the audio input signal but lets the spikes get through, and the base-emitter diode further clamps the base of each pulse at about -0.5 volt, just enough to turn on the transistor.

These spikes are therefore amplified by the transistor. But since the spikes are quite large, and since the bias on the transistor is such that only the bases of the spikes cause conduction in the transistor, the output consists of square pulses rather than triangular spikes. This is much like a grid-leak-biased Class-C amplifier.

Figure 9 shows some of the actual waveforms in the circuit. 9A shows the waveforms at the junction of  $R_1$  and  $C_1$ ; the waveforms are offset from each other to show detail, and show various degrees of clipping at the negative end by the instantaneous audio input (in these particular figures, d.c. levels were used instead of audio signals to permit photographs to be taken). 9B shows the same pulses after  $C_1$ ; the d.c. level is removed, and each pulse is clamped at the negative end. Unfortunately, this circuit also is limited in the maximum amount of modulation permitted. The lowest waveform in (B) is about the smallest which will still insure that transistor  $Q_1$  turns off during the spike; since the width of the output pulse is about equal to the width of the spike at its base, this is about the narrowest pulse which the circuit can supply. Similarly, the uppermost waveform in 9(B) represents about the widest pulse which the circuit can supply. This is because the clamping level between the spikes depends on the distance between spikes. The wider horizontal lines at the bottom are clamped higher than the narrower ones.

(to be continued)

## RCA Victor looked into it...

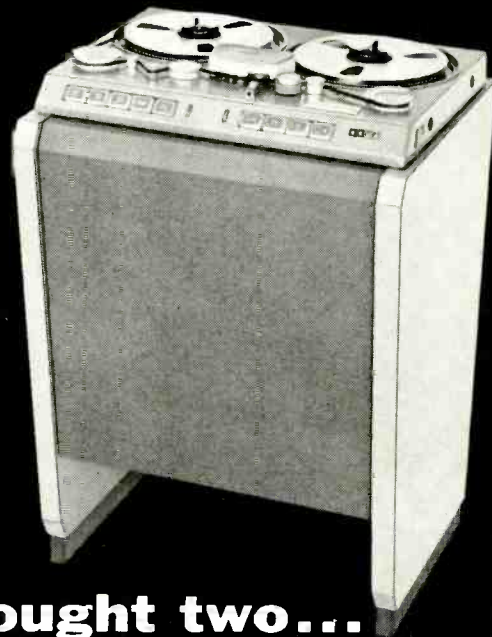
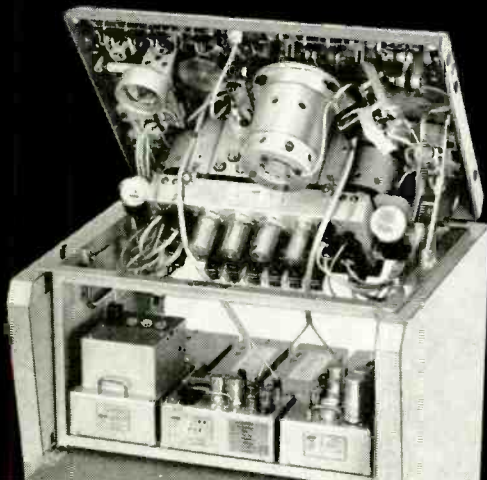

and bought two...

## EMT STUDER C-37 MASTER TAPE RECORDERS

RCA Victor Records, ever alert to upgrade quality, can't afford to take chances. After evaluation of the C-37 from every aspect, RCA bought their first two machines. These are employed in Victor's most sensitive application... DYNAGROOVE stereo mastering, where quality demands are stringent and equipment failure intolerable. After many months of continuous service, C-37 performance remains steadily faultless. Peak quality is matched with a zero breakdown and repair record. Look into the complete C-37 story... available in brochure upon letterhead request only.

**GOTHAM**  
AUDIO CORPORATION  
2 WEST 46 STREET, NEW YORK, N.Y., 10036 • 212-CO-5-4111





## AUDIO ETC.

(from page 14)

rated, make use of both channels in an antiphonal effect. Perhaps I'm just checking on the channel separation of my receiver, but I like it!

With regard to equipment, there doesn't seem to be much excuse for rattly microphones or pickups in a commercial radio station. Neither would one expect to be able to identify each of a pair of turntables by sound alone. Hum and rumble abound on the air at levels which would not be tolerated by any knowledgeable audio buff. Some stations seem to be particularly plagued by scratched records. It is interesting to note the time required and technique used to detect and correct a "repeater" groove. There is one large New York station which seems to have a staff of experts in this particular skill. They should be expert—they get lots of practice. I should think they would profit by some attention to record care, instead.

Many of the foregoing difficulties would appear to stem from inadequate monitor speakers, or inadequate attention to them. I well remember, when I was designing and selling transcription pickups to broadcast stations, the night I spent in various control rooms all over the country. It was absolutely impossible, psychologically, for a small staff to concentrate for any long period on the sound of the monitor speakers. It was common practice to "knock down" the monitor if someone had a good joke to tell during a record. One could hardly blame them for it considering that professional broadcasters put in seemingly endless hours and still keep the show on the air. Is it any wonder that critical judgment may lapse occasionally? Nevertheless, I think it is the obligation of radio station management to provide sufficient variety and interest for operating personnel, and to select people with the right set of aptitudes, knowledge and personality for each job. This in turn will bring a sweet flow of fresh, clean sound to the listening public. There are so many of us who value high-quality sound and interesting material that an appreciative audience is ensured.

One of the most regrettable things about current radio programming is the dearth of live performances, and the poor quality of most of those which are available. The Metropolitan Opera is a case in point. How could anyone feel the excitement of opera whose sole contact with it is the Saturday afternoon broadcasts? The format is dull, the commentary often pedantic, and the whole approach more suited to a religious experience than not-too-highbrow entertainment. But worst of all is the sound. It's been the same for twenty years,

## FAIRCHILD is EVERYWHERE!



In the new multi-million-dollar RCA Victor Studios in Hollywood, U.S.A., you will find FAIRCHILD RECORDING EQUIPMENT assisting in the creation of the newest sound for RCA Victor Records. FAIRCHILD INTEGRA COMPONENTS are to be found in a multitude of channels in this new RCA Hollywood plant controlling level and channel response. FAIRCHILD INTEGRA COMPONENTS are helping to produce the latest in the world famous DYNAGROOVE sound.

### THROUGHOUT THE WORLD - LEADERS LOOK TO FAIRCHILD . . .

NATIONAL BROADCASTING CO. • COLUMBIA BROADCASTING SYSTEM • AMERICAN BROADCASTING COMPANY • CAPITOL RECORDS • MGM RECORDS AND PICTURES • DECCA (U.S.) • MERCURY RECORDS • FORD MOTOR COMPANY • ELECTRICAL MUSIC INDUSTRIES LTD. (EMI) WARNER BROTHERS • U. S. INFORMATION AGENCY—VOICE OF AMERICA • DEUTSCHE GRAMAPHON • DISCOS MEXICANOS • WCBS • WBNS • WNEW • WTTG • WIP • WSM • KDKA • WEFM • KPOL • KMLA • KMLX • WPAT • WBZ • CKBL • U. S. ARMY/AIR FORCE MOTION PICTURE SERVICE • DECCA (England) • UNITED NATIONS • GOTHAM RECORDING • RECORDAK (Division of Eastman Kodak) • PHILLIPS ORGANIZATION (Netherlands) • BELL TELEPHONE LABORATORIES • WIP • U. S. ARMY PICTORIAL SERVICE • UNITED RECORDERS • RADIO RECORDERS (Hollywood) • EMPIRE BROADCASTING CORP. • NEW YORK WORLD'S FAIR • BANKERS TRUST NEW YORK • CONSOLIDATED EDISON NEW YORK • WHDH • DOT RECORDS • KAPP RECORDS • REEVES SOUND STUDIOS • GENERAL MOTORS

### FAIRCHILD Products of Interest to the Recording, Broadcasting and Sound Reinforcement Industry.

**MODEL 600-602 CONAX**  
automatic high frequency control system that allows higher recorded disk levels and minimizes tracing distortion.

**MODEL 661 AUTO-TEN**  
an automatic noise reduction system.

**MODEL 662**  
transistorized preamp/line amp.

**MODEL 663**  
compact compressor—miniaturized overload protection system.

**MODEL 664**  
program equalizer

**MODEL 668 LUMITEN**  
noise-free audio attenuator.

**MODEL 688 TRANSISTORIZED POWER AMPLIFIER** with exclusive TRANS/GARD protection system.

**MODEL 673 DYNALIZER**  
an automatic spectrum equalizer. Changes response to complement human hearing curves.

Write to FAIRCHILD  
for complete details.

# FAIRCHILD

RECORDING EQUIPMENT CORPORATION  
10-40 45th Ave., Long Island City 1, N. Y.

as far as I can tell. It cries for FM stereo and the full treatment. I can hardly wait.

The sound of the Philharmonic broadcasts has certainly changed—but we needn't rake up all that again. The only really exciting live music comes through on the occasional chamber-music programs heard still on some of the smaller stations. With all the good musical organizations in this country (getting better and more numerous all the time), the opportunities for live pickups are legion. Stations in the smaller cities often do a bang-up job on their local musical events. I know there are cost problems and union problems and that recording is so

good and a lot safer and so forth and so on, but there still is no substitute for hand-made music being turned out before your very ears.

As I warned you at the outset, this is a collection of observations of an opinionated person who has fairly clear and strong ideas about what is the best possible, both musically and technically, which can be achieved under a given set of circumstances. I have trouble understanding why a 95 per cent level of excellence can't be the standard instead of the more likely 50 per cent level. I suppose I am also a snob, but to paraphrase Ogden Nash, when people call me that I hope they do so behind my back. **AE**



# The Tape Guide

HERMAN BURSTEIN

(Note: To facilitate a prompt reply, please enclose a stamped, self-addressed envelope with your question.)

Herman Burstein  
280 Twin Lake E., Wantagh, N. Y.

### High-Frequency Danger

*Q. The item in the March "Tape Guide" concerning high-frequency danger to tweeters from tape recorders used in fast forward and rewind functions probably upset many of the tape users who read it. If this danger really does exist, how is it that a reasonably flat VTVM placed across the tweeter registers negligible voltage at high volume setting? It seems to me that the space between tape and head created by the tape lifter eliminates practically all output at any frequency. In addition, this separation severely limits the high frequency response of the head despite the high speed. Is this correct?*

A. The warning of possible damage to tweeters due to high-speed tape winding was made by a reputable company (Electro-Voice), and one may surmise that it was made with foundation. The danger of course varies from one tape machine to another, depending upon the spacing between the playback head and the tape. Electro-Voice pointed out that the danger is greatest for machines with close spacing. In any case, however small the danger, it seems pointless to risk damage to a valuable component when all one has to do is turn down the gain control.

Your observations appear incorrect on two counts: (1) The mechanical sluggishness of a meter may fail to reveal transients that are very brief but of high amplitude; an oscilloscope would be more appropriate. (2) A playback head responds to wavelengths on the tape, not to frequency per se. If the head responds to a wavelength equivalent to 1,000 cycles at 7.5 ips, it will produce a frequency of about 21,000 cycles when this tape moves past the head at 1200

feet in 90 seconds, as home machines typically do.

In connection with Point 2, I think you have in mind the fact that at a given speed a given separation between the head and the tape produces increasing loss as frequency increases. But we are worried about *long wavelengths* (low frequencies at normal tape speed), which become high frequencies at high tape speed and threaten damage to the tweeter.

### Frequency Specification and db

*Q. Please tell me how I may figure out how much of a frequency loss or gain there is if the specification of a tape recorder operating at 7.5 ips states: 40 to 15,000 cps  $\pm 3$  db. If 0-db is measured with a 1000-cps note, how many cps would I lose or gain at 15,000 cps? I understand that the answer would be an algebraic function of logarithms to the base 10. What I want explained is how many cps are equal to 1 db, and how many I lose or gain at 15,000 cps.*

A. Decibels gain or loss does not translate into cps. Decibels refer to a ratio between two amounts of power. Three decibels means specifically that one amount of power is twice as great as another amount of power. If frequency response is 40 to 15,000 cps  $\pm 3$  db, relative to 1000 cycles as 0-db. This means the following: no frequency between 40 and 15,000 cps will be reproduced with more than twice as much power as 1000 cps, nor with less than half as much power as 1000 cps—assuming that input signals are of the same magnitude at all frequencies. 1000 cps is used as a reference (0-db) because it is approximately at the middle of the audio range in terms of octaves. On program material, a change of 3 db is about the first definitely noticeable change to the human ear. Æ

## ACOUSTICAL REARGUARD



**D-12**

Range: 40-15,000 cps  
Response:  $\pm 3$ db over entire range  
Dimensions: 5 $\frac{1}{2}$ " x 2 $\frac{1}{2}$ " x 2 $\frac{1}{2}$ "  
Data sheet available on request

Insensitive to sound reaching this dynamic microphone from the rear...An exceptionally pronounced cardioid pattern produces an acoustical shield of approximately 180° that effectively isolates unwanted sounds originating from noisy audiences, feed-back or reflection.

## FOR SUPERIOR SOUND



**C-60**

Range: 30-18,000 cps (cardioid)  
Response:  $\pm 2.5$  db over entire range  
Dimensions:  $\frac{3}{4}$ " Dia. x 4"  
Data sheet available on request

A high quality condenser microphone for music and speech. Its characteristics provide truest fidelity for reproduction and recording. The C-60's many uses and users attest to the unusual versatility of this microphone. Available with either cardioid or omni-directional capsule.

## CONDENSER • DYNAMIC MICROPHONES



**AKG of America**

Division of North American Philips Company, Inc.  
125 Park Avenue, New York, N. Y. 10017

7-64



## SYSTEMS

(from page 22)

has ruled out all other solutions, we may resort to the ultimate distributed loudspeaker system, giving every listener essentially his own loudspeaker. Loudspeakers may be mounted in pew-backs, desk fronts, and tables. Such systems usually represent the result of esthetic design goals taking priority over acoustic goals, but each application would be studied from an acoustical, as well as an esthetic, point of view.

In practice, for every example of a well designed, properly installed distributed or central loudspeaker system, we can find scores of less than satisfactory installations. In addition to the basic decision between a central or distributed loudspeaker arrangement, the remainder of the sound system must be carefully engineered including the selection of the correct loudspeaker type. Most of the unsuccessful central systems the author has encountered have had insufficient gain before feedback. This is most often the result of using loudspeakers with rough frequency response and inadequately controlled or unknown directional characteristics. Most poor distributed loudspeaker systems suffer from one or more of the following deficiencies: 1. Inadequate number of loudspeakers; 2. loudspeakers having poor high-frequency dispersion characteristics; or 3. loudspeakers poorly located. Inadequate coverage is the result of any of these deficiencies. The frequency response, power handling capacity, and efficiency of loudspeakers are important in both central and distributed systems; but it is lack of understanding of loudspeaker directional characteristics that underlies the cause of many system failures and inadequacies. The directional characteristics of loudspeakers will be the subject of a forthcoming article. **AE**

## SPEAKER

(from page 32)

phragms to the airgap spacers was General Cement No. 32-2A Plastic Cement, available at most radio parts stores. General Cement No. 346 Epox Cement also was used. These two adhesives were only marginally satisfactory, but were the best of many adhesives tried. The graphite used was Dixon's Jet-4 Microfyne Graphite, available at most hardware stores.

### Miscellaneous

Although the directivity of a single electrostatic diaphragm is just as bad as that of a moving-coil speaker of the same size, the effect is greater with an

## What makes the FAIRCHILD 688 the world's finest Power Amplifier?

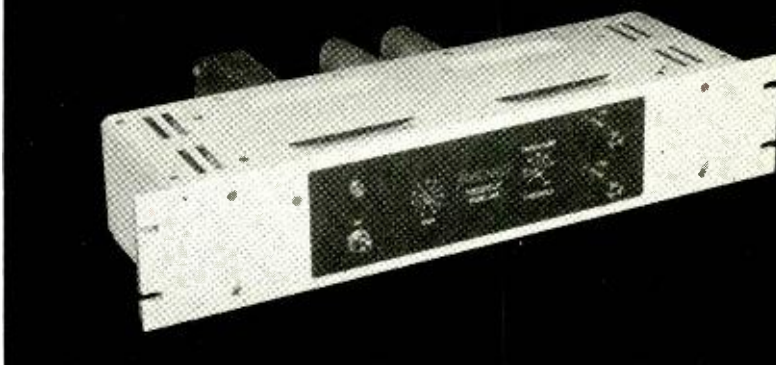

**Just this!** Only the FAIRCHILD 688 Power Amplifier delivers a true and continuous 50 Watts (not music power) at any frequency from 10 cycles to 50,000 cycles, and with a low, low distortion under 1% with full 50-Watt output! Only the FAIRCHILD 688 Power Amplifier produces clean, and reliable 50 Watts into 16 ohms! Only the FAIRCHILD 688 Power Amplifier is stable enough to keep on producing 50 Watts at any frequency up to 50KC — not for a second, or 5 or 10 seconds, but continuously without damage to the transistor circuitry! Only the FAIRCHILD 688 Power Amplifier, with transformer-free output, produces 50 Watts with outstanding transient response.

Only the FAIRCHILD 688 has the **New Exclusive TRANS/GARD** overload protection system. The electro-optical TRANS/GARD system allows input of the amplifier to be overloaded by as much as 40 db and still only result in a 1 db change in output of the amplifier. FAIRCHILD TRANS/GARD does not dissipate the power handling capabilities of the FAIRCHILD 688 50-Watt design. This amazing TRANS/GARD system, which does not introduce distortion, protects the amplifier and speaker systems from burnout. Only the 688 and TRANS/GARD prevent sound reinforcement systems from blasting listeners out of their seats due to inexperienced performers in front of a microphone. The unique FAIRCHILD TRANS/GARD system protects the transistors, transducers, loudspeakers and even the listener!

The Model 688 is available with or without transformer input, and a 70V line transformer output is available as an option. Gain 83 db. Sensitivity .15V for 50-Watt output. Height 3½"; Width 19". Rack mountable.

Write to FAIRCHILD — the pacemaker in professional audio products — for complete details.

# FAIRCHILD

RECORDING EQUIPMENT CORPORATION  
10-40 45th Ave., Long Island City 1, N. Y.

electrostatic because it has a flat power response curve whereas a moving-coil speaker does not. Because of this, an on-axis frequency response curve on a single electrostatic unit will show a rising response characteristic with frequency.<sup>9</sup> Since an electrostatic speaker system usually contains many tweeters connected in parallel, one cure for directivity is to fan them out on a spherical surface so that each one faces outward in a slightly different direction. Another interesting approach suggested by Walker<sup>5</sup> is to cover one whole wall of the room with electrostatic speakers.

The electrostatic speaker is not a perfect speaker. The diaphragms exhibit

standing wave resonances at various frequencies, and these can be seen by observing the reflection of a light bulb on the diaphragm while the frequency is varied. As might be expected, the biggest resonance amplitude-wise is at the fundamental resonant frequency of the diaphragm. The metal grids also exhibit resonance effects, and several electrostatic designs have applied damping materials to the grids to reduce these resonance.<sup>1, 6, 8, 14</sup>

The depth positioning of the woofers, mid-ranges, and tweeters with respect to each other is important if good transient response is wanted. All of the speakers should be in approximately the

same plane, whether or not that plane is flat or spherical, and should be connected in-phase as well. Musical transients lose their sharpness if the higher harmonics from a tweeter arrive at the listener's ear either sooner or later than the fundamental frequencies from a woofer. On several speaker systems the author could tell by listening if the tweeter was more than 1/4-in. away from the plane of the woofer. For moving-coil speakers, this plane seems to be about half way between the voice coil and front edge of the cone. The time delays in the

crossover networks should affect this depth positioning, but they don't seem to, and the author doesn't understand why not. If the tweeter is out of phase with the woofer, the sound jumps back and forth from one to the other instead of becoming fused into a common "wall of sound." These two effects can make the difference between just an ordinary sounding speaker system and a good one.

A full range electrostatic is the finest loudspeaker the author has ever listened to. For the same reasons the electrostatic tweeter is the finest tweeter the author has ever heard. The technical rea-

sons behind this good performance are given in the first part of this article. The performance of an electrostatic is so good that the very best auxiliary equipment is required to demonstrate their performance.

This article was written to help others build their own electrostatic speaker. I'm sold on them as being the best loudspeaker that anyone knows how to make today. Why don't you build one and see for yourself? **Æ**

## BIBLIOGRAPHY

<sup>1</sup> Janszen, Pritchard, and Hunt, "Electrostatic Loudspeakers, Technical Memorandum #17." Harvard University (Acoustics Research Laboratory), Cambridge, Mass. 1950. Available as microfilm for \$5.70 or as photocopy for \$16.00 (specify number PB125992, A.T.I. No. 207794) from:

Photoduplication Service  
Library of Congress  
Washington 25, D. C.

<sup>2</sup> A. A. Janszen, "Electrostatic Loudspeaker." U. S. Patent #2,631,196. A copy of any patent can be obtained by sending \$.25 per patent to:

U. S. Patent Office  
Washington 25, D. C.

<sup>3</sup> F. V. Hunt, "Electroacoustics." Wiley and Sons, 1954. Chapter 6. \$6.00.

<sup>4</sup> A. A. Janszen, "An Electrostatic Loudspeaker Development." *Journal of Audio Engineering Soc.*, April, 1955.

<sup>5</sup> P. J. Walker, "Wide Range Electrostatic Loudspeakers." *Wireless World*, May, June, and August, 1955.

<sup>6</sup> C. I. Malme, "A Wide-Range Electrostatic Loudspeaker." M. S. Thesis, June, 1958. Massachusetts Institute of Technology, Cambridge, Mass. Available as microfilm for \$4.70 from:

Microreproduction Service  
Massachusetts Institute of Technology  
Cambridge 39, Massachusetts

<sup>7</sup> G. A. Briggs, "Loudspeakers." October, 1958. \$4.95, published in England. Chapter 21.

<sup>8</sup> C. I. Malme, "A Wide-Range Electrostatic Loudspeaker." *Journal of Audio Engineering Soc.*, January, 1959. This article contains most but not all of the information in item 6.

<sup>9</sup> A. A. Janszen, "Testing Electrostatic Loudspeakers." *Radio and TV News*, March, 1959.

<sup>10</sup> A. A. Janszen, "Electrostatic Loudspeaker." U. S. Patent #2,896,025. Available by sending \$.25 per patent to:

U. S. Patent Office  
Washington 25, D. C.

<sup>11</sup> W. T. Selsted, "Electrostatic Earphone." *Journal of Audio Engineering Soc.*, April, 1961.

<sup>12</sup> D. T. N. Williamson and P. Walker, "Electrostatic Loudspeakers." U. S. Patent #3,008,013.

<sup>13</sup> D. T. N. Williamson and P. Walker, "Electrostatic Loudspeakers." U. S. Patent #3,008,014.

<sup>14</sup> C. I. Malme, "Transducer." U. S. Patent #3,014,098.

<sup>15</sup> A. A. Janszen, "A Full Range Electrostatic Speaker." *Proceedings of IRE NEREM Conference*, 1962.

<sup>16</sup> W. T. Selsted & G. A. Brettell, "Electrostatic Earphone." U. S. Patent #3,084,229.

## Now?...there's no reason not to buy the Uher 8000 by Martel...

### Why?...Because greater production efficiency and increased demand by Audio professionals has enabled Martel to lower the price. How can anyone resist the Uher 8000 now?



Audio Magazine reports: "...practically any use that can be imagined is possible with the Uher 8000."

"There are seven position-four speeds with three OFF positions between. Selecting the speed also adjusts equalization for each. A second switch together with an interlocked RECORD button, controls all of the electronic functions in its eleven positions, which are marked: 1-4—mono record or play on upper track; 2-3—mono record or play on lower track; STEREO—record or play; MULTIPLAY I—permits recording on the upper track from microphone and mixing with material from lower track; MULTIPLAY II—permits recording on lower track and mixing material already recorded on upper track; DIA-PILOT I—used for recording from microphone and/or from phono record or another tape machine on upper track as commentary for slides; DIA-PILOT II—after making recorded commentary on upper track, this position is used to record sub-sonic tone on lower track at points where a slide is to be changed and for playback with slide projector thereafter, with the slide changing at each point when the tone button was depressed in the second run-through; ECHO 1-4—permits adding delayed sound to an original recording on upper track, the amount of delay depending on the speed of the tape; ECHO 2-3—same operation for lower track; SYN-PLAY I—used for recording on one track for later recording another signal in synchronization with the first but on a second track when the switch is turned to the SYN-PLAY II position. Thus, practically any trick type of recording can be made with no external interconnecting or switching.

AKUSTOMAT makes it possible to use sound as a controlling medium for the recording operation. The machine can be used as a dictating machine, for example, without the need for a start-stop button—one simply speaks and the machine starts recording, and when the dictator pauses, the machine stops. Thus it may be used to monitor and record sounds of an intermittent nature over a long period of time without actually running except in the presence of some sound. We know no other machine which has this feature. In short, practically any use that can be imagined is possible with the Uher 8000.

If you're interested in the complete review of the Uher 8000, Write for nearest dealer and reprint of complete review.

**MARTEL  
ELECTRONICS**

see your local dealer or for complete review write

Los Angeles  
2356 So. Cotner

New York City  
1199 Broadway

Chicago  
1141 Merchandise Mart Plaza

## CORRECTION

In Part 1 of this article Fig. 2 and Fig. 7 were interchanged. Fig. 2 should have been Fig. 7 and vice versa. The captions are correct.



## EQUIPMENT PROFILE

(from page 37)



Fig. 4. Harman-Kardon solid-state FM-stereo tuner, Model F1000T.

The F1000T is designed to match the A1000T in appearance, human engineering, and performance. It definitely matches the A1000T in all aspects: The prominent location of the tuning knob, the pushbutton attenuators, and the behind-the-panel controls, and the general appearance and layout all match. In addition performance level is clearly consistent.

The circuit, although entirely solid state, is in some respects similar to the Citation tuner. First and foremost a tuned pre-selector assembly is used which takes a balanced antenna input, tunes it, and sends an unbalanced output through the attenuators to the r.f. stage. Standard, albeit solid-state, circuits handle the oscillator, mixer, i.f., and ratio detector functions. Also the multiplex decoding. Of course, small design changes in an apparently standard design may mean considerable difference in the performance of an FM tuner.

The performance of the F1000T is quite respectable. It pulled in 34 stations loud and clear on our standard antenna; sensitivity in 2.5  $\mu$ v IIF; capture ratio is 4 db; stereo separation 33 db; selectivity 34 db; AM suppression 51 db; crossmodulation index 65 db.

Summing up, the Harman-Kardon 1000 series tuner and amplifier are well worth considering if you are in the buying mood. F18

### SIGNAL-TO-NOISE RATIO FOR TAPE RECORDERS

Over the years we have advocated standard measurement techniques for high-fidelity equipment as an important step towards defining that much maligned term. Signal-to-noise ratio of tape recorders is one of those critical areas which has to be pinned down so that the specifications of a particular machine may be validly compared with any other machine. Various people and manufacturers have commented to us about the obvious variation, even in our own equipment reports. Fortunately, we know now that the NAB is in the process of approving a technical standard which includes this parameter. According to this standard, playback signal-to-noise is determined by recording certain discrete frequencies (NAB standard test tape) at 0-VU and at 400 cps; the tape is then erased on the machine and played back with the input shorted. Of course this is not the complete detailing of the test, but it does give the essential points.

Let us now look at the results of using this new standard. The last tape recorder we tested was the Concord 884, and the signal-to-noise we measured, using a different method, was 58 db. With the new standard method we measured 48 db. We feel that the new method, when approved, will be a step forward towards more meaningful reports. We are all for it, and hereby adopt it as our standard.



Available in 3 Impedances  
 Model 100 (8 ohms) \$39.50  
 Model 103 (300 ohms) \$39.50  
 Model 112 (1200 ohms) \$44.50

Whether you listen to records, tape or FM—listen to stereo in its fullest dimension with the world's most comfortable personal headset receiver. Exclusive Direct Acoustical Coupling guarantees you the ultimate in comfort with a quality of reproduction equal to that of the very best high quality speaker system.

Listen to the David Clark 100 Series at your Stereo Dealer—enjoy a truly personal and unique musical experience.



High Quality Personal Headset Receivers and Accessories for Stereophonic and Monophonic Applications.

**David Clark COMPANY INC.** WORCESTER, MASS.

CIRCLE 49

New!



## INSTRUMENTS for AUDIO MEASUREMENTS

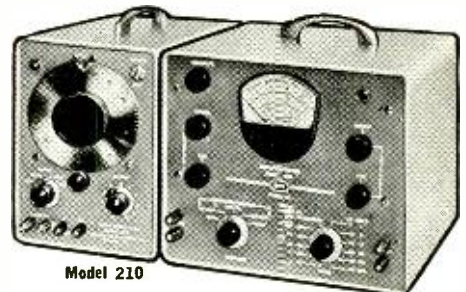

Model 210

Model 410

### MODEL 410 DISTORTION METER

- Measures audio distortion, noise level and AC voltages • Also a versatile vacuum tube voltmeter.
- Distortion levels as low as .1% can be measured on fundamental frequencies from 20 to 20,000 cps, indicates harmonics up to 100,000 cps • Distortion measurements can be made on signal levels of .1 volt to 30 volts rms • The vacuum tube voltmeter

provides an accuracy of  $\pm 5\%$  over a frequency range from 20 cps to 200 KC. For noise and db measurements, the instrument is calibrated in 1 db steps from 0 db to -15 db, the built-in attenuator provides additional ranges from -60 db to +50 db in 10 db steps.

### MODEL 210 AUDIO OSCILLATOR

- Provides a sine wave signal from 10 cps to 100 kc • Output level within  $\pm 1$  db when working into 600 ohms (reference 5 kc) • Power output, variable to above 150 mw • Hum and noise, -70

db at 5 volts output • Distortion is less than .2% at 5 volts output from 50 to 20,000 cps, slightly higher at higher output and frequency extremes.

**These instruments are supplied with many B.C. station installations for FCC Proof-of-Performance tests.**

**BARKER & WILLIAMSON, Inc.**  
 Radio Communication Equipment Since 1932  
 BRISTOL, PENNSYLVANIA • STIllwell 8-5581



CIRCLE 57

# LISTEN



## SCHOEPS MICROPHONES

Technical data\* can only give you the characteristics of a microphone—data can't describe your most important factor—the sound. Get a Schoeps Microphone on a 30 day trial—and listen!

\*You will receive this with your microphone

Designed by Schoeps  
Manufactured by Schoeps  
Patented by Schoeps



Shown: the M221B with MK26—3 pattern capsule

INTERNATIONAL ELECTROACOUSTICS INCORPORATED  
333 SIXTH AVENUE NEW YORK 14, N. Y. 212 WA 9-8364

CIRCLE 50

## NEW! LAFAYETTE AM/FM STEREO RECEIVER Model LA-230



# 139<sup>50</sup>

LA-230

The beautiful LA-230 makes an ideal heart for your stereo system. Features a sensitive AM and FM stereo tuner with "Stereo Searcher" circuit for easy station location; a 24-watt stereo amplifier with a clean response of 20-20,000 cps and complete stereo preamp facilities. Just add speakers for complete stereo system.

Imported

Free!

LAFAYETTE Radio ELECTRONICS  
Dept. AE-4, P.O. Box 10,  
Syosset, L.I., N.Y. 11791

Rush me FREE Giant 422 Page 1964  
Cat. 640

LA-230WX AM/FM Receiver  
\$..... Enclosed

Shipping Charges Collect

Name \_\_\_\_\_

Address \_\_\_\_\_

City \_\_\_\_\_

State \_\_\_\_\_

Zip \_\_\_\_\_

CIRCLE 58

# JAZZ and all that

Bertram Stanleigh

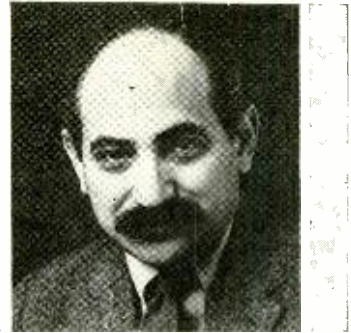

## The Jeremy Steig Quartet: Flute Fever Columbia Stereo CS 8936

A new performer with lots of ideas and a very different quality of sound. Both the sound and the ideas require a few hearings before one can adjust to them. This is far out, frenetic playing that comes from deep within Steig's psyche and speaks in a direct, artless fashion. Willis Conover's liner notes quote Steig, "I'm not Dizzy Gillespie and I know it." But in fact, Steig is very close to Dizzy in his technical mastery, his ability to handle a long phrase filled with short, staccato notes and his way of making a meaningful statement at a pace that most jazzmen can only maintain if they dispense with expression. He's also a bit of a nut, and some of his sounds are as strange as anything that has hit microgroove to date. When he hums while playing, the sound defies description (on first hearing, I thought my stylus was damaged). In addition to Steig, this record introduces a young and able pianist named Denny Zeitlin who combines good ideas with clean, rich sounding tone. The balance of the quartet consists of Ben Riley on drums and Ben Tucker on bass, but neither of these rhythm men has much opportunity to take over, and the recording balance is particularly unfavorable to Tucker whose low notes lack the resonance that more careful miking could have produced. An artist as well as musician, Steig painted the cover reproduced on this set, and the liner notes bear his line drawings of the group.

## Johnny Coles: Little Johnny C Blue Note Mono 4144

A warm and articulate trumpeter who manages to express himself fully without unduly forcing the dynamic range of his instrument, Coles is represented by a group of six selections that are just as much a showcase for pianist Duke Pearson. Five of the tunes are by Pearson and so are the liner notes. The sixth selection, *Hobo Joe*, is by the group's tenor sax, Joe Henderson. The remaining players are Leo Wright, alto and flute Bob Cranshaw, bass, and Walter Perkins and Pete La Roca, each of whom contribute a single side on drums. Throughout, the combo functions with a unanimity of expression that results in exceptional music making. Recording on this platter is also of a particularly high order with spine tingling presence on the reeds and brushes—not just boosted highs, but the kind of absolutely perfect mike placement that results in close up sound with natural balance over the whole frequency range.

## Art Blakey and the Jazz Messengers: The Freedom Rider

Blue Note Mono 4156

Blakey's eloquent seven minute and twenty-two second drum solo is the title number of this set, and it is a musical experience of shattering intensity. Whether it is social commentary, as the liner notes suggest, is another matter. For me, this is an experience so fundamentally musical as to obscure any extramusical considerations. It is absolute music that not only requires no explanations as to its origins or motivations, but is completely detached from anything that can be put into words. It is as fine and profound as any musical experience on records, easily the best

thing that Blakey has committed to wax. The four remaining numbers, with the *Jazz Messengers*, feature compositions by two members of the group, Wayne Shorter and Lee Morgan. These are first rate pieces, played to perfection, but it is difficult to give them very serious consideration in such close juxtaposition with *The Freedom Rider*. The sound is sheer perfection, a marvel of clarity with tremendous level.

## Bill Baron, Ted Curson & Orchestra: Now Hear This

Audio Fidelity Stereo AFSD 6123

The title suggests that an orchestra of substantial proportions accompanies this sax and trumpet duo. In fact, the *orchestra* consists of Dick Berk on drums, Ronnie Boykins on bass, and Bill Barron's brother Kenny on piano. Together they swing through a group of pleasantly extrovert numbers fashioned by Barron and Curson for maximum freedom of expression, and in Barron's *Big Bill*, *Hurdy Gurdy* and *Jes Swingin'* and Curson's *The Leopard* and *Dwackdi Mun Fudalick* these boys reveal substantial expressive talents and technical resources. It is in the three standards that fill out the disc that things fall somewhat short. *Around the World* and *You are Too Beautiful* disintegrate into a series of riffs with none of the cohesion of the previous home brew, and the final offering, Ketelby's *In a Monastery Garden* is simply not jazz material.

## The Ronnie Brown Trio: Jazz for Everyone Philips Stereo PHS 600-130

A pleasant trio, whose leader proves himself a proficient technician on vibes and piano, this group has a bright, energetic approach to the standards, and they can really swing. But in its first waxing it has had the misfortune to have been recorded live at a Hollywood nitery called P. J.'s. The sound of this club is very much like that of every other night club in the world—noisy, and in an effort to make itself heard, the group plays more loudly than it should. Not loud enough, however, so that much detail is not lost in the constant din of background chatter. This is not jazz for serious listening, rather it is a pleasant background for drinking and conversation. Since the sound of drinking, conversation and applause have already been supplied, the do-it-yourself fans who might otherwise be encouraged to add their own sounds of talk and elbow bending would be wise to wait until the Ronnie Brown Trio has a record date at a recording studio. They're worth waiting for.

## Gerald Wilson Orchestra: Portraits Pacific Jazz Stereo 80

This is big band jazz of great color and variety, performed with sensitivity and precision by the kind of dream orchestra that critics love to concoct in their imaginations. Joe Pass, guitar, Teddy Edwards and Harold Land, tenor, Jimmy Woods, alto, Jack Wilson, piano, Leroy Vinnegar, bass, are some of the distinguished sidemen who grace this release. At the heart of this enterprise is Gerald Wilson, who is responsible for all the arrangements as well as the direction of this eighteen piece aggregation. His refined style and supple rhythm are matched by a superb ability to



blend choirs in a manner that produces rich tonal depth without sacrificing transparency in loud passages. Of the disc's seven numbers, five are composed by Wilson, four of them portraits of persons who have made a great impression on him. The remaining two works are *So What* by Miles Davis and *'Round Midnight* by Thelonius Monk. The band rocks, soars, swings and bounces in a smoothly polished manner that can best be compared with vintage Ellington. Recording is clear and close up, but it would seem to me that such imaginative arrangements and solos should have been matched with a more inventive stereo mixing technique. What we have here is simply a rock steady band divided into right, left and center.

**Les Soeurs Blanches: Missa Bantu  
Philips Re-Processed for  
Stereo PCC 611**

This setting of a Mass for the first Sunday after Easter, sung by the Congolese Sisters of Katana, is a fascinating further glimpse into the musical worship of the African. As a sequel to the highly popular *Missa Luba*, it lacks much of that previous recording's surging drive, but it is nonetheless worthy of serious study for its poly-rhythmic effects and the drum accompaniments in the *Kyrie*, *Gloria*, and particularly in the *Offertorium*. The music is Gregorian, but the voices have the special sound of Africa. The recording was made in Bukavu Cathedral, in the extreme eastern part of the Congo, by the mayor of the town. While it is by no means comparable with modern professional recordings, it is a worthwhile document and a moving spiritual experience.

**Jesse Fuller: San Francisco Bay Blues  
Good Time Jazz Stereo S 10051**

Labelled "The Amazing One Man Band," Jesse Fuller lives up to this claim by producing more variety of sound than the average three or four piece group. With the big toe

of his right foot, he plays a six string pedal instrument of his own invention dubbed the *foxdella*. His left foot operates a high hat cymbal, while he plies his twelve-string guitar and alternately sings or plays the harmonica or kazoo, both of which are attached to him by a neck harness. Phenomena of this variety are far from unheard of, but one man bands who produce genuinely expressive music are as rare as one arm trombonists. Fuller is the ultimate exception, he employs his instrumental resources with consummate skill and refinement, and he sings like a great traditional blues singer. In addition to his own versions of *Midnight Special*, *Whoa Mule*, *John Henry*, and *Where Could I Go But to the Lord*, he presents a definitive version of his popular *San Francisco Bay Blues* and several other original songs, including an amusing *Brown-skin Gal (I've Got My Eye on You)*. Recording a one man band in stereo would seem to be a pointless effort, but *Good Time Jazz* demonstrates how effective it can be by placing the *foxdella* on one side, the twelve-string guitar on the other, leaving Jesse's voice right in the center. I wonder how many microphones it takes to record a one man band?

**Clyde McPhatter: Songs of the Big City  
Mercury Stereo SR 60902**

Clyde McPhatter present a refreshing kind of folk music that differs substantially from that of city dwellers who express themselves in a country idiom. In terms of both material and style, McPhatter is a truly urban singer. Musically he is closer to rock and roll and pop music than to folk music or jazz, and his accompaniments include all of the stock attributes of pop discs: electric organ, string section, vocal chorus and liberal use of echo. But his message is that of genuine social commentary. In direct, unsubtle lyrics he depicts the New York of the poor and the oppressed, the crowding, the squalor, the despair and the joy of city living. Such tunes as *Deep in the Heart of Harlem*, *My Block*, *A Suburban Town*, *Spanish Harlem* and *Second Window*, *Second Floor* all offer graphic insights into the world of the tenement dweller. **ZE**



**WHY BUYING A VACUUM TUBE  
AMPLIFIER NOW COULD BE A MISTAKE  
YOU'LL REGRET LATER**

Just as surely as stereo replaced mono, so too will the all-transistor amplifier replace the old-fashioned vacuum tube type. We predict that vacuum tube amplifiers will be obsolete for high quality home music reproduction, possibly within a year. If you have ever tried to trade mono components for stereo, you know what obsolescence does to trade-in values! So don't make the mistake of going the vacuum tube way. If you are now buying an amplifier, you should carefully consider a thoroughly proved, successfully designed all-transistor amplifier such as the Altec 360A Royale II.

**ADVANTAGES OF PROPERLY DESIGNED  
TRANSISTOR AMPLIFIERS**

First, transistors point the road to improved performance, they sound better, and they represent progress. Second, transistor amplifiers will sound "as good as new" indefinitely because they are not subject to gradual deterioration of quality that is inevitable with heat-generating vacuum tubes. Each time you turn a vacuum tube amplifier on or off, the heating and cooling cycle adversely affects vacuum tubes as well as critical circuit components such as condensers, resistors, capacitors, etc. Unlike vacuum tubes, transistors have the promise of indefinite life and do not affect other nearby circuit components because they operate "cool!"

**ALTEC 360A IS ONE OF FEW  
TRANSISTOR AMPLIFIERS NOW  
AVAILABLE**

So far, few major manufacturers have announced all-transistor amplifiers. This is understandable because successful design of transistor amplifiers requires highly specialized engineering skills and *experience with transistors*. Our 360A integrated all-transistor pre-power amplifier has been part of our **PLAYBACK** line since last year, and selling fast! Why we succeeded so early while most other manufacturers are still afraid to try is well explained by the following from the April issue of *Audio Magazine*:

"Professionals in the recording and broadcasting industries know that Altec has been making solid-state amplifiers for some time now—for professional use only. The "Royale II" reflects the experience Altec has achieved in making those amplifiers.

"Surprisingly enough, Altec has been making solid-state equipment with relatively little fanfare—certainly it is surprising in view of all the fuss that is being made in this area. Of course, when one realizes that Altec is related to Ling-Temco-Vought, Inc., one can understand their advanced knowledge of solid-state devices plus their relative reticence!"

It will pay you to go **PLAYBACK** all the way—not only with **PLAYBACK** speakers but with the all-transistor 360A **PLAYBACK** amplifier as well.

Altec Lansing Corporation  
Anaheim, California

© 1964 ALC

CIRCLE 51

# NOW PERSONAL TV LISTENING



You Can Enjoy TV... Or Ignore It With the

## TELEX TV LISTENER

Enjoy television in private without disturbing others. Full rich sound through a comfortable, lightweight individual earphone. Others don't hear a thing. Keeps house quiet and peaceful during noisy Westerns and children's programs. Ideal for late night viewing after family is asleep. Switch sound on or off, and control volume remotely from your chair.

15 ft. listener cord and 5 ft. Earset® cord. Tune down commercials. Perfect for the hard of hearing, motels, institutions. With extra Earset\* two can listen. See your local dealer.

A Product of Sound Research

**TELEX/Acoustic Products**

COMMUNICATIONS ACCESSORIES

3054 Excelsior Blvd. • Minneapolis 16, Minn.

CIRCLE 59

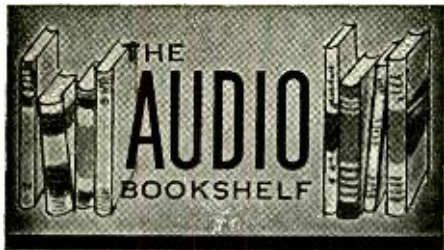

**Maintaining Hi-Fi Equipment**  
**Joseph Marshall**  
 A valuable reference for anyone whose living or hobby is servicing hi-fi equipment. Outlines the professional approach for servicing all types of hi-fi components. Covers trouble-shooting of electronic, mechanical and acoustic problems. 224 pages.  
**No. 58 Paperback \$2.90\***



**Designing and Building Hi-Fi Furniture**  
**Jeff Markel**  
 Written by a professional hi-fi furniture designer who has taught furniture design at leading colleges, this book is an authentic reference of value to the hi-fi fan and professional custom builder. Covers everything from types of woods to furniture finishing for the mechanically adept; design principles, styles and arrangements for the decor minded. 224 pages.  
**No. 79 Paperback \$2.90\***



**"The AUDIO Cyclopedia"**  
**Howard M. Tremaine**

- 1280 pages
- 3400 topics
- 1600 illustrations

Here is one single volume with the most comprehensive coverage of every phase of audio. Concise, accurate explanations of all audio and hi-fi subjects. More than 7 years in preparation—the most authoritative encyclopedic work with a unique quick reference system for instant answers to any question. A vital complete reference book for every audio engineer, technician, and serious audiophile.



**No. 123 \$19.95\***

**McProud High Fidelity Omnibook**  
 Prepared and edited by C. G. McProud, publisher of AUDIO, and noted authority and pioneer in the field of high fidelity. Contains a wealth of ideas, how to's, what to's, and when to's, written so plainly that both engineer and layman can appreciate its valuable content. Covers planning, problems with decoration, cabinets and building hi-fi furniture. A perfect guide.  
**No. 115 \$2.50\***



**The 5th AUDIO Anthology**  
 Edited by C. G. McProud, publisher of AUDIO. An anthology of the most significant articles covering: stereo recording and reproduction; stereo multiplex; measurements; stereo technology, construction and theory — which appeared in AUDIO during 1958 and 1959. The 5th is truly a collectors' item and a valuable reference for the professional engineer, teacher, student, hobbyist and hi-fi fan. 144 pages.  
**No. 125 \$3.50**



**The 6th AUDIO Anthology**  
 Edited by C. G. McProud, publisher of AUDIO. Includes articles on the two most significant milestones in the field of high fidelity: FM STEREO and TRANSISTORS IN AUDIO EQUIPMENT. A meaningful reference for everyone in the fields of audio engineering, recording, broadcasting, manufacturing and servicing of components and equipment. A necessary book for the high fidelity enthusiast. 144 pages.  
**No. 130 \$3.95**



**Tape Recorders and Tape Recording**  
**Harold D. Weiler**  
 A complete book on home recording by the author of *High Fidelity Simplified*. Easy to read and learn the techniques required for professional results with home recorders. Covers room acoustics, microphone techniques, sound effects, editing and splicing, etc. Invaluable to recording enthusiasts.  
**No. 112 Paper Cover \$2.95\***



**"the best of AUDIO"—**  
 edited by C. G. McProud  
 A new compendium of AUDIO knowledge. Here is a collection of the best of AUDIO — The AUDIO Clinic by Joseph Giovanelli . . . noted audio engineer and the original high fidelity answer-man — EQUIPMENT PROFILES edited by C. G. McProud . . . Editor of AUDIO. Here is a wealth of hi-fi and audio information. Answers to the most important issues in high fidelity and a valuable reference.  
**No. 124 Volume I \$2.00\***



**AUDIOGUIDE**  
 By the editors of AUDIO, the original magazine about high fidelity. A 1962-1963 product review of stereo high fidelity components. Valuable reference for the high fidelity enthusiast and hobbyist. Part I contains a thorough discussion of the *Problems of a Stereo Installation*; Part II is a complete treatise on *Selecting a Tape Recorder*. Indispensable to the prospective buyer of stereo components and tape recorders. Includes a section on where to buy various stereo hi-fi components and accessories. 156 pages.  
**No. 127 \$1.00**

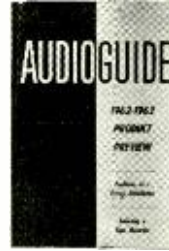

**● MONTHLY SPECIAL! SAVE \$5.00**  
 Save almost 50% with this collection of AUDIO books.  
 "best of AUDIO" (\$2.00) 5th AUDIO ANTHOLOGY (\$3.50)  
 McProud High Fidelity Omnibook (\$2.50) and  
 Tape Recorders & Tape Recording (\$2.95)  
**TOTAL VALUE ALL FOUR BOOKS . . . \$10.95**  
**Your cost only . . . \$5.95 Postpaid**  
 This offer expires June 30, 1964, and is good only on direct order to the Publisher.  
**CIRCLE OS400**

**High Fidelity Simplified**  
**Harold D. Weiler** 3rd Edition  
 The complete hi-fi story — answers all questions about tuners, changers, amplifiers, tape recorders, speakers, record players, etc. Lots of ideas for custom installations. Tells how to achieve concert hall reception in your home. 216 pages.  
**No. 142 \$3.30**



**AUDIO Bookshelf—RADIO MAGAZINES, INC.**  
 P. O. Box 629, Mineola, New York 11502  
 Please send me the books I have circled below. I am enclosing the full remittance of \$..... (No C.O.D. or billing.)

58	79	112	115	123	124
125	127	130	142	251	OS400

NAME \_\_\_\_\_  
 ADDRESS \_\_\_\_\_  
 CITY \_\_\_\_\_ STATE \_\_\_\_\_ ZIP \_\_\_\_\_

**Getting The Most Out Of Your Tape Recorder**  
**Herman Burstein**  
 Written in "plain talk" for the man who has, or wishes to buy, a tape recorder. It answers the myriad questions raised by tape recording enthusiasts. Its chapters cover every phase of operation and maintenance—from adding a tape recorder to the hi-fi system, to a thorough dissertation on microphones. Lots of practical information on how to buy. 176 pages.  
**No. 251 \$4.25**





# Hi Fi and the British

Alan G. Watling

## A Britisher Searches the British (Hi Fi) Soul and Finds: Tradition

Just as many Britishers think that America is all Silver Screen, hamburgers and big cities, there must be some AUDIO readers who still visualize British sound reproduction equipment as mahogany radiograms owned by retired Reverends who live in Voigt Corner Horns. Yes, they do still visualize, I mean. Despite Briggs, Walker, Leak and Co. Which is a sad thing, because they don't live in them, I mean. For one thing, mahogany is hard to come by, and for another, their feet would get stuck in the exponential bit.

Perhaps it would help if I explained our position a bit. Tradition is our slogan and even though Hi Fi is hardly that, there is still a strong breath of Olde Worlde when you lift the record player lid. Record player, please note, not phonogram. One almost expects to see a blue and gold label pelting round at 78,

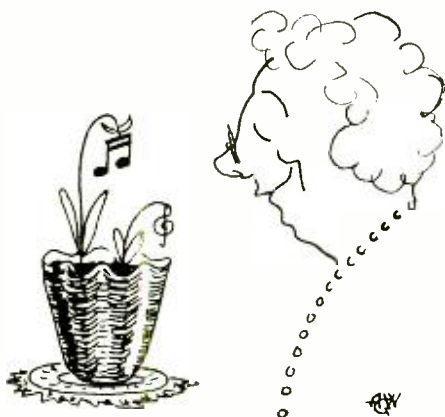

Fig. 1. Efficient drainage.

beg pardon, there is. This must be one of the few which escaped being made into flowerpots during the Great Plague. At that time the phrase Hole in the Middle stood for efficient drainage, and a 12-inch was only used for Greater Flowering Bugwort. The actual sound obtainable from the original record was a masterpiece of aberration, suffering from all the distortions we now spend good money to avoid, but British, boy, British, right through to its West African Shellac. The Long Life needle tore the guts (pardon, ladies) out of the crescendoes, and carried on to rip off the label and beat itself to death on the British Cast Iron spindle. All of which meant a stiff

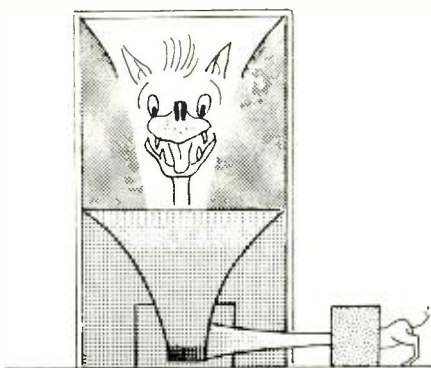

Fig. 2. Woofers.

upper lip and a new elastic band on the armature.

The performance which was committed to the disc was the product of the real heroes of the British Recording Tradition,—the Engineers. When you can only afford one electric-type microphone, and the man in the power room is pedalling a little bit slowly, then the problem of Balance is one of art rather than science. This then becomes a problem of forceful administration, at which the British are hot stuff. Caruso was definitely recorded on the playing fields of Eton. So we see the attitude to Hi Fi slowly being moulded—on the potter's wheel, so to speak. One speaks of Music with humility, of Artistes with reverence (at least ten per cent), but of Equipment with that slightly curled lip that has New Worlders reaching for their tomahawks. You do still use them don't you? As for a man who actually Designed Equipment and had the nerve to

start making it in a tin shed as a Limited Company, well, he might as well leave for the Colonies.

Looking at it objectively, it is difficult to see when we considered the admiration of equipment as something typically American. It really isn't true, I suppose. After all, we're mad keen on craftsmanship, as long as it's wrought iron or knotty elm. It's when its gets knobs on it that we start hiding it in the tool-shed and calling it Father's Little Weakness. And we are scared out of our boots when it comes to technical jargon. Gain on the highs becomes "prominence in the upper musical register," and even now tweeters and woofers are often mistaken for those pretty prints of birds and dogs that greet you in the Squire's country house. It puts the people who use it into the "crank" category, which often makes it difficult to recognize the real cranks. So perhaps we admire your more extrovert ads more than we dare admit—freedom to be enthusiastic in public was never a British trait.

Coming back to the present, we are being faced with a solid-state crisis. It is obviously very American to be computerized and transistorized circuit-wise, so whatever we do we must keep the British Line in our designs. That's why I think there is a really glowing future for a massive output transistor with a Shakespearean Name (Macbeth Mark IV?) and a wrought-iron heat-sink. The free-standing cabinet to be on a plinth of genuine Robin Hood yew. The speaker hidden behind a Hogarth print (on open-weave Mylar of course).

We would never sell the stuff, of course, but think of the Prestige. **AE**

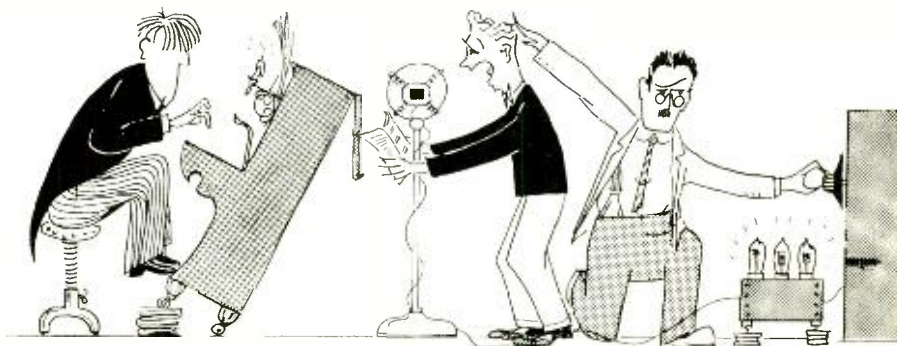
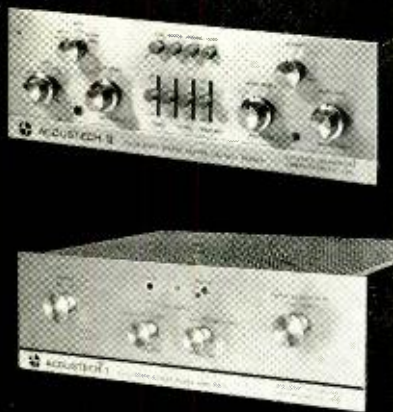

Fig. 3. Problem of balance.

“...major  
step  
forward”



## ACOUSTECH SOLID STATE AMPLIFYING SYSTEM

“... better than the best”  
“... seems to ‘grab hold of’ and control a speaker to a degree that has led many listeners to remark that the speaker itself ‘never sounded better.’”  
“... the finest square wave response I have ever observed”

These are examples of the acclaim accorded the Acoustech I Solid State Stereo Power Amplifier since its introduction at the 1962 New York High Fidelity Show. Now the first “all-out” solid state amplifying system is made possible with the new Acoustech II Stereo Decade Control Center. These two units afford the listener a new standard in music reproduction and reliability possible only with solid state circuitry throughout.

For full information on these remarkable instruments, send coupon below.

Acoustech I \$395, Acoustech II \$348 (slightly higher west of Rockies)

\*High Fidelity Magazine, August, 1962  
\*\*HiFi/Stereo Review, February, 1963



ACOUSTECH, Inc., 139 Main St.  
Cambridge, Mass. 02142 Dept. A-6.

Name \_\_\_\_\_

Address \_\_\_\_\_

City \_\_\_\_\_ State \_\_\_\_\_

CIRCLE 54

## AUDIOCLINIC

(from page 2)

pedance of the stage driven by a device is at least ten times higher than the impedance of the device itself, there will be a resulting 3-db increase in signal appearing at this stage over what would be present if impedances were matched. You would expect this to be true because with the impedances matched, a voltage division action takes place in which half the voltage is lost across the device driving the stage and hence, is not available for use by the stage. This approach is best applied where the device is terminated in a cathode follower. Clearly, your equipment meets this specification, so you need not concern yourself any further with this problem. Just relax and enjoy the music.

**Finest**... “The KSC-1 is easily the finest speaker in its price class that I have heard.”

... Larry Zide, American Record Guide\*

**Admirable**... “Its handling of percussives, plucked strings, and other sharply articulated sounds is very good; its tonal balance, admirable; its general timbre quite natural and not at all ‘honky’, ‘boxlike’, or overly ‘projected’ at the listener. It will... permit organ records to sound authentic, if not awesome.”

... High Fidelity Magazine\*

## The Startling New KSC-1 SPEAKER SYSTEM

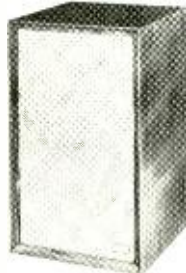

Listen and Compare... then see if you don't agree that this remarkable 3-way speaker system produces extraordinary realistic sound quality that is a delight to hear... compares with the best you've ever heard anywhere. Three magnificent speaker units from SEAS of Norway, meticulously blended, plus ingenious cabinet design. Beautiful oiled walnut, unfinished, other fine finishes.

**NEW KSC-55 LOW COST SYSTEM** of radical new design, with superb 10" wide range coaxial SEAS speaker. Delightful realistic performance. Nothing else like it near this low price.

\*Send for reprint of complete review.

At your audio dealer or write for information to

**KSC SYSTEMS, INC.**  
P.O. Box 303, Knickerbocker Sta., N.Y. 2, N.Y.

CIRCLE 60

Cough  
too  
much?  
Short  
of  
breath?



You may have a Respiratory Disease.  
Don't take chances, see your doctor,  
says your Christmas Seal association.

## CLASSIFIED

Rates: 10¢ per word per insertion for noncommercial advertisements; 25¢ per word for commercial advertisements. Rates are net, and no discounts will be allowed. Copy must be accompanied by remittance in full, and must reach the New York office by the first of the month preceding the date of issue.

**HIGH FIDELITY SPEAKERS REPAIRED**  
AMPRITE SPEAKER SERVICE  
168 W. 23rd St., New York 11, N. Y.  
CH 3-4812

**MILITARY DISCOUNTS**—name brands. Free recording tape and stereo handbook. Include rank, serial number. Electronics International, Inc., Box 3066, Charlottesville, Virginia.

**HI-FI COMPONENTS**, tape recorders at guaranteed “We Will Not Be Undersold” prices. 15-day money-back guarantee, 2-year warranty. NO CATALOG. QUOTATIONS FREE. HI-FIDELITY CENTER, 1797-V 1st Ave., New York 28, N. Y.

**HARPSICHORD**. Same as owned by Philadelphia Orchestra and RCA Victor. In kit form for home workshop assembly, \$150. Clavichord kit, \$100. Free brochure. Write: Zuckermann Harpsichords, Dept. R, 115 Christopher St., New York 14, N. Y.

**STEREO TAPES**: 50% off. Send for free literature. Stereo Tape Supply Co., P. O. Box 3361, Orlando, Fla.

**SELL**: Genuine laboratory model Edison record player, lowboy mahogany console with approximately 145 1/4" Edison records, all in excellent condition. Make offer. Bill O'Dell, 2500 Marshall Rd. c/o Valley Park, Mo. 63088.

**FOR SALE**: Scott 310-C, \$100; Fisher 202-R AM/FM plus MPX-100 adapter, \$250. Fairchild Compaider, \$50 Electro-Voice crossover (one) X336, \$25, (two) X2635, \$40 a piece, Electro-Voice SP-15, \$50, patch panels, patch cords. A. Yacevich, Jr., Tamarac Rd., Troy, N. Y.

**AMPEX 612** reproducer. Finest player ever made. Plays half, two and four track stereo/monophonic. Three heads, all correct equalization. Preamplifier, alignment tape, portable case, extra parts included, \$265. John Maxson, 5053 Les Chateaux, Dallas, Texas.

**SCOTT** integrated amplifier, latest model (299D) originally \$255, with case, now \$165 only two months old. Joseph Weigbein, 4811 N. Hopkins St., Milwaukee 9, Wis.

**PICK UP THE HIDDEN FM PROGRAMS NOW ON THE AIR**. Build a sub-carrier activity adapter for your FM tuner and get music without commercial announcements of any kind. Complete text with schematics, \$3. Wired adapters, \$75. Complete background music receivers \$150 and up. We specialize in sub-carrier activity equipment. Music Association, 65 Glenwood Rd., Upper Montclair, N. J.

Electro-Voice Georgian, blonde. Asking \$450. Also Fisher 60-watt amplifier, AM/FM combination. Garrard changer. Make offer. Carl Freedman, Jamesville, N. Y. 315 492 0026.

**SELL**: Magnecord 728, four heads, \$450. William Bucci, 49 Ayrmont Lane, Matawan, N. J.

**DISCOUNT RECORDS**—all labels—all artists—free details. Write Cliff House, Box 42A, Utica, N. Y.

**FOR SALE**: Fairchild 2 speed turntable model 412-2 with walnut base; Empire 980 (nearm); B&O (ADC-1) stereo cartridge. Cost over \$240. Asking \$95, (\$105 with ADC-1). Joseph Basile, 242 Cranz Place, Akron, Ohio 44310. 216 535 7278.

**TEST EQUIPMENT SALE**: Hewlett-Packard 350-A attenuator, \$39.50; DAVEN VT-795-G 600 ohm “T” network (new), \$125; RCA broadcast microphone 77DX (new) \$95; Ballantine VTVM 300E, \$159.50, 302C \$149.50; Dumont oscilloscope 304H, \$125, 304AR, \$175, 301A, \$275; Lambda transistorized power supply LT-2095M (new), \$165; Gertsch Ratiotran RT-11R, \$275, ST-100A, \$42.50; General Radio impedance comparator 1605-AR, \$475, 544-B, \$249.50. All excellent condition. If you like bargains in test equipment, get on our mailing list! Electronicraft, Inc., Box 13, Binghamton, N. Y. 13902. Phone 607 724 5785.



**save over 40% on hi-fi**

Write For Our Price Now. YOU'LL BE GLAD YOU DID.

Up to 24 mos. to pay

- \* 15 day money-back guarantee.
- \* Full 2 yr Warranty-Parts & Labor.
- \* Factory Franchised all lines. We ship from stock.
- \* Trade-ins Highest allowance-Send your list.
- \* 19th year of reliable service-world-wide.

\* We guarantee "WE WILL NOT BE UNDERSOLD."

Best Buy. Hi-Fi List Free.

1797-U 1st Ave. New York, N. Y. 10028

**HI-FIDELITY CENTER**  
"The House of Low Low Prices"

CIRCLE 61

**HI-FIDELITY RECORDS FROM YOUR EDITED TAPES.**

For rates and services refer to May issue of Audio—Page 60.

**Ohio Recording Service**  
2520 Monroe Street  
Toledo, Ohio 43620

CIRCLE 62

**CANADA High Fidelity Equipment**

Complete Lines • Complete Service

Hi-Fi Records — Components and Accessories

**ELECTRO-VOICE SOUND SYSTEMS**

126 DUNDAS ST. WEST. TORONTO, CANADA

CIRCLE 63

**FAST SHIPMENTS**

TIME PAYMENTS

COMPONENTS • KITS

- BEST-BY-COMPARISON PRICES.
- VISIT OUR STORE
- FACTORY SEALED CARTONS
- SEND FOR "QUOTES" ON PACKAGE DEALS AND SAVE MORE

WRITE FOR MONTHLY SPECIALS

**CARSTON Studios**

125-A East 88 St., New York 28, N. Y.

CIRCLE 64

**SUPPORT YOUR MENTAL HEALTH ASSOCIATION**

NATIONAL ASSOCIATION FOR MENTAL HEALTH

## Industry ...

● **Conlon Joins Elpa.** Elpa Marketing Industries, Inc., New Hyde Park, New York, has announced the addition of Frank E. Conlon to their organization. Mr. Conlon, formerly with the General Electric Company, will give Elpa additional depth in planning and implementing various scheduled marketing programs.

● **Ampex Closing Sunnyvale Plant.** Ampex Corporation announced plans for a gradual transfer of operations from its Sunnyvale (California) plant over approximately 14 months to other present and future company facilities. C. Gus Grant, vice president, operations, said the company has undertaken a program to investigate other employment opportunities within Ampex and elsewhere for the approximately 300 employees at the Sunnyvale plant. "Because the transfer will take place over a 14-month period we hope to be able to find employment for the majority of these people," Grant said. Grant termed the closing a fundamental part of Ampex' long-range plans, which call for a variety of facilities strategically located to serve new and future world markets. "This decision is the result of long and careful deliberation and is designed to enable Ampex to meet most effectively new and vigorous competition from both domestic and overseas manufacturers throughout the free world."

● **Music Merchants to Receive Special 256-Page Advertising Course.** Music merchants who join in the unusual "Total Selling For Music Stores" advertising clinic conducted by top authority Clyde Bedell at the 1964 Music Show will receive as part of the comprehensive package a new 15-part printed advertising course of 256 pages plus a full study course manual and a special Music Merchants supplement, announced William R. Gard, executive secretary of the National Association of Music Merchants. Gard disclosed further details of the extraordinary advertising and selling project to be conducted by Bedell during convention week June 28-July 2 at Chicago's Conrad Hilton Hotel in urging early advance reservations for the clinic "to make certain that music merchants are assured of a seat at the sessions." The 11 x 14 advertising course consisting of 15 separate chapters will be given to every participant as part of the special package price of \$39.95 for NAMM members and will be supplemented by the 24-page manual designed for follow-up sales meetings with company staffs. The manual includes suggestions and instructions for holding meeting, as well as assignment which can be given to personnel studying the course together.

## NEW LITERATURE

● **Improved TV and FM Reception.** Cornell-Dubilier has just published a 20-page booklet analyzing the cause of TV and FM reception difficulties and their remedies. The booklet describes the reasons for poor TV and FM reception and the basic forms of antennas available and their purpose. Cornell-Dubilier Electronics Division, Newark 1, N. J. **F-8**

● **Component Catalog.** A new catalog of stereo components is available from Bell Sound. The 16-page catalog describes the full line of Bell stereo tuners, amplifiers, receivers, tape decks, and tape recorders and includes complete specifications, description, and illustrations on all items. The new catalog, designated CL-643, is available upon request to TRW Columbus Division, 6325 Huntley Road, Columbus, Ohio. **F-9**

● **Portable Tape Recorder.** Literature on the Freeman "550 Senior" professional portable tape recorder is now available from Freeman Electronics Corp. Features, specifications, available accessories and pictures of this latest model Freeman portable tape recorder are also included. Freeman Electronics Corp., 729 N. Highland Ave., Los Angeles 38, Calif. **F-10**

## ASSEMBLE YOUR OWN ALL-TRANSISTOR Schober ELECTRONIC ORGAN



3 NEW MODELS

Recital Console II	\$1500
Console II	\$850
Spinnet	\$550

This is the all-new, all-transistor Schober Recital Model...the most versatile electronic organ available today. Its 32 voices (plus amazing "Library of Stops"), 6 couplers and 5 pitch registers delight professional musicians...make learning easy for beginners. Comparable to ready-built organs selling from \$5000 to \$6000.

The pride and satisfaction of building one of these most pipe-like of electronic organs can now be yours...starting for as low as \$550. The Schober Spinnet, only 39 1/4 inches wide, fits into the smallest living room. The new, all-transistor Schober Console II is the aristocrat of "home-size" organs...with two full 61-note manuals, 17 pedals, 22 stops and coupler, 3 pitch registers and authentic theatre voicing.

**AND YOU SAVE 50% OR MORE BECAUSE YOU'RE BUYING DIRECTLY FROM THE MANUFACTURER AND PAYING ONLY FOR THE PARTS, NOT COSTLY LABOR.**

It's easy to assemble a Schober Organ. No special skills or experience needed. No technical or musical knowledge either. Everything you need is furnished, including the know-how. You supply only simple hand tools and the time.

You can buy the organ section by section...so you needn't spend the whole amount at once.

You can begin playing in an hour, even if you've never played before—with the ingenious Pointer System, available from Schober.

Thousands of men and women—teenagers, too—have already assembled Schober Organs. We're proud to say that many who could afford to buy any organ have chosen Schober because they preferred it musically.

Send for our free Schober Booklet, describing in detail the exciting Schober Organs and optional accessories; it includes a free 7-inch "sampler" record so you can hear before you buy.

### THE Schober Organ CORPORATION

43 West 61st Street, New York, N.Y. 10023

Also available in Canada, Australia, Hong Kong, Mexico, Puerto Rico, and the United Kingdom

THE SCHOBER ORGAN CORP., DEPT. AE-14  
43 West 61st Street, New York, N.Y. 10023

Please send me FREE Schober Booklet and free 7-inch "sampler" record.

Enclosed find \$2.00 for 10-inch quality LP record of Schober Organ music. (\$2.00 refunded with purchase of first kit.)

Name \_\_\_\_\_

Address \_\_\_\_\_

City \_\_\_\_\_ State \_\_\_\_\_ Zip No. \_\_\_\_\_

CIRCLE 55



— first choice  
of those who  
demand the best!

**NEW**

**Solid  
State  
RECORDERS**

**INCOMPARABLE  
PERFORMANCE**

Quarter-Track Record/Play Data			
ips	db	cps	s/n
7-1/2	±2	50 — 30,000	56db
3-3/4	±2	30 — 20,000	52db
1-7/8	±3	30 — 12,000	46db

The most complete recording instruments ever designed for stereo use. Audio circuitry, ±1/4 db from 10-100,000 cps; extended range, 5-500,000 cps. Plug-in circuit modules are printed on epoxy and gold plated. Engineered to space craft reliability.



THE HALLMARK  
OF CROWN —  
SUPERLATIVE  
CRAFTSMANSHIP  
THROUGHOUT!

**INDIVIDUAL PERFORMANCE  
RECORD SUPPLIED  
WITH EACH CROWN**

WRITE DEPT. AU-06



CIRCLE 56

**ADVERTISING  
INDEX**

Acoustech, Inc. .... 54  
Acoustic Research, Inc. .... 15  
AKG of America .... 46  
Altec Lansing Corporation .... 6, 51  
Audio Bookshelf .... 52  
Barker & Williamson, Inc. .... 49  
Benjamin Electronic Sound Corp. .... 11  
Bozak .... 10  
British Industries Corporation .... 3  
Carston Studios .... 55  
Clark, David, Company, Inc. .... 49  
Classified .... 54  
Crown International .... 56  
Dynaco, Inc. .... 7  
Eastman Kodak Company, .... 38, 39  
Electro-Voice, Inc. .... 1, Cov. IV  
Electro-Voice Sound Systems, Inc. .... 55  
Elpa Marketing Industries .... 41  
Empire Scientific Corp. .... 5  
Fairchild Recording Equipment Corp. .... 45, 47  
Finney Company .... 56  
Fisher Radio Corp. .... 9  
Garrard Sales Corp. .... 3  
Gotham Audio Corporation .... 44  
Harman-Kardon .... Cov. III  
Hi Fidelity Center .... 55  
International Electroacoustics, Inc. .... 50  
KSC Systems .... 54  
Lafayette Radio .... 50  
Lansing, James B., Sound Inc. .... 13  
Martel Electronics .... 48  
McIntosh Laboratory, Inc. .... 43  
North American Philips Co., Inc. .... 14  
Ohio Recording Service .... 55  
Pickering & Company, Inc. .... 17  
Schober Organ Corporation .... 55  
Scott, H. H., Inc. .... Cov. II  
Sherwood Electronic Laboratories, Inc. ... 18  
Shure Brothers, Inc. .... 31  
Telex Acoustic Products .... 51  
YL Acoustic Co., Ltd. .... 56

**SYMPHONIETTA  
NEW  
HIGH  
FIDELITY  
SPEAKER  
SYSTEM**



of the 4-way horn-loaded type. Expensive true-fidelity sound reproduction at a popular price. Further information available on request. U. S. and Canadian representation (importers and distributors) is wanted. Apply directly to:



**YL ACOUSTIC CO., LTD.**  
19 Shiba-Tamura-Cho, Minato-ku, Tokyo, JAPAN

CIRCLE 65

**NOW...PERFECT FM  
ELIMINATE  
FM  
INTERFERENCE!  
With the Sensational  
New! FINCO  
FM BAND PASS FILTER**



ENGINEERED TO  
MOUNT ANYWHERE

Get only pure FM signals. Use a Finco FM Band Pass Filter to stop interference and block out unwanted signals from T.V., Citizens Band and Amateur transmitters, motors, autos and fluorescent lamps. Size: 4 1/4" x 2" x 1 1/2". Available at your Finco Hi-Fi dealer. Satisfaction guaranteed!

**Model 3007 Only \$6.95 List**

**THE FINNEY COMPANY**  
34 W. Interstate St. • Bedford, Ohio

CIRCLE 66





“...by combining this unit, Citation A, with a *solid state basic amplifier* of comparable quality, a sound path could be set up that approaches the classic goal of amplifier design—a straight wire with gain.”

—HIGH FIDELITY MAGAZINE

## THE NEW CITATION B

PROFESSIONAL 80 WATT SOLID STATE STEREO BASIC AMPLIFIER



**Handsome front panel:** facilitates custom installation. Features include current-adjustment meter, on/off switch with pilot light and low-cut filter. Removable bottom panel conceals idling adjustment controls.



**Computer-grade silicon output transistors:** heavy-duty, solid state devices, virtually impervious to abuse. Will take 100% more power than their use in Citation B will ever demand.

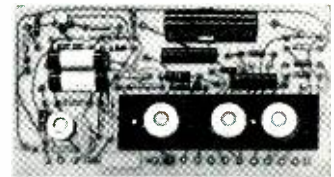

**Driver stage:** Wideband silicon driver transistors are mounted on rugged, military-type epoxy glass board. Board pivots for easy accessibility or removal.

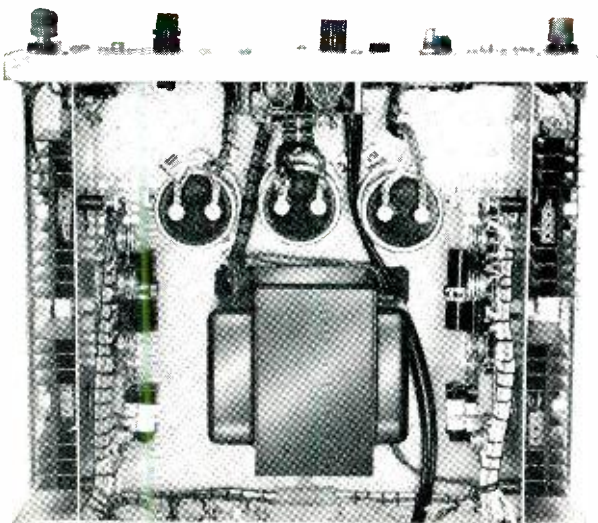

**Top view of chassis:** computer construction throughout. Five sub-assemblies assure easy accessibility and minimum operating temperature through efficient heat dissipation; laced military wiring harness couples each stage.



**Electrolytic capacitors:** engineered to computer-grade specifications for unlimited shelf life and consistent, long-term performance.



**“Heat sink”:** heavy-duty finned aluminum device which rapidly draws heat away from output transistors—insuring long life, fail-safe performance.

The “classic goal of amplifier design” is now reality. The big “B” is here. The Citation B. A power-packed “brute” loaded with 80 watts of flawless performance—a true product of the computer age. • The “B” has the widest frequency response of any basic amplifier—1 to 100,000 cps. • The “B” has the best square wave response—less than one microsecond rise time. • The “B” has the highest damping factor—50 to 1 at 10 cps. (No other power amplifier is even close.) • The big “B” is the only power amplifier completely free of hang-over or clipping at full power output.

The Citation B reflects Harman-Kardon's solid state leadership in every way—performance, design and construction. “A straight wire with gain” when matched with Citation A, the big “B” will also enhance the performance of any other high quality stereo preamplifier. For more information—write Citation Division, Harman-Kardon, Inc., Plainview, N.Y., Dept. A-6.

**harman kardon**

A subsidiary of THE JERROLD CORPORATION

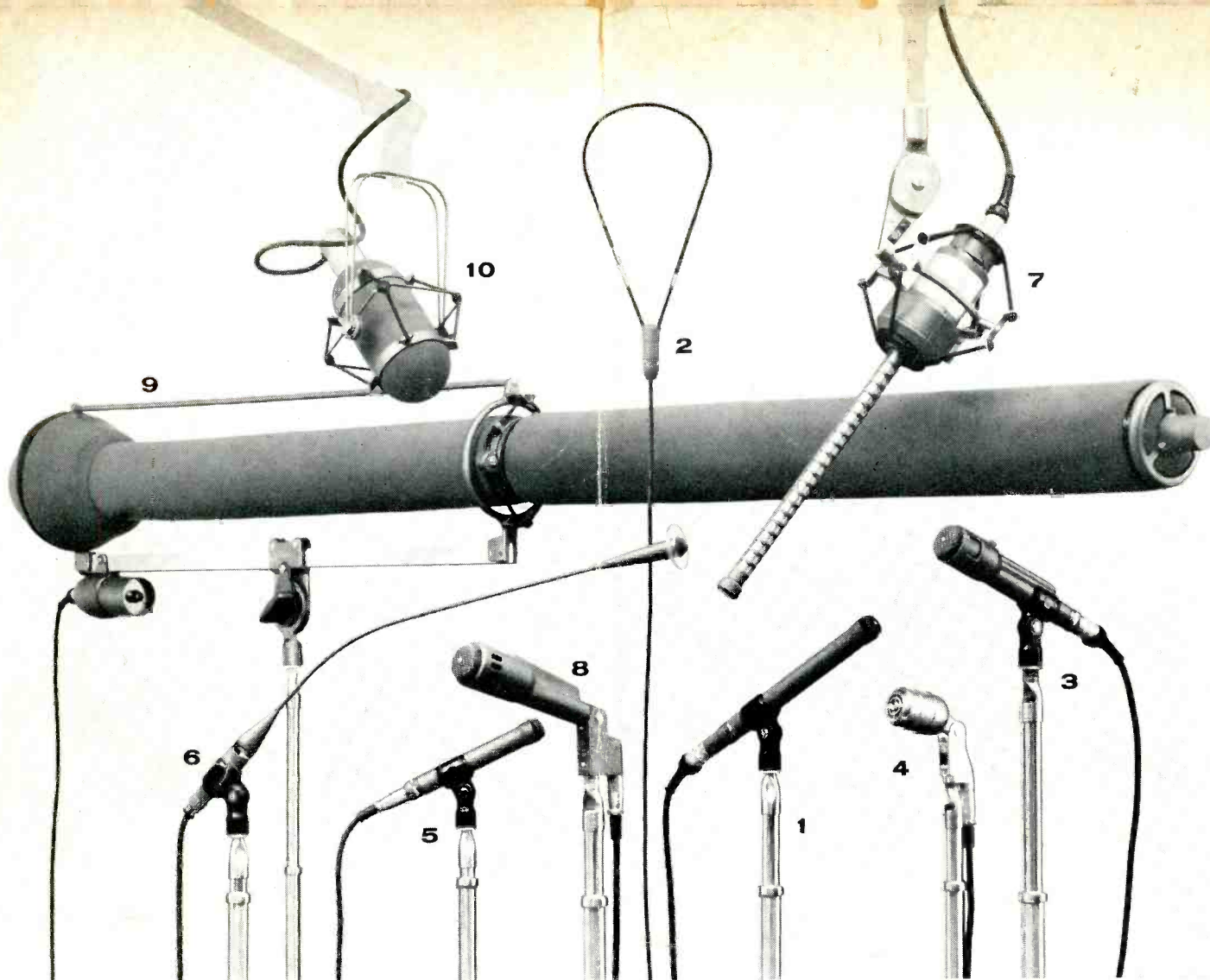

## Ten Good Reasons Why Leading Audio Engineers (Who'll Stop at Nothing to Improve Quality) Choose E-V Professional Microphones!

**1.** High FIDELITY is your stock in trade. And the peak-free 40-20,000 cps response of the E-V 655C provides it simply and directly, with no complex added equipment to burden you.

**2.** It's quite easy to maintain complete COMPATIBILITY between the sound of lavalier microphones and stand units. Simply use the tiny E-V 649B with your larger E-V microphone. Voice quality mixes perfectly.

**3.** The reputation for RELIABILITY enjoyed by the E-V 666 comes from its ability to deliver superb cardioid response even after accidental abuse that would destroy many a lesser microphone.

**4.** The ready AVAILABILITY of E-V professional microphones at leading radio parts distributors everywhere is an E-V pioneered policy begun back when the "workhorse of the industry", the E-V 635, was introduced.

**5.** Outstanding in its FLEXIBILITY is the new E-V 654A. This versatile micro-

phone slips easily into floor or desk stands, or can be hand held or used as a lavalier.

**6.** Ten E-V professional models give you unusual VARIETY. For instance, if you require close-up sound pickup, yet mustn't hide the performer, the ultra-thin E-V 652 solves both problems handsomely.

**7.** The CREATIVITY of E-V engineers comes from intimate knowledge of field problems. It earned them an Academy Award for their unique solution to film and TV sound problems with the E-V 642 microphone.

**8.** ECONOMY is vital in every studio operation, yet quality must be upheld. And the E-V 665 is ideal where superb cardioid performance is needed, but the utmost in mounting flexibility is not required.

**9.** Even the 7-foot long E-V 643 ultra-directional microphone is protected by this unique E-V GUARANTEE: except for refinishing, all repairs are free no

matter what happens to the unit during the first two years!

**10.** The VITALITY of E-V design comes from constant improvement of existing models, plus fresh new ideas that solve your problems. Newest is the E-V 668, specifically created for boom microphone applications.

Put all ten good reasons to work for you in your studio or in the field by choosing the E-V Professional microphone that's right for your sound pickup requirements. Your E-V distributor can offer up to 15 years of experience in assisting studios to better sound. See him today, or write for a complete distributor list and free microphone catalog.

**ELECTRO-VOICE, INC.**  
Dept. 641A, Buchanan, Michigan

