

AUDIO

FEBRUARY, 1962
50¢

...the original magazine about high fidelity!



IT'S SOUNDCRAFT IN THE GREAT MOTION PICTURES!

FROM METRO-GOLDWYN-MAYER SAMUEL BRONSTON'S PRODUCTION OF "KING OF KINGS"



If you believe that all recording tapes are the same . . . read these facts about Soundcraft: today's great motion pictures depend on the most extensive stereophonic techniques and effects. To achieve them requires a magnetic product capable of satisfying the most critical demand. For years one name has consistently won virtually 100% acceptance of the uncompromising technicians of this industry. That name—Soundcraft. The fact is the development of the Soundcraft Magna-Stripe Process revolutionized the course of the entire industry—led to the advent of the stereo sound tracks of the great wide screen films. For this, Soundcraft was awarded the only Academy Award "Oscar" ever given to a recording tape manufacturer. Today the sound you hear in the great MGM (Camera 65), Todd AO, Cinemascope and other wide screen productions is reproduced on Soundcraft magnetic products. Motion picture producers investing millions of dollars can't afford to take chances. That's why "It's Soundcraft in the great motion pictures!" You, too, can have this same measure of superior performance and reliability in your own recordings by switching to Soundcraft—where professional performance is the standard and satisfaction the guarantee. See your Soundcraft Dealer today and let him put you on the right "sound" track with Soundcraft.

REEVES **SOUNDCRAFT** CORP.

Main Office: Great Pasture Road, Danbury, Connecticut • New York: 10 East 52nd St.
Chicago: 28 E. Jackson Blvd. • Los Angeles: 342 N. LaBrea • Toronto: 700 Weston Rd.



AUDIO

FEBRUARY, 1962 Vol. 46, No. 2

Successor to **RADIO**, Est. 1917

C. G. McPROUD • *Publisher*

DAVID SASLAW • *Editor*

JANET M. DURGIN
Production Manager

Contributing Editors

EDWARD TATNALL CANBY

JOSEPH GIOVANELLI

HAROLD LAWRENCE

CHARLES A. ROBERTSON

CHESTER SANTON

HERMAN BURSTEIN

HENRY A. SCHOBER
Business Manager

SANFORD L. CAHN
Advertising Director

EDGAR E. NEWMAN
Circulation Director

Representatives
Bill Pattis & Associates,
4761 West Touhy Ave.,
Lincolnwood 46, Ill.

James C. Galloway,
6535 Wilshire Blvd.,
Los Angeles 48, Calif.

AUDIO Articles

- A Test Record for Evaluating Stereophonic Systems **18** B. B. Bauer, G. Sioles, A. Schwartz, and A. Gust
The Transistor Amplifier **23** George Fletcher Cooper
Reduction of Feedthrough in Audio Switching **28** R. D. Herlocker
Electronic Organ Tone Generators **34** D. Wolkov
In two parts—Part I

AUDIO Reviews

- Light Listening **8** Chester Santon
Record Revue **52** Edward Tatnall Canby
Jazz and All That **60** Charles A. Robertson

AUDIO Profiles

- Harman-Kardon FM stereo adaptor **46** Citation MA
Rek-O-Kut Auto-Poise Kit **48**
Isotone Speaker System **48** "Eroica"

AUDIO in General

- Audioclinic **2** Joseph Giovanelli
Letters **6**
Audio ETC **12** Edward Tatnall Canby
Editor's Review **16**
This Month's Cover **30**
Tape Guide **32** Herman Burstein
The Campbell Letters **50**
About Music **66** Harold Lawrence
New Products **68**
New Literature **70**
NEW! NEW! NEW! → Audio Teasers **73** Norman H. Crowhurst
Industry Notes **75**
Advertising Index **76**



AUDIO (title registered U. S. Pat. Off.) is published monthly by Radio Magazines, Inc., Henry A. Schober, President; C. G. McProud, Secretary. Executive and Editorial Offices, 204 Front St., Mineola, N. Y. Subscription rates—U. S., Possessions, Canada, and Mexico, \$4.00 for one year, \$7.00 for two years; all other countries \$5.00 per year. Single copies 50¢. Printed in U.S.A. at 10 McGovern Ave., Lancaster, Pa. All rights reserved. Entire contents copyrighted 1962 by Radio Magazines, Inc. Second Class postage paid at Lancaster, Pa.

RADIO MAGAZINES, INC., P. O. Box 629, MINEOLA, N. Y.
Postmaster: Send Form 3579 to AUDIO, P. O. Box 629, Mineola, N. Y.



SHERWOOD

THE
FIRST
FM
STEREO
MULTIPLEX
RECEIVER



the S-8000
64 watts \$299⁵⁰

only for those
who want the ultimate . . .



At last, Stereo Multiplex is here . . . and, once again, Sherwood is first . . . ready immediately with a brilliant combination of Sherwood's "high rated" FM tuner design plus all circuitry necessary to receive the new FCC-approved FM multiplex stereo . . . two 32-watt amplifiers, two phono/tape pre-amplifiers and all controls necessary for playing records, tape or TV. The S-8000 Receiver needs only the addition of speakers to complete a basic system for FM stereo listening enjoyment. Overall size, just 16 x 4 x 14 inches deep. Sherwood's dramatic Correlaire Furniture Modules are the perfect setting for your Sherwood hi fi components. Choose from sixteen interchangeable modules, styled with a contemporary flair in hand-rubbed Walnut and Pecan woods. Have truly flexible room arrangements. A beautiful four-color brochure is yours for the asking. Sherwood Electronic Laboratories, Inc., 4300 N. California Ave., Chicago 18, Illinois.

For Complete Technical Details Write Dept. A-2

GRADO

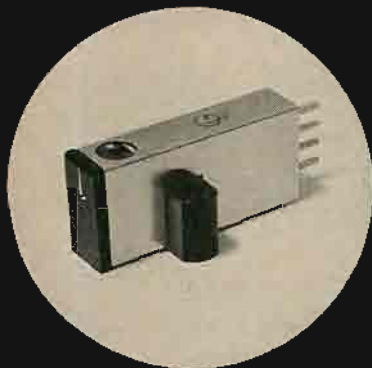

IMPORTANT TRADE IN POLICY!!

If you own ANY Grado cartridge and would like to own a new Laboratory or Classic Cartridge, do the following:

Return your present Monaural or Master Cartridge to your dealer with \$36.00 and receive a factory sealed Laboratory Series Stereo Cartridge valued at \$49.50.

Return your Custom Cartridge and \$25.00 and receive a brand new Classic Series Stereo Cartridge valued at \$37.50.

All new cartridges are completely covered by Grado's 5 year diamond stylus guarantee.

All trade ins must be made through your franchised Grado dealer.

ASK YOUR DEALER ABOUT THE GRADO DUSTAT

A NEW VELVET TOUCH RECORD CLEANER

Senator Stereo Cartridge	\$24.95
Classic Stereo Cartridge	\$37.50
Laboratory Stereo Cartridge.....	\$49.50
Laboratory Series Tone Arm.....	\$39.50

For further details write to:

GRADO LABORATORIES, INC.

4614 7th Avenue Brooklyn 20, New York
Export-Simonfrice, 25 Warren St., N. Y. C.

AUDIOclinic



JOSEPH GIOVANELLI*

Indoor FM Antennas

My question concerns getting maximum possible gain from indoor, flexible, folded-dipole FM antennas (made of 300-ohm twin lead). Outdoor antennas are barred where I live.

My old FM tuner, though fine in sound quality, is unfortunately low in sensitivity compared to modern tuners. I get full limiting on most local stations. On some stations, however, I get decent limiting only after wearying experimentation with antenna placement. A few stations cannot be limited.

I find that sometimes a few inches in length makes a lot of difference in reception. Perhaps the size of my present antenna (58-in. long, lead-in about 5 feet) or its type is not ideal. I have seen indoor antennas which were about 10-in. longer. Is there an optimum length?

I have also noticed a stub of 300-ohm line attached to the junction of the antenna midpoint and the lead-in on some antennas. I was not in a position to measure this antenna and stub or to examine how it was constructed. Perhaps this type could provide a little more gain (every little bit helps). If you think the stub-type antenna has advantages, could you kindly tell me what length (dipole and stub) to use in making it? Is the free end of the 300-ohm line stub joined (that is, the two wires at the free end) or are they left unconnected? S. W., New York City, New York.

A. The length of the folded dipole made from twin lead is not really critical. Any length between 47-in. and 54-in. will work well.

The stub arrangement will not improve the sensitivity of the antenna but it can sometimes be helpful when attempting to eliminate multi-path distortion or to eliminate interfering signals. This is done by tuning the stub to the interfering station's frequency. The length of the stub can be anything from 18-in. downward. No exact figures can be given for this length as it is a function of the kind of interference and of the room's loading of the antenna (which would shift the resonant frequency of both antenna and stub). Connect the stub to the junction of the lead-in and the dipole proper. The free end of the stub is shorted. You can use a single-edged razor blade to short the wires at different points along the length of the stub until you find one position which gives you better performance. (In many instances, however, the stub is of no help. Hence, such a location will not be found). Once you find the proper point, however, you can cut the excess lead and short the wires at this point. The stub is then complete.

*3420 Newkirk Ave., Brooklyn 3, N. Y.

Embossed Aluminum Records

Q. I have two recordings made by my father in the early 1930's on aluminum discs. The label says: "DO NOT USE STEEL NEEDLES. USE ONLY FIBRE NEEDLES."

As I remember, we used a bamboo needle sharpened to a triangular point. Later, we used cactus needles, sharpened to a round point. I now wish to transcribe these old records onto tape. What do you recommend to get the best possible fidelity and cause the least possible damage to the original recordings? Charles F. Hempstead, Millington, New Jersey.

A. Some readers may not be familiar with the type of recordings described here. These recordings were cut, or rather, embossed directly onto the surface of an aluminum disc. No acetate covering was placed over the aluminum as is done in present-day recordings. This embossing process is similar in a way to clay modeling in that the tool does not actually cut the material but rather shapes the material to form the grooves and their associated pattern.

The discs were played with cactus or thorn styli. On no account should you, when transcribing these discs onto tape, use anything but thorn or cactus. Heed the instructions on the label. Sharpen the stylus to a sharp, round point with the included angle between 60 and 70 deg. A few rotations of the disc with the stylus riding in the grooves should then be sufficient to give the stylus a shape which will give excellent reproduction. After each record is played the stylus must be resharpened. If at all possible, try to obtain a sharpener intended for this use. They are, of course, difficult to obtain, but, when they can be found, save a considerable amount of time.

A Passive Phono Equalizer

Q. I would like to use a passive network with RIAA equalization to connect between my magnetic phono pickup and the crystal microphone input of my tape recorder. An input of one megohm and 1.3 mv rms will give maximum recording level of zero VU. The phono cartridge is a variable reluctance type. With both coils in this stereophonic unit tied together I get 5 mv maximum output from most records. I could connect the coils in series if I need more signal to make up for losses in the network. Robert E. Consoliver, Minneapolis, Minnesota.

A. Here is a verbal description of a passive equalizer network which could be used between a cartridge having a recommended load resistance of 47,000 ohms, and the microphone input of an amplifier or recorder. From what you tell me about

LOWEST SILHOUETTE OF ANY AUTOMATIC ON THE MARKET



GARRARD'S NEW AUTOSLIM

AUTOMATIC/MANUAL INTERMIX CHANGER



This entirely new ultra-compact 4-speed record changer was designed to provide reproduction of Garrard calibre in a minimum of space. It is the most economical Garrard automatic ever presented. Introducing a new standard of styling, features and performance in the low budget range, the Autoslim will grace any music system, with the precise look of engineering excellence built into it. Only **\$39.50**



Autoslim is so compact, it will fit in where other automatic players will not. Only 6½ inches in height overall... Ideal replacement unit.



Unified control panel has completely separate positions for playing records automatically or individually.



Intermixes any size or sequence; with separate removable spindles for safe handling of records. Short spindle for single play.

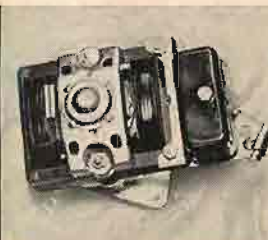

Garrard's 4-pole shaded "Induction Surge" motor, with dynamically balanced rotor, gives Autoslim constant speed, with no hum or vibration.



Extra-sensitive stylus pressure control in cast aluminum tone arm insures correct tracking pressure at all times as per cartridge manufacturer's specifications.

FOR LITERATURE WRITE DEPT. GB - 12 GARRARD SALES CORP., PORT WASHINGTON, NEW YORK.

There's a Garrard for every high fidelity system... all engineered and wired for Stereo and Monaural records.



Type A
Automatic
Turntable
\$79.50



AT6
Automatic
Turntable
\$54.50



Autoslim
Intermix
Changer
\$39.50



Model T/II
Manual
Player
\$32.50

Garrard
World's Finest

Canadian inquiries to Chas. W. Pointon, Ltd., 66 Racine Road, Rexdale, Ontario. • Territories other than U. S. A. and Canada to Garrard Engineering & Mfg. Co., Ltd., Swindon, Wilts., England



MINE, ALL MINE!

THANKS. It has been only a few months since the Luxor Magnefon Stereo Tape Recorder was introduced to the Editors, the Engineers and the Audiophiles on this side of the Atlantic. Since then the Editors have praised; the Engineers have been amazed and the Audiophiles, bless them, have been **BUYING!** Had we known earlier that the Luxor Magnefon was the recorder that you had been waiting for, we would have sent a supply over with Lief Ericson in the first place. We now have a whole batch of new literature on this fabulous "Do Everything" recorder... why not write for some now... instead of borrowing from your knowledgeable neighbors? The Luxor Magnefon is available at better Audio shops for \$289 (slightly lower in the EAST).

THE LUXOR MAGNEFON MP 110 A FROM SWEDEN
Sole U.S. Distributors
AmeLux ELECTRONICS CORPORATION 60 East 42 Street, New York 17, N. Y.

your equipment, however, I am not sure if you will have sufficient gain. Unfortunately, when a passive network is used, there must be losses so that apparent boosts can take place as is required in equalization circuits of this type. In order that there be the required boost and rolloff, there must be some sacrifice in gain. The following network seems to offer the minimum amount of loss in gain.

One side of the cartridge is grounded as is the "cold" input terminal of the amplifier. The "hot" side of the cartridge is connected to one end of a 270,000-ohm resistor, the other end of which is connected to one end of a 27,000-ohm resistor. The far end of the 27,000-ohm resistor is connected to one end of a 0.02 μ f capacitor, the other end of which is grounded. The "hot" amplifier input is connected to the junction of the two resistors. The cartridge is shunted by a resistor whose value depends upon the characteristics of the cartridge, but is likely to be in the range of 4700 to 6800 ohms. The value of this resistor is adjusted to give you the flattest possible frequency response in accordance with the RIAA playback curve. If highs are too pronounced, reduce the value of the resistor, and vice versa.

All components should be placed in a shielded container with appropriate connectors mounted on the container but insulated from it. The container itself is grounded to the preamplifier.

What Kind of Amplifier?

Q. I own a tuner-preamplifier combination. The output of this is connected to my tape recorder. I use the speaker contained in that tape recorder as the transducer for the equipment. However, I wish to improve upon this arrangement. I know I need a power amplifier. Could I use an integrated amplifier-preamplifier combination with my present unit? Would the duplication of controls be a hindrance? Later on I plan to purchase another tape recorder and FM tuner and I will then have two systems—one for my son. I could then use the amplifier and preamplifier for my own setup. If I get a power amplifier, I would still need an audio control. I prefer the integrated arrangement. Joseph Dias Jr., Bridgeport, Connecticut.

A. You certainly can use the tuner section of your existing unit with whatever integrated combination you purchase. If you connect your present unit to the new preamplifier-amplifier combination, by way of the tape output connection which is probably incorporated into your unit, you will not need to be concerned with the duplication of controls. You see, the volume and tone controls on your present unit are not effective at the tape output connection. Thus, these controls may be rotated to any position without altering the sound quality which will be heard at the speaker terminals of your new, integrated unit. In making these connections, it is necessary to use the shortest possible lengths of cable to avoid a loss in high frequencies. (There are exceptions to this rule where the tape output is from a cathode follower.) If a long run of cable must be used, then use the conventional output and set the tone controls of your present unit to their "flat" positions and set the volume control to some level that does not cause overloading of either unit.

After these connections have been made,

(Continued on page 65)



toot

That first note on an honest-to-goodness instrument of your very own! Can you remember that magnificent moment? Surely no accomplishment since has seemed quite as satisfying, no sound as sweet. We can't provide that kind of sonic bliss. But we can offer the next best thing—Audiotape. Recordings on Audiotape have superb range and clarity, minimum distortion and background noise—all the qualities to delight jaded adult ears. Make it your silent (but knowledgeable) partner in capturing everything from small fry tooters to symphony orchestras.

Remember, if it's worth recording, it's worth Audiotape. There are eight types, one exactly suited to the next recording you make. From Audio Devices, for 25 years a leader in the manufacture of sound recording media—Audi discs*, Audiofilm*, and . . .



*TRADE MARK

audiotape
TRADE MARK

"it speaks for itself"

AUDIO DEVICES INC., 444 Madison Ave., New York 22, N. Y.
Offices in Los Angeles • Chicago • Washington, D. C.

**YOU WON'T
FIND THIS**

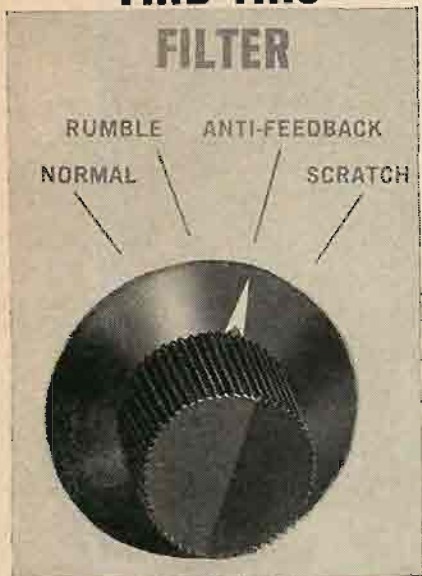

**CONTROL
ON ANY
OTHER P.A.
AMPLIFIER
IN THIS
PRICE
CLASS**



What's different? The anti-feedback position—which equalizes frequencies most sensitive to generation of feedback "howl" without reducing articulation. This increases sound output under difficult acoustical conditions by at least 100%. And there's plenty more that makes the new Harman-Kardon COMMANDER Series of public address amplifiers different. Features usually reserved for much costlier equipment are included: 25 & 70 volt and recorder outputs, fader/mixer and master volume controls, magnetic cartridge input, locking covers, etc. Find out why sound men now use the COMMANDER Series for all their needs. Write for detailed catalog, Commercial Sound Division, Harman-Kardon, Plainview, L.I., N.Y.

Send free detailed catalogs: Desk 2-B

Name _____
Address _____
City _____ State _____

harman kardon

LETTERS

"Red-Face" Department

Sir:
I wonder whether there isn't a numerical slip, which might cause confusion, in Mr. Herlocker's article "Electronic Organ Tuning" (Audio for December, 1961). After examining his handy Table in Fig. 1, it seems to me that the 'indicated number of seconds' should be reduced by a factor of two, or that the frequencies assigned to the notes on the keyboard should be reduced by this same factor (i.e., that all notes should be lowered by an octave).

Consider, for example, the first fifth listed in the table, from A at 220 cps to tempered E at 329.63 cps. It is quite true, as Mr. Herlocker states, that in tempering the note E we have to reduce its frequency by 0.37 cps, i.e. from 330 cps to 329.63 cps. It is also true that if we were to sound untempered E at 330 cps together with tempered E at 329.63 cps we would have beats at the rate of 0.37 cps. However, it does not follow that we hear beats at this same rate when we sound together the note A and the tempered note E. In the latter case, the beating notes are the third harmonic of A at 660 cps and the second harmonic of E at 659.26 cps, so that the beat rate is 0.74 cps, rather than 0.37.

JAMES W. ALEXANDER
29 Cleveland Lane
Princeton, N. J.

Mr. Herlocker's Reply:

I have checked my figures, both mathematically and experimentally, and find, of course, that your values for tempering of the tones are correct. As you pointed out, beating one tone against another a fifth higher effectively beats the third harmonic of the first tone against the second harmonic of the second tone. For a given number of cycles per second detuning the second tone (as in tempering the scale), this beating of the harmonics will give twice that number of beats per second. The caption for my chart, therefore, should be altered to read that "fifths are flatted by twenty beats in the indicated number of seconds."

R. D. HERLOCKER
8528 Schreiber Drive
Munster, Ind.

Kit Magazine

Sir:
I have been aware for years that AUDIO is a progressive magazine. My December issue has convinced me that it is also a novel magazine. The concept of issuing such a publication in "kit form" is certainly novel. However, I did not receive all of the parts for my kit. I would appreciate it if you would forward to me the copy for pages 60, 61, 64, 65, 68, 72, 73, 76, 77, 80, 81, 84, 85, 88 and 89, so that I may paste it in on the blank pages. As an alternate, a nice fresh, complete copy would do nicely.

DANIEL A. RICE
7 Alexander Ave.
Sausalito, Calif.

(Our experiment with a kit magazine proved to be unsuccessful. We are discontinuing production of this model and will replace it with a factory-assembled unit. Ed.)

THE CAMPBELL LETTERS

As promised last month we have gathered together the most pertinent letters concerning John W. Campbell's article about "sineward distortion." See page 50.

PURCHASING A HI-FI SYSTEM?

TIME PAYMENTS AVAILABLE
Up to 2 years to pay!

**Send Us
Your List Of
Components
For A
Package
Quotation**

**AIREX
WON'T BE
UNDERSOLD**

All merchandise is
brand new, factory
fresh & guaranteed.

Free HI-FI Catalog

AIREX RADIO

CORPORATION

85-AM Cortlandt St., N. Y. 7, WO 4-1820

Jim Lansing*
Alec Lansing
Electrovoice
Jensen
Hartley*
University
Acoustic Research
Janszen
Wharfedale
USL Citizen Band
Gonset* Hallcrafters
Texas Crystals
Concertone* Viking
Bell* G.E.
Weathers
Harman-Kardon
Eico* Pilot* TEC
Sherwood*
ESL* Frazier
Superscope
Dual Changer
Bogen* Leak
Dynakit* Fisher
H. H. Scott
Thorens*
Conrac
DeWald
Sony* Roberts
Challenger
Wallensak
Garrard* Norolco
Miracord
Glaser-Steers
Rek-O-Kut
Components
Tandberg*
Fairchild
Pickering* Gray
Audio Tape
Magnecord*
Rockford Cabinets
Artizon Cabinets
*Fair Traded

HEART DISEASE #1 Enemy



HEART FUND

#1
Defense



PIONEER



HIGH POWER HIGH STABILITY

17W+17W Stereo Tuner-amplifier

SM-Q300

We are indomitable in our effort to develop audio devices capable of reproducing natural tone as well as of high performance.

Our new product, Model SM-Q300, which we have recently put on the market, is an excellent stereo tuner-amplifier incorporating our unique ideas and high-level engineering skill.

The most outstanding feature of SM-Q300 is its ability to reproduce wonderful distortion-and noise-free hi-fi tone, in addition to its powerful output. This is an outcome of the adoption of the following features:

1. A new circuit unique to PIONEER is used for the phase inverter of the main amplifier.
2. A silicon diode voltage doubler circuit of excellent regulation is used for the power supply circuit.
3. The use of 4-gang variable resistors makes it possible to regulate the volume simultaneously at the intermediate amplifier and the power amplifier.
4. Noise elimination much sharper than any hitherto available has been achieved by incorporating a scratch filter and a whistle filter into the cathode following circuit.

Also adopted is a new control system under which switching from stereo to monaural and vice versa, adjustment of horizontal tone spread and mixing of the left and right channel tones can be operated with a single knob.

In addition, adjustment of the tone balance for the right and left channels can be made without budging from the listening position using a remote sub-balancer terminal. Output jacks for FM multiplex and a center channel amplifier are also provided.

Specifications:

19 Electron tubes and 6 germanium diodes
Tuner left

Tuning range: MW 535 to 1,605Kc, SW 3.8 to 12Mc

Practical sensitivity:

MW 100 μ V (1Mc, output 500mW, at 30% modulation)

SW 100 μ V (7.5Mc, output 500mW, at 30% modulation)

Tuner right

Tuning range: MW 535 to 1,605Kc, FM 80 to 108Mc.

Practical sensitivity: MW identical with Tuner 1

FM 10 μ V (95Mc, output 500mW, at 30% modulation)

Audio section

Circuit: 6BQ5p.p. 2-channels

Inputs and gain:

MAG PU 3.4mV, MIC 4mV, XTAL PU 35mV

TAPE (PLAY) 160mV, AUX 160mV

Equalizer: NF type, RIAA curve

Output: For speaker—4, 8, 16 ohm (each channel), center channel terminal, tape recording terminal

Output power: 17W x 2

Undistorted output power:

15W x 2 (distortion below 1% at 1Kc)

Response: 20 c/s to 50Kc, ± 1 db (main amplifier section, at 500mV output)

Outerdimension: 18 1/2(W) x 14(D) x 5 1/2(H) inch

Weight: 26.61 lbs.



PIONEER ELECTRONIC CORPORATION

5 Otowacho 6-chome, Bunkyo-ku, Tokyo, Japan

DISTRIBUTORS

Canada: Importhouse of Canada Scarborough, Ontario

Singapore & Malaya: Hwee Seng & Co. Beach Road, Singapore

Light LISTENing



CHESTER SANTON*

The symbol  indicates the United Stereo Tapes 4-track 7 1/2 ips tape number.

Percussion! Staged For Stereo

Capitol STAC 1637

Strings! Staged For Stereo

Capitol STAC 1639

In its new Staged For Stereo series, Capitol has combined the best ideas put forth by other labels for ultra-directional stereo in motion. Avoiding the excesses occasionally indulged in by others, the label now makes available to the stereo convert a group of recordings that will keep him happy during his apprenticeship without drawing a wince from his acquaintances who happen to have more sophistication in stereo matters. On the basis of the first five releases, the series is off to a very good start. The arrangements show restraint and more than a suggestion of taste. In the percussion album, a group called the Mallet Men handle the drums, tympani, vibes, bells, maracas, celeste, xylophone, triangle, chimes, and bongos that make up the typical orchestra of this type. Reeds, brass, and strings lend variety to tunes that contain the word "eyes" in their title. The cohesive pattern of the rhythm would indicate that these men all occupied the same room during the recording session. A step forward that other firms might well emulate.

In "Strings Staged For Stereo," the thirty-three strings of maestro Norrie Paramor offer an opportunity to judge how well recording crews in Britain have caught on to our sound-in-motion techniques. The switching of instrument location is done with moderation. In place of the added reverb so popular in domestic releases of this type we have the wide-open space of the vast studios they've generally favored over there. This record's strongest point is the enormous depth of the stereo sound. I've noticed improved depth on some of my other stereo discs since switching to a pickup with only .3 mg stylus mass but this record beats them all. Some tapes will have to improve in range, clarity and flatness of response if they are to compete with recent discs reproduced with the latest crop of stereo pickups.

This new Capitol series is packaged in gray plastic containers that reveal both sides of the record through "windows" of clear styrene. A plastic spindle holds the record in place within a circular receptacle designed to prevent contact of the disc's playing surface with the album package. The contraption can be opened with one hand but the package has the weight and bulk of three discs in regular cardboard jackets. The "window" of one album in my shipment arrived with a crack that stretched from "sill" to "sill," requiring the immediate application of some cloth tape in order to protect the hands of the unwary.

Mort Sahl on Relationships

Reprise R 5003

Mort Sahl, I'm happy to relate, is still a member of our group. Quite early in the

* 12 Forest Ave., Hastings-on-Hudson, N. Y.

course of the long rambling discussion on this record, he mentions a component sound system currently in process of installation at his home. The story shows some signs of having been embroidered into a gag for the act. The audience is quick to get the punch line that will certainly draw a chuckle from anyone ever involved in an elaborate installation. Sahl (perhaps we should refer to him as Mr. Sahl from now on as a sign of respect for one who would consider placing eleven Bozak 310's in his ceiling) draws his laugh when he recounts that he doesn't know how the system is going to sound but that the street lights have already dimmed when the system was turned on. The rest of the Sahl monologue is filled with a lot of other matters about life in general—all of them quite irrelevant until he tells us in the next record how it sounds.

Kean (Original Broadway Cast)

Columbia  OQ 432

The career of the famous Shakespearean actor, Edmund Kean, might never have been chosen as the subject for a musical had Alfred Drake been unavailable to play the role. It's hard to visualize any other current Broadway singing star in a part that calls for the amount of florid acting that Drake seems only too delighted to provide. Listening to his ripe impersonation of the actor, one may well wonder how Kean's more flamboyant contemporaries behaved on stage. If you're willing to put up with some of the corner aspects of this period piece, there is much to enjoy in some of the top songs in the score—particularly those delivered by Alfred Drake. *Man and Shadow*, *Sweet Danger*, and *To Look Upon My Love* are in the tradition of the better musicals. They offer ample evidence that songsmiths Robert Wright and George Forrest are now ready to strike out on their own after having adapted Grieg's music for "Song of Norway" and Borodin's for "Kismet." It was while playing in the London production of "Kismet" that Drake first became acquainted with the dramatizations of Kean's life by Alexandre Dumas and, more recently, Jean Paul Sartre. The leading role in the Sartre play, as a matter of fact, was offered to Drake when an American version was being planned. He chose instead to interest Wright and Forrest in a musical version that shows promise of a good run on Broadway.

The score was recorded in three sessions, each three hours in length. The sound is the cleanest I've heard in any Columbia original cast album.

The Gay Life (Original Broadway Cast)

Capitol SWAO 1560

A new score by Howard Dietz and Arthur Schwartz, no matter how frothy, is an event of some weight in Broadway annals. While "Gay Life" will hardly erase memories of Dietz-Schwartz shows that produced *Dancing in the Dark*, *You and the Night and the Music*, *Alone Together*, and other classics, this continental play is reassurance that a great theatrical team can go back to harness easily after a decade of inactivity. Fay and Michael Kanin's book for this show is based on Arthur Schnitzler's "Anatol." Vienna and Carlsbad

at the turn of the century are suggested only slightly in the accents of the leading players. Walter Chiari, featured in many Italian plays, musicals and films for the past 16 years, naturally sounds less American than other members of the starring trio. Jules Munshin knows his way around in enough accents to hold down the comedy role with aplomb to spare. Barbara Cook still reveals plenty of the healthy Mid-Western ebullience that carried her through "Plain and Fancy," "Candide," and "The Music Man." She comes closest to sounding Austrian when denouncing French girls in *The Label on the Bottle*. The poignant tunes in the score—*Magic Moments* and *Something You Never Had Before*—fall her way gracefully. Compromises are to be expected whenever Broadway tries to produce a European-style comedy with a mixed cast. The irony of the "Gay Life" recording is the fact that Barbara Cook, who makes the least attempt to sound European, turns in the most spirited performance.

Let It Ride (Original Broadway Cast)

RCA Victor LSO 1064

Funny plays about horses never seem to stop running. During the depression years, "Three Men on a Horse" was a smash stage hit. It later became the musical "Banjo Eyes"—tailored to the ocular talents of Eddie Cantor. Now, the same story of the greeting card poet with the uncanny knack for picking winning horses reaches Broadway as a new musical with George Gobel in the leading role. Underlining the endurance of the plot is the presence of Sam Levene in the part that first brought him into prominence when he played it in the original "Three Men on a Horse." In his first venture in the legitimate theatre, Gobel shows no sign of fluster in ensemble song or soliloquy. At the start of his involvement with the racetrack crowd, he delivers a humorous "pupil and master" duet with Sam Levene in *I'll Learn Ya*, a touching ballad in *Everything Beautiful*, and a sad-type song *His Own Little Island* when his luck is at its lowest. The Broadway horse crowd that Damon Runyon used to write about is recalled in *Broads Ain't People*, *Let It Ride*, *He Needs You*, and *There's Something About a Horse*. The score by songwriters Jay Livingston and Ray Evans uses no violins in the orchestra. Brasses, reeds and percussion put a hard finish on an already shining vehicle.

Mexico! Mariachi Miguel Dias

Audio Fidelity AFSD 5957

The sound of a typical street band recorded in a South-of-the-Border studio is Audio Fidelity's latest contribution to hemisphere solidarity. Mariachi bands are to be found in almost any Mexican plaza or market place if they're not busy at the nearest wedding or fiesta. Depending solely on their music making for a livelihood, they play from memory most of the music of the region that has survived in instrumental form. The original Mariachi groups played only string instruments such as the guitar, guitarron, violin, and vibuela. Present-generation musicians are apt to play anything at hand that can be carried from village to village. Violin and trumpet lead the guitars in the brisk tunes selected for this AF release. A novel arrangement of the well-known *La Cucaracha* is a highlight of the album. Easily-separated stereo underlines a novel feature of Mariachi music. Once he starts a selection with the others, this trumpeter keeps himself busy all the way. Northern ears accustomed to an occasional trumpet solo will be struck by his unceasing commentary. The close-up miking, unchanged over the years, brings even the casual phrases into the foreground.

Live Concert—Music Made Famous by Glenn Miller

Warner Bros.  WSTC 1428

This tape drives home its main point before the first selection is over. The best way to revive memories of the original Glenn Miller band is to collect a large audience on the other side of the mikes and give it complete freedom to react to the Miller performers still available at this time. The Ray McKinley orchestra has done its share to keep alive the

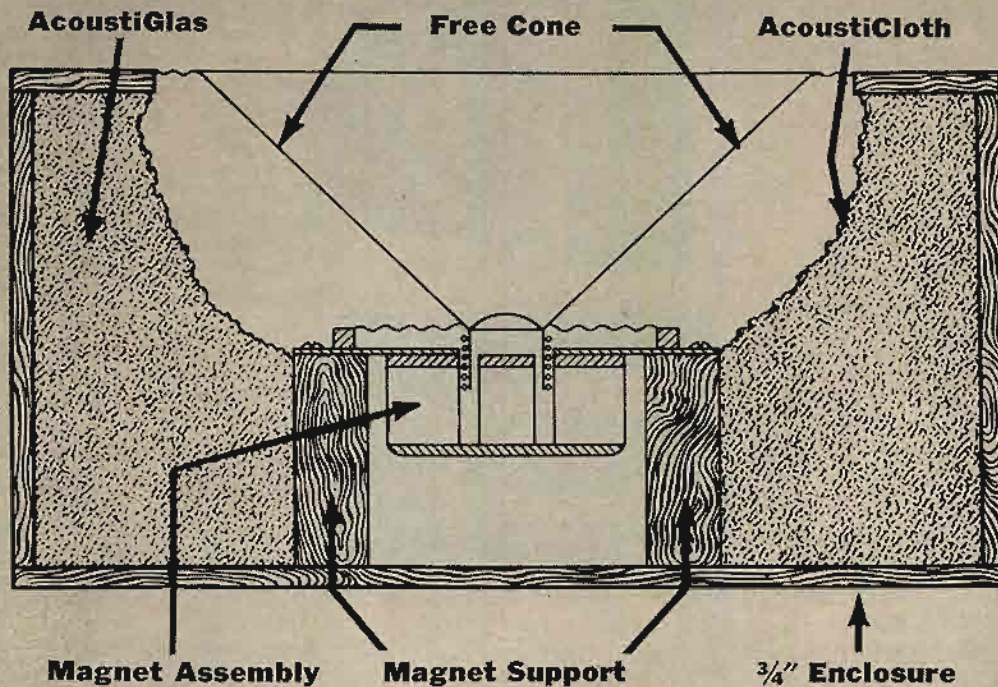

Prediction:

This will be the world's most imitated loudspeaker design.

It will never be exactly duplicated. Our patent attorneys saw to that. But it is so obviously the right way to design a loudspeaker that it is bound to have countless imitators.

The Fisher XP-4 is the world's first loudspeaker system in which the conventional metal frame supporting the outer edge of the bass speaker cone has been completely eliminated. This structure is often the source of undesirable reflections from the back of the cone, causing uneven frequency response and unnatural coloration of the sound. It is also vulnerable to parasitic vibration, which can result in serious distortion.

Now, unit construction, a principle that has revolutionized the automobile industry, has been applied to loudspeaker design. In place of the metal speaker frame, the Fisher XP-4 utilizes the heavy walls of the cabinet itself as a massive supporting structure for the bass speaker cone. Thus the bass speaker and the entire enclosure are a single inseparable unit. Reflections are eliminated by packing the space behind the bass speaker cone with AcoustiGlas. Cone breakup has been eliminated by designing the cone as a rigid piston.

The combined result of these advanced design features is a low and middle-frequency sound that recreates the original in thrilling clarity, without a trace of 'speaker tone.' That fatiguing 'boxy' sound is gone. Uneven middle-frequency 'caw' quality is gone. Excessive treble hiss is gone. In their place you will find the music itself, in direct, see-through contact with the original performance, clean and full-bodied. For only in the Fisher XP-4 are the all-important middle frequencies totally unaffected by reflections that are invariably generated between the back surface of the cone and the near surface of the conventional speaker frame. The proof is in the listening.

The Fisher XP-4 reflects, in its every aspect, the precision engineering that brought it into being and made it possible to produce this novel design with such complete success. It will set the standard in speaker design for years to come.

Available in oiled walnut, cherry or mahogany, \$199.50*. In unstained birch, sanded finish, \$189.50*.

The Fisher XP-1, the revolutionary 'Free-Piston' 3-way speaker system that proved it was possible to combine high bass compliance and high efficiency in a compact enclosure, \$129.50*. (Unstained, sanded, \$124.50*.)

The Fisher XP-2, the 2-way speaker system that combines Fisher XP design principles with moderate price, \$84.50*. (Unstained, sanded, \$79.50*.)

FREE! Write for 1962 Fisher Handbook—a 40-page illustrated guide and component catalogue for custom stereo installations.

Please include complete specifications on the XP-4, XP-1 and XP-2.

Fisher Radio Corporation
21-29 44th Drive, Long Island City, N. Y.

Name _____

Address _____

City _____ Zone _____ State _____



The Fisher

*Prices slightly higher in the Far West. EXPORT: Canada: Tri-Tel Associates, Ltd.

the Weathers Moderne Trio . . . a complete, three channel stereo speaker system which gives full stereophonic reproduction in every part of any size room. It consists of two full range speakers and a unique Hideaway non-directional speaker that is completely concealed from view. You can place it anywhere — and still be sure of superb performance. The Moderne Trio is the smallest and most efficient stereo speaker system yet devised. It fits any size room and blends with any decor. It produces to perfection all stereophonic recordings and adds greater depth to monaural discs.



Moderne Stereo Speaker

A superlative instrument with the finest performance per cubic inch of any speaker yet devised.



Professional Pickup System

the finest performance per unit of cost in stereo cartridges.

One without the other is excellent . . . BUT . . . Combine the speakers and the Professional Pickup System and the results are far beyond all you've ever hoped for . . .

we guarantee it!

Weathers Industries

66 E. GLOUCESTER PIKE
BARRINGTON, N. J.

Miller Legend but the concert on this tape, recorded at the Santa Monica Civic Auditorium, has the distinct advantage of the services of some bandmen who worked for Glenn and the spotlighted efforts of most of the old vocal crew. Only Marion Hutton is missing. Ray Eberle reminisces about the old days before singing *A Nightingale Sang in Berkeley Square*, *Serenade in Blue*, and *Moonlight Cocktail*. The Modernaires with Paula Kelly are on hand for *Chattanooga Choo Choo* and *Wham*. Tex Bencke rises to the occasion with a sax chorus more sensitive than his earlier ones. The full impact of this exceptionally live-sounding tape comes when the entire band gets its teeth into the real showpieces—*In the Mood*, *Anvil Chorus*, and *American Patrol*. The original Miller band always did its best when keyed up by an appreciative audience. It never sounded better than this crew does with the help of the crowd on this tape.

Frank Sinatra: I Remember Tommy
Reprise RSL 1707
Frank Sinatra: Come Fly With Me
Capitol SW 920

Sinatra, on tape and disc, looks to the past in these latest releases. The Reprise reel brings back the days when he was one of the more carefree members of the Tommy Dorsey band—showing few visible signs of becoming an institution that would cross several lines of the entertainment world. Equally important as a preservative agent, along with the Sinatra voice, are the updated arrangements of Sy Oliver whose pencil work with the Dorsey band has always been one of its most distinctive features. With Oliver conducting the band in the backbone of the old book, this recording will carry weight with listeners who have paid scant attention to Sinatra releases in recent years. This reel offers smoother sound than the disc version which, like other Reprise pressings before it, cannot be classified as an outstanding pressing job.

Capitol's stereo disc by Sinatra has more than passing interest because it indicates that the label is not totally committed to Duophonic reprocessing of its mono masters to achieve a stereo effect by electronic means. This album was first recorded only in mono four years ago. In terms of sales it easily qualified for Duophonic release. Capitol's decision to re-record the same lineup of tunes in bona fide stereo is a good sign that the conversion of mono items may be on the wane.

Paul Weston: Music For My Love
Capitol ZT 1563

This is the first background music tape I've heard on this label since Capitol decided to release four-track material. As in the case of RCA and Columbia, UST is not involved in the processing or distribution of tapes bearing this label. It may not be sheer coincidence that the three largest domestic labels decided to set up their own facilities for the production of tape releases. One clear-cut advantage enjoyed by these firms is easy to spot on any tape unit of better than average treble response. They are able to maintain close control of the equalization used in the finished tape product, keeping it in line with the overall concept planned when their recording crews first went into action. The subtle blend of tone colors Paul Weston uses in his latest background album certainly benefits from such a consistent approach. The familiar string choir has the same balance of highs and lows that distinguish the best of his disc releases. The nature of the music selected for this recording—the gentle love songs of former years—appeared to dictate the choice of supplementary instruments. A soft quartet of woodwinds shares the spotlight with mandolins and solo accordion in *Goodnight Sweetheart*, *Always*, and the *Anniversary Song*. Separation has the taken-for-granted ease of the better stereo tapes.

Paul Lavalle: The Spectacular Sound of Sousa
MGM S 3976

This release is designed to tingle even the most cautious pulse. The Band of America led

(Continued on page 71)

BASICALLY OUTSTANDING



D 19 B



D 24 B

These three products of AKG (Vienna) are bass-ically unique. In the mikes, as in all AKG cardioids, the directional characteristic extends well down into the low frequencies where it's needed most; and in the 'phones, the bass is re-created faithfully without need of a resonant cavity formed by hot, bulky, airtight " earmuffs".

D 19 B is a dynamic cardioid mike of semi-pro quality with a range of 40 to 16,000 cycles and directional discrimination of 15 dB at 180°. Sensitivity is 0.18 mv/ μ bar. Choice of 60-Ohm, 200-Ohm, and high impedance. A bass-cut switch for close speech when the full musical range isn't needed. For the serious tape fan, a bargain at \$52.

D 24 B. More and more recording and broadcast studios are switching to this truly-professional dynamic cardioid mike. Range is 30 to 16,000 cycles; front-to-back ratio 20 dB. Sensitivity is 0.18 mv/ μ bar, impedance 200 ohms. Bass-attenuating switch for close talking. Good for years of the highest-quality service. \$165

K 50 headphones are strictly unique (literally the only ones of their kind). They re-create the full musical range of 30 to beyond 20,000 cycles without earmuffs to puff up the bass, need as little as 0.156 milliwatts input yet won't blast with 90, weigh under 3 ounces, and even with the light cool earcushions are comfortable after hours of listening. Easily convertible between mono and stereo and cost only \$22.50 (\$24.50 with earcushions to exclude room noise.)

Leading audio dealers everywhere can now demonstrate AKG quality. Catalog of all AKG products on request. In **Canada**, Eberdt Co., Montreal; McCurdy Radio, Toronto. **USA** import/service agents, Electronic Applications, Inc. Wilton, Conn. Phone (203) PORTer 2-5537; TWX WILTON 426.



K 50



AUDIO ETC.

Edward Tatnall Canby

I. CANBY CONNECTORS

My headphone project is moving forward by fits and starts, most interestingly. I keep running into snags, not only in the matching-up of electrical values, as per last month's installment, but in the major pluggery—and in the implications of that pluggery. Phones, then, are again my taking-off point this month, this time for an essay on plugs and sockets. After that—a look at a first batch of the phones themselves.

Headphones conveniently bring to a head a whole history of connectology, to coin a word, pointing up for us right now an increasing overlap between two areas that once were neatly and thoroughly divided in all hi fi—the “Before and After,” before the power amplifier and after it.

High impedance vs. low. Shields and “hot” leads vs. simple pairs. Hum-prone connections vs. non-hum. Capacitance-sensitive vs. non-cap. Ten years ago there was no confusion at all between these primary connective areas—except, perhaps, for the beginner, who had to learn the hard way that you didn't use bell wire to hook up your magnetic phono cartridge and, though several yards of speaker line was OK, ten feet from the record player to the preamp was too much. You learned this and more—and you learned that practically every connecting circuit in hi fi (outside the actual components themselves) fell clearly into these two areas, “Before and After” the amplifier, with maybe a third area of sorts in the 110-volt power connections.

The cathode-follower circuits, wonderfully convenient, began the process of overlap between these two; for they are indeed in-between, speaking electrically and practically. We joined them up to the Before area, made all their connections interchangeable with the Before-type system, and to this day you can't tell a cathode follower output from a hi-Z input by the plugs and the cables. But they are different, and the cathode-follower signal continues to find itself related in more ways than one to the kind of signal we find on the other side of the power amplifier.

After the cathode follower came stereo and confusion in the highest. Grounds upon grounds, ground loops, hum, phasing trouble and so on. We still treated the cathode-follower lines like high-impedance, but it became more and more obvious that they really weren't the same. After all, they were immune to many of the new stereo ground-and-hum problems—just like speaker lines. And you really didn't need all that fancy shielding, anyhow.

Then, you see, came “stereo” phones. That did it. For the phones we are now getting are so entangled in both connection areas, straddling every fence you can think of, that it's a question of just where they should find a place in the home hi-fi system.

I have my own practical working-plan for phones. My theory is that since you can't

force them entirely into either “Before or After” areas—let me call these the “A” area and the “B” area from here on out—the thing to do is to design them to get the best out of both. Can be done, as we shall see. Has been done already, a decade ago.

I've already wired up my phones according to this plan, for use either before or after the power amplifier, and I've set up my connectors to make it quick and easy. But you must know more about my connector systems.

The Canby “A” system

Plugs and sockets have been my pet peeve, as old readers may remember, ever since in one of my earliest articles, circa 1947, I suggested that hi fi really would be wonderful if only one could just plug the components together, like plugging toasters and lamps into the wall. That was quite a thought in those days. It is still in the process of being realized—and I still feel the same way.

I've long since developed my own mobile defense against the bare wire and the hot soldering iron. In fact, I have two systems of connectors, originally designed to cope with the very different problems of the once-so-simple “A” and “B” areas of hooking-up. A lot has happened since, but my “A” and my “B” systems remain basically different and separate—though the headphone has strained my ingenuity in keeping them so.

First, there is the elaborate and extensive “A” system, involving many different types of connector, all primarily intended for the “A” type of connective circuitry, low in level and generally high in impedance.

Within its own confines, this “A” system will convert almost any type of shielded plug or socket, singly or in stereo pairs, into any other type you can name. Its functional base is a bi-directional shielded connector made by Amphenol that at my establishment we refer to indelicately as hermaphrodite. The hermaphrodites connect both ways, via a screw collar that can screw all the way back and off, converting a female shielded receptacle into a male shielded plug. Never a mechanical mismatch here! (Amphenol connector is the Series 75 straight microphone plug.)

I have dozens of short lengths of shielded cable with one of these handy hermaphrodites on each and a vast collection of assorted connectors at the other ends. By hooking these units together I can usually connect from any type of “A” plug or socket to any other in a few seconds; extra lengths and special conversion units allow me to link five or six assorted sections in a row, through as many different kinds of pluggery, to “route” my signal to the kind of plug or socket I want via intermediate steps—the total capacity still not adding up to excess and the whole nicely shielded,

just in case. With a fistful or a bagful of these handy gadgets I can quickly hook up equipment that would take a bare-wire man much longer than he'd like to think, and would take me hours via snip-and-solder.

I have whole kits of “A” cables, ready for emergencies of all sorts; I use dozens of them to match up new equipment to other equipment or to my existing setup. I keep spares on hand to replace faulty cables with emergency ones, assembled to order in a jiffy. Wonderful idea, I think.

I won't soon forget the day—if I may twit the Boss-publisher—that he and myself tried to hook a new German portable tape recorder into his home living room system. Wrong plugs. Nothing matched anything. He uncovered his patch board, inside a console, and went to work with professional gusto, but it was a long and perspiring time before we got any signal out of the recorder into his big stereo speakers. I figured a few of my “A” connector links could have done it in a couple of minutes; but I didn't happen to have any in my suitcase that day.

My main use for these connectors is in the setting up of sudden-impulse experiments in hi fi and recording, via my assorted tape machines, phono players and what-not. Enormously useful and I'm seldom really stumped for an alternative “route” when the connecting cable I want is not to be found, or there is only one of them and I'm in stereo.

“B” Connectors

My “B” system is a parallel arrangement of a simpler sort, based on speaker line operations, out of amplifiers. It is unlike the “A” system as the electrical characteristics of its signal material differ from the normal “A” signal. The “B” system is unshielded and ungrounded, but every line and connector is carefully polarized for standard phasing. All the “B” connectors are variants of the Jones plug (and socket) with two connectors, one larger than the other so you can't reverse phasing. (I have phase-reverse switches for that purpose, on plug-in extension cords.) I use ordinary rubber covered light cord between the connectors. (The Jones plug I use is the 202 series.)

My prime thought was to make all my speakers and amplifiers detachable and minus trailing wires, when I first thought up this “B” system. Accordingly, on each of my speakers I place a very short (6-in.) cord ending in a Jones male plug. On all my amplifier outputs (two separate ones for stereo) I also put 6-in. female cables. In between these I run extension cords, of various convenient lengths. I have whole bagsful. All are polarized the same way. So, at least in theory, my speakers remain in the same phase no matter what I connect them to, once they are set up the right way in the first place.

You'd be surprised how many types of equipment can be hung on this “B” system. Phase switches, the phase meter, which plugs into the stereo speaker system on both channels, all my power amplifiers and all varieties of speakers, “harness” arrangements to hook up three-speaker stereo systems, anything, everything at low impedance that can tolerate ordinary light cord and no shielding or grounding. (The amplifier source takes care of that automatically through the common or “O” connection.)

Instant Impedance switch

I have even added such Canbyesque gadgets (highly recommended) as a pair of in-

FM MULTIPLEX STEREO

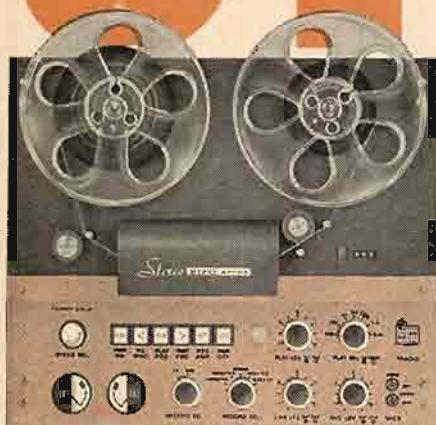

**TRANSISTORIZED
4-TRACK STEREO TAPE DECK RP100**
Completely assembled, wired and tested.

\$399.95

Semi-kit includes a completely assembled and tested transport, electronics in kit form.

\$299.95

Luggage-type Carrying Case—\$29.95
Standard 19-inch Rack Mount—\$9.95

A top quality stereo tape recorder permits you to build a stereo tape library of your favorite music at low cost. As your musical interests change, you may record the new music that interests you at no additional cost.

Perfected 4-track stereo/mono recording, 4 & 2 track playback. True high fidelity transistor electronics, individual for record & playback, plus separate record & playback heads permitting off-the-tape monitor. 2 recording level meters, mixing, mic & level controls, switched sound-on-sound recording. Electro-dynamically braked supply & take-up reel motors; hysteresis synchronous capstan motor. Individual solenoids for pinch-roller & tape lifters. All-electric, interlocked push-button transport control & interlocked safety "record" pushbutton. Precision tape guidance & sweep loading — no pressure pads. No slurring or tape bounce problems. Digital turns counter. Vertical or horizontal mounting. Modular plug-in construction. An original, exclusive EICO product designed & manufactured in U.S.A. (patents pending).



FM-AM STEREO TUNER ST96
Kit \$89.95 Wired \$129.95
Includes Metal Cover and FET



70-WATT INTEGRATED STEREO AMPLIFIER ST70
Kit \$94.95 Includes Metal Cover Wired \$149.95
40-WATT INTEGRATED STEREO AMPLIFIER ST40
Kit \$79.95 Includes Metal Cover Wired \$129.95

ST96: FM and AM stereo tuners on one compact chassis. Easy-to-assemble: prewired, pre-aligned RF and IF stages for AM and FM. Exclusive precision prewired EYETRONIC® tuning on both AM and FM.

FM TUNER: Switched AFC (Automatic Frequency Control). Sensitivity: 1.5uv for 20db quieting. Frequency Response: 20-15,000 cps ± 1 db. Multiplex-ready: Regular and MX outputs built in.

AM TUNER: Switched "wide" and "narrow" bandpass. High Q filter eliminates 10 kc whistle. Sensitivity: 3uv for 1.0V output at 20db S/N ratio. Frequency Response: 20-9,000 cps ("wide"), 20-4,500 cps ("narrow").

BOTH AMPLIFIERS: Complete stereo centers plus two excellent power amplifiers. Accept, control, and amplify signals from any stereo or mono source.

ST70: Cathode-coupled phase inverter circuitry preceded by a direct-coupled voltage amplifier. Harmonic Distortion: less than 1% from 25-20,000 cps within 1 db of 70 watts. Frequency Response: $\pm 1/2$ db 10-50,000 cps.

ST40: Highly stable Williamson-type power amplifiers. Harmonic Distortion: less than 1% from 40-20,000 cps within 1 db of 40 watts. Frequency Response: $\pm 1/2$ db 12-25,000 cps.



**NEW FM MULTIPLEX
AUTODAPTOR MX99**
Kit \$39.95
Wired \$64.95
Cover optional \$2.75
An original EICO
contribution to the art of
FM Multiplex reception.

(Patent Pending)

Designed for all EICO FM equipment (HFT90, HFT92, ST96) and any other component quality, wide-band FM tuners having multiplex outputs, the new MX99 incorporates the best features of both matrixing and sampling techniques. It is free of phase-distorting filters and provides the required, or better-than-required, suppression of all spurious signals including SCA (67kc) background music carrier, re-inserted 38kc sub-carrier, 19kc pilot carrier and all harmonics thereof. This is very important for high quality tape recording, where spurious signals can beat against the tape recorder bias oscillator and result in audible spurious tones in a recording. This adaptor will synchronize with any usable output from the FM tuner and will demodulate without significant distortion tuner outputs as high as 7 volts peak-to-peak (2.5 volts RMS).

The MX99 is self-powered, provides entirely automatic stereo/mono operation and includes low impedance cathode follower outputs to permit long lines. An indicator lamp turns on when the station selected is broadcasting multiplex stereo. A separation of 35db between channels is typical across the entire audio spectrum. An over-all gain of unity is provided from input to output on both stereo and mono.

EICO, 3300 N. Blvd., L.I.C. 1, N. Y. A-2
 Send free 32-page catalog & dealer's name
 Send new 36-page Guidebook to HI-FI for which I enclose 25¢ for postage & handling.

Name
Address
City Zone State.....

Over 2 MILLION EICO instruments in use.
Most EICO Dealers offer budget terms.
Add 5% in West.



© 1962 Electronic Instrument Co., Inc.
3300 N. Blvd., L.I.C. 1, N.Y.

Listen to the EICO Hour, WABC-FM, N.Y. 95.5 MC, Mon.-Fri., 7:15-8 P.M.

Export Dept., Roburn Agencies Inc., 431 Greenwich St., New York 13

At the Summit!



THORENS TD-124 Transcription Turntable

Among transcription turntables, the flawless Swiss-precision Thorens TD-124 stands alone . . . at the peak of performance, peak of precision workmanship, peak of critical acclaim. It's as unapproachable by competition as if at the crest of its homeland Alps. And—like clear, fresh, Alpine snow on an isolated peak—your record music, when played on a TD-124, is completely uncontaminated. Not a trace of wow, rumble or flutter. Created for the finest music systems, TD-124 improves *any* system not already using it. It's unmatched in performance and convenience

Features: 4 speeds, all adjustable ($\pm 3\%$) while record is playing. Built-in illuminated strobe. 11½ lb., 12" dual-table with exclusive clutch for fastest starts and smoothest running. Built-in level and leveling screws. Mirror-finished bearings. Replaceable 12" or 16" tone-arm mounting board. Exceeds NAB specs for wow, rumble, flutter. **GUARANTEED FOR 1 FULL YEAR.**

\$99.75 net

See and hear ALL the members of the "TD" family of fine turntables at your franchised dealers today, there's one for every budget! For additional information write us direct.



THORENS DIVISION
ELPA MARKETING INDUSTRIES, Inc.
New Hyde Park, N. Y.

stant impedance switches for my stereo amplifier. Two three-way switches are mounted on a short angle frame; on one side eight marked wires lead to all four output terminals for each channel, 0 (common), 4, 8, 16, on the other side the usual pair of 6-in. Jones females take the speakers (phones). With these I can now switch impedances in seconds, without unscrewing the terminals, for quick and handy adaptation to any speaker and for rapid A-B trials of speakers or phones with different impedance ratings.

This and many another more temporary setup (such as my three-speaker harnesses of a few years back) are invariably wired for the "B" system, always polarized to standard and always 100 per cent interchangeable. Jes' fine and dandy. But now we have cathode followers and we have phones. The "B" system begins to get mixed up with the "A".

Permoflux "A"

As long as I used phones merely for mono monitoring I ran into few complications of this sort. My phones worked OK, too, off the cathode-follower or monitor-style outputs. For many years now I have used my two pairs of 1952 Permoflux phones for this purpose, on a pair of Ampexes and various other machines. They just plug in—and they always make plenty of noise.

These phones, you see, are precisely adapted to the "A" area monitor type of circuitry. They are of a proper impedance and sensitivity to "read" the Ampex and other monitors with fully adequate volume, never overloading the circuits. Their impedance isn't marked on them for reference but is, if I remember, around 600 ohms. Whatever it is, it works. They operate to perfection—I can, indeed, "just plug them in."

It was thus an unpleasant surprise to find that the newer phones would not operate on the same monitor circuits. No volume. Impedance too low. And yet they are furnished with the "A" type phone plugs! Crazy. Have to use transformers or extra amplification to get any noise out of them.

Permoflux "B"

Now soon after binaural and stereo first came along, in the early '50s, I discovered that my Permofluxes would also play beautifully and equally well out of a power amplifier. Pretty loud and you had to watch the volume control, but not nearly as loud as the new 8-ohmers. (These vary from 4 to 45 ohms but 8 is common.) With the volume-control setting well advanced, the Permofluxes brought through no amplifier noise and the sound quality was superb. If the mismatch hurt the amplifiers, I never had any evidence of it.

There was an added convenience in numbers, I discovered. When I used phones for more than one person, each added pair in parallel brought the resistance down and made the match better—the volume improved slightly with each additional phone I used, up at least to five or six, the most I've tried. (You could work out these matching relationships, given the figures, according to conventional speaker matching procedure.)

Phone connectors

So, a few years ago, I decided the time had come for a new decision. I figured that the thing to do was to shift the phones basically over to the "B" system of connectors, along with my speakers and amplifiers,

avoiding all further phone plugs, grounds, shields. I would standardize on a double speaker plug arrangement, and conversion cables would take care of mono, phone plugs, et al. So now every set of phones that comes in gets a pair of male Jones plugs, taped together side by side as a unit with black plastic tape. Four contacts, two and two.

For Ampex monitoring (on the "A" side) I have a simple cable conversion; a standard phone plug leads through a Y to my normal female phone receptacle, two Jones sockets taped together. (I don't use the more compact four-contact Jones connector because I want to keep complete interchangeability. I can plug two separate extension cords into these bound-together sockets, for instance, to connect anywhere into my "B" system.) This little conversion cable just stays plugged into my Ampex. For monitoring, the phones go directly into it, and become automatically mono, at maybe 300 ohms. For binaural or "stereo," the phones pull free in a jiffy and are ready for two-channel work, without rewiring. Very neat, I say.

For multiple phone listening I now have a good looking five-holer box of side-by-side, built-in Jones females, wired in parallel with a phase switch at one end for checking—and for phase demonstration. I can plug in a stereo-mono switch if I need extra drama in my phone presentation.

You'll note that I use a rigidly four-wire system, exactly like any stereo speaker arrangement (and interchangeable with all of mine). It seems to me that four-wire connections are obviously right for all two-channel phones. We've long since converted to four-wire in all phono cartridges and most pickup arms, though three-contact systems were common in the early stereo period. Let's get away from that illusive and dangerous "common ground" and the phase confusions that it can create! We've always used four wires for speakers in stereo. Why anything less satisfactory in phones?

I've received a number of phones with three-wire cabling, most with a so-called "ground" or shield as the common circuit element. I have converted all of them to the four-wire system—and let me tell you, it isn't always easy. Some phones are hermetically sealed. Some are stuck together with foil and rubber cement; once opened up you have to glue them together again. And some phone makers use that deadly cloth-and-metal-strand kind of connecting lead that is virtually impossible to solder.

And so—on to a few of these actual phones themselves.

2. SOME TWO-CHANNEL PHONES

I must be as helpful as I can, and also somewhat circumspect. I do not test via instruments in this column, as everybody ought to know. (And yet one big manufacturer once enthusiastically tried to persuade the management to have me "test" their professional line of test instruments! I respectfully declined.) Mine is basically a listening evaluation, and that is that. Listening and its concomitant evaluations of convenience, comfort, practicability, and musicianly satisfaction.

I've only tried four sets of phones so far, with my ancient Permofluxes (not related to the present model of the same name) as a convenient comparison standard. Good standard too, for those phones, back ten years almost, were remarkably wisely designed and are still beautifully adapted to hi-fi listening. Their designers solved cer-

(Continued on page 55)

ASTONISHING*

Cabinart SPEAKER SYSTEMS
outperform high-rated, higher priced systems

FREE 10 DAY TRIAL OFFER You Must Be Satisfied Or Your Money Back

Check These Cabinart Stand-Out Features

- ✓ Maximum possible speaker response
- ✓ Expertly engineered and matched
- ✓ Newer low resonance
- ✓ Smoother mid-range
- ✓ Less off-color tone

Acoustic dampening material inside

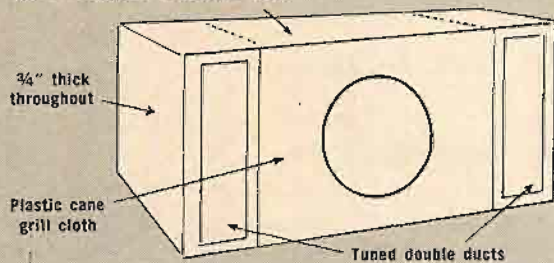

* E. T. Canby says, "The Cabinart speaker system . . . is really an astonishing piece of equipment at its price which is an unbelievable \$15 (mfr's note: now \$18) — speaker and enclosure, complete and integrated . . . with an 8" speaker inside of quite extraordinary quality. I am really impressed by the sound and by the simple ingenuity of the entire construction." In Audio, November, 1961.

Reprint of Mr. Canby's complete review of Cabinart speaker systems is available on request.

Pioneers in hi fi quality since 1948.

CABINART

ACOUSTICAL DEV. CORP. Haledon, New Jersey

Cabinart Is One Of America's Largest Manufacturers of Speaker Systems and Enclosures

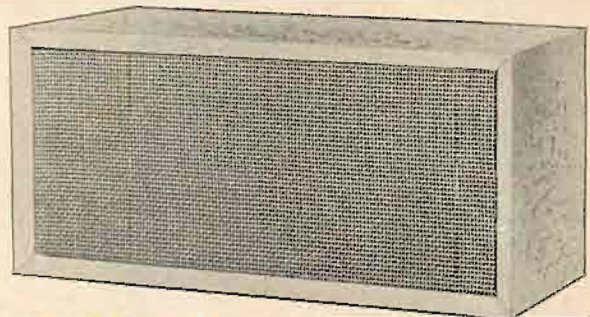

mark I 8" model

11" high x 9½" deep x 23" long
Shipping Weight: 27 lbs.
Sculptured Front Walnut Veneer, Oiled Finish \$30.00

Extended range speaker response 45 to 13,000 cps. 8 Ohm imp.

\$18⁰⁰

Unfinished

Prices F.O.B. Factory

mark II 12" model

14" high x 11½" deep x 23¾" long
Shipping Weight: 37 lbs.
Sculptured Front Walnut Veneer, Oiled Finish \$43.20

12" coaxial incl. 3" Alnico V PM tweeter, 8 Ohm imp. Speaker response 40 to 15,000 cps.

\$27⁰⁰

Unfinished

These units are also available from distributors everywhere. If your distributor does not have these items in stock, place your order **DIRECT WITH US FOR IMMEDIATE DELIVERY!** Your order will be shipped one day after it is received!

Cabinart Acoustical Dev. Corp.
39 Geyer St., Haledon, N. J.

Please ship the following to be used in my home for 10 full days. I understand unit (s) may be returned and my money refunded within that time unless fully satisfied.

-Mark I Unfinished \$18.00 each
-Mark II Unfinished \$27.00 each
-Mark I Oiled Walnut \$30.00 each
-Mark II Oiled Walnut \$43.20 each

(Please make check or money order payable to Cabinart Acoustical.)

Name _____

Address _____

City _____ State _____

EDITOR'S REVIEW

KITS

IN THE "PIONEER" YEARS it is most likely that the main reason for purchasing a kit was to save money; how else can we explain subjecting ourselves to the jumbled heap of parts and inadequate instruction manuals which characterized the early efforts? Now, however, moneysaving is no longer the prime reason for purchasing a kit—the amount of money saved is just not enough any more. Besides, with the modern trend towards labor-saving devices (dishwashers, clothes dryers, power steering, electric can openers, and so on), it is highly incongruous to expect people to perform labor *merely* to save money.

If it isn't money, why are kits growing in popularity? Our guess is that the kit builder experiences a tremendous amount of satisfaction and is happy to tell everybody about it. Listen to a kit builder tell of his triumphs and difficulties in assembling *his* amplifier (or whatever) and there can be no doubt that a small but vital part of him will always be within that unit. He loves it.

This brings us to the nubbin' of the matter; as long as we are dealing with a man in love, and not just a moneysaver, why not give him something he will treasure: an instruction manual which instructs rather than merely directs. Although current manuals are adequate insofar as directions are concerned; they require the builder to follow steps carefully, as in a cooking recipe, to ensure success. The builder has not the vaguest idea why a particular step is necessary or what it means in relation to the unit he is building. On the other hand, the only instruction he receives is on how to solder.

The most natural place to start would be with the product itself. Almost every manual contains a description of the circuit, yet few are highly informative. They are not informative because the language used is only understood by those who are already informed. Why not explain what ultra-linear operation is all about? Or a long-tailed pair? Or a Baxendall-type tone control? All too often we find words of this level used in the circuit description while the construction-step terminology is at the level of the novice. The logic is wrong here; it is the beginner who needs to be informed about the circuit, and therefore the terminology should be at his level. But we can't assume that he won't want to understand the design thinking that went into the product just because he is a beginner. At least he should be given some real meat to chew on if he wants to eat. By providing a thorough circuit explanation, using careful terminology,

both the novice *and* the advanced kit builder will find it valuable.

Another area which could be expanded profitably is related to the construction sequence. Those of us who have a considerable amount of experience in kit building know that a great deal of thought is concentrated in this area. Usually the sequence reflects the best soldering and assembly techniques available. Thus, a discussion of the thinking that went into the construction sequence will inform the kit builder about how to avoid ground loops and hum as well as the how and why of shielding—plus a variety of other techniques. Here again, if the terminology is carefully selected, the instruction would be applicable from the newest novice to the advanced assembler.

For maximum value, the descriptions should be related to a construction unit. For example, the circuit explanation and construction thinking related to the power supply should be read just prior to assembling it. In this way the instruction and the experience are integrated. We feel that both the kit builder *and* the manufacturer will gain: The kit builder will profit because he is much better informed about the object of his interest; the manufacturer will profit because he has customers who are enamored to the point of "telling the world."

THE TECHNICAL MAN

Recently we had a conversation with a charming lady who seems to think that the technical man (that means you and me) is a rather peculiar beast who lives primarily to manipulate a slide rule and conjure mysterious devices (which will certainly destroy everybody). Unfortunately, there are too many people who agree with this lady's estimation of the technical man—without really knowing what they are talking about. All that these people need do is glance at the pages of *AUDIO* to disabuse them of the idea that we technical people do not read about, and understand, much more than the mysterious jargon of our secret cult. Consider the wide range and thoroughly musical orientation of our *Record Reviews*; or the wide spectrum of thought reflected in *ABOUT MUSIC*. Our answer to these uninformed, but wordy critics comes from Alexander Pope's "Essay on Criticism" Part III:

*The bookful blockhead ignorantly read,
With loads of learned lumber in his head,
With his own tongue still edifies his ears,
And always list'ning to himself appears.*

RUSHING...

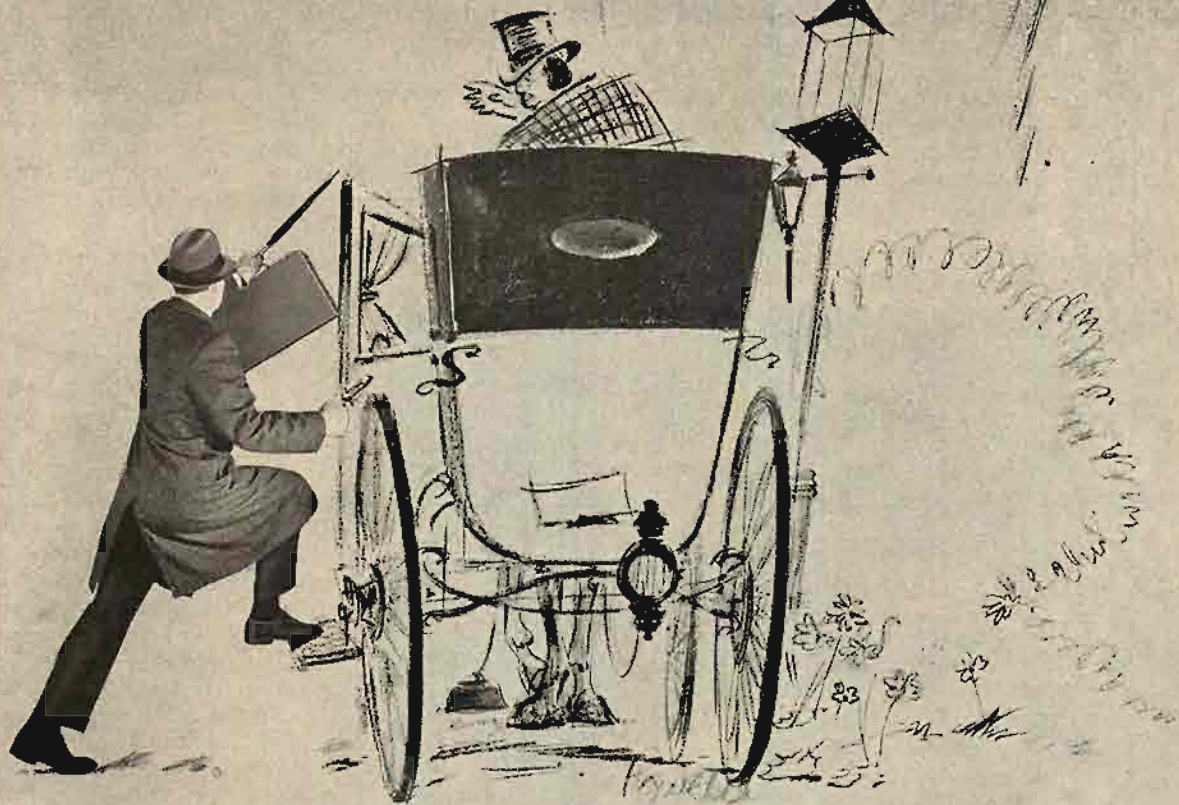

to get to his...

STANTON

stereo fluxvalve pickup

PICKERING & COMPANY INC. offers the stereo fluxvalve pickup in the following models: the Calibration Standard 381, the Collector's Series 380, the Pro-Standard Mark II and the Stereo 90. Priced from \$16.50 to \$60.00, available at audio specialists everywhere.

“FOR THOSE WHO CAN HEAR THE DIFFERENCE”

Pickering and Company—Plainview, Long Island, New York

AUDIO • FEBRUARY, 1962

17

A Test Record for Evaluating Stereophonic Systems

B. B. BAUER, G. SIOLES, A. SCHWARTZ, AND A. GUST*

A sweep-frequency test reveals resonances and other faults not necessarily uncovered by spot frequencies.

AT THE LAST Convention of the Audio Engineering Society in New York an interested crowd of engineers and audio specialists gathered daily to watch an operator place a pickup on a record and an automatic recorder draw a curve on graph paper—in just over one minute. This seemingly insignificant event was fully appreciated by the tech-

* CBS Laboratories, Stamford, Conn.

nical audience: here was a test record which could be used to automatically record phonograph characteristics. Significantly, although aimed mainly at the requirements of pickup designers and audio professionals, the new record answers several important needs of the high fidelity enthusiasts.

Conventional test records contain 25-30 spot frequency tones per channel. To evaluate a pickup or a phonograph

system, the user plays the record and reads the output in db on a VTVM. Then a correction for the record calibration is added (by careful users). This provides the pickup response data which is then transferred manually to semi-logarithmic graph paper. With two channels and two sets of crosstalk (separation) points the complete procedure takes the better part of an hour.

The CBS Laboratories STR-100 has a full set of spot frequency tones, with voice announcements preceding each tone, and it also includes two precisely cut sweep-frequency bands, one each for the left and right channels. These bands are synchronized to operate with a General Radio Type 1521-A recorder at a chart speed of $7\frac{1}{2}$ ipm. The first band starts with a 1000-cps left channel "keying" tone, which may be used to set level. As soon as this tone ceases the frequency drops to 40 cps and starts rising immediately and continuously at a logarithmic time-rate of 1 decade in 24 seconds. Thus the sweep from 40 to 20,000 cps requires $24 \log (20,000/40) = 64.8$ seconds. After a brief pause (which is sufficiently long to allow the operator to reset the recorder) a 1000-cps right-channel tone is heard and this is similarly followed by a sweep from 40 to 20,000 cps. If one channel of a stereophonic pickup is connected to the automatic recorder the response and separation curves for the particular channel will be obtained in a fraction of the time formerly required. A typical set is shown in Fig. 1.

Another significance of the sweep test is that spot frequencies tell only about the performance at specific points of the spectrum and the sweep test provides information about performance at every frequency. Users may be surprised to discover that a pickup which appears to be "flat" with a spot frequency test may be found to have a peak or dip between the frequency spots!

A circuit for starting the recorder automatically when the keying tone ceases is shown in Fig. 2.



A cartridge under test.

The 1000-cps keying tone preceding the sweep initiates the cycle. All relays are initially de-energized as shown in the schematic diagram. Left and right channel inputs are combined in the cathode of V_1 , insuring that the keying tone will be present for either direct or crosstalk measurements. The cathode follower output is fed to the high gain amplifier, V_2 , through a high-Q, LC, 1000-cps filter allowing only 1000 cps to feed through. Following this usage is a cathode follower, V_3 , employed as a power amplifier to drive a sensitive relay, K_1 , (Elgin Advance) after rectification by the two IN2482 diodes. A Zener diode and clipping-range control prevent high-signal levels from overheating the sensitive relay.

With K_1 energized, relay K_2 is energized and locks itself across the power supply through contact 1. At the cessation of the keying tone, K_1 is de-energized—thereby actuating K_3 , which starts

Are there any buzzes or rattles in the loudspeakers or the cabinet? (This might indicate poorly tracking pickup, dirt in the voice coil, loose panels in the cabinet, and so forth.) Is the glide tone relatively steady in loudness or does it go through a series of up-and-down gyrations? (Small variations are normal; large variations might indicate that the pickup or the loudspeakers are inadequate or that the room needs additional sound absorption in the form of carpet, drapes, or similar materials.)

In this manner, just by playing bands 1A and 2A, a listener can quickly spot trouble or reassure himself that everything is all right—in less than three minutes.

The technical user who does not have a recorder available but must employ spot frequency bands for calibrations work will still find that the sweep-tone bands have an added value. Unexpected

announcements are then heard directly over the loudspeakers. (See Fig. 3.) Start with the left channel and play band 3A. Note the meter reading and call this "0" db for the 1000-cps tone. As the voice announcements in the loudspeaker identify the frequencies being reproduced make a note of the db readings. With an ideal pickup performance, they should be as shown in Table I.

TABLE I

Frequency	Relative Output (db)
1000	0
20,000 to 500	0
400	-2
300	-4.4
200	-3
100	-14
80	-16
60	-18.4
50	-20
40	-22
30	-24.4
25	-26
20	-28

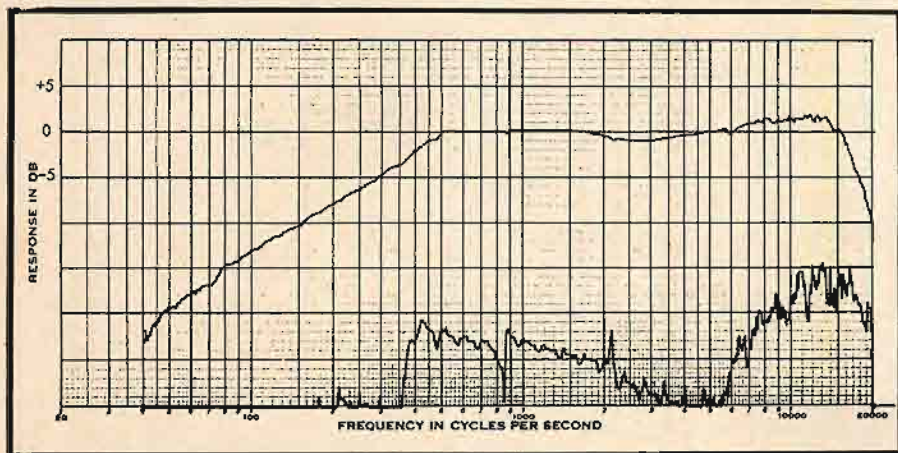

Fig. 1. Automatically plotted response and cross-talk curves of typical high-grade magnetic pickup.

the recorder motor at the instant the sweep begins. At the termination of the sweep band, the reset switch is manually set at RESET momentarily to de-energize K_2 and the circuit is then ready for the next sweep.

The Three Minute Test

The sweep tone bands, 1A and 2A, originally were intended for audio engineers and pickup designers with access to an automatic curve recorder. Even without a recorder, however, these bands provide a rapid and convenient qualitative appraisal of the reproducing system. They will help to answer a number of questions. Are the left and right channels correctly connected? (A surprising number of sets are reversed.) Do the left and right sounds appear to originate at the appropriate loudspeakers throughout the glide tone duration (which indicates good channel separation) or do they wander in between or beyond the loudspeakers (which would indicate poor channel separation)?

peaks, dips, buzzes or rattles are revealed which otherwise might remain undetected with the spot frequency test alone.

Using the Spot Frequency Test

Two bands are provided (3A and 3B) each of which contain 30 spot frequency test tones for the left and right channels, respectively, with voice announcements preceding each tone. Since this record has been primarily designed to serve the needs of the scientific worker, these bands have been placed on the opposite sides of the record in exact spatial relationship so that the respective tones are at the same distance from the center of the record. This arrangement improves the accuracy of record calibration.

With magnetic pickups, an auxiliary plug and jack arrangement may be used to allow the pickup to be "bridged" with the VTVM, and simultaneously connected to a preamplifier with correct termination impedance, as recommended by the pickup manufacturer. The voice an-

Next, without changing connections, turn the record over and play band 3B. A similar set of readings will be obtained, except this time they will indicate crosstalk. Plot relative output in db vs. frequency, which should provide a curve similar to Fig. 1, except, of course, on a point-by-point basis. Repeat for the other channel, and the task is done. Corrections for deviation from ideal response are not needed.

Similar measurements can be performed on ceramic pickups. To this end, the left and right channels should be terminated with 10,000-ohm resistors. An ideal ceramic pickup terminated in this manner will have a response as in Table I and it will work satisfactorily if connected to the input terminals normally intended for magnetic pickups.

Limits of Response

In a less formal fashion, the spot frequency bands may be used to "estimate" the frequency limits of your equipment—or of your own sense of hearing or that of your friends. This is because of the convenience afforded by the voice announcements. Starting at the beginning of band 3A, adjust the 1000-cps tone for a moderately loud signal and then observe the announcement following which you can just perceive a high frequency tone. The succeeding tones will become louder as the frequency is decreased, and then weaker again as the low-frequency end is approached. Observe in the low-frequency end which frequency just can be heard. Repeat for the right channel band 3B. Here are the

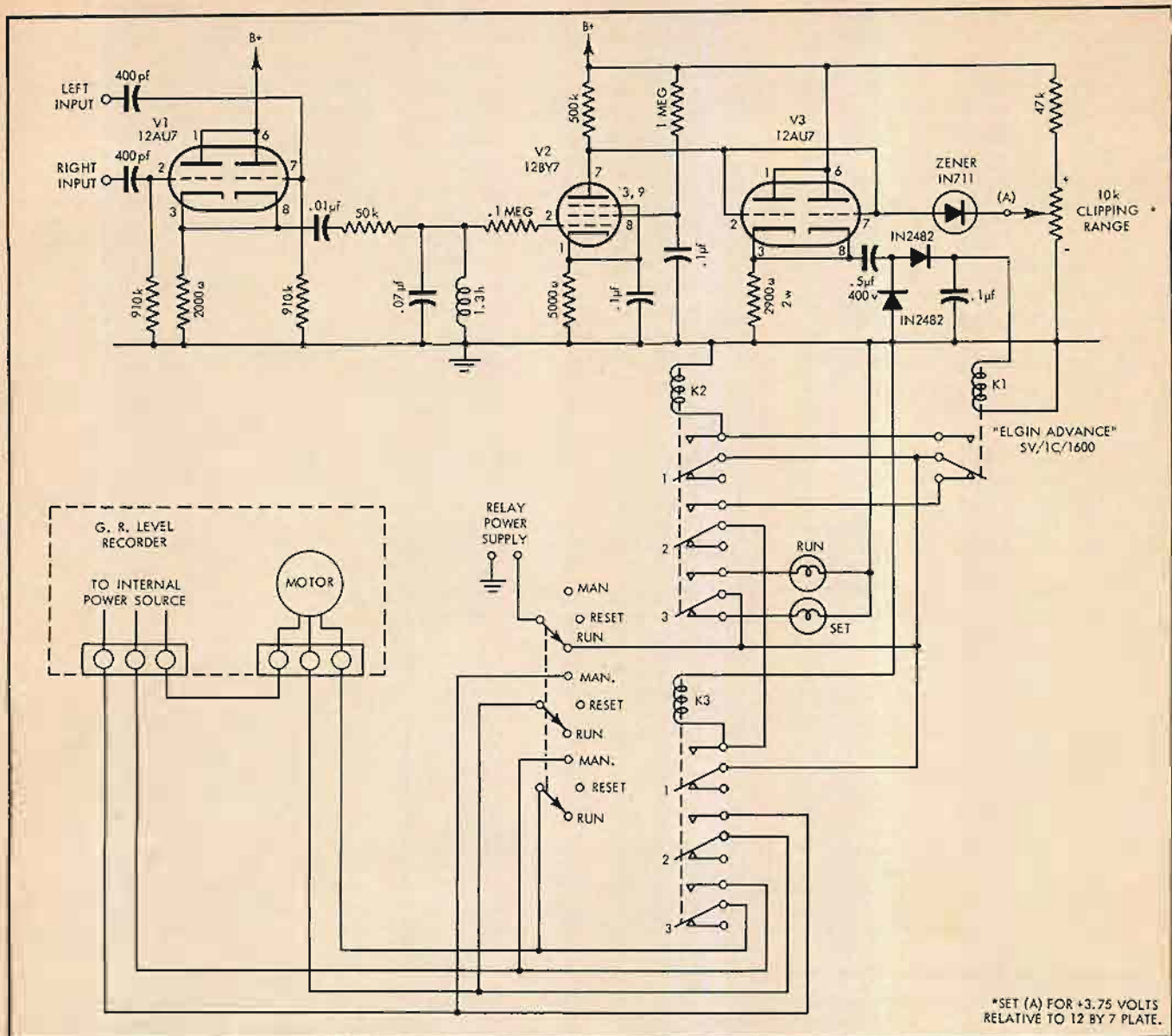

Fig. 2. Synchronizing circuit for automatically starting curve recorder.

facts about the approximate frequency range of your system!

You may wish to repeat these tests with the treble, bass, and rumble controls in different positions and note what difference they make in the frequency response of your system.

Response Characteristics

In designing a test record there is always the question as to which response characteristic to provide. In the STR-100 a constant displacement characteristic is provided below 500 cps and a constant velocity characteristic above 500 cps. This means that the response of a perfect velocity-responsive (magnetic or dynamic) pickup will rise at 6 db per octave below 500 cps and will be "flat" above 500 cps, as indicated by Table I. In this manner, the pickup performance is evaluated by comparing it with two straight lines, which simplifies the task.

Some test records in the past have

been recorded with constant-velocity characteristic at all frequencies. This introduces a problem in that amplitudes at low frequencies become unmanageably large; therefore the response must be broken into two separate bands, one recorded at a level 20 db below the other. This approach does not lend itself to a good graphical presentation on a curve recorder, and, therefore, it was not considered.

Why not use the RIAA characteristic? There is an argument in favor of this approach, which runs as follows (see Fig. 4): Let a test record be recorded with the RIAA characteristic, (A) of Fig. 4, then an ideal velocity-responsive pickup will reproduce this characteristic on a velocity basis, (B) of Fig. 4. The preamplifier is designed to provide an inverse characteristic (C), of Fig. 4; therefore the output of the amplifier into the loudspeaker voice coil or dummy load will be constant as a function of

frequency, (D) of Fig. 4. If this event takes place, then the over-all system is satisfactory.

This argument is fine with two exceptions: First, in the event the over-all response of the system is not flat, then the user has no convenient means of determining whether the problem is with the amplifier or the pickup. Of course, one could measure the pickup by itself and compare the resulting curve with the published RIAA characteristic, on a point-by-point basis. This is far less convenient than simply matching response against two straight lines. Second, because of the rise of the RIAA curve above 2120 cps, cutters and recording styli cannot handle the output on a steady-state basis at standard recording level, and it becomes necessary to produce the record at considerably below the standard level. This would introduce the possibility of error because of noise and rumble.

A test record with RIAA characteris-

tic would be useful for over-all checks of packaged equipment. But it would not be convenient for testing high-fidelity components, where each component must meet specific performance standards.

RIAA Function Generator

For the designer who wishes to assure himself of the performance of a pre-amplifier for magnetic pickups, an RIAA function generator has been devised. This circuit is composed of R and C elements, and it may easily be constructed by any technical person (Fig. 5). The design of this generator follows the theory previously employed to calculate an ideal compensation network for ceramic phonograph reproducers.¹ When connected to a low impedance amplifier (30 ohms or less), and driven by a constant voltage oscillator, the circuit will develop an ideal RIAA shaped curve across a 10-ohm resistor. With an input voltage of 8 volts, the output at 1000 cps is about 10 millivolts. With constant voltage input to the RIAA generator network, the output of the magnetic pickup preamplifier should be "flat" for all audio frequencies. Then, a pickup whose response follows the two straight lines of the STR-100 test record, will produce an ideal response with an RIAA-cut record and a particular amplifier.

The STR-100 also may be used to test the over-all system performance. In that case, the response in db will be the difference between the RIAA response and the STR-100 response. This is given in Table II.

Low-Frequency Sweep

In the STR-100 record, low-frequency sweep bands are available for the left and right channels, from 200 down to 10 cps. These sweep frequency bands, 4A and 5A, are recorded at a level +3 db above the standard recording level to provide a rather severe tracking test at low frequency, which is convenient for testing arm and speaker resonance. Each band starts with a keying tone of approximately 1000 cps. The cessation of this tone indicates that the sweep is starting. This low frequency sweep is also synchronized to the General Radio Type 1521-A recorder.

Because the chart paper of the recorder does not go down to 10 cps, bands 4A and 5A have been recorded in a descending mode. In this manner, if the 200-cps point is placed correctly on the chart, all the other frequencies will properly be in place. The motor drive of the recorder should be set in the "reverse" mode of operation, the pen

¹ B. B. Bauer, "Compensation networks for ceramic phonograph reproducers," I.R.E. Transactions on Audio; Jan.-Feb., 1957.

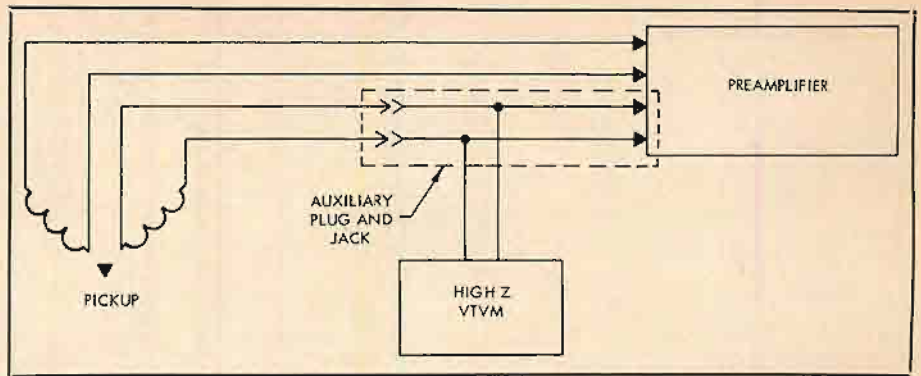

Fig. 3. Auxiliary plug and jack for spot-frequency measurements.

TABLE II

Frequency	Relative Output (db)	Frequency	Relative Output (db)
1000	0	800	+0.7
20,000	-19.5	600	+1.8
18,000	-18.8	500	+2.6
16,000	-17.7	400	-1.9
14,000	-16.6	300	+1.1
12,000	-15.3	200	+0.2
10,000	-13.7	150	-0.6
8000	-11.9	100	-0.9
6000	-9.6	80	-1.3
5000	-8.2	60	-2.3
4000	-6.6	50	-3.0
3000	-4.8		-4.2
2000	-2.6		-5.8
1500	-1.5		-7.0
1000	0		-8.6

being placed at 200 cps and the gear engaged as soon as the keying tone has ceased. The sweep will end off the chart. If desired, the recording may be started at the 2000-cps ordinate on the chart continuing down to 100 cps; remembering however for correct presentation to divide all frequencies by 10.

Arm Resonance Test

The low-frequency sweep is ideal for detecting and remedying any arm resonance that may be present. The principle is illustrated in Fig. 6, by the vector velocities acting on the stylus under

three conditions of arm resonance. Symmetrical resonance is shown (A) of Fig. 6. Here the resonance generates a velocity, v_a , which is additive with say, the left modulation velocity, v_l ; since no crosstalk velocity is generated, separation is unaffected: Symmetrical resonance shows up as a peak or dip in the main channels. In (B) of Fig. 6 a condition of vertical arm resonance is illustrated: Here the arm velocity, v_a , at resonance produced by the modulation velocity, v_l , introduces a component of crosstalk velocity, $-v_c$. This will result in a loss of channel separation. (C) of Fig. 6 shows the effect of horizontal or torsional arm resonance: Again the velocity v_a introduces a crosstalk velocity component, v_c . Torsional resonances, often have a high "Q" and the loss of separation may be in the form of sharp "peaks" in the crosstalk channel graph. These often go undetected by the spot-frequency test, but are clearly evident with the sweep-tone test.

Standard-Level Test

For some time there has been a need for accurately calibrated standard 1000-cps tones for specifying pickup sensitivity data. Standard lateral recording level is 5 cm per second rms velocity at 1000 cps, which corresponds to $5/\sqrt{2} = 3.54$ cm per second rms velocity for each of the two 45-45 deg. channels. Thus the voltage sensitivity of a pickup measured on the STR-100 record can be expressed

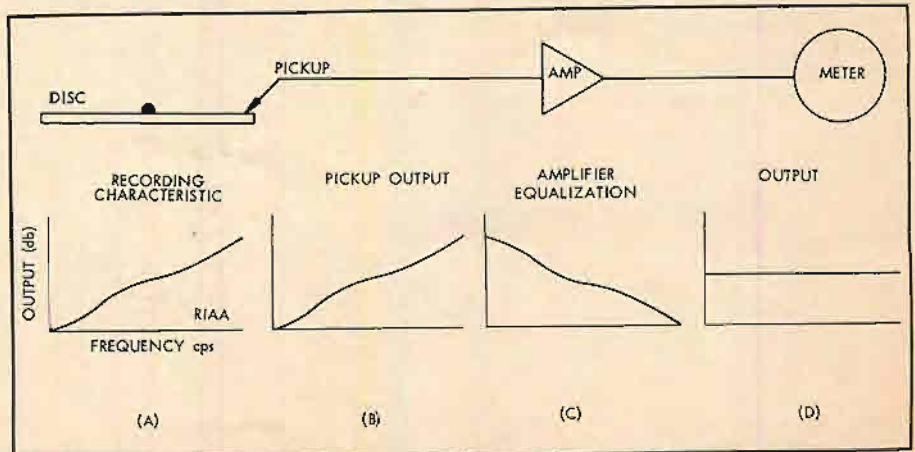

Fig. 4. Frequency-response relationships between record and amplifier output.

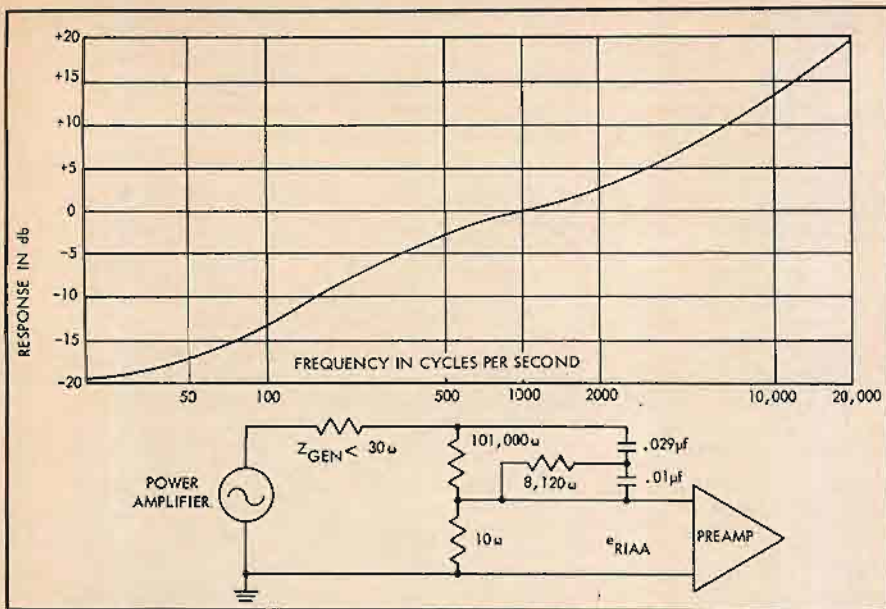

Fig. 5. RIAA function generator for testing magnetic pickup preamplifier.

in terms of volts per channel for 5 cm/sec rms lateral velocity.

Wavelength-Loss Test

The corresponding left and right high-frequency bands, 1B-6B and 2B-7B, at the outside and inside radii of side B are intended for research studies of high-frequency response as a function of stylus force and mass, radius, wear, and other pickup design factors. In this manner the engineer will be able to determine the effect that a particular pickup design may have on high frequency response and record life.

The wavelength-loss bands contain only the high frequencies—20,000, 18,000, 16,000, 14,000, 10,000, and 5000 cps, in addition to the 1000-cps reference level. The recording level of these bands has been purposely placed well below the standard 1000-cps reference level of bands 6A and 7A. To test the wear at the left channel side of the stylus, for example, turn the volume control to normal "loud" level, and the bass control to a minimum setting to attenuate any hum and rumble in the system. Start the pickup at the outside of band 1B. As the voice announcements are made, listen for the just perceptible highest frequency tone. Then repeat this test on band 6B, and again note the just perceptible high-

est frequency. If it is the same frequency and level as in 1B, then the stylus is probably a fine one and the stylus force is not unduly large. If the just perceptible tone in the inner bands is at a lower frequency, or is considerably less audible than the corresponding tone in the outer band, then the stylus needs replacement or the stylus force should be reduced.

The wavelength loss or the wear test for the right channel side of the stylus employs bands 2B and 7B.

Compliance and Tracking Test

Can your pickup properly track heavily modulated low-frequency tones such as common to organ music and the like? A partial answer to this question will have been provided already by the low-frequency sweep test. Any pickup which passes this test without perceptible distortion is apt to do well even on the heavily modulated passages. A more quantitative answer is given with the aid of band groups 4B and 5B. These consist of 100-cps laterally and vertically modulated grooves, respectively, with progressively increasing amplitudes of modulation.

Band groups 4B and 5B also are helpful in selecting the minimum proper tracking force for a pickup. If the pickup

plays all the bands in these groups without evidence of distortion or rattle, then it probably has an adequate margin of safety. You can try to reduce the stylus force of this pickup. On the other hand, if only the first 1 or 2 bands of these groups will play without evidence of rattle or distortion, then probably a greater stylus force is indicated, or there is something wrong with the pickup.

Lateral and Vertical Compliance

Band groups 4B and 5B also are intended to provide an operational measurement of lateral and vertical compliances. Lateral compliance measurement by means of compliance meter² is well known, but a similar meter for vertical compliance has not been made available.

The bands are recorded with lateral (for 4B) and vertical (for 5B) modulation at peak amplitudes of .001, .002, .003, .004, and .005 cm respectively. To measure lateral or vertical compliance, adjust the stylus force, in grams, until the pickup just fails to track one of the respective bands in groups 4B or 5B. At this point the displacement divided by compliance just equals the tracking force. Compliance in cm per dyne is given by the equation:

$$C = \frac{\text{peak amplitude in cm}}{980 \times \text{stylus force in grams}}$$

The lateral compliance determined by use of the bands in group 4B may be at variance from the lateral compliance measured with a compliance meter. This is because the actual force on the groove-walls may vary from that determined with the gram gauge, as a result of the arm friction, side thrust, arm inertia, and so forth.

Conclusion

The STR-100 record brings to the audio specialist and the high-fidelity enthusiast a combination of tools which permit obtaining factual information in a rapid and convenient manner. In addition to the quantitative measurements which it affords, it provides the following important value: Any system capable of playing this record on both sides with correct left-right placement, smooth and extended frequency range, and absence of distortion or evidence of poor tracking will offer strong presumptive evidence of being in "top-notch" operating condition. AE

Acknowledgement

The Authors are grateful to Dr. P. C. Goldmark for his interest, advice and encouragement of this project.

² B. B. Bauer. "Measurement of Mechanical Compliance and Damping of Phonograph Pickups," *Journal of the Acoustical Society of America*; 19:2:319, March 1947.

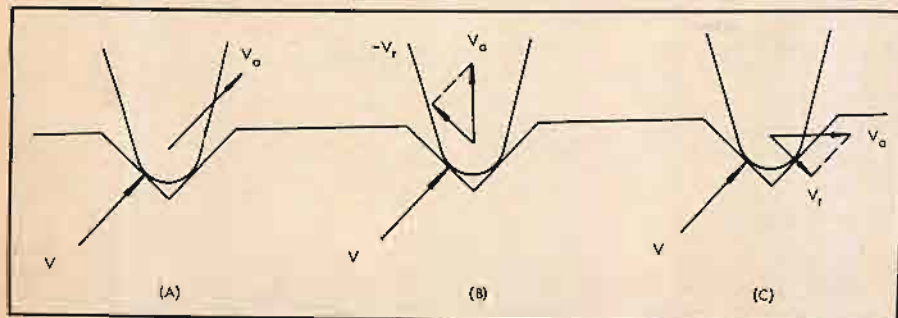

Fig. 6. Crosstalk conditions for different arm resonances.

The Transistor Amplifier

GEORGE FLETCHER COOPER

Here is a basic circuit for a general purpose amplifier which can be made to deliver powers ranging from 100 mw up to 10w with minimum design effort

EVERY NOW AND AGAIN one seems to come across a really simple circuit which is easily designed and can be used over and over again in a variety of sizes. Sometimes, indeed, the circuit becomes so attractive to the designer's eye that he persists in using it even where it is completely unsuitable. I don't know whether I have reached this point of negative return yet with the transistor amplifier circuit I am describing here: I hope not, but at the moment it really looks like the answer to many problems that are around. That is why the title at the head of the page is so forthright.

I find that a basic two-stage transistor amplifier which can work efficiently when the second stage is delivering real power is an extremely useful standard part. Real power in this context has meant anything from 100 mw up to 10 w, depending on the scale in which the design has been planned, but in each application the design procedure has been exactly the same with only the numbers changing. What is more the design has been modified very easily to provide a high-power economy circuit which I will describe in a following article.

The output stage of a general purpose amplifier is most conveniently made a grounded emitter stage. It is very attractive at first to consider a ground collector stage with its very low output impedance but when you come to work out the drive circuit your enthusiasm is rapidly damped by the high voltage swing needed. I lost all my love for the grounded base circuit in the days of point contact transistors, when only too often there just was no choice but to accept the input transformer needed for the low emitter impedance. Split-load circuits have, on paper, considerable attractions and if I were designing an amplifier in which high quality and economy were to be wedded I should investigate them closely.

The other problem with the output stage is whether it should be class A or class B. When using transistors there is a whole bunch of factors to be taken into account which we never had with tubes. In general with class B the output transformer will be smaller, because

there is no polarizing magnetic flux, or not much anyway, to make you use a big gap and more turns. The power consumption will be less, though in the following article I shall show you that for moderate quality this does not have to be true. Smaller transistors can be used. Against all these advantages we must consider that a class-B stage uses two transistors where a class-A stage needs to use only one, and this is not only an

I find that most amplifiers do not need to be power economizers. Either they are running off the power line and use transistors solely for reliability, or they run off rechargeable batteries (for example in an automobile) where current economy has not really very much justification. This affects the question of weight, too. If you want a pocket job or a ten-watt amplifier you can hide in your beard there is nothing in this article for you.

Fig. 1. The basic circuit.

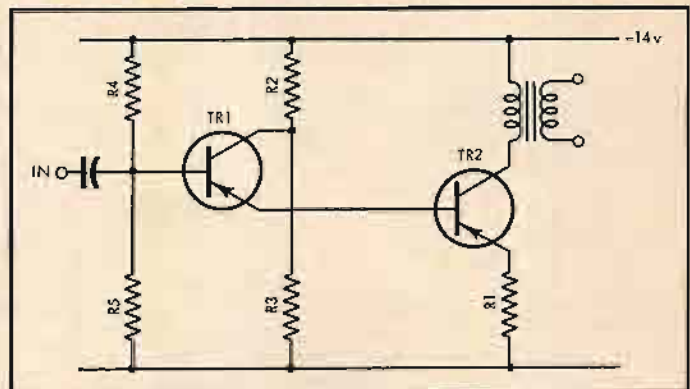
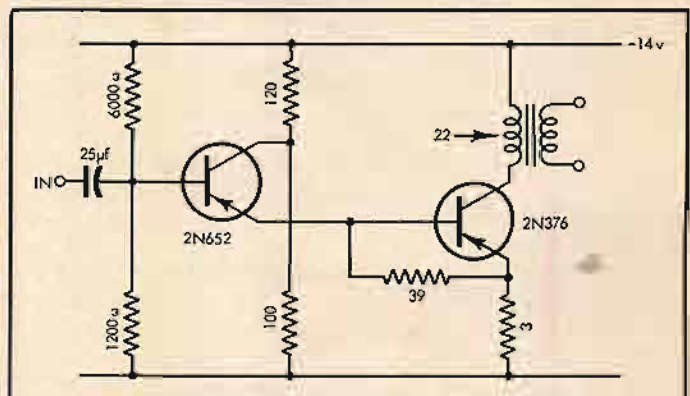

Fig. 2. Roehr's 2-watt high-quality amplifier.



economy in itself but gets rid of all the phase-splitting circuit problems. When the bias goes a little wrong in a class-A stage it affects the quality at signal peaks, but with a class-B stage the low-level quality can get very bad indeed if the bias goes wrong and you get crossover distortion. For some reason this kind of distortion sounds much worse, at a given percentage harmonic, than peak clipping. I would guess that this is because every cycle of a real signal must cross the base line but the high peaks are only a small fraction of the time.

As you may have realized this preamble leads to the fact that the output stage is to be class A. This is a deliberate choice in which long-term economy in the first design and quality in the second is traded for simplicity. We now go on to consider the driver for a class-A grounded-emitter output stage.

Drivers for transistor power stages introduce far more problems than do their tube counterparts. The input impedance of the power stage is generally low and a substantial drive current is needed. This tends to settle the operating

level of the driver at a higher level than we should expect from tube practice unless we choose to use a transformer. Without a transformer we take the drive current at the full supply voltage even though we really need only a fraction of it. The other problem is that of drive circuit impedance. In low-level transistor amplifier stages we try to use a high source impedance because of the non-linearity of the input characteristic. This keeps the input current undistorted and as the transistor is a current amplifier this is what we need. You will remember that in tube circuits there is an upper limit to the grid circuit impedance above which grid current distortion becomes troublesome. When we come to use power transistors, however, we need to deal also with the way in which the current amplification factor, beta, falls as the current rises. The over-all result is that when the power transistor has this sort of charac-

tween the two stages and eliminate these components entirely. The biasing of the driver stage then takes control of the whole amplifier.

It is perhaps time to draw the basic circuit diagram. Figure 1 shows the outline of the circuit which requires both discussion and development. The output transistor must first be selected. Let us assume that we are using a 14-volt supply and that for practical reasons to be considered later the peak collector swing will be 10 volts. If we now decide the output power we want all else will follow quite logically. To start with let us take an output power of 10 watts. At 10 volts peak we need a peak current swing of 2 amps ($10 \text{ volts} \times 0.707 \times 2 \text{ amps} \times 0.707 = 10 \text{ watts}$). The steady collector current of T_2 must be rather more than 2 amps so that it is not completely cut off on the down swing. The quiescent dissipation in T_2 is

course, and you alter the inductance in proportion. The core must be gapped and must have enough iron to remain below saturation even with the peak current of 4 amps flowing. And as you do not want to waste signal power in the winding resistance you will need enough copper to keep the resistance below, say, $\frac{1}{4}$ ohm. The secondary, naturally, depends on the load and is just the usual transformer problem.

Now we turn to R_1 . I have found two quite widely separated descriptions of this circuit which both come independently to the conclusion that across R_1 we should drop about 1.5 volts. For our 2 amp quiescent current this makes $R_1 = 0.75$ ohms. This is the sort of resistance value you need to construct for yourself, remembering that it must dissipate 3 watts. Do not use ordinary resistance wire for this: most resistance wires have very low temperature coefficients and there is some advantage in making this resistance from copper or nickel wire with a good big structure to get rid of the heat. Then when the ambient temperature rises the resistance rises too, thus helping to counteract the increase in transistor cut-off current. This 1.5 volts in R_1 , the half-volt in the transformer and the transistor saturation voltage account for much of the difference between the 14-volt supply and the limit of 10 volts peak.

For a 1-watt amplifier we should have proceeded in exactly the same way, to arrive at a current of 0.2 amp, a transistor dissipation of 2 watts, a load impedance of 50 ohms and an emitter resistance, R_1 , of 7.5 ohms. The transformer primary inductance for an 80 cps 3-db point will be 100 mh, or for 40 cycles 200 mh. All these calculations you can do in your head as you go along.

Now you need to know the current gain of the output transistor. We have already decided this is not a constant, so we look at the characteristics to find what base current we need for our quiescent collector current and also what base current we need for the full drive current. Sometimes we can get this directly from the maker's data, sometimes we need a roundabout approach. Picking out another set of data since I don't have the 2N1147 data handy, I find that at 4 amps the current gain is 36 and at 2 amps it is 45. A driver must then provide a peak current of $4/36 = 110$ ma and should run at a quiescent current of $2 \text{ amps}/45 = 44$ ma. It is advantageous to use transistors with higher current gains than this, but anyway, for our example, we find we need a driver which can go up to 110 ma. There is no difficulty in finding a suitable transistor.

The transistor characteristics also tell me that to get this base current into T_2 I shall need around 0.5 volts drop, base-

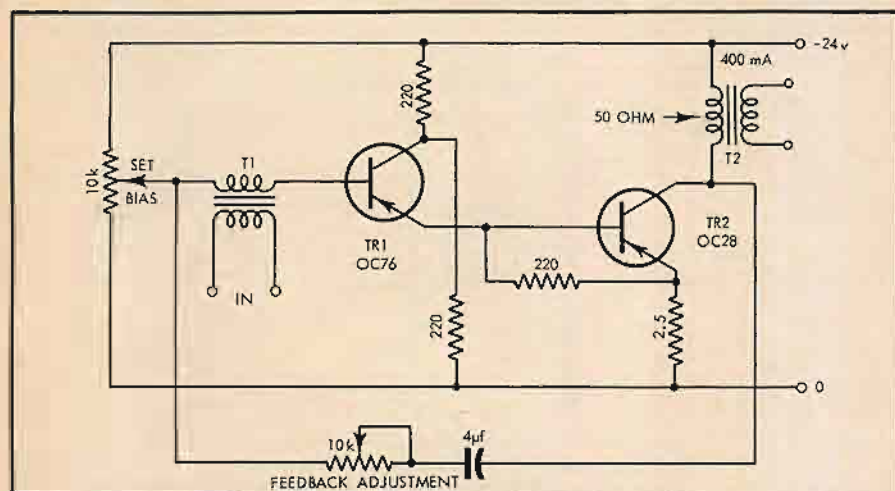

Fig. 3. This circuit provides more gain than Fig. 2 with good damping for the load. (T_1 secondary impedance = 10,000 ohms, secondary inductance = 5 h. T_2 primary impedance = 50 ohms, primary inductance = 33 mh. Apparent output impedance = $1/40 \times$ load impedance. With 18-volt supply use CST1739 for TR_2 .)

teristic it is profitable to use a low drive impedance and get a distortion balancing effect. At high base currents the base impedance is low, so that we get rather more base drive for our input volts than we should: this is the input circuit distortion. However, this high base current is not amplified as much as it should be so that the over-all effect is to give less distortion than either effect independently would prove. Like all distortion balancing schemes it is by no means perfect, but it does suggest that a low impedance driver is a good idea.

Here we want current drive, but not much in the way of voltage and an emitter follower or grounded collector stage will be exactly what is needed. We find that it has even more to commend it. The low impedances involved would make it necessary to use very large capacitances and rather low-resistance bias circuits. With the emitter follower it is perfectly practicable to use direct coupling be-

therefore 20 watts, and if the junction is not to rise more than 50 deg. C above the ambient temperature we need a thermal resistance, junction-to-ambient, of 2.5 deg. C/W. A good big transistor, say the Cleveite 2N1147, has at worst 1 deg C/W internally, so the transistor must be mounted on a plate giving 1.5 deg. C/W. This is a sheet of painted aluminum, perhaps 50 sq. in. and .1-in. thick: it rather depends on whose curves you look at what size it comes out. You will need silicone grease to fill the space between transistor shell and cooling fin so that there is no air to impede the heat flow.

The choice of power has fixed transistor and also its cooling plate. The transformer, too, is pretty well fixed. The load impedance presented at the primary side must be 5 ohms ($10 \text{ volts}/2 \text{ amps}$), so that if the response is to be 3-db down at 80 cps the inductance must be $(5/2\pi \times 80)h = 10$ mh. Other frequencies, of

WIN EMPIRE'S 1ST ANNUAL 'ROUND- THE-WORLD MUSIC FESTIVAL (FOR 2)

A 'Round-the-World musical trip, lasting 21 days, awaits the lucky winner (and his guest) of Empire's 1st Annual Music Contest. Imagine... you'll be attending such greats as the Athens, Dubrovnik, Bregenz, Salzburg, Bayreuth, and Edinburgh Festivals. You'll be taken on personalized tours through many world-famous cultural centers, like Rome, Paris, and Munich; plus special field trips, such as a tour of the MGM factory in Hamburg, etc. And best of all, this is at no cost to you! Transportation, rooms, meals, tickets and tours are pre-paid by Empire... your host on this incomparable trip. Your Hi-Fi dealer has complete itinerary.



THIS IS THE

new empire troubador

...world's most perfect record playback system

Have you ever dreamt of attending an international programme tour through such cultural centers as Paris, Rome, Edinburgh, Dubrovnik, Bregenz, Bayreuth, Salzburg, and Athens—witnessing in person their presentations of opera, ballet, drama, symphony concerts, chamber music, recitals, and even art exhibitions? Each year thousands of people from all parts of the world attend one or perhaps two of the great music festivals. . . . Now two people will have the opportunity to attend most of the leading festivals—the winners of the Empire 'Round-the-World Music Festival. It's easy—here's all you do: Listed in alphabetical order are

ten outstanding features of the new Empire Troubador, world's most perfect record playback system. The collective thinking of the leading high fidelity music editors and critics listed these features in what they felt is the respective order of importance. Your task—MATCH THEIR LIST. That's it! . . . no long, drawn-out essays . . . no jingles . . . no box-tops. Just rearrange the outstanding Empire features in the order of importance that you feel will match the master list. You may win Empire's Round-the-World Music Festival.

VISIT YOUR DEALER — ASK FOR A COPY OF THE COMPLETE EMPIRE FESTIVAL ITINERARY — HEAR THE INCOMPARABLE EMPIRE TROUBADOR — YOU'RE ONLY ALLOWED ONE ENTRY.

OUTSTANDING FEATURES OF THE EMPIRE TROUBADOR
(world's most perfect record playback system)

- A. All 3 Speeds — 33½, 45, 78 RPM, with fine speed adjustment.
- B. Dynamically Balanced Playback Arm — with built in calibrated gram scale accurate to 0.1 grams. Dial exact stylus force required.
- C. Lowest Rumble — No Wow and Flutter — Rumble better than -64 DB; Wow and flutter less than .05%.
- D. Maximum Compliance — Playback arm pivots use vertical and lateral ball-bearing suspensions.
- E. No Acoustic Feedback — Rigidized arm structure eliminates resonance — no turntable isolation required.
- F. Rugged — virtually impossible to damage the retractable stylus mechanism or turntable system.
- G. Sensational Dyna-Lift — Automatically lifts the arm from the record at the end of the music.
- H. Simplicity — only 2 moving parts; flexible belt couples turntable directly to heavy-duty, constant speed hysteresis motor — no intermediate idlers.
- I. Tracks at Less than 1 Gram — with no measurable distortion.
- J. Truly Compatible Mono-Stereo Cartridge — frequency response 15-30,000 cycles per second; channel separation better than 25 DB.

OFFICIAL RULES

1. On an official entry form, or plain stationery, list all the outstanding features (code letters) of the New Empire Troubador in their order of importance. Only one entry per person. Be sure to include your address.
2. Judges will be determined by Empire Scientific Corp. The entry form listing the outstanding features in their order of importance exactly as on the judges' list will be the winner. In the event of a tie, an opinion question on "record playback systems" will be sent to all contestants involved in the tie. The judges, as determined by Empire Scientific Corp., will judge the answers to the opinion question on the basis of originality and aptness of thought. The participant submitting the best answer in the opinion of the judges will be the winner. The decision of the judges will be final.
3. The prize must be accepted as scheduled in advertisements. Any tax or liability pertaining to the award will be the sole responsibility of the winner. No substitution of the prize will be allowed. Empire Scientific Corp. reserves the right at all times to change the festivals and cities named without notice.
4. Entry envelopes must be postmarked no later than midnight June 15, 1962. All entries become the property of Empire Scientific Corp., and none will be returned. Mail entries to Empire Scientific Corp., Box 615, Garden City, Long Island, N.Y.
5. The contest is open to all residents of the United States and Canada. The contest is prohibited to employees of the Empire Scientific Corp., its selling agents, affiliated companies, its advertising agency, and their families. This contest is subject to Federal, State, and local regulations.
6. Winner will be notified by mail no later than 15 days after final drawing.
7. Winner and guest of his choice will be flown by jet plane across the Atlantic. All connecting intercity transportation will be arranged by Empire Scientific Corp. All hotel accommodations, meals (2 per day), fares, sightseeing, admissions to festivals, and transportation from terminals to airports will be paid for by Empire. The above is only valid if prize is accepted as scheduled.

HINT: Your local dealer has entry blanks...and Empire Troubadors... ask him for a live demonstration — he'll be happy to oblige. Pay close attention to the "silent" Empire 208 3-speed turntable; Empire 980 dynamically balanced playback arm, featuring the sensational Dyna-Lift—Empire 108 first truly compatible mono-stereo cartridge; and handsome walnut base. Complete: \$200.

Official Empire 'Round-the-World Music Festival Entry Blank.

mail to: **empire** SCIENTIFIC CORP.
P.O. BOX 615, DEPT. AF
GARDEN CITY, L. I., N. Y.

MATCH THE JUDGES' LIST

1 _____	1. Fill in name and address
2 _____	2. List the features (by code letter only) in their correct respective order.
3 _____	
4 _____	
5 _____	NAME _____ (please print)
6 _____	ADDRESS _____
7 _____	CITY _____ ZONE _____ STATE _____
8 _____	DEALER'S NAME _____
9 _____	
10 _____	Note: All contest entries subject to Official Rules

emitter. For T_1 the base-emitter drop is only about 0.2 volts so that the base of T_1 is held at about $1.5 + 0.5 + 0.2 = 2.2$ volts. For this we use the voltage divider R_1, R_2 . The thermal stability of the system will be good if the base source impedance, which is R_1 and R_2 in parallel, is not too large compared with the product of the two current gains and R_3 . (R_3 is the base-emitter resistance of Tr_2 shown in Fig. 2.) We can easily have a total current gain of 2000 times, so that if R_3 is 0.75 ohms we are dealing with impedances of around 1500 ohms. As a lazy mathematician I shall make $R_1 = 2200$ ohms so that R_2 is around 10,000 ohms. This lifts the base of Tr_1 about 10 per cent above where it should be and will do the same to the current in Tr_2 : in practice it is convenient to use a small potentiometer for trimming purposes.

Now we only need about one volt of

thus reduces the effective transconductance, but with practical values this effect is too small to worry about.

We need to consider one more general aspect of the design. If Tr_1 is driven hard it will be cut off and this will leave the base of Tr_2 open-circuited. Under these conditions R_1 loses all its stabilizing effect since the voltage drop across it has no reference to the base conditions. An additional resistor must therefore be connected from the base of Tr_2 , back either to ground or to the emitter. This resistor not only prevents the risk of thermal runaway in Tr_2 but it also provides a stabilizing effect for Tr_1 against changes which may take place in the V_{bc} of Tr_2 . You will appreciate that if Tr_2 was in the cut-off state and passing only I_{co}' , the emitter of Tr_1 would be in a pretty uncertain condition: with the additional resistor there is somewhere for the emitter of Tr_1 to continue to drive

dio," Vol AU-7, No. 5, Sep-Oct 1959; pp. 125-128. It is a 2-watt amplifier using Motorola transistors and it gives only 1 per cent distortion at the 2-watt level. The current in the second transistor at 25 deg. C is around 550 ma, which is higher than we might have expected, but almost 2 watts is obtained at -25 deg C, when the current is down below 400 ma. This paper gives a very detailed study of the effects of I_{co}' on the performance of the amplifier and shows how important the base-emitter resistance in the second stage can be. The input impedance is almost entirely the impedance of the base-bias voltage divider, since with the high-gain transistors used by Mr. Roehr the rest of the circuit probably contributes only around 10-15,000 ohms in parallel with the net 1000 ohms.

The input level needed is around 1.2 volts, or, say 1.5 mw, giving a gain of just over 30 db. Much more gain is really available if you want it because an input transformer can be used with its secondary in series with the base of the first transistor. This transformer will provide a step up to match the 15,000 ohm input impedance and thus gives an extra 12 db of gain. In the circuit shown in Fig. 3 this extra gain has been obtained just so that it can be used up in negative feedback from the output collector. By this means the amplifier has an impedance of about 1/5 of the load impedance. For normal loudspeaker work this low source impedance is regarded as providing good damping but the particular application here was a three-wire multistation call intercom with private loud-to-loud working from any slave to the master. With a low source impedance there is no change of level when the system is switched over from the general call on four slaves to private speech on the wanted one.

There would seem to be a lower limit to the use of this amplifier circuit with germanium transistors. The base current of the second transistor is the emitter current of the first. It does not seem practicable to get this down below some hundreds of μ a because of the leakage current. Thus we must expect that the second transistor will need to work up in the tens of ma region, which can be regarded roughly as implying hundreds of mw. To get round this difficulty it is necessary to go to a silicon transistor for the first stage and it is pleasant to notice that at present prices the saving in other components will almost make this a paying proposition. Indeed for manufacturers who must count the cost of every soldered joint, and it costs much more to get a resistor into a circuit than the price of the resistor, this circuit will probably pay off.

The reader will have noted that as we

(Continued on page 65)



drive for Tr_2 itself, plus the 1.5 volts we have across R_3 . We shall therefore examine what we can do to make life easier for Tr_1 . If we take its collector back to the negative line we have around 10 volts available but at the same time we have a dissipation in the quiescent state of 500 mw. All we really want is perhaps 2 volts at 45 ma, or 135 mw. For a small transistor this is the difference between life and death. Anyway Tr_1 must be kept cool, because changes in I_{co}' at Tr_1 are changes in the base drive to Tr_2 and are amplified again. The collector of T_1 is therefore fed from a fairly low impedance voltage divider R_1, R_2 which brings the collector to around 5-6 volts above ground. The parallel combination of R_1 and R_2 as a source impedance is added to the collector impedance of Tr_1 and

current into. On this reasoning it becomes tempting to connect the extra resistor from base to emitter so that although the feedback from R_1 reduces its effective loading when Tr_2 is amplifying, the total emitter load of Tr_1 is low when Tr_2 is cut off.

Having thus described the circuit as it is developed we can now turn to some particular versions of it. Although these are actual amplifier designs the important feature to notice is that they all have the same configuration, with the same voltages at the first base and the second emitter. I do not recommend any particular one of them. For your job there is yet another version which you can design to suit your needs.

The circuit shown in Fig. 2 is that given by Roehr in "IRE Trans. on Au-

AR^{INC.} *loudspeakers*

USED PROFESSIONALLY as monitors for recording sessions, in broadcast stations and laboratories, with medical test equipment for precise reproduction of heartbeats—applications where only an accurate facsimile of the original sound, without pseudo-hi-fi exaggeration, will serve.



New Orleans recording session with Jim Robinson, Ernie Cognolotti, and Louis Cottrell. Note the AR-3 (one of a stereo pair) being used to monitor playback. Courtesy Riverside Records and HI-FI/STEREO REVIEW

RATED #1 FOR HOME USE by half a dozen equipment reviewers. Three consumer magazines have reported on AR loudspeakers; two of them adopted AR speakers as reference standards, and the third gave AR its rarely used top rating.

Priced from \$89 (for an unfinished AR-2) to \$225 (for an AR-3 in oiled walnut, cherry, or teak). A 5-year guarantee on all models covers materials, labor, and reimbursement of any freight to and from the factory. Catalog is available on request.

AR speakers are on permanent demonstration at AR Music Rooms—on the west balcony of Grand Central Terminal in New York City and at 52 Brattle Street in Cambridge, Massachusetts. No sales are made or initiated at these showrooms.

ACOUSTIC RESEARCH, INC., 24 Thorndike Street, Cambridge 41, Massachusetts

Reduction of Feedthrough in Audio Switching

R. D. HERLOCKER*

Feedthrough of signal through a supposedly open circuit can be reduced by splitting the load

FEEEDTHROUGH may be defined, at least for the purpose of this article, as the undesired passage of a signal or other alternating emf through a supposedly open circuit. It has long been a problem in the switching of audio signals. In communications work, it can cause cross-talk between the various lines being switched. In those electronic organs where keying is done in the signal line, it can be responsible for an extremely annoying high pitched whine, which is most evident when no keys are depressed.

Feedthrough is a function of three factors: The generator resistance, the load resistance, and the capacitance of the switching mechanism. *Figure 1* shows a simple switched circuit where E_g is open-circuit generator voltage, R_g is the generator resistance (including any isolating or other resistors between the generator and the switch), R_L is the load resistance, and C_s is the capacitance of the switch. The output emf with the switch closed is

$$E_L = E_g \left(\frac{R_L}{R_g + R_L} \right) \quad \text{Eq. (1)}$$

When the switch is opened, the output emf becomes

$$E_L = E_g \left(\frac{R_L}{R_g + R_L - jX_c} \right) \quad \text{Eq. (2)}$$

where $X = 1/\omega C_s$, the reactance of the switch capacitance. For calculation purposes, this reactance should be taken at the highest frequency to be passed by the switch. If the reactance at this frequency is more than about eight times

* 8528 Schreiber Drive, Munster, Indiana.

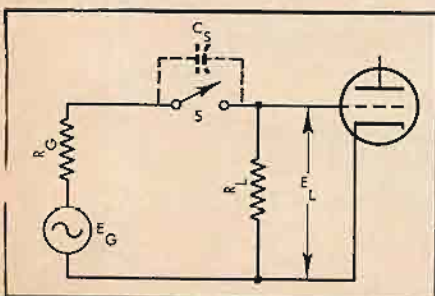

Fig. 1. Simple switched circuit.

the value of $R_g + R_L$, Eq. 2 may be simplified with negligible error (less than one per cent) to

$$E_L = \frac{E_g \cdot R_L}{X_c} \quad \text{Eq. (2a)}$$

Then, the feedthrough, expressed as a fraction of the signal output with the switch closed, becomes

$$F = \frac{R_g + R_L}{X_c} \quad \text{Eq. (3)}$$

which is Eq. (2a) divided by Eq. (1).

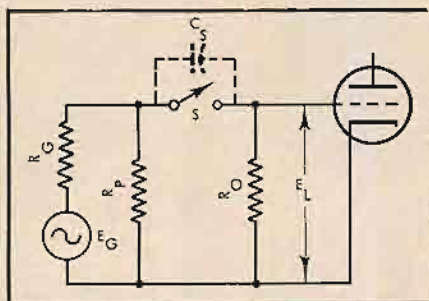

Fig. 2. Split load reduces feedthrough.

This fraction will usually be very small, but because of the nearly logarithmic characteristic of hearing, this minute amount of signal fed through the capacitance of the open switch may be audible, and be quite distracting.

Several expedients have been used to lessen or eliminate feedthrough, such as the special "anti-capacity" switches developed for telephone and similar services, and the "Crossed-wire" switching contacts used in several electronic organs. However, these switches are expensive, and the crossed-wire designs require precision shop work far beyond the scope of most non-professional shops to insure positive switching, combined with easy keying. Other organ designers have bypassed this particular problem completely by keying their oscillator plate supply circuits instead of the signal circuits. Of course, this introduces other problems, affecting the whole philosophy of organ design, but these are beyond the scope of this article.

A limited degree of improvement can be had by making the load impedance as

low as possible, consistent with adequate signal output when the switch is closed. The limiting factor here is apt to be the generator impedance. As may be seen from Eq. (3), the theoretical maximum improvement in feedthrough-to-signal ratio would only be 6 db if the load resistor were reduced from the value of the generator impedance all the way to zero. Doing this, however, would lose the signal too.

There is another method of decreasing the feedthrough-to-signal ratio, which can give improvements of 20 db or even more over the simple circuit of *Fig. 1*. Unfortunately, it is not universally applicable, because for every 2 db reduction in feedthrough, about 1 db of signal is lost. Where sufficient signal strength is available, or where the loss can be made up readily by an extra stage of amplification, a great improvement in the feedthrough-to-signal ratio can be obtained.

Briefly, this expedient consists of splitting the load resistance, as seen by the generator, into two equal or nearly equal sections. They are in parallel when the switch is closed and form the shunt arms of a two step attenuator when the switch is open, as shown in *Fig. 2*.

The improvement in the feedthrough ratio obtained by this arrangement is a function of the load seen by the generator and of the ratio of the two resistances, R_p and R_o , which make up R_L , as well as the reactance of the switch capacitance. When the switch is closed, the output is the same as Eq. (1) with the exception that R_L is now the parallel resistance of R_p and R_o . When the switch is opened, the output (or feedthrough) becomes

$$E_L' = E_g \left(\frac{R_p R_o}{R_g (R_p + R_o - jX_c) + R_p (R_o - jX_c)} \right) \quad \text{Eq. (4)}$$

If X_c is at least ten times the value of R_g , this equation can also be simplified with negligible error to

$$E_L' = E_g \left(\frac{R_p R_o}{X_c (R_p + R_o)} \right) \quad \text{Eq. (4a)}$$

THIS IS THE MANUAL CONTROL SYSTEM USED IN PILOT'S MULTIPLEX CIRCUIT

No, we haven't forgotten anything. We designed it that way. There are no "user-operated" controls. This is only one of the many features that makes PILOT's unique signal sampling Multiplex circuit—used in all PILOT Multiplexers, Stereo Receivers and Stereo Tuners—simpler, more effective and more trouble-free than any circuit presently being manufactured for stereo demodulation.

TO BE SPECIFIC:

1. **The circuit is simplicity itself**—there are no controls to manipulate, no special adjustments to make. You can connect PILOT's fully automatic 200 Multiplexer to the FM tuner of your stereo system in less than a minute without any tools, and you never have to touch the Multiplexer again. (The PILOT 100 Multiplexer can be connected just as easily, and in most cases it, too, need never be touched again.) And, in PILOT's Stereo Tuners and Receivers, where the Multiplex circuit is built into the unit, no extra controls of any kind are needed for Multiplex Stereo reception.

2. **Maximum separation (30 db or better)** is provided by PILOT's Multiplex circuit. The left (L) and right (R) channel signals are extracted directly from the incoming composite signal by means of unique signal sampling and "memory" circuits. Sampling of the composite signal (a combination of

L + R and L - R signals) takes place at a rate of 38,000 times a second, and the "memory" circuits maintain a constant output signal level between sampling instants.

Other stereo demodulating methods, such as frequency separation and time division, require filtering and matrixing and cannot maintain perfect channel separation across the entire audio spectrum.

3. **No frequency separation filters or matrices are used.** For this reason PILOT's Multiplex circuitry gives you perfect separation across the entire audio spectrum.

4. **An ultra-stable synchronized oscillator** assures locking and accurate phasing and maintains high-level performance despite varying input signal levels.

5. **Virtually any high-fidelity FM tuner can be used with PILOT Multiplexers for stereo reception.**

6. **Equipped with the only fully-automatic stereo indicator.** The FM Stereo indicator on PILOT's 200 Multiplexer and 654M Stereo Receiver will light and stay lit if the station you're tuned to is broadcasting in stereo.

If you'd like us to be even more specific, we'll be glad to send you a reprint of a December, 1961, AUDIO article which discusses these features in detail.

MULTIPLEXERS (PILOT 100, \$49.50...PILOT 200, \$79.50) STEREO RECEIVERS (PILOT 654M, 60 watts, FM / MPX, \$329.50 ...PILOT 602S, 30 watts, AM / FM / MPX, \$299.50...PILOT 602M, 30 watts, FM / MPX, \$249.50) and STEREO TUNERS (PILOT 280, \$99.95...PILOT 380, \$179.50). For further information, see your PILOT dealer or write:



PILOT RADIO CORPORATION, 37-38 36TH STREET, LONG ISLAND CITY 1, NEW YORK

and the feedthrough, expressed as a fraction of the signal output (Eq. (4a) divided by Eq. (1)) is

$$F' = \frac{R_p R_o (R_L + R_g)}{R_L X_c (R_p + R_g)} \quad \text{Eq. (5)}$$

For any given values of R_p , R_L , and X_c there will be an optimum ratio of R_p to R_o , which may be found by expressing R_o and R_p in terms of their ratio (K) and R_L : $R_p = R_L(K+1)$ and $R_o = R_L(K+1)/K$. Then the feedthrough becomes

$$F' = \frac{R_L(K+1)^2(R_L+R_g)}{X_c K(R_L+R_g+KR_L)} \quad \text{Eq. (6)}$$

Differentiating with respect to K , and equating to zero, gives

$$K(\text{optimum}) = \frac{R_g + R_L}{R_g - R_L} \quad \text{Eq. (7)}$$

It has been found that the feedthrough ratio (F) varies so slowly as K is varied in the neighborhood of the optimum value that K can range from 1.0 to 1.5 for any value of R_L lower than $0.2 R_g$ with no significant change in the feedthrough ratio. Therefore, the remainder of this discussion is based on $K=1.0$, or $R_p = R_o = 2R_L$.

The improvement in feedthrough suppression obtained by splitting the load may be readily illustrated by taking the ratio of the feedthrough with the single load (Eq. 3) to that with the split load (Eq. 6):

$$\text{Improvement ratio} = \frac{R_g + 2R_L}{4R_L} \quad \text{Eq. (8)}$$

Equation (8) shows that the equivalent load must be much smaller than the generator resistance to obtain any significant improvement over the simple load arrangement, as shown in Fig. 1. In fact, when K (Eq. 6) is set at 1.0, there is more feedthrough with the split load than with the simple one, if R_L is greater than $0.5 R_g$. However, as the equivalent R_L is decreased with respect to R_g , the relative improvement in feedthrough is increased, almost in direct proportion.

Figure 3 shows graphically the effects of the various factors involved. The load resistance, whether single or split, and the switch reactance are both shown in

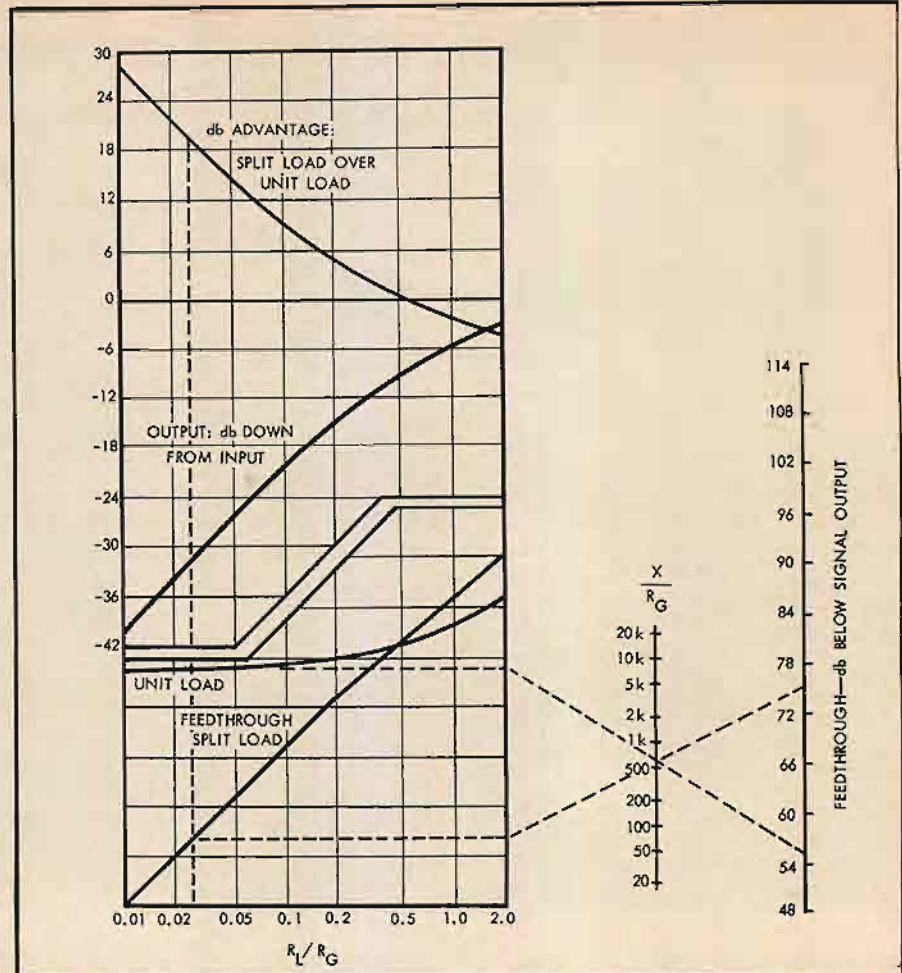

terms of their ratio to the generator resistance, and feedthrough is expressed as db below the signal output.

As an example of the use of this circuit, an electronic organ keying circuit is fed a one volt signal from generators with 10,000 ohm equivalent resistance (which includes isolating resistors). Keying is done by leaf switches which have a capacitance of 6.3 pf. The highest frequency to be passed is 4200 cps, giving a reactance at this frequency of 6 megohms. The load resistance is not critical, and may be varied over a wide range.

If the load resistance is now set at 265 ohms ($0.0265 R_g$), the closed circuit output is 0.0256 volts, or 31.8 db under the one volt input. This, and the following values, can be calculated from the preceding equations, or may be read off

approximately on Fig. 3. For a unit load (as in Fig. 1), the feedthrough voltage is 0.0000438 (87.1 db below one volt), or 55.3 db below the closed circuit output. Splitting the load into two 530 ohm resistors (R_p and R_o in Fig. 2) does not alter the closed circuit output, but cuts the feedthrough voltage to 0.00000459 (107.8 db below one volt), which is 76.0 db below the signal output. Thus, splitting the load has resulted in a 20.7 db improvement in the signal-to-feedthrough ratio, with a 31.8 db loss in the signal. A greater improvement in the feedthrough ratio could have been obtained, but at the cost of a lower signal output. Conversely, as may be seen from Fig. 3, if more signal output is needed, a portion of the advantage of the split load arrangement must be sacrificed. AE

THIS MONTH'S COVER

The system shown on the cover this month provides music in the home of Capt. William B. Rippert of the Ordnance Corps. Although Capt. Rippert resides now at the Aberdeen Proving Ground in Maryland, the natural walnut finish bookcase and enclosures for his equipment were made in Bavaria. The basic system includes the following:

1. AR-1 speaker systems.
2. Dynakit Mark III amplifiers.

3. Special preamp based on Dyna PAM-1's.

4. Sherwood S3000II FM tuner.
5. Thorens TD-124 turntable.
6. ESL 1000 pickup arm with Shure M3D cartridge.
7. Viking 85Q tape deck.
8. Channelmaster antenna rotator with Taco 610 ten-element yagi.

He also has a Telefunken Professional tape recorder, Model M24, with Telefunken and AKG mikes. For monitoring recordings he uses Brush and Permoflux

headphones as shown at the right.



COMPARE STEREO MULTIPLEX SYSTEMS

FEATURE-FOR-FEATURE * DOLLAR-FOR-DOLLAR
NEW ALTEC STEREO DUET IS YOUR BEST BUY!

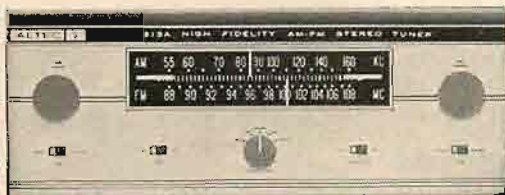

New Altec 313A AM/FM Stereo Tuner

- BUILT-IN MULTIPLEX
- DISTRIBUTED "T" MX-CARRIER (38 KC) FILTER
- FM STEREO, AM/FM STEREO, AM OR FM MONO
- INDIVIDUAL AM AND FM "ELECTRON-RAY" TUNING INDICATORS
- INERTIA-TYPE FLYWHEELS FOR SMOOTH TUNING
- AM LOCAL/DISTANT RECEPTION CONTROL
- FM LOCAL/DISTANT RECEPTION CONTROL
- FM SQUELCH CONTROL FOR SILENT TUNING
- AUTOMATIC FREQUENCY CONTROL FOR POSITIVE STATION-LOCK
- SOFTLY ILLUMINATED TUNING SCALE
- MEETS SCA SUPPRESSION REQUIREMENTS
- MEETS FCC RADIATION REQUIREMENTS
- \$291.00 INCLUDING CABINET



Altec 353A Stereo Amplifier/Preamplifier

- MATRICING NETWORK FOR CENTER STEREO SPEAKER
- CONNECTIONS FOR AUXILIARY SPEAKERS THROUGHOUT HOUSE
- RECORDER OUTPUT FOR PROFESSIONAL-QUALITY RECORDING
- STEREO OR MONO INPUTS FOR AM, FM, MX, TAPE MACHINE, TAPE DECK, TV, MAGNETIC OR CERAMIC PHONO, TWO MICROPHONES
- FULL-SWEEP STEREO BALANCE CONTROL
- STEREO STANDARD/REVERSE CHANNEL SWITCH
- COMPENSATING LOW LEVEL LOUDNESS CONTROL
- STEREO BASS AND TREBLE CONTROLS
- ON/OFF RUMBLE FILTER
- 100 WATTS STEREO PROGRAM PEAK POWER; 50 WATTS RMS CONTINUOUS, STEREO OR MONO
- \$225.00 INCLUDING CABINET

Enjoy balanced stereo with look-alike duet from Altec! The pair is a harmonious stereo system with precise balance of engineering and styling. Price includes self-ventilating matching cabinets in your choice of platinum gold or platinum pink control panels. Compare now at your professional Altec high fidelity consultant's, or write Dept. A-2.

© 1961 Altec Lansing Corp.



ALTEC LANSING CORPORATION

A Subsidiary of Ling-Temco-Vought, Inc.

1515 SOUTH MANCHESTER AVENUE, ANAHEIM, CALIFORNIA
NEW YORK • LOS ANGELES

The Tape Guide

HERMAN BURSTEIN*

More Low-Frequency Sounds

The preceding issue carried a letter from a correspondent who complained of a strange, erratic, low-frequency sound that occurs when recording. From the symptoms described, including the fact that the noise continued when the oscillator in his machine was used in conjunction with another tape recorder, it seemed that the fault lay in the oscillator. However, this correspondent has revised the description of the symptoms, as follows:

Q. After further observation, I must change my description of the symptoms. First of all, the frequency and pitch of the sound does change with a change in tape speed. The lower speed causes a lower pitch and fewer bursts of noise. There seems to be less amplitude to the noise, but this may be due to the decrease in pitch. The noise is very erratic. There might be many bursts of noise in a given time period, then a good deal less for an equal period. A similar noise can be deliberately generated by touching the pressure pads or pushing them away from the heads. Another change I must note is that more noise occurs when only the record head is connected than when only the erase head is connected. Under the revised circumstances, I am inclined to feel that this noise is in the transport and not in the recording amplifier. This noise is not extremely loud; in fact, it is barely audible while music is being played. It is about as annoying as the residual hum found in some inexpensive power amplifiers. If this noise is due to friction between heads and tape, is there anything that can be done? Would a conversion from quarter-track to half-track raise the signal-to-noise ratio enough to help, or am I just too much of a perfectionist?

A. The revised description of your troubles indicates that friction between the tape and the heads may be responsible. I doubt that changing from quarter-track to half-track heads would elevate the signal-to-noise ratio sufficiently (although it would increase the ratio of audio signal to tape amplifier noise) because the head would pick up not only more audio signal but also more friction noise. I suggest that you try lubricating the heads, the pressure pads, and the tape guides with a commercial preparation such as Long Life lubricant manufactured by EMC Recordings Corp. of St. Paul, Minn., or RC-2-22 lubricant manufactured by Robins Industries Corp. of College Point, N. Y. Do not use lubricant on the capstan and pressure roller, or else you will have tape slippage and wow.

There is some possibility that the noise may be inherent in the tape itself, due to

irregularities in the thickness of the base and/or the magnetic coating. Such variations are translated into noise during the process of recording. Have you tried various brands of tape?

As for your being too much of a perfectionist, **CERTAINLY NOT!** It is only because of perfectionists such as yourself that high fidelity reproduction continues to improve.

Extension Speaker

*Q. I have a *** tape recorder with its own speaker, and would like to hook up an extension speaker. If this doesn't require technical skill, please advise me how to go about it.*

A. You can readily do this without any more technological skill than is needed to handle a soldering iron. Find the two leads going to the speaker in the tape recorder, break one of them, and then make the switching arrangement shown in Fig. 1. Use a make-before-break switch so there will always be a load on the output transformer.

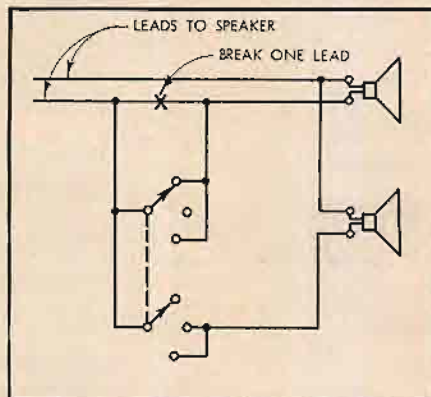

Fig. 1. Hookup for extension speaker

The switch can be purchased at most audio dealers and electronic supply houses. Quite likely you can find a place to mount the switch somewhere on the tape recorder deck or case. Otherwise you will have to mount it externally.

Looking at the diagram, note that one of the two leads goes to both speakers. The other lead is switched to speaker A, or speaker B, or both.

Number of Motors vs. Performance

Q. Can I get as good performance from a tape machine with one motor as from one with three motors?

A. So far as I know, the top quality home machines with one motor have about as good wow and flutter specifications as those with three motors. It is not uncommon these days to come across single-motor home machines with wow and flutter of

0.1 per cent or less. However, a three-motor machine is essentially a sturdier and at the same time a simpler affair. For professional use, where the transport is working many hours a day and most days in the week, and where it is working hard for editing purposes (being called upon to shuttle the tape back and forth innumerable times with many quick starts and stops), the additional ruggedness and greater mechanical simplicity of a three-motor unit is advantageous. In home use, it is open to question whether the advantages of a three-motor transport are of substantial importance. A one-motor machine can be more compact, which is often important in the home, but seldom so in professional studios. It may be added that one of the frequent advantages of the three-motor unit is its ability to wind and re-wind tape much faster than a one-motor unit, something like two to three times as fast. This is important in professional use, where time is money.

Does 1/4-Track = 4-Track?

Q. What is the difference, if any, between quarter-track and four-track tape?

A. These terms are used interchangeably with respect to home machines, but they do not really mean the same thing. A two-channel stereo tape that has two tracks recorded in one direction and two-tracks in the opposite direction is properly called a quarter-track stereo tape. Many home machines also permit one to record monophonically on each of the four tracks; here we have a quarter-track mono tape. The point is that each track occupies about one-quarter of the tape width (after allowing space for separation between tracks). The term four-track stereo tape, although often used in the same sense as quarter-track stereo tape, properly designates a tape where four channels are being simultaneously recorded, as is sometimes done in professional studios. A two-track tape means that two channels are being simultaneously recorded; this can be either of the quarter-track variety already described, or it can be of the half-track variety, where about half the tape width is used for each channel.

Connecting to External System

Q. I am planning to buy a fairly inexpensive tape recorder, one with its own case and speaker. However, I may want at times to connect it to my audio system to get better sound in playback. Will this involve special problems or require changes in the tape recorder?

A. Most tape recorders made for home use have an output jack which supplies a signal that can be fed into an external audio system. It is simply necessary to connect a cable, equipped with the proper plugs, between this jack and one of the high-level input jacks of your audio pre-amplifier or integrated amplifier. A suitable cable can be purchased at most audio dealers. When you plug this cable into your tape machine, it will usually cut out the signal to the speaker in the tape recorder. However, in some tape machines this doesn't happen. Then, perhaps, you can cut off the machine's speaker, but not the output signal, by turning down the machine's volume control. However, if turning down the control also reduces the signal going to the external audio system, you can have an audio technician install an output jack in the tape machine so that it cuts out the internal speaker when a plug is inserted. This is a simple and usually inexpensive modification. AE

* 280 Twin Lane E., Wantagh, N. Y.

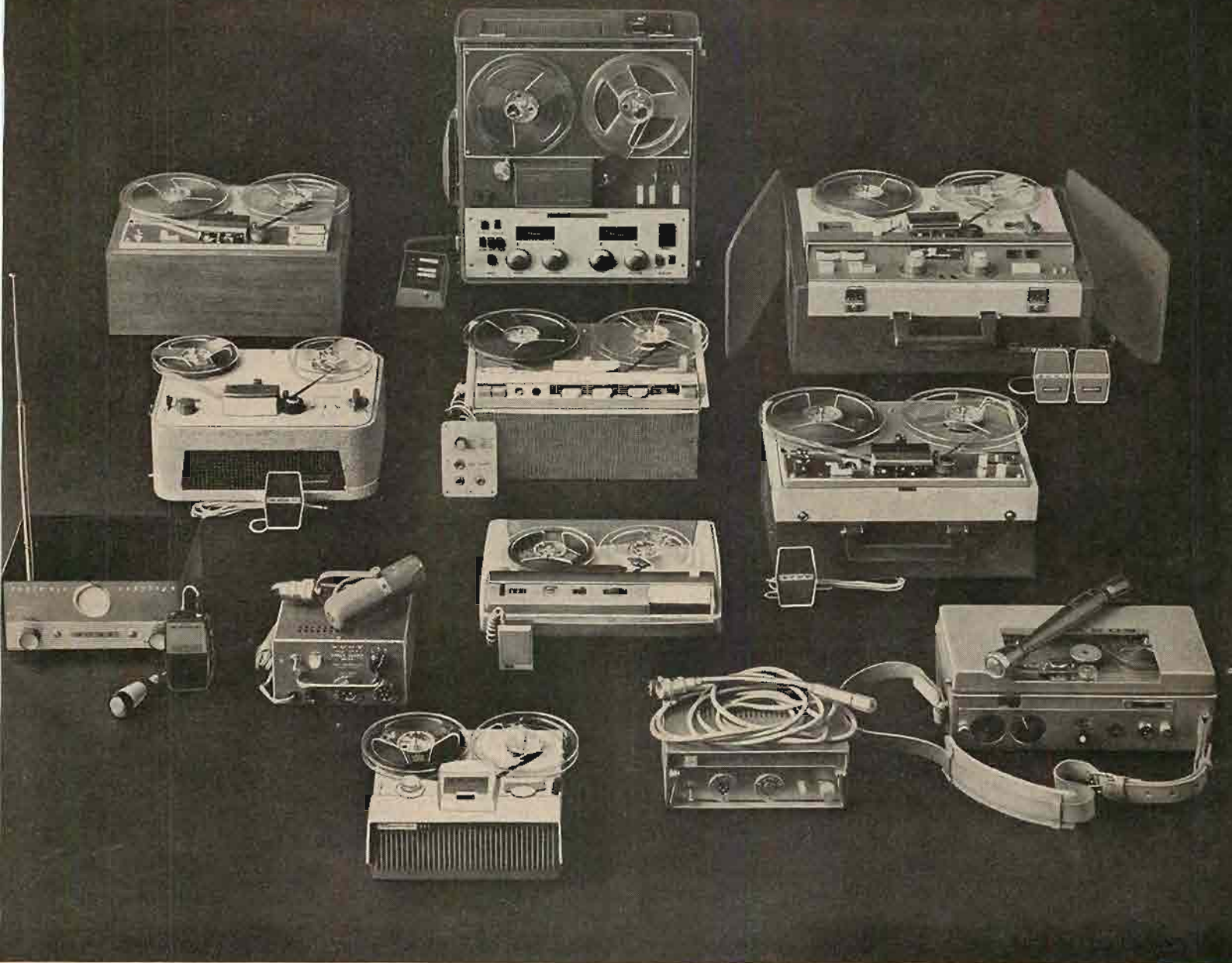

This is Sony.

THE MOST COMPLETE LINE OF QUALITY TAPE RECORDING EQUIPMENT IN THE WORLD

■ **SONY Sterecorder 300**—A complete professional-quality hi fi stereo tape system with 4 & 2 track recording and playback in one portable unit. \$399.50. ■ **SONY Sterecorder 777-S**—All transistorized professional 4 & 2 track stereo recorder featuring the revolutionary Sony Electro Bi Lateral Heads. The world's finest tape recorder. \$725. ■ **SONY Sound on Sound Recorder 262 SL**—The perfect recorder for language, music and drama students. 4 track with stereo playback. \$199.50. ■ **SONY Stereo Tape Deck 262 D**—4 & 2 track stereo recording and playback tape transport to add tape to your existing hi fi system. \$89.50. (Also available, not pictured, the new SRA-2 stereo recording amplifier for the 262 D. \$89.50.) ■ **SONY Tape recorder 111**—A popularly priced, high quality bantam recorder for everyday family fun. \$79.50. ■ **SONY Portable 101**—2 speed, dual-track, hi-fidelity recorder with 7" reel capacity.

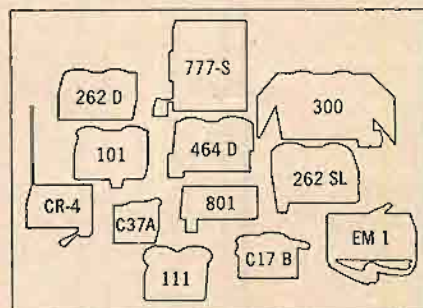

\$99.50. ■ **SONY Sterecorder 464 D**—Dual performance 4 track stereo tape deck with built-in recording & playback pre-amps for custom installations and portable use. \$199.50. ■ **SONY Executive Portable 801**—Handsomely-styled battery operated precision recorder for executive desk or portable use. \$295. ■ **SONY Newscaster Portable EM1**—A professional on-the-spot battery powered portable recorder with precision spring wind constant speed motor. \$495. ■ **SONY Condenser Microphone C37 A**—For purity of sound reproduction, the unqualified choice of professional studios throughout the world. \$295. ■ **SONY Condenser Microphone C17 B**—Miniature size ($3\frac{3}{4}$ " x $\frac{5}{8}$ " diameter) and exceptional background isolation unidirectional cardioid pattern. \$350. ■ **SONY Wireless Microphone CR-4**—Pocket size mike and transmitter providing complete freedom from entangling microphone cables. \$250.

For additional literature and name of nearest franchised dealer write Superscope, Inc., Dept. 7 Sun Valley, California

The Tapeway to Stereo

SUPERSCOPE

All Sony Sterecorders are Multiplex ready!

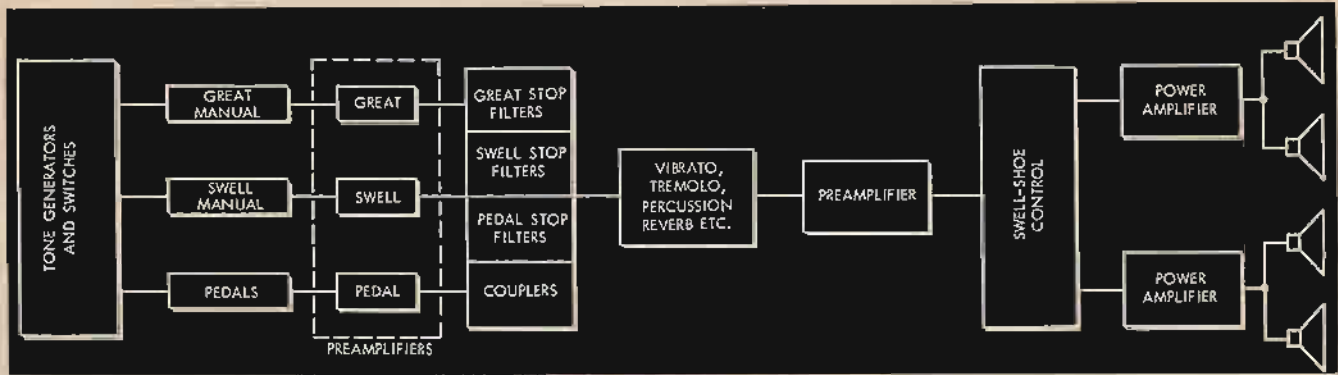

Fig. 1. Block diagram for electronic organs.

Electronic Organ Tone Generators

D. WOLKOV*

Electronic organs produce musical tones by means of electro-mechanical or electronic oscillators, with the electronic type being used in the majority of existing organs.

In Two Parts—Part I

WHAT IS A MUSICAL INSTRUMENT? Is an electronic organ a musical instrument? There are purists who insist that there is only one organ which is a musical instrument—the air organ. Certainly, the electronic organ family which starts with \$39 toys and ends at \$50,000 systems has many members which are not musical instruments.

A musical instrument must be capable of producing all of the responses needed by the musician—legato, staccato, percussive attacks, changes in tone, subtle nuances. In addition, in an organ, the musician demands the capabil-

ity of changing the voice of his instrument, much more than muting a violin or a trumpet. Complete discussions on the psychology of music are contained in references 1, 2, and 3.

Before proceeding to an understanding of the mechanisms and techniques used in the production of electronic musical tones, we need to recall that musical sounds are usually complex waves (was this not the reason for the advent of the high-fidelity art?) as opposed to the sine-wave simplicity of a code oscillator. Incidentally, sine waves are monotonous, square waves contain odd harmonics, triangular (or sawtooth) waves contain all harmonics, and complex

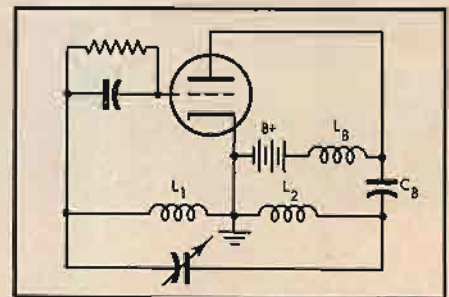

Fig. 2. Hartley oscillator.

waves contain a peculiar pattern of harmonics.

Every musical note has a definite fundamental pitch (frequency) and "tone quality" or "timbre" which depends upon wave shape. A musical note not only includes a fundamental frequency (usually less than 6000 cps in an organ) but also one or more "harmonics" or "overtones." These harmonics are an integral multiple of the fundamental frequency. The ear does not distinguish the harmonics independently, but instead identifies the note as a complex tone having the pitch of the lowest component or fundamental. The complete frequencies for nine octaves corresponding to open air pipes ranging from 1/8 foot to 32 feet is given in Table I.

Musical notes in our western culture

* 10 Sunbeam Rd., Syosset, N.Y.

OPEN PIPE LENGTH	32'	16'	8'	4'	2'	1'	1/2'	1/4'	1/8'
NOTE:									
C	16.35	32.70	65.4	130.81	261.62	523.25	1046.50	2093.00	4186.00
C [#]	17.32	34.64	69.29	138.59	277.18	554.36	1108.73	2217.46	4434.92
D	18.35	36.70	73.41	146.83	293.66	587.33	1174.65	2349.31	4698.63
D [#]	19.44	38.89	77.87	155.56	311.12	622.25	1244.50	2489.01	4978.03
E	20.60	41.20	82.40	164.81	329.62	659.25	1318.51	2637.02	5274.04
F	21.82	43.65	87.30	174.61	349.22	698.45	1396.91	2793.82	5587.65
F [#]	23.12	46.24	92.50	184.99	369.99	739.98	1479.97	2959.95	5919.91
G	24.50	49.00	98.00	195.99	391.99	783.99	1567.98	3135.96	6271.92
G [#]	25.95	51.91	103.82	207.65	415.30	830.60	1661.21	3322.43	6644.87
A	27.50	55.00	110.00	220.00	440.00	880.00	1760.00	3520.00	7040.00
A [#]	29.13	58.27	116.54	233.08	466.16	932.32	1864.65	3729.31	7458.62
B	30.86	61.73	123.47	246.94	493.88	987.76	1975.53	3951.06	7902.13
OCTAVE NUMBER	00	0	1	2	3	4	5	6	7

TABLE 1. Frequencies of 9 octaves in the equal tempered scale.

An 8-Fold Improvement In Stereo Controls



Here's the kind of variable resistor performance that pays off in greater circuit design freedom . . . in continued customer satisfaction. Thanks to their new high stability SURETRAK* elements, these new Stackpole single-shaft dual controls stay within initially close tolerances throughout years of use or disuse — and with minimum derating.

To learn more about this basic advance in variable resistors for stereo, ask your local Stackpole sales engineer about Type LST (bushing mount) or Type LST-T (twist-tab mount), or write: Electronic Components Div., Stackpole Carbon Co., St. Marys, Pa.

1. High Stability SURETRAK* Elements — the first inherently stable carbon composition elements. Less than 3% resistance change from 20°C to 105°C . . . less than 7% change under 95% RH for 240 hours at 40°C . . . negligible change with age and mechanical wear. Excellent load life at 70°C.

2. Controlled Characteristics assure that whatever resistance changes do occur will be of similar magnitude and direction in both front and rear SURETRAK elements.

3. Automatic Element Matching for maximum uniformity between front and rear elements.

4. Zero Backlash between shaft and both sections.

5. Precise Mechanical Assembly assures uniform electrical and mechanical performance.

6. Velvety Smooth "Feel" available if desired for professional quality stereo equipment.

7. Tailored Attenuation — Linear over all or only a portion of the attenuation curve as needed.

8. Precision to Fit Any Budget — Degree of tracking limited only by price considerations . . . as close as ½ db tracking now possible.

*Trademark

STACKPOLE VARIABLE composition RESISTORS

GOLDITE 70+® FIXED COMPOSITION RESISTORS • SLIDE AND SNAP SWITCHES • CERAMAG® FERRITE CORES • FIXED COMPOSITION CAPACITORS • CERAMAGNET® CERAMIC MAGNETS • BRUSHES FOR ALL ROTATING ELECTRICAL EQUIPMENT ELECTRICAL CONTACTS • GRAPHITE BEARINGS, SEAL RINGS, ANODES • HUNDREDS OF RELATED CARBON AND GRAPHITE PRODUCTS

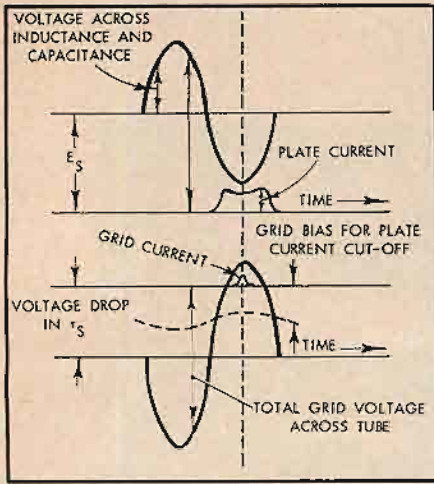

Fig. 3. Time-current-voltage relationships in a vacuum tube oscillator.

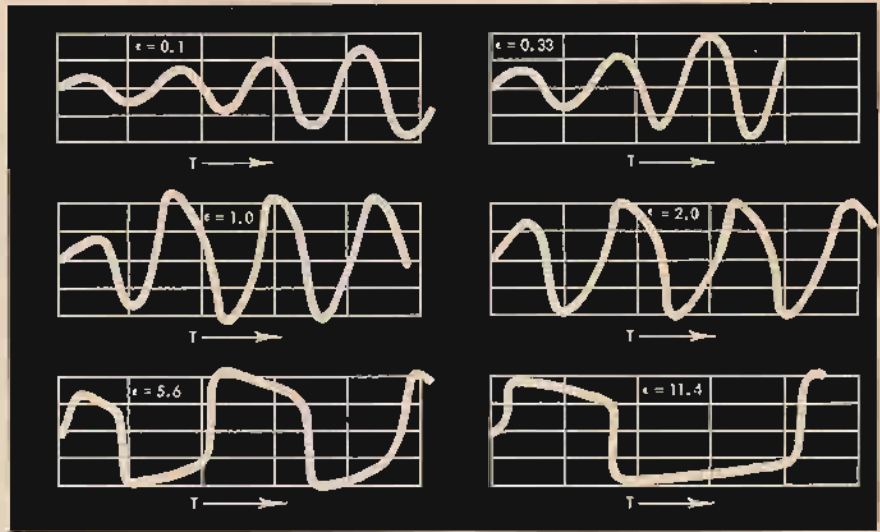

Fig. 4. Typical solutions to van der Pol's equation for different ϵ 's.

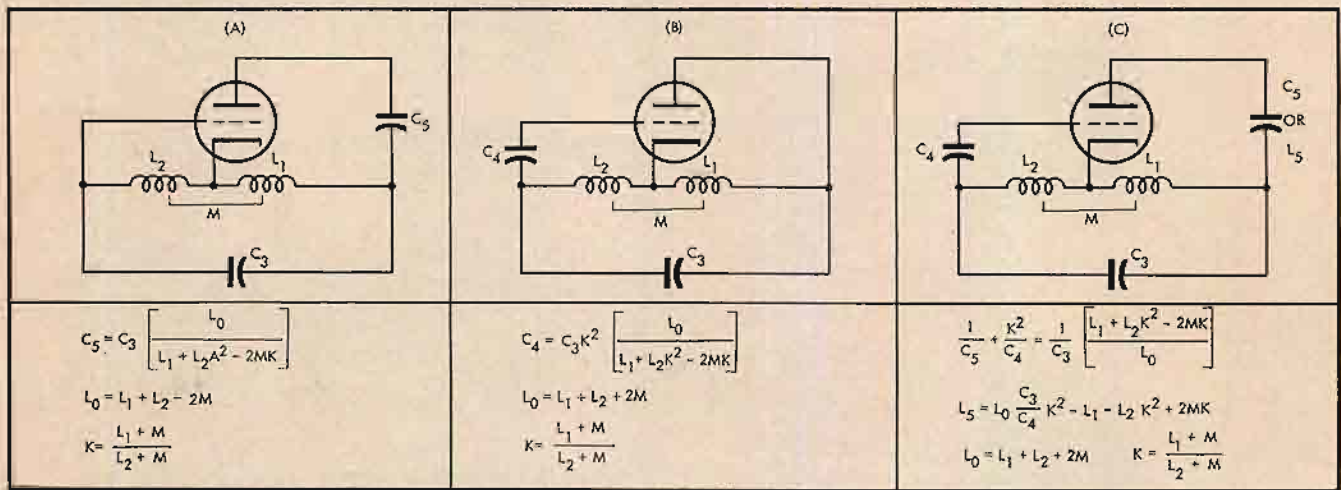

Fig. 5. Stabilization of Hartley oscillators: (A) plate stabilized; (B) grid stabilized; (C) plate and grid stabilized.

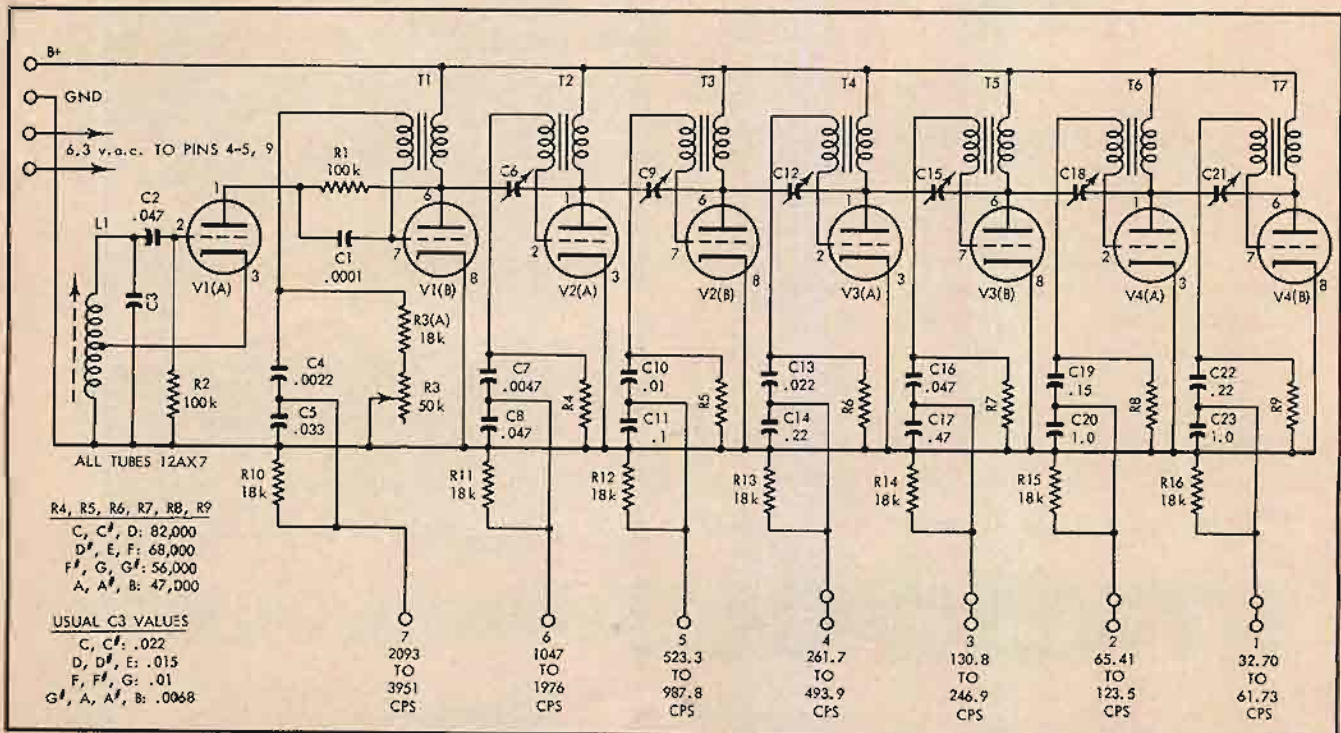

Fig. 6. Tone generator for Schober Concert Model.

Which cable has the **Beldfoil***?



Both shielded cables have the same number of twisted pairs with identical AWG. But . . . the cable with exclusive Belden BELDFOIL is smaller in diameter.

What does this mean to you? It means that when you specify BELDFOIL, you are really buying extra space—extra conduit space, extra raceway space, extra console and rack space.

A new development by Belden—BELDFOIL shielding is 100% effective. It is a major development in quiet cables. BELDFOIL eliminates crosstalk and is superior for stationary or limited flexing at both audio and radio frequencies.

BELDFOIL shielding is a lamination of aluminum foil with Mylar which provides a high dielectric strength insulation that is lighter in weight, requires less space, and is usually lower in cost. For multiple-paired cables, with each pair separately shielded, the Mylar is applied *outside* with an *inward* folded edge.** This gives 100% isolation between shields and adjacent pairs.

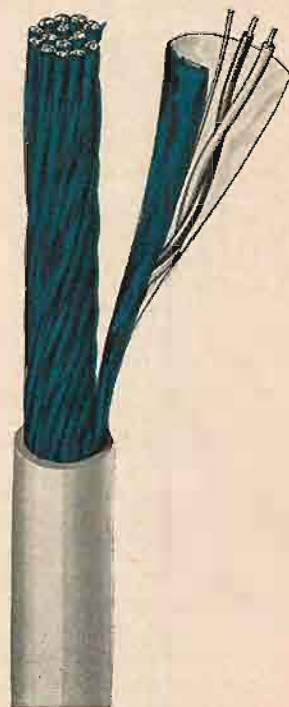
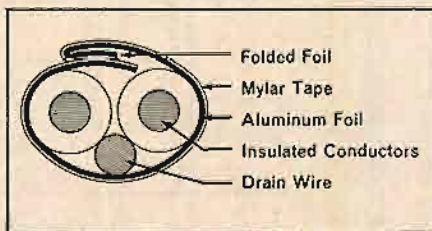

For complete specifications, ask your Belden electronics jobber.

*Belden Trademark
Reg. U. S. Pat. Off.
**Patent applied for



power supply cords • cord sets and portable cordage • electrical household cords • magnet wire • lead wire • automotive wire and cable • aircraft wires • welding cable

8-5-0

AUDIO • FEBRUARY, 1962

37

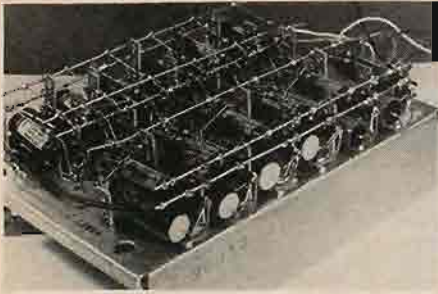

Fig. 7. Conn tone generator chassis.

occur at specific frequencies. The internationally agreed frequency for the note A above middle C is 440 cps. The next A up is 880 cps and the next A down is 220 cps. All of the intermediate twelve tones in an octave are approximately $12\sqrt{2}$ apart in frequency.

The $12\sqrt{2}$ relationship is a characteristic of the equally tempered scale used on all keyboard instruments. Such a scale involves a compromise. The musical fourth and fifth intervals are tuned to a frequency ratio slightly different from $12\sqrt{2}$. If a musical fifth interval were tuned to an exact frequency ratio such as 1.5 to 1, there would be no beat. However, the tempered scale ratio is 1.498 to 1. The second harmonic of one note and the third harmonic of the other are not exactly alike but are close enough to produce an audible beat since their frequency ratio is 2.996 to 3.

Figure 1 is a block diagram for an idealized electronic organ. In practice, some of the functions are performed in blocks different from those shown. In describing the designs of various organs, we will frequently be in more than one block at a time. We will discuss tone generators first and then proceed with tone modifying devices later. Recognize, of course, that in many fine organs no such artificial separations exist.

Musical instruments are *mechanical* oscillators. In contrast, the front end of an electronic organ is an *electronic* oscillator. Basically, there are two types of tone generators: the first type attempts to reproduce air organ sounds, and the second type simulates them electronically. The latter type we can break into two sub-groups. In the first sub-group, electronic oscillators generate complex patterns and tone modifying networks provide frequency modifications. In the second sub-group, musical sounds are produced by the electronic "addition" of appropriate sine waves, a process known as "synthesis."

Tone generators can also be classified in terms of their design. Three such groups are important:

1. Vacuum tube or transistor oscillators
2. Electro-mechanical oscillators
3. Neon tube (relaxation) oscillators.

Electronic Oscillators

Vacuum-tube (or transistorized) oscillators form the basis for tone generation for the largest number of organs. A vacuum tube is able to act as an oscillator because of its ability to amplify. The power required by the input of the tube is much less than the output of the tube. Thus, an amplifier can supply its own input. When this is done under certain conditions, oscillations will occur.

In general, voltage feedback from the output is applied to the grid 180 deg. out of phase and of sufficient magnitude to produce continuous oscillation.

In the Hartley oscillator (which is the one most prevalent in electronic organ design, Fig. 2), the coupling is accomplished by applying to the grid a portion of the voltage developed in the resonant circuit. The frequency at which oscillations occur is the frequency at which the voltage from the plate circuit is of exactly the proper phase and magnitude to supply its own input (see Fig. 3).

A mathematical analysis (Reference 4) shows that in order for the voltage on the grid to have exactly the required phase, the frequency of oscillation must

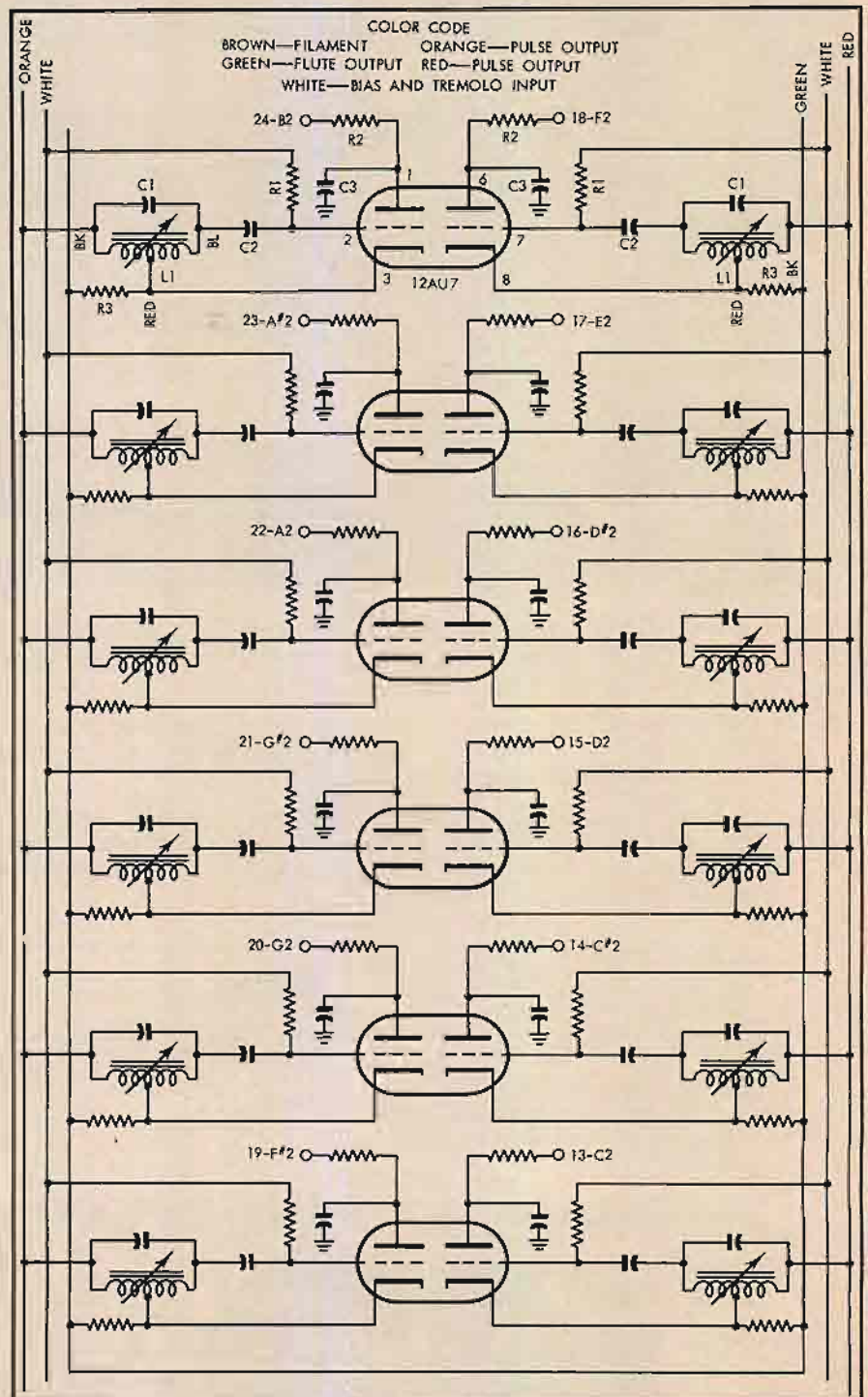
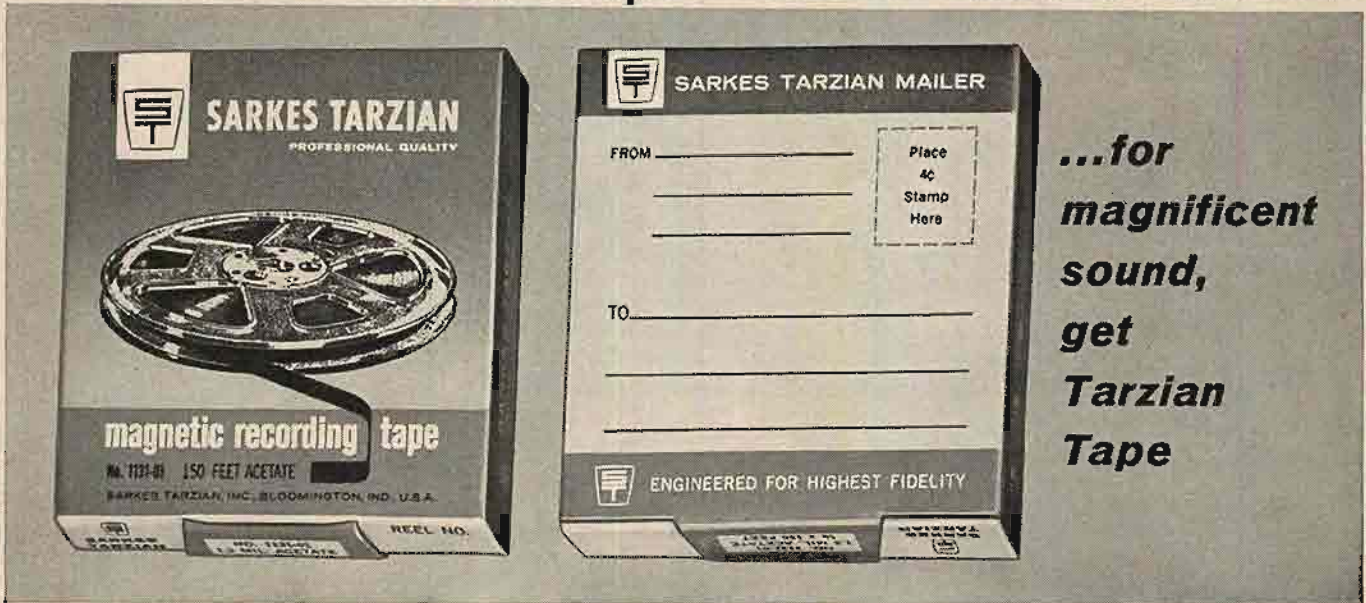

Fig. 8. Conn tone generator schematic.

LOOK ask DEMAND inquire ARGUE beseech INSIST



To earn a 3" reel of tape... be a surveyor for Tarzian

Tarzian Tape has been advertised since December of 1960 in publications dealers are presumed to read...since February of 1961 in publications you are presumed to read. Tape quality is excellent—our engineers say, our users say. Sales are good, but would be better if more dealers carried the line. The line is 1½ mil and 1 mil acetate tape, and 1 mil Mylar* tape, in 3", 5" and 7" reels. The price is competitive.

If you have tried Tarzian Tape or if you would like to try Tarzian Tape, here's how to get a 3-inch reel of it for no money, down or otherwise. Just ask your dealer for Tarzian Tape. If he has it, check the box and ask him what dealer publications he reads. If he does not carry it, check the box and ask him why not, and what dealer publications he reads. If he says he's never heard of it, by all means ask him what dealer publications he reads.

Send us your name and address and his name and address, and his answers and a verification by any dealer employee. We'll send you a self-mailing box (as illustrated) of 3" 1½ mil acetate professional quality Tarzian Tape. The coupon is for your convenience. Use it as a guide if you'd rather reply on some other piece of paper.

*DuPont trademark for polyester film

Sarkes Tarzian, Inc., Dept. FLI
Magnetic Tape Division,
E. Hillside Drive, Bloomington, Indiana

Send me a 3-inch reel of 1½ mil acetate Tarzian Tape in return for the survey work shown below:

Dealer Name: _____

Address: _____

Dealer does carry Tarzian Tape
Dealer does not carry Tarzian Tape Why not?

He reads these dealer publications:

Dealer to sign this verification: The raw tape user named below got the answers shown above from me.

User name _____
Address _____



SARKES TARZIAN, Inc.

World's Leading Manufacturers of TV and FM Tuners • Closed Circuit TV Systems • Broadcast Equipment • Air Trimmers • FM Radios • Magnetic Recording Tape • Semiconductor Devices

MAGNETIC TAPE DIVISION • BLOOMINGTON, INDIANA

Export: Ad Auriema, Inc., N.Y. • In Canada, Cross Canada Electronics, Waterloo, Ont.

Electro-Voice®

SETTING NEW STANDARDS IN SOUND

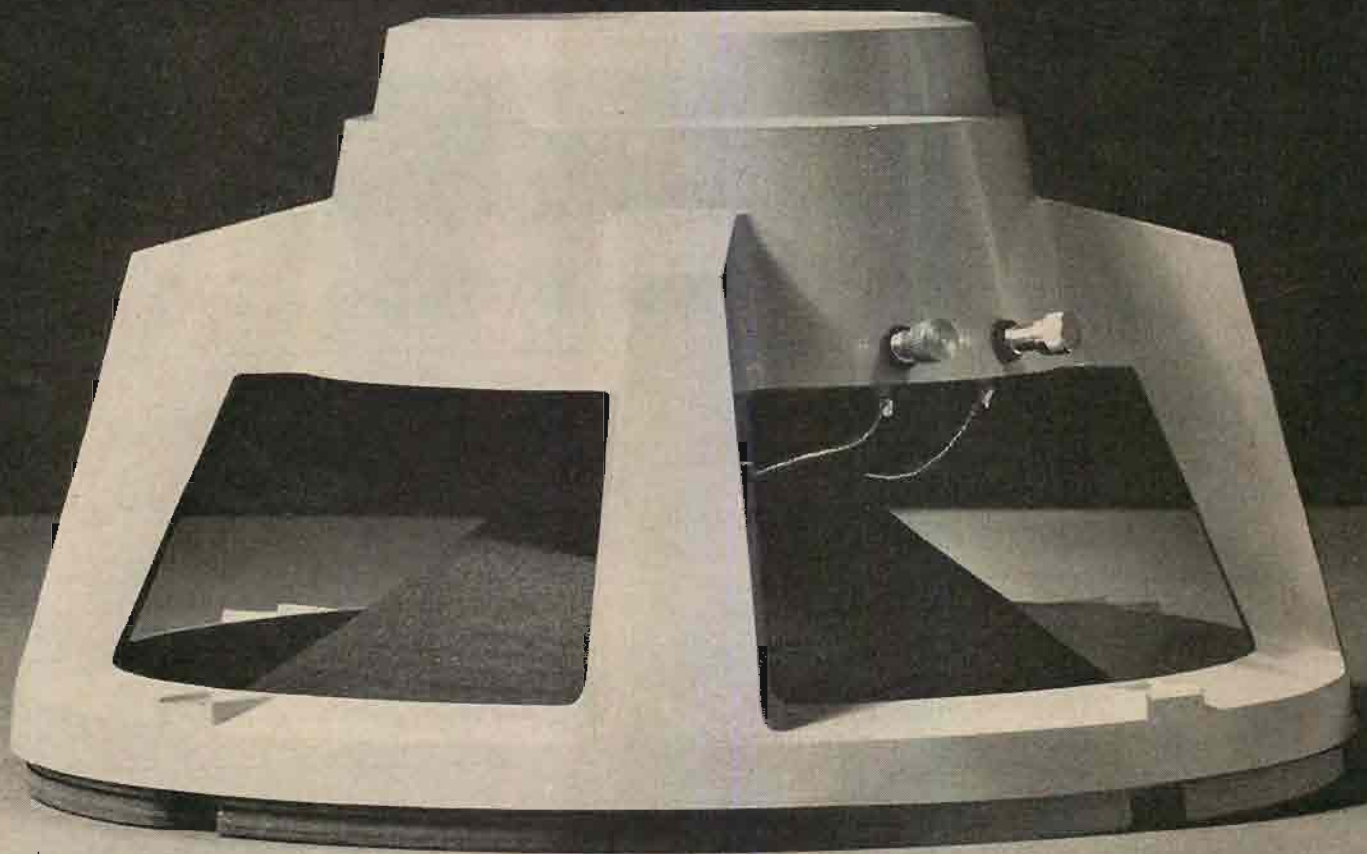

Now, One Look Tells You... **The Best Buys**

Take a close look at the all-new Electro-Voice SP12B and 12TRXB custom loudspeakers. Speakers with the honest beauty of precision... created by the sure, deft hand of a master designer.

Here is beauty with a reason... beauty that actively mirrors the superb performance of these famous speakers. Chosen for over a decade as "best buys" by listeners and laboratories alike, now the SP12B and 12TRXB look better and sound better than ever before.

No mystery about why they sound so good. Every detail of design has been refined, every manufacturing tolerance tightened to assure the highest level of musical performance and engineering integrity in your high fidelity system.

We urge you to carefully judge the SP12B and 12TRXB on every basis... on facts and figures, on appearance, and finally with your own critical ear. In every way these speakers give a full measure of satisfaction. And the real beauty is that they are very modestly priced.

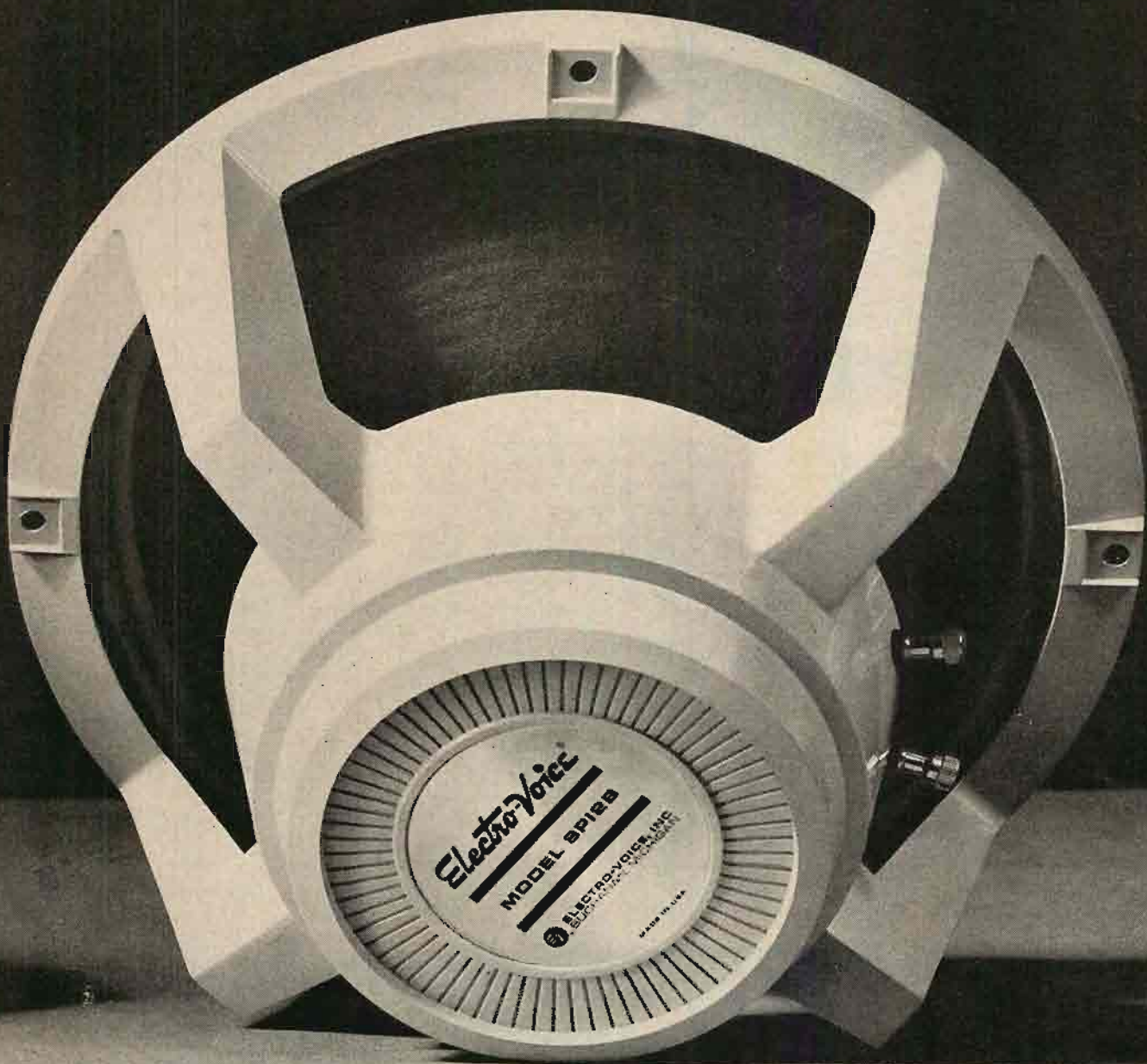

Are Better Than Ever!

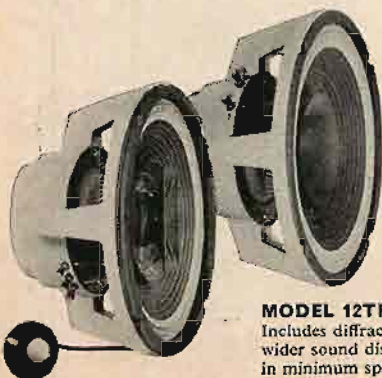

MODEL SP12B
Coaxial Full-Range Loudspeaker. Features Radax dual cone plus long-throw, high-compliance suspension. Ideal for built-in and custom installations. \$35.00.

MODEL 12TRXB 3-Way Loudspeaker.
Includes diffraction tweeter for extended range, wider sound distribution. Provides optimum sound in minimum space. Perfect for stereo. \$66.00.

Electro-Voice

ELECTRO-VOICE, INC., Dept. 224A
Buchanan, Michigan
Please send my free high fidelity catalog
plus list of E-V sound specialists featuring
the new SP12B and 12TRXB.



Name _____

Address _____

City _____ State _____



ELECTRO-VOICE, INC., Consumer Products Division, Buchanan, Michigan

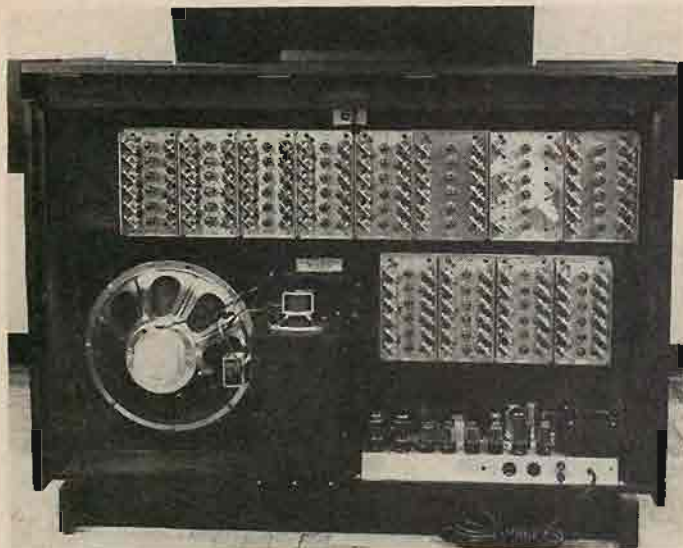

Fig. 9. Rear view of Conn organ showing location of tone generators.

be higher than the resonant circuit frequency. It can be demonstrated that the frequency stability will be highest when the natural oscillations differ as little as possible from the theoretical " f " of the tuned circuit.

Although frequency stability is directly proportioned to the Q of the tank circuit, the use of a high Q means loose coupling. Thus, high stability and high power output are mutually incompatible. In practice, the best organ designs are such that no power is taken from the oscillators. As a compromise, some designs draw minimal power.

The complete mathematical solution of even the simplest vacuum tube oscillator is extremely complex. Van der Pol was able to arrive at useful approximations by using such assumptions (Reference 4) as:

- a. The grid bias voltage is obtained through external means;
- b. That no grid current flows; and
- c. The μ of the tube is constant.

See Fig. 4 for some graphical solutions.

It is a necessary condition that α , the damping factor of the circuit, be negative. The waveform is dependent on the product, ϵ , of α and LC. As mentioned earlier, sawtooth, square, and sinusoidal wave forms are useful in electronic organs.

To keep the inductances, capacitances, and resistances (external to the tube) constant in value is a problem in the design and temperature control of those parts. On the other hand, regardless of the design, the effective impedance of the tube itself changes with use and with supply voltages.

However, by adjusting the other circuit parameters, the dependence of the frequency on the tube impedances can be minimized. Through the use of the reactances in the series grid and plate circuits, it is possible to design oscilla-

tors which to a first approximation are independent of tube conditions (see Fig. 5). In the ideal cases, compensation is perfect and the frequency is independent of tube conditions. In practice, however, the compensating reactances are not perfect and they must be adjusted by trial. This is what is meant by tuning. Further information on the design of stable electronic oscillators is given in References 5, 6 and 7.

A continuously running oscillator, though it simplifies the design of the oscillator, brings on design problems in the keying circuits. Most musical instruments have an envelope in which the sound intensity rises rapidly and then decays gradually. Usually, continuously running organ oscillators have associated with them decay and de-clicking circuits for each key.

A gated oscillator is one in which plate voltage is applied through the switch closure and the amplitude of oscillation builds up as shown in Fig. 4. In the past, designers tackled de-clicking as an easier solution to the problem of keying 300 volts B+ in the plate circuit of the oscillator. Allen Organ and others are now using transistors and are effectively keying the oscillator with 15 volts. The switch design for these low currents is one that takes the designer into the area of dry circuit contacts. Many of the switches used in current organ manufacture are electro-mechanical achievements.

Before inspecting the structure of oscillators used in present organ designs, it should be mentioned that for reasons of economy organ designers will often compromise so that each oscillator may supply more than one tone. This complicates or may even void the possibility of playing the associated notes simultaneously. This is particularly true as a compromise in the design of pedal generators and leads to the one-note-at-a-time pedal playing.

Polyphonic music is pleasing because of minute changes in pitch and timbre. A chorus of human voices all singing the same note sounds richer than one voice. A piano has three strings for most of the notes not only for acoustical power but also to provide a very slow beat frequency. This beating comes about because of the not-quite-exact tuning of the three strings (or two) associated with the note. Air organ builders created a similar effect by paralleling sets of pipes.

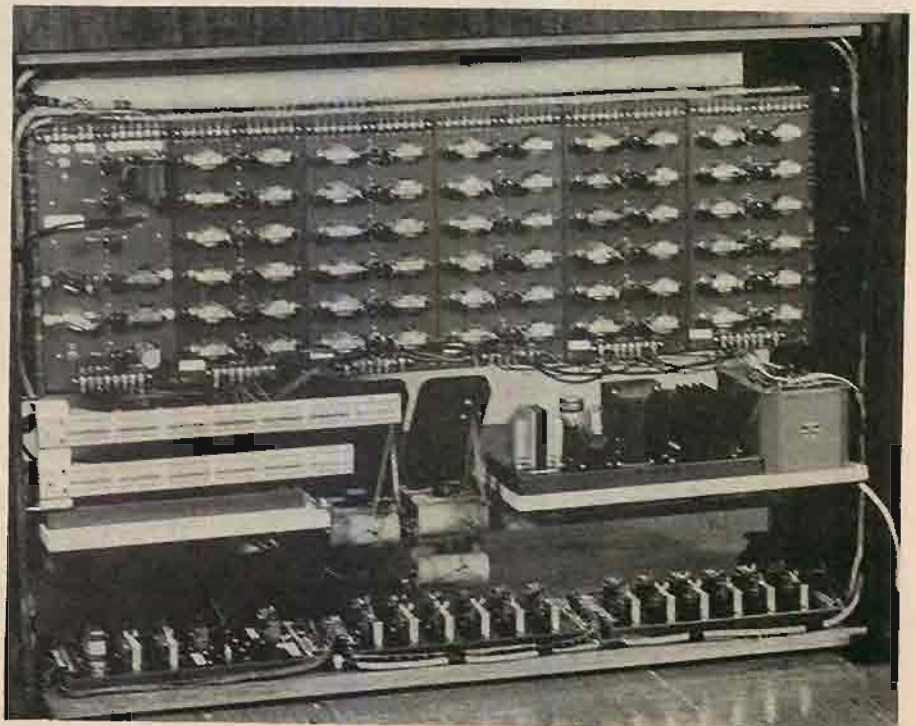
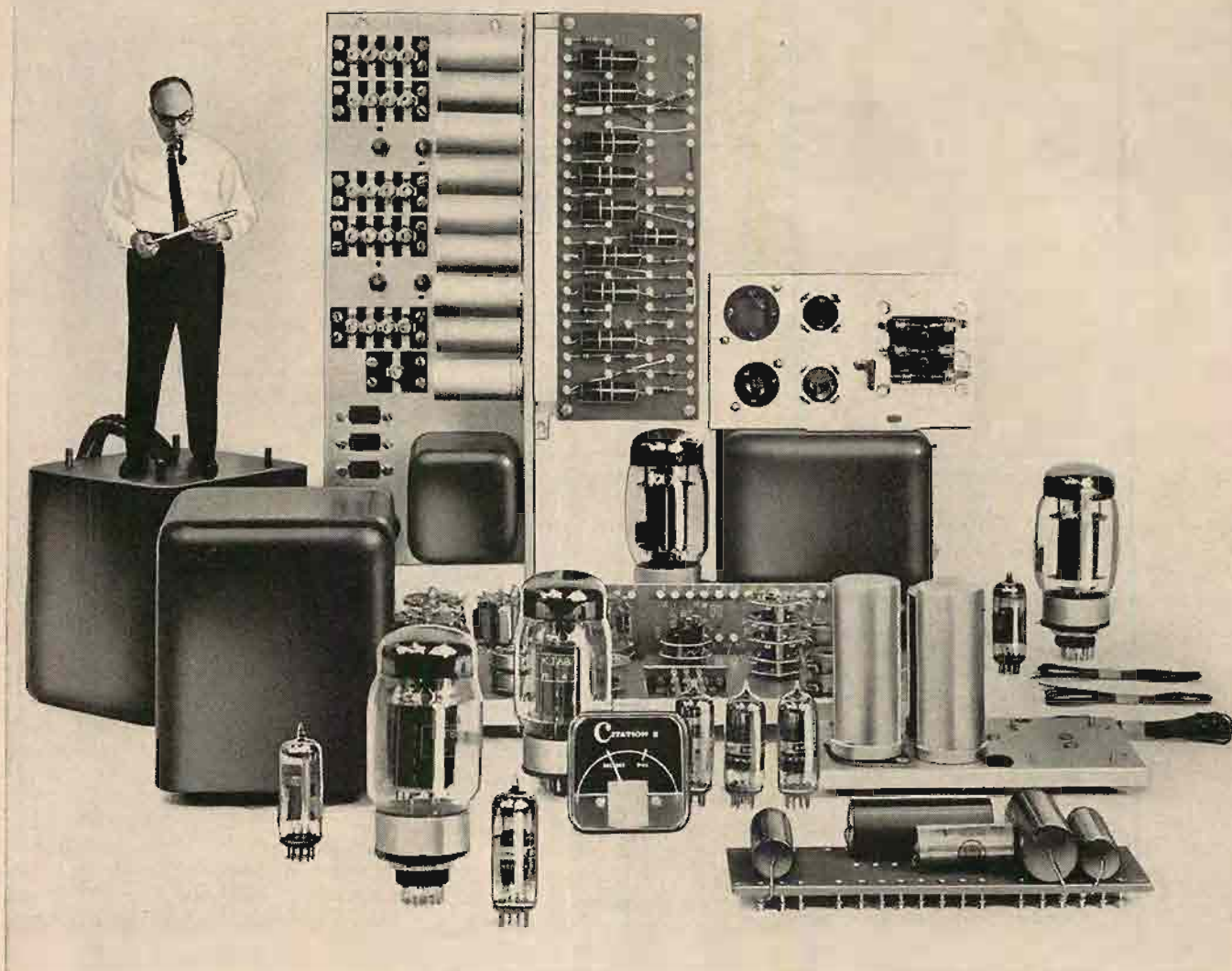

Fig. 10. Rear view of Artisan organ (kit) showing location of tone generators.



We don't pack an engineer into each new Citation Kit but...

... the engineering built into each kit is so precise that the unit constructed in the home will be the equal of the factory-produced instrument.

It is far more difficult to design a kit than to produce a completely manufactured product. In the plant the engineer can control his design from the moment of inception until the final packaging. The kit builder has only his tools, his ingenuity and little, if any, test equipment.

Therefore, the complex process of in-plant production and control which guarantees the fine finished product must somehow be *embedded* in the kit design. The Citation engineering group at Harman-Kardon, headed by Stewart Hege-man, has succeeded in doing just this in the design of all Citation instruments.

Heavy duty components, operating at tight tolerances, have been selected for the Citation Kits. As a result, even if every component is operated at its limit—remote as this possibility is—the instruments will perform well within their specifications.

Only Citation provides rigid terminal boards for mounting resistors and condensers. Once mounted, these components are

suspended tightly between turret lugs. Lead length is sharply defined. The uniform spacing of components and uniform lead length insure the overall stability of the unit.

Improper routing of leads, particularly long leads, can result in unstable performance. To prevent this, the Citation II is equipped with a template to construct a Cable Harness. The result: each wire is just the right length and in just the right place to achieve perfect performance.

To meet the special requirements of the Citation III X, FM Stereo tuner, a new tuner cartridge was developed. This embodies most of the critical tuner elements in one compact unit. The cartridge is completely assembled at the factory, totally shielded and perfectly aligned—eliminating the difficult problems of IF alignment, oscillator adjustment and lead definition.

All resistors and condensers have been uniformly mounted and labeled on special component cards to eliminate hunting through paper bags. All of the small parts have been packaged in cellophane bags which are mounted on cardboard for ease of identification and handling. The unique

Citation packaging techniques save much unnecessary time searching and sorting out parts.

These truly remarkable achievements in Control Engineering are only a few of the many exciting new developments in kit design from the Citation Division of Harman-Kardon.

Send for free reprints of independent laboratory test reports plus a Citation catalog. Write Dept. A-2, Citation Kit Division, Harman-Kardon, Inc., Plainview, N.Y. (Export Office, EMEC, Plainview, N.Y.)



Citation III

HK-64

harman kardon

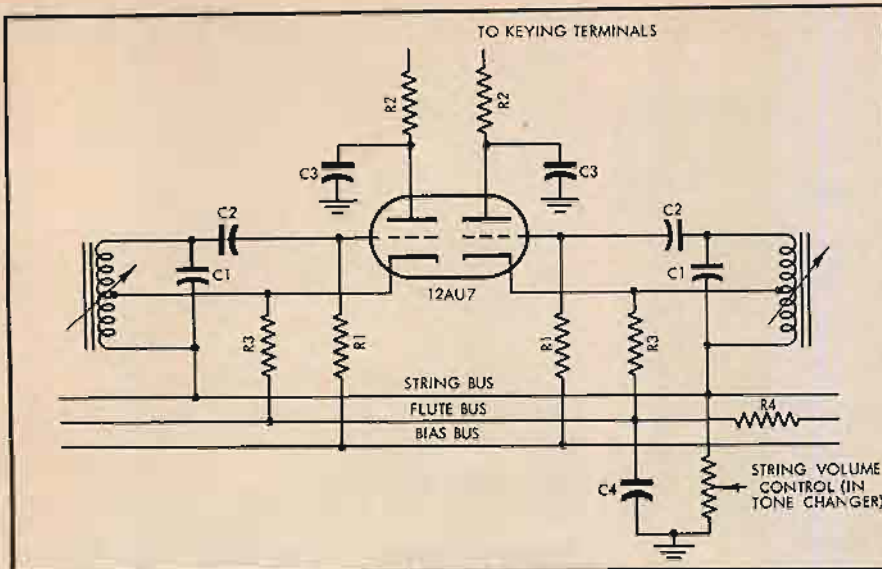

Fig. 11. Schematic of a portion (two notes) of an Artisan tone generator.

There are two groups of organs which use vacuum tube (or transistor) oscillators as the tone source in the organ. In the first type, one oscillator is used for all C's, another for the C#'s, and so on. Thus, twelve oscillators are required. The other C's, C#'s, etc. are obtained by frequency-division techniques which will be described later. Baldwin, Schober, Kinsman, and others use frequency division. In the second group, each tone in the entire instrument has its own separate oscillator. Conn, Allen, Artisan, and others use this design.

What are the relative advantages? Tuning is less time consuming when only twelve oscillators are involved. This means, however, that all C's, C#'s, and so on are always locked in phase. Some organists feel that such a scheme robs these instruments of a richness in tone. Others feel that in chord playing, the in-phase relationship for the doubled note is outweighed by all of the other random phased notes in the chord. When twelve oscillators only are required, high-quality components can be used to create extremely stable oscillators. Alan Douglas in his article (Reference 8) discusses the relative merits of frequency division *vs.* individual oscillators. In the final analysis, as always, the sounds of the organ should be basis of judgement rather than the circuitry.

Figure 6 is a complete schematic of one of the twelve Schober Concert Organ tone generators. V_{1a} is the master oscillator, a modified grounded-plate Hartley, which operates at the frequency of the highest note. The oscillator is tuned by adjusting the slug in L_1 . The design utilizes the techniques for stability discussed earlier. The oscillator output is used only to drive the locked frequency dividing blocking oscillators, consisting of the seven remaining triode sections.

Assume for a moment that neither

R_1 , nor C_6 is connected to the plate of V_{1B} . The pulse transformer, T_1 , has a low inductance value and is so connected that a positive pulse at the plate will put a negative pulse on the grid. When the circuit is first turned on, a small random signal will appear on the grid. If this signal happens to be positive, this will result in a much larger negative signal on the plate because of the high tube amplification. This causes the grid to draw a large sharp pulse of current. The current passes through the resistance of R_2 and R_{2A} in series, thus creating a large voltage drop across the resistance with the negative voltage at the grid. The negative voltage charges up the two capacitors C_4 and C_5 in series, and the tube is cut off.

This fast negative capacitor charge corresponds in time to the "flyback" or vertical portion of a sawtooth wave. The capacitors can discharge only through the resistors. Time for discharge is relatively slow and corresponds to the diagonal part of the sawtooth wave. As soon as the capacitors have discharged sufficiently to take the grid voltage above the cutoff point, the cycle begins again.

To avoid loading the master oscillator, the first blocking oscillator is synchronized to and thus controlled by the master oscillator. This is done by feeding d.c. to the master oscillator plate through the plate winding of T_1 , and setting the R (R_2 and R_{2A}) and C (C_4 in series with C_5) of V_{1B} for a free-running frequency somewhat below the final frequency desired. When a negative oscillator pulse passes through the winding, it adds to the negative pulse beginning to build up because of the block-oscillator action and fires the blocking oscillator. Since the blocking oscillator fires once per master oscillator cycle, the frequency outputs of the two are identical.

The next blocking oscillator V_{2A} operates in the same way as the first with

two exceptions. First, its R and C are chosen for a free-running frequency slightly less than half of the first stage. Second, synchronizing pulses are fed to its plate from V_{1B} through C_6 . This stage, therefore, produces a frequency exactly half that of V_{1B} , or one octave below it. All of the remaining blocking oscillators divide in the same way. The variable factor is the amplitude of the sync for which the trimmers C_{12} , C_{15} , C_{18} and C_{21} are used.

The 18,000-ohm resistors, R_{10} through R_{16} , place a constant load across the output so that the changes between no load and the load imposed when a tone is keyed will be a minimum. The resistors also serve to keep the capacitors discharged so that they will not cause clicks or pops when the tones are keyed.

Conn's engineering approach (and also that of the Allen and Artisan instruments) is to provide separate keyed oscillators for each note in the scale, all running without any synchronization. This corresponds to the choral effect of the air organ. Conn employs a Hartley type oscillator which provides both pulse and flute (sine) tones.

Figure 7 shows the construction of a Conn tone-oscillator family and the schematic corresponding to this structure is shown in Fig. 8. Note that two wave shapes are derived from each oscillator, depending on the method of pulling them from the circuits. Figure 9 shows the oscillator chassis installed in the organ. A complete description of the Conn family of organs is given in AUDIO, September and October, 1956, (Reference 9).

Figure 10 shows eight sets of two-channel tone-generator assemblies assembled in the Artisan, which, similar to the Conn tone generator, takes two wave shapes from the oscillators rather than one sawtooth or square wave. Tuning is accomplished by changing the air gap and consequently the inductance, of the coil. Figure 11 is the schematic and Fig. 12 shows the wing nut arrangement for changing the air gap. Windings in the coil are arranged to obtain two different basic wave forms from each oscillator; a "flute" (sine) wave, and a "string" (pulse) wave.

To be continued

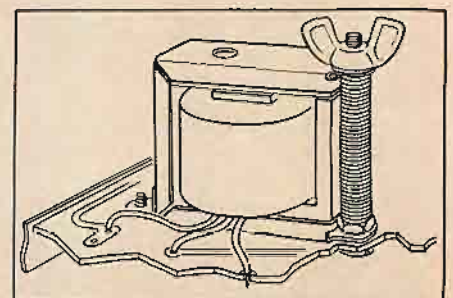
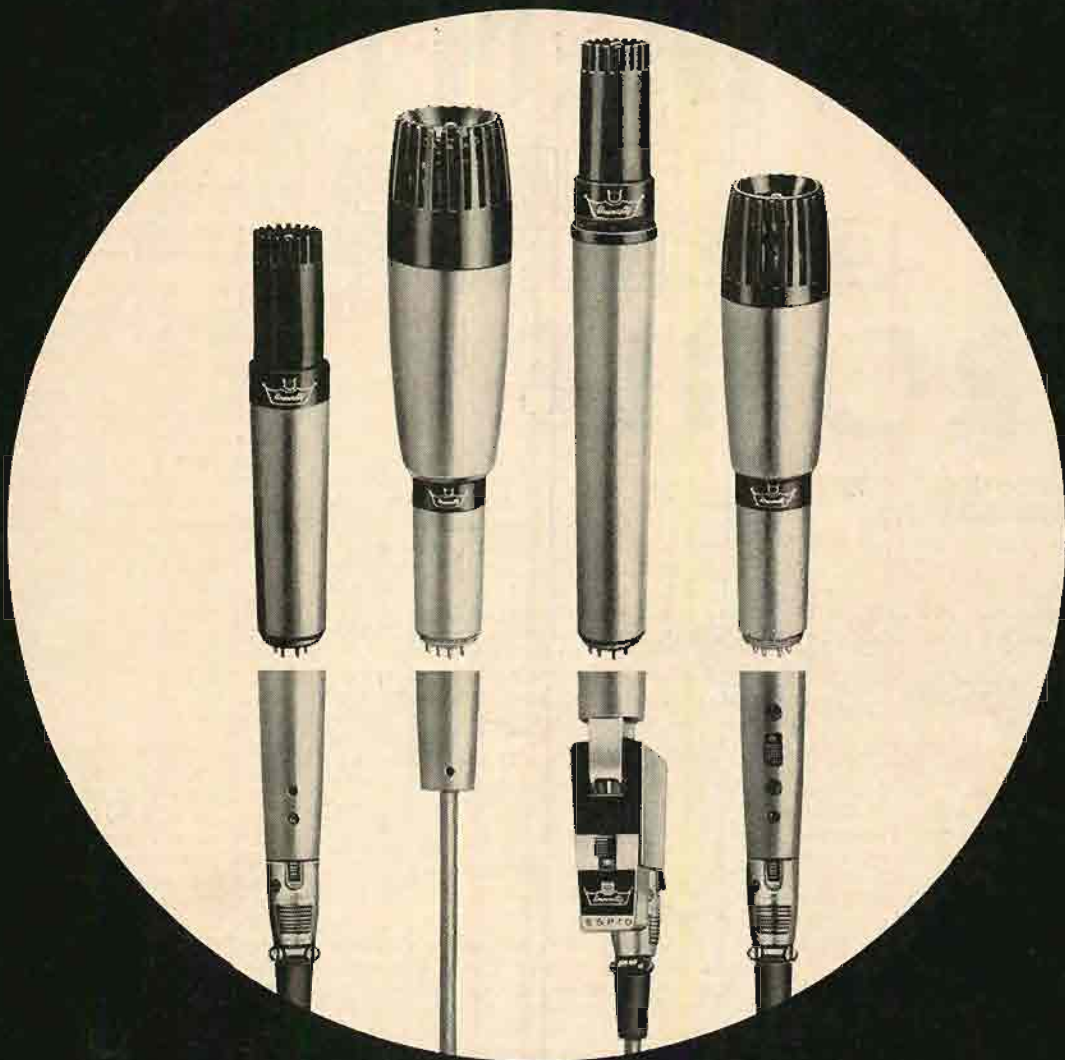

Fig. 12. Coil assembly showing tuning mechanism for Artisan organ.



YOU ARE NOW LOOKING AT 20 DIFFERENT MICROPHONES

MODULAR MICROPHONES!*

Another exclusive concept that makes
UNIVERSITY microphones better.

20 microphones? Yes—for any **one** of University's MODULAR MICROPHONES can provide at least **five** different methods of operation! University has inaugurated a new era in microphone design and construction—**professional** microphones offering **total interchangeability** with every conceivable type of adapter! This permits long-term savings as well as improved versatility, for you can add suitable adapters as your microphone requirements change—**without buying additional microphones**. You need never compromise quality to meet a price.

And it works as simply as this: equipped with a minimum of basic University MODULAR MICROPHONES, any one of University's interchangeable adapters may be chosen to complete the microphone assembly you require...with or without switches, for cables with and without quick-disconnect plugs, for screw-on or slide-on floor and desk-stand operation. And you can make **instant impedance changes** without tools, rewiring or soldering!

*TRADEMARK

For the complete story on University's new line of omni-directional, cardioid and lavalier MODULAR MICROPHONES, send for the free 16-page brochure. Write: Desk R-2, University Loudspeakers, Inc., 80 S. Kensico Ave., White Plains, New York.



EQUIPMENT

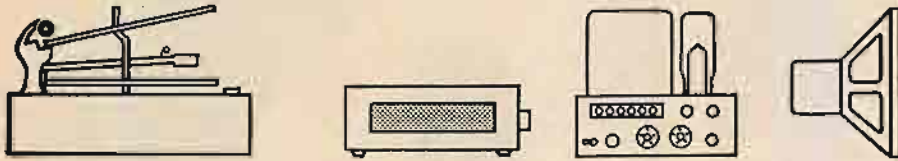

PROFILE

HARMAN-KARDON CITATION MA FM STEREO ADAPTER

Users of the Citation III FM tuner have had a long wait for their FM Stereo adapters, but at long last they are finally available. We spent about two and a half hours on Christmas Day making the conversion to the Citation III tuner, and everything went along smoothly—including the performance after the tuner was back in its accustomed place.

The MA FM adapter comes as a single factory-assembled and factory aligned chassis which connects electrically to the Citation III by means of a single-pin plug for the input and an octal plug for power and output connections. Mechanically, the adapter simply attaches on the top of the tuner chassis as shown in Fig. 1, being fastened by two existing screws on the top plate and by one of the screws which holds the bottom plate.

The adapter circuit is shown in Fig. 2. The dotted box at the upper left contains a 67-ke filter in the series leg which is permanently in the circuit, and a shunt leg which is switched in by one position of the selector switch. The pilot signal is fed to the "side amplifier" through a small capacitor. The audio signal passes through an equalizing network to the grid of a cathode follower which feeds a bridge circuit that effectively isolates the 38-ke switching frequency from the audio circuit. The switching signal alternately turns on one or the other of the two pairs of diode switches—this being a time-division system—and the outputs of the diode

switches are fed to two identical parallel-T networks that do double duty as 38-ke null circuits and as the de-emphasis networks. The networks are unsymmetrical so as to provide both of these functions at once. Their outputs are fed to two anode-followers with a small amount of inverse cross-feeding to increase separation, and thence to two terminals on the octal plug.

The side amplifier consists of a triode section followed by two 19-ke filter circuits and an amplifier stage which feeds a primary winding of a transformer to provide synchronization to the 19-ke oscillator which employs the secondary of the transformer as a cathode-tapped oscillator coil. A transformer in the plate circuit of the oscillator tube is tuned to 38 ke, and this feeds the diode-bridge switch.

Construction

There is no actual construction required on the MA FM Adapter itself, but there is some modification required to the Citation III to accommodate it. This is minimal, however, and is made primarily to provide the heater and plate power and the necessary switching. The adapter kit contains a new dress panel which replaces the one on the original tuner to show the new switch positions and to make space for the indicator light. The old power switch and the old volume control are removed and replaced by a combination power switch and function switch, and by a three-gang volume control—one for mono and the other two for stereo outputs. Additional plate-supply filtering is provided in the adapter.

SEPARATION

Last month, in our Profile of the Pilot 602M FM-stereo receiver, we reported stereo reception as "better than 20 db." Further investigation has caused us to doubt that figure. As a result we have revised our method of testing for stereo separation. We will fully describe the method we currently use in some future issue. Meanwhile Pilot tells us that the minimum separation acceptable in their factory tests is 30 db.

The new selector switch has four positions—off, mono, stereo, and stereo with the 67-ke SCA filter in the circuit. In both stereo positions, the indicator light is illuminated.

Wiring consists primarily in running six shielded cables from the rear of the tuner chassis to the new switch and the ganged volume control. In some instances—the instructions indicate—there is no octal power socket on the main tuner chassis, and if not, it must be added, although there is a simple blank cover plate over the hole which means that the constructor does not need to cut a 1½" hole in the chassis. The few additional connections are for heater and plate supply to the octal socket, and connections for the indicator light on the front panel.

Operation

We found the completed stereo tuner—now a Citation III—unaffected in its normal mono performance, as it shouldn't be, of course, since there were no changes in the basic tuner—and equally effective on the three stereo stations in the New York area. One advantage in particular, in our opinion, is the presence of a volume control on the tuner panel which works on stereo. With such external adapters as we have previously tried out, there was no method of controlling the stereo output except on the preamp itself. With a control on the tuner, the operating point of the contour control can be set to an optimum value for any station. Engineers at Harman-Kardon maintain that the absence of filtering in the audio circuits permits an improved square-wave response with resultant "Citation Sound"—due, it is thought, to as wide a pass band as possible. In any case, the quality of reproduction—when we could properly assess the actual quality of the performance, recorded or otherwise—is in keeping with the mono quality of the Citation, which is recognized as excellent throughout the industry. B-27

Fig. 1 (below). Citation MA FM Adapter in place on top of the Citation III tuner. Fig. 2 (right). Schematic of the Adapter.

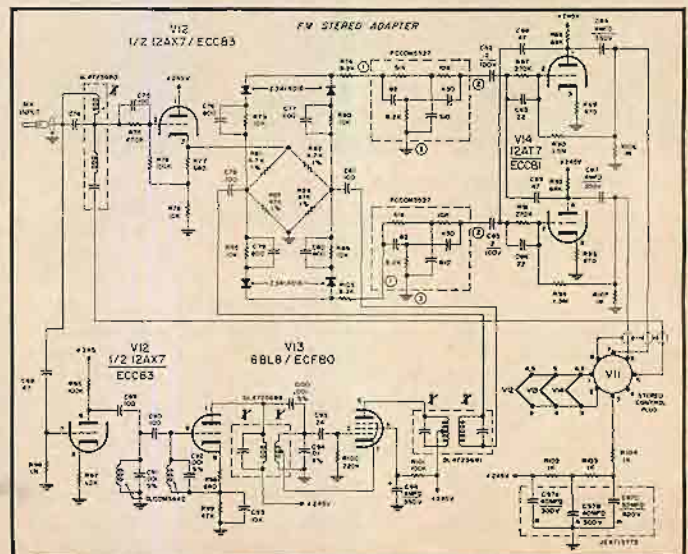
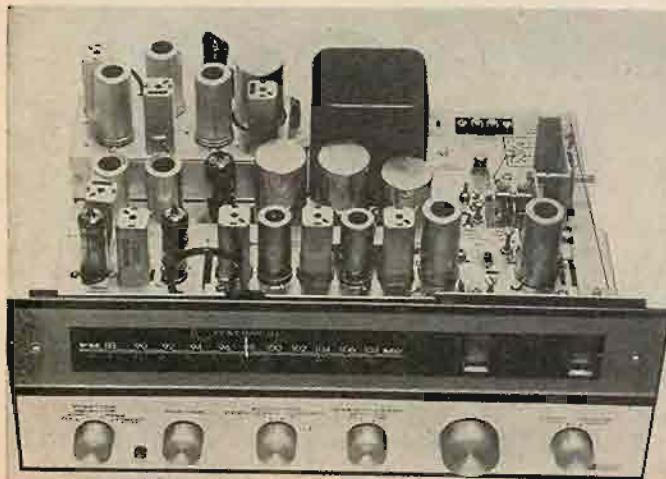

DYNAKIT

there is no finer performance

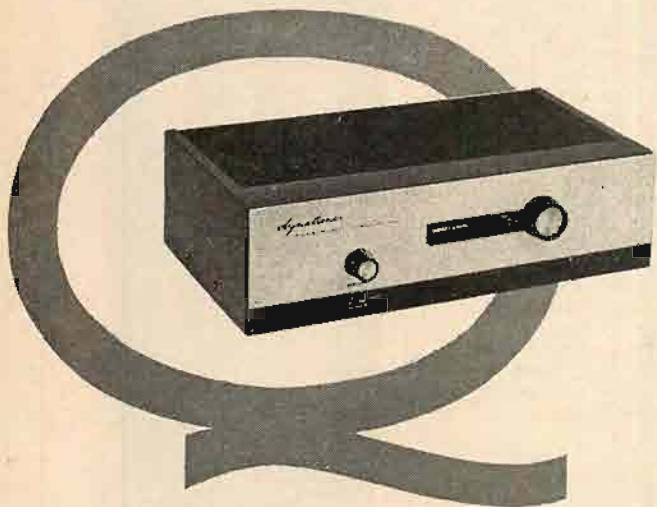

QUALITY

For the audio perfectionist the FM-Multiplex Dynatuner has set new standards for useable sensitivity under the most difficult conditions, with lower distortion at all signal strengths — faster limiting, simpler and more accurate tuning, better capture ratio, superior interference rejection, no overloading, outstanding AM and multipath rejection, superlative selectivity, and lower hum and noise. For the kit builder, assembly and alignment are completed in just 6 hours, and performance specs are met the first time. FMX-3 Multiplex integrator \$29.95 kit.

FM-1 \$79.95 kit, \$119.95 assembled and tested.

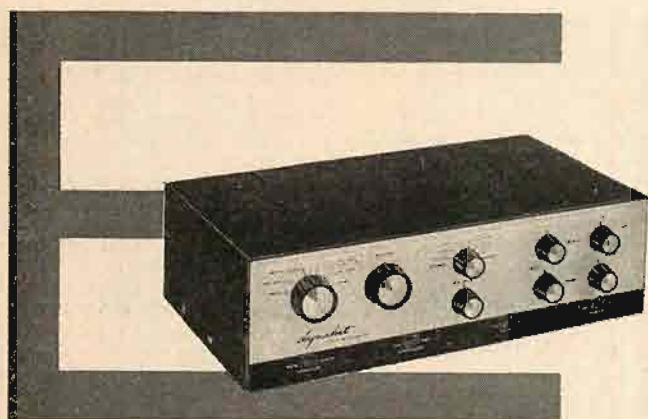

ECONOMY

Easily the finest value in the high fidelity field, this "no distortion" preamp has won acclaim for impeccable performance, at just about the lowest price ever for a stereo preamplifier. Full control flexibility in a simple, modern arrangement makes it easy to build and a pleasure for the non-technical music lover to use. You'll revel in its near-perfect freedom from hum, noise, and distortion. Just \$59.95 buys the most important improvement in your music system.

PAS-2 \$59.95 kit, \$99.95 assembled and tested.



DEPENDABILITY

It's more than two years old, but we've never had to make a single change in the Stereo 70 amplifier. Patented Dynaco output transformers and circuitry, and the superior reliability of the finest etched circuit construction assure continued superiority of performance. In the words of Hirsch-Houck Laboratories (December 1959 issue of High Fidelity Magazine) "This amplifier's components are operated more conservatively than those in any other commercial amplifier we have tested . . . Its power and distortion ratings are completely conservative. Its listening quality is unsurpassed." Could we say more?

Stereo 70 \$99.95 kit, \$129.95 assembled and tested.

QUOD ERAT DEMONSTRANDUM: which was to be proved

write for
detailed literature

DYNACO, INC.

3912 Powelton Ave., Phila. 4, Pa.
Cable Address: Dynaco, Phila.

REK-O-KUT AUTOPOISE KITS— MODELS APK AND AP320

With the ever-decreasing stylus-force requirements of the newer pickup cartridges, it becomes more and more difficult for the average person to place the stylus on the starting groove of a record smoothly and without possible damage to either record or stylus assembly. This is still more of a problem when some members of the family are either incapable of or disinterested in learning how to handle a phono arm carefully. All of us have heard of the distaff or junior members of the family who "won't touch that delicate thing." And when the audiofan of the family is very particular about the equipment, the problem is multiplied, for he is the one who is most likely to insist on the use of a turntable for his record playing.

Once the Rek-O-Kut Autopoise is installed on your turntable, troubles of this nature are entirely eliminated. From then on, all you do is to place a record on the turntable and press a button. The Autopoise takes over, lifts the arm from the rest, moves it over to the lead-in groove, starts the turntable motor, lowers the stylus to the record ever so gently, and then completely relinquishes control of the arm until the record is finished playing. At this time, it raises the arm again, moves it back to the rest and lowers it, then shuts off the turntable motor. (Almost like that little box with a switch and the hand—turn the switch on and the hand comes up out of the box, turns the switch off, and then returns to the inside of the box.) If you wish the record to stop anywhere during its playing, simply push the button again and the arm raises, moves to the stop, lowers, and the turntable is turned off.

Operation

The actuating device for the Autopoise is a small clock-type motor which drives a cam through one revolution in ten seconds. The cam causes the arm to raise and lower and to be moved from rest to starting groove or from the record to the arm rest, and the arm position controls the turntable motor. For completely manual playing you can pick up the arm itself and place it on the record anywhere, and by so doing you have started the turntable. From any place on the record you may pick up the arm and return it to the rest and by so doing you stop the motor. And there is no mechanical connection between the arm and the actuating mechanism during the playing cycle. If some one inadvertently moves the arm way past the turntable spindle, it will not set down on the starting groove the next cycle unless you first return the arm to the rest, which determines the set-down position of the stylus.

While all this may sound complicated, it is so easy to install that it may be done completely in less than an hour. Any turn-

table will do, but the arm must be any one of the Rek-O-Kut models.

Assuming you already have a Rek-O-Kut arm. You secure the Model APK kit, which has the actuating mechanism, a new arm base, a new gimbal assembly, and the push-button switch. You make a few conversions to your present arm, still using the old arm tube, counterweight, and cartridge shells. If you do not have a Rek-O-Kut arm, you buy the AP-320 model, which includes the complete arm. The more recent Rek-O-Kut turntables—N-33H, NL-33H, N-34H, and S-34H—are already drilled for the Autopoise, but if you have an older turntable or one of some other make, a template is furnished so that the necessary holes may be drilled where required. The Autopoise is mounted only to the conical arm base—no other mechanical fastening is required. Once installed and adjusted—for height and set-down position—it should need no further servicing or adjustment. The cam followers are nylon, and the position of the arm rest—adjustable by loosening a single screw—determines the exact place where the stylus lands on the record. The operating cycle of ten seconds is long enough to ensure extremely smooth handling of the arm, and there is no jerkiness in the action at any point in the cycle. Figure 3 shows the unit in place on a turntable.

For those who are so inclined, a remote operation can be set up by extending the leads to the starting pushbutton, or by paralleling another momentary-contact pushbutton.

Performance

Aside from inspecting the APK kit separate from any turntable and watching it work without an arm, we also tried it out on a Rek-O-Kut NL-33H table. Since there is no restriction of the arm in any sense when it is playing, there should be no reason why it should affect flutter or wow, but it was measured anyhow and found a wow figure of about .05 per cent and a flutter figure of approximately the same amount, with the total of wow and flutter measuring just under 0.1 per cent—just about half of the NAB standard for broadcast equipment. One thought we had on first observing the system was that the clock motor might have an a.c. field that would introduce hum into the pickup circuit, but the clock motor which operates the Autopoise runs only when the unit is in its cycle.

On the whole, our opinion of this device is that it provides the smoothest possible handling of the arm, making it possible, for instance, to use the turntable in a drawer of a cabinet. You put the record on, close the drawer, and then press the button—eliminating once and for all the jumping from the starting groove which so often accompanies this type of installation. The Autopoise is a truly delightful device. B-28

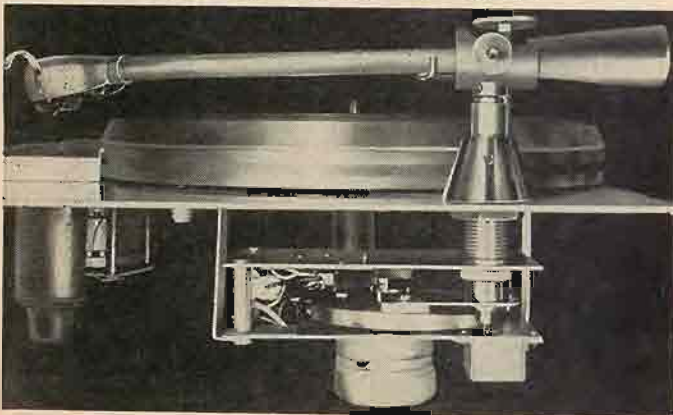
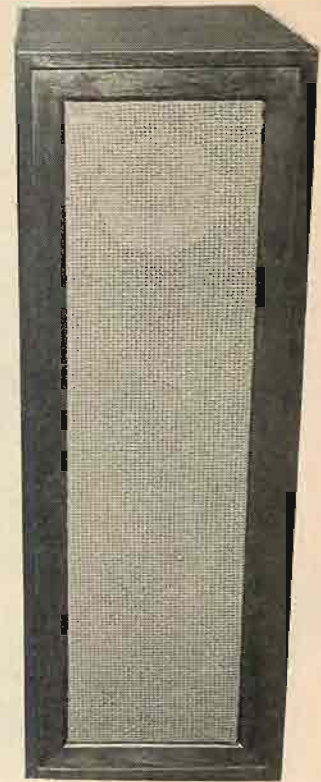

Fig. 3. Rek-O-Kut Autopoise mechanism mounted on a turntable in operating position.



ISOTONE "EROICA" SPEAKER SYSTEM

The Isotone "Eroica" is a 3-speaker system which consists of one 8-in. and one 10-in. speaker in parallel to handle the low and midrange frequencies, plus a compression-type tweeter to handle the frequencies from 5000 cps up to the limit of the system. There are two unusual aspects of this system. First of all the two low-frequency speakers are on opposite sides of the enclosure; the 8-in. speaker facing forward and the 10-in. speaker facing toward the rear. In addition, the compression tweeter also faces towards the rear. Thus, this system must be placed at least a foot away from the wall. We found that the best stereo effect was obtained with the unit placed so that the tweeter was angled about 30 deg. from the wall.

The other unusual aspect of this speaker system is the elaborate, and patented, internal labyrinth, so the midrange is reinforced and made to blend with the low frequencies. Because of this feature, the bass must be boosted at the amplifier. This requirement is perfectly reasonable in view of the special treatment exacted by the variety of rooms into which we may place this system. In reality, since our main concern is the sound which the entire system produces, it should not disturb us if the tone controls must be adjusted.

Before we go on to the listening evaluation we would like to dwell momentarily on the enclosure. The housing for the "Eroica" measures 40-in. high, 22-in. deep and 14-in. wide. It comes in either oil-finished walnut or mahogany. Its height and relatively narrow width effectively mask the 6.5 cubic-foot internal volume.

When properly located, and with the tone controls adjusted, the Isotone "Eroica" produces excellent sound. The midrange is particularly strong although the entire range is quite smooth.

The high-frequency range seems unusually wide although placement of the tweeter is fairly critical. The over-all sound of the system can be characterized as smooth and rich at the extremes. B-29.



JBL goes all the way — with product warranty as well as product quality. It is — and always has been — JBL's policy to repair or replace **without charge**, at any time during the life of a product manufactured by James B. Lansing Sound, Inc., any unit whose performance is impaired by a cause beyond the control of the owner. The only limitation is the availability of parts. And, frequently, it is possible to use today's parts to bring a discontinued model up to better-than-new performance. This is another reason why it's a smart idea for the music enthusiast to invest in the very best loudspeakers available. Like any fine musical instrument, they don't wear out, are almost always worth restoring to top-notch playing condition. Write for your free copy of the new JBL catalog and ask us to enclose a copy of the JBL warranty card.

JBL PRECISION TRANSDUCERS ARE MANUFACTURED BY JAMES B LANSING SOUND, INC., AND ARE MARKETED BY JBL INTERNATIONAL, LOS ANGELES 39, CALIFORNIA

The Campbell Letters

From the very day of publication, John Campbell's article concerning "sineward distortion" has been the subject of much comment by readers. Here are some of the comments plus a rejoinder by Mr. Campbell.

Sir:

I have gotten a number of earnest arguments from several readers, complete with mathematical arguments as to why sine-wave analysis is perfectly correct and adequate. All such analyses, of course, starting with the built-in assumption that sine-wave analysis is correct . . . which makes that assumption come out as the proven conclusion, naturally enough.

In the time since I wrote the article, I've gotten quite a bit more data. Dr. Wayne Batteau, of United Research, who's been playing what he calls "the ears game" has got some three-dimensional sound recordings that'll raise hair on a bald pate! I do NOT mean ordinary stereo; that's two dimensional at the very best; he's got *three* dimensions. You should hear a plane take off and fly over your head, curve, and climb. . . . Or a father and small son discussing it, just off to your right rear, and hear the father's voice coming from about 5'2" up, and the son's voice coming from about 3' up. . . .

Dr. Batteau claims to have clear evidence that the human auditory system can distinguish pips separated by 2 microseconds or less—and some clues that the "less" may be as small as 0.2 microseconds! That the curious crumpling and folding of the external ear is *no* accident—but a magnificently engineered acoustic delay-line, and that it is that acoustic delay-line that allows us to do vertical sound-source location. An acoustic delay line even that short is highly significant . . . to a system that readily distinguishes 2 microsecond shifts!

John W. Campbell, Jr.,
1457 Orchard Road,
Mountainside, New Jersey

Sir:

When I saw the article on "Sineward Distortion in High-Fidelity Amplifiers" I scanned it with interest, hoping to learn of a new principle, because I had never heard the expression "sineward distortion" before. I read on patiently, through misleading presentations of evolution, music, hearing, neurology, and the basis of Fourier analysis, patiently, ignoring the incomplete factual bases and the wrong deductions, because I wanted to find out what Mr. Campbell had discovered.

And at last Mr. Campbell stepped down from his soap-box and told us: He has discovered phase-shift!

Dear Mr. Campbell: Phase-shift is not new. Respectable physiologists have never deprecated it except to make this claim: The "quality" (Tonfarbe) of a steady "note" (periodic acoustic oscillation) as perceived by the ear is largely a function of the frequencies of the Fourier components of the waveform and their relative amplitudes, and is only negligibly affected by their phase relationships (and is certainly not affected by the process through which the waveform is generated, whether it be synthesis or the filtering of square or saw-tooth waves!). The reason that the phase-shifting amplifier sounds bad roots somewhere else: It sounds bad because phase-shift relative to frequency disturbs transient response—and the importance of transient response is well known, wherefore we have square-wave tests and such.

Furthermore, Mr. Campbell: Fourier analysis is a method of mathematical analysis, and is quite unconcerned with the mechanism of the ear. It is merely a way of describing wave shapes. Let those who do not understand it accept this much: It is a perfectly valid tool when it is used correctly. Similarly, sine-wave response, distortion figures, and so forth, are valid tools when they are applied and evaluated correctly. We must, of course, know how to interpret the results. We can find, for example, relationships between certain performance measures, such as that between harmonic distortion and intermodulation distortion.

One should have both the sine-wave response plot and the phase-shift curve to predict the transient response of a system if it is inconvenient to measure it more directly. But one can actually make a shrewd guess from only one of these, since all ordinary amplifier circuits are approximate to so-called "minimum-phase" systems, in which a definite relationship exists between response and phase-shift. In short, it amounts to this: Phase-shift relative to frequency occurs in the vicinity of a rise or drop in response—hence the worry about "holes" in the response curve, and hence the insistence on flat response well beyond the limits of audibility. That is also the reason why our tone-controls are phase-shifting controls as well!

The details are in the textbooks. The reproduction of sound can be analyzed and reproduction defects can be quantized. We need information about the ear only in order to know how much reproduction defect it will tolerate, or even detect. (Hence we can pass over Mr. Campbell's dubious description of the workings of the ear without further comment.)

Let's forget the term "sineward." It's imprecise and misleading, and useful only in science fiction.

Peter Moretti
Dept. of Mech. Eng.
Stanford, Calif.

Sir:

Mr. Campbell's article is quite a piece of science fiction, however it is not all a loss if it causes some thought about testing. Certainly the specifications that Mr. Campbell gives are not sufficient to guarantee a high-fidelity amplifier. He does not indicate what kind of a load he was operating the amplifier into when he made all these measurements. If he is, in fact, using a feedback amplifier, a drop of 1 db at 55,000 cps indicates a problem. Feedback will not make a poor amplifier good; it must be good before the feedback is applied.

Mr. Campbell does not mention the response of the amplifier at frequencies below 10 cps. It is possible to have a peak in the response at or below 1 cps which may cause distortion in the amplifier or the associated speaker. Many designers do not realize the importance of protecting the power amplifier and speaker from low frequencies which they cannot handle.

The phase shift situation shown in Fig. 3 would most certainly cause a peak in the response curve which would be indicated by an increase in the amplification at the frequency of positive feedback or by ringing

on the top of lower frequency square waves. I refer Mr. Campbell to authorities such as Terman to find illustrations of peaking in feedback amplifiers.

The problem is not in the use of sine waves to test amplifiers; it is in the failure to use them properly. The response of an amplifier should be fully checked before the inverse feedback loop is connected and again after it is connected. If the amplifier does not cover the full frequency range desired before the inverse feedback is added—back to the drawing board! Any deficiency in the pre-feedback response will result in a smaller feedback margin at the deficient frequency ranges with the accompanying loss in distortion and output impedance reduction at these frequencies.

I can't imagine why anyone would feed in a square wave of sufficient level to overload an amplifier. The square wave is most useful to check for peaks in the frequency response of the amplifier without going to the trouble of making a frequency run after each adjustment.

A little study of basic network theory would demonstrate that there is a most definite relationship between the sine wave frequency response of a network and its transient response. In amplifiers we can have the additional complication of driving one of the tubes beyond its linear operating point. However, this would show up immediately in intermodulation or harmonic distortion measurements.

W. B. Bernard, Capt., USN Retired,
144 Harrison Drive,
Sarasota, Florida

Sir:

Mr. Campbell's article on waveform distortion interested me very much indeed, because I have heard strange, intangible defects in some very highly regarded amplifiers.

Remarkable though the article is, it suffers from a number of inaccuracies, which if corrected would add considerable force to the argument.

First, there is no such thing as the instantaneous phase of a random music waveform. In fact, phase is defined first and foremost for sinusoidal waveforms, and even then, if measurements are being made, one must follow the oscillation through at least one cycle in order to determine the pattern and set up phase angles with respect to the zero line.

Also, since sound waves exist in space as well as time, phase is defined only for a fixed point with respect to the source.

Probably what Mr. Campbell means when he asserts that the ear is phase-sensitive is that the brain is somehow informed of the instantaneous position of each eardrum, and also, that the brain is, after one cycle of the fundamental, able to note the phase angle between that fundamental and its harmonics. (The phase angle between the crossing of the axis of the fundamental and the nearest crossing of the axis of the harmonic can be measured.)

His most serious error, however, was in condemning Fourier analysis of complex waveforms. Fourier analysis (the breakdown of a complex wave into its component sine

(Continued on page 58)

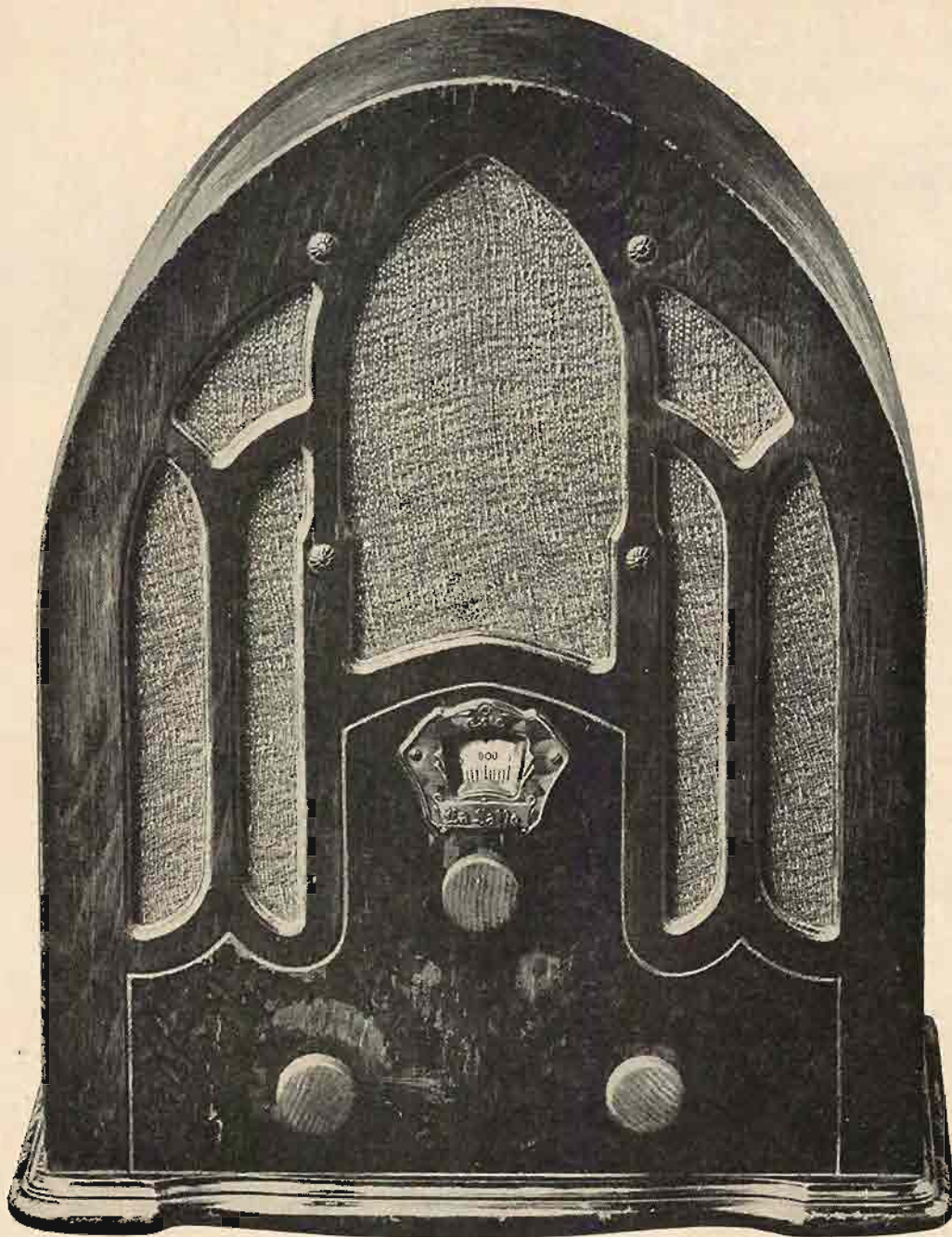

You've Been Listening To Turntables For Years!

From "Dardanella" to "Never On Sunday," from Caruso to Como—as long as good music has been played on radio, it has been played on single-play turntables — **not automatics!***

From the earliest days, broadcasters have known there is no substitute—no equal to the turntable. For professionals concerned with the quality of record reproduction and protection of valuable record libraries, there can be no compromise.

The same reasoning applies to the equipment you select for your home. You want to enjoy all the quality modern records are capable of producing. You want unlimited playback without the noise and distortion of excessive

groove wear. You want simple design—no troublesome gadgetry, no breakdown and repairs. In other words—you need a turntable.

Rek-O-Kut is the only home component manufacturer presently producing and supplying professional turntable equipment to recording studios and radio stations. In broadcasting — turntables are the standard. In turntables—Rek-O-Kut is the standard. Its quality has never been equalled... its reputation is unrivalled. Rek-O-Kut — the first name in turntables.



REK-O-KUT

*Write for FREE BOOKLET "Single-play Turntables versus Automatic Turntables."

Rek-O-Kut Co., Inc., Dept. A-2, 38-19 108th St., Corona 68, N.Y. Export: Morhan Exporting Corp., 458 B'way, N.Y.C. Canada: Atlas Radio, 50 Wingold Ave., Toronto 19

RECORD REVUE

Edward Tatnall Canby*

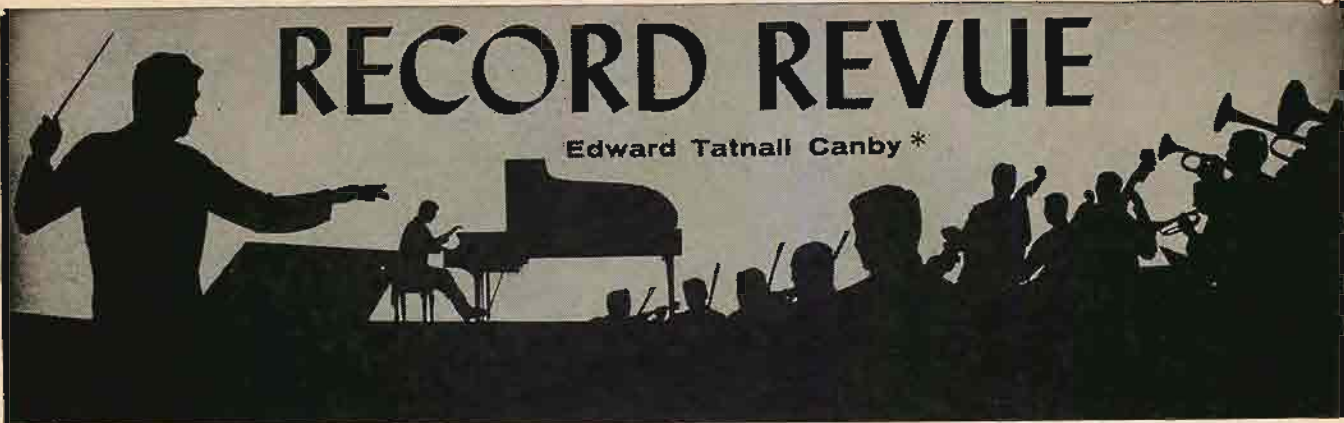

For Trolley Lovers

Interurban Memories (Pacific Electric; North Shore Line).

Mobile Fidelity MF7 stereomonic

Do I hafta play this? Well I certainly will—for my childhood delight was the trolley car and these interurbans bring back memories of our Connecticut 45-mile-an-hour intercity trolleys, the ones we kids called "Waterburles" because that's where they went, via our neighborhood. But the North Shore trolley-trains went a good 80, and in 1935 I took the trip from Milwaukee to Chicago up front in one, just to see what it was like. Terrific.

The two famous lines here recorded are already dead or dying. Among a ton of steam RR recordings, this one is a welcome change, and it'll strike many a heart poignantly even if the old coaches did sound like subways and elevateds, or elderly commuter trains.

Stereomonic? Well, the company says it's new sensation, a stereo disc that plays perfectly on your mono machine. Where have I heard that before? A somewhat subtle hint is given as to how, in the publicity. You figure it. This system isn't cut 45/45, it's *sum-and-difference*. Get it? I *think* I do. Better not ask, though. Just play the record and see what happens. It'll play on a stereo machine, that's for sure.

HERE AND THERE

A Procession With Carols. Choir of Kings College, Cambridge, England.

London OS 25285 stereo

Here's an interesting experiment in dramatic stereo (*much* too late for Xmas, but the better for it) complete with diagrams of the ground-plan for the large gothic chapel in which this complete musical service took place, moving procession-like, by stages from one end of the church to the other.

Instead of an ambulatory mike set-up, the mikes for this documentary were fixed in one position throughout, regardless of the distance to the singers as they moved from one place to another.

You are seated (before your stereo speakers) in a side pew, at a point marked by an arrow on the convenient map. The stations where the choir sings, successively, beginning at the door far away to your distant left, are indicated by numbers; the choir enters the front of the chapel, moves closer in procession for each piece of music (with readings by various persons in between), passes you and goes "offstage" to the right, into the partly hidden choir stalls on each side of the sanctuary, at the front of the church.

The service is presented ostensibly complete (though perhaps modestly edited to remove coughs and sputters and the inevitable too-

long pauses). The musical portion includes works of many types, all sung in the inimitable English cathedral choir style by the highly trained boys' and men's voices. Occasionally the "audience," the congregation, joins in on all sides of you for a hymn.

Some of the music is less than perfect in the singing and there is often a tenseness, a nervous feeling, that can probably be explained by the "live" performance we are hearing—no retakes at leisure here, no coffee breaks. But these slight musical faults are more than offset by the convincing realism of the over-all continuity, for the length of each LP side.

The record is unusual for its stereo daring, in a negative sort of way—for this is surely the most "off-mike" professional recording ever issued! Also one of the lowest in level, for long passages while the choir sings far off in the chapel, perhaps hundreds of feet from the mikes. No attempt at all was made to follow the procession, to adjust the pickup to suit each of the various places at which the choir performs. Only a couple of pieces are actually heard in a normal close miking; all the rest are 'way off, to left or right, behind pillars, around corners.

The recording people were absolutely right. The seemingly "offmike" effects are, in this situation, both dramatic and highly musical and the quiet plastic is able to take the low levels with only marginal interference from surface blemishes. All in all an interestingly successful experiment in recording technique.

The Choir of Salisbury Cathedral.

London OS 25279 stereo
(mono: 5643)

This British cathedral recording is not continuous, like London's "Procession with Carols", above (OS 25285), with the Cambridge King's Chapel Choir, but presents a straight-forward musical service, equivalent to a concert of the choir's repertory music. It is all English, this music, and concentrates on the period that was once thought of as a sort of British musical Dark Age, the bulk of the 17th and 18th centuries. Only Henry Purcell (with one large work here, sung in Latin) has generally been included among the "great." Of the others, William Boyce has been mildly appreciated as a minor composer of little symphonies.

Yet these men, who are now being dutifully resurrected right and left (along with the rest of the once-despised "pre-Bach" composers of other countries) turn out to have a lot to say in their own special fashion. Most of this material is highly worthwhile, if not tops in greatness; only towards the end of the period, heading into the 19th century, does the music become overblown and false—or so it seems with our ears of today.

The choir, if the mikes are to be trusted in such a large cathedral, is a rather gentle one, somewhat overweighted in the male adults, tending towards the wispiest of small, breathy little boys' voices in the sopranos and altos. Diction is not always clear (reverberation?), styling not nearly as fancy as that of the King's College choir with its elaborate rolled "r"s and forced consonants.

One piece is most amusing—an enormous bass solo voice paired against the tiniest

boy's voice you ever heard, on equal terms. I could almost see the two, one soloist reaching easily up to the knees of the other! Yet I suppose it was intended to be in dead earnest. After all, the choir boys in this cathedral have been rehearsing continuously in the same room for 600 years. The weight of that tradition must be almost too great to bear.

Brooks Smith—Beethoven "Kreutzer" Sonata (with Jascha Heifetz).

Heifetz—Bach Concerto for Two Violins (with Erik Friedman). New Symphony Orch. of London, Sargent.

RCA Victor LM/LSC 2577
stereo or mono

If the above titling looks zany, it is. In view of the way the performances stack up here, I figured I'd better reverse some of RCA's billing credits for these two works, which everybody knows require equal cooperation between equal artists, in one case violin and piano, in the other case, two equal violins.

In the famous "Kreutzer"—of all such sonatas the most completely "equal" in its pairing of two instruments—it is not Heifetz but the pianist Brooks Smith who leads.

Heifetz, for reasons one can't expect to guess, is competent but tired, where the music must be of fiery incandescence. Perhaps he has played the work too many hundred times. Brooks Smith does an alive, exciting job at his piano, like Rudolph Serkin at a slightly lower voltage; but RCA gives him no credit at all, beyond one line of small type. Such is musical value versus name appeal!

In the other work, conversely, it is Heifetz who is clearly the leader in the intertwined, overlapping counterpoint for the two fiddles that old Bach has left us. Were it not for differences in violin "personality," the two solo parts would be quite impossible to distinguish in the listening, as Heifetz must have realized after his tricky re-recording job, playing both parts, that was issued years ago. Now, he picks a partner for tonal contrast—and easily dominates him in the playing, though in this case RCA gives extravagant praise to Mr. Friedman for having been chosen as the Great Man's colleague. Fiddlesticks! Don't we all know that great artists tend to pick their companions-in-music with an eye for their own solo status? Why didn't Heifetz pick a big-name violinist to play with him?

Nevertheless, the results are good in the Bach, since one can quite clearly tell Mr. Heifetz's playing from Mr. Friedman's, which is softer, less assertive, less well shaped and colored, though otherwise entirely adequate for the job. I wouldn't be surprised if he was a bit nervous, in the great Presence. Had every right to be. (Mr. Friedman is all of 22.)

The Voice of Erna Sack. (Historic Reissues).
Telefunken TH 97004

The voice of Erna Sack was two voices, both of them on this disc. In normal soprano range, she had a warm German *fräulein* voice, sweetly wobbly, full of sentiment, soft and yielding. (Yielding in pitch, anyhow.) Above

* 780 Greenwich St., New York 14, N. Y.

PING PONG STEREO IS NOT A TECHNICAL ADVANCE!

AN IMPORTANT MESSAGE TO STEREO RECORD BUYERS

We feel the time has come to clear the air with regard to the many new "gimmick terms" which some recording companies are now passing off to the consuming public as great, new, stereophonic technical advances.

It is of great concern to me personally that the consuming public is being confused and misled to believe that certain supposedly "new" recording techniques are important steps forward in stereo recording.

I maintain most of these terminologies are purely commercial sales gimmicks to capitalize on the trend of "Ping Pong" stereo records. In my opinion, it is a mistake to present "Ping Pong" stereo as an advance in stereophonic recording technique.

Obviously it is not.

Certainly it is being used as a commercial sales gimmick.

True or real stereophonic recording, as employed on Audio Fidelity Records, utilizing the "Stereophonic Curtain of Sound®" technique, does not require gimmickry such as recording in different rooms or at different times, etc., in an attempt to achieve separation, high signal-noise ratio, brilliance and clarity.

It is my assumption that the "knowing" record consumer is now ready to mature and progress beyond the "Ping Pong" gimmickry stage in stereo records and will evaluate and enjoy stereo as it should be heard.

If this is so, as an outstanding example of Audio Fidelity's stereophonic recording, may I recommend that you listen to our latest "Curtain of Sound" recording—"Paris," featuring Jo Basile, with accordion and Mashed String Orchestra. We feel this recording, from the standpoint of musical performance, selection of material and stereophonic sound reproduction, is among the finest Audio Fidelity has ever produced... and certainly one of the greatest stereophonic recordings available at this time.

Sidney Frey, PRESIDENT

P.S. We would be very interested in hearing your own views on this subject. Please write. Send for our NEW, FREE complete catalogue.



AFLP 1955
Mono—\$4.98

AFSD 5955
Stereo—\$5.95



AUDIO FIDELITY RECORDS

DEPT. A2, 770 ELEVENTH AVENUE, NEW YORK 19, N.Y.

the normally-expected top—she herself didn't discover this for a long time—she could go on upwards indefinitely. The upper voice is in the piccolo range, high above 99 per cent of all normal sopranos. It sounds that way. Not like a human voice but more like a slightly unsteady tin whistle, afflicted with a cold. The higher she went, the more unhuman it sounded. A preposterous sound, if you ask me, and she only used it for added fancy cadenzas—after all, no composer ever wrote for such squeaks in the super-stratosphere. Most of her singing is just normally pleasant German schmalz.

The "historic" recording is not exactly candid in its get-up. No dates, like the British EMI collectors' series, which gives exact dates and information on every recording presented. By the end of the war, Miss Sack was something less youthful, her main reputation having been pre-war. Out of the "enormous" recorded Sack repertoire, Telefunken has by

the sound of it picked a group of her last recordings, made probably during the war or after it; they are most of them clearly hi-fi and sounding tape-like, with clean highs. The singing, to match, is rather tired and the cadenza passages the worse for wear—she must have been getting towards the end of her rope for these. The very fine sound quality is no excuse for their revival in preference to older discs of better performances that surely were available.

One band, the last on side 1 of this LP, features what is clearly an older Sack recording, minus highs, quite dead in the acoustics, somewhat distorted in the louder parts and at the inner grooves—sounds to be, perhaps, of the early or mid-thirties. On that band, by no accident I'd say, the singing is decidedly better, the voice much steadier and more convincing, the vocal gymnastics more secure. Who cares if it is lo-fi? Can't have your Sack and hi-fi too.

More Beecham Lollipops Royal Philharmonic, Beecham.

Angel S 35865 stereo

The key part of this title is "pops"—as in our American prototype, the Boston Pops, though the Boston pops music takes place in concerts of an informal, beer-hall sort, complete with tables and refreshments, whereas the Beecham pops items served mainly as encore material for his regular concerts. As he says in an inimitable introduction here, these are "little epilogues, corollaries, or afterthoughts" which are "short, taking, and popular in style." Popular not in the American way, of course, but merely in the old-fashioned sense that people like these pieces and don't have to take them too seriously in the listening.

The thing about both Beecham and Arthur Fiedler, of the Boston Pops Orchestra, is that these men have a uniquely high standard for their pops music, both in the music itself and in the performance. Fiedler's is foamier, peppier, sometimes a bit too stumpy and brash but always accurate and musically well phrased and shaped. Beecham's playing is precisely like his playing of all music (I speak figuratively, since he plays merely upon his orchestra)—impeccably accurate, beautifully balanced, every note neatly calculated in impact, duration, shape, function.

The lollipop category does not degrade these works, taken from the most important composers; instead, the impact if anything is enhanced, making more of the music than you might have thought possible. Here we have Berlioz, Debussy, Saint-Saëns, Tchaikovsky, Gounod and Mozart, a cross section of the major Beecham interests, omitting only the heavyweights and the ultra-serious composers of the Beecham stable, such as Wagner and Delius.

There's an earlier bunch of lollipops on Angel S 34406.

Sousa On Review. Eastman Wind Ensemble, Fennell.

Mercury SR 90284 stereo

Don't even need to play this one in order to recommend it to you—it is a sequel to last year's excellent Sousa disc, same performers, same label, and may there be many more, unto the last of the Sousa output. That'll take quite awhile. This professional ensemble, associated with a "classical" music school, does bang-up playings of Sousa, though for some other less worthy types of semi-pops music the group has played with its collective nose a bit high in the air. Not for Sousa—and I agree; he really is a tremendous composer within his self-chosen narrow area. Like Johann Strauss and his relatives. Or Offenbach. Or Gilbert and Sullivan.

Most of the Eastman band records in this series mix Sousa with other march composers. This disc and "Sound Off!" are all-Sousa.

American Band Marches. The Salvation Army New York Staff Band, Holz.

Westminster WST 15056 stereo

Couple of weeks ago I stopped for a red light at the corner of 14th Street and 8th Avenue in New York and caught the sight and sound of one of those timeless half-circles for Salvation, the good ladies of The Salvation Army in their bonnets singing and plop-ploping at the direction of a bonneted leader in the focus of the concavity. They didn't bother with harmony—not enough brass instruments—and the denizens of 14th Street hardly even noticed. Life was much too busy and anyhow, my light changed green at that point.

It wasn't that group which plays here, by a long shot. But this one has a satisfyingly Salvation Army sound to it, quite surprisingly alien to the snazzler and zippler bandism of, say, the Marines and the West Pointers, or the Harvard Band on Yale-Harvard day. This is the super-Salvation band of New York, the one that played *Old Soldiers Never Die* to Gen. MacArthur (and plays it here). It's sincere, competent and practically never out of tune, but it still—bless it—sounds like the Salvation Army.



WHAT GOES ON UNDER THIS COVER IS YOUR BUSINESS!

The view above, of the disassembled Neumann U-67 condenser microphone, is one of the rare occasions you'll have to inspect its inner assembly... (unless you can't resist the temptation) because the U-67 operates virtually service-free. Reasons why? Design innovations perfected after 30 years of extensive research. Here are a few:

TWO MYLAR® DIAPHRAGMS/Polyester foil with evaporation deposited gold, forms each of the two diaphragms. Its effective resistance to heat, moisture, and aging, gives it longevity far beyond the limitations of commonly used materials.

PRINTED CIRCUITS/Shock damage and instability are not for the U-67. Printed circuits are used where advantageous.

GRID CIRCUIT COMPONENT PROTECTION/As a safeguard against humidity, all input components are encapsulated in high resistance silicon compound.

EF 86 TUBE/"Garden-Variety" plug-in EF 86 tube, replaceable by user, achieves outstanding low-noise performance without microphonics. Tube socket is of Teflon.®

To such developments add the most versatile operating facilities ever built into one microphone... switch controlled directional characteristics (all three patterns), voice-music bass cut-off switch, and overload protection switch for extreme close-up miking. These separate compensation possibilities and its foolproof construction, make the U-67 the most functional and the most desirable studio microphone available. Professional net: \$435, at your franchised professional equipment dealer.

*For complete specifications
and more details on the U-67, request bulletin 1-a.*

GOTHAM AUDIO CORPORATION



2 W. 46 St., New York 36, N. Y. (212) CO 5-4111 • 1710 N. La Brea, Hollywood 28, Cal. (213) HO 5-4111

and just as well. Not a hint of ugly commercialism nor TV dress-up.

The jacket notes may give you pause. The Army, with its ancient theme of the Church Militant, the soldiers of the Lord, is evidently still a major force the world over. "Mr. Leidzen (one of the composers) has contributed hundreds of compositions to Salvation Army publications", you'll read. And "This typical brass band march is a favorite with thousands of Salvation Army Bands throughout the world". *What—thou . . . ?* Are there that many? Well, it says here that these players represent 50,000 Salvation Army bandmen who serve in 87 countries! And as I read that astonishing statement, I suddenly remember the last Salvation Army band I heard, back in 1953. It was, come to think of it, exactly like the one on 14th Street in Manhattan. An uneven semi-circle of bonneted ladies and slightly elderly males with uniform caps, and the handful of brass instruments was as dolefully out of tune as ever; after the hymn was over, the leader got up and exhorted the passersby. Where was it? In Neuchatel, Switzerland, on the lake front, and I can't remember whether it happened in French or German. German. French, or Hottentot, the Salvation Army still marches on.

P. S. There's a colossal bass drum in the first march on side 1 of this disc. I thought for a few moments it was some new species of rumble in my turntable. **AE**

AUDIO ETC

(from page 14)

tain problems, back then, better than any of the phone makers of the present have yet managed to do.

I've found, in this small cross-section of the present market, an expected but still startling variation in many aspects, not only in the external appearance and head-holding arrangements but in the sound itself which, hi fi or no, varies decidedly from one set of phones to another, and in macro respects at that.

I'm not too bothered. Yes, I am aware that these phones mostly offer the standard types of "specs" with the usual 20-to-20,000 label that is more or less obligatory in all hi-fi advertising these days. I take most such claims with tolerance and a certain humorous disbelief, come one come all—I feel about the same way I do when I read that this year's Valiant, say, is "completely new." Oh yeah? But if they didn't say that they'd lose most of their customers, even though anybody with half an eye can see that the car is practically the same as last year's, and properly so. It's our fault, and it's ours that we insist on "20 to 20,000" on everything hi fi that we buy, even including phones.

The proof's in the hearing, not the advertised specs. I listened. First, I tried one set of the phones that plug into your ears, miniature-size, and quickly decided one pair was enough. All the others I had on hand were variably large, went on over the ears and were variably cushioned and air sealed; all, if I'm right, depend on the air-space semi-sealed inside the headpieces to bring through the bass end. (There are phones that don't. I'll investigate that later.)

Beyer

First—*Beyer*. These German phones were the most expensive I tried and they were also the most asked-about. I ran a test record (I'll do *that* much testing) into them and found I could hear a 12,000-cps tone, that being about my own top measurement; 10,000 was loud and clear. Going on down, I got all the way to 50 cps easily and without finger pressure on the earpieces (using the older type Beyer ear surround, now be-

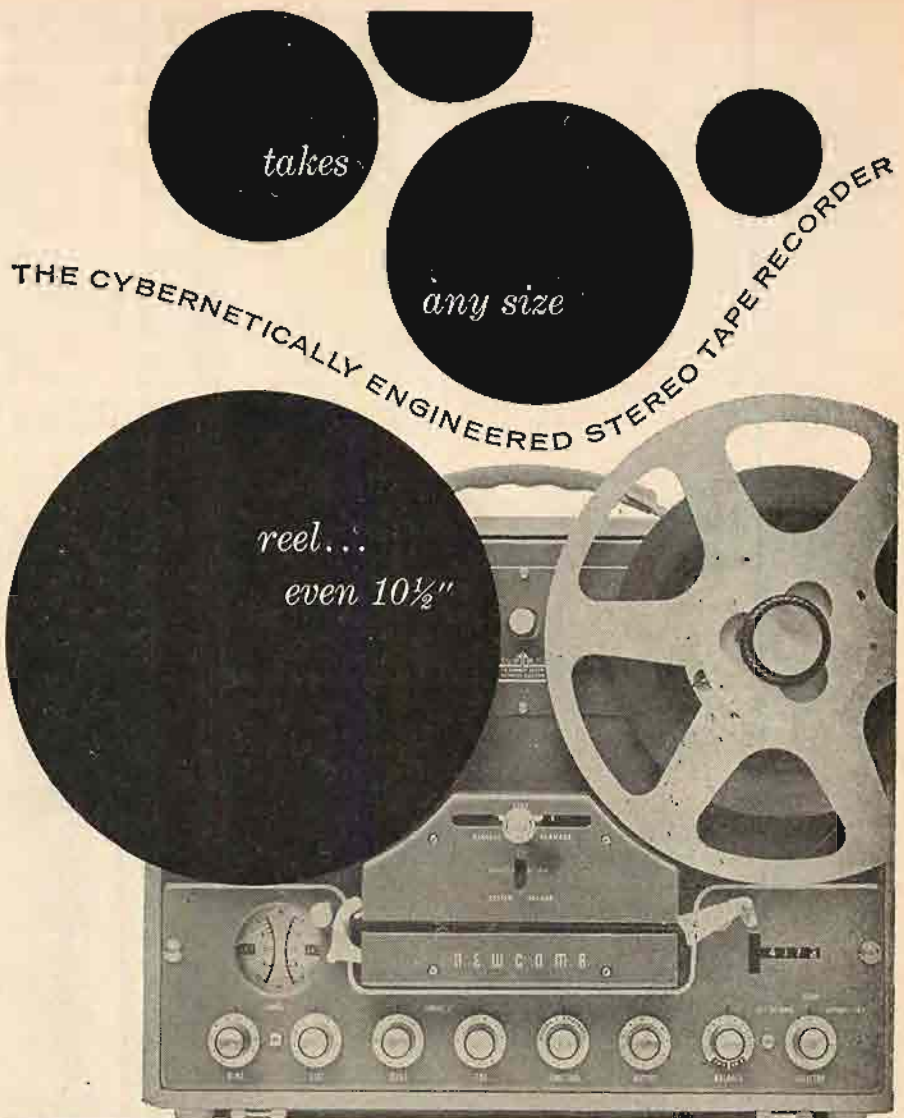

NEWCOMB

- MIXING CONTROLS
- 2 INPUTS EACH CHANNEL
- CANNON SOCKETS
- AUTOMATIC SHUT-OFF
- TWO SPEEDS—7½ or 3¾
- NAB HUB EQUIPPED
- DUAL-ACTING TENSIONER
- PLUG-IN TRANSFORMERS
- MONITOR WHILE RECORDING
- POINTER-TO-POINTER LEVEL METERS
- 4-DIGIT COUNTER
- INTERLOCKED FUNCTION SWITCH
- POWERFUL, COOL-RUNNING, FULLY-SYNCHRONOUS MOTOR

Why is Newcomb's Model SM-310 *the most wanted* stereo tape recorder? Many reasons. One of the first attractions is the fact it takes any size reel including 10½". Then, as acquaintance grows, you become increasingly impressed with its natural ease of operation. Controls are logically arranged. The natural thing to do is the right thing to do. Tape transport is governed by a central joystick. There is now a pause-edit position between "stop" and "play." And this is just one of the features planned with *you*, the operator, in mind. Lighted volume level meters are arranged pointer-to-pointer. The counter displays *four* digits. Tape is loaded easily—in a straight line without looping or threading. And it's so easy on tape...no stretching...no jerking even though the machine reaches playing speed instantaneously. You can operate the Newcomb recorder in any position—vertical or horizontal. All necessary preamplification is built in along with a balance control and ganged volume control. Available in either half-track (SM-310) or quarter-track (SM-310-4) models. The latter records quarter-track and plays back either quarter- or half-track. Matching power amplifier and reproducers are also offered. Learn all the details in your free copy of Bulletin SM-3. Write for yours today.

NEWCOMB AUDIO PRODUCTS COMPANY
Dept. T-2 6824 Lexington Avenue, Hollywood 38, California

ing replaced by larger ones that are more easily sealed). With only a slight finger pressure I heard a distinct smudge of sound that was 40 cps on the test record, coming through the amplifier noise. (I had not yet hooked in the required resistors.) I could not hear 30, 25, or 20 cps—but how many large loudspeakers will bring them through minus doubling?

All in all, these Beyer phones without the slightest doubt can cover the full musical range of sound and they do it (my ear says) with smoothness and considerable presence, once you have them there rightly matched up to their signal source.

The Beyers aren't exactly streamlined in looks. Heavy, black, and German looking (like an old Mercedes), and the single overhead band just happened to rest on a very sore bump on my head (banged it on a

kitchen cabinet door)—which didn't add to my comfort. Not Beyer's fault; but a pair of bands, or a foam-type pillow, would have helped. The early-type earpieces just hang loose at the ears. Though finger pressure is cautioned against in the directions, I found the ear seal somewhat inadequate without it. The newer and larger surrounds (they snap on) fit much more closely. You can get a replacement pair for your present Beyers if you wish.

The Beyer phones are *extremely* sensitive, as is their proper boast. But this leads to problems. Minus resistors (furnished loose in an envelope), the phones require so little speaker output power (they won't work on cathode-follower monitors) that the amplifier noise almost equals the signal itself in volume. It's resistors from the word go. I can't see why they don't install them ready-

connected in the phone lines, this being the case. (Well—probably because the phones might have to be used off 600 ohms, or via a transformer system.)

External difficulties, these, part of the present maladjustment in respect to hi-fi needs that is typical of any "phase 2" development. What matters is that the Beyer phones do sound very good. You can get them to work rightly for you with a bit of patient dickering, a few connectors, resistors, switches, and then you'll be in hi-fi Heaven for fair. Given a few extra polishings-up, less weight, a better head suspension and further earpiece improvement, these phones would be pretty close to the ideal.

Permoflux '52

As a comparison, my old *Permoflux '52* phones are big, clumsy but very comfortable, with inside-out fleece for the cushioning, leather-side to your ears, plus leather-covered dual headbands. They aren't too easy to put on nor adjust, tending to tangle in their own springs and cables, but once on, they are remarkably pleasant to wear, hour after hour.

These Permofluxes have the highly desirable medium impedance rating (200 ohms?), will play very nicely on both sides of the amplifier, "A" monitor or "B" power output. They provide adequate volume off any normal monitor circuit, and they play with practicable volume, not too excessive, off any power amplifier. Resistors not really required. In these respects they are to my way of thinking ideal, and that is one reason why I ring them in here, a decade after their original appearance.

In sound, the Permofluxes still rate as the next-best phones I've heard so far. They are bright and clear up to 8000 cps, fade out before the 10,000-cps figure. Not as good as Beyer, but plenty good enough for virtually complete musical intelligence and for first-rate speech quality. There's a slight peakiness in the "presence" range, admirably designed to compensate for the lack of very high highs. In the bass, the Permofluxes do as well as Beyer. I could hear the 40-cps tone faintly, though 50 cps was markedly better. (It sounds louder than 40 cps anyhow because of the ear's falling-off in response to lower tones.)

For speech realism I'd place the Permoflux '52 sound at the very top. Excellent! On music, these phones easily equal Beyer in over-all effect, but technically lack the Beyer extended upper range, nor is the response quite as peak-free. Still, these two phone models both bring through an exemplary sense of musical balance and naturalness—the Permofluxes doing a more imaginative job partly because their huge earpieces shut out more of the intruding outside world, so you can lose yourself in sheer sound! Good idea, decidedly.

Now I wonder whether I could mount a Beyer driver in a Permoflux "chassis"? Or maybe in a Telex. I'm always ready to dicker in *that* fashion. . . .

Telex

The *Telex* phones, quite inexpensive, were by far the most comfortable I tried. An excellent external design, using foam rubber of the sort that has a very soft, easily wrinkled-up leather-like exterior surface. It isn't sweaty, it doesn't press too hard and it contours itself to your head with marvelous ease under very light pressure. A rubber covered dual headband and a very simple slide adjustment keeps these extremely light phones in place. The ensemble is a nice brown in color, with contrasting

AUDIBLY SUPERIOR..

... **TRANSIENT RESPONSE**—Unique low inertial single metal diaphragm system results in superior transient response and crystal clear definition at highest levels. Especially obvious when recording cymbals, trumpets or piano.

... **FREQUENCY RESPONSE**—AT LAST, a condenser microphone WITHOUT high frequency peaks. Piano and voice are reproduced without shrillness.

... **LACK OF DISTORTION**—Significantly lower distortion, never exceeding 0.3% at sound pressure levels to 115dB above 0.0002 microbar. Impossible to overload condenser capsule.

... **FRONT-TO-BACK RATIO**—Highest wideband rejection over the important midrange; at least 26dB. Since directional patterns are varied acoustically rather than electrically, frequency and sensitivity characteristics are not disturbed.

UNEQUALLED PERFORMANCE

The unique feature that makes Schoeps microphones superior to all others is its patented single metal diaphragm construction. Pattern switching is achieved by altering the acoustic chambers behind the diaphragm. This system guarantees not only a smoother high frequency response but also a higher front-to-back discrimination in the cardioid pattern.

GREATEST VERSATILITY

Schoeps microphones are available in two series. The CM 60 series uses a standard 6AU6 plug-in tube. The smaller M221B series (illustrated) features a number of interchangeable condenser capsules. A full range of accessories, including a unique MS stereo adapter, makes Schoeps the most versatile microphone in the world.

Schoeps is the only condenser microphone approved for use by the entire French radio and television broadcasting system.

COMPARE THE SCHOEPS

You are cordially invited to try the Schoeps microphone on location or in your own studio. We are confident that you will find the Schoeps system vastly superior to any condenser microphone. Write or phone for a demonstration. Literature is available on request.

INTERNATIONAL ELECTROACOUSTICS INCORPORATED
333 SIXTH AVENUE NEW YORK 14, N. Y. 212 WA 9-8364



Actual Size



cream joints, and, really, these phones are good looking on anybody's head. Impressive.

The Telex phones reproduced upwards about as high as the old Permofluxes (I couldn't hear any 10,000 cps, but the important tones just below were very much there), and have a similar slight brilliance in the upper "presence" end. But these phones suffer somewhat from one lack, not enough bass. Couldn't hear anything below 60 cps; but what counts is the over-all bass power, which fell off seriously enough to give a rather thinnish sound to music. Not at all bad and I expect a minor engineering dicker could fix these phones to be the most desirable in their price range. Three wire; I rewired them to four, and you'd better do the same.

General Phones

General Phones. This set of phones, which came in some time ago, has me mystified. High fidelity is the name attached, along with "20 to 17,500 cps" and "no annoying peaks." They are supposed to be easy to wear ("easiest wearing headphones ever made"). Not for me.

But what really bothered me about these phones was the sound. Did I do something wrong? Are they defective, or out of order? (But the two sound the same, so it's both of them.) All I know is that I could just barely hear the 6000-cps test tone and not a whisper of sound any higher; and in the bass I got down no further than a faint 80 cps, even with the earpieces pressed to my head. The over-all effect was surely "peak-free" but it was so completely muffled and lifeless that every listener who has tried them has made faces.

These phones are built in the old style, on free-turning spindle mounts that go 'round and 'round, with a heavy dual overhead spring; the things tied themselves in knots long before you could get them on your head. The ear surrounds are of heavy, thick rubber, uncomfortably sweaty and un-contoured for not much of a seal. The mechanism is described as "variable reluctance" and it surely is; but the metal diaphragm drive looks like a variant of the old and familiar pre-hi-fi arrangement we've had for a half century or so. The phones, I note, were adapted from a military tank communications system.

Knight

The last set of phones to come in, shortly before a late deadline, was the Allied Radio mail-order *Knight KN 840*, modest in price and quite radical in looks—cream-white phones with fancy brushed-metal arms running up to a flat black plastic top piece lined underneath with foam. The phones turn 'round on spindles and can be telescoped for fit, but tangling is unlikely since the earpieces stay at least three inches or so apart and can't be crossed. Four-wire connections, neatly brought together into a paired, shielded, gray plastic cable, like a lamp cord. The phone plug is three-contact; I snipped it off and attached my usual four-contact Jones plug combo.

(Note the usual anomaly: two "hot" leads and two surrounding "shields," the two channels kept entirely separate right up to the phone plugs, where the "shields"—at 45 ohms—join into a common "ground.")

Good looking, these Knights, but in practice I found that I must have a very peculiar head, for I couldn't find a comfortable "hang" for the square overhead ensemble. Stuck out on both sides, and the phones sort of dangled straight down, and didn't



FM • STEREO • MULTIPLEX All on One Chassis and in KIT FORM

That's Right — No external Multiplex Adapter required... PACO introduces the new model ST-35MX FM Stereo Multiplex tuner, featuring the finest multiplex circuitry, ALL ON ONE CHASSIS... ALL IN ONE CABINET AND IN KIT FORM (with factory pre-aligned multiplex section).

by **PACO**

The ST-35MX FM Stereo-multiplex tuner is designed for the discriminating Audiophile who demands the ultimate in distortionless FM Stereo reception. Its incomparable features include ultra high sensitivity, rock-stable AFC, pin point selectivity combined with broad band response.

The ST-35MX has been engineered to meet the most critical standards. Highly styled in a handsome black and gold case... it is the perfect companion to Paco's popular SA-40 Stereo preamp-amplifier or any other fine quality stereo system.

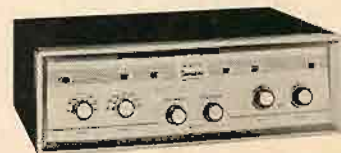

**Model SA-40
STEREO PREAMP-AMPLIFIER KIT**
Kit Net Price: \$79.95
Factory Wired Net Price: \$129.95



**Model ST-25 MX
FM STEREO TUNER KIT**
Kit Net Price: \$69.95
Factory Wired Net Price: \$99.95

AVAILABLE THREE WAYS IN HANDSOME GOLD AND BLACK ENCLOSURE

MODEL ST-35MX (Kit) with full pre-aligned multiplex circuitry and PACO detailed assembly—operating manual.
NET PRICE \$99.95

MODEL ST-35PAMX (Semi-Kit) with both tuner and multiplex sections factory-wired and completely prealigned for hairline sensitivity. Complete with PACO detailed assembly — operating manualNET PRICE \$119.95

MODEL ST-35WMX (ready to operate). Factory-Wired, aligned, calibrated and assembled complete with operating manualNET PRICE \$139.95



**Model MX-100
STEREO MULTIPLEX ADAPTER**
Kit Net Price: \$49.95
Factory Wired Net Price: \$69.95

PACO Electronics Co., Inc.
a division of **PRECISION Apparatus Co., Inc.**
Subsidiaries of Pacotronics, Inc.
70-31 84th Street, Glendale 27, Long Island, New York

See the full line of PACO Hi-Fi Stereo components on display at all leading distributors throughout the world.

Manufacturers of Fine Electronic Equipment for over 30 years.

seal very well with their somewhat shiny rubber flanges. The top of my brain-case simply wasn't flat enough.

As to sound, these Knights, oppositely to the Telex phones, had a nice bass response but I found their highs rather deficient with a slight whistling sound, a peakish effect, somewhere in the lower middle, and a lack of "presence." Not musically very satisfying and the speech sibilants were not too convincing.

These phones are electrically interesting in that, in contrast to Beyer (4 ohms) and the numerous 8-ohm models, these rate at 45 ohms each "to optimize speaker damping." Thus on the cathode-follower type of "A" area monitor circuit they were distinctly louder than the other newer models, though still considerably fainter than my optimum Permoflux '52 phones. As might

be expected, too, they were much louder than Permoflux off a standard power amplifier output and brought through the expected amplifier noise, due to the necessary low volume-setting minus resistors. Even at 45 ohms the resistors are definitely needed.

Allied Radio has gone to considerable lengths to provide unusually easy matching-up for these phones under present conditions. There's a companion Control Unit, the KN-841, which includes everything you'll likely need, with level set, "stereo" balance and "stereo"-mono for chairside use. This, you see, makes the phones strictly "B" devices: the Control Unit connects to the power amplifier output, preferably at 16 ohms. (But it still makes use of the three-conductor phone plug.)

Allied also has put a 1-watt power jack (see above) on its Knight KN 771 ampli-

fier to take these phones direct. More "B" circuitry (but still via the three-conductor "shielded" phone plug).

Watches and Clocks

All in all, I can so far recommend only two of these sets without serious reservations as hi-fi headphones. And both of them are expensive. Or were. The Beyers run up in the \$80 range. The Permofluxes cost \$50 in 1952, might rate a good \$70 now and well worth it, I'd say.

Now this does not mean I am condemning the other, and much less expensive phones. You get what you pay for these days, 20 to 20,000 or no. Good phones cost money. They are a bit like watches compared to clocks, after all. Just because they are small they aren't going to be cheap. Likely the other way 'round.

With headphones still a novelty and demand a bit hesitant, people don't tucker to the idea of astronomical sums for phones. So these makers have had to strike towards what are really too-low prices—or else. \$15, \$25, \$30—how much *top* hi fi can you get from a pair of *loudspeakers* at these prices? How much do you pay for top loudspeaker quality—not counting the enclosure? And in pairs, remember. Phones come in pairs.

Until we learn that headphones must *cost like speakers* if they are to equal speakers in sound quality, we are bound to be offered "20 to 20,000" phones at too-low prices and consequently, in spite of ingenuity, too-low quality. Too low, that is, for ultimate perfection, which we all want. And so I trust that the various makers will accept my somewhat frank remarks (and readers too) as friendly evaluation, rather than criticism. At a relatively low price you may have, in all of these and others, a good starting buy to launch you into the wonders of headphoney without breaking your pocketbook.

With continued application of thoughtful cybernetics—engineering for *people*—with a jiggering-up and dickering-around of sound quality here and there, for more over-all presence and naturalness, the present phones can surely be modified into highly worthwhile low-cost transducers, easily superior to most pairs of speakers in the same price range. Keep *that* in mind.

And as always, if the makers will borrow good ideas from each other, if they will figure out a better and a standard type of electrical configuration and pluggery for our use, if they'll persuade all of their customers that a bit of cash can do wonders for hi fi in headphones just as everywhere else, we'll soon reach really high levels of achievement in this new phone area at every price level.

In later comment I expect to offer some general ideas towards the perfect "all-American" or "all-universe" phone, as well as evaluate a few more models. Æ

CAMPBELL

(from page 50)

waves) *preserves waveshape*, and is a true and accurate method of investigation. If audio engineers have preferred to ignore the phase relationships inherent in a Fourier series, that is their error, not the mathematicians'. To do violence to his example, a square wave generated by sine waves added in the proper frequencies, amplitudes, and phase relationships is absolutely indistinguishable from a square wave generated by clipping. There is *no* difference between them—*none*.



INSTRUMENTS FOR PRECISION CIRCUIT ANALYSIS

For every type of service. These quality instruments are supplied as original equipment with many broadcast station installations.

NEW B & W Model 410 Distortion Meter



- Measures: Audio distortion, noise level and audio voltage level.
- Ideal for FCC Proof of Performance Tests and laboratory measurements.
- Measures distortion as low as .1% on fundamental frequencies from 20 to 20,000 cycles.
- The sensitive vacuum tube voltmeter circuit measures AC voltage with an accuracy of $\pm 5\%$ through a frequency range of 20 to 200,000 cycles.
- The calibrated attenuator permits noise and db measurements over an extremely wide range.
- The Model 410 is a quality instrument, attractively styled and nominally priced.
- Drop us a card for a Spec Sheet.



MODEL 200 AUDIO OSCILLATOR

- Frequency Range: 30 to 30,000 cycles.
- Frequency Response: Better than ± 1 db. 30 to 15,000 cycles with 500 ohm load.
- Stability: Better than 1%.
- Calibration: $\pm 3.0\%$ of scale reading.
- Voltage Output: 10 volts into 500 ohm load.
- Distortion: Less than .2% at 5 volts output.



MODEL 600 DIP METER

- Covers 1.75 to 260 mc in 5 bands.
- Monitoring jack & B+ OFF switch.
- Shaped for use in hard-to-get-at places.
- Sturdy, color coded, plug-in coils.
- Adjustable, 500 microamp meter.



Barker & Williamson, Inc.
Canal Street & Beaver Dam Road, Bristol, Penna.

Specialists in Designing and building equipment to operating specifications

B&W also design and manufacture filters for: ANTENNAS • RADIO INTERFERENCE • RADIO RANGE • UHF and VHF as well as many special types designed to performance specifications. Available to commercial or military standards.

All these considerations, of course, do not detract from the possibility that phase shift between fundamentals and harmonics is a source of listening fatigue, and I for one am grateful that Mr. Campbell brought the matter to light.

Robert McNeill
Briarcliff Manor, New York

Sir:

The article on "Sineward Distortion" by John Campbell, is not new. Referring to October, 1956 issue of *CQ*, there is an article entitled "The Sawing Machine," by the same John Campbell. The title referring to a sawtooth generator capable of forcing this mysterious distortion out in the open.

The original article showed examples and one practical solution. It seems Mr. Campbell should have sent the first story to *AUDIO*, as it seemed to arouse little interest at the time.

In 1956 Mr. Campbell was editor for *As-tounding Science Fiction*. Space travel was once science fiction, and apparently some think the same of "Sineward Distortion."

Perhaps a few examples and solutions will bring it down to earth.

John C. Cook
1736 Eveleth Avenue
San Leandro, Calif.

Sir:

A complex waveform, even a genuine musical tone, is or can be composed of a number of harmonically related sine waves. For example, a plucked string in a music instrument can be demonstrated to be vibrating in several modes simultaneously with each mode producing its sinewave component of the net musical waveform.

A complex waveform can be converted into a sine wave only by removing from it all but one sinewave component, usually the lowest or fundamental frequency. No amount of phase distortion will do the job. However, phase distortion will alter the waveform. Mr. Campbell made a point of this alteration by phase distortion, even though it directly conflicts with his contention that the complex wave is not made up of components. By definition, phase ex-

presses a relationship between two or more things or conditions, and if the waveform did not have two or more components in it, it could not possibly suffer phase distortion.

The not quite oscillating phase shift oscillator in *Fig. 2* will not function as a perfectly good RC coupled amplifier stage. It is not valid to state that it can be tested with a conventional sinewave generator without misbehavior or that its frequency response is flat across the audio spectrum. On the contrary, it is very difficult to test because of its misbehaviors and the frequency response is far from being flat. This conclusion is based upon theory and my own laboratory tests.

The three tube version in *Fig. 3* is not the equivalent of *Fig. 2*. In fact, it is not even an amplifier. With the feedback shown the output is tied directly to the input, thus making it impossible for gain (or loss) to exist. It is nothing but a frequency-sensitive shunt across essentially a common input and output terminal.

There are so many things wrong with

(Continued on page 67)

And — has the KLH sound*

Up to now, the bottom price for a high quality stereo system has been well over \$500 — more than many people feel they can afford. The KLH Model Ten — uncompromised in performance, lower in price, and operating with smaller, less costly electronic components — substantially lowers this cost threshold for a good high fidelity system.

The Model Ten is a summation of everything that is known about the sophisticated design of high performance speaker systems. It is produced with the most advanced, automated techniques, quality-controlled as carefully as any other KLH speaker.

We have never been more pleased with any other loudspeaker we have made. We believe you will be, too.

*KLH loudspeaker systems are sold exclusively through franchised dealers.

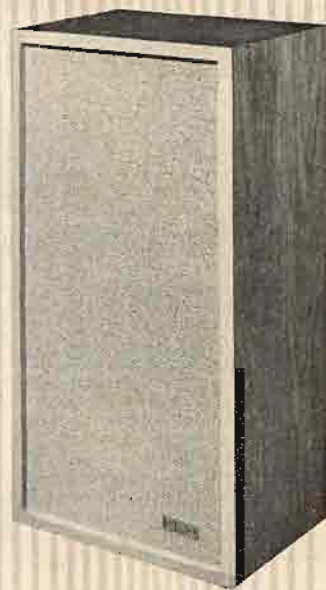

*The KLH Model Ten speaker system
Is smaller than our other models —
a true bookshelf speaker,
Costs less than our other models —
under \$90,
Operates with a 12 watt amplifier —
up to 60 watts if you wish,
And — has the KLH sound.*



KLH RESEARCH AND DEVELOPMENT CORPORATION
30 CROSS STREET, CAMBRIDGE 39, MASSACHUSETTS

JAZZ and all that

CHARLES A. ROBERTSON*

STEREO

Chicago: The Living Legends
Riverside Stereo 9389/9390

After winning so much praise for visiting New Orleans and recording the veterans still living at home, the "Living Legends" series moves on to the next logical place to look for survivors of the great early days of traditional jazz. The search continues with the same keen sense of discovery as before, and the assembled Chicago groups prove to be equally lively and full of surprises. Riverside's mobile recording unit made the trip this time, but Chris Albertson again took charge of the project and spent two weeks scheduling sessions last September. This two-volume set contains his account of the proceedings, with photographs, and introduces all the historic figures who turned up. In addition to the generous samplings here, each spirited contingent will have at least one album to itself, and the entire series promises to be a jazz event of major import.

One stroke of good fortune is the presence of Earl Hines, who happened to be passing through town on tour, and his name still epitomizes Chicago jazz to many people. His famous piano style was born and bred there, and he remained for more than twenty-five years before moving to San Francisco. He solos as strongly as ever on *Caution Blues*, while the entire sextet shimmies on *Sister Kate*. It is the first recording of Hines with a regular band of his own in better than a decade, and piano fanciers will appreciate hearing his powerful left hand striding out with the horns once again.

Another working group still holding the traditional banner high is Franz Jackson's Original Jass All-Stars, and years of playing for patrons of such local clubs as the Red Arrow and Jazz Unlimited have formed a compact unit which marches jauntily by to the tune of *1919 Rag*. Life moved faster in Chicago, and both the temperature and tempo increases on *Hotter Than That*. Vocalists also grew in popularity and began to preempt more and more solo space. The team of Alberta Hunter and Lovie Austin recreates the first blues session on the Paramount label, showing how the way was paved for Bessie Smith to record *Downhearted Blues*. Al Wynn's Gutbucket Seven features Blind John Davis on *How Long Blues*, and provides a haven for Bus Moten, a refugee from Kansas City who once sang with his brother Bennie's great band. Little Brother Montgomery plays and sings the blues with several proteges, then accompanies the most venerable performer to appear. At eighty-four, Mama Yancey promptly steals the show with her own *Santa Fe Blues*.

Among the surprises uncovered is Junie Cobb's New Hometown Band, a seven-piece dance outfit which might be described as a Chicago counterpart of Buddy Tate's Celebrity Club orchestra in Harlem. Cobb writes the material, plays piano, and gives the

legendary "Banjo Ike" Robinson at home. The Mississippi Sheiks, a small skiffle group headed by guitarist-singer Walter Vinson, recalls the time when rent parties were the order of the day.

A show of hands by all concerned would probably reveal that the majority first recorded on acoustic equipment, and the series spans a good forty years of recording history. But a generation capable of mixing bathtub gin is fully prepared for stereo. The irrepressible Lil Armstrong borrows two front lines and places them face-to-face on opposing sides of the stage. Trumpet breaks and trombone smears fly back and forth at random, and no arrangement could ever plot the course followed on *Bugle Blues*, and *Muskrat Ramble*.

Barrett Clark and Richard Cohn were in charge of the mobile unit and first set up operations at Prince Hall Masonic Temple. The location proved unsuitable because of street noises, let alone acoustics that allow Jimmy Archey's trombone to run rampant behind Alberta Hunter. The remaining sessions took place at The Birdhouse, a citadel of modern jazz which probably never will be the same again, and even the acrobatics of the dual front lines fail to elude the engineers. Riverside eventually may get around to taking a more leisurely look in its own backyard for living legends, even though Prestige is already exploring the New York scene. For a starter, the label's new contract with Red Garland could be used in tracing Harlem piano styles. Putting Garland in the studio beside Luckey Roberts, his pianistic mentor, should reveal quite a bit about the links between new and old.

Howard McGhee: Maggie's Back In Town
Contemporary Stereo S7596

Words of praise always greet the initial recording of a jazz veteran staging a comeback, but everything depends on what is said after the third or fourth time around. Howard McGhee has steadily improved since returning to the studios with a version of the score to "The Connection" on Felsted, and each of his albums is better than the one before. On a Bethlehem set and an appearance with Teddy Edward on another Contemporary release, McGhee demonstrates that he can hold his own with the new crop of trumpet players. Now, stepping out with only a rhythm section, McGhee meets the supreme test and passes with flying colors by simply playing what he feels. "After I got myself together," McGhee explains, "I began listening to what all the guys were doing, and I decided to play like me. I don't play like I used to play, running up and down the horn and hitting the high notes. Now I play what I feel."

At forty-three, McGhee no longer worries about current trends or fashions, but utilizes everything learned over the years to create a timeless style. He knows the blues from before the swing era, remembers the story of bop from the inside, and is mature enough now to play ballads with controlled passion and melodic imagination. The temptation

to show off his old technical prowess and speed wins out briefly, however, and he whips up considerable excitement on *Brownie Speaks*, and his own *Demon Chase*. Teddy Edwards contributes *Sunset Eyes*, and the hearty welcome of the title tune. McGhee is complete master of all he surveys on *Willow Weep For Me*, *Summertime*, and *Softly, As In A Morning Sunrise*. After winning attention as a young piano virtuoso, Phineas Newborn also is rapidly acquiring a sense of maturity and emotional directness, and his pointed dialogues with McGhee come off brilliantly in stereo. Leroy Vinnegar, bass, and drummer Shelly Manne give the quartet a buoyant foundation. Not only does McGhee attain a new peak, but he somehow compresses into the short span of a single set all the experience of a lifetime.

Van Alexander: Swing! Staged For Stereo!
Capitol Stereo STAC 1635

In keeping with the trend to special stereo series in super packaging, Capitol is introducing a "Staged for Stereo" line, and the first five releases boast all the luxurious features that drive many autoists to the purchase of compact cars. Each vinyl platter comes snugly enclosed in a dustproof plastic case, and only a few additional steps would be required to manufacture a workable turntable. A rigid rim prevents any damage from outside pressure, and a spindle for the center hole provides further insurance against scratches caused by rubbing against the case. A little more ingenuity in designing the spindle might have resulted in a method of putting records into play without the contaminating touch of human hands. Still, the Tempest owner can quell any extravagant tastes at a price considerably less than the outlay for a Cadillac. If every compact car buyer responds to the lure, perhaps the theory behind this type of merchandising is valid after all.

On the other hand, the accompanying booklet is a masterpiece of economy, as it dispenses with most of the excess verbiage usually dragged out to explain stereo and describe special effects. Simple diagrams for each selection illustrate the exact placement of various instruments. Quite a few different seating plans are tried out, so the diagrams really come in handy and do away with any necessity of reading the adjectives in the text more than once.

Van Alexander handles the new line's entry in the swing division, turning out sleek, high-powered models with the help of a bunch of Hollywood studio regulars. When studying Henderson's style twenty-five years ago, Alexander certainly never imagined his mentor might be frustrated. Since posthumous analysis is supposed to have established the fact well enough for the word to be used in the title of a recent Henderson reissue album, Alexander may be worrying about the frustrations of a soft Hollywood life. At least, it appears as though he would gladly give up a movie or television contract to write for the old Chick Webb band once again. He stages a drum battle between Shelly Manne and Alvin Stroller on *Get Me To The Church On Time*, and pits Irv Cotler against Milt Holland in percussion duels on *Old Man River*, *Strike Up The Band*, and his own *Tappin' On The Taps*. He dips into the Ellington book for *In A Mellowtone*, featuring tenor-sax exchanges from Babe Rusin and Plas Johnson, and pays tribute to Henderson on *Stealin' Apples*, with duet trumpet passages by Joe Graves and Shorty Sherock.

Capitol engineers have always regarded stereo as an opportunity to open out a wide stage in the living room rather than as an excuse for trick effects, so the new series finds them going about their duties pretty much as always. Aside from the packaging, about the only difference from a plain, ordinary Capitol album is the changing of orchestral settings for each number. The scenes shift rapidly, highlighting twin pianists Bobby Stevenson and Henri Rose on *I Won't Dance*, and *Lulu's Back In Town*. Latin drummers Frank Guerro and Jack Navarra deliver a mambo version of *Way Down Yon-*

* 732 The Parkway, Mamaroneck, N.Y.

NEW

.....VALUE ENGINEERED

FOR LOWEST INSTALLED COST

8" SPEAKERS FOR DISTRIBUTED SOUND

This new line of Jensen 8-inch Professional Series loudspeakers is specially designed to meet the exacting rigorous demands for commercial sound installations. The 8-inch size is ideal for the majority of all distributed sound systems giving more than adequate low frequency range without enclosure and mounting complications.

A wide selection of models to meet every need—from the lowest cost highly competitive application to the most sophisticated highest quality system.

This entire line is *value engineered* for lowest installed cost of the entire system. Convenient 10-pack with or without preattached 70.7 or 25-volt transformers are options available. Handy KWIKON* instant connectors for input and power tap adjustment.

For full details write for individual data/specifications available on each speaker.

1. AVAILABLE IN HANDY 10-PACK

Added savings and convenience in bulk-packed carton of ten speakers, with or without preattached transformers.

2. PREATTACHED TRANSFORMERS

CHOICE OF 70 AND 25-VOLT LINE TYPES

Especially designed for use with the popular "constant voltage" distribution systems. Center-tapped primary windings for balanced-line or special circuit needs. Tapped secondary for adjustment of power to 8-ohm speaker in 3 db steps from 1/8 watt to 4 watts. Core size 3/8" x 3/8". Two 3/16" dia. mounting holes on 2 3/8" centers. Prices below are for transformers only.

70CV4. For 70-volt distribution systems.

25CV4. For 25-volt distribution systems.

List Price.....\$4.75



3. KWIKON* INSTANT CONNECTORS

Simply twist bare ends of two 12" input leads supplied for each speaker to incoming signal cable leads, insulate with wire-nut or tape. Slide sleeve clips onto input terminal lugs of speaker or preattached transformer as speaker assembly is raised into place. KWIKON* instant connectors also provide simple fast power tap adjustment on transformer.

*T.M.



C-855



C-840
C-850

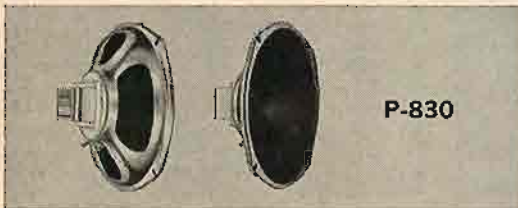

P-830

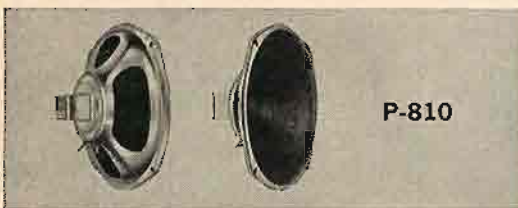

P-810

Model	Power Rating Watts	Magnet Weight Ounces	Loudness Level ⁽³⁾	Overall Depth	Net Weight Pounds	List Price
C-855	12	10.0 ⁽¹⁾	85.0	3 1/16"	2 1/2	\$13.50
C-850	12	10.0 ⁽¹⁾	85.5	3"	2 3/8	12.95
C-840	11	6.0 ⁽¹⁾	84.5	2 1/2 1/16"	2	10.95
P-830	10	2.5 ⁽²⁾	84.0	3 1/4"	1 1/4	7.25
P-810	9	1.47 ⁽²⁾	82.0	3 5/16"	7/8	5.80

(1)—SYNTOX-6® Ceramic. (2)—DP-Alnico-5.
 (3)—db above 2x10⁻⁴ dynes/cm.² @ 10 Ft. for input power of 1.0 watt standard 800-1250 cps warble signal.
 Speakers conform to applicable EIA Standards. Max. O.D. 8 1/2"; width and height 7 1/16". Recommended baffle cutout 6 1/2" dia. Nom. voice coil impedance 8 ohms. Facilities for standard 2-hole mounting transformers up to 3/4 x 3/4 nominal core size.

Jensen MANUFACTURING COMPANY
 Division of THE MUTER COMPANY
 6601 S. Laramie Avenue, Chicago 38, Illinois
 In Mexico: Universal De Mexico, S.A., Mexico, D.F.

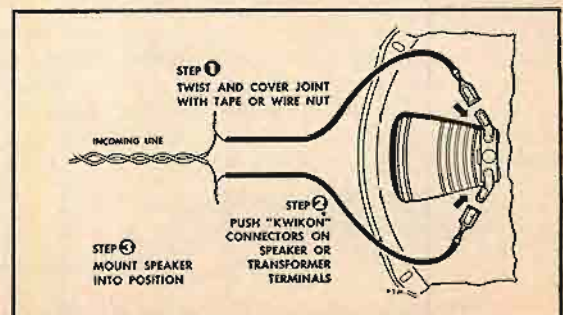

der in New Orleans, while a sauba beat enlivens *High Noon*.

But producers started to try out this innovation on vocalist dates even before stereo was publicly introduced. By now, there is close cooperation from all concerned in creating dramatic presentations, but engineers may start asking for stagehand pay if the scenery must be shifted so often.

Clark Terry: Color Changes

Candid Stereo 9009

Since giving up the life of a traveling band musician for a less arduous staff position at NBC, Clark Terry has wasted few of the newly acquired leisure hours. He answers studio calls for everything from stereo spectaculars to space flight with Thelonious Monk, and recently joined forces with Bob Brookmeyer to take on a couple of club dates.

Work as a sideman keeps the former Duke Ellington and Quincy Jones trumpet star so busy that any projects of his own are apt to be turned out to pasture for awhile. They come back friskier than ever, and Terry has enough ideas in shape to fill several albums whenever he takes up the reins on one of his own. Entries are always varied and colorful, but Terry believes the combination picked this time sums up his feelings about jazz better than ever before.

A good example of his conditioning process at work is *Blue Waltz*, which Bob Wilbur imported from Vienna and recorded with Terry's help not so long ago. The present octet version boasts the sonorities of Julius Watkins on French horn, the prancing trombone bursts of Jimmy Knepper, and the finely groomed tenor-sax solos of Seldon Powell and Yusef Lateef. The European tour continues with three reminiscences of Terry's

visit to Paris three years ago, starting with *No Problem*, a Duke Jordan original now serving also as a theme for the French film "Liaisons Dangereuses." Terry adds warm, personal impressions of such local landmarks as *La Rive Gauche*, and *Chat Qui Peche*.

But it is Terry's own grand tour of New York studios that distinguishes this effort from his other albums as leader. He was alert enough while making the rounds to study various recording techniques and observe the changes being wrought by stereo. Quite a bit of what was learned along the way is employed here to enhance arrangements and create novel orchestral textures. Rather than try to make eight men sound like twice as many, Terry is satisfied to work out a number of enticing instrumental groupings. Besides alternating between trumpet and flugelhorn, Terry uses stereo to pit himself against the opposite flutes of Powell and Lateef on *Flutin' and Flugin'*. Lateef switches in turn to oboes on an exotic Far Eastern salute to *Brother Terry*, and plays sultry English horn on *Nahstye Blues*. The rhythm team on Tommy Flanagan, piano, Joe Benjamin, bass, and drummer Ed Shaughnessy responds amiably to all the changing moods. Of course, Terry learned about such things from Ellington first, but some lessons can be mastered only by leading a group in the studio. Terry knows from experience, and the engineering by Bob d'Orleans of Nola Studios is equally skilled.

The future of Candid is in doubt at the moment, and one of the most promising new jazz labels may be forced to suspend operations. Despite all the lofty claims made at the launching as to noncommercial aims, the project is running up against the hard facts of distribution. Unless a certain number of releases is forthcoming each month, distributors soon become dissatisfied. Retailers often refuse to handle a new line that is unable to tie up established artists to exclusive contracts. Candid has yet to reach the market place in many areas, and may do so only through the remainder route. Collectors should keep their eyes peeled, as the opportunity to obtain desired items at a reasonable price may disappear rather quickly. Everything in the catalog meets the same high standards of production as the current Terry offering, and there is something to suit every taste. If the gaps in enough collections are filled now, Candid could get another lease on life.

Thelonious Monk with John Coltrane Jazzland Stereo JLP9465

As contract restrictions were never cleared away to permit a location recording at New York's Five Spot Cafe when Thelonious Monk and John Coltrane played there in 1957, it was thought until now that no tangible memento of the historic meeting existed. Luckily, Riverside slipped the original quartet into Reeves Sound Studios long enough for at least three numbers in stereo, and removal of the last legal block finally brings about the release of the next best thing to a recording made on-the-spot. Hearing the group in its natural habitat four years ago was an experience few will forget. The sound and the place went together, or as J. J. Johnson describes it, "Since Charlie Parker, the most electrifying sound that I've heard in contemporary jazz was Coltrane playing with Monk at the Five Spot. It was incredible, like Diz and Bird."

Apart from Coltrane's heralded "sheets of sound," the entire group did things with sound unheard of before or since. Anyone who was there should be able to select the right volume setting to accurately recreate the sharp impact of the interplay between tenor sax and Monk's piano. Others less fortunate should be advised that listening at more than a comfortable room level is necessary if the same kinetic effect is to be achieved at home. Stereo also helps, and Jack Higgins engineered the date with due regard for the proper placement of Shadow Wilson, drums, and Wilbur Ware, bass, to



WIN this 20th Century music room

designed by Marion Heuer...

furniture by Harvey Propper... superb hi-fi/stereo with source of sound

by Shure... piano by Baldwin... carpeting by V'Soske

... fabrics by Boris Kroll, hi-fi/stereo amplifiers and preamplifier by Marantz, automatic turntable by Garrard, turntable by Thorens, speaker systems by Acoustic Research, FM/MX Multiplex tuner by Sherwood, tape player by Ampex, Stereo Dynetic Phono Cartridge and Tone Arm by Shure, PLUS \$5,000 cash to add a new room to your home or remodel an existing room from original plans by internationally renowned interior designer Marion Heuer, A.I.D. No purchase is required; simply listen to a Shure Cartridge demonstration at your hi-fi dealer's showroom and describe your reaction to its singular sound recreation qualities (in 25 words or less). If your statement wins you can begin building your music room. Should the winner have purchased a Shure cartridge as a result of the demonstration, a magnificent \$1,000 RCA Victor stereo record library will also be supplied, as are all other awards, by Shure Brothers, Inc., 222 Hartrey Avenue, Evanston, Illinois. Entry blanks and details at hi-fi dealers only. (Contest ends February 28th, 1962.)

SHURE

Stereo Dynetic®

HIGH FIDELITY PHONOGRAPH CARTRIDGES

ensure a realistic balance. Three alternate masters unearthed from other sessions fill out the set, so it looks as though Riverside has nothing more by the quartet hidden away. Besides writing all the material, Monk plays nearly ten minutes of unaccompanied piano on *Functional*.

Los Muchucambos: Percussive Latin Trio
London Stereo SP44012

Los Chiriguanos: Pulsating Sounds Of Paraguay
Elektra Stereo EKS7702

As each major label has succeeded in duplicating the stereo hijinks of its neighbor, the men in charge are finally looking for something new and different. A little bush beating among Parisian clubs uncovered these two South American groups, both of which feature soloists playing the Paraguayan harp. Audiophiles and followers of ethnic byways alike should treasure an instrument that will "make evil spirits fly, make the rivers stop flowing, make the cattle forget to eat." Of course, Phase 4 engineers emphasize the percussive antics of Los Muchucambos, and the trio bestirs itself to rhythmic frenzies with the aid of such unusual objects as the tumba, charanga and tambora. Rafael Gayoso and Romano Zanotti harmonize masculine and romantic counterparts to the saucy vocalizing of Julia Cortes, who introduces the lively European hit *Pepito*, then delivers the slow, searing Aztec lament *Subo Subo*. Harpist Ignacio Alderette appears as guest on three traditional native themes. Novel arrangements completely reshape such Latin favorites as *La Cucaracha*, *Granda*, *Perfidia*, and *Adios*.

Los Chiriguanos are two members of the Chirigua Indian tribe who met in Paris, where they were spotted by Fred Hellerman while playing at l'Escale on the Left Bank. Hellerman recorded the pair at Barclay Studio Hoche and brought the tapes to America. Pablo Vincente Morel made his 37-string guarani harp himself, and it bears a poetic and physical resemblance to the large Irish harp. However, its sound and rhythms are thoroughly Latin, and both harpists offer rival versions of *Pajaro Camapana*, on which they imitate the strange cries of a jungle bird waking the forest at dawn. Angel Sanabria sings of his native land and plays guitar to partner Morel, and they blend well together in stereo. Both programs will be valued for the music long after most stereo spectaculars are forgotten.

The Swingin' Peters Sisters
Capitol Stereo ST10290

While other more famous groups of the swing era bit the dust long ago, the Peters Sisters seem destined to go on forever. The three girls from California played the old Cotton Club along with Duke Ellington, then went on to become fixtures in stage shows at movie houses across the country. But their secret of survival lies in touring all over Europe and distant places in the Far East and South America. They headlined at the Folies Bergere for three years, and audiences in localities never reached by groups traveling for the State Department, or any other jazz show, know about American swing because of the trio's determined efforts. The act is the same one that played the New York Paramount more than twenty years ago, right down to the gossamer costumes billowing about each three-hundred pound frame. They belt out the old songs in the old arrangements, but some concessions are made to stereo in this London appearance with Geoff Love's big band and the assisting Rita Williams singers. Rollicking riffs bounce merrily about the stage on *The Glory of Love*, *Tain't What You Do*, and *It's D'Lovely*. And who remembers when Chick Bullock wrote songs like *Who Stole The Jam*?

The Best Of The Dukes Of Dixieland
Audio Fidelity Stereodisc AFSD5956

Now that The Dukes are roosting elsewhere, Audio Fidelity has gathered up a

dozen choice remnants from various stereo discs and offers the lot at a clearance price. Some new owners of stereo equipment may still be unacquainted with The Dukes, especially those who made last Christmas an excuse for taking the plunge into two-channel sound, and they will find no better material to show off their new toy at twice the price. Those owners adventurous enough to have played around with stereo from the very beginning will remember that a recording of The Dukes hastened its arrival by many months. The potent little group from New Orleans made excellent test material then, and the transients are just as steep and the dynamics just as gusty today. Included is a sampling of the night in glory-land The Dukes spent giving a concert in Carnegie Hall, along with *Down By The Riverside*, *South*, and *Bourbon Street Parade*.

Bob Gibson & Bob Camp: At The Gate Of Horn

Elektra Stereo EKS7207

With seven albums listed in the Schwann catalogue, Bob Gibson enjoys some repute as a folk singer, but whatever dignity and pretensions he may have acquired quickly disappear when Bob Camp becomes his partner. Riotous good fun is the only object the pair seems to have in mind, and the Gate of Horn audience knows exactly what to expect. Followers of the ethnic trail should be warned that the one authentic touch in this program is the grease on the introductory *Skillet Good And Greasy*. Most of the songs come fitted with new words and music by one or the other, and they end up singing straight jazz choruses on *Daddy Roll 'Em*, and



LOOK AGAIN

ONLY ERIC HAS THE EXCLUSIVE VBI

IT'S THE EXCITING NEW ERIC 3560T, 3 CHANNEL STEREO 60 WATT "MUSIC POWER" AMPLIFIER. Ladies admire the satin-gold decor finishes...men can't resist the realism of sound reproduction. Here is tomorrow's amplifier...today! Exclusive Visual Balance Indicator lets you visually preset and determine actual output to speakers! Clean response—20 to 20,000 cps; total harmonic distortion less than 1% and individual controls for ultimate in sound reproduction.

A touch of the finger and sound comes alive in a way you've never experienced before! Pure sound...excitingly crisp...brilliant! Only Eric, the West's leading AM-FM tuner manufacturer, could develop this advanced amplifier so perfect in engineering and so low in price. \$149.95...slightly higher in the East. Write today for complete specifications.

Ask for Eric...highest quality at the lowest price.

ERIC MULTIPLEX ADAPTOR, MX 6000. Another example of Eric fine engineering and low price! Only the MX6000 has the exclusive "Stereo Announcer" which automatically lights up when stereo is being broadcast. The unit is compatible with all Eric tuners and most other makes using wide bandwidth. Additional amplifier stage assures strong "fringe area" reception. Separate balance control for optimum separation. Audio-ophile net...\$59.95. MX800 semi-automatic...\$39.95.



ERIC ELECTRONICS CORPORATION
1823 COLORADO AVE., SANTA MONICA, CALIF.

Betty And Dupree. Foremost among the original material is a humorous paean to *The Thinking Man*. An accurate and incisive description of Chicago cops might apply equally well to police forces in other localities. Only once do they fail to hit the mark on *Butternut Hill*, which is hardly durable enough to draw laughter twice from any listeners not at the club. Bassist Herb Brown joins the festivities, and the whole affair receives a life-like stereo recording from Mark Abramson. Several other albums use Gate of Horn in the title, but this seems to be the only session actually held at the Chicago club.

**Harry Belafonte: Mark Twain
RCA Victor Stereo LSP1022**

The first tentative steps taken by a youthful pop singer on entering the folk music field are now firmly implanted in stereo, thanks to

RCA Victor's new system of electronic re-processing. Since this initial LP, Harry Belafonte has perfected his delivery and now stages presentations with his own troupe, but his ideas for making ethnic material sound both authentic and appealing to the general populace were already fully formed. Millard Thomas, an old friend from the American Negro Theatre, assists on guitar throughout, while Alan Greene conducts on those portions where orchestra and chorus are heard. Some of the songs are available in polished, later versions, and the success of the refurbishing varies according to the amount of unnatural resonance added. None of Belafonte's many new partisans will want to miss hearing their hero introducing a calypso beat on *The Fox*, or telling the story of the lady with the cockeyed look on *The Drummer And The Cook*.

**Frank Sinatra: Sinatra Swings
Reprise RSL1704 (4-track stereo tape)**

It is common knowledge that Frank Sinatra's Capitol contract made him unhappy, and everyone thought the amount of loot going into company coffers was the reason. Rumors even had the singer holding back at sessions, but inhibitions were never mentioned as playing a part in his reluctance to perform. Now that Sinatra owns a record company and hires the publicity people, his side of the story is told for the first time. No rash statements are made about his being inhibited though, as even the more gullible fans would hardly believe that. His current offering is simply billed as the most uninhibited ever, and even hardened analysts might throw up their hands at the idea of such a novel complaint as being less uninhibited.

As it is, Sinatra sounds pretty browbeaten on *Curse Of An Aching Heart*, and dolefully sympathetic on Joe Marsala's *Don't Cry Joe*. If he nearly breaks a blood vessel on *Granada*, let it serve as remainder of a time when he was running around Spain with no inhibitions at all. Rotund Billy May and band are as jovial and extroverted as ever in an accompanying role, and tape bounces the dynamics along without repression of any sort.

**Rudi Bohn: Percussive Oompah
London Stereo SP44009**

Phase 4 engineers practice feats of legerdemain with the little German band of fond memories, contracting or expanding its size at will on this outing in the Bavarian Alps. All the instruments usually employed at a small beer garden are aligned well forward, and solo parts are delivered with all the presence of the foaming head on an overflowing glass. Accordion, clarinets, flutes, tuba, marimba, glockenspiel, cymbals and other percussion strut about the stereo stage like characters in a comic opera. Meanwhile, conductor Rudi Bohn cues in tuttiis from full trumpet trombone, saxophone and woodwind sections as they leap from Alp to Alp in the background. Rating this recording as the best of its kind is meaningless, simply because there was never anything like it before. Hearing is believing, and the setting will make the heart of any tourist information official swell with pride. Besides waltzing, marching and polkaing about, the lusty group whistles through *Mack The Knife*, and exchanges hearty toasts on *Trink, Trink, Bruderlein, Trink*.

**The Modern Jazz Quartet: European Concert
Atlantic ALP1915 (4-track stereo tape)**

One intermission during a jazz concert is enough, and this twin-pak tape runs better than forty minutes in either direction. Should the need arise to cut the performance short in the home, it is always possible to stop the tape during the applause at the end of each selection. Any imprint caused due to failure to rewind and store the reel will be lost in the tumult. Perhaps now a few persons who have always resented the policy of letting audience reaction consume valuable space will be able to put the bursts of applause to good use. Unobtrusive announcements by John Lewis are also a help, and the awed crowd sits with bated breath through every number.

As to the music itself, the concert reviews a good share of the Modern Jazz Quartet's achievements during almost a full decade of coexistence. Except for some of the activities at Music Inn, this is the first time the MJQ has consented to the release of a public performance. The event took place in Scandinavia in April, 1960, during a tour of Europe, and engineer Gosta Wilholm hit upon an excellent focal point for stereo listeners. The MJQ reputation is maintained throughout, and special mention should be made of the superb extended versions of Milt Jackson's *The Cylinder*, and Ray Brown's *Pyramid*.

**MONO
Duke Ellington: The Indispensable Duke Ellington
RCA Victor LPM6009**

If any Ellington record be dispensable, the fault lies in the processing rather than the

**For the
1 family in 17
that demands
Recording-Studio Quality
from their tape recorder...**



People actively engaged in the musical arts—amateurs as well as professionals—are finding the Continental '400' the practical solution to the problems of complexity and cost posed by professional recording equipment.

Guild-crafted by Philips of the Netherlands—styled by the Continent's top designers, the Continental '400' is simple to use yet amazingly versatile. The 3-speed, 4-track '400' offers professional quality recording and playback, both stereo and mono, at moderate cost for home use.



**the Norelco®
CONTINENTAL '400'**
world's most advanced,
most versatile, portable
stereo/mono tape recorder

Completely self-contained with dual recording and playback preamps, dual power amplifiers, stereo-dynamic microphone and two stereo-matched wide-range Norelco loudspeakers.

- VERSATILITY:** 4-track stereo recording and playback, as well as 4-track monophonic recording and playback, at any of its 3 speeds.
- FREQUENCY RESPONSE:** at 7½ ips, 50-18,000 cps; at 3¾ ips, 50-14,000 cps; at 1½ ips, 60-7000 cps.
- PROFESSIONAL EXTRAS** (at no extra cost): mixing, monitoring and sound-on-sound facilities.
- SIGNAL-TO-NOISE-RATIO:** 48 db or better.
- WOW AND FLUTTER:** less than .15% at 7½ ips.
- CROSSTALK:** 55 db. **HEAD GAP:** .00012".

NORTH AMERICAN PHILIPS COMPANY, INC. High Fidelity Products Division 230 Duffy Avenue, Hicksville, L.I., N.Y.

music. The majority of the twenty-four sides on this double-LP collection from the band's 1940 to 46 period first appeared on wartime shellac. Original copies in good playing condition are harder to locate than many pressings from earlier years, and collectors will welcome the chance to replace worn-out stock. The remastering does credit to the Victor engineers concerned, and the refurbished sound improves greatly on the releases of the war years. Dom Cerulli's informative notes help to recreate an era when many youngsters who are just beginning to learn about jazz were born, while the program is arranged to start them off in chronological order.

The Ellington organization, unlike other bands, was virtually untouched by the draft and maintained uniformly high standards all during the conflict. But unsettled times, along with a recording ban which lasted from 1942 to 44, had an effect on the band and personnel changes occurred more rapidly than ever before. Gains or losses in the trumpet section included Cootie Williams, Rex Stewart, Ray Nance, Shorty Baker, Taft Jordan and Cat Anderson. Tenor-sex star Ben Webster gave way to Al Sears, and Jimmy Hamilton was brought in to replace Barney Bigard on clarinet. The death of Jimmy Blanton was sorely felt, and not until Oscar Pettiford took over the bass chores in 1945 did the band hear his like again. The nineteen-year-old Blanton shows how the art of bass playing was revolutionized through his efforts in two duets with Ellington, whose piano style sounds closer to its stride origins than today on *Pitter Panther Pitter*, and *Mr. J. B. Blues*.

Released for the first time in this country are versions of *Blue Cellophane*, with a superb trombone solo by Lawrence Brown, Kay Davis' wordless vocal on *Mood Indigo*, *Blue Is The Night*, *Black Beauty*, and *Just You, Just Me*. Ellington's writing takes a sophisticated turn on *Perfume Suite*, a four-part collaboration with Billy Strayhorn which was too exquisite and costly for most followers of the band when issued. They know how to accept such things in jazz by now, or else they have succumbed to the Twist. Among the other high points are *Chelsea Bridge*, *Carnegie Blues*, *Black And Tan Fantasy* and *Morning Glory*. As the two other Ellington LPs available on Victor cover the same era, the band's output from this period must be about exhausted, so perhaps company heads will dig back further on the next visit to the vaults. **Æ**

Al Viola: Guitar Lament

Wold-Pacific WP1408

What may become the guitar student's lament is a definite gain for the listener in this instance. Al Viola wraps up a dozen solos to go along with the printed scores contained in an instruction book, which he wrote for Leeds Music. The Hollywood virtuoso plays concert guitar in flamenco, jazz and classical styles, and the novice will need to work hard before mastering them all. Viola cites his own favorites as, "Segovia, Laurindo Almeida, George Van Eps—and that's it!" However, two other guitarists come to mind on hearing Viola's elegant touch on jazz numbers, which he treats less blandly than Johnny Smith yet not quite so earthily as Charlie Byrd. In any event, Viola belongs in top company, and his thoughtful and varied arrangements are all based on such vocalists favorites as *Lover Man*, *Black Coffee*, and *A Sunday Kind Of Love*. Recordings of acoustic guitar are too scarce for collectors to pass this one by, and engineer Richard Bock outdoes himself in the department of pure sound. **Æ**



Remember those in need across the world. Every \$1 sends one gift package thru the CARE Food Crusade, New York 16, N. Y.

TRANSISTOR

(from page 26)

have described it the circuit suffers from the usual disadvantage of class-A circuits: a 2-watt amplifier draws some 8 watts from the battery the whole time it is switched on even though no signal is being amplified. There is, however, an interesting extension of the circuit, the floating-bias amplifier, which can be a real power economizer. I shall describe this in a second part to the article. This modified version of the amplifier is quite as efficient as a class-B amplifier and to my mind very much easier to build. **Æ**

AUDIOCLINIC

(from page 4)

the only controls on your present unit which you will need to use will be the tuning knob, the AM-FM selector, and the on-off switch. When the tape output connection is employed as has been discussed, you must connect your tape recorder to the appropriate output on the integrated unit. This will provide the means by which you can record from either the tuner or from any other input fed into the integrated unit. **Æ**

EXCLUSIVE!

Startling new features available only in Audio Dynamics components provide almost unbelievable performance.

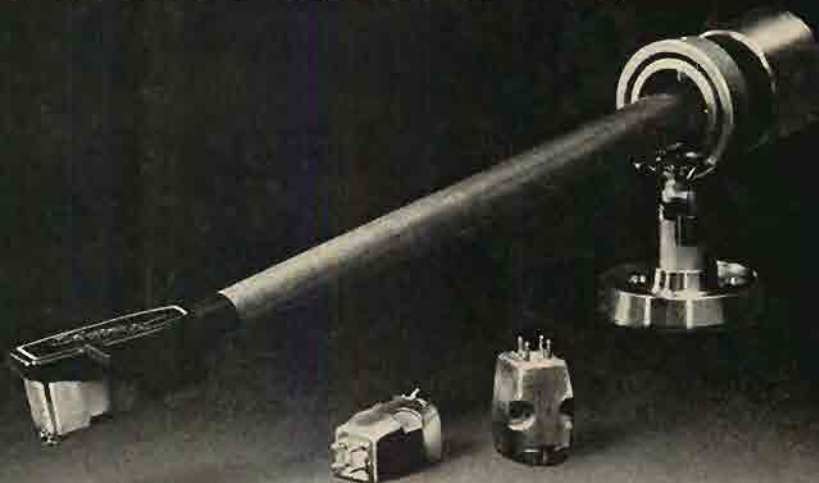

Forget about record wear. Play records at peak performance even if they are warped. Hear the entire audible range without distortion. How? With these technically superior features available only in Audio Dynamics components:

First, the ADC-1 and ADC-2 cartridges that give you:

Lowest stylus mass: a mere half-milligram eliminates high frequency distortion and helps to provide excellent channel separation.

Unusually high compliance: at least 20×10^{-6} cms/dyne, delivers clean, tight bass.

Both of these qualities result in:

Lowest tracking force: less than 1 gram!, renders record wear and distortion negligible.

Next, The Pritchard Tone Arm:

Very low inertia with perfect balance: gives highly stable tracking at low stylus pressure.

Only 1 3/4" rear overhang: makes installation easy in the tightest cabinet space.

The side thrust compensator: first of its kind in an American model, helps to maintain even groove wall pressure.

Single ball bearing mountings: Minimize lateral-vertical friction.

An accurately machined and treated walnut tone arm: suppresses extraneous resonances.

New type wire guide: Tone arm wire can no longer exert drag on the moving system. It moves as a unit on its own axis!

Plug-in head: easily accommodates all quality cartridges.

And now the Pritchard Pickup System. By combining the ADC-1 cartridge and the Pritchard tone arm, a remarkable system is produced. This system tracks at 3/4 gram! Surely with these exclusives, it is worth your while to hear superb Audio Dynamics components at your dealers' today!

Pritchard Pickup System Model ADC-85	\$85.00
Pritchard Tone Arm Model ADC-40	39.50
Plug in Cartridge Shell Model ADC-S40	6.95
ADC-1 Stereo Cartridge	49.50
ADC-2 Stereo Cartridge	37.50

For more information on Audio Dynamics components, write:

AUDIO DYNAMICS CORPORATION

1677 Cody Avenue
Ridgewood 27, New York

AUDIO DYNAMICS

MUSIC BIG AS LIFE

Utah's High-Fidelity CONTINENTAL SPEAKERS



C12RD 12" WOOFER
2 Lb. Alnico
V Magnet and
2" Voice Coil

YOU GET LIFE-SIZE SOUND in every range, from 20 to 20,000 CPS, with Utah's precision-engineered stereo/high-fidelity speakers. Tweeters and mid-range speakers feature a specially engineered horn formula to enhance "presence". Each speaker has color-coded 4-way terminals.



1124 Franklin St.
Huntington
Indiana

Please mail me prices, specifications and performance details of your Continental speaker line.

NAME _____

ADDRESS _____

CITY _____

STATE _____

ABOUT MUSIC

HAROLD LAWRENCE

35-mm Magnetic Film

JUST WHEN it has reached a self-styled peak of technical perfection, the recording industry casts off old techniques and grows new ones. Its latest molting—the adoption of 35-mm magnetic film—has the average record collector scratching his head. His first reaction is to place the new medium in the category of photography: "Why use film to make discs?" Obviously, he reasons, the new product is not a picture-record (although engineers in England and elsewhere have been experimenting with a sight-and-sound disc for several years). Is it then a movie-style sound recording, à la wide-screen stereo? Or is it merely a gimmick to boost the sales of records?

Before proceeding to the whys of 35-mm recording, a description of the medium itself is in order.

The 35-mm film strip used in sound recording is identical with that of its optical counterpart in almost every detail. The cellulose-acetate base is 5 mils thick, nearly four times the thickness of professional magnetic tape stock; the perforations (64 per foot) conform to the standard sprockets of film machines and still cameras designed for 35-mm film; and the strip is transported past the heads at a speed of 18 ips. When used exclusively for sound recording, the stock is fully coated with the same iron-oxide mixture applied to magnetic tape.

Loading film on the vertically mounted machines is an intricate procedure compared to tape loading, because of the idlers, flywheels, and clamps around and beneath which the film must be threaded. (See photograph.) An experienced film recordist, however, can perform the operation in 15 seconds, only a few seconds longer than the time required for threading magnetic tape. Unlike tape, which can be fast-wound without leaving the threading path, magnetic film must be removed from its guides and rewound along separate idlers. To facilitate the location of "takes," index stickers are generally placed on the film base.

Magnetic film recording is a costly undertaking. A roll of 35-mm magnetic film is three times as costly as a 10½-in reel of ½-in. tape; and since the film contains only a third of the recording time available on the tape, the film user pays nine times more per minute of program material.

Do the advantages of 35-mm magnetic film recording outweigh its Rolls Royce price?

Stripped of the adman's high-flown prose, the new film medium definitely represents a step forward in the art of high fidelity sound reproduction. Here are some of its benefits:

The thicker film base virtually eliminates the bugbear of print-through, and provides a more stable storage medium. Because of the nature of the transport mechanism, the film is *guided* rather than pulled past the recording head. The closed-loop film path

with damped stabilization guarantees flutter-proof operation and makes for better transient response. The faster recording speed of 18 ips represents another advance. The width of each of the three tracks on magnetic film is 220 mils, as opposed to 90 mils on ½-in., three-channel magnetic tape; this makes possible the reduction of background hiss to the barest minimum. The dramatic improvement in the signal-to-noise ratio is most apparent at first hearing in softer musical passages. For example, a limpid solo clarinet, a *pianissimo* harp glissando, or a high tremolo whispered by the



Fig. 1. Engineer Ted Gosman loading 35-mm film at the Bayside Studio of Fine Recording Corp.

(Photo by the author)

violins emerge now with a cleaned-up, transparent purity of sound in which the acoustics of the hall are more realistically projected.

Recording with 35-mm Film

There is nothing a symphonic conductor dreads more than the voice which issues from the intercom box near his podium: "We have to reload!" When the announcement interrupts a particularly good take, the panting maestro must hold himself in a state of suspended inspiration while the engineers feverishly load the machines. With magnetic tape, he can record continuously for some thirty minutes, arranging his rest period to coincide with the reloading operation. Even with this latitude, there are times when a fast re-load is necessary. Recording with a 35-mm film aggravates the situation. Faced with a ten-minute deadline, the recording director must plan his break-points with extreme care. He cannot now afford the luxury of

26 W. 9th St., New York 11, N. Y.

allowing the machines to roll more or less continuously during a series of takes, but must start and stop like an auto in downtown traffic. Paradoxically, the advent of 35-mm film recording takes us part of the way back to the days of the 78-rpm disc with its limit of ± 4 minutes.

Until recently, magnetic film editing was performed exclusively with the "Movieola," the machine designed for motion picture work. The editor operates this device by means of a foot pedal, the film is fed over the playback head at 18 ips and into a large cloth basket. When the splice point has been established and marked with a crayon pencil, the strip is rewound, placed on an optical splicing block of non-magnetic material, and cut diagonally by a guillotine. Then the butts are joined by means of a clamp and sprocketed splicing tape. For purely sound recording, the movieola is a cumbersome editing instrument. Other more practical arrangements have been made in recording studios both here and abroad.

In motion picture production, synchronization of course plays an indispensable role. The various cinematic components—music, sound effects, sight, dialogue—all must occur at precisely the right points in the final "mix." Each track is therefore "scored" in synchronism with all other tracks. A footage counter (or "reader") enables the editor to plot the entry, duration, and close of each "element." Music recordists seldom utilize this built-in feature of the 35-mm film medium. On special occasions, however, it is absolutely essential. A case in point in Beethoven's "Wellington's Victory," in which the composer indicated the exact spots at which the sounds of battle were to be integrated into the musical score. He pinpointed 188 cannon shots and 26 musket volleys, specifying their direction as well (French on the left, English on the right). In the Mercury version of this festive work, the music was recorded in London, the cannon and muskets at West Point. The gunfire and music tracks were run off in perfect synchronization using five magnetic film recorders, each sprocket-driven from the same current supply.

Magnetic film recorders capable of holding 30-minute rolls are used in the film-to-lacquer transfer. The bulky masters are then stored in heavy-duty metal cans (total weight: approximately 16 lbs.). In this age of miniaturization (tiny transistor radios, slim TV receivers, ultra-miniature 8-mm still cameras, and so forth) these ponderous rolls of edited magnetic film seem strangely anachronistic. Æ

CAMPBELL

(from page 59)

Mr. Campbell's concept of how the ears work that I hardly know which errors to point out in a short letter. First, multiplying the number of nerve fibers by the number of bits per second capability of each does *not* give you the bandwidth or bandpass of the ear. If a telephone cable carried ten telephone circuits, each capable of handling, say, 4000 cps, you surely wouldn't say the bandpass of the cable was 40,000 cps. And if such logic were correct, as stated by the author, there would be no capability left for loudness detection since the full capability would have been used for frequency detection. Furthermore, each nerve fiber is capable of handling not a piddling 12 bits per second, but can handle up to about 1000 bits per second.

Contrary to Mr. Campbell's concepts, the ears *do* analyze sound waves for frequency components. By actual measurements of

action potentials on individual nerve fibers it has been found that each nerve is "tuned" to a narrow band of frequencies. The bandwidth of each increases with loudness. The number of bits per second transmitted by a single fiber is a function of both frequency and loudness.

The ears are relatively insensitive to phase in a complex waveform. This I have read many times and have verified it on both myself and my wife. Mr. Campbell's lengthy proof of phase sensitivity is OK, but it was for sensitivity to phase in the sounds reaching the two ears. That is a completely different subject that has no bearing on amplifier design.

I'll bet it must have been a shock to the Hammond Organ people to learn that *no* successful music instrument has ever been built that used sine waves. Depressing a key on a Hammond does nothing more than connect the outputs of a number of sine wave generators to the audio system. Of course the number of sine waves and their relative amplitudes are controlled, but they *are* sine waves.

Sineward distortion as defined by Mr. Campbell still does not exist. The article was just science fiction.

Kenneth E. Stone,
91 Pine Street,
Iselin, N. J.

Sir:

Cleverly interweaving accepted science with imaginative conjecture has earned John W. Campbell, Jr. a reputation as a science fiction author. There are parts of the article that persuade me to believe Campbell is sincere in his ridicule of "hide-bound" scientists who consider the ear insensitive to phase shift. This view is held in spite of his pure fabrication concerning "sineward distortion." An RC phase-shift network is given an illusory flat frequency response (maybe it was short circuited) and an erroneous attenuation—"in practice it takes a high-gain pentode to oscillate." Numerous triodes and transistors provide more than the required voltage gain of 29 for a phase-shift oscillator with three identical RC sections.

On the other hand, "Physicists and acoustics people have, for years, said that the human ear is not sensitive to phase shift in sound. That's still standard theory. It's false," is a statement requiring expansion. The location of point sound sources is commonly credited to *two-ear* phase detection as opposed to phase distortion sensitivity. The "phase-shift" which humans are incapable of detecting is more properly called "phase-distortion," i.e. a *steady state* displacement of the phases of harmonics of a periodic waveform with respect to themselves. Mounds of data obtained under controlled experiments classify the human auditory system as being incapable of sensing phase distortion. If these experiments over several decades are accurate, the ear is insensitive to straight phase distortion and therefore, since waveshapes are determined by phase relations among the harmonics, the ear is insensitive to waveshape. I might add for those "do-it-yourselfers" that experiments of this type must be carefully devised to avoid erroneous conclusions. Phase shift of Fourier components can result in rather spike-like waveforms which the amplifier in use may clip, causing audible distortion coincident with phase shift adjustment. Multiple-point sound sources (such as stereo) are to be avoided for these tests, because relative phase shift between the amplifiers can mislead the listener by changing the apparent amplitude of the harmonics. Abrupt phase shifts are detectable as "clicks" and slow periodic ones as vibrato.

If the work of physics and acoustics people is to be discredited by conjectures linked to physiology and evolution (without supporting evidence) perhaps a conjecture of similar nature and opposite hypothesis is all that is needed to restore nature to equilibrium. The human auditory system is a twin receptor system linking transducers, relay stations, nerve networks, pattern recognizers, coders, decoders, and so forth, into one harmonious whole. Being a reliable, long life, successful system constructed from rather unreliable components, redundancies are not only implied but demanded. For example, in the ear there are five hairlike cells per nerve fibre associated with frequency determination. Why should we depend on phase data alone to locate sounds? We don't! If one ear can locate a sound source without aid from the other, each ear must contain a phase detector. False! Optical center *Gestalt* (a square is recognized independent of orientation) implies auditory phase detection capability. Persuasive but not conclusive. Auditory *Gestalt* could just as easily be the ability to recognize aurally a clarinet independent of the orientation of the instrument.

With the cochlea of the ear capable of resolving frequencies which differ only one part in a hundred, it seems quite proper to view this part of the auditory system as a Fourier analyzer. Thus, every impinging waveform is resolved into its sinewave components at proper relative amplitude. After propagating through several frequency non-linear linkages (see Fletcher-Munson curves) it would be naive to believe that phase relations among the harmonics have been preserved in the impinging sound. Even in the presence of phase distortion in the ear, if both right and left channels have similar phase distortion, a common data processor can still perform phase and time discrimination. Note this point well, for it shows any common right-left phase distortion will not affect the ability to locate a sound source and therefore phase relation between fundamental and harmonics is unimportant *even at the source of sound*. Hence, waveform is unimportant in the battle for survival of the fittest.

Relative right-left phase should not be our only source of direction information. In abrupt noises, the time displacement between the spectrum impinging on one ear and the other ear gives a very rapid location signal to the brain, making us jump the right way when lions roar. In addition the 180-deg. ambiguity of our two sensor system is minimized by our "pointed ears" which alter the rearward spectrum drastically. Likewise, spectrum changes resulting from trees, bushes, and head interference aid the survival of a one-eared man, but he's still more vulnerable than the two-eared type and eventually would be exterminated by the stereo model.

A baritone and a soprano singing harmony sound quite pleasant to the ear, in spite of the fact that drastically different waveforms are being emitted from the tone sources. If their tone relation is a musical third, the third harmonic of the baritone's note is the same frequency as the second harmonic of the soprano's note and the same respectively for the sixth and fourth, ninth and sixth, and so forth, harmonics. In view of this consonance having nothing to do with waveform and everything to do with harmonics, still further strength is given to the argument that the auditory system must resolve a sound into its sine-wave components.

T. C. Penn,
911 Northlake,
Richardson, Texas

NEW PRODUCTS

• **Slim-Line Speaker System Kit.** Designed to permit complete assembly, even by an unskilled person, in less than an hour, the new Model KS-1 speaker system kit is claimed to be the first slim-line kit in the high fidelity field. The KS-1 includes a 3-way speaker system with crossover networks, finish-sanded birch or walnut cabinet, grille cloth, AcoustiGlas padding, and stage-by-stage instructions. The system is

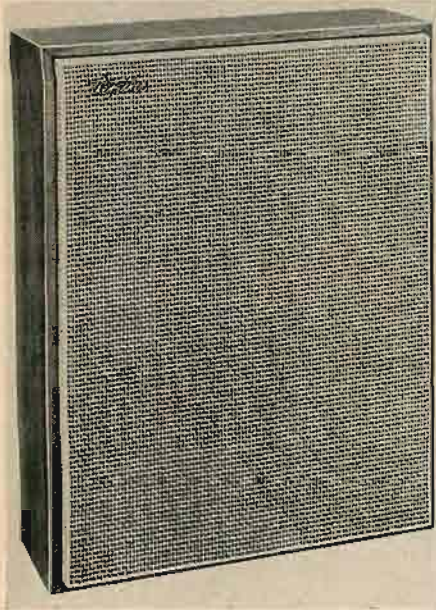

only 5¼-in. deep, 24-in. high, and 18-in. wide. The speaker complement includes a 10-in. woofer, a 5-in. mid-range, and a 3-in. super tweeter. Crossover is at 1400 and 5000 cps and impedance is 8 ohms. Price of the kit in birch is \$59.50; the factory-assembled system costs \$84.50. In walnut the kit costs \$64.50 and the assembled system cost \$89.50. Fisher Radio Corp., L. I. C., N. Y.

B-1

• **Modular Design AM-FM-Stereo Receiving System.** Featuring modular design, the new H. H. Scott Model 355 receiver includes an FM-stereo tuner, an AM tuner, a stereo control center, and 80-watt amplifier. The modular concept permits complete isolation of the heat-producing power amplifier, which can be physically separated from the rest of the unit and installed up to 50 feet away from the main chassis. Each section is self-powered. The 355 includes a stereo-guide which helps



locate FM-stereo broadcasts. FM sensitivity is rated at 2.5 µv (IHFM), the control center includes provision for two low-level inputs, separate bass and treble controls for each channel, stereo balancing facilities, complete tape recording and monitoring facilities with front panel control and output. Complete specifications are available. H. H. Scott, Inc., Maynard, Mass.

B-2

CORRECTION

Last month's Test Equipment Roundup erroneously showed the wrong photograph for the B & W oscillator. Here is the correct one.

B & W

• **Model 200 Audio Oscillator.** The Barker & Williamson Model 200 Audio Oscillator is intended for use where a stable, accurately calibrated source of frequency from 30 cps to 30,000 cps is required. The Model 200 achieves its 30,000-cps range in three steps, each step being continuous. The output is 10 volts into a 500-ohm load, with an attenuator available to reduce the output if necessary. The Model 200 utilizes an RC oscillator circuit whose



output achieves harmonic distortion of less than 0.5 per cent from 100 cps to 15,000 cps at 10 volts output. Frequency response better than ±1 db is claimed over the 30 cps to 15,000 cps range (500-ohm load), with stability exceeding 1 per cent. No zero reset or line calibration is required and dial calibration is accurate to ±3 per cent of scale reading. Barker & Williamson, Inc., Bristol, Pa. Price: \$138.50.

• **Transistorized 8-Watt Amplifier.** The McMartin Model LT-80 transistorized amplifier is designed for general purpose audio and public address applications. Providing 8 watts for continuous duty, the LT-80 also provides a peak power of



20 watts. No input transformer is required for a telephone line input although a plug-in 600-ohm transformer is available. A special feedback circuit prevents the transistors from being damaged upon removal of the speaker load. The power transistors are fused to protect them from being destroyed in event of an overload. Power response is ±2.0 db from 30 cps to 15,000 cps. Transistors include five 2N241, one 2N114, and two 2N251. Hum and noise are -60 db below 8 watts for microphone -70 db below for program, and -65 db below for phono (with accessory preamp). Continental Manufacturing Corp., Omaha, Nebraska.

B-3

• **Medium Priced Speaker System.** A new medium priced speaker system is available from Sherwood Electronic Laboratories.

The Sherwood "Ravinia" 3-way 3-speaker system features response within ±2 db from 45 cps to 17,500 cps with low intermodulation distortion and peak-free transient response. The system consists of a 12-in. woofer; an 8-in. mid-range speaker with sealed, Fiberglas-filled backplate; and a 2½-in. ring radiator super-tweeter, also with Fiberglas-filled backplate. Crossover



points are 600 cps and 3500 cps with 12 db per octave attenuation. Level controls are provided for mid-range and tweeter balance. Cabinets are available in three finishes; walnut, unfinished hardwood, and a utility finish. Price for the walnut finished SR-3W is \$139.50. The hardwood and utility finishes are respectively \$10 and \$20 less. Sherwood Electronic Laboratories, Chicago, Ill.

B-4

• **Condenser Microphone System.** The Schoeps Model M221/26 microphone system utilizes a single metal diaphragm and is available with a multiple pattern capsule. It is claimed to be the only condenser microphone featuring a low inertial diaphragm with three acoustically selected



patterns. The M221 series is available with a number of interchangeable condenser capsules. Nonlinear distortion is maintained below 0.3 per cent at levels up to 115 db above 0.0002 microbar. A special attenuator can be installed between capsule and preamp to prevent overloading. A full range of accessories are available. International Electroacoustics, Inc., New York.

B-5

• **Three-Way Speaker System.** A new loudspeaker system featuring a type of transducer new to the high fidelity field is being



Here's why Scott Speakers sound so good!

The sound is so smooth... so effortless... that you'll swear the musicians are sitting right inside your H. H. Scott speakers. Actually, this amazing sound is achieved by a unique and important advance in speaker design.

The key to this advance is a radically new crossover network design. This Scott designed network is different from conventional crossovers. First, the low-range Scott woofer operates over a very narrow band of frequencies assuring smooth reproduction of fundamental bass tones. The higher crossover frequency of conventional networks forces these woofer units to provide response into the mid-frequency range resulting in compromised performance. Second, the Scott network is designed so that crossover points do not cause dips affecting smoothness of the overall response. Scott's three-way speaker systems perform as if they were composed of one perfect speaker giving smooth and accurate response over the entire audio range.

The new Scott speakers have won praise from leading critics and musicians. Audio magazine said... "The S-2 provides a well-balanced tonal picture... The transition between frequency ranges is quite smooth... a remarkable device."

As Berj Zamkochian, famous organist of Boston's leading Symphony Orchestra, said after listening to a recording of his own performance over Scott speakers: "I have never heard any reproduction of organ which sounded so faithful to the original. I felt I was sitting in the center of Symphony Hall."

Hear superb H. H. Scott speakers for yourself. We are sure you will agree that they are the finest musical reproducing systems ever made.



H. H. Scott speaker systems are available in three models. **Model S-2 Wide-Range System** — A Three-way acoustic compliance system consisting of a low resonance high excursion woofer, two dual-cone mid-range units and a wide-dispersion tweeter. **Model S-3 Wide-Range System** — Three-way system of truly bookshelf size. Depth is only 9 3/4". **Model S-4** A modestly priced, two-way acoustic compliance system. Uses same type multiple crossover circuitry found in higher priced S-2 and S-3. All three systems are available in your choice of oil-finished walnut, hand-rubbed mahogany, unfinished hardwood and unfinished pine. Prices start at \$89.95 for the S-4, \$114.95 for the S-3, and \$179.95 for the S-2. All prices slightly higher West of the Rockies.

Write for complete technical details, and new 1962 catalog.



H. H. Scott Inc., 111 Powdermill Rd., Maynard, Mass.
 Export: Morhan Exporting Corp., 458 Broadway, N. Y. C.
 Canada: Atlas Radio Corp., 50 Wingold Ave., Toronto



**MAGNETIC STEREO CARTRIDGE
model SX-1**

SPECIFICATIONS

Response	20-20,000 cps
Out put	4 mV / 5 cm / 1,000 c/s
Channel Isolation	20 dB 40-12,000 c/s
Channel Balance	±0.5 dB at 1,000 c/s
Compliance	3×10^{-6} cm / dyne
Load Resistance	50-70 kilo ohms
Tracking Force	3 grams
Stylus	0.7 mil Diamond
Weight	12.5 grams

SONOVOX

SONOVOX CO., LTD.
101 Tokiwamatsuchō, Shibuyaku, Tokyo, Japan

Circle 70A

YOU SAVE MONEY!

**RUSH US YOUR
LIST OF HI-FI
COMPONENTS
FOR A SPECIAL
QUOTATION
WRITE FOR FREE
AUDIO DISCOUNT
CATALOG A-15**

*New low prices on ampli-
fiers, tuners, tape record-
ers, speakers, etc.*

KEY ELECTRONICS CO.
120 LIBERTY ST.
NEW YORK 6, N.Y.

Circle 70B

marketed by Bogen and Rich, Inc. The Rich 20/20 series utilizes a pneumatically loaded cone-type woofer which drives a non-resonant dome to obtain good efficiency with relatively small cone excursion. The mid-range and tweeter units utilize the new transducer design which is similar to an electrostatic speaker in that the vibrating surface is flat, but unlike electrostatics in that they do not require high polarizing voltages. Instead the flat voice coil and transducer is mounted between bar magnets and operates from the

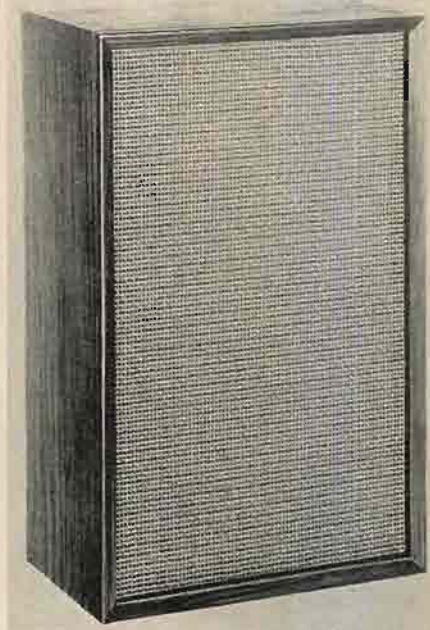

normal speaker connections of the amplifier. The tweeter is essentially the same as the mid-range unit but utilizes a corrugated sheet rather than a flat surface. It is claimed that the efficiency of the Rich 20/20 system is from 6 to 10 db higher than most of the available low-efficiency systems presently marketed. Input impedance is 8 ohms and power handling capacity is 60 watts of program material. Crossover frequencies are 1000 cps and 6000 cps. Minimum recommended amplifier power is 20 watts. Price of the Rich 20/20 in oiled walnut cabinet is \$200.00. Bogen and Rich, Inc., Yonkers, N. Y. **B-6**

NEW LITERATURE

• **Relay Catalog.** Universal Relay Corp. has recently released their latest 20-page illustrated bulletin, listing and describing many of the 1,200,000 relays, steppers, sensitrols, solenoids, contractors, rectifiers, and related items from their normal stock. Most of the different items shown are carried in stock in production quantities. Universal Relay Corp., 32 White Street, New York 13, New York. **B-7**

• **Thin Speaker Systems.** Advanced Acoustics Co. announces the availability of a new 2-color catalogue sheet covering descriptive material on their new Wafaire Bi-Phonic Coupler thin speaker systems. The Wafaire reproduces the full range of the audio spectrum by means of a large wood panel which vibrates as a single system. The resulting speaker system is only 3/8-in. thick and can be hung on a wall like a picture or concealed within a wall. The new catalogue sheet provides full specification data, descriptive material, prices and other information. In addition to the Wafaire catalogue sheet free reprints of technical articles covering the bi-phonic principle can also be obtained upon written request. Electronic Research

Association, Inc., 67 Factory Place, Cedar Grove, N. J. **B-8**

• **Revised "Guide to HI FI."** A completely revised and updated version of their 36-page booklet entitled "Guide to High Fidelity Stereo and Monophonic Sound" has been published by EICO. Written by Mannie Horowitz of EICO's engineering department, the booklet covers such subjects as the "factors comprising high-fidelity" (including the nature of sound, and the problems that a sound reproducing system has to contend with—harmonic distortion, interference, and the like); the component parts of a high-fidelity system; the meaning of stereo and how to convert a mono system to stereo; and how to save money when buying high fidelity equipment. The revised version of the booklet takes into account all the developments that have come along in this fast-moving field since the first edition was published. It is available from EICO for 25¢ to cover the cost of postage and handling. EICO Electronic Instrument Co., Inc., 33-00 Northern Blvd., L.I.C. 1, N. Y. **B-9**

• **Citation Kits Brochure.** A new question-and-answer brochure, explaining the features, installation, construction, and philosophy of the Citation high fidelity kits, is now available from Harman-Kardon, Inc. Among the questions answered in the 8-page brochure are: What is a blend control and how does it operate? How are the Citation preamplifiers and tuner installed within a cabinet? How does the packaging used in Citation help save the kit builder time and effort? Why is it necessary to extend the frequency range of an amplifier beyond the normal range of hearing if no one can hear beyond 20,000 cps or below 20 cps? The brochure is available free by writing to: Citation Division, Harman-Kardon, Inc., Plainview, Long Island, N. Y. **B-10**

• **Four-Track Tape Recording Booklet.** A booklet describing four-track tape recording has been published by Minnesota Mining and Manufacturing Company (3M). The booklet is a non-technical description of the method and its benefits. Four-track recording, the booklet points out, demands not only superior equipment, but also the highest quality tape. However, it is the most economical method of tape recording yet devised, because more sound can be recorded on a given length of tape. The pamphlet is available by writing Dept. Y1-522, Minnesota Mining and Manufacturing Company, 900 Bush Avenue, St. Paul 6, Minnesota. **B-11**

• **Precision Test Instrument Catalog and Technical Reviews.** New 24-page short Catalog ES-10 listing the complete Bruel & Kjaer line of integrated sound, vibration and data analysis instrumentation is available from B & K Instruments. Also available are two 22-page Technical Reviews "RMS Recording of Narrow Band Noise With a Level Recorder" and "Effective Averaging Time of an RMS-Level Recorder." Influences in the Level Recorder that affect the measurement of the theoretically true rms value of a statistically fluctuating signal are extensively explored. To obtain copies of the Technical Reviews, request TR-4-60 and TR-1-61. B & K Instruments, Inc., 3044 West 106th Street, Cleveland 11, Ohio. **B-12**

• **Loudspeakers and Systems.** James B. Lansing Sound, Inc. has issued a 30-page pocket-size brochure on its JBL Loudspeakers and Loudspeaker systems. The new publication is numbered SC-509. The first part of this publication is devoted to extended-range speakers, low-frequency drivers, high-frequency drivers and horns, and dividing networks. The second half of the catalogue is devoted to JBL loudspeaker enclosures starting with the Paragon and the Metregon stereo reproducers plus more than a dozen smaller sizes each of which is available with or without its own complete sound system. James B. Lansing Sound, Inc., 3249 Casitas, Los Angeles, Calif. **B-13**

LIGHT LISTENING

(from page 10)

by Paul Lavalie has always been one of the flashier organizations among the big-time bands. This is an outfit with a youthful flair, its loose-gaited swing reflecting Lavalie's very active participation in the affairs of school and college bands across the country. No military band is apt to tackle Sousa's marches with quite the swaggering showmanship of this crew. Much of this spirit is traceable to the days when the band was called upon to win the immediate attention of radio and television audiences. The program includes just about every well-known Sousa march. For a final touch, Lavalie adds a simple device that could spruce up other albums of this sort—drumming segues that carry over interest from one march to the next. The sound is refreshingly crisp and the miking pattern, with a pickup pattern more distant than average, puts the entire band in the spotlight.

50 Years of Movie Music

Decca DL 79079

They really went back to the beginning in this one. The staff at Decca Records obviously had a lot of fun recreating Hollywood's early days in this stereo recording. Start the disc and the lights in your room will appear to flicker as the nasal nickelodeon piano lurches into the music that accompanied the silent films issued at the turn of the century. If this record is a clue, audiences of that day had some pretty fancy stuff lavished upon them as they sat in the converted stores that housed the first projectors and screens. This upright twangs its way through excerpts from *Poet and Peasant*, *Melody in F*, and the *Erl King*. Equally entertaining is the early-style orchestral film music written and conducted by Jack Shaindlin who once played the piano at the age of 15 in a Chicago silent movie house. Music for chase and slapstick sequences leads the way to an ancient newsreel medley. This opens with a fiery march that once worked equally well for national figures or football games. Then follow "serious" themes suitable for fires or floods, jazzier ideas for parading damsels in beauty contests and, finally, the inevitable horse race. Raymond Bohr plays a theatre organ solo in Erno Rapee's *Charmaine* from "What Price Glory." The early talkies are represented by an excerpt from "Sunny Side Up" and the town's golden years come in for attention in *Beyond the Blue Horizon* from the Ernst Lubitsch classic Monte Carlo, starring Jeanette MacDonald. Other high points in Hollywood's story include samples of "Flying Down to Rio," "King Kong," "The Informer," "Spellbound," "Intermezzo," and "The Third Man." The album brings us up to date with Elmer Bernstein's theme from "Man with the Golden Arm."

Sy Oliver: Dance Music for People Who Don't Dance Anymore

Riverside RLP 97502

The big bands are still with us on discs—if you know where to look for them. After coasting along for several seasons on labels that offered him only meager promotion, Sy Oliver's first appearance on a Riverside recording may now get him some of the attention he has rated since the heyday of the great bands of the early Forties. His present band features noted stars of the Swing Period such as trumpeter Charlie Shavers and drummer Jimmie Crawford, a sidekick of the old Lunceford days. Sam "The Man" Taylor gives the band some present-day glamour in the reed section. The choice of tunes in this album may tend to puzzle youngsters unfamiliar with the folk tune arrangements Sy turned out for both the Lunceford and the Tommy Dorsey bands. Stereo underlines the sly humor of the Oliver treatment of *Annie Laurie*, *Arkansas Traveler*, *I'm a Little Teapot* and *The Blue Tail Fly*.

Ray Anthony: Dream Dancing

Capitol ⚡ ZT 723

Many theories have been applied to stereo recordings of the larger dance bands. Each label has preferred to think that it alone had the best formula for effective presentation of a name band. In searching for new ways to establish channel differentiation, some record companies almost outsmarted themselves as their orchestras became less and less recognizable. In contrast, Capitol presents in this tape release a major band just as it would be deployed in a ball room appearance. The spacing-for-stereo of the key sections of the orchestra is completely right in its logic. Now the ear is free to enjoy the music and the illusion of depth created by the placement of the Ray Anthony trumpet in the ranks of the band. One of Ray's all-time best-selling albums, this set of danceable mood music was first issued back in 1956. For the stereo re-release, Anthony used the same arrangements and most of the same musicians in quiet favorites such as *September Song*, *Laura*, and *Moonlight in Vermont*.

Dancing on Sunday

United Artists UAS 6146

It takes a sequel to "Never on Sunday" to reveal more fully the scope of native popular music making the rounds in Greece. The hard brilliance of the strumming Bouzouki made famous in the Mercouri film is a prominent feature of this album. It is a perfect complement to the upper-register percussion. If this trend in music keeps up, the names of Greek composers such as Hadjidakis, Theodorakis, Plessas, and Yacoulef may yet become household words over here. Some of these men have been busy in music fields other than movie making. The varied collection of tunes offered here includes a few traditional melodies but the title song will sell the album simply because the word Sunday appears in it. Crisp sound adds further seasoning to these off-beat instrumentals recorded in Greece.

Song Without End (Original Sound Track)

Colpix ⚡ CXC 602

This particular sound track offers better listening for piano fans on tape than it does on disc. While no playback medium can disguise the corny nature of some of the choral excerpts from Hollywood's lavish appraisal of the life and music of Franz Liszt, the sound is definitely more acceptable in the tape medium. In one respect tape has almost an unfair advantage. The man who selected the recording characteristic for the Colpix disc certainly placed no faith in the generally accepted virtues of the RIAA curve. The formula, whatever its nature, defies my efforts to find a listenable playback setting. As processed by UST, the sound of the piano heard throughout the picture in the off-screen performances of Jorge Bolet has a chance to establish its normal character. Liszt's pyrotechnics, which embrace both ends of the keyboard, fare better on this reel than they would on the average stereo record. The chorus heard in Handel's *Largo*, Wagner's *Pilgrim's Chorus* from Tannhauser and Liszt's *Un Sospiro* still has some of the boxed-in effect that was noticeable in the disc version. The Los Angeles Philharmonic Orchestra makes only fleeting appearances in the recording. Perhaps it's just as well because it sounds only slightly better on the tape than it did on the disc. I suppose Hollywood has its own problems in determining the length of its so-called concert sequences in films dealing with music. Far too much of this recording is given over to snippets of selections. Make no mistake Bolet is good and his piano has received realistic recording. The difficulty lies in the fact that he is heard in this reel for a total of only twenty-four minutes. ZE

KLIPSCH MODEL H

FOR
STEREO
OR
MONOPHONIC



Unparalleled among small speakers, the Model H is compatible with the KLIPSCHORN or any other Klipsch speaker for stereo. Compare it with any small speaker... at any price. Priced at \$221. Other Klipsch speaker systems up to \$2,112. Write R. L. Moers, Director of Sales, for free brochure and name of your nearest Klipsch dealer.

KLIPSCH and ASSOCIATES, INC.

BOX 96, HOPE, ARKANSAS

ADVANCE ORDERS

BOUND VOLUMES

1961 Issues

Audio Magazine

Order Now

LIMITED NUMBER
AVAILABLE

\$10.00 EACH POSTPAID
U. S. DELIVERY ONLY

Send Order
and Remittance Today

Book Division
Radio Magazines, Inc.

P.O. Box 629
Mineola, N. Y.



No. 120
THE 4th AUDIO ANTHOLOGY
 \$2.95 Postpaid

This is the biggest Audio Anthology ever! Contains a wealth of essential high fidelity know-how in 144 pages of complete articles by world-famous authors.



"the best of AUDIO" No. 124

A new compendium of AUDIO knowledge.

Here is a collection of the best of AUDIO—The AUDIOclinic by Joseph Giovanelli...noted audio engineer and the original high fidelity answer-man—EQUIPMENT PROFILES edited by C. G. McProud...Editor of AUDIO. Here is a wealth of hi-fi and audio information. Answers to the most important issues in high fidelity and a valuable reference on the performance of leading makes of high fidelity components. Volume I \$2.00



the **AUDIO** bookshelf

A convenient service to AUDIO readers. Order your books leisurely by mail—save time and travel, we pay the postage.

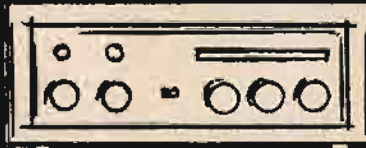

NEW! Greatest Reference Work on Audio & Hi Fi No. 123

"The AUDIO Cyclopedia" by Howard M. Tremaine

Up to the minute, including stereo!

- 1280 pages
- 3400 topics
- 1600 illustrations

Here is one single volume with the most comprehensive coverage of every phase of audio. Concise, accurate explanations of all audio and hi fi subjects. More than 7 years in preparation—the most authoritative encyclopedic work with a unique quick reference system for instant answers to any question. A vital complete reference book for every audio engineer, technician, and serious audiophile. \$19.95



No. 115
McPROUD HIGH FIDELITY OMNIBOOK

Prepared and edited by C. G. McProud, publisher of Audio and noted authority and pioneer in the field of high fidelity. Contains a wealth of ideas, how to's, what to's and when to's, written so plainly that both engineer and layman can appreciate its valuable context. Covers planning, problems with decoration, cabinets and building hi-fi furniture. A perfect guide. \$2.50 Postpaid.



No. 112
TAPE RECORDERS AND TAPE RECORDING

by Harold D. Weiler

A complete book on home recording by the author of *High Fidelity Simplified*. Easy to read and learn the techniques required for professional results with home recorders. Covers room acoustics, microphone techniques, sound effects, editing and splicing, etc. Invaluable to recording enthusiasts. Paper Cover \$2.95 Postpaid.



HANDBOOK OF SOUND REPRODUCTION No. 110

by Edgar M. Villechaut

Right up to date, a complete course on sound reproduction. Covers everything from the basic elements to individual chapters of each of the important components of a high fidelity system. \$3.75 Postpaid.

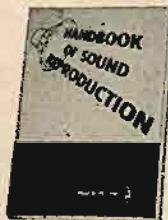

SPECIAL! You pay only \$2.75 for this book when you order it with any other book on this page.

MONTHLY SPECIAL!
SAVE \$5.40

Save over 50% with this collection of AUDIO books. 4th Audio Anthology (\$2.95) McProud High Fidelity Omnibook (\$2.50) best of AUDIO (\$2.00) Tape Recorders & Tape Recording (\$2.95)

TOTAL VALUE OF ALL FOUR BOOKS \$10.40

Your cost ONLY \$5.00 POSTPAID

This offer expires March 31, 1962
 Good only on direct order to Publisher
CIRCLE OS200

AUDIO Bookshelf
RADIO MAGAZINES, INC.,
 P.O. Box 629, Mineola, New York

Please send me the books I have circled below. I am enclosing the full remittance of \$_____ (No C.O.D. or billing.)
 All U.S.A. and CANADIAN orders shipped postpaid. Add 50¢ for Foreign orders (sent at buyer's risk).

BOOKS: 110 112 115 120 123 124 OS200

NAME _____ ADDRESS _____

CITY _____ ZONE _____ STATE _____



AUDIO will pay \$5 for questions or answers used. Send questions or answers to: Audio Teasers, P. O. Box 629, Mineola, N. Y.

NORMAN H. CROWHURST

Answers to Last Month's Teasers

Answer 1. When the 250k resistor is used as a "load" for the ceramic pickup, it causes bass loss, because the pickup has an impedance essentially that of a capacitor; the effect is the same as using too small a grid resistor following a small coupling capacitor. When the 5-megohm control is used, this bass loss is avoided, but "static hum" is picked up when the control is part way up. This is because the input impedance of the grid circuit reaches its maximum. Full on, the ceramic capacitance bypasses the static, and off, it is grounded.

If the static hum is picked up in the instrument, complete shielding of the control and input lead may cure the hum. But if it is due to the input tube—the fact the return impedance of grid to ground is too high, a smaller control is the answer, and other means must be sought to avoid the bass loss. Shunting the instrument ceramic

with a larger capacitance will attenuate its output uniformly, and allow a smaller value control to be used without bass loss (Fig. 1).

Answer 2. (a) Impedance on a transformer winding reflects in proportion to turns squared. If, for example, a 16-ohm load connected to the secondary reflects a plate-to-plate load of 10,000 ohms, the reflected impedance at the screen taps would be 0.4×0.4 , or 0.16 of 10,000 ohms, which is 1600 ohms. The impedance reflected to the screen taps is 16 per cent of that reflected to the plate connections.

(b) That comparison of loading is based on the incorrect assumption that the same load is connected to the secondary and fed separately from plate or screen connections on the primary. In practice, both feeds occur simultaneously.

Suppose the plate-to-plate voltage is 100 (rms). The power supplied from the plates will be $100^2/10,000 = 10$ watts. The corresponding screen-to-screen voltage will be 40 volts and the corresponding screen-to-screen current swing will be one tenth of the plate-to-plate current swing. The plate-to-plate current swing is 100 mA (rms). So the screen-to-screen swing is 10 mA. The power delivered by the screens is 40 volts times 10 mA or 0.4 watts. So the screens deliver only 4 per cent not 16 per cent of the plate power.

Answer 3. A pentode with a plate coupling resistor previously used for a triode

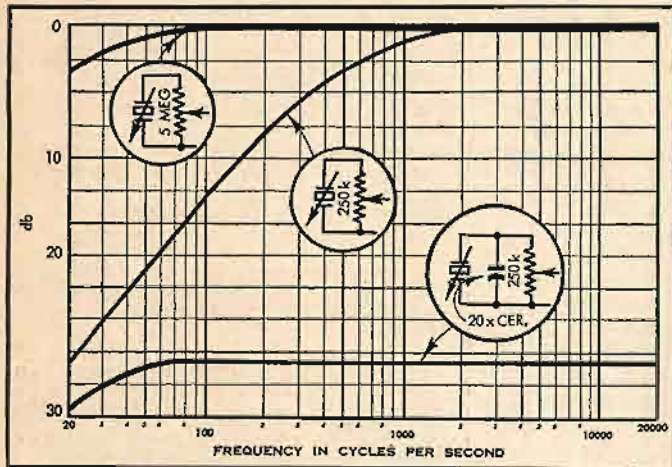

Fig. 1. Smaller value control to reduce hum.

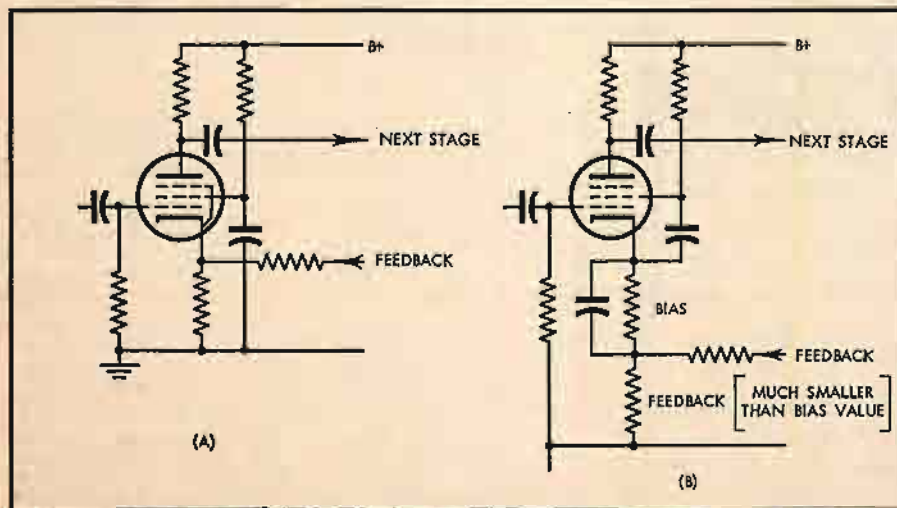

Fig. 2. Using a smaller cathode feedback resistor and bypassing the bias resistor.

Only General Electric gives you this:

New OrthoNetic Stereo Cartridge



Purest musical response... even beyond 20,000 cycles!

Breakthrough in musical reproduction! General Electric's new VR-1000 ORTHONETIC Cartridge gives precise, undistorted reproduction of every note on your high-fidelity records—even at frequencies above the normal range of human hearing!

Even the most subtle overtones come through...

Ordinary cartridges shave off the higher harmonic frequencies that give orchestral instruments their characteristic color.

Thanks to a revolutionary new suspension and damping system, the VR-1000 ORTHONETIC Cartridge fully reproduces these harmonic frequencies, with barely measurable loss or distortion.

This means that every instrument has its true coloration; even the most sensitive ear can listen without the fatigue caused by musical distortion.

Tracks at pressures as low as one gram—prolongs record life...

The low-moving mass of the ORTHONETIC assures highest fidelity even on the fastest passages, minimizes record wear.

Provides up to 30 decibels per channel stereo separation. Ask your General Electric cartridge dealer for full specifications or write VR-1000, General Electric Co., Audio Products Dept., Decatur, Ill.

Progress Is Our Most Important Product

GENERAL ELECTRIC

FAIRCHILD "500"

Exclusive
ANTI-SKATING* / **Makes the Difference**

Anti-Skating... the most important arm development... now makes conventionally designed arms virtually obsolete. The Fairchild 500, with the exclusive Anti-Skating system overcomes the obstinate inward pull found in most conventional arms. This skating is the basic cause of right channel distortion. Only the uniquely designed Fairchild 500 applies continuous skating correction with balanced compensation for skating at the inner diameters where friction between stylus and groove is greater. This remarkable anti-skating arm, coupled with the unmatched Fairchild SM-2 Cartridge with its linear separation, linear response and low stylus mass—makes this Fairchild 500 the ultimate system to duplicate the sound of the original master. Complete details are available. Only \$58.00 for complete Arm-transport and SM-2 Cartridge. Also available Arm only (500A) \$29.95; SM-2 Cartridge only \$37.50. *Patent pending

FAIRCHILD

RECORDING EQUIPMENT CORPORATION
10-40 45th Ave., Long Island City 1, N. Y.

Circle 74A

IF YOU ARE MOVING

Please notify our Circulation Department at least 5 weeks in advance. The Post Office does not forward magazines sent to wrong destinations unless you pay additional postage, and we can NOT duplicate copies sent to you once. To save yourself, us, and the Post Office a headache, won't you please cooperate? When notifying us, please give your old address and your new address.

Circulation Department
RADIO MAGAZINES, INC.
P. O. Box 629, Mineola, N. Y.



ISOTONE

acoustical tone equalizing music system

An acoustical Landmark.

Incomparably superior tonal balance due, mainly, to the tremendous air loading of speaker units. Speakers mounted front and rear for much better sound dispersion. A MUST for the music epicure. Brochure on request. Dealers please inquire.

Three models: 1 cubic foot, 2 cubic feet and (illustrated) the Eroica, 6 cubic feet at \$265. ASK for Isotone.

ISOTONE ASSOCIATES

3402 Third Avenue
New York 56, N. Y.

Circle 74B

stage will have a little more than twice the gain, so that over-all feedback is doubled by the change. But screen current, as well as plate current, passes through the cathode resistor. The effect of the additional feedback will be to try and linearize input stage total current by means of an amplified version of the plate voltage. As input stage total current includes its screen current, which is extremely nonlinear, an additional nonlinear element is included in the loop. Screen current nonlinearity does not matter when screen voltage is held constant, by decoupling, and when the cathode is similarly decoupled to ground.

The remedy is to use a smaller value of cathode feedback resistor, and bypass the one used for bias (Fig. 2). In this way the nonlinear voltage due to screen current contribution is made much smaller than the fed back voltage across the smaller resistor.

This Month's Questions

Question 1. To check phasing of loudspeaker units to be used in a multiway system, a small cell is connected to each unit and the terminal to which the positive pole has to be connected to make the cone move forward is marked with a red dot. The system uses 12 db/octave crossover (an L and a C in the feed to each unit). Assuming the filter elements of the crossover are fed from the amplifier in parallel and that the unmarked terminal of the woofer goes to ground, the red dot one to low-pass output, which way must the tweeter be connected for correct phasing?

Question B-2. The loudspeaker supplied with a solo organ intended to be attached to the front of a piano keyboard didn't look very good to a certain audioman. Convinced a high fidelity loudspeaker would get better results, he (a) connected the organ speaker to his high fidelity system and found it gave very obvious intermodulation distortion; (b) connected his high fidelity speaker to the organ, but found it did not give so sweet tone as with its own "crummy" speaker. He checked that the difference was not due to impedance differences—they were near enough the same. What is the explanation?

CLASSIFIED

Rates: 10¢ per word per insertion for noncommercial advertisements; 25¢ per word for commercial advertisements. Rates are net, and no discounts will be allowed. Copy must be accompanied by remittance in full, and must reach the New York office by the first of the month preceding the date of issue.

HIGH FIDELITY SPEAKERS REPAIRED
AMPRITE SPEAKER SERVICE
168 W. 23rd St., New York 11, N. Y. CH 3-4812

ENJOY PLEASANT SURPRISES? Then write us before you purchase any hi-fi. You'll be glad you did. Unusual savings. Key Electronics, 120 Liberty St., New York 6, N. Y. CLOverdale 8-4288.

LOW, LOW quotes: stereo tapes, components, recorders, HI-FI, Roslyn 4, Pa.

SALE ITEMS—bulk tapes—component quotes. Bayla, Box 131-0, Wantagh, N. Y.

LEARN WHILE ASLEEP. Hypnotize with your recorder, phonograph or amazing new "Electronic Educator" endless tape recorder. Astonishing details, sensational catalogue FREE. Sleep-Learning Research Association, Box 24-AD, Olympia, Washington.

MAILTAPE. Reusable 3-inch mailing containers. No wrapping. Supply mailing and return labels ensures returns. Four: \$2.20. Ten: \$4.30. Quality 150' tapes included. Four: \$4.10. Ten: \$8.30. Check with order. Refundable. Rusco, 108 Brighton Avenue, Boston, Mass.

SELF-HYPNOSIS tape or LP record. Learn quickly, easily. Free literature. McKinley-Smith, Co., Dept. ATR, Box 3038, San Bernardino, California.

15-INCH STEPHENS WOOFER. Model 105-LX. All diecast frame, 2½ pound magnet, 2 inch V. C., 20 watts. \$35.00 or trade for University HF-206 super tweeter.

WANTED: Jensen Imperial or Triplex speaker system and Knight 25-watt basic amplifier. Shuster, 17 Ravine Court, Clifton, N. J.

SCHOBER ELECTRONIC ORGAN. Concert model. Meets AGO specifications. Jaeger, 123 East 37th Street, New York City, N. Y. MU 4-3139.

PROFESSIONAL RECONDITIONING all audio and recording equipment. Low prices on components with service. Best trade-in deal in the country. Dick Simms, Audio Trading Post, Inc., 58 West 48th Street, New York 36, N. Y. JUDson 2-2356. 2nd Floor.

MAGNECORDS FOR SALE. Several different professional models newly reconditioned. Send for list. Audio Specialties, Box 12203, San Antonio 12, Texas.

MAN, LONG-EXPERIENCED HI-FI INSTALLATIONS and administration looking for appropriate position, New York City area. Answer CB-1, AUDIO, P. O. Box 629, Mineola, New York.

WANTED: Buy, Magnecord 728 recorder. Sell, Concertone 505E ½-track recorder plus pair Dynaco variable impedance microphones.

GLOBAL TAPE RECORDING EXCHANGE HOBBY CLUB. We bring the world to you via tape. This is the most rewarding hobby known for all ages. Tapesponding can put you in contact with people all over the world for exchanges of ideas, music, educational knowledge, or small talk. Free details. Write to MAILWAY CO., 216 W. Jackson Boulevard, Chicago 6, Ill. or 51 West 35th Street, New York 1, N. Y. or 601 S. Vermont, Los Angeles 5, California or 2006 E. Courtland, Spokane 27, Wash.

FM/Q ANTENNAE

THE FINEST OF ITS KIND . . .
Get more FM stations with the world's most powerful FM Yagi Antenna systems.

To be fully informed, send 30¢ for book "Theme And Variations" by L. F. B. Carini and containing FM Station Directory.



APPARATUS DEVELOPMENT CO. WETHERSFIELD 9, CONN

Circle 75B



Quick-See RETRACTIBLE Album File
GLIDES IN AND OUT OF CABINET OR WALL FOR FRONT-VIEW, FLIP-THROUGH SELECTION

Eliminates visibility problem of edge-stacked albums, stops jacket-bottom wear. Installs anywhere in five minutes with 4 screws. Sturdy welded steel construction, ball-bearing tracks, balanced suspension. 9 models for LP's & tape, hold to 125 albums; black or brass, \$6.95 up. Write for brochure A. Dealer inquiries invited.

KERSTING MFG. CO., 504 S. DATE, ALHAMBRA, CALIF

Circle 75C

AUDIO unlimited

Specializes in SAVING YOU MONEY

- ✓ FACTORY FRESH COMPONENTS
- ✓ LOWEST POSSIBLE QUOTATIONS
- ✓ FAST DELIVERY

We are FRANCHISED DEALERS for most HI-FI lines. Most orders SHIPPED PROMPTLY from stock. RECORDING TAPE at LOWEST PRICES. FREE 95 page STEREO CATALOG.

190-A Lex. Ave., Cor. 32 St., New York 16, N. Y. Visit Our Showroom

Circle 75D

SAVE UP TO 40% on HI-FI COMPONENTS AND PACKAGES

- 15 Day Money Back Guarantee
- EASY PAY PLAN — UP TO 24 MONTHS TO PAY
- WE GUARANTEE WE WILL NOT BE UNDERSOLD

Please write for FREE return mail quotation, and wholesale catalog. Also pre-recorded tape catalog on request.

HI-FIDELITY CENTER
"The House Of Low Prices"

220-U East 23rd St. New York 10, N. Y.

Circle 75E

Industry Notes . . .

• **GOTHAM TERMINATES DISTRIBUTION CONTRACT.** Gotham Audio Corp. announced the termination of its distribution contract with Norted Audio Co. as of December 31, 1961. Prior to this date Norted was the distributor of the Neumann PA-2a turntable, the Neumann DST stereo cartridge, and the Beyer dynamic headphones, all of which are exclusively imported by Gotham. All inquiries regarding these products pertaining to sales, service, and engineering applications should now be addressed to Gotham Audio Corp., 2 West 46th St., New York 36, N. Y.

• **EMPIRE TROUBADOR GOES "ROUND THE WORLD."** Taking heed of the opinion that the most tempting contest prize is travel, Empire Scientific Corp. is sponsoring a contest with the prize being a "Round-the-World Music Festival." For 21 days, the winner and his guest will have the privilege of hearing some of the world's greatest music in the cultural centers of Europe. The object of this contest will be to arrange ten features of the Empire Troubadour record playing system in their order of importance as determined by top-ranking music editors and critics who will be the judges for the contest. Full details of the contest are given in advertisements. The contest is aimed at acquainting the listening public with the finest music in the world as well as with the Empire line.

• **BOGEN-PRESTO LAUNCHES "FISH BOWL" DEALER CONTEST.** Offering cash prizes totalling \$5000 plus providing photographs of dead fish and live girls, the Bogen-Presto Div. of the Siegler Corp. has cast bait at their dealer organization in order to fish up additional business. The prizes are scaled according to the size of the fish (sale) caught by the individual dealer. All that the dealer has to do to enter is to sell a piece of Bogen-Presto equipment; to win he has to guess the combined weight of the live girls and the dead fish.

• **PILOT RADIO BOUGHT BY JERROLD.** The acquisition of Pilot Radio Corporation by Jerrold Electronics was announced on January 12 by Sidney A. Harman, Jerrold President. Pilot will be continued as a separate entity, and will operate as an independent division of Jerrold Electronics, of which Harman-Kardon is also a division.

MAIL ORDER HI-FI

COMPONENTS RECORDERS TAPES

At wholesale prices. Shipped within 24-28 hrs. We'll airmail low quotes on packaged Hi-fi. (Free catalogue.)

CARSTON 125-N EAST 88 ST. NEW YORK 28, N. Y.

Circle 75F

LONDON CALLING THE WORLD . . . KEEP HI-FI COSTS LOW — buy BRITISH EQUIPMENT from the United Kingdom Mail Order Specialists!

• AMPLIFIERS • MOTORS • TUNERS
• SPEAKERS • PICK-UPS

All goods Packed, Insured and Shipped promptly at minimum cost. Send us details of your needs!

C. C. GOODWIN (Sales) Ltd. (Dept. A)
7, The Broadway, Wood Green, London, N.22. Eng.

Circle 75G

TOP ALLOWANCE FOR YOUR USED COMPONENTS AT audio exchange

WHEN YOU PURCHASE The Fisher FM-100-B FM—Multiplex Wide-Band Tuner with Exclusive Stereo Beacon

Features 0.6 microvolt sensitivity, Micro Ray Tuning Indicator, Automatic switching between mono and stereo, MPX noise filter.



TRADE 4 WAYS

- TRADE Hi-fi for hi-fi
- TRADE Amateur radio* for hi-fi
- TRADE Hi-fi for amateur radio
- TRADE Amateur radio* for amateur radio*

*Includes HAM; SWL; Citizen's Band; Test Equipment

AUDIO EXCHANGE EXCLUSIVES:
Trade-Back Plan • New Equipment from over 100 manufacturers • Used Equipment sold on 10-day unconditional money-back guarantee . . . plus 90-day service warranty • Special GE credit plan • Custom installation for stereo and monaural equipment. • Hi Fi service laboratory.

Get more! Pay less when you trade at

audio exchange

For Trading info., write dept. PLEASE MAIL ALL ORDERS AND INQUIRIES TO JAMAICA 153-21 Hillside Ave., Jamaica 32, N. Y. • AXtel 7-7577 WHITE PLAINS, N. Y. BROOKLYN, N. Y. MANHASSET, N. Y. 203 Mamaroneck Ave. 1065 Flatbush Ave. 451 Plandome Rd.

Circle 75A

CANADA High Fidelity Equipment

Complete Lines • Complete Service

Hi-Fi Records — Components and Accessories

ELECTRO-VOICE SOUND SYSTEMS

126 DUNDAS ST. WEST, TORONTO, CANADA

SAVE YOUR COPIES OF AUDIO

Attractive and practical for your home or office

3 for \$7.00
6 for \$13.00

ORDER NOW — send check or money order

MAGAZINE FILE CO. 520 FIFTH AVENUE NEW YORK 36, N. Y.

FREE DESCRIPTIVE FOLDER UPON REQUEST

LAFAYETTE

STEREO HI-FI COMPONENTS

Designed for the Home

Engineered To Professional Standards

DEDICATED TO MUSIC

Made in U.S.A.

LAFAYETTE LT-700

**Criterion FM STEREO
MULTIPLEX TUNER**

NO MONEY DOWN **124.50**

Ready for Stereo and no Adapter Needed . . . opening a new era in stereo, the new Lafayette Criterion FM Stereo Multiplex Tuner is entirely self contained with its own built-in multiplex facilities. Capable of achieving the highest



Completely Wired and Tested

Laboratory Standards, its exceptional selectivity and sensitivity together with drift-free AFC performance insures effective reception of even the weakest multiplex or monaural FM signals.



**KT-250A 50-WATT INTEGRATED
STEREO AMPLIFIER**

KT-250A

LA-250A

74.50

99.50

in Kit Form

Completely Wired

- 3rd Channel Output
- Separate Bass & Treble Controls
- 50-Watts Monophonically - 25 Watts Each Stereo Channel
- Response: 15-40,000 cps \pm .5 db (at normal listening level)

Pacesetter quality, performance and design. Features include: unique "Blend" control for continuously variable channel separation—from full monaural to full stereo, 4-position Selector, Mode, Loudness and Phase switches. Also provides outputs for 4, 8, and 16 ohm speakers. Hum-free operation is insured by use of DC on all pre-amp and tone control tubes. Individual bias and balance controls. Harmonic distortion, less than 0.25%. IM distortion, less than .5%. Hum and noise 77 db below full output. 14 1/2"W x 12 3/4"D x 5 1/2"H. Shpg. wt., 28 lbs.

Made in U.S.A.

**KT-600A Criterion
PROFESSIONAL STEREO
CONTROL CENTER**

KT-600A

LA-600A

79.50

134.50

In Kit Form

Completely Wired

- Response 5-40,000 cps \pm 1 db
- Precise "Null" Balancing System
- Bridge Control Provides Variable 3rd Channel Output
- Variable Cross Channel Signal Feed Eliminates Hole-In-The-Middle Effects
- Tape Head Playback Equalization for 4-Track Stereo

Sensitivity 2.2 mv for 1 volt out. Dual low impedance "plate follower" outputs 1500 ohms. Less than .03% IM distortion; less than .1% harmonic distortion. Hum and noise 20 db below 2 volts. 14x10 1/2 x 4 1/2". Shpg. wt., 16 lbs



Made in U.S.A.



**KT-550
Criterion 100-WATT
BASIC STEREO AMPLIFIER**

- Rated at 50-Watts per Channel
- Response from 2-100,000 cps; 0-1 db at 1-Watt
- Massive Grain Oriented Silicon Steel Transformers
- Multiple Feedback Loop Design (over 50 db)
- Metered Calibration Control Panel
- Absolutely Stable Under Any Conditions of Load

A new "Laboratory Standard" dual 50-watt amplifier guaranteed to outperform any basic stereo amplifier on the market. Advanced engineering techniques plus the finest components ensure flawless performance. Distortion levels so low they are unmeasurable. Hum and noise better than 90 db below 50-watts. Complete with metal enclosure. 9 1/4"H x 12 1/2"D. Shpg. wt., 60 lbs.

Made in U.S.A.

KT-550

LA-550

134.50

184.50

In Kit Form

Completely Wired

LAFAYETTE RADIO SYOSSET, L. I., N. Y. JAMAICA 33, N. Y. NEW YORK 13, N. Y. BRONX 58, N. Y.
NEWARK 2, N. J. PLAINFIELD, N. J. PARAMUS, N. J. BOSTON 10, MASS.

FREE! YOURS FOR THE ASKING!

LAFAYETTE RADIO, Dept. AB-2
P.O. Box 10
Syosset, L. I., N. Y.

Send FREE 1962 Catalog featuring the complete line of Lafayette Stereo Components.

\$ Enclosed for Stock No.

Name

Address

City Zone State



ADVERTISING INDEX

Acoustic Research, Inc.	27
Airex Radio Corporation	6
Altec Lansing Corporation	31
Amelux Electronics Corporation	4
Apparatus Development Co.	75
Audio Bookshelf	72
Audio Devices, Inc.	5
Audio Dynamics Corporation	65
Audio Exchange	75
Audio Fidelity Records	53
Audio Unlimited	75
Barker & Williamson, Inc.	58
Belden	37
British Industries Corporation	3
Cabinart Acoustical Dev. Corp.	15
Carston	75
Classified	74
Dynaco, Inc.	47
EICO	13
Electronic Applications, Inc.	11
Electro-Voice, Inc.	40, 41
Electro-Voice Sound Systems	75
Elpa Marketing Industries, Inc.	14
Empire Scientific Corp.	25
Eric Electronics Corporation	63
Fairchild Recording Equipment Corp. ..	74
Fisher Radio Corporation	9
Garrard Sales Corp.	3
General Electric	73
Goodwin, C. C. (Sales)Ltd.	75
Gotham Audio Corporation	54
Grado Laboratories, Inc.	2
Harman-Kardon	6, 43
Hi Fidelity Center	75
International Electroacoustics Incorporated	56
Isotone Associates	74
Jensen Manufacturing Company	61
Kersting Manufacturing Company	75
Key Electronics Company	70
KLH Research & Development Corp.	59
Klipsch and Associates, Inc.	71
Lafayette Radio	76
Lansing, James B., Sound, Inc.	49
Newcomb Audio Products Company	55
North American Phillips Co., Inc.	64
Paco Electronics Co., Inc.	57
Pickering & Company, Inc.	17
Pilot Radio Corporation	29
Pioneer Electronic Corporation	7
Reeves Soundcraft Corp.	Cov. 11
Rek-O-Kut Co., Inc.	51
Sarkes Tarzian, Inc.	39
Scott, H. H., Inc.	69
Sherwood Electronic Laboratories, Inc. ..	1
Shure Brothers, Inc.	62
Sonovox Co., Ltd.	70
Stackpole Carbon Co.	35
Superscope, Inc.	33
Transis-Tronics, Inc.	Cov. 1V
University Loudspeakers, Inc.	45
Utah Electronics Corp.	66
Viking of Minneapolis	Cov. 111
Weathers Industries	10



**P: Actual Performance*

$$P^* = \frac{25 \text{ to } 16k \sim \pm 2 \text{ db}}{55 \text{ db signal to noise}}$$

Tiny though the transistor might be, Transis-Tronics has used it to set a new pace for the entire high fidelity industry. TEC all-transistor amplifiers and tuners have become the "mighty oaks" of high fidelity — no hum, no heat, no microphonics. The transistor, unlike the old-fashioned tube, is a "life-time" device, therefore, both the TEC amplifier and the TEC FM tuner come to you with full two-year unconditional guarantees. Regardless of price, the S-15 and FM-15 are the most efficient amplifiers and tuners on the market today. TEC S-15 STEREO AMPLIFIER is all sound, rated at 20 watts of music power per channel with a 4 ohm load. With 8 and 16 ohm loads, the power is slightly reduced. TEC FM-15 TUNER, the perfect companion to the TEC S-15, will give you years and years of trouble-free listening. The low power consumption characteristic of transistors means that both the TEC amplifier and tuner can be operated with either 117 vac at 18 to 24 vdc as the power source. AND, NATURALLY, EQUIPPED FOR MULTIPLEX. Transistor Engineered Components • Transis-Tronics, Inc. • 1601 W. Olympic Blvd., Santa Monica, Calif.

TEC™

FROM LITTLE ACORNS



The FM-15 (top) and the S-15 (bottom) are available as separate units or in a handsome walnut or teak combined package. How? No heat means the tuner can be stacked with the amplifier without danger of drift.