

AUDIO

JULY, 1962
50¢

...the original magazine about high fidelity!

CDC



THIS IS THE LAST CARTRIDGE YOU'LL EVER BUY!

empire 880^P

World's Most Perfect Mono/Stereo Cartridge

ENGINEERED TO OUTPERFORM, OUTLAST AND OUTPLAY ANY CARTRIDGE ON THE MARKET TODAY.

A RESEARCH TRIUMPH — THE AMAZING DYNA-LIFE[®] STYLUS

Its ultra-sophisticated hand-polished diamond stylus is the world's lightest. Coupled with a new magnetic element of lowest dynamic mass, this assures the longest possible life of the Empire 880P.

DYNAMIC MASS
less than $.5 \times 10^{-3}$ gms

{ Lower dynamic mass and higher compliance than any other cartridge made . . . eliminates distortion and makes possible a lighter stylus, better frequency response, greater channel separation, and the remarkable new standard for . . . }

COMPLIANCE
 30×10^{-6} cm/dyne

TRACKING FORCE — AS LOW AS 1/4 GRAM

At such low tracking force, the Empire 880P not only eliminates record wear, but also eliminates distortion. To achieve the benefits of low force tracking with the 880P cartridge, a tone arm capable of tracking at such low levels must be used. We track every cartridge with the Empire 980 arm at less than a half gram before releasing it.

PERFORMANCE RANGE
6 to 30,000 cps

{ This is well beyond the range of human hearing

{ Greater separation than any other cartridge means greater enjoyment of stereophonic sound

CHANNEL SEPARATION
more than 30 db

empire 880^P Audiophile Net \$47.50



*Patent Pending

EMPIRE SCIENTIFIC CORP., GARDEN CITY, N.Y.—WRITE FOR LITERATURE

CREATORS OF THE EMPIRE TROUBADOR... WORLD'S MOST PERFECT RECORD PLAYBACK SYSTEM

AUDIO

JULY, 1962 Vol. 46, No. 7

Successor to RADIO, Est. 1917

C. G. McPROUD • *Publisher*

DAVID SASLAW • *Editor*

JANET M. DURGIN
Production Manager

Contributing Editors

EDWARD TATNALL CANBY

JOSEPH GIOVANELLI

HAROLD LAWRENCE

CHARLES A. ROBERTSON

CHESTER SANTON

HENRY A. SCHOBER
Business Manager

SANFORD L. CAHN
Advertising Director

EDGAR E. NEWMAN
Circulation Director

Representatives

Bill Pattis & Associates,
4761 West Tonby Ave.,
Lincolnwood 46, Ill.

James C. Galloway,
6535 Wilshire Blvd.,
Los Angeles 48, Calif.

AUDIO Articles

- Thirty Pounds of Magnet and an 18-inch Cone 19 *S. Robert Russell*
High-Quality, Low-Power Stereo Amplifier 23 *Joseph Giovanelli*
Effect of Phase Shift on Hearing 36 *R. Klein and J. Tributsch*

AUDIO Reviews

- Light Listening 8 *Chester Santon*
Record Revue 38 *Edward Tatnall Canby*
Jazz and All That 42 *Charles A. Robertson*

AUDIO Profiles

- Canby Headphone Review 32 *Edward Tatnall Canby*
Koss Headphone 32 *Model SP-3*
Permoflux Headphone 32 *Models B-DHS-28,
B-DHS-17, HS-8*
Pioneer Headphone 33 *Model SE-1*
AKG Headphone 33 *Model K 50*
Sharpe Headphone 33 *"Live Tone"*
Telex Headphone 33 *Model HPD 53A*
EICO 4-track Stereo Tape Deck Kit 34 *Model RP-100*
Harman-Kardon Stereo Tuner Amplifier 49 *Model TA-5000X*

AUDIO in General

- Audioclinic 2 *Joseph Giovanelli*
Letters 6
Audio ETC 12 *Edward Tatnall Canby*
This Month's Cover 14
Editor's Review 16
Tape Guide 29 *Herman Burstein*
About Music 44 *Harold Lawrence*
New Products 46
Advertising Index 56

SHERWOOD

only for those who want the ultimate



S-8000 FM/MX 64-watt Stereo Receiver \$299.00. 16½" x 4½" x 14" deep. Combines Sherwood's brilliant FM stereo tuner design, two 32-watt amplifiers, two phono/tape pre-amplifiers, and all circuitry necessary to receive FM stereocasts.

RAVINIA Model SR3 3-way speaker system \$139.50. Walnut Cabinet 26¼" x 15" x 13¼" deep. 12" high-compliance woofer, 8" midrange, and 2½" ring-radiator tweeter. Features low intermodulation distortion, flat frequency response (±2½ DB) to 17 KC.



S3000II FM/MX Stereo Tuner \$160.00. 14" x 4½" x 10½" deep. Identical tuner design to S-8000. Other tuners: S-2100 FM Stereo/AM Tuner \$199.50. S-2000 II FM/AM Tuner \$150.50. (Same but without FM stereo feature)

FM Stereo Multiplex Adapters may be used to convert Sherwood and other FM tuners for stereocast reception. \$49.50 to \$69.50.



S-5500 II 64-watt Stereo Preamplifier-Amplifier \$164.50. 14" x 4½" x 12½" deep. Identical to amplifier used in S-8000. Other amplifiers: S-5000 II 80-watt Stereo Amplifier-Preamplifier \$199.50.

This typical room setting includes Sherwood's "Superb Stereo Starters,"—one S-8000 Receiver and two SR3 Loudspeakers. Sherwood Electronic Laboratories, Inc., 4300 N. California Ave., Chicago 18, Illinois. Write for complete technical details.



WRITE DEPT. A-7



AUDIO (title registered U. S. Pat. Off.) is published monthly by Radio Magazines, Inc., Henry A. Schober, President; C. G. McProud, Secretary. Executive and Editorial Offices, 204 Front St., Mineola, N. Y. Subscription rates—U. S. Possessions, Canada, and Mexico, \$4.00 for one year, \$7.00 for two years; all other countries \$5.00 per year. Single copies 50¢. Printed in U.S.A. at 10 McGovern Ave., Lancaster, Pa. All rights reserved. Entire contents copyrighted 1962 by Radio Magazines, Inc. Second Class postage paid at Lancaster, Pa.

RADIO MAGAZINES, INC., P. O. Box 629, MINEOLA, N. Y.
Postmaster: Send Form 3579 to AUDIO, P. O. Box 629, Mineola, N. Y.



GRADO

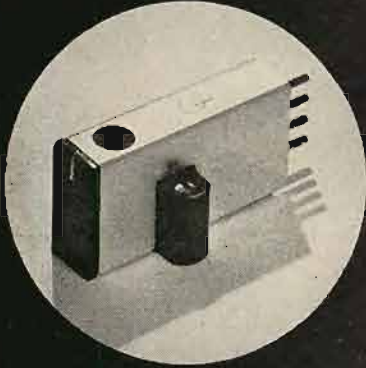

"Fantastic sound, equal to the finest tape I have ever heard."

The new GRADO STEREO CARTRIDGES represent a major step forward in bass depth and solidity, in mid range detail and in high frequency sweetness and smoothness. The complete lack of shrillness and stridency is most refreshing.

All GRADO cartridges are extremely rugged and not magnetically attractive. They are ideal for record changers.

Gentleness to records and the diamond stylus is proven by the following fact:

ONLY GRADO GUARANTEES ITS DIAMOND STYLUS AGAINST NORMAL WEAR FOR A PERIOD OF 5 YEARS!!

Senator Stereo Cartridge	\$24.95
Classic Stereo Cartridge	\$37.50
Laboratory Stereo Cartridge	\$49.50
Laboratory Series Tone Arm	\$39.50

For further details write to:

GRADO LABORATORIES, INC.

4614 7th Avenue Brooklyn 20, New York
Export-Simonfrice, 25 Warren St., N.Y.C.

AUDIO CLINIC

Joseph Giovanelli

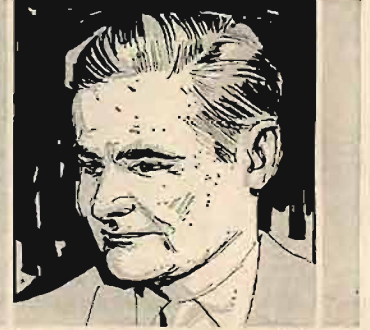

Send questions to:

Joseph Giovanelli
3420 Newkirk Ave.
Brooklyn 3, N. Y.

Include stamped, self-addressed envelope.

Triode and Pentode Operation

Q. Much has been said lately about triode operation of output tubes in amplifiers. After looking at several amplifiers which can operate in triode or pentode, it seemed to me that triode operation delivers less power but no account is given as to the advantages of triode operation. What is the advantage of triode operation? R. H. Knoebel.

A. You are correct as to the fact that triode operation does give you less power output. The advantages claimed for this type of operation are mainly in the realm of lower distortion. Proponents of this argument claim that the triode, because it has lower plate impedance than the pentode, can be matched accurately to the output transformer. In this instance, an accurate match means that the primary impedance is equal to twice the impedance of the plate circuit. When this match is effected, maximum power (with minimum distortion) is supplied to the loudspeaker or other load placed across the secondary of the transformer. (If absolute maximum power is to be transferred regardless of distortion, the transformer's impedance must equal that of the impedance of the plate circuit of the output stage.)

On the other hand, the impedance offered by the primary winding of the transformer cannot even approach the plate resistance of a pair of pentodes. There are those who believe that the triode is more linear than the pentode. This, too, would cut down on distortion.

This subject has been argued as long as I can remember. There has been no definitive resolution of this argument so far as I have ever heard. Personally, I believe either mode of operation can give good performance if the circuitry is properly designed.

Do we Lose with FM Stereo?

Q. If my understanding of FM stereo is correct, then I believe quality has been sold down the river for the second time in the FM band.

As originally specified, the FM bandwidth was 150 kc with 25-kc guard bands. With the advent of "stereocasting" systems the bandwidth was narrowed to allow a second channel to be transmitted on the same channel as the conventional signal to which we had become accustomed. This carrier was to operate in the range of 67 kc.

An FM detector puts out more or less sound depending upon carrier deviation, therefore the net result was to decrease the signal-to-noise ratio, which means a decrease in the dynamic range of the programs

transmitted over the main channel. Classical music, especially, benefits from good dynamic range, in fact requires it. In order to keep the station sounding loud at all times, I believe some stations resorted to compressors, further limiting the dynamic range.

Now with the advent of FM stereo, the remaining bandwidth has been further narrowed.

Although the monophonic signal-to-noise ratio remains within 1 db, the stereo becomes worse, and, if I am right, the dynamic range again suffers. Possibly some stations will resort to compressors till the sound is flat as a pancake. Conformity in FM will then be complete.

You might argue that two channels would give twice the dynamic range of one, but would they? Fred Butterfield, Brooklawn, New Jersey.

A. I think you are painting a somewhat worse picture of conditions than is warranted.

True there is definitely a loss in signal-to-noise ratio with this system, as there was when Major Armstrong transmitted his original multiplex signals. He, however, believed that this loss was not serious enough to offset the advantages inherent in simultaneous transmissions over a single carrier.

Your basic worry seems to be the possible loss of dynamic range. I have not heard anything which could indicate that stations are chopping their dynamic range in order to maintain most of their original coverage. Whatever practices stations will eventually adopt only time can tell. The immediate result is that the fringe area listeners are going to suffer. They probably will have to remain content with monophonic listening. Listeners in the primary signal coverage area of the station, however, should enjoy virtually noise-free reception.

Because the advertisers who use and support the facilities of these stations pay mainly for the audience in the primary coverage area and because the audience will still receive good sound quality, there would seem to be little advantage in reducing the quality of the programming by reducing the dynamic range.

Keep in mind that the multiplex industry offers new possibilities for sponsorship of FM programs. This fact could induce higher standards of programming. Advertisers seem to be becoming aware that listeners to "fine music" are a potentially good market.

Replacing Components in Obsolete Equipment

Q. In 1950 I purchased a Brook Model 10C4 all-triode 30-watt amplifier and pre-amplifier. I now have a noisy volume control. I find that Brooks Electronics is now out of business.

Can you tell me where I may secure a new volume control suitable for this unit? Joseph Lebart, New York, New York.

all-transistorized
New Sony Sterecorder 777

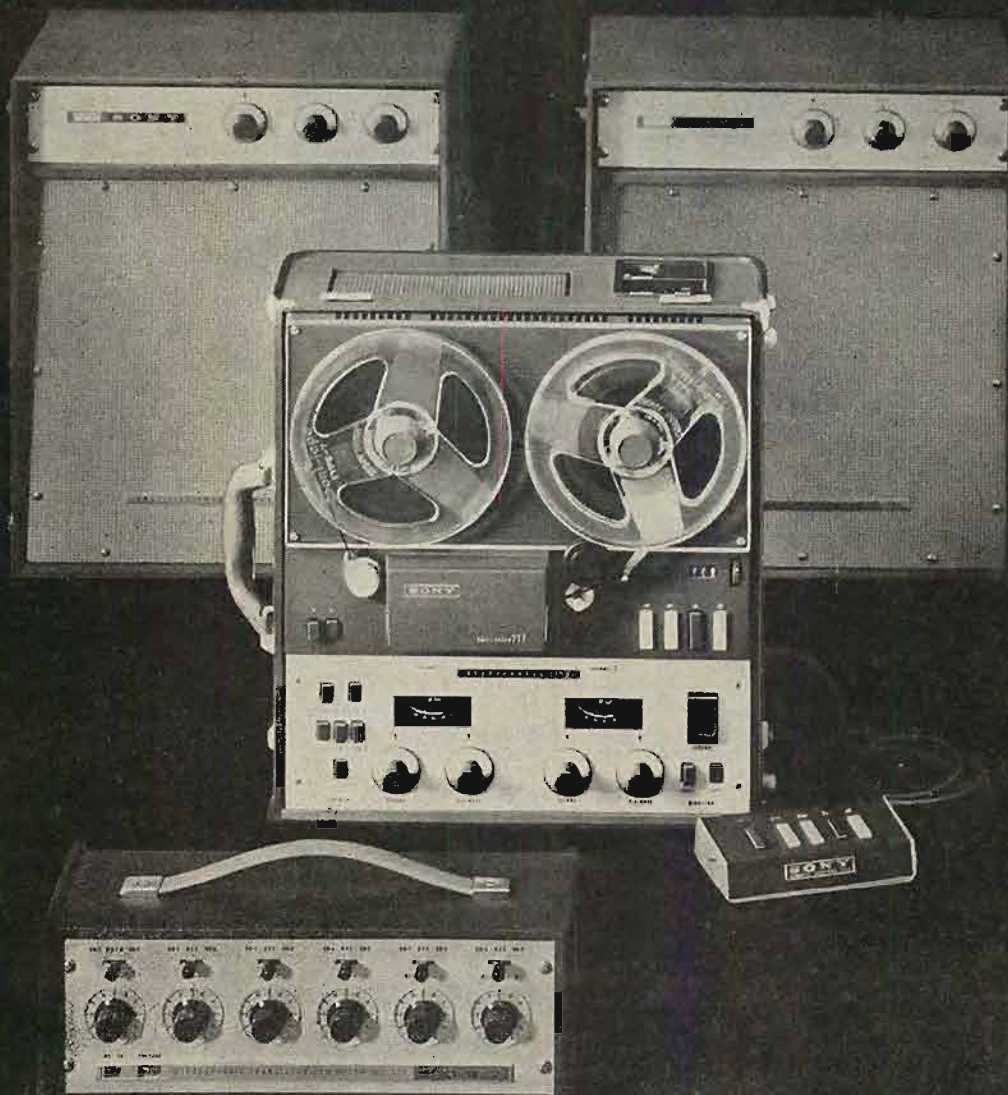

the first/complete/portable/all-transistorized/high fidelity PROFESSIONAL RECORDING & PLAYBACK SYSTEM

The most advanced achievement in recorder engineering to date, the superb new remote-controlled professional Sterecorder 777 series features the exclusive and patented Sony Electro Bi-Lateral 2 & 4 track playback Head, a revolutionary innovation that permits the playback of 2 track and 4 track stereophonic or monophonic tape without track width compromise—through the same head!

Included in an array of outstanding features are individual erase/record/playback heads, professional 3" VU meters, automatic shut-off, automatic tape lifters, an all-solenoid, feather-touch operated mechanism, electrical speed change, monitoring of either source or tape, sound on sound facilities, and an all-transistorized military plug-in type circuitry for simple maintenance. The three motors consist of one hysteresis synchronous drive motor and two hi-torque spooling motors.

Unquestionably the finest professional value on the market today, the 777 is available in two models, the S-2 (records 2 track stereo) and the S-4 (records 4 track stereo). Both models can reproduce 2 and 4 track tapes.* And, the Sterecorder 777 models will integrate into any existing component system. \$595 complete with portable case and remote control unit.

*Through the exclusive Sony Electro Bi-Lateral 2 and 4 track playback head.

Sony has also developed a complete portable all-transistorized 20 watt speaker/amplifier combination, featuring separate volume, treble and bass controls, mounted in a carrying case that matches the Sterecorder 777. \$175 each.

Also available is the MX-777, a six channel all-transistorized stereo/monophonic mixer that contains six matching transformers for balanced microphone inputs and recorder outputs, individual level controls and channel selector switches, Cannon XL type receptacles, a switch to permit bridging of center staging solo mike. \$175 complete with matching carrying case.

The first/complete/portable/all-transistorized/high fidelity/professional recording & playback system: \$1120 complete.

Sold only at Superscope franchised dealers. The better stores everywhere.

For additional literature and name of nearest franchised dealer write Superscope, Inc., Dept 7 Sun Valley, California.

**All Sony Sterecorders
 are Multiplex ready!**

SUPERSCOPE

The Tapeway to Stereo

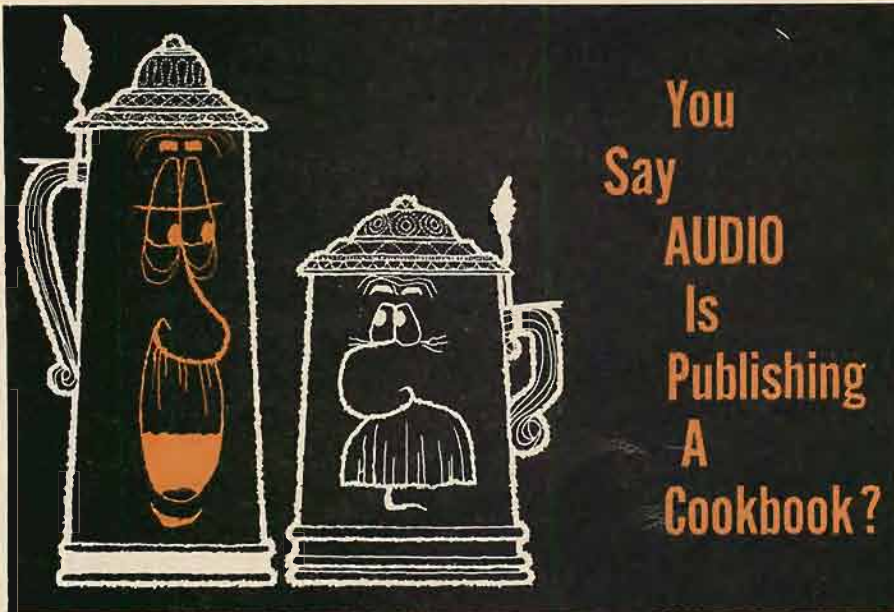

Yes, AUDIO is publishing a cookbook—not that we intend to extend the subject of gastronomy to include recipes in future pages of AUDIO.

You may ask...why?

And we would answer—Simply because we feel that people who read AUDIO, and enjoy the finest quality music reproduction also enjoy really good food on their tables.

Your next question may be...Is it a different kind of cookbook?

Of course our reply would be—Yes! Oh, it doesn't have a revolutionary format and it appears to look like any ordinary cookbook. But, the secret of its goodness is the recipes that fill its 148 pages... recipes responsible for the heart warming, flavorsome, homespun aromas experienced only in the kitchen of an Adirondack country home.

The name of the book is PLACID EATING, and it is chock full of palate-tempting recipes compiled by Climena M. Wikoff, owner of the Mirror Lake Inn...at (you guessed it) Lake Placid, New York.

Actually, the first edition (now out of print) was discovered by Mr. AUDIO (C. G. McProud) during his stay at Mrs. Wikoff's Mirror Lake Inn, where, in Mr. McProud's own words—*"...every meal is so tasty that eating becomes a real joy, where each night's dessert excels the one from the night before, where one has to*

push himself away from the table before upsetting the daily calorie count."

Here is a cookbook that will enable you to recreate in your own homes superb dishes experienced only at the Mirror Lake Inn—dishes like *Lake Trout Baked In Wine* and *Adirondack Apple Pie*, recipes for which are reproduced below—

LAKE TROUT BAKED IN WHITE WINE

Remove heads and tails from a 2-pound fish. Split open down back and rinse well. Remove backbone and rub inside with lemon, salt, pepper and thyme to taste. Knead 1 tablespoon of butter and anchovy paste the size of a large pea; placing mixture inside fish. Place fish in a greased baking pan and cover with ¼ cup of white wine. Bake 25 to 50 minutes in moderate oven, 350 degrees. Baste frequently. Garnish with parsley and lemon and serve with plain boiled potatoes.

ADIRONDACK APPLE PIE

1 c. sugar	3 tbsps. white corn syrup
2 tbsps. sifted flour	6 to 8 tart apples, thinly sliced
½ tsp. grated nutmeg	pastry
½ c. orange juice	
½ c. melted butter	

Mix together the sugar, flour, nutmeg, orange juice, corn syrup and melted butter. Add the sliced apples and mix thoroughly. Butter a pie pan heavily before putting in your pastry. Fill the pie shell with the apple mixture and make pastry strips for the top which should be dipped in melted butter before putting on the pie. Bake in 400 degree oven for 15 minutes; reduce heat to 250 degrees and bake 35 to 40 minutes longer.

This colorful book, plastic bound for easy handling, will contribute many wonderful adventures in food for everyone in the family. Order a copy today, the Lady-of-the-house will adore you for it. Incidentally...it makes a wonderful gift for anyone. PLACID EATING, 152 pages, Plastic Bound: \$3.95.



RADIO MAGAZINES, INC., Dept. K99
P.O. Box 629, Mineola, New York

Enclosed is my remittance of
please send me copies of
PLACID EATING @ \$3.95 each.

(No C.O.D., all books sent postpaid in U.S.A. and possessions, Canada, and Mexico. Add 50¢ for Foreign orders.)

NAME ADDRESS
CITY ZONE STATE

A Brook is, as you have said, out of business. The company never did provide complete parts lists for their products, so data as to exact values of replacement parts is not available except from service shops which may have taken the trouble to note certain of the more troublesome components for their own reference. (You can see that even when this company was in business, it was possible to obtain parts only by direct request to the company.) You are not alone in your problem. Others have written me about components for this manufacturer's equipment as well as about other companies whose parts are also difficult to locate. There is usually no source for direct replacements. Perhaps there is some replacement information in a Sams *Photofact* covering this model. Try that source.

As an alternative, you might remove the potentiometer in question and measure its full resistance. Then measure the resistance from the tap to one end. I would imagine that the potentiometer is the usual audio taper. (When removing the potentiometer, be sure to note the location and terminal arrangement so that it can be replaced without difficulty later.)

Often common sense will suggest a solution to a component problem. If an output transformer opened, it would be possible to look in a tube manual and obtain the proper impedance that the plates of the output tubes should see. Then it becomes a matter of searching through the literature supplied by the manufacturers of transformers until one is found which will meet the specifications of your circuit. Unfortunately, this transformer may be of a size which will not readily adapt to mounting in the original position. Also, there may be some difficulty with the feedback when this new transformer is substituted. This will mean that some circuit changes will have to be made involving the R-C constants of the feedback loop.

Power transformers can be troublesome because of the possibilities of extra bias windings which may have been used. An inspection of the schematic and of the instrument itself will often reveal whether this was a standard transformer or one which contained some unusual windings and voltages.

Probably the most difficult components to replace are inductances used in equalizer circuits. It would take someone really skilled in equalizer design to work out the probable inductance used in such instances.

Æ



\$2.50 each

SAVE YOUR COPIES OF AUDIO

- Each file holds a full year's copies.
- Jesse Jones Volume Files for every publication.
- Covered in durable leather like Kivar, title embossed in 16 Kt gold.

Satisfaction guaranteed

Attractive and practical for your home or office

3 for \$7.00
6 for \$13.00

ORDER NOW — send check or money order
MAGAZINE FILE CO.
520 FIFTH AVENUE
NEW YORK 36, N.Y.

FREE DESCRIPTIVE FOLDER UPON REQUEST



crunch

Apples taste better when you're six years old. What's more they *sound* better. Those crunching noises reverberating through your head are exciting. You keep wondering if they can be heard on the "outside." Remember?

Naturally, you'll never hear an apple like that again. But if you've retained even a little sonic sensitivity, we can offer you an experience almost as pleasant.

Make your next recording on Audiotape.

You'll find that the wonderful quality of this tape provides more clarity, more range, eliminates noise and distortion

problems. And you'll find this quality is consistent from reel to reel and within every reel of Audiotape.

Whether you're taping a small apple-cruncher or a great symphony orchestra, there's an Audiotape exactly suited to your needs. From Audio Devices, for 25 years a leader in the manufacture of sound recording media—Audiodiscs*, Audiofilm* and . . .

audiotape
TRADE MARK

AUDIO DEVICES INC., 444 Madison Ave., N.Y. 22, N.Y.
Offices in Los Angeles, Chicago, Washington, D.C.

*TRADE MARK

portable
perfection
for
hi-fi fans



From Denmark comes this aristocrat of portables. Superb AM-FM-Shortwave performance with all the features you've ever wanted in a portable: 12 transistor power with push-pull output and a 5" x 7" speaker, flywheel tuning, full range independent tone controls, pushbutton selection, loud-speaker - earphone output and separate tuner output, plus plug-in connection for an auto antenna for over-the-road hi-fi.

Complete information is available on request. Write for the name of your nearest dealer.



By appointment
to the Royal Danish Court

DYNACO

DYNACO, INC.
3912 Powelton Ave., Phila. 4, Pa.

LETTERS

Hi Fi in Germany

SIR:

With the object of improving the quality standards for the high-fidelity reproduction of gramophone records, magnetic tapes and radio broadcasts, the dhfi, Deutsches High-Fidelity Institut e.V., an incorporated association, has been formed at Frankfurt (Main). Germany has thus followed the lead set by the United States, where the establishment of an Institute of High-Fidelity Manufacturers has provided considerable stimulation to transcription techniques and to the encouragement of music in general.

Full membership is reserved to manufacturers or importers of Hi Fi equipment; any other interested persons may become paying members. The founders of the Institute are Messrs. Braun AG, Frankfurt (Main); Dynacord, Straubing (Donau); Elbau, Bogen (Lower Bavaria); Electroacoustic GmbH, Kiel; Garrard-Audioson GmbH, Frankfurt (Main); Klein & Hummel, Stuttgart; Shure Brothers Inc., Evanston & Dusseldorf; Dietrich Hahn, Advertising Consultant, Dusseldorf, and Ernst Pfau, Technical Writer, Asperg (Wurt.). Herbert Ticho of Garrard-Audioson GmbH and Dieter Ludenia of Electroacoustic GmbH were elected members of the executive committee and Manfred Walter of Braun AG the chairman.

The dhfi is a non-profit organization, and its terms of reference include the maintenance of quality specifications and standards of measurement to protect the concept of High Fidelity from debasement and falsification, and to stimulate the efforts of engineers, designers and manufacturers to enhance the quality of sound reproduction.

Public demonstrations of high-fidelity sound are to be arranged, critical listening encouraged, and a forum provided for music lovers and professional musicians to discuss their technical problems with experienced sound engineers. The Institute is to publish bulletins at regular intervals, for the information of members, the trade, and trade Press and the listening public.

All activities to further the development of high-fidelity sound techniques, and to bring them within reach of the general public, are to be fostered.

HI TICHO

Deutsches High-Fidelity Institut
Russelsheimer Strasse 22
Frankfurt (Main), Germany

Single-Speaker Stereo

SIR:

I wish you would quit publishing untried construction articles like "Single-Speaker Stereo." I fear it has cost me my friend, Nathanael Ulysses Timothy Shodgrass. The last time I saw him, he was reading the article, snorting "Horizontal circular track! Have they never heard of the Doppler effect?" and other remarks that were even less complimentary. I gathered that Shoddy was going to build the equipment, for he always wanted his picture in a national magazine.

I received a brief note that told me that he had used a simple sampling technique with one amplifier and two speakers, letting the inertia of the speakers integrate the waveforms. His first experiment, using an amplifier that he had picked up for \$2.98, was a failure: even his restricted switching speed had been too fast for the amplifier, which had finally let off only a few dismal squawks. But he was building a

single-speaker set-up with a six-foot vertical circle, planning to give it the full 100,000 rps suggested in the article. Apparently this was his undoing. He was a kind of eccentric genius—one must speak well of the dead—but he never was very good at simple calculations. At least, the indications are that he did not allow for the stresses which would be encountered at this speed.

It is possible that some other experiment that Shoddy was working on led to his disappearance. But I rather think that, as the speaker arm came up to speed, something gave way. I figure that the approximate million miles per hour was too much for the kind of materials that Shoddy probably used. Anyway, his shack has entirely disappeared. And, although I do not have definite proof, I suspect that Audio is to blame.

However, I am even more disturbed by the attribution of the final quotation to Lengthfellow. It is from the pen of Sir Balderdash Rott, and will be found in his "Pay for the Past Wastrel."

DAVID F. SIEMENS, JR.
8222 Yarmouth Ave.
Reseda, California

Audio Clubs—Who to Contact

California

Victor J. Richmond (will help)
1547 28th Avenue
San Francisco 22, Calif.
Earl Cummins
1054 Belvedere Lane
San Jose 29, California

District of Columbia

Irving Zuckerman
2015 Massachusetts Ave., N.W.
Washington 6, D.C.

Indiana

Richard P. Geer
2206 South Gertrude St.
South Bend 14, Indiana

Kentucky

Louisville Audio Society
Morris A. Ray, Jr.
Longwood Circle
Louisville, Kentucky

Maryland

Hector Davis
4326 Rowalt Dr.
College Park, Md.

Michigan

Mr. & Mrs. James D. Taylor
14281 Maiden Avenue
Detroit 13, Michigan

New York

Patrizio Rossi
39 State Street
New Rochelle, New York

Texas

P. S. Howerton
The Carbide Audio Club
P.O. Box 471
Texas City, Texas

Virginia

Robert W. Wagner
428 New Orleans Drive
Alexandria, Virginia

ANNOUNCING
THE SCULLY 270

A NEW
STANDARD OF QUALITY
FOR
PROFESSIONAL
TAPE REPRODUCERS

Engineered and crafted with a degree of precision and quality never before equalled in tape equipment, the Scully 270 sets new industry standards for guaranteed performance.

The complete unit is guaranteed for one year.

The amplifiers, in both monaural and stereo, are guaranteed for five years.

The Scully 270 is the first in a new line of highest quality professional tape equipment. Companion to the Scully lathe, Model 270 establishes a new high in performance specifications. We invite you to read and compare them.

Frequency Response: $\pm 1\frac{1}{2}$ db, 50 to 15,000 cps @ $7\frac{1}{2}$ ips.

Signal to Noise Ratio: -60 db.

Flutter and Wow: .1% RMS @ $7\frac{1}{2}$ ips, 0.2% RMS $3\frac{3}{4}$ ips.

Rewind Time: 4,800 foot roll 105 seconds.

Tape Capacities: up to 14" reel size, $\frac{1}{4}$ " or $\frac{1}{2}$ " tape width.

Reproduction Capacity: Monaural, half or full track, stereo, 2, 3, or 4 channel.

Power Requirements: Auto transformer 108 to 240 volts, 50/60 cycles at 275 watts.

May we send you complete technical specifications and engineering data for your consideration. Please address your correspondence to Mr. Lawrence J. Scully, President.

SCULLY RECORDING INSTRUMENTS CORPORATION

480 Bunnel Street

Bridgeport, Conn.



LIGHT LISTENING

Chester Santon

Buddy Cole: Ingenuity in Sound
Warner Bros. Stereo Tape WSTC 1442
New Perspectives in Piano Sounds
Warner Bros. Stereo Tape WSTC 1441

Both of these tapes are part of the new Stereo Workshop Series released by Warners a few months ago on stereo discs. If the first two reels are indicative of the four-track sound we can expect in this series, the Workshop releases will have a more far-reaching effect on the tape medium than they will on the future of stereo discs. The Buddy Cole tape, in particular, is a truly outstanding item. This is not the first time that Warner Bros. has been the source of an exceptionally good tape. Gus Farnery's Wurlitzer organ reels on that label are still my favorite demonstration tapes when that richly-endowed instrument is used to challenge my woofers. For my money, Buddy Cole's swinging workout on two Hammond organs, with a hand-in-glove assist from driving guitars and percussion, is the first four-track reel to capture all the sound of these particular instruments. One is tempted to speculate just how this stunt was pulled off at the UST processing plant. The sound is completely honest all the way up the spectrum. These highs are not the result of a sudden tilt in the recording curve at the point where most tapes begin to fall off in response. The response on this tape is all the more impressive when you consider the fact that each tune has been recorded two or three times. Twice, in order to place a Cole performance on each channel; three times on other occasions in order to give the percussionist a chance to double on extra instruments. This recording definitely backs up the maker's claim that no limiters were used at any point in the recording chain.

The companion release in the Workshop series offers less excitement to the ear because the eye is asked to accept a pretty far-fetched image of a piano. As David Swift presides at the keyboard with the aid of a small orchestra, his left hand is heard in the left channel while the right hand shifts for itself in the other channel. This arrangement may approach some sort of logic on console speakers a few feet apart; it gets rather ludicrous on a speaker setup that's seven or eight feet apart. Since Swift relies heavily on Boogie Woogie throughout much of his program, the effect on speakers more than ten feet apart beggars any description I could give you.

I Can Get It For You Wholesale (Original Broadway Cast)
Columbia Stereo Tape OQ 457

Show business history shows signs of repeating itself in this latest musical about New York's garment center. Twenty-five years ago, composer Harold Rome unveiled his first line of goods on Broadway in a show called "Plus and Needles," a revue produced and cast by the International Ladies' Garment Workers' Union. When producer David Merrick decided to stage the widely-read Jerome Weidman novel "I Can Get It For You Wholesale," Rome was the logical man for lyrics and music. On the evidence of this record, casting presented no problems—with one notable exception. In the part of Harry Bogen, the play's central character, Elliott Gould fails to register the tremendous drive of the gold-plated heel whose spectacular rise in the garment district was the basis of the novel's appeal. Gould's generally colorless performance is explained, in part, by the fact that he

came to this show directly from the chorus of David Merrick's "Irma La Douce" after a career as a dancer in several other shows. In listing Gould's earlier credits, the producer mentions that the actor was at one time a toy salesman and an elevator operator at both Gimbel's and Macy's. While neither job is a disreputable pursuit, this information scarcely explains to the record buyer why the more important role in the show was entrusted to a performer of such modest theatrical experience.

In fairness to Gould, it must be admitted that the score of this musical is by no means an inspired creation. As with so many shows these days, most of the tunes do little more than advance the story line. Few of the musicals appearing on records this season have impelled me to get up from my easy chair and repeat a band on an original-cast album because the song was a real knockout. Despite the best efforts of experienced troupers such as Bambi Lynn, Lillian Roth, Sherree North and Harold Lang, practically all the songs in "I Can Get It For You Wholesale" seem to evaporate as soon as they're over. Harold Rome is not the first Broadway composer to face this problem but the letdown here appears all the more severe in view of the great songs he gave us in "Fanny" and "Wish You Were Here."

Larry Elgart: Music in Motion
M-G-M SE 4028

M-G-M has chosen to seek safety in numbers in figuring a miking pattern for its latest sound series. Their "21 Channel Sound" means that space had to be found in the recording studios for at least twenty-one microphones. As a concession to listeners who feel that an excellent job can be done with only three or four mikes, it was decided to omit equalizers and limiters during the recording and mixing process. The response characteristics of a wide variety of mikes were used to attain a less complicated system of equalization. Several other factors help to minimize the problems that usually arise when the number of channels reaches an abnormally high figure. The band was permitted to use its regular seating arrangement, and even more important, no screens were used to isolate specific instruments. Add to this fortunate circumstance the clarity and discipline of one of my favorite dance bands and you have a recording that manages to surmount most of the hurdles in fine style. Few bands today could manage to sound this good under so close a scrutiny.

Gordon Jenkins: France
Time S/2061

The way new releases are promoted these days, the casual shopper is probably under the impression that the recording industry has been enjoying major technical breakthroughs at least twice a month for the past year or two. It is a fortunate circumstance for some record labels that the average buyer carries home to an average console the fruits of their latest "scientific" discoveries. Were this same shopper in a position to check out each new sound process on a bona fide component system, he would be less tempted to believe the gushing copy that accompanies the introduction of each new gimmick. Not that the basic idea in this first record of the "Process 70" series on the Time label is exactly a new one. The claim here is an improvement in signal-to-noise ratio of 4 db.

The improved ratio is on the record but it's been put there by the time-honored use of peak limiters. This method is far cheaper than the newer approach that aims to reduce noise level on the master recording through use of 35 mm magnetic film instead of tape. The only new wrinkle I can detect in Time's "Process 70" technique is greater severity in the control of natural peaks in volume that you're bound to get even in popular music if the orchestra is a sizeable one. As a consequence, the Gordon Jenkins arrangements of carefree French tunes have been placed in what amounts to a sonic strait-jacket. Then, as compensation for the ultra-close miking, an extra amount of reverberation was introduced in order to get something that almost passes for room ambience. As used here, a good deal of the miking and reverb theories are self-defeating; normal room acoustics would have doubled the realism of this record.

Each selection on the disc is preceded by a short skit in French or English that purports to offer glimpses of Parisian life that lend themselves to sonic exploitation. A collision in a Parisian traffic jam, complete with local horns and subsequent verbal skirmish, is more effective as an atmosphere builder than the railway and airport episodes. Mildly diverting the first time around, these skits are bound to lose some, if not all, of their freshness under repeated playing. This disc will probably sell in greater quantity as part of a sound series but I would find it difficult to shake the thought that it would have sounded better as a normal release.

Patachou at the St. Regis
Audio Fidelity AFSD 5961
Eileen Farrell: This Fling Called Love
Columbia CS 8539

I see little point in searching through each month's record releases for new singing stars when the established favorites are still turning out solid material such as this. These two stereo discs offer a choice of language as Patachou, an international favorite since 1953, allows Audio Fidelity's mikes to eavesdrop on a program of French songs familiar to the patrons of the famed Maisonette of New York's Hotel St. Regis. In her fourth release on this label, Patachou concentrates on the Parisian repertory that distinguished her first AF release. The only thoroughly familiar item in this collection is the old American hit *These Foolish Things* but the humor, charm and pathos of the enforced Patachou manner should gain wider recognition for the other tunes.

When Metropolitan Opera star Eileen Farrell decided to rock the music world with a pop album a few years ago, some observers were certain that the project was a one-time stunt. Her subsequent releases squelched that theory and her latest Columbia disc finds her in the most congenial company this series has afforded. Percy Faith provides an ideal musical background for the rich and flexible Farrell voice in these velvety ballads. Alex Wilder's *April Age* and Andre Previn's *Faraway Part of Town* are the only rarely-heard items in a collection that I find more appealing than her earlier releases. It's difficult to imagine a more sumptuous yet totally unaffected treatment than the one Eileen Farrell lavishes on *Stormy Weather, My Romance, Where or When, and I've Got You Under My Skin*.

Ralph Burns: Music from "No Strings"
Epic BN 630
LeRoy Holmes: Music from "All American"
M-G-M SE 4034

Supplemental coverage of two current Broadway shows is the task of these orchestral albums. In the Epic release, we find an inevitable development. Ralph Burns, the arranger responsible for the orchestration of the musical "No Strings," now adds strings to what was once the stringless score of the latest Richard Rodgers show. To his credit, Burns does not allow the pendulum to swing too far in the opposite direction. As a responsible member of the Rodgers team, he has kept the number of string players at a very manageable figure. The tempos are more than brisk enough to preserve the effervescent

The Fisher KX-200 80-Watt Stereo Control-Amplifier StrataKit, \$169.50.*



It has four things that others haven't.

1. StrataKit Construction. Assembly by totally error-proof stages (strata). Each stage corresponds to a *separate* fold-out page in the Instruction Manual. Each stage is built from a *separate* transparent packet of parts. Major components come already mounted on the extra-heavy-gauge steel chassis. Wires are *pre-cut* for every stage—which means every page. Result: Absolutely equal success by the experienced kit builder or the completely unskilled novice!

2. Built-In d'Arsonval Meter. For laboratory-accurate adjustment of bias and balance. Assures peak performance from the start; permits 'touching up' for continued peak performance throughout the years, regardless of tube aging. No other single-chassis control-amplifier kit has this vital feature.

*Walnut or Mahogany cabinet, \$24.95. Metal cabinet \$15.95. Prices slightly higher in the Far West.

Export: Fisher Radio International, Inc., Long Island City 1, N.Y. Canada: Tri-Tel Associates, Ltd., Willowdale, Ontario.

3. Third-Speaker Output with Volume Control. Blends the two stereo channel outputs to feed a third loudspeaker system—at *any* desired volume level. Ideal for center-channel stereo fill-in or for a mono extension speaker in another room of the home. A Fisher exclusive among control-amplifier kits.

4. The Fisher Name. No comment necessary.

FREE! \$1.00 VALUE! Just published!
THE KIT BUILDER'S MANUAL, a new
guide to high-fidelity kit construction.

Fisher Radio Corporation
21-29 44th Drive
Long Island City 1, New York
Please send me the Kit Builder's Manual without charge.

The
Kit Builder's
Manual

NAME _____
ADDRESS _____
CITY _____ ZONE _____ STATE _____

03711

AR INC.

turntable

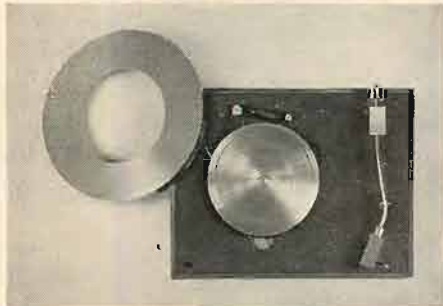

PROFESSIONAL quality. The AR turntable meets NAB specifications for broadcast equipment on wow, flutter, rumble, and speed accuracy. The 3.3 lb. machined, individually balanced aluminum platter is belt-driven from synchronous motors.



STABLE performance. The suspension design makes it possible to deal a moderate hammer blow directly to the top plate without making the needle jump grooves.



COMPLETE (except for cartridge) including arm, walnut base, transparent dust cover, and even needle force gauge.

\$58⁰⁰
LESS CARTRIDGE.

ACOUSTIC RESEARCH, INC.
24 Thorndike St., Cambridge 41, Mass.

features of the show that is close to the top of this season's list of outstanding musicals.

The Strouse-Adams score for "All American," Ray Bolger's latest starring vehicle, gets better than average treatment at the hands of LeRoy Holmes and his orchestra. Since Holmes took the trouble to visit the show several times during its pre-Broadway run in Philadelphia, this M-G-M album contains an extra tune that once was part of the musical during its tryout days. Special permission was granted to M-G-M to include in this release *Back to School Again*, a tune that's bound to carry weight mainly with the historians of Broadway musicals. The sequence of tunes in these orchestral highlights is not the same as that of the original cast performance that was released a month earlier. In an effort to gain contrast, it was decided to alternate the romantic songs with those of a brighter tempo. The liberty is a minor one that will undoubtedly be overlooked by nine out of ten purchasers interested in an orchestral version of a lightweight score.

Billie Holiday: The Golden Years Columbia C 3 L 21

Drawing on a variety of sources for this deluxe three-disc album, Columbia traces the recording career of jazz singer Billie Holiday from the years 1933 to 1941. The chronology begins with the first record Billie ever made (Columbia 2856). The orchestra, led by Benny Goodman, already boasted a good sample of top names in jazz that were to crop up with regularity on practically every side she was to cut in later years on labels such as Brunswick, Vocalion and Okeh. The number of private collections culled for this release totals more than a half a dozen. About sixty-five percent of the album is devoted to recordings made in the '30's. In addition to her own band, Billie is accompanied in most of the songs by Teddy Wilson, whose band began to work with her in 1935. Much of their effort went into the revitalization of pop tunes of that day.

The highlight of the album is a series of airchecks made in 1937 when Billie was appearing with Count Basie's band. Taken from broadcasts originating in the Savoy Ballroom, *Swing Brother, Swing*, *I Can't Get Started*, and *They Can't Take That Away From Me* find Billie at the zenith of her style if not here career. In all three orchestras that dominate this album are to be found the trumpet of Buck Clayton and the sax of Lester Young. Remastering by Ted Brosman has preserved the flavor of an ingratiating period in the life of a great entertainer. Columbia's carefully documented brochure (photos, notes by John Hammond and Ralph Gleason and detailed information on each band of the three discs) goes beyond smart packaging in paying tribute to Billie's unique artistry.

Ira Ironstrings Destroys the Great Bands Warner Bros. Stereo Tape WSTC 1439

Maestro Ironstrings first won a fame of sorts back in 1958 when he lent his name to an album with one of the more laconic titles in the catalog: "Music For People with \$3.98." Despite the best efforts of titlers at other record firms, that first Ironstrings caption remains one of my favorite album headings. In its third tape reel for the Warner Bros. label, this somewhat unraveled musical organization proceeds to rewrite the history of twelve famous dance bands. The tunes selected are closely associated with bands in many categories. The list starts with Paul Whiteman; runs past the now dusty corn bins of Clyde McCoy and Ted Weems; salutes such middle-of-the-road groups as Johnny Long and Russ Morgan and works up to the great names that really made the era what it was. In this last group are the bands of Tommy Dorsey, Glenn Miller and Benny Goodman. Of course, some bands are far easier to spoof than others. Ironstrings does little to dislocate the reputations of some bandleaders; others come in for quite a drubbing. The greatest amount of latitude for kidding around naturally comes in *Heartaches* from the Weems book and McCoy's *Sugar Blues*. There have been other efforts in recent years to resurrect the styles of bygone bands. This attempt offers a bonus in the form of sly arrangements that should find some response in any normal funnybone.

Pops Concert U.S.A. Epic Stereo Tape EC808

In transferring to quarter track one of the better collections by the Cleveland Orchestra, Epic has made available to tape fans a better-than-average assortment of works that generally make up the warm-weather programs of our leading orchestras. It's gratifying to note that conductor Louis Lane chose to include the seldom-heard *Overture* to "Candide" by Leonard Bernstein along with light staples such as Morton Gould's *American Salute*, *Three Dances* from Rodeo by Aaron Copland and *Serenata* by Leroy Anderson. Walter Piston's *Ballet Suite* from "The Incredible Flutist" rounds out a collection that deserves a prominent place in any well-balanced tape library.

The sound of this tape shows off the new reverberation rate of Severance Hall, a rate increased by a full second when the acoustics of the hall were altered a year or two ago. The new liveliness of the hall is a decided advantage in this reel. In far too many four-track tapes featuring large orchestras, the average concert hall sounds fairly dull by the time the tape has gone through the duplicating process. There is always the possibility of a new breakthrough in duplicating equipment but, as things stand now, quarter-track tape's brightest future seems to lie in closeup miking of small groups of players under rigidly controlled studio conditions. Only those tapes with exceptional instrumental presence can make one forget that the upper frequency response on most four-track reels is still inferior to that of a good stereo disc. The problem may be solved to everyone's satisfaction in the years ahead. In the meantime, one way to get around the difficulty is to select on the basis of room acoustics any tapes that feature an orchestra large enough to require a good-sized concert hall.

Roger Wagner Chorale: Victor Herbert On Stage Capitol ST 1707

Two recent stereo releases of the songs of Victor Herbert point up an interesting contrast in musical approach. A few months ago, the Robert Shaw Chorale demonstrated in RCA Victor album LSC 2515 how Herbert's old-fashioned charm comes over in a straightforward recording. No furbelows were to be found anywhere in the Shaw treatment; the chorus carried the full weight of the project.

Capitol's musical tour of the first quarter of the 20th Century is a far more elaborate affair. The Roger Wagner Chorale is only one element in a heaping basket of goodies. Greig McRitchie's orchestral arrangements and Rober Wagner's vocal stylings strive for every "commercial" effect in this already highly saleable music. Wherever extra mellowness was desired by McRitchie, the English horn of William Kosinski was pressed into service. Violin solos by Israel Baker and Jacques Gassel are applied with a generous hand to make this release the most ornate of the current crop of Herbert songs in stereo. Considering the fancy treatment, it's quite remarkable that the border line of corniness has been avoided. There are plenty of smoothly-organized and well-played instrumental versions of the Herbert songs in the stereo catalog. This release, on the other hand, marks only the second attempt to present them in stereo with the attention to style that they deserve.

Clancy's Clowns: Saxophobia Capitol ST 1614

Capitol has figured out a way to present the funnier novelty tunes of the Twenties in combination with sure-fire stereo. All they had to do was line up five members of a saxophone clown act, set the gain, and then duck for cover. Once the dust had settled, Capitol found in its possession one of the most spontaneously clever demonstrations of stereo I've heard in months. There isn't an artisan of the mixing panel in action anywhere at the present time who can throw switches the way this comedy sax team tosses notes. The listener is given one break. The instruments are lined up in strict order according to pitch:

(Continued on page 39)

Honest weight, accurate weight—they're one and the same. People have come to look upon counterbalanced scales as assurance of accurate weight. And for good reason, too.

Springs are uncertain. They expand with heat, and contract with cold. The more you extend a spring, the more it pulls back. With every change of extension, there's a change in pulling force. Pick-up arms that use springs are susceptible to these changes. When several records are stacked on the turntable, the arm is raised; the length or extension of the spring is altered; the pulling force changes, and consequently, the force of the stylus changes, too. With warped records, the arm is constantly rising and falling, and the stylus force is constantly changing.

The Miracord-Studio arm uses no springs. It is like a fine apothecary or chemist's scale—mass-balanced, and freely suspended on low-friction bearings. Stylus force is set by shifting the mass of the counterbalance. Once set, this stylus force remains constant with one or with ten records on the platter.

During actual play, the Miracord-Studio arm is completely disengaged from the automatic mechanism. It responds freely and effortlessly without the slightest trace of friction or drag.

Location of the pivot at almost the level of the record surface minimizes wow due to warped records. Tracking error geometry is at an absolute minimum—zero degrees at 2-inch radius, and slightly over 1 degree at 6 inches—and there are no resonant peaks within or even beyond the audible spectrum.

Unlike other transcription arms, you don't have to buy the Miracord-Studio separately. It is an integral part of the Miracord, the only record playing instrument with a dynamically balanced turntable and mass-balanced transcription arm which you can play manually or as automatically as you please.

Miracord 10H with hysteresis-synchronous motor is \$99.50; the Model 10 with 4-pole induction motor, \$89.50. Prices include arm, but do not include the cartridge and base.

Make it a point to see the Miracord at your high fidelity dealer, soon—or write for new 6-page descriptive catalog.



MIRACORD

BENJAMIN ELECTRONIC SOUND CORP., 97-03 43RD AVENUE, CORONA 68, NEW YORK • SOLE U.S. DISTRIBUTOR FOR ELECTROACUSTIC® RECORD PLAYING COMPONENTS

**HONEST
WEIGHT
NO
SPRINGS**

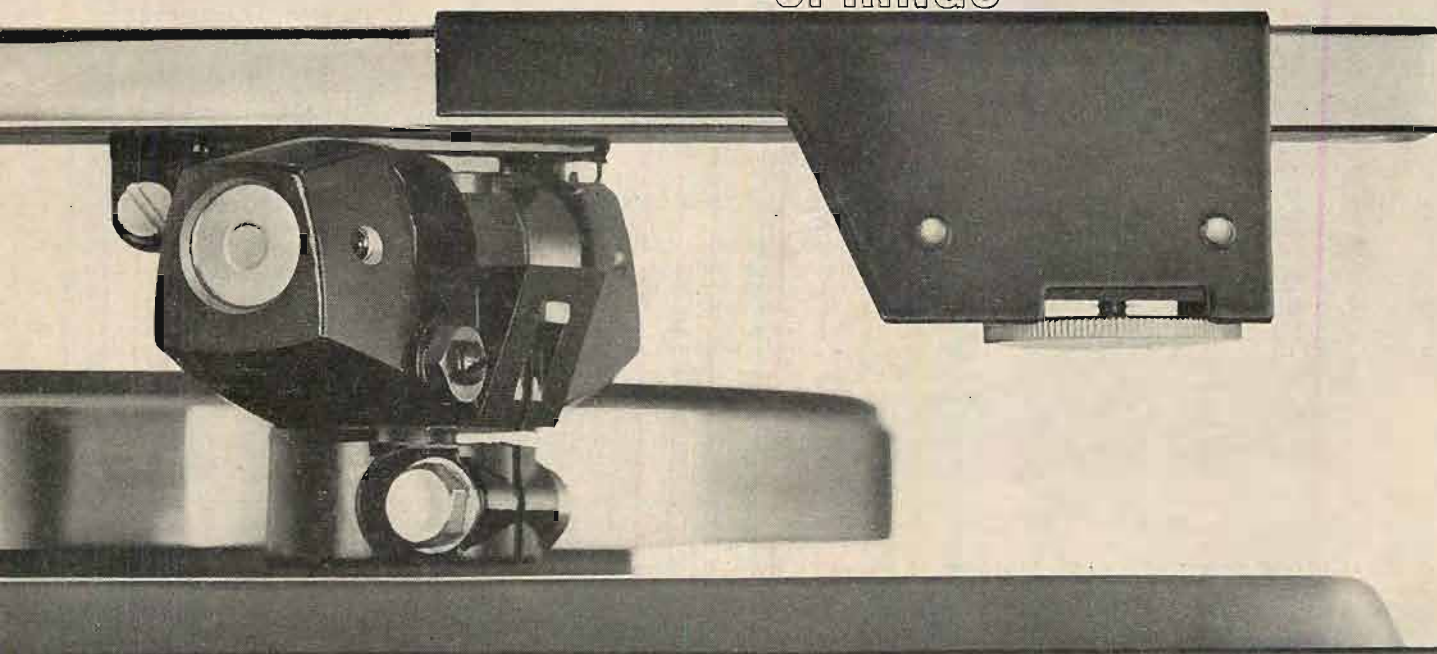

AUDIO ETC.

Edward Tainall Canby

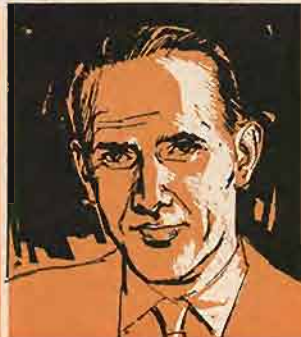

PRAGMATIC ATTENUATOR

In my earlier discussions of earphone listening in January and February you'll remember that my biggest headache was in playing low-impedance phones off low-impedance amplifier speaker outputs. Too well matched and blasting my ears off even with the amplifier volume set at the lowest point, thereby introducing objectionable amplifier noise on top of the over-loud music. The ultrasensitive Beyer phones were particularly subject to this effect and it's a wonder I didn't blow them out.

Well, over these months I've been pecking away at the problem of attenuation-with-matching, and have helpfully been advised by a number of people, amateurs, professional engineers, and phone manufacturers, to my great confusion. I appreciated the advice but not the built-in contradictions, the wide range of recommended circuit values and even of circuits, as so warmly defended by each and all. One ardent store salesman even succeeded in selling a stereo speaker attenuator to my assistant for seven bucks. Via phones, as this salesman ought to have known (and so should we), the attenuation over ten graduated steps varied from zero to almost none. Only the last step had any audible effect on the basic problem, and that wasn't nearly enough for the price. Live and learn.

Eventually, I began to see that most of my informants were being more helpful than I had first thought; for their ideas did overlap considerably, once I caught on. And their values, perhaps not always workable each by each, did set up a kind of invisible average (a species of intermodulation, you might say), upon which I could base my own developing ideas as to how to solve this seemingly ultra-elementary circuit problem.

Elementary from the electrical point of view. Very tricky from the practical, thanks to hidden variables all over the place. How are you to cut down amplifier output so that at roughly normal settings of the amplifier volume control your phones will produce a roughly normal loudness at the ears, yet providing an amplifier load such that phones and amplifiers will continue to be more or less "matched" within reasonable tolerances?

Well, I finally evolved my solution recently, and it suits me to a T (or an L, I should say), though the actual gadget is an outlandish concoction of pairs of polarized Jones plugs and wired-in resistors plus two dangling 5000-ohm volume controls taped together. Based on a circuit out of the Sharpe phone people. It works, and works well, within reasonable tolerances.

A Rusty Nail

Reasonable tolerances! That's the trick. That four-syllable word can be stretched a long way for sheer convenience.

There are two approaches to this sort of problem. One is the ideal. It is never ideal because the values given are, paradoxically,

ideal themselves, rather than of a literal sort. Take a formula, line up the ohms of this and that, and figure out a "perfect" match. My assistant loves this sort of thing. He dug up batches of formulas, for so many db attenuation at such-and-such impedance. He even worked out one combination that resulted in a fine gadget featuring a big one-watt resistor straight across the amplifier terminals. I suggested that what he really wanted was a rusty nail. That would give an equivalent value, and probably would be more adjustable to meet varying needs.

I do not mean to imply that formulas never work, nor are unnecessary. Far from that. But every formula, as any good engineer knows, has built-in unseen factors that must be considered from the start. It goes

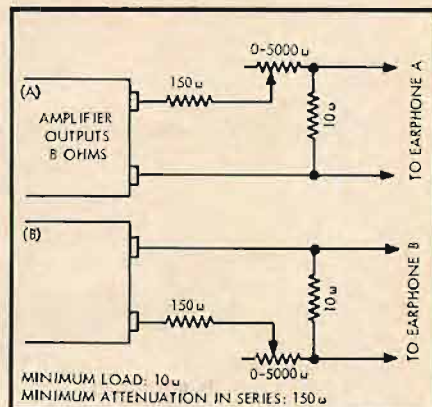

Fig. 1. Sharpe-Canby pragmatic attenuator.

so far, and no further. A formula has no intelligence of its own, no innate adaptability. That is where the human sense comes in.

And so the other approach, the pragmatic, calls for a kind of all-out tolerance thinking, as of maximum "swing." You start with the extremes, you evaluate what happens there, and then you close in towards the ideal middle, until you find, not an exact solution, but a range of tolerable solution.

What do I mean by extremes in this case? Well, I'll illustrate graphically, though some amplifier designers are going to pass quietly out in the next few lines. I'm tossing them an extreme compliment, even so.

An amplifier output is supposed to be loaded. What can you get away with, more or less safely? Well, here are my allowable tolerances—in practical form. One extreme: a load of infinity in ohms. The other: a load slightly less than zero. Say, that rusty nail.

You see, modern amplifiers are built so that they will take the open-speaker-line treatment. No load at all. I do it every now and then, by mistake. I'm always pulling out a speaker plug just as Beethoven reaches the loudest climax in the Ninth Symphony, or as a stereo railroad train

rumbles past the left mike, full steam.

As for shorting, you can do that, too, but at "zero" ohms you won't have any signal left for your phones to hear.

Ah yes, the ideal load for an eight-ohm output is maybe eight ohms. So we'll make that the rough middle. In fact, the standard type of earphone amplifier output adapter circuit has a ten-ohm resistor across, as a leg of an L. That's what mine does. But for years I've used my old middle-impedance phones directly on speaker lines, loading up to a mild 300 ohms or so, with no observable problems in amplifier performance.

I suspect I could listen for a good many years via a set of 50,000-ohm crystal phones across the speaker outputs and no other load at all, though I haven't tried it. The amplifier's designer might faint away, if he were watching, but the amplifier would just go a bit blue at the tubes, and keep right on working.

What is much more "practical," from this zany pragmatic viewpoint, is the resistance one puts lengthwise into the phone leads, in series, to cut down volume. That, you see, depends on variables: 1. What your ears want. 2. The sensitivity of the phones—which varies considerably from brand to brand. 3. The impedances, nominal, that are involved. I.e., for example, 300/300, or 10/10. What you need is a fixed resistance that is near the middle of the possible variation (or suits your particular needs optimally). Or else—for wider flexibility—a variable resistance. Or a combination, if you want to have it that way.

Variable Resistance

My circuit is a highly pragmatic modification of the Sharpe suggestion, which was simply a ten-ohm resistor across each pair of lines, preceded by the nominal value of 150 ohms in series to make an L-pad facing towards the amplifier output. (A pair of them, of course, one for each phone.)

Sharpe suggested that the value of the series resistance, in one leg of each phone circuit, could be varied up to 300 ohms for more attenuation. My immediate discovery was that, with my several fairly potent stereo amplifiers and for my ear-tastes, 150 ohms wasn't nearly enough. Not for some phones, anyhow. I had to lower the volume control too far—well below the normal speaker setting.

That was where I stumbled on the pair of used 5000-ohm volume controls. No sooner discovered than put to work. With these added to the original 150 ohms, I could get anything up to an extreme—which, you see, is just what I wanted, to established pragmatic tolerances. Up to 5150 ohms.

Works jes' fine. To be sure, the volume controls go too far and their action is in effect of the tapered sort; most of the effect is in the first eighth of turn. Fine—just what I needed to know. Tapers off slowly from there. I never did try to find the exact values I was getting at the optimum setting for a given phone; I don't need them. I have, however, established a workable range, which is what matters.

If I wanted to scrounge around for, say, a pair of 1000-ohm variable resistors I'd probably get a bigger "scale" on my adjustment. But I don't really need it.

Nothing has blown out yet, either. My Dynakit Stereo 70 puts out plenty of horses at maximum and, theoretically, could melt down this whole little system of mine in a flash. But, theoretically, too, it could melt down my loudspeaker voice coils not to mention my own precious ears. In practice, at normal volume settings on the amplifier, and with most 10/10 low-impedance type phones, I get exactly what I want. Good

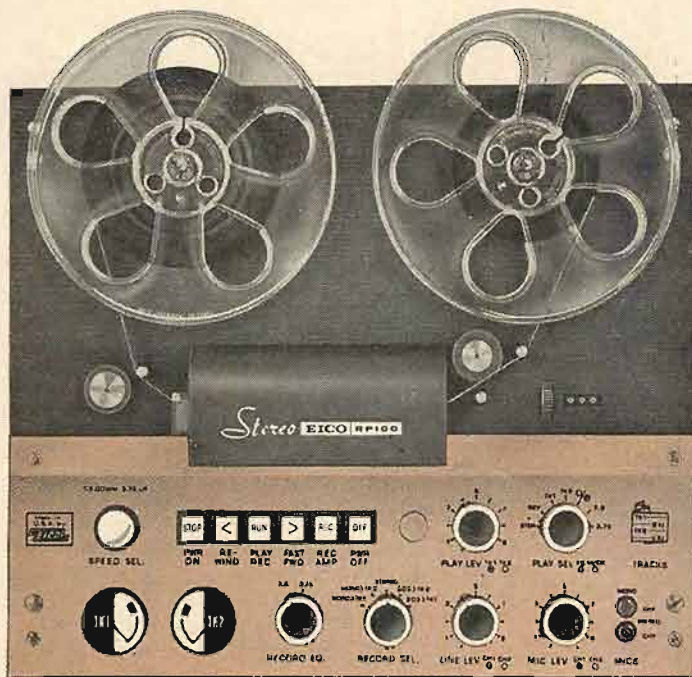

9 New Features Now In The New 1962 EICO RP100 Transistorized Stereo / Mono 4-Track Tape Deck

A great tape recorder made greater:

1. New professional studio recording hysteresis-synchronous capstan motor: 24 stator slots for ultra-smooth drive, ultra-quiet and vibrationless professional bearing system.
2. Two new take-up and rewind reel motors, both extra-powered for effortless operation.
3. New cored-out steel capstan flywheel with all the mass concentrated at the rim for improved flutter filtering.
4. New optimally designed capstan drive belt brings wow down to negligibility.
5. New relay provides instantaneous extra power to the take-up reel motor at start to minimize tape bounce. Provides near-perfect stop-and-go operation and eliminates any risk of tape spillage when starting with a nearly full take-up reel.
6. New automatic end-of-tape stop switch cuts off take-up reel motor power. Also permits professional editing techniques, whereby tape being edited out runs off the machine while you are listening to it.
7. Playback preamps remain on during stop-standby mode to permit cueing.
8. Recording level adjustment during stop-standby.
9. Shock-absorbent helical spring tape lifters practically eliminate tape bounce at start of fast winding.

And All These Well-known RP-100 Features:

Separate stereo 1/4 track record and playback heads permitting off-the-tape monitor and true sound-on-sound recording; separate transistor stereo record and stereo playback amplifiers meeting true high fidelity standards; monaural recording on 4 tracks; digital turns counter; electrodynamic braking (no mechanical brakes to wear out or loosen); all-electric push-button transport control (separate solenoids actuate pinch-roller and tape lifters); unequalled electronic control facilities such as mixing mic and line controls, two recording level meters, sound-on-sound recording selected on panel, playback mode selector, etc. Modular plug-in construction.

Wow and flutter: under 0.15% RMS at 7 1/2 IPS; under 0.2% RMS at 3 3/4 IPS. **Timing Accuracy:** ± 0.15% (±3 seconds in 30 minutes). **Frequency Response:** ± 2db 30-15,000 cps at 7 1/2 IPS, 55db signal-to-noise ratio; ± 2db 30-10,000 cps at 3 3/4 IPS, 50db signal-to-noise ratio. **Line Inputs Sensitivity:** 100mv. **Mike Inputs Sensitivity:** 0.5mv.

Semikit: Tape transport assembled and tested; electronics in kit form \$299.95

Factory-assembled: Handwired throughout by skilled American craftsmen \$399.95

An original, exclusive EICO product designed and manufactured in the U.S.A. (Patents Pending)

Carrying Case \$29.95
Rack Mount \$9.95



©1962 EICO Electronic Instrument Co. Inc.
3300 Northern Boulevard, L. I. C., I., N. Y.



FM-AM Stereo Tuner ST96
Kit \$89.95 Wired \$129.95
Includes Metal Cover and FET



70-Watt Integrated Stereo Amplifier ST70
Kit \$99.95 Wired \$149.95
Includes Metal Cover

40-Watt Integrated Stereo Amplifier ST40
Kit \$79.95 Wired \$129.95
Includes Metal Cover



FM MULTIPLEX AUTODAPTOR MX99 (Patent Pending)
Kit \$39.95 Wired \$64.95 Cover Optional \$2.95

An original EICO contribution to the art of FM-Multiplex reception

The MX-99 employs the EICO-originated method of zero phase-shift filterless detection of FM Stereo signals (patent pending) described in the January 1962 issue of AUDIO Magazine (reprints available). This method prevents loss of channel separation due to phase shift of the L-R sub-channel before detection and matrixing with the L+R channel signal. In addition, the oscillator synchronizing circuit is phase-locked at all amplitudes of incoming 19kc pilot carrier, as well as extremely sensitive for fringe-area reception. This circuit also operates a neon lamp indicator, whenever pilot carrier is present, to indicate that a stereo program is in progress. The type of detection employed inherently prevents SCA background music interference or any significant amount of 38kc carrier from appearing in the output. However, very sharp L-C low pass filters are provided in the cathode-follower audio output circuit to reduce to practical extinction any 19kc pilot carrier, any slight amounts of 38kc sub-carrier or harmonics thereof, and any undesired detection products. This can prove very important when tape recording stereo broadcasts. The MX-99 is self-powered and is completely factory pre-aligned. A very high quality printed board is provided to assure laboratory performance from every kit. The MX-99 is designed for all EICO FM equipment (ST96, HFT90, HFT92) and component quality, wide-band FM equipment.

EICO, 3300-N. Blvd., L.I.C. 1, N.Y. A-7

Send free 32-page catalog & dealer's name

Send new 36-page Guidebook to Hi-Fi for which I enclose 25¢ for postage & handling.

Name _____

Address _____

City _____ Zone _____ State _____

Over 2 MILLION EICO Instruments in use.
Most EICO Dealers offer budget terms.
Add 5% in West.

Listen to the EICO Hour, WABC-FM, N. Y. 95.5 MC, Mon.-Fri., 7:15-8 P.M. Export Dept., Roburn Agencies Inc., 431 Greenwich St., New York 13



In The Superb Tradition of Tandberg



List \$498.

MODEL 6-44 3 SPEED/4 TRACK STEREO RECORD/PLAYBACK TAPE DECK

Distinctively...

BETTER, CLEARER, MORE NATURAL SOUND

- Exhibits magnificent record/playback frequency response, exceptionally low tape tension and virtually no wow and flutter.
- Permits direct record of FM Multiplex Stereocasts at 3¾ and 7½ ips with original clarity and brilliance, and without "beep" signals.
- Offers distinguished 3 speed performance for 4 track Stereo/Mono record; 2 and 4 track Stereo/Mono playback.
- Incorporates 3 precision laminated heads, individually gapped—one each for record, playback and selective erase; and an advanced design hysteresis synchronous motor.
- Provides finger-light push button control, automatic microswitch operated tape stop and free position turntable action for easy, independent tape threading.
- Achieves maximum versatility through facilities for Sound-On-Sound, Track Adding, Echo Effects, Remote Control . . . and you may mount vertically, too.

FREE OFFER

(for a limited time only)

Your franchised Tandberg dealer is authorized to give you, free with your purchase of a MODEL 6-44 . . .

2 Tandberg CM-6 Crystal Microphones
and

1 Tandberg TC-56 Carrying Case

See Your Dealer or Write Direct

Tandberg OF AMERICA, INC.
8 THIRD AVENUE, PELHAM, NEW YORK

listening volume at normal amplifier control settings. Enough variable adjustment to cope with any and all phones that come my way.

For general home use, you won't need the variable feature unless you have a batch of headphones. But you'll never know precisely what value of fixed resistance will suit *you* until you try. So why not make it variable anyhow—ideally, say 150 to 1000 ohms—and be prepared for anything?

In earphone listening I operate about as follows. If the phones are of the low-impedance type, I set the pair of 5000-ohm controls about an eighth turn from the maximum-volume position (i.e., no resistance), then turn the amplifier volume control up to a normal speaker range—roughly halfway open, more or less. Then I adjust volume and balance, first via the two variable resistors, to get an equality of sorts, then if I need it via the balance control on the amplifier, which has more precision. Seldom necessary.

That's all. For some very loud phones, a bit more resistance. For 300/300 phones, only the basic 150 ohms, plus a bit of extra push from the amplifier. Pragmatic.

If I am right, the formula for this type of L-pad circuit says that the actual amplifier load is a combination of the two factors, the fixed load across (10 ohms here) and the variable load that is in series before it, the combination maintaining more or less consistent loading on the amplifier as the variable resistance changes, within "reasonable" tolerance.

Reasonable, indeed, by my definition! Reasonable, remember, means anything that works and doesn't blow out either the amplifier, the phones or my ears.

* * *

I should note that there are other assorted ways of achieving the needed attenuation for phones out of amplifiers, including two-armed T-pad circuits, not to mention simplified arrangements as sug-

gested by several makers that simply eliminate one or another factor—simple resistors in each phone line minus any load across, or just the opposite, a fixed load across and no lengthwise resistance. These are mostly no more than pragmatic jugglings of the factors, within the same sort of tolerance limits I've set up for myself. But minus variables they may not always work out for you, even though there is theoretically a proper loading and all that. Too loud, or maybe too faint. You need the adjustment, ahead of time.

There are all sorts of ready-made phone adapter boxes now on sale, mostly assorted adaptations of the same order of basic element. They should work fine on the phones offered by the same manufacturer, for which they are intended. But beware of all other phones! The variables are too great, still, from brand to brand, unless the adapter box has variables to match.

A final observance. As those who are experienced in matching problems will know, the low-impedance phones can be multiplied, two, three, five phones in parallel, with little or no change in volume level per phone. Minor differences, depending on the brands and the somewhat different loadings-down from one set of phones to the next. Middle-impedance phones, the 300/300 type, are not so easily doubled up. Volume drops off considerably when two or more are inserted. Amplifier power reserve (and my pragmatic attenuator) can usually take care of the difference without much trouble and no real danger.

A mixture of various impedances is inconvenient, if not particularly hazardous. A low-impedance phone grabs most of the sound. The higher-impedance phones are fainter by a lot and if you turn up volume you'll blow the low-impedance listeners through the ceiling. In respect to multiple listening, low-impedance clearly wins hands down. Æ

THIS MONTH'S COVER

On the cover this month we see the living room of Mr. E. D. Nunn. Obviously this room provides adequate space for good audio sound; it measures 28 x 41 feet with a 16-foot-high beam. The speakers are at the far end of the room and are three-section full-range electrostatics made by Arthur Janszen of KLH. The speakers are driven by a McIntosh Model 275 amplifier which provides 75 watts per channel. Mr. Nunn is President of Audiophile Records and has a complete recording studio in his home. His recording equipment consists of

two modified stereo Magnecorders and one stereo Ampex. His microphones are of the condenser type and are homemade. The mastering equipment consists of a Presto lathe with an aluminum-Bakelite turntable. The cutting head is a Westrex 2B. This head is driven by a McIntosh Model 275 amplifier with both channels connected in parallel to deliver some 180 watts with intermodulation of less than 0.3 per cent. A homemade equalizer-preamp is used. Mr. Nunn's home is located in Saukville, Wis.

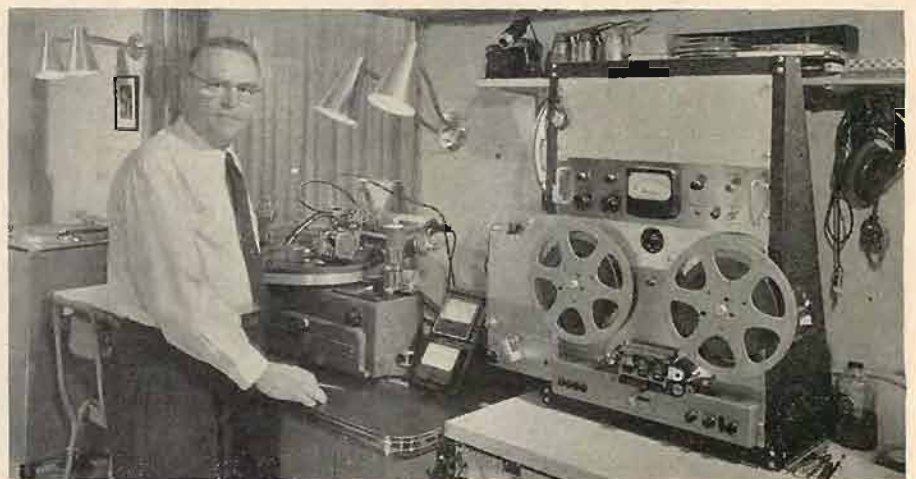



Exciting New 8" Coaxial Speaker PAX - 20G

Employs High Performance Horn-Tweeter. Though an 8" woofer is small, Pioneer has successfully adapted to it a horn-tweeter with unusually low distortion at high frequencies and fine transient characteristics.

Low Crossover Frequency. By using a radical new design, Pioneer's PAX-20G has been given an exceptionally fine midrange and a crossover at an amazingly low 3,000 cps.

Finest Overall Characteristics. The careful matching of the high magnetic circuit 8" woofer and the horn tweeter has produced a small coaxial speaker with unequalled overall high-performance.

This outstanding speaker will reproduce natural tones from rich lows to brilliant, shimmering highs smoothly, without distortion — in fact, its characteristics compare very favorably with much larger speakers.

Specifications:

Voice Coil Impedance: 8 or 16 ohms, Resonance Frequency: 50 — 70 cps, Frequency Range: 40 — 20,000 cps, Maximum Power Input: 15 watts, Sensitivity: 102 db/watt, Crossover Frequency: 3,000 cps, Total Flux: Woofer: 62,500 maxwell, Tweeter: 14,000 maxwell, Flux Density: Woofer: 10,000 gauss, Tweeter: 9,000 gauss

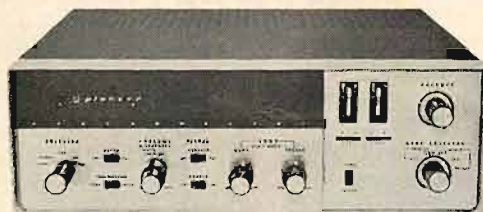

Powerful But Compact 90 (45/45) watts STEREO AMPLIFIER SM-801

Maximum output 90 watts, undistorted output 70 (distortion under 1% at 1 kc.)

For better power supply regulation a new silicone diode double voltage rectification circuit has been used.

DC ignition preamp heater — lowest hum level.

This new SM-801 is designed for the connoisseur who wants professional stereo quality at a reasonable price.



PIONEER ELECTRONIC CORPORATION

5 Otowacho 6-chome, Bunkyo-ku, Tokyo, Japan

Distributors Canada: Importhouse of Canada, 2939 Eglinton Ave. E., Scarborough, Ont.
Singapore & Malaya: Hwee Seng & Co., 259 Beach Road, Singapore 7

EDITOR'S REVIEW

VIEL GLÜCK

In our letters column (page 6) there is a notification of the formation of the dhfi (Deutsches High Fidelity Institut). The letter speaks for itself in explaining the purposes and organization of this new group overseas. We would like to take this opportunity to wish them good luck and to hope that they succeed in their endeavor to maintain high quality standards for consumer equipment.

Although the formation of a high fidelity institute in Germany may seem rather remote from the main stream of our interest, it is certainly true that a moderate amount of equipment sold on the American market is imported from that area of the world. Thus a movement to raise standards, or at least define minimum standards, may certainly be of value here.

Naturally, one of the prime purposes of such an institute would be to have shows or fairs wherein the consumer would have an opportunity to view and listen to the latest equipment. In this respect they are rather fortunate; they have several examples of well run fairs close at hand: the Festival International du Son in Paris and the London International Audio Fair. In fact as some of our confrères would have it, they might do better to use those shows as a model rather than the ones given in the United States. The feeling seems to be that the European shows place more emphasis on live music than do our shows. Although we are loath to comment on the relative merits of the European versus the U. S. shows, we do think that extra emphasis on live performances is desirable.

Again, dhfi *viel glück!*

YOUR FAVORITE PROJECT

Not too long ago one of our readers wrote to suggest subjects for articles. In reality, he was talking about projects he would like to undertake if he were guided by means of an article. Some of the projects he mentioned were a transistorized stereo record and playback preamp for semi-professional tape decks. Another one was a transistorized stereo microphone mixer with perhaps three inputs for each channel. He also suggested several other possible topics.

Frankly, we appreciated his interest and suggestions and thought it might be a good idea to invite other readers to suggest projects they would like to see presented in the form of articles. We hereby do so.

Of course, it hardly needs saying that those of you who have completed a project you are particularly proud of, and would like to share it with other readers, are definitely invited to send us the manuscript. For those who have completed a rather interesting project but feel unable to set it down on paper, please feel free to communicate with us. *We may* be able to help you.

AUDIO CLUBS—WHERE TO WRITE

Many readers have contacted us to inquire about who the focal point might be in their particular locality. Those names that could be forwarded were. On the other hand to facilitate direct contact and reduce the time interval, we are presenting a list of those people (see page 6) who have agreed to be focal points, or coordinators, or whatever you may call them.

One of the problems raised by several correspondents is the need for speakers to address these newly formed (and already existing) clubs. We wonder if any of the existing clubs (or some of the individuals) might have ideas as to how this need could be satisfied.

Of course, we would be delighted to help in obtaining speakers, but it is clearly impossible for us to satisfy the needs of the many different localities involved. *We will* do as much as we can.

MANY NEW THINGS

To our new readers, we would like to point out that in our August issue we will present our annual Product Preview. In that issue we will list and describe all the products which will be on dealer shelves come Fall. In many cases, the products described are already on dealer shelves. The point of this is to inform you of the product listing forthcoming in August and give a bit of information about some of the new products to be featured.

For example, one of the items to be shown is an integrated amplifier with only three controls on the front panel; the rest of the controls are hidden behind a panel à la TV. Other new items to be shown include a transistorized amplifier, a new professional tape deck, and a solid-state preamp.

One of the trends we noted in organizing the Preview is the renewed concentration on dressing up component high fidelity to satisfy the lady of the house. On the other hand, an expected trend hasn't quite materialized. As yet there is not a great influx of transistorized amplifiers and other equipment. Instead there seems to be some cautious "foot wetting" by some companies and a general "wait and see" attitude. Of course, this does not in the least reflect upon the quality of either the tube or transistorized equipment available. Rather it indicates that the manufacturers are understandably cautious. Frankly we agree with their caution.

Now that we have succeeded in whetting your appetite it is time to say, "see you in August."

AUDIO AMPLIFIER CERTIFICATES?

The following statement appeared in the June, 1962 issue of *Wireless World*, a British publication. We thought the idea might be interesting for us to consider.

The Audio Manufacturers' Group (*British equivalent of IHFM. en.*) have recently introduced a scheme for certifying audio amplifier specifications. Under this scheme a certificate indicates that certain parameters of the amplifier have been measured according to standard procedures by an independent testing authority and that the manufacturer's claims for these parameters have been confirmed. The parameters which must be measured include the harmonic distortion, output power, sensitivity, frequency response, hum and noise, damping factor, crosstalk and power consumption. All this data must be quoted in technical publicity material, and any other data given in such material must also be checked under this scheme. The manufacturer must also undertake that all production models are made to the same standards as the tested sample, and a procedure is laid down for checking this in the event of a complaint. Any manufacturer can take part in this scheme; he does not have to be a member of the Audio Manufacturers' Group.

At Last!

A CARTRIDGE DESIGNED ESPECIALLY
FOR AUTOMATIC TURNTABLES!

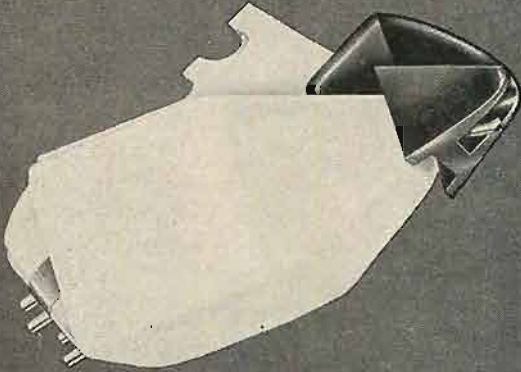

A NEW KIND OF CARTRIDGE FOR A TOTALLY NEW REQUIREMENT!



... AND ANY OTHER AUTOMATIC
TURNTABLE EVER TO BE MADE!

The Pickering Model U38/AT is a cartridge designed especially for the new generation of automatic turntables. A true STANTON Stereo Fluxvalve, it combines excellent hum shielding with high output for unequalled signal-to-noise ratio.

High compliance is provided for the special turntable features while preserving the ruggedness demanded by automatic operation. Improved frequency response and lower inductance make the new Pickering U38/AT a truly universal cartridge to match the universal features of the automatic turntable.

TECHNICANA: PICKERING Model U38/AT is a STANTON Stereo Fluxvalve with a white body and black V-GUARD stylus assembly. Weight is 14 grams; Mounting centers: 7/16" to 1/2". Supplied with universal mounting hardware. \$46.50 AUDIOPHILE NET

RESPONSE: ± 2 db from 20 to 20,000 cycles.

CHANNEL SEPARATION: 35 db

OUTPUT: 10 mv each channel

TRACKING FORCE: 2 to 5 grams

IMPEDANCE: 47,000 to 100,000 ohms

SHIELDING: Complete mu-metal



"FOR THOSE WHO CAN HEAR THE DIFFERENCE"

PICKERING & COMPANY, INC., Plainview, N. Y.

The hermetically sealed STANTON Stereo Fluxvalve is warranted for a lifetime and is covered under the following patents: U.S. Patent No. 2,917,590; Great Britain No. 783,372; Commonwealth of Canada No. 605,673; Japan No. 261,203; and other patents are pending throughout the world.

BELL LABORATORIES' NEW CONNECTOR STREAMLINES CABLE SPLICING



Telephone craftsman uses special pneumatic tool to flatten connector onto insulated wires. Metal tangs pierce insulation and produce a splice that is equivalent to a soldered joint.

Along the cable routes of the Bell System, wires are spliced at a rate of 250,000,000 a year. Conventionally, connections are made by "skinning" the insulation, twisting the bare wires together, and slipping on an insulating sleeve. Now, with a new connector initiated at Bell Telephone Laboratories, (diagram at lower right) splices can be made faster, yet are even more reliable.

The craftsman slips the two wire ends—with insulation intact—into the connector, then flattens the connector with a pneumatic tool. Springy phosphor bronze tangs inside the connector bite through the insulation to contact the copper wire. The stable, low-resistance splice established is maintained for many years, even under conditions of high humidity, corrosive atmospheres and vibration.

Ultrasensitive measuring techniques devised by our engineers demonstrate that the new connector provides the equivalent of a soldered connection,

even with voltages as low as 25 millionths of a volt.

Working with our manufacturing partners at Western Electric, our engineers developed this connector into a design capable of being mass-produced at low cost. It is being introduced in the Bell System.

NEW WIRE CONNECTOR HAS THREE PARTS:

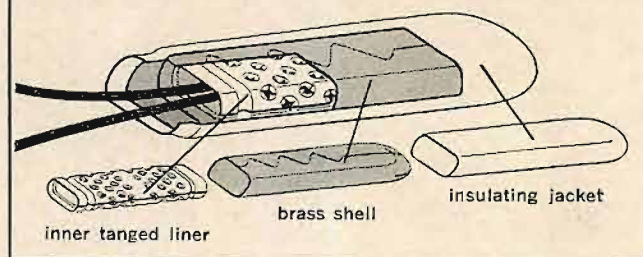

BELL TELEPHONE LABORATORIES

World center of communications research and development

Thirty Pounds of Magnet and an 18-inch Cone

S. ROBERT RUSSELL*

Speaker manufacturers, and many audiophiles, will shudder at the trouble and improvisations required to build this speaker—but for those who have the skills and interest, here's how:

THIS IS NOT A TEASER ARTICLE intended to keep readers sitting on their wallets until the 73-pound woofer described is available at hi-fi salons. Natural and economic laws will keep it from ever being marketed. Furthermore, I have no connection with any speaker factory and, as a matter of fact, have never even seen one.

The monster was built solely because my ears insist that bass from a large woofer in a large enclosure is more aesthetically satisfying than that from a frantically pumping small cone in a bookshelf cabinet. Advertisements claiming the Liliputian models are equal, or even superior, to their full grown kinfolk fail to convince my hearing.

That may prove only that the low-frequency fibres on my basilar membranes refuse to become agitated by condensed woofers. Apparently nothing less than a large, high-efficiency bass driver can stir them into action. Being a charter member of the tinkerer's guild I built one. Here, more or less step by step, is how it was done.

First mental pictures of the speaker visualized it with one of the polystyrene cones Electro-Voice uses in their peerless 30-inch woofer. Compromise No. 1 came when my supply source advised they did not stock it. I settled for an 18-inch, curvilinear paper job.

My combination living and dining room is 29 x 16 feet. Two 10-cubic foot enclosures could have been accommodated. My wife shows a tolerance in hi-fi matters unusual throughout our American matriarchy, but suitable wall space was just not available. Compromise No. 2 was a double-voice-coil woofer in a single cabinet.

Dual voice coils demand considerably more than just adding another winding to a good, single-voice-coil speaker. A natural law that magnetism varies as the square of the distance enters the picture. There are two methods of making a dual coil. Both require substantially greater magnets to maintain a high standard of speaker output.

One method is called "bifilar." It con-

sists of winding both coils simultaneously from two spools of wire. Placing one winding on top of the other is called "stacking." A bifilar winding finishes twice as long as a single coil with the same number of turns. It is no thicker and will work in the same gap which was right for a single winding. One half of its length, however, will be outside the area of maximum flux. This demolishes its efficiency. Doubling the front plate thickness is the remedy only if enough magnet is added to bring flux in the gap up to its original strength.

Any manufacturer who did this, assuming his original speaker was top quality with a heavy magnet, would have a product only a Texas oil millionaire could afford. With a bifilar, the turns of one winding are separated by turns of the other. The field generated by a winding weakens rapidly as its turns are separated. A stacked winding was chosen for its superior efficiency.

Stacked windings are no longer than a single winding and do not call for a thicker front plate. They do require twice the gap width for free movement. This means that, like the bifilar, they demand a formidable increase in magnet.

Fortunately large magnets are available. Salvage and surplus outlets across the country advertise magnetron magnets at reasonable prices. They are made in a wide variety of sizes and shapes. The decision to use magnetron magnets forced a reversal in what is the usual magnet assembly design procedure.

General practice is to make the magnet circuitry so efficient that the smallest possible magnet will produce the desired flux in a predetermined gap. Precharged magnetron magnets cannot be machined. Size and shape of the steel needed to make one into a speaker assembly is determined by the magnet dimensions. If they necessitate wasteful circuitry the only remedy is to use a heavier magnet. That is a brute force method no manufacturer could adopt and keep his stockholders happy.

Design of our brute force magnet assembly would depend upon voice-coil dimensions. A short-throw high-efficiency

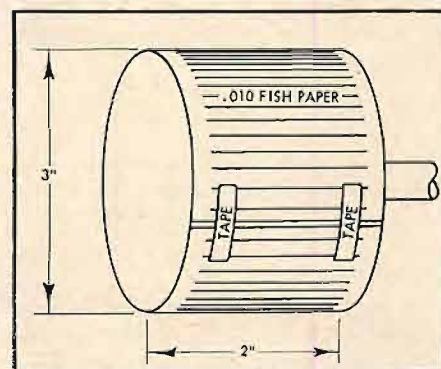

Fig. 1. Winding mandrel. Slotted .010 fish paper in place on top of one turn of unslotted paper of some thickness—with hold-down tapes.

woofer needs a large diameter voice coil so that the winding, of relatively large wire, is held to a minimum width. A three-inch diameter was selected. Number 26 wire was on hand and would give 10- to 15-ohms impedance with only some 2.5 ohms d.c. resistance.

Being committed to the brute force magnet system it was decided to give the voice coil a generous .020 clearance inside and out. A large enough magnet would compensate for spillover or fringing flux loss at so wide a gap. The .020 clearance on the inside of the coil around the pole piece could be accurately controlled by making the winding mandrel 3.040 inches. Bore diameter of the front plate could not be determined until the

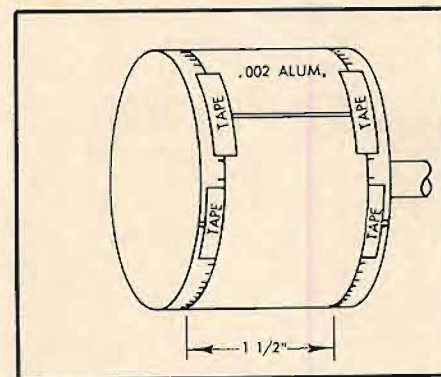

Fig. 2. Winding mandrel. Aluminum coil former in place on top of slotted fish paper.

* 1725 Laird St., Key West, Fla.

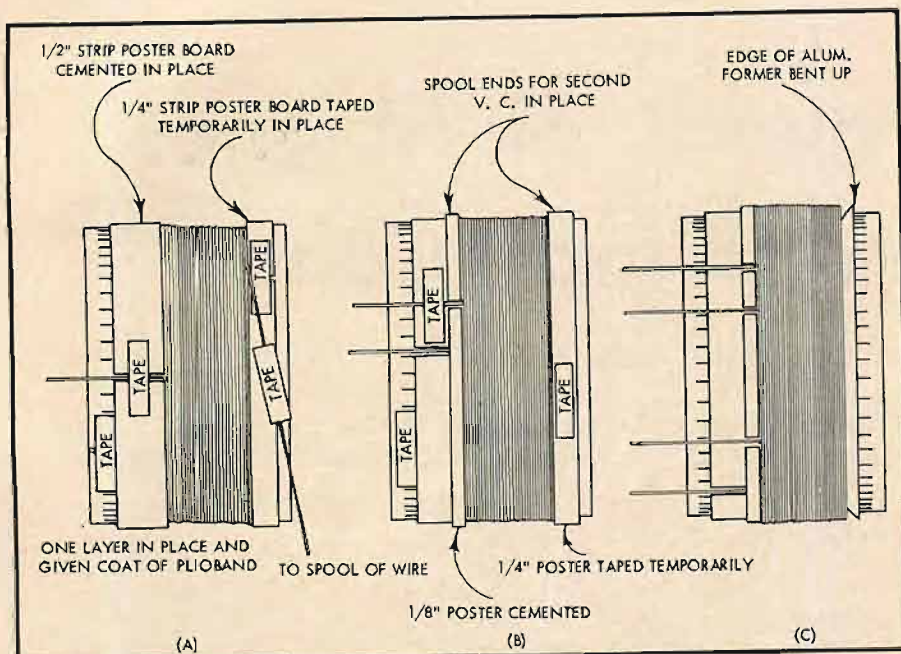

Fig. 3. First layer completed, (A); second layer completed, (B); second winding completed with tapes removed, (C).

wall thickness of the finished voice coil was known.

Simply multiplying the wire diameter of .016 by four—two two-layer windings—and adding the .002 thickness of the aluminum it would be wound on would not give the true coil thickness. Layers of cement used to bind and harden the windings would increase the coil diameter by an unknown amount. So winding the voice coil became the first step in the project.

One voice-coil fiasco taught that a tightly laid winding made rock hard by cement can be removed from a solid mandrel only by cutting it off. The solution was a slotted strip of .010 thick insulating material known as fish paper. It was cut two inches wide, the width of the mandrel, and 10 inches long. A tinkerer's pal, the ubiquitous razor blade, was used to cut slits, spaced 1/4-inch or so apart, across the strip leaving a 1/8-inch uncut border on each side. A wooden ruler pressed firmly down on the paper served as a stop for the closest border. Cutting through the border when the slotting is almost completed is a temper-detonating experience.

The slotted strip was placed on the mandrel directly under the aluminum coil former (see Fig. 1). When the coil was finished the two unslotted borders were cut away using a razor blade while turning the winder crank. Long nose pliers pulled out the narrow strips left under the coil and it slid easily from the mandrel.

Actual winding of the voice coil is painstaking but not difficult. An unslotted strip of fish paper went next to the three-inch mandrel with its ends butted together. The slotted strip was pulled tightly around it and its ends secured with the 1/4-inch wide Scotch tape

sold for Christmas packaging. The two layers gave the required .020 clearance inside the voice coil.

The 1 1/2-inch aluminum former went on next, centered on the slotted strip (see Fig. 2). A single layer of heavy twine was wound on to compress it and the strips beneath it. Enough twine was unwound on the right hand side to expose about 1/8-inch of former. Tape secured the former ends to the slotted strip. The same thing was done on the left side. When the remainder of the twine was unwound the former laid smoothly in place.

If Khrushchev's 50-megaton bomb fallout produces four-handed mutations they will be ideally equipped for the above operation.

Each winding was to have 93 turns, 47 on the first layer and 46 on the second. Forty-seven turns at .016 occupy slightly more than 3/4 of an inch. Seven eighths was measured over from the tape on the right edge of the former. A mark was made where the winding should start. The right side would be the bottom of the finished voice coil.

Before starting the actual winding a dozen or more inch-long strips of tape were stuck down on the bench within easy reach. They were for securing a partly finished layer to keep it from spinning loose if the phone shrilled or

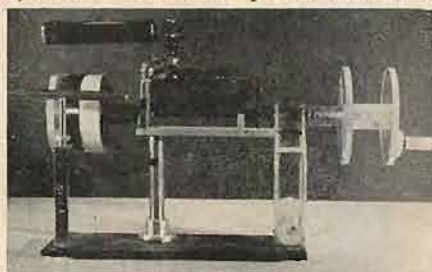

Fig. 4. Coil winder made by the writer.

the wife summoned.

A smoothly brushed coat of Pliobond prepared the former for the winding. Tape stuck the wire down at the starting mark (see Fig. 3). A three-inch end was left sticking out to the left. A sharp, right-angle bend at the tape and the wind was under way. No. 26 wire all but guided itself. Layering No. 38 for a tweeter voice coil is much more demanding. Figure 4 shows a coil winder I built to make the winding easier.

When 47 turns were smoothly layered a half turn was spaced away from the last turn and tacked down with tape. A coat of Pliobond was brushed on the layer. When it was dry the tape was removed and the layer remained in place.

Two strips, one 1/4-inch wide and the other 1/2-inch, were cut from .027 poster board. Both were just long enough to encircle the former. The 1/4-inch strip was taped to the former snugly up against the right edge of the winding. The 1/2-inch strip was cemented permanently against the left edge of the winding. Its length was shortened slightly so that the three-inch starting end of wire lay between its ends.

These strips would form spool ends for the next layer. It went on smoothly. The final turn was bent sharply left and taped to the cardboard. The layer was given a coat of Pliobond.

Winding the second voice coil followed the same pattern. Its starting lead was brought out about 90 degrees further around the former. Another strip of 1/4-inch-wide poster board was taped on top of the first one at the coil bottom end. A 1/8-inch strip was cemented to the 1/2-inch one on the coil right end. It was notched out for leads. These strips form spool ends for the second winding. It went on without mishap.

The final layer was well doped as those beneath it had been. When dry the 1/4-inch strips taped on the right side were peeled off. An artist's spatula was carefully inserted under the edge of former projecting from under the winding and it was gently worked up into an almost vertical rim. A thin bead of Pliobond was painted into the "V" between the winding and the bent up aluminum. When it had started to harden the rim was pressed snugly against the winding.

When thoroughly air dried the coil was removed from the mandrel, given a final coat of Pliobond and placed under a heat lamp. After the cement had cured surplus aluminum on the turned up rim was cut down even with the winding. The coil wall thickness was .077. Cement had added .011 to the .066 materials thickness. (See Fig. 5.)

It was now possible to figure the diameter of the magnet assembly front plate bore. A three-inch pole piece with .020 clearance all around makes the inside of the voice coil 3.040. Add 0.154,

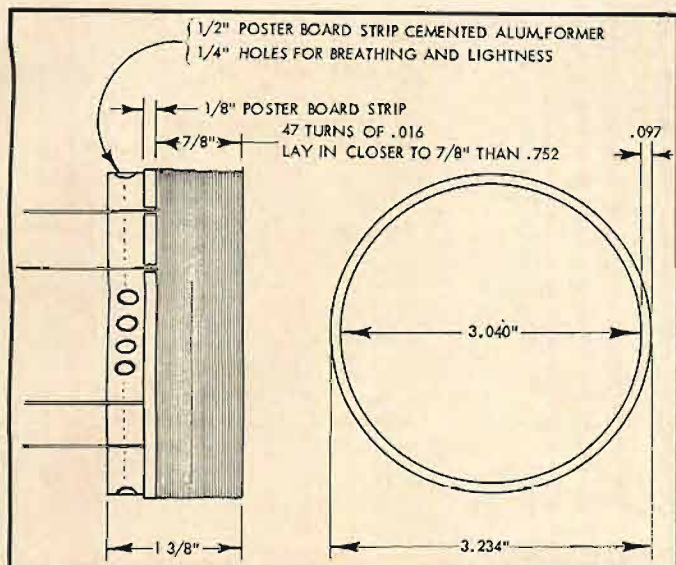

Fig. 5. Stacked dual voice coil.

which is the .077 coil thickness doubled, and .040 for .020 clearance all around, and the bore diameter must be 3.234. Magnet assembly work was postponed in favor of marrying the cone and voice coil.

The 18-inch cone had been made to take a 2½-inch voice coil. Careful razor blade work cut its apex down until the hole was the same diameter as the inside—not outside—of the dual voice coil. Acetone softened the newly cut edge and allowed it to be worked outward into a narrow rim for more cementing surface.

A slightly tapered jelly glass was used to form the rim. It was inserted into the hole from the front of the cone and rotated until a lip was pressed out. The lip had a slight inward taper. Inserting the glass from the outside of the cone corrected that. The procedure was repeated until the hole had a straight out lip into which the voice coil fitted snugly.

A piece of 4×4 pine 6½-inches long was lathe turned so that the voice coil fitted snugly over it. Its ends were faced true. It was the start of a jig which would accurately align the voice coil and cone for cementing. This round plug was screwed fast in the center of a two-foot square of ¾-inch plywood. (See Fig. 6.)

The cone was placed face down over the wooden plug. Its rim was pressed flat on the board and held there by an Upson board ring stapled to the base board. The voice coil was slipped over the wooden plug with its four leads guided down inside the cone. (See Fig. 7.) An artist's spatula coaxed the coil inside the cementing rim. Heat lamp-baked Pliobond locked it there.

When the cone was removed from the jig the coil ends inside it were cut to one inch. Seven-inch lengths of Belden voice-coil lead wire were soldered to them. A large sewing needle carried these flexible wires through the cone. Inside wires were pressed tight against

the cone and held in place by strips of onion skin paper and cement. A rule showed that the completed cone would require a basket five-inches deep.

Examination of the cone's pressed-in compliance rolls showed that they moved more freely in one direction than the other. They were carefully cut off and replaced by a ring of Pellon, made airtight by a coating of Devcon liquid rub-

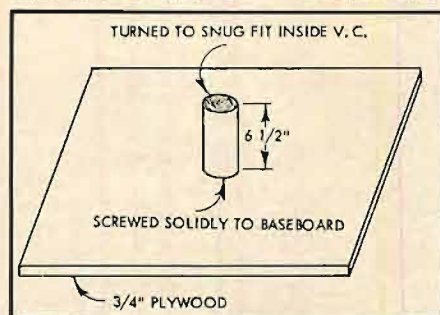

Fig. 6 Jig for aligning cone and voice coil. ber thinned with trichloroethane. The outer edge of the Pellon was cemented to an Upson-board ring. A cone assembly is not complete without a device to hold its voice coil centered. Most woofers use flat, corrugated discs. Because their ancestors had legs they are called "spiders." Those available were all too small with too high resonance frequencies. That called for another "roll your own" project.

Two matching halves of a spider press,

a male and a female, were lathe turned from one-inch thick aluminum (see Fig. 8). Their backs were bored out to accept electric hot plate heating elements.

A parade of spiders was pressed out using different materials, some logical and some fantastic. Buckram was the eventual choice. It was first wetted then ironed dry in the press. After being sprayed with clear acrylic to prevent moisture absorption it became a 7½-inch spider with a subsonic resonance.

A perfect spider was carefully centered on an Upson board ring and cemented there. The spider and rim compliance rings had been drilled for 6-32 machine screws so as to provide adjustable cone centering and alignment. Upson board used for rings was hardened and moisture proofed by soaking in household cement thinned with acetone. Cementing the spider to the cone completed the assembly.

An adequate basket could not be designed without knowing the size, shape, and particularly the weight, of the magnet assembly it must carry literally on its back. Working out a magnet assembly automatically became the next step.

A friend located large magnetron magnets at the Gainesville Scrap Iron and Steel Corp., some 400 miles away, bought them and delivered them to my door. That statement is really relevant. Transportation charges on heavy magnets over any considerable distance can send their cost rocketing.

The magnets selected weighed 15 pounds each. Two were bolted end to end, unlike poles together. They formed a "W" which had a shallow center leg. Three-inch steel shaft would extend this leg to form the center pole-piece of the assembly. A front plate to complete the magnetic circuitry would be 5½×15½ inches. Thickness of the plate would not be less than one inch.

An electronics engineer friend, who incidentally is not a hi-fi buff, identified the magnets, looked up specifications and assured me they would produce at least 500,000 Maxwells across a ⅓-inch gap one-inch deep. He also called my project a great waste of time as the best speaker it was possible to make could then be bought for 15 dollars and presented a magazine advertisement as proof.

Fig. 7. Cone and voice coil aligning jig in use.

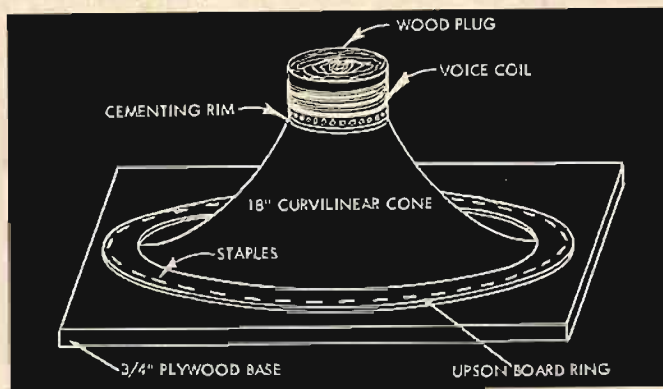

To avoid saturation of the entire front plate it was decided to make it of two-inch steel and bevel it to 13/16ths at the pole piece. Geographical location forced another compromise. Key West is famed for scenery and climate but lacks heavy industry. One inch was the thickest steel in town. A piece was cut, bored and beveled. When it and the pole piece were bolted in place the assembly weighed an even 60 pounds.

A basket made previously for an earlier 18-incher—a junior model with a mere 15 pounds of magnet—was rejected as not strong enough to support the 60-pound assembly without danger of sag. A new design was worked out around Reynolds Aluminum Corp., “do it yourself” tubing and fittings. (See Fig. 9.)

Its 18-inch rim was made by rolling and welding $\frac{1}{4} \times 1$ aluminum into a hoop. The ledge upon which the cone rim would rest was a ring jig sawed from $\frac{1}{2}$ -inch plywood and cemented in place with Devcon epoxy resin glue.

Two aluminum rings, 16 inches in diameter with $9\frac{1}{2}$ -inch holes in their centers, were sabre sawed from $\frac{1}{8}$ -inch stock. They were to become the base of the basket.

To assemble a built-up basket so that it is true, with its rim and base concentric, requires a jig. The rim and one base plate were utilized as follows:

Two circles, 16 and 18 inches in diameter, were drawn in the center of a two-foot square of $\frac{3}{4}$ -in. plywood. One of the 16-inch pieces was located exactly within the 18-inch circle and fastened there with wood screws and washers.

Four 4×5 -inch shelf brackets were used to hold the rim in position. They were located precisely on the outside of the 18-inch circle and screwed down with their 5-inch arms pointing up. Their 4-inch arms aimed at the corners of the board. Their squareness was checked with a tri-square and inaccuracies corrected by bending.

Twelve holes were drilled in the rim. They were equally spaced around its circumference, centered in its one-inch width, and tapped for 10-32 machine screws. They would be used to fasten 12 basket uprights permanently to the rim. “C” clamps secured the rim to the shelf brackets temporarily, five inches up from the base plate, the basket depth required by the cone.

Measurement for the aluminum elbow and tubing uprights showed that a $\frac{3}{4}$ -inch elbow would contribute $1\frac{1}{4}$ inches to the height. Tubing length would then be $3\frac{3}{4}$ inches. The same length would do for the horizontal legs which would bolt between the flat aluminum base rings.

Tubing was cut to length and assembled on elbows. The screws and expansion washer locking devices furnished

with the elbows were used. Permanency was assured by giving them a heavy coat of Devcon plastic steel. Maple dowels, well buttered with plastic steel, were pressed into the tubing.

Next came fitting the uprights to the rim. One was clamped in a vise with an arm straight up like a letter “L.” A saw cut was made on the inside of the “L” precisely one-inch down and exactly half way through. Another cut straight down the upright divided it into two equal halves. When this cut met the first one a one-inch-long half-round of dowel and aluminum fell free. It left the upright with a shelf upon which the rim would rest.

Twelve uprights were needed. Thirteen were made up. The extra one was for

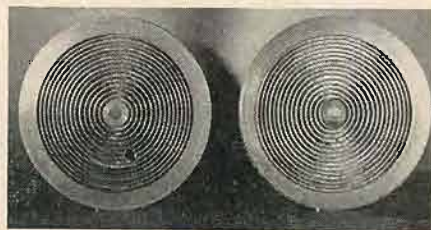

Fig. 8. Two matched halves of press used to make $7\frac{1}{2}$ -inch flat spiders. Hot-plate heating elements are recessed into backs. (Starch from buckram fouls grooves.)

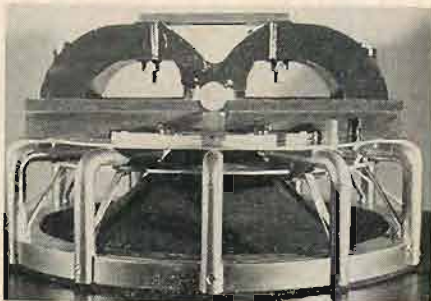

Fig. 9. Woofer, before prettying up, face down to show magnets. Half-dollar is to give perspective.

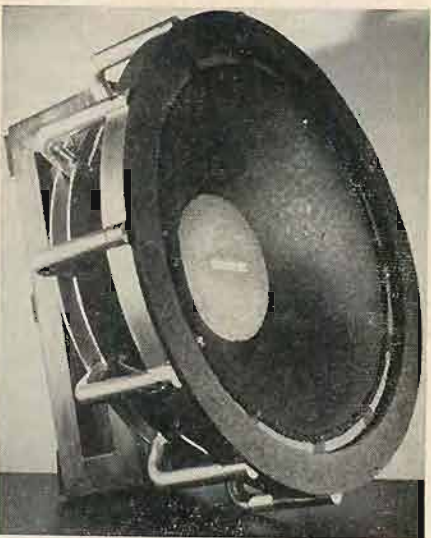

Fig. 10. Plexiglas windows in dust cover allow inspection of pole pieces for clinging steel particles.

spoiling, something at which I am exceptionally proficient. Two holes spaced $1\frac{1}{2}$ inches apart were drilled straight down through the horizontal leg of each upright. When assembled the basket base would consist of the upright horizontal arms bolted between the two 16-inch aluminum rings.

An upright was then held in position with the rim on its shelf and lined up with one of the holes previously drilled and tapped in the rim. The position of this hole was located on the upright. It was drilled and the hole countersunk so that the arm could be bolted to the rim. Epoxy resin glue reinforced the bolt. The system was followed until all 12 uprights were in position and square with the rim. Yes, I ruined one of them.

Holes were drilled down through the base plate using the previously drilled holes in the horizontal arms for guides. It was then unscrewed from the wood base and used as a template to drill its twin. The arms were bolted between the two plates. Diagonal braces added rigidity. Except for drilling the mounting and binding-post holes the basket was complete.

It was placed on the magnet assembly, centered with the pole piece and bolted down with brass bolts. Each of the two main $5/16$ " bolts went through the basket base, down through the magnet assembly from plate and magnets and was secured with brass nuts and washers.

A wooden dust cover was fitted over the magnets. Since building a speaker using charged magnets is a constant battle with metallic dust and particles it was given Plexiglas inspection windows. (See Fig. 10.) Machine screws clamped the cover tightly against a felt gasket.

The coneless speaker was placed face up on the floor for a completely unscientific test of magnet strength. An 8-inch length of $\frac{1}{2} \times 3$ hot-rolled steel was held a foot or so away from the assembly with its $\frac{1}{2} \times 8$ edge down, centered over the pole piece and across the rectangular front plate. As it was lowered pull could be felt at five inches. At about one inch the steel was snatched from my hand and snapped down to the assembly with the report of a piston shot.

Attempts to pull it free lifted the speaker from the floor. The edges of hot-rolled steel are slightly rounded rather than sharply square. Only some $7/16$ of metal was in contact with the pole piece which projects $1/16$ above the front plate. Yet pull on so small an area was sufficient to lift some 70 pounds off the floor. It occurred to me then that losses at the gap anticipated through saturation of too thin a front plate might not be serious.

The cone was placed in the basket and a $\frac{1}{4}$ -inch-wide ring of $\frac{1}{8}$ polyure-

(Continued on page 51)

High-Quality, Low-Power Stereo Amplifier

JOSEPH GIOVANELLI

Our own Mr. Giovanelli describes how he converted his system to stereo, and the reasons for making his decisions.

RECENTLY I SWITCHED TO STEREO. Like many others I had what I considered to be a fine monophonic system and, therefore, could see no need to scrap the equipment. In order to achieve the stereo effect, I merely duplicated my original monophonic system. At that time there was very little choice of stereo preamplifiers, integrated preamplifier-amplifier units, and the like.

It was not long before I became annoyed with the balancing problem. Since all equipment was duplicated, balance was achieved by turning the volume control knobs, one on each amplifier. It would not have bothered me much if, after having achieved a good balance between channels, the system stayed in balance from tape to tape and, later, from disc to disc. The whole business became a real production when I wished to raise or lower the volume of both channels simultaneously. This necessitated rebalancing. (It should be said here that in my case balancing was difficult for an additional reason—because the equipment cabinet was located much nearer to one speaker than to the other one. Of course, with a little practice one can learn to make this adjustment even under such conditions, but it was annoying nevertheless.)

I did not mind the duplication of the remaining controls because it gave me a great deal of flexibility. I could listen to a monophonic recording and at the same time record another program by means of the unused channel. I could match the two channels to suit the room acoustics.

When I had time I tried to figure out just what I wanted my amplifier to do. It should be self-contained with both amplifier channels and the power supply mounted on a single chassis. Only aluminum should be used because of the ease with which it can be worked and because of its non-magnetic properties. It should be at least as small as *one* of my original power amplifiers. It should be kept as cool as possible and be made as light in weight as possible. Also, the amplifier should be inexpensive to build, making

use of as many parts from the junk box as possible.

The sound produced by this amplifier must be good. Intermodulation must be under one per cent at full output. Above all, this is the most important.

Since I very much liked the pream-

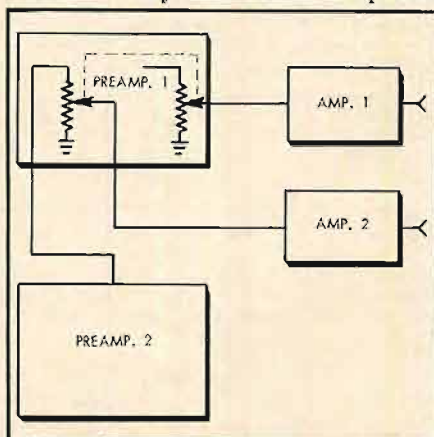

Fig. 1. Circuit arrangement for controlling the gain of both channels simultaneously.

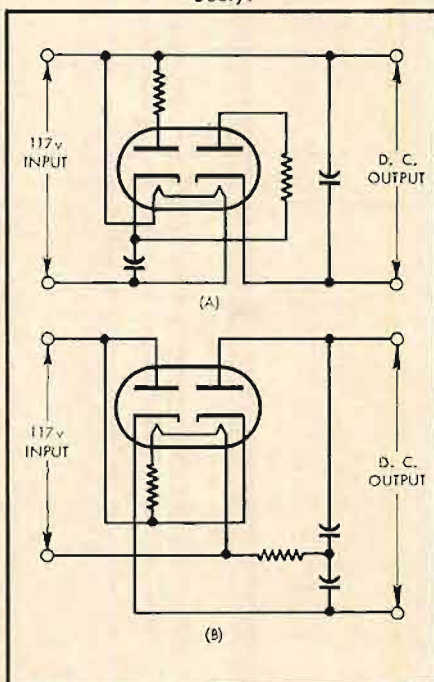

Fig. 2. Voltage doublers: (A) half wave, and (B) full wave.

plifiers I was using, I did not wish to scrap them, so balancing would have to be accomplished in the power amplifier circuit itself. Yes, while I was about it, why not paint the lily and build the balance circuit in such a way that balancing could be accomplished remotely from any part of the room? (This last sounds like a tall order, but, as can be imagined, it is far more comfortable and convenient to balance a stereo system while seated in a favorite listening position.)

How to meet these requirements? That was the big question. I will tell you how my reasoning went, how I rejected some ideas and kept others. When I am through, why not try building the finished amplifier?

Balancing and Volume Considerations

As previously noted, controlling the volume of both channels simultaneously was a problem.

I overcame this by means of ganged potentiometers in one of the preamplifiers, rather than by using the single pot which normally served as the volume control. The first gang was connected in the normal manner and served to adjust the volume of this preamplifier. The second gang controlled the output of the other preamplifier. This preamplifier was connected in the usual manner. The output of the unmodified preamplifier was connected across the second gang of the potentiometer of the modified preamplifier, and the input of the power amplifier for that channel was connected between the arm of that second gang and ground. This circuit arrangement is shown in Fig. 1.

This allowed me to adjust the volume of each channel with the turning of one knob. The control on the unmodified preamplifier was turned up fully. The fact that this worked proved that the preamplifiers are of good design since turning up the gain of the unmodified preamplifier could result in overloading its output circuit if that circuit were not properly designed.

The first preamplifier had to be turned up so that it would provide sufficient

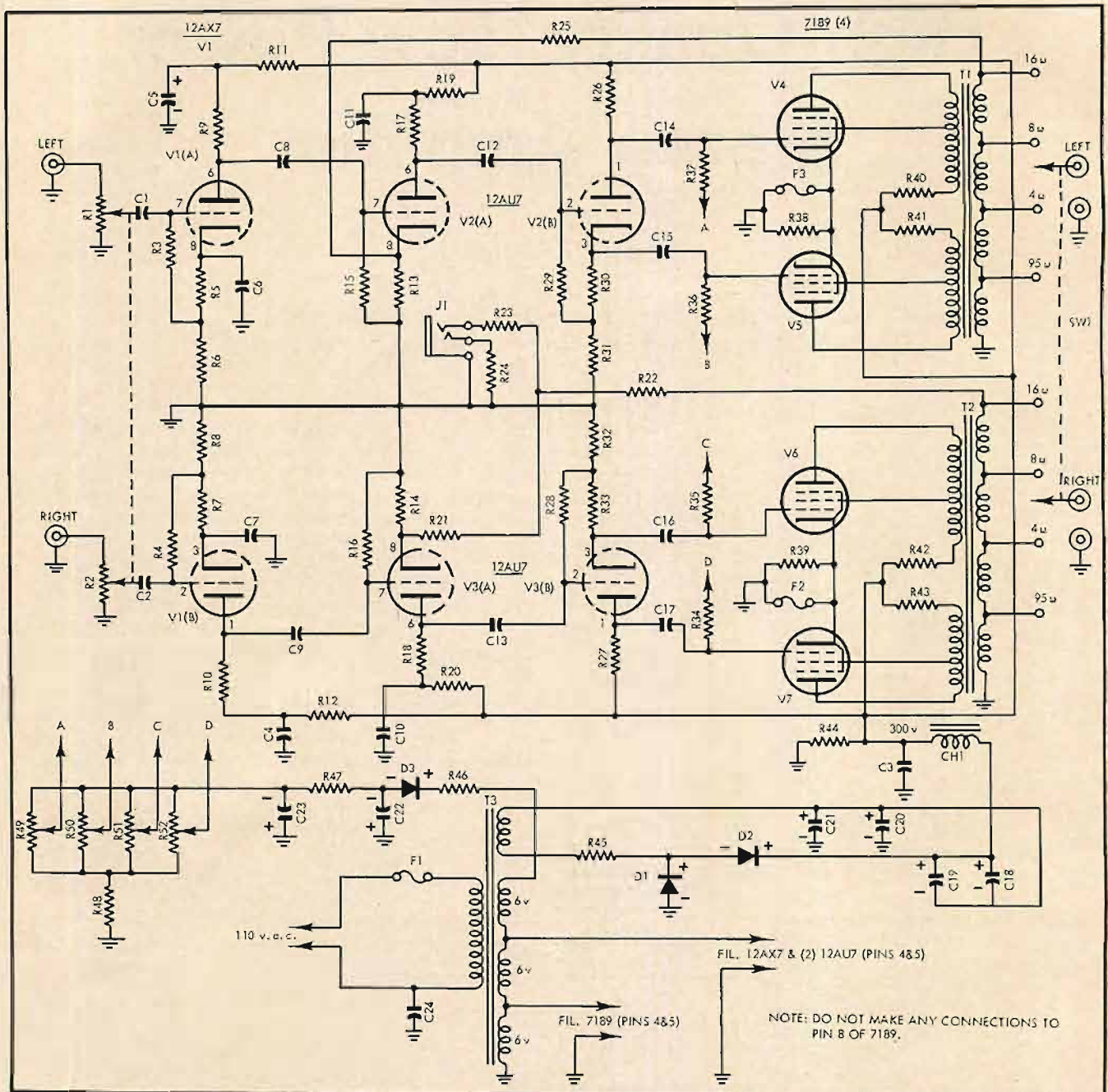

Fig. 3. Above, Schematic of amplifier, and below, the complete parts list.

PARTS LIST		
RESISTORS	R27 51 k	CAPACITORS
NOTE: UNLESS SPECIFIED, ALL RESISTORS ARE ONE WATT	R28 0.5 MEG	C1 0.05µf, 600 v.d.c.
R1, R2 0.5 MEG EACH, GANG.	R29 0.5 MEG	C2 0.05µf, 600 v.d.c.
R3 1 MEG	R30 3600Ω	C3 120µf, 450 v.d.c., ELECTROLYTIC
R4 1 MEG	R31 47 k	C4 40µf, 450 v.d.c., ELECTROLYTIC
R5 2200Ω	R32 47 k	C5 40µf, 450 v.d.c., ELECTROLYTIC
R6 8200Ω	R33 3600Ω	C6 330 pf
R7 2200Ω	R34 270 k	C7 330 pf
R8 8200Ω	R35 270 k	C8 0.05µf, 600 v.d.c.
R9 100 k	R36 270 k	C9 0.05µf, 600 v.d.c.
R10 100 k	R37 270 k	C10 40µf, 450 v.d.c., ELECTROLYTIC
R11 20 k	R38 130Ω, 5 w	C11 40µf, 450 v.d.c., ELECTROLYTIC
R12 20 k	R39 130Ω, 5 w	C12 0.05µf, 600 v.d.c.
R13 5600Ω	R40 10Ω, 2 w, 1%	C13 0.05µf, 600 v.d.c.
R14 6800Ω	R41 10Ω, 2 w, 1%	C14 0.1µf, 600 v.d.c.
R15 0.5 MEG	R42 10Ω, 2 w, 1%	C15 0.1µf, 600 v.d.c.
R16 0.5 MEG	R43 10Ω, 2 w, 1%	C16 0.1µf, 600 v.d.c.
R17 100 k	R44 50 k, 5 w	C17 0.1µf, 600 v.d.c.
R18 100 k	R45 10Ω, 10 w	C18 150µf, 150 v.d.c.
R19 20 k	R46 20Ω	C19 100µf, 150 v.d.c.
R20 20 k	R47 6200Ω	C20 150µf, 150 v.d.c.
R21 6800Ω	R48 3300Ω	C21 100µf, 150 v.d.c.
R22 100Ω	R49 50 k, 2 w, WW, POT.	C22 50µf, 50 v.d.c.
R23 100Ω	R50 50 k, 2 w, WW, POT.	C23 50µf, 50 v.d.c.
R24 125Ω	R51 50 k, 2 w, WW, POT.	C24 0.05µf, 600 v.d.c.
R25 10.8 k	R52 50 k, 2 w, WW, POT.	
R26 51 k	R53 1000Ω, POT. (REMOTE)	
		MISCELLANEOUS
		V1 12AX7
		V2 12AU7
		V3 12AU7
		V4 7189
		V5 7189
		V6 7189
		V7 7189
		D1, D2 SARKES-TARZIAN M 500
		D3 SARKES-TARZIAN M 150
		F1 1.5 AMP., SLOW-BLOW
		F2, F3 0.1 AMP., SLOW-BLOW
		CH1 8h, 250 mA, 50 v.d.c. RES.
		SW1 SINGLE POLE 4 POSITION FOR EACH CHANNEL.
		T1 PARTRIDGE 5201
		T2 PARTRIDGE 5201
		T3 TRIAD R-63-B

output to balance the modified preamplifier. When the modified preamplifier is turned up fully, all the signal feeds into its power amplifier. Since the two preamplifiers are identical save for the modification of one of them, the unmodified preamplifier would have to be turned up fully in order to transmit equal output to its power amplifier. As the volume of the modified preamplifier is turned down, that of the unmodified one will be attenuated also.

One thing is very important: *The two gangs of the potentiometer must track.* That means that for a given rotation of the shaft, the change of resistance of one section should be the same as the change of resistance of the other section. If the pot does not track perfectly, the volume of the two channels will not be changed equally, and this in turn will cause the system to shift from a balanced to an unbalanced state with various settings of the potentiometer.

One word of caution is in order here. If the leads between this added volume control gang on the modified preamplifier are fairly long—two to three feet—loss of highs may result. When this occurs, shunt the section of the volume control between the arm and the “top” with a small capacitor. The value of this capacitor will be in the vicinity of 50 or 100 pf. The use of low-capacitance shielded cable may eliminate the necessity for the added capacitor.

This preamplifier arrangement does allow for a crude balance between channels which can be achieved as follows: Suppose that the modified preamplifier is connected to the right channel and the non-modified preamplifier to the left. Suppose further that the controls are set as suggested, with the left control up full and the right one set to any convenient volume. We are now listening to a stereo tape and we notice that the left channel is too prominent. All we need do is turn the volume down on the left channel. Suppose, however, that the right channel is too prominent. If we turn down the right channel, the left channel will be attenuated at the same time, and no balance can be established. If the right channel has level adjustments for all inputs, they can be set slightly lower than the same settings of the same controls of the left channel. This would give us a situation in which the left channel is always prominent, and balance can be effected by merely adjusting this channel as necessary.

(Note that many preamplifiers do not have level controls for all inputs, especially the phono input, although such a control is very much to be desired, especially when the phonograph stage is driven by high-input cartridges. Because of this lack of level controls, it was also necessary to assume here that

in such a case the balancing must be done from the power amplifier.)

Power Supply

No matter how good the circuitry, the limiting factor will be the output transformer. A good one is likely to be heavy, and two are needed. That means that power supply components should be as light as possible in order to counterbalance the weight of the output transformers. Of course, since you cannot select an output transformer without knowing the tubes with which it is to be associated, that is the next thing to consider. The choice of tubes hinges considerably upon the power supply voltage and current which is to be available. (Remember, I said that the power supply would have to be light.) Since power supply components can be very light if a.c.-d.c. circuitry is employed, I began to explore the possibility of this type of circuit arrangement.

If the filtering is good enough, there probably will not be much hum. Series filament strings, however, can be hum producers, but of course there will be feedback and this will counteract this source of hum considerably. On the other hand, I don't like to use feedback for anything but the minimizing of distortion. Often when feedback is used to minimize hum, the hum appears anyway in the form of a background, modulated with the signal. Since this is a power amplifier, it therefore need not possess a great deal of gain: $\frac{1}{2}$ volt is probably more than adequate sensitivity. It will take a lot of doing to develop sufficient hum voltage to bother such an insensitive circuit, but there still will be a possibility of some residual hum. Further, it would be hard to find suitable tubes. The 50C5 would not give us the ten watts we wanted because the plate voltage cannot be made high enough without damaging the tube.

Another disadvantage of this type of circuit is that it is sometimes advisable to ground the preamplifier to a radiator or waterpipe in order to eliminate hum. This could cause trouble with a “hot” chassis of the type associated with a.c.-d.c. equipment if the plug is accidentally placed in the wall socket in the wrong way.

There is, however, a cure for that. Simply remove one prong from the plug, the prong which connects the plug to the chassis side of the line. The ground could be established by connecting the wire which formerly went to this prong to the radiator as mentioned, and the plug inserted into the wall socket. If the polarity is correct, the remaining prong will make contact with the “hot” side of the line and ground will be taken from the radiator. If the polarity is reversed, the “hot” terminal will be connected to ground, and no current will flow.

Since the voltage provided by a.c.-d.c. circuits is too low for a power tube, why not use a voltage-doubler circuit? There are two types, a half-wave, and a full-wave. Each has some advantages. The half-wave type shown in *Fig. 2* has the advantage that one side of the line can be grounded, making it possible for us to use the scheme with the radiator, but the ripple frequency of such a doubler is equal to the line frequency, and this means that it will be harder to filter than would be true of the full-wave type of doubler. However, the full-wave type has the advantage that the line frequency is doubled, making it as easy to filter as with conventional a.c.-operated power supplies of the type found in most high-fidelity equipment. This is an advantage because the filter components can be smaller, and this can mean a lighter power supply. This type of circuit, however, has the disadvantage that the line cannot be returned directly to ground.

Naturally, I wished to use the full-wave type, so I decided that if there was hum of the type that could be cleared up only by connecting the chassis to the ground system, I would use an isolation transformer.

Why not use a filament transformer as well? (Many of you may say at this point that if I was going to use both a filament transformer and an isolation transformer I might just as well use a conventional power transformer in the first place. The answer to this is simply that the B current is quite high—215 ma or thereabouts—and a power transformer capable of delivering this amount of current would be both costly and bulky.) This would allow me to use better tubes than can be used with the series string. Actually, almost any tubes can be hooked in series-parallel, but I really do not like that kind of string since it does give rise to hum. It is likely that the filament transformer would be small enough to be mounted underneath the chassis, and there is usually quite a bit of space around the power supply section which might otherwise be wasted. (In the final version of this amplifier, the filament transformer is combined with the plate transformer.)

As it finally wound up, I used a power transformer having the requisite filament windings. The final design involved fixed bias for the output stage. I derived this from the filament windings, as shown in *Fig. 3*: three 6.3-volt windings are connected in series to give 18 volts to the bias supply.

The other winding on this transformer gives the voltage and current required by the voltage doubler so that the output from the power supply would be 325 volts under load.

Well, my light power supply did not end up particularly light, but I was

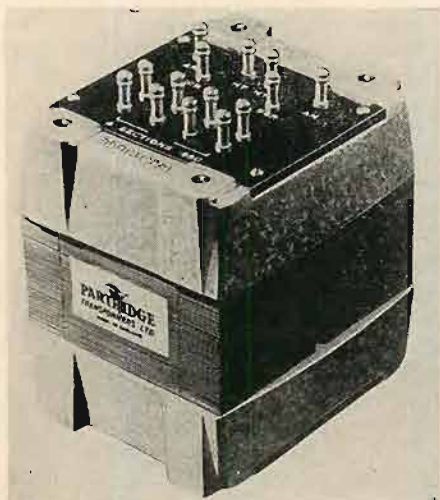

Fig. 4. Partridge transformer, Model 5201.

glad to sacrifice that for the sake of good voltage regulation.

Of course, not everybody who may wish to build this amplifier will care about compactness, so the conventional power supply can be used if the requisite voltages and currents are available. Your power supply may be dictated by whatever parts are available.

Heat must be taken into account, therefore the rectifier tubes were replaced by silicon diodes. Since the circuit was to be a voltage doubler, two such diodes were necessary, and I used the type which can be mounted in a dual holder.

Because this is a voltage doubler, the regulation depends upon the two capacitors associated with the diodes, $C_{18, 19, 20, 21}$. They are rather large. Since they were, the diodes had to be protected against the surge currents which would occur at the instant that the equipment received a.c. A small limiting resistor of surprisingly high wattage rating was placed in series with one side of the line feeding the diodes in order not to ruin them and not to overheat the capacitors. This resistor is R_{15} in the complete schematic of the amplifier, Fig. 3.

Output Stage

What type of circuitry should be used? At first a 12AX7 used as a voltage amplifier and split-load phase inverter driving the output tubes seemed to be the most compact idea. The output tubes might be EL84's or the like. Then the thought struck me that there should be a dual power pentode, one tube envelope for push-pull output. A search disclosed the 6360, a 9-pinner which would be compact indeed. This tube, however, is designed primarily for radio-frequency work. The next thing was to ask the manufacturers of tubes what they had in the works, which would be suitable and up came the General Electric 7189, a single power pentode, which necessitated using two per channel.

So far, then, at this point we have de-

ecided to use a 12AX7 driving the 7189's. However, we must still design the circuitry for these tubes, a task which cannot be done until we know the nature of the output transformer. Actually, some of the circuitry cannot be designed at all; it must be worked out by the good old trial-and-error method. This is most true of the feedback circuit. The feedback is dependent on both the circuit gain and the characteristics of the output transformer.

(By way of an aside, note that I like to connect speakers in parallel when possible in order to improve the damping of the speakers. The parallel hookup will allow each speaker to act as a load for the others. In addition to this the amplifier will act as a load for all speakers.

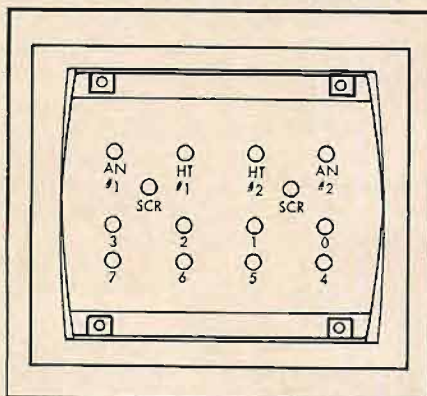

Fig. 5. Connections of Partridge transformer.

When the speakers are connected in series, the total impedance is increased over the value of the impedance of a single speaker, and hence, the loading cannot be as great, which, in turn, will render the damping less effective.

(Of course, when speakers are connected in parallel, the impedance needed to drive them becomes lower than the impedance needed to drive any one speaker. It is obvious that if there are a great number of such speakers connected in this way, the output transformer must have a very low-impedance tap in addition to the standard taps provided on most transformers.)

I wanted to find a transformer with lots of iron, and one wound with heavy wire. I guess I am still old fashioned enough to believe that a good grade of iron and lots of it can go a long way in making a good transformer. Of course, this can be carried too far, but by and large I have found that a lightweight transformer simply will not give the lows with any respectable power level. The heavy wire keeps the d.c. resistance low compared to the inductance, which makes it possible to have an amplifier with as low a source impedance as possible, thereby improving the damping characteristics. As pointed out earlier, I needed one with a low-impedance tap.

I selected the Partridge 5201 output transformer. Its primary impedance is

such that it will match 9000 to 12,000 ohms. This transformer is equipped with screen taps which are employed in this circuit to lower distortion. In addition to the 3.8, 8.5, and 15-ohm secondary taps, the unit is arranged for 0.95-ohm loads, ideal for multiple speaker installation or for unique requirements which may not always be foreseen. Of course, the 7189 requires a load of 14,000 ohms plate-to-plate. This transformer is rated at 12,000 ohms; not enough of a mismatch to make me want to use a different transformer. The transformer is shown in Figs. 4 and 5.

It is clear that this transformer is ideal for use with the General Electric 7189 when this tube is set up for 10-watt operation. It is also ideal in terms of my other criteria—iron and copper. In addition to all of these good qualities, it possesses extremely low leakage inductance, which means a greater power yield.

Biasing

Once having decided upon the components to be used in the output stage, the design proceeded along conventional lines.

The output stage is wired as a fixed-bias stage, and potentiometers $R_{49, 50, 51, 52}$ are used as fixed-bias balancing controls. $R_{40, 41, 42, 43}$ are incorporated in the B leads to enable measurement of the balance of this stage. (Measurement can be made in the cathode circuit rather than the B circuit. Such a modification should be made as a safety measure. This was not done in my model since it is a throwback to a design using a dual pentode output tube in which the cathode

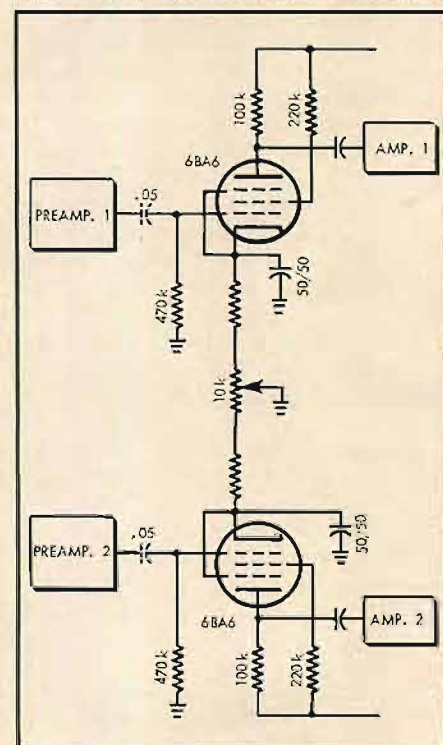

Fig. 6. Schematic of remote balancing control.

was common to both sections.) The transformer primary is a split winding, making it possible to feed B voltage separately to each plate. Balance is obtained when a voltage of 0.43 volt is read across each metering resistor. Since the value of the resistor is 10 ohms and we need a current of 43 ma in each plate circuit, 0.43 volt will be developed across these resistors when the correct amount of current is flowing. You will notice that there is some interaction between the balance pots, so balance must be repeated several times before the stage is truly adjusted.

Be sure that the potentiometers are set for maximum bias before voltage is applied to the stage so that the amplifier will not draw excessive current prior to balancing. However, failure to do this probably will not result in damage to the 7189's because the bias circuitry was designed so that the voltage does not go completely to zero when the pot is set to the minimum voltage positions. This was accomplished by raising the low ends of the pots off ground and returning them there via a fixed resistance voltage divider, $R_{1,2}$. Be sure that no "hot" portions of your voltmeter come in contact with the chassis of the amplifier and that you do not touch the chassis and the meter while balancing the stage.

The question might well be asked at this point: "Why make your measurements in the B leads when all you needed to do was to measure the voltage from the arms of each balance pot to ground?" This could be done if tubes were made exactly as specified on the data sheets. Unfortunately, equal bias voltages do not necessarily indicate equal plate currents. Equal plate currents are very important in an output stage in order to minimize saturation of the iron in the output transformer. Assuming that the tube is within tolerance at its installation, it is nearly certain that it will not remain right on the nose. As filament emission falls off, each pentode section will almost certainly age differently from the other. This is not a flaw in the design of the particular tube; it is simply the nature of vacuum tubes to perform in this manner. With all measuring done in the plate circuits, however, both the amount of current and the equality of that current in each tube section can be checked.

Driver Stage

Originally I had hoped that the input circuit for this amplifier would consist basically of a 12AX7 driving the 7189's. However, the 12AX7 stage did not work so well as I had hoped, and I tried a 12AU7, which gave me the distortion characteristics I wanted, but did not provide sufficient gain. Therefore, a 12AX7 dual triode was added ahead of the 12AU7, one triode used for each

channel. In order that the feedback should remain stable, I did not include the 12AX7 triode in that loop. However, it was obvious that this triode gave more gain than was needed. I realized that I could use a 12AU7 in place of the 12AX7, but it seemed more practical to use the 12AX7 and reduce the gain by means of some cathode degeneration, thereby reducing the distortion produced by this stage. This explains the reason for the input circuitry of each channel.

The cathode-to-ground circuit provides the degeneration required for improved distortion characteristics plus some frequency compensation at the upper end of the spectrum beyond 40,000 cps. I elected to place the frequency compensation at this point in the circuit rather than in the main feedback loop. Otherwise changes in the setting of the balance control would cause changes in frequency response in the main loop of the right channel.



Fig. 7. Remote balancing control with cable.

Remote Balancing

There was one requirement which had not been met as yet; namely, balancing the channels from a remote location.

One possible method was to balance the circuit at the speakers by means of a ganged potentiometer circuit, but this method was too wasteful of power. A friend suggested that I balance the circuit in the cathodes of remote cut-off pentodes. The balance control would not have to handle any signal, just d.c., and low-voltage d.c. at that. The scheme is shown in Fig. 6. The values are arbitrary.

I never did build the circuit, but it does seem reasonable. If you have a stereo system and have no means for balancing it, this circuit can be made to work very well with a bit of experimenting. Just be sure that you keep the signal level to the input of this balance network to less than one volt in order that distortion can be held down to reasonable levels. It should be connected between the amplifier and the preamplifier and mounted close to the amplifier. If it must be located somewhere remote from the power amplifier, I recommend

that you follow the balancing stage by a 12AU7 cathode follower, one section feeding from each 6BA6. Since most preamplifiers are equipped with cathode follower outputs, it is not particularly important that this circuit be located near them.

The use of this arrangement called for two additional tubes and I did not like that, especially because the distortion would probably be higher in view of the nature of this circuit. I never built this arrangement, as I have said, and so did not verify this fact. Of course, I realized that I could omit the 12AX7 because of the gain provided by the 6BA6's. However, I elected to use a simpler system.

An examination of Fig. 3 will show that the two channels are nearly identical except with regard to the main feedback circuit. One of them is conventional, save for the fact that there is no feedback capacitor shunting the resistor. The characteristics of the output transformer used here are so exceptionally good that stability was excellent well beyond the 20 db of feedback employed in this amplifier. By eliminating this capacitor it was possible to obtain the high-frequency performance which is shown in the PERFORMANCE DATA section of this article.

The right channel is not like this one in terms of the feedback network, although it still does eliminate the feedback capacitor. In order for me to explain the differences, look again at the conventional feedback loop used with the left channel—the channel not containing the balance jack. This channel was adjusted to have a feedback of about 20 db. I decided that the balance could easily be achieved by slightly varying the feedback of the right channel. A variation of 6 db of feedback would be all that would be required to account for differences in balance between channels of the program sources used, all other things being equal. Therefore, the feedback of the right, or balance channel would have to have a feedback loop whose gain is adjustable from 17 db to 23 db, which gives us a gain of plus or minus 3 db with respect to the other channel. Therefore, I juggled the values of cathode and feedback resistors in the unconventional channel so that when no plug is inserted in the balancing jack, the feedback of this channel is equal to that of the left channel. All that was required now was to find a means for adjusting the feedback in the balance channel, and of course this would have to be done with a potentiometer in order that any desired amount of feedback between 23 and 17 db could be obtained.

Suppose we take the 16-ohm tap of the output transformer through 100 ohms to the feedback loop. From the junction of the 100 ohms and the feed-

back resistor we take another resistor also of 100 ohms and connect it to ground. Notice that this is the same as saying that the feedback is connected to the tap on a voltage divider. Because the value of each of the resistors in the divider are equal, the voltage between the tap and ground is half that of the voltage across the entire divider. Half the voltage represents a loss of 6 db at this point. This, therefore, represents a loss of feedback of 6 db. Now suppose we lift the low side of the grounded 100-ohm resistor and connect this to one side of a variable rheostat, and ground the other side of this rheostat. When this rheostat is at maximum resistance (assuming that the resistance of this rheostat is reasonably high—1000 ohms) the voltage divider action will be virtually nonexistent and full feedback will be applied to the input. (Naturally, the values of cathode resistor and feedback resistor are adjusted to provide 23 db of feedback under these conditions.) However, when the rheostat is at its zero resistance, the 100-ohm resistor is again grounded, as has been shown earlier, and the feedback has been reduced by 6 db. Intermediate settings of the rheostat, or potentiometer wired as a rheostat, will produce intermediate degrees of feedback.

In the present circuit this potentiometer is not connected directly to the circuitry but is applied through a closed circuit phone jack. When this phone jack is inserted, the potentiometer is connected as described. However, when the potentiometer is removed (by removing the plug from the jack) the tip of the jack is grounded via an additional 100-ohm resistor. The purpose of this arrangement is to reduce the feedback by approximately 3 db so that when the balance jack is removed from the circuit, the gain in each amplifier channel will be about the same.

When you do use the balance control, you can sit in your favorite listening position and adjust from there, and that will eliminate most of the annoyance of having to balance stereo sources. It might well happen that you would not want to use the control at all times. Portable operation might be the reason for this, or it might be that the wires on the floor would interfere with your teenagers having a dance, or who knows what. Then all that is required is to remove the plug from the balance jack and the amplifier will operate in the normal manner.

For protection and ornamentation the balance pot should be enclosed in a container, such as the Bud CU2100 Minibox used with my instrument, *Fig. 7*. When mounting the pot and cable, be sure to provide an anchor for the cable so that it cannot be pulled from the lugs of the pot. A cable clamp is a good method

since, in addition to preventing the cable's accidental detachment by a sudden pull, it prevents twisting, which would eventually break the connections.

Comments

Good grade components should be used for this will keep maintenance to a minimum. Should trouble develop, however, the voltage and resistance chart in Table II may be used as a check list.

Performance Data

Naturally, once I completed the unit described here, I hoped it would "measure out." Let's not kid about it; the very first model was not a success, but the one shown here was definitely a success as can be seen from the table of

TABLE I
Performance Data

Interchannel cross-talk	60 db
Signal-to-noise ratio at one watt output	60 db
Voltage regulation from zero to maximum drive—both channels	1.4 per cent
D.c. transient response	One cycle of ringing
Squarewave response	Excellent—0.1 μ f across the output made no significant difference here
Frequency response	Flat 20 cps to 40,000 cps; \pm 1.5 db from 10 cps to 90,000 cps
IM distortion using 60 cps and 7000 in 4:1 ratio	0.3% at 14 watts
Harmonic distortion (14 watts output)	20 cps, 1%; 50 cps, 0.2%; 1000 cps, 1%; 20,000 cps, 1.5%
Voltage sensitivity for maximum power output	0.8 volt
A.c. supply requirements	110–120 volts at 0.8 amp

performance data obtained with fine measuring equipment. A Heath AG-9 audio oscillator was used in conjunction with a General Radio Wave Analyzer and Tektronix 'scope.

One of the tests shown here may not be familiar to you and should therefore be explained. This is the d.c. transient response figure for an amplifier. Most of you are already familiar with the transient response at high frequencies. It is desirable that an amplifier reproduce the starts and stops of program material with no lag and no overhang added to the signal by virtue of shortcomings in the amplifier circuitry. The frequency response of the amplifier should be at least five times that of the highest frequency to be reproduced if good high-frequency transient response is to be obtained. There is a phenomenon similar to this which occurs at the low frequencies, and is observed on occasions such as when the tuning dial of an FM tuner is adjusted. Some amplifiers do not respond to this adjustment. The effect is that the signal is turned off or reduced in volume during the tuning operation. It is often necessary to reduce the bass response during this adjustment. Obviously, tuning is not as easy as it should be. Even when this type of distortion is not severe enough to make tuning difficult, it can muffle the true character of a really low bass note. This distortion is often produced by too large a time constant in some of the coupling circuits. When a signal is applied to such a circuit, the grid to which it is connected goes negative and the tube draws less plate current. This continues until the charge has had time to leak off through the grid-return resistor. Defective output tubes can also cause the same condition.

The object of the test is, naturally, to see if such overloading exists. It is performed as follows: A load of the

(Continued on page 53)

TABLE II
Voltage and Resistance Values

PIN	1	2	3	4	5	6	7	8	9
V1	150k 210	1 MEG 4.7	9500 Ω 7.4	0.2	0	150k 210	1.1 MEG 4.8	10k 7.8	5
V2	100k 210	500k 72	50k 94	0.2	0	150k 118	500k 0	3800 Ω 5.8	6
V3	80k 210	550k 72	50k 94	0	0.2	150k 118	500k 0	3600 Ω 5.8	
V4	300k -11.6	300k -11.6	3.4 0.6	0	0	50k 310	50k 305	0 0	50k 310
V5	300k -11.6	300k -11.6	3.4 0.6	0	0	50k 310	50k 305	0 0	50k 310
V6	300k -12.4	300k -12.4	0.8 0.6	0	0	50k 310	50k 305	0 0	50k 310
V7	300k -13.6	300k -13.6	0.8 0.6	0	0	50k 310	50k 305	0 0	50k 310

The Tape Guide

HERMAN BURSTEIN*

Unsynchronized Bias Oscillators

*Q. I have a **** stereo tape recorder which has two different bias oscillators feeding separately each of the sections of the record head. The two bias frequencies are not exactly the same and for that reason an annoying audio frequency beat is produced, simultaneously recorded on each track. One of the solutions which I think will cure the trouble is to feed both tracks from the same oscillator. What do you think?*

A. Instead of rebuilding one of your oscillators in order to supply two channels, I suggest that you first try synchronizing the oscillators. To do so, connect a .05- μ f capacitor from the plate of one of the push-pull oscillators to the corresponding plate of the other oscillator.

Playback Equalization

*Q. I have a **** tape recorder. I checked the playback equalization of the machine at 7.5 ips, using the Ampex test tape, and I found response to be unsatisfactory at the bass end, where it dropped 4 db at 100 cps and 7 db at 50 cps. However, response followed the NAB curve from 200 to 10,000 cps (which is as far as the tape goes). I wrote to the manufacturer and so far have not received any answer from them. Please let me know what solutions you have available.*

A. By good luck I have a schematic of your tape recorder. Figure 1 is a schematic of the first two stages of the playback amplifier, including the feedback equalization network. Your bass deficiency is probably due to the 1.5-meg resistor in the equalization network. Note that the ratio

* 280 Twin Lane E., Wantagh, N. Y.

of this resistor to the 50k resistor (when the latter is at maximum value) is 30:1, whereas NAB equalization calls for a ratio of 63:1, corresponding to 36-db bass boost. Moreover, it should be noted that feedback equalization tends to get "sloppy" at the very low end. Accordingly, I suggest that you try replacing the 1.5-meg resistor with one having a value between 3 and 4 meg. Also try replacing the 12AX7 tube used for the first two stages. If this has become weak, resulting in loss of gain, equalization at the low end would become all the more sloppy. If you still don't get satisfactory results, you might try the following: Connect a 100-200k resistor between the two cathodes. This provides some positive feedback, which increases the gain of the two stages, resulting in better equalization at the low end. One more suggestion: Replace the .047- μ f coupling capacitor, as marked in Fig. 1, with a 0.1 μ f capacitor. The .07- μ f capacitor, in conjunction with a resistor of only 100k, results in 3-db loss at approximately 35 cps. Hence you may pick up 1 or 2 db at 50 cps by going to a larger coupling capacitor.

Two weeks later, the following was received from the same reader:

Q. Thank you for your letter in which you included modifications of the feedback equalization network for my tape recorder. Following your instructions I replaced the 1.5-meg resistor with a 4-meg resistor, and replaced the .047- μ f coupling capacitor with a 0.1- μ f unit. I did obtain the proper bass equalization.

After fixing the playback amplifiers, I tried to adjust the recording equalization. Feeding in a constant signal from 50 to 15,000 cps, I recorded a tape and played it back. I obtained a 6-db drop around

5000 cps at 7.5 ips; above 5000 response returned to normal. Please advise me about the possible cause of this poor response.

A. I am glad to know that you have solved the problem of getting adequate bass response in playback. The playback curve you sent me, which is flat within 1 db between 50 and 15,000 cps, is about as good as one could hope for.

The 6-db droop in the mid-treble range when recording is unusual. The fault may lie in the record equalization, although there is the possibility of some quirk in the particular recording head contained in your tape machine.

On the assumption that equalization is to blame, try the following: First locate the resistor between the record head driver and the record head which is in parallel with a capacitor. Try increasing the value of either the capacitor or the resistor so that treble boost furnished by this network begins at lower frequency. If this works, you may wind up with too much treble boost at the high end of the treble range. Then you might try increasing the bias current slightly, which would not only reduce response at the upper end but also diminish distortion. There is one more course you might follow, either in place of or together with bias adjustment, to reduce excessive treble boost at the high end: There is a variable capacitor across the cathode resistor of the tube that drives the record head. The value of this capacitor is such as to produce boost only at the very high frequencies. Try adjusting this capacitor so that the frequency at which it becomes effective is moved up; possibly you might even have to remove this capacitor, although I am inclined to doubt this.

Copying Tapes

Q. Recently I read something about copying tapes where it said that an "equalizer" is necessary. I have a tape recorder (including preamp) that is not only a discontinued type but one that is impossible to obtain any technical information on. In view of this how would I go about making tapes from tapes by constructing my own equalizer starting from scratch? Because the tapes to be copied were recorded on my old machine, I would like to use the same unit to play them back when recording on a new machine I have purchased. I could reverse the functions of each machine if advisable. I definitely get too much tape hiss in the re-recording process, and I cannot cut down on the highs to eliminate this. If I do, I get a poor response. I kept recording level as high as possible in the original recording, so that signal-to-noise ratio is as good as I can get it. I do most of my recording at 7.5 ips, but thought that certain material that has a known limited frequency range would best be recorded at 3.75 ips. I thought that this slower speed would cut down on tape hiss. Typical of this limited frequency range material would be tape dubbings of old radio broadcasts and old 78-rpm records. I seem to recall someone once recommending the slower speed in a case like this.

A. Inasmuch as your old machine has a preamp (for playback as well as recording, I assume), there is no need for an equalizer if you wish to copy tapes on your new machine. After all, the signal coming out of the old machine is presumably flat in playback, and that is what you want to feed into the new unit for copying purposes.

Do you have excessive hiss simply when playing on your old unit a tape previously recorded on that machine? If so, I suggest that you take a virgin or bulk erased tape

(Continued on page 40)

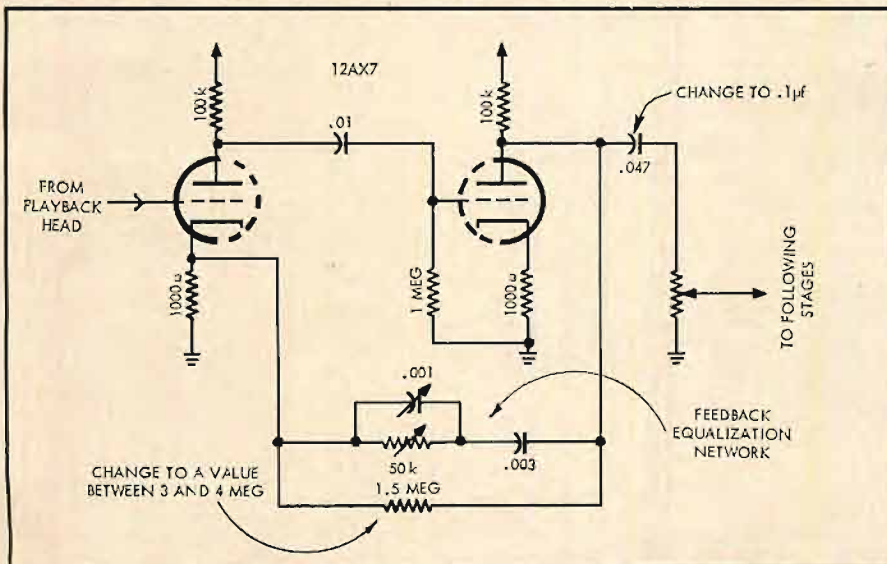



***NOW* take another look at**

NEW  MODEL 644

SOUND SPOT MICROPHONE • LIST \$110.00

If you are in the commercial sound business, you have had your share of . . . "they couldn't be done" . . . jobs at one time or another in your business life. These jobs could not be solved because general purpose microphones just couldn't do the job. That, fortunately, is past history. E-V's new Model 644 ushers in a new era in the concept of microphone pick-up. So *take another look* and see how many of those "tough" jobs the 644 reclassifies to "simple and easy". Your local E-V distributor has all the details on the Model 644. See him today or write for complete data to Electro-Voice, Inc., Buchanan, Michigan, Dept. 722A.

Electro-Voice[®]

See the new E-V Model 644 at any of

- ARIZONA**
Phoenix—Emmett Research Labs, 1309 East McDowell
Phoenix—Kelton Audio Equipment Co., 806 N. First St.
Tucson—Inland Electronic Supply, 715 East Broadway
Tucson—Sound Shop, 4659 East Broadway
- ARKANSAS**
Little Rock—Carlton Bates Co., 1210 East 6th Street
Texarkana—Lavender Distributing, 522 E. Fourth St.
- CALIFORNIA**
Bakersfield—Bakersfield Audio and Alarm, 2534 "F" Street
Berkeley—Pacific Radio Supply, 2801 Shattuck Ave.
Culver City—Electronic Trading Post, 4364 Sepulveda
Gardena—Stereo Hi Fi Center, 13996 Crenshaw Blvd.
Glendale—Pacific Union Supply, 1545 North Verdugo
Hollywood—Hollywood Radio Supply, 5250 Hollywood Blvd.
Hollywood—Pacific Radio Exchange, Inc., 1401-7 Cahuenga Blvd.
Los Angeles—Arco Electronics, 111 South Vermont Ave.
Los Angeles—Hannon Eng., 5500 W. Washington
Los Angeles—Kierulff Sound Corp., 1015 Figueroa St.
Los Angeles—Radio Products Sales, 1501 S. Hill St.
North Sacramento—California Radio & TV Supply Co., 2537 Del Paso Blvd.
Oakland—Fisher Electronics, 520 13th Street
Oakland—Millers Radio & Television Supply, Inc., 530 East 8th Street
Orangevale—Strayer Electronics, 9353 Greenback
Sacramento—Lombards Electronics, 1827 Jay Street
Sacramento—Norcal Electronics, 1115 "R" Street
Sacramento—Sacramento Electronic Supply Company, 1219 "S" Street
San Diego—Radio Parts Co., 2060 India Street
San Francisco—Eber Electronics, 2385 Market Street
San Francisco—House of Sound, 104 9th Street
San Francisco—San Francisco Radio and Supply, 1284 Market Street
San Francisco—West Coast Electronics, 539 Market St.
San Francisco—Zack Radio Supply, 1422 Market St.
San Jose—Munday & Collins Audio Visual Center, 270 Willow Street
San Jose—Peninsula Electronics, 656 South First Street
San Leandro—Styles & Engelman, 2255 Bancroft Ave.
Santa Barbara—Channel Radio Supply, 18 E. Ortega
Stockton—Dunlap Radio & Television Supply Company, 27 South Grant Street
- COLORADO**
Denver—Davis Audio Visual, 2149 South Grape Street
Denver—Electric Accessories, 1620 Blake Street
Denver—Empire Radio & TV Co., 1100 Broadway
Denver—Interstate Radio & Supply, 1200 Stout Street
Denver—L. B. Walker Radio Co., 300 Bryant Street
Denver—L. B. Walker Radio Co., 100 North Victoria
Grand Junction—L. B. Walker Radio, 537 N. 1st Street
- CONNECTICUT**
Bridgeport—Harty of Bridgeport, 2465 Main Street
New Haven—M & S Sound and Television Company, 65 Kensington Street
New London—Aikins Electronic Supplies, 531 Broad St.
- DELAWARE**
Wilmington—Zowie Electronics, Fifth & French Street
- DISTRICT OF COLUMBIA**
Washington—Capitol Radio Wholesalers, 2120 14th Street, N.W.
Washington—Electronic Wholesalers, 2345 Sherman, N. W.
Washington—Silberne Industrial Sales, 3400 Georgia, N. W.
- FLORIDA**
Miami—East Coast Electronics, 1900 N.W. Miami Ct.
Sarasota—Hess Sound & Electronics, 1015 Gen. Spaatz
West Palm Beach—Goddard Distributors, Inc., 1309 North Dixie
- GEORGIA**
Atlanta—Specialty Distributing, 763 Juniper St., N.E.
Atlanta—Southeastern Radio Parts, 400 W. Peachtree
- HAWAII**
Honolulu—Precision Radio Ltd., 1160 South King Street
- ILLINOIS**
Arlington Heights—Roy Bauman Music, 24 E. N.W. Hwy.
Benton—Lampley Radio Co., 452 East Church Street
Champaign—Electronic Parts Co., 905 South Neil St.
Chicago—Allied Radio Corp., 100 N. Western Ave.
Chicago—Allied Voice and Vision, 921 Rush St., North
Chicago—Evergreen Allied Hi Fi, Inc., 2025 W. 95th St.
Chicago—Musicraft, 48 East Oak Street
Chicago—Newark Electronics, 223 West Madison St.
Evanston—Allied Hi Fi Stores, Inc., 602 Davis Street
Oak Park—Allied Voice and Vision, 7055 W. North Ave.
Peoria—Selectronic Supplies, Inc., 983 South Adams
Quincy—Gates Radio Company
Rockford—Elmqvist Sound and Communication, 731 Seventh Street
Rockford—Rockford Hi Fi, 120 N. Church
Wood River—Audio Electronics, 932 Whitelaw Avenue
- INDIANA**
Columbus—Preston Sound Equipment, 910-25th St.
Evansville—Ohio Valley Sound, 20 East Sycamore St.
Gary—Cosmopolitan Radio Co., 524 Washington St.
Indianapolis—Graham Electronics, 122 South Senate
Indianapolis—Meunier Radio Supply, 811 E. Michigan
Indianapolis—Radio Distributing, 814 North Senate
Logansport—Hill & Son Sound Engineering, 2220 Spear
Terre Haute—C. T. Evinger Co., 1216 Wabash Ave.
West Lafayette—Robert C. Merchant Company, 229 South River Road
- IOWA**
Davenport—TCR Distributors, 1205 East River Drive
Sioux City—Dukes Radio Company, 209 Sixth Avenue
- KANSAS**
Wichita—Excel Distributors, 345 North Water
Wichita—McClelland Sound, Inc., 229 West William
- KENTUCKY**
Covington—American Sound, Inc., 675 West Third St.
Lexington—Kenneth E. Smith, 598 Mitchell Avenue
Louisville—Lewis Sound Service, 226 West Liberty St.
Louisville—Peerless Electronic Equipment, 2210 S. 7th
- LOUISIANA**
New Orleans—Crescent Electronic Supply, Inc., 537 South Claiborne Avenue
- New Orleans—Epcor, 3622 Toulouse Street
New Orleans—Radio Parts, Inc., 1112 Magazine St.
New Orleans—Southern Radio Supply, 1909 Tulane
- MAINE**
Portland—Maine Electronic Supply Corp. of Bangor, 148 Anderson Street
Portland—Radio Service Lab., 1004 Congress Street
- MARYLAND**
Baltimore—Kann-Ellert Electronics, 2030 Rock Rose Ave.
Baltimore—Maynard E. Harp & Son, 2824 Loch Raven
Baltimore—Radio Electronic Service, 5 North Howard
Frederick—Hankeys Radio, Evergreen Place & Elm St.
- MASSACHUSETTS**
Boston—DeMamba Radio Supply Company, Inc., 1095 Commonwealth Avenue
Boston—Lafayette Radio, 110 Federal Street
Boston—Radio Shack Corp., 730 Commonwealth Ave.
Boston—E. A. Ross & Co., 341 Columbia Street
Medford—East Coast Electronics, 296 Salem Street
Southbridge—Charles Bastein, 95 Cole Avenue
Springfield—Del Padre Supply, 999 Worthington St.
- MICHIGAN**
Battle Creek—All Tronics, Inc., 3149 Fifth Avenue
Detroit—Consolidated Sound Co., 20924 Harper Ave.
Detroit—M. N. Duffy & Co., 2040 Grand River Ave.
Detroit—Industrial Communications, 8300 Fankell
Detroit—KLA Laboratories, 7375 Woodward
Detroit—Michigan Music Company, 15900 Hamilton
Detroit—Radio Specialties Co., 12775 Lyndon
East Lansing—Tape Recording Industries, 1101 East Grand River Avenue
- MINNESOTA**
Minneapolis—Audio King, 913 West Lake
Minneapolis—Harry Starks, Inc., 112 North 3rd Avenue
Minneapolis—Lew Bonn Company, 1211 LaSalle Ave.
Minneapolis—Minnesota Audio Visual, 1012 Marquette
Minneapolis—Northwest Sound Service, 73 Glenwood
Rochester—S. M. Supply Co., 902 N.W. 7th Street
- MISSOURI**
Cape Girardeau—Suedekum Electronic Supply Co., 2215 Broadway
Kansas City—Burstin-Applebee, 1012-14 McGee
Rolla—Show-Me Electronics, Inc., Highway 72, East
St. Louis—Interstate Industrial Electronics, Inc., 8406 Olive Street Road
St. Louis—Interstate Radionics, Inc., 4445 Custine Ave.
St. Louis—Van Sickle Radio Electronics, 1113 Pine St.
Sedalia—Radio & Television Supply, 321 East Main St.
- NEBRASKA**
Lincoln—Scott Electronic Supply, 2201-07 "O" Street
Scottsbluff—Joachim Radio Supply, 1913 Broadway
- NEVADA**
North Las Vegas—Electronics Specialties Company, 3420 "C" East College Street
- NEW HAMPSHIRE**
Concord—Evans Radio Co., Route 3A Bow Junction
- NEW JERSEY**
Camden—General Radio & Supply Co., 600 Penn St.
Camden—Radio Electric Service Co., 513 Cooper St.
Elizabeth—Jersey Radio TV Supply, 1068 Elizabeth

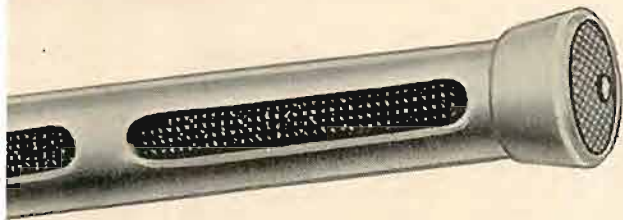

Now, after over 2 years of field testing, the 644 has thoroughly proved its ability to solve sound jobs previously thought impossible! If you haven't yet tried the 644, pick the job that other microphones couldn't "reach"... then find out for yourself why the 644 is the brightest new idea in microphones!

those "impossible" sound jobs!

compare polar patterns yourself

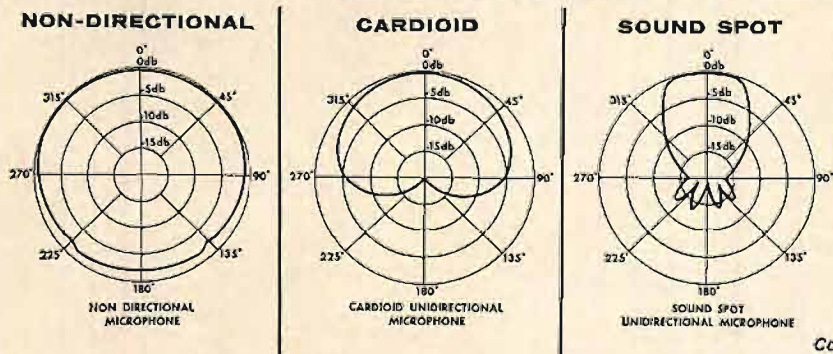

- Four times greater working distance than the best cardioids, depending on acoustics
- Greatly reduces feedback
- Retains "on-mike" presence despite extended working distance
- Excellent outdoors... less wind noise
- Priced low to fit most budgets
- Lasts a lifetime

Another better product for better sound from . . .

ELECTRO-VOICE, INC.

Commercial Products Division • Loudspeakers-Microphones



these Electro-Voice Microphone Headquarters

BUCHANAN, MICHIGAN

Hackensack—Nidisco Hackensack, 55 State Street
 Jersey City—Nidisco Jersey City, Inc., 713 Newark Ave.
 Mountainside—Federated Purchaser, Inc.,
 1021 U.S. Route 22
 Passaic—Nidisco Passaic, 294 Passaic Avenue
 Ridgefield—Nidisco-Cliffside, Inc., 484 Bergen Avenue
 Trenton—Nidisco-Trenton, Inc., 985 Princeton Avenue
 Union City—Nidisco Jersey City, 2812 Hudson Blvd.

NEW MEXICO
 Albuquerque—Sound Equipment & Hi Fi House,
 3011 Monte Vista Blvd., NE

NEW YORK
 Albany—Audio-Video Corp., 324 Central Avenue
 Albany—Fort Orange Radio, 904 Broadway
 Albany—Seiden Sound, Inc., 355 Central Avenue
 Bethpage, L. I.—S & R Electronics,
 4020 Hempstead Turnpike
 Binghamton—Morris Distributing Co., 195 Water St.
 Brooklyn—National Radio Parts Distributors,
 572 Albany Avenue at Rutland Road
 Buffalo—FM Sound Equipment, 1241 Main Street
 Buffalo—Genesee Radio and Parts, 2550 Delaware
 Buffalo—Radio Equipment Corp., 312 Elm Street
 Carle Place, L.I.—E. J. Korvette, Incorporated
 Glen Cove Road & Westbury Avenue
 East Meadow, L.I.—Sound Service Engineers,
 1788 Hempstead Turnpike
 Elmira—Stack Electronics, 306 Railroad Avenue
 Hempstead—Newmark and Lewis, 43 Main Street
 Hempstead—Standard Parts, 277 North Franklin St.
 Jamaica—Lafayette Radio Electronics, 165 Liberty Ave.
 Middletown—Certified Electronics, Incorporated
 Wickham Avenue Ext., Route 84
 Mineola, L.I.—Arrow Electronics, 535 Jericho Turnpike
 New York City—Airex Radio Corp., 85 Cortland St.
 New York City—Audio Unlimited, Inc., 190 Lexington
 New York City—Florman & Babb, 70 West 45th St.
 New York City—Harvey Radio Co., 103 West 43rd
 New York City—Leonard Radio, 69 Cortland Street
 New York City—Magic-Vue Television, 323 E. 13th St.
 New York City—Midway Radio & TV, 60 West 45th
 New York City—Murray's Audio Center, 12 East 42nd
 New York City—Sam Goody, Inc., 235 West 49th St.
 New York City—Soncraft Corp., 115 West 45th St.
 New York City—Terminal Hudson, 48 West 48th St.
 Rochester—Rochester Radio Supply, 600 East Main St.
 Troy—Trojan Electronic Supply, 15 Middleburgh St.
 Tuckahoe—Boynton Studio, 10 Pennsylvania
 Utica—R. & H. Audio Visual Co., 227 Columbia Street
 Yorkville—Valley Electronic Labs, 27 Rock St. 5A

NORTH CAROLINA
 Asheville—Freck Radio & Supply Co., 38 Billmore Ave.
 Durham—Womack Electronics Supply, 601 Ramsey St.
 Gastonia—Stroup Hi Fi Center, 112 Green Drive
 Raleigh—Southeastern Radio Supply, 414 Hillsboro St.

NORTH DAKOTA
 Fargo—Walter Electronics Co., 402 North "P" Avenue

OHIO
 Akron—Electronic Engineering Co., Div. of Solsound
 Industries, Inc., 362 West Bowery Street
 Canton—Burrroughs Radio, Inc., 2705 Fulton Road, NW

Canton—Walkeradio, 1546 Fulton Road, NW
 Cincinnati—Economy Electronic Distributing, 629 Elm St.
 Cincinnati—Steinbergs, Inc., 633 Walnut Street
 Cincinnati—Traut Company, 4815 Whetsel Avenue
 Cleveland—Audiocraft Company, Inc., 2915 Prospect
 Cleveland—Broadway Electric Supply Company, Inc.,
 6207 Broadway Avenue, SE
 Cleveland—Grossman Music Corp., 740 Balivar Road
 Cleveland—Olson Electronics, 6813 Pearl Street
 Cleveland—Olson Electronics, 2020 Euclid Avenue
 Cleveland—Pioneer Electronic Supply, 5403 Prospect
 Cleveland—Progress Radio, 565 East 185th Street
 Cleveland—Progress Radio, 13310 Miles Avenue
 Cleveland—Progress Radio Supply Co., 415 Huron Rd.
 Cleveland—Winteradio, 1468 West 25th Street
 Columbus—Anderson Hi Fi Center, 2244 Neil Avenue
 Columbus—Electrical Contractors, 1343 Holly Avenue
 Columbus—Electronic Supply Corp., 814 West 3rd Ave.
 Columbus—Hughes-Peters, Inc., 481 East 11th Street
 Columbus—Olson Electronics, 142 North High Street
 Columbus—Thompson Radio Supplies, 182 E. Long St.
 Columbus—Whitehead Radio, 124 North Grant Ave.
 Dayton—Custom Electronics, 1918 South Brown Street
 Dayton—Srepa, Inc., 314 Leo Street
 Dayton—Stotts-Friedman Co., 108 N. Jefferson Street
 Elyria—El-A-Company, 235 Lodi Street
 Lima—Hutch and Son, Roberts at Lenore
 Lima—Lima Radio Parts Co., 600 North Main Street
 Middletown—Hinkles Electronics, 5021 Roosevelt Ave.
 Parma—Winteradio Electronic Supply, 5373 Ridge Rd.
 Toledo—Jamieson's Hi Fi Specialists, 3417 Dorr Street
 Toledo—Toledo Radio Specialties, 1215 Jackson St.
 Toledo—Warren Radio Company, 1002 Adams Street
 Youngstown—Armie's Electronics, 320 West Federal St.
 Zanesville—Thompson Radio Supplies, 110 South 6th

OKLAHOMA
 Oklahoma City—Trice Wholesale Electronics,
 4701 North Stiles
 Tulsa—S & S Radio Supply, 537 South Konosha

OREGON
 Pendleton—The Town Shop, 142 South Main

PENNSYLVANIA
 Altoona—Altoona TV Supply, Inc., 1720-22 Union Ave.
 Braddock—M. Leff Radio Parts Co., 223 Braddock Ave.
 Clifton Heights—Delaware Valley Electronics Supply,
 224 Baltimore Pike
 Cornwells Heights—Bucks County Sound and Recording
 Laboratory, 2002 Newportville Road
 Johnstown—Cambria Equipment, 17 Johns Street
 McKeesport—Barno Radio Company, 927 Walnut Ave.
 Philadelphia—AC Radio Supply, 1539 W. Passyunk
 Philadelphia—Almo Radio Company, 913 Arch Street
 Philadelphia—Barnett Brothers Radio, 622 Arch Street
 Philadelphia—Friend's, 614 Arch Street
 Philadelphia—Radio Electric Service Company,
 NW Corner 7th and Arch Streets
 Pittsburgh—Comcor Electronics, Inc., 937 Liberty Ave.
 Pittsburgh—Hamburg Brothers, 213 Galveston Avenue
 Pittsburgh—Radio Parts Co., Inc., 6401 Penn Avenue
 Pittsburgh—South Hill Electronics, 1420 West Liberty
 Pittsburgh—Tydings Electronics, Inc., 3337 Penn Avenue
 Reading—George D. Barbey Co., 333 North Fourth St.

Wilkes Barre—Communications Engr., 41 N. Franklin
 Wilkes Barre—General Radio and Electronic Co.,
 396 South Main Street

SOUTH CAROLINA
 Charleston—Radio Labs, 475-477 East Bay Street
 Columbia—Dixie Radio Supply Co., 1628 Laurel St.
 Florence—Southern Electronics, 355-65 North Irby St.

SOUTH DAKOTA
 Aberdeen—Burghardt Radio Supply, 102 South Second
 Rapid City—Burghardt Radio Supply, 726 Jackson
 Sioux Falls—Burghardt Radio Supply, 208 N. Weber
 Sioux Falls—Warren Radio Supply, 196 E. Sixth St.
 Sioux Falls—Warren Supply Co., 115 S. Indiana Ave.
 Watertown—Burghardt Radio Supply, 621-4th St., SE

TENNESSEE
 Memphis—Hirsh Electronics, 1658 Union Avenue

TEXAS
 Corpus Christi—Wicks Radio Equipment, 513 Staples
 Dallas—Adleta Company, 1907 McKinney
 Dallas—Chandler Sound Equipment, 3407 Ross Avenue
 Dallas—Crabtree's Wholesale Radio, 2608 Ross Ave.
 El Paso—Midland Specialty Co., 500 W. Paisano Drive
 Fort Worth—Clifford Herring Sound Equipment,
 1705 West 7th Street
 Houston—Busacker Electronic Equipment, 1216 W. Clay
 Houston—Sterling Electronics, Inc., 1616 McKinney
 San Antonio—Vandergriff Audio, 4106 San Pedro Ave.

UTAH
 Ogden—Ballard Supply Co., 3109 Washington Blvd.
 Ogden—Tri State Electronic Supply, 2763 Washington
 Salt Lake City—Deseret Book Co., 44 East S. Temple
 Salt Lake City—Electronic Sales, 175 Social Hall Ave.

VERMONT
 Burlington—Radio Service Lab, 703 Pine Street
 White River Junction—Electronics Supply, Inc.

VIRGINIA
 Danville—Womack Radio & Supply, 513 Wilson St.
 Hampton—Buckroe Electronics, Inc., 815 Buckroe Ave.
 Norfolk—Cain Electronics, 14th and Monticello Avenue
 Norfolk—Electronic Engineering, 4201 Hampton Blvd.
 Norfolk—Priest Electronics, 6431 Tidewater Drive
 Richmond—Radio Supply Co., 3302 West Broad Street
 Roanoke—H. C. Baker Sales Co., Ltd., 19 Franklin Road

WASHINGTON
 Seattle—Western Electronic Supply, 717 Dexter Ave.
 Seattle—Seattle Radio Supply, 2117 2nd Avenue
 Tacoma—C & G Electronics, 2502 Jefferson Avenue
 Yakima—Lay & Nord, 112 South Second Street

WEST VIRGINIA
 Charleston—Electronic Specialties Company,
 Delaware at Randolph
 Huntington—Electronic Supply, Inc., 422 11th Street
 Wheeling—General Electronics Dist., 735 Main Street

WISCONSIN
 Appleton—Valley Radio Distributors, 518 N. Appleton
 Madison—Satterfield Electronics, 1900 South Park St.
 Milwaukee—Allied Radio, 5314 N. Port Washington
 Milwaukee—Taylor Electric, 4080 N. Port Washington
 Sheboygan—J. J. Koespell, South 9th at Commerce

EQUIPMENT

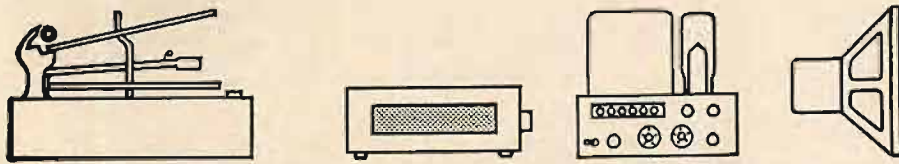

PROFILE

CANBY HEADPHONE REPORT

General note. Judging earphone sound is not at all easy in a comparative sense. You are situated inside a special earphone world as you listen; you are subjectively influenced by the seeming space around you—and in effect the phones themselves become entirely removed from the sound. Excellent for music, but not helpful in phone evaluation! The familiar acoustics of a comfortable living room, in which loudspeakers may be compared, is wholly lacking; there is no "room-sound" in phones and, thus, one less base from which evaluation can start. Instead, you are "in" each recording hall and the qualities of the phones are inevitably confused with those of the music itself.

A-B comparisons of phones do show up differences, immediately. To pin down the quality of the differences, their *value*, is another matter. Often the "best" seems to depend mainly on which phones are thrown next to each other in sequence. After a thinnish bass in one set of phones, a big, boomy bass may seem welcome—for the moment.

We set about testing phones with the intention of being very scientific and statistical. We ran musical comparisons, followed by test tones—first a series of steps, identified by voice, from 20,000 down to 25 cps, then a glide tone, to bring out peaks in the phones' response. (Pitch was identified in this case by quick reference to the step tones and via musical intervals—octaves, fifths, and so on. Accurate only up to about 4000 cps, where the judgment of musical intervals becomes inaccurate.) Short listening sessions were complemented by long evenings of listening, using one pair of phones at a time for a half hour or more.

Because individual ear response varies greatly from person to person and even from ear to ear, and because our own hearing does not go up to the very top, we used two assistants, young people with young ears. One could hear 19,000 cps, the other just made 16,000 cps. They ran their own tests and left me their comments, phone by phone, noting over-all musical quality as well as apparent peaks in response and the range at top and bottom.

The net result of all this, alas, was mostly chaos! Our young assistants had good ears for pure tones but good in different ways; they did not always agree. Their musical abilities were less important, though both are competent listeners. All six of our ears had their peculiarities, we began to realize, including peaks that complemented the peaks in the phones.

We found that a straight response check, frequency by frequency, proved very little in the high range and in the bass merely

confirmed what was easily heard in any short piece of music. All the phones produced at least something up in the very high range—those that sounded muffled, or brilliant, or hollow, quite impartially. The differences in *musical* sound were much greater for the ear than any differences the higher spot-frequency checks could locate.

Two of these tests did show a clear correlation with the observed musical effectiveness of the phones. The glide test clearly picked out the peaks in phone response, most of them in the 3000-cps range and again from 6000–8000 cps, sometimes still again in the very high range. The relative numbers and violence of these peaks and valleys did in fact relate directly to the tone quality of music, in respect to the upper portion of the range.

The glide tone also provided an interesting check on manufacturing uniformity. When the two phones varied in their response, the sound jumped from side to side, according to the relative strength at each ear. Some phones leapt dramatically back and forth on this glide tone test. Others were noticeably more uniform—i.e., the response of the two phones was more closely matched. (The ears' fixed differences cancel out.)

In the bass range, the spot-frequency check from 80 cps down through 60, 50, 40, 30 and 25 cps was significant in terms of musical listening. Some phones "boomed," like an old-fashioned bass reflex, with noticeable doubling or even rattling. Others simply ceased to function. A few produced smooth, undoubled bass, audible through the semi-shake of 30 and 25 cps—felt rather than heard.

To include all our accumulated data, both the agreements and the contradictions, would merely confuse the issue. We have used most of it, therefore, as background supplemental information, reinforcing my generalized evaluations, with numerous grains of salt according to my best judgment.

It is very clear that the outer construction of the ear units in respect to cavities and other resonances has a crucial effect on earphone performance. Bass, of course, depends on a clean seal. But much else is affected by the cavity shapes inside the phones and the coupling-up of air parcels and the moving masses of the transducers. This probably accounts for some very large discrepancies between the published response and the observed effect, "on the head."

Finally, comfort in the wearing is a big consideration, taken along with the necessity for a good seal between 'phones and the head, without fatiguing pressure. A soft and headshaped contour, both overhead and at the sides, is important for this comfort-plus-seal factor.

Koss Model SP-3

The basic Koss 'phone set comes in a number of models varying mainly in the incidental accommodations—switches, wiring, and so on. Koss has gone in for a whole catalogue of accessory equipment to meet all sorts of varying needs in the hooking-up and use of earphones.

The current Koss 'phones are the loudest phones, for a given input, that I ever have heard, easily producing sound that can be heard a couple of rooms away. They definitely need resistance adaptation in order to play out of speaker lines; Koss provides



a number of boxes for the purpose, to choice. The 'phones are light in weight in spite of their size, with a somewhat flimsy sliding wire head-size adjustment, a big foam rubber headband, very comfortable, and round, uncontoured, loosely-fitting foam ear surrounds which surprisingly, seem to give a quite adequate seal.

In sound, the Koss phones are brash but very musical. Bass is huge and a bit boomy, but very pleasant. Treble is bright but not too brilliant, the coloring pleasantly golden, rather than harsh. An impressive sound, though perhaps a bit tiring on the long pull. **G-12**

Permoflux Models B-DHS-28 (300/300), B-DHS-17 (12/12), HS-8 "Feather-Lite" (8/8).

The present "standard" line of Permoflux phones is outwardly very nearly identical with those made as far back as a decade ago, using the same drivers, rubber molds, leather stitched headbands, lambswool ear surrounds. A new lower-priced line, the Feather-Lite, has been added primarily for communications, language teaching, and the like, though stereo phones are available.

We received two models in the standard line, one in low impedance, 12/12 ohms, the other at 300/300, for comparison with the



ten-year-old Permoflux phones. The new phones retain the excellent sense of natural space that characterized the early models, as well as the practical qualities of wearing comfort. Comparisons between low and medium-impedance phones were not fruitful because of the different circuitry required; it's safe to assume that the impedance rating is not particularly a factor in sound quality and the phones should be reasonably uniform in sound whether 12/12 ohms, 16/16, 300/300, or 600/600—all offered in this line.

The newer Permofluxes present a clearly wider tonal range than the old ones of ten years back, with a fuller bass sound and a more brilliant high end. On loud, bright musical passages this brilliance becomes somewhat metallic. My tests tentatively gave the cause as a twin pair of "presence peaks," in the 2000-3000-cps range and again in the 6000-8000-cps range. (The old phones present mainly the lower peak.) Since virtually every brand of phone exhibits some of this presence-range brilliance, the Permofluxes are not out of line. Perhaps the "octave coupling" (as an organist might put it) makes for an extra brassiness in the louder music.

The Permofluxes have excellent musical bass, though of a "soft" variety, somewhat like that of the Koss phones. (On spot frequency check, bottom notes doubled or buzzed.) The over-all sound is of the cushioned ride, soft-sprung type, with the exception noted above. There was some minor unevenness as between the phones in each pair. The 300/300 set was louder in one ear than the other with its original 3-wire connections; the unbalance disappeared inexplicably when we re-wired the set to a four-wire arrangement. Don't know how it happened. Voice frequencies—speaking and singing—were particularly pleasant and "alive" in these phones, again probably because of the presence-range accentuation.

The new "Feather-Lite" phones have stronger peaks in the 3000-cps area, weaker highs, and a thin bass. They are excellent for the communications purposes that are their original intent. **G-13**

Pioneer Model SE-1

These Japanese-made phones are imported for sale in the U.S. My pair was sent direct from Japan by one of our readers, but is identical with those sold here.

The neat gray-plastic phones have skin-type rubber earpieces, a rounded square

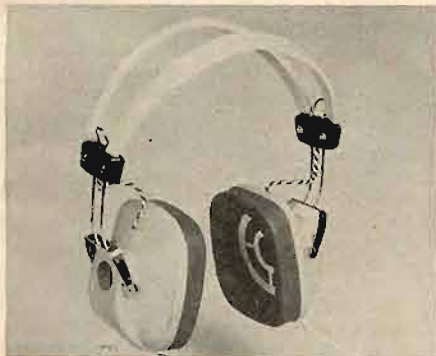

in shape, which provide a snug and easy seal, surprisingly sound-proof. Dual overhead bands are very comfortable. The phones are three-inch speakers, mounted behind a "grille cloth" and guard. A hand switchbox is built into the cable (optional in the U.S., \$5 extra) shifting from phones to speakers. With speaker lines hooked to it, I should think its use in the hand might be a bit clumsy; it is drilled for perma-

nent mounting with screws, in case you use the speaker hook-up. (Resistance, 100 ohms, and 8 across in an L, is built into the switchbox. Not really enough for a big amplifier.)

These are very good phones for music, with a taut, big bass, a smooth upper end, quite clean and minus extra "presence." The highest highs are missing; however, all-in-all, for extended listening these are really excellent phones, especially in view of their price. **G-14**

AKG Model K 50

These handy miniature phones from Vienna, a feather-light headband and a pair of tiny sound units resting against the ears via clear plastic discs, have some unusual qualities. The phones give excellent over-all listening pleasure, with unusually clean, non-boomy bass and sharp definition



in the treble. One of my assistants reports an annoying peak at 14,000 cps; I can't hear it. Brilliance around 8000-cps contributes a slightly crackly edge to string tone and the like. The little earpieces produce an astonishingly loud sound, difficult to force into distortion. The bottom bass is smooth, without doubling, peaks, or rattles. I could feel 25 cps.

I got fine bass with the aid of the supplementary small rubber ear cushions now provided, plus a very light finger pressure. But minus cushions and without pressure the bass end is largely absent. Cushions advised. With them good bass balance is available even without finger pressure and more bass, the very lowest, comes through when you press. The phones are very comfortable for long listening if you don't wear glasses. Glasses hurt. **G-15**

Sharpe "Live Tone": 10/10; 300/300

The Sharpe phones, offered in a basic form with many optional variations in impedance and wiring, are unlike any others in the physical configuration of the phone units themselves. The Sharpe people have evidently made a long and detailed study of factors affecting the earphone transduction; their headpieces are intricately and ingeniously made, with liquid-filled ear surrounds (glycerine, I think) and a variety of noise attenuating and resonance-damping elements mounted in the large, round ear cups. There is no question that this pays off; the "sound" of the unactivated phones when placed over the ears is astonishing. Outside noise is virtually non-existent and one has the strange feeling of being inside an anechoic chamber. Moreover, the phones though heavy are extremely comfortable on the head. A side-benefit: the liquid ear surround allows glasses to be worn without breaking the sound-seal and in perfect comfort for long periods.

In sound the Sharpe phones, compared to Permoflux and Koss, give much more of a



"sports car ride." Tones are clean and crisp over the whole range. The bass appears to be somewhat weak; of my two pairs, the 300/300 was the better in over-all sound, the 10/10 ohms set seeming to present more in the way of mid-range peakiness and a less satisfactory bass range. The fact that a crisp and clean bass may sound weakish at first in comparison to a tubbier, mellow type of bass response must be taken into account.

Generally, I found the Sharpe phones among the best for steady, continuous listening to music. In such listening, the characteristic peaks and valleys of response tend to give way to the more important over-all balance and presence of the total sound, and here the Sharpes come into their own. **G-16**

Telex Dyna-Twin Model HDP 53A, 8/8

These phones were tested again, briefly to compare the with others received later. Their ultra-soft, thick brown foam ear surrounds continue to offer the most comfortable fit of any of the larger phones, with the exception of the ultra-comfortable



(but much heavier) Sharpe phones. The upper range of the Telex is slightly on the brilliant side but without harshness and with good definition. The lower end falls off smoothly, for a balance that is thinish, but very musical. A bass boost on my amplifier helped to fill out the sound's bulk.

With a fuller bass response these phones could rate very high. **G-17**

EICO 4-TRACK STEREO TAPE DECK KIT, MODEL RP-100

The Eico Model RP-100 tape deck records and plays back $\frac{1}{4}$ -track in both the stereo and mono modes. It will also play $\frac{1}{2}$ -track stereo or mono tapes.

An unusual feature of the RP-100 is the 14 transistor record and playback sections in addition to the push-pull vacuum tube bias oscillator (with its own power supply on a separate sub-chassis). The record and playback electronics are entirely independent. Two record level meters are provided, one for each channel. Separate line and microphone mixing level controls are provided in each channel and all transport mechanism controls are electrical. Automatic, solenoid-operated tape lifters remove the tape from all heads when the fast forward or rewind buttons are pressed. Other features include electro-dynamic braking and automatic end-of-tape stop switch which removes power from the take-up reel motor.

The RP-100 is a 3-motor machine utilizing a hysteresis-synchronous capstan motor and 2 reel motors of the 4-pole induction type. The microphone input sensitivity is 0.5 mv while the line input sensitivity is 100 mv. The output is approximately 1.0 volt at 5000 ohms output impedance.

The RP-100 is obviously intended for the very serious audiofan who desires a tape deck with almost professional quality. For example the measured wow and flutter of 0.12 per cent rms at $7\frac{1}{2}$ ips, and 0.2 per cent at $3\frac{3}{4}$ ips, together with its speed accuracy of 0.13 per cent, clearly indicates this attempt. The frequency response of the playback system is within 1.5 db from 20 to 15,000 cps at $7\frac{1}{2}$ ips. The related signal-to-noise ratio is 52 db. At $3\frac{3}{4}$ ips the frequency response was within 2 db from 20 to 10,000 cps and signal-to-noise ratio was 49 db. The measurements clearly indicate a fine tape deck.

Construction

Constructing the RP-100 is an unusually simple task because separate sub-chassis are used for the five main assembly categories: the power supply, the bias oscillator, the playback preamp, the record preamp, and the main deck. Each sub-assembly is assembled independently on its own chassis, and subsequently interconnected by means of cables and plugs, a rather neat and convenient method which undoubtedly is the commercial variant of military technique.

There is one feature about the instructions manual which should be noted and complimented. That is the use of a separate and removable section for the "construction manual." For construction this section is removed and used as a separate book. After the RP-100 is completed, the remaining section provides installation, operation, maintenance, and other information. The construction book is concise and logical except for the incongruity of the usual basic explanation in the introductory pages as contrasted to the relatively sophisticated language used in the construction steps themselves. Aside from this all-too-common fault, the manual should lead the serious kit constructor through the various procedures with nary a hitch. A special note for those who are apprehensive about constructing a kit utilizing transistors; it is easier than you think. All of the transistors are mounted in special sockets so that soldering is to the socket lugs rather than to the transistor leads. In other words



Fig. 1. Underside of EICO Stereo Tape Deck.

you won't be ruining transistors by having to solder to those ever-so-sensitive leads. After we had tested this machine as indicated we asked to use and listen to it. Now let us see what Mr. Canby has to say about his experience. . . .

Mr. Canby's In-Use Comment . . .

This deck offers an almost bewildering array of features, to meet every conceivable need for the home audiofan as well as many semi-pro users in teaching and the like. It combines the standard pushbutton alternative controls (as opposed to the "T" or joystick drive)—interlocked stop, fast forward and reverse, playback and record (three-head system) with several unusual details in the operation, of a sort more commonly found on large pro machines.

Thus, I found that editing and cueing are unusually easy because in the at-rest position, with the STOP button down and capstan turning, the tape is always in contact with the heads and thus will play by hand via rocking or winding the reels. In this position, too, there was "no slip," or forward pulling of the tape by the take-up torque, as occurs in some home machines. Tape lifters operate only in the fast-motion positions.

A further advantage of this arrangement is the instant stop-and-go for recording and playback—there is no start-up lag and no tape slack to take up. The precision start is comparable to that on a professional machine. I found it simple to "start on a dime" for coordinated A-B tests, for instance, and there are many other situations where a tight-working motion of this kind saves time and patience and promotes accuracy.

Interlocked pushbuttons are inherently noisy and these are no exception. A "silent" start—say, during the quiet just before music begins at a concert—is not possible.



Fig. 2. EICO Model RP-100 Stereo Tape Deck.

There is the "pop" of the button, which can be startlingly loud in the wrong place. This is offset, however, by the unusual record arrangement, whereby the RECORD button may be pressed along with STOP, to feed signals to the two meters for level-checking. Push it along with RUN and you get your recording. This is an ingenious variation on the so-called PAUSE control and in the long run offers useful flexibility in operation.

An essentially constructive aspect of the mike circuits caught me unprepared, as it may catch others for awhile. This American machine, unlike most European imports, is designed to use dynamic microphones of medium-high impedance—10,000 to 20,000 ohms. Moreover, the mike input connections are of the new miniature "Cannon" screw-down type, where most home-type recorders have used phone plugs. Crystal and ceramic mikes, of very high impedance, are not recommended. I heartily approve of the use of better-grade microphones as well as the new connectors, which are clearly less subject to shielding troubles and more secure in their contacts than the old phone plugs as well as less bulky.

A rigid A-B test of recording quality, a recording put down on tape and then re-played against the original through the same playback channels, showed at $7\frac{1}{2}$ ips a commendable similarity, as compared to the input music. At $3\frac{3}{4}$ ips there was almost the same performance, due to compensating slow-speed equalization, switched in on the recorder's control panel both in recording and playback—two separate switches.

The slower speed, as is usual today, did not show any pronounced over-all dullness of tone; the quality was merely somewhat less smooth. An evening-long musical recording at the slow speed through my broadcast mikes (using the mike transformer and preamplifier of an Ampex) produced excellent tapes of good presence and clarity. I made two-track mono recordings, to reduce signal-to-noise to the minimum, a procedure that is a useful alternative in the 4-track type of recorder.

Tape speed, checked by strobe, was virtually perfect at the higher speed and very close to it at the slower. Warm-up variation is eliminated by the hysteresis capstan motor. Speed change is by a slip-belt, moved from one pulley to another. A warning says don't change speeds while in the running position; I did so many times with impunity before I noticed the warning. Foolproof.

I tried an exacting musical wow-flutter test, the recording of a slow piano solo. At $7\frac{1}{2}$ ips the musical playback was accurate and acceptable. At $3\frac{3}{4}$ ips, the extremely demanding piano tones came back with a trace of watery quality, a barely noticeable unevenness. (I have long since learned that I hear wow in piano when other ears do not.) On all other types of music this effect was not audible.

In actual operation, the deck is flexible but cybernetically complex, for the eyes and fingers. The decorative dual control knobs are ambiguous; the top one has a single white pointer dot, but the bottom has two slot-like projections, placed opposite to each other; neither the eye nor the fingers can tell which one is "it," without considerable turning-around of the pair of knobs. As is common today, the single and dual knobs look exactly alike and invite confusion for the fingers. One dual knob has only two positions on the bottom but a whole circle of them on the top and I found myself trying to force the bottom half on numerous occasions. Some knobs

(Continued on page 49)

*Heathkit®
puts
professional
quality
into new
low cost
stereo tape
recorder*

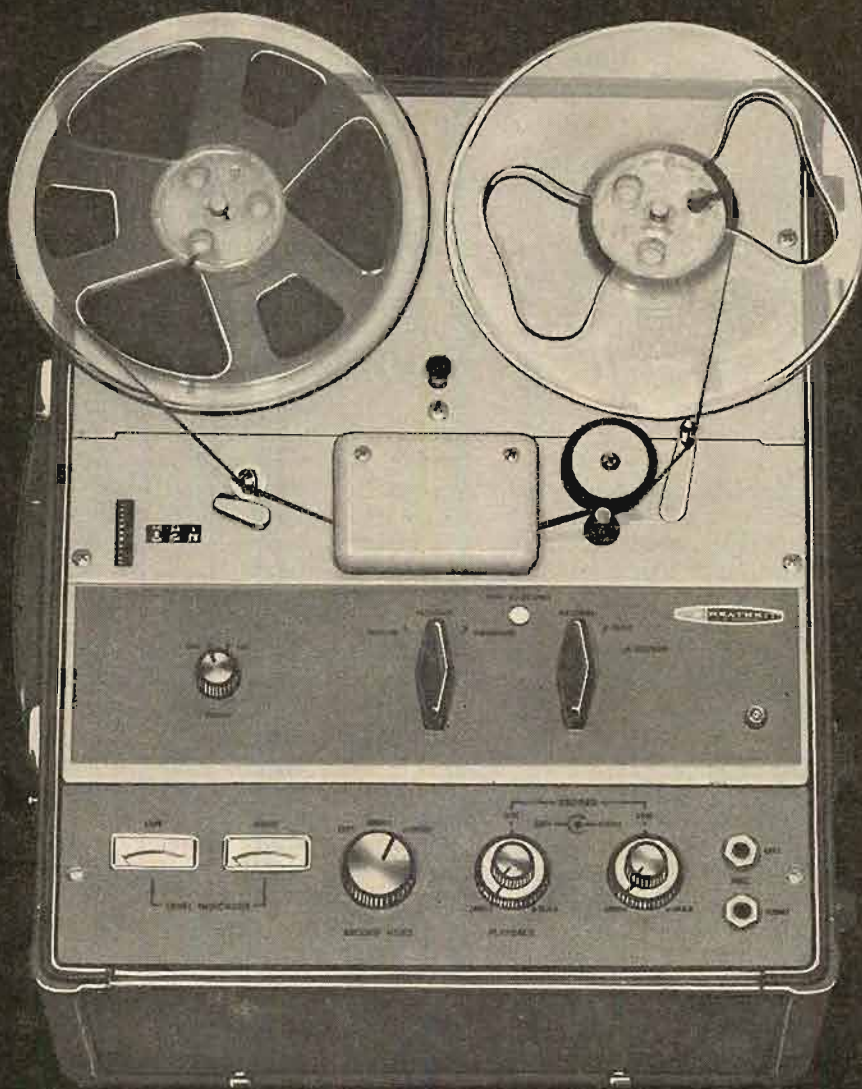

Here's the latest example of the Heath ability to give you more for less . . . the all new Heathkit 4-Track Stereo Tape Recorder. Its obvious quality yields professional results (less than .18% wow & flutter at 7½ ips). Its many extra features assure better, more convenient performance (see chart at right). Its fast, easy circuit board construction makes any tyro confident of technical excellence. Its versatility is remarkable . . . record and playback 4-track stereo tapes or playback 2-track monophonic tapes . . . use it as part of your stereo music system or as a portable. Choose your model now: the Model AD-12 provides the mechanism for playback of stereo or mono tapes (converts to a recorder later by adding the electronics) \$124.95; the model AD-22 includes both mechanism and electronics for stereo record and playback, \$179.95. Optional carrying case, \$37.50. Accessory ceramic microphones, \$9.95 ea.

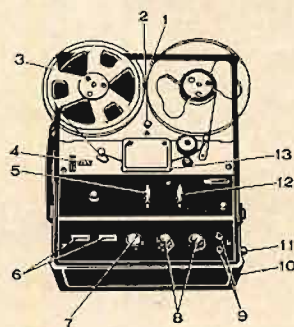

FEATURES

1. Die-Cast aluminum panel.
2. Speed change lever (7½ & 3½").
3. Seven inch reel capacity.
4. Three-digit counter.
5. Fast forward—rewind lever.
6. VU-type level meters.
7. Stereo /Mono record switch.
8. Mixing level controls (mic. & line).
9. Microphone inputs.
10. Cathode-follower output jacks.
11. Line inputs.
12. Record-playback lever.
13. 4-track record-playback and erase heads.



HEATH COMPANY
Benton Harbor 41, Michigan

Ordering instructions: Fill out the order blank, include charges for parcel post according to weights shown. Express orders shipped delivery charges collect. All prices F. O. B. Benton Harbor, Mich. A 20% deposit is required on all C.O.D. orders. Prices subject to change without notice. Dealer and export prices slightly higher.

Enclosed is \$ _____; send _____

Name _____

Address _____

City _____ Zone _____ State _____

Effect of Phase Shift on Hearing

R. KLEIN and J. TRIBUTSCH*

More evidence relating to the never-ending controversy over whether the human ear is sensitive to phase shifts.

THE STATEMENT HAS BEEN MADE¹ that the ear perceives sound as a complete pattern, rather than a series of frequencies which comprise the particular sound, and in order to preserve this pattern, the phase relationship between the fundamental and harmonics must be maintained. We feel that the ear perceives sound as a series of frequency components, in the manner of a harmonic wave analyzer, and that phase relationship between these components has no bearing on the basic structure of the sound. In order to establish this, we conducted a simple experiment in our own laboratory. This experiment made use of a complex wave consisting of a 60-cps fundamental and a 180-cps third harmonic. These frequencies were chosen to permit easy duplication of the experiment.

The equipment was set up as shown in Fig. 1, and the 180-cps source varied just enough to create a slowly changing phase shift between the two frequencies. We could detect no audible change in the character of the sound as we shifted phase between the fundamental and the third harmonic. The oscilloscope however, showed a marked change in the shape of the pattern, the extremes of which are shown in Fig. 2. This indicates that the ear is not sensitive to phase shift between frequencies contained in a complex wave.

Anyone duplicating this experiment must make sure that the 60-cps source is free of harmonics. A filter may be used to attenuate harmonics to a level of 0.1 per cent or less. Another point of caution is the power amplifier, which must have extremely low hum, certainly in-

audible at the maximum levels used. This is necessary to prevent the formation of beat frequencies between unwanted harmonics and the 180-cps source. If these beat frequencies were present, it might give the impression that varying the phase relationship is actually changing the tone of the complex sound.

We do not wish to imply that nature made a mistake by making our ears insensitive to phase changes. As a matter of fact, it is probably necessary that our ears do not detect phase changes between fundamentals and harmonics in a complex wave shape—if they did, considerable confusion could result. If sound from one source were to reach your ear from two different paths, one direct and the other a longer path due to reflection, cancellation or reinforcement would occur, depending upon the relative phase angles of the sounds at the ear, if phase affected sound. Also, the resultant wave would be changed in phase; the amount of phase shift that would occur depends on the wavelength of the sound and the length of the direct and reflected paths. It can then be seen that varying amounts of phase shift will occur with different frequencies. This will produce a definite change in wave shape, due to phase shift between fundamental and harmonics. In this example, we have mentioned the effects of only two sound paths. However, under ordinary conditions, sound may reach the ear by many paths, which results in even further disturbances to the phase relationship of the frequencies contained in the original sound. Therefore, it can readily be seen that if the ear did respond to patterns rather than frequencies, the character of the sounds we hear would be continuously changing with changes in our relative position to the sound source.

It should be pointed out that in some cases phase cancellation will cause the

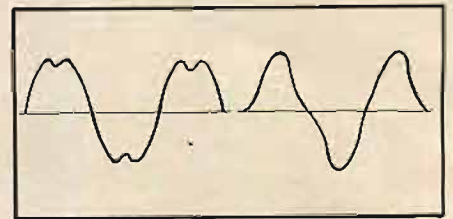

Fig. 2. Scope patterns resulting from different phase relations between 60-cps fundamental and third harmonic.

partial or complete elimination of some frequencies contained in a complex wave shape. This changes the character of the original sound, but is due only to the fact that some frequencies present in the original sound have been reduced in amplitude or eliminated, and not because the phase relationship between fundamental and harmonics has been altered.

At this point, a certain amount of confusion may result from the use of the term "phasing" in connection with stereo sound systems. To define exactly what phasing refers to in this case, let us use the following example. If a single frequency is simultaneously fed to both channels of a stereo playback system so that the output at both speakers is equal in amplitude, and both channels are in phase, the cones of the left and right speakers will move in and out together at the same instant of time. This will reinforce the sound heard by a listener standing directly between the two speakers. But if one of the channels is 180-deg. out of phase with the other, the cone of one speaker will move in while the cone of the other moves out at the same instant of time. This will cause reduction in sound heard by the same listener. Phasing, as applied to stereo sound systems, describes an electrical condition of the system.

The fact that the ear cannot detect changes in phase in stereo listening, other than the electrical phasing just mentioned, can be demonstrated with a simple experiment. Connect a stereo amplifier to a pure single-frequency source (say 2000 cps), with one channel fed directly from the source and the other through an adjustable phase shifting network. Connect the vertical input of an oscilloscope to the direct source and the horizontal input to the phase-shifted source, which will allow the amount of

(Continued on page 50)

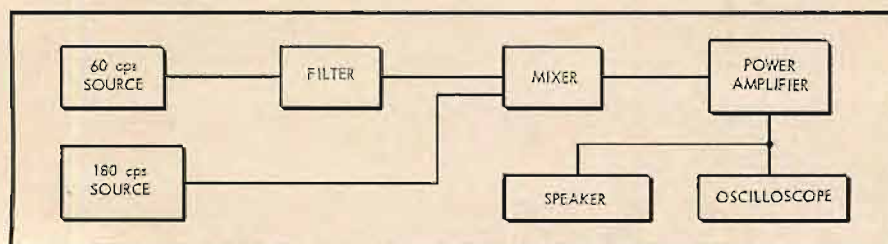

Fig. 1. Block diagram of set-up used in authors' tests.

* Electronic Systems Corp., P. O. Box 6293, Milwaukee, Wis.

¹ John W. Campbell, "Sinewave distortion in high fidelity amplifiers," *AUDIO*, December, 1961.



JBL
full-range
HIGH EFFICIENCY

loudspeakers
deliver

THE SMOOTHEST, CLEANEST SOUND THIS SIDE OF LIVE PERFORMANCE

James B. Lansing Sound, Inc., makes the most efficient loudspeakers in the world. At high levels and low, response is smooth, clean, complete. Definition is impeccable. They are without equal when it comes to reproducing transients. They clear the steepest wave front with room to spare, carry plenty in reserve for instantaneous peaks even when reproducing a full orchestra at realistic listening levels. And they don't need public address power to do it. JBL full-range speakers have earned an unchallenged reputation for possessing "presence," the elusive quality that spells the difference between total musical re-creation and mechanical-sounding reproduction. JBL transducers remain alone in their field, the only units made with voice coils at least one-fourth the diameter of their cones, with rigid cast-aluminum frames, with advanced magnetic circuitry free of wasteful stray fields. Big voice coils stiffen the cone for precision bass response. Big voice coils are attached directly to high frequency radiators for brilliant high-end reproduction. Big voice coils formed of aluminum ribbon wound on its narrow edge submit a large amount of conductor to the numerous lines of force in the long-circumference magnet gap. This is essential to high efficiency. It also takes precision construction to create the tight electrical and mechanical coupling that is directly related to efficiency. These JBL speakers are made with the precision usually reserved for the manufacture of scientific instruments. You can hear the difference. It's the difference that makes the eyes light up, that fires the old enthusiasm of the most sophisticated audiophile. Turn one on. Turn it up full. Treat your ears to the original magic of high fidelity.

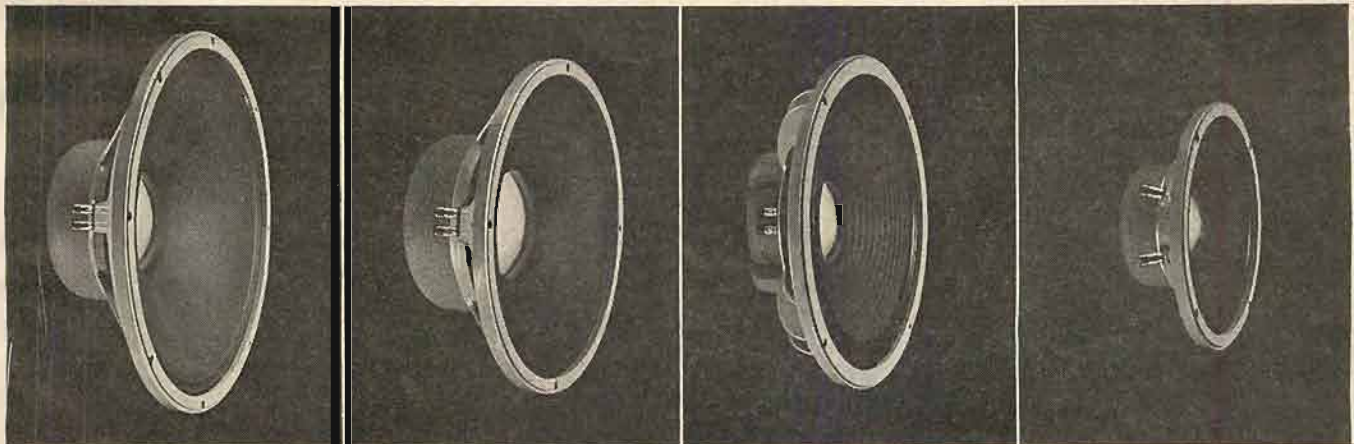

THE JBL D130
 The classic 15" full-range precision transducer. 4" voice coil, dural dome, 16 ohms.

THE JBL D131
 Never before or since has so much engineering and care been lavished on a 12" unit. 4" voice coil, 16 ohms.

THE JBL D123
 The original compact 12" loudspeaker, only 3 3/4" deep, 3" voice coil, 16 ohms.

THE JBL D208 and D216
 8" transducers made with the same precision workmanship that goes into larger JBL speakers. 2" voice coils. D208 is an 8 ohm unit; D216, 16 ohms.

These high efficiency precision transducers are designed for use in exponentially-tapered horn or bass-reflex acoustical enclosures.

PRODUCTS OF JAMES B. LANSING SOUND, INC., ARE MARKETED BY JBL INTERNATIONAL, LOS ANGELES 39, CALIF

RECORD REVUE

Edward Tatnall Canby *

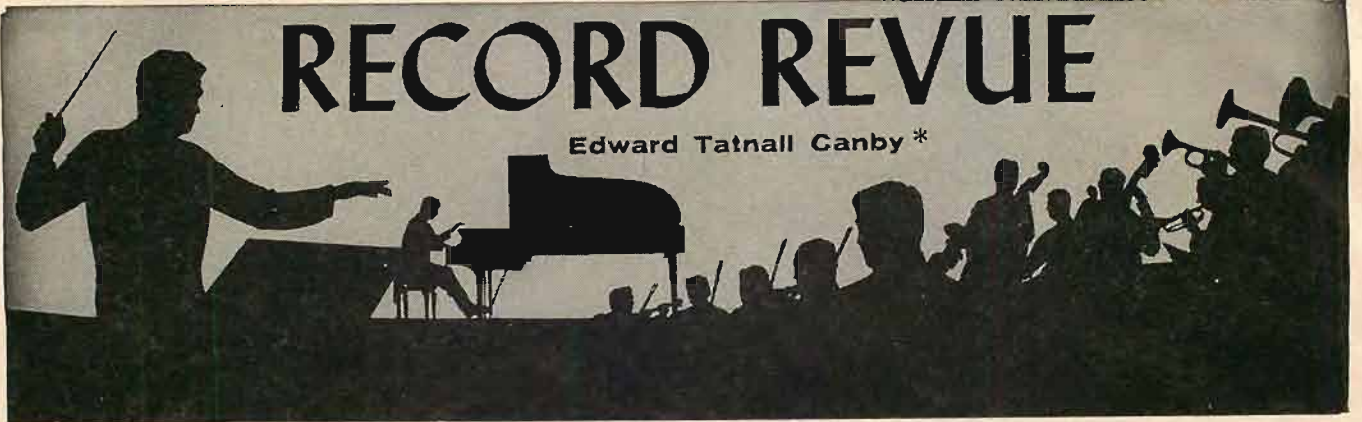

Folklore From Hungary. Orch. and Chorus "Duna" Ensemble, Budapest, Belva Vavrincz.

Westminster WST 17008 stereo

This companion disc to Westminster's record of Bartok's "Three Village Scenes" (Audio, June, 1962) is nominally the sort of popular, state-sponsored folk music that is now produced in quantity throughout the iron curtain world but its idiom derives astonishingly from Bartok's own twin sources, authentic old-type Hungarian folk music (untouched and unarranged) plus the dissonant instrumental idiom that Bartok was able to create out of it for his own "classical" use.

The music even sounds like Bartok. But it is Bartok well watered-down in comparison with the real thing. Just play a few numbers as performed by this skillful and enthusiastic ensemble, then listen to the "Village Scenes" of Bartok, composed 45 years ago, and note how much more telling, how incredibly vigorous, is the older work!

Still, as such popular music goes, this "folklore" is well up to standard for its type, matching the best that comes from Russia, and many another country, on the Monitor label. The Bartok influence is healthy, adding a bit of dissonant spice to an otherwise pretty soggy harmony; the tunes are the best Hungarian—probably also aided by Bartok via the famed Bartok collections made in the early years of the century. Good record.

MORE CLASSICS

Brahms: Symphony #1. Pittsburgh Symphony, Steinberg.

Command CC 11011 SD stereo

A companion recording to Command's highly successful Second Symphony, released last fall, this is an equivalent performance, briskly modern, quite rapid for the most part but poetic and musical throughout, with good phrasing and expression. These two can be taken as the best of the up-to-date musical approach to Brahms, contrasting with equally legitimate performances in an older manner that move more slowly, dwell at length on the Romantic expression, tend towards a somewhat heavy, "dark brown" quality that is probably very much what Brahms intended, in his own day. (On the other hand his own performances would never have sounded tired and dull, as some of the more massive versions inevitably do now).

Brahms isn't around any more and so his music must sink or swim in Twentieth century style, for better or worse. The Steinberg "solution" to the updating problem should keep the old man afloat a while longer.

Command's recording technique matches the Steinberg modernity. In the earlier Second Symphony, the striking close-up view of the orchestral insides now seems to me a bit too revealing, bringing to the fore a good many unimportant accompaniment figures and the like which are best left where Brahms put them in the first place, largely submerged in

the total sound. This newer mike job somehow seems to have been re-thought. Perhaps it's just a different piece of music; but my impression is that here the mikes pick up less of the uninteresting musical innards, more of the real inner beauty that is always worth highlighting via the recording art—so unimaginable in Brahms' own day. In any case, this is surely a fine example of enlightened microphone technique, making the most of the musical material in terms of recording itself.

Debussy: Images for Orchestra (Gigues; Ibéria; Rondes de Printemps). Stravinsky: Symphonies for Wind Instruments. Ravel: Pavane pour Une Infante Défunte. L'Orch. de la Suisse Romande, Ansermet.

**London CS 6225 stereo
(mono: CM 9294)**

The peculiar French-Swiss temperament of this musical team, out of Geneva, is ideal for these colorful and now somewhat old-fashioned masterpieces of French Impressionism, bringing out the impressionistic shimmer of moods and colors, the once-so-new color-harmonies, the ever-gorgeous instrumentation, with a freshness of sound that is enhanced by London's ever-gorgeous stereo recording.

The Stravinsky work is tossed into the pot for reasons more literary than musical—the "Symphonies" were dedicated to Debussy. (As a sort of funeral piece they also tie in with the Ravel funeral dance, the "Pavane for a Dead Princess".)

As usual in recordings of the big compound Debussy suite, the London annotator doesn't know a tune when he hears one. He ascribes "Gigues" only vaguely to the British Isles. (Perhaps they recall "unpeopled landscapes as imaginary as the Allemonde of Pelleas and Melisande" is his explanation). This, obviously, because he doesn't recognize the main Debussy theme, heard constantly throughout, as the ultra-familiar Scottish border tune, "The Keel Row"! The Debussy "Jigs" are clearly British-Scotch-Irish in concept.

The suite's sections actually, are three impressionistic visits to three geographic areas—Britain, Spain and France. "Rondes de Printemps" is supposed to have tunes from Western France in it; if so, they are probably as familiar to most Frenchmen as "The Keel Row" is to most of us, not including London's commentator.

Franck: Symphony in D Minor. Detroit Symphony, Paray.

**Mercury SR 90285 stereo
(mono: MG 5085)**

Franck: Piano Quintet in F Minor. Clifford Curzon; Vienna Philharmonic Quartet.

**London CS 6226 stereo
(mono: CM 9294)**

Here are two noble attempts to bring back the mystical-Romantic atmosphere of César Franck's rapidly fading masterpieces and, in

terms of these dynamic "outlander" performers and in the dynamic medium of stereo, neither succeeds very well.

Oddly enough, César Franck bloomed best in the leisurely days of the 78 record—when there were so many record sides to fill, anyway, that it wasn't even worth trying to hurry things up. Now, on long-play, Franck is paradoxically too nervous, too hurried, not well projected as music. The big moments of typically Franckian emotion are somehow misunderstood, played down, by-passed. Distressing to an old Franck fan.

Paray is French, all right, but he bounces. He moves in a hurry, with zest and musical vigor. The gentle Franck, in Detroit, is somehow given a chrome-plate streamlining that merely makes him seem more out of date than he is. Not bad—and many new listeners will perhaps be helped by the hurry. Not those of us who remember how we first heard the typical Franck harmonies, the breathtaking changes of key, the ever-so-Romantic pauses, the sweetly poignant melodies all the same shape, always rising on the second phrase above the first... these things, alas, are played down now in favor of dynamic progress. Progress to where?

It isn't twelve-tone music, this, though it was a precursor. Its effects are those of harmonic contrast—at leisure and savored to the full. You can't rush it.

A similar effect is heard in the even more dated Quintet, a magnificent "live" piece for an old-fashioned chamber-style concert, the performers working themselves into a positively visible lather or, alternatively, ruminating at length over the perfumed Franckian moodiness. On records, it just doesn't go. Too noisy, too ruminative, by turns. And again, these performers do the streamlining act, somehow managing to miss the very moments for which Franck was most loved in their urge to get along to the next and the next and the next, and so, to the end.

For me, the end of both these works was an anticlimax. With all due respects, it just seems to me that these performers don't hear Franck as he once was heard, and played. Probably inevitable. The old man really is pretty dated, right now.

Bach: Choruses and Arias from the Saint Matthew Passion. Seefried, Toepper, Fischer-Dieskau, etc., Munich Bach Choir, Choir Boys, Richter.

Deutsche Gramm. 136233 stereo

Here is an excellent condensation, a few major items out of the huge "St. Matthew Passion", performed, as can be seen, by some of the top stars of German singing plus an expressive and sincere Bach chorus and a batch of little-boy angels of convincing purity. It makes a gorgeous choral stereo record and should be a fine introduction to "Big Bach" for those who would like to try this moving and immense sort of musical experience.

I wish DG would remove itself from its eternal yellow trade-color. This disc has a handsome reproduction of "The Last Supper" which is nullified by the garish yellow plaque above it.

Bach: 15 Two Part Inventions; 15 Three Part Inventions. Ralph Kirkpatrick, clavichord.

DG Archive ARC 3174 mono

The little Inventions, one for each key, are familiar to all keyboard students amateur and pro. Their proper vehicle is the clavichord, the tiny, table-top personal instrument that, before the piano, was the only keyboard machine capable of loud and soft expression via the performer's finger pressure. (Organ and harpsichord both featured fixed tonal dynamics for each "stop" or set of strings, regardless of the amount of push on the keys.)

The clavichord also is the only keyboard instrument ever to have provided a vibrato via finger motion—up and down, in this case. The tiny strings can scarcely be heard across a silent living room but their very fragility, plus the mechanism by which the hammer is also the bridge, allows a change of pitch through varying pressure on the key. A much-prized effect in earlier days, though Kirkpatrick does not make extensive use of it in these works, rightly.

This recording poses a neat technical problem. The recorded level is necessarily at standard, on a par with that of other types of recording on disc. The instrument is so tiny, however, that a proper level must be set via the home volume control—almost inaudibly faint—or the sound is rendered gross and ugly, amplified far above its intended impact. Thus we have here an absolute recording, i.e., one that has no room-likeness of its own and must be reproduced *literally*, at the actual sound-level of the original source, for proper effect. Interesting. If you will do so, maintaining the necessary mouse-like silence in your own living room, you'll be rewarded with some delightful Bach, of a delicate and wispy sort that is musically the stronger for its faintness.

The Kirkpatrick interpretations on this extremely difficult little instrument (it plays violently sharp if you use too much finger pressure) are somewhat restrained and occasionally a bit nervous—understandably so—but otherwise are models of good taste. This is part of a major keyboard series in which this American performer covers the entire non-organ keyboard repertory of the composer.

Shostakovich: Symphony #5. Minneapolis Symphony, Skrowaczewski.

Mercury SR 90060 stereo
(mono: MG 50060)

I like this new Minneapolis conductor with the utterly impossible name. He is of the neo-Romantic school, tending towards leisurely tempi and emotion, whereas his predecessor, Dorati, represented the now slightly out-of-date steel-foundry approach.

This Shostakovich Fifth is neo-Romantic in itself, and the Sk----- interpretation, avoiding the unctuousness of the Stokowski school, livens things with a lightly modern touch while maintaining a reasonably poetic expression in keeping with Shostakovich's mood.

I'm not one of those who feel that this composer was forced by the Russian state to compose in an official manner. He was, of course, forced in an outward sense; but this music was in him and remains his, out of himself, State or no State. Somebody else might simply have folded up and quit, or composed himself into quick oblivion via defiance.

It isn't a "great" symphony at all and it's often pretentious, as is so much in Shostakovich. But the wonderfully expert colors and rhythms, the skillful construction and dynamic drama, make it always worth hearing. Under very good auspices in this case. **AE**

LIGHT LISTENING

(from page 10)

soprano, alto, tenor, baritone and bass sax. The ensemble work is intricate but it is still possible to follow the antics of each player. Whatever their costumes, there's nothing ragged in the playing of these clowns. Impeccable team work is behind each stunt they carry off with seeming nonchalance. Outstanding items are *Ragging the Scale*, a *Barney Google* complete with racing effect and an elaborately hesitant *Chicken Reel*. There is no kidding around, however, where the sound of the recording is concerned. Instrumental presence is very good. In several selections the bass saxophone located at far right will send any well-intentioned woofer into a proper tizzy.

Bror Kalle's Kapel: Danish Delight
Capitol ST 10306
The Ol'Calliope Man Visits a German Hofbrau

Reprise R 6015

The tourist making plans to visit Europe this summer cannot say that the record producers weren't ready for him before the season began. By mid-March, even the newer labels were on the market this year with the sort of music you could expect to find in the Continent's more informal places of entertainment. Authentic music recorded on the scene in foreign locales has long been available in the "Capitol of the World" series but a step into native lore is a new one for an outfit such as Reprise. As more Americans sample local color at first hand, recordings of this type should gain an increasing share of the market. Of the two records sampled here, the Capitol in stereo and the Reprise in mono, the Danish item recorded in Copenhagen hasn't the faintest suggestion of American influence. Composer-conductor Bror Kalle (Uncle Carl) leads a small orchestra in the infectious folk tunes of Denmark. The polka, the fast waltz, the hopsa and the schottische are all represented in this sampling of Scandinavian night-life. One familiar element in this potpourri is

the accordian of Mogens Ellegaard who introduced American audiences to this sort of fare a few years ago during his appearances here. Ellegaard's single accordian disc on another label (Vox STVX-426090) remains to this day the outstanding example of Scandinavian accordian artistry. This guy is really at home on that keyboard. Most of the releases in the "Capitol of the World" series have been available solely in mono but the bright, unclouded sound of this album indicates that stereo presents no mysteries to Danish engineers.

The German Hofbrau music on the Reprise release has a number of American tunes mixed in for good measure. These are garnished, as are the middle-European favorites, with the sound of the tiel, musette and Swiss hand bells. The calliope mentioned in the title of the album may keep away some listeners who tend to associate that instrument, quite understandably, with the out-of-tune set of pipes once part of every circus. There is really no cause for concern here. The calliope heard sparingly in this release has a very mild and bland sound. At no point does it dominate the Sande and Greene Fun-Time Band in bouncy versions of such established favorites as *Beer Barrel Polka*, *O Mein Papa*, *Lili Marlene*, and *Two Hearts in Three-Quarter Time*. **AE**

IF YOU ARE MOVING

Please notify our Circulation Department at least 5 weeks in advance. The Post Office does not forward magazines sent to wrong destinations unless you pay additional postage, and we can NOT duplicate copies sent to you once. To save yourself, us, and the Post Office a headache, won't you please cooperate? When notifying us, please give your old address and your new address.

Circulation Department
RADIO MAGAZINES, INC.
P. O. Box 629, Mineola, N. Y.

AF AUDIO
FIDELITY
LIMITED TIME OFFER!

VOLUME 2

STEREO

MORE BEST OF THE PHENOMENA

DUKES

OF DIXIELAND

...YOU HAVE TO HEAR IT TO BELIEVE IT!

HIGH SOCIETY • BILL PICKLES • TROMBONEUM • LASSUS TROMBONE
SLIDE FROG SLIDE • WASHINGTON POST MARCH • ASLEEP IN THE DEEP
THUNDER AND BLAZES (ENTRY OF THE GLADIATORS) • SWANEE RIVER
WITH A PACK ON MY BACK • MAPLE LEAF RAG • YA RA RA BOOM DE AY

2.98

MANUFACTURER'S NATIONALLY
ADVERTISED PRICE
(catalog price will be 4.98-5.95)

MONO OR STEREO

MORE BEST OF THE DUKES OF DIXIELAND, VOL. 2
... Tremendous public demand for AUDIO FIDELITY's special 2.98 offer of The Best of the Dukes of Dixieland (now a collector's item) has stimulated this new release at the same low price! But... the offer is limited! BUY NOW AND SAVE UP TO \$3.00.

Mono—AFLP 1964 • Stereo—AFSD 5964

NEW! ▶▶▶

FREE! ▶▶▶

Complete catalog—fully illustrated with complete selection listings for each record—mono and stereo. Send for your copy now!



Audio Fidelity Records are produced with true Stereophonic Curtain of Sound recording technique and the highest standard in high fidelity!

AVAILABLE AT YOUR RECORD SHOP, OR WRITE TO:
AUDIO FIDELITY, INC., Dept. A 7,
770 Eleventh Ave., New York 19, N.Y.

TAPE GUIDE

(from page 29)

and play it on the old unit. If the hiss is still excessive, the cause can be a defective tube in the playback preamp, magnetized heads, incorrect playback equalization, or possibly some fault in the rest of your audio system which peaks the high notes (as a poor speaker might do). If the hiss disappears when playing a fresh tape, the fault would lie in the record amplifier, consisting perhaps of a faulty tube, excessive treble boost or a defective bias oscillator that produces excessive distortion and therefore noise.

Does the hiss become pronounced only after copying a tape originally recorded on the old machine? If so, the new machine might be at fault. This can easily be checked by recording and playing a tape on the latter.

If neither machine alone develops excessive hiss, but the two together do so in the copying process, the reason may be as follows. Many tape machines, at least in the past, did not follow the principle of supplying all the treble boost during recording in order to maximize the signal-to-noise ratio. Instead, they employed some treble boost in recording and some (an appreciable amount) in playback. Such a machine would reproduce more tape hiss and tube noise than one which limits treble boost to the record mode. Still, the increase

in hiss and noise might be marginal, that is, not so great as to be especially noticeable. However, when a tape made on such a machine is copied, the extra hiss and noise, added to the hiss and noise that inevitably occur in the copying machine, may raise the hiss level to bothersome proportions. Keep in mind that when tapes are made and copied on the best of machines the hiss level rises. This is a problem that has plagued commercial recorded tapes.

Copying at reduced speed should cut down the apparent amount of tape hiss, primarily because of the reduced treble response. Copying at reduced speed will increase your distortion if you try to maintain the same ultimate signal-to-noise ratio. Unfortunately, there is very little one gets for nothing in electronics.

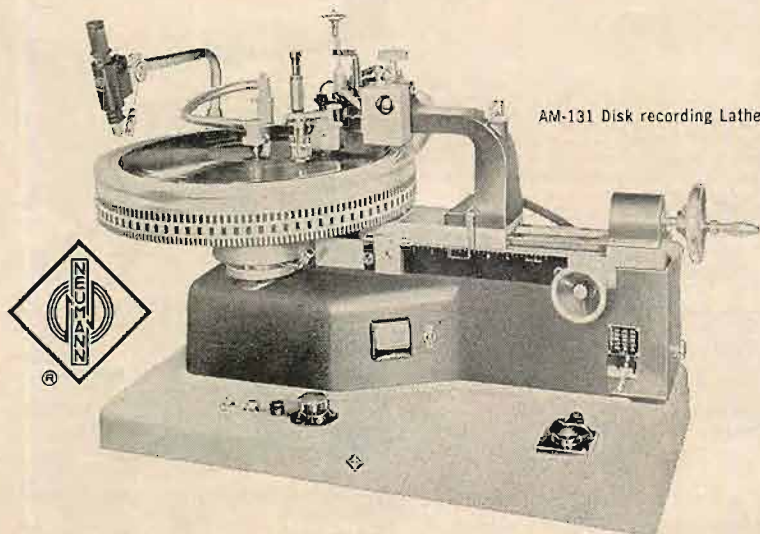

AM-131 Disk recording Lathe

...they make beautiful recordings together!

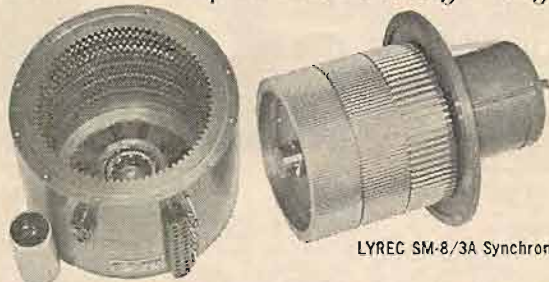

LYREC SM-8/3A Synchronous Drive

THE NEUMANN MASTER DISK RECORDING LATHE AND THE LYREC 3 SPEED SYNCHRONOUS MOTOR*—Together, they produce flawless fidelity disks for many discriminating companies coast-to-coast. The motor, constructed of the finest Swedish steel, is actually three separate motors in one, operating without belts, gears, or chains, for the greatest possible synchronous precision. World famous for condenser microphone craftsmanship, Neumann has spared nothing to achieve the ultimate in disk recording. Everything is included: standard U.S. inspection microscope, stylus heating, vacuum chuck turntable, suction fixtures, automatic cutter lift, and much, much more. All lathe models are equipped with the same LYREC synchronous drive. Prices range from \$4975 (pictured above) to \$12,000 by purchase or lease. Whether you're planning your first lathe, considering an addition, or converting your present lathe to the LYREC synchronous drive, write or wire collect for complete information to Dept. L.

*Electronic 16 2/3 rpm speed converter available as an accessory.

GOTHAM AUDIO CORPORATION

2 West 46 Street, New York 36, New York (212) CO 5-4111

In Canada: J. W. Woods & Co., Box 158, Don Mills, Ontario



Recording From FM-stereo Broadcasts

Q. I hope that you may be able to help me with a recent problem. I have two stereo tape recorders, one using a 100-ke bias frequency, the other a 70-ke bias frequency. On recording from FM multiplex I get excellent recordings from the 100-ke recorder using bulk erased tapes with the erase head disconnected since the erase head only adds noise. When using the 70-ke recorder I get a signal of about 6000 cps impressed on the recording at a level only about 20 db below the recorded signal. Of course this makes the tape unusable.

A. In order to make it possible to distinguish between the left and right audio signals, the FM-stereo broadcast contains a 19-ke pilot signal. The multiplex receiver generates a 38-ke signal in order to separate the L and R signals. The 19-ke pilot enables the tuner to produce at 38-ke signal which is accurate enough in frequency and phase for stereo separation. Depending on the design of the multiplex receiver, harmonics of the 38 ke may appear in appreciable quantity at the output of the tuner, along with the L and R signals. These harmonics are 76 ke, 114 ke, 152 ke, and so on. They beat with the bias-current frequency, producing sum and difference frequencies. What apparently is happening in your case is that the 76-ke harmonic beats with your 70-ke bias frequency, producing a difference signal of 6000 cps, which is what you claim to be hearing.

There are two possible cures. One is to install a filter either at the tuner output (each channel) or at the tape recorder input (each channel). You might ask both the manufacturer of the tuner and of the tape recorder about a suitable filter. You might try building a simple trap yourself, consisting of an inductor in series with a capacitor; this combination is placed in parallel with the output of the tuner (each channel). The resonant frequency of the inductor-capacitor network should be 76 ke. The inductor can be a 2.5-mh r.f. choke, and the capacitor would be determined by the formula $C = 25,000,000 / f^2 L$; where C is capacitance in pf, f is frequency in ke, and L is inductance in mh. For a resonant frequency of 76 ke, with an inductance of 2.5 mh, C turns out to be about 1750 pf. Instead of using an r.f. choke as the inductance, you could use a TV width coil with an adjustable ferrite core. This would enable you to tune the filter to exactly the bias frequency.

The second course is to increase the oscillator frequency of the tape recorder to at least 92 ke, or decrease it to 60 ke or less. Thereby the difference frequency between the 76-ke harmonic and the oscillator fre-

quency would be at least 16 kc, which is outside the audible range, at least for adults. Either change in oscillator frequency involves problems. The higher oscillator frequency might well result in your erase head not working effectively, because of its increasing impedance as frequency rises and because of increased losses due to self-capacitance of the head's windings. Also, you would have to increase the amount of bias current supplied to the record head, because the impedance of that head rises in the same way, and soon. The lower oscillator frequency would increase the likelihood of beat notes between the oscillator frequency and the harmonics of the higher audio frequencies. Again, you would probably have to adjust the amount of bias current supplied to the record head, this time downward. Probably you wouldn't have to do anything about the erase head, unless by chance it was overheating because of too much current going through it.

The preferable course seems to be to introduce a 76-kc filter.

About two weeks after the above answer was mailed, the following was received from the same reader: "I followed your suggestion and obtained two 1.5-10 mh TV width controls and used them in series with two 0.0018 ceramic disc capacitors. I put these in parallel with a 76-kc signal from an audio oscillator and adjusted the the slugs of the width controls for minimum output as viewed on an oscilloscope. I mounted the two filters in an aluminum box on the shielded cable from the multiplex adaptor to the stereo preamp. The unwanted signal was gone. Thank you for your advice."

Automatic Tape Shut-off

Q. The automatic shut-off feature when the tape breaks or comes to the end of the reel is very desirable. My tape recorder does not have this feature. Can it be modified?

A. I can only agree that an automatic shut-off is a desirable thing. But it is a fairly sophisticated mechanism, and therefore you ordinarily find it only on the expensive tape machines. Not only must it stop the transport mechanism when the tape breaks or runs out, but it must provide proper braking of the reels so that the tape doesn't spill, possibly getting snarled among the heads, capstan, pinch roller, and so forth. Furthermore, it must in no way interfere with tape travel: it must not prevent intimate contact between the tape and the heads, and it must not induce wow and flutter. Possibly the manufacturer of your unit has a solution. (See North C. Ham's article on page 23 of the June, 1962, issue. ED.)

That Strange Sound Again

Another reader has sent in some comments about the problem of a "strange low-frequency sound" which was brought up in the January, 1962, issue. James B. Williams, 316 Dixie St., Minden, Louisiana, writes: "I had the same trouble and after two trips back (to the store where I purchased my tape recorder) the trouble was still there. The trouble with mine was in the oscillator coil. This particular coil was designed wrong; I put in a new one with the same results. I changed every part in the oscillator circuit and finally in desperation I removed the case from the coil, leaving the coil held in place by its leads. That did it. I don't have the least idea why, but brother when it works like it does now, who cares? Hope you can forward this to the writer in trouble." Æ

The superiority of new Altec Dynamic Microphones is all the more amazing when you discover their moderate price!

There are six dynamic microphones in Altec's new professional studio series. Each sets new standards of performance and durability in its class. Each offers distinctive features of significant value to the professional user, especially since the highest price model is yours for under \$100.00! Let's take a look at some of these features:

PROOF of Superior Performance

Each Altec 684A Omnidirectional and 685A Cardioid Microphone comes to you with its own certified calibration curve made on a Bruel & Kjaer Graphic Recorder. In the entire professional field, this practice is unique with Altec. The one shown here is typical of the 684A. The curve you receive gives visual proof of the remarkably smooth response provided by your Altec Microphone.

BALANCED PAIRS FOR STEREO: For stereo work, any pair of 684A or 685A Microphones is perfectly matched in performance characteristics. The calibration curves offer rapid means of assuring yourself of this balance.

DESIGNED FOR RIGOROUS PROFESSIONAL USAGE: The exclusive sintered bronze filter positively bars all foreign matter. These Altec Microphones may be used safely in any situation the professional engineer finds himself; not only in a protected studio, but anywhere—a

metals grinding mill if need be. Only Altec offers this absolute protection against the gradual degradation of quality common in ordinary microphones that can't prevent dust, moisture, and minute ferrous particles from restricting diaphragm movement.

Also featured are diaphragms of indestructible polyester that cannot be damaged by blasts, shock, impact—designed specifically for rigorous usage in any professional applications.

EXCLUSIVE ALTEC MICROPHONE EXCHANGE POLICY: After expiration of normal full year guarantee, you may exchange an inoperative microphone for a comparable new unit at a fraction of original cost. This Altec policy is unique in the industry; offered to better serve microphone users.

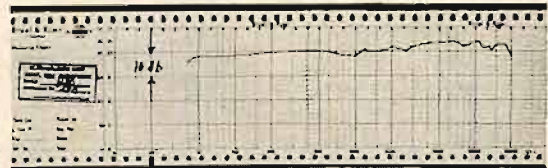

ALTEC 684A OMNIDIRECTIONAL MICROPHONE

Frequency Response: 35 to 20,000 cycles • Output Impedance: 30/50, 150/250, 20,000 ohms • Output Level: -55 dbm/10 dynes/cm² • Hum: -120 db (Ref.: 10⁻¹ Gauss) Price: \$78.00 net

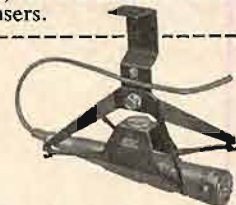

ALTEC 685A CARDIOID MICROPHONE

SHOWN IN ALTEC 181A BOOM MOUNT
Frequency Response: 40 to 16,000 cycles • Output Impedance: 30/50, 150/250, 20,000 ohms • Output Level: -54 dbm/10 dynes/cm² • Discrimination: Average front-to-back, 20 db • Hum: -120 db (Ref.: 10⁻¹ Gauss) Price \$96.00 net

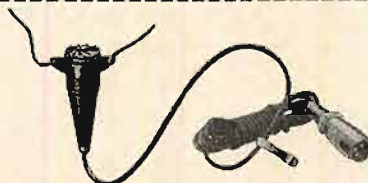

ALTEC 686A LAVALIER MICROPHONE

Frequency Response: 70 to 20,000 cycles • Output Impedance: 30/50, 150/250 ohms • Output Level: -55 dbm/10 dynes/cm² • Hum: -120 db (Ref.: 10⁻¹ Gauss) Price: \$45.00 net

For specific engineering details, call your nearest Altec Distributor (listed in your Yellow Pages) or write Dept. A7M

ALTEC LANSING CORPORATION

A SUBSIDIARY OF LING-TEMCO-VOUGHT, INC.
1515 South Manchester Avenue, Anaheim, California

© 1962
Altec
Lansing
Corp.



OTHER ALTEC DYNAMICS PRICED FROM \$42.00 • ALTEC MINIATURE CONDENSER MICROPHONE SYSTEMS: Omnidirectional, \$236.00; Cardioid, \$275.00. • Altec offers a complete line of microphone accessories including desk and floor stands, switches, wall and boom mounts.

JAZZ and all that

CHARLES A. ROBERTSON



STEREO

Sounds Of Synanon

Pacific Jazz Stereo 48

Established four years ago at Santa Monica, California, as a refuge for drug addicts and a place where victims can work together to cure themselves, Synanon House is drawing national attention since recent visits by television cameras and the people from Time and Life. As the articles and photo essays cite the importance of the resident jazz combo in morale building, this album rounds out the story by presenting the music actually heard daily in the common room. The septet makes no effort to copy the latest jazz trends or turn out something commercial enough to cash in on all the publicity, and the program consists entirely of originals by members. Some sound joyous and full of hope, while others are wholly introspective yet marked by a feeling of confidence and repose. Just as Synanon bears little resemblance to ordinary institutions, the group itself is refreshingly unlike any now playing the clubs.

Readers of Down Beat were among the first to become informed about the foundation through dispatches from West Coast editor John Tynan, who continues to send in regular reports on help musicians are receiving there. Nearly all the current septet has remained two years or more, and Tynan relates individual case histories in the liner notes, along with an account of Synanon's struggles to get started. Enough experienced players to form the nucleus of a jazz combo are usually in residence, but Tynan and his fellow editors always point out that musicians form only a small percentage of all dope users and are no more apt to succumb than members of other professions. But newspaper headlines are reserved for the arrest of jazz personalities, and the higher figures quoted for doctors and nurses are just so many statistics to the majority of readers. As a sure cure has yet to be discovered, there is no telling which group holds the best recovery record. Musicians would be hard to beat for lack of response to compulsory treatment though, and time served in a federal hospital rarely results in anything more than a temporary cure.

Among the techniques developed under Charles E. Dederich, who has headed the foundation from the beginning, are several which seem to take vicissitudes of the jazz life into account. "No dope fiend wants to get well; he wants to want to get well," is one of the sayings at Synanon, and the doors are open around the clock so as not to turn away anyone acting on a sudden impulse. This convenience has undoubtedly saved quite a few visitors from ending up in court. After winning a battle against alcoholism five years ago, Dederich took the methods which proved successful in his own case and adapted them to aid addicts in curbing the desire for narcotics. Some of the psychology of Alcoholics Anonymous is used, especially during the important period of final rehabilitation. It is here that many institutions fail, and the numbers of patients who go back on drugs shortly after being released is one of the most discouraging aspects of the entire drug problem. The part Synanon's jazz combo plays in preparing for the first few months of scuffling is not to be underestimated.

Before checking in at Synanon, most of the septet had spent terms in various institutions without finding the help they required. Arnold Ross, pianist and leader by virtue of his twenty-five years experience in jazz, worked

fifteen of those years with Jack Jenney, Vaughan Monroe, Harry James and Glen Miller's Army orchestra before acquiring a drug habit while on a tour of Europe. Joe Pass has played guitar for nearly the same length of time, but the jazz reputation he so richly deserves was never attained because of a continual bout with drugs that started soon after leaving high school. David Allan, whose trumpet style recalls an early association with Chet Baker, served in Army bands in the Pacific during World War II and nearly finished an economics course at Whittier College before narcotics took over. As prior stretches were served by each in respective government hospitals located at Camarillo, Fort Worth and Lexington, a more widely treated threesome would be hard to find in any group.

Despite an inability to win a lasting victory over drugs, Ross worked as arranger and conductor of the Bob Crosby and Spike Jones television shows, in addition to appearing as pianist during the last ten years on numerous LPs under such leaders as Nelson Riddle, Dave Pell and Billy May. Not only does he contribute three originals and solo strongly throughout, but a good share of the album's success must stem from his passing on words of advice to other members. If Synanon had existed to permit his meeting with Joe Pass to take place a decade ago, their story might be much different. Instead of interment in commercial groups, the guitarist would have made a valuable partner, on the basis of present performance, or set out on an illustrious career as a single.

Because of the group's therapeutic nature, instrumentation depends upon the players at hand and is rather unusual. Greg Dykes blends in with the trumpet on baritone horn, and his solos betray the fact that he also is a valve trombonist. The fifth man in the rhythm section is conga drummer Candy Layton, whose amateur standing or good taste prompts him to exercise more restraint than most professionals. Bill Crawford, a former clarinet student at the New England Conservatory of Music, also took up drums since arriving at Synanon, and bassist Ronnie Clark was once associated with Don Cherry and Billy Higgins of the Ornette Coleman quartet. The septet's strong point is a spirit that should endure, even though future events force members to seek a livelihood for a time in Twist outfits. The American Federation of Musicians local, instrument manufacturers and interested citizens have all contributed to Synanon, and not the least among the well wishers is Dick Bock, whose skill as a producer makes the sounds come alive.

Jeanne Lee and Ran Blake: The Newest Sound Around

RCA Victor Stereo LSP2500

These two newcomers are likely to cause as much talk as Ornette Coleman did a season or so ago, especially since RCA Victor is giving this album a promotional push. As there is no question about their being far-out, any arguments probably will be based on which partner holds the lead at any given moment. The pair met while students at Bard College, where they were graduated in June a year ago, and continued to rehearse after arriving in Manhattan to pursue separate careers. Entering an amateur night contest at the Apollo Theatre as a lark, they scored a hit and were brought back for three more weeks. This album marks their professional debut, but several jazz clubs are showing interest in signing contracts.

Observers of the musical scene during the last thirty years will detect much of the old among the new, even though the familiar sounds are in a strange setting. Ran Blake's wide dynamics and use of tone clusters come straight from Henry Cowell by way of Thelonious Monk's eccentric rhythms and uncanny timing. It is hardly proper to call him an accompanist, at the totally improvised nature of the performance often permits the pianist to take over the lead from the singer. Jeanne Lee, in turn, appears to know a lot about modern pianists and sings more than once like Cecil Taylor plays. At least, she is working on one of the few unique styles to come along in quite a while, and where it will go from here is anybody's guess. Greater variety in programming would help next time, particularly two or three additional numbers similar to *Evil Blues*, and *When Sunny Gets Blue*. George Duvivier assists on bass, and the tunes include *Lover Man*, *Blue Monk*, *Summertime*, *Laura*, and *Where Flamingos Fly*. Each gets one chance alone, with Blake delivering a sermon of his own on *Church On Russell Street*, which happens to be located in Hartford, Connecticut. All the new sounds seem to have confused the engineers, and the singer remains in one channel during her lovely solo *Sometimes I Feel Like A Motherless Child*. But the stereo version gives purchasers some leeway to place the pianist in the best perspective.

Billy Strayhorn And The Orchestra:
Johnny Hodges, Soloist

Verve Stereo V/V68452

The number which ends this set would serve as an appropriate album title, for new jazzmen are more touched with stardust than Johnny Hodges. One slight drawback stands in the way of using the Hoagy Carmichael tune on the cover. It happens to be a showcase for Lawrence Brown's trombone, and the featured soloist's alto sax takes a secondary role for the first time in the entire program. Hodges has earned the rest, having just landed after completing a personally conducted tour of his special part of the Ellington universe. Eight compositions that Hodges helped make famous during the productive 1937-1945 period are revisited, including *Jeep's Blues*, *Gal From Joe's*, *I Got It Bad*, and *Don't Get Around Much Anymore*. Harry Carney and Shorty Baker solo once or twice, but the occasion is primarily one for Hodges to take care of numerous requests for fresh, stereo remakes of these particular titles. His answers are beautifully phrased as always and more generous than usual.

The orchestra Billy Strayhorn picked to head is the full Duke Ellington crew, with pianist Jimmy Jones sitting in, but contract restrictions preclude proper billing. As a reward for keeping Hodges in orbit, the band steps out on its own during a new pair of blues originals, with Cat Anderson's trumpet breaking through the stratosphere on *Juice A-Plenty*, and *Tailor Made*. Thanks to Rudy Van Gelder's fine engineering the band sounds like Ellington of the Golden Era once again, and the tonal textures of Hodges on a slow ballad were never more velvety and luxuriant.

The Limelitters: Through Children's Eyes
RCA Victor LSP2512

Robbinsdale Chorale: Folksong U. S. A.

Audio Fidelity AFSD5965

Sing Along With Jonathan And Darlene Edwards
RCA Victor LSP2495

Long before the craze gained momentum nationally, Sing Along was a popular pastime among children at camp or in school. It remained for The Limelitters to return this strenuous form of group activity to its proper place, with the aid of seventy elementary school pupils at the Community Theater in Berkeley, California, last year during Christmas vacation. Also returned to favor is the folksy repertoire typical of such gatherings, and the stereo version of the live performance in Al Schmitt's spacious recording opens up the auditorium to all outdoors. The trio goes over big by not playing down to the youngsters, who even take in stride Lou Gottlieb's casual dropping of "identify with" in one of the introductions. They respond with

(Continued on page 48)

“Brings
out sound
from records
that more
expensive
cartridges
do not”

Preston McGraw
United Press
International Hi Fi
equipment reviewer

the incomparable new

SHURE SERIES M33

Stereo Dynetic®

HIGH FIDELITY PHONOGRAPH CARTRIDGES

NOT HOW MUCH? BUT HOW GOOD?

According to United Press' Preston McGraw, the Shure series M33 cartridges are "so good that a hard-shelled listener might suspect Shure engineers of not knowing what they had when they hung a price tag on them."

We knew, all right, Mr. McGraw. It's just that we don't believe the best sounding cartridge need be the most expensive. The new Series M33, after all, was developed by the same team of engineers who developed the redoubtable Shure M3D series . . . the world's first truly high fidelity stereo cartridge. Numerically, Shure has made more highest-quality stereo cartridges than any other manufacturer—and they're used by more critics and independent hi-fi authorities than any other. Chronologically, Shure had a two year head start on the others. In short, Shure has learned how to make these critical components in the kind of quantities that result in lower prices.

THE SOUND OF SPECIFICATIONS

Again quoting Mr. McGraw: "Professional engineers are largely impressed by specifications, and the specifications of the M33 (except for compliance) are not unprecedented. But the way it sounds is something else again. The M33 puts flesh and bones on specifications. It brings out sound from records that more expensive cartridges do not."

He's right. To begin with, Shure specifications (as published) are not theoretical laboratory figures, or mere claims . . . they are actual production standards. 20 to 20,000 cps. response may appear average. But what the bare specifications don't show is that the M33 series goes right through the audible spectrum without a hint of the break-up prevalent in most other cartridges. Also, it is remarkably free from disconcerting peaking at this frequency or that. Result: absolutely smooth, transparent, *natural* sound re-creation. (Incidentally, where would you find a record that goes from 20 to 20,000 cps. with genuine music on it?)

Separation is over 22.5 db. at 1000 cps. Much more than necessary, really. Again, the separation figure doesn't show that the M33's separation is excellent throughout the audible spectrum. No cross-talk between channels. Even when an oboe plays.

And the matter of compliance: 22×10^{-6} cm. per dyne for the M33-5. Now there's a specification! According to Mr. McGraw, the Shure stylus feels like a "loose tooth." And so it should. The incredible compliance of the M33-5 gives it the ability to respond instantly to the manifold and hyper-complex undulations of the record groove.

Superior sound is one outcome of the superb compliance. Another is the ability to track the record at low force. The M33-5 will track at forces as low as any other cartridge on the market today.

SPECIFICATIONS	M33-5	M33-7
Channel Separation (at 1000 cps)	Over 22.5 db	Over 22.5 db
Frequency Response	20 to 20,000 cps	20 to 20,000 cps
Output Voltage (per channel, at 1000 cps)	6 mv	6 mv
Recommended Load Impedance (per channel)	47,000 ohms	47,000 ohms
Compliance; Vertical & Lateral	22.0×10^{-6} cent. per dyne	20.0×10^{-6} cent. per dyne
Tracking Force	$\frac{1}{4}$ to 1.5 grams	1.5 to 3 grams
Inductance	600 millihenrys	600 millihenrys
D.C. Resistance	750 ohms	750 ohms
Stylus:	.0005" diamond	.0007" diamond
Terminals	4 terminal. (Furnished with adapters for 3-terminal stereo or monaural use.)	
Mounting Centers		Fits Standard $\frac{1}{2}$ "

One other item: if your tracking force is 4 to 6 grams, the even lower cost M77 Stereo Dynetic will deliver the best sound you can possibly get from your cartridge-arm combination.

THE ULTIMATE TEST

Give a listen. In fact, compare the Shure M33 series with any other cartridge, regardless of price, in A-B tests (we do it all the time). If you are not impressed with the distinct difference and greater naturalness of the Shure, don't buy it. That's punishment enough for us.

PRICES:

Why spend more than you must? M33-5 and M33-7 net for \$36.50 The M77 is only \$27.50

If you *insist* on Shure when you buy, you can *demand* more from the rest of your system when you play . . . write for literature, or still better, hear them at your high fidelity showroom: Shure Brothers, Inc., 222 Hartrey Avenue, Evanston, Illinois.



Mixers aren't new. But one that will fade and blend two program sources with a single control is. That's one of the exclusive features on the new Harman-Kardon COMMANDER Series of public address amplifiers. Equally unique, yet typical of the exceptional value of this product group is an Anti-Feedback Filter which increases sound output by 100% under difficult acoustical conditions and Multiple Inputs for still greater installation flexibility. That's not all! The popular priced COMMANDER Series includes features usually reserved for costlier "deluxe" equipment such as: master volume control; input for magnetic cartridge; outputs for tape recorder, booster amplifiers and both 25 and 70 volt speaker lines; locking covers; DC on filaments of hi-gain stages, etc. Get all the facts now. Write Commercial Sound Division, Harman-Kardon, Plainview, L.I., N.Y.

Send free detailed catalogs: Desk B-7

Name _____

Address _____

City _____ State _____

harman kardon



ABOUT MUSIC

Harold Lawrence

PHILHARMONIC HALL

THE PHILHARMONIC HALL at Lincoln Center opened its doors to its first audience on May 27. It was no gala occasion, however. Workmen had unveiled the exterior a few days before, but visitors had to hunt for the opening in the high wooden fence that surrounded the building, proceed through a corridor filled with construction dust, and up the fire staircase leading to the auditorium. Inside the rectangular room, it was apparent that much work remained to be done: bare wooden slats surrounded the stage, many of the acoustical "clouds" (see below) were unpainted, the gold-upholstered seats were not all properly installed, and there was an overabundance of white plaster surfaces. No orchestra was tuning up off stage; the only "instrument" to be played was a cannon of the type used at yacht races (page 45).

In front of the stage, a long table had been set up at which the hall's architect, Max Abramovitz, and its chief acoustical designer, Dr. Leo Beranek, presided. Mr. Abramovitz reviewed the architectural features of the auditorium. The lack of proscenium, he said, was designed to create a feeling of intimacy between the performer and the audience by eliminating the formal division between playing and listening areas. Another factor engendering this atmosphere is the height of the three terraces sloping toward the stage; the highest of which is lower than the lowest seat in the upper level of Carnegie Hall. 106 acoustical "clouds," suspended from the ceiling, served as a reflective path to "bring in" the audience sonically from all parts of the hall. Through the use of lighting, a 98-rank pipe organ, located behind a wooden grill at the

back of the stage, could be made to disappear from view when not in use. The color scheme of blue and gold was executed in the following manner—blue ceiling, gold acoustical clouds, blue walls, gold seats (tones ranging from lemon gold to coffee, which, as Ross Parmenter noted in *The New York Times*, May 28 "gave the suggestion of an expanse of ripe wheat."), gold terraces, and gold for the acoustically "transparent" screening in front of the organ. On both sides of the stage, special booths for television cameras had been constructed, the windows of which would be covered by sliding panels when no broadcasting is in progress. The total cubage of 850,000-foot places Philharmonic Hall in the category of a large auditorium. The orchestra platform is 61-foot wide; the seating capacity is 2612, with 1378 in the Orchestra, 309 in the Loge, 442 in the First Terrace, and 402 in the Second Terrace. At the upper level, the hall is 100-foot wide. (Boston's Symphony Hall is 75-foot wide, Vienna's Musikverein 65 feet, Amsterdam's Concertgebouw 95 feet, and New York's Carnegie Hall 100 feet.) Philharmonic Hall is 139-foot deep. Mr. Abramovitz and his staff have taken into consideration the intermission period in designing the hall: "The audience will not have to spill out on to the streets and sidewalks," but instead will stroll through a spacious plaza located between Philharmonic Hall and the New York State Theater.

The quest for "intimacy" was carried over into the acoustical design of the hall, Dr. Beranek reported. As a prelude to his work, he dispatched various members of his staff to several cities in Europe, the United

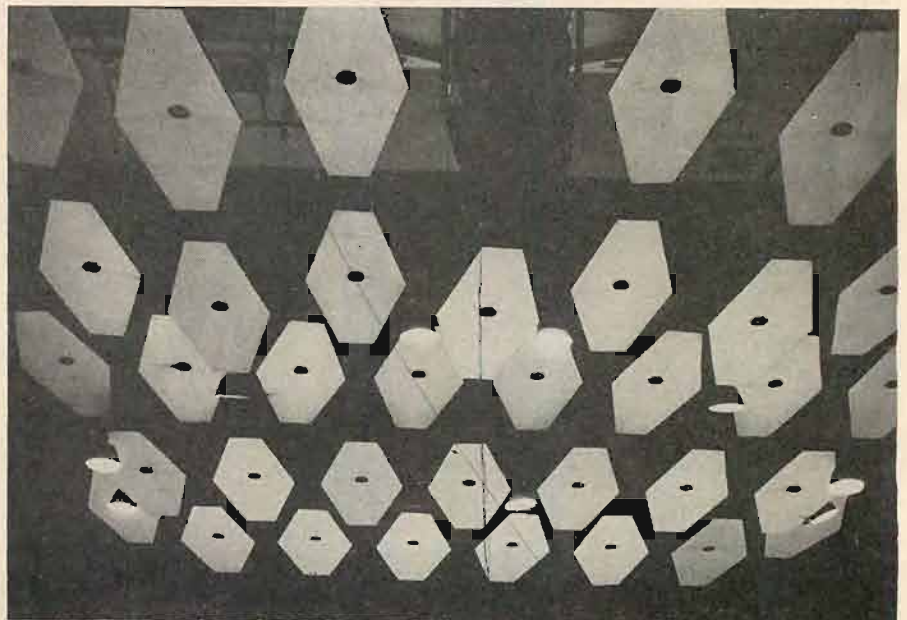

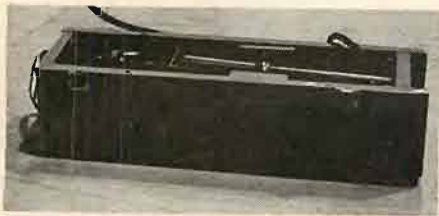

States, South America, and the Middle East in order to study the leading halls. In addition, musicians, conductors, and music critics were consulted on "esthetic" points. Among the details sought were: 1. reverberation period; 2. dimensions; 3. materials used in construction; and 4. age of hall. Dr. Beranek injected a personal note on the subject of the kind of "sound" he hoped to achieve frankly expressing a preference for "rich bass." He noted that in two of the world's finest music auditoriums, the Musikverein and the Concertgebouw the walls were primarily of plaster. Thin wood, he said, leads to reduced bass and a "more brittle" sonic result.

It is relatively easy to achieve acoustical and musical intimacy, he said, in a hall whose capacity is not above 1600 seats. The problems mount, however, in proportion to the increase in audience. Low terraces, acoustical clouds, and a proscenium-less stage, he hoped, should solve them.

Hope was an important element in the business of designing halls for concert music. For, as Dr. Beranek readily admitted, it is impossible to predict exactly how an auditorium will sound, even after the most exhaustive research has been accomplished. With this in mind, a certain flexibility was built into the design of Philharmonic Hall. The back and side walls of the stage have been provided with a four-foot space so that experiments can be carried out after the official opening of the hall for an indefinite period of time. As required, reflecting panels or absorbing materials may be placed in this passage. A jury composed of musicians and engineers will listen to rehearsals and meet regularly to discuss their impressions. The entire scope of repertoire will be auditioned, from solo recitals to opera and symphonic performances, in classical, romantic, modern, and, as Dr. Beranek put it, "super-modern" compositions. Thus, the hall will not be "fixed" acoustically. Thanks to the side and back passages, a continuous process of "tuning" began to take place, beginning with the first orchestral rehearsal of the New York Philharmonic on Monday, May 28, through a period of "from 1 to 40 years." A special work has been commissioned by Lincoln Center for the "tuning": Daniel Pinkham's *Catacoustical Measures*.

In reply to our query regarding the reverberation time of the hall, Dr. Beranek states that the period would lie between 1.85 and 1.95 sec., with the ultimate goal of 1.9 sec. (Carnegie Hall's reverberation period is 1.7 sec., and that of the Concertgebouw and Musikverein Halls 2 sec.)

Since the subway tracks run within 50 feet of the building's foundations, Dr. Beranek had the foresight to rest the hall on lead-astbestos pads and vibration isolation points. A comparison of noise level readings made in the cellar of Harvey's Bar (now demolished) and the hall's basement, reveal that the hall is down 15 to 30 db in rumble, and virtually undetectable.

The cannon concluded the program with a bang calculated to expose rattles, loose parts, and metallic vibrations in the hall. The resounding shot demonstrated that Philharmonic Hall was tight as a drum.

Now, as Dr. Beranek stated it, "we shall hear very soon what our (musical) problems are." Æ



WHAT CARTRIDGE SHOULD YOU USE IN YOUR RECORD CHANGER?

THE selection of a cartridge for use with a record changer—mono or stereo—would appear to pose no special problem. Yet, there are certain things to be considered.

A cartridge that tracks at some featherweight fraction of a gram may introduce problems if the record changer arm is not capable of tracking at that force. To adjust it, and attempt to use it at such a low force may introduce complications. Joe Marshal, noted audio authority, discussed this in his article *INSIDE THE CARTRIDGE* (High Fidelity Magazine, Jan. 1962)—"An attempt to reduce needle pressure with an arm not designed for low needle pressure will usually result in high distortion due to loading the needle with the mass and friction of the arm."

Induced hum is another problem to be considered and anticipated with a magnetic cartridge. The very nature of the magnetic cartridge makes it an efficient hum transducer. In the field of an unshielded AC motor, it is prone to reproduce hum in the loudspeaker system.

The record changer owner must make fairly certain that the tracking capabilities of the arm and motor shielding are suitable for use with a magnetic cartridge. He can avoid these complications, and enjoy superlative performance by selecting a ceramic stereo cartridge.

Sonotone was the first to develop the use of ceramics in piezo-electric phono pickup applications. And today, the new Velocitone Mark II cartridge stands out as one of the most notable attainments in high quality record reproduction. The Velocitone Mark II tracks at 2 to 4 grams — well within the capabilities of any record changer arm. And it will perform in the magnetic field of an entirely unshielded motor without the trace of magnetically induced hum.

With magnetically induced hum and stylus force problems out of the way, here's the kind of performance you can expect from the Velocitone: usable frequency response from 20 to 20,000 cycles ($\pm \frac{1}{2}$ db from 20 to 6,000 cps; ± 1 db to 17,000 cps). Output is 11 mv. per channel with better than 30 db separation over the entire audible spectrum.

The Velocitone is provided with matched equalizers (no tools required) so that it operates as a constant velocity device, and can feed directly into the 'magnetic' phono input of any stereo preamp. What's more, the Velocitone's performance is unaffected by extreme temperature and humidity changes. A universal terminal plug assures easy installation.

The Velocitone Mark II, priced at \$22.25 with two 0.7 mil turnover diamond styli, gives you, in effect, two cartridges for the price of one. Diamond/sapphire \$19.25; dual sapphire \$14.75. Ask your hi-fi dealer to demonstrate the new Velocitone Mark II, the cartridge that is performance-matched to your record changer. Write.

SONOTONE® CORPORATION

ELECTRONIC APPLICATIONS DIVISION • ELMSFORD, NEW YORK

CANADA: ATLAS RADIO CORP., TORONTO

CARTRIDGES • SPEAKERS • TAPE HEADS • MIKES

ELECTRON TUBES • BATTERIES • HEARING AIDS



NEW PRODUCTS

● **Slim Speaker Systems.** The new Goodmans "Slimform" speaker line features three models all in genuine hand-rubbed oiled-walnut veneer cabinets, constructed of ¾-inch stock and acoustically lined. Model G-1 includes an 8-in. driver, 6-in. closed-back midrange, 3½-in. high-fre-

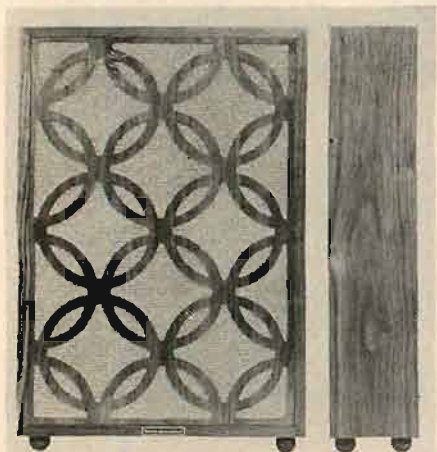

quency tweeter, and a frequency response of 40 cps to 17,000 cps. Model G-2 includes a 10-in. driver, 6-in. closed-back midrange, 3½-in. high-frequency tweeter, and the same frequency range as the G-1. Model G-3 includes three 8-in. woofers, a 6-in. closed-back midrange, 3½-in. high-frequency tweeter, and again the same frequency range as the G-1. All models feature a tuned port, crossover network, and 16-ohm impedance. Models G-1 and G-3 measure 25-in. high, 17-in. wide, 5¼-in. deep. The G-2 is 6¼-in. deep. The slimform speaker series has been designed to stand on legs, or when the legs are removed, to fit into bookshelves, room dividers and other limited-space areas. The G-1 is priced at \$56.50, the G-2 at \$59.50, and the G-3 at \$79.50. Rockbar Corp., Mamaroneck, N. Y. **G-1**

● **Turntable with Motor-Driven Tone Arm.** The Rek-O-Kut Rondine II features the well-known Rek-O-Kut turntable integrated with a motor-driven independent tone arm. The Rondine II measures only 14½ x 14½ in. so that it may be easily installed in any furniture cabinet. Factory-installed spring mounts permit drop-in mounting in cabinets. The turntable features a heavy cast platter, hysteresis-synchronous motor, Rekothane belt-drive system, and a heavy-steel deck plate. The motor-driven "Auto-Poise" tone arm is factory installed and includes the S-320 tone arm with all its



features. By pressing a button, the "Auto-Poise" mechanism lifts the arm from its rest and places it on the record as the turntable starts, disconnects completely from the tone arm during play, lifts the arm and returns it to the rest after the record is finished, and then shuts off the turntable. The Rondine II is also available without "Auto-Poise" but with the Model S-320 tone arm factory installed. Price for

the Rondine II with "Auto-Poise" (Model R-320A) is \$169.95 and for the Rondine II with the Model S-320 tone arm installed is \$129.95. The turntable, Model R, is available separately at \$79.95. Rek-O-Kut Co., Inc., Corona, N. Y. **G-2**

● **New Phono Pickup Arm.** The new Stanton "Unipoise" tone arm, model 200, is designed to permit tracking forces of one-half gram. This arm is especially designed to accommodate the new super-compliant styli, such as the Pickering Model D-3805AA. The low-tracking-force potential of this arm is achieved by use of an exclusive single-pivot bearing and ultra lightweight construction; the entire moving assembly weighs only 6 ounces. Arm



balance in all planes is adjustable by means of a calibrated stylus-force adjustment with a range of one-half to two grams. The Model 200 features a built-in arm-rest. Installation requires only one hole and is done in a few minutes. No soldering is necessary as cables are provided which plug into special receptacles integrated on the mounting system. The Model 200 will accept most mono and stereo cartridges. It is supplied with template and complete installation instructions. Price is \$36.00. Pickering and Co., Plainview, L. I., N. Y. **G-3**

● **Cooling Fan.** The new Rotron "Whisper Fan" is a quiet and compact fan designed to deliver maximum cooling with a minimum of acoustical disturbance, thus making it suitable for cooling high-fidelity equipment. It can be installed simply by placing it standing up near the amplifier.



A rubber mat is suggested to reduce the possibility of transmitting vibrations. Also it may be mounted in a panel cut-out by either clips or screws. The "Whisper Fan" is only 4 11/16-inches square by 1½-inches per minute. Price for the "Whisper Fan" is \$14.85. Optional accessories include a decorative grille, filter, connecting cords, and mounting clips. Rotron Manufacturing Co., Woodstock, N. Y. **G-4**

● **Magnetic Tape Splicing Kit.** The Cousino Magnetic Tape Splicer consists of a plastic splicing block, a supply of pre-cut tape-tabs, a razor blade, instructions, and a plastic pocket case. The bottom of the



splicer has an adhesive coating which permits the splicer to be mounted on the recorder or a work table without tools. It can be removed and replaced without marring the finish. Cousino, Inc., Toledo, Ohio. **G-5**

● **Transcription Tone Arm.** The first separate Thorens transportation tone arm to be marketed in America has just been announced by Elpa Marketing Industries. The new Thorens, Model BT-D-12S, is claimed to have the following features: extremely low inertia in both vertical and horizontal planes; complete independence of turntable leveling due to precise balancing and spring-applied stylus force; resonant frequency well below 16 cps with ordinary pick ups and much lower with more compliant pick ups; a precision cueing device is integral with the arm and permits it to be raised and lowered without actually touching it directly. Adjustments include static balancing with damped counterweight to accommodate



cartridge weights from 5 to 19 grams; spring-applied stylus force with knob calibrated from zero (for balancing) to 8 grams; vertical height (range 1½ inch) and stylus overhang (range 7/16 inch). Since the slide for stylus overhang is an adjustable part of the plug-in shell, this critical dimension may be individually set for each cartridge in use to achieve the 0.5-deg.-per-inch maximum tracking error which the arm is capable of with optimum overhang. The design for the vertical pivot is claimed to keep the stylus in a vertical plane for every height adjustment. Varying friction below 0.1 gram in any direction at the stylus is also claimed. Over-all arm length is 12½ inches. The arm is supplied with a mounting board for immediate use on Thorens TD-124 and TD-121 turntables but will fit any standard 12-inch turntable. Price of the BT-D-12S tone-arm is \$50.00 and it is also available factory mounted with a transcription turntable as the Model TD-135 for \$110.00. Thorens Division Elpa Marketing Industries, New Hyde Park, N. Y. **G-6**

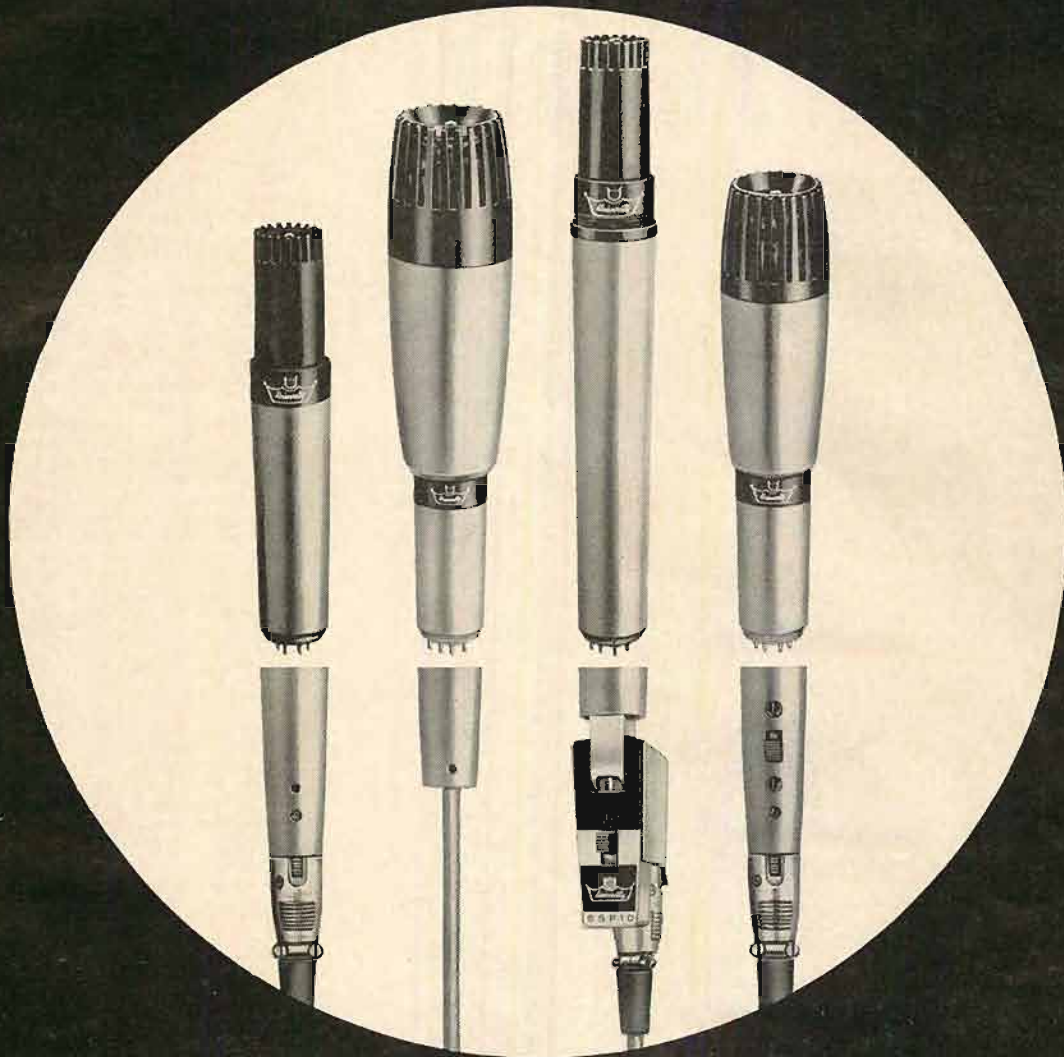

YOU ARE NOW LOOKING AT 20 DIFFERENT MICROPHONES

MODULAR MICROPHONES!*
 Another exclusive concept that makes **UNIVERSITY** microphones better.

20 microphones? Yes—for any **one** of University's MODULAR MICROPHONES can provide at least **five** different methods of operation! University has inaugurated a new era in microphone design and construction—**professional** microphones offering **total interchangeability** with every conceivable type of adapter! This permits long-term savings as well as improved versatility, for you can add suitable adapters as your microphone requirements change—**without buying additional microphones**. You need never compromise quality to meet a price.

And it works as simply as this: equipped with a minimum of basic University MODULAR MICROPHONES, any one of University's interchangeable adapters may be chosen to complete the microphone assembly you require...with or without switches, for cables with and without quick-disconnect plugs, for screw-on or slide-on floor and desk-stand operation. And you can make **instant** impedance changes without tools, rewiring or soldering!

*TRADEMARK

For the complete story on University's new line of omni-directional, cardioid and lavalier MODULAR MICROPHONES, send for the free 16-page brochure. Write: Desk R-7, University Loudspeakers, Inc., 80 S. Kensico Ave., White Plains, New York.



A Division of Ling-Tanec Electronics, Inc.

STILL AVAILABLE!

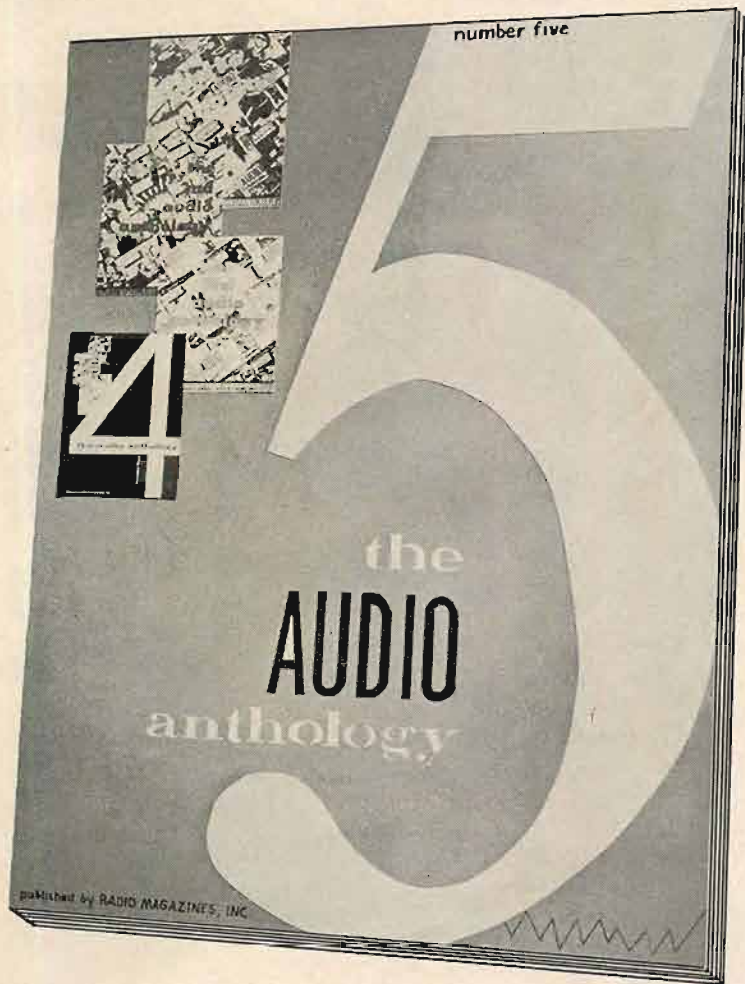

- THE BIGGEST AND BEST VOLUME EVER!
- MORE THAN 50 ARTICLES COVERING STEREO RECORDING AND REPRODUCTION; STEREO MULTIPLEX; MEASUREMENTS; STEREO HIGH FIDELITY TECHNOLOGY; CONSTRUCTION AND THEORY; etc.
- 144 PAGES WITH COMPLETE ARTICLES BY WORLD FAMOUS AUTHORITIES IN THE AUDIO AND STEREO HIGH FIDELITY FIELD.
- ATTRACTIVELY PRINTED AND BOUND FOR EVERLASTING USE. AN IMPORTANT STEREO HIGH FIDELITY REFERENCE BOOK.

Order The 5th AUDIO ANTHOLOGY NOW-ONLY \$3.50

RADIO MAGAZINES, INC., Dept. A
P.O. Box 629, Mineola, New York

Enclosed is my remittance for \$..... I understand that my copy of the 5th AUDIO ANTHOLOGY will be mailed to me.

Use handy order form. We pay postage anywhere in the U.S. add 50¢ for Foreign orders.

Name.....

Address.....

City..... Zone..... State.....

I am: Engineer
Musician

Student
Other.....

Audio Enthusiast

JAZZ

(from page 42)

full voice on *This Train*, *The Whale*, *I Had A Mule*, and *Hey Jimmie Joe John Jim Jack*. Allan Reuss, guitar, and drummer Earl Palmer are added to help keep everyone in the corral and on the beat. The mature approach should appeal to adults as well, and a lyric sheet is enclosed to remind them of the words.

The Robbinsdale Chorale, which is ninety voices strong, devotes itself to show tunes in addition to the folk melodies promised in the album title. Actually, this midwestern group of mixed voices does some of its best on *Nothin' Like A Dame*, *Little Bit O'Luck*, and Meredith Willson's *Pick-A-Little*. In the folk area, it operates like an outside Kingston Trio, but the tempos adopted should be slow enough to satisfy Sing Alongers on *Shenandoah*, *Santiago*, *Banua*, and *John Henry*. Instead of depending on tricks to brighten arrangements, director John Adams sets things in stereo motion by calling on various sections in turn or playing one against another. The entire force charges across the landscape on *Battle Hymn Of The Republic*.

The Edwards, for the benefits of those who never met the eccentric couple before, are Jo Stafford accompanied by husband Paul Weston at the piano. The piano is really had at in this gentle spoofing of Sing Along, and anyone able to negotiate the changes of tempo and style deserves to be graduated to solo status. While the better half keeps fairly good time, she generally sings off key and tosses off obligatos guaranteed to curl Mitch Miller's whiskers. A hearty supporting chorus bounces across the stereo stage on such popular favorites as *Moonlight Bay*, *That Certain Party*, and *Be My Little Baby Bumble Bee*.

Theodore Bikel: The Poetry And Prophecy Of The Old Testament

Elektra Stereo EK57220

Marjorie Lord: Claudia's Letter

Fan Stereo 1002

The literature of Biblical times lends itself to vivid interpretation, but both these productions manage to be absorbing without the slightest attempt to imitate the grandiose effects of the late Cecil B. De Mille. If Elektra really had an eye on the box office, the title of Theodore Bikel's first non-singing album would spell out in no uncertain terms, "Song of Songs and Other Readings from the Old Testament." For it is his graphic retelling of the King Solomon story that will draw the attention of many listeners and cause sales to mount. The verses in this version are selected from three different Bible texts, newly arranged in a sequence that makes a more important figure of the shepherd, Marian Selde gives a sensitive reading of the part of Schulammit, while Bikel assumes the two male roles. The result is a dramatic and impassioned poem in three parts, enacted with the accompaniment of a symphonic suite composed by Dov Seltzer. Like the material Seltzer writes for the Oranlm Zabar Israeli Troupe, the music combines ancient Near Eastern tradition with modern overtones. He also furnishes appropriate underscorings for such excerpts as *The Creation*, *Expulsion From Paradise*, *By The Rivers Of Babylon*, and *Psalms 98 and 159*. Stereo permits the settings to be unobtrusive yet clearly defined, and they were apparently recorded in Vienna. The depth of feeling indicates Bikel's intimate knowledge and long understanding of the texts.

While a Bible is usually within easy reach, few households possess a copy of the letter written by the wife of Pontius Pilate about the arrest, trial and crucifixion of Jesus. The manuscript was found in a monastery, where it had lain for centuries, and comparisons with Pilate's report to Tiberius Caesar attest to its authenticity. Every young actress who hears this reading will undoubtedly start looking for a copy, as it affords an opportunity to cover a wide range of emotions. Marjorie Lord succeeds in running the gamut a far greater distance than from A to B, and her portrayal

of Claudia is genuinely alive and wholly believable. Earle Hagen, a composer for television and films, provides a sympathetic score and conducts the studio ensemble of Hollywood musicians. The Polymax pressing adds to the brilliance of the stereo version.

Henry Mancini: Experiment In Terror
RCA Victor Stereo LSP2442

A second venture at scoring for the large screen involves Henry Mancini once more with the murderers and felons pursued so valiantly on the "Peter Gunn" and "Mr. Lucky" television series. With the half-hour time limit removed, the composer is at liberty to try a greater variety of tracking procedures, ranging from the jaunty ragtime of a pianist for silent movies to the persistent rhythms of the currently popular Twist. An expanded investigative staff also permits the deployment of a big, swinging band on *Kelly's Tune*, and *Ftuters' Ball*. As befits the Irish sounding titles, the methods followed consist of a spirited revamping of the old Sauter-Finnegan book. A pair of autoharps are brought into play on the theme, with due regard for the advantages of stereo, but Mancini's true ingenuity comes out when he tangles with the Twist on an alternate version of the theme. In this and two other tunes, he almost makes the twanging guitars sound musical as they pound away at the beat.

The song best qualified for promotion to the ranks of best sellers seems to be *Nancy*, which surprisingly enough was written for the murder sequence and features the solo piano of Jimmy Rowles. With the addition of suitable lyrics, the slow, haunting melody may attract as much attention as *Moon River*, the hit from Mancini's first film score. In any event, Erroll Garner, Ahmad Jamal, Red Garland and other jazz pianists on the lookout for mood material are likely to find it highly effective. As in the case of the "Breakfast at Tiffany's" album, the source of the recording is RCA Victor's Music Center of the World and not the movie soundtrack. **ZE**

EQUIPMENT PROFILE

(from page 34)

are step-type, others continuously variable. Yet all look and feel identical. Even at the expense of good looks I would suggest that a variety of knobs, according to function, would be helpful.

I felt, too, that however laudable in terms of electronics, the provision of separate equalization switches for recording and playback which must be set by hand each time the speed is changed is likely to lead to unintentional mistakes. The asymmetrical location of these switches, too, one a knob by itself, the other the bottom half of a similar knob (the top being the playback mode switch) invites forgetfulness. I forgot one or the other on numerous occasions, with unpleasant results in the recorded sound. It would seem that these functions might somehow be ganged, and/or combined with the speed change—though this might present insuperable layout problems, I suppose. That's what designers are for.

There are no pressure pads on this tape drive and the reel take-up and hold-back action is dynamic via the two reel motors, as in most professional machines. (An idiosyncrasy typical of this drive is that there is no tension at all with power off. Tape cannot be loaded without unwinding, since the reels turn freely.) Tape contact is assured by accurate machining of the guides and via a round felt-edged holdback friction wheel to the left, opposite the capstan; this and the capstan rubber idler move together to grab or release the tape simultaneously on both sides of the heads. Good. Generally, this system, together with the in-

genious quick-start control, gives very accurate operation in all tape motions.

The RP-100 is a true tape deck, a "chassis," complete but minus case and minus accoutrements such as mikes. For convenience in assembly and for those who never mount anything, there are two simple heavy wire end-pieces which can serve as a stand, a bit rickety but solid enough for practicality. They are reversible—you can turn the thing upside down. Just one more aspect of useful kit designing. **G-18**

HARMAN-KARDON AM-FM-FM-STEREO TUNER-AMPLIFIER, MODEL TA-5000X

The Harman-Kardon "Stereo Festival III" is one of the well-known Award Series. The Festival III is intended to be a complete audio control center and mono-stereo tuner on a compact chassis. Although not the very top of the Harman-Kardon line, the performance and convenience it offers are considerable.

Apparently, judging by the fact of its inclusion in this set, there is still need for an AM tuner in the high-fidelity home; perhaps to feed lively music to the teenagers "in their lair." Unfortunately the AM section is the weakest member of this system (from a variety of viewpoints)—however, it is presumably sufficient for "lively music."

The amplifier section provides 25 watts of power in each channel and a complete control center is provided for handling the usual variety of signal sources. A stereo headphone jack is provided on the front panel. It will accommodate low-impedance stereo head phones.

Circuit Description

The AM tuner section features a built-in ferrite loopstick antenna, a 1/2-6BL8 r.f. amplifier, a 6AJ5 converter, a 1/2-6BL8 i.f., and a 6EQ7 detector. The FM tuner section has a balanced 300-ohm antenna input and uses a 1/2-6AQ8 as a tuned grounded-grid r.f. amplifier, a 1/2-6BL8 oscillator, a 1/2-6AQ8 mixer, three i.f. stages consisting of a 6AJ5, a 1/2-6BL8 and a 6EQ7, a 6BN6 limiter, and a diode discriminator (Foster-Seeley). A 1/2-6BL8 is used as a reactance tube for a.f.c. The input stage to the multiplex adapter section is a cathode follower. The multiplex circuitry itself is rather straightforward and consists of two tubes and four diodes. Essentially what happens is that the 38-ke carrier is reconstituted by doubling the 19-ke pilot and then the carrier is reinserted into the composite main signal which is then detected. The four diodes are used in a ring detector configuration.

The amplifier section contains two 12AX7 preamplifier stages, a 12AX7 voltage amplifier and tone driver stage, a 12AU7 phase inverter and driver, plus a pair of 7355 output tubes in a push-pull configuration. A silicon rectifier is used to supply the power.

Performance

The sensitivity of the AM section, by IHFM methods, was 230 microvolts. The frequency response of this section was fairly flat (within plus or minus 2 db) up to 5000 cps but dropped off very rapidly above that.

The FM-tuner section on the other hand is certainly adequate for high-fidelity reception both in mono and FM stereo. Sensitivity was 6.8 microvolts which is adequate for all but the very extreme fringe

NOW YOU CAN BUILD A FINE Schober Organ FOR ONLY \$550



You can assemble this new Schober Spinet Organ for \$550 — or half the cost of comparable instruments you have seen in stores. The job is simplicity itself because clear, detailed step-by-step instructions tell you exactly what to do. And you can assemble it in as little as 50 hours.

You will experience the thrill and satisfaction of watching a beautiful musical instrument take shape under your hands. The new Schober Electronic Spinet sounds just like a big concert-size organ — with two keyboards, thirteen pedals and magnificent pipe organ tone. Yet it's small enough (only 38 inches wide) to fit into the most limited living space.

You can learn to play your spinet with astounding ease. From the very first day you will transform simple tunes into deeply satisfying musical experiences. Then, for the rest of your life, you will realize one of life's rarest pleasures — the joy of creating your own music.

For free details on all Schober Organs, mail the coupon now. No salesman will call.

THE *Schober Organ* CORPORATION

43 West 61st Street, New York 23, N. Y.

Also available in Canada and Australia.

MAIL THIS COUPON TODAY

The Schober Organ Corporation
Dept. AE-8
43 West 61st Street
New York 23, New York

Please send me FREE booklet and other literature on the Schober Organs.

Please send me the Hi-Fi demonstration record. I enclose \$2 which is refundable when I order my first kit.

Name

Address

City Zone ... State

Build your own superb
SCOTT/KITS



HAVE FUN . . . SAVE MONEY

Have fun . . . save money . . . build the best! Now you can get world-famous Scott stereo components in kit form. Think of it . . . you can build the fabulous new LT-110 FM Multiplex Stereo Tuner . . . your choice of two complete stereo amplifiers, or a preamp and separate power amp . . . all from H.H. Scott!

Write today! Find out about these exciting Scott-kits.

FREE Choice of 3 Booklets



H. H. Scott, Inc., 111 Powdermill Road, Maynard, Mass Dept. 035-07

Send me the booklets checked below:

20-page "Guide to Custom Stereo" Complete technical information on kits 16-page booklet explaining FM Stereo

Name _____

Address _____

City _____ Zone _____ State _____

Export: Morhan Exporting Corp., 458 Broadway, N.Y.C.

CIRCLE 50A

*Chief Fidelitone
ingredient:*

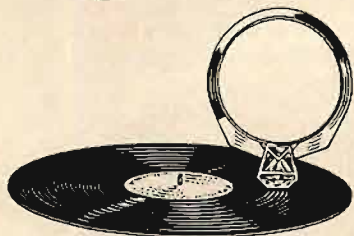

QUALITY

We don't use just diamonds—we use gem stone *quality* diamonds.

And it's the same with each component of each Fidelitone diamond needle. The finest materials, engineering talent, and workmanship—all combine to assure you of quality needles for quality sound reproduction equipment.

When you need a needle, get quality—specify Fidelitone—on top since 1929.

Fidelitone

"Best buy on records"
Chicago 26, Illinois
CIRCLE 50B

areas. The capture ratio was 5 db and the frequency response was within 0.5 db from 20 cps to 15,000 cps in the mono mode and was within 2 db in the FM-stereo mode. Channel separation in the FM mode is over 30 db at 500 cps tapering down to 13 db at 15,000 cps and in the other direction down 18 db at 20 cps.

At 20,000 cps the audio amplifier provides 25 watts per channel at a total harmonic distortion of just a fraction over 1 per cent, each channel driven separately. For the same distortion level the TA-5000X put out 20 watts per channel when both channels are driven simultaneously. The frequency response of the TA-5000X, at normal listening levels (1 watt output), was within 2 db from 10 cps to over 50,000 cps. IM distortion was below 1 per cent at 10 watts and gradually rose to 2 per cent at 20 watts.

The Harman-Kardon "Stereo Festival III," Model TA-5000X is a solid-performing FM-stereo tuner and 50-watt stereo amplifier which should be of real interest to the audiophile requiring a compact and modestly priced system. **G-19**

PHASE SHIFT

(from page 36)

phase shift to be monitored. Connect a pair of stereo headphones to the output of the amplifiers, and after setting level and your ears have become accustomed to it, slowly shift phase on the one channel from zero to 180-deg. and back again to zero. Be careful not to let the amplitude change. Both ears are now receiving a signal of the same frequency and amplitude, the only difference being that the phase angle between them is being changed. If the ear could detect changes in phase angle, then we should be able to hear some change in the character of the sound when the phase angle is changed. We heard absolutely no change in the character or apparent direction of the tone when the phase angle was changed. The only way we could produce a discernible change in sound was by varying the amplitude to one ear. We found that reducing the amplitude to the right ear would cause the sound to move from dead center towards the left side, and vice versa; in effect a sort of pseudo stereo. **Æ**

EMPLOYMENT

MARKETING EXECUTIVE

Experienced in sales management—advertising management—product planning.

Knowledge of both consumer home music and industrial/professional markets. Heavy magnetic recording marketing experience. Strong technical background.

Excellent professional and personal history.

Interested in associating with quality company possessing strong product engineering capability.

Location, any. Salary requirement, middle to high teens—less if incentives are right. Write CG-2, AUDIO, P. O. Box 629, Mineola, N. Y.

**FOR FULL QUALITY
STEREO-MULTIPLEX
OR MONOPHONIC
FM RECEPTION**

USE

FINCO®

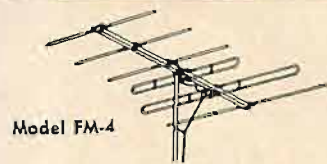

Model FM-4

World's Most Complete
line of HI-FI Phased
FM ANTENNAS

The "Top Rated - Best Buy" Line!

Ask your dealer to explain the advantages of these outstanding antennas or write for Catalog 20-213.

THE FINNEY COMPANY

34 West Interstate Dept. A Bedford, Ohio

CIRCLE 50C



MAGNETIC STEREO CARTRIDGE

model SX-1

SPECIFICATIONS

Response 20~20,000 cps
Out put 4 mV / 5 cm / 1,000 c/s
Channel Isolation 20 dB 40~12,000 c/s
Channel Balance ±0.5 dB at 1,000 c/s
Compliance 3 × 10⁻⁶ cm / dyne
Load Resistance 50~70 killo ohms
Tracking Force 3 grams
Stylus 0.7 mil Diamond
Weight 12.5 grams

SONOVOX

SONOVOX CO., LTD.
101 Tokiwamatsucho, Shibuyaku, Tokyo, Japan

CIRCLE 50D

THIRTY POUNDS OF MAGNET

(from page 22)

thane foam cemented to the narrow, slightly turned over rim left after the original compliance rolls were cut away. The foam was intended to at least partially damp out rim distortion which causes a cone periphery to assume weird shapes when driven even moderately hard. A generous application of black tire paint stiffened it without appreciably increasing its weight.

Bona fide transducer engineers will writhe at my expedients. The late Boss Kettering is reported to have said, "An engineer can prove with slide rule and formulas exactly why your idea will not work. When it outperforms anything made previously he can show, with slide rule and formulas, just why it is superior."

A six-inch diameter by 1/2-inch thick disc was turned from extruded styrofoam and cemented in the center of the cone. This made the cone a more efficient piston by improving its shape, by closing the 3-inch voice-coil hole and by adding an almost weightless stiffener.

Styrofoam can be turned by fastening it on the end of a high-speed electric motor shaft and using sandpaper for a tool. It is perhaps advisable to perform the operation out of doors. There is a bare possibility that womenfolks may not fully appreciate the beauty of a house decorated with drifts of styrofoam snow.

With the cone in place and its voice coil centered, its surround—as anticipated—was much too loose. Twelve 1 1/2 x 1/2-inch pieces of 3/8" thick polyurethane plastic foam were cemented to the Pellon, evenly spaced like spokes of a wheel. This added stiffness which could be modified. A razor blade sprayed with Windex will slide through plastic foam or rubber like a hot knife through butter. A thin slice was shaved from each of the foam spokes and the result tested with a spring scale calibrated in grams. When 5/16 of practically linear excursion was achieved an audio generator was fired up. The woofer cone resonance was 27 eps.

Frequencies from 6 to 20 eps produced a papery, "shishing" sound when the cone should have been virtually silent. Hours were spent tracing it down. A spot on the surround where the plastic foam made imperfect bond with the Pellon was the culprit. A touch of cement applied with a toothpick was the remedy. After the cure the cone pumped lazily back and forth at 6 eps producing a gentle breathing sound audible only close by.

Next came the shakedown which con-

sisted of driving the cone to its maximum excursion for several hours at 10 eps. This gives the speaker a harder workout than a year of playing at living-room volume. It will show up detrimental changes in cone, spider, or surround characteristics.

The shakedown was noisy. When driven well past linear excursion the unloaded cone thumped loudly at each reversal of direction. The workbench top and its cupboard doors and drawers all rattled violently. Everything loose on the bench contributed sounds.

Ignoring the cacophony I planned a test for basket strength and rigidity. Mounting the speaker on a board and driving it around town in the back of a pick-up truck should locate basket weakness.

That test was cancelled by the speaker itself. It walked off the vibrating bench top and crashed to the floor. The impact smashed a piece out of a Spanish tile and chipped a toothpick-size splinter from one of the magnets. My reflex grab at it jammed a finger through the cone. When hoisted back to the bench the voice coil was still in perfect alignment. Further test for basket strength were considered superfluous.

The tear in the cone was easily repaired and did not affect performance. I shall make up another cone when the shock wears off.

And that, except for painting and prettying up, is how you can make your own super woofer. The possibility of building them on order for profit may seem attractive. Here is some encouragement.

Two separate, tightly partitioned, and preferably well separated, work rooms are an absolute must. Lathe work, filing, hack sawing or any other operation which produces metal chips must be isolated. Cleaning a magnet assembly of metal particles means hours of work with a bright light, magnifying glass, Scotch tape, toothpicks, pipe cleaners, tweezers, compressed air, an even temper, and infinite patience. Going through it once is more than enough.

Something like four months of spare time work went into this woofer. If I sold it for 250 dollars, I would have earned, after deducting all cash laid out, considerably less than one dollar an hour. Guided by what I have written you should be able to reduce the man hours substantially, possibly to where your return would rocket to two dollars an hour.

But hobbies are seldom remunerative. I shall continue to build speakers fully

World's Only 'Portable Recording Studio'...



the all-in-one **Norelco**[®] CONTINENTAL '400' 4-Track Stereo Tape Recorder

A recording studio in a suitcase—that's how NORELCO '400' owners describe this most advanced (and most popular) self-contained stereo tape recorder. **VERSATILITY:** 4-track stereo recording and playback, as well as 4-track monophonic recording and playback, at any of its 3 speeds. **PROFESSIONAL EXTRAS** (at no extra cost): mixing, monitoring and sound-on-sound facilities. **AUDIO FACILITIES:** completely self-contained, including dual recording and playback preamplifiers, dual power amplifiers, two NORELCO wide-range, stereo-matched speakers (one in the detachable lid) and stereo dynamic microphone. For complete specifications, write to NORELCO. In the meantime, see and hear the Continental '400' at any leading Sound or Photo Dealer.

High Fidelity Products Division
NORTH AMERICAN PHILIPS COMPANY, INC.
230 Duffy Avenue, Hicksville, L. I., N. Y.

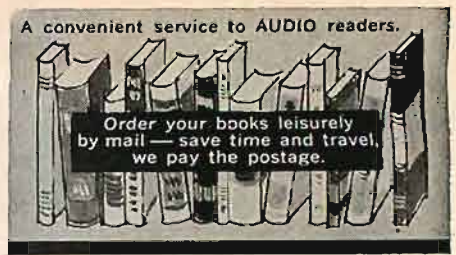
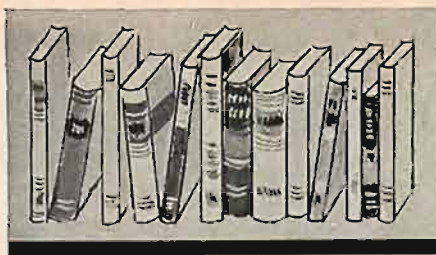

Order your books leisurely by mail — save time and travel, we pay the postage.

Maintaining Hi-Fi Equipment



Joseph Marshall
A valuable reference for anyone whose living or hobby is servicing hi-fi equipment. Outlines the professional approach for servicing all types of hi-fi components. Covers troubleshooting of electronic, mechanical and acoustic problems. 224 pages.

No. 58 Paperback \$2.90*

Understanding Hi-Fi Circuits

Norman H. Crowhurst

One of the best known and highly popular technical hi-fi authors analyzes all the important circuits of a hi-fi system in this important book. Fully covers all types of audio circuits: inverter, driver, output stages, feedback, damping—plus much more. A valuable reference for the student, hobbyist and technician. 224 pages.

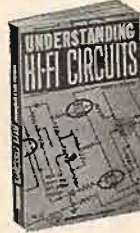

No. 64 Paperbound \$2.90*

Basic Audio Course

Donald C. Hoefler

This book is written for the hi-fi enthusiast who wants to venture into the interesting technical side of hi-fi components. Covers the fundamentals of audio and high fidelity systems from preamp to loudspeaker—the nature of sound—analyses of components—recording techniques. 224 pages.



No. 66 Paperback \$2.75*

McProud High Fidelity Omnibook



Prepared and edited by C. G. McProud, publisher of Audio and noted authority and pioneer in the field of high fidelity. Contains a wealth of ideas, how to's, what to's, and when to's, written so plainly that both engineer and layman can appreciate its valuable content. Covers planning, problems with decoration, cabinets and building hi-fi furniture. A perfect guide.

No. 115 \$2.50*

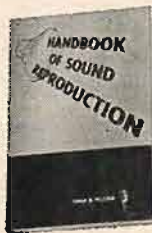

Handbook of Sound Reproduction

Edgar M. Villchur

Right up to date, a complete course on sound reproduction. Covers everything from the basic elements to individual chapters of each of the important components of a high fidelity system.

No. 110 \$3.75*



Designing and Building Hi-Fi Furniture

Jeff Markel

Written by a professional hi-fi furniture designer who has taught furniture design at leading colleges, this book is an authentic reference of value to the hi-fi fan and professional custom builder. Covers everything from types of woods to furniture finishing for the mechanically adept; design principles, styles and arrangements for the decor minded. 224 pages.

No. 79 Paperback \$2.90*

Tape Recorders and Tape Recording

Harold D. Weiler



A complete book on home recording by the author of *High Fidelity Simplified*. Easy to read and learn the techniques required for professional results with home recorders. Covers room acoustics, microphone techniques, sound effects, editing and splicing, etc. Invaluable to recording enthusiasts.

No. 112 Paper Cover \$2.95*

"the best of AUDIO" — edited by C. G. McProud



A new compendium of AUDIO knowledge. Here is a collection of the best of AUDIO — The AUDIO Clinic by Joseph Giovanelli . . . noted audio engineer and the original high fidelity answer-man — EQUIPMENT PROFILES edited by C. G. McProud . . . Editor of AUDIO. Here is a wealth of hi-fi and audio information. Answers to the most important issues in high fidelity and a valuable reference.

No. 124 Volume I \$2.00*



Stereo... How It Works

Herman Burstein

A well known authority writes on the exciting technology of stereo. Its theory and operating techniques including recording, playback, broadcasting, simulcasting, multiplexing. Covers stereo discs and tapes with a unique and practical approach. 224 pages.

No. 80 Paperback \$2.90*

MONTHLY SPECIAL! SAVE \$5.25

Save over 45% with this collection of AUDIO Books.

Handbook of Sound Reproduction (\$3.75) "best of AUDIO" (\$2.00)

McProud High Fidelity Omnibook (\$2.50)

Tape Recorders & Tape Recording (\$2.95)

TOTAL VALUE OF ALL FOUR BOOKS \$11.20

Your cost ONLY \$5.95 POSTPAID

This offer expires July 31, 1962. Good only on direct order to Publisher
CIRCLE OS300

Installing Hi-Fi Systems

Jeff Markell & L. J. Stanton

Full of practical hi-fi installation knowhow that eliminates installation headaches before they start. Covers every aspect of the job—electrical work, all types of enclosures, acoustics, room layout, special stereo requirements, etc. Valuable for hobbyists and custom installers. 224 pages.

No. 86 Paperback \$3.20*



AUDIO Bookshelf — RADIO MAGAZINES, INC.

P. O. Box 629, Mineola, New York

Please send me the books I have circled below. I am enclosing the full remittance of \$..... (No C.O.D. or billing.)

58 64 66 79 80 86
110 112 115 123 124 OS300

NAME _____

ADDRESS _____

CITY _____ ZONE _____ STATE _____

*All U.S.A. and CANADIAN orders shipped postpaid. Add 50¢ for Foreign orders (sent at buyer's risk).

"The AUDIO Cyclopedia"

Howard M. Tremaine

Here is one single volume with the most comprehensive coverage of every phase of audio. Concise, accurate explanations of all audio and hi-fi subjects. More than 7 years in preparation—the most authoritative encyclopedic work with a unique quick reference system for instant answers to any question. A vital complete reference book for every audio engineer, technician, and serious audiophile.

• 1280 pages
• 3400 topics
• 1600 illustrations



No. 123 \$19.95*

realizing that I do so only for my own amazement.

Performance of the woofer, when driven by different combinations of high-quality components is soul satisfying. Organ lows are sharply defined and can be felt as well as heard. That one statement, in my not over-humble opinion, is more informative than pages of curves. What curves do not reveal is often more important than what they are intended to prove. Furthermore many published curves appear to have been drawn by an astrologer.

A-B tests were made between the speaker described and one with 15 pounds of magnet alternated in a 10-cubic foot bass-reflex enclosure. The same cone was transferred from one basket to the other. A good 12-inch speaker was used as a microphone, transformer-coupled to an ultra-linear amplifier. When driven by the same signal strength the heavier speaker produced almost five db more output than its lighter brother.

Comparison with an outstanding make of bookshelf woofer strengthened my preference for the king-size units. Male listeners agreed with me. But the ladies—ah-h-h-h. They demanded that a home reproduction system must look like something else or be either miniscule or invisible. Preferably invisible.

Makers of full-size speaker systems can easily reverse this trend. They need only instruct Madison Ave. to flood women's magazines with photos of socialites posed before oversized speaker cabinets. This would create an immedi-

ate demand for large systems, possibly disguised as grand pianos, and put home reproduction back up on the high level it had reached before stereo brought miniaturization.

Speaker shrunkeners may possibly be up against an obstacle which is more aerodynamic than acoustic. Perhaps there is more to accurately reproducing a 30-cps fundamental than simply pumping sufficient air into motion.

Any tone is maintained for a definite time interval ranging from milliseconds to minutes. A 10-inch cone must move more than one inch to reproduce 30 cps at 250 acoustic milliwatts. In the same elapsed time an 18-incher will give an equal output while moving only about 0.2 of an inch. Can it be that turbulence or even cavitation within the rapidly pulsing small cone modifies its tone?

Research into this possibility, by using smoke or vapor, suitable lighting and a high-speed camera, might be enlightening. The published findings, however, would never restore large speaker systems to their former popularity with the speed of a Madison Ave. prestige campaign.

Any resemblance to slide rule, integral calculus, or engineering in the foregoing conclusions and statements is purely coincidental. All are the result of rule of thumb "figgerin'."

That confession may benefit my soul but it fails to diminish my love for a large woofer in a large enclosure. Lush bass rolling smoothly from one of the big fellows stirs me inwardly exactly as does the bass drum with a military band. \AA

LOW POWER STEREO AMPLIFIER

(from page 28)

proper type is connected across the output terminals of the amplifier, and this load is shunted by the scope. So far this is, of course, normal test procedure. The input is connected to a d.c. source which can be interrupted by some sort of switch. A telegraph key is excellent for this purpose. The input d.c. voltage is adjusted to that value which was found to give maximum power output from the amplifier commensurate with low distortion. This voltage is alternately applied and removed by means of the switch, and the trace from this is observed on the scope face. There should be only a slight, sharp blip on the tube's face each time the current is applied and removed—in the ideal amplifier. Some amplifiers will show several cycles, each one of which has a lower amplitude than its predecessor. The amplifier described in this article showed approximately one such cycle, which is excellent.

I believe that it is also in order to mention that the power output was

measured using an ohms reading. No attempt was made to measure with "music" output; I believe that this entire concept is misleading. If the amplifier is of fine quality, there will be no difference between the "music output" rating and the conventional methods of measuring power output.

You may ask what the reason for this is. Well, the music output is taken as follows: The amplifier is set to read an output of x per cent distortion. A reading is then taken of the plate voltage, with the signal still applied. Before the signal is introduced, the plate voltage is measured. If there is any difference in plate voltage, the difference is then made up and a new test is run. Naturally, somewhat more output can be obtained in this manner. The procedure is then repeated until the absolute maximum is reached. This kind of thing can make a poor amplifier have the same power output as a fine one. A fine amplifier will exhibit little plate voltage

UNEQUALLED PERFORMANCE

The unique feature that makes SCHOEPS audibly superior to all other microphones is its patented multiple-pattern, single metal diaphragm construction. It guarantees the smoothest high frequency response and highest front-to-back discrimination in the cardioid pattern.

BEST! Transient response — low inertial diaphragm system means clearest definition at highest level.

BEST! Frequency response — no high frequency peaks to cause shrillness.

LOWEST DISTORTION! Never exceeds 0.3% at sound pressure levels to 115dB. Switchable attenuator; 15dB before preamplifier.

FRONT TO BACK RATIO — Highest wideband rejection over the important midrange: at least 26dB.

COMPARE THE SCHOEPS in your own studio or on location. You will find the Schoeps system vastly superior to any condenser microphone. Write or phone for demonstration. Literature available on request.



International Electroacoustics
Inc.

333 Sixth Ave., New York 14, N. Y.
212 WAtkins 9-8364

The FAIRCHILD 661

AUTO-TEN®

... A NEW REVOLUTIONARY
AUTOMATIC ATTENUATOR*



The new Fairchild Model 661 AUTO-TEN now becomes your "third hand" for complex mixing and level control problems. This completely transistorized automatic attenuator can perform level control functions many times faster than the speed of the human hand.

The attack time of 40 milliseconds and the variable release time of from .3 seconds to 7 seconds assures greater flexibility, accuracy, and reliability. The Fairchild 661 handles impedances from 150 to 47,000 ohms without distortion or frequency discrimination and can automatically attenuate up to 60 db. The Fairchild 661 is the ultimate solution to:

- Noise reduction in film recording and multi-track tape playback
- Maintaining silence in LP spirals
- Automation of broadcast channels
- Improvement of separation in studios
- Minimizing feedback in PA systems.

Fairchild 661 AUTO-TEN \$125.00

*Patent Pending.

Write for complete descriptive literature

FAIRCHILD

RECORDING EQUIPMENT CORPORATION
10-40 45th Ave., Long Island City 1, N. Y.

YOU SAVE MONEY!

RUSH US YOUR
LIST OF HI-FI
COMPONENTS
FOR A SPECIAL
QUOTATION
WRITE FOR FREE
AUDIO DISCOUNT
CATALOG A-15

New low prices on amplifiers, tuners, tape recorders, speakers, etc.

KEY ELECTRONICS CO.
120 LIBERTY ST.
NEW YORK 6, N.Y.

BOUND VOLUMES

1961 Issues
Audio Magazine

Order Now

LIMITED NUMBER
AVAILABLE

\$10.00 EACH POSTPAID
U. S. DELIVERY ONLY

Send Order
and Remittance Today

Book Division
Radio Magazines, Inc.
P.O. Box 629
Mineola, N. Y.

fluctuation with or without signal, while the poorer amplifier will exhibit a marked voltage fluctuation. This difference is compensated for during the test, and that is why I said the poorer amplifier is given a better chance than it deserves.

To be perfectly fair about it, the proponents of this test procedure believe that the voltage will not sag during actual use of the amplifier. They contend that the amplifier draws its peak power in program peaks, and the charge on the capacitors will be sufficient to handle such peaks. Whether this is true or not, the amplifier is given the benefit of the doubt in this test, and it does allow a claim for a higher power rating than would otherwise be possible. Perhaps this is all right as long as everyone plays the game, but the poorer amplifier nonetheless has an advantage always which it could not and probably should not enjoy.

For this reason I included the voltage regulation of the amplifier, measured with both channels operated at full power output: 14 watts per channel.

All other tests were standard and will not be discussed for that reason.

Experiments were performed with the channel containing the balance feature, and it turned out that the distortion figures for that channel were the same as for the one which was a straightforward circuit, and this was true regardless of the setting of the balance control, from maximum to minimum.

It should also be mentioned that the signal-to-noise ratio was taken at a power level of one watt so that a more realistic picture of the amplifier performance would be obtained. A somewhat higher figure could have been obtained at the maximum output of 14 watts, but I assume that average listening level is one watt or less, so used that figure in the tests.

An amplifier capable of this kind of performance can be used with the most inefficient speakers available. An amplifier with higher power, but at the cost of higher distortion, would probably not be used to supply more than this 14 watts of relatively distortionless output to the speaker. Some of the speakers used in association with this amplifier are quite inefficient, but can be easily operated with this amplifier.

Well, there it is. Build it and use it well. I have gone into considerable detail in this article to show you some of the workings of a designer's mind. After following the various steps in my reasoning in building the unit, you probably will appreciate the new stereo power amplifier kit you were thinking of buying, and can send a few good wishes to some of the engineers whom most of us never think of when we put the plug into the wall socket and listen.

CLASSIFIED

Rates: 10¢ per word per insertion for noncommercial advertisements; 25¢ per word for commercial advertisements. Rates are net, and no discounts will be allowed. Copy must be accompanied by remittance in full, and must reach the New York office by the first of the month preceding the date of issue.

HIGH FIDELITY SPEAKERS REPAIRED
AMPRITE SPEAKER SERVICE
168 W. 23rd St., New York 11, N.Y. CH 3-4812

ENJOY PLEASANT SURPRISES? Then write us before you purchase any hi-fi. You'll be glad you did. Unusual savings. Key Electronics, 120 Liberty St., New York 6, N.Y. CLOverdale 8-4288.

PROFESSIONAL RECONDITIONING all audio and recording equipment. Low prices on components with service. Best trade-in deal in the country. Dick Simms, Audio Trading Post, Inc., 58 W. 48 St., New York 36, N.Y. JUDson 2-2356, 2nd Floor.

WE RENT STEREO TAPES: both 2- and 4-track; all labels. Over 2500 different. FREE BROCHURE. Stereo-Parti, 811R Centinela Ave., Inglewood, California.

HIGH FIDELITY DEALERS AND SERVICE MEN: earn big profits from a professional approach to sound reproduction. A card or letter brings full information. No obligation. WILLIAM N. GREER ASSOCIATES, Consulting Engineers, El Imparcial Building, San Juan, Puerto Rico.

SALE ITEMS—tapes—recorders—component quotes. Bayla, Box 131-0, Wantagh, N. Y.

FOR SALE: RCA FM-AM tuner, ST-4. 13 tubes, perfect condition. Cost \$150, will sell \$75 or best offer. Rek-O-Kut T-12 two-speed turntable, excellent, cost \$85, will sell \$50. Al Hawkes, Hardy Road, Westbrook, Maine.

SELL OR SWAP: Two hysteresis recording motors; one new, 900 rpm, \$20; one rebuilt, 900 and 1800 rpm, \$15. J. H. Moore, P. O. Box 2514, Tulsa 1, Oklahoma.

BEST OFFER: Ampex recorder 601-2, Rek-O-Kut Imperial disc cutter with accessories, 10 mikes, stands, mixers, 1000' mixed length mike cable with connectors, transformers, etc. Goodman, 10 Woolson St., Mattapan, Mass. CY 6-7332.

SELL: Ampex 401A professional portable tape recorder, full-track, \$800; Shure 558 dynamic microphone, desk stand, \$35. V. R. Hein, 418 Gregory, Rockford, Ill.

FOR SALE: Lansing Hartsfield, \$375; Lansing C-34 with 375, 537-509, 150-4C, \$275. Plus crating and shipping. Pair Mk II Kelly ribbon tweeters, crossovers, \$120. Marantz Model 8, grille \$210. W. Torgeson, 6425 12th Ave. S., Minneapolis 23, Minn.

TERRIFIC BUY for organ music enthusiast! Latest Altec Lansing theater sound system sacrifice for \$250; cost over \$550. A. Zentz, 4008 Joliet Avenue, Lyons, Ill. Phone HI 7-3020.

REL 646 B FM tuner, \$150. Colbert three-way electronic crossover, \$45. High-quality Western Electric tweeters, small horn with drivers, \$45. Otto Fichtman, 600 Timpson Place, Bronx 55, New York.

WANTED: Used Magnasync, dummies, interlock, Box CG-1, AUDIO, P. O. Box 629, Mineola, N. Y.

Three QUAD electrostatic speakers, newly overhauled by manufacturer, \$200 each; three, \$500. Two Janszen Z-400's, \$90 each, both, \$160. Dourian, 2020 F St., N. W., Apt. 231, Washington 6, D. C.

LP RECORDS FROM YOUR TAPE. 40 minutes, \$6, p. p. Write for quantity prices. Quick service. Custom Recording, 923 Kansas Avenue, Kansas City, Kansas.

AUDIO ENGINEER

Hi Fi design experience for expanding department of leading kit manufacturer. Send resume to:

DYNACO, Inc.
3912 Powelton Ave., Phila. 4, Pa.

FMI/Q ANTENNAE

THE FINEST OF ITS KIND . . .
Get more FM stations with the world's most powerful FM Yagi Antenna systems.

To be fully informed, send 30¢ for book "Theme And Variations" by L. F. B. Carini and containing FM Station Directory.



APPARATUS DEVELOPMENT CO.
WETHERSFIELD 9, CONN

CIRCLE 55C

ELECTRONIC WORLD HI-FI RECORDING TAPE

Splice Free—Guaranteed 1st Quality
15-day Money Back Guarantee

		3-23	24+
22A	3"	225' Acetate .45	.39
50A	5"	600' Acetate .74	.67
90M	5"	900' Mylar 1.11	.99
12A	7"	1200' Acetate 1.09	.99
12M	7"	1200' Mylar 1.19	1.09
18A	7"	1800' Acetate 1.59	1.45
18M	7"	1800' Mylar 1.99	1.85
24M	7"	2400' Mylar 2.59	2.49

Add 15¢ Per Reel Postage & Handling—10¢ 24+ Reels
Any ast. permitted For 24+ price.
Don't Buy Any Hi-Fi Components or Tape Recorders until you get our Low, Low Return Mail Quotation.
Generous Trade-In on Old Equipment. WE GUARANTEE WE WILL NOT BE UNDERSOLD. Easy Pay Plan Up to 24 mos. to pay.
CATALOG AND BEST BUY LIST FREE.

ELECTRONIC FAIR
Dept. U—1797 1st Ave., New York 28, N.Y.

CIRCLE 55D

AUDIO unlimited

Specializes in SAVING YOU MONEY

- ✓ FACTORY FRESH COMPONENTS
- ✓ LOWEST POSSIBLE QUOTATIONS
- ✓ FAST DELIVERY

We are FRANCHISED DEALERS for most Hi-Fi lines. Most orders SHIPPED PROMPTLY from stock. RECORDING TAPE at LOWEST PRICES. FREE 95 Page STEREO CATALOG.

190-A Lex. Ave., Cor. 32
St., New York 16, N. Y. Visit Our Showroom

CIRCLE 55E

HI-FI RECORDING TAPE

Splice Free (except 2400') Fren. Resp.;
20, 20,000 cps. 15 day money-back guarantee

	3-11	12-23	24+
1200' 7" Acetate	\$1.29	\$1.17	\$.99
1800' 7" Acetate	1.79	1.59	1.45
1800' 7" Mylar	1.99	1.95	1.85
2400' 7" mylar	2.69	2.59	2.49
2400' 7" tensilized mylar	2.99	2.95	2.90

Can Be Assorted. Add 15¢ Postage Per Reel
10¢ for 24+ Lot Orders

HI-FI COMPONENTS, TAPE RECORDERS

- Same Day Shipment • Best-By-Comparison Prices •
- Factory Sealed Cartons • Send for "Quotes" on Package Deals and Save More • Write for Monthly Specials

125-N EAST 88 ST. NEW YORK 28, N. Y.

CARSTON Studios
CIRCLE 55F

CANADA
High Fidelity Equipment

Complete Lines • Complete Service
Hi-Fi Records — Components
and Accessories

ELECTRO-VOICE SOUND SYSTEMS

126 DUNDAS ST. WEST. TORONTO, CANADA

CIRCLE 55G

This amplifier was designed with my own special needs in mind, but I did take into account its general use once I decided to write it up. In the same manner, a manufacturer is faced with the problem of trying to please everybody and do it competitively. Some people want simplicity while others wish elaborate flexibility and myriad input connections. I hope that you can look upon an amplifier or whatever with the knowledge that much work went into its development. Maybe there is something about it that you do not like, but that something may be just the thing for which someone else bought that same piece of equipment.

That is where the fun of building your own unit comes in. What I have given here are my own ideas of how a unit might be conceived and built. Perhaps there are features which you want added. Perhaps you wish to take away something from the unit. Maybe you have a preamplifier with a stereo focus control, and so you do not need the balance feature. In that case you can adjust each channel to have 20 db of feedback. *J*, can be removed then.

Perhaps you will not want a level control in each channel. You can use a fixed load resistor instead, and with a voltage divider you can provide two input connectors, one for full sensitivity of the amplifier and one for reduced sensitivity.

Certainly you may wish to change the power supply system used here. Perhaps you have a power transformer from an old TV receiver. This will work very well, but you will have to allow for the extra space in the layout required by this type of transformer and its associated components. The diodes probably will have to go unless you use several of them in series in each branch of the full-wave rectifier. If you elect not to use the diodes, you must revert back to the tube-type rectifiers and the heat from them must be taken into account.

Perhaps some of you are not interested in stereophonic reproduction. In this case you need build only one of the channels.

These are but a few of the possible variations of the simple amplifier circuit. If some one of them appeals to you, try it. It seems to me that an article is merely a springboard for one's own thinking. More can be learned by adapting it than can be learned by adopting it.

TAKE THE TIME

... to write to us and we will show you how to keep your HI-FI COSTS LOW!

BRITISH EQUIPMENT — Amplifiers, Tuners, Speakers, Motors, Pick-ups from the United Kingdom HI-FI Mail Order Specialists carefully packed, insured and shipped promptly at minimum cost.

C. C. GOODWIN (SALES) LTD. (Dept. A)
7, The Broadway, Wood Green, London N.22, England.

CIRCLE 55H

NEW! Garrard DUST COVER

Hard-molded from clear vinyl
... to protect your Garrard from dust and accidents



\$4.95

Model #	Fits Garrard Models
DC 1 (Illus.)	Model 210
DC 2	RC 88 and Model 88 mk II
DC 3	Type A
DC 4	Model AT6
DC 5	Autoslim

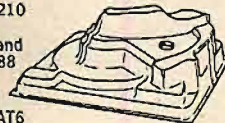

NOW AT YOUR DEALER

Garrard Sales Corporation, Port Washington, N. Y.
CIRCLE 55A

Partridge P5201

SPECIFIED

in the article by Joseph Giovannelli — see "High Quality Low Power Stereo Amplifiers" this issue. \$29.95



\$29.95

... the Output Transformer with a guarantee of better listening ...

This superb Partridge made Transformer — widely used all over the world in high quality equipment — is available from stock from the Partridge New York Agents (address below). Ask now for full details and free catalogues of the complete range.

Write now to:

ULTRA ELECTRONICS INC.

235 East 60th Street, New York, 22
Made by: Partridge Transformers Ltd.,
Roebuck Road, Chessington,
Surrey, England.

CIRCLE 55B

LAFAYETTE

STEREO HI-FI COMPONENTS

Designed for the Home Engineered To Professional Standards



DEDICATED TO MUSIC

Made in U.S.A.

LAFAYETTE LT-700

Criterion FM STEREO MULTIPLEX TUNER

NO MONEY DOWN **124.50**

Ready for Stereo and no Adapter Needed . . . opening a new era in stereo, the new Lafayette Criterion FM Stereo Multiplex Tuner is entirely self contained with its own built-in multiplex facilities. Capable of achieving the highest



Completely Wired and Tested

Laboratory Standards, its exceptional selectivity and sensitivity together with drift-free AFC performance insures effective reception of even the weakest multiplex or monaural FM signals.



Made in U.S.A.

KT-250A 50-WATT INTEGRATED STEREO AMPLIFIER

KT-250A **74.50** in Kit Form
LA-250A **99.50** Completely Wired

- 3rd Channel Output
- Separate Bass & Treble Controls
- 50-Watts Monophonically - 25 Watts Each Stereo Channel
- Response: 15-40,000 cps \pm 5 db (at normal listening level)

Pacesetter quality, performance and design. Features include: unique "Blend" control for continuously variable channel separation—from full monaural to full stereo, 4-position Selector, Mode, Loudness and Phase switches. Also provides outputs for 4, 8, and 16 ohm speakers. Hum-free operation is insured by use of DC on all pre-amp and tone control tubes. Individual bias and balance controls. Harmonic distortion, less than 0.25%. IM distortion, less than .5%. Hum and noise 77 db below full output. 14 1/2"W x 12 3/4"D x 5 1/2"H. Shpg. wt., 28 lbs.

KT-600A Criterion PROFESSIONAL STEREO CONTROL CENTER

KT-600A **79.50** In Kit Form
LA-600A **134.50** Completely Wired

- Response 5-40,000 cps \pm 1 db
- Precise "Null" Balancing System
- Bridge Control Provides Variable 3rd Channel Output
- Variable Cross Channel Signal Feed Eliminates Hole-In-The-Middle Effects
- Tape Head Playback Equalization for 4-Track Stereo

Sensitivity 2.2 mv for 1 volt out. Dual low impedance "plate follower" outputs 1500 ohms. Less than .03% IM distortion; less than .1% harmonic distortion. Hum and noise 20 db below 2 volts. 14x10 1/2"x4 1/2". Shpg. wt., 16 lbs



Made in U.S.A.



KT-550 **134.50** In Kit Form
LA-550 **184.50** Completely Wired

KT-550 Criterion 100-WATT BASIC STEREO AMPLIFIER

- Rated at 50-Watts per Channel
- Response from 2-100,000 cps; 0-1 db at 1-Watt
- Massive Grain Oriented Silicon Steel Transformers
- Multiple Feedback Loop Design (over 50 db)
- Metered Calibration Control Panel
- Absolutely Stable Under Any Conditions of Load

A new "Laboratory Standard" dual 50-watt amplifier guaranteed to outperform any basic stereo amplifier on the market. Advanced engineering techniques plus the finest components ensure flawless performance. Distortion levels so low they are unmeasurable. Hum and noise better than 90 db below 50-watts. Complete with metal enclosure. 9 1/4"H x 12 1/2"D. Shpg. wt., 60 lbs.

LAFAYETTE RADIO Dept. AG-2, P.O. Box 10, Syosset, L. I., N.Y.

Name _____
Address _____
City _____ Zone _____ State _____



LAFAYETTE RADIO OTHER LOCATIONS
NEW YORK 13, N.Y. | JAMAICA 33, N.Y. | BRONX 58, N.Y.
NEW MAIL ORDER AND SALES CENTER. SYOSSET, LONG ISLAND, N.Y. NEWARK 2, N.J. | PARAMUS, N.J. | PLAINFIELD, N.J. | BOSTON 10, MASS.

ADVERTISING INDEX

Acoustic Research, Inc.	10
Altec Lansing Corporation	41
Apparatus Development Co.	55
Audio Bookshelf	52
Audio Devices Inc.	5
Audio Fidelity Records	39
Audio Unlimited	55
Bell Telephone Laboratories	18
Benjamin Electronic Sound Corp.	11
British Industries Corporation	55
Carston Studios	55
Classified	54
Dynaco, Inc.	6
EICO	13
Electro-Voice, Inc. Cov. IV, 30,	31
Electro-Voice Sound Systems	55
Empire Scientific Corporation Cov. II	50, 54
Employment	50, 54
Fairchild Recording Equipment Corp.	53
Fidelitone	50
Finney Company	50
Fisher Radio Corporation	9
Garrard Sales Corp.	55
Goodwin, C. C. (Sales) Ltd.	55
Gotham Audio Corp.	40
Grado Laboratories, Inc.	2
Harman-Kardon	44
Heath Company	35
Hi Fidelity Center	55
International Electroacoustics Incorporated	53
Key Electronics Company	54
Lafayette Radio	56
Lansing, James B., Sourd, Inc.	37
North American Philips Co., Inc.	51
Partridge Transformers, Ltd.	55
Pickering & Company, Inc.	17
Pilot Radio Corporation Cov. III	111
Pioneer Electronic Corp.	15
Schober Organ Corporation	49
Scott, H. H., Inc.	50
Scully Recording Instruments Corporation	7
Sherwood Electronic Laboratories, Inc.	1
Shure Brothers, Inc.	43
Sonotone Corporation	45
Sonovox Co., Ltd.	50
Superscope, Inc.	3
Tandberg of America, Inc.	14
Ultra Electronics, Inc.	55
University Loudspeakers	47

Only these FM Stereo Receivers have Pilot's unique signal-sampling multiplex circuit*

You get the best possible FM Stereo reception because PILOT's unique signal-sampling multiplex circuit gives you maximum separation (30 db or better) across the entire audio spectrum. It is the simplest, most effective, most trouble-free circuit presently being manufactured for stereo demodulation. There are no troublesome frequency separation filters and matrices or extra controls as are required by other multiplex circuits. This is just one of the many features that make PILOT Stereo Receivers the perfect electronic "heart" for your high-fidelity system.

* Patent Pending



PILOT 602M...30 watts music power...frequency response 20-20,000 cycles, ± 1 db...harmonic distortion 1% at full power...12-control flexibility...FM sensitivity 3 uv IHFM...wide band RF and IF circuits for undistorted reception at full modulation...6 inputs...5 1/4" high x 14 1/2" wide x 10 3/4" deep. With cover... **249⁵⁰**

(Also available with added AM as Model 602S. Complete, 299.50)



PILOT 654M...60 watts music power (IHFM mid-band rating)...frequency response 10-50,000 cycles plus 0.5 db or minus 1 db...hum and noise: completely inaudible (80 db below full output)...intermodulation distortion: less than 0.3%...14 controls, including rumble and scratch filters...6 inputs...plus a fully automatic stereo indicator that lights on stations broadcasting FM stereo...5 1/4" high x 14 1/2" wide x 12 3/4" deep. Black and brass styling. With cover... **329⁵⁰**



PILOT RADIO CORPORATION, 37-36 36TH STREET, LONG ISLAND CITY 1, NEW YORK

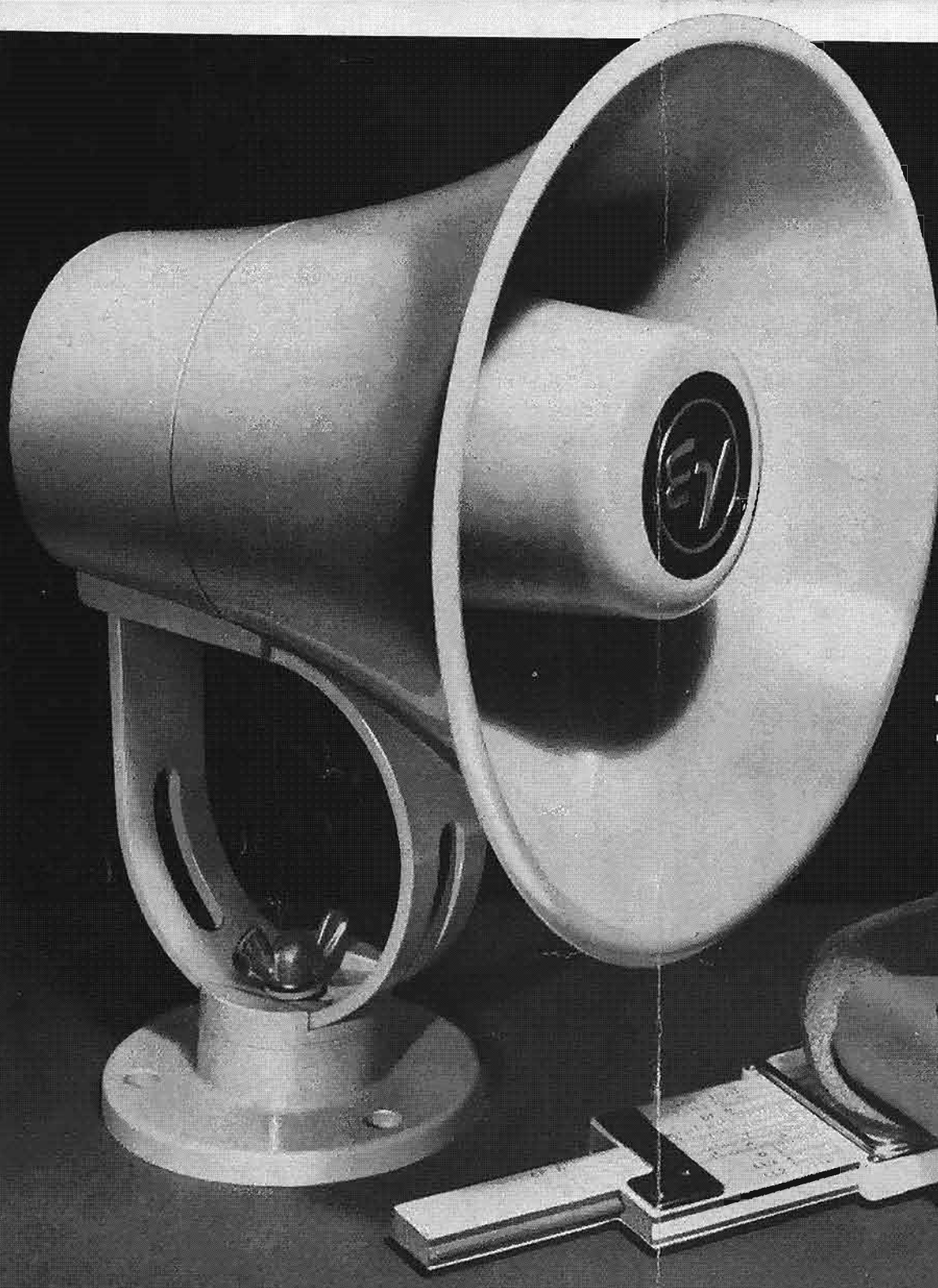

Take
a
close
look
at
the
new
ELECTRO-VOICE
PA7

A Bold Departure in Paging Speakers!

Look carefully at the new Electro-Voice PA7 paging speaker. The speaker that defies tradition to give you more value than any other paging unit on the market!

Even the horn is new! Molded of tough, unbreakable Cycolac* plastic, it outlasts metal yet doesn't "ring" like ordinary bells. And the color is molded in. Fading, peeling, rusting problems are gone forever!

Inside, a brand new ring-type diaphragm of fiberglass-reinforced Acoustalloy® provides the authoritative voice of the PA7. Unusually high efficiency is coupled with smoothly rising response and low distortion. Test it with voice—even music! This is crisp, commanding sound that puts even larger speakers to shame!

Although the PA7 is light in weight, the ingenious swivel mounting is strictly heavy-duty for quick, absolute positioning anywhere . . . mobile or fixed!

Every detail of design and performance of the PA7 reflects the refreshing, new ideas that have made E-V PA speakers the finest in the industry! Ideas that mean highest quality and reliability for you and your customers!

Measure this remarkable new paging speaker against your personal yardstick of quality. No matter how critically you judge the Electro-Voice PA7, you'll find it's better than you expected. Except the price. That's much better!

*T. M. Borg-Warner



SPECIFICATIONS: Frequency Response 400-13,000 cps, Sound Pressure Level 119 db (at 4' on axis, 7.5 watts input, 2-4 kc), Power Handling Capacity 7.5 watts, Impedance 8 ohms, Dispersion 120°, Size 6 1/2" diameter x 6" deep, Weight 2 lbs.

\$27.00 LIST
(Normal trade discounts apply)

ELECTRO-VOICE, INC.
Commercial Products Div., Dept. 726A
Buchanan, Michigan

 ... THE SMART MOVE IS TO ELECTRO-VOICE!

