

# AUDIO

AUGUST, 1960  
50¢  
BUYER'S GUIDE ISSUE

*...the original magazine about high fidelity!*



# RCA-6EU7

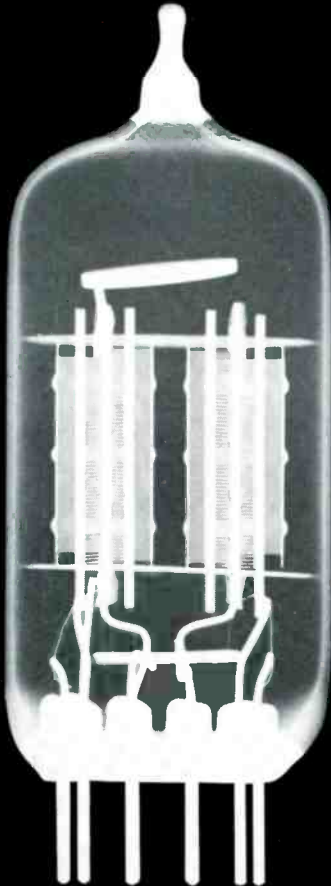

## ...A NEW LOW-NOISE TWIN TRIODE

### to improve performance and simplify the design of Audio Pre-Amplifier Stages

Low noise, high performance, moderate cost—provided by the new RCA-6EU7, a high-mu, nine-pin miniature twin triode designed especially for high-gain, resistance-coupled, audio pre-amplifier stages—in high fidelity amplifiers (monaural or stereo), amplifier kits, tape recorders, juke boxes, and public address systems.

**Noise and hum are minimized** by the use of double-wound, helical heaters, and a new base layout which keeps heater leads well away from the grid leads.

**Low microphonism, high mechanical strength, and reliability** are assured by a short, rugged cage which provides sturdy support for the tube electrodes.

**New base arrangement also simplifies stereo layouts.** The accompanying diagram shows how the basing arrangement facilitates the design of an amplifier using the two triode units for isolated stereo channels.

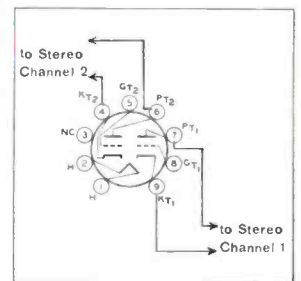

For technical information, contact the RCA Sales Representative at our office nearest you, or write directly to RCA Electron Tube Division, Commercial Engineering, Section H-91-DE, Harrison, New Jersey.

**EAST:** 744 Broad Street, Newark 2, N. J. HUmboldt 5-3900. **MID-WEST:** Suite 1154, Merchandise Mart Plaza, Chicago 54, Ill. WHitehall 4-2900. **WEST:** 6355 E. Washington Blvd., Los Angeles 22, Cal. RAymond 3-8361.



The Most Trusted Name in Electronics  
RADIO CORPORATION OF AMERICA

# AUDIO

ENGINEERING MUSIC SOUND REPRODUCTION

**C. G. McProud, Editor and Publisher**  
 Henry A. Schober, Business Manager  
 Janet M. Durgin, Production Manager  
 Edgar E. Newman, Circulation Director

**Sanford L. Cahn, Advertising Director**  
 Midwest Representative—  
*W. A. Cook and Associates*  
 230 East Ohio Street, Chicago 11, Ill.  
 West Coast Representative—  
*James C. Galloway*  
 6535 Wilshire Boulevard, Los Angeles 48, Calif.



**CONTENTS**

Audioclinic— <i>Joseph Giovanelli</i>	2
Letters	6
Light Listening— <i>Chester Santon</i>	8
Audio ETC— <i>Edward Tatnall Canby</i>	10
Editor's Review	16
Microphone Calibration— <i>Dan Peters</i>	19
1.02 Cubic Feet and 45 cps.— <i>Richard Sequerra</i>	20
Start with Mono—Build up to Stereo— <i>C. F. Barton</i>	22
<b>BUYERS' GUIDE SECTION</b>	
Amplifiers and Preamplifiers	23
Tuners	27
Loudspeakers and Enclosures	41
Record Changers	50
Turntables	52
Pickup Arms	56
Phono Pickups	58
Tape Recorders	89
Tape Accessories	92
Microphones	92
Miscellaneous	93
Electronic Organ Kit	95
Tape Guide—Equalization— <i>Herman Burstein</i>	28
Record Revue— <i>Edward Tatnall Canby</i>	60
Jazz and All That— <i>Charles A. Robertson</i>	66
About Music— <i>Harold Lawrence</i>	78
AUDIOMAN No. 11— <i>James S. Swinehart</i>	88
Advertising Index	96

**COVER PHOTO**—Living room stereo demonstration in the display of British Industries Corporation at the recent British Exhibition U.S.A. during June. The visitor entered the complete display at the lower right corner of the photo, climbed a few steps and proceeded along the raised passage seen at the left. While listening to properly reproduced stereo music from the equipment on display, he could observe a lucid description of each element of a home system as detailed on easy-to-read placards with suitable illustrations. As he passed out of the living-room area, he saw a display of the non-hi-fi products imported by British Industries Corporation. The equipment used in the display consisted of a Garrard 88 changer, Leak tuner and Leak amplifier installed in a River Edge chairside table, with two Wharfedale speakers opposite. The entire display was designed by Rex Frey of Lord & Taylor, New York.

**AUDIO** (title registered U.S. Pat. Off.) is published monthly by Radio Magazines, Inc., Henry A. Schober, President; C. G. McProud, Secretary, Executive and Editorial Offices, 204 Front St., Mineola, N. Y. Subscription rates — U. S. Possessions, Canada, and Mexico, \$4.00 for one year, \$7.00 for two years, all other countries, \$5.00 per year. Single copies 50¢. Printed in U.S.A. at 10 McGovern Ave., Lancaster, Pa. All rights reserved. Entire contents copyrighted 1960 by Radio Magazines, Inc. Second Class postage paid at Lancaster, Pa.

**RADIO MAGAZINES, INC., P. O. Box 629, MINEOLA, N. Y.**  
 Postmaster: Send Form 3579 to **AUDIO, P. O. Box 629, Mineola, N. Y.**

only for those who want the ultimate

**SHERWOOD**  
 "TOP RATED"  
 again and again  
 —and NOW AGAIN!



Model S-5000, 20+20 watt "stereo"  
 Dual Amplifier-Preamplifier, Fair Trade Price—\$189.50



Model S-2200, FM-AM-MX Stereo tuner,  
 Fair Trade Price—\$179.50



**AMERICAN AUDIO INSTITUTE**  
 194 EAST 194 ST. PATERSON 4, N. J.

October 27, 1959

Sherwood Electronic Labs., Inc.  
 4300 North California Avenue  
 Chicago 18, Illinois

Gentlemen:

We find that the incorporation of a center-channel output and a damping factor selector in July, 1959, increases the Summary Rating of the Sherwood S-5000 to the highest of all 18 Stereo Amplifiers tested in the AAI Evaluation Test Reports.

Sincerely,

AMERICAN AUDIO INSTITUTE

*Felix R. Brey*  
 Felix R. Brey  
 Executive Director

The "Most honored of them all" S-5000 stereo amplifier-preamplifier is joined by the S-2200 stereo tuner. As with its "Top Rated" predecessors, the S-2200 features FM "Interchannel Hush" plus push button selector, internal plug-in adaptor for Stereo FM Multiplex, 2 "Acro-beam" tuning indicators, simulcast FM/AM stereo. All Sherwood tuners feature FM sensitivity below 0.95 microvolts and 1/2% distortion @ 100% FM. For further details write: Sherwood Electronic Laboratories, Inc., 4300 N. California Avenue, Chicago 18, Illinois.

For complete specifications write Dept. A-8.



for the finest in high fidelity kits

# ACROSOUND

These popular Acrosound kits are simple and fast to assemble . . . bring the newest sound advancements into your home in a matter of hours! Best of all, Acrosound's easy-to-build, reasonably priced kits save you dollars!



## ACRO'S PREAMPLIFIER

A new all feedback preamplifier with low noise, 2 MV referred to phono input, high gain, 60 DB phono and tape, and low distortion, 0.15% 1M for 1.5V out. Extra features include individual bass and treble controls, rumble and scratch filters, phase switch, third channel output, light matrix, and exclusive Mic. Dub switch. Supplied with two low noise 7199 pentode/triode, two 7247 dual triode tubes. **\$69.50** Factory Wired \$114.50

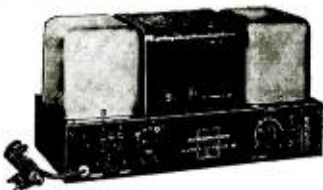

## ACRO'S ULTRA LINEAR II AMPLIFIER

This famous 60 watt basic amplifier has long been a favorite of discriminating audiophiles. Acro perfected Ultra-Linear circuitry has been combined with a unique feedback system to provide an amplifier with unusually low distortion, superior feedback stability, and finest transient performance. Construction time is only two hours. Supplied with two EL-34 output tubes, one 12AX7, one 12AU7, and GZ34 rectifier. **\$79.50** Factory Wired \$109.50



## ACRO'S STEREO 20-20 AMPLIFIER

A two channel stereo amplifier which provides a full 18 watts in each channel, or a total of 36 watts of low distortion stereo in your listening room. Distortion is only 1.5% 1M at 18 watts per channel, 0.5% at 16 watts. Excellent square-wave and transient performance. Supplied with four EL-84/6BQ5 output tubes, two 12AX7 driver tubes. Finest performance and lowest price for a dual amplifier. **\$69.50** Factory Wired \$99.50

write for information to:

**ACRO PRODUCTS CO.**  
410 Shurs Lane, Phila. 28, Pa., Dept. AUD-3  
Acro . . . the first name in audio!

# AUDIO clinic



JOSEPH GIOVANELLI\*

## Grounding a Home Music System

Q. (The following is a composite answer to two letters written on two different dates by the same reader. Each of these letters, of course, received a personal reply.)

Letter 1—I am putting my equipment into a cabinet in which I will have to cut several holes in the back for power leads, audio leads, etc. To make it neater, I have taken a Bud Minibox and arranged it for several power outlets. I have also taken another Bud Minibox and used other types of sockets for audio connections and antenna leads. My problem is that in using standard phono connectors I have used two wires, one from the center pin and one from the ground lug. Is there any danger of a ground loop because of the fact that the two phono connectors are connected on the ground side through the metal box itself?

Letter 2—I have now converted my system to stereo. I would now like to know what is the proper and complete way to ground the entire system and how it should be grounded to the 117-volt outlet box or waterpipe ground.

When I lift the tonearm to place it on a record, I get a hum until I remove my finger from the arm. Should the tonearm be grounded to the turntable? Will this get rid of the hum which occurs when the tonearm is touched?

I certainly would appreciate any help you can give me. I would like you to discuss this in your column some time, as I imagine quite a few people would be interested in this important part of a system.

Charles A. Hasek, Jr., Pittsburgh, Pa.

A. (1) After all your equipment has been properly mounted in the cabinet, link all chassis together with heavy bus wire, No. 12 or heavier. It should then be possible to mount all connectors to the Minibox and use both terminals on the connectors without getting into complications with ground loops. By so doing, hum conditions will be minimized and the shock hazard sometimes present when two chassis are touched simultaneously will be eliminated.

(2) In general, it can be stated that the turntable and tonearm should be grounded to the preamplifier which can be done by means of a phono connector plugged into one of the unused inputs, and the ground from the arm and table taken to the skirt of the connector. This will eliminate the hum which occurs when the tonearm is touched and will minimize the problem of static electricity.

\* 3420 Newkirk Ave., Brooklyn 3, N. Y.

3. Since hum and its causes are sometimes quite complicated, the problem of grounding any type of home music system to a waterpipe or radiator depends on the amount of hum and upon the nature of the hum. If the system runs perfectly well, do nothing at all about such grounding. I cannot say just how far to go with grounding the entire system to waterpipes and the like since sometimes this will aggravate a hum condition rather than relieve it. If any of the equipment you plan to use is of the a.c.-d.c. variety, do not ground it or any associated components to a radiator. Failure to observe this precaution is almost certain to cause a blown fuse and damage to your equipment.

## "Putter," Flutter and Tracking Force

Q. My main problem is as follows: I have an odd difficulty in the turntable. There are two objectionable sounds. One is that it has apparently more flutter in pitch at the center of records, as compared to the edge (this one really is strange, as flutter should be uniform if the turntable causes it) and it has an odd, "puttering" sound for a small part of a revolution on many records. It sounds as if it shakes the record a little. This "puttering" is much worse at a cold start, reducing to a much less noticeable amount after the motor warms up. It is much worse near the center of the records. If one increases the stylus force, the noise is suppressed. But I feel that it should not exist at all.

I will tell you what my investigation has shown: It is not caused by warped records. I proved this by putting a large rubber band under one side of the record, and no effect in pitch, no change in "puttering" took place. This nearly eliminated cartridge and arm as suspects. Also I turned the turntable with my finger, and at no speed did this "puttering" occur (I couldn't tell about the flutter here.) Since I never use the 45 speed, I interchanged the idler wheels. This also had no effect upon these two phenomena. The only things that I have not checked are the motor and idler rubber mounts. They may be too old. I cannot see how a motor of itself could cause these defects, since it runs so fast. If it runs at all, I should think that it would be satisfactory.

The trouble with something of this sort is that it is just bad enough to notice. If something really went wrong, it could be seen and adjusted.

Another, simpler question: How may one know if he is using enough tracking force? I presently use 4 grams. Three grams





*Progress Report #3 from Garrard Laboratories*

**THE FUTURE  
OF RECORD PLAYING  
HAS BEEN TURNING  
ON THIS MOTOR  
FOR THE PAST  
8 MONTHS**

*It's true. Behind the locked doors of the Garrard laboratories, our engineers have been testing some significant new gramophone motors. Someday you can expect one of them to establish its own standard of quiet efficiency, just as the present Garrard motors are doing today. When it is finally released, it will reflect all the arduous months of creative engineering that went into it. Our designers developed it out of a 40-year tradition of experimentation, the perfectionist tradition that has enabled Garrard to produce and provide so many of the meaningful advances in the world's finest record playing equipment.*

**Garrard**  
world's finest

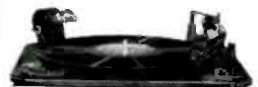

Sonotone's 1960  
census.....over

10,  
000,  
000

(yes, 10 million)

cartridges  
now in use!



Only a few years ago, Sonotone invented the ceramic cartridge... and has been setting sales records ever since. And no wonder! Over the years, Sonotone has developed its fine cartridge line to the point where today it's the standard of the industry. Models available for virtually every type of phonograph... used as original equipment by over 70 manufacturers. In fact, Sonotone has already sold over 10,000,000 cartridges. You'll hear the difference when you change to Sonotone ceramic or new crystal cartridges.

# Sonotone

ELECTRONIC APPLICATIONS DIVISION, ELMSFORD, N. Y., DEPT. C26-80.  
IN CANADA, CONTACT ATLAS RADIO CORP., LTD., TORONTO

LEADING MAKERS OF



BATTERIES • CARTRIDGES • SPEAKERS • TAPE HEADS • MIKES • ELECTRONIC TUBES

*seemed to sound just as good except on very heavy organ passages. More force does not seem to improve anything. Some records seem to be over-recorded.*

*Robert Tabony, Durham, N. C.*

A. Sometimes a phenomenon which sounds like "flutter or putter" is caused by the stylus being in poor contact with the disc. This, in turn, can be caused by a defective cartridge, too low a tracking force, a worn stylus, or a tracking error in the arm.

You have not necessarily eliminated tracking force as a factor. You stated that the condition disappears with increased tracking force. This could mean that, prior to the increased tracking force, the records were tracked too lightly.

It could also mean that the cartridge is defective and hence requires a greater than normal tracking force for adequate sound reproduction.

It may also mean that the stylus has worn and that it maintains adequate contact with the grooves only because of the added force. This will, in addition, cause severe record wear.

It could mean that the turntable is involved, though no "puttering" was heard when the turntable was spun with your finger. This does not preclude the possibility that the turntable well is defective or is in need of cleaning and lubrication. Remember that the angle of force applied by your finger is not at all the angle of force applied by the motor and idler assembly. This last consists, in addition to its rotational components, of a lateral component tending to push the turntable away from the idler. It is this lateral component which may show up the noise from the well assembly. The added tracking weight may exert a force on the turntable in such a direction as to cancel some of this lateral component.

You want to know how to determine correct tracking force. First you should use the cartridge manufacturer's recommendation as a guide. The tonearm with which the cartridge is used, however, will have some effect. When making the tests, be sure that the cartridge and stylus are in good condition. Play a record starting with the cartridge manufacturer's recommended force. Adjust tracking force above and below this value until the sound reproduction is at its best. Use the minimum force which will bring about this result. When selecting a suitable test record, avoid one which is seriously over-recorded. Such a record is difficult and sometimes impossible to track cleanly.

Going back to the major problem, I tend to suspect tracking error or stylus wear in preference to some of the other possible causes listed earlier. Tracking error will cause the force applied to the needle to be transmitted to the cartridge at such an angle that it will not exert maximum force upon the cartridge elements. This is the same as saying that the compliance of the cartridge has been decreased which can cause distortion in various forms, in addition to record wear.

The stylus can influence the quality of reproduction. When a stylus wears, it makes contact with more and more of the groove's surface. This restricts the freedom of the stylus to move. This will cause considerable record wear and can cause some very strange-sounding distortion, similar to that which you have described. This is especially true when the turntable has a slight vertical warping. Æ

AUDIO • AUGUST, 1960



# A TRIO OF TIMELY TRIUMPHS FROM AKG



of Vienna, long acknowledged one of the world's top designers and builders of professional transducers, who now bring to the quality-conscious amateur recordist Earwitness Fidelity in two superb new mikes and a remarkable new headset, all priced far below the level of their performance.

**NEW—D 11 N Dynamic Cardioid Mike** for the professional-minded amateur. Instant choice of high or low impedance for tube and transistor circuits—just plug in and record. Bass-attenuating switch to clarify speech—useful range 30 to 15,000 cps—sensitivity 2.5 mV  $\mu$ bar at 1 kc with high impedance—resistance to high humidity and close-talk overload—rugged, attractive two-tone plastic case with table stand—user net \$34.95.

**NEW—C 14 Condenser Omnidirectional Mike** for the multitudes who could not previously afford the unique characteristics of this outstanding type of microphone. Extraordinary smoothness and clarity from 30 to 18,000 cps—high impedance for tube circuits—160V polarising current from dry cells or easily tapped from instrument circuit—sensitivity 3 mV/ $\mu$ bar—all parts and instructions for easy installation included, net \$22.95.

**NEW—K50 Dynamic Headphones**, light as a feather and faithful as a mirror, for mono and stereo realism in a tight little world of your own, free of ambient aural interference and creating none. With less than one milliwatt input, retains every shading of tone and dynamics from 30 to 20,000 cps. Easily disassembled for cleaning, instantly fitted to any head. The finest in music listening for only \$28 in mono, or \$32 in the stereo model.



If your Dealer cannot supply you with AKG products, write to the USA import and service agents—Electronic Applications, Inc., Stamford, Connecticut.

# Silky Tone from Orient

MADE BY UNSURPASSED SKILL OF LONG EXPERIENCED CRAFTSMEN, LIKE ART OF LUXIOUS SILK GARMENTS, NEAT PRODUCTS ARE THE BEST CHOICE FOR STEREOPHONIC INSTALLATIONS.



## GA-12

Engineered for resonance-free tracing at 1-1/2 gr. stylus force. Plug-in heads have 4 terminal-tips so that any type of cartridge can be mounted. (A spare head is attached to change cartridge when playing.)



## NE-20

Combined with utmosty acclaimed electrostatic tweeter and 8" woofer in handsomely finished enclosure.

### Specifications:

Freq. range; 35-20,000 c/s  
 Input power; 8 watts  
 Input impedance; 16 $\Omega$   
 Tweeter; electrostatic type 2 elements  
 Woofer; 8" dia. permanent dynamic type  
 Network; built-in crossover network (fc-5,000 c/s) AC 117v. power supply  
 Dimension; 350 x 580 x 310 m/m



## P-68H

This remarkable 4 speed turntable, with synchronous hysteresis motor, guarantees optimum performance of stereo reproduction.

### Specifications:

Turntable; 12" diameter aluminum diecasting  
 Speed; 16-3/4, 33-2/3, 45, 78 rpm.  
 Power consumption; 15 watts  
 S/N; 45 db. minimum  
 Wow; 0.25% maximum



## VS-500

Features 4-coil moving magnet system with wide range response, low distortion, superb channel isolation and perfect shielding.

### Specifications:

Freq. range; 30-18,000 c/s  
 Output voltage; 5mV 1,000c/s 5cm/sec.  
 Channel isolation; 30 db 1,000 c/s  
 Channel balance;  $\pm 1$  db. 1,000 c/s

# NEAT

NEAT ONKYO DENKI CO., LTD.  
 4-1chome, Kanda Hatagocho, Chiyoda-ku, Tokyo, Japan

# LETTERS

## Silicon Diodes

SIR:

After I submitted the manuscript for my article on Silicon Diodes in the July, 1960 issue, the Triad Transformer Company brought their S-144A output transformer which was designed for the 7189A's in the tapped screen mode.

In designing this new transformer the Triad people have come up with a really fine unit, and I have been able to reduce the rolloff capacitor on the plate of the 5879 covered in Fig. 9 of the article to 51  $\mu$ f.

As far as size is concerned, the S-144A will fit on the same height-reducing bracket covered in the original article.

L. B. DALZELL,  
 1162 Fleetridge Drive,  
 San Diego 6, Calif.

SIR:

Mr. Dalzell's article, "The Silicon Diode in Audio Equipment," in the July issue was informative but he made an assumption which is not true most of the time. That is, if one diode has a PIV of 600 volts, two in series will have a combined PIV of 1200 volts. This is true only if the reverse characteristics of the two diodes are the same, and they usually are not. It would not be unusual for the reverse leakage current to vary by 50 per cent about a typical value as given by the manufacturer. Thus if two 1N2071 diodes were picked off the shelf and 1200 volts applied to the pair in series, one might drop 400 volts while the other one would drop 800 volts, thus exceeding the manufacturer's maximum rating. I think that about 75 per cent of the PIV rating would be a safe figure to use for two diodes in series. 900 volts would thus be maximum for two 1N2071's.

All this depends on the difference between the diodes. A rating up to two times each PIV can be used if selected units are chosen. Probably most units will withstand about 110 to 120 per cent or more of the manufacturer's maximum rating. I personally prefer to operate a single diode at 75 per cent of its maximum ratings to ensure a safety margin for long, reliable operation. This is before any considerations of a pair in series.

Diodes can be checked and matched pretty well by using a variable d.c. supply and a protective series resistor to limit the reverse current so that power dissipation in the diode is kept under 200 milliwatts at room temperature. The resistor will prevent destruction of the diode if the Zener knee is passed. Raise the voltage until 0.2 ma reverse current flows. The voltage dropped across the diode will then be the maximum usable voltage and should usually be greater than 600 volts for a 1N2071. 600 volts should still be used as a maximum. Two units with the same leakage current at a specified voltage can be considered a matched pair.

BRUCE R. KAUFMAN,  
 624 1/2 S. Fifth St.,  
 Champaign, Ill.

## This One is For the Birds

SIR:

We like your man Charles A. Robertson (JAZZ AND ALL THAT) very much, particularly for his attitude that Dixieland is still a vital part of Jazz, as contrasted with some of his contemporaries and their "let-the-simple-minded-cornballs-have-their-fun" views.

Don't you think, however, that he missed the boat on his review of the Bye Bye Birdie (Columbia KOL 5510) LP? The central character is not a take-off on Elvis, but of fellow rock-and-roller, Conway Twitty. Conway Twitty—Conway Birdie. Obvious, wot?

JIM TANNEHILL,  
 P. O. Box 515,  
 Fort Wayne, Indiana.

(It sure do seem obvious, friend—thanks. ED.)



**MONAURAL CONSOLE OWNER** — WHY DON'T YOU RELEGATE THAT ANTIQUE RELIC TO THE ATTIC AND GET INTO STEREO THE EASY WAY WITH THE PILOT "602"?

**MONAURAL COMPONENT OWNER** — YOU'LL NEVER BE ABLE TO PERFECTLY MATCH YOUR PRESENT EQUIPMENT. GET INTO TRUE STEREO WITH THE PILOT "602".

**MONAURAL EAVESDROPPER** — STOP LISTENING TO YOUR NEIGHBOR'S STEREO WITH ONE EAR. GET A STEREO SYSTEM OF YOUR OWN WITH A PILOT "602".



1/2 Actual Size — 5 1/2" High x 15 1/2" Wide x 11 3/4" Deep

**GET** INTO STEREO THE EASY WAY WITH THE AMAZING NEW PILOT "602" ■ IT'S A STEREO FM/AM TUNER ■ IT'S A STEREO PRE-AMPLIFIER ■ IT'S A 30-WATT STEREO AMPLIFIER ■ IT REPRODUCES STEREO OR MONOPHONIC SOUND ■ IT FEATURES PILOT'S NEW SIMPLI-MATIC TEST PANEL — BALANCE OUTPUT TUBES USING YOUR SPEAKER SYSTEM — WITHOUT EXTERNAL METERS ■ IT FEATURES PILOT STEREO-PLUS FOR CENTER FILL ■ IT'S ONLY 249.50 ■ IT'S THE

Controls: Master Volume/Power, Automatic Shutoff, Loudness, Stereo Balance, Dual TroLok Controls (Bass Channels A & B, Treble Channels A & B), 8 position Selector, FM tuning, AM tuning. Inputs: 2 pair non-shorting for permanent simultaneous connection of multiplex adapter, tape recorder or TV—1 pair for turntable or changer. Outputs: 4—Channel A & B tape, Multiplex 1 & 2. Sensitivity: FM—2uv for 20 db of quieting on 300 ohm antenna; AM—3uv for 1 volt DC at detector; Phono—3 millivolts; Multiplex—110 millivolts; Tape recorder 110 millivolts. Tube complement: 16 tubes, 1 tuning indicator, 4 silicon diode power rectifiers, 3 germanium diodes. Speaker impedances: 4, 8 and 16 ohms. Weight: 26 lbs. Write for complete specifications.

# PILOT 602

**ONLY PILOT COULD HAVE BUILT THE NEW "602"**

FOUNDED 1919 ■ PILOT RADIO CORPORATION, 37-04 36 STREET, LONG ISLAND CITY 1, NEW YORK

AUDIO • AUGUST, 1960

7

# Light LISTENing



CHESTER SANTON\*

The symbol  indicates the United Stereo Tapes 4-track 7 1/2 ips tape number. When Mr. Santon has listened to the tape only, the tape number is listed first. Otherwise, the corresponding tape number is furnished by United Stereo Tapes.

**Fred Waring and the Pennsylvanians in Hi Fi Capitol  ZW-845**

Capitol's initial four-track releases are on the market and I made it a point to try this one first. The two-track version of Waring in Hi Fi has been one of my favorite reels for the past two and a half years. (When I converted to four track about a year ago, the narrower gap of the playback head brought out better high-end response in most of my two-track tapes—this one in particular). Old ZD-12 has had a lot of use at all sorts of listening levels so I knew which sections to spot check in ZW-845. At the same volume setting, tape hiss is equally low on both reels. Frequency response is identical, a situation I would have considered highly unlikely two years ago. There is one subtle difference between the two-track and the four that is noticeable on a large system. You can't measure it because it's a difference solely in terms of presence. There is quite a crowd of performers heard in this recording—a mixed chorus and a sizable orchestra. The two-track gives the illusion of about ten per cent more liveness in the studio and a mike placement about a foot closer. This difference is subtle enough to be apparent only when wives are not in the room. (This is being read, I assume, by more than one husband). Forgetting the considerable disparity in the price of these two tapes, the four-track has fifteen selections while the two-track had only eleven. One of the added items is a specialty of the Waring shows, *Dry Bones*. Tape's superiority in pinpointing a sound source gets a real workout as each phrase pops up in a different section of the glee club to the accompaniment of widely spaced sound effects by the orchestra. From the opening flourish of *I Hear Music* to the famous Waring sign-off, *Sleep*, this reel is equivalent to a well paced stage production with all the buoyancy of the Pennsylvanian's brand of showmanship. Capitol has rolled up some heavy artillery to the pop music sector of tape's latest firing line.

**Frank Chacksfield: The Million Sellers Richmond  RPH-45007**  
**Frank Chacksfield: Evening in Paris and Evening in Rome London  LPM 70005**

The Richmond tape reviewed this month is part of the first four-track release that brings the price of open reels to a figure just a shade above a dollar per track. At \$1.95, these recordings from the London catalog are bound to win a good share of attention. This is the first time UST has made available a standard

\* 12 Forest Ave., Hastings-on-Hudson, N. Y.

length tape at this price. (A few demo tapes on the SMS label have been around at \$3.95).

It was easy to check the characteristics of this particular Richmond tape because the Chacksfield orchestra has just been released by the parent firm on the London label. The results of such a comparison will come as no surprise to disc collectors who have encountered instances where an artist was issued by a record company at more than one price level. If the Richmond tape is played first, the bass response will appear to be virtually normal and the highs more or less acceptable. Switch to the Chacksfield orchestra in the tunes from Paris and Rome and you can spot the difference quite easily on a properly maintained unit. The bass is firmer on the London reel and encompasses lower frequencies. The upper end is sweeter although it takes in more territory. How much of the difference between these two reels is traceable to the master tapes is the secret of a few insiders at London but I find it difficult to believe that the masters are as far apart in quality as these two reels would indicate. We may be witnessing here an application of a theory long used in the marketing of records. When an artist is put on the market by the same outfit in several price ranges, the lower-priced item cannot be permitted to enjoy a quality of sound equal to that of the higher-priced release. While hoping that this theory will not take too firm root in the tape field, I must admit, in terms of entertainment value, the Million Sellers do rate a lower price tag. Signal-to-noise ratio is about the same in both reels but the Evening in Paris and Evening in Rome tape has the better arrangements.

Padilla's *Ca C'est Paris* has just the right atmosphere of the bustle of Parisian traffic to set the mood for favorites such as *J'Attends*, *La Vie En Rose*, *Mademoiselle De Paris* and a new treatment of Offenbach's *Can Can*. The woodwind section of the orchestra has its innings on the Roman side of the reel. The oboist featured in *Catari* would not sound out of place in England's leading concert orchestras. If you go for continental stuff, this is top drawer.

**Caesar Giovannini: Silk, Satin and Strings Concertapes  4T-3006**  
**Rudolf Friml: Indian Love Call Westminster  4T-107**

Both of these tapes offer extra features in background music. The Concertapes reel is the more glamorous of the two. Strings throbbing all over the place—a lot of patsy from the percussion section. The choice of tunes gives an inkling of the producer's goal. *Jalousie*, *Laura*, *Holiday For Strings* are naturals for a full treatment by a large string orchestra working with excellent morale. These are Mid-Western arrangements that recall the days when Chicago radio originated many network shows featuring sizable studio orchestras in light music. If any nostalgia is induced by this reel, it will first overcome those who can remember when radio had the budget for such luxuries.

The Friml tape from the Westminster vaults is a tasty dish—one of the very few reels featuring a leading composer conducting his own music. Listener restfulness is built into this one because Friml knows exactly what he

wants in the interpretations and he gets it with a minimum of fuss. Whether you're dealing with records or tapes, I've found it a good rule of thumb to seek out the version that has the composer on the podium whenever such a choice is possible. These performances of *Donkey Serenade*, *Rose Marie*, *Vagabond King* and *Giannina Mia* will give many years of service as basic items in a tape library.

**Dick Dia: Mandolino Italiano Audio Fidelity AFLP 1923**

Audio Fidelity's latest addition to the Italian wing of their catalog ransacks the tonal possibilities of the mandolin. Impresario Sid Frey, never one to do things in half-hearted fashion, has hired for this recording a mandolinist who, for the past fifteen years, was musical director of New York's leading station specializing in light Italian music. Dick Dia arranged the tunes and plays them with a medium-sized ensemble in a way that reflects every year of his programming experience. The interest in "everyday" Italian music that more and more European travelers are bringing back every year has been pushing the mandolin into the limelight. This record demonstrates that the instrument can be put to more use than mere serenade strumming. In a well-rounded program, Dia surprises the metal strings with a mazurka and a tango. In a moment of abandon, he even tackles one of the favorite display pieces of brass and woodwind instrumentalists—*The Carnival of Venice*. The AF person-to-person approach in solo miking allows, in this case, a confrontation of more than average versatility. At full volume, as in some past releases, you can still climb inside the instrument if you care to. During background listening however, the sonic outline of mandolin softens at normal volume and the diversity of the music selected by Dia becomes the key feature of the album.

**Voices in Song . . . American Musical Theatre Time S/2003**

Time Records has joined the other new outfits who are going in for a brand of exaggerated stereo separation that the major firms have never indulged in. I'm not referring to the altogether desirable separation of signals that today's stereo cutters can manage in the record groove. It is their new philosophy of studio mike placement that has me wondering. There is a possibility that the newcomers are looking forward to wider acceptance of the compatible stereo disc proposed a few months ago by Design Records. Unlike Columbia's compatible disc, rejected by the industry several years ago, the Design sampler record went in for channel isolation to an alarming degree. I noticed that killing the left channel of the Design sampler during playback virtually obliterated the sound of the vocal soloist. About five per cent of voice amplitude could be heard with only the right channel working. Under such conditions of unorthodox separation, I daresay you could play this type of compatible disc for several months with a rusty nail file and still extract separate signals at the end of that time with any stereo pickup. In the songs from the musical theatre recorded by Time Records in the disc under consideration, the well-trained Gene Lowell Choir was split into two sections. The four young ladies far on the right—the six men on the left. With Hal Mooney's orchestra in the background, each group has good clarity when heard by itself. Singing together, the sound of the two halves becomes muddy. They also remain separated by a distance proportionate to the spacing of one's speaker setup. The effect is forced even when the loudspeakers are only six to eight feet apart. This is mentioned with some regret because the show tunes—in addition to the inevitable stuff from Music Man, "My Fair Lady" and "Oklahoma"—include rarities such as *Friendship* from Cole Porter's "DuBarry Was A Lady" and *Tomorrow Mountain* from the Ellington-Latouche show "Beggar's Holiday."

**Chuck Sagle: Ping Pong Percussion Epic BN 568**

Under a title of singular candor, Epic presents its answer to the recent stereo percus-

(Continued on page 74)



They  
Reign  
Supreme...



# FISHER

STEREO FM-AM RECEIVERS

## THE FISHER 800

Twice as sensitive as any competitive receiver—and 50% more powerful! 1 microvolt sensitivity, 24 controls. 60 WATTS of pure audio power. **\$429.50**



## THE FISHER 600

The nation-wide best-seller! FM sensitivity, 1.8 microvolts for 20 db quieting. 'FM-calibre' AM. 22 controls. 40 watts of music power. **\$369.50\***

\*Slightly Higher in the Far West. Cabinets Are Optional.

**BEST WAY** to enjoy stereo at its best, in small rooms or large! Choose the 800 or 600, and a pair of compact Free-Piston FISHER XP-1 Speaker Systems. Technical specifications, validated by the laboratory reports of leading audio publications, prove, beyond the shadow of a doubt, their absolute superiority!

WRITE TODAY FOR COMPLETE SPECIFICATIONS AND EDITORIAL REPORTS!

FISHER RADIO CORPORATION • 21-29 44th DRIVE • LONG ISLAND CITY I, NEW YORK

Export: Marhon Exporting Corp., 458 Broadway, New York 13, N. Y. ■ Available in Canada through Canadian-Marconi

# AUDIO ETC.

Edward Tatnall Canby

## 1. THREE WAYS TO THREE SPEAKERS

**B**EFORE HE ENDED his work for me, my ex-assistant Ray Prohaska had been busy on and off for months on a masterly all-in-one triple-play three-speaker system for my New York apartment. It was a system whereby three different means of achieving three speaker channels out of two inputs were combined and could be put into operation, each of the three, by the simple expedient of pulling out batches of plugs and inserting different ones.

These three systems were the result of my continuing curiosity as to the various means by which a practical three-speaker system might be set up in component form. I chose these three as being of fairly equal interest as well as of considerable diversity; Ray worked up the circuitry, checked the phasing and figured the probable and theoretical results we should get (as opposed to the actual, upon which we kept all our twenty fingers crossed) and, most important, he made the actual physical hook-ups for me, that gave form and substance to the fine theories.

Ray's enthusiasm sometimes carried him farther than I could have imagined. In this triple-threat installation, he made use literally of dozens of plugs and sockets on the various required speaker-amplifier connections (including a pair of remote-control phase-switch inserts for safety, one for the center speaker and another for one of the side speakers). When he had done, most of my floating supply of cables, connectors, and the like, were tied up in the system, the output connections of several amplifiers had sprouted an appalling forest of female sockets—8-ohm, 4-ohm, 16-ohm—all screwed onto the terminals one on top of another; into these went the male connecting plugs, variously for the three differing systems, all neatly polarized along with the females (but oh! how often do we still end up with a mysteriously reversed phase . . .) and the pay-off, the whole batch was marked cryptically as to function. Once put together, the system of course had to be marked up for reference—but how?

'Round and about the plugs was an imposing tangle of brown shrubbery, the connective cables, and it was worth your life to trace any one of them from end to end; maybe Ray had the whole thing memorized by that time, but he did at least conceive of the idea of labeling the plugs and sockets via little loops of masking tape, marked with semi-legible letters and numbers, LA, R2 and the like, which told Jim which speaker, which amplifier was involved. Fine idea, as of that particular moment—for him.

It worked, too, this triple system. If I remember rightly (I can't believe it now), we spent one entire evening during which I sat and listened, while he plugged and unplugged demonstrating each of our three-speaker arrangements in turn, one after the other with only minutes and a couple

of phasing confusions between. Terrific! But he didn't even try to explain the pluggings to me, that time.

Then, alas, Ray left. And about a week later I suddenly needed a stereo amplifier, quickly, to use in the field, and there was nothing to do but commit the ultimate in mayhem, grab dozens of plugs and cables, pull them all out and make off with the amplifier—which I did. To be sure, I made a feeble attempt to help myself later on: maybe I should put colored tape, red tape and blue tape and green tape, around the various matching connections as then operating, in case I couldn't figure out the LA and A2 codes. So I stuck a lot of bits of tape on, here and there and hoped for the best, and in moments the whole thing was an unplugged shambles.

You can guess the rest. Some time many moons later I finally took a long, hard look at the remains of Ray's plug-together system, with a view to reconstruction. Not a chance! Reluctantly, at last, I unscrewed the whole forest of plugs and sockets, put all the connecting cords back on the shelf and left a note to my new assistant. Begin all over again and set things up, for one—just one—of the three-speaker arrangements. That'll be plenty to begin with, thank you.

Fortunately, though, Ray did leave me a fine sheaf of diagrams and layout patterns, most of which at the time I really thought I understood. I even put a few helpful remarks of my own on the margins—luckily, as I now see it. I still have those diagrams and I did hear all three systems; I proved to myself that they did, indeed, work out, and heard also that there was so little difference between them on casual musical comparison that I decided instantly I would leave all measurements and possible distortions to others and go no further than to reassure myself that I could, in fact, enjoy three-speaker stereo by any one of the three. That's what was important, as far as I was concerned.

I might interpolate here, for those who haven't read their back-issues, that last year to my surprise I found that what we were then innocently calling "three-channel" home stereo reproduction was under certain conditions a decidedly workable and useful adjunct to the straight two-way arrangement.

In one of my regular listening spots, to be sure, "three-speaker" was unnecessary and, indeed, impractical; two speakers flanking a fireplace and an excellent listening room combine there to give me all I need out of two speakers; there's no place for the third, anyhow. But in the other place, my eccentrically shaped New York apartment, the three-speaker set-up (all three systems) made for a decided improvement in a rather bad listening situation. My two regular speakers, there, are placed at either end of a grand piano (the only possible locations, as I had found by experiment) and at best are considerably too far apart.

There, the center speaker and its volume control gave me a much more natural and useful spread of sound, plus a flexibility, via the volume control, that deals usefully with differing types of stereo material. I'm making a permanent set-up of it—as permanent as any in my slightly unstable listening arrangements.

I've been studying those diagrams hard and, with some trepidation I hereby describe the three ways in which we achieved useful center-speaker sound, derived from the two regular stereo channels at the stereo amplifiers inputs. I remember all too well the simple-minded pits of confusion into which Ray and I fell, time and again, in respect to the actual workings of these circuits. (Especially do I remember a long session on the concept of "positive-going" and "negative-going," used to describe an instant of theoretical signal amounting to a half-wave and theoretically helpful in straightening out which parts of the circuits—and the speakers—went which way simultaneously, given identical inputs.) It's all so utterly simple, this kind of thing, that like many a great simplicity, the truth has a way of avoiding your finest efforts, and I admit to frequently recurring bafflement and ditherhood, just when I thought all was clear.

Hence Ray's passel of diagrams, done up to convince himself as well as me; hence his elaborately simple set of battery analogies, using single cells as on-paper generators of theoretical positive-going or negative-going signals.

## "Pilot"

One of these systems I have already described at some length, and a technical paper appeared in this magazine on it awhile before that—we called it the "Pilot" system because of that company's use of the principle, but we set it up in our own way, Pilotless, just to be objective. This three-speaker method is excellent—if it happens to work out with your particular amplifier (or if the amplifier is deliberately designed for it), but can get you into technical pickles in respect to amplifier performance. We were lucky, or Ray was cagey; the small Eico AF4 stereo amplifier that we altered to operate "Pilot" didn't show any noticeable change of response or instability.

This "Pilot" system involves some fairly drastic internal modifications of the stereo amplifier circuit and it is not, therefore, a method recommended to the uninitiate—the guy like me, minus my assistant. If you buy it ready-made, fine and dandy. If you try it on your own amplifier, be sure you know your business, and have testing equipment on hand, to find out what's happening.

The system achieves a center-speaker A + B sum signal by relocating the "zero" point on the output transformers, at the possible risk of feedback dislocation and

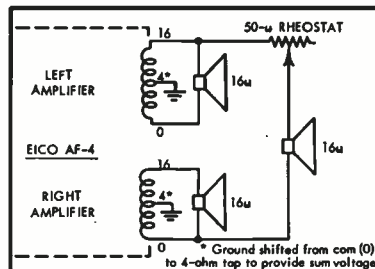

Fig. 1

Over 2 MILLION EICO instruments in use throughout the world. Add 5% in the West.



# IF YOU LOVE TO CREATE... BUILD **EICO** KITS

In **STEREO** and

**Mono Hi-Fi...**  
the experts say  
your Best Buy  
is **EICO**



Stereo Amplifier-Preamplifier HF81t



Stereo Preamplifier HF851t



FM Tuner HFT90t  
AM Tuner HFT94t  
FM/AM Tuner HFT92t



100W Stereo Power Amplifier HF89  
70W Stereo Power Amplifier HF87  
28W Stereo Power Amplifier HF86



Stereo Integrated Amplifier AF4t



3-Way Speaker System HFS3  
2-Way Bookshelf Speaker Systems HFS5 and HFS1



Stereo Automatic Changer/Player 1007



- Exclusive advanced systematized engineering
  - Latest and finest quality parts
  - Exclusive "Beginner-Tested" easy step-by-step instructions
  - Exclusive TRIPLE quality control
  - Exclusive LIFETIME guarantee at nominal cost
- IN STOCK — Compare, then take home any EICO equipment — right "off the shelf!" — from 1500 neighborhood EICO dealers throughout the U. S. and Canada.

**HF81 Stereo Amplifier-Preamplifier** selects, amplifies, controls any stereo source & feeds it thru self-contained dual 14W amplifiers to a pair of speakers. Provides 28W monophonically. Ganged level controls, separate balance control, independent bass and treble controls for each channel. Identical Williamson-type, push-pull EL84 power amplifiers. "Excellent" — SATURDAY REVIEW. "Outstanding . . . extremely versatile." — ELECTRONICS WORLD. Kit \$69.95. Wired \$109.95. Incl. cover.

**HF85 Stereo Preamplifier:** Complete master stereo preamplifier-control unit, self-powered. Distortion borders on unmeasurable. Level, bass, & treble controls independent for each channel or ganged for both channels. Inputs for phono, tape head, mike, AM, FM, & FM-multiplex. One each auxiliary A & B input in each channel. "Extreme flexibility . . . a bargain." — HI-FI REVIEW. Kit \$39.95. Wired \$64.95. Incl. cover.

**New HF89 100-Watt Stereo Power Amplifier:** Dual 50W highest quality power amplifiers. 200W peak power output. Uses superlative ultra-linear connected output transformers for undistorted response across the entire audio range at full power, assuring utmost clarity on full orchestra & organ. 60 db channel separation. IM distortion 0.5% at 100W; harmonic distortion less than 1% from 20-20,000 cps within 1 db of 100W. Kit \$99.50. Wired \$139.50.

**HF87 70-Watt Stereo Power Amplifier.** Dual 35W power amplifiers identical circuit-wise to the superb HF89, differing only in rating of the output transformers. IM distortion 1% at 70W; harmonic distortion less than 1% from 20-20,000 cps within 1 db of 70W. Kit \$74.95. Wired \$114.95.

**HF86 28-Watt Stereo Power Amp.** Flawless reproduction at modest price. Kit \$43.95. Wired \$74.95.

**FM Tuner HFT90:** Prewired, prealigned, temperature-compensated "front end" is drift-free. Prewired exclusive precision eye-tronic traveling tuning indicator. Sensitivity: 1.5 uv for 20 db quieting; 2.5 uv for 30 db quieting, full limiting from 25 uv. IF bandwidth 260 kc at 6 db points. Both cathode follower & FM-multiplex stereo outputs, prevent obsolescence. Very low distortion. "One of the best buys in high fidelity kits." — AUDIOGRAFF. Kit \$39.95. Wired \$65.95.

**AM Tuner HFT94:** Matches HFT 90. Selects "hi-fi" wide (20-9000 cps @ -3 db) or weak-station narrow (20-5000 cps @ -3 db) bandpass. Tuned RF stage for high selectivity & sensitivity. Precision eye-tronic tuning. "One of the best available." — HI-FI SYSTEMS. Kit \$39.95. Wired \$65.95. Incl. cover & F.E.T.

**New FM/AM Tuner HFT92** combines renowned EICO HFT90 FM Tuner with excellent AM tuning facilities. Kit \$59.95. Wired \$94.95. Incl. cover & F.E.T.

**New AF-4 Economy Stereo Integrated Amplifier** provides clean 4W per channel or 8W total output. Kit \$38.95. Wired \$64.95. Incl. cover & F.E.T.

**HF12 Mono Integrated Amplifier (not illus.):** Complete "front end" facilities & true hi-fi performance. 12W continuous, 25W peak. Kit \$34.95. Wired \$57.95. Incl. cover.

**New HFS3 3-Way Speaker System Semi-Kit** complete with factory-built 34" veneered plywood (4 sides) cabinet. Bellows-suspension, full-inch excursion 12" woofer (22 cps res.) 8" mid-range speaker with high internal damping cone for smooth response, 3 1/2" cone tweeter, 2 1/4 cu. ft. ducted-port enclosure. System Q of 1/2 for smoothest frequency & best transient response. 32-14,000 cps clean, useful response, 16 ohms impedance. HWD - 26 1/2", 13 1/2", 14 3/8". Unfinished birch. Kit \$72.50. Wired \$84.50. Walnut or mahogany. Kit \$87.50. Wired \$99.50.

**New HFS5 2-Way Speaker System Semi-Kit** complete with factory-built 34" veneered plywood (4 sides) cabinet. Bellows-suspension, 3/4" excursion, 8" woofer (45 cps. res.) & 3 1/2" cone tweeter. 11 1/4" cu. ft. ducted-port enclosure. System Q of 1/2 for smoothest freq. & best transient resp. 45-14,000 cps clean, useful resp. 16 ohms.

HWD: 24", 12 1/2", 10 1/2". Unfinished birch. Kit \$17.50. Wired \$54.50. Walnut or mahogany. Kit \$39.50. Wired \$69.50.

**HFS1 Bookshelf Speaker System** complete with factory-built cabinet. Jensen 8" woofer, matching Jensen compression-driver, exponential horn tweeter. Smooth clean bass; crisp extended highs. 70-12,000 cps range, 8 ohms. HWD: 23" x 11" x 9". Kit \$39.95. Wired \$47.95

**HFS2 Omni-Directional Speaker System (not illus.)** HWD: 36", 15 1/4", 11 1/2". "Fine for stereo" — MODERN HI-FI. Completely factory-built. Mahogany or walnut \$139.95. Blond \$144.95.

**New Stereo Automatic Changer/Player:** Jam-proof 4-speed, all record sizes, automatic changer and auto/manual player. New extremely smooth, low distortion moisture-proof stereo crystal cartridge designed integrally with tonearm to eliminate mid-range resonances. Constant 4 1/2 grams stylus force is optimum to prevent groove flutter distortion. No hum, turntable attractions, acoustic feedback, center-hole enlargement. Only 10 3/4" x 13". Model 10070: 0.7 mil diamond, 3 mil sapphire dual styli. \$59.75. 1007S: 0.7 mil. 3 mil sapphire, \$49.75. Incl. FET.

†Shown in optional Furniture Wood Cabinet WE7: Unfinished Birch, \$9.95; Walnut or Mahogany, \$13.95.

††Shown in optional Furniture Wood Cabinet WE70: Unfinished Birch, \$8.95; Walnut or Mahogany, \$12.50.

EICO, 33-00 N. Blvd., L.I.C. 1, N. Y. A-8  
Show me how to SAVE 50% on easy-to-build top-quality Hi-Fi. Send FREE catalog, Stereo Hi-Fi Guide plus name of neighborhood EICO dealer.

Name \_\_\_\_\_  
Address \_\_\_\_\_  
City \_\_\_\_\_ Zone \_\_\_\_\_ State \_\_\_\_\_

Listen to the EICO Hour, WABC-FM, N.Y., 95.5 MC, Mon. to Fri. 7:15-8 P.M., Sat. 11-12 P.M.

© 1960 by EICO, 33-00 N. Blvd., L. I. C. 1, N. Y.



**THIS IS THE  
GREATEST  
'CONTINENTAL'  
OF THEM  
ALL...**



*the* **Norelco**<sup>®</sup>  
**CONTINENTAL '400'**

*The exciting specifications on the new Norelco*  
**CONTINENTAL '400'**  
*(EL3536/54) provide only an indication of what "the greatest Continental of them all" holds in store for the music lover, studio-recording or high fidelity enthusiast who is seeking a professional quality stereo machine at a modest price.*

*New 4-track stereo-record/stereo-playback tape recorder guild-crafted by Philips of the Netherlands*

- ◆ **FOUR-TRACK STEREPHONIC RECORDING AND PLAYBACK** ◆ **FOUR-TRACK MONOPHONIC RECORDING AND PLAYBACK** ◆ **THREE TAPE SPEEDS—1 1/8, 3 3/4 AND 7 1/2 IPS**
- ◆ **COMPLETELY SELF-CONTAINED, INCLUDING DUAL RECORDING AND PLAYBACK PREAMPLIFIERS, DUAL POWER AMPLIFIERS AND TWO NORELCO WIDE-RANGE LOUDSPEAKERS (SECOND IN LID)**
- ◆ **CAN ALSO BE USED AS A QUALITY STEREO HI-FI REPRODUCING SYSTEM WITH TUNER OR RECORD PLAYER** ◆ **FACILITY FOR MIXING PHONO AND MIKE INPUTS**
- ◆ **HEAD-GAP WIDTH—.00012"** ◆ **FREQUENCY RESPONSE—50 TO 18,000 CPS AT 7 1/2 IPS** ◆ **WOW AND FLUTTER—LESS THAN .15% AT 7 1/2 IPS** ◆ **SIGNAL-TO-NOISE RATIO—48 DB OR BETTER** ◆ **CROSSTALK—55 DB** ◆ **PORTABLE STYLED BY THE CONTINENTAL'S TOP DESIGNERS** ◆ **RUGGED**



A Norelco dual element stereo-dynamic microphone is standard equipment with the **CONTINENTAL '400'**

*For a convincing demonstration of all of the features and qualities that make the Continental '400' "the greatest 'Continental' of them all," visit your favorite hi-fi center, or photo dealer, or write for complete literature to:*  
**North American Philips Co., Inc.**  
**High Fidelity Products Division**  
**230 Duffy Avenue,**  
**Hicksville, L. I., N. Y.**

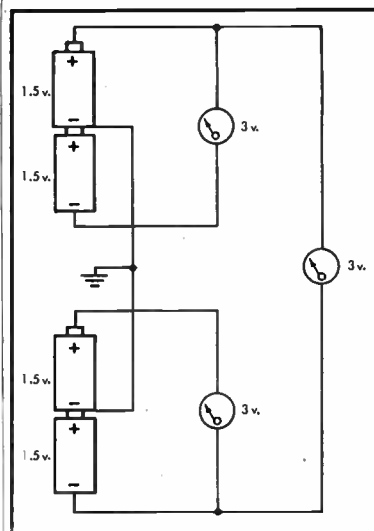

Fig. 2

associated trouble. (We had none.) Our new center tap was at the original 4-ohm point; the central speaker took off from the original "O" on one amplifier, now become -4 ohms, and from the 16-ohm tap on the other, which would be +4 ohms. Net result, if you follow me, was a 16-ohm output of A plus B. The side speakers tapped from the ex-16-ohm (now +4) points on each amplifier to the ex-zero, as above now -4, the result being again 16 ohms of channel A and channel B respectively. Clear as mud, isn't it?

It works very nicely, once your amplifiers themselves have been checked out as OK in this new and slightly dizzy output arrangement. The feedback complications are strictly for the experienced pro to solve—if he can.

I note that in the "Pilot" battery analogy set up by Ray (Fig. 2), 3 volts into each channel measures three volts at each of the three speakers—i.e., the center speaker volume is the same as that of the outside speakers, given an equal signal. In practice, I've found, the center speaker should be cut down considerably below the outside pair for most stereo sound. Too much center volume weakens the stereo effect, tends to blend it into plain mono-in-the-middle.

**E-V ST-1**

One of our three systems was commercial—an Electro-Voice transformer that takes the partial output of one amplifier and passes it on, 1:1 but isolated, in reversed phase as shown in Fig. 3. This is a tricky

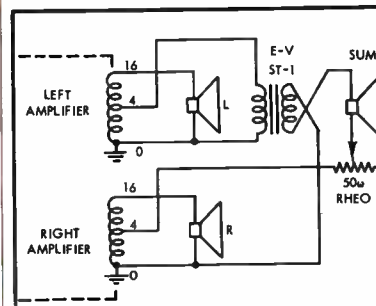

Fig. 3

# PRICES CUT ALMOST $\frac{1}{3}$

on Audiotape on 1½-mil **MYLAR\***

**T**HAT'S RIGHT! Audio Devices has cut at least 31% off the price of its premium-quality Audiotape on 1½-mil "Mylar." Now you can enjoy all the advantages of DuPont's fabulous "Mylar" for little more than the cost of ordinary plastic-base tape.

Audiotape on 1½-mil "Mylar" is the finest tape in the Audiotape line. Its tough, durable "Mylar" base and professional-quality oxide make it the perfect tape for schools, recording studios, radio and TV stations, military users—as well as discriminating home recordists.

See your Audiotape dealer as soon as possible. At the new low prices, his stock will move fast. (Similar price reductions have also been made on Master "Low Print-through" Audiotape on 1½-mil "Mylar.")

\*"Mylar" is DuPont's trademark for its polyester film—the toughest, most durable recording tape base material known to man. "Mylar" cannot dry out or become brittle with age. Radical differences in temperature and humidity have no effect on it. Recording tapes on "Mylar" can't break or stretch in normal use, regardless of temperature or humidity. Most importantly, "Mylar" is a known, tested base material—proven by years of use in telemetry, automation and electronic computing applications. Millions of feet have been recorded by professional and amateur sound recordists, too.

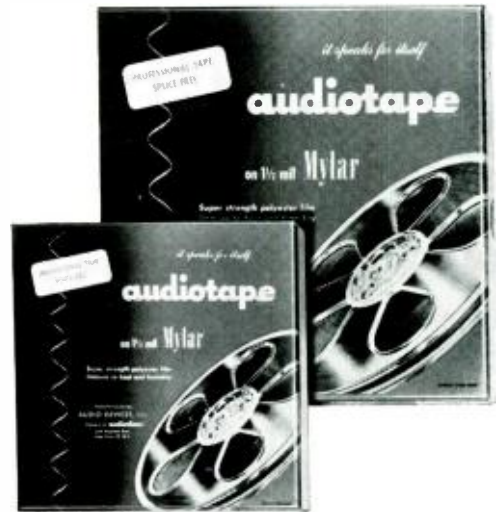

**audiotape**  
TRADE MARK

AUDIO DEVICES, INC., 444 Madison Ave., N. Y. 22, N. Y.

In Hollywood: 840 N. Fairfax Ave. • In Chicago: 5428 N. Milwaukee Ave.

# THE TUNG-SOL 6080 FAMILY

*All fit the same socket...*



**But which fits your application**

There's often a wide choice of tubes which meet one set of electrical requirements. But depending on many other factors, such as the kind of environment in which the tubes are expected to operate, your choice may be limited. For this reason Tung-Sol produces many *tube families* for many types of applications where varied operating conditions are expected.

Consider the Tung-Sol 6080 family, for example. The 6080, the 6080WA, the 6080WB and the prototype 6AS7G all fit the same socket. The electrical ratings of these series regulator tubes are the same. But which do you need where?

*Knowing the differences can make all the difference!*

Technical details on the Tung-Sol 6080 family spelling out the essential differences between these electrically identical tubes are available on request.

The 6080 family is just another fine example of how Tung-Sol gives you just the right tube to do the best job. Tung-Sol Electric Inc., Newark 4, N. J.

## GET YOUR FREE SUBSCRIPTION TO TUNG-SOL TIPS



If you still haven't gotten your free subscription to Tung-Sol's widely acclaimed monthly series, *Tung-Sol Tips*, you still can. Just ask your local Tung-Sol distributor or write directly to Tung-Sol and begin getting your issues regularly. They're jam-packed with technical information covering many significant topics to help the industrial serviceman in his job.

 **TUNG-SOL®**

Technical assistance is available through the following sales offices: Atlanta, Ga.; Columbus, Ohio; Culver City, Calif.; Dallas, Texas; Denver, Colo.; Detroit, Mich.; Irvington, N. J.; Melrose Park, Ill.; Newark, N. J.; Philadelphia, Pa.; Seattle, Wash. Canada. Toronto, Ontario.

idea, since it avoids the "shorts" you get if you just try to hook up your channels in parallel for a third speaker.

If I remember rightly, the E-V transformer may be used in various optional ways as outlined in the instructions; our set-up, as the diagram left with me shows, used my Sherwood stereo amplifier unchanged—no internal rewiring—as per one of the E-V circuit suggestions. The outer two speakers are connected conventionally to the 8-ohm taps. The E-V transformer takes off from the 4-ohm tap of one amplifier output. Its secondary, wound reversed, sends one lead to the center speaker and the other back to "zero" on the opposite amplifier. The center speaker completes the circuit out of its other lead into the 4-ohm tap of the second amplifier. Clear as concentrated asphalt, no doubt, but that's how it looks in the diagram, and that's how it was when it worked.

I had heard dire mutterings about the inevitable added distortion with another transformer in the circuit—two is plenty

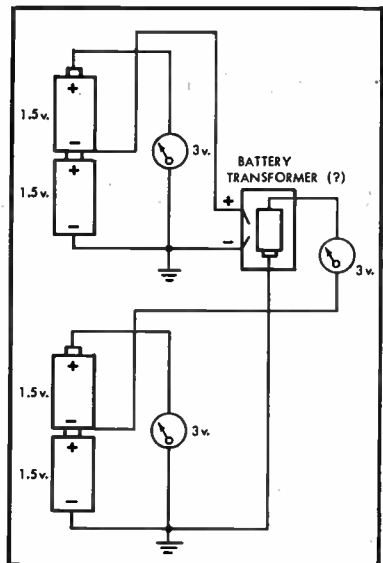

and maybe too much already, the mutterings warned. I can only say that the E-V ST-1 didn't have any audibly noticeable effect on the stereo music's quality to this listening musical ear—as usual, we didn't measure. The thing seemed to work perfectly well and indeed, as I say, there was no very startling difference between it and the "Pilot" system, allowing for a quite different and more expensive amplifier.

I'm prepared to hear further groans about undesirable compromises in such a device but I must say that as a practical means for acquiring a third speaker output in stereo it works out very simply and well. No doubt the increased naturalness and realism of the stereo sound itself—the end in view, after all—easily makes up for whatever minor quality differences there might be, if any. As a general-purpose remedy for bad stereo, where three-speaker sound is indicated, I'm for the E-V ST-1 transformer and suggest you try it if you have a place for such a gadget.

Don't use any center speaker, of course, if you already have satisfactory stereo without it.—Don't use any third speaker unless the outer pair are set wide apart, too, at least eleven or twelve feet, and more

(Continued on page 83)





*A Crowning Achievement!*

**NO TURNTABLE  
REGARDLESS OF PRICE  
WILL OUTPERFORM THE**

**new *Connoisseur* E2S**



For the first time in transcription turntable design, you have the ultimate in performance at a practical price. This remarkable new 2-speed Stereo turntable, with its hysteresis synchronous drive, assures you the superb quality offered by any fine turntable regardless of its price. Custom-crafted and succinctly assembled, each is a work of art. No mass production methods here — merely the unsurpassed skill of fine English craftsmen working to watch-like precision. Compare these specifications with any other turntable on the market costing considerably more. You'll be amazed!

- Hysteresis synchronous motor drive for 33 $\frac{1}{3}$  and 45 rpm recordings.
- Rumble factor: - 50 db when referred to 7 cm/sec. at 1000 cycle signal.
- Wow content is less than .15% and flutter down to .1%.
- Hum level is down 80 decibels.

**\$59.50** AUDIOPHILE NET

Formica-covered base — optional for \$14.95

**CONNOISSEUR INTEGRATED  
STEREO PICK-UP AND ARM**

for the price of a quality pick-up alone.

A superb quality companion for only the finest of turntables, this hand-crafted stereo pick-up and automatic-control arm is unsurpassed. .005/6" diamond stylus; 3.5 gram stylus force; 20-18,000 cps;  $\pm$  2 db; 25 db Channel separation.



Automatic control action permits arm to be raised or lowered delicately and accurately without touching the pick-up arm.

Audiophile Net **\$49.50**

*Old world precision serving a new world of sound*

For complete specifications and trade discounts on each write:

**ERCONA CORPORATION**

(Electronic Division)

Dept. A-8, 16 West 46th Street, New York 36, New York



**BRITANNIA  
rules the  
SOUND WAVES**

with incomparable performance of fine English craftsmanship. Your customers will appreciate these superb custom components. Known the world over for performance, these, as all ERCONA products, have been designed for the ultimate in sound reproduction. We will appreciate your further inquiry.



**SERIES 700  
MARK III  
SPEAKERS**

Improve sound systems with an R & A speaker that brings true high fidelity, yet priced unbelievably low for such performance. Add one for superb stereo or to extend listening pleasure to other rooms in the home. Co-axial construction in 8", 10" and 12" models. Audiophile net from \$13.95

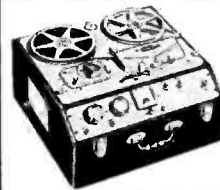

**DESIGNED FOR  
THE ULTIMATE  
IN RECORDING  
PERFECTION**

**Ferrograph**

**PROFESSIONAL TAPE RECORDERS**

Incomparable recording and reproduction of both Stereo and monaural that has become the standard of the BBC. Ferrograph will satisfy the most exacting recording requirements and are available in stereo or standard monaural equipment. Portable or custom models. Audiophile net from \$399.50



**Reslo  
STUDIO-QUALITY  
MICROPHONES**

England's most honored line of microphones assure highest broadcast quality recordings. Extremely rugged, each features a dural ribbon cartridge weighing only 1.3 mg (1/960 oz.) and triple screen protected. All impedances available for

professional or home use. Audiophile net from \$59.50



**DUPLEX  
COAXIAL  
DU120  
VITAVOX  
REPRODUCERS**

A truly outstanding 12" dual loudspeaker for full range reproduction and free of distortion and peaks with a nominal frequency response from below 30 to above 15,000 cps with inbuilt cross over at 2000 cps. Special acoustically designed enclosures available. Audiophile net: \$89.50

# EDITOR'S REVIEW

## DEPARTMENT OF CONFUSION

**W**ITH PRACTICALLY EVERYONE in the radio-phonograph business building stuff which he labels "stereo" and touting it by advertising in the public prints in words which imply that reproduction is superb, the average listener does not know which way to turn. "Should I buy 'hi-fi' or stereo?" seems to be the important question.

We have long felt that the high fidelity industry as a whole has erred in putting too much stress on stereo and not enough on high fidelity. Any \$29.95 phonograph may be labeled "stereo," and no one will raise questions about it. But when a unit of the same quality is called "hi-fi," then someone is likely to raise an eyebrow or two, at least.

Without question, there are some good "stereo" sets available that are not assembled from components. However, most of them seem to put the two speakers in a cabinet with a spacing not exceeding three feet which makes the listener sit about the same distance from the cabinet as he would have to with a five-inch television set. Under normal listening conditions, there is no stereo effect at all.

We do not mean, by all this, to imply that it is not possible to obtain good stereo reproduction from a single cabinet—provided the cabinet is designed for that purpose. There are some very good single-cabinet stereo speakers on the market, and in certain rooms they are even better than the conventional pair of loudspeakers at a spacing of, say, six to ten feet. We are only referring to those units which may have an over-all length of four feet, with the speakers both facing forward, or nearly so, with a spacing of less than four feet. At normal listening distances, there is no dimensional quality to the reproduction at all.

All of which leads us to another word—DIMENSIONAL reproduction. We suggested this possibility to Abraham Schwartzman, Executive Secretary of the Institute of High Fidelity Manufacturers, and his opinion was that it was likely to add more confusion to an already confused picture. Particularly since we now have reverberation, exhibited in depth at the recent meeting of the National Association of Music Merchants in Chicago. Hi-fi, stereo, component high fidelity, reverberation, and now Dimensional Sound—and we use the latter to specify a form of reproduction where the stereo effect is readily apparent. It is a suggestion, however, and we submit it for what it is worth.

One other item along these lines has long engaged our attention. We believe firmly that if a person can see two loudspeakers, he can hear two. In many of the larger cabinets which house two speaker systems, there will be a grille cloth over each one separately, with—usually—a blank wooden panel between. In discussing this with one manufacturer and pointing out our belief, he explained that people like the two-speaker visibility because *they want other people to know that they have stereo*—the "status symbol" at work again.

No matter what other people want, this observer would prefer to have two well-spaced speakers behind a single grille so the actual location of the speakers was not readily apparent. That will give the best stereo illusion, in our opinion.

## HIGH FIDELITY SHOWS

Only a month away is the New York High Fidelity Show—to be held in the N. Y. Trade Show Building. Over 100 American and foreign exhibits will be unveiled at 4:00 p.m. on September 7. As the time approaches we begin to anticipate the excitement of the annual event—we actually enjoy them.

In addition to the usual demonstrations with which we are all familiar, two exhibitors have planned some unusual features. Acoustic Research is staging a series of *Live vs. Recorded* concerts in which the internationally famous Fine Arts Quartet will be compared directly with recordings of their playing. The sound of the actual instruments and the sound of the stereo playback system will be switched back and forth instantaneously, without losing the musical beat. These concerts are to be held four times each day (except Sunday, when there will be only two) in the New Orleans Room of Hotel New Yorker, just across the street from the Trade Show Building. The Quartet will play selections from Tchaikovsky, Bartok, and other composers.

Another interesting feature is the McIntosh Maintenance Clinic, which will be held in room 606 of the Trade Show Building. All McIntosh owners are invited to bring in their equipment for check and adjustment by factory technicians—*absolutely free*. There is no charge for parts or labor, and each unit will be checked thoroughly and put into brand-new condition. Visitors to the show may bring their equipment in and leave it while they are enjoying the four floors of exhibits, and on the way out they can pick it up in a completely new condition.

## THE CHICAGO SHOW

While not everyone will be able to attend the New York High Fidelity Show, those who live in the Midwest may well plan on seeing the Chicago High Fidelity-Home Entertainment Show at the Palmer House, September 23-25. In addition to the usual exhibits, this show will feature a full-time FM broadcast all three days of the show. Station WXFM, Chicago, will set up broadcasting facilities at the show and will interview exhibitors both live and by tape during the show hours, with advance interviews being presented for some two weeks before the opening day. Exhibitors will be invited to discuss their own products, interior decorators will take part in discussions on how hi-fi stereo equipment can be placed to best advantages in the home, and visitors to the show will be interviewed and invited to view the broadcasts.

See you there?

# more

...so much more for everyone...for every application...in the complete line of Stanton Stereo Fluxvalves\*.

Here is responsible performance...in four superb models...for all who can hear the difference. From a gentle pianissimo to a resounding crescendo—every movement of the stylus reflects a quality touch possessed only by the Stereo Fluxvalve.



**STANTON Calibration Standard: Model 381**—An ultra-linear professional pickup for recording channel calibration, radio stations and record evaluation by engineers and critics...from \$48.00



**Collectors Series: Model 380**—A precision pickup for the discriminating record collector...from \$29.85



**Pro-Standard Series: MK II**—A professional pickup outstanding for quality control...from \$24.00



**StereoPlayer Series: Stereo 90**—A fine quality stereo magnetic pickup for the audiophile...\$16.50

**LISTEN!**...and you will agree Pickering has more for the best of everything in record reproduction—mono or stereo. **More Output—More Channel Separation—More Response—More Record Life!**

In short...more to enjoy...because, there's more quality for more listening pleasure.

\* U.S. Patent No. 2,917,590

FOR THOSE WHO CAN HEAR THE DIFFERENCE



**Pickering**

PICKERING & CO., INC., PLAINVIEW, NEW YORK

**LISTEN!**—Ask for a Stereo **FLUXVALVE** demonstration at your Hi-Fi Dealer today!

Send for Pickering Tech-Specs—a handy guide for planning a stereo high fidelity system...address Dept. B-80

STEREO FLUXVALVE, STEREOPLAYER, COLLECTORS SERIES, PRO-STANDARD SERIES, CALIBRATION STANDARD ARE TRADEMARKS USED TO DENOTE THE QUALITY OF PICKERING & CO., INC. PRODUCTS.



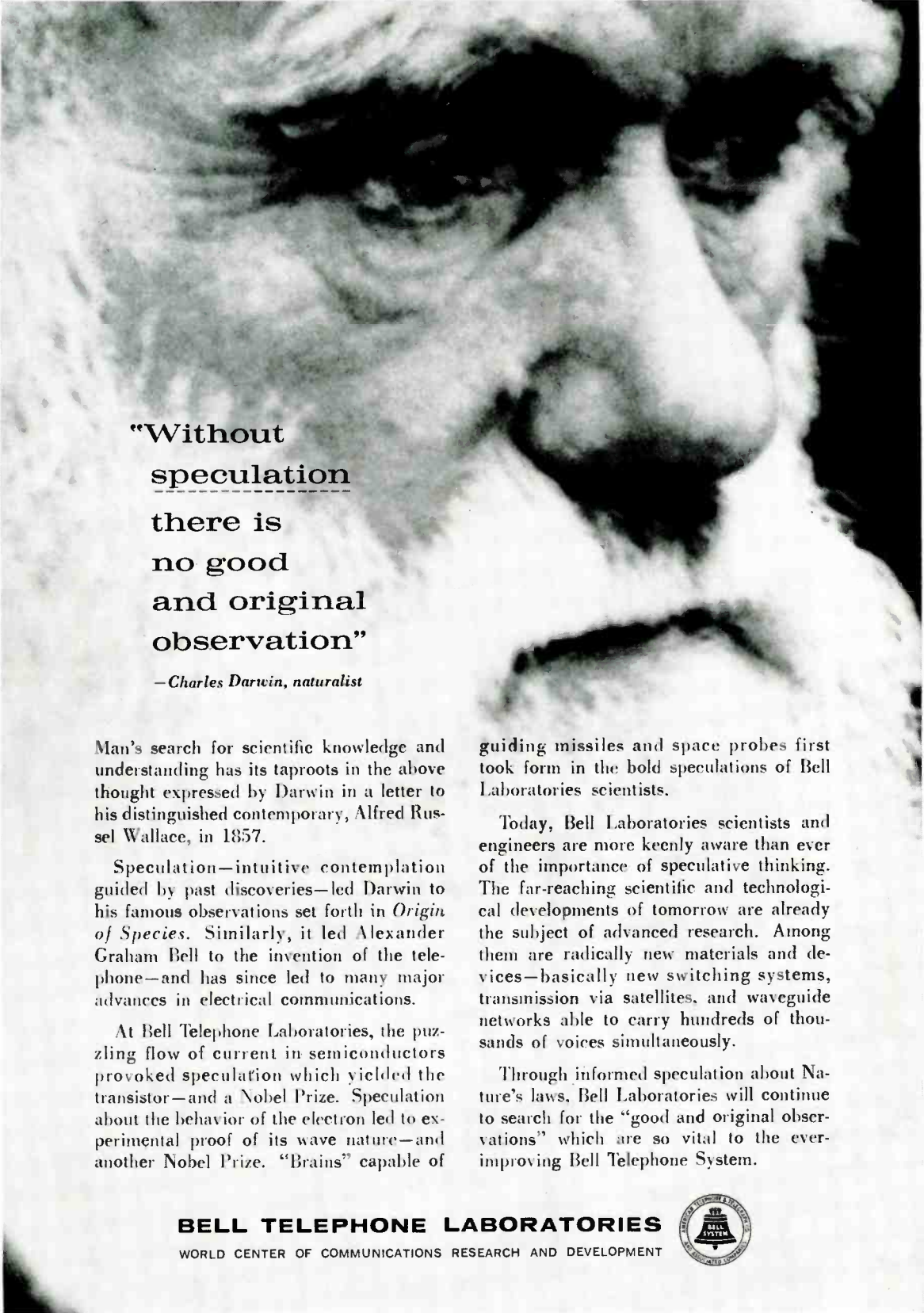

**“Without  
speculation  
there is  
no good  
and original  
observation”**

—Charles Darwin, naturalist

Man’s search for scientific knowledge and understanding has its taproots in the above thought expressed by Darwin in a letter to his distinguished contemporary, Alfred Russel Wallace, in 1857.

Speculation—intuitive contemplation guided by past discoveries—led Darwin to his famous observations set forth in *Origin of Species*. Similarly, it led Alexander Graham Bell to the invention of the telephone—and has since led to many major advances in electrical communications.

At Bell Telephone Laboratories, the puzzling flow of current in semiconductors provoked speculation which yielded the transistor—and a Nobel Prize. Speculation about the behavior of the electron led to experimental proof of its wave nature—and another Nobel Prize. “Brains” capable of

guiding missiles and space probes first took form in the bold speculations of Bell Laboratories scientists.

Today, Bell Laboratories scientists and engineers are more keenly aware than ever of the importance of speculative thinking. The far-reaching scientific and technological developments of tomorrow are already the subject of advanced research. Among them are radically new materials and devices—basically new switching systems, transmission via satellites, and waveguide networks able to carry hundreds of thousands of voices simultaneously.

Through informed speculation about Nature’s laws, Bell Laboratories will continue to search for the “good and original observations” which are so vital to the ever-improving Bell Telephone System.

**BELL TELEPHONE LABORATORIES**

WORLD CENTER OF COMMUNICATIONS RESEARCH AND DEVELOPMENT



# Microphone Calibration

The author describes a system for calibrating microphones that does not require the use of a previously calibrated standard. No expensive equipment is required, making the system attractive to the audio enthusiast.

DAN PETERS\*

**Y**OU WOULD CERTAINLY consider a man foolish if he spent several hundred dollars for a fine suit without having this suit properly fitted. Yet, many hi-fi enthusiasts perform a comparable act by spending considerable sums of money for audio equipment and never "fit" the system to its environment.

By the use of test records, and low-cost test equipment kits, the serious enthusiast has at his disposal economical means to adjust a system properly right up to the amplifier output. However, the loudspeaker, and the acoustic path between it and the listener's ear, generally go without quantitative measurements of any type. Instead, discussions of loudspeaker performance rely upon such vague descriptions as wide-range, boomy, vibrant, and so on.

Perhaps audio enthusiasts do not perform accurate checks upon loudspeakers and enclosures because such measurements require a calibrated microphone. Calibrated microphones are expensive, and the expense is hard to justify, considering the few times that they are necessary. It shall be the purpose of this article to describe a method of calibrating any microphone for use as a standard during frequency-response checks.

An expensive microphone is not necessary. In fact, in lieu of a microphone, a small loudspeaker will serve nicely. The irregularities in the frequency response are not important, since the calibration curve will indicate their location and magnitude, thereby enabling the proper allowance to be made.

The method used, the reciprocity principle, was described in a book entitled "Theory of Sound," by Lord Rayleigh in 1877; and apparently was not new then. In applying the principle to microphone calibration; two loudspeakers, one of which must be reversible, and the microphone to be calibrated are employed. The first step consists of setting up the equipment as shown in Fig. 1. Loudspeaker  $L_A$  serves simply as a sound source. The loudspeaker of your sound system provides a convenient  $L_A$ , being already connected to an amplifier. The reversible loudspeaker  $L_R$  and the micro-

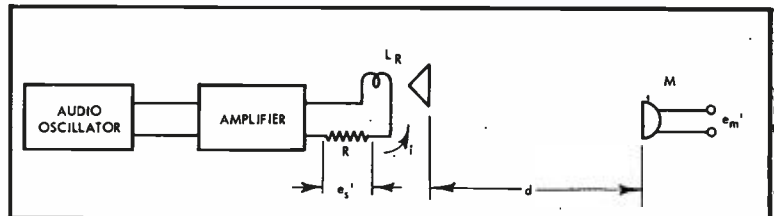

Fig. 2. Rearrangement of equipment for the second step in calibrating a microphone.

phone  $M$ , whose calibration is desired, are placed in juxtaposition a distance  $d$  in front of  $L_A$ . Set distance  $d$  the same as your intended test microphone-to-loudspeaker spacing, because the low-frequency response of many microphones will vary with the distance from the sound source. The distance will depend upon the information desired from the loudspeaker tests to follow. A microphone-to-speaker spacing of less than two feet will help to exclude the effect of room acoustics, while greater spacings provide a measure of effect of the room characteristics. Locate the microphone with its axis coincident with the axis of the sound source since the high-frequency response of most microphones changes for different angles of incidence.

Feeding an audio tone into  $L_A$  will result in a sound pressure  $p_o$  at  $M$  and  $L_R$  thereby generating open circuit voltages,  $e_m$  and  $e_s$  respectively. Measure and record these voltages at each frequency of interest, either by the use of a millivoltmeter, or by an audio amplifier followed by an a.c. voltmeter. If you make all measurements with the same

meter, the frequency response and accuracy of the measuring instruments will not affect the results. Use sufficient signal into  $L_A$  to mask any background noise, but keep the amplitude low enough to avoid overloading it. Otherwise the harmonics will give erroneous results.

Next, connect the equipment as shown in Fig. 2. Again supply power and measure voltages  $e_m'$  and  $e_s'$ , using the same meter as used in the preceding steps. Actually, the current in  $L_R$  is the quantity of interest and the 1-ohm resistor  $R$ , provides a 1-volt drop for every ampere of current, thereby allowing the use of the same voltmeter as used in the other measurements to make this measurement. Use a non-inductive resistor for  $R$ .

After completing the second set of measurements at the same frequencies as used in step 1 substitute the readings in the following formula to find the microphone sensitivity.

$$S_m = K \sqrt{\frac{e_m e_m'}{e_s e_s'}} \quad (\text{Continued on page 79})$$

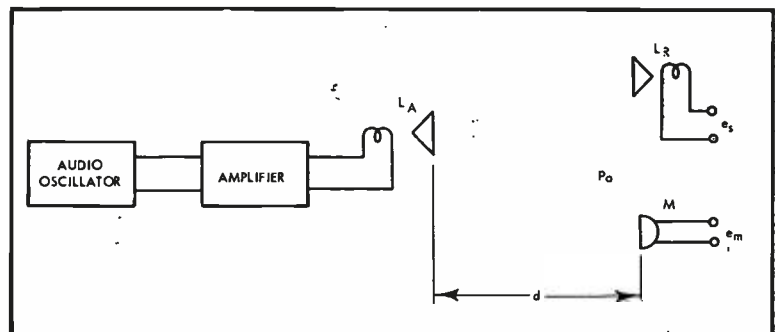

Fig. 1. Equipment set-up for the first step in calibrating a microphone.

\* 171 Reservoir Drive, Boonton, N. J.

# 1.02 Cubic Feet and 45 cps.

A combination of design approaches makes it possible to achieve exceptionally good "listening" in an enclosure which is smaller than most of us would expect to be acceptable.

RICHARD SEQUERRA\*

**I**N GENERAL the past ten or more years have given birth to at least a hundred articles describing revolutionary loudspeaker systems. Each one, we were told, was the harbinger of a new era in the reproduction of music. Even though there has been a constant improvement in the state of the art, and the aforementioned articles have been contemporary with the improvements, a great deal of confusion and question remains with the public at large.

Basically, these articles fall into two groups. The first is a product report, by the manufacturer, which establishes the technical validity of the loudspeaker system and supplements conventional advertising techniques. The second is the unusual application of acoustic principles by the home engineering or advanced audiofan describing his own "one-of-a-kind" loudspeaker system. Both of these groups have been valuable to the high fidelity industry and I think that it is time to add a new dimension to these groups.

Let it be stated at the outset that in spite of any technical measurements and tests, (which in the writer's opinion show a design direction only), the yes or no judgment of any loudspeaker system is still subjective and it is suspected

\* Pilot Radio Corporation, 37-04 36th Street, Long Island City 1, N. Y.

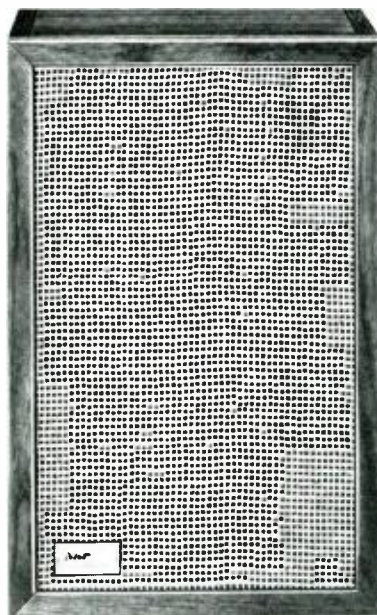

Fig. 1. The Pilot PSV-3 loudspeaker system from the outside.

that all of the factors which determine preference are not yet known, while many that are known are not completely understood.

The prejudices involved in the Pilot

PSV-3 loudspeaker system are as follows:

- (1) The frequency response of a loudspeaker system should be flat and completely free of any spurious noises or colorations.
- (2) The loudspeaker system should be capable of reproducing in the average-sized living room, 14 by 20 feet a 45-cps tone not more than 10 db down from the 1000-cps level.
- (3) The system should be capable of reproducing a sound pressure level of about 100 db three feet from the speaker when driven from a 10-watt amplifier. In this writer's opinion, loudspeaker systems should work well from modest power amplifiers allowing adequate margin when used with the higher power amplifiers.
- (4) The loudspeaker system should be small enough to be placed anywhere, in any position, to allow for the maximum flexibility in loudspeaker placement.
- (5) Since these units are to be used in the living room, their styling and woodcraftsmanship must be in keeping with the finest in design and cabinetry.
- (6) The over-all sound quality must stand up under any reasonable A-B listening test comparison.
- (7) Lastly, the price must allow the use of these loudspeaker systems with even the most inexpensive stereo system.

The seven preceding points reflect the writer's opinion and judgment. Wherever possible, the PSV-3 was designed and developed with these points in mind.

Figure 1 shows the external appearance of the Pilot PSV-3 loudspeaker system. It measures 18 x 11 x 9 in. The wood panelling is 3/4-in. thick throughout, which completely eliminates cabinet vibration. The cabinet is finished in oiled walnut and the four corners have been given an unusual design treatment by cross veneering.

Figures 2, 3, and 4 show front, top, and back views of the speaker mounting module. Figure 2 shows a 6-in. midrange speaker which is front-surface mounted, and the 3 1/2-in. tweeter, which is front-

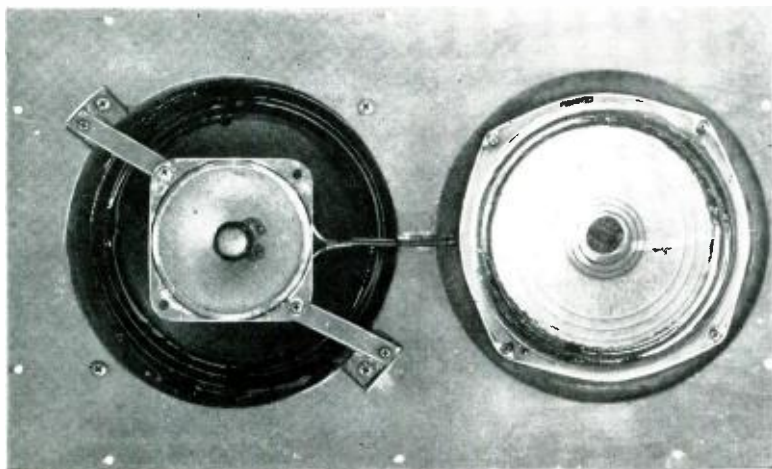

Fig. 2. Front view of the speaker panel showing the 8-in. woofer and the 3 1/2-in. tweeter at the left and the 6-in. midrange unit at the right.



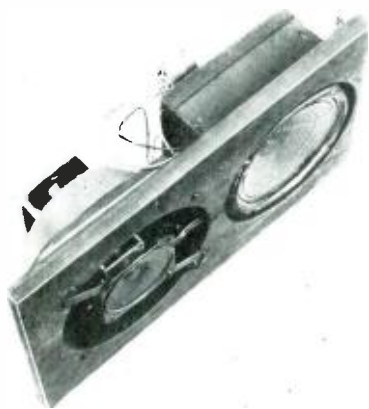

Fig. 3. Top view of the speaker panel to show the separate housing for the 6-in. midrange unit.

surface mounted coaxially with the 8-in. woofer. The edge rolls of the midrange speaker have been especially treated to eliminate edge resonance. In Figs. 3 and 4 are shown the 8-in. woofer and the separate enclosure for the 6-in. midrange speaker. The components of the crossover network are mounted on the back of this compartment.

Figure 5 is a schematic of the electrical crossover network. The electrical networks are designed to work in conjunction with the acoustical mechanical characteristics of 12 db per octave, resulting in the frequency division shown in Fig. 6.

The combination works as follows: the low limit of the 8-in. woofer is set by its enclosed resonance. The high-frequency limit is set by the value of  $L_1$  and the mechanical crossover of the moving system. The low limit of the midrange speaker is set by the size of its enclosure and the value of the series capacitor. The upper frequency limit is set by the moving system mechanical crossover. The tweeter is the armoured type and its low limit is set by the enclosure and the value of the series capacitor. At the high-frequency end, the cone is designed to roll off smoothly from 16,000 cps up.

Development of the techniques of working out these electro-mechanical constants could not have been possible

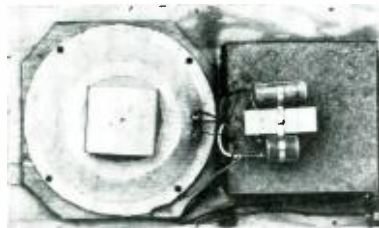

Fig. 4. Rear view of speaker panel. Cloth cover around woofer keeps orlon fluff from interfering with cone action.

without the aid and cooperation of Mr. R. Shoterfeld, Chief Engineer of Pilot Radio. This technique has been successful and is analogous to bandpass work at radio frequencies.

During the development of this system "white noise" testing was used extensively in eliminating spurious noises and colorations from this system. "White noise" is defined as an electrical wave whose spectrum is continuous and uniform as a function of frequency. Since "white noise" contains at one time all audio frequencies at equal amplitude when applied to a loudspeaker system, it shows up to the ear any peaks or holes in the response, as well as the on-off axis distribution of sound.

It is felt at Pilot that this test is the one that most corresponds to subjective evaluation, i.e., a loudspeaker system that sounds most uniform and peak free on "white noise" is the one that will be preferred in listening tests.

A word of explanation is necessary concerning the front surface mounting of the 6-in. midrange speaker and the 3½-in. tweeter. If these speakers are mounted behind a ¾-in.—or even a ¼-in.—panel, the defraction or scattering of sound twenty feet off axis is quite noticeable and tends to pin-point the sound at its source. However, when both are front-surface mounted, they have a wide open transparent quality with a greatly enlarged polar distribution.

The 8-in. woofer is a special unit which with a unique treatment is made to have a free-air resonance of less than 40 cps. When a woofer operates in a small closed-box baffle, the woofer produces rapid variations in the pressures of the enclosed air. The temperature of the gas rises when it is compressed and there is not enough time during the operation of the system for the heat to flow away. Hence, the apparent volume of the enclosure "looks" smaller to the speaker unit. However, when such an enclosure is filled with a soft, light-weight material such as orlon fluff, the heat is permitted to flow away because

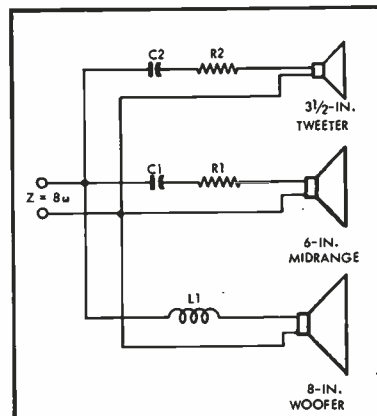

Fig. 5. Schematic of electrical crossover networks.

the speed of sound in the enclosure decreases from 344.8 meters per second to 292 meters per second. Therefore, the adiabatic or rapid compression characteristics are changed to isothermal or slow compression characteristics. This means that with orlon fluff the enclosure is made to "look" larger. The size of a small closed-box baffle determines the low-frequency system resonance—The larger the box, the lower the system resonance, the smaller the box, the higher.

An optimum enclosure may be made smaller and still keep identical acoustical characteristics by the use of orlon fluff. The low-frequency system resonance of this system is 66 cps with usable acoustic output down to 30 cps. The covering on the back of the 8-in. woofer is to prevent the orlon fluff from interfering with the speaker cone. The entire assembly is sealed.

We at Pilot feel that our design conditions have been met completely and the writer has personally carted two of the PSV-3 loudspeaker systems around, one under each arm, to give "on-the-spot" demonstrations. Up to this point, they have received unqualified raves in A-B listening tests by many hard-core professionals in the field.

Fig. 6. Approximate frequency responses of the electrical crossover networks.

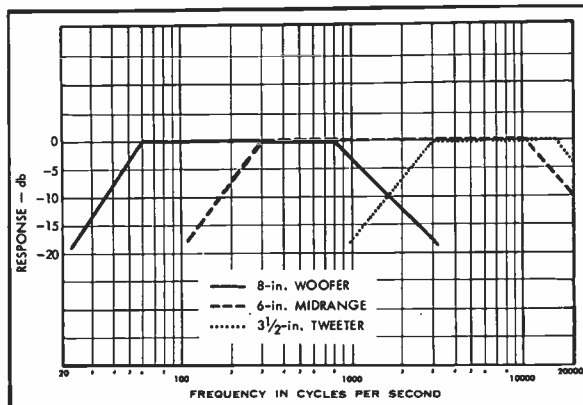

# Start with Mono—Build up to Stereo

C. F. BARTON\*

Although these suggestions come from a dealer and should be followed by every hi-fi specialist, they can be kept in mind by the individual who is planning a high fidelity system for himself.

**W**HILE THE TREND of all advertising is directed towards selling Stereo, there are still many prospects who prefer to keep within their smaller budgets and be satisfied with monophonic installations. Our approach to these people is to sell a basic system with *two* speakers and a carefully selected group of components that will lend themselves readily to the later build-up into a quality stereo system. We keep in mind the cost of conversion to stereo and by careful selection minimize this cost when stereo is wanted. In this manner we still make a substantial sale and at the same time develop satisfied customers.

Custom cabinets are designed with additional component space for the later conversion to stereo, and the speakers are matched, with provision for expansion to three-way systems without rebuilding speaker enclosures.

Consideration is given to tape for the future, and in some instances it may be necessary to utilize the space presently provided for record storage. This is done to minimize size and cost of the components cabinet. Records and tape must of course be stored elsewhere. This is usually no great problem.

Frequently we incorporate the television chassis in the components cabinet and utilize the better sound qualities of the hi-fi system's amplifier and speaker system. This reduces space requirements in the room and becomes a selling point especially appealing to the woman of the house.

As an example the custom built monophonic system shown is, at the present time, only a phonograph system with built-in TV. Space above the preamplifier is provided for a future FM tuner. Drawers are now installed in the space later to be used for a tape deck. Speaker enclosures are custom crafted to match the components cabinet, but are separate and can be placed elsewhere. However, as now placed they appear to be an integral part of the main cabinet. Provision is also made to increase the speaker system—at present a Bozak 207A in each

\* Audio Consultant, 40 Fleetwood Place, Bridgeport 10, Conn.



A monophonic system designed with the intent of changing over to stereo as the customer's budget can accommodate the additional equipment.

cabinet—to a Bozak 302 system without any cutting or altering of the speaker enclosures. The Garrard RC88, with lift up top installation, is of course already wired for a stereo cartridge. The balance of the system is composed of a Leak TL50 Plus amplifier, and of course the Leak Vari-Slope III matching preamplifier.

To expand to stereo it is only necessary to change to a stereo phono cartridge and replace the preamplifier, which if done within a reasonable period will have definite resale or trade-in value, and add another Leak TL50 Plus amplifier, which completes the system. Tape may then be added, or even before the change to stereo, as can the FM tuner.

This method of selling provides an opportunity for the dealer to make repeat sales. The customer expands the system as he has the necessary extra

money, and can choose several different ways of doing it, depending upon the cost and available money to be invested. For example:

1. Speaker system expansion
2. Tuner added
3. Tape added
4. Finally, stereo completed with necessary amplifiers.

These steps of expansion are more readily sold later than at the time of the original sale, particularly if cost is a deciding factor. I believe firmly that too much emphasis can be placed on stereo when a lesser approach such as this will result in more sales of better-quality components. The end result is a better satisfied customer due to minimized service interruptions and lower initial investment by the customer.

(Continued on page 81)

# BUYER'S GUIDE SECTION

Along about the first of September, the serious audio fan begins to think about his planned improvements—converting to stereo, adding a tape recorder, or whatever. So that he may have an advance glimpse of the new merchandise which will be available with the start of the traditional buying season, we present the Annual Buyer's Guide Section.

**W**ITH NEARLY TWO HUNDRED separate items, along with prices of many more items which are not described, the second Annual Buyer's Guide is considerably larger than last year's, and is—we believe—more complete. In most instances, a single product is described in each category from each manufacturer. In many cases, this may be the only product of that manufacturer. When the manufacturer offers a wide variety of items—as do, for example, those who make loudspeakers—it is obviously impossible to list everything. However, for more complete data, it is suggested that the reader write the manufacturer directly—or to us—for specific information. Because of the large number of manufacturers represented in this section, they are not coded in the usual fashion on the Readers' Service Card. If the manufacturers of interest happens to advertise in this issue, you may use the card and encircle the corresponding number. If there is room, you may write the name of any

non-advertisers on the card and mail it. We will forward them your requests for further information.

Any compilation of this type is subject to omissions and errors. Any manufacturer not herein represented may be considered to have (1), not been asked for information (our mistake); (2), the information was mislaid (ours again), or (3), he didn't send it (his). If we find enough such omissions, we shall try to fill in later. Since this is a catalog-type presentation, it must be pointed out that the statements made about the various products are the specifications as furnished by the manufacturer and are not the results of our own measurements or tests.

We are sincerely grateful for the co-operation given us by all the manufacturers represented and by their advertising agencies. Without their concerted help we could not have prepared this material. We trust you will find it interesting and informative throughout the year.

## AMPLIFIERS AND PREAMPLIFIERS

### ACRO

• **Stereo Preamp Kit.** Designed as a mate for the superb line of Acro amplifiers, the Acro Stereo Preamplifier is an extremely versatile unit which incorporates every essential stereo function. Evidencing the advanced design engineering incorporated in the amplifier line, this unit features a printed circuit board and modular design which make construction simple and enjoyable. Controls are easily accessible and uncluttered and include a selective rumble and scratch filter, a mike dub in, phasing switch, input level, individual bass and treble in each channel which provide 16 db of boost and 20 db of cut, an input se-

lete amplifying system, embodying two 25-watt stereo channels which may be combined for 50-watt monophonic operation when desired. Among its features is a matrixing network for "three-channel" stereo. Circuitry includes feedback-type equalization plus feed-



back around all tubes for minimum distortion. All low-level tubes have d.c. on heaters. Fourteen inputs include two each for magnetic cartridge, ceramic cartridge, tape head, tape recorder, tuner, microphone, and multiplex. Frequency response is 20 to 20,000 cps  $\pm$  1.0 db at 25-watts output; 10 to 30,000 cps  $\pm$  0.5 db at 10 watts. Harmonic distortion is less than 1.0 per cent. Tone controls are gauged and provide 14 db of boost or cut at 50 and 10,000 cps. Rumble filter attenuates at the rate of 12 db/octave below 30 cps. Silicon rectifiers are used in power supply. Engineered to the professional standards of other Altec-Lansing equipment, the 353-A meets every criterion of the most discerning music lover. Altec Lansing Corporation, 1515 S. Manchester Ave., Anaheim, Calif. User net price, \$225.00.

353A "Quartet" 20-w mono ampl. ....	\$111.00
350A 100 w mono ampl. ....	171.00
440C Mono preamp. ....	147.00
345 60-w stereo ampl. ....	270.00
445A Stereo preamp. ....	189.00

### BOGEN-PRESTO

• **Stereo Preamplifier-Amplifier.** Literally a home music center (lacking only program source) the Bogen-Presto AP-40 is designed to channel either stereo or monophonic programs to several places in the home simultaneously. Further, two different program

sources can be handled at the same time. An illuminated indicator panel instantly identifies the program sources and channels being used. The power amplifier provides 20 watts per channel for stereo use or 40 watts for monophonic operation. Featuring many engineering refinements the AP-40 has two nine-position rotary selectors for handling inputs from FM, AM, Multiplex, Phono (mag.), Phono (xtal or ceramic), Tape, TV, Aux. A Mono/Stereo switch permits use of stereo cartridges with mono records. The Speaker Selector switches operate with a double set of output terminals so that program may be directed to local or remote speakers. In addition there is a variable Blend control, inde-

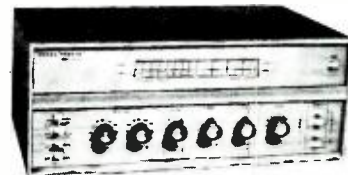

pendent volume controls, separate bass and treble controls for each channel, plus switches for loudness contour, scratch and rumble filters. Bogen-Presto, a division of the Siegler Corporation, P. O. Box 500, Paramus, N. J. User net price, \$199.50 (without enclosure). Metal enclosure \$9.95, walnut \$27.75.

BP-50, stereo 50-watt basic amp. ....	\$ 99.50
PR2, stereo control center. ....	99.50

### DE WALD

• **Thirty-Watt Stereo Amplifier.** Less than \$100 in cost, the Model N-1200-B "Concerto" embodies a complete stereo control system and two power output channels with a combined continuous-power rating of 30 watts. Included are a full complement of controls to permit full flexibility of operation. Tape-monitoring and tape-output jacks permit direct tape recording with complete control of volume and

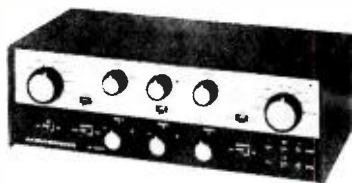

lector with 8 inputs including FM multiplex and tape head, an output selector with 7 modes which are indicated on 6 panel-light matrix, and a loudness contour switch. D.c. filament supply on all tubes plus careful design bring the equivalent noise level down to 2 microvolts at the input grid on the low-level input. Harmonic distortion is less than 0.05% at 1.5 volts output; intermodulation distortion is 0.15% at 1.5 volts output. Acro Products, 369 Shurs Lane, Philadelphia 28, Pa. User net price, \$69.50 for the kit; factory wired, \$114.50; self-powered kit, \$79.50—factory wired, \$129.50.

Stereo 20-20, 36-w ster ampl kit. ....	\$69.50
Ultra-Linear II, 60-w pwr ampl kit. ....	79.50

### ALTEC

• **Stereo Amplifier-Preamplifier.** This latest addition to the Altec-Lansing line of high fidelity equipment, Model 353-A, is a com-





tone. Bass and treble controls are included for each channel. Fourteen input jacks mounted in the rear of the amplifier are isolated from each other so any or all of them may be used at any time without interference or signal loss. Hum level is -75 db below full output for either channel and intermodulation distortion is approximately 1% at 12 watts. DeWald Radio Division of United Scientific Laboratories, Inc. 33-15 37th Ave., Long Island City, N. Y. User net price, \$99.95.

N-2200, 50-w comp stereo amp ..... \$139.95  
N-5000B, 15-w mono amp ..... \$2.95

## DYNAKIT

• **"Stereo 70" Power Amplifier Kit.** This amplifier kit is designed to meet the needs of the discriminating listener for a moderate-power high-performance power amplifier. Engineered for both stereophonic and monophonic operation, the Stereo 70 incorporates two 35-watt channels which can be paralleled by means of a convenient switch to provide 70 watts of single-channel output. The high power capability and low internal impedance of the



amplifiers provide excellent damping for all types of high fidelity speaker systems, including the low-efficiency types, without need for individual adjustments. Frequency response is  $\pm 0.5$  db from 10 to 40,000 cps; power response—20 to 20,000 cps without exceeding 1.0 per cent distortion within 1.0 db of 35 watts. Sensitivity is 1.3 volts rms for 35 watts output. Hum and noise level is more than 90 db below 35 watts. The use of prewired printed circuitry, detailed step-by-step instructions and pictorial diagrams, enables even the novice kit builder to construct this amplifier with complete confidence. Average construction time is about five hours. Dynaco Inc., 617 N. 41st. St. Philadelphia 4, Pa. User net price, including protective cover, \$99.95.

Mk II 50-w amp kit ..... 69.75  
Mk III 60-w amp kit ..... 84.95  
Mk IV 40-w amp kit ..... 59.95  
Stereo preamp kit, PAS-2 ..... 34.95  
Preamp kit, mono ..... 12.95  
Stereo control kit ..... 12.95  
Preamp power supply kit ..... 8.95

## EICO

• **Low-Cost Stereo Amplifier Kit.** This new Eico amplifier brings full stereo performance to even the most budget-minded music lover. It is engineered to provide true hi-fi quality at power levels which are adequate for driving high-efficiency speakers to concert volume. The input selection, mode of operation, tone and level controls insure complete flexibility of operation. The AF-4 employs a moderate single-ganged tone control so that available gain, released by this type of control, is converted into distortion-reducing negative feed-



back. The problem of distortion, created where available gain is expended on severe bass and treble boost, is thereby avoided. The feedback level around each power amplifier is 27 db, which results in intermodulation and harmonic distortion figures, taken at average listening levels, which fall well within high-fidelity standards. Front panel controls are: input selector, mode, level, tone, and on-off. Five pairs of inputs are provided for low- and high-gain program sources. A service-selector switch permits parallel or separate operation of the power amplifiers for stereo or monophonic use, respectively. Exact engineering specifications were not available at press time. Electronic Instrument Co., Inc., 33-00 Northern Blvd., Long Island City 1, N. Y. User net price, in kit form, \$88.95; factory wired, \$64.95.

HF81 ster preamp-amp ..... kit, \$69.95; wired, \$109.95  
HF85 ster preamp ..... kit, \$39.95; wired, \$ 64.95  
HF30 pwr amp ..... kit, \$39.95; wired, \$ 62.95

## EMI

• **Forty-Watt Stereo Amplifier.** Designed to a performance standard far surpassing its compact size, the EMI Stereoscope Model 555 is an integrated preamplifier/amplifier delivering 20 watts (peak) per channel with less than 0.1% total harmonic distortion at 1000 cps. Features a built-in cathode ray tube which can be used to achieve precise balance either between channels or output level to speakers, or to check the frequency response of the system as well as turntable rumble. A seven-position rotary control is provided for

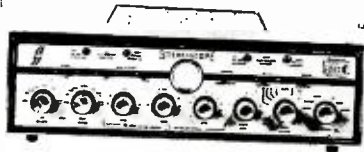

each channel to select inputs from tuner, microphone, tapc head, RIAA, 78, old LP, tape preamp. A function switch permits selection of normal or reverse stereo, monophonic through one channel or combined output of both, and left or right channel only. Four lights indicate the mode selected. Tone and volume controls are separate for each channel while the scratch and rumble filters operate for both channels. Operating with the CRT are the output power monitor switch and the 60-cps tone injection switch. There is a speaker phase reversal switch plus an output jack for a sum signal which provides a 1-volt audio signal to drive a third amplifier and speaker. Uses 34 db of negative feedback and has a damping factor of 30. Distributed in United States by Scope Electronics Corp., 10 Columbus Circle, New York 19, N. Y. User net price, \$267.50.

## ERIC

• **Stereo Amplifier-Preamp.** The new Model 2169 stereo amplifier employs two pairs of EL84's in the output stages to provide outputs of 20 watts per channel, with dual-triode amplifier and phase splitter preceding the output stages. Another dual triode serves as the pre-

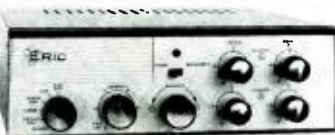

amp-tone control section providing for two low-level inputs and three high-level inputs for each channel. Separate tone controls are provided for each channel, and the unit is further equipped with a ganged loudness control, balance control, stereo-mono switch, and stereo reverse switch. Eric Engineering Company, 1823 Colorado Ave., Santa Monica, Calif.

## FISHER

• **Stereo Audio Center and 36-Watt Amplifier.** Extreme versatility plus solid 18 watt per channel power characterize the Fisher X-100 stereo master audio control and amplifier. In stereo operation the X-100 can drive two



speaker systems as well as center sum-signal amplifier and speaker. In monophonic operation inputs to either channel drive both amplifiers and speaker systems. Fourteen input jacks; six for low level, eight for high level, four magnetic (phono cartridge or tape head), and two for ceramic, provide sufficient flexibility for almost any combination of stereo or monophonic operation. Three output jacks plus seventeen controls and switches—including independent bass and treble controls for each channel—providing a range of adjustment to satisfy the most critical ear. Harmonic distortion is 0.8% at full rated output and frequency response is within 1 db from 20 to 20,000 cps. Hum and noise is more than 90 db below full rated output and channel separation is better than 50 db. Fisher Radio Corporation, 21-21 44th Drive, Long Island City 1, N. Y. User net price, \$159.95.

X-202, 50-w stereo preamp/amp ..... \$229.50  
10CX, stereo preamp ..... 199.50  
SA-100, 50-w stereo amp ..... 119.50  
SA-300, 60-w stereo amp ..... 79.50  
30A, 20-w amp ..... 59.50  
PR-6, preamp ..... 12.95

## GENERAL ELECTRIC

• **"Stereo Classic" Amplifier.** The G-E Model G-7700 is an integrated unit combining a high quality stereo preamplifier with matching power amplifiers on a single compact chassis. Notwithstanding its modest dimensions, it leaves nothing to be desired in audio performance. Power output is 56 watts, 28 watts per channel in stereo operation. Frequency response is 20 to 20,000 cps  $\pm 0.5$  db at rated

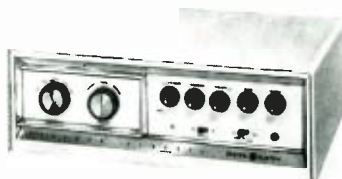

output; distortion is below 1%. Hum and noise level down 68 db and 79 db on low- and high-gain inputs respectively. Channel separation is better than 40 db over entire frequency range. Output stage of amplifier is operated with fixed bias for optimum ability to handle the low average level plus high peaks of music reproduction. Front panel controls include rumble filter plus continuously variable loudness-contour adjustment. Rear panel has speaker phasing control. The G-7700 is compact despite its large power output, measuring 5 1/2" h x 15" w x 12" d. The cabinet is finished in beige vinyl. General Electric Company, Audio Components Products Section, West Genesee St., Auburn, N. Y. User net price, \$189.95.

MS-4000A, 56-w stereo amp ..... \$169.95  
G-7600, 40-w stereo amp ..... 139.95  
MS-2000A, 40-w stereo amp ..... 119.95

## GROMMES

• **Stereophonic Amplifier.** The new Grommes 36PG is a stereophonic/monophonic preamplifier and 30-watt power amplifier all in one compact unit. Featuring ganged controls, two separate loudness contours, sum-signal speaker output, and silicon rectifiers. Frequency response is  $\pm 0.5$  db, 20 to 20,000 cps at 1 watt. Harmonic distortion is 0.6% at 15 watts (1000 cps) and intermodulation dis-



tortion is 2% at 15 watts. Hum and noise are 75 db down at the tuner input and 50 db down at the phono input (below 15 watts). Sufficient controls are provided to achieve wide range of adjustments. Sensitivity at the Aux and tuner inputs is 0.4 volt; magnetic phono 0.004 volt; tape head .0045; crystal phono 0.25 volt for rated output. Precision Electronics, Inc., 9101 King St., Franklin Park, Illinois. User net price, \$169.95; cover \$10.00.

## HARMAN-KARDON

• Stereo "Citation" Preamp and Amplifier Kits. Pioneering a new concept in kits, the Harman-Kardon Citation line spares neither effort nor expense to achieve superb quality of music reproduction. Indeed some believe that the Citation II power amplifier (shown) will outperform any amplifier in its class, kit or not. In any case the top models in this line of kits, designed by Stewart Hegeman, are not inexpensive—they are obviously intended for the quality-at-any-price music lover. These models are the Citation I stereo preamplifier and the Citation II 120-



watt stereo power amplifier, both priced at \$159.95 without enclosure. Utilizing the same design concept but reduced in scale and price are the Citation IV stereo preamplifier and the Citation V 80 watt stereo power amplifier both to become available this fall. To give some picture of the quality of these units we will list some of the performance specifications for the Citation II. Power output is 120 watts, or 60 watts per channel. Harmonic distortion less than 0.5%, 20-20,000 cps at 60 watts; intermodulation distortion less than 0.5% at 60 watts. Frequency range 18-40,000 cps, +0, -1 db at 60 watts; 2-80,000 cps +0, -1 db at 1 watt. Hum and noise are better than 90 db below 60 watts. Harman-Kardon Inc., 520 Main Street, Westbury, N. Y. Kit price for the Citation IV will be \$109.95 and for the Citation V is \$119.95, both without enclosure. Walnut enclosure for Citation I and IV, \$29.95; metal enclosure for Citation II and V, \$7.95.

## HEATHKIT

• Fifty-Watt Stereo Amplifier Kit. The top model in the Heath line of stereo amplifier-preamp kits, the AA-50 provides excellent performance at modest cost. With five switch-selected inputs for each channel—two low level and three high-level—plus an additional low-level input for monophonic magnetic cartridge, the AA-50 is flexible enough to accommodate a wide variety of equipment. A four-position function switch permits any monophonic source to be played through either

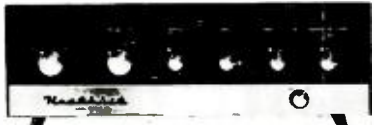

channel or through both channels simultaneously. Stereo features are: a stereo reverse switch, separate balance control, special separation control, ganged volume controls, and separate concentric bass and treble controls for each channel. An output is provided for a sum-signal speaker. Two circuit boards simplify assembly. Harmonic and intermodulation distortion are less than 2% at rated power output. Hum and noise for magnetic phono input is 58 db down from 25 watts; auxiliary inputs, 70 db down. Heath Company, Benton Harbor, Mich. User net price, \$79.95.

SA-2, 28-w stereo ampl kit ..... \$54.95  
AA-40, 70-w stereo pwr ampl kit ..... 79.95  
SP-2A, stereo preamp kit ..... 56.95

## KNIGHT-KIT

• Knight-Kit 40-Watt Stereo Amplifier. Both economy and impressive performance are combined in the Knight-Kit 40-watt stereo amplifier, a complete preamplifier and power amplifier on a single chassis. Two 20-watt channels may be paralleled for monophonic operation when desired. Frequency response is 15 to 35,000 cps  $\pm$  1.0 db at 10 watts out-

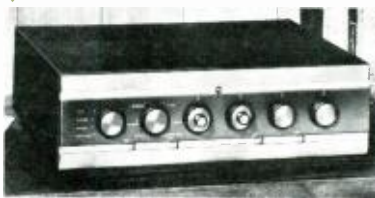

put. In addition to offering all conventional functions for 2-channel stereo, this unit provides a unique third, or "center channel" output which permits feeding full-range program material to a center speaker for elimination of the "hole-in-the-middle" effect, or for feeding an extension speaker for monophonic listening. Bass and treble controls offer 15-db boost and droop at 20 and 20,000 cps, respectively. Among other advanced features are printed circuitry plus printed-circuit switches for ease of assembly; dual-concentric clutch-type tone controls for individual or simultaneous adjustment of the two channels, and switch-controlled Fletcher-Munson-type loudness control. Harmonic distortion is less than 0.5 per cent at rated output. Allied Radio Corporation, 100 N. Western Ave., Chicago 80, Ill. User net Price, \$79.50.

20-w stereo ampl ..... \$44.50  
60-w stereo pwr ampl ..... 84.50  
Stereo preamp ..... 64.95

## LAFAYETTE

• 50-Watt Stereo Amplifier Kit. The new Lafayette KT-250A offers remarkable versatility, high-quality reproduction and distinctive styling in a low cost unit. Featuring a unique separation control, clutch-operated volume/balance control, independent bass and treble controls for each channel, loudness contour switch, phase reversal switch, plus five pairs of inputs (three high-level, two low-level), and outputs for tape recording and sum-signal stereo. Special circuit features



are individual bias and balance controls, d.c. applied to all preamp and tone-control tubes for low-hum operation, hum balance control, excellent d.c. power supply regulation provided by silicon diodes, and use of new low-voltage, high-current output tubes (6CW5/EL86) for reduced distortion. Power output is 50 watts total or 25 watts per channel  $\pm$  1 db at less than 1% total harmonic distortion at 1000 cps. Frequency response is 20 to 50,000 cps  $\pm$  1 db at rated output. Hum and noise, 70 db below rated output with volume at maximum position at high-level inputs; 50 db down at low-level inputs. Channel separation greater than 65 db at 1000 cps. Lafayette Electronics Mfr. Corp., 104-46 Dunkirk St., Jamaica 12, N. Y. user net price, \$74.50.

## LEAK

• Newly-Styled "Point One" Stereo Preamp. Impressive new styling enhances the appearance of the latest version of the well-known Leak "Point One" stereo preamplifier. Decorator-designed, the new front panel offers changeable color panels for both faceplate and knobs, enabling the user to match the decor of any room. The new escutcheon plate is interchangeable with the present one, permitting present owners the option of inexpensive conversion to the new styling. The "Point One" includes provisions for playing stereo, stereo reverse, left channel only, right



channel only, and monophonically. There are five dual inputs for virtually any type of stereo or monophonic source, including microphone. Bass and treble controls permit boost and cut of 16 db at 30 and 15,000 cps, respectively. All controls are of the dual-ganged type, operative on both channels simultaneously. Distortion is less than 0.1 per cent for 1.25-volt output. A balance control allows for a great difference in sensitivity between speakers. This new unit has been expressly matched to all Leak power amplifiers. British Industries Corporation, 80 Shore Road, Port Washington, N. Y. User net price, less cabinet, \$119.50.

Ster 50 ster ampl ..... \$199.00  
Ster 20 ster ampl ..... 149.00

## McINTOSH

• Power Amplifier Kit. In addition to factory-built units, the 30-watt unity-coupled amplifier is now available in kit form. When completed, the amplifier is identical to the regular factory-wired MC30. Output is 30 watts with a frequency range of 15 to 50,000 cps  $\pm$  0.5 db, or 20 to 30,000 cps  $\pm$  0.1 db. From 10' to 100,000



cps at 15 watts, the output is  $\pm$  1 db over the range. Harmonic distortion is stated as less than 1/4% at 30 watts, with IM distortion below 0.5% and hum and noise 90 db or more below rated output. McIntosh Laboratory, Inc., 2 Chambers St., Binghamton, N. Y. User net price, \$120.00.

C-20 stereo preamp ..... \$225.00  
MC-30, 30-w amplifier ..... 143.30  
MC-60, 60-w amplifier ..... 158.50

## MARANTZ

• Stereo Console. The Marantz Model 7 is a self-powered stereo preamplifier-control unit which features a high order of versatility, together with remarkable ease of operation. It will deliver unexcelled performance when used with either stereo or monophonic program sources. Typical of the quality inherent in this unit is the volume control. Especially

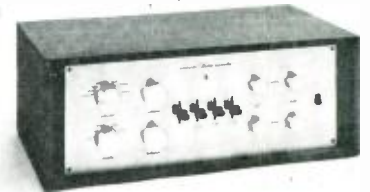

developed for Marantz, each control is individually tested for 2-db tracking at any point of rotation down to 65 db attenuation; total range is 90 db. Separate step-type feedback tone controls with identical curves are incorporated in each channel. The steps are in increments of 3.0 db at 50 cps and 2 1/2 db at 10,000 cps; both controls are removed from the circuit in flat position. A full-range



balance control permits complete cutoff of either speaker. Frequency response is 20 to 20,000 cps  $\pm$  0.5 db. Intermodulation and harmonic distortion are reduced to negligibility. Hum is far below thermal noise. Nine pairs of inputs and three pairs of outputs are mounted on rear panel. The Model 7, while not inexpensive, offers a measure of performance well in keeping with its price. Marantz Company, 25-14 Broadway, Long Island City 6, N. Y. User net price, less cabinet, \$249.00; cabinet, in mahogany, walnut or blond, \$24.00.

1 mono Audio Consolette .....	\$158.00
2 40-w pwr ampl .....	219.00
5 30-w pwr ampl .....	147.00
electronic crossover .....	90.00
8 60-w stereo pwr ampl .....	237.00

## PACO

• **Stereo Preamp-Amplifier Kit.** The Paco Model SA-40 consists of two 20-watt amplifiers, each with its own preamplifier-control system, on a single chassis. It is mounted in an attractive gold and satin black case, with satin gold panel to blend harmoniously with all decors. The amplifiers deliver a true 20 watts output per channel due largely to a well-regulated low-impedance power supply. There is no clipping even on sustained high-



level passages. Distortion is kept to a minimum because of the unique main feedback circuit which eliminates phase-shifting components. In addition to all the standard controls and switches the Model SA-40 includes: two dual phono inputs to permit the use of both record changer and manual turntable, special switching which affords selection of additional speaker systems anywhere in the home, and Balance-Right and Balance-Left test selector for a simplified aural check on the balance of two speakers for best stereo results. Frequency response measured at 1.0 watt steady-state output is 30 to 90,000 cps  $\pm$  1.0 db. Intermodulation and harmonic distortion are less than 1.0 per cent and 0.2 per cent, respectively, at full rated output. The SA-40 is supplied with step-by-step assembly instructions and giant-size wiring diagrams to ensure easy and successful assembly. PACO Electronics Company, Inc., 70-31 84th St., Glendale 27, N. Y. User net price, in kit form, \$79.95; factory wired, \$129.95.

## PILOT

• **Sixty-Watt Stereo Control-Center Amplifier.** The Pilot 248 is a fine stereophonic amplifier (harmonic distortion 0.5% from 20 to 20,000 cps at rated power) combined with a versatile control center. A total of 14 inputs for monophonic use or 7 pairs for stereo. Fifteen controls include a scratch filter, a rumble filter, and a tape monitor switch. The 248 has Pilot's Stereo-PLUS Curtain-of-sound, an ad-



ditional speaker connection which can be used for center fill-in for stereo or for monophonic listening in another room. Output is 30 watts per channel or 60 watts total; sensitivity is 1 volt for full output. Intermodulation distortion is less than 0.5% and frequency range is 20-20,000 cps. Each Pilot 248 is shipped with a certificate showing final test values for that particular instrument. In distinctive brass and black styling. Pilot Radio Corporation, 32-06 36th St., Long Island City 1, N. Y. User net price, \$249.50.

216A, stereo preamp .....	\$199.50
240, 30-w stereo ampl .....	134.50
264, 60-w stereo pwr ampl .....	179.50

## REALISTIC

• **Forty-Watt Stereo Amplifier.** Newest amplifier in the Realistic line, the Stereolyne-40



delivers 40 conservatively rated watts monophonically, or 20 watts per channel for stereo. Distortion at full power is only 0.9% rms at 400 cps; frequency response is 20-20,000 cps  $\pm$  1 db. Hum and noise is better than 59 db down for low-level inputs and 79 db down for high-level inputs, referred to 20 watts output. Eight controls and two switches on the front panel provide sufficient flexibility to accommodate almost any program source. In addition there is a hum-adjust control on the rear panel. Comes complete with attractively styled gold-finish metal cabinet, trimmed in maroon and white. Radio Shack Corporation, 730 Commonwealth Ave., Boston 17, Mass. User net price, \$79.50.

AF-15, 15-watt ampl .....	\$39.95
AF-12, 12-watt ampl .....	29.95

## SARGENT-RAYMENT

• **100-Watt Stereo-Control Amplifier.** Designed for extreme simplicity in operation, the S-R 2051 features specially designed push-button switches which eliminate the need for the complex mode switch used on most stereo preamps. Included in the total of 12 push-buttons are switches for rumble and scratch filter, tape monitor, stereo reverse, and loudness. In addition to the push-buttons there are individual bass and treble controls for each channel, a stereo channel-separation control, a



speaker phase-reversal control, a balance control, and a volume control. Both scratch and rumble filters are "notch" type. Outputs include jack for sum-signal output, and separate outputs from each channel for tape recording. Power output is 100 watts total, or 50 watts for each channel at less than 1% harmonic and 1.5% intermodulation distortion. Frequency response is 20 to 20,000 cps plus or minus 1 db; hum is 85 db below rated output. In keeping with the design concept evidenced by the push-buttons, a functional attractive metal cover is included in the base price. Sargent-Rayment Company, 4926 E. 12th St., Oakland, Calif. User net price, \$247.50.

SR2040, 40-w stereo control ampl .....	\$189.50
SR5100, 100-w stereo pwr ampl .....	183.60
SR534, 40-w stereo pwr ampl .....	106.60

## H. H. SCOTT

• **Dynaaural Stereo Amplifier.** A new 88-watt complete stereo amplifier, the H. H. Scott model 272 features the patented Dynaural Rumble Suppressor and a new sum-signal level control. Also included are a phono level controls and acoustic level controls. The Dynaural Rumble Suppressor was invented in 1946 and was used to delete the noise inherent in old shellac records. When the long-playing record appeared this suppressor was

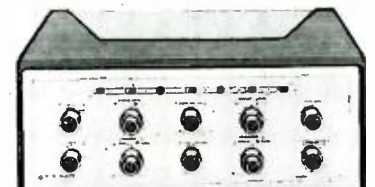

no longer necessary. With stereo, rumble again became a problem and hence its re-introduction in this unit. The suppressor operates only between notes or in extremely soft passages where rumble becomes a nuisance; in loud passages the intensity of the sound masks the rumble. Utilizing massive, 14 pound output transformers with 6CA7/EL34 output tubes, the 272 has a power rating of 88 watts, or 44 watts per channel. Total harmonic distortion is only 0.8% and power bandwidth is down to 20 cps. H. H. Scott, Inc., 111 Powdermill Road, Maynard, Mass. User net price, \$269.95.

299B, 50-w stereo ampl .....	\$209.95
222B, 30-w stereo ampl .....	144.95

## SHELL

• **40-Watt Stereo Control Amplifier.** A complete monophonic-stereophonic control center, the Shell 2020P "Manhasset" features visual balance of the stereo channels by an electronic "eye" tube. Located on the front panel, with individual channel balance controls nearby, the "eye" permits precise dynamic balancing of the input signals. In addition a built-in signal generator provides a reference voltage for balancing. The "eye" is also useful as monitor for recording. Controls are also provided for selecting mode, loudness contour, mono channel 1, channel 2, or combined, and rumble filter. Bass and treble controls are separate within each channel. Power output is 40 watts, or 20 watts for each channel with intermodulation distortion less than 2%; harmonic distortion less than 1% between 30 and 10,000 cps. Frequency response is 30 to 20,000 cps  $\pm$  1 db at rated output. 18 db of feedback is used with a stability margin of 15 db. Hum and noise are down 80 db at the tuner and auxiliary inputs, 65 db at the tape input, and 70 db at the phono magnetic input. Shell Electronics Mfg. Corp., 112 State St., Westbury, N. Y. User net price, \$129.95.

## SHERWOOD

• **36-Watt Basic Amplifier with Stereo Pre-amp.** With the new S-4400, a person who now owns a basic amplifier of similar power capability or a mono amplifier-preamp can convert easily to stereo. This unit offers the important control features essential to stereo operation—dual loudness control, stereo reverse switch, phase reverse switch, and function switch.



It also includes a presence-rise switch, phono scratch and rumble filters, tape monitor switch, output tube balance control, tape head equalization. Preamp heaters are supplied with d.c. for low hum. Two low-level inputs and three high-level inputs are provided for each channel. Output section is 36-watt power amplifier. The S-4400 may be used with any other power amplifier for the second channel, or with an S-360, which is a 36-watt basic amplifier. Sherwood Electronic Laboratories, Inc., 4300 N. California Ave., Chicago 18, Ill. User net price, \$159.50.

S-360, 36-w basic ampl .....	\$59.50
------------------------------	---------

## STROMBERG-CARLSON

• **64-Watt Stereo Control Amplifier.** Stromberg-Carlson Model ASR-8.80 is a completely versatile amplifier which can be used for stereo or monophonic reproduction and has been "human-engineered" for use by the less technically inclined. However, sixteen operating controls provide flexibility to delight the



most discriminating audiophile. Indicator lights show the program source in use. Each of its two channels has a continuous power rating of 32 watts at a harmonic distortion



of 0.9%. Intermodulation distortion is 1% at 20 watts. Frequency response is 18 to 38,000 cps plus or minus 0.8 db. The exclusive "output balance signal" permits balancing the two channels by a built-in signal tone. Each channel has its own controls—loudness/volume, bass and treble—plus a master gain control which affects both channels simultaneously. Full frequency feedback provides minimum distortion at all frequency levels. D.C. is superimposed on all preamp filaments to reduce noise and hum substantially. Matching impressive performance with distinctive appearance, Stromberg-Carlson amplifiers are decorator designed. Stromberg-Carlson, Special Products Division, 1400 N. Goodman St., Rochester 3, N. Y. User net price, \$199.95.

ASR-333, 24-w stereo ampl ..... \$ 99.95  
 ASR-422, 40-w stereo pwr ampl ..... 99.95  
 ASR-433, 24-w stereo ampl ..... 129.95  
 ASR-434, stereo preamp ..... 99.95  
 ASR-444, 60-w stereo ampl ..... 169.95

## TUNERS

### ALTEC

• **AM-FM Tuner.** Employing a fully shielded extra large tuning capacitor directly mounted to the chassis for perfect grounding, the carefully designed circuit layout and complete isolation between transformers and power mains in the 306A tuner reduce coupling to a point that easily exceeds FCC radiation requirements. The FM section employs a Foster-Seeley discriminator, "cascode" low-noise r.f.

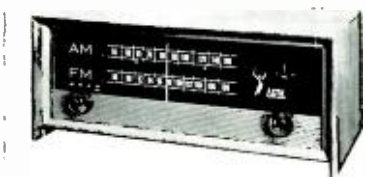

stage, triode low-noise mixer, a.f.c., and two limiters. AM section has three i.f. transformers for flat pass band, and sensitivity is 3 microvolts on an outside antenna and 50 microvolts with the built-in Ferrite loopstick. Distortion is less than 1.5 per cent at 30 per cent modulation on AM and less than 1 per cent at 100 per cent modulation on FM. Cathode follower output. Altec Division, Ling-Altec, 1515 S. Manchester Ave., Anaheim, California. User net price, less cabinet, \$139.50.

307A FM tuner ..... \$96.00

### AMPEX

(Note: This material was received just prior to deadline without technical specifications. On the assumption that you would want to see it anyhow, we included the photograph and a brief description.)

• **Stereo Tuner and Control Center.** The Ampex Model 550 Stereo Control Center and AM/FM Tuner is the newest addition to the Ampex line of audio components. This unit combines on one chassis a stereo audio control center and a stereo AM-FM radio. The AM and FM radio are independently tuned,

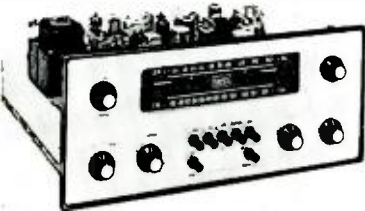

so that AM-FM stereo broadcasts may be received. Provisions for later addition of a multiplex adapter are included. The audio control center portion provides push-button selection of five sources: AM, FM, Tape, Phono, or External, with further selection of Stereo or Single and Listening—Record functions. Ampex Audio, Inc., 1020 Kifer Road, Sunnyvale, Calif. User net price, \$275.00.

## BOGEN-PRESTO

• **Stereo Music Center.** The new Bogen-Presto Model RP-40 Stereo Receiver is a versatile combination stereo tuner, control center and 40-watt amplifier capable of channeling either stereo or monophonic programs to several places in the home simultaneously. The tuners in the RP-40 are said to achieve a 1-microvolt

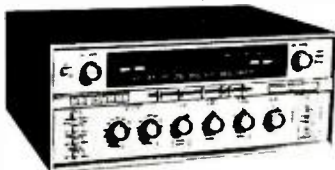

sensitivity. The FM tuner uses a tuned r.f. stage, three-tuned i.f. circuits with two stages of amplification, dual limiters, and a ratio detector, arranged to provide a predetermined level of interstation hush. AGC on FM and AVC on AM. Separate tuning indicators provided for AM and FM. Wired for multiplex. The control center and amplifier are essentially the AP-40 40-watt amplifier described in the amplifier product section. Bogen-Presto, a Division of the Siegler Corp., Paramus, N. J. User net price, \$329.50; metal enclosure, \$10.75; walnut enclosure, \$27.75.

TP-40, ster FM/AM tuner ..... \$189.50  
 SRB20, ster recor ..... 219.50  
 STP52, ster tuner/preamp ..... east, \$179.50  
 west, \$182.00

### DE WALD

• **Stereo Tuner.** Modest price and good performance are combined in the De Wald Model N-1000-B "Ambassador" FM-AM stereo tuner. Included in the circuitry are eight tubes plus diode detector and rectifier, with four stages of i.f., including discriminator. Sensitivity is 3.0 microvolts for 20-db quieting. Frequency response is 20 to 20,000 cps and hum level is



stated as being 70 db below 1.0 volt. Response of a.f.c. is +0.8 megacycles at 100 microvolts. Output jacks include AM, AM-FM monophonic, FM stereo, AM tape, FM tape, and multiplex. The tuner is cased in an attractive black picture-frame housing with brushed-brass face plate. De Wald Radio Division of United Scientific Laboratories, Inc., 35-15 37th Ave., Long Island City 1, N. Y. User net price, including cabinet, \$99.95.

N-803-B, mono AM/FM tuner ..... \$77.95  
 N-804-B, FM tuner ..... 74.95

### DYNAKIT

• **FM Tuner Kit.** The Dynatuner FM Kit is a complete printed circuit design for simple, virtually error-proof assembly by even the novice builder. Designed primarily for maxi-

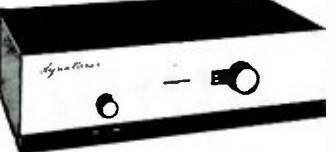

mum linearity and stability, the Dynatuner also maintains a high sensitivity. A tuned r.f. input utilizing a cathode-coupled dual triode provides 4-microvolt sensitivity (IHF) with excellent rejection of spurious signals and minimum cross-modulation. The i.f. coils are uncoupled so that alignment can be attained by simple peaking methods, using the tuning eye for an indicator. The use of minimum phase shift i.f.'s, wide-band detection, and linear design has led to a tuner of extremely low distortion. The intermodulation distortion is less than 0.25% over the useful range of operation and does not exceed 0.5% with a signal level as low as 10 microvolts. Dynaco Inc., 3912 Powelton Ave., Philadelphia 4, Pa. User net price, \$79.95. Available about October, 1960.

## EICO

• **Wide-Range AM Tuner Kit.** The new Model HFT94 is a basic AM tuner designed primarily for high fidelity application. It matches in size and appearance the EICO HFT90 FM tuner, the two tuners making excellent companion units for stereo operation. The HFT94 offers a choice of wide bandpass to 14,000 cps for high fidelity operation, or narrow bandpass to 7000 cps when the objective is to receive distant stations. A high-Q filter eliminates 10-kc whistle while reducing response by no



more than 3.0 db at 9000 cps. A full-wave rectifier and heavy filtering provides a stable hum-free supply. R.f. and i.f. coils are supplied pre-aligned so that no test instruments are needed for satisfactory operation of the completed kit. Additional features include slide-rule dial, flywheel tuning, auxiliary output for recording, and front-panel volume control. Image rejection is 58 db. Precision tuning is achieved by a traveling eye indicator which contracts into an "exclamation point" at the exact center of each broadcast channel. The HFT94 is also available completely wired, ready for installation. Electronic Instrument Co., Inc., 30-00 Northern Blvd., Long Island City 1, N. Y. User net price, \$39.95; fully wired, \$65.95.

HFT-90 FM tuner ... kit, \$39.95; wired \$65.95  
 HFT-92 AM/FM tuner kit, \$59.95; wired \$94.95

### ERIC

• **Simplified FM Tuner.** Featuring a tuned r.f. amplifier stage for maximum gain, the 2457 has better than 1.5-microvolt sensitivity for 20 db quieting. The unit employs a Foster-Seeley discriminator, and is equipped with AFC with a front-panel defeat switch. The dial is calibrated in megacycles plus an additional log scale for convenience, and there is sufficient space to accommodate a multiplex adapter. Control shafts are sufficiently long to permit installation with a cabinet panel. Output is from an cathode follower to allow the use of an output cable up to 200 feet long. Eric Engineering Company, 1823 Colorado Ave., Santa Monica, Calif.

### FISHER

• **Super-Sensitive FM Tuner.** Introduced by the manufacturer as the most sensitive FM tuner in the world, the Fisher FM-100 requires only 0.4 microvolt for 20 db quieting with a 72-ohm antenna. Frequency response is 20 to 20,000 cps  $\pm 0.5$  db, with a 60-db signal-to-noise ratio for 100-microvolt input, and distortion is less than 0.5 per cent at full modulation. The wide-band ratio detector, using a matched pair of germanium diodes, offers completely linear and distortion-free operation entirely free of hum. Instantaneous-acting dual dynamic limiter stages are highly



effective on any signal, whether strong or weak, eliminating ignition interference and other noise elements. A Multiplex Separation control is included on the front panel, plus Main and MPX channel positions on the selector switch, while power and electrical connections and space have been provided for simple plug-in installation of the Fisher

(Continued on page 39)

# The Tape Guide

## Equalization

The fundamental facts about the elements which affect frequency response of tape recorders should be understood by any serious tape fan, along with the reasons for equalizing and the types of equalization required. Here they are—

HERMAN BURSTEIN\*

**A**T VARIOUS TIMES in earlier articles we have touched upon the subject of equalization in tape recorders, for example in connection with frequency response, distortion, and signal-to-noise ratio. The purpose of the present article is to bring together the various aspects of the subject and present in one place a composite picture of this complex topic. Without an understanding of equalization the tapefan cannot have a full basic comprehension of the tape recorder.

Perhaps the best way to launch the discussion is to consider what the record-playback response of the tape recorder would be like if there were no frequency compensating circuits in it. A typical unequalized response curve appears in Fig. 1 for a machine operating at 7.5 ips, with bias current at a value normally used. The need for frequency-compensating

circuits is instantly apparent, because in their absence there would be grave deficiencies both in bass and treble. In other words, bass boost and treble boost are needed.

The following discussion will deal with the factors responsible for the bass and treble losses; with losses that vary with wavelength and tape speed compared with those that vary purely with frequency; with the optimum location of compensating circuits as between record and playback; with the NAB equalization curve; with possible variations in equalization at a given speed; with changes in equalization as tape speed is changed; and with the basic types of equalization circuits employed (in elementary terms).

### Record and Playback Losses

Following are the factors that account for the departure of the curve in Fig. 1 from flat response.

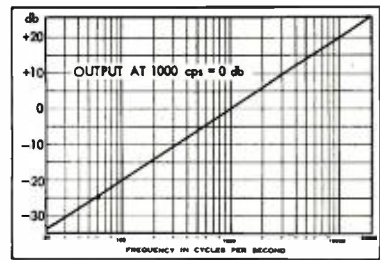
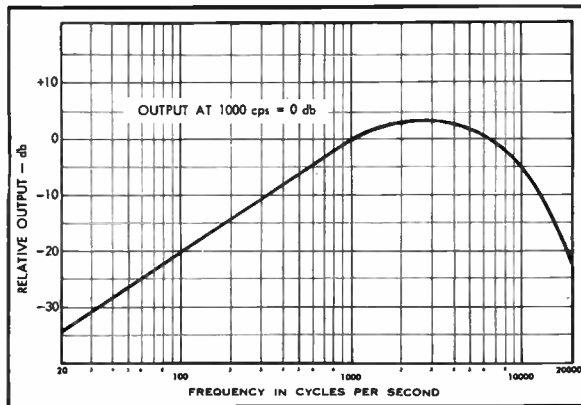

Fig. 2. Output of an "ideal" playback head, assuming equal recorded flux on the tape at all frequencies.

1. *Velocity Characteristic of the Playback Head.* Assuming a tape is recorded so that it contains equal amounts of signal (magnetic flux) at all frequencies, the response of an ideal playback head would be as in Fig. 2, that is, rising steadily with frequency. A tape head is called a "velocity device" because its output depends upon how rapidly the magnetic field presented by the tape to the head changes, in other words upon the velocity of this field. The higher the frequency, the greater is the rate of change of the magnetic field on the tape—i.e., the more cycles there are per second—and therefore the greater is the output of the playback head. This accounts for the sloping portion of the left side of Fig. 1, which is a straight line. (The line is perfectly straight only in theory. In practice, the line tends to wiggle a bit (contour effect) at the very low end and to decline more than is shown (wrap effect) due to interactions between the tape and the entire head. However, the line is sufficiently close to straight to be described in that manner.)

The following factors account for the

Fig. 1. Unequalized record-playback response of tape recorder, 7.5 ips, .00025-in head gap.



# Committed to perfection . . .

SONY Sterecorder 300 — The ultimate in quality and precision from world famous Sony — a complete 4 track and 2 track stereophonic tape recording and playback system in one compact package. \$399.50 Complete with carrying case, 2 dynamic microphones and stereo speaker.



SONY C-37A Condenser Microphone — Acclaimed the world's finest! \$295.00 Complete with Power Supply and carrying case.



SONY CR-4 Radio Wireless Microphone. This amazing Sony compact transistorized professional microphone and transmitter is ideally suited for all applications where freedom from wired communications is desired. \$250.00 Complete with FM Receiver and carrying case.

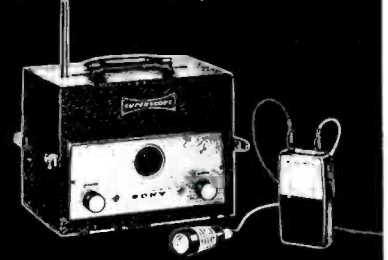

The SONY/SUPERSCOPE commitment to perfection has led to revolutionary achievements in the audio electronics field. The STERECORDER 300, for example, is unquestionably the most versatile, perfectly performing stereo tape recorder on the market today.

The Sony-developed gold membrane in the C-37A Condenser Microphone is another example of Sony superiority.

The 262-SL sound-with-sound tape recorder at \$199.50, the 262-D four track stereo recording and playback tape transport at \$89.50, the 101 transistorized dual track monophonic recorder at \$99.50, and the many other Sony/Superscope products are all remarkable achievements; the inevitable results of Sony/Superscope's commitment to engineering perfection.

*For literature, or the name of your nearest franchised dealer, write: Superscope, Inc., Dept. 2, Sun Valley, California.*

**SONY SUPERSCOPE** *The Tapway to Stereo*

SUPERSCOPE INC., SUN VALLEY, CALIFORNIA



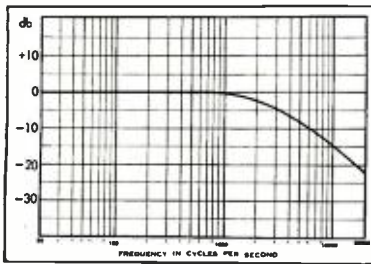

Fig. 3. Typical demagnetization loss in recording at 7.5 ips.

sloping portion of the right side of Fig. 1.

#### 2. Demagnetization Loss in Recording.

When a signal is recorded on the tape, the magnetic particles of the coating arrange themselves to form the equivalent of small bar magnets along the length of the tape. Each such magnet has a south pole and a north pole. The higher the frequency, the larger is the number of bar magnets formed in a given span of tape. That is, the shorter is each magnet. The north and south poles of a magnet tend to have a cancelling effect upon each other, and the closer the poles are to each other the greater is the cancelling effect, which is called demagnetization loss. Thus as frequency rises, demagnetization losses increase quite rapidly, resulting in treble losses such as shown in Fig. 3, based on a tape speed of 7.5 ips.

3. *Bias Erase in Recording.* Bias current, which is applied to the record head in order to reduce distortion and increase the amount of signal recorded on the tape, also causes this head to behave in the same manner, but to a lesser degree, as when the bias frequency current is applied (in much greater amount) to the erase head. In short, the record head behaves slightly as an erase head. The recorded frequencies most susceptible to erasure are the treble ones, because they do not penetrate the tape as deeply as the middle and low frequencies; that is, the high notes lie closer to the surface of the tape. The result is to produce a relative drop in treble response. Figure 4 shows typical treble loss at 7.5 ips due to the bias current normally employed at this speed.

#### 4. "Iron Losses" in the Record and

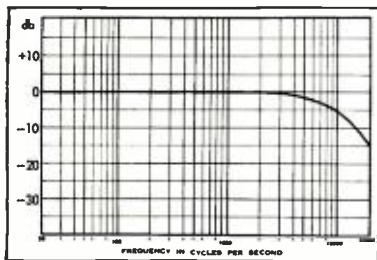

Fig. 4. Typical bias-erase loss in recording at 7.5 ips.

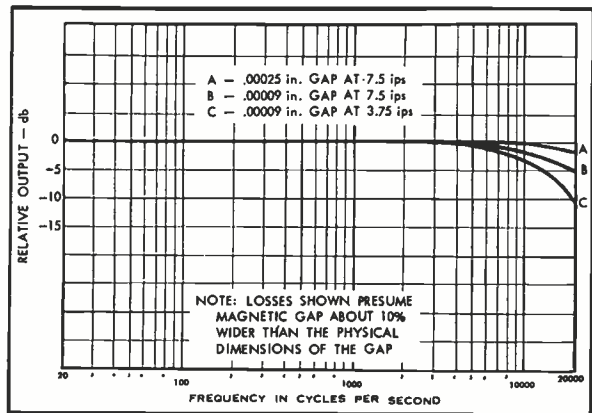

Fig. 5. Losses due to gap of the playback head.

*Playback Heads.* The magnetic fields passing through the core of a tape head induce what are known as eddy currents in the head. Also, the core to an extent resists magnetization and demagnetization, this resistance being referred to as hysteresis. Both phenomena represent a dissipation of energy. This dissipation of energy increases with frequency, resulting in treble losses. However, in modern high-quality heads, the treble losses

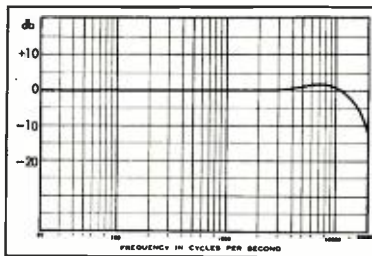

Fig. 6. Typical high-frequency loss due to excessive capacitance across the playback head.

due to eddy currents and hysteresis—collectively termed iron losses—are quite small and often entirely negligible, perhaps 1 db or so at 15,000 cps.

5. *Gap Loss of the Playback Head.* The upper response limit of the playback head depends upon the width of its gap. The narrower the gap, the higher are the frequencies that the head is capa-

ble of reproducing at a given tape speed. Curve (A) in Fig. 5 shows the declining treble response at 7.5 ips for a playback head with a gap of .00025 in.) which used to be fairly standard. Curve (B) shows the virtually negligible loss at 7.5 ips with a modern head having a gap of but .00009 in. On the other hand, even with a gap of .00009 in. there is a significant loss at 3.75 ips, as shown by Curve (C) in Fig. 5.

6. *Electrical Losses of the Playback Head.* The inductance of the playback head winding, together with capacitance across the head—capacitance of the winding itself, of the cable to the playback amplifier, and of the amplifier itself—can produce a significant drop in treble response, as illustrated in Fig. 6. Usually, however, in a well-constructed tape recorder the capacitances are kept low enough to avoid undesirable loss. Therefore it will be assumed in further discussion that treble loss due to this factor does not take place.

Figure 7 presents a composite picture of the various losses described above. It may be seen that when the various losses are added up the final result is the unequalized response curve of Fig. 1.

#### Wavelength Effect and Tape Speed

The preceding description of losses that take place in recording and playback has been couched in terms of the

Fig. 7. Composite picture of factors responsible for unequalized record-playback response of Fig. 1.

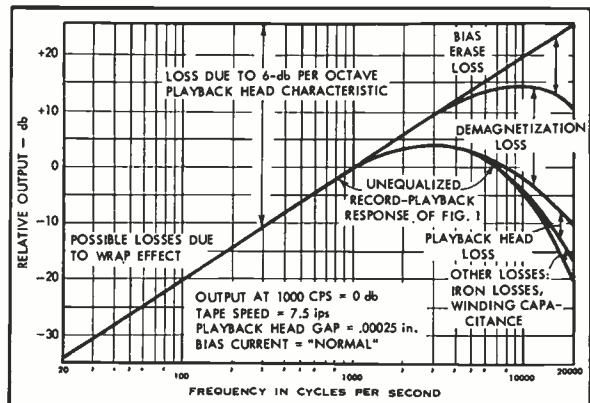

he loves the sound...she loves the style

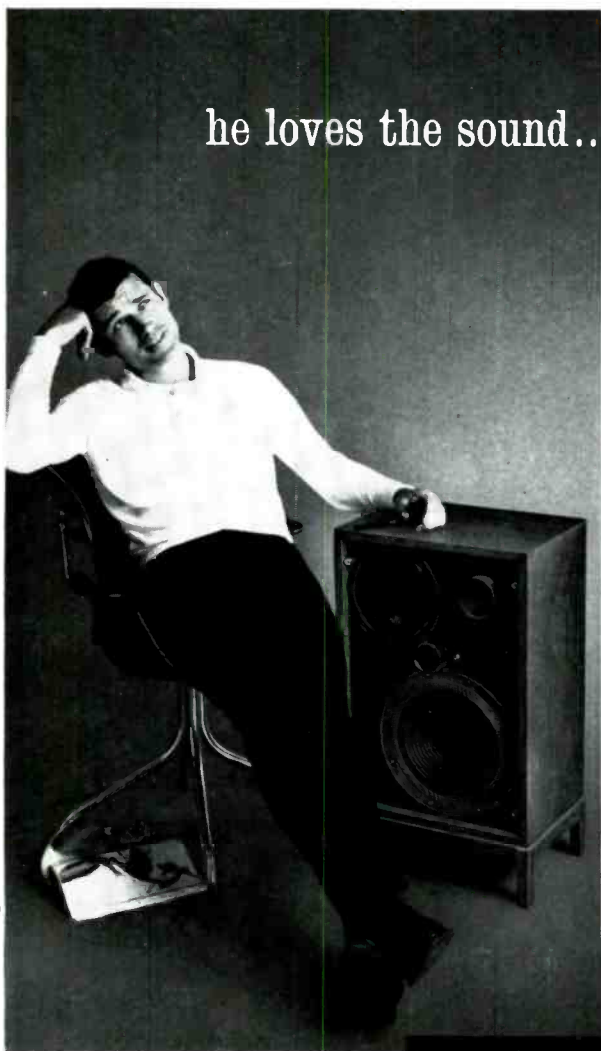

The performance of the Medallion XII is incomparably smooth and musically rich throughout its phenomenal response range . . . *virtually linear from 28 to 22,000 cps*. This is skillfully accomplished by three outstanding loud-speaker components, all beautifully integrated within its precisely matched enclosure. Clean bass from the very threshold of feeling is reproduced by a special 12" high compliance woofer . . . the vital mid-range by a newly designed 8" cone speaker . . . the very highest frequencies by the fabulous new Sphericon Super Tweeter that actually reaches the supersonic range of 40,000 cps! And at your fingertips are network controls that assure perfect tonal balance whatever the acoustics of your room. Further, the highly efficient Medallion achieves ample output with any amplifier capable of delivering as little as ten clean watts.

**FINISHES**—Walnut, oiled walnut, fruitwood, mahogany. **DIMENSIONS**—24" x 17" x 12½" d. **NET PRICES**—System: \$139.95. Grilles: Contemporary, \$9.95; Period, \$14.95. Base: \$14.95. (Enclosure also available without speakers, finished or unfinished, and as a ready-to-assemble kit.)  
*Chair from Herman Miller.*

## YOU GET BOTH

with the new and excitingly different



## MEDALLION XII

3-way speaker system featuring the exclusive "Select-a-Style" snap-on grilles

The unique concept of Medallion XII cabinetry contributes still another important dimension to styling for sound . . . a choice of *five* distinctive grille styles: Contemporary, Colonial, Swedish Modern, French Provincial and Italian Provincial. Each grille is authentically interpreted, meticulously crafted and carefully hand-rubbed in a variety of glowing fine-furniture finishes. Simply "Select-a-Style" to match your decor . . . snap it on! *It's that easy!* Should your decorating scheme ever change, only the grille needs to be replaced. *It's that economical!* As for placement, the compact Medallion is so perfectly proportioned that it is equally handsome as either highboy or lowboy . . . whether you prefer it directly on the floor, or on its matching sculptured base. Here indeed is performance surpassed only by the Medallion paired for stereo!

*For a truly exciting visual and aural treat, visit your University dealer. Or write for our latest high fidelity catalog containing the complete Medallion story. Desk R-5, University Loudspeakers, Inc., White Plains, N. Y. A Division of Ling-Altec Electronics, Inc.*

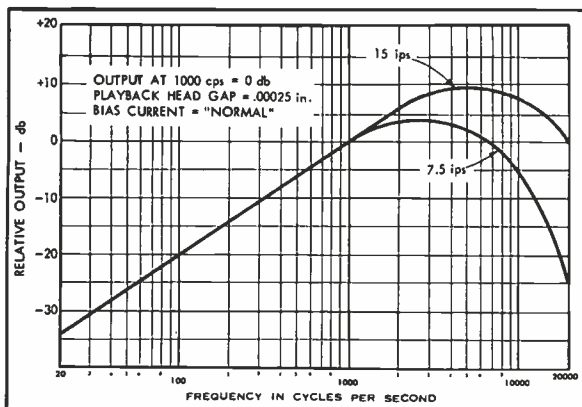

Fig. 8. Comparison of unequalized record-playback response at 7.5 and 15 ips.

variation of the loss with frequency at a given tape speed. Actually, however, a number of these losses vary with the wavelength of the signal recorded on the tape—that is, with the distance along the tape occupied by one cycle of the audio signal. The shorter the wavelength, the greater is the loss. Inasmuch as the wavelength grows shorter as frequency rises, at a given tape speed, the loss also increases with rising frequency. On the other hand, if tape speed increases, which also increases the wavelength, the loss diminishes; and vice versa with a decrease in tape speed. We see, therefore, that the type of loss in question does not remain the same at a given frequency. The amount of loss depends on both the frequency and the tape speed.

Treble losses that vary with wavelength—that is, with frequency and tape speed—are (1) demagnetization loss in recording; (2) bias erase in recording; (3) gap loss of the playback head. On the other hand, the iron and electrical losses of the record and playback heads vary purely with frequency, regardless of the speed at which the tape machine is operating.

To make clear how treble losses vary with tape speed, Fig. 8 shows the unequalized record-playback response of a tape machine at 7.5 ips and at 15 ips. When the speed is doubled, a given wavelength represents a frequency twice as great, that is, an octave higher. Hence the treble loss that occurs at a given frequency at the lower speed occurs at twice that frequency at the higher speed.

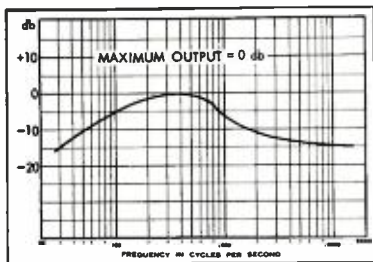

Fig. 9. Distribution of peak audio energy for a typical symphonic composition.

All other things remaining the same, a doubling of tape speed can improve performance, so far as treble response is concerned, from fair to excellent. For example, it could extend the upper response limit from 8000 cps at 3.75 ips to 16,000 cps at 7.5 ips.

Figure 8 shows us two important things with respect to equalization requirements. (1) The lower the tape

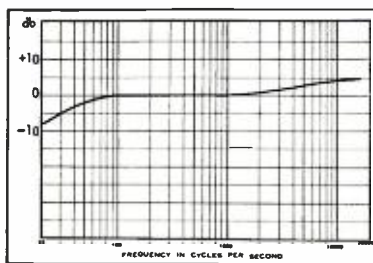

Fig. 10. Approximate relative permissible recording level at various frequencies at 7.5 ips.

speed the greater is the required treble boost. (2) On the other hand, the lower the tape speed, the less is the required bass boost. It may be seen in Fig. 8 that the point at which bass boost should commence is an octave lower at 3.75 ips than at 7.5 ips. This fact should be kept in mind in later discussion.

### Location of Equalization Circuits

The designer of a tape recorder has the choice of incorporating the necessary bass boost and treble boost in the record amplifier, in the playback amplifier, or in both. The proper choice is that which takes into account not only considerations of frequency response but also considerations of distortion and of signal-to-noise ratio. Sometimes economy becomes important enough a factor to alter the picture.

The most logical place for bass boost is in playback. At 7.5 ips, well over 30 db of bass equalization is needed to achieve flat response at this end of the audio spectrum. At lower speeds, the amounts of bass boost required are still in the vicinity of 20 db or higher. Such quantities of bass boost, if employed in recording, would greatly overload the tape and produce tremendous distortion.

On the other hand, a slight amount of bass boost in recording is usually tolerable, because in most music and speed there is a drop in audio energy at the very low end. Figure 9 shows a typical distribution of peak audio energy for an orchestra playing a typical symphonic composition. Hence it is desirable to taper off the playback bass boost at the extreme low end, and supply bass boost in this region in recording instead.

The most logical place for treble boost is in recording. At 7.5 ips, over 20 db of treble boost is usually required to achieve flat response. As much or more is needed at lower tape speeds. If this were supplied in playback, it would inordinately accentuate tape hiss and noise of the playback amplifier. However, if considerable treble boost is used in recording, does this not overload the tape and cause distortion? The answer is that two factors permit substantial treble boost in recording before the overload point is reached. (1) As indicated in Fig. 9, there is a substantial drop in audio energy at the high end of the audio spectrum, offsetting the rise in recording level due to treble boost. (2) For the same amount of distortion, one

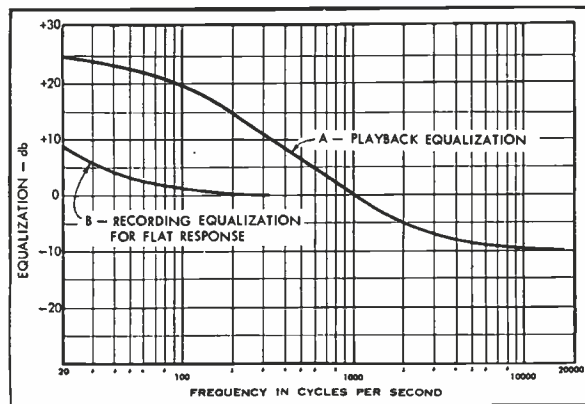
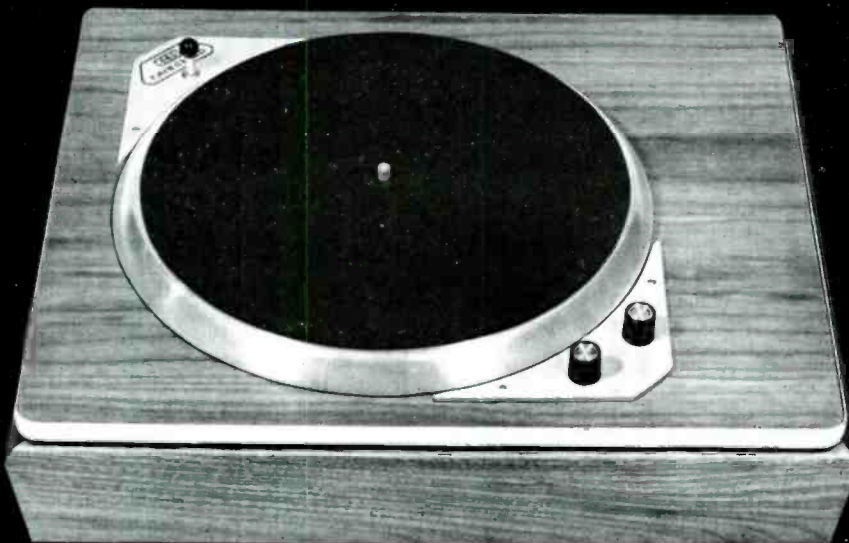

Fig. 11. NAB tape equalization.



# NOW...A NEW FAIRCHILD PRECISION TURNTABLE AT ONLY \$69.95



FAIRCHILD "440"

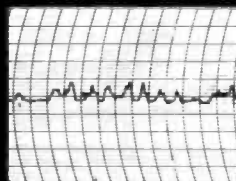

BRAND "A"

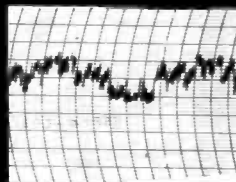

BRAND "B"

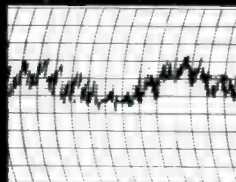

EVERY MODEL 440 COMES WITH INDIVIDUAL WOW AND FLUTTER GRAPHS AS INDICATED ABOVE.

Fairchild Recording is proud to introduce the 440... a new precision turntable that is certain to set new standards for the serious record collector.

Based on the proven principles of the widely known Fairchild professional model 530G (\$629.50) and the current 412-1 (\$87.50), the 440 is truly a masterpiece. It combines famous Fairchild "know-how" in the field of superior electro-mechanical audio equipment with a design that is clean, modern and functional.

Note these exclusive features found in no other turntable *even at much higher prices*:

- *Two speeds...33 1/3 and 15 RPM. Speed selected by automatic Push-Pull Selector; no belts to adjust, no "digging" under the chassis.*
- *Speed Sentinel Control permits speed variation of  $\pm 1\frac{1}{2}\%$  of specially selected Fairchild motor. Strobe disc supplied.*
- *Single endless belt drive that is self adjusting for proper*

*belt tension. Thickness held to 2/10,000 of an inch by exclusive Fairchild process.*

- *Turntable platter is solid cast aluminum contoured for easy record handling. Main bearing is babbitt, rifle drilled for trouble free, noiseless operation.*

- *Handsome shock mounted walnut mounting board and matching walnut wrap-around...only \$19.95.*

Performance speaks for itself. Compare the graphic recordings made under identical test conditions of the Fairchild 440 and two competitively priced units. Note that wow and flutter of the Fairchild turntable is remarkably low—in fact, it exceeds professional NARTB standards by over 100%! Rumble, both vertical and lateral, is an impressive 56db below 7 cm/sec at 500 cycles. Unquestionably the new Fairchild 440 sets performance goals that make it the finest turntable in its class. See it, operate it. Your dealer will be pleased to demonstrate the precision Fairchild 440.



**FAIRCHILD**

RECORDING EQUIPMENT CORPORATION  
10-40 45th Avenue, Long Island City 1, N. Y.

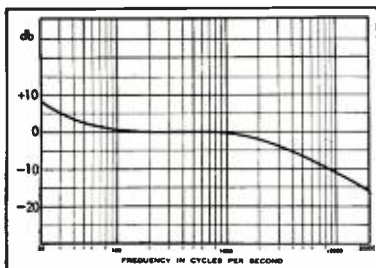

Fig. 12. The NAB recording characteristic (signal to be recorded on the tape).

can record at a somewhat higher level as frequency increase, as illustrated in Fig. 10.

To the extent that gap loss and perhaps iron losses occur, additional treble boost is required above the amount needed to compensate for demagnetization loss and bias erase. Such additional treble boost should be incorporated in the playback amplifier for two reasons: (1) to avoid carrying total treble in recording to the point where excessive distortion results; (2) because the gap loss and iron losses vary with the individual head used for playback, and it is not easy to anticipate when recording a tape on one machine—referring here primarily to commercial tapes—what kind of head will be used to play the tape on another machine.

While economy is a factor in any tape recorder, it becomes a dominant factor in low-price tape machines, and a compromise is then often made with optimum principles of equalization. Instead of providing nearly all the bass boost in playback and nearly all the treble boost in recording, the bass boost is divided equally between record and playback, and so is the treble boost. Thus the same equalization circuitry may be used for recording and playback, which simplifies circuitry and reduces cost.

#### NAB Equalization

NAB (formerly NARTB) equalization conforms to the principles for op-

timum location of equalization circuits, as follows.

1. It stipulates that bass boost shall take place principally in playback, as shown by Curve A in Fig. 11. This curve tapers off at 50 cps; if perfectly flat response is desired, the remainder of the bass boost is supplied in recording, as shown by Curve B.
2. It stipulates that treble boost shall take place principally in recording, except to the extent required to compensate losses of the playback head, namely gap loss and iron losses. The latter losses shall be compensated, if necessary, in playback.

NAB equalization does not provide for a specific record equalization (treble boost) curve. Instead, it simply states that record treble boost shall be such that, in conjunction with the playback equalization of Fig. 11, record-playback response shall fall within certain limits, as follows: flat within  $\pm 1$  db between 100 and 7500 cps; not more than 1 db or 4 db down at 50 cps; and not more than 1 db up or 4 db down at 15,000 cps.

While the NAB standard does not provide for a specific equalization characteristic in recording, it does provide for a specific recording characteristic on the tape, assuming the signal fed into the tape recorder is of equal magnitude at all frequencies. This recording characteristic appears in Fig. 12. The characteristic of Fig. 12 and the playback equalization curve of Fig. 11 bear a complementary relationship to each other. That is, given one, the other can be deduced by allowing for the fact that output of the playback head rises 6 db per octave (per Fig. 2). Since it is much easier to measure playback equalization than the magnetic field on the tape, NAB equalization is stated as a playback equalization curve instead of in terms of the amount of magnetic flux to be recorded on the tape at each frequency.

NAB playback equalization was originally designated as a standard only for the 15 ips speed. However, with improvements in tape machines and in tapes, NAB equalization was also found practical at 7.5 ips, and by common acceptance it has become virtually standard for the latter speed as well. At speeds below 7.5 ips; it is desirable to employ less bass boost than specified by NAB. Thus at these lower speeds it is customary to find a similar playback bass boost curve, but commencing at a frequency that is substantially lower than in Fig. 11. At these lower speeds the principles of optimum equalization are followed for the most part, at least in the better tape recorders.

It would be possible for NAB equalization to be stated in terms of a specific recording equalization curve were it not for the following two factors: (1) At a given tape speed, the amount of bias current employed varies somewhat from one tape recorder to another. Accordingly, there is a variation in bias erase and in the amount of record treble boost that is needed. (2) Iron losses, if any, in the record head vary from one tape recorder to another. Since these are supposed to be compensated in the record amplifier, the amount of record treble boost that is required will vary from one tape machine to another.

In view of the fact that NAB equalization has been adopted for 7.5 ips, it becomes all the more difficult to prescribe a specific equalization characteristic for recording. At 7.5 ips the treble losses due to demagnetization and bias erase are much greater than at 15 ips, so that much more treble boost—at least 10 db more—is needed when recording at 7.5 ips than at 15 ips.

#### Variations in Equalization at a Given Speed

Referring to Fig. 1, it would appear that playback bass boost should start—i.e. attain a rise of 3 db—at about 1000 (Continued on page 71)

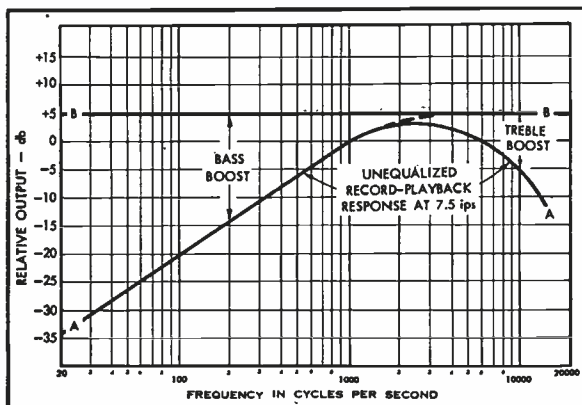

Fig. 13. Combination of relatively small amounts of treble and bass boost to achieve flat frequency response.

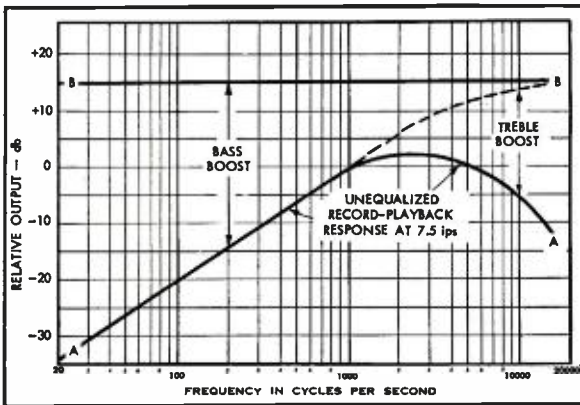

Fig. 14. Combination of relatively large amounts of treble and bass boost to achieve flat frequency response.

# *pioneer*

## “STEREO-MIMMY”

### SE-1

(A Long-awaited Earphone for Stereo Use)

### ENJOY YOUR STEREO ALL BY YOURSELF !

Late at night when your family as well as neighbors are fast asleep and if you want to enjoy music to your heart's content and do so with a booming sound coming out of your stereo, you are simply making yourself a nuisance to other people. Especially the dynamic sound of stereo penetrates far and wide, disturbing peaceful slumber of those already in bed. However to listen to music at almost inaudible sound renders even a splendid music entirely disappointing. This is, therefore, the very reason there have been persistent demands for a gadget that is capable of reproducing with excellent tone quality from low to high frequency ranges without becoming an annoyance to others.

STEREO-MIMMY, an earphone for stereo use, recently placed on the market by the PIONEER is a hi-fi earphone employing a specially designed speaker for the earpiece unit, and it has natural tone quality surpassing that of an ordinary hi-fi speaker. Particularly its low frequency characteristic is noteworthy, reproducing the low band better than a woofer of large caliber. Accordingly the above-mentioned difficulties are solved completely, and from now on you can enjoy all by yourself enchanting music to the fullest measure with that satisfying stereophonic feeling so familiar to every stereo enthusiast. In addition although conventional earphones have a common defect that they are apt

to tire their users, the PIONEER's "STEREO-MIMMY" does not give a feeling of fatigue even after many hours' continuous use as it fits snugly into ear and is also very agreeable to the touch. It can be, of course, easily handled by a woman or a child. Besides stereophonic reproduction, "STEREO-MIMMY" has an extensive field of applications such as communications, monitoring reproduction equipments of all varieties, etc.

Model No.	SE-1
Impedance	8-16 ohms
Frequency range	25-13,000 cps
Max. power input	0.5 watt



**FUKUIN ELECTRIC, LIMITED**

5 Otowacho 6-chome, Bunkyo, Tokyo, Japan

**FUKUIN ELECTRIC, LIMITED**



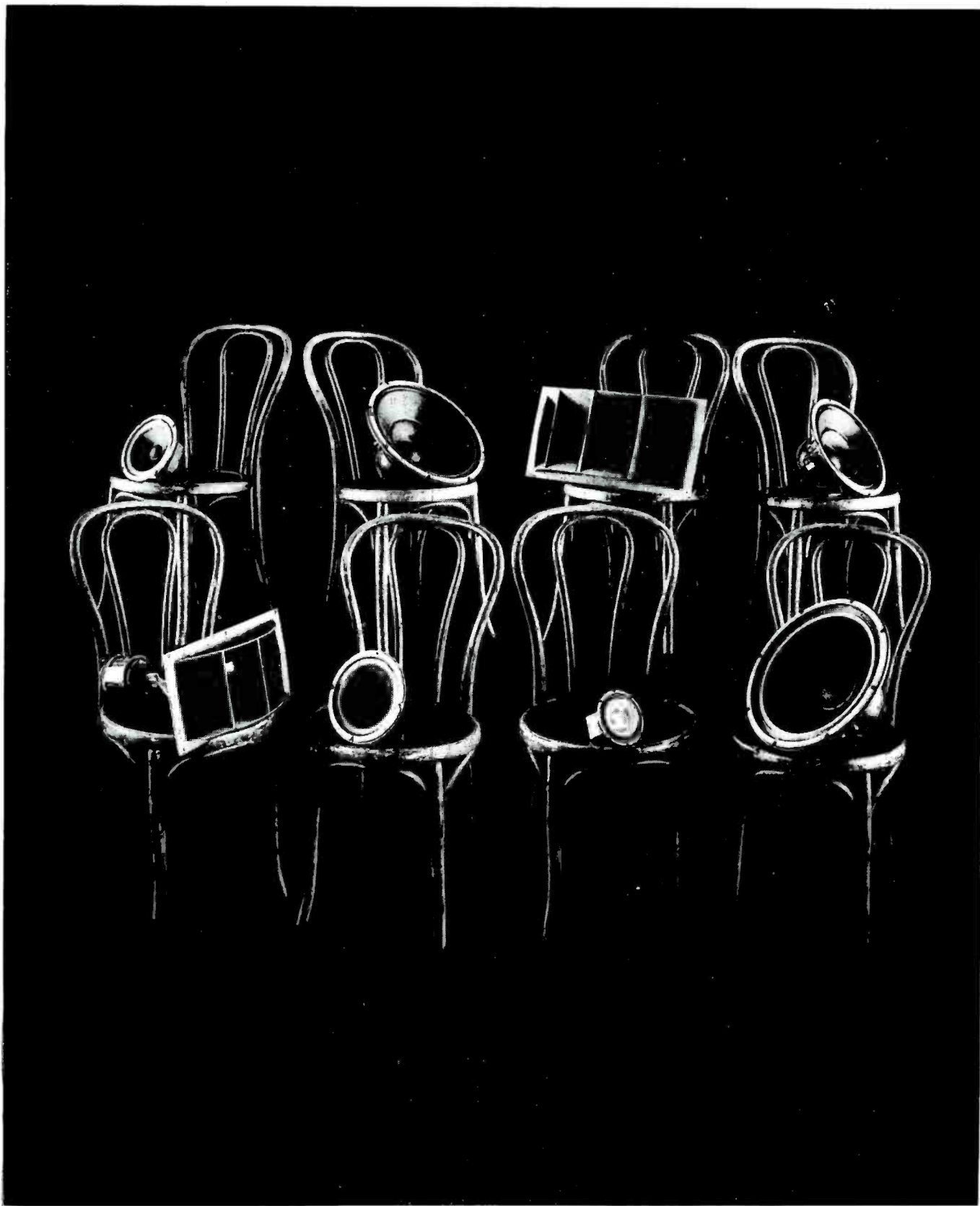



# ORCHESTRA and CHORUS CONDUCTED BY ALTEC ~

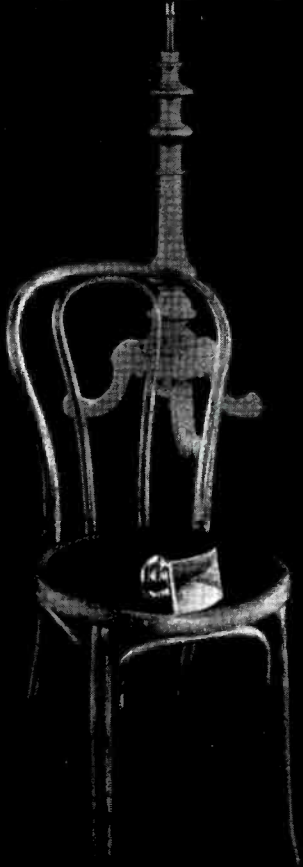

The distinguished components you see gathered here, under the Altec maestro's baton, are virtuosos in their field. Blending years of sound engineering skill with precision craftsmanship and devotion to quality, each Altec member performs in the highest tradition of high fidelity. When you are adding to your present equipment, converting to stereo, or building your own more advanced hi fi system in mono or stereo, you cannot buy finer components and speakers nor achieve surer success than with components by Altec. Yet the costs are in remarkably reasonable range. Compare Altec advances and professional quality at your Altec dealer's. Altec offers you the most complete line of quality matched stereo and mono high fidelity components and systems in the world.

#### COMPONENTS SHOWN: TOP ROW, LEFT TO RIGHT

- 402B BASS SPEAKER**, big speaker sound in compact 8" size. With controlled linear excursion. 14 watts power, 16 ohms impedance, 40-10,000 cycle range, .45 lb. magnet, 1" voice-coil diameter, 55 cycle resonant frequency, 3 $\frac{3}{8}$ " deep. Weighs 12 lbs., 13 oz. .... **\$19.50**
- 415 BIFLEX FULL-RANGE SPEAKER** offers a guaranteed frequency range of 30-14,000 cycles. 25 watts power, 8 ohms impedance, 2.4 lb. magnet, 3" voice-coil diameter, maximum cone resonance of 45 cycles. 1 $\frac{5}{16}$ " dia., 7" deep. Weighs about 20 lbs. .... **\$67.00**
- 511B SECTORAL HORN**, smooth distribution at all frequencies. Use with 802D Driver, 500-cycle cross-over and 803B Speaker. LF cut-off: 500 cycles. 10 $\frac{1}{8}$ " high, 23 $\frac{3}{16}$ " wide, 18 $\frac{1}{2}$ " deep. Weighs about 18 lbs. .... **\$39.80**
- 412B BIFLEX FULL-RANGE SPEAKER**, offering exceptionally smooth response over entire audible frequency range, in small size. Guaranteed range, 40-15,000 cycles, 20 watts power, 8 ohms impedance, 1.8 lb. magnet, 3" voice-coil diameter, maximum cone resonance of 50 cycles. 12 $\frac{1}{4}$ " diameter, 5 $\frac{5}{8}$ " deep. Weighs about 14 lbs. .... **\$54.00**

#### BOTTOM ROW, LEFT TO RIGHT

- 802C HIGH FREQUENCY DRIVER** with tangential compliance delivers smooth response to 22,000 cycles. Power, 30 watts (nominal). Range: 500-22,000 cycles with N-500D network and 511B horn; or 800-22,000 cycles with N-800E network and 811B horn. 16 ohms impedance, 1.3 lb. magnet. 3 $\frac{1}{16}$ " high, 4 $\frac{1}{2}$ " dia. Weighs about 8 lbs. .... **\$63.00**
- 811B SECTORAL HORN**, for use with 802D driver and 800-cycle crossover, or to be combined with 803B bass speaker, or 415A Biflex. LF cutoff: 800 cycles. 800 to 22,000 cycle range, 90x40° distribution. 8 $\frac{5}{8}$ " high, 18 $\frac{3}{8}$ " wide, 14" deep. Weighs about 11 lbs. .... **\$30.00**
- 755C FULL-RANGE LOUDSPEAKER** has new slim profile, ideal for built-in installations. Smooth response over audible range of 40-13,000 cycles. 15 watts power, 8 ohms impedance, 2" voice-coil diameter, 90° distribution. 8 $\frac{3}{8}$ " dia., 2 $\frac{1}{2}$ " deep. Weighs 3.75 lbs. .... **\$29.95**
- 2000B HIGH FREQUENCY SPEAKER**, a direct radiating tweeter with unique gap suspension, built-in cross-over network. 14 watts power, 8 ohms impedance, 1500-18,000 cycle range. .45 lb. magnet, 1" voice-coil diameter, 3 $\frac{1}{8}$ " deep. Weighs 1 lb., 14 oz. .... **\$15.00**
- 803B BASS SPEAKER**, exceptional linearity over range of 30-1600 cycles. 20 watts power, 16 ohms impedance, 2.4 lb. magnet, 1 $\frac{5}{16}$ " dia., 7" deep. Weighs about 19 lbs. .... **\$69.50**
- 3000B HIGH FREQUENCY COMPRESSION DRIVER SPEAKER** can be used to extend response of the Biflex to 22,000 cycles. 20 watts power, 8 ohms impedance, 3000-22,000 cycle range. 90x40° distribution. 3 $\frac{3}{16}$ " high, 4 $\frac{7}{8}$ " wide, 4 $\frac{1}{16}$ " deep. Weighs about 1 lb. .... **\$42.00**

Write for free catalogs: Address: Dept. AD-6D

ALTEC LANSING CORPORATION, a subsidiary of Ling-Altec Electronics, Inc.  
1515 South Manchester Avenue, Anaheim, California  
161 Sixth Avenue, New York 13, New York

for the best in sound systems, choose components by



# BREAKTHROUGH in MICROPHONE DESIGN — from ALTEC

*compare its dramatic  
improvement in performance*

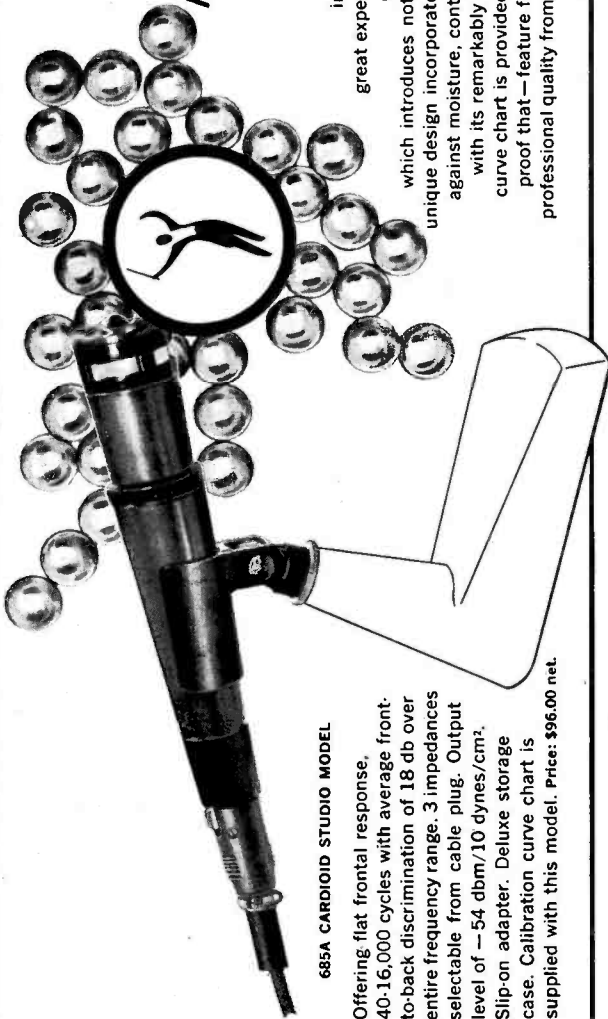

## 685A CARDIOID STUDIO MODEL

Offering flat frontal response. 40-16,000 cycles with average front-to-back discrimination of 18 db over entire frequency range. 3 impedances selectable from cable plug. Output level of —54 dbm/10 dynes/cm<sup>2</sup>. Slip-on adapter. Deluxe storage case. Calibration curve chart is supplied with this model. Price: \$96.00 net.

Big news of the year in microphones is Altec's recent introduction of a new concept in microphone design. From Altec's great experience in engineering and manufacturing broadcast equipment and extensive acoustical research, comes a breakthrough development which introduces notable improvements in microphone performance and styling. This unique design incorporates Altec's famous sintered bronze filter for unmatched protection against moisture, contaminants, and blast—and Altec's new rugged "golden" diaphragm with its remarkably smooth, wider response and output. Individual certified calibration curve chart is provided with models 684A and 685A. Make a comparison; it is convincing proof that—a feature for feature—Altec offers the year's best value in microphones. True professional quality from Altec—the best you can buy, no matter what price you have in mind.

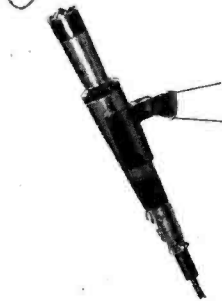

## 684A

**OMNIDIRECTIONAL STUDIO MODEL**  
Uniform response over 35-20,000 cycles. High output of —55 dbm/10 dynes/cm<sup>2</sup>. Slip-on adapter. Deluxe storage case. Calibration curve chart is supplied with this model. Price: \$81.00 net.



## 686A DYNAMIC LAVALIER MODEL

Just 3 1/2" long, weighing 3 ounces (not including cable and plug). Uniform response over 70-20,000 cycles. 2 impedances selectable at cable plug. Includes 24 feet of cable, neck cord with slip-on adapter and tie clip. Deluxe storage case. Price: \$54.00 net.

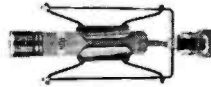

## M30 CARDIOID CONDENSER SYSTEM

Frequency response of 20-20,000 cycles with directional cardioid pattern of outstanding discrimination. Balanced output of —53 dbm/10 dynes/cm<sup>2</sup>. First miniature directional microphone capable of translating the entire frequency and dynamic range. Price: \$334.00 net.

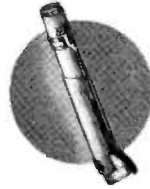

## M20 "LIPSTICK" CONDENSER SYSTEM

Just 3 1/8" x 5/8", this small, versatile microphone is widely used in laboratory recording because of its extreme sensitivity as well as broadcast studios. Balanced output of —48 dbm/10 dynes/cm<sup>2</sup>. Omnidirectional pick-up pattern. Price: \$236.00 net.



**ALTEC LANSING CORPORATION**  
A subsidiary of Ling-Altec Electronics, Inc.  
1515 Manchester, Anaheim, California  
161 Sixth Avenue, New York 13, N.Y.

For more detailed technical information and specifications, write to Dept. ADM-2



# BUYER'S GUIDE SECTION

(from page 27)

MPX-20 multiplex adaptor when desired. The i.f. stages are flat-topped, with an unusually wide band for maximum fidelity and minimum distortion, plus steep skirts to eliminate adjacent- and second-channel interference. Included in the circuitry of the FM-100 are a dual-triode mixer-oscillator, the Fisher Microap cascade r.f. stage, four wide-band i.f. stages, and a wide-band ratio detector. Four controls on the FM-100 include Tuning, Selector Switch, Muting Control, and Multiplex Separation. Fisher Radio Corporation, 21-21 44th Drive, Long Island City 1, N. Y. User net price, less cabinet, \$159.50.

600 AM/FM ster trn, preamp and 20-w ampl ..... \$349.50

## GENERAL ELECTRIC

• **AM-FM Tuner.** Model FA-12 is a new unit which features high sensitivity, precision tuning, and an unusually low hum and noise level. It is equipped with an FM multiplex jack for reception of multiplexed programs when used with an adapter. FM sensitivity is 5.0 microvolts for 30 db quieting, and AM sig-



nals of 200 microvolts/meter provide a 20-db signal-to-noise ratio. FM frequency response falls within  $\pm 2$  db of flat from 20 to 15,000 cps, while AM response is down 25 db at 10 kc for interference suppression. Tuning meter indicates center-channel tuning on FM and peak of AM signal, and there is no audible drift. Circuit employs r.f. amplifier stage in both AM and FM channels for increased sensitivity and reduced noise. General Electric company, Specialty Electronic Components Department, Utica, New York. User net price, \$129.95.

## HARMAN-KARDON

• **Professional FM Tuner Kit.** Claimed by the manufacturer to be one of the most sensitive tuners, the Citation III FM Tuner Kit may very well be just that if their previous kits are any indication. Featuring a new front-end design, which utilizes the equally new "Nuvisor," the Citation III has a sensitivity of 0.65 microvolts for 20 db of quieting with virtually no distortion. We may well ask, since this is a kit, is the user going to get the



level of performance obtained in the laboratory? Naturally, this will depend on the care exercised by the builder—but every other possible source of trouble has been engineered out. The critical converter-i.f. subassembly is factory assembled and aligned. Two meters are built in to permit home alignment of the limiters and discriminator. Lead length is sharply defined by a heavy duty terminal board. Frequency response is 1 to 52,000 cps  $\pm 0.5$  db with distortion less than 0.1% at 100% modulation and unmeasurable at 30% modulation. Hum level is 65 db below 100% modulation. Harman-Kardon, Inc., 520 Main St., Westbury, N. Y. User net price, \$149.95 for the kit, factory wired \$209.95. WC1 walnut enclosure \$29.95.

TA 230, stereo AM/FM receiver ..... \$259.95  
TA 224, stereo AM/FM receiver ..... 199.95  
ST 360, stereo AM/FM tuner ..... 199.95  
T 230, stereo AM/FM tuner ..... 119.95  
T 220, stereo AM/FM tuner ..... 89.95

## HEATHKIT

• **FM-AM Stereo Tuner Kit.** Outstanding features in both circuitry and styling in the PT-1, a 16-tube deluxe FM-AM combination, include: three circuit boards for easy construction and high stability; wired, prealigned 3-tube FM tuning unit; tuning meter; a.f.c. with on-off switch, and flywheel tuning. FM and AM circuits are separate and individually tuned.



Cathode-follower outputs with individual level controls are provided for both sections. Other features include variable AM bandwidth, 10-kc whistle filter, tuned-cascade FM front end, FM a.g.c. and amplified a.v.c. for AM. Unique i.f. limiter design automatically provides the number of limiting and i.f. stages required for non-flutter reception of weak or strong stations. Depending on signal strength anywhere from one to four limiters or i.f.'s are automatically provided. FM sensitivity is 2.0 microvolts for 20-db quieting. Harmonic distortion is less than 1.0 per cent. Frequency response is 20 to 20,000 cps  $\pm 2$  db on FM. A jack is provided for use of a multiplex converter without changing existing circuitry. The tuner is housed in a vinyl-clad steel cabinet finished in black with gold trim. Heath Company, Benton Harbor, Mich. User net price, \$89.95.

BC-1A AM tuner ..... \$26.95  
FM-4 FM tuner ..... 39.95

## KARG

• **Stereophonic Multiplex FM Tuner.** A superior quality FM tuner with built-in protection against obsolescence, the Karg CT-2 is ready for multiplex FM with controls on the panel and special circuitry. Sensitivity of the tuner is 1.5 microvolts for 30 db quiet-

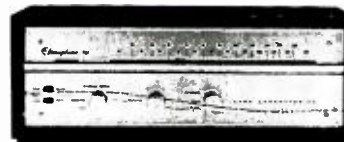

ing and frequency response is 20 to 20,000 cps  $\pm 1$  db. Hum and noise with unmodulated 1000-microvolt signal is 65 db below full output. Audio output is 5 volts at 100% modulation for each channel. The dial is 10" long, calibrated every megacycle. High dial ratio permits precise tuning. Muting controlled by switch on front panel. Twin audio channels give two independent output signals for stereo. A third output is available—a non-emphasized detector output for use with any self-powered multiplex adapter. Karg Laboratories, Inc., 30 Meadow St., South Norwalk, Conn. User net price, \$139.50.

XT-1A, FM tuner ..... \$199.50  
XT-3A, FM tuner ..... 290.00

## KNIGHT

• **Stereo FM/AM Tuner Kit.** This new Knight-Kit Deluxe Stereo FM/AM Tuner features Dynamic Sideband Regulation on FM and provision for a multiplex adapter. The FM sec-



tion features a dual limiter circuit for extra sensitivity—2.5 microvolts for 20 db quieting—continuously adjustable AFC, prealigned r.f. coils and i.f. transformers, moving bar type "magic eye" tuning indicator. The AM section features excellent sensitivity—3 microvolts for 10 db signal-to-noise ratio, narrow and wide i.f. bandwidth, moving bar type tuning indicator, 10-kc whistle filter, built-in loop-stick antenna. Hum for both sections is 60 db below 1 volt. Harmonic distortion in the FM section is less than 1% (1000 microvolts at 100% modulation). Frequency response of the AM section with narrow i.f. is 20 to 7000 cps, 6 db down at 3.5 kc; wide i.f. is 20 to 10,000 cps, 6 db down at 6.5 kc. Allied Radio Corp., 100 N. Western Ave., Chicago 80, Illinois. User net price, \$87.50.

FM/AM tuner kit ..... \$49.95  
FM tuner kit ..... 38.95

## LAFAYETTE

• **Stereo Tuner Kit.** Designed for flexibility, the Lafayette KT-500 stereo tuner kit fulfills virtually every function desired in a stereo tuner at a moderate price. In addition, the

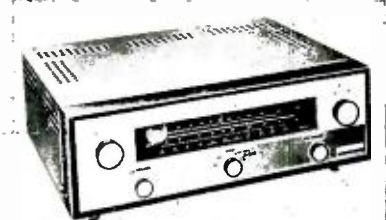

performance is surprising for this price category. Sensitivity of the FM section is 2 microvolts for 30 db quieting; AM terminal sensitivity is 5 microvolts. FM bandwidth is 200 kc and AM bandwidth is 8 kc at 6 db down. Frequency response is 20 to 20,000 cps  $\pm 0.5$  db on FM and 20 to 5000 cps  $\pm 3$  db on AM. Harmonic distortion is less than 1% on FM and less than 1% on AM for 100% modulation. Hum level is 60 db below 80% modulation. Designed for easy assembly, the kit is built around two printed circuit boards and pre-aligned i.f.'s. Lafayette Electronics Mfg. Corp., 104-46 Dunkirk St., Jamaica 12, N. Y. User net price, \$74.50 for the kit; factory wired, \$124.50.

## LEAK

• **FM Tuner.** The new "Trough-Line II" tuner matches in appearance the newly-styled Leak "Point One" stereo preamplifier. Sensitivity of 1.5 microvolts for 20-db quieting makes practical the reception of FM stations on



considerable distances. Cathode-follower output delivers 1.6 volt and facilitates the use of long output leads with negligible high-frequency attenuation. Automatic frequency control is included in the circuitry for drift-free tuning. A magic eye assures tuning accuracy. Controls include on-off switch, a.f.c. off-on, tuning, and local-distance. Chassis dimensions are 10 1/2" w x 7 3/4" d x 3 3/4" h. British Industries Corporation, 80 Shore Road, Port Washington, N. Y. User net price, less cabinet, \$149.00.

## MADISON-FIELDING

• **Low-priced FM Tuner.** With high sensitivity—1.5 microvolts for 20 db quieting—the series 630 FM tuner features 360-kc bandwidth, an i.f. rejection of 65 db, a hum level 55 db below 100% modulation, and variable AFC. New type of dial uses a fixed indicator, with the dial scale moving behind it. The

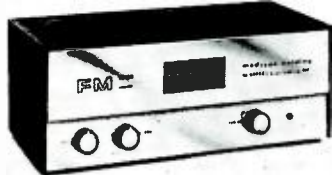

variable AFC feature permits drift-free reception of the weak stations most tuners usually reject. Multiplex adapter can be added easily by removing a plate on the surface of the chassis. The panel is of heavy aluminum, finished in brass and black, and the entire unit is furnished with a vinyl-clad enclosure measuring 4 9/16 x 13 5/16 x 6 1/2 deep. Brand Products, Inc., 256 E. 49th St., New York 17, N. Y. User net price, \$84.95.

## MONARCH

• **Stereo FM/AM Receiver.** Monarch model STA-245 is a complete stereo unit mounted on a compact chassis. Featuring dual amplifiers, separate FM and AM tuners (including FM multiplex adapter) for simulcast reception, plus a full complement of controls, the STA-245 qualifies as a music center. FM sen-

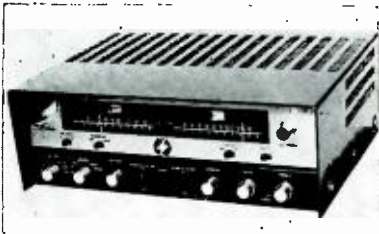

sitivity is 1.9 microvolts for 20 db quieting. Sensitivity at the magnetic input is 3 millivolts at 1000 cps; tape input 1.5 millivolts at 250 cps; auxiliary input 250 millivolts at 1000 cps. Power output is 45 watts. Enclosure is handsomely designed in black with gold accents and escutcheon. Monarch International, Inc., 7035 Laurel Canyon Blvd., North Hollywood, Calif. User net price, \$219.95.

## PACO

• **Stereo FM/AM Tuner Kit.** The Paco model ST-45PA stereo FM/AM tuner kit features separate pre-wired and prealigned AM and FM tuner circuitry on two printed circuit boards. Having separate FM and AM circuits, the Paco model ST-45PA can play simulcast stereo as well as separate AM or FM. A multi-



plex socket is provided with space beside it for a multiplex adapter. The FM tuner has a sensitivity of 2 microvolts for 30 db quieting. Bandwidth is over 200 kc, with harmonic distortion less than 1% from 20 to 20,000 cps. The circuit includes dual limiters and a Foster-Seeley discriminator. The AM tuner has a tuned r.f. stage with a three-gang tuning capacitor. The built-in ferrite antenna is rotatable as well as removable. The circuit includes a 10-kc whistle filter. Both AM and FM sections have separate flywheel tuning, cathode-follower outputs and individual output level controls. PACO Electronics Co., Inc., 70-31 84th St., Glendale 27, L. I., N. Y. User net price, \$99.95 for the kit; factory wired, \$134.95.

## PILOT

• **30-Watt Stereophonic Receiver.** The Pilot model 602 combines on a compact chassis a sensitive FM tuner, a fine AM tuner, a 30-watt stereophonic amplifier and a versatile control center. With the addition of speakers

and a changer or turntable a complete system is available. The 602 features the "Simpli-matic Test Panel" which permits balancing the amplifier output tubes using the speaker system as an indicator, and "Stereo-Plus Curtain-of-Sound," a special set of speaker connections to effect a monophonic output from a stereo source. Can be used to



fill the "hole-in-the-middle" or for a speaker in another room. Thirteen controls and switches achieve a high degree of flexibility. Distinctive brass and black enclosure is only 5 1/2" h x 10 1/2" d x 14 1/2" w. Over-all frequency response is 20 to 20,000 cps. FM sensitivity is 2 microvolts and AM sensitivity is 3 microvolts. Pilot Radio Corporation, 37-06 36th St., Long Island City, N. Y. User net price with enclosure, \$249.50.

590 AM/FM ster tun, ster preamp .... \$239.50  
480 AM/FM tuner ..... 159.95

## REALISTIC

• **FM/AM Tuner.** Realistic FM/AM tuner is a modestly priced unit whose specifications read like a much more costly tuner. Its low-noise cascode FM front end achieves a sensitivity of 2 microvolts for 30 db quieting at 100% modulation. FM circuit also a separate mixer, oscillator, AFC, two i.f.'s, double-tuned limiter, and a Foster-Seeley discriminator.



The AM section utilizes a tuned r.f. stage, broadband tuned i.f. stage with a separate crystal diode detector. Sensitivity of the AM section is 50 microvolts per meter with a ferrite loop stick. Frequency response of the FM section is 20 to 20,000 cps  $\pm 1$  db; for the AM section 20 to 5000 cps  $\pm 1$  db. Distortion is respectively 0.2% and 0.5% at 30% modulation. Supplied in gold cabinet with calibrated, illuminated slide-rule dial. Radio Shack Corp., 730 Commonwealth Ave., Boston 17, Mass. User net price, \$59.95.

FM tuner ..... \$39.95

## H. H. SCOTT

• **Wide-Band FM Tuner.** The H. H. Scott Model 314 is a new, moderately priced, FM tuner incorporating H. H. Scott's exclusive wide-band design. Sensitivity is 2.5 microvolts (IHPM) with little distortion. The front end

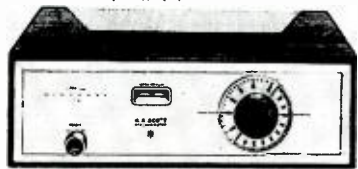

is silverplated and the chassis is copper bonded to aluminum in order to minimize circuit losses and help maintain a high signal-to-noise ratio. Detector and limiter bandwidths are 2 megacycles. A multiplex output is provided. The 314 is designed to match the appearance of H. H. Scott amplifiers such as the 222. An accessory knob kit is available to match the 299. H. H. Scott, Inc., 111 Powdermill Rd., Maynard, Mass. User net price, \$114.95.

## SHELL

• **FM Tuner.** A sensitive tuner with low hum level, the Shell series 800 "Hampton" is a good value for the beginning enthusiast. FM

sensitivity is 1.5 microvolts for 20 db quieting and hum level is 70 db below 1 volt output. A multiplex output is provided and multiplex adapters are available. Frequency response is 20 to 20,000 cps  $\pm 1$  db. An electron eye tube is provided for aid in tuning and AFC pull-in is 200 kc  $\pm 15$  kc with 1 volt at the detector. The edge-lighted slide-rule dial is designed for easy reading. Four switches are provided including AFC defeat output defeat, and multiplex. Shell Electronics Mfg. Corp., 112 State St., Westbury, N. Y. User net price, \$79.95.

## SHERWOOD

• **FM/AM/MX Stereo Tuner.** The Sherwood model S-2200 fulfills today's stereo requirements with separate reception of FM and AM simulcasts as well as tomorrow's needs utilizing FM multiplexing. Front panel controls



and internal plug-in space are provided for a Sherwood model AMX multiplex plug in adapter. Featured in the Model S-2200 tuner is one of the most sensitive FM circuits ever developed, permitting 20 db quieting with only 0.95 microvolt signal input; 3.6 microvolts affords a signal-to-noise ratio of 50 db. This unusual sensitivity makes FM reception practical beyond 100 miles. In addition, highly stable coil design, delayed automatic gain control, and Foster-Seeley type discriminator preceded by three limiters, assure a minimum of distortion even with modulation over 100 per cent. The AM section features a selection of either a 15-kc wide "hi-fi" band-pass or a sharply selective 5-kc bandwidth for listening to weaker stations without noise and interference. A high-Q filter traps out 10-kc interstation whistle while reducing audio response less than 3 db at 8 kc. A built-in ferrite-rod antenna is pivot-mounted and may be oriented for best reception of distant stations. FM frequency response is 20 to 20,000 cps within  $\pm 0.5$  db. Sherwood Electronics Laboratories, Inc., 4300 N. California Ave., Chicago 18, Ill. User net price, less case \$179.50.

S-2000II, FM/AM tuner ..... \$145.50  
S-3000III, FM/MX stereo tuner ..... 110.50

## SARGENT-RAYMENT

• **Stereo AM/FM Tuner and Control Center.** A deluxe AM/FM tuner and control center, the SR-5000 offers every feature which could be desired in an instrument of this type. Sensitivity of 1.8 microvolts for 20 db quieting on FM and 20 microvolts with ferrite loop on AM. Frequency response is  $\pm 1$  db, 20 to 20,000 cps. Special steps taken to reduce heat are elimination of all power tubes and transformers from the chassis (necessitating power take-off from another unit or a separate power supply), and redesign of the front end so that a diode mixer takes the place of a tube. The control center characteristics are exceeded

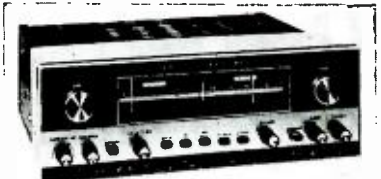

only by SR-2000 stereo preamp, sufficient controls and functions being incorporated to satisfy the most sensitive ear. Distortion at 5 volts output is 0.5% intermodulation and 0.1% harmonic. Hum and noise, when obtaining power from SR-900 power supply or equal, is 75 db below 2 volts output on high level input and 60 db below on phono channel. Sargent-Rayment Co., 4926 East 12th Street, Oakland, Calif. User net price, \$249.40.

SR-1000B, ster AM/FM tuner ..... \$184.50  
SR-1020, FM tuner ..... 97.50  
SR-7000, ster AM/FM tuner, preamp .. 199.40



# LOUDSPEAKERS AND SYSTEMS

## ADVANCED ACOUSTICS

● **Bi-Phonic Coupler.** Radically different for a speaker system, the 440 Bi-Phonic Coupler is claimed to be an extension of the ancient practices of musical instrument design and construction. Musical instruments radiate low frequencies directly from an unbuffered soundboard whose excursions are nowhere near the violent motion most speakers undergo to produce those low notes. The Bi-Phonic Coupler emulates musical instruments by using instead of a cone woofer a 15 x 22 inch sturdy wooden panel which is driven by a

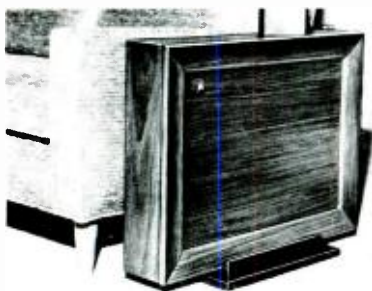

20-pound magnet structure which is 7½-inches in diameter. Thus it can reproduce low notes with barely perceptible motion; achieving its maximum excursion instantaneously so that hangover notes are eliminated. Being unbuffered, the 440 produces a double-sided "Figure 8" radiation pattern extending on both sides of the board. Its 4½-inch depth simplifies the installation problem and lends itself to unusual placement—such as on the ceiling, on a wall, or even on a room divider. High frequencies are reproduced by a polar type, phenolic diaphragm tweeter. Frequency response is stated to be from 30 cps to beyond audibility and power handling capability 50 watts. Impedance 8 ohms. Available in mahogany, walnut, or oiled walnut. Advanced Acoustics Corp., 67 East Centre St., Nutley 10, N. J. User net price, \$134.50.

## ACOUSTIC RESEARCH

● **Low-Cost "Acoustic-Suspension" Speaker System with Super Tweeter.** Selling for little over a hundred dollars, the AR-2a consists of an AR-2 speaker system in combination with a 1¾ inch dome-type super-tweeter.

The AR-2 speaker system uses the AR patented acoustic-suspension principle in which a small enclosure provides improved rather than compromised reproduction quality. In this principle the woofer cone is mounted on very free suspensions, so compliant that they are unable to provide the elastic restoring force normally required of them. The missing elasticity is then rein-



duced by the pneumatic spring formed by the air within the cabinet. The cone literally rides on air instead of on mechanical springs. The small enclosure size is necessary for optimum performance. The 1¾ inch super-tweeter uses a very small, stiff, hemispherically shaped diaphragm as a direct radiator which provides a nearly ideal performance in the high treble range.

The AR-2a is a 4-speaker system consisting of a single 10-inch woofer, two 5-inch tweeters, and the 1¾ inch super tweeter. Frequency response is more than adequate to cover the entire range of musical instruments. Cross-over frequencies are 2000 cps and 7500 cps. Dimensions of the AR-2a are 13½" h x 11½" d x 24".

Recommended for use with amplifiers having power output of 20 to 40 watts. Acoustic Research, Inc., 24 Thorndike St., Cambridge

41, Mass. User net price mahogany or birch \$122.00; unfinished pine \$109.00; walnut, cherry, or korina \$128.00.

AR-1 full-range speaker system, mah	...	\$185.00
AR-1W woofer only, mah	.....	145.00
AR-2 full-range speaker system, mah	...	96.00
AR-3 full-range speaker system, mah	...	216.00
AR-3st super-tweeter for AR-1 or	.....	35.00
AR-2, mah	.....	92.00
AR-3t mid-range & super-tweeter for	.....	92.00
AR-1 or AR-1W, mah	.....	92.00

## ALTEC

● **Economy Speaker System.** The Monterey Jr. is a compact moderately-priced system whose quality of reproduction equals that of some systems costing considerably more. A small ruggedly-built hass reflex enclosure houses an Altec 402A 8-in. "controlled-linear-excursion" speaker and the newly-designed 2000A direct-radiator cone tweeter. Frequency range of the Monterey Jr. is stated by the manufacturer to be 20 to 18,000 cps, and power rating is 15 watts. Impedance is 16 ohms. A single



Monterey Jr. is excellent for monophonic listening, while two make an ideal medium-priced stereo system. It can be flush-mounted in a wall or ceiling, or used in a console as an integral part of a music system. Dimensions are 11¼" h x 23" w x 11¼" d. User net price, in walnut, blond or mahogany, \$79.50; unfinished, \$89.50.

830A "Laguna" corner spkr system	...	\$599.00
832A "Corona" corner spkr system	...	399.00
833A "Verde" spkr system	.....	309.00
605A Duplex 15" loudspeaker	.....	177.00

## AUDAX

● **Multi-Speaker Systems.** Designed by George Nelson, one of the country's leading furniture and industrial designers, the new Audax speaker series brings a distinctive blend of beauty and functionalism to component high fidelity. "The idea behind the Audax speaker systems was to make them interesting, exciting furniture pieces, beautiful in appearance as well as sound," said Mr. Nelson. The Audax cabinets are finished on all four sides,

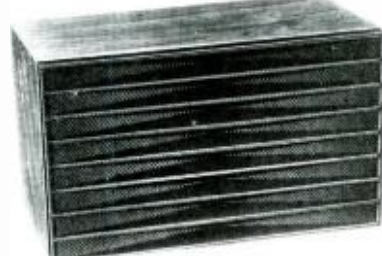

to be used as wall units or free standing. Each model has detachable legs and a new type of speaker grille, a three-dimensional "acoustical screen" which can be removed easily for cleaning. Model CA-80 contains two 8-in. extended-range speakers. Model CA-100 has two 10-in. woofers, plus two cone tweeters. Both units are identical in external appearance. Both are intended for bookshelf placement, and also may be used as floor units. Both systems use Audax "Paraflex" speakers, a patented new design with many innovations, giving a sound quality which is smooth and natural. Audax, Inc., Division of Rek-O-Kut Company, Inc., 32-19 108th St., Corona 88, N. Y. User net price for the CA-80 is \$99.95; for the CA-100, \$139.95.

CA-60, compact 2-way spkr sys	.....	\$ 59.95
A-180W, 18" woofer	.....	150.00
A-150-X, 15" coaxial spkr	.....	109.95
A-150-W, 15" woofer	.....	74.95
A-120-X, 12" coaxial spkr	.....	69.95
A-120-W, 12" woofer	.....	42.95
A-60-M, 6" mid-range spkr	.....	35.00
A-35-T, 3½" tweeter	.....	9.95

## AUDIO-TECH

● **Wide-Range Speaker System.** Although extremely compact, the Audio-Tech Model ME12 has a frequency range of 37 to 20,000 cps. Containing a 12-in. woofer and a 3-in. cone-type tweeter, it incorporates a special calibrated level control for high-frequency bal-

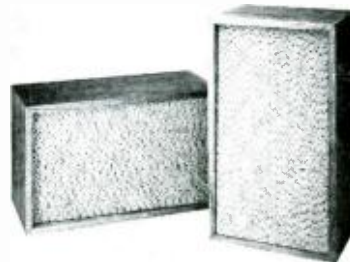

ance. Colored binding posts permit easy determination of polarity for connection in stereo music systems. The speakers are fused to prevent damage from accidental overload. Enclosures are made from selected walnut, mahogany, and fruitwood, with a handsome hand-rubbed oil finish. Audio-Tech Laboratories, 3420 Newkirk Ave., Brooklyn 3, N. Y. User net price, \$109.50.

JA-15 wide-range spkr sys ..... \$225.00

## BOZAK

● **Small Speaker System.** The Spinet, a new, small speaker system has been introduced by Bozak to meet the needs of listeners who have a pronounced space problem. Measuring a compact 14½" h x 23¼" w x 11½" d, it has a naturalness of response in bass, mid-range and treble which is compatible with the larger



Bozak speaker systems. The Spinet is available in two models: the two-way B-500 system, and the three-way B-502 system. Both models utilize the same finely-constructed, integrated components found in larger Bozak systems, and upon which the Bozak "Systematic Growth" idea is based. This latter enables users to start with a modest installation, and then to "build" on it as they desire, without having to replace initial components. The Spinet is available finished in mahogany, blond, walnut or ebony, or unfinished for those who wish to match the cabinet to an existing decor. R. T. Bozak Sales Company, Barrien, Conn. User net price B-500, \$147.50; B-502, \$209.50.

B-310A, wide-range spkr sys	.....	\$770.00
B-305, wide-range spkr sys (contemp)	.....	415.00
B-304, stereo spkr sys (contemp)	.....	620.00
B-302A, 3-way spkr sys (contemp)	.....	249.50

## BRADFORD

● **Compact Wide-Range Speaker Enclosure.** The Bradford enclosure, made in four sizes for 8-, 10-, 12-, and 15-in. speakers, is only two inches larger than the speaker it contains. Its construction is based on a variable-damping principle, in which speaker damping is varied automatically by a pressure relief valve in the rear of the cabinet. Operation of the valve is coordinated with cone excursion. In reality, it is an "acoustic spring" acting uniformly over the entire rear surface of the cone. Boominess and the effects of cabinet resonance are virtually eliminated. The Brad-





ford enclosure will enable the user to realize the potential of most any speaker with which it is used. Bradford Audio Corp., 27 E. 38th St., New York 16, N. Y. Prices of the Bradford enclosure range from \$39.50 to \$69.50, depending on size and finish.

4-12B Spkr system, mah ..... \$525.00  
Baker's Ultra 12, 12" spkr ..... 85.00

## BTH

● **18-in. Dual-Channel Concentric Speaker.** Originally designed for motion picture theatres, the K10A speaker has found considerable favor for use in home systems. Built to commercial standards of performance it compares favorably with current high-quality speakers designed for home use.

The speaker is a coaxial type and features separate magnets for woofer and tweeter. This is to ensure complete absence of electromagnetic intermodulation. (Large signal currents in the woofer voice coil can modulate the field in the tweeter voice coil gap.) The woofer cone is curved and made of thick, soft paper so that it gives good performance up to its design limit of 2000 cps (crossover is 1700 cps) and falls off rapidly above that frequency. Its bass resonance is 32 cps and power handling capacity is 20 watts. The tweeter horn starts at the rear of the speaker, splits at the beginning of the woofer cone, and terminates in two equal sections about 3-in. square which behave as two separate horns, giving excellent dispersion. It loads effectively down to 1200 cps which is well below crossover. The crossover is supplied with the speaker. Frequency response of the speaker is 30-1500 cps. Manufactured in England. BTH speakers are distributed in the United States by Gramercy Sound Associates, 175 Fifth Ave., New York 3, N. Y.

## EICO

● **3-Way Speaker System Semi-kits.** The EICO HFS-3 and HFS-4 provide extraordinarily pure reproduction of bass frequencies with good efficiency in an enclosure of only 2 1/4 cubic feet. Both are 3-way systems consisting of a 12" bellows-suspension woofer and an 8" closed back mid-range speaker with a high internal damping cone. A 3 1/4" cone tweeter is supplied in the HFS-3 for those who prefer softer highs; a compression-driver horn tweeter is supplied in the HFS-4 for those who prefer more brilliance and projection in the highs. (In all other respects, the HFS-3 and HFS-4 are identical.) The impregnated cloth-bellows woofer surround underlies the excellence of the bass reproduction. Built-in crossover networks (600 and 4000 cps) with a level control provided for the tweeter. The enclosure is tuned to 25 cps by a tubular ducted port. The tuned enclosure loads the woofer and reduces cone excursion and distortion in the 28 to 60 cps region. Phase-coded terminals. Frequency range 28 to 14,000 cps. Power handling capacity 30 watts; rated impedance 16



ohms. The cabinet is completely factory constructed ready to receive speakers and networks. Available in walnut, mahogany, or unfinished birch. Electronic Instrument Co., 33-00 Northern Blvd., Long Island City 1, N. Y. Kit price HFS-3, mah \$87.50; HFS-4, mah \$98.50.

HFS-2, omni-directional spkr sys, mah. \$139.95  
HFS-5, 2-way spkr sys, mah, kit ..... 59.50  
HFS-1, 2-way spkr sys kit ..... 39.95

## ELECTRO-VOICE

● **Thirty-Inch Woofer.** This is the world's first mass-produced 30-in. loudspeaker. Engineered expressly for use in the well-known E-V "Patrician" 700, the Model 30W is also highly recommended for use in any custom installation of exceptional quality. The speaker frame is a massive one-piece rigid casting which sup-

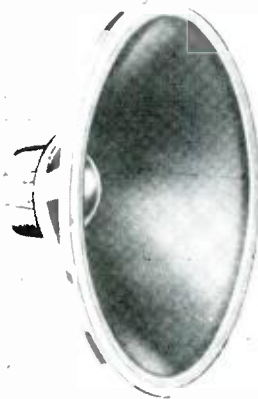

ports a true piston formation cone. The cone in itself is revolutionary, being a one-piece molding of polystyrene foam manufactured by a newly-developed injection-forming process. The 30W is capable of reproducing bass tones in the range of 18 cps with earth-shaking reality. While these tones do not exist in pure form in commercially-recorded music, there are undertones and sub-harmonics in this area which add distinctly to realism in reproduction. User net price, \$139.00.

● **Ultra-Compact Speaker System.** Economy, size, and performance combine to make the E-V "Leyton" an excellent choice for stereo systems where space is at a premium. Fortunately this latest addition to the broad E-V line of ultra-compact systems performs way beyond its minimal dimensions. Bass is delivered from a highly-compliant 12-in. woofer with a long-throw voice coil. Midrange and high frequencies are delivered by an 8-inch

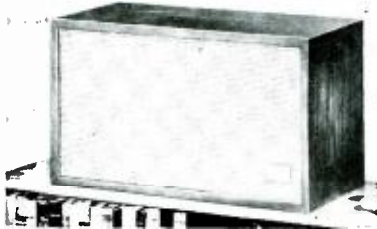

Radax speaker. All components are specially designed and matched to provide a level of performance hardly expected from such a small box. Supplied in hand-rubbed hardwood veneers, it will add distinction to the most tasteful surroundings. Available in walnut, mahogany, or lined oak. Electro-Voice, Inc., Buchanan, Mich. User net price, \$84.50.

Esquire 200, ultra-compact spkr sys ... \$133.00  
Regal 300, ultra-compact spkr sys .... 179.00  
Royal 400, wide-range spkr sys ..... 249.50

## EMI

● **Professional Studio Monitor Speaker System with Built-in Amplifier.** Hand made and identical with the systems used in the recording studios of EMI in England, DLS1 is a superb speaker system which will appeal to the connoisseur with unlimited budget and limited space. Built high rather than wide, the DLS1 stands 50-inches high but is only 13 1/2 inches



wide and 17-inches deep. Although these dimensions were chosen for the system's design function as a studio monitor, it works out very well in a home. Three speakers are used in the column: a large elliptical cone woofer and two smaller units to cover mid- and high-frequencies. The axes of all speakers are vertical so that maximum horizontal dispersion is achieved over a wide frequency range. Frequency range of the system is 30 to 15,000 cps. An EMI 25-watt, extremely low distortion amplifier is built into the base of the column. The amplifier uses four adjustable, frequency correcting networks to attain linear response over the required frequency range. The column is mounted on four large, concentric casters. Exclusive United States distributor, Scope Electronics Corp., 10 Columbus Circle, New York 19, N.Y. User net price, \$594.00.

## FISHER

● **Free-Piston Three-Speaker System.** Utilizing the unsurpassed design of the Fisher XP-1, the new XP-2 is even more compact and easily out-performs many larger and higher-priced speakers. It offers high compliance plus high efficiency, and can be used with amplifiers rated as low as 10 watts. The unit contains



two 8" woofers and one 5" tweeter, with a crossover network constructed of air-core coils and oil-filled capacitors. Over-all frequency response is rated from 35 to 15,000 cps. The cabinet, measuring 22" wide, 12" high, and 11 1/4" deep, is constructed with interlocking joints and shows no nails or screws. Fisher Radio Corporation, 21-21 44th Drive, Long Island City 1, N. Y. User net prices, unstained birch, \$79.50; mah, wal, cherry, \$84.50 (\$87.50 in Far West).

XP-1, unf, \$124.50, finished ... \$129.50  
WS-1, aux spkrs for stereo ..... 49.50 (pair)

## FRAZIER

● **Compact Two-Way Speaker System.** The Monte Carlo, the newest and smallest Frazier two-way speaker system, is made to order for stereo. Measuring only 15 1/2" w x 10 1/2" h x 11 1/4" d, its size permits its use as a bookcase-type speaker, and it is the most economical of all Frazier models for starting a stereo sys-

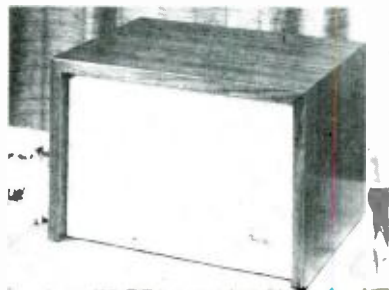

tem. It employs a modified Helmholtz-radiator principle, and has a frequency range from below 70 to 15,000 cps. Power handling capacity is 12 watts continuous. Tweeters are mounted for right and left placement for stereo. The cabinet is equipped with two concealed plastic feet and is finished in hand-rubbed natural walnut. The Monte Carlo is shipped two to the carton, matched for stereo. International Electrotechnics Corporation, 2649 Brenner Drive, Dallas, Tex. User net price, \$85.00.

Dixielander, wide-range spkr sys .....	\$290.00
Capri, wide-range spkr sys .....	150.00
Cortez, 2-way spkr sys .....	140.00
Fiesta, 2-way spkr sys .....	69.50
Del Mar, 2 spkr sys .....	89.50
Patio, wide-range spkr .....	50.50

## GENERAL ELECTRIC

● *G-E Two-Way Speaker System.* Engineered for high-quality sound reproduction in a limited space, the Model G-501 is a compact speaker system by General Electric's audio components section. Termed a "stereocompact"

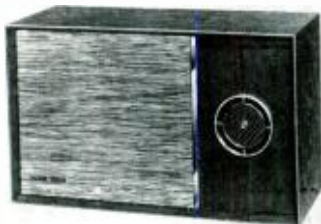

system, the G-501 will deliver excellent audio performance, yet is only 22" w x 13" h x 9" d, true bookshelf dimensions. The new unit is based on GE's extended-bass design, and has a woofer, tweeter, and electrical crossover network all housed in a dramatically styled enclosure. The G-501 presents a departure from previous G-E speaker systems, blending rich wood finishes, new grill patterns, and greater use of metal trim. User net price, \$85.00.

A1-401, 12" coaxial spkr .....	\$49.95
A1-403, 12" woofer .....	32.95
A1-404, tweeter .....	18.95
1201A, 12" wide-range spkr .....	24.95
850D, 8" wide-range spkr .....	10.95
LC-12, 12" extended bass coaxial spkr ..	89.95

## GOODMANS

● *Super-quality 8-in. Speaker.* The Axiom 80 (shown) is capable of the highest accuracy of sound reproduction at medium power levels. It has an audio range of 20 to 20,000 cps and a power handling capacity of 12 watts. Flux density is 17,000 gauss. The low-frequency diaphragm of the Axiom 80 is a true "free-



edge" suspension, being suspended by three pairs of double-acting cantilevers to produce an extremely low and linear axial stiffness and a powerful radial centering action. Resonance is 20 cps. Ideal for monitoring applications. New Triaxiom series consists of dual-cone low-frequency units with aluminum-diaphragm high-frequency pressure drivers. Three 12" models range from 25 to 45 watts; three 15" models from 30 to 50 watts. Axiette II is economically priced 8" unit covering range from 40 to 15,000 cps and capable of handling 12 watts. Rockbar Corporation, 650

Halstead Ave., Mamaroneck, N. Y. User net price, \$69.50.

Axiette II .....	\$ 27.00
Triaxiom 212, 12", 25-w .....	69.50
Triaxiom 412, 12", 35-w .....	92.50
Triaxiom 615, 15", 50-w .....	147.00

## HARTLEY

● *Compact Full-Range Speaker System.* The Hartley "Capri" comprises a full-range 10" speaker mounted in a handsome natural wood cabinet which measures 24" w x 13½" h



x 12" d. The grill is made of bamboo, adding a note of distinction to the appearance. The driver is the new model 320 which is a paper polymerized adaptation of the model 220 chemical cone speaker. It has a 15,000-line magnet, 8-ohm voice coil, one-piece molded flange surround, large dome high-frequency propagator attached to the aluminum shorted-turn portion of the voice coil, which is in turn damped and separated from the wound portion of the coil by a polysiloxane coating. Hartley Products Company, Inc., 521 E. 162nd St., New York 51, N. Y. User net price, \$120.00.

Holton Jr., wide-range spkr sys .....	\$195.00
Duo, complete stereo spkr sys .....	280.00

## HEATH

● *Wide-Range Speaker System Kit.* Taking a cue from the motion picture theater, the Heath "Legato" kit (model HH-1) features theater-type sound reproducers to produce the ultimate in listening realism. The system, a modified infinite baffle, uses two 15" Altec low-frequency drivers to cover frequencies

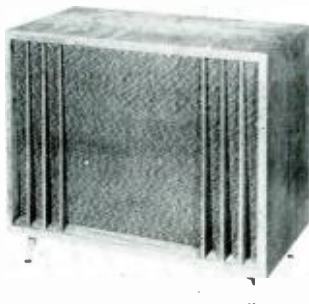

from 25 to 500 cps and a specially designed sectoral exponential horn with high-frequency driver to cover frequencies from 500 to 20,000 cps. Perfect sound balance is attained by proper phasing of the high- and low-frequency drivers and using a well designed crossover network. Precisely determining the correct amount of phase shift permits transition to the high frequencies so smoothly that it cannot be measured. Power handling capacity of the system is 50 watts; voice-coil impedance is 16 ohms. Internal reflections are absorbed by the splayed back panel and a 3" lining of fiberglass. The African Mahogany enclosure emphasizes simplicity of line and form to blend with either modern or traditional settings. Heath Company, Benton Harbor, Mich. User net price, \$299.95.

AS-2U, acoustic suspension spkr sys kit, mah .....	\$79.95
SS-2, basic range spkr sys kit .....	39.95
SS-1B, range extending, spkr sys kit ..	99.95
US-4, 8" dual cone spr .....	6.95
US-1, 12" spkr .....	7.50
US-2, 12" dual cone spkr .....	11.95
US-3, 12" coaxial spkr .....	19.95

## I.H. MFG.

● *Air Coupled Speaker System.* Economy and performance are main features of the I.H. "La



Scala" Model LS-555. Using an air-core transformer of special design to match the impedance of the speaker to the amplifier also helps match the enclosure to the room. The result is sound which is hard to believe from such a small speaker. The cabinet is a modest 9 x 9 x 16 inches and is handsomely styled of genuine hardwoods—walnut, mahogany, or blond—and matching grille cloth. Frequency response is stated to be 50 to 15,000 cps. Power handling capability is 10 watts at an efficiency of 7%. Impedance 4 ohms. I.H. Mfg. Co., Inc., 121 Greene Street, New York 12, N.Y. User net price, \$84.95.

MS-555 "Minstrel" spkr sys .....	\$29.95
----------------------------------	---------

## ISOPHON

● *Six-speaker Midrange and Tweeter Combination.* Manufactured in Western Germany by a leading manufacturer of speakers, the HK 6-8 is ideal for stereo systems using a single woofer and two separate high-frequency speakers. It comes complete, ready for installation in the home with a handsome six-sided, non-resonant enclosure which houses six 3½-in.



speakers and a crossover network. Placement of the speakers, one on each of the six faces, assures an extremely wide sound dispersion. In effect, the sound pattern will be almost hemispherical in shape. Power handling capacity of a single HK 6-8 is 18 watts and the frequency response is 350 to 17,000 cps. Matches transformers with 4-6, 10-15, or 800-ohm impedances. Isophon Speaker Division, Arnold Ceramics, Inc., 1 E. 57th St., New York 22, N. Y. User net price, \$59.85.

IV-25, 3-way, 4-spkr sys (25-w) .....	\$198.50
IV-20, 3-way, 4-spkr sys (20-w) .....	169.50

## JANSZEN

● *Wide-Range Speaker System.* The Z-400, an inexpensive wide-range speaker system, marks the first time that the well-known Janszen electrostatic tweeter has been available in a compact, shelf-mounted enclosure. In the Z-400



the Janszen is acoustically paired with the Model 350 11-in. dynamic woofer. The high-compliance cone of the 350 is specially treated to provide low-frequency reproduction which perfectly complements the Janszen tweeter.



The Z-400 is stated to cover the range from 30 to beyond 30,000 cps with exceptional uniformity and low distortion. Tweeter and woofer are integrally mounted in a totally-enclosed Fibreglas-filled enclosure which may be placed vertically or horizontally as desired. A built-in power supply and high-pass filter furnish power for the two push-pull electrostatic elements, and eliminate the need for external crossover networks and attenuators. The Z-400 measures 15" h x 26" w x 13 1/2" d, and is available in walnut, mahogany and birch finishes. Neshamny Electronic Corporation, Neshamny, Pa. User net price, \$199.50.

Z-300, wide-range spkr sys, mah ..... \$149.75  
 130, electrostatic mid-range, tweeter .. 184.00  
 65, electrostatic tweeter, mah ..... 89.50  
 350, 11" woofer ..... 44.50

## JENSEN

● "Satellite" Stereo Speaker System. The new Jensen "Galaxy III" speaker system achieves wide panoramic stereo sound with two tiny satellites and a single bookshelf size unit. The latter, called the "bass center" speaker, may be placed on floor or shelf wherever conven-



ence and decor dictate. Finish on all four sides allows vertical or horizontal positioning. The Jensen "Flexair" 12-inch high-compliance woofer has unusually low resonance and is capable of total motion of 1-inch, providing clean bass as low as 20 cps. The small satellite units handle midrange and high frequencies. Their placement is not critical as long as they are placed to the left and right of the center unit. They may be spaced as much as 20 feet apart and still provide stereo sound with excellent spatial center-fill. The Galaxy III system provides the equivalent of two complete 3-way speaker systems with the added feature of a "derived third channel" for eliminating the "hole-in-the-middle" effect. Frequency range of the complete system is 20 cps to beyond audibility and power rating is 30 watts. Jensen Manufacturing Company, 6601 S. Laramie Ave., Chicago 38. User net price, \$229.50. Available unfinished at \$195.00.

Galaxy II, stereo spkr sys ..... \$169.50  
 TR-30, 3-way spkr sys ..... 119.50  
 TF-3, 3-way spkr sys ..... 79.50  
 DF-1, 2-way spkr sys ..... 69.50

## KLIPSCH

● 3-Way Speaker System. The Cornwall speaker system, engineered by the creator of the famous Klipschorn corner horn system, is designed to integrate with the Klipschorn to form a wide stage stereo system. The Cornwall is useful in combination with one large corner horn in a stereo set-up where a second corner is not available. Ideally, however, it is



used with two corner horns as the middle channel in a three-speaker stereo system using either independent or derived center channel. The Cornwall is a 7-cubic-foot enclosure housing the same driver units—bass, midrange, and tweeter, as the Klipschorn and affords smooth effortless bass down to 35 cps. Klipsch and Associates, Inc., Hope, Arkansas.

## KLH

● Full-Range Two-Way Speaker System. Housed in a cabinet measuring 24 3/4" h x 21 1/2" w x 11 1/4" d and supported 1 1/2" above the floor by runners, the volume of the Model 7 is 2.6 cu. ft. The speaker complement is a 12" acoustic suspension woofer and

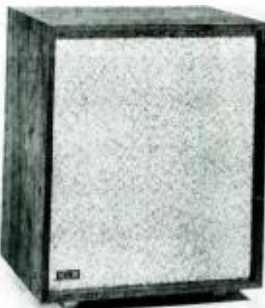

two small cone-type direct radiators operating as rigid pistons over the range from 1500 to 20,000 cps. The use of two such loudspeakers gives a surprisingly large apparent sound source. Low- and high-frequency sections are coupled by an LC crossover network at a frequency of 1500 cps. The relative levels of low- and high-frequency sections may be varied  $\pm 2\frac{1}{2}$  db to provide some degree of control over different room acoustics. Cabinet shape chosen to fit decors where the longer rectangle shape of the Model Six might not fit. Efficiency is identical with that of Model Six. KLH Research and Development Corp., 30 Cross St., Cambridge, Mass. User net prices: mah, korina, \$198.00; wal, oiled wal, \$203.00; unf wal, \$198.00; unf birch, \$189.00.

Model ONE, 2 wfrs, mah, \$378.00; wal, \$390.00  
 Model SIX, 1 wfr, 1 twtr; wal ..... 129.00

## KNIGHT

● 15-inch Wide Range Speaker. This unusually rugged speaker, model KN-600HC, incorporates several refinements which provide performance of the highest calibre. In addition to the massive, one-piece, cast alloy frame, this speaker features a 3/8-inch thick polystyrene woofer cone which achieves a free air resonance of 25 cps with a power handling capacity of 50 watts. The cone suspension is woven



and silicone impregnated to insure high compliance. Speaker loading and type of enclosure are not critical with this speaker thus affording a high degree of flexibility. The axially mounted, compression type tweeter, terminates in a rectangular diffraction horn which distributes the highs over a wide area. An electronic crossover network is built in and includes a brilliance control on a 36-inch cable to adjust the tweeter for varying room acoustics. The precision, aluminum-ribbon voice coil has an impedance of 8 ohms. The ceramic woofer magnet weighs 4.6 pounds. Over-all frequency response is 25 to 15,000 cps. Allied Radio Corporation, 100 N. Western Ave., Chicago 80, Ill. User net price, \$64.50 approx.

KN-810A 18" 3-way spkr, 25 watts ... \$54.95  
 KN-815A 15" 3-way spkr, 50 watts ... 89.95  
 KN-850 12" 3-way spkr, 50 watts ... 69.50

## LAFAYETTE

● Bookshelf Speaker System. Featuring a unique enclosure (patent applied for), the



Lafayette "Elliptoflex" speaker system is a high-efficiency system utilizing a high-compliance speaker for improved low-frequency response. The "Elliptoflex" enclosure achieves its high efficiency because of the elliptical port and a triangular-shaped diffracting ring mounted on the front of the baffle board. These features tend to broaden the frequency response, improve transient response, and create a "lens" effect, changing relative particle velocities—and, consequently, phase relationships—so as to produce a smooth transition from front to rear radiation. These engineering advances are coupled with the Lafayette free edge 8K-58 12" coaxial speaker with 8" cone tweeter, 1 1/4 pound magnet, and special 3/4" wide sheepskin suspension, and built-in crossover-network level control. The "Elliptoflex" speaker system is finished on four sides in a variety of hardwood veneers for attractive room placement either horizontally or vertically. Lafayette Electronics Mfg. Corp., 104-46 Bunkirk St., Jamaica 12, N.Y. User net price, \$64.50.

SY-343, spkr sys ..... \$39.50  
 SK-131, super tweeter ..... 19.50  
 SK-58 12" coax spkr ..... 29.50  
 SK-133, 12" woofer ..... 25.50

## JBL

● "Minigon" Stereo Speaker System. Evolved from the well-known JBL-Ranger Paragon, the JBL-Ranger Minigon gives full stereo coverage through the patented radial refraction system. Modest in size, the Minigon is not a simple miniaturization of the larger JBL-Ranger systems. It has been designed specifi-



cally to function with the JBL "Linear Efficiency" speaker systems which require sealed enclosures. All joints are lock-mitred, wood welded and carefully tested for air leaks. The complete Minigon installation consists of two cabinets with mirror-image symmetry. The cabinets are finished on all four sides so that either can be used as a left or right. Last, but not least, is the unusually attractive appearance of the Minigon. James B. Lansing Sound, Inc., Los Angeles 39, Calif. User net price, \$249.00 each with LE10 woofer, LE30 tweeter and LXS dividing network.

## MADISON FIELDING

● Economical Bookshelf Speaker System. On a par with speakers costing two to three times as much the Troubadour is ideal for budget systems or as a supplementary speaker. Only 9" high by 9" deep and 14" wide, the Trou-



bador offers amazingly clean reproduction with distinct lows starting at 50 cps to highs up to 15,000 cps. The special acoustically designed enclosure provides excellent low-frequency damping. Impedance is 8 ohms. Brand Products, Inc., 256 E. 49th St., New York 17, N.Y. Available in walnut, mahogany, or ebony. User net price, \$29.95.



from **McIntosh**  
*... the finest performance available*  
**the MacKit 30**  
A 30-Watt Unity Coupled Amplifier Kit\*



\*Identical to the renowned McIntosh MC-30 Amplifier

Price \$120

*Enjoy the wonderful experience and satisfaction  
of putting the finest amplifier together yourself.*

A "Mark of Excellence" Product by

**McIntosh**  
LABORATORY, INC.  
4 Chambers St., Binghamton, N. Y.

Now available at Franchised McIntosh Dealers



### NEAT

● **2-Way Speaker System.** Unusual speaker system combining an electrostatic two-element tweeter with an 8-inch cone type woofer. The Neat NE-20 system has a frequency range of 35 to 20,000 cps and power handling capability of 8 watts. Has built-in crossover network (crossover frequency 5000 cps) and a 117-volt a.c. power supply for the tweeter. Neat Onkyo Denki Co., Ltd. No. 4, 1-chome, Kanda Hatagocho, Chiyoda-ku, Tokyo, Japan.

### NORELCO

● **Speaker Series.** Illustrated is Model AD-5277M, the most powerful in the new T-7 series of twin-cone speakers manufactured by Philips of The Netherlands, and featuring Ticonal 7, a high-coercivity alloy which provides the highest possible concentration of flux densities in the voice-coil air gap. Weight for weight, Ticonal 7 is said to be about 30 per cent more powerful than any of the conventional magnet materials used in speaker construction. Voice-coil impedance of the new T-7 speakers is held constant throughout the entire frequency range by means of a copper ring fitted



into the air gap. The ring acts as a shorted turn which induces a current opposite in polarity to that flowing through the voice coil, which reduces that current, thereby lowering the impedance to its proper level. The resonant frequency of the T-7 speakers is very low, resulting in an extremely straight response curve in the bass region. In addition to the cone for low and middle notes, the speakers are equipped with a high-note cone which extends the upper frequency range. Model AD-5277M is a 12-inch speaker with a frequency range of 35 to 18,000 cps and 20-watt continuous power handling capacity when properly housed. Cone resonance is 35 cps. High Fidelity Products Division, North American Philips Company, Inc., Hicksville, N. Y. User net price, \$72.50.

- 1 Integrated spkr sys ..... \$150-160
- 2 Encl for 8" spkrs ..... 50-60
- 3 Encl for 8" spkrs ..... 31-35

### PACO

● **2-Way Semi-Kit Speaker System.** A compact 2-way speaker system, the Model L-2 kit features a factory-built and finished cabinet crafted of furniture-grade plywood. The integrated system incorporates a special design 10-inch Jensen long-excursion woofer and a horn-loaded compression tweeter. Low-frequency response is extended by a pre-tuned, tube-loaded port. Frequency range is stated at 45 to 14,000 cps. Impedance is 8 ohms. The compact cabinet, 23" x 13" x 12", is available,



### PILOT

● **Compact, 3-Way, Wide-Range Speaker System.** Exceptional bass response and realism are featured in the Pilot PSV-1 "bookshelf" speaker system. It achieves extremely wide sound dispersion in horizontal or vertical positions by means of Pilot's "Acoustimatic Turret," an array of tweeters and midrange speakers that can be oriented from outside the cabinet. Solid bass is achieved by a 12" Air-



flex heavy duty woofer in an Orlon fiber filled enclosure. Two 3" tweeters and two 6" midrange units have been angled for wide horizontal sound distribution. Frequency range of the system is 40 to 16,000 cps. Built-in crossover network; crossover frequencies 800 and 8000 cps. Finished on all four sides in a choice of hand-rubbed mahogany or walnut. Pilot Radio Corporation, 37-06, 36th Street, Long Island City 1, N. Y. User net price, \$139.50.

- PSV-2, 3-way spkr sys ..... \$69.50
- PSV-3, 3-way spkr sys ..... 64.50

### POLYCOUSTIC

● **Small-Speaker-Array Wide-Range Speaker System Kit.** Perhaps the first speaker system using the small-speaker-array principle, the Polycoustic PC-28K kit uses a large number of small speakers in series-parallel array. The array consists of 22 selected six-inch speakers and 6 three-inch hard-cone tweeters. The speakers are arranged to use all of the available front panel surface. Thus over 75% of the cabinet is a radiating piston. Low distortion



is achieved because each speaker handles only 1/28th of the audio load so the cone excursion is exceedingly small even for bass notes as low as 30 cps. High-frequency dispersion is 180 deg. at 5000 cps, 120 deg. at 10,000 cps. Over-all frequency range is 30 to 15,000 cps. power handling capability 25 watts, impedance 8 ohms. Polycoustic Company, 958 Arguello Drive, San Leandro, California. User net price, \$176.31 (f.o.b. San Leandro).



### QUAD

● **Full-Range Electrostatic Speaker.** Perhaps the first full-range electrostatic speaker in the world, this speaker may herald the future for the industry. Completely free standing and non-critical as to placement, it radiates from both sides in a figure-eight pattern which minimizes reflections from the walls and ceiling. Frequency range of the speaker is 45 to 18,000 cps and its impedance is 16 ohms. Dimensions are 31" high, 34 1/2" wide, 10 1/2" deep at bottom. Manufactured in England, exclusive United States distributor is Electronics of City Line Center, 7644 City Line Ave., Philadelphia 31, Pa. User net price, \$345.00.

### R & A

● **Coaxial Speaker Series.** Manufactured by a well-known British speaker manufacturer, the 700 series Mark III models are a group of high quality woofer/midrange speakers. Although they vary in fundamental resonance (80, 65, 60 cps respectively for the 8-, 10-, and 12-inch speakers) they all provide smooth frequency response up to 10,000 cps. All feature Alcomax III Anisotropic magnet systems with a flux density of 12,000 gauss. The magnet assembly is easily removable without demag-



netization and has zero external field. Power handling capacity is 15, 20, and 25 watts respectively for Model 780 (8"), Model 7100 (10"), and Model 7120 (12") speakers. Voice-coil impedance is 8 ohms for all models. Distributed in the United States by Ercon Corporation, 16 W. 46th St., New York 36, N. Y. User net price, Model 780 \$13.95, Model 7110 \$15.95, Model 7120 \$17.95.

### REALISTIC

● **Low-Cost Speaker System.** The Realistic "Trio" is an impressive performing 3-speaker system which compares well with similar systems costing considerably more. The Trio enclosure has a laminated mahogany finish on all four sides, permitting horizontal or vertical placement in any desired location. The two tweeters are mounted on a separate inner mounting board which can be rotated 90 degrees to permit full dispersion regardless of the position in which the speaker is used. The 8-in. woofer is equipped with a center-mounted acoustic cut-off filter to yield cleaner lows. A dual high-pass filter network gives smooth crossover, with over-all frequency range of 35 to 17,000 cps. A pair of Trios is ideal for a stereo music system. Radio Shack Corporation, 730 Commonwealth Ave., Boston 17, Mass. User net price, \$39.95.

- Solo-1, 2-way spkr sys ..... \$15.95
- Solo-11, full-range spkr sys, mah ..... 29.50
- Electrostat-3, electrostatic spkr ..... 27.50

# This is the only common sense when you buy a speaker system!



THE KNOWLEDGEABLE audio-hobbyist demands that the components of *his* sound system achieve the reproduction of music which most closely represents *his* personal approach to perfection. He makes his choice of a speaker by one common sense—the sense of hearing—the one sensible way to evaluate the tonal qualities of a speaker. Yes, he buys by ear, by listening, by comparing to determine the sound of music which is most natural, most satisfying. His final selection is based upon a deeply personal judgment of the speaker which offers the greatest listening joy.

Because of its magnificent musical values the audio-hobbyist maintains an inflexible preference for Wharfedale. The name Wharfedale to him is synonymous with the world's finest speaker systems. When he purchases a new speaker system he does not desire, and cannot be sold, any speaker system except a Wharfedale. And, when the demand for Wharfedale speakers exceeds the supply, he will wait pa-

tiently, for months if necessary, for his Wharfedale speaker.

Now, for this man and for those who may profit by his special knowledge, sound judgment and good advice, England's G. A. Briggs has created the great new Wharfedale '60, the first full range shelf-size speaker system which incorporates the sand-filled principle. Its compactness has been achieved without a degree of compromise. The Wharfedale '60 brings you rich, non-strident high notes without electronic, mechanical or acoustical tonal coloration. The sand-filled panel, coupled with specifically designed speakers matched to each other and tuned to perform perfectly within the enclosure permits a full, rich, glowing bass completely free from any suggestion of false resonances. This is why, of all shelf-type speaker systems, the Wharfedale '60, in our sincere opinion, is the speaker system which achieves the closest approach to the perfect recreation of the live performance of music. Today, a great many

people who enjoy the emotional experience of music are buying high fidelity components. It is unfortunate that competitive advertising claims—even though justified—far from being a helpful guide to selection, often offer a bewildering barrier to making an intelligent choice. But, of this you may be sure. The one way to buy a speaker system is to listen with your own ears. If the sound pleases you, it is the world's best for you.

And, no one can satisfactorily evaluate the characteristics of the speaker which will please you most by employing any visual device which purports to measure sound performance. We feel sure that your high fidelity dealer will advise you not to invest in any speaker system which may provide you with less listening pleasure until you have heard the sound of the Wharfedale '60. With the creation of the decorator designed Wharfedale '60 the commonplace look of ordinary stereo systems has been replaced by the perfect proportion of beauty.



THE WHARFEDALE '60 IN GENUINE WALNUT EITHER DILED OR POLISHED, GENUINE MAHOGANY AND GENUINE LIME OAK. IS PRICED AT \$109.50

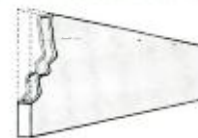

The Wharfedale '60 exclusive sand-filled panel gives optimum results with bass frequencies. It consists of two layers of wood with a completely inert filler of dry sand between them to permit cleaner, truer bass down to 20 cycles.

The compact enclosure offers performance generally ascribed to an infinite baffle plus metered pre-balanced wave pressure release. Finished on four sides. Will perform excellently vertically or horizontally.



# Wharfedale '60

For illustrated brochure write Dept. WK10  
Wharfedale Division, British Industries Corp., Port Washington, N. Y.



Note: A new Wharfedale "chairside" equipment cabinet has been coordinated in styling with the Wharfedale '60 Speaker System. The "chairside" cabinet holds your entire stereo system... your record changer, tuner, preamplifier and amp fier. Priced at \$109.50.



## RFL

● **Dual-Channel, Single-Cabinet Speaker Systems.** "Special Fidelity" line of single cabinet speaker systems for stereo or monophonic systems. The line consists of six-decorator-styled models with designs by Petruccelli and Drake-Smith. Unlike multiple cabinet stereo systems, these single-cabinet systems are non-critical as to location and eliminate the "hole-in-the-middle" effect. The deluxe series incorporates the Provincial, the Classic, the Contemporary (illustrated) and the Colonial.



The low-boy Suburban and the compact Metropolitan round out the line. Radio Frequency Laboratories, Inc., Audio Products Div., Boonton, N. J. Used net price: Provincial (platinum-walnut or fruitwood) \$795, Classic (mahogany) \$765, Contemporary (walnut) \$735, Colonial (pine) \$630, Suburban (walnut or brown mahogany) \$375, Metropolitan (walnut or two-tone) \$225.

## RJ

● **RJ/Wharfedale Speaker System.** Combining the RJ/S enclosure with the Wharfedale Super S/P/S/AL speaker, this compact assembly is ideally suited for stereo music systems. The RJ enclosure, when it was introduced six years ago, established an entire class of products. The RJ is distinguished from all other small-size speaker enclosures by a unique in-



ternal design, which is covered by two U.S. patents. Basically, the RJ enclosure gives undistorted bass notes without compromise because of size. The RJ/Wharfedale will fit handily into a single shelf of a bookcase. Dimensions are 11" h x 23 1/2" w x 10" d. RJ Audio Products, Inc., 80 Shore Road, Port Washington, N. Y. Used net price, in unfinished birch hardwood, \$50.50; in mahogany, walnut, or blond finish, \$59.50.

RJ 8, enclosure for 8" spkrs. mah ..... \$37.50  
RJ 12-S, enclosure for 12" spkrs, mah .. 49.50  
RJ 15, enclosure for 15" spkrs, mah .... 56.00

## SONOGRAF

● **Wide-Dispersion Speaker System.** Manufactured in Norway with typical Scandinavian feeling for wood, the Sonograf Model 253-SS is an unusually handsome speaker system featuring an almost uniform radiation pattern over 360 deg. The complete system consists of two C25 APS (acoustic phase shift) cabinets,



two type 25 woofers and two type 23K tweeter assemblies. Each enclosure can be considered to be two separate cabinets coupled by means of the APS network. The rear of the mechanical driver actuates the air mass in the first chamber which in turn serves as the excitation for the APS network. The output of the network drives the second chamber. Outputs of both chambers are additive. Output of the acoustical chamber is coupled to the air mass of the listening room by means of four slots, each slot separated by 90 degrees. The APS network improves both low-frequency and transient responses. The type 23K tweeter assemblies match the rest of the system in appearance and have a frequency response of 2000 to 18,000 cps  $\pm$  2 db. Total system response is 20 to 20,000 cps within 8 db and power handling capability is 36 watts. Impedance 4 ohms. Sonograf Electric Co., 37 East 28th St., New York 16, N. Y.

## STENTORIAN

● **12-inch Extended-Range Speaker.** Excellent performance is the key feature in this high-fidelity speaker manufactured by Whitley Electrical Radio Company in England. The model HF1214 has a frequency range of 25 to 14,000 cps with a cone resonance of 39 cps.



The 1 1/2-inch diameter voice coil is driven by a 5 1/2 pound Alcomax magnet structure with a flux density of 14,000 gauss. Power handling capacity is 15 watts and voice-coil impedance is 16 ohms. The patented Stentorian canbric cone is used, and the speaker is mounted on an unusually sturdy die-cast, non-resonant frame. Distributed in the United States by Barker Sales Co., 339 Broad Ave., Ridgefield, N. J. User net price, \$52.50.

HF1012U, 10" spkr ..... \$18.95  
HF812U, 8" spkr ..... 14.95  
T-359, 3 1/2" tweeter ..... 14.95  
T-10, tweeter ..... 20.95

## TANNOY

● **16-inch Dual-Concentric Speaker.** Designed specifically for home systems where space is a problem, the Tannoy Dual-Concentric III LZ can be "infinite baffle mounted" in enclosures with a volume as small as 1 1/4 cubic feet. Like all Tannoy dual-concentrics the III LZ incorporates two completely separate speakers, a



horn-loaded tweeter and a direct radiator woofer. The low leakage magnet assembly uses the patented Tannoy "magnetic shunt," one of the notable developments in speaker design within the last ten years. By the use of this device, magnetic losses are reduced considerably, with resultant smoother response, better damping, improved transient response, and higher efficiency. The tweeter has a light alloy diaphragm working in conjunction with a precision phase-matching throat. The woofer has a curved cone, a plastic surround, and a resonant frequency of 27 cps. Power handling capacity is 20 watts and the impedance is

adjustable to 4, 8, or 16 ohms. Crossover network is included with speaker. Tannoy (America) Ltd., Box 177, East Norwich, N. Y. User net price, \$112.75.

15" Monitor Dual Concentric with crossover ..... \$179.00  
12" Monitor Dual Concentric with crossover ..... 138.00  
12" Direct Radiator ..... 79.00  
12" woofer ..... 78.75  
15" woofer ..... 123.75  
Tweeter ..... 86.00

## UNIVERSITY

● **Medallion XII Speaker System.** Featuring an unusual "Select-A-Style" furniture concept wherein interchangeable speaker grilles to match Provincial, Modern and Contemporary furnishings are optional. Relatively compact for a designer-accent cabinet (24" H x 17" W



x 12 1/2" D), the Medallion XII is well suited for stereophonic speaker arrays. The 3-way speaker system includes a 12" high-compliance woofer with a long-throw voice coil; an 8" midrange speaker; and the Sphericon super-tweeter. Frequency response is linear from 28 to 22,000 cps. Includes controls for adjusting system to room acoustics. User net price (cabinet only), \$139.95. "Select-A-Style" frames, \$9.95-14.95.

● **3-Way 12-in. Diffaxial Speaker.** This is the most elaborate of University's series 200 speakers. An excellent performer, the model 312 features a sturdy die-cast basket and a center mounted Sphericon super-tweeter which incorporates its own reflector baffle to prevent interaction between tweeter and woofer. It also provides 120-deg. dispersion in all directions. Midrange is provided by the multi-element Diffusicone that achieves uniform



dispersion in the 1000-3000 cps range. Built-in adjustable "brilliance" control. Frequency range stated as 28 to 40,000 cps. Power handling capacity 35 watts, impedance 8-16 ohms. University Loudspeakers, Inc., 80 S. Kensico Ave., White Plains, N. Y. User net price, \$73.00.

6201, 12" coaxial spkr ..... \$57.75  
Diffusicone-12, 12" Diffaxial ..... 39.75  
Model 308, 8" 3-way Diffaxial ..... 42.00  
Diffusicone-8, 8" extended range ..... 28.00  
UC-153, 15" 3-way Diffaxial ..... 83.00  
UC-152, 15" 2-way Diffaxial ..... 45.00  
UC-123, 12" 3-way Diffaxial ..... 66.50  
UC-122, 12" 2-way Diffaxial ..... 35.50  
UC-121, 12" extended range ..... 28.00  
UC-82, 8" wide-range ..... 16.95  
T202, Sphericon super-tweeter ..... 24.95

## STEREO SYSTEM FOR A MILLION- AIRE: 4 SELECTIONS

*Gentlemen's Quarterly* magazine asked James Lyons, editor of *The American Record Guide* (the oldest record review magazine in the United States), to poll hi-fi authorities on which audio components they would choose for the best possible stereo system, without any regard for price.

Three writers in the audio field and one audio consultant made up independent lists. The ideal systems they projected in the April, 1960 issue of *Gentlemen's Quarterly* are suitable for discriminating millionaires—one of the systems, using a professional tape machine, would cost about \$4000.

**ACOUSTIC RESEARCH AR-3** loudspeakers are included in three of the lists,\* and these are moderate in price. (There are many speaker systems that currently sell for more than three times the AR-3's \$216.) AR speakers were chosen entirely on account of their musically natural quality.

Literature on Acoustic Research speaker systems is available for the asking.

*\*In two cases alternates are also listed. For the complete component lists see the April, 1960 *Gentlemen's Quarterly*, or write us.*

ACOUSTIC RESEARCH, INC. 24 Thorndike Street Cambridge 41, Massachusetts

## VITAVOX

● **Hallmark Speaker System.** Built by Vitavox, Ltd., of London, the new Hallmark speaker systems are based on a unique enclosure design, and incorporate the Vitavox DU120 duplex-coaxial full-range speaker. Nominal frequency range of the units is 30 to 15,000 cps and English power rating is 15 watts. A built-in control affords adjustment of the balance between bass and treble. The graceful



appearance of the enclosures, which serves to enhance the decor of any room, conceals the detailed technical features of the interiors which are acoustically designed to ensure excellent results from cabinets of moderate dimension. Hallmark speaker systems are available in Lowboy (illustrated) and Tallboy models in a wide range of finishes. Distributed exclusively in the United States by Ercoma Corporation, 16 W. 40th St., New York 36, N. Y. User net price, \$199.50.

DU-120, 12" coax spkr ..... \$89.50

## WEATHERS

● **TriPhonic Stereo System.** An unusual approach to stereo speaker design, the Weathers stereo speaker system consists of the non-directional Hideaway Bass and a pair of Harmony stereo speakers. No bigger than an unabridged dictionary (11 x 9 1/4 x 3 3/4 inches) the Harmony stereo speakers have a stated frequency range from 70 to 15,000 cps and have a power-handling capacity of 3 watts. The speaker is a full-range moving coil type



with an impedance of 4 ohms. The Hideaway Bass may be hidden out-of-sight under a table, chair, sofa, or behind drapes because of its small size (16 1/2 x 16 1/4 x 5 1/2 inches) and its non-directional characteristic. Frequency range of the speaker is 30 to 80 cps and power handling capacity is 10 watts. Impedance is 8 ohms. Harmony speakers available in ebony or cordova. Hideaway Bass available in ebony. Weathers Industries, 68 E. Gloucester Pike, Barrington, N. J. User net price (complete system), \$119.50. Separately, Hideaway Bass, \$69.50; Harmony speakers, \$29.75 each.

## WHARFEDALE

● **Compact 2-way Speaker System.** Designed by G. A. Briggs, the Wharfedale '60 achieves a truly unique music quality, its small size notwithstanding. Employing the exclusive, non-resonant, sand-filled panel construction this system achieves an exceptionally clean bass down to 20 cps. This panel consists of two layers of wood with a completely inert filler of dry sand between them. Thus the enclosure, compact as it is, offers the smooth performance generally ascribed to an infinite baffle. The speakers are designed specifically for this system and are matched to each other as well as tuned for the enclosure. The 12"



woofer has a fundamental free air resonance of 25 cps and utilizes an extra heavy cone which provides excellent transient response and freedom from breakup. It has a 9 1/2-lb. magnet assembly and a resin-impregnated fabric surround. The 5" tweeter is sealed in a compartment isolated from the woofer. Both speakers have rigid die-cast chassis. Power handling capacity of the system is 30 watts and impedance is 8 ohms. Crossover network and precision wire-wound treble control are built-in. Available in walnut (oiled or polished), mahogany, limed oak, or unfinished birch. British Industries Corp., 80 Shore Road, Port Washington, N. Y. User net price (finished), \$109.50.

SFB/3 Deluxe, 3-way spkr sys ..... \$279.00  
Coaxial 12, 12" dual concentric spkr ... 139.50  
Super 12/FS/AL, wide-range 12" spkr ... 89.50  
W/10/FSB, wide-range 10" spkr ..... 47.50  
Super 8/FS/AL, wide-range 8" spkr .... 26.50  
Super 3, 3" tweeter ..... 26.50  
W12/FS, 12" woofer ..... 52.50  
W15/FS, 15" woofer ..... 89.50

## WIGO

● **Coaxial Speaker.** The new Wigo line of high-fidelity speakers was devised to eliminate technical overlap and duplication while retaining complete compatibility between the various components offered. Model CX212, illustrated, is a factory-assembled coaxial system comprising the Model ERD-12 extended-range



speaker, the Model CX2 twin tweeter, and the FW2 3000-cps crossover network. Each item may be purchased separately. The ERD-12 is highly efficient and has a 40-cps cone resonance. Response range is 30 to 15,000 cps. A sturdy cast-aluminum frame supports the 8-lb. 13-oz. magnet assembly. Power rating is 30 watts. The CX2 twin-tweeter array extends frequency response to beyond audibility, at the same time enhancing high-frequency dispersion. United Audio Products, 202 E. 19th St., New York 3, N. Y. User net price, Model CX212, \$79.50; ERD-12, \$59.50; CX2, \$20.00; FW2, \$5.00.

## RECORD CHANGERS COLLARO

● **Stereo Transcription Changer.** Deluxe 4-speed automatic-manual intermix changer with heavy-duty, precision balanced, shielded and triple interleaved 4-pole motor is equipped with 6-lb. non-magnetic turntable, 12" in diameter. Flutter is guaranteed below .04%, wow guaranteed below 0.15%, rumble guaranteed down 50 db. Each unit is packed with individual laboratory specification sheet. Permits manual operation when desired, and is

provided with double muting switch and an R/C network to give absolute silence during change cycle. Unit plays 7", 10", and 12" records in any order. Arm has removable pickup head with 5-pin plug to accommodate all standard stereo and mono cartridges. Dimensions: 12" x 13" x 5" above motor board



and 2 1/2" below. Rockbar Corporation, 650 Hulstead Ave., Mountoneck, N. Y. User net price, less cartridge, \$59.50; With Shure M7D, \$83.50.

4TR200 trans turntable ..... \$49.50  
TSC-740 changer ..... 42.50  
TP-59, man rec player ..... 29.95

## DUAL

● **Deluxe Changer-Turntable.** The United Audio DUAL-1006 is a precision-built machine in all respects. It will track and operate automatically with stylus force as low as 1.5 grams. Operating at all four standard speeds, it incorporates a motor of unusually high power, assuring constancy of speed under any normal load condition. Field coils are tropicalized, and thorough shielding prevents hum. The lightweight tone arm is of one-piece construction and is equipped to accommodate interchangeable cartridge by means of a locking-key snap-in arrangement. Direct set of ball

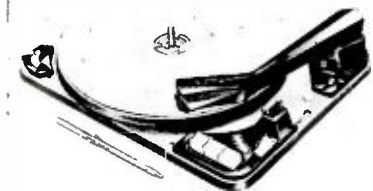

bearings in both axes insures freedom of lateral and vertical motion. Finger-tip stylus-force adjustment is mounted directly on the tone arm assembly. Patented roller-feeler guide in the tone-arm head permits the 1006 to operate automatically and intermix, regardless of record size. Fast change-cycle time is constant irrespective of operating speed. A stereo-mono switch introduces a phase-cancelling feedback circuit to remove vertical signal when stereo cartridge is used to play monophonic records. Notwithstanding its many features, the DUAL 1006 is simple to operate, only three push buttons being used to govern start, stop, reject, and repeat functions. A muting switch assures silence during changing cycle. United Audio Products, 202 E. 19th St., New York 3, N. Y. User net price, \$69.95.

## EICO

● **Stereo Changer/Player.** The Elco-Dual 1007 is a luxury stereo changer/player at a popular





# Fleetwood

PRESENTS A NEW HIGH FIDELITY COMPONENT TV RECEIVER

*to increase the ways you can enjoy  
your precision audio equipment*

Now you can experience the great moments of television with heightened realism through a combination of high fidelity video and high fidelity audio. The new Fleetwood Component TV Receiver makes use of broader bandwidths to bring you a picture of unsurpassed definition, sharpness, and detail. A ratio detector comparable in quality to your FM tuner delivers the audio signal to the pre-amplifier of your component system. There is also a built-in audio amplifier so that a loudspeaker may be directly driven from the receiver when you choose. The new Fleetwood component is built to professional monitor specifications and abounds with extraordinary new features. Model 1000 is equipped with a sonic, wireless remote control. Model 1010 is non-remote. You pre-set the fine tuning for each channel and rarely need touch this control thereafter. Fleetwood definition control permits adjusting the picture to the degree of sharpness most pleasing to your eyes.

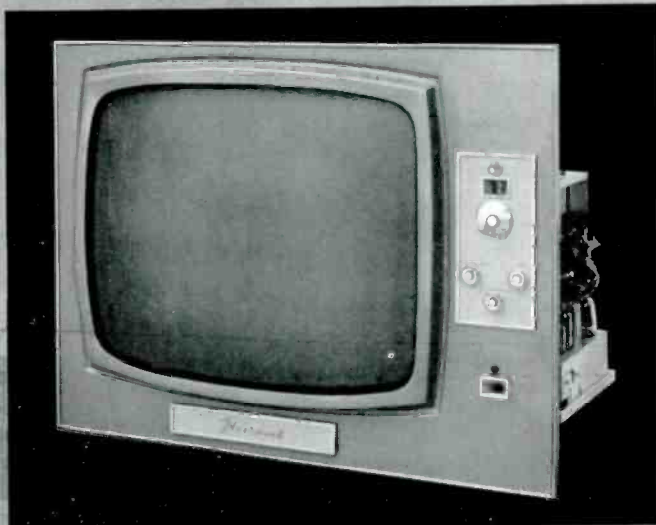

The 23", 110° deflection picture tube provides 282 square inches of viewing, and yet the depth of the set behind the frame is only 13 $\frac{1}{4}$ ". Custom installation has been made as simple as possible. Tube, mask, and frame are factory installed. Never before has a television receiver so superior in all respects, so complete in all details been made available to the non-professional. Write for a complete description.

FLEETWOOD COMPONENT TELEVISION IS MANUFACTURED BY  
**CONRAC, INC.** GLENDORA, CALIFORNIA



FLEETWOOD COMPONENT TELEVISION IS MARKETED BY JBL INTERNATIONAL, LOS ANGELES 39, CALIFORNIA

price. Featuring unusually simple operation and extreme flexibility, the 1007 is ideal for the listener who enjoys convenience coupled with good performance. Utilizing a powerful two-pole induction motor with rotor individually balanced, rumble is reduced to a minimum. The 0.7-mil and 3-mil turnover stylus (the 0.7-mil stylus is diamond in model 1007D and sapphire in model 1007S) achieve close to 4 grams stylus force with no appreciable variation due to height of record stack. Compliance of the cartridge is  $3.4 \times 10^{-6}$  cm/dyne horizontal;  $2.0 \times 10^{-6}$  cm/dyne vertical. Channel separation is approximately 19 db at 1000 cps. Frequency range is 20 to 16,000 cps. Electronic Instrument Co., Inc., 33-00 Northern Blvd., Long Island City 1, N.Y. User net price, \$59.75 (model 1007D); \$49.75 (model 1007S).

## GARRARD

● **4-speed Intermix Record Changer.** The lowest priced Garrard changer, the Model 210 offers features and performance found in changers costing much more. Features include

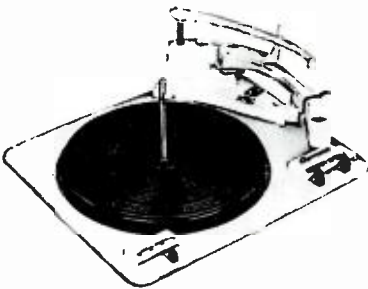

a die cast tone arm with plug-in shell, 4-pole "Induction-Surge" Garrard motor, easy accessibility and operation of the side-slide controls, complete wiring for stereo, and a full manual operating position. Sporting an attractive fawn and white color scheme, set off by satin black turntable, the 210 looks as well as it performs. Garrard Division of British Industries Corp., Port Washington, N.Y. User net price, with plug-in head less cartridge, \$44.50.

4HF, transcription turntable and arm . . . \$59.50  
T/11, manual player . . . . . 32.50

## GLASER-STEERS

● **Stereo Record Changer.** The GS Seventy-Seven is precision-engineered, completely automatic in operation, and offers new features and refinements which enhance the enjoyment of stereo records, at the same time allowing enjoyment of monophonic records to the utmost. Stylus force is variable over a wide range with easily accessible vernier adjustment. Variation of stylus force between first



and last record on a stack is less than 0.9 gram. The damped, acoustically isolated tone arm is not resonant within the audio range, and moves both laterally and vertically on pinpoint bearings. Rumble, wow, and flutter have been reduced to insignificance by improved motor design. As in earlier Seventy Seven models, the turntable pauses during a change cycle, and resumes motion only after the stylus has been lowered to the next record, to reduce stylus and record-surface wear. The idler disengages automatically in "off" position to prevent wow caused by flat spots. A dual-channel muting switch and R-C network maintain silence for both stereo channels during record change and at shut-off. Glaser-Steers Corporation, 155 Oratton St., Newark, N.J. User net price, less cartridge, with two cartridge shells, \$59.50.

CSC cover for GS-77 . . . . . 9.75  
CS400 4-speed stereo changer . . . . . \$47.50

## HEATHKIT

● **Automatic Four-Speed Changer Kit.** In reality a semi-kit because most of the unit is pre-assembled, the Heath RP-3 series is available in several versions, the differences primarily consisting of the type of cartridge supplied. The RP-3 features a turntable pause which stops rotation during the change cycle thus eliminating the record wear associated with the fall of a record on a moving turn-



table. Flutter and wow are only 0.18%. Other features include automatic intermix, a filter across the power switch to prevent switch "pop," a muting switch, and a metal tone arm. Tracking force is 2 grams. Supplied with a changer base kit, a stylus pressure gauge, and a removable 45-rpm spindle. Heath Company, Benton, Harbor, Mich. User net price, \$59.95 (less cartridge).

AD-10, manual ster player kit . . . . . \$33.95

## LESA

● **Four-Speed Record Changer.** Fully automatic, the new Lesa Model CD2/21 record changer has only two controls for all operating cycles, speed selection, start, stop, reject. Up to eight records of any size may be played with automatic intermix. For manual operation, the record balance is simply moved to its side position. When operated manually, the tone arm is returned to rest automatically.



after each record. A built-in click suppressor eliminates switching noises by means of an R-C network. A 4-pole, carefully balanced, heavy-duty motor drives the CD2/21's turntable which has an exceptionally high moment of inertia. The tone-arm mechanism is jam-proof, the arm capable of being moved or handled at any time without damage to the mechanism. The record changing cycle time of 6 seconds is the same for all record sizes and speeds. Pre-wired for both monophonic and stereo operation, the Lesa changer is equipped with a universal plug-in shell which accommodates all standard cartridges. Electrophono & Parts Corporation, 530 Canal St., New York 13, N. Y. User net price, \$39.95.

SM5/DU2 4-sp man rec player . . . . . \$29.95

## MIRACORD

● **Push-Button Operated Changer.** Recognized by now as an old stand-by, the Miracord has kept step with stereo requirements without major model changes. The XS-200 still employs a heavy-duty 4-pole motor, push-button operation, and the "Magic Wand" center spindle drop mechanism, but over-all performance for stereo applications has been improved by the use of a heavy cast turntable and additional motor shielding. Unit is furnished with two output cables for stereo, and



removable plug-in head accommodates stereo or mono cartridges. Audlogersh Corporation, 314 Broadway, New York 12, N. Y. User net price, \$67.50.

## THORENS

● **Four-Speed Semi-Automatic Player.** The Thorens TD-184 is a four-speed turntable with integral arm, wired for stereo, and features the same basic adjustable-speed drive as the TD-124 transcription turntable. Semi-automatic operation—a simple dialing motion selects record size, starts table motion, and positions arm on first groove of record. Ad-



justable piston controls lowering speed of arm. Position trip shuts off player at end of record. Idler is disengaged and lifts arm. Turntable rides on nylon-seated ball bearing. Arm tracking force is 2 grams. Plug-in adapter accommodates all standard stereo or monophonic cartridges. Thorens, New Hyde Park, N. Y. User net price, \$75.00.

TD-134, manual 4-speed player . . . . . \$59.95  
CBA-83NS, auto 3-speed player . . . . . 59.95  
CD-43NS, auto stereo changer . . . . . 79.95

# TURNTABLES

## AUDIO EMPIRE

● **Stereo/Balance Turntable.** Deriving its name from the dynamically-balanced hysteresis synchronous drive motor, the Audio Empire Model 208 Turntable is a three-speed (33 1/3, 45, 78 rpm) belt-driven turntable. The precision-machined, heavy aluminum base plate and turntable are virtually vibration free because



of the belt drive and the "acoustic isolation" type of suspension for both motor and base plate. Incorporates pop-up 45-rpm adapter spindle. Available in satin chrome or satin gold finish. Dyna-Empire, Inc., 1075 Stewart Ave., Garden City, L. I., N. Y. User net price, \$87.50. Base in walnut, mahogany, or fruitwood, \$12.50.

# stereo in a nutshell

The compact component has come of age. And in the vanguard of this trend is Crosby's new Madison Fielding 650 Receiver — AM and FM tuners, stereo preamp and powerful dual 14-watt amps (48 watts peak)—truly stereo in a nutshell. This exciting compact (a Lilliputian 14½" x 5¾" x 11¾") features exclusive pushbutton source selection, center channel stereo output, individual channel controls, mono-stereo blend and microbeam AM/FM tuning. Just add the changer and a couple of speakers. Then enjoy music to stir the soul. And the price barely stirs the purse . . . a compact \$219.95.

model **650**

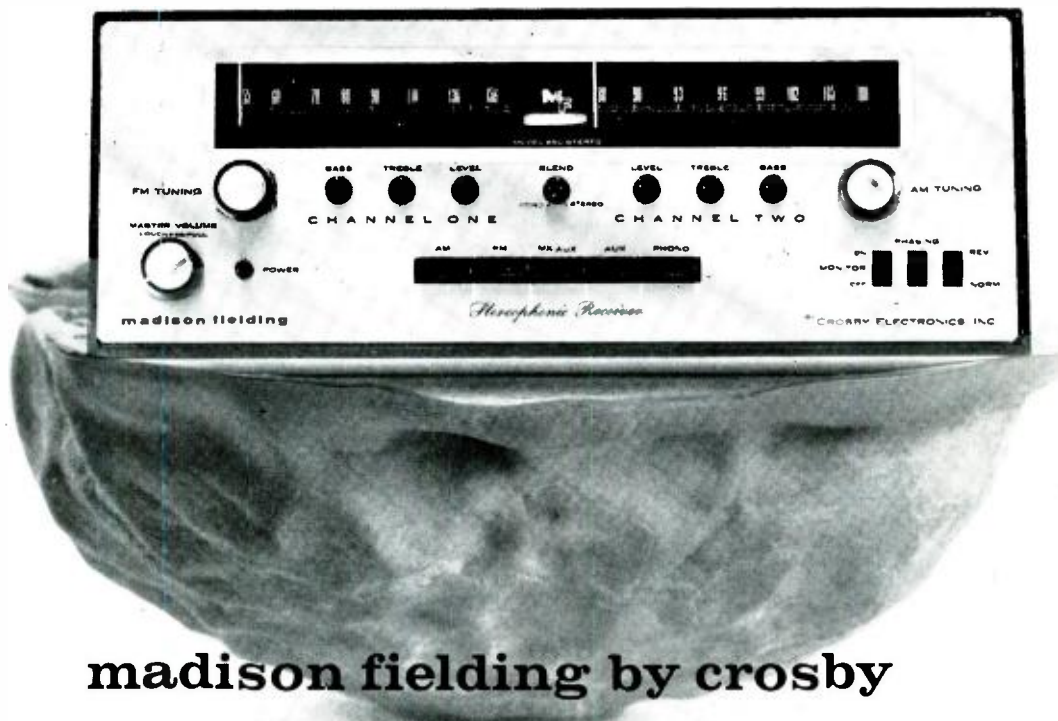

**madison fielding by crosby**

Crosby Electronics, Inc., Syosset, L. I., N. Y.

Export: Microwave International Corp. • 36 West 44th Street, New York 36, N. Y.

Manufacturers and designers of stereophonic components, speakers and the Crosby Compatible Stereo FM Multiplex System.



## BOGEN-PRESTO

• **Series "T" Turntables.** One of the oldest manufacturers of professional recording equipment, Bogen-Presto has built their many years of experience into the four turntables bearing the "T" Series designation. Consisting of the 33 1/2 rpm Model TT3 and the three-speed Models TT4, TT5, and T68AH, all have 12-inch turntables except the T68AH which has a 16-inch turntable. Wow and flutter of all mod-



els is less than 0.15% at the 33 1/2 rpm speed. Rumble for the TT3 and TT4 is 53db below average recording level; for the TT5 and T68AH rumble is 58db below average recording level. All Series T turntable platters are made of homogeneous aluminum alloy castings precisely machined. Hysteresis synchronous motors are used on all models, the TT5 and T68AH using heavy-duty professional models. The single-speed TT3 is driven by a seamless belt, the other models employ idler wheel couplings, a separate idler being used for each speed. Bogen-Presto, a Division of the Sirizler Corp., Paramus, N. J. User net price: TT3, \$59.95; TT4 (shown), \$99.50; TT5, \$129.50; T68AH, \$170.00.

## CONNOISSEUR

• **Two-Speed Stereo Turntable.** The new Connoisseur, two-speed turntable incorporates a hysteresis synchronous motor and features performance characteristics found in more expensive units. Operating speeds are 33 1/2 and 45 rpm from a single, constant-speed motor with speed change effected by a double-stepped cone, ground integrally on the motor shaft. The motor shaft is suspended in graphite



nylon bearings and all revolving shafts are precision ground and lapped to a mirror finish. Rumble is down 50 db referred to 7 cm/sec at 1000 cps. Wow is 0.15% and flutter is 0.1%; hum level is down 80 db. The turntable is 12 inches in diameter and lathe turned of a non-ferrous material. The motor mechanism is mounted outside the turntable rim to reduce hum induced in the pickup by about 12 db as compared with under-the-turntable mounting. Available with wood finish, formica-covered base at slight additional cost. Distributed in the United States by Ercona Corp., 16 West 46th St., N. Y. User net price, \$59.50.

Type B, 3-speed turntable ..... \$119.50

## EMT

• **Professional Integrated Playback Unit.** Designed for the broadcast studio, the EMT 930 ST is a complete playback unit including pre-amplifier, arm, and moving coil cartridge. Professional features include cueing light, strobe disc and vernier speed control, instant start-stop braking, and a remote control. The EMT930ST can be cued to a syllable and offers a choice of three speeds. Output is plus 6 VU; wow and flutter 0.15% peak-to-peak; signal-to-noise ratio is 60 db or better. Also



available in a stereo version. Electronic Applications, Inc., 194 Richmond Hill Ave., Stamford, Conn. User net price, \$1150.00.

## FAIRCHILD

• **Belt-Driven, Two-Speed Turntable.** The new Fairchild Model 440 features 2-speed operation (33 1/2 and 45 rpm) from a single belt drive plus a "Speed Sentinel" control that varies turntable speed by  $\pm 1\frac{1}{2}\%$ . Speed change is effected by a "finger" system which controls



the placement of the belt. The "Speed Sentinel" applies d.c. to the motor windings to control the rotational speed. The entire assembly is mounted on a channel for easy installation. Each turntable is packed with its final inspection record in the form of a graph. Fairchild Recording Equipment Corp., 10-40 45th Ave., Long Island City 1, N. Y. User net price, less base and mounting board, \$69.95.

412-1, single-speed turntable ..... \$ 87.50  
412-2, two-speed turntable ..... 107.50

## GARRARD

• **Three-Speed Transcription Turntable.** Featuring a speed control and a built-in stroboscope, the Garrard Model 301 is designed for the professional and the high quality enthusiast. In addition to speed accuracy, the 301



has less than 0.2% wow and less than 0.05% flutter. Quality workmanship, long associated with the Garrard name, is reflected in the accurately machined rotating parts. Comes complete with 45-rpm adapter and mounting hardware. Garrard, a Division of British Industries Corp., Port Washington, N. Y. User net price, \$89.00.

## NEAT

• **Four-Speed Turntable.** Featuring an illuminated stroboscope, the Neat Model P-68 is an attractive turntable with high-priced performance characteristics which belie its price tag. Driven by a 4-pole induction motor which is designed to reduce vibration and noise, the P-68 has wow and flutter of less than 0.25%. The heavy, die-cast turntable is 12 inches in diameter and is composed of a special aluminum alloy. The magnetic speed regulator and



the built-in stroboscope permit correcting turntable speed as necessary. The speed regulator has an adjustment range of 15% in pitch. The stroboscope marks on back of the turntable are illuminated by a neon lamp and reflected by a mirror to provide a speed indicating signal during operation. Neat Onkyo Denki Co., Ltd., No. 4 1-chome Kanda Hatagocho, Chiyoda-ku, Tokyo, Japan.

## PICKERING

• **"Gyropoise" Turntable.** Engineered specifically for microgroove records—both monophonic and stereophonic—the Gyropoise 800 Stereotable is a single-speed machine operating at 33 1/2 rpm. It embodies a unique method of magnetic suspension, on which patents are pending, which eliminates vertical rumble to the point that it becomes inconsequential in the playing of stereo records. Vertical period of spring suspension is below 5 cps; compound vertical rumble attenuation is 12 db/octave



below resonance; noise is 65 db below reference level; speed accuracy is  $\pm 0.2$  per cent total variation. Pickering & Company, Inc., Plainville, N. Y. User net price, chassis only, \$59.95. Model 800CB, complete base, in mahogany, walnut, or blond, \$15.00.

## REK-O-KUT

• **Hysteresis-Motor Turntable Kit.** Meeting professional standards throughout, the Model K-33-H turntable kit can be assembled in 30 minutes or less, using only simple tools. A single-speed unit (33 1/2 rpm), it features a high-efficiency hysteresis synchronous motor built to Rek-O-Kut's exacting specifications.



Noise level is 52 below average recording level. The crown-spindle belt drive uses a custom-made endless-woven fabric belt with thickness held at  $\pm 0.001$  in. An adjustment is supplied for belt tension. A built-in strobe disc permits constant speed check. The solid cast-aluminum turntable is lathe-turned, and tapered for easy disc handling. The entire assembly is finished in silver-tone aluminum. Where economy must be observed, the K-33-H presents an ideal means of possessing a high-quality turntable at modest cost. Rek-O-Kut Company, Inc., 38-19 108th St., Corona 68, N.Y. User net price, \$59.95.

N-33H 33 1/3 w/hys sync motor ..... \$ 69.95  
K-33 1/3 w/4-pole motor (kit) ..... 39.95  
B-12H 3-sp w/hys sync motor ..... 139.95  
B12GH 3-sp w/hys motor ..... 99.95



# A *Bozak* FOR EVERY MUSIC LOVER



Whether your requirements are modest or magnificent, there is a fine-music Bozak Speaker System to satisfy every individual need.

**For Limited Space:** The new Bozak "Spinets," quality two- and three-way Systems in compact, functional enclosures measuring only 14½" x 23½" x 11½", that outperform any speakers near their size and price.

**For Built-ins:** Panel-mounted and wired two- and three-way Systems for convenient installation where you want them — in wall, bookcase, or well-made furniture.

**For the Hobbyist:** The easily assembled, acoustically superior infinite-baffle E-300 Kit enclosure, with Bozak's one line of one quality components: the popular B-207A coaxial, the outstanding B-199A woofer, the unique B-209 midrange, the sweet-natural B-200X tweeter, distortion-free crossover networks—and, soon to be announced, the multi-purpose 8" auxiliary speaker.



**For Decor:** The industry's widest selection of custom-crafted fine furniture enclosures in Provincial, Urban and Contemporary styling with matching equipment cabinets — choice of fine finishes — or unfinished for special individual requirements.

**For Stereo:** The original and incomparable single-cabinet dual-matched System—the Bozak B-304 Stereo Fantasy. Or any pair of Bozak Systems.

**For the Connoisseur:** Supreme in realism of music and sound reproduction, the magnificent B-310A and B-400 Systems.



*Reward your appreciation of fine music . . . see a Bozak Franchised Dealer for The Very Best in Sound.*

**BOZAK • DARIEN • CONNECTICUT**





## SONOGRAF

• **Three-Speed Belt-Driven Turntable.** A truly professional-quality turntable, the Sonograf Model 2500 features direct belt drive at all three speeds (33 1/3, 45, 78 rpm) with a special, resilient "T" belt that virtually eliminates the need for periodic adjustment. Vertical and lateral rumble is -55 db and flutter



eliminates transfer of dust from mat to record. Weathers Industries, 66 E. Gloucester Pike, Barrington, N. J. User net price \$74.50.

ML-1, one-speed turntable ..... \$ 59.95  
 KL-1, ML-1 in kit form ..... 34.50  
 K601, 33 1/3 rpm rec player ..... 111.75

and wow are with 0.1%. Speed accuracy is  $\pm 0.0$  with the stroboscope or  $\pm 0.1\%$  not using the stroboscope. The built-in stroboscope is visible in daylight and may be used to adjust speed while the record is playing. Built-in provisions for levelling the turntable, plus the built-in bubble-type level, simplify installation and subsequent adjustment. The motor is a heavy-duty synchronous, capacitor-start type, which is double sprung for acoustic isolation. The speed control is magnetic. Built-in 45-rpm adapter spindle, on/off switch, and a.c. "pop" suppressor. Sonograf Electronics Co., 37 East 25th St., New York 16, N. Y. User net price, \$99.95.

## THORENS

• **Transcription Turntable.** Engineered for the finest music systems, the Thorens Model TD-124 is a four-speed machine featuring a full 12-inch, 11 1/2-pound table for lowest wow and flutter. The main table is made of cast iron to provide shielding against hum pickup. A cover table made of aluminum, plus an attractive rubber mat, mitigates the attraction



of magnetic pickups. Precision-machined, the Thorens Roto-Drive is adjustable  $\pm 3.0$  per cent for exact musical pitch. A built-in illuminated strobe allows setting to exact speed while record is playing. Easy levelling is accomplished by means of a built-in level-bubble and easily accessible levelling screws. The precision 4-pole motor is equipped with a compliant belt-plus-idler arrangement which provides excellent motor vibration isolation. The TD-124 operates on 50- or 60-cycle a.c. at any voltage from 100 to 250 volts. Thorens, New Hyde Park, N.Y. User net price, \$99.75.

TDK-101 33 1/3 rpm kit ..... \$47.50

## WEATHERS

• **Two-Speed Lightweight Turntable.** Approaching the two-speed problem with the same ingenuity that resulted in the well-known Weathers single-speed model, the Model ML-234 uses two separate synchronous motors; one for the 33 1/3 rpm speed and one for 45 rpm. Each motor couples directly to the turntable by means of a small soft-rubber wheel, and a simple speed-shift lever selects one motor and disengages the other. The Weathers method of reducing rumble and other rotational errors by reducing the mass of motors and turntable is utilized in the ML-234 and is reflected in a rumble of -70 db. Wow and flutter are, respectively, 0.15% and 0.1%. The turntable mat is of special design which

## PHONO ARMS

### AUDIO EMPIRE

• **"Stereo/Balance" Arms.** Precise in appearance and excellent in performance, the Audio Empire "Stereo/Balance" models 98 (12") and 98P (16") are well suited for high quality monophonic and stereophonic systems. Maximum tracking errors of  $+0.75$  deg. for the 98 and  $\pm 0.6$  deg. for the 98P plus arm resonances



of 12 and 8 cps respectively for the 98 and 98P indicate the level of performance. Calibrated stylus-force adjustment from zero to eight grams and counterweighted zero balance adjustment for any cartridge from 2 to 25 grams. Precision ball bearings used for vertical and lateral motions. Available in satin chrome or satin gold finishes. Dyna-Empire, Inc., 1075 Stewart Ave., Garden City, Long Island, N.Y. User net price, \$34.50 for model 98; \$44.50 for model 98P; extra shells, \$6.50.

### BOGEN-PRESTO

• **Professional Quality Tone Arm.** The Bogen-Presto PA1 tone arm is a precision unit built to professional tolerances. Ball-bearing suspension plus a combination of spring balancing and counterweighting enable the PA1 to track at extremely low stylus forces. Adjustment of



stylus force is accomplished by rotating the knurled knob at the rear of the arm until the calibrated arm marking is reached. Range of adjustment is zero to 20 grams less the cartridge. The PA1 uses plug-in heads. Maximum tracking error is 1.9 degrees. Bogen-Presto, a Division of the Siegler Corp., Paramus, N.J. User net price, \$24.95.

### ESL

• **Gyro/Balance Tone Arm.** Designed on the principle that an arm should be balanced in every plane and the stylus force provided by a spring, the ESL Gyro/Balance arm has many advantages. Because of this design, turntable levelling is unnecessary, and on demonstration the ESL arm is often shown playing records with the turntable in an absolutely vertical plane—in fact, if it were possible to keep the record and platter in place and provide proper



bearings for the turntable itself, the arm would play records upside down. Ball bearings are used throughout for all vertical and horizontal motions, assuring smoother operation, increased record life, and longer trouble-free performance. In operation, the spring force is reduced to zero by turning the two knurled knobs backward; the sliding weight at the back is then adjusted for perfect balance of the arm and cartridge. The knobs are then turned forward to obtain the desired stylus force. The head is of molded plastic and is fitted with four terminals. A wire ground lead is carried through the assembly for connection to a terminal strip under the turntable base. Stylus force adjustable from zero up to 8 grams. Electro-Sonic Laboratories, Inc., 35-54 36th St., Long Island City 6, N.Y. User net price, \$34.95.

### FAIRCHILD

• **12-inch Stereo Tone Arm.** Continuing the tradition of excellence exemplified by the previous Fairchild arms, the SA-12 features low arm friction and lateral and vertical cutoff below 15 cps. Precision ball-bearings are used for vertical and lateral arm motions, all bear-



ings being protected against dust accumulation. Micrometer-style counterweight permits accurate stylus force adjustment. Plug-terminated cables are supplied with the arm to eliminate the need for soldering delicate wires. The universal shell slide permits easy installation of all cartridges and features self-cleaning contacts. Rear overhang only 2 1/4 inches. Built in spirit level. Fairchild Recording Equipment Corp., 10-40 45 Ave., Long Island City 1, N.Y. User net price, \$39.95.

### GARRARD

• **Precision Tone Arm.** Despite its modest cost the new Garrard Type TPA/12 will give completely satisfying performance with either monophonic or stereo records up to 16 ins. in diameter. Practically friction-free movement is assured by use of precision spring-loaded cone-type ball-bearing pivots. Suitable for use



with any turntable, the TPA/12 is stereo-wired and the plug-in shell will accept any standard cartridge. A new simple weight adjustment is easily accessible, and permits precision control of tracking force. The features of static balance, spring loading, and viscous damping have all been combined in the TPA/12 to give a remarkable measure of audio performance. Garrard Sales Corporation, Port Washington, N.Y. User net price, \$19.95.

### GENERAL ELECTRIC

• **"Stereo Classic" Compatible Tone Arm.** Every design feature of this tone arm is directed toward optimum performance from stereophonic records. These design features also give the Model TM-2G outstanding mono-



phonic qualities. The arm was developed specifically for use with G-E cartridges, as an integrated all G-E pickup system. The arm's primary feature for excellent stereo reproduction is its static balance. When adjusted, the arm maintains its lateral equilibrium at all times, even if the turntable is not perfectly level. An unusual two-step tracking-force adjustment is used for (1) balancing the arm to zero tracking force, and (2) for making a



# NEW "DECORATOR GROUP" LOUDSPEAKERS

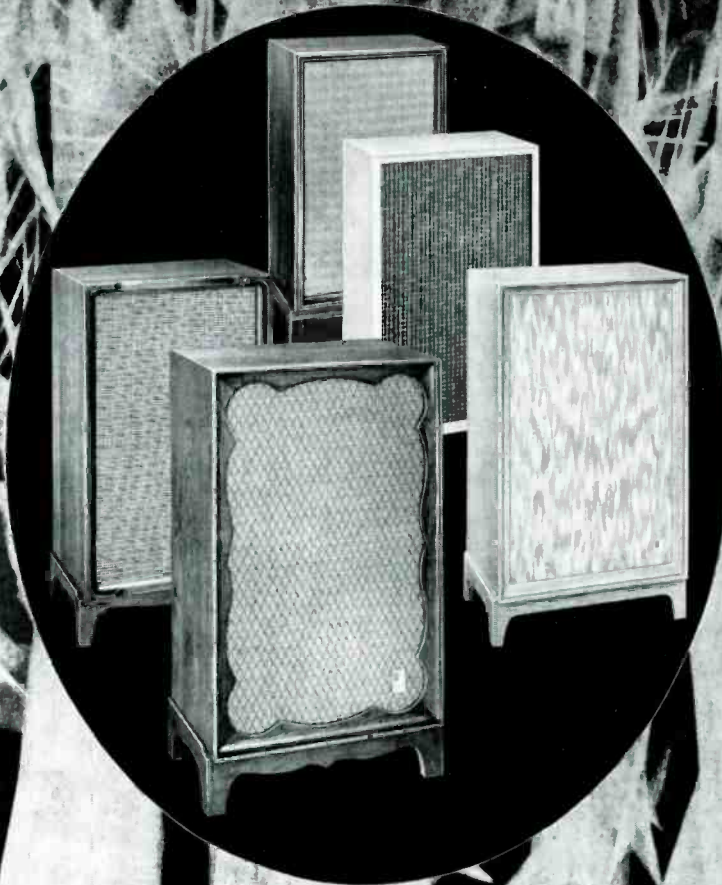

*a style for every wood . . . a wood for every mood*

From the "style woods" of the world, Jensen chooses only the finest for their exclusive Decorator Group speaker cabinetry. The woods are mated with graceful furniture designs to fit the mood of your home—whatever it may be. You may choose from smart modern Danish in warm Walnut, subtle Contemporary in clean Lined Oak, elegant Traditional in rich Mahogany, authentic Provincial in lustrous Cherry, or a special unfinished utility model. Use as a shelf-type or as a diminutive console with matching base. Jensen's world-wide acceptance as the finest name in high fidelity speakers assures you of superior-quality components brilliantly matched and balanced to provide the finest home speaker systems ever produced. Visit your high fidelity center and see the Jensen TR-30 TRI-ette system soon. Hear a demonstration of the rich full-range sound. You will find it a rewarding experience.

## TR-30 Tri-ette 3-WAY SPEAKER SYSTEM

Featuring a new advanced-design 12" FLEXAIR® woofer, precisely coordinated with the BASS-SUPERFLEX® enclosure to carry bass down lower and better than ever before. Midrange and supertweeter components are smoothly balanced with new compression unit designs.

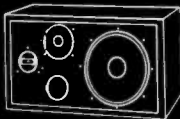

TR-30 TRI-ETTE furniture models—\$159.50 (without base)  
unfinished model—\$134.50 console base—\$9.95

**jensen** MANUFACTURING COMPANY  
6601 S. Laramie Ave., Chicago 38, Illinois  
In Canada: Renfrew Electric Co., Ltd., Toronto  
In Mexico: Universal De Mexico, S.A., Mexico D.F.  
Division of the Muter Co.

Write for free illustrated brochure "KU".

"T.M."

precise tracking-force adjustment between zero and six grams. Among other features are a built-in arm rest, an easily removable cartridge head, a terminal board with four stereo lead terminals and one ground terminal, and trim, modern styling with brushed aluminum and chrome finish. Accommodates records up to 12 ins. in diameter. Specialty Electron c Components Dept. General Electric Company, West Genesee St., Auburn, N. Y. User net price, \$29.95.

## GRADO

• **Laboratory Series Tone Arms.** Engineered to accept all cartridges, but available with matched Grado cartridges, this arm is the first in a series designated the "Laboratory Series." Intended to retain all the advantages of the integrated tone arm/cartridge combination with none of the disadvantages, this arm



can be adjusted for overhang and weight within the shell. Because of this, the arm need not be rebalanced when changing cartridges. Constructed of fine gunstock walnut with precisely machined aluminum fittings the arm looks and performs magnificently. Electrical connections are by screw terminal so that a soldering iron is not required for installation. To simplify installation in small cabinets the arm has been designed with a very small rear overhang. Adjustments are provided for vertical and lateral balance as well as linear tracking force. A vertical stop is provided to prevent stylus damage. Tracking error is  $\pm 0.8$  deg. Grado Laboratories, Inc., 4614 Seventh Ave., Brooklyn 20, N. Y. User net price, \$39.50; with matched custom cartridge, \$69.50; with matched master cartridge, \$85.00.

"Micro-Balance" ster tone arm ..... \$29.50

## REK-O-KUT

• **New Stereo Tonearm.** Available in two models—S-220, 12", and S-260, 16"—the new Rek-O-Kut "Micropoise" arms incorporate anchored single-jacket cable which terminates in two color-coded plug-in leads, two shields, and a ground wire. The arm is designed to be balanced statically with the cartridge in-

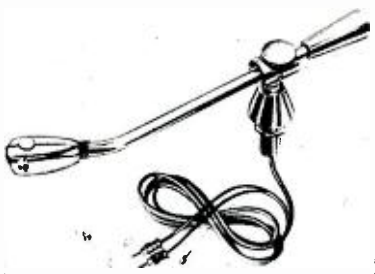

stalled and then the spring-tensioned balance control is set at the desired stylus force, from 0 to 6 grams. The gimbal mounting assembly includes twin sets of five-ball, one-millimeter bearings to provide what the company describes as "the freest vertical and lateral motion found in any tonearm today." The arm is mounted to the base through a single hole, with a single locknut being tightened to secure it. Rek-O-Kut Company, Inc., 35-19 108th St., Corona 68, N. Y. User net prices: S-220, \$29.95; S-260, \$34.95.

## SHURE

• **Stereo Tone Arm.** Modern, high-compliance light-tracking cartridges require arm balance of a high order in all planes to deliver undistorted sound. The new Shure arm pivots on drag-free precision bearings and easily made adjustments for balance, stylus force, arm height, and—for the first time—overhang for any type of cartridge mounting are provided. Available as model M232 for 12" records or as Model M236 for 16" records, the arm comes with detailed instructions for

mounting most of the available cartridges on the market. Removable head is designed to hold cartridge on its mounting plate by single screw through a slot in top of head for overhang adjustment. Direct-reading stylus-force gauge has instant disconnect, and "micrometer" counterweight assembly permits visual static balance check. Shure Brothers, Inc., 222 Hartrey Ave., Evanston, Ill. User net prices: M232, \$29.95; M236, \$31.95.

## SME

• **Precision Pickup Arm.** Featuring an arm mount that permits overhang adjustment without the need for changing original mounting holes, the British-made SME arm em-

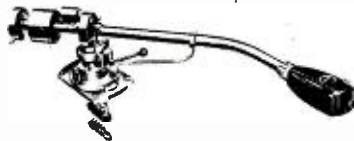

plays a mounting plate fitted with a long slot in which the base of the arm may be moved backward and forward as required. The arm rests on knife edge bearings, and two counterweights are used, one to adjust static balance with the smaller one at the zero position, and then the second weight is moved to the desired stylus force. Lever-operated arm lifter is provided, with hydraulic "dash-pot" arrangement to allow gradual set-down of arm even though level is moved rapidly. Accommodates all standard mono and stereo cartridges, and head is interchangeable with Ortofon type G. Lectronics of City Line Center, Inc., 7644 City Line Ave., Philadelphia 31, Penna. User net prices: Model 3009 (12") \$87.00; Model 3012 (16") \$99.00.

## SONOGRAF

• **Model 2400 Playback Arm.** The Sonograf model 2400 "All Balance" tone arm is designed for quality performance at a moderate price. Ability to track without sideward load into the record groove even with the turntable tilted at angles up to 80 deg. reduces stylus wear caused by warped records or non-level turntables. For the same reason it



reduces record wear. Calibrated adjustment for tracking force reads directly in grams and operated without disturbing the static balance of the arm. Static balance is such that the center of gravity for all components is situated in the axis of rotation, both vertical and horizontal. Adjustable ball-bearings are used for vertical and lateral motions. Interchangeable shells. Sonograf Electronic Company, 37 East 28th Street, New York 16, N. Y. User net price, \$29.95.

## PHONO PICKUPS AUDIO EMPIRE

• **Stereo/Balance Cartridge.** Featuring wide frequency response and low tracking force, the Audio Empire model 108 is a high-quality stereo cartridge at moderate cost. Frequency response is 15 to 20,000 cps  $\pm 2$  db with usable output at 30,000 cps. Output voltage is 8.0 millivolts per channel balanced within 1 db. Channel separation is more than 25 db. Inductance is 500 mH and d.c. resistance 1250 ohms; recommended load impedance is 47,000 ohms. Vertical and lateral compliance is  $6 \times 10^{-6}$  cm/dyne and the recommended tracking force is from 1.5 to 5 grams. Supplied with a 0.7 mil diamond stylus. Dana Empire, Inc., 1075 Stewart Ave., Garden City, N. Y. User net price, \$34.50.

## CBS ELECTRONICS

• **Constant Displacement Stereo Cartridge.** Four versions of this ceramic pickup have been introduced—with either diamond or sapphire, and either in phase or out-of-phase—these terms referring to the phasing of the two channels of the ceramic element. In-phase cartridge, SC-1, provide conventional phasing of the output signals for each channel, which permits the use of the cartridge with either stereo or monophonic records in any dual-amplifier or conventional stereo amplifier system, or it can be used in monophonic systems by connecting the cartridge outputs in parallel. The out-of-phase condition, Model SC-2, is used with certain types of two-way stereo amplifiers in which a single push-pull output



stage handles both channels, with the matrixing of outputs being done in the secondary circuits of the necessary two output transformers. In-phase models are maroon, out-of-phase models are gray. Frequency response, 30 to 10,000 cps  $\pm 3$  db; channel separations, 20 db; stylus force, 5-7 grams. Compliance,  $2 \times 10^{-6}$  cm/dyne; capacitance of each side, 500  $\mu$ af. Output voltage, 400 mv at stylus velocity of 5 cm/sec. Stylus radius, 0.7 mil.

• **Professional 55 Model.** Offered with a 0.5-mil diamond, and only in the in-phase condition, this unit is housed in transparent plastic, and is furnished with two plug-in equalizing networks. Specifications are the same as for models SC-1 and SC-2 except for frequency response, which is 20 to 15,000 cps  $\pm 3$  db. Styl can be replaced by the user with only a small screwdriver needed. CBS Electronic Sales Corp., Division of CBS, Inc., 100 Endicott St., Danvers, Mass. User net price: Models SC-1D and SC-2D (diamond stylus), \$24.25; SC-1S and SC-2S (sapphire stylus), \$17.00; Professional 55, \$28.95.

## CONNOISSEUR

• **Stereo Pickup and Arm.** Incorporating traditional British simplicity of design, the new Connoisseur "cushioned-control" integrated pickup arm is equipped with a 0.6-mil diamond stylus stereo ceramic pickup and a lifting device which permits raising or lowering the stylus with an extremely gentle action.



Rotating the large knob above the pivot point of the arm lifts the arm from its permanent magnet mooring; rotating in the opposite direction lowers it with no more than its normal 3 gram stylus force. Frequency response is 20 to 20,000 cps  $\pm 2$  db. Channel separation from 20 to 25 db and the constant velocity output is 20 mv feeding into a 50,000-ohm load. Finished in ebony with satin-finish aluminum highlights. Distributed in the United States by Ercona Corp., 16 West 46th Street, New York 36, N. Y. User net price, \$59.50.

(Continued on page 75)



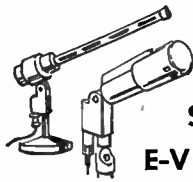

**"Accidental"  
Tests Prove  
Superiority of  
E-V Microphones**

Electro-Voice conducts many microphone tests to determine durability. Occasionally, though, we hear of a field experience more effective than anything performed in our laboratories. Take, for instance, the time a local engineer, preparing for a game at a high school stadium, accidentally dropped a microphone down a flight of concrete steps. The case was damaged, but lack of time forced him to hook up the one he dropped. His worry about failure proved unnecessary because the microphone performed without the slightest loss in quality.

Such unusual and unexpected circumstances come to our attention because we are asked to ascertain the condition of microphones after mishaps. We were not surprised at the durability exhibited because of our own unique method of testing every E-V microphone model. We drop it, we roast it, freeze it, drench it with salt water, explode guns near it, test for pressure at high altitudes, and subject it to abrasive wear and tear.

Now, we don't suggest you abuse your E-V microphones as we do when testing. But, should an accident occur, it's nice to know the chances of anything affecting performance are limited.

The cited example is only one of the many requests received to check over field equipment and provide consultation in the field when desired. Lou Burroughs, one of the founders of E-V, and Vice-President of Broadcast Engineering, has retained intensive contact with TV and Broadcast Engineers. His on-the-scene consultation has enabled him to help in the solution of many ticklish problems and has kept him abreast of situations which require special microphones.

**The 30W — A Woofer  
for the Wildest  
Audiophile**

The creation of a large, low-frequency speaker is not unique to Electro-Voice, nor is the 30W the largest speaker ever built. E-V, however, did recognize the inherent advantages a woofer of this size could have over a smaller speaker. Such a woofer, because of its ability to re-

produce efficiently the lowest bass frequencies without distortion—would offer the ultimate clarity desired by high-fidelity perfectionists.

Electro-Voice, committed for many years to ultra-rigidity in speaker construction, produces a complete line of speakers having rigid, one-piece, die-cast frames. There is no exception to this.

It was inconceivable that an exception could be made with a giant woofer just because of its size. Actually its great size demands extra rigid construction to insure smooth response. Regardless of the extensive and expensive tooling required in shaping the die, core, and die frame, the 30W is now here. It is the world's largest and finest woofer, complete with an absolutely rigid die-cast frame and super bass voice. The die press required to produce the frame is one of the largest in the industrial state of Michigan.

Equal care and design went into all phases of the 30W development. It includes a super-heavyweight (9¼ lbs.) ceramic magnet to increase efficiency and minimize distortion. The new, super-stiff cone of polystyrene foam was originally designed for the 30W. It has almost three times the cone area of an 18-inch woofer and moves an amazing column of air without extra demand on the amplifier. The true-piston performance made possible by the die-cast frame and foam cone enables this speaker to perform beyond the demands of the most confirmed audiophile—absolutely distortion-free to below 25 cps.



**FOAM CONE:  
Engineering  
Breakthrough  
for  
Better Bass**

The "foam cone", just recently introduced in super-quality Electro-Voice low-frequency woofers, represents a major breakthrough in loudspeaker design—and a marked improvement in the delivery of clear, transparent, undistorted bass.

Rigidity of the cone is essential for smooth response. Until the advent of foam, larger woofers were forced into some sort of compromise between acceptable weight and high rigidity. Conventional "paper" cones in smaller diameters can be thickened to the point of inflexibility without undue weight increase, but this is not true of cones with larger diameters—and it is in these larger

cones that the resultant "muddy" sound is the most pronounced. Conventional material, in the thickness required for absolute rigidity, would be beyond the weight limitation which is fixed by magnet size and available amplifier power (without expensive redesign of both components.)

Exhaustive research turned up "foam". Its correct name is polystyrene (a very hard plastic)—and the word "foam" is related to the form of the material in its final state. Air is entrained in it by agitation while it is liquid. When it cools in the mold, it retains the "foam" structure (internally)—along with its exceptional hardness and stiffness. Thus a thickness—and a stiffness—many times that of "paper" is possible with no increase in weight.

Furthermore, the ratio of stiffness to weight and thickness is completely predictable and calculable. The engineer can specify the proper thickness for the required rigidity. Weight will stay well within limits—and the molding of the cones can be controlled to sub-microscopic accuracy.

The result is a true inflexible cone—which operates as a piston. There is no distortion of shape and none in the resultant sound. It all came about because Electro-Voice is dedicated to achieving perfection demanded by the Audiophile—and has the engineering talent in quality and quantity to solve the problem.

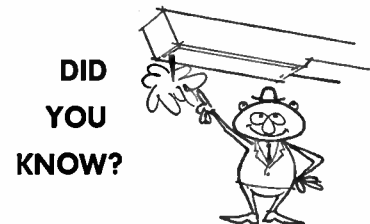

A phonograph needle (stylus) travels and tracks between 500 and 600 yards every time one side of an LP record is played and heat at the tip approaches 1000° F. This high temperature is the basic cause of needle wear. The diamond, with its resistance to heat and abrasive wear and its unequal hardness, is the ideal stylus to keep record wear at a minimum. It lasts 20 times longer than a sapphire, too. Ask for Electro-Voice Power Point Needles and prolong your record life.

Want more information on any of the items mentioned in the Sounding Board? Simply check the appropriate boxes below and mail the coupon to Dept. 80A, Electro-Voice, Inc., Buchanan, Michigan.

Foam Cones  
 Microphones  
 30 W  
 Needles & Cartridges

NAME \_\_\_\_\_  
ADDRESS \_\_\_\_\_

**Electro-Voice®**  
ELECTRO-VOICE, INC.  
BUCHANAN, MICH.



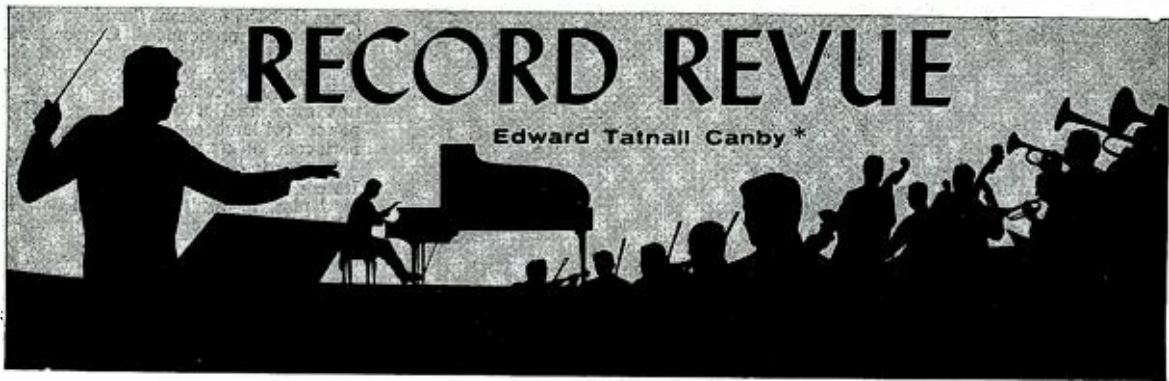

## 1. FOUR STEREO CLASSICS

**Festival Casals de Puerto Rico 1959:**  
**Haydn: Symphony No. 45 ("Farewell");**  
**Mozart: Symphony No. 36 ("Linz")** Festival Casals Orch., Casals.  
**Columbia MS 6122 stereo**

Performance recording has always been a risky affair, and nowhere more so than in the atmosphere of excitement generated at a musical festival. When the leading figure is world-famous, as with Toscanini in the long series of broadcasts or Casals in the more recent festivals under his direction, the atmosphere is so charged (Columbia's own word for it) that a recording of the proceedings is apt to sound merely hysterical to the listener who merely listens at home, far from the excitement of the living occasion. Numerous earlier Casals festival recordings have shown this trait in unfortunate ways. It is a plain fact that no recording can reproduce the actual impact of such a performance on those present at the time—what comes through, instead, is the petty weakness of playing, born of too much excitement, the minor slips that are rightly lost in the general fervor of the actual occasion but which show up mercilessly in the cold beam of the cardioid microphones.

With that prelude as explanation, I can say at once that these two symphonies come through with remarkable success. Perhaps it is simply that Casals, having learned painfully, via a heart attack, the lesson of too-great expenditure of physical energy, now is conducting with a minimum of outward drama and maximum of musical economy. (The rehearsal recording made just before his heart attack of some years ago bears this out.) There is little hysteria here, only a few of the inevitable clinkers that get through in a "live" performance, generally a warm sense of the music with all the proper intensity of the occasion channeled into the playing itself. Even the microphone pickup is good—and it was miserable in some of the earlier Casals recordings.

What is most interesting, I think, is the markedly "old-fashioned" approach of this elder statesman of music. Slow movements are really slow, the Romantic implications in Haydn's score are allowed full play, the minuets have a maximum of that white-wigged gentility that is now so seldom heard in such music; for younger musicians must make all musical expression over into the hard, tense expressiveness of our own day.

The famous "farewell," in which the musicians one by one blow out their candles and leave the stage as the Haydn Symphony nears its end, was enacted in full for this performance. You can hear it—a series of bumps and jiggles as the departing players knock into chairs and music stands on their way out.

**Haydn: Symphony No. 94 ("Surprise");**  
**No. 101 ("Clock").** Vienna Philharmonic,  
 Montoux.  
**RCA Victor LSC 2394 stereo**

Papa Montoux, whether conducting in Boston or Vienna, is a superb interpreter of Papa

\* 780 Greenwich St., New York 14, N.Y.  
 Ⓢ United Stereo Tape, 7½ ips, 4-track.

Haydn, Frenchman or no. I suggest that Montoux is the brightest conductorial light in the RCA roster, and perhaps the best of the old men still alive.

His Haydn is (with Viennese help) lumpy and lyric, of the old school but not in any mannered way, less old-fashioned sounding by far than Casals' (Casals Festival 1959, on Columbia). He is a master stylist, this man with the walrus handlebar mustaches and the jolly walrus face; he can make any orchestra of any nationality sound musical.

**Wagner: Das Rheingold (complete).** Flagstad, London, Svanholm, Kmentt, etc., Vienna Philharmonic Solti.

**London OSA 1309 (3) stereo Ⓢ 90006**

It seems to me increasingly clear that opera on records must be judged on its own impact, quite separately from stage performance—and that this new form of opera listening brings tremendous new vitality to the operatic medium, in an oddly "private" home-style fashion. The glitter and occasion of the opera house itself are absent entirely; but the music and the opera's sense come through with astonishing force, given a well-done recording.

This job is surely well-done, to put it mildly. The technique is, paradoxically, that of a simulated stage production—allowing for recording needs—and much of it was got down with unbroken continuity and all the original fire of the opera itself. For the singers' benefit, the more of this sort of realism in recording session, the better the results, with wise microphoneing.

Unlike many opera recordings, then, this one features the singers at "stage distance"—minus solo mikes. In stereo, it works wonderfully well. In mono, the effect is less good, since close-up recording tends to make up for the lack of spatial literariness inherent in the mono medium. The stage motions are handled expertly here; not a trace of false or exaggerated movement, no singers seemingly suspended in space (not even the swimming Rhine maidens!), none of the sea-sick stereo that sometimes comes forth in our less inhibited stereo operas. Indeed, I found the imaginative illusion actually more effective than the dated stage effects still promoted in most live performances.

To follow the actual text here, in German and English, is to understand Wagner as no opera-goer can ever do, unless he knows the music and the words by heart. I found it a gripping and cohesive performance with very few weaknesses and an abundance of strength.

**Beethoven: Cello Sonata Op. 69. Brahms: Cello Sonata, Op. 99.** Maurice Gendron, cello, Philippe Entremont, piano.

**Columbia MS 6136 stereo**

I'd vote this the finest chamber music recording of the year—if I had heard all of them. It's the best I've heard myself, anyhow.

Here is a young French team playing German music, to perfection. Generally speaking, the French don't dig German art nor Germans but, in spite of their generalized dislike, they manage a real passion for Beethoven and a considerable preoccupation with Schumann and

Brahms. Somehow, these super-Germanic musical leaders of the last century are now removed from politics and even from nationality in the French mind—they are true classics of the Western musical art, from the French viewpoint. Given the right place, given the right performers, French playing of German music can be superb. This is it, right here.

Entremont, in his mid-twenties, is already a wonderfully imaginative pianist, enthusiastic in everything he plays, full of immense energy but every bit of it effortlessly controlled. You'll be aware immediately of his exciting personality here—he's a sort of French Rudolph Serkin, electric, dynamic, but gentle too, his entire output of musical voltage going straight into Beethoven's music expression, without a trace of the show-off virtuoso anywhere. Gendron is in comparison a somewhat restrained player on the cello, even less the showy virtuoso; but his technique, as well, goes efficiently into Beethoven's music and the teamwork between the pair is breathtakingly perfect, down to the smallest detail of phrasing or dynamics.

In Brahms, these two are excellent but not quite as much at ease as in the brilliant middle-period Beethoven. Brahms, for our time, tends to be overpoweringly heavy and, indeed, he requires a certain massiveness for good effect. The massiveness is here, outwardly, but I feel somehow that it is not entirely comfortable for these light-fingered and ebullient technicians. Nevertheless, sheer musicality, the deep understanding and expression of the musical language itself, carries this Brahms into the higher regions of fine playing.

The stereo version adds a nice sense of space around the piano and places the cello modestly to one side for a very natural illusion of living music in the making.

**Netania Davrath sings Folk Songs of Russia.** Orch. cond. Robert DeCormier.

**Vanguard VSD 2056 stereo**  
**Out of the Ghetto. Songs of the Jews in America.** Leon Lishner, bass. Lazar Weiner, pf.

**Vanguard VRS 9068 mono**

Folk music comes in sharply different categories these days—here is one recording in thoroughly classical style and another in a local popular manner, both musically top ranking for my ears, in the material and the delivery.

Netania Davrath, from Russia and then Israel, is said to be equally at home in Mozart, Verdi and Russian folk song—she is very much so in this folk song, which she sings with a notably good Russian styling and to a typically cordium-style orchestra. Her voice has that peculiarly whippy, little-girl brightness that is so wonderful in popular Russian choirs, and a number of the songs are ultra-familiar and very beautiful, too. I've heard some, such as "Parting," sung in similar style by the great Piatninsky chorus. Davrath is just as good.

Leon Lishner sings his American Yiddish in the noble style of Schubert and Brahms—a big, art-song basso with piano accompaniment. No matter; the singing is beautifully done and the music is good too.

# AN UNPRECEDENTED RECORDING!! ON AUDIO FIDELITY RECORDS

## LOUIE and the DUKES OF DIXIELAND

AN UNPRECEDENTED RECORDING! Louis "Satchmo" Armstrong, the great jazz trumpeter who wended his way from New Orleans to Chicago, and the Dukes of Dixieland, who 30 years later followed the same path as their idol, join together in this, an unparalleled recording by AUDIO FIDELITY RECORDS. Superior recording techniques have given an unequalled realism to perennial favorites which Louie sings accompanied by the Dukes of Dixieland, this is one of the most exciting moments of this recording. Listen to the inspired playing of Louie's trumpet with the most prominent and organized jazz group that is performing today!

**AFLP 1924 / AFSD 5924**



### OTHER NEW RELEASES ON AUDIO FIDELITY RECORDS . . .



**PICTURES AT AN EXHIBITION . . . MOUSSORGSKY - RAVEL . . .** Ravel's orchestration of the "Pictures" is probably the most brilliant orchestral tour-de-force in the literature. For the first time it has been done full justice in this breath-taking **FIRST COMPONENT SERIES** release. **FCS 50004**



**BRAHMS SYMPHONY #4 IN E MINOR—OP. 98 . . .** The definitive recording—artistically and technically — of Brahms' Fourth. This inspired reading by Alfred Wallenstein, captured with perfect faithfulness, is an outstanding addition to Audio Fidelity's great **FIRST COMPONENT SERIES**. **FCS 50001**



**MANDOLINO ITALIANO! . . .** A phenomenal rendition, great arrangements and fantastic sound by **DICK DIA** make this the greatest recording by a mandolin virtuoso that has ever been created!!! Popular Italian favorites performed in true, scintillating Italian style. Selections include the popular Sicilian Tarantella, Tango of the Roses, Carnival of Venice, Santa Lucia, Non Dimenticare, and Tra Veglia e Sono.

**AFLP 1923 / AFSD 5923**

**THE AUDIO FIDELITY 1st COMPONENT STEREO SERIES**

FCS50.000 FCS STEREO TEST RECORD	FCS 50.008 MARCHES FROM OPERAS
FCS 50.002 SYMPHONY #6. PATHETIQUE	FCS 50.009 RUSSIAN MASTERPIECES
FCS 50.003 SYMPHONIE FANTASTIQUE	FCS 50.010 SWAN LAKE: SLEEPING BEAUTY
FCS 50.005 BOLERO. Ravel: CARMEN SUITE	FCS 50.011 POPULAR OVERTURES
FCS 50.006 ROMEO & JULIET: NUTCRACKER SUITE	FCS 50.012 OVERTURE!
FCS 50.007 MARCHES FOR CHILDREN	FCS 50.013 STRAUSS WALTZES

For our free complete catalog containing stereophonic technical information, monaural and stereo records, and stereo mastertapes (2 and 4 track) write to: Dept. A8, Audio Fidelity, Inc., 770 Eleventh Ave., N. Y. 19



**Sing-Along in Yiddish with Marv Kurz.**  
**Golden Crest 3076 mono**

Here's more Yiddish, but of an utterly different sort! The craze for the so-called sing-along (a sort of audience-participation kick) is spreading all over the place and here a genial New York popularizer named Marv weeps and shouts and antics his way through these very New-Yorkish old-country songs, with a batch of his friends to help him out. It's raucous, loud, exaggerated, but heart-warming for plenty who know the old songs—the Sweet Adeline repertory of Yiddish—and amusing for many who don't. Musically not exactly profound and not in the least bit Schubertian.

**Songs of the Sabras. Karmon Israeli Folk Dancers and Singers.**

**Vanguard VSD 2059 stereo**

—And finally, the newest in Jewish musical expression, the budding Israeli folk-popular music. No question about it, the Israeli musicians are right when they say: our music is borrowed and not yet mature—but give us time. There is, indeed, already a recognizable Israeli style even to such distant ears as mine, in spite of the divergent origins of a lot of Israeli material, its relatively oversimplified and unsubtle harmonies—sometimes

sounding almost British or Scotch—and its unassimilated near-Eastern aspects.

In this recording, you'll notice a peculiarly intense singing style, the voices childishly earnest (in the best sense) and without a trace of vibrato. Youth is clearly dominant; common purpose shines through the whole performance, naïvete of a sort both pleases and, a bit, leads to a sameness. And yet these Hebrew-singing voices are haunting, even in their not-profound music: the relatively crude little canons and counterpoints, the girls against the boys, have a ring of newness and truth.

Especially, I like the vocal quality and the amazingly expressive effect of the absence of vibrato. What couldn't we do with voices like this for Bach, for madrigals, chansons of Renaissance Europe! But these people wouldn't be interested. They have their own musical job to do.

**Behind the Great Wall. (Sounds and music of China, from the film of Robert Menegoz.)**  
**Monitor MP 525**

Here, if I'm right, is part of the sound track of what turned out to be the first snuffie—scents of old China and new, released straight into your nostrils as you watched. The picture wasn't taken with that in mind, though, and the music as here

presented doesn't smell at all. It's interesting and so are the sound effects.

The disc is of course only a brief excerpting of the complete film, but the job is well enough done as such things go. A Western-slanted orchestra of native instruments play a "written-down" musical suite, here and there in the continuity, the movements of which are interspersed with other recordings as a sort of binder—the crudely Western harmonies of this music are revealing, with a strong feel of Russian pops music in them; the one clear outside influence of "our" civilization in the record's music. Against it, the purely native sounds of music and people give a frightening glimpse into the utter foreignness of this enormous and dynamic civilization, bursting its seams so ominously now, as well as enchantingly in the hearing. It doesn't take much on-the-spot recording today to project Red China on the march in vivid fashion.

Non-musical sounds here include a children's chanted reading lesson in Peking, some vigorous city street noises, (the new and the old dynamically jumbled together), an ancient marriage procession, river traffic in a Chinese gorge, the sound of the first train over a new railroad bridge and the people screaming for joy, railroad work chants, adapted straight from the Folk by former boatmen, and so on. The sounds are strung together a bit confusingly, with few breaks,



ROBERT D. HARVEY

*This is the KLH Model Eight FM Receiver.  
It reproduces recorded as well as broadcast music.  
We designed it to bring the listener and the music together  
with a minimum of equipment between them.  
It is built to laboratory standards of performance and quality.  
We hope there is a place in your life for a KLH Model Eight.*



KLH RESEARCH AND DEVELOPMENT CORPORATION  
30 CROSS STREET, CAMBRIDGE 39, MASSACHUSETTS

*Descriptive literature, with the name of  
your nearest franchised KLH dealer,  
is available on request.*



but the jacket notes keep you on the track most of the time.

**Folk Songs of the Louisiana Arcadians.**  
Recorded in Grand Mamou, Louisiana.  
Collected by Dr. Harry Oster.  
**Louisiana Folklore Soc. LFS A-4** (Folk-Lyric Recording Co., Baton Rouge, La.)

This is quite a fascinating record of still-existing French folk music in the depths of the U.S., in spite of some rather crude editing of the on-the-spot documentary tapes. Like most such special recordings, an impressive roster of participants, editors, commentators is given but the sales source of the actual LP is omitted—I give you the name of the commercial producer above, who should know where the darned thing is available.

The Arcadians ("Cajun" in modern slang) were French settlers in Nova Scotia who were mercilessly driven out a century after their arrival when the British took the place over—that would be around 1714. They ended up in Louisiana, which passed from the French to the Americans direct, and there they still are, still—amazingly enough—speaking some French and singing it, too.

The Cajun folk songs are a bit like those of French Canada, French with superimposed modern influence, the French aspect reflecting the song and language of a forgotten age, preserved through the folk process of transmission. The music here is divided (by the scholars—not the singers) into that dating from the Nineteenth century and after, versus the Eighteenth century and earlier, though all of it, of course, is performed in its present-day living form. The mixture is a curious one, the clearly French aspects of the songs blended into a good deal of equally plain American hill-billy style, as perhaps of the Ozarks to the North. Harmonicas and guitars are heard in force; this is not "reconstructed" nor "authentic" folk music in the scholarly sense but simply the music that still exists of its own accord in the small and relatively isolated town where it was taken down.

Editing problems involved two typical folk phenomena. First, many songs tend to go on and on, too long for the LP requirements. Second, the singing is done at a sort of party affair, with much talking, laughter, applause. The editors have made uncomfortable fade-outs in a few songs and have chosen to give a tantalizingly small segment of the always-interesting after-comment that follows each performance. More would have been in order, surely.

The only proper solution to this problem is to manage the original recording so that there are clean breaks of silence after each piece—but this is more than most folksong collectors can pull off under the somewhat harrowing circumstances!

A fine book of background material and complete texts in English and French comes with the record.

### 3. BACH, HANDEL & CO.

**Handel: Acis and Galatea.** Joan Sutherland, Peter Pears, Owen Brannigan, David Galliver, St. Anthony Singers, Philomusica of London, Boulton.

L'Oiseau-Lyre SOL 60011/12 stereo

This is an early masque by Handel, charming and wonderful in its formalized mythological fancy—shepherds and shepherdesses, the giant Polyphemus, the hero's touching death and his conversion into a god. The whole thing is a series of fanciful tableaux, more or less in the Italian opera fashion—the action happens in fits and starts, followed by long musical commentary. Since the music is what we're after, the convention is most pleasant. Nobody could write music like Mr. Handel, and it is particularly nice to hear the fresh, ingenious early Handel, borrowing mightily from Henry Purcell of England and from his Italian friends on the continent too, skillfully pulling together the best of every style he had encountered in his traveling career.

A charming and very British-sounding performance, wholesome as fresh milk and just as good. You'll be amazed, and amused, at the preposterous text, Handel's first in English; but the music will carry you onwards,

# Mullard TUBES CIRCUITS

for

# STEREO

**MULLARD tubes and circuits, already acclaimed throughout the world for their advanced engineering and reliability, are in great demand for today's stereo amplifiers.**

Heading the preferred list for power output tubes is the **MULLARD EL-34/6CA7**. This extremely linear output pentode which is capable of 60 watts push-pull in Class AB<sub>1</sub> (60 watts per channel stereo—120 watts monophonic) gives a special superiority even to the finest components. This linearity coupled with a uniformity that is already well known make the **MULLARD EL-34/6CA7** the first choice for superb sound reproduction.

Design and build your stereo equipment around **MULLARD**. Circuit and interchangeability data for all **MULLARD** Electron Tubes are available at your distributor or write to Technical Services Division.



"Circuits for Audio Amplifiers" is a new MULLARD publication in which the wide range of MULLARD high quality audio circuits is presented conveniently in one book. Four introductory chapters are devoted to theoretical and practical considerations of high quality sound reproduction with monophonic equipment or with stereophonic systems. The rest of the book comprises circuit descriptions, constructional details, and some performance figures of 12 MULLARD circuits. These circuits include well-known MULLARD designs, some modifications and improvements to these circuits, and a number of completely new ones. Only \$2.50 from your dealer or by mail from our Technical Services Division.

**INTERNATIONAL ELECTRONICS CORP.**  
81 SPRING ST., NEW YORK 12, N. Y.



take  
the controls—  
see why everything  
a tape recorder should do...

the new  
**UHER**  
**Stereo Record III**  
does best!

From the moment you hear its incomparable high fidelity performance—from the instant you realize the wide range of capabilities the versatile controls put at your command—you know that the Uher Stereo Record III is an exciting new experience in stereo tape recording.

Here's what the Stereo Record III does . . . and why it does it best!

**High Fidelity Performance, Unsurpassed**—Broad 40 to 20,000 cps frequency response; negligible wow and flutter 0.1%; high -55 db signal-to-noise ratio and constant speed hysteresis-synchronous motor assure the highest possible performance standards.

**Versatility, Unlimited**—Sound-on-sound! Play back on one track, record on the other—simultaneously. It plays either 2 or 4-track pre-recorded tape, 4-tracks of ½ mil tape, on a 7-inch reel, played at 1½ ips provide more than 17 hours of play. The optional AKUSTOMAT automatically operates the tape transport only when voice or program material reaches the microphone. The Stereo Record III is adaptable for synchronizing automatic slide projectors.

**Flexibility, Unequaled**—Fool-proof and jam-proof controls provide individual adjustments of each channel: volume, tone, fade-in and fade-out, channel and speaker selection. Fingertip control of pause, stop, rewind, fast rewind, forward, fast forward, speed selections of 7½, 3¾, or 1½ ips, and a recording safety lock. Has an accurate digital cueing meter.

Monitoring facilities, plus dual recording level indicators, simplify making stereo or mono recordings. High and low impedance inputs accommodate any type of program source. Outputs for external speakers and for direct connection to external high fidelity amplifiers are provided. Truly portable—weighs only 33 pounds. Complete with 2 Dynamic High Impedance Microphones, Amplifiers, Speakers and Carrying Case. \$399:50

**FAMOUS UHER UNIVERSAL**—High fidelity performance—a most remarkable dictating/playback instrument—3 speeds from 15/16 ips—voice activated—automatic continuous playback. With Remote Control Microphone, Carrying Case, Reel, Dust Cover.

\$299.95 plus f.e.t.



Your dealer invites you to take the controls of the exciting Uher Stereo Record III.

For further details write: Dept. A-8, WARREN J. WEISS ASSOCIATES  
Sole U. S. Agents, 346 West 44th Street, New York 36, New York

making sense of the story even when the words practically fall over themselves in confusion.

**Handel: Israel in Egypt.** Miriam Burton, Betty Allen, Leslie Chabay; Dessoff Choirs, Symphony of the Air, Boepple.  
Vox STPL 511.642 (2) stereo

I have no hesitation in being partial to this recording of Handel's most dramatic and perhaps greatest oratorio; this is without any question the best recorded performance of it so far, by a wide margin.

It isn't the solos, whose role is relatively small. It isn't the orchestra, which is large and was interestingly distributed to bring out the brass and woodwinds and the tympani. It is part the chorus, which is a double one in most of the work, one bank of singers on each side of the orchestra. The impact, via Paul Boepple's conception, is mainly in the sheer cumulative drama of a work that obviously—once you hear it in this fashion—was meant to be done with exactly this intensity. Too many performances just let it ride along, in the old fashioned oratorio manner out of the Nineteenth century, degraded to a stodgy musical lip service.

The recording is one of those rare concert tapes that come out sounding like recording sessions, with the added aliveness of actual performance. There are almost no audible audience sounds, the balance and stereo effects (Carnegie Hall) are remarkably good, the musical boo-boos are few. (A few sections were done over after the performance, to correct faults.) Only one major slip got into the record; it is in a solo part and you'll need experienced ears to spot it.

The astonishing impact of the Handel music in the performance was somehow captured in the recording as well. I had my fingers crossed; I was amazed to hear how successfully it had been managed.

Note: The audience was asked to pause before clapping, so there are no sounds of applause to mar the endings.

**Handel: Concerti Grossi Op. 6, Nos. 1, 2, 3.** Handel Festival Orch., Halle, Horst-Tanu Margraf. Epic BC 1074 stereo

Halle, in Saxony, was Handel's birthplace and thus has a good claim on the composer who is usually known as the greatest of musical Englishmen. It is decidedly interesting to hear this remote German conception of these concerti, so very much a part of London (yet so clearly out of continental music of Handel's time, too), and this set of playings is unusually rewarding in several respects.

First, there has seldom been such a clear presentation on records of the sense of the concerto grosso, with its larger body of "ripieno" or orchestral strings setting off the solo trio, two violins and cello, plus harpsichord. In older performances the very shape of this contrast was garbled; the solos and harpsichord were often omitted. In many recordings of technically proper performances, the solo group of players is mistakenly so amplified and reverberated that the relationship is utterly falsified. Here the balance between the solos and the "tutti" is exactly right, the dramatic interchange between the two groups is just about perfectly achieved. Don't study music history—just listen to this! It tells its own story in seconds.

The solo fiddles (the cello and harpsichord provide the bass and harmony) sound thin, sharp and clear, not loud, as fiddles should in the live performances: the main orchestra's music is much louder and fuller, in contrast—which is obviously as it should be. (The power of the solo mike usually throws the balance the other way, with the solos louder than the orchestra.) Somebody in this recording crew knew his Baroque music.

Next, the playing is notable for the pure, blended string tone, light and almost Italian in style, marvelously clear in the harmonies. It is a classic sound, decidedly, almost detached, but there's every indication in the result that such a pure blend is what Handel could well have had in mind himself. The music fairly blossoms under such treatment.

And yet, I must note a characteristic mod-



eruity of approach that is both good and not so good. These players take their Handel in the new young contemporary style that seems to rise up everywhere in the Western world—fast, rigid in tempo, march-like, with very little give, the phrasing, or shaping, of the musical patterns almost non-existent but the accuracy of the notes showing care and sincerity of purpose. This is not hard, in different playing; it's just modern, as our young people understand their music.

I do like this lean, economical quality, the lack of sentimentality, the business-like exposition. I decidedly enjoy the sharp accuracy of the playing. But I miss the phrasing. I dislike the mathematical, machine-like exposition of rows of notes all exactly equally emphasized. This all-too-typical mannerism of the modern young performer makes for a dry, noncommittal sort of expression that seems to say—here are the notes, each perfectly shaped and exact; you infer the expressiveness for yourself; it's not our business. It is an attitude worlds removed from the still-familiar juicy unctuousness of many of our older conductors and their orchestras, but it is a rapidly spreading attitude, nevertheless, and we'll hear plenty more of it.

Lack of phrasing, shaping, may be quite all right in music of today, where it is intended as part of the new designs. But I can't really believe that a Handelian theme should be any less shaped and shapely than, perhaps, a spoken sentence in plain English. One does not pronounce "decoration" "deh-kor-ray-shun", in so many equal and detached machine-syllables; no more should a tune of Mendel's day be played, as these players often do, as a string of perfectly equal notes, without accentuation. It's not good, even when the playing is as beautifully accurate as this.

Lovely, natural stereo with smooth, easy presence and, as above, the right balance between solos and orchestral strings.

**Bach: Cantatas No. 56, ("I Will Carry the Cross with Gladness"), No. 82 ("Oh Lord, 'Tis Enough").** Mack Harrell, bar.; RCA Victor Orch. and Chorus, Shaw.  
RCA Victor LSC 2312 stereo

The fervent, reverent, intensely musical baritone singing of the late Mack Harrell carries this record of two cantatas for baritone solo to a height well above some of Mr. Shaw's other well-bred offerings. It isn't possible to put a commentator's finger upon the subtle sincerity that makes Harrell's singing greater than the excellent music-making of the Shaw-conducted orchestra—just a quality that I can only call "noble," and if you don't know what I mean, I can say no more.

These Easter cantatas are in themselves wonderfully noble, resigned, dignified, the finest of Bach in the peculiarly expressive cantata medium. The nobility is implied in the orchestra, via expertly polished, smooth and perfect playing, but without Mr. Harrell I think I would find it too velvety-pious, i.e., a bit dull. On the other hand, the singing voice is here the leader among equals and it is entirely right that the soloist should excel in sheer musicianship and expressivity, above his associates. A lovely record.

(For those who like their titles in the original, even if in parentheses, these cantatas are "Ich will den Kreuzstob gerne tragen" and "Ich habe genug.")

**A Program of Bach Arias.** Bach Aria Group, Wm. Scheide. (Julius Baker, R. Bloom, Eileen Farrell, N. Farrow, B. Greenhouse, Jan Peerce, Carol Smith, Paul Ulanowsky, M. Wilk).

Decca DL 79408 stereo

Year after year, and now in stereo, the Bach Asia Group goes along on the same track, putting its distinguished roster of important soloists to work on isolated Bach arias, detached from their context in Cantatas, Masses and other larger works; the group's success in New York concerts has always been great; and perhaps it's no wonder, since people tend to

(Continued on page 81)

# Janszen Electrostatic

whose push-pull design gives remarkable range and clarity to mid and upper frequencies

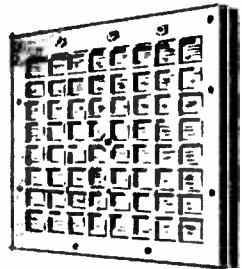

## + Model 350 Dynamic

the only cone woofer specifically designed to match electrostatics



## + Small Cabinet

used vertically or horizontally, on shelf or floor, singly or in pairs for stereo



# = Z-400 from \$134.50

Send for literature and name of nearest dealer.

sound without fury

\*incorporating designs by Arthur A. Janszen and made only by

**NESHAMINY ELECTRONIC CORP.,**  
Neshaminy, Pennsylvania



# JAZZ and all that

CHARLES A. ROBERTSON\*

## STEREO

**Bill Russo: School Of Rebellion**  
Roulette SR52045  
**Stan Kenton: Standards In Silhouette**  
Capitol ST1394

Since January of 1959, Bill Russo has scheduled weekly rehearsals of an orchestra which he calls a school for composers, musicians and listeners. Of the twenty-two members in attendance on its LP unveiling, about half stayed the full course and numbered among them are some of the top studio names in New York. Meanwhile, Stan Kenton plays a set arranged by Bill Mathieu, one of Russo's students and a fellow Chicagoan who helped in the planning of the orchestra. As Russo got his start as an arranger for Kenton in 1950, the interlocking influences of a decade are now brought full-circle.

Although attacking the established order, Russo's rebellion is affirmative rather than destructive and will require considerable time to accomplish. Its immediate effects are a general lightening of orchestral textures, the absence of screaming brass, and a subtle control of dynamics. Four cellos add a colorful touch, and the percussive drive of Ed Shaughnessy keeps the ensembles from sagging. Whether Russo finally achieves all his goals or not, he now commands a remarkable orchestra and articulate soloists.

On display are seven Russo compositions and a statement of musical intent: "Our music is American, but in a different way than most jazz today. The America of Melville, Emerson, and Thoreau is better and stronger than the America of Norman Mailer and Tennessee Williams. This is the mainstream which attracts me—an America which is fresh and new and vital and curious. There is more to this country than the city dweller, the Negro slave, the machine. There are the farms of Illinois, the precise churches of New England, remembrances of Spain in Tampa and Santa Fe, and beautiful horses. We use the traditions of Europe as we wish. Our credentials are not from Europe's institutions but we are not afraid to use anything the world offers us."

That seems like a tall order, and Russo would hardly claim to have filled it in the space of one LP. But he shows great progress since Kenton days, retaining the best elements of the style while leaving brittle concertizing and Hollywood-Freeway jazz far behind. Today he stands closer to the sylvan reaches of *Tanglewood*, or the searching insight of *An Ethete On Clark Street*. Included is a brilliant arrangement of *Manteca*, and cellist Seymour Barab solos on Fred Carlin's jaunty *What Is The Difference*. Other soloists are Frank Soslow, Dick Meldonian, Bill Elton, Larry Wilcox, and Lou Mucci.

One of Russo's theories of composition divides the orchestra into halves, allowing for questions and answers between members of the same section and making the whole less unwieldy. This split, with the rhythm section centered, is ideal for stereo. Because Russo planned it that way, the effect is more per-

suasive than when arbitrarily contrived in the studio or on the arranger's desk.

Stan Kenton is always sensitive to new jazz trends, especially when they concern the area staked out for his band. Not that Bill Mathieu asks for anything in his arrangements that is unfamiliar. But Kenton is often too pretentious in concert, overly romantic on ballads, or too frantic when he turns to straight jazz. He also usually assigns a tune exclusively to one of these categories. Mathieu's treatments bear the concert tag, but the point is never belabored. Instead, he strips away orchestral devices that once were considered modern and places emphasis on a series of soloists, generally starting them off with melodic statements before building and resolving tensions. Proper tempering and superb stereo makes this one of Kenton's best albums.

Rolf Ericson's trumpet expresses the melancholy of *Meaning Of The Blues*, and trombonist Don Sebesky is featured on the seldom-heard *When Sunny Gets Blue*. Charlie Mariano's alto sax ascends to a climax on *Django*, while trombonist Archie LeCoque and Bill Trujillo on tenor sax, tell the story of *Lonely Woman*. This last title is a lovely Benny Carter tune, not the Ornette Coleman original of the same name. When Kenton or Russo creates an orchestral background for the new alto-sax discovery, the millennium will be here.

**Earl Hines: Earl's Pearls**  
MGM SE3832

Pleasant as it would be to have a new solo album from Earl Hines, the opportunity to hear the patriarch of jazz pianists sounding his tribal call again is welcome in any context. A new recording contract, with the promise of additional LP's in the offing, resulted from his leaving San Francisco last winter on a cross-country tour of nightclubs. As the leader gives fresh proof of his pre-eminence as an accompanist, it seems incorrect to call his companions a supporting group. If more pianists perfected the art to the same degree, fewer modern groups would regard the instrument as expendable. Listening to the interaction between piano and Calvin Newborn's guitar is a constant joy. While depending upon Carl Pruitt, bass, and Bill English, drums, for rhythmic excitements, Hines explodes his own fireworks right along side.

Of course, Hines never needed a crutch during solos and at times the help seems superfluous. There are new editions of *Rosetta*, *Stealin' Apples*, and *St. Louis Blues Boogie Woogie*. Among the surprises are a supremely lyric *Manhattan*, and a swing version of *The Saints*. Hines also vocalizes, sounding like a subdued Fats Waller, on *I Can't Believe*, and *You Can Depend On Me*. Fine stereo keeps the guitar under control and the Hines piano tone is among the best ever.

**Eddie Condon: Tiger Rag And All That Jazz**  
World Pacific 1292  
**Jack Teagarden: Jazz Maverick**  
Roulette SR25119

Two good reasons for the dominance of dixieland in New York's smart East Side clubs

are set down here with due regard for traditional virtues. Eddie Condon directs a septet, composed of both former and present employees at his emporium, on Original Dixieland Band tunes. Rex Stewart, Cutty Cutshall, Bud Freeman and Herb Hall make up the front line, while George Wetling delivers a stable rhythmic propulsion on drums. Revisited are *Sensation*, *Ostrich Walk*, *Lazy Daddy*, and *Reisenweber Rag*. George Avakian, during his short stay with World Pacific, produced the date with his usual respect for the niceties of balance and stereo placement.

Jack Teagarden leads the band which he brought to The Roundtable, this time in a studio, and the audience response of his last release is replaced by a relaxed, moody atmosphere. This is a great help as the trombonist sings *A Hundred Years From Today*, assisted only by Don Ewell on piano. Ewell contributes *Roundtable Romp*, and a freshly conceived solo on *Tin Roof Blues*. Besides writing *Blue Dawn*, Don Goldie displays increasing ability and a trumpet tone and style remarkably like King Oliver's. The leader also vocalizes on *Ever Lovin' Baby*, *Aunt Hagar*, and *Ain't 'Cha Glad*. His trombone sounds especially golden in stereo.

**Andre Previn: West Side Story**  
Contemporary S7572  
**Bill Evans: Portrait In Jazz**  
Riverside RLP1162

If the proof of jazz versions of show tunes is lyric inventiveness, the trios concerned here have it—and to spare. Leonard Bernstein's score seems rather challenging for three men, but Andre Previn and His Pals are experienced at hanging from musical cliffs. The pianist started the jazz-show album trend with Shelly Manne back in 1956, and the pair have alternated as leaders in accounting for a long series of best-sellers. With an assist from bassist Red Mitchell, they surmount their biggest obstacle to date. In the best of stereo, it makes pleasurable listening. Ben Shahn's painting "Handball" is reproduced on the liner cover.

Bill Evans engages in an attempt to gain wider public acceptance on his current LP. The fact that it comes a little late should not deter any of his admirers. Due to the success of previous efforts, the pianist recently completed a cross-country tour and his reputation is steadily growing. Accompanied by bassist Scott LaFaro and drummer Paul Motlan, he offers melodic improvisations on *When I Fall In Love*, *Spring Is Here*, and *What Is This Thing Called Love?* Neither of two originals quite equals *Peace Piece*, from his previous album. But perhaps that inspired performance is one to regret, as the pianist has difficulty in recapturing it in answer to casual requests. Credit the tape editor for creating the same reflective atmosphere by placing in sequence *Some Day My Prince Will Come*, and *Blue In Green*. Fine stereo from Jack Higgins of Reeves Sound Studios.

**Ray Bryant: Madison Time**  
Columbia CS8267  
**Wild Bill Davis: Dance The Madison!**  
Everest SDBR1094

While part of the music industry is turning former rock-and-roll stars into ballad singers in an attempt to keep teenage audiences, another faction is capturing a large share of the market by gradually converting it to jazz. Credit for the deepest inroads goes to The Madison, a new dance step made popular by Ray Bryant, the same pianist who accounted for such fine solo LP's when with Prestige. Now listed among the top sellers and on another label, he accomplished the switch without compromising his high standards in the slightest. Of course, the beat is kept prominent for dancers, but the band avoids the disturbing, unmusical traits which some others still use to attract the youngsters. Buddy Tate is on tenor sax, while Al Grey, Benny Morton, and Urbie Green are the trombonists. Harry Edison plays trumpet, and among the added starters is his *Centerpiece*, along with *The Hucklebuck*. Besides the title tune, two new Bryant compositions in the same vein are included, with Eddie Morrison calling off the directions for *Split T*, and *Hit It!*

\* 752 The Parkway, Mamaroneck, N. Y.

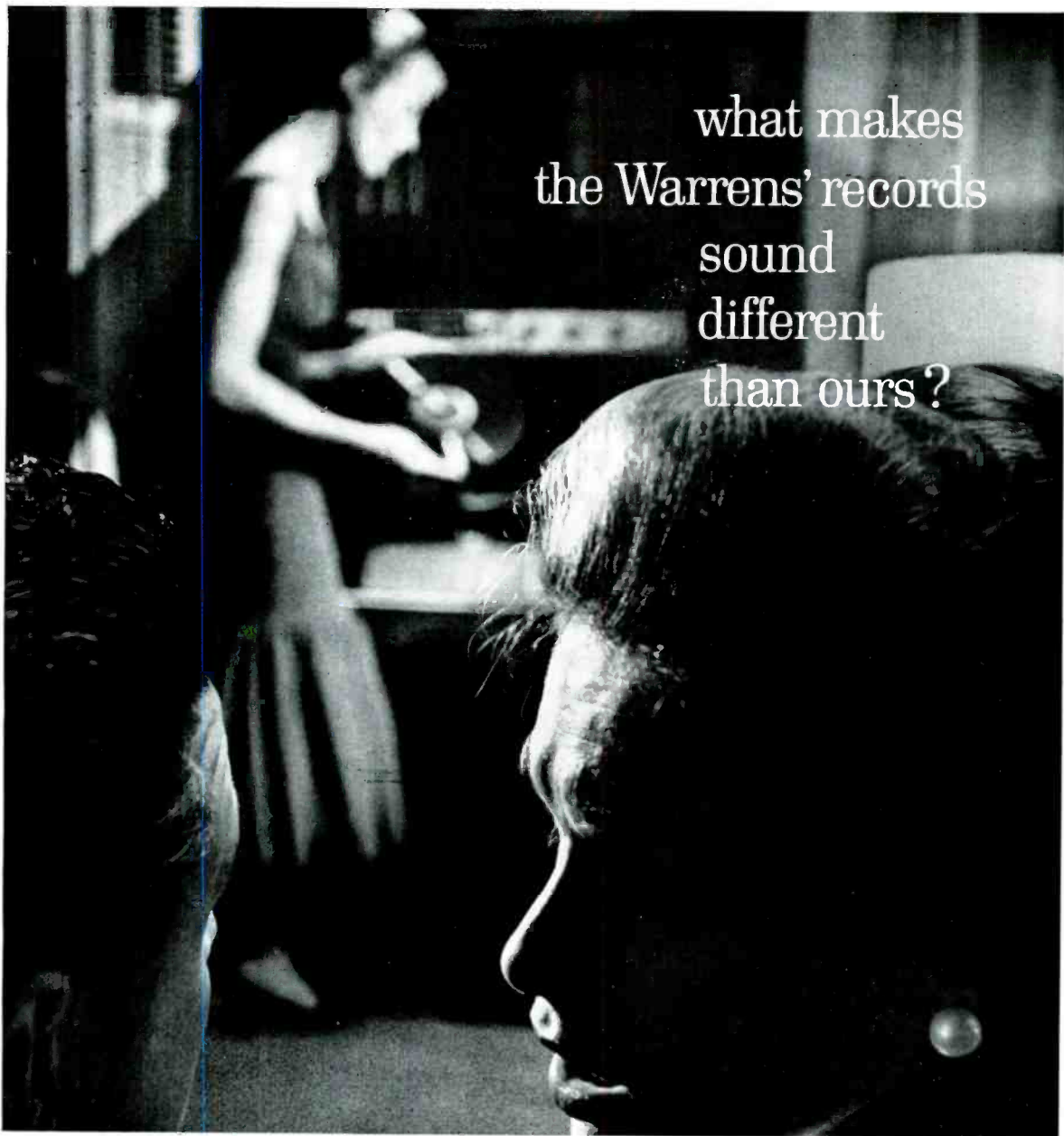

what makes  
the Warrens' records  
sound  
different  
than ours?

they know what to play . . .

They know how to draw from today's wealth of magnificent recordings for the musical fare most appropriate to the occasion . . . for serious listening, for background music, for entertaining, for development of their own and their children's musical tastes. And they know that the self-same selections can sound good when re-created in one way . . . and superb when re-created in another.

and what to play them with . . .

They know that faithful sound re-creation begins with the phono cartridge . . . it is the most important single element in any home music center . . . for it is both the source of sound and the means of preserving the original perfection of the recording. The balance of the system is the proper domain of your High Fidelity dealer, who works within your budget and your decorating requirements.



*this booklet on the  
art of selecting,  
playing and  
preserving records*

is available for 25¢. Send to:

SHURE BROTHERS, INC., 222 HARTREY AVENUE, EVANSTON, ILLINOIS, DEPT. FF

*tasteful music  
begins with a* **SHURE**  
*Stereo Dynetic  
phono cartridge*

from \$16.50 to \$89.50



Just which Madison Street the step was named after is uncertain. But whether it originated in Detroit, Baltimore or Cleveland, there can be no doubt about its antecedents going back to the Chicago of Pine Top Smith and beyond. Wild Bill Davis moves it along a bit further on its new career by transferring the catchy rhythms to organ, aided by the essential drummer and a complement of jazzmen. Among other tunes given the same danceable treatment are *Soft Winds*, *Flying Home*, and *Intermission Riff*. Both liners provide dance charts, and the stereo in each case is uncluttered by the obnoxious sounds which once soothed adolescent ears.

**Gordon Jenkins: Presents Marshall Royal Everest SDBR1087**  
**George Shearing: White Satin Capitol ST1334**

Listeners who like a modicum of jazz and a plethora of strings will find the experts on these albums creating a restful mood. Besides leading the Count Basie sax section, Marshall Royal keeps a watchful eye on other departments in the band. When one of his rare alto-sax choruses gets on record, jazz critics throw brickbats at the velvety tone. Musicians are more tolerant, especially since they know that only Benny Carter and Johnny Hodges can reveal the melodic possibilities of the instrument so thoroughly. More adventurous than when he provided Louis Armstrong with a string background, Jenkins alternates on piano with Hank Jones. The twenty-two members of the ensemble are spread across the stereo stage, while a fourteen-piece choral group and Basie's rhythm section splash colorful effects about on occasion. Jenkins revives *Goodbye*, and provides two fresh originals. Slip this one into an old Jackie McLean liner—and enjoy it.

George Shearing's profitable excursions into the mood world are looked upon with even greater disfavor in jazz circles. But the pianist always picks such gorgeous tunes as *There's A Small Hotel*, *Old Folks*, and *There'll*

*Be Another Spring*. Billy May's arrangements permit a covey of woodwinds to nestle among rustling strings. Better keep the liner, the photo on the cover is a collector's item.

**Les Baxter: Teen Drums Capitol ST1355**  
**Buddy Morrow: Poe For Moderns RCA Victor LSP2208**

Should some organizations stamp approval on good records for teenagers, it might help parents make a suitable selection, yet drive young customers away in droves. While unburdened with awards, neither release is likely to be too irksome for payola-wise elders or too cultural for the junior set. Les Baxter surrounds jazz-drummer Milt Holland with a battery of Afro-Cuban, Brazilian, and Puerto Rican percussionists, then lets the whole rhythmic gang loose in stereo. Only once does an electric guitar get out of hand, but Plas Johnson's tenor sax keeps temperatures on the rise. Plenty of side effects from hand cymbals, tambourines, and timbales, in addition to booming conga drum.

Buddy Morrow translates the writings of Edgar Allan Poe into stirring big-band performances—designed to shock, amuse and educate. Bernie Green, Ray Martin, Charles Grean, Norman Leyden, and Bob Davie are among the composers of the spine-shaking interpretations. The Skip-Jacks, one of the brightest new vocal groups around, sing *The Bells*, and *The Raven*. Keith McKenna, a teacher of high-school English, recites *Annabel Lee*, and *Ulalume*, just as he does for his students in Bellport, Long Island. Chances are they will play his versions for their youngsters.

**The Windjammers RCA Victor LSP2196**  
**Oscar Brand: Boating Songs And All That Bilge Elektra EKS7183**

Either of these albums is awash with enough hearty humor to buoy up the spirits

of a roomful of boating enthusiasts on forced leave ashore. A vocal trio formed by Norwegian youths, The Windjammers hope to continue careers launched in the Louis de Rochemont film of their nine-month voyage on a three-masted square rigger. It must have taken Viking courage to invade a studio in Nashville, the stronghold of country music, but engineer Bill Porter repays the visit with good stereo treatment. Nor are they afraid to take friendly digs at Harry Belafonte and the rival Kingston Trio. They are Harald Tusberg, Kaare Terland and Sven Erik Libnaek, who appeared on the screen as pianist with the Boston Pops, and a broad Scandinavian accent salts each song. *Beatnik Bill*, in fact, was anticipated with an extra syllable to fit *Barnacle Bill*, but it turns out to be set to the tune of *Buffalo Gals*. Among sea faring songs included are *Sailor Man*, *Eddystone Light*, and the theme of the film.

Oscar Brand commissions a spanking new set of original tunes dedicated to the sail and power boat fraternity afloat on coastal and inland waterways. The log is complete with entries on boat shows, power squadrons, skin divers, the small boat mob, and the yacht club boys. Some of the lyrics are too risqué to pass customs, while others are nautical but nice. The only one not penned by Brand happens to be one of the best, a fervent plea to *Blow Me Home From Old Manhasset*, credited to Gene Raskin. Masquerading as crew is a seasoned group of accompanists called The Sea Wolves. They stride manfully about the deck, surrounding the singer in stereo engineered by Hoyt Hughes of Gotham Recording.

#### MONO

**Jim Chapin and Bob Wilber: Fun With Drumsticks Music Minus One MM0125**  
**Oranin Zabbar Troupe: Hora Elektra EKL186**

Either of these aids to self instruction should also come in handy to get rid of summer doldrums or as a refuge from campaign speeches. Acting as guiding spirits for novice

## A mediocre tube is like a mediocre singer!

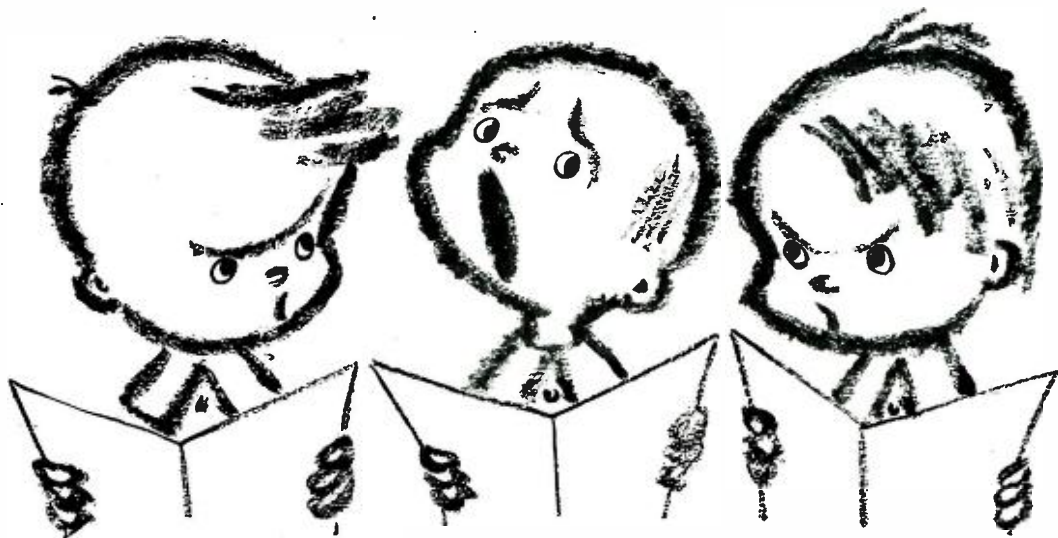

**DON'T SETTLE FOR MEDIOCRITY... USE GENERAL ELECTRIC HI-FI TUBES!**

GENERAL  ELECTRIC

411-202



drummers, Jim Chapin and Bob Wilber chart a course that ranges from big band riff choruses to more intricate solo improvisations. An enclosed sheet contains a few helpful hints from Sam Ulano, whose own drum albums are used as lesson material by many teachers. In his opinion, the layman can safely bypass most of the rudimental strokes and provide a smooth and steady beat for dancing by concentrating on one called the Rudiment of Rhythm. This is conveyed by use of the words "paint a brush," rather than notation. More complicated than the "mommy-daddy" stroke usually given beginners, it is still easier to enunciate than "pork chops and lyonnaise potatoes," the phrase which causes Gene Krupa's facial contortions. Anyone who has been routed out of bed to prepare a bottle and a howling infant in the middle of the night should be able to master it without too much trouble.

Advanced students will find plenty of space to demonstrate their wares during open spots in the ensembles on Ellington's *Cottontail*, and the Basie-styled *Like Help!* Erik exchanges with solo horns will sharpen techniques on *The Lady Is A Tramp* and Wilber's *Pink Ice*. Chapin remains at the drums throughout the session to lend a steady hand, keeping time with barely audible brushes on sock cymbal and softly pedaled strokes on bass drum. Pianist Hank Jones and bassist Wilbur Ware are allowed to operate with less restraint. Due to the large variety of drum passages, Wilber and his cohorts probably play a wider assortment of breaks than any group since Louis Armstrong's Hot Five. Jim Nottingham, Urbie Green, Phil Woods, or George Dorsey take turns with Wilber, who confines himself to tenor sax, at stepping into the breach, be it a two- or sixteen-bar gap.

As the kit includes a pair of drumsticks, aspiring drummers can begin practice on the nearest telephone book at once. For that matter the box itself makes a nice bouncy pad. When wiser students start checking for warped sticks, record dealers may take some comfort in the knowledge that theirs are not the only goods so afflicted. The company which prevails upon Saul Goodman to do a parade-beat album and resume manufacturing sticks to go with it will be doing drummers a real service. Off the market for several years, this product of the New York Philharmonic percussionist now is especially valued and the drummer fortunate enough to own a pair scores all offers.

The Oranm Zabar Trompe invites all those who are thrilled by Israeli folk dancers to emulate the performances by means of a combined sing-along, dance-along album. Fred Berk, who directs the dance division at the 92nd St. Y-M-Y-W-I-A in Manhattan, describes the four basic steps and gives detailed information on linking them together in dances which fit the dozen tunes. Some are rich in tradition and others are creations of the new Israel. All are stimulating and the zestful rhythms are a sure cure for that tired feeling. The booklet supplied also lists original lyrics and translations. A stereo version is available and Dov Seltzer's arrangements give it the benefit of an extra accordian, plus other instruments added to those of the Israeli troupe. But monophonic grooves are more likely to survive a trip to summer camp or school gym.

#### Singin' The Blues

RCA Camden CAL588

Pete Johnson: Pete's Blues

Savoy MG14018

Because of the short life of wartime shellac, many recordings on these LPs are harder to locate in good condition than collector's items of thirty-five years ago. In fact, Leonard Feather goes one better, extracting from RCA Camden archives several sides not previously released. By not attempting to compress the whole subject into one album, he assembles a rare treat for blues enthusiasts and a few surprises for jazz historians. His only requirements are a good blues and performers of such caliber as Fats Waller, Lizzie Miles, Wingy Manone, Jimmy Rushing, Jack Teagarden, Earl Hines, Johnny Moore, and Hot Lips Page. The price is low and the quality high.

The Pete Johnson reissues first appeared on

AMAZING  
DEMONSTRATION!

New H. H. Scott  
88 watt Stereo Amplifier drives  
20 KLH Speakers at once!

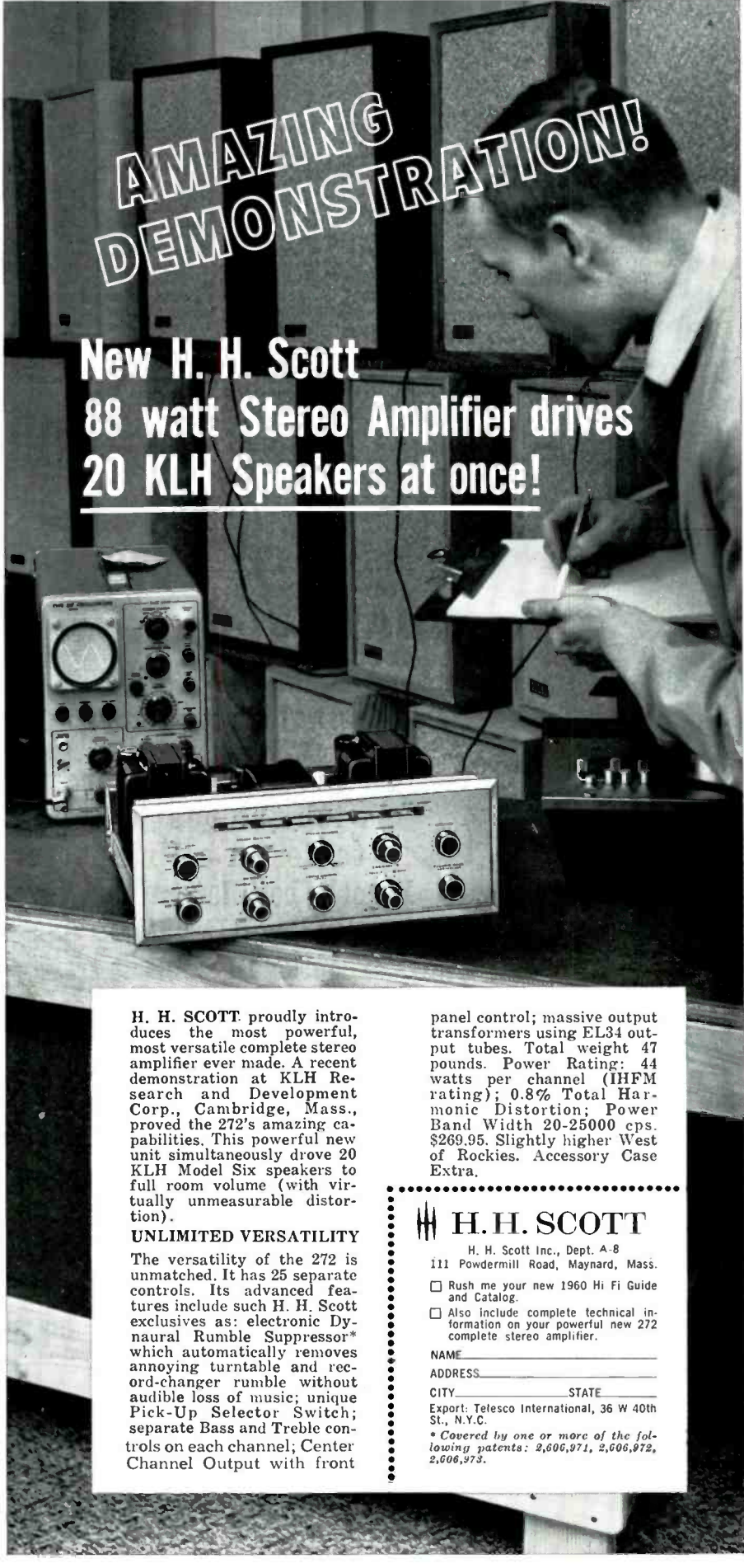

H. H. SCOTT proudly introduces the most powerful, most versatile complete stereo amplifier ever made. A recent demonstration at KLH Research and Development Corp., Cambridge, Mass., proved the 272's amazing capabilities. This powerful new unit simultaneously drove 20 KLH Model Six speakers to full room volume (with virtually unmeasurable distortion).

#### UNLIMITED VERSATILITY

The versatility of the 272 is unmatched. It has 25 separate controls. Its advanced features include such H. H. Scott exclusives as: electronic Dynaural Rumble Suppressor\* which automatically removes annoying rumble and record-changer rumble without audible loss of music; unique Pick-Up Selector Switch; separate Bass and Treble controls on each channel; Center Channel Output with front

panel control; massive output transformers using EL34 output tubes. Total weight 47 pounds. Power Rating: 44 watts per channel (IHF rating); 0.8% Total Harmonic Distortion; Power Band Width 20-25000 cps. \$269.95. Slightly higher West of Rockies. Accessory Case Extra.

**H. H. SCOTT**

H. H. Scott Inc., Dept. A-8  
111 Powdermill Road, Maynard, Mass.

Rush me your new 1960 Hi Fi Guide and Catalog.

Also include complete technical information on your powerful new 272 complete stereo amplifier.

NAME \_\_\_\_\_

ADDRESS \_\_\_\_\_

CITY \_\_\_\_\_ STATE \_\_\_\_\_

Export: Telesco International, 36 W 40th St., N.Y.C.

\* Covered by one or more of the following patents: 2,606,971, 2,606,972, 2,606,973.

the National label in 1946, and the Kansas City boogie-woogie stylist is abetted by such stalwarts as J. C. Higginbotham, Ben Webster, Al Nicholas, Clyde Bernhardt, and Budd Johnson. Page reappears here and is featured throughout in about the best example of his trumpet playing to reach L.P. As the pianist is now seriously ill at his home in Buffalo, New York, any royalties will doubtless be appreciated. The people who arrange benefit concerts and memorials appear uninterested.

**The Selah Singers: His Eye Is On The Sparrow**  
**Gospel MG3002**  
**Prof. Alex Bradford: Walking With The King**  
**Gospel MG3006**

Alan Lomax picked The Selah Singers to represent gospel groups at his Carnegie Hall concert and the performance was one of the highlights of the evening. One reason for its omission from the United Artists recording of the event might be that the lead soloist eluded the engineers. During the number which also serves as a title for the quartet's first L.P.,

Jimmy Mitchell suited his actions to the words, nearly taking flight in picturesque swoops about the stage. Thernion Rith first organized the group in 1930 at St. Mark Church in Brooklyn. Since then it has traveled extensively, but the eminence it enjoys at present is largely due to the addition of Mitchell about a year ago. A mighty-voiced youngster from Norfolk, Virginia, he shows great staying powers and should be around for quite a while. Adequate recording, and the program includes *Old Rugged Cross* and *Trouble In The Land*.

Professor Alex Bradford boasts the singular distinction of having appeared at both the Newport Jazz Festival and the Newport Folk Festival. The present collection is made up of recent outstanding single sides, all composed and arranged by the leader. A female group features Mattie Barber on *Big Wind Blowing* and a fantastic coloratura soprano, Carrie Williams, on the title song. Its masculine counterpart offers the tenor voice of Jonathan Jackson on *His Precious Love*. Either group whips up enough intensity and volume to ex-

ceed the groove capacity. According to the latest information, John Hammond combined the two, added voices to bring the total under Bradford's direction to one hundred, and will release the result on Columbia shortly. It should be quite something. Better take this opportunity to prepare for it.

**Memphis Slim and the Real Honky Tonk**  
**Folkways FG3535**  
**Al Smith: Hear My Blues**  
**Prestige Bluesville 1001**

Because of the revival of interest in authentic forms of the blues, record companies have issued more good examples in recent months than in the entire first ten years of L.P. In this instance, collectors have a choice between continuing their studies of a veteran of country blues or meeting a young urban singer who creates his own material. Much of Memphis Slim's work seems sophisticated when compared to older pianists, but the experts may want to decide whether *San Juan Blues*, a tune remembered from days in Memphis, supplies the missing link between Morton's "Spanish tinge" and the boogie-woogie train blues. His second ad-lib concert at Folkways finds him in a singin' mood and there are only two piano solos. His right hand rings out percussively on *The Bells*, and a figured bass charges through *Boogie After Midnight*. His versions of familiar blues are highly individual, especially *John Henry*, *How Long*, and *Sail On Little Girl*. And the origins of the new dance step, *Madison Time*, are disclosed on *Pine Top's Boogie*.

Al Smith gained experience with the Gospel Clefs and various church groups before switching to the blues field at the insistence of Eddie Davis, the driving tenorman who lends support on the singer's first L.P. In addition to a flexible tenor voice, Smith possesses the knack of writing original tunes in the new hybrid style that combines gospel and blues. The six heard show a deep blues feeling and are more worthy of attention than the work of the many gospel graduates who have climbed on the hit parade. Of course, that could be Smith's next stop, so collector's are advised to listen to him now. Shirley Scott plays the organ, along with bassist Wendell Marshall and drummer Arthur Edghill.

**Freddie Redd Quartet: The Connection**  
**Blue Note 4027**

If visitors to The Living Theatre's off-Broadway production of "The Connection" are disappointed in not finding a sensational exposé of narcotics addiction, apparently they are satisfied enough by the experience to pass the word along to friends. In spite of mixed reviews, the play has just embarked on the second year of its run and Freddie Redd's music, which forms an integral part of the action, is now available as performed by the musicians in the cast. The composer took on the difficult task of describing the varying states of mind which Jack Gelber has his characters assume as the play progresses. At the same time, the music must seem improvised by jazz as well as theatrical standards. The result also is likely to disappoint the listener who expects melodramatics. Nor will it please the cool, hip nightclub audience which resents being carried below the surface of emotion. Forced to avoid outward manifestations of joy, anger, or hope, Redd relies on the blues to express inner truths that the author can only hint at in words. There can be no doubt that his work benefits greatly from Redd's sympathetic approach.

The restrictions imposed are not so stringent as to preclude humor on *Wiggin'*, determination on *Music Forever*, and tenderness on *Theme For Sister Salvation*. Besides being an ideal choice for the alto-sax part, Jackie McLean still makes his solos seem freshly minted. Joining Redd at the piano in the rhythm section are bassist Michael Mattos and drummer Larry Ritchie. As the music requires all the personal involvement the listener can give, those unable to view a performance are urged to read the play, now readily accessible in a paperback edition.

**Says Larry Zide in**

**The American Record Guide**

**about the DUAL-1006 combination turntable/changer**

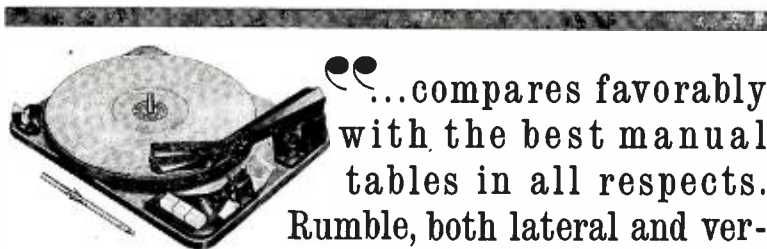

...compares favorably with the best manual tables in all respects.

Rumble, both lateral and vertical, was exceptionally low...It has, further, an arm that tracks exceptionally well at tracking forces equal to those of fine transcription arms. If you desire...automatic (changer) features...and also wish the finest turntable-arm performance, then the Dual is as close to this ideal as can be had.

Write for complete reprints of this and other reviews from such publications as Audio, Electronics World, Popular Electronics and Hi Fi Systems. Better yet, visit your authorized United Audio dealer and learn for yourself why the Dual-1006 is so widely acclaimed as being in a class by itself.

**OPERATING FEATURES OF THE DUAL-1006:** Fully automatic changer operation • Unrestricted single play, manual or automatic • Free-floating tonearm tracks and trips at as low as 1½ grams • Tracking force varies less than .5g from first to tenth record • Foolproof record indexing principle intermixes all size records • Elevator-action changer spindle functions without pusher arms or stabilizers • Built-in stylus force gauge • Four speeds: 16, 33, 45, 78 • Rumble-free precision motor • Automatic drive wheel disengagement • Multi-purpose stereo/mono switch • Price: \$79.95

**united Audio**

PRODUCTS OF DISTINCTION  
 12-14 West 18th St., New York 11, N. Y.



## TAPE GUIDE

(from page 34)

eps. Yet, as shown in *Fig. 11*, NAB equalization calls for bass boost to start at 3180 cps. How does one reconcile this seeming contradiction? The answer, in broad terms, lies in the fact that, within a certain range, various playback equalization curves prove feasible at a given tape speed. In other words, the point at which bass boost reaches 3 db, known as the turnover frequency, can vary within a fair range and still permit relatively flat response through suitable adjustment of record equalization.

When the bass turnover frequency is changed, this in turn changes the requirements for record treble boost in order to achieve more or less flat response. If the bass turnover frequency is lowered, less record treble boost is needed. When the bass turnover frequency is increased, more record treble boost is required. In sum, the amounts of playback bass boost and record treble boost vary in the same directions. The advantage of more record treble boost is that more signal is recorded on the tape, resulting in a better signal-to-noise ratio; the disadvantage is that the greater amount of record treble boost raises the danger of excessive distortion.

*Figures 13 and 14* serve to clarify how it is possible to employ various combinations of playback bass boost and record treble boost at a given tape speed. *Figure 13* illustrates the situation where relatively little record treble boost and playback bass boost are employed. Curve A-A is the original unequalized record-playback response. Curve A-B represents record-playback response after application of treble boost in recording. The distance between Curves A-A and A-B represents the amount of treble boost that has been supplied. Curve B-B, which is a straight line, represents flat response after application of bass boost in playback. The distance between Curves B-B and A-B represents the amount of bass boost that has been supplied.

Now consider *Fig. 14*, where all the curves have the same meaning as in *Fig. 13*. Now, however, note that greater treble boost has been supplied in recording (distance between Curves A-A and A-B), so that more signal has been put on the tape, resulting in greater output at the high end in playback. And note that, in turn, greater bass boost is required in playback (distance between Curves B-B and A-B) in order to achieve flat response.

### Change of Equalization with Speed

Possibly *Fig. 13* or *14* or some intermediate combination of recording and

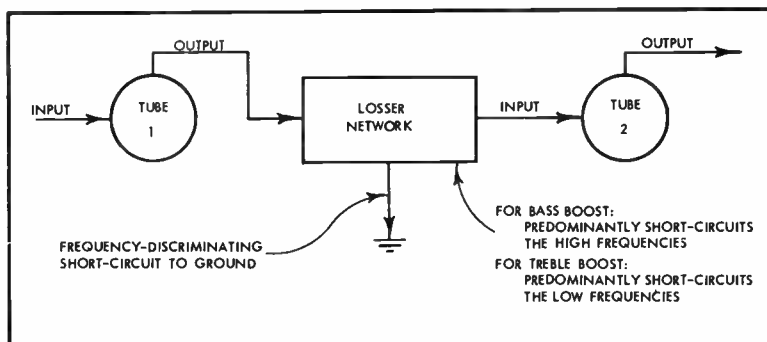

Fig. 15. How lossy equalization works.

playback equalization may be optimum with minimum distortion and maximum signal-to-noise ratio. At any given tape

HERE'S THE YEAR'S BIGGEST NEWS IN STEREO  
... and look at the price!

# Concertone 505

Stereo Recorder • Monaural Recorder  
• Sound on Sound Recorder  
• Plays Half Track and Full Track Monaural  
• 2 Track and 4 Track Stereo

from \$495

NOW... for the first time... a modestly priced professional stereo recorder that has exciting features found only in the finest instruments. You won't believe it until you see it!

**FEATHER TOUCH PUSH-BUTTON OPERATION • 4 HEADS, INCLUDING SEPARATE 2-TRACK AND 4-TRACK PLAYBACK HEADS • 3 MOTORS, INCLUDING HYSTERESIS DRIVE • MECHANICAL FLUTTER FILTER • DYNAMICALLY BALANCED CAPSTAN FLYWHEEL • INSTANT SOURCE/TAPE MONITORING • TWO RECORD/PLAYBACK PREAMPLIFIERS • INSTANT START/STOP • AUTOMATIC CUT-OFF SWITCH • 3¼-7½ IPS SPEEDS • AUTOMATIC TAPE LIFTERS • TAPE LOCATION INDICATOR • SEPARATE MICROPHONE/LINE INPUTS, EACH CHANNEL.**

See the phenomenal  
**CONCERTONE 505**  
at your dealer, or send  
the coupon for a  
descriptive brochure and  
the name of your  
nearest dealer.

A  
E

**AMERICAN CONCERTONE**  
DIVISION OF AMERICAN ELECTRONICS, INC.  
9449 West Jefferson Boulevard  
Culver City, California Dept. AUD-8

Gentlemen:  
Please send your illustrated brochure on the new CONCERTONE 505 STEREO RECORDER, and the name of nearest dealer.

Name \_\_\_\_\_  
Address \_\_\_\_\_  
City \_\_\_\_\_ Zone \_\_\_\_\_ State \_\_\_\_\_



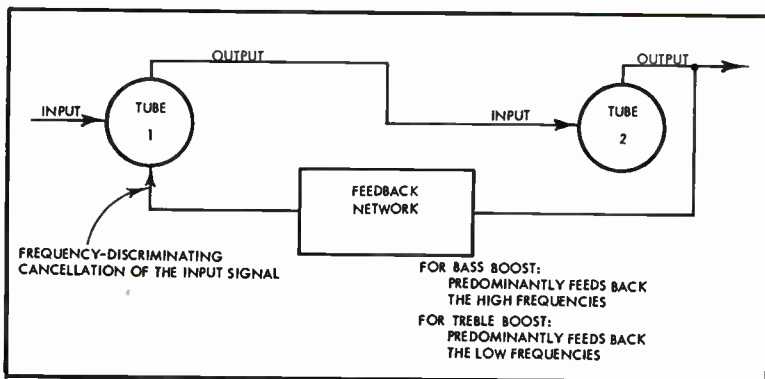

Fig. 16. How feedback equalization works.

**GRADO** "Truly the world's finest..."

**NEW**  
LABORATORY SERIES TONE ARM

<ul style="list-style-type: none"> <li>Gunstock walnut wood</li> <li>Smaller in size and mass</li> <li>Vertical balance adjustment</li> <li>Lateral balance adjustment</li> <li>Tracking force adjustment</li> </ul>	<ul style="list-style-type: none"> <li>Vertical azimuth adjustment</li> <li>Interchangeable cartridges</li> <li>Adjustable overhang alignment</li> <li>Completely wired to preamp</li> <li>Ultrafine shielded cable</li> </ul>
--	--

LABORATORY SERIES TONE ARM \$39.50  
 With Custom Cartridge \$49.50 — With Master Cartridge \$85.00  
 Custom Cartridge \$32.50 — Master Cartridge \$49.50 — Micro Tone Arm \$29.95

For further information write: **GRADO LABORATORIES, INC.**  
 4614 Seventh Ave., Brooklyn 20, N. Y. • Export — Simontrice, 25 Warren St., N. Y. C.

speed there is only one optimum combination. Since a given playback curve implies complementary recording equalization that will achieve flat response, it may be stated simply that at each tape speed there is only one playback equalization curve which represents optimum performance.

The foregoing statement should not be taken too strictly. Thus it has been found that NAB playback equalization, considered ideal for 15 ips, can also be used very satisfactorily at 7.5 ips. True, a moderate departure from the NAB curve at 7.5 ips may yield better results in terms of distortion and noise; however, the improvement would be a slight one.

Going down the speed scale, namely to 3.75 ips and lower speeds, we arrive at situations where NAB equalization in playback would entail a serious sacrifice in performance. Thus a quality tape machine will accompany a change in tape speed with a change in playback equalization when the speed change entails going below 7.5 ips. In some tape machines, however, for reasons of economy, the same playback equalization is used for both 7.5 ips and 3.75 ips. The equalization employed may then be NAB or it may be an intermediate curve part way between the NAB one and the optimum curve for the 3.75 ips speed.

From earlier discussion it is obvious that as speed is reduced, greater treble boost is needed in recording to overcome the increased high-frequency losses. In other words, a reduction in tape speed also calls for a change in recording equalization. However, this is not always done. In some of the less expensive machines, the manufacturer may aim for response extending to about 15,000 or 16,000 at 7.5 ips, which means that without any change in record equalization response will extend to about 7500 or 8000 cps at 3.75 ips. Response extending to about 8000 cps surpasses the performance of most AM radios and permits a fairly good quality of reproduction, pleasing to many persons. Thus the manufacturer may consider that response to 8000 cps still gives the individual a good run for his money. (It isn't so many years since high-quality tape recorders offered response to only about 8000 cps at 7.5 ips.)

In a number of tape machines, despite their ability to extend response to 12,000 cps or better at 3.75 ips, there may be little or no change in record treble boost compared to that employed at 7.5 ips. Instead, these machines reduce the amount of bias current when the tape machine is shifted to the lower speed. This reduces the high-frequency loss due

to bias erase. Some tape machines employ a combination of methods, namely a change in record treble boost plus a change in bias current. Generally, it is sought to avoid treble boost at 3.75 ips substantially greater than that at 7.5 ips, for there is too much danger of running into tape overload.

Decreasing bias current entails an increase in distortion. Hence in recording at 3.75 ips with a machine that employs the latter technique it is advisable to reduce the recording level by several db. Experience will tell the operator how much to reduce level.

In machines which do not reduce bias current but rely on an increase in record treble boost to achieve extended response at 3.75 ips, it is similarly advisable to reduce recording level to avoid possible overload at the very high end.

#### Equalization Circuits

Equalization circuits are of two basic kinds: loss and feedback. Loss equalization, illustrated in Fig. 15, involves the principle of short-circuiting all frequencies to ground, but with some frequencies short-circuited to a greater degree than others, so that in relative terms bass boost or treble boost is achieved. Thus if treble boost is desired, a loss is produced at all frequencies, but with the loss growing progressively less as frequency rises. Conversely, if bass boost is desired, the loss circuitry produces more of a short-circuit at high frequencies than at low ones.

In the case of feedback equalization, the principle employed, as shown in Fig. 16, is to take the signal from one stage of an amplifier and apply it to an earlier stage, thereby cancelling part of the original signal, so that over-all amplification is reduced. The signal fed back to the earlier stage goes through a network that favors either the low frequencies or the high frequencies. If bass boost is desired, the network admits the high frequencies more easily, thereby cancelling the highs to a greater extent and achieving bass boost in relative terms. If treble boost is needed, then the network admits the bass frequencies more easily.

There are pros and cons for both loss and feedback equalization circuits. Feedback circuits are claimed to achieve less distortion. Sometimes they may also serve important ancillary purposes, such as reducing high-frequency losses. On the other hand, it is claimed that loss circuits, with suitable design, can be about as distortion-free. Above that, they can generally provide more exact equalization, and this equalization tends to be more immune from the effects of tube aging. Æ

*Brilliant* <sup>says</sup> **MARILYN KING**  
of the famous King Sisters,  
Capitol recording stars

THE NEW  
**Roberts**  
"990" 4-TRACK STEREO  
TAPE RECORDER  
is YOUR BEST BUY!

*Only ROBERTS "990" combines these features:*

- "Instant" multiple adjustment head
- 4-track stereo record/play
- 4-track monaural record/play
- 2-track stereo playback
- Dual head outputs
- Dual pre-amp outputs
- Dual power amplifier outputs
- Dual monitor speakers
- Portable and easily custom installed

Send for Roberts' great new Stereo Tape Information Kit. 34 tape application methods described. Includes the sensational Roberts Pictograph. Enclose 25¢ for handling and postage.

#### ROBERTS ELECTRONICS, INC.

829 No. Highland Ave., Los Angeles 38, Calif. • Dept. D  
Please send me your Stereo Tape Information Kit.

NAME \_\_\_\_\_  
ADDRESS \_\_\_\_\_  
CITY \_\_\_\_\_  
STATE \_\_\_\_\_

Enclose 25¢ (stamps, cash) for handling, postage



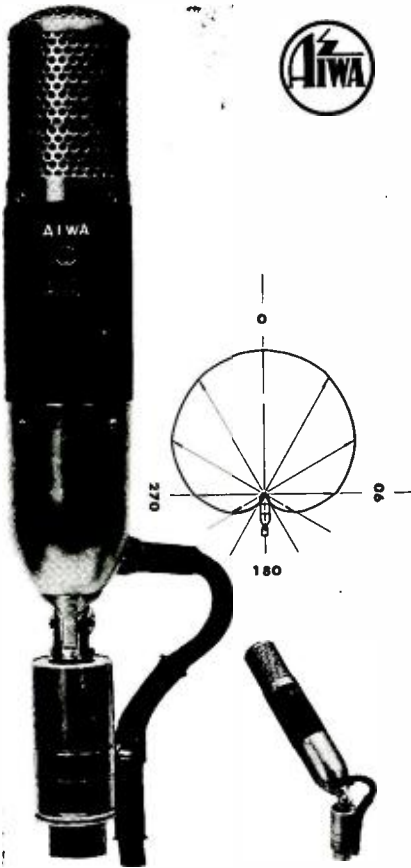

# AIWA

## UNI-DIRECTIONAL RIBBON MICROPHONE

### MODEL VM-18

#### Features:

- \* Small size and slim shape facilitate handling.
- \* Comparatively high sensitivity and fine response characteristics.
- \* Sturdy construction with short ribbon diaphragm.
- \* Humming minimized.
- \* Equipped with a low frequency attenuation circuit.

#### Specifications:

- \* Type: Ribbon Microphone
- \* Impedance: 600 ohm  $\pm$  20% (At 1000 c/s at 0 point of the switch)
- \* Sensitivity: 75 db (Odb = 1V/m bar 1000 c/s)
- \* Directionality: Uni-directional
- \* Noise Level: Below 30 db
- \* Dimensions: 9 5/8" (length) 1 1/2" (dia.) Weight 2.2 lbs. (9 feet-cord & plug included)

## AIWA CO., LTD.

601 West 26th Street  
New York 1, N.Y.



## LIGHT LISTENING

(from page 8)

sion albums that have been racking up enormous sales in the past few months. Such albums have replaced the trains and racing cars we had in the early days of the stereo disc. Oddly enough, the ping pong antics devised by Chuck Sagie for the far-flung percussion section of this informal orchestra are less distracting than some of the side-to-side effects in this month's choral or dance band releases. The tunes are old reliables—*Sheik of Araby*, *Who's Sorry Now*, *Muskrat Ramble*. The sound is easily the greatest excuse for buying the record. It is very clean in areas of the spectrum that most stereo discs do not attempt to enter.

### Les Elgart: The Band With That Sound Columbia CS 8245

The dance orchestra directed a few years ago by Les and Larry Elgart was universally respected for the vigor of its individuality and the precision of its ensemble. Then the Elgarts decided there was talent enough with the group to form two orchestras. Larry went over to the RCA Label with a band of his own while Les remained at Columbia. Several excellent stereo discs have been issued by Larry's orchestra but this is the first stereo recording I've heard featuring the Les Elgart organization. Of the two bands, I must confess that Larry currently offers the more arresting arrangements for living room listening. It would seem that he had charge of the individualism in the old band. The relaxed heartiness of the Les Elgart beat is still ideal for dancing but the miking and the arrangements heard on this record are far too channel-conscious for my comfort. You can get away with anything these days if you're turning out a novelty record for the stereo novice, but the tossing around the melody gets here makes no more sense than it would in the ballroom. Unless your neck needs the exercise, get the mono version.

### Guy Lombardo at Harrah's Club Capitol ST 1393

Sampled on a large and brawny stereo system, this release may stump a few listeners who haven't paid much attention to Guy Lombardo's stereo recordings. The average supper club, when used for recording purposes, usually contains its liveliest sound at the customer's tables. On the stage of Harrah's Club at Lake Tahoe, Nevada, the Lombardo crew has chanced upon an acoustical environment that's one of the surprises among the month's releases. A swing band might present a problem if the same mikes were to be used in a room of this liveness. In Lombardo's case, this is the first recording in stereo that does justice to the bass foundation of the band's lower reed and brass instruments. The lineup of tunes offers a wide sample of the music Guy is playing these days. The next time I put on the disc, (when introducing Aunt Hannah to the delights of stereo) I'll skip the band with the two pianos in *Humoresque* and the group of songs contributed by the club audience. On the plus side, there are the newest additions to the Lombardo library—*Love, Look Away* from "Flower Drum Song" and Carmen Lombardo's latest tune *Return To Me*.

### Companeros de Mexico: The Sound of A Chorus Medallion MS 7503 (Ⓢ 47003)

The Medallion label is a new product of Kapp Records. It is aimed, with elaborate pledges of good behavior in engineering practice, at the listener equipped to properly appreciate such behavior. Their first release shows promise as well as problems that should evaporate in future albums. This recording was made below the border in the studios of RCA Mexicana. A native male chorus and the noted Colombian baritone Carlos Ramirez, who

won his greatest fame in Hollywood musicals, are the featured attractions. Since Senores Cardenas and Gonzalez are listed as the recording engineers in the production staff credits, we can assume that the singers had every reason to feel at ease during the sessions. The stereo miking pattern is quite similar to our own on the evidence of this recording. Musically, more than one Latin American country is represented but Mexican songs well known in the United States are the backbone of the album.

Devotees of folk music are bound to consider the style a bit too slick but local color will carry the day for the general listener. In my review copy, there was sign of overloading during loud passages—a blemish not found in the other Medallion discs.

### Pat Suzuki: Looking At You RCA Victor LSP-2186

The star of the recent Rogers and Hammerstein Broadway musical "Flower Drum Song" returns to the style of the opening phase of her career with this collection of ballads. Four years ago, as an unknown singer in a Seattle night club, she was heard by Bing Crosby in the type of song she offers on this record. When he recommended her to Victor's recording executives, it was on the basis of her ballad style. It was then decided that most of her subsequent career be devoted to brassy tunes with an application of just enough Oriental burnish to set them apart from the work of other vocalists. Now, with the help of Ralph Burns' unassuming arrangements, the other half of Pat Suzuki's personality has a chance to live it up quietly with songs such as *My Funny Valentine* and *I See Your Face Before Me*.

### Del Wood: Flivvers, Flappers and Fox Trots RCA Victor LSP 2203

The major recording centers—New York and the West Coast—apparently do not dominate all facets of the art. If one feels compelled to produce an unthrottled revival of the Twenties, the Nashville studios of RCA Victor is a good place to start. Enshrined there, under the custody of Del Wood, is a tear-stained ragtime piano that can coax out the real flavor of *Bye Bye Blackbird*, *Varsity Trot*, and *Tiger Rag*. The small orchestra, selected for determination as well as skill, is loaded with snappy noise makers. If you're a glutton for memories, the occasional intrusions by the chorus will seem far too few. These include such gems as *Will you love me when my carburetor's busted?* Recommended for light-headed listening.

### The New Moon, White Horse Inn, and The Girl Friend Epic BN 566

With very little fanfare, Epic's light music division has been turning out a polished series of albums devoted to excerpts from the great musical comedies and operettas of the past. The repertory company heard in the three records issued so far includes the Michael Sammes Singers and Johnny Gregory's orchestra. The leading roles are sung by Doreen Hume and Bruce Trent. Were these enthusiastic young performers considerably less talented than they are, these new productions would still be welcome because the catalog has no other recent sampling of Jerome Kern's "The Cat and The Fiddle" or Vincent Youman's "No, No, Nanette" or "Hit the Deck." The score from "Hit the Deck" is in the limelight on the East Coast this summer during the open-air revival of the show at Jones Beach. The first two releases in this series were issued in mono only. Stereo, in this third one, emphasizes the quaintness of show music of the Twenties.



## BUYER'S GUIDE

(from page 58)

### DYNACO

● *Stereodyne II Cartridge.* Utilizing the variable reluctance principle, this cartridge made by Bang and Olufsen of Denmark is designed for superior reproduction from either mono or stereo microgroove records. It has a frequency response from 30 to 15,000 cps  $\pm 2$  db, compliance of  $5 \times 10^{-6}$  cm/dyne, and an output of 7 mv per channel for a stylus velocity of 5 cm/sec. Channel separation is better than 22 db, and tracking force is from 2 to 4 grams. Recommended load is 47,000 ohms for rated frequency response. The unit employs an unusual construction, with the entire moving

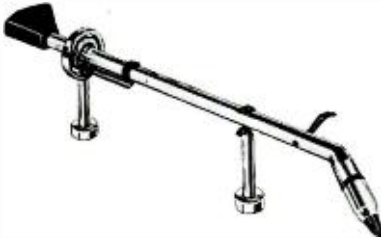

element being enclosed in a plastic cone permanently attached to a metal shell surrounding the body of the cartridge. It is mounted at an angle, as shown. The mechanism consists of a light mumetal cross which is attached to a slender aluminum tube with the stylus affixed to the end. Four terminals. User net price, \$29.50.  
 ● *TA-12 Utilized Arm-Cartridge.* A similar pickup to the Stereodyne II is united with a novel arm for use with turntables to work with minimum stylus force, which is adjustable. Unit mounts in a single hole. Distributed in the U. S. by Dynaco Inc., 617 N. 41st St., Philadelphia 4, Pa. User net price, \$49.95.

### ELECTRO-VOICE

● *Magneramic 31MD-5 Stereo/Mono Cartridge.* Employing ceramic elements in connection with a special printed circuit which is an integral part of the cartridge, the Magneramic 31MD-5 is designed to be fed into the usual magnetic pickup inputs of stereo preamps. Frequency response is given as 20

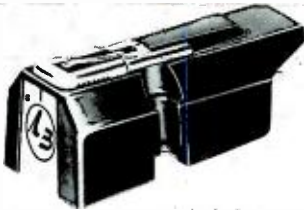

to 20,000 cps  $\pm 2$  db, with a channel separation of 28 db at 1000 cps and an output of 10 mv. Compliance is  $3.5 \times 10^{-6}$  cm/dyne and the cartridge is available with either 0.5- or 0.7-mil stylus, the former being recommended for use with transcription arms with a stylus force of 2-4 grams. The cartridge is also available for ceramic inputs. Electro Voice, Inc., Cecil and Carroll Sts., Buchanan, Michigan. User net prices: Magneramic 31MD-5, \$24.00; same, for ceramic inputs, \$22.50.

### FAIRCHILD

● *Compatible Rotating-Magnet Cartridge.* Model SM-1 is a moving-magnet pickup of unusual design. The stylus bar extends from a precision-ground rubber "ball" in which the



*the cybernetically engineered professional stereo tape recorder by*

# NEWCOMB

You now have your choice of either quarter-track (Model SM-310-4) or half-track (Model SM-310) versions of the exciting new stereophonic tape recorder by Newcomb. Specifications for the two are identical. They are deeply satisfying to work with because they are cybernetically engineered. That is, controls are so arranged that the natural thing to do is the right thing to do. Tape movement is controlled by a central joystick... the easiest machines to operate you've ever tried... easiest on tape, too. Broken, spilled, stretched tape are things of the past when you work with a Newcomb recorder. And few, if any, machines include such a wealth of features. Newcomb recorders take any reel size - 3" to 10 1/2". They have twin, illuminated recording level meters arranged pointer-to-pointer for instant comparison, four digit counters, mixing controls for "mike" and "line" for both channels, balance control, ganged volume control, two speeds - 7 1/2 or 3 3/4 inches-per-second with automatic compensation for 3 3/4. The Newcomb tape machine is designed to be an inseparable, dependable, indispensable companion for the serious recordist. Write for the complete story contained in Bulletin SM-3.

NEWCOMB AUDIO PRODUCTS CO., Dept. T-8, 6824 Lexington Ave., Hollywood, Calif.

### NEW PORTABLE STEREO TAPE MUSIC SYSTEMS

**PORTABLE STEREO SPEAKER SYSTEMS** - Four choices are offered, varying in size and efficiency. The latest techniques are used to reproduce big bass in a compact space and to achieve unprecedented sound coverage. Speakers have kickproof metal grilles, carrying handles, and are covered in scratchproof, washable, warm gray fabricoid to match the SA-80 and SM-310.

Model SA-80 portable 2-channel amplifier is a powerful and worthy companion to the Newcomb Recorders... 40 watts peak per channel... ganged controls - bass, treble, volume, balance... reels store in cover.

magnet is mounted, (the ball constituting the suspension and damping), generating the signal in two sets of coils. Frequency response is from 20 to 15,000 cps  $\pm 2$  db, and output is 11.5 mv for a stylus velocity of 5 cm/sec. The unit has a d.c. resistance of 2000 ohms and an inductance of 0.5 lly, and is designed to operate into a load of 47,000 ohms, with any value from 35,000 to 100,000 being acceptable. Recommended tracking force is 3-4 grams. Channel separation is better than 25 db at 1000 cps, and compliance is  $4 \times 10^{-6}$ . Because of internal copper case for electrostatic shielding and a munmetal outer case, the hum is extremely low, being 65 db below the signal when mounted on the turntable. Fairchild Recording Equipment Corp., 10-40 45th Ave., Long Island City 1, N. Y. User net price, \$34.95.

## GENERAL ELECTRIC

• **Variable Reluctance Stereo Cartridge.** With a series of small changes in the design, the new VR-22 stereo cartridge is even better than its predecessor with respect to output, channel separation, and extended frequency response, and the two channels balance within

$\pm 2$  db to 15,000 cps. The shielding has been improved, and the grounding of the shield and the method of shorting the two "ground" terminals are well thought out. Available in two models, VR225 with 0.5-mil stylus and VR227 with 0.7-mil stylus, with the former tracking at 2-4 grams in transcription arms



# 2 for the money

circuit by  
**Pilot**

tubes by  
**Amperex**

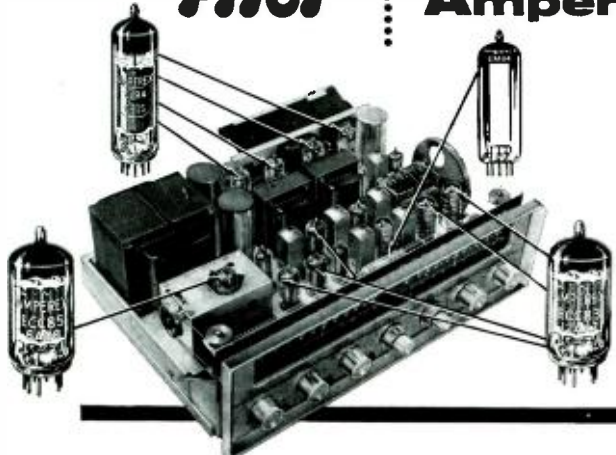

For the discriminating audio enthusiast who has been searching for high quality at a moderate cost, the new **PILOT "602" Stereo FM/AM Tuner-Preamp-Amplifier** is a most logical choice. Here is extreme FM sensitivity—assured by the Amperex 6AQ8/ECC85 dual-triode. To reduce hum and noise to complete inaudibility (and to prevent microphonics)—5-12AX7/ECC83's. For precise and effortless tuning—the 6FG6/EM84. For distortion-free power—4-6BQ5/EL84's. For absolute dependability—Amperex *throughout!*

These and many other Amperex 'preferred' tube types have proven their reliability and unique design advantages in the world's finest audio components.

Applications engineering assistance and detailed data are always available to equipment manufacturers. Write: Amperex Electronic Corp., Special Purpose Tube Division, 230 Duffy Ave., Hicksville, Long Island, New York.



about hi-fi tubes  
for hi-fi circuitry

### AMPEREX TUBES FOR QUALITY HIGH-FIDELITY AUDIO APPLICATIONS

#### POWER AMPLIFIERS

6CA7/EL34: 60 w. distributed load  
7189: 20 w., push-pull  
6BQ5/EL84: 17 w., push-pull  
6CW5/EL84: 25 w., high current, low voltage  
6BM8/ECL82: Triode-pentode, 8 w., push-pull

#### VOLTAGE AMPLIFIERS

6267/EF86: Pentode for pre-amps  
12AT7/ECC81: Twin triodes, low  
12AU7/ECC82: hum, noise and  
12AX7/ECC83: microphonics  
6BL8/ECF80: High gain, triode-pentode, low hum, noise and microphonics

#### RF AMPLIFIERS

6ES8: Frame grid twin triode  
6ER5: Frame grid shielded triode  
6EN7/EF183: Frame grid pentode for IF, remote cut-off  
6EJ7/EF184: Frame grid pentode for IF, sharp cut-off  
6AQ8/ECC85: Dual triode for FM tuners  
6DC8/EBF89: Duo-diode pentode

#### RECTIFIERS

6V4/EZ80: Indirectly heated, 90 mA  
6CA4/EZ81: Indirectly heated, 150 mA  
SAR4/GZ34: Indirectly heated, 250 mA

#### INDICATORS

6FG6/EM84: Bar pattern  
1M3/DM70: Subminiature "excitation" pattern

#### SEMICONDUCTORS

2N1517: RF transistor, 70 mc  
2N1516: RF transistor, 70 mc  
2N1515: RF transistor, 70 mc  
1N542: Matched pair discriminator diodes  
1N87A: AM detector diode, subminiature

and the latter at 5-7 grams. Frequency response, 20-20,000 cps  $\pm 3$  db for the VR225, and 20-17,000 cps  $\pm 3$  db for the VR227. Channel separation is up to 30 db at 1000 cps, and output is 9 mv for a stylus velocity of 5 cm/sec. Inductance of the unit is 420 mH, nominal, and resistance is 1600 ohms per channel. Recommended load resistance is 47,000 ohms. Lateral compliances are  $4 \times 10^{-6}$  and  $3 \times 10^{-6}$  cm/dyne and vertical compliances are  $2.5 \times 10^{-6}$  and  $2 \times 10^{-6}$  for the 225 and 227 respectively. Audio Components Section, General Electric Company, Auburn, N. Y. User net prices: VR225, \$27.95; VR227, \$24.95.

## GOTHAM

• **Double Dynamic Stereo Cartridge.** Said to be the first stereo cartridge, the Neumann Model DST features a low impedance (18 ohms) and is designed to work into a load of at least 50 ohms. Channel separation is over 30 db in the midrange and is greater



than 12 db at 10,000 cps. Output is 1.05 mv for 7-cm/sec velocity, and the unit is intended to track at 6 grams stylus force. Frequency range is from 30 to 15,000 cps,  $\pm 2$  db. The DST cannot be mounted in most arms, but will fit directly into SME arms. Gotham Audio Corporation, 2 West 40th St., New York 36, N. Y. User net price, \$69.00.

## GRADO

• **Moving-Coil Stereo Cartridges.** Made in two models, the Custom for use in record changers and the Master for turntable use, these cartridges are similar in design. Both employ a moving element consisting of a hollow plastic cube on which are wound two coils and from which extends the stylus bar. This cube is supported in a rubber "grommet" which serves to hold the coils in the magnetic field as well as provide the necessary damping. The specifications given are for the Custom



and Master series respectively. Frequency response, 10-24,000 cps and 10-30,000 cps. Interchannel output balance, 0.5 db on each; frequency balance, 0.5 db each. Output, 3.5 mv and 2.5 mv respectively at a stylus velocity of 5 cm/sec. Impedance, 1000 and 700 ohms; Tracking force, 3 grams each. Input load, any value over 5000 ohms for both models. Channel separation, in excess of 20 db and 25 db. In addition, the Master series is fitted with a radioactive element to reduce static accumulation on the record surface. Grado Laboratories, Inc., 4614 Seventh Ave., Brooklyn 20, N. Y. User net prices: Custom, \$32.50; Master, \$49.50.

## PICKERING

• **Precision Pickup Cartridge.** Designed for the discriminating record collector, the Model 380 is a moving-magnet cartridge of excep-



AUDIO • AUGUST, 1960



tionally smooth response. It is fitted with a removable stylus assembly which comprises the only moving element and which can be replaced instantly without tools. Two types are available, one for use with transcription-type arms and the other for use in record changers. Compliance is high, and the cartridge is practically insensitive to minor record warp. Output is approximately 12 mv per channel for 5 cm/sec. Pickering & Company, Inc., Plainview, N. Y. User net price, from \$29.85, depending upon stylus.

Model 381, calibration standard ..... \$48.00  
Mk II, Pro-Standard Series ..... 24.00

### PRIMO

• *Stereo Variable Reluctance Cartridge.* The Primo variable reluctance cartridge model C-56 is a high-compliance pickup with a stylus tracking force of 3 to 4 grams. Frequency



range is 20 to 17,000 cps and channel separation is 24 db at 1000 cps. Compliance is  $1.4 \times 10^{-9}$  cm/dyne both vertically and laterally. Supplied with a 0.7 mil diamond stylus. Power output is 9 millivolts at a stylus velocity of 5 cm/sec. Primo Co., Ltd., 2043 Miura, Mitaka-shi, Tokyo, Japan.

### H. H. SCOTT

• *Cartridge for Vintage 78 Records.* Developed jointly by London Records and H. H. Scott, Inc., the new 78-rpm cartridge has a 3-mil stylus and is interchangeable on the London-Scott arm with the Model 1000 stereo cartridge. An ideal pickup for the owner of a



collection of 78's, the new cartridge provides excellent sound from the older records. Stylus pressure is automatically adjusted when the 78 head is slipped on the London-Scott arm. Frequency range is 20 to 20,000 cps. H. H. Scott, Inc., 111 Powdermill Rd., Maynard, Mass. User net price, \$59.95.

Model 1000, ster cartridge ..... \$89.95

### SHURE

• *Professional, Custom and Standard Dynetics.* The Shure Standard Dynetic model M81



(Continued on page 38)

## SENSITIVE

H. H. Scott's famous Wide-Band Circuitry makes this the most sensitive tuner available for under \$180! Usable sensitivity 2.5 uv (IHFM standards). H. H. Scott's unique wide-band transformers separate stations so close together you were never able to listen to them before.

## DRIFT FREE

You never have to retune the station, whether it's strong or weak. Exclusive H. H. Scott Wide-Band design keeps the station in tune without the need for distortion-producing A.F.C.

## FAMOUS H. H. SCOTT QUALITY

The same silver-plated Wide-Band front end... the same copper bonded to aluminum chassis... the same Wide-Band detector found in all H. H. Scott tuners.

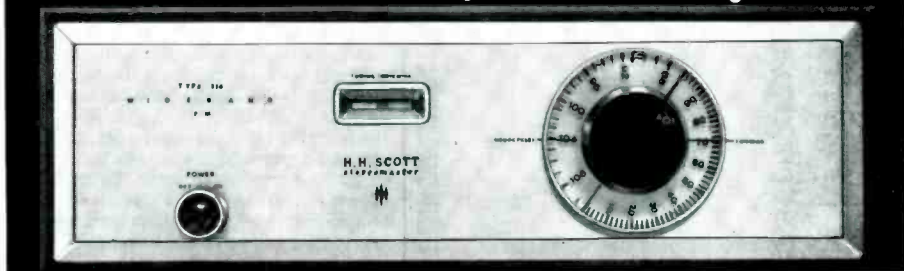

# new TUNER

## H.H. SCOTT • WIDE BAND • \$114.95\*

Here at last is an H. H. Scott Wide-Band FM tuner at a modest price. The new 314 ranks with the very finest FM tuners available. H. H. Scott's exclusive Wide-Band design delivers more distortion-free sensitivity; long range reliability; better station separation, even when measured by stringent IHFM standards. The fine performance of this unit is made possible by the use of special Wide-Band circuit components manufactured exclusively for H. H. Scott. The new 314 measures a compact  $15\frac{1}{2}$  wide x  $5\frac{1}{4}$  high x  $13\frac{1}{4}$  deep. Listen to this fine tuner at authorized H. H. Scott dealers everywhere. You'll be amazed at the fine performance it offers at this exceptional price.

\*West of Rockies \$116.95

Get The Most Out of Your Records  
With The London/Scott Matched  
Stereo Arm and Cartridge!



"Best pickup, barring none, regardless of price."—*Hi Fi Systems*

"The London-Scott is still without a serious rival."—*Saturday Review*

"The ne plus ultra of stereo cartridges."—*The Gramophone*



## H. H. SCOTT

H. H. SCOTT, INC., 111 Powdermill Road, Dept. A-B  
Maynard, Mass.

- Please rush me complete technical specifications on your new 314 Wide-Band FM tuner.
- Also include your new catalog and award winning booklet "How To Use High Fidelity Components in Your Decorating Plans".

Name.....

Address.....

City..... State.....

Export: Telesco International, 36 W. 40th St., N.Y.C.



RECORDS SOUND BEST  
with

**DYNACO** **D & B**  
**STEREODYNES**

Choose either the Stereodyne II (mounts in all standard arms) or the slim, trim TA-12 arm-cartridge combination for the most natural sound from both stereo and mono recordings.

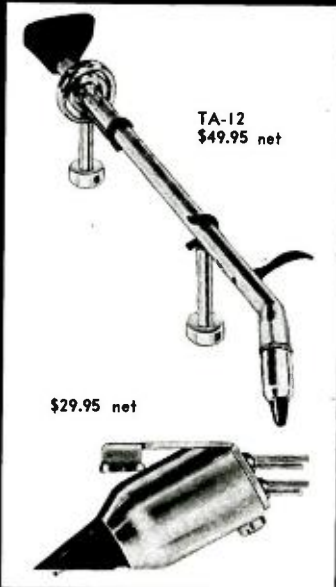

TA-12  
\$49.95 net

\$29.95 net

DESIGNED TO THE HIGHEST  
DYNACO STANDARDS

- ★ unequalled performance
- ★ outstanding engineering
- ★ unsurpassed value

Rigorous laboratory testing of every unit assures that your cartridge will exceed every specification.

- Smoothest response:  $\pm 2$  db from 30 cps to 15 KC. With standard Westrex 1A test disc.
- True stereo: More than 22 db channel separation effectively maintained throughout the audio spectrum, with accurate balance and proper phase relationship.
- Superior tracking: highest compliance, low mass, plus exclusive symmetrical push-pull design for minimum record wear and lowest distortion.
- Complete freedom from hum.

Hear and compare it at your favorite dealer's showroom.

Write for complete specifications

**DYNACO, INC.**

3912 Powelton Ave. • Phila. 4, Pa.  
CABLE ADDRESS: DYNACO, PHILA.

# ABOUT MUSIC

HAROLD LAWRENCE\*

## His Maestro's Voice

**T**HE REHEARSAL was proceeding smoothly. The orchestra was one of England's leading musical organizations. Suddenly a passage containing descending chromatic runs for the violins slowed the session to a standstill. During several repetitions, the conductor sang, gesticulated, pleaded, but the expected results failed to materialize. Finally, the concertmaster, in the best tradition of English "leaders," came to the rescue: turning slightly in his chair, he directed the following words to the stands behind him—"If you can't play it, don't." The advice, proposed with such refreshing candor, was effective. At the next attempt, the violinist with the sticky fingers mimed his part when he reached the danger zone and the troublesome bars emerged clear as a Heifetz scale.

The preceding incident illustrates an especially happy relationship between conductor and players in which each recognizes the fact that there are times when, to paraphrase Ruggiero Ricci's remark to a violin class, "the hand runs cold." Co-operation of such a frank nature is possible, of course, only when there is mutual respect between the orchestra and its musical director. The ingredients which make up such a relationship are the subject of numerous books on the art and technique of conducting. But much can be learned, too, from regular attendance at orchestral rehearsals.

The conductor's entrance into the hall at rehearsal time is always a revealing moment. If one were to calibrate the level of talk, random music and general hubbub of an orchestra settling down to work, one would surely discover that there is a correlation between discipline and noise. It is safe to predict that the conductor whose initial presence in the hall fails to bring about a sharp decline in chatter and clatter will have difficulty in shaping an effective performance. The rehearsal which begins on a note of quiet attention, on the other hand, is almost bound to be a healthy and fruitful one. There are many ways of evoking an alert response on the part of the players. Charles Munch tells of the conductor of an amateur orchestra in Strasbourg who hung a big bell from his stand and rang it furiously at the beginning of each rehearsal to let his presence be known. There are other methods. First and foremost, the conductor must inspire trust, not necessarily in what he is about interpretively, but in his ability to translate into succinct orchestral terms his concept of a given work.

For this purpose, a good voice is essential. It can be loud or soft, rough or gentle, demanding or coaxing; but, above all, it must be audible. There is a close analogy

between conductor and singer here. One of the latter's principal concerns is to project his voice so that it carries to all parts of the hall, and yet retains a wide range of nuances and dynamics. The conductor, too, has a large area to encompass. Not surprisingly, the efficiency of his work is in direct proportion to the number of players reached by his voice. The conductor who has difficulty making himself heard beyond the inner ring of first desk musicians is in trouble, for the more remote player who is not addressed directly is not likely to raise his hand and ask the maestro to repeat his remarks or to speak louder. Instead, he will probably shrug his shoulders, converse with his colleague, or read the magazine or newspaper which he has propped up on his stand. When necessary, the concertmaster may repeat certain key instructions in a loud voice so as to avoid any ensemble catastrophes.

It is interesting, too, that an orchestra hears what it wants to hear. A soft spoken conductor of few words—Leopold Stokowski, for example, seldom has to compete with talk or other extra-musical sounds. His rehearsals are conducted with the utmost economy: a few words directed toward an instrument or section to indicate color, phrasing, intensity, bowing, and the stamp of his personality is plainly felt. It is remarkable to note how the orchestra adjusts its noise level so that it can hear his softest comments. Antal Dorati is also audible at all times during rehearsals, although his voice is a cornet to Stokowski's viola. Of Dorati's voice, a member of the London Symphony Orchestra remarked, "You can't get away from it." And what a voice it is! Dorati's speech is rapid, articulate, and amazingly varied in expression. Neither conductor wastes words; every comment is meant to produce results.

This is not to say that conductors who turn out great performances are always economical in their work methods. Shortly after World War I, William Mengelberg was rehearsing his famed Concertgebouw Orchestra in Beethoven's *Coriolan* Overture. After conducting the first two notes of the work, he rapped his baton and delivered a lengthy talk on the music of Beethoven. Once again, he began the work, stopped once more after the second note to add some further verbal notes on Beethoven. Following another repetition of the first two notes, Mengelberg then summoned the concertmaster to his side, and the two men pondered the significance of the opening bars. At least thirty minutes passed before the orchestra reached the third note of the overture. The performance at the concert was no doubt an excellent one, despite the

\* 26 W. 9th St., New York 11, N. Y.

fact that so much time was spent in "explanation" and so little in actual playing at the rehearsal. But this was certainly because Meigelberg was the orchestra's permanent conductor. Nowadays, with the pattern of fewer rehearsals and more guest appearances, most conductors cannot afford the luxury of discussing the philosophy of a composer or of a musical work. They must get down to business, or else run the risk of producing a less than meticulous performance.

Too little talk can also result in inefficient rehearsals. In his book, *About Conducting*, Sir Henry J. Wood wrote: "A point that drives the professional player quite mad is the conductor who is continually stopping to go back to so-and-so cues without explaining his reason; [it's] 'for my sake, gentlemen.'" **Æ**

## MICROPHONE CALIBRATION

(from page 19)

where:  $f$  = frequency in cycles per second

$K$  = a constant

The constant  $K$ , whose value is given in the derivation of the formula in the appendix, is not important if only a frequency-response curve is desired. Only if the absolute sensitivity of the microphone is required does  $K$  become necessary.

After the sensitivity has been found for all frequencies of interest, select one value considered an average and plot all the other points in db, using the selected point as 0 db.

### APPENDIX

Derivation of formula used in the text. Referring to Fig. 1:

$$e_g = S_R p_o \quad (1)$$

$$e_m = S_m p_o \quad (2)$$

where  $S_R$  = sensitivity of  $L_R$  in abvolts per dyne per square centimeter.

$S_m$  = sensitivity of  $M$   
 $p_o$  = pressure

However, since  $e_g$  is produced by a conductor cutting a magnetic field,

$$e_g = Blv \quad (3)$$

where  $B$  = flux density of speaker gap, in gauss

$l$  = length of the wire in the voice coil, in centimeters

$v$  = velocity of the coil, in centimeters per second.

From the "Ohms Law" of mechanical circuits,

$$v = \frac{p_o A}{Z_m} \quad (4)$$

• Maximum range reproducer — 30 cps to well beyond audibility

• Only 18" x 24" x 4½" thin

a dream from every angle ...

### THE "440" BI-PHONIC COUPLER

The first complete full range reproducer, so radically different that it is classed as a musical instrument. Like a precious violin, the Bi-Phonic Coupler is hand-crafted of selected woods — with the panel structure radiating bi-directionally (unlike the usual restricted "boxed-in" speakers) — reproducing the full realm of sound with acoustic depth, fundamental tonal purity and realism. The wafer-thin Bi-Phonic Coupler beautifully blends into any decor arrangement.

**ADVANCED ACOUSTICS CORPORATION**  
67 East Centre Street, Nutley 10, N. J.  
A subsidiary of Electronic Research Associates, Inc.

In mahogany, oiled or lacquer walnut ..... \$134.40  
Ebony base (optional) ..... \$7.50

Circle 79A

## why the MOVICORDER?

The MOVICORDER is a precision instrument with electronic, mechanical and construction features usually found only in costly broadcast studio equipment. The MOVICORDER contains separate record and playback amplifiers, a hysteresis synchronous drive motor, two custom reel motors, five heads (including one for the new four track tapes), 2 VU meters, records sound on sound plus many more features. It is truly a complete, professional quality stereo recorder with specifications and reliability second to none. For the complete facts on one of Denmark's finest exports see the MOVICORDER at an authorized Movic dealer or write direct: Dept A

**MOVIC COMPANY, INC.**  
12432 SANTA MONICA BLVD., LOS ANGELES 25, CALIF.

Circle 793



# YOU'RE "IN THE CONCERT HALL" WITH KOSS STEREOPHONES

## Add dramatic new realism to your recorded music

With dramatic Koss Stereophones, you'll thrill to new worlds of stereo sound reproduction. Your records or tapes sound just as if you had an orchestra seat in Carnegie Hall. Through these comfortable Stereophones, you hear music as perfectly as it can be recorded. Add personalized listening and sound perfection to your high fidelity stereo installation. \$24.95.



Circle 80A

where  $A$  = diaphragm area in square centimeters  
 $Z_m$  = mechanical impedance of the vibrating system, in mechanical ohms.

Combining Eqs. (1), (3), and (4):

$$S_R = \frac{e_s}{p_o} = \frac{BIA}{Z_m} \quad (5)$$

Referring now to Fig. 2, the pressure  $p$  at  $M$  caused by  $L_R$  located  $d$  centimeters away is given by:

$$p = \frac{rAv}{2\lambda d} \quad (6)$$

where  $r$  = acoustic impedance of the atmosphere, in mechanical ohms (41.5 for air).

$\lambda$  = wavelength in centimeters

The velocity  $v$ , for a current of  $i$  amperes in  $L$  is given by:

$$v = \frac{Bli}{Z_m} \quad (7)$$

Combining Eqs. (6) and (7):

$$p = \frac{rBIAi}{2\lambda dZ_m} \quad (8)$$

From Eqs. (8) and (5):

$$S_R = \frac{riS_R}{2d\lambda} \quad (9)$$

Now the pressure  $p$  acting upon  $M$  produces a voltage  $e_m'$  given by:

$$e_m' = S_m p \quad (10)$$

Combining this with Eq. (9):

$$S_m = \frac{2d\lambda e_m'}{S_R r i}$$

Substituting for  $S_R$  from Eqs. (1) and (2), we obtain, after eliminating  $p_o$ :

$$S_m = \sqrt{\frac{2d\lambda e_m' e_m}{e_s e_s'}}$$

However, since  $i = e_s'$  by virtue of the 1-ohm resistor:

$$S_m = \sqrt{\frac{2d\lambda}{r} \frac{e_m e_m'}{e_s e_s'}}$$

But  $\lambda = v_s/f$ , where  $v_s$  = velocity of sound and  $f$  = frequency in cycles per second. Thus:

$$S_m = \sqrt{\left(\frac{2dv_s}{r}\right) \left(\frac{e_m e_m'}{f e_s e_s'}\right)}$$

Thus a calibration curve for the sensitivity of  $M$  can be obtained without the use of a previously calibrated standard.  $\square$

#### REFERENCES

Lord Rayleigh, "Theory of Sound." MacMillan and Company, Vol. 1, p. 145.

H. F. Olson, "Calibration of microphones by the principles of reciprocity and similarity." RCA Review, Vol. 6, July, 1941.



# Sansui

## STEREO AMP.

#### FEATURES:

- Can receive stereophonic broadcasts of both AM-AM and AM-FM independently at the same time and facilitates reception of any kind of broadcasts—AM, SW, FM.
- By pushing the "presence switch", it can reproduce powerful low sound which has hitherto not been possible.
- Easy to see "glamour magic eye" is equipped for tuning indication.
- By only changing the mode switch, output of as much as 15W-15W for stereo and 30W for ordinary broadcast can be obtained.
- A highest class versatile "mammoth" amplifier that can also be used as a crossover 3500c/s channel amplifier.

#### SM-30 (OUTPUT 15W-15W)

#### SPECIFICATIONS:

4-germanium diodes, 23 tubes 6BQ5p.p.x2

Maximum Power Output: 15W-15W

Frequency Characteristics: 40 c/s~70K c/s, within -1db (at 10W output)

Distortion: 1% at 14W output

Gain (input for 10W output):

TAPE ... 1.23mV MAG ... 3.17mV

MIC ... 1.34mV X-TAL ... 54mV

AUX ... 74mV

Frequency Response:

88~108Mc/s for FM

535Kc/s~1605Kc/s x 2 for MW

3.5Mc/s~10Mc/s for SW

**SANSUI ELECTRIC CO., LTD.**

460, Izumi-cho, Suginami-ku, Tokyo, Japan

Circle 80B



## HI FI vs. STEREO

(from page 23)

Our policy is to advise and guide the customer into a decision which will provide the right quality of merchandise and satisfy his immediate and future needs at a price that is within his means, if possible. If he cannot afford the system as presented every possible substitution is considered with him, at the same time explaining the resultant compromise he must accept in going to lower priced components. Many times this approach results in selling the original proposed system even though it means straining the budget a little.

Honesty and a full explanation gains the confidence of the prospect in the majority of cases. The same interest in and consideration of the customer must be shown in delivering and installing his system just as carefully as though it were worth several times as much as he paid for it. Then follow up with a visit or two after installation to insure that all adjustments are right, and you have gained not only a customer but a friend as well, and possibly a prospect or two.

One more point in closing. We have confused the public by making such a concentrated issue of stereo. Many a prospect, wanting to be sure he gets the newest and latest in a music system, insists that it be Stereo rather than High Fidelity. There has been a sad lack of explanation to the uninitiated public that stereo is still high fidelity, only more of it in the way of components. In selling a system such as described above it takes some time to *unsell* the idea that it is still made up of the same components with respect to quality as those used in stereo. Once this is done, and sometimes it isn't easy, the prospect sees the advantage of progressive build-up to stereo and the small difference in cost in the end. At the same time it appeals to many to be able to enjoy the benefits and pleasure of a good hi-fi system much sooner than waiting until it can be afforded as a complete one-time purchase.

Æ

## RECORD REVUE

(from page 65)

Imagine that big-name artists are quite infallible, even in such an assemblage as this.

They aren't. I could not play all of this record, frankly, though it has many powerful aspects inevitably, with such potent individual performers. The music simply is done untold violence, in the blithe ignoring of current trends towards a taken-for-granted authenticity—the accompaniment is with piano, a "big-name" but wholly inappropriate, for all that—and even more importantly, in the sense of style, which is utterly at variance with Bach's best interests as of today. Each of these singers, and each performer, renders his Bach in strictly modern high-power concert style.

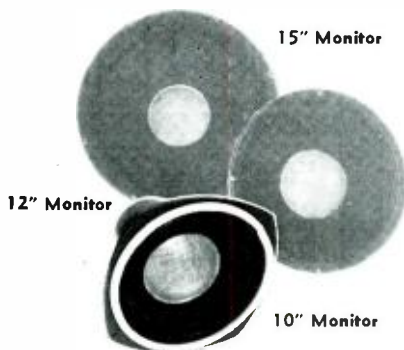

DESIGNED  
FOR  
STEREO  
BY

**TANNOY**

### The NEW, COMPACT 'MONITOR' DUAL CONCENTRIC, Type III LZ

From a line of laboratory standard speakers comes the 10" Dual Concentric — not an adapted speaker but one designed specifically to operate in small enclosures, yet provide the extended range integrated sound source with incredibly low harmonic distortion already acclaimed outstanding features of the larger 15" and 12" Monitors.

Here is a speaker with ALL the basic attributes of larger systems: superb transients — good, solid, fundamental bass (not cabinet-simulated sound) — sustained mid and upper range frequency response smoothly maintained beyond audibility — the TANNOY formula for unparalleled presence.

#### Write for details to:

Tannoy (Canada) Limited  
36 Wellington St. East,  
Toronto 1, Ontario.

Tannoy (America) Limited  
P.O. Box 177,  
East Norwich, L. I., N. Y.

Circle 81A

never before in Hi-Fi history  
has an FM tuner offered  
so much for so little



## SR-1020

- Designed for tomorrow! Incorporates both circuitry and switching for broadband multiplex operation
- Traditional quality S-R engineering, offering unusually high stability, sensitivity, and cool operation
- Full 15-month guarantee — best in the hi-fi field

only  
**\$97.50**

ASK YOUR HI-FI DEALER FOR DESCRIPTIVE TECHNICAL BROCHURE

**SARGENT-RAYMENT CO.**  
4926 E. 12TH STREET OAKLAND 1, CALIFORNIA

Circle 81B

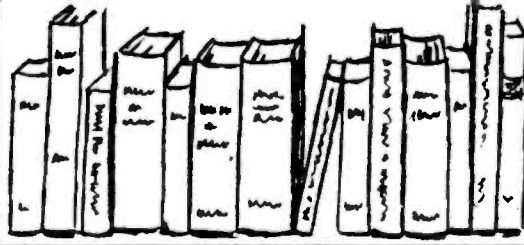
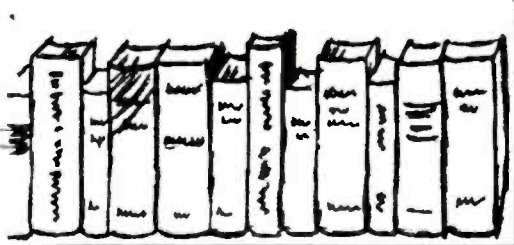

NEW!

No. 120  
THE 4th AUDIO ANTHOLOGY  
\$2.95 Postpaid

This is the biggest Audio Anthology ever!  
Contains a wealth of essential high fidelity  
know-how in 144 pages of complete arti-  
cles by world-famous authors.



"the best of AUDIO" No. 124

A new compendium of AUDIO knowledge.

Here is a collection of the best of AUDIO—The AUDIOclinic  
by Joseph Giovanelli...noted audio engineer and the original  
high fidelity answer-man—EQUIPMENT PROFILES edited by  
C. G. McProud...Editor of AUDIO. Here is a wealth of hi-fi  
and audio information. Answers to the most important issues  
in high fidelity and a valuable reference on the performance of  
leading makes of high fidelity components. Volume 1 \$2.00



# the AUDIO bookshelf

A convenient service to AUDIO  
readers. Order your books  
leisurely by mail—save time and  
travel, we pay the postage.



NEW! Greatest Reference Work on Audio & Hi Fi No. 123

"The AUDIO Cyclopedia" by Howard M. Tremaine

Up to the minute, including stereo! • 1280 pages  
• 3400 topics  
• 1600 illustrations

Here is one single volume with the most comprehensive  
coverage of every phase of audio. Concise, accurate explanations  
of all audio and hi fi subjects. More than 7 years in prepara-  
tion—the most authoritative encyclopedic work with a unique  
quick reference system for instant answers to any question. A  
vital complete reference book for every audio engineer, techni-  
cian, and serious audiophile. \$19.95



No. 115  
McPROUD HIGH FIDELITY OMNIBOOK

Prepared and edited by C. G. McProud,  
publisher of Audio and noted authority  
and pioneer in the field of high fidelity.  
Contains a wealth of ideas, how to's,  
what to's and when to's, written so  
plainly that both engineer and layman  
can appreciate its valuable content.  
Covers planning, problems with decoration,  
cabinets and building hi-fi furni-  
ture. A perfect guide. \$2.50 Postpaid.



No. 112  
TAPE RECORDERS AND TAPE RECORDING

by Harold D. Weiler  
A complete book on home recording by the author of  
*High Fidelity Simplified*. Easy to read and learn the  
techniques required for professional results with home  
recorders. Covers room acoustics, microphone tech-  
niques, sound effects, editing and splicing, etc. Invalua-  
ble to recording enthusiasts. Hard Cover \$3.95. Paper  
Cover \$2.95 Postpaid.



HANDBOOK OF SOUND REPRODUCTION No. 110  
by Edgar M. Villchur

Right up to date, a complete course on  
sound reproduction. Covers everything  
from the basic elements to individual  
chapters of each of the important  
components of a high fidelity system.  
Regularly \$6.50... offered for a limited  
time at only \$3.75.



SPECIAL! You pay only \$2.75 for this  
book when you order it with any other book on this page.

AUGUST  
SPECIAL!  
SAVE  
\$7.90

Save over 60% with this collection of AUDIO books.  
3rd Audio Anthology (\$2.50) 4th Audio Anthology  
(\$2.95) McProud High Fidelity Omnibook (\$2.50)  
best of AUDIO (\$2.00) Tape Recorders & Tape  
Recording (\$2.95)

TOTAL VALUE OF ALL FIVE BOOKS \$12.90  
Your cost ONLY \$5.00 POSTPAID

This offer expires August 31, 1960  
Good only on direct order to Publisher  
ORDER #OS68

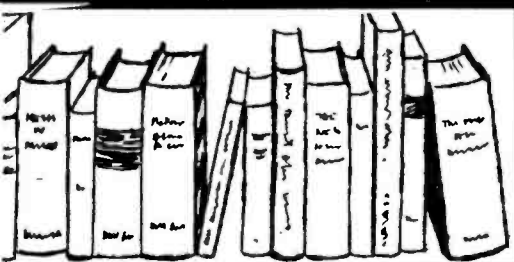

AUDIO Bookshelf

RADIO MAGAZINES, INC., Dept. 68  
P.O. Box 629, Mineola, New York

Please send me the books I have circled below. I am enclosing the  
full remittance of \$..... (No. C.O.D.)

All U.S.A. and CANADIAN orders shipped postpaid. Add 50¢ for Foreign orders  
(sent at buyer's risk).

BOOKS: 110 112 115 120 123 124 OS63

NAME \_\_\_\_\_ ADDRESS \_\_\_\_\_

CITY \_\_\_\_\_ ZONE \_\_\_\_\_ STATE \_\_\_\_\_



# 10 Hi-Fi Editors acclaim the **PACO SA-40** 40 WATT STEREO Preamp/Amplifier KIT



**C. G. McPROUD**  
Editor and Publisher of **AUDIO**:  
"... fulfilled the specifications  
exceptionally well... excellent  
performance at a reasonable  
price..."

**JOHN DIEGEL**  
HIGH FIDELITY:

"... overall performance superior  
to that of many amplifiers in its price  
range... completely stable..."

**JIM LYONS, Publisher**  
**The American Record Guide**:  
"... met or exceeded all (its)  
important specifications... a winner  
... an exceptional value for  
the money..."

**WILLIAM STOCKLIN**  
Hi-Fi Editor  
**ELECTRONICS WORLD**:  
"... harmonic distortion results  
are extremely good... will provide  
true high fidelity performance..."

**JULIAN SIENKIEWICZ**  
Hi-Fi Editor  
**POPULAR ELECTRONICS**:  
"... outstanding versatility...  
offers nearly all that could  
be asked for..."

**CHARLES TEPFER**  
Hi-Fi Editor  
**ELECTRONICS ILLUSTRATED**:  
"... integrated... neater... listening  
tests revealed it to be a Good Buy..."

Here you have read a sampling from just a few of the recent **RAVE REPORTS** on the **PACO SA-40**. Now we invite you to send for your personal portfolio of the complete reports. Read them, and you'll agree—for the critical audio enthusiast who wants quality at a moderate price—the **PACO SA-40** is the one truly logical choice to make. **WRITE:**

**PACO ELECTRONICS CO., INC.**  
70-31 84th Street, Glendale 27, L. I., New York  
Kit Division of **PRECISION Apparatus Company, Inc.**  
a subsidiary of **Facotronics, Inc.**

But what is worst for me is the unmusical, bouncing, hard, brassy, intractable rhythms, that drag the performers along against their better natures, and force all their petty disagreeableness into full play. This unhappy and ugly ensemble must be attributed to the conductor, for he's the one who should be shaping and smoothing and blending the various personalities into a musical whole.

All in all, a dismally bad recording in view of the potentially noble artistry available among these famous personalities, but I'll admit that the slow arias are good listening even so, for in them the hard rhythms are less able to assert themselves, the individual performers can take their own heads, so to speak, and express better what they know of the musical line—which is plenty. The fast arias are the intolerable ones.

**I Solisti di Zagreb Play Telemann.** (Four concerti, a sonata for strings).  
**Vanguard BGS 5028 stereo**

This excellent modern-style small orchestra tackles five out of the many hundreds of works by the relatively facile Telemann, contemporary of Bach and much better known in his own day. The music, interestingly, borrows much of the then Italian style and is here played by an Italian-school orchestra of today; it sounds, to me, even more like Vivaldi than it usually does. Somehow, the Italian aspects of the music are brought out here, whereas a German chamber orchestra would manage to make the very same music sound more German than Italian! (There's a French influence in Telemann, too; it would be good to hear a French orchestra do these same works.) Thus do nationalistic influences continue to operate, even a couple of centuries after the fact.

The Zagreb players are about the best in the business and their styling is beautifully suited to Vanguard's rich but careful stereo mixing. Some very unusual harmonies and drama are here, marking Telemann for what he was, a facile composer who on occasion could be suddenly very profound. Two oboe concerti, one for violin and one for viola, plus a work for strings, all of them short and concise.

## AUDIO ETC.

(from page 14)

in a large room. This whole three-speaker deal is to provide a helpful remedy in case of stereo trouble. It won't add a thing to your music if you already have good stereo. It'll merely subtract, by acting as a mono "blend" device. You can do that with the turn of a knob on most stereo amplifiers.

### Reversed Cartridge

My favorite system of the three we tried for achieving three-speaker stereo sound is the one that I plan to make permanent, because of its utter simplicity and—let me face it—the ingenuity of it. No reflection on E-V at all, but this one is more my own idea, for better or worse, and so I've taken a fancy to it even though it has some very dangerous mental pitfalls as you think it through. I may be in some of them still, for all I know.

This system has no transformers, no circuit changes in the amplifier at all, requires nothing extra other than the two leads to the third speaker. For convenience, I've added a switch in my pickup line in case I want to revert to conventional stereo, but you won't need even this if you stay faithful to this three-way arrangement.

All you have to do, for this system, is to hook your center speaker directly to two corresponding taps at the two amplifier outputs—mine was hooked to the two 8-ohm taps. Volume control (an old rheostat, 50-ohms, did very well for all these systems) on the middle speaker goes without saying.

# 3 Great New Kits for Stereo by **PACO**

... with the famous specially-prepared giant-size diagrams and super-simple step-by-step instructions for fool-proof assembly and wiring. Crafted by **PACO**, Kit Division of **PRECISION Apparatus Company, Inc.**, world-famous manufacturers of laboratory electronic test equipment for over a quarter of a century.



**The PACO SA-40 40 WATT STEREO PREAMP-AMPLIFIER** The Last Preamp-Amplifier You'll Ever Have to Buy

**Model SA-40-KIT**, complete with gold and satin black cabinet. ....Net Price: \$79.95  
**Model SA-40W-FACORY-WIRED**, complete with gold and satin black cabinet. ....Net Price: \$129.95



**The PACO ST-45 AM-FM STEREO TUNER** A Truly Unusual Engineering Achievement in Stability and Sensitivity

**AVAILABLE THREE WAYS:**

**Model ST-45-KIT**, with factory pre-aligned transformers, complete with gold and satin black cabinet. ....Net Price: \$84.95

**Model ST-45PA-SEMI-KIT**, with both FM and AM tuner sections factory-wired and completely pre-aligned and calibrated for hairline sensitivity, complete with gold and satin black cabinet. ....Net Price: \$99.95

**Model ST-45W-FACORY-WIRED**, aligned, calibrated and assembled, complete with gold and black satin cabinet. ....Net Price: \$134.95



**The PACO ST-35 FM TUNER**

**AVAILABLE THREE WAYS:**

**Model ST-35-KIT**, with factory pre-aligned transformers, complete with gold and satin black cabinet. ....Net Price: \$59.95

**Model ST-35PA-SEMI-KIT**, with tuner section factory-wired and completely pre-aligned for hairline sensitivity, complete with gold and satin black cabinet. ....Net Price: \$69.95

**Model ST-35W-FACORY-WIRED**, aligned, calibrated and assembled, complete with gold and satin black cabinet. ....Net Price: \$89.95



**NEW PACO 2-WAY SPEAKER SYSTEM SEMI-KIT** featuring Jensen Mid-Range Woofer and Horn-Type Tweeter

**Model L2-U-SEMI-KIT**, with unfinished, sanded cabinet. ....Net Price: \$59.95

**Model L2-F-SEMI-KIT**, with walnut-finished cabinet. ....Net Price: \$69.95

**AVAILABLE AT LEADING ELECTRONIC PARTS DISTRIBUTORS & WHEREVER GOOD SOUND IS SOLD.**

You'll want much more data... the performance specifications will amaze you... write for complete, illustrated brochure to:

**PACO ELECTRONICS CO., INC.**  
70-31 84th Street, Glendale 27, L. I., New York  
Kit Division of **PRECISION Apparatus Company, Inc.**



this is only part of the  
**BOGEN-PRESTO**  
high fidelity  
picture...



...the rest is in the quality and performance of the components. For literature describing Bogen-Presto tuners, amplifiers, turntables, and accessories, write to Desk 4

**BOGEN-PRESTO**  
BOX 500, PARAMUS, N. J.  
A DIVISION OF THE SIEGLER CORPORATION

Circle 84A

save on  
**Stereo hi-fi**



send for  
**ALLIED'S  
BARGAIN  
SUPPLEMENT**  
**free**

SAVE MOST on quality Stereo hi-fi. See top buys in Allied-recommended complete systems, KNIGHT® quality Stereo hi-fi units, and KNIGHT-KIT® build-your-own Stereo. You'll find hundreds of money-saving values in famous name amplifiers, tuners, changers, speakers, cabinetry, accessories—as well as recorders, P. A. systems, test instruments and electronic supplies. Extra big savings on stereo records and tapes! Send for your FREE Allied Supplement packed with bargain buys and newest products!

**ALLIED RADIO**

**FREE  
SUPPLEMENT**

ALLIED RADIO, Dept. 73-H  
100 N. Western Ave., Chicago 30, Ill.

Send FREE Allied Supplement No. 195

Name \_\_\_\_\_

Address \_\_\_\_\_

City \_\_\_\_\_ Zone \_\_\_\_\_ State \_\_\_\_\_

Circle 84B

But how can that be? You'll be getting only the difference signal between the two stereo channels, and that isn't really quite what's needed, now, is it? You can't be that naive! It just won't work, old boy...

Well, to tell the truth, I always get a bit nervous when I describe these simple things. Can I have made a ghastly mistake—am I utterly befuddled over something painfully elementary? Have I stuck my foot into my mouth?

Maybe, but I haven't finished yet. Two more minor changes—not additions—in the total circuitry. First, reverse the phasing of one outer speaker, and second, reverse the leads on one channel of your stereo cartridge—all as shown in Fig. 5.

WHAT! Doesn't that give you vertical response only? Fine thing. But—whoa, don't jump to conclusions. (I almost did myself, there.) It does not, because you are not paralleling the two sides of the cartridge, reversed, which would indeed give you vertical-only response. Rather, you are still sending out two signals, to two amplifiers; you have merely reversed one set of leads before it reaches the amplifier input.

Now, if I am still on the straight and narrow track (I imagine I'm falling into another abyss at each stage in this argument), the amplifiers don't really know the difference, so to speak, when the cartridge signals are reversed. Yes, I know there are ominously subdued rumblings to be heard concerning common grounds and the like—but, as I plunge blindly onward I can state (faintly) that this doesn't seem to affect the case, or didn't when we tried it. Natch, I'm assuming a four-wire cartridge and arm harness. Any three-wire system will botch my idea for a fare-thee-well, needless to say.

Four wires, all independent (a fifth may be a protecting ground, as on some cartridges), and one pair reversed. At the other end of your amplifiers you come out with stereo in your two speakers, but out of phase; that's all. However, you've reversed the phase on one speaker, so it's in phase after all.

And as for the center speaker, it now gets not the difference but the sum signal—which, if I am right, is what we're looking for.

Simple, you see—so simple that I keep thinking, there must be something wrong somewhere; it can't be this easy.

Well, I got sound out of it, anyhow, and I liked it. My switch, next to the arm, converts to standard when I want to use the arm for two-speaker stereo, and I have been careful to mark things up so that this particular cartridge won't accidentally get into an ordinary system with its leads still reversed. Got to watch it, there. Other than that, I haven't done anything special and don't intend to. (But I can get all-vertical response very neatly, now, as well as lateral-only, by using my other permanent switch, the one that parallels the pickup leads. In the normal position I get lateral mono, in the reversed position I get verti-

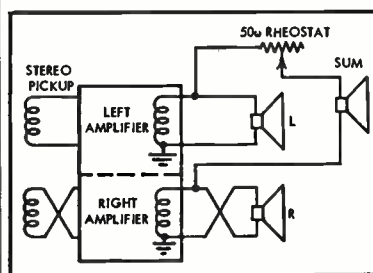

Fig. 5

cal mono. Fine for Edison discs and vertical-cut radio transcriptions.)

Only one further item to note: according to the battery analogy, this system gives you double the voltage at the center speaker, as compared with the two side

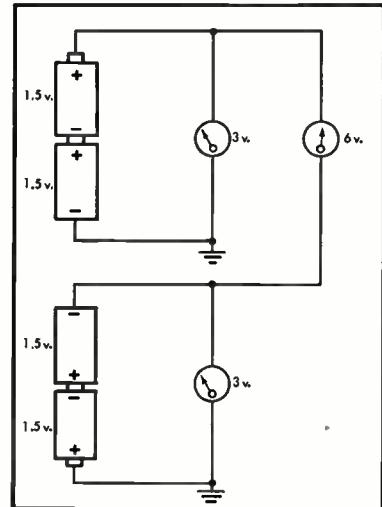

Fig. 6

speakers. Feed three volts d.c. into the battery analogy circuit, Fig. 6, and you get 3 on the outside meters, six on the middle one.

No problem in practice. It's only a 3 db difference anyhow, and your volume control on the center speaker—always necessary—takes it down to size. In fact I didn't even notice the difference when we tried our various systems; I merely saw it, on paper. At most, it gives you a slightly more mono effect with the center speaker all the way up and an imperceptibly greater range of control.

P.S. It's mostly irrelevant, but the system we rigged in this fashion used a Shure M3D cartridge in a Dyna-Empire arm. The amplifier was, again, the Sherwood system as used with the E-V transformer. The outer speakers were a convenient pair of KLH Sixes that I had on hand, the center speaker was practically the original AR2.

I note, by the way, that whereas outer stereo speakers, any pair, should always be identical if this is humanly possible, the center speaker can be somewhat different in sound, as in this case. Mostly a matter of symmetry, I guess; your ears can "take" a difference in the middle better than a lopsided difference between one side and the other.

## 2. STEREO FROM MONO?

This last winter I had a considerable running correspondence with none other than Prof. Doktor Hermann Scherchen, the eminent conductor who is also editor of the technical journal *Gravesano Blätter*, on acoustics and related matters, and director of the very famous laboratories for assorted research in acoustics at Gravesano, Italian Switzerland. Many a reader will remember Dr. S. for the drums in that Westminster Haydn "Military" Symphony, a hi-fi standby at the shows long before stereo came along... but his remarks to me had to do with his own work in approximating the impact of stereo via mono recording. His English was so delightful that for awhile I was not entirely clear as to where we were aiming, but in the end he went into German, which left me to cope with my own not-so-delightful know-

ledge of that language.

Anyhow, he sent me over a small gadget of his designing, called the Stereophoner, licensed for manufacture in England, hailed by numerous greats as a splendid answer to the challenge of better sound without recourse to stereo and doubled everything. Nothing quite like it, they all said, and their combined opinion was impressive.

Well, the Stereophoner came, and I like stereo better. But, remember, I'm an American, and American tastes in these matters are very significantly different from those in Europe.

The Stereophoner was a small box, three or four inches square and not at all heavy—clearly no transformers—which accepted a single speaker signal, two leads, and put forth two signals, four wires, labeled right speaker and left speaker. There was a volume control, a rheostat, and by the feel of it a very simple one, a single element and no more.

It was not proper for me to delve inside the stereophoner and I did not, the thing being well sealed up. But I did take it over to an engineer friend of mine and we set it up to see what happened.

Clearly, minus transformers and inserted in the low-impedance speaker line, this gadget was not likely to be over-complex. We tried each channel separately and found that the volume control affected only one of the outputs. We played various signals through each half—no time delay (and unlikely, at that), no observable alterations other than the very simplest, which you can guess at yourself. To wit: one channel was attenuated in the lows, the other in the highs. That was all, as we figured it.

The "volume control" on one channel served to alter the relationship between these two.

We tried a few pieces of music on the Stereophoner and there was indeed a spread of sound between the two speakers that was distinctly more varied and less bunched-up in the center than the usual identical signals sent from a mono source into two stereo loudspeakers. This was clearly a technological improvement of a mono signal, in a relatively narrow sense. The two speakers did not seem, as in two-speaker mono, to be tied together with a single common emitting source right in the middle between them.

And yet there were lacks, and falsehoods. Lacks as compared with real stereo, falsehoods in respect to musical integrity. I felt, most of all, the lack of stereo's finest value for me, the dynamic, a live stereo-reverberation or wall-bounce that does so much to place stereo music in a living sense of space. This simple dividing network circuit could do little to approximate that—nothing, would be a safer term. It did not provide any sense of highs alternately on both sides, reverberating, and it could not, by its nature.

Moreover, with the higher tones sent predominantly to one side and the lower tones to the other, a familiar effect was apparent—the disembodiment of instrumental sound. In such a situation, many instruments are bisected, the fundamental tones being sent to one side and the coloring overtones to the other. Thus you may hear the fundamental pitch of a clarinet to the right, but the characteristic tone color to the left, remotely.

Actually, the ears don't take the sound in that fashion—at least, not consciously. Since every musical instrument changes its spectrum from tone to tone and often violently in mid-tone, the audible effect most obvious in the listening is a sort of erratic flutter, or jumping. The sound is first on one side, then the other, or flutters rapidly

between, or seems oddly vaporous and indeterminate, not easily located in any direction yet, somehow, nervously on the move.

Granted that this poses interesting aesthetic questions as to what in the long run is desirable—granted that these effects are unusual and perhaps interesting in themselves, and even just possibly useful to the musical sense in terms of a more dynamic character to each sound. Could be, and would be—if we didn't already have stereo.

With mono alone on the scene, the Stereophoner and other gadgets of similar design could be quite useful as listening enhancers. The general idea is not new by any means, of course.

But we do have stereo—and stereo is so very much better, so much truer to the musical intention (when used rightly), so much more steady and reliable, so very much more accurate in its projection of whole instrumental sounds, that for my ear the Stereophoner and other such devices are obsolete, and poor substitutes at best.

*(Readers may remember a similar idea proposed by Tenny Lode in the January, 1950, issue of AUDIO. Mr. Lode described—and marketed, too, at that time—a pair of complementary networks which introduced a peak in the response of one loudspeaker in the vicinity of 800 cps and a corresponding dip in the response of the other, with the total output being "flat" for the two speakers. Thus the midrange was boosted on one speaker, while the highs and lows predominated on the other—permitting the use of a relatively narrow-range speaker for the boosted-midrange output. There was a stereo effect, but as Mr. Canby says, it is not stereo. Ed.)*

#### The American Way

Now all the above, I think, reflects an American viewpoint and is deliberately set forth as such, in view of our many European readers who may be following this argument.

There are two aspects that make my argument American. One, of course, is our economic opulence, our urge to spend more and more and make our home neighbors do it too, in the conviction that this leads to greater and greater prosperity for all. We sell stereo because it is new, it brings in cash, gives new sorts of satisfaction to an audience that can afford it, more or less. We have remarkably few inhibitions when it comes to launching new products and we do it precipitately, piling on the bad with the good! With us, it's all or nothing; no cautious innovations hereabouts.

In Europe, stereo is a more difficult economic proposition for most people, and its introduction is both cautious and careful. No all-out, slam-bang promotion over there—it would not be worth it. Mono still necessarily rules, just as for a long time the 78-rpm disc held on in Europe after our precipitate conversion to LP.

It is therefore of much greater interest to a European record collector, than to one of our people, to hear that a device is available that can create a sense of improved realism without the necessity for a dual stereo system throughout. To many a European collector, this sort of gadgetry is helpful and common-sense, avoiding the spendthrift luxury of the stereo system. Considering some of the unfortunate stereo discs we've perpetrated for sensation, over here, and considering our outrageously bad mass-production stereo equipment and our outrageously over-exaggerated stereo publicity, we can commend the European for his common-sense caution and conservatism.



## Experts disagree

- Engineers choose the new ESL-C99 Micro/flex stereo cartridge because of its patented, inherently linear D'Arsonval movements and exclusive Micro/flex separating system.
- Musicians, on the other hand, prefer the ESL simply because it makes records sound better.
- Are you enjoying this superlative cartridge yet? It's only \$49.50 at your dealer's.



FOR LISTENING AT ITS BEST  
**Electro-Sonic  
Laboratories, Inc.**

DEPT A • 35-54 36th St • Long Island City 6, N.Y.  
Circle 85A

**BUILD YOUR OWN**  
*Concert Quality*  
**ELECTRONIC ORGAN**  
**SAVE 50%**



- Step by step instructions
- Pay as you build
- Over 14 models

THE *Artisan* **ELECTRONIC ORGAN**

Send for free literature

**ELECTRONIC ORGAN ARTS**

4445 YORK BLVD., LOS ANGELES 42, CALIF.

Please send me free information

NAME \_\_\_\_\_  
ADDRESS \_\_\_\_\_  
CITY \_\_\_\_\_ ZONE \_\_\_\_\_  
STATE \_\_\_\_\_  
A-8

Circle 85B



# Primo

## STABLE PERFORMANCE AND UNIFORM QUALITY

Primo Dynamic Microphone is now being used by 70% of general tape-recorder manufacturers in Japan and gaining a high reputation.

High Performance Impedance Switch System to be used as Noise Survey Meter.



Model: DM-172

### SPECIFICATIONS

Frequency response: 50-10,000 c/s  $\pm 3$  dB  
Sensitivity: -73 dB(600 ohm at 1,000 c/s)  
Impedance: 600 ohm or 50 K ohm convertible  
Dimensions: 45(dia) X 115 mm  
Directional Characteristics: Non Directional



Model: DM-173

**SUPER SMALL SIZE TYPE DYNAMIC MICROPHONE FOR TRANSISTOR TAPE RECORDER**  
\*Most suitable for office use recorder.  
\*DM-173-T type with telephone coil can be used by the switches.

### SPECIFICATIONS

Frequency response: 150-8,000 c/s  $\pm 3$  dB  
Sensitivity: -60 dB (10 k ohm at 1,000 c/s)  
Impedance: 1 k ohm or 10 k ohm  
Dimensions: 56mm/height)  $\frac{1}{2}$  40mm/width) x 20mm/thickness)  
Directional Characteristics: Non Directional.

Model: DM-4

### DYNAMIC MICROPHONE UNIT DM-4

Among the every kind of dynamic microphone units we are selling the DM-4 is one of the most popular. This really excellent microphone unit is now being installed into the microphone cases of the majority of tape recorder manufacturers in Japan, resulting in a complete and perfect tape recorder microphone. Frequency response: 70-10,000 c/s  $\pm 3$  dB available Unit Impedance: 60 ohm

**PRIMO COMPANY, LTD.**

2043 MURE, MITAKA-SHI, TOKYO, JAPAN

On the other hand, I can promote an opposite argument to equal effect. We may be zany, over here, given to wild claims, headstrong and undisciplined advances, helter-skelter commercialism. We certainly are; but I can't help thinking that in the long pull, we Americans often come out with the best, and quietly get rid of the worst after it has had its fling.

The noise of innovation, in all its crudity, is what the world hears from us. The subsequent slow boiling-down, the winnowing of the chaff, tends to be lost in the general enthusiasm—but it goes on, just the same. Give us time, and we end up with good judgment.

I think, thus, that we have a wider, more imaginative, less traditional, more open-minded viewpoint towards innovations in musical sound than is common in Europe. We promote the wildest, crudest, most exaggerated forms of sound, but we also experiment in a wide-swinging manner, we learn as listeners to like new sounds that were never heard before and to understand their new possibilities, even in the reinterpreting of the old in music; whereas Europeans—speaking very generally—tend to be more absorbed in relatively conservative sounds, solid, impeccable, beautifully tailored, yet not so advanced, often.

I have noticed this again and again in European stereo versus American. Ours is flamboyant, often crude and frequently downright awful. But we are right in the thick of intense development of the stereo medium, with liberal and splendid new sounds emerging that, for all their newness are already proving immensely valuable in terms of musical projection.

In Europe, the average of stereo quality is high, but the sound tends towards the conservative; the stereo tool is used carefully and precisely, to the point where for our ears some European stereo might as well be mono, so discreet is its impact. Within a conservative limitation, much European stereo is superbly beautiful. It is seldom radical.

Generalities, obviously, and I'm off my point, but not altogether. To return to the Stereophoner, my second point—the first being the matter of economics—is simply that we in America have moved generally beyond such devices as this in our expectations for reproduced sound. We have heard what we feel to be a more useful, more dramatic, more precise array of musical sounds in true stereo itself; we are disappointed by any compromise, and especially by any synthetic sense of spatial location.

Heaven knows, our stereo might well seem to be as synthetic as you can get! But, oddly, it has a real, progressive, constructive syntheticism, out of which musical art is being made in new forms. The two-channels-out-of-one synthetic effect is by comparison unconstructive, dead, limited, unprovocative, like so much synthetic orange juice.

Well . . . perhaps I speak for a small minority hereabouts—who knows. But I'll bet you can't sell the Stereophoner and its electrical cousins over, no matter how hard you try.

Not to me, anyhow. I've gone back to my stereo discs and tapes.

I should add, here, that there are interesting variants possible on the idea of a dual-channel doctored output derived from a single signal, among which is one once used by my friend Jan Syrjala, for two-speaker ballet music on a round-the-world dance tour. (The entire orchestral repertoire was taped ahead of time and went along for the dancing, via a pair of Ampex 350's and supporting equipment.) Jan's trick, which I trust is no secret, seems to me very sensible. Instead of a pair of channels with high roll-off in one and low roll-

## CLASSIFIED

Notes: 10¢ per word per insertion for noncommercial advertisements; 25¢ per word for commercial advertisements. Rates are net, and no discounts will be allowed. Copy must be accompanied by remittance in full, and must reach the New York office by the first of the month preceding the date of issue.

**HIGH FIDELITY SPEAKERS REPAIRED  
AMPRITE SPEAKER SERVICE**  
168 W. 23rd St., New York 11, N. Y.  
CH 3-4812

**ENJOY PLEASANT SURPRISES?** Then write us before you purchase any hi-fi. You'll be glad you did. Unusual savings. Key Electronics, 120 Liberty St., New York 6, N. Y. EVERgreen 4-6071.

**WRITE** for confidential money-saving prices on your Hi-Fidelity amplifiers, tuners, speakers, tape recorders. Individual quotations only; no catalogs. Classified Hi-Fi Exchange, AR, 2375 East 65th St., Brooklyn 34, N. Y.

**SALE:** 78 rpm recordings. 1900-1950. Free lists. Collections bought. P. O. Box 155 (AU), Verona, N. J.

Low quotes on everything. Hi Fi and Stereo tapes. Bargain list. HiFi, Roslyn 4 Pa.

Components, recorders, free wholesale catalogue. Carston, 125-N East 88th Street, New York 28, N. Y.

Ampex, Concertone, Crown, Magnecord, No-relo, Presto, Bogen, Tandberg, Sherwood, Rek-O-Kut, Scott, Shure, Dynakit, others. Trades, Boynton Studio, Dept. AM, 10 Pennsylvania Ave., Tuckahoe, N. Y.

**FOR SALE:** Presto 6N Turntable. First \$75 takes. N. Y. C. pickup only. AXtel 7-3589.

**VIKING** professional tape deck model 95, brand new, with 4 track playback head \$400. Long, Box 3202, Lafayette, Louisiana.

Marantz Stereo Preamp Mod. 7, original carton, sacrifice \$200, Long, Box 3202, Lafayette, Louisiana.

**E-V ARISTOCRAT III** Speaker \$140 or best offer. Bogen DB-20 amplifier plus gold cover \$45. Charles Leigh, 10 S. Lanning, Hopewell, N. J.

Ampex 400A professional tape recorder, \$400. V. R. Hein, 418 Gregory, Rockford, Illinois.

**HEWLETT-PACKARD** audio oscillator, 20-20,000 E. Johnson, Montgomery Road, Middletown, N. Y.

Privately owned and treated with loving care. Must sell Ampex Mod. 122 Stereo (\$250), Ampex Mod. 980, 4 track Stereo (\$500), (8 months old) Garrard Turntable Mod. 301 with G. E. arm and cartridge (\$45), Fisher 80-C Preamp and Fisher 80-A2 Amp (\$65), Donald Moloney, 2633 Milwaukee, Chicago, Illinois.

**RENT STEREO TAPES**—over 1,500 different—all major labels—free catalog Stereo-Part I 811-H Centinela Ave., Inglewood 3, California.

### IF YOU ARE MOVING

Please notify our Circulation Department at least 5 weeks in advance. The Post Office does not forward magazines sent to wrong destinations unless you pay additional postage, and we can NOT duplicate copies sent to you once. To save yourself, us, and the Post Office a headache, won't you please cooperate? When notifying us, please give your old address and your new address.

Circulation Department  
**RADIO MAGAZINES, INC.**  
P. O. Box 629, Mineola, N. Y.



Fastest, Easiest Way To Learn All About Audio  
NEW Rider "Picture-Book" Course

## BASIC AUDIO

by Norman H. Crowhurst

The Rider "picture-book" approach has made many technical subjects understandable to many hundreds of thousands of people. Now, everything about sound and audio reproduction is made crystal-clear. If hi-fi is your interest—or if you work with tape recorders—or the broad subject of sound reproduction interests you—or if you assemble your hi-fi equipment or buy a complete "package"—you must read BASIC AUDIO.

If you already own sound reproducing equipment—this "picture-book" course will give you an all-around background on all the important details of sound reproduction. It will enable you to get the most from your equipment.

You can learn easily, rapidly at very low cost. You build your knowledge step-by-step. There's one idea and one specially prepared illustration per page. More than 400 illustrations for maximum understanding.

Beyond a knowledge of electricity at the basic level, no previous electronic experience is needed to get the maximum from this course. Whatever electronics circuit theory is required to make the entire panorama of sound reproduction and recording visible to you is provided.

This Rider "picture-book" audio course is completely different from anything that has ever been presented. We guarantee your satisfaction.

#201, 3 vols., soft covers \$8.70; #201-H, cloth \$9.95  
At your jobber or book store, or order direct AU-8.

John F. Rider Pub., Inc., 116 W. 14th St., N.Y.C.  
In Canada: Charles W. Zaiton, Ltd., 86 Renise Road, Reading, Ont.

Circle 87C



THE FINEST OF ITS KIND . . .

Get more FM stations with the world's most powerful FM Yagi Antenna systems.

To be fully informed, send 25¢ for book "Theme And Variations" by L. F. B. Carini and containing FM Station Directory.



APPARATUS DEVELOPMENT CO.  
WETHERSFIELD 9, CONN

Circle 87D

CANADA  
High Fidelity Equipment  
Complete Lines • Complete Service  
Hi-Fi Records — Components  
and Accessories

### ELECTRO-VOICE SOUND SYSTEMS

126 DUNDAS ST. WEST, TORONTO, CANADA

Circle 87E

ELECTROSTATIC TWEETER

THRILLING  
HI FREQUENCY  
RESPONSE

ONLY \$19.95  
ORDER BY  
MAIL

**kierulff** 1015 S. FIGUEROA  
SOUND CORPORATION LOS ANGELES  
CALIFORNIA

Circle 87F

off in the other, as in the Stereophoner, Jan's channels were a hump and a valley. That is, from his single mono signal he derived a pair of channels one of which was normal at both low and high end but sagged in the middle; the other was normal in the middle range but was rolled off at both high and low ends. Complementary curves, concave and convex. (Obviously like Tenny Lode's. Ed.) (Maybe that's where he got it. E. T. C.)

The effect, he says, is most realistic, and useful for ballet in action. Some instruments, notably the big drums, produce largely the extremes of tonal range—strong lows plus short, high-range overtones; these instruments sound out clear and complete through one side channel, the one with the concave curve, high and low ends normal. But other instruments are just the opposite. Violins, for instance, are lacking in lows and are very strong in mid-range highs. Their predominantly mid-range sound is neatly picked out by the opposite speaker and sounds clearly on the other side of the listening expanse from the drums.

I'd suggest that if the people at Gravesano want to develop Stereophoner II, they might approach Messrs. Lode and Syrjala. But they're so busy making stereo now, it probably wouldn't work out. **Æ**

**PACKAGE HI FI  
or SINGLE COMPONENTS**  
You'll find our prices low  
and service fast.  
Write for our quotation  
**CENTER ELECTRONICS Co., Inc.**  
74-A Cortlandt St. New York 7, N. Y.

Circle 87G

**BEST IN HI-FI VALUES!**

**NO DELAY SERVICE** | All orders rushed to you in factory-sealed cartons.  
**Write for free catalog.**

**audion** 25-A Oxford Road  
Massapequa, New York

Circle 87H

**A NOTE TO THE HI-FI BUYER**  
AIR MAIL us your requirements for an **IMMEDIATE WHOLESALE QUOTATION**  
Components, Tapes and Recorders  
**SHIPPED PROMPTLY AT LOWEST PRICES**  
**WRITE TODAY FOR FREE CATALOG**

**audio unlimited** 714-A Lexington Ave.  
New York 22, N. Y.

Circle 87K

**LOOKING FOR a pleasant surprise?**  
Write for our new hi-fi catalog. You'll be glad you did.

**KEY Electronics**  
120 Liberty St.,  
New York 6, N. Y.  
CL 8-4288

Circle 87M

**RENT  
stereo tapes**

• OVER 1500 DIFFERENT ALBUMS  
• POSTPAID TO AND FROM YOUR HOME

SEND FOR FREE BROCHURE **stereo-parti**

811-C CENTINELA AVE.  
Circle 87N

In the United States,  
Gotham Audio Corporation  
—and only Gotham—distributes  
the Neumann line... sound  
standard of the world!

**GOTHAM AUDIO CORPORATION**  
2 W. 46 St., N. Y. 36, N. Y. Tel: CO 5-4111  
Formerly Gotham Audio Sales Co. Inc.

Circle 87A

**Corral**

**NEW**

**12" TETRAAXIAL SPEAKER**

**MANUFACTURER  
FUKUYO SOUND**

2-25, Horiune, Kita-ku, Tokyo  
Cable: CORALFUKUYO

Circle 87B

## BUYER'S GUIDE

(from page 77)

is a new, low-cost magnetic stereo cartridge especially designed for use with record changers. The Professional (M3D) and Custom (M7D) are designed for mounting in transcription tone arms and record changers respectively. The Standard has a frequency response of 30 to 15,000 cps and the Professional and Custom have a response of 20 to 15,000 cps. All have outputs of 5 mv per channel, and channel separations of more than 20 db at 1000 cps. Recommended load impedance is 47,000 ohms. The Professional has an inductance of 365 mh, a d.c. resistance of 33 ohms and a compliance of  $4 \times 10^{-4}$  cm/dyne. The Custom and Standard have an inductance of 400 mh and a d.c. resistance of 400 ohms. Compliance of the Custom is  $3.5 \times 10^{-4}$  cm/dyne and of the Standard is  $3.0 \times 10^{-4}$  cm/dyne. All have four terminals and fit standard mounting dimensions. Shure Brothers, Inc., 222 Hartrey Ave., Evanston, Illinois. User net prices: M3D, \$45.00; M7D, \$24.00; M8D, \$16.50.

## SONOTONE

• Series "12" Crystal Stereo Cartridges. Designed for high output at low cost, the new Sonotone crystal stereo cartridges models "12TH" and "12TL" are made entirely of plastic except for the stylus, crystal elements and mounting brackets. This construction



makes them suitable for mass production, which in turn effects price reduction. Supplied with standard 0.7 mil and 3 mil turnover sapphire styli, both cartridges come complete with mounting bracket and terminal plug. The "12TH" cartridge has an output of 2.5 volts and the "12TL" has an output of 1.0 volts. Stylus replacement is facilitated because the turnover lever need merely be snapped out and replaced by another turnover lever/stylus assembly, which can then be snapped back in. Sonotone Corporation, Elmsford, New York. User net price, \$6.45 for either cartridge.

## STEREOTWIN

• Moving Magnet Stereo Cartridge. Model 210D is completely hum free and features a mounting clip which provides optimum position in either transcription arms or changers. Stylus assembly may be changed instantly

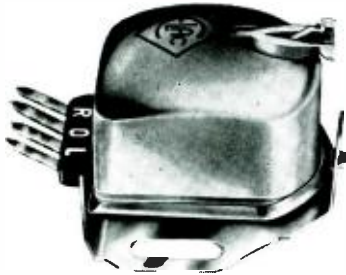

without tools. Output is approximately 12 mv for a 5 cm/sec stylus velocity, with separation of more than 22 db at 1000 cps, over 10 db at 10,000 cps. Vertical and lateral compliance,  $5.5 \times 10^{-4}$  cm/dyne, and tracking force approximately 5 grams in changers. 3 to 4 grams in transcription arms. Audiogersh Corporation, 514 Broadway, New York 12, N. Y. User net price, \$34.50.

# AUDIOMAN NO 11

Young college professor finds time for music, hi-fi, organ building, swimming, sailing, and to become latest Audioman.

**W**HEN HE CAN find the time outside his activities at Wagner College where he is an Assistant Professor of Chemistry, Dr. James S. Swinehart puts together kits of various kinds, records and listens to music, and swims and sails when the weather permits. And being unmarried, he doesn't have to get his equipment in decorator-approved cabinets before the quality of the equipment meets his demands. When he was selected as an Audioman, his cabinet work was not completed. It isn't yet, but he is working on it.

But that doesn't mean that he does not have good equipment—even in his 1960 Rambler he has a Becker FM radio with a 7-watt amplifier and an AR-2 so his traveling listening should not be appreciably less in quality than his fixed listening.

For equipment, Dr. Swinehart uses a Fisher FM-90X tuner, two Dynakit preamps with a Dynakit stereo adapter, and two Dynakit power amplifiers, Marks II and III. His turntable is Components Corporation, and he uses ESL and Grado arms with a Grado pickup for 78's and a Grado Custom and a Shure M3D for mono and stereo LP's. He listens through three AR-3's, the third one to become a center speaker when he gets a living room large enough to need one. He has an Ampex 350 with extra electronics for stereo, and he uses two Sony microphones.

The cabinet shown below is fitted with movable shelves so he has been able to make any necessary accommodation for the various units of equipment (when the picture was taken, he still had a Fairchild amplifier for one channel). But this arrangement is acceptable to the serious audio-fan because it permits him to keep the system up to date without having to spend all of his time in modifying the cabinet. However, his new cabinetry is nearly complete, and then everything will be all set—for how long?



Like most Audiomen, Dr. Swinehart is continually being called upon by friends to help in the planning and installation of their systems, and he estimates that his advise is asked at least twice a week, and he has helped in the installation and design of more than thirty systems.

Activities around his college keep him from taking part in community activities, but Dr. Swinehart does find time to attend plays, operas, and concerts—at least one of them each week. And just to keep in practice with his listening, he has another AR—this time a 2—in his bedroom. Seems as though we might just like to go back to school again if one can find enough leisure for all these activities. Æ

Flexible enough to permit easy servicing and the usual audioman's proclivities for changing equipment.



AUDIO • AUGUST, 1960



## WEATHERS

● **FM Pickup System.** Utilizing a different design principle than virtually all other pickups, the Weathers MM-1 is a nongenerator which achieves extremely low stylus tracking force. This low tracking force is achieved because the motion of the stylus is not used to generate a voltage and thus an extremely compliant armature is possible. In addition, because the cartridge is an electrostatic de-



vice, it is not susceptible to hum pickup from turntable motor fields. Frequency response of the system is  $\pm 1$  db 20 to 20,000 cps. Stylus tracking force is 1 to  $1\frac{1}{2}$  grams; lateral compliance is  $16.4 \times 10^{-6}$  cm/dyne and vertical compliance is  $8.2 \times 10^{-6}$  cm/dyne. It must be operated in conjunction with the "Micro Touch" arm and P-151 Polarizing Supply. Weathers Industries, 66 East Gloucester Pike, Barrington, N. J. User net price, \$92.10.

## TAPE RECORDERS AMERICAN CONCERTONE

● **Stereo Tape Recorder.** Professional quality sound in a moderately priced instrument makes the Concertone 505 an ideal investment for the advanced non-professional. The 505 records and plays back 2-track stereo and monophonic tapes and in addition can play back 4-track stereo and monophonic tapes. Featured in the 505 is a direct-drive capstan motor and capacitor type induction reel motors. Manufacturing tolerances are stated



to be within two millionths on some parts. Push-button controls are solenoid operated. Automatic reel-end cutoff switch prevents tape runaway. Self-energizing brakes assure smooth operation without tape stretch. Dual inputs are supplied for microphones and auxiliary devices. Four separate level controls permit mixing of all inputs. Frequency response is 50 to 15,000 cps  $\pm 2$  db at  $7\frac{1}{2}$  ips. Lightweight for easy portability, the 505 weighs only 36 lbs. including recording and playback preamplifiers. American Concertone division of American Electronics, Inc., 9449 W. Jefferson Blvd., Culver City, Calif. User net price, \$495.00 (less carrying case).

TR-100, portable transistorized rec. . . \$199.95  
33, professional stereo rec. . . . . 995.00  
Series 90, line of professional rec. . . 845.00 up  
Series 500, line of stereo rec. . . . . 379.00 up

## AMPEX

● **Portable Stereo Tape Recorder.** The Ampex model 970 is a new model of their portable stereo tape recorder featuring a self-contained matched pair of amplifier/speakers for stereo playback monitoring. The new unit utilizes the same tape transport as the Ampex model 960 portable deck, installed in a longer portable case with a two-channel stereo amplifier and two 7" oval speakers which face outward from each end of the unit. Sound-directing panels are in front of each speaker thus permitting some directional control of the sound. Monitoring "off-the-tape" while recording can be done either through earphones or the unit's own speakers because the 970 has separate record and playback preamps as well as separate heads for record, playback, and erase. Capable of recording and playing two-track



stereo and  $\frac{1}{2}$ -track monophonically. It can also play four-track tape. It can also be used as a public address system—in stereo or mono. Capable of essentially distortionless frequency response from 30 to 20,000 cps at  $7\frac{1}{2}$  ips, and 30 to 15,000 cps at 3 $\frac{3}{4}$  ips. Its precision engineered timing accuracy is such that it offers perfection of pitch held to tolerances of  $\frac{1}{2}$  of a half-tone. Flutter and wow less than 0.2% rms at  $7\frac{1}{2}$  ips; under 0.25% at 3 $\frac{3}{4}$  ips. High-impedance inputs are provided for microphone and high-level program sources. Azimuth alignment of stereo head gaps is within 20 seconds of an arc, equivalent to less than 10 millionths of an inch. The appearance of the 970, in a distinctive gray carrying case is in keeping with its impressive performance. Ampex Audio, Inc., 1020 Kifer Road, Sunnyvale, Calif. User net price, \$595.00.

960, stereo recorder . . . . . \$ 495.00  
952, tape deck, uncased . . . . . 449.50  
354, prof. stereo/mono rec. . . . . 1775.00  
2010, amp-spkr, matches 960 . . . . 199.50 ea.

## CROWN

● **Professional Stereo Tape Recorder.** A machine of advanced design, the Crown 714C (Stereo X) records and plays back four-track stereo, plays two-track stereo, and records and plays 4-track monophonic tapes. Featured in the 714C are three speed operation (15,  $7\frac{1}{2}$  and 3 $\frac{3}{4}$  ips), forced air cooling, patented differential magnetic braking to assure smooth operation without tape stretch,



automatic stop to prevent tape runaway, and non-magnetic capstan. The all-aluminum panels are satin anodized and markings are deep engraved for performance. Four high-impedance microphone inputs are provided; four level controls permit mixing of all inputs. Cathode follower outputs plus standard rack mount permit adaptability to a large variety of equipment. At 15 ips frequency response is 50 to 28,000 cps plus or minus 2 db, flutter and wow is 0.06%; at  $7\frac{1}{2}$  ips fre-

quency response is 30 to 17,000 cps within 2 db, flutter and wow is 0.09%; at 3 $\frac{3}{4}$  ips frequency response is 30 to 9000 cps within 2 db, flutter and wow is 0.18%. Timing accuracy is 99.5%. Crown International, South 17th St. and Mishawaba Road, Elkhart, Indiana. User net price, \$715.00.

712, 2-track stereo rec. . . . . \$695.00  
752, stereo player . . . . . 337.00

## FERROGRAPH

● **Professional Stereo Tape Recorder Series.** The Ferrograph 808 series offers complete stereo recording and playback facilities as well as monophonic recording and playback. Both the standard half-track (model 808/2) and quarter-track (model 808/4) stereo machines are available with 3 $\frac{3}{4}$  and  $7\frac{1}{2}$  ips tape speeds. Portable units, the 808 series have matched outputs at low-level to feed a high fidelity system. Both models accommodate reels up to 8 $\frac{1}{4}$ " and have a flat frequency response ( $\pm 2$  db) of 40 to 15,000 cps at 15 ips; 50 to 10,000 cps at  $7\frac{1}{2}$  ips and 50 to 8000 cps at 3 $\frac{3}{4}$  ips. Signal-to-noise ratio is better than 50 db, 200 to 12,000 cps; 45 db unweighted including hum. Three motors are used including one hysteresis-synchronous



drive motor for the capstan. Other features include recording VU meter, auto-switch cutoff, "Ferrodexer" gear driven turn counter, and azimuth adjustment for heads. Distributed in United States by Ercma Corporation, 16 West 46th St., N. Y. User net price, either model \$595.00.

## HEATHKIT

● **Stereo-Mono Tape Recorder Kits.** The Heath TR-1A series consists of three models; the two-track TR-1AH, the four-track TR-1AQ, and the two-track TR-1A. The TR-1A records and plays back monophonic tapes only; both other models record and playback either stereo or monophonic tapes. The tape deck mechanism is extremely simple to assemble. Precision bearings and close machining tolerances hold flutter and wow to less than 0.35%. Power is provided by a four-pole, fan-cooled induction motor. One lever controls all tape handling functions of forward, fast-forward or rewind modes of operation. The deck handles up to 7" tape reels at  $7\frac{1}{2}$  or 3 $\frac{3}{4}$  ips as determined by belt position. The TR-1A series decks may be mounted in either a vertical or horizontal position (mounting brackets included). The TE-1 Tape Electronics kit features NARTB equalization, separate record



and playback gain controls, cathode follower outputs and provision for mike or line inputs. Recording level is indicated on a "magic eye" tube. A safety interlock minimizes the possibility of accidental erasure by locking in "play" position. Bias-erase current is provided by a push-pull oscillator for low noise and distortion and a heater balance control allows adjustment to minimum hum level. Cathode follower output is at 600 ohms impedance. Two circuit boards are used for easy assembly and high circuit stability. Heath



Company, Benton Harbor, Michigan. User net price: TR-1A \$99.95, TR-1AH and TR-1AQ \$149.95.

TR-1 Series, tape decks ..... \$159.95-169.95  
TE-1, tape rec elec kit ..... 39.95

## LAFAYETTE

• *Two-Speed Tape Recorder.* Though small in size, the Lafayette RK-400 is a full-function tape recorder providing all the features and performance normally associated with larger tape units. Convenient operation provided by the single function control plus an



on/off volume control. A simple capstan adjustment changes speed from 7½ to 3¾ ips. Frequency range is 60 to 5500 cps at 7½ ips. Record level indicated by light. Complete with crystal microphone. Finished in scuff resistant pyroxylin material. Lafayette Electronics Mfg., Corp., 164-46 Dunkirk St., Jamaica 12, N. Y. User net price, \$54.50.

## MAGNECORD

• *Stereo Magnecordette.* The Series 100 Magnecordette is a portable professional-type tape recorder which both records and plays back in-line stereo. A two-speed machine, operating at 7½ and 3¾ ips. It is also capable of standard monophonic recording and playback when desired. Separate VU meters and gain controls are incorporated for each channel, as well as a master gain control which operates on both channels simultaneously. Frequency response is 40 to 15,000 cps ± 2.0 db at 7½ ips; 50 to 7500 ± 2 db at 3¾ ips. Inputs are provided for two high-impedance microphones, also for auxiliary de-



vices such as tuners, phono cartridges, etc. Two-motor drive system holds flutter and wow to less than 0.3 per cent. Noise level is down more than 48 db. Binaural monitoring is accomplished by means of a panel-mounted phone jack. Playback outputs are cathode followers which deliver 1.0 volt from normal output level. This is truly a fine instrument for the serious hobbyist who demands a high measure of audio quality as well as dependability of performance. Magnecord Division, Midwestern Instruments, Inc., 41st St. and Sheridan Road, Tulsa, Okla. User net price, in portable carrying case, \$449.95.

728-4X, prof stereo rec, less case... \$ 759.00  
M90-BAC, prof rec w/amps, cases .. 2255.00  
P75-AC, prof rec/ampl in case .... 880.00

## MOVIC

• *Two-Speed Stereo Tape Recorder.* Manufactured in Denmark, the Movie model A-2 is a skillful blend of old world craftsmanship and new world design. Features in this precision machine include: sound-on-sound recording capability, two built-in output amplifiers, echo-chamber effect if desired, hysteresis-synchronous capstan motor, separate amplifiers for the two built-in VU meters, two custom designed reel motors to provide unusually gentle tape handling, cue switch for easy editing, either channel can be monitored through the internal speaker. The two playback amplifiers have cascaded input stages with d.c. on the heaters for low noise. NAB equalization is provided in the feedback network for both 7½ and 3¾ ips speeds. Both amplifiers have adjustable treble equalization



and a cathode follower output to both jacks. The two record amplifiers have NAB equalization in the feedback networks for both 7½ and 3¾ ips tape speeds. A specially designed push-pull erase/bias oscillator circuit (Patent Pending) gives an unusually clean wave form. Wow and flutter are less than 0.1% rms and signal-to-noise ratio is 50 db or better at 7½ ips. Frequency response at 7½ ips is 45 to 14,000 cps ± 2 db. Movie Company, Inc., 12432 Santa Monica Blvd., Los Angeles 25, Calif. User net price, \$645.00.

A-2-15, prof 7½/15 ips rec ..... \$710.00

## NAGRA

• *Portable, Professional, Tape Recorder.* The Nagra IIIB is a completely transistorized professional, 3-speed (3¾, 7½, 15 ips) tape recorder. Incorporating three heads and a servo-controlled motor, the Nagra IIIB has a speed constancy of 0.2%. Wow and flutter is 0.15% at 15 ips and 0.2% at 7½ ips. Signal-to-noise ratio is 58 db or better. The recorder operates from any 12-volt source or from the self-contained flashlight batteries; battery condition and level being indicated



by the built-in meter. Output is +6 VU at 600 ohms balanced. A monitor-speaker is built in and an AGC circuit controls speech level during recording. All normal microphone inputs are incorporated in addition to two line mixers. Electronic Applications, Inc., 194 Richmond Hill Ave., Stamford, Conn. User net price, \$1,045.00.

## NEWCOMB

• *Stereo Tape Recorders.* Now available in the ¼-track version as Model SM-310-4 as well as the earlier ½-track Model SM-310, the Newcomb stereo tape recorder is "cybernetically engineered for intuitive operation." Control of the tape transport is centered in a "joy stick" which is sensibly moved to the left to rewind, to the right for fast forward, and toward the operator for record and play modes. Both models will operate either vertically or horizontally and take from 3" to

10½" reels, as well as NAB hubs. Two speeds, 7½ and 3¾ ips, are provided, and flutter is less than 0.2% at the higher speed, less than 0.25% at the lower. Response is from 30 to 15,000 cps ± 2 db at 7½ ips, and 40 to 10,000 cps at 3¾ ips. Equalization is



in accordance with NAB standards, and output is approximately 1.3 volts from cathode followers. Two input jacks are provided for each channel, one for microphone and one for high-level sources. Newcomb Audio Products Co., 6824 Lexington Ave., Hollywood 38, Calif. User net prices: SM-310-4, \$499.50; SM-310, \$499.50.

## NORELCO

• *Stereo Tape Recorder.* Engineered and manufactured by Philips of The Netherlands, the new Continental "400" features half-track stereo playback and quarter-track stereo and monophonic record and playback for tape economy, three speeds—7½, 3¾, and 1½ ips—for versatility, and simple piano-key con-



controls for ease of operation. It is fully compatible with conventional recorded tapes. The unit comprises a tape-drive mechanism, two preamplifiers with controls, two 4-watt power amplifiers, and a Norelco wide-range speaker, all housed in a high-fashion portable carrying case. Also furnished is a Norelco dynamic stereo (dual element) microphone. A second speaker is supplied for stereo playback. Dubbing facilities permit recording sound on sound. The Continental 400 has inputs for recording from microphone, tuners, and phonograph, with facilities for mixing the microphone input with either of the other two. An output jack for monitoring with stereo headphones is also provided. Special Philips magnetic heads with a gap of only 0.00015 in. make possible extended high-frequency response even at lower recording speeds. Frequency ranges at the various speeds are: 7½ ips—50 to 18,000 cps; 3¾ ips—60 to 14,000 cps; 1½ ips—60 to 7000 cps. Noise level is down 55 db, and flutter and wow are less than 0.3 per cent. High Fidelity Products Division, North American Philips Company, Inc., Hicksville, N. Y. User net price, \$399.50.

## ROBERTS

• *Multiple Track Tape Recorder.* Providing multiple recording facilities in one basic unit, the Roberts "Duet" Model 90-D provides both amateur and professional a simple method for multiple recording, sound-on-sound, sound-with-sound. After recording the basic or "master" track, the second simultaneous recording may be made while monitoring the basic recording either through earphones or an external amplifier-speaker system. A simple switching arrangement enables playback of both tracks simultaneously or individual play-

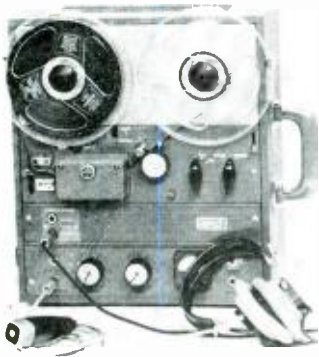

back of either track. Erasure of the second track can be accomplished without erasing the basic track. These features are especially valuable to musicians and vocalists in that they can record accompaniment and background music on the basic channel and record and re-record their own vocal or instrumental parts until they achieve the effect they desire. In addition to its dual recording feature, the "Duet" performs all functions of a half-track monaural and 2-track stereophonic record play unit. Specifications are identical to those of the Roberts 90-C recorder/reproducer. Roberts Electronics Inc., 829 North Highland Avenue, Los Angeles 38, Calif. User net price including headphones and microphone, \$339.50.

990, 4-track ster rec ..... \$450.00

## SUPERSCOPE/SONY

• **Stereo Recorder/Playback System.** Everything required for stereo recording and playback, including two VU meters and two power amplifiers and speakers, is incorporated in the Sony "Stereoorder" Model CS-300. A precision-built instrument in all respects, it incorporates a hysteresis-synchronous drive motor and affords instant selection of 7½ and 3¾ drive speeds. Frequency response is 50 to 15,000 cps ± 2 db at 7½ ips; 50 to



10,000 cps at 3¾ ips. Flutter and wow content are less than 0.15% at 7½ ips and less than 0.25% at 3¾ ips. Stacked high-frequency erase head erases both channels when recording stereo, or one channel (half track) when recording monophonically. Individual level controls are provided for each channel to permit recording sound-on-sound. Automatic tape lifters protect recording heads and tape during fast forward and rewind. Pushbutton operation is provided for on/off, and selection of stereophonic or monophonic mode. Designed for portable use, the CS-300 will satisfy the most fastidious user. Superscope, Inc., Sun Valley, Calif. User net price, \$399.50 including two F-7 microphones.

262-SL, 4-track mono/stereo rec ..... \$199.50  
101, ½-track mono rec ..... 99.50

## STUZZI

• **Portable Transistorized Tape Recorder.** The Stuzzi Magnette is a fully transistorized, battery operated, completely portable tape recorder. Manufactured in Austria, the Magnette weighs only 8 pounds and achieves performance equal to more expensive, heavier units. The self-contained speaker system provides fine tone quality for music, dictation, or conference recording. Vibration proof, the Magnette incorporates a 7-transistor, 2-diode amplifier which provides ample volume and

reliable performance. Other features include a battery life indicator, 3¾ and 1¾ ips tape speeds, usable as a portable PA system, separate motors for fast wind and capstan drive, and can be played through an external amplifier. Easy to load and operate, the Magnette



provides push-button controls, a 3-digit counter, VU level and Magic-eye modulation indicators. Frequency range is 50 to 9000 cps at 3¾ ips; 60 to 4000 cps at 1¾ ips. Distributed in United States by Ercona Corp., 16 West 46th St., N. Y. User net price, \$269.50.

## TANDBERG

• **Stereo Tape Deck.** Feature for feature the Tandberg Series 6 Tape Deck represents magnificent performance in a compact, handsomely styled package. A three-speed machine (7½, 3¾, 1¾ ips) it records 4-track both monophonically and stereophonically, and plays back 4-track. The unique 4-track stacked precision lamellar record head has double mu-metal shielding to give crosstalk rejection of 60 db. Built-in are four separate preamplifiers,



two for recording and two for playback. The pause control achieves precise pick up on stop-and-go recording or playback. Frequency response is 30 to 20,000 cps at 7½ ips; 30 to 15,000 cps at 3¾ ips; and 50 to 7000 cps at 1¾ ips. Flutter and wow are 0.1, 0.2, and 0.25% at the three respective speeds. The Series 6 incorporates a hysteresis synchronous drive motor, military-type printed circuitry, and special toroid-type windings on the power transformer to cancel stray hum. The 4-track stacked erase head selectively erases 1 or 2 tracks. 6 inputs are provided; 2 each for microphone, high level, and low level. Tandberg of America, Inc., 8 Third Ave., Pelham, N. Y. User net price, \$498.00.

5-2, stereo rec/pbk sys ..... \$489.00  
4, mono rec/ster pbk sys ..... 349.50

## TELECTRO

• **Series 900 Tape Decks and TRP-21 Record/Play Amplifier.** The Series 900 offers a variety of facilities in a simple tape-transport mechanism without electronic equipment. For those who wish a complete recording system, including record and play amplifiers and the necessary bias oscillators, the Telectro line includes the Model TRP-21 record/play preamplifier, which provides for recording from low-level microphone input or from a high-level source such as a tuner, and in the play mode has an output of approximately 5.0 volts. Controls on the TRP-21 include a record/play selector, equalization switch, noise balance, and gain control. Recording level is shown by a VU meter. The tape transport itself is available in five forms, depending on the head complement. Model 900-1 is equipped for monophonic recording and playback and for 2- or 4-track stereo playback; 900-2 has

three heads—monophonic erase and play/record heads, and a 4-track stereo head which may be used as a monitor during monophonic recording, or for playing back both 2- and 4-track stereo tapes; 900-3 has two heads, stereo erase and 4-track record/play; 900-4 is equipped only for playback, and has a single 4-track head which will play mono and stereo tapes; 900-5 has three stereo heads, making it possible to monitor a tape during recording. All models are for 3-speed operation—7½, 3¾ and 1¾ ips. Flutter and wow content is less than 0.25 per cent. Signal-to-noise ratio is better than 45 db when used with the TRP-21. Speed accuracy is within NARTB standards. The mechanism employs a single motor with belt drive to the reel hubs and to the capstan, the latter having a large fly-



wheel for speed stability. Transport controls are push-button operated. They include: stop, rewind, wind, play, and pause. The TRP-21 frequency response is 50 to 15,000 cps ± 2 db. Inputs are supplied for a low-level microphone and high-level tuner, with maximum recording level sensitivity of 0.002 volt. Telectroscopic Corporation, 35-18 37th St., Long Island City, N. Y. User net price: Model 900-1 tape transport, \$89.95; 900-2, \$104.00; 900-3, \$101.00; 900-4, \$89.95; 900-5, \$126.25. Model TRP-21 record-play preamplifier, \$124.95.

## UHER

• **Multi-use Stereo Tape Recorder.** Combining a standard tape recorder with a provision for voice operation and automatic slide projector synchronization, the Uher Stereo Record III is an ideal machine for instructional use. Other features which make this machine ideal for school use are the ability to record sound-on-sound—playback on one track while recording on the other—and jam-proof controls. In addition this machine has all the features of a standard four-track stereo/mono machine: ability to play 2 and 4-track tapes, digital counter, hysteresis-synchronous motor, stereo record and playback, 3 speeds, electron-eye level indicators, and a frequency range of 40 to 20,000 cps. The unit is completely



self-contained since playback amplifiers and speakers are built-in. Distributed in United States solely by Warren Weiss Associates, 1650 Broadway, New York 19, N. Y. User net price, \$399.50. Akustomat accessory which provides voice operation and slide projector synchronization, \$44.95.

## VIKING

• **Two-Speed Stereo Integrated Tape Recorder.** The new Viking Stereo-Pro is a high performance integrated tape recorder with dual recording and playback preamplifiers. This unit combines the Viking 85 deck and two Viking RP62 recording amplifiers. The Stereo-Pro is designed for quick set-up and utmost portability. Unit has tape-reel storage compartment



below amplifiers, front-panel mounted high level inputs, microphone jacks, and output jacks for monitoring and music system. The 85 is the finest Viking deck designed for the home music system. Containing two motors—one for record, the other for fast forward, rewind and footage counters—it uses a dual-centric switch knob to control all mechanical operation. The inner knob controls forward, stop, and edit functions, while the outer ring controls fast-forward and rewind. Universal head-mounting bracket permits changing or adding to the head complement at will. All models are equipped with long-wearing laminated heads, tape lifters, non-resonant pres-



sure pads and automatic tape run-out switch. Frequency response is 30 to 14,000 cps  $\pm$  3 db. Signal-to-noise ratio is better than 55 db. Flutter is less than 0.2% at 7½ ips. The RP62 record/playback preamplifier is engineered to match the operating characteristics of the 85 deck. Bias oscillators may be synchronized for stereo recording. NARTB tape equalization is fixed in recording, variable in playback. Distortion is less than 1.0% at indicated normal recording level. Viking of Minneapolis, Inc., 9600 Aldrich Ave., South, Minneapolis, Minn. User net price, Stereo-Pro ES (½-track) \$344.50, Stereo-Pro ESQ (½-track rec/¾ or ¼-track pbk) \$374.50, Stereo-Pro RMQ (¼-track rec/pbk) \$374.50.

Stereo-Compact, 85 deck, two RA72 preamps ..... \$297.50  
85 Series Decks ..... 130-179.50  
RP62 rec/pbk preamp ..... 77.50  
RA72, rec preamp ..... 57.50

## TAPE ACCESSORIES

### BIB

• **Tape Splicer.** An indispensable accessory for any tape recordist, this new British-made splicer is extremely simple to use and can be employed both for mending broken tapes and for editing purposes. Made of nickel-plated brass, the BIB splicer comes mounted



on a flock-sprayed base, or can be mounted directly on any tape deck. The body of the splicer has two pivoted clamps which lock the tape sections in a channel. Both vertical and diagonal mitres are provided for either editing or mending. Horizontal mitres are also provided for use in trimming off surplus mending tape. Distributed in the United States by Ercona Corporation, 16 W. 46th St., New York 36, N.Y. User net price, \$3.95.

### S. G. BROWN

• **Type K Professional Headphones.** Actually two miniature high-quality speakers, the type K headphones can be connected to any sound system, tape recorder, or similar equipment. Frequency range is 50 to over 10,000 cps.



Utilizes a bakelized conical diaphragm and a moving coil type driver. Wired for stereo, they may be utilized for a monophonic system. Sensitivity at 1000 cps is 35 db above 1 dyne/cm<sup>2</sup> for 1 mw input. Will handle inputs up to ¼ watt. Type K headphones come complete with rubber ear cushions and a highly flexible, 6-foot, one piece, nylon covered cable. British Industries Corp., Port Washington, N.Y. User net price, \$28.95 (52 ohm); \$34.50 (600 ohm); \$36.50 (15,000 ohm).

### GOTHAM

• **Dynamic Audiometry Headphones.** Featuring a frequency range of 20 to 15,000 cps and a sensitivity of 25 mv for a sound pressure level of 100 phons, the Beyer DT-48 dynamic headphones are mounted in earcushion enclosures. Their resonance-free performance and the extreme frequency range, together



with very low distortion—less than 0.1% from 50 to 15,000 cps, and less than 0.3% from 20 to 50 cps—makes them ideal for audiometric testing of the human ear, as well as for professional monitoring for recording or broadcast. Extremely rugged, none has been damaged so far by overload. Resistor kit included with each pair makes connection to hi-fi equipment simple, and bridging transformers are available for broadcast monitoring across 600-ohm lines. Gotham Audio Corporation, 2 West 46th St., New York 36, N.Y. User net price, \$79.60.

### KOSS

• **Stereo Headphones.** Extremely useful for the tape recording enthusiast, Koss "Stereophones" model SP-3 provide complete separation of stereo channels. Consisting of a specially designed 3¼-inch reproducer in each earpiece, the SP-3 has a frequency range from 30 to



15,000 cps. Usable in both stereo or monophonic systems, it comes complete with a plug and jack that connects easily to any amplifier or directly across speaker leads. Soft sponge foam ear and headpieces provide comfortable wearing and shut out 95% of outside noise. Impedance 4 ohms. Koss, Inc., 2227 North 31st Street, Milwaukee 8, Wisconsin. User net price, \$24.95.

### MICROTRAN

• **Bulk Tape Eraser.** The Model HD-11 reduces the residual sound level of typical fresh virgin unrecorded tape by 3 to 15 db depending on its previous exposure to stray magnetic fields. In addition it provides a 75-db minimum erasure of saturated magnetic tape. These



demagnetization levels are achieved by using electrical grade laminations combined with a vacuum impregnated heavy duty coil. Spindle mounting of reel permits rapid, thorough coverage without missed spots. Reels from 5 to 10½ inches in diameter are accommodated. Adapter hub for NARTB wheels available. Microtran Company, Inc., 145 E. Mineola Ave., Valley Stream, N.Y. User net price, \$27.50.

Telephone pick-up coil ..... \$4.77

## MICROPHONES

### AKG

• **Dynamic Stereo Microphone.** Manufactured in Austria, the AKG Model D88 is a dynamic microphone suitable for XY or MS stereophonic recording, as well as for monophonic recording.



### CHARACTERISTICS

Frequency range: 80-15,000 cycles (flat, stereo matched frequency response, falling slightly at the low frequency end). Sensitivity of each system: low impedance, -75 db re 1V/dyne/cm<sup>2</sup>; high impedance, -52 db re 1V/dyne/cm<sup>2</sup>. Output impedance of each system: 200 ohms, with transformer, 50,000 ohms. Directional characteristic for stereo recordings: double cardioid (the two systems are so arranged that their directions of maximum sensitivity (live side of microphone) form an angle of 90° to the horizontal). Directional characteristic for monophonic recordings: broadangle cardioid. Unchanged recording direction for stereo and monophonic recordings. Electronic Applications, Inc., 194 Richmond Hill Ave., Stamford, Conn. User net price D88/200, low impedance, \$72.00; D88/HI, high impedance with cable transformer, \$77.50.



## AMERICAN

● **Dynamic and Ribbon Cardioid Microphone.** A versatile microphone of exceptional quality, the American DM330 is made to the most exacting requirements of radio-television broadcasting and motion picture recording. Cardioid, bi-directional or omnidirectional polar patterns. Smooth frequency response from 40 to 15,000 cps. Polar patterns and impedance are quickly changed by removing nameplate and adjusting linkage bars. Combined, matched ribbon and dynamic units incorporate a new principle in the relative placement of pressure and velocity units, resulting in electrical cancellation over an extended frequency range. Built-in, shock-proof mount gives extra protection. "Slide-Lock" permits easy removal from stand. American Microphone Mfg. Co., Division of G. Textron Electronics, Inc., Rockford, Illinois. User net price, \$250.00.

## DYNACO

● **Ribbon Microphones.** Suitable for the highest quality recording and broadcasting applications, the Dynaco-B & O Model 53 microphone uses a replaceable duralumin ribbon only .0001 in. thick and weighing 1.3 milligrams. The extremely small mass eliminates resonances within the audible range. The unit is bidirectional, which allows controlled discrimination of the pick-up area and facilitates

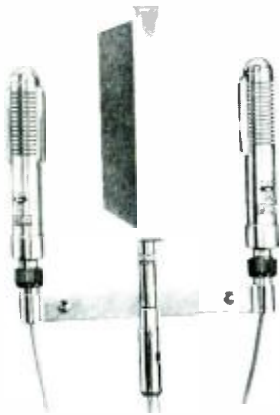

a natural balance of the primary pick-up with room acoustics. When used with the Stereo-Spacer—an acoustically absorbent "partition" between the microphones—these units provide the effect of 10-ft. separation while avoiding unnatural pinging effects typical of poor stereo. A 3-position switch provides music, speech, and off positions, and a built-in transformer enables operation at 50, 250, or high impedances. Model 50 is identical in all particulars except output impedance, which is fixed at 50 ohms.

### CHARACTERISTICS

Frequency range: 30 to 13,000 cps.  $\pm$  2.5 db.  
Pattern: Bidirectional.  
Output impedance: Model 53—50, 250, or high; Model 50—50 ohms.  
Dimensions:  $7\frac{1}{2}$ "  $\times$  1  $\times$   $3\frac{1}{16}$ " dia.  
Dynaco, Inc., 617 N. 41st St., Philadelphia 4, Pa. User net price, Model 53, \$59.95; Model 50, \$49.95.

## ELECTRO-VOICE

● **"Sound Spot" Microphone.** A new concept in directional microphones, the Model 644 was

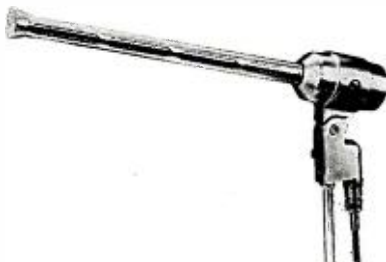

designed to operate at considerable distances from the sound it is picking up. For this reason, it will permit a far greater degree of TV camera flexibility than has heretofore been possible, especially in intimate dialogue scenes where camera placement has been governed largely by the ability of the microphone to pick up voices of the performers. The 644 uses a combination cardioid and distributed front opening, enabling it to maintain proper response far away from a sound source. Its front effective acceptance angle is 45 deg. on each side of center. Random noise cancellation from the rear and sides exceeds 20 db. Frequency response is smooth from 40 to 12,000 cps. Weight is 2 lbs. 9 ozs. Electro-Voice, Inc., Buchanan, Mich. User net price, \$110.00.

## PRIMO

● **Dynamic Microphone.** Designed for use with portable transistorized tape recorders, the DM-168 microphone is a small sealed unit mounted in a molded plastic case and fitted with a remote control switch. Frequency re-



sponse ranges from 100 to 9000 cps with a deviation of 8 db, making it particularly suitable for voice use. Output impedance is 600 or 50,000 ohms, and the switch contacts are capable of controlling 200 ma d.c. at 24 volts. Primo Co. Ltd., 2043 Mure, Mitaka-shi, Tokyo, Japan.

## SONY

● **Variable-Directional-Pattern Condenser Microphone.** The Sony C-37A is designed for professional recording and broadcast application where utmost performance, dependability, and fidelity are essential. Frequency response is stated to be entirely free of resonant peaks and dips within the specified range of 20 to 18,000 cps. The C-37A is operated in conjunction with the Model CI-2 power supply unit. This power supply incorporates a variable switch permitting three different frequency characteristics for complete versatility in any acoustic surroundings. A small screw switch on the back of the microphone housing offers a choice of uni-directional cardioid pattern, or conventional omnidirectional pattern. Microphone and power supply may be separated by as much as 240 feet without affecting performance characteristics.

### CHARACTERISTICS

Frequency response: 20 to 18,000 cps  $\pm$  2.0 db.  
Pattern: Choice of cardioid or omnidirectional.



Output level: Omnidirectional, -72 db; cardioid, -70 db.  
Impedance: 200 ohms.  
Finish: Gray with satin chrome.  
Dimensions:  $7\text{-}11\frac{1}{16}$ "  $\times$  1  $\times$   $1\text{-}13\frac{1}{16}$ " d, with cradle.  
Weight: Microphone, 1 lb. Power supply, 6 lbs.  
User net price, C-37A system complete including power supply, \$295.00.  
Superscope, Inc., Audio Electronics Division, Sun Valley, Calif.  
CR-4, wireless microphone system . . . \$250.00

## TURNER

● **Combination Impedance Dynamic Microphone.** Specifically designed for AM, FM, and TV broadcast use, especially in the studio, the Turner model 210A is also very useful for high fidelity applications and excellent for



stereo recording. Very wide frequency range coupled with smooth response. Non-directional pickup pattern up to 200 cps becoming somewhat directional at the high frequencies. Combination output impedance of 50 ohms (35/80-ohm input) or 200 ohms (150/250-ohm input) selected at the terminal end of cable.

### CHARACTERISTICS

Frequency range: 40 to 20,000 cps.  
Pattern: Omnidirectional.  
Output level: 50-ohm, -86 db; 200-ohm, -80 db.  
Output impedance: 0 db = 1 volt per microbar 50/200 ohm.  
Finish: Non-reflecting neutral brown.  
The Turner Microphone Co., Cedar Rapids, Iowa. User net price, \$125.00. This company makes a complete line of microphones. Write for information.

## MISCELLANEOUS

### CLAROVOX

● **Record Handler.** Especially designed to prevent damage to records during handling, the Clarovox "Miragrip" enables any record to be picked up with ease and firmly held without leaving visible or audible marks, and with no danger of slipping. The pliers-like design is such that the Miragrip can be conveniently used with one hand, as negligible effort is needed to hold the record absolutely firm. The metal handles are chrome-plated and the rubber gripping sleeves are available in a variety of colors. The Miragrip is manufactured by Clarovox Products of Coventry, Eng., and is distributed exclusively in the United States by Ercona Corporation, 16 W. 46th St., New York 36, N.Y. User net price, \$4.95.



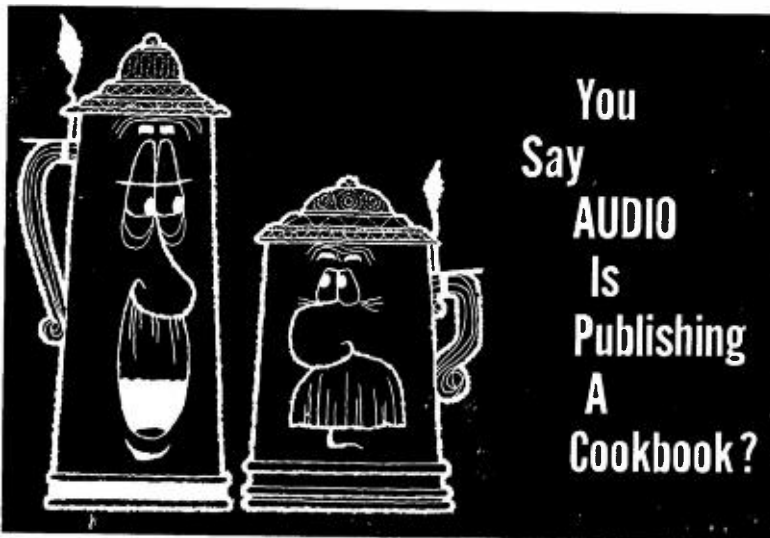

Yes, AUDIO is publishing a cookbook—not that we intend to extend the subject of gastronomy to include recipes in future pages of AUDIO.

You may ask... why?

And we would answer—Simply because we feel that people who read AUDIO, and enjoy the finest quality music reproduction also enjoy really good food on their tables.

Your next question may be... Is it a different kind of cookbook?

Of course our reply would be—Yes! Oh, it doesn't have a revolutionary format and it appears to look like any ordinary cookbook. But, the secret of its goodness is the recipes that fill its 148 pages... recipes responsible for the heart warming, flavorsome, homespun aromas experienced only in the kitchen of an Adirondack country home.

The name of the book is PLACID EATING, and it is chock full of palatempting recipes compiled by Climena M. Wikoff, owner of the Mirror Lake Inn... at (you guessed it) Lake Placid, New York.

Actually, the first edition (now out of print) was discovered by Mr. AUDIO (C. G. McProud) during his stay at Mrs. Wikoff's Mirror Lake Inn, where, in Mr. McProud's own words—"*... every meal is so tasty that eating becomes a real joy, where each night's dessert excels the one from the night before, where one has to*

*push himself away from the table before upsetting the daily calorie count."*

Here is a cookbook that will enable you to recreate in your own homes superb dishes experienced only at the Mirror Lake Inn—dishes like *Lake Trout Baked In Wine* and *Adirondack Apple Pie*, recipes for which are reproduced below—

#### LAKE TROUT BAKED IN WHITE WINE

Remove heads and tails from a 2-pound fish. Split open down back and rinse well. Remove backbone and rub inside with lemon, salt, pepper and thyme to taste. Knead 1 tablespoon of butter and anchovy paste the size of a large pea; placing mixture inside fish. Place fish in a greased baking pan and cover with ½ cup of white wine. Bake 25 to 30 minutes in moderate oven, 350 degrees. Baste frequently. Garnish with parsley and lemon and serve with plain boiled potatoes.

#### ADIRONDACK APPLE PIE

1 c. sugar	3 tbsps. white corn syrup
2 tbsps. sifted flour	6 to 8 tart apples, thinly sliced
½ tsp. grated nutmeg	pastry
½ c. orange juice	
½ c. melted butter	

Mix together the sugar, flour, nutmeg, orange juice, corn syrup and melted butter. Add the sliced apples and mix thoroughly. Butter a pie pan heavily before putting in your pastry. Fill the pie shell with the apple mixture and make pastry strips for the top which should be dipped in melted butter before putting on the pie. Bake in 400 degree oven for 15 minutes; reduce heat to 250 degrees and bake 35 to 40 minutes longer.

This colorful book, plastic bound for easy handling, will contribute many wonderful adventures in food for everyone in the family. Order a copy today, the Lady-of-the-house will adore you for it. Incidentally... it makes a wonderful gift for anyone. PLACID EATING, 152 pages, Plastic Bound: \$3.95.



**RADIO MAGAZINES, INC., Dept. K99**  
P.O. Box 629, Mineola, New York

Enclosed is my remittance of .....  
please send me ..... copies of  
PLACID EATING @ \$3.95 each.  
(No C.O.D., all books sent postpaid in U.S.A. and possessions,  
Canada, and Mexico. Add 50c for Foreign orders.)

NAME ..... ADDRESS .....

CITY ..... ZONE ..... STATE .....

## CONRAC "FLEETWOOD"

• *High-Quality TV Chassis.* The Fleetwood Model 1000 is a wall, partition, or cabinet-mounting 23-inch TV receiver with remarkable audio and visual performance. The sonic wireless remote control tuning unit provides at-the-chair controls for channel changing, volume

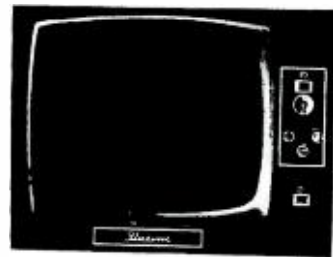

adjust, and on/off. The remote control unit is a fully transistorized transmitter and the receiver is a five-tube, delayed-action system. The Model 1000 uses a 23-inch, 110-degree picture tube which permits an over-all set depth of only 15 27/32 inches. A high-fidelity audio channel affords faithful reproduction. Two separate audio outputs are provided; one for connection to a loudspeaker, the other for connection to a high-fidelity system. Conrac, Inc., Glendora, Calif. Also available as non-remote, model 1010.

## ELECTRODYNE

• *Program Equalizer.* The model 251-A Equalizer is Electrodyne's miniaturization of an instrument that has long been standard for corrective equalization in recording and reproduction of sound. The small size of the 251-A permits mounting close to mixer controls. Two sliding levers are provided—one for equaliza-



tion and the other attenuation. The 251-A is a passive LCR, bridged-T network, which does not require a power supply and therefore can be inserted directly into a transmission line. Impedance is 600 ohms in an out, and insertion loss is 14 db. Electrodyne Corp., 503 South Grand Ave., Santa Ana, Calif. User net price, \$260.00.

1001-A, straight-line mixer control ... \$ 40.00  
201-A, microphone ampli ..... 150.00

## GARRARD

• *Stylus Pressure Gauge.* The Garrard Model SPG3 is an accurate, easy-to-use stylus pressure gauge with an extremely modest price tag. It features a large, legible scale, visible through a clear plastic window, with widely spaced gram markings. It can be used either to check the weight of the tone arm or to set



AUDIO • AUGUST, 1960



a pre-determined weight. It comes complete with a 5-gram brass weight, which is used as a standard so that the unit can be "zeroed" to insure utmost accuracy. The scale pan is plastic to avoid damaging delicate styl. The SP63 can be used with any cartridge or arm. Garrard Division of British Industries Corp., Port Washington, N.Y. User net price. \$2.65.

## HOMEWOOD INDUSTRIES

● **Furniture Finishing Kit.** Furn-A-Finish Kit is intended to aid the "do-it-yourselfer" who is constructing high-fidelity furniture and enclosure kits. Available in mahogany, walnut, golden oak, fruitwood, maple, cherry, ebony, harvest wheat (blond), and natural finishes, the kit comes complete with instructions for



aiding even the most inexperienced finisher. Enough material is supplied to finish 30 square feet with a double coat of top varnish. The kit consists of five containers of finishing material, brush, and three large sheets of 7/0 and 5/0 sandpaper. Home Wood Industries, Inc., 26 Court Street, Brooklyn, N.Y. User net price, \$3.88.

## LAFAYETTE

● **Dual channel VU Balance Meter.** The Lafayette TM-66 provides a solution to the problem of balancing stereo. Utilizing two separate coils in a single magnetic field, each stereo channel feeds a separate coil through a full-wave bridge rectifier. When the signals are equal and balanced the meter will not deflect. Individual channels can be measured separately. Lafayette Electronics Mfg. Corp., 104-46 Dunkirk St., Jamaica 12, N.Y. User net price, \$11.95.

## ROBINS

● **Complete Accessory Line.** Everything the recordist or audiofan needs in the way of conveniences seems to be available from Robins Industries. Included are a bulk tape eraser, record changer covers in three colors, tape reel holders, spot tape eraser, and so on. The changer covers are: model CC-6 in white, CC-7 in brown, and CC-8 in clear, all with list prices of \$6.95. The covers are 15½ x 12 x 5 in. Tape reel holders are designed to hold reels on vertically mounted recorders and to hold warped reels steady. List price is 85¢ for a package of 2. Model SD-1 Strob-Disc provides a simple, easy, and inexpensive check of accuracy of turntable speed simply by viewing with 60-cps light. While the disc may be viewed by incandescent light, the complete kit of disc and neon viewing lamp gives a much easier-read indication. List price of disc and light, \$1.50; disc alone, 50¢. For turntable leveling, the ESK-4 kit will fill the bill. It consists of four adjustable rubber feet for mounting under the turntable base and a level for mounting on the turntable plate. The feet are adjustable in height, allowing exact leveling. List price, \$3.50. Robins Industries Corp., 36-27 Prince St., Flushing 54, N. Y.

## SIGMA

● **Professional 4-Channel Audio Mixer.** The Sigma Model SA3761 is a professional audio mixed which permits mixing four different audio inputs and delivers a common output signal. It was designed expressly for broadcast studios and central sound systems. It will feed directly into the microphone input of Ampex Tape Recorder Models 402, 403, and 350 and, with an adapter cable, into Models 400, 400A, 401, and 401A. The mixed contains four separate amplifiers with individual, professional-grade potentiometers, to adjust gain. The mixed introduces 8 db of gain with all



controls at the maximum position. Frequency response is 50 to 15,000 cps ± 1 db. Total harmonic distortion is less than 0.2% with a 400 cps tone applied at a level of -50 dbm. Noise is at least 68 db below the signal level for an input of -50 dbm. Sigma Electric Co., 11 East 16th St., New York 3, N.Y.

## STATICMASTER

● **Record Brush.** The Staticmaster record brush Model 3R500 employs a polonium strip as a static neutralizer to make cleaning records rapid and simple. The brush of the Staticmaster is made of genuine Jaguar hair which is both strong and soft. Nuclear Products Co., 10173 East Hush St., El Monte, Calif. User net price, \$14.95.



# ELECTRONIC ORGAN KIT

## SCHOBER

● **Electronic Organ Kits.** Offering two models, the Concert and the Consolette, the Schober Organ kits represent a novel approach to the construction of professional musical instruments. By dividing the organ into a number of relatively inexpensive subassembly kits, the individual may assemble the organ as fast or



slowly as he desires, one kit at a time, with a starting investment as low as \$18.94. The Concert Model, when finished, meets the standards of the American Guild of Organists and represents a commercial value of \$3000 to \$4000. Kit cost is approximately half that amount. The Consolette is a full-range organ smaller than a spinet. Its commercial value is more than \$1800. Write for prices and descriptive literature to Schober Organ Corp., 2248 Broadway, New York 24, N.Y.

**THE QUESTION:** Do you know where you can find information about the current articles in magazines about microwaves, loudspeakers, television repairing, electronic musical instruments, traveling-wave tubes, transistor amplifiers, oscilloscopes, or any other electronic subject?

**THE ANSWER:**

# LECTRODEX

FORMERLY

## RADIOFILE

Not a new publication, but one which for over ten years has served engineers, libraries, experimenters, researchers, hobbyists, radio amateurs, radio and TV repairmen, and anyone else connected with radio or electronics. Covers radio, television, electronics, and related subjects, and published bi-monthly as a cumulative index throughout the year, with the last issue of the year an Annual which may be kept as a permanent record of all electronic periodical literature.

**LECTRODEX**—the electronic magazine index—has been expanded to include over twenty five publications in the radio and electronics fields. Sold by subscription only, \$3.00 for one year, \$5.50 for two years. Back Annuals are available for the years 1947, 1949, 1951, 1952, 1953, 1954, 1955, 1956, 1957, 1958 and 1959 at \$1.00 per Annual Postpaid. Order your subscription and Annuals today!!!

**RADIO MAGAZINES, INC.**

P.O. Box 629,

Mineola, N. Y.

# Now!

## LAFAYETTE RADIO EQUIPMENT AVAILABLE THROUGH A SELECT GROUP OF AUTHORIZED FRANCHISED DISTRIBUTORS!

Lafayette Radio, world's foremost electronics and hi-fi supplier, expands its facilities to serve you better. After careful screening, a select group of representatives has been appointed as Authorized Franchised Distributors of Lafayette's own top quality equipment and stereo kits. Lafayette dependability, plus your dealer's reliability and facilities, guarantee you the finest in quality and service. See your authorized dealer, or shop the Lafayette catalog—we know you'll be satisfied.

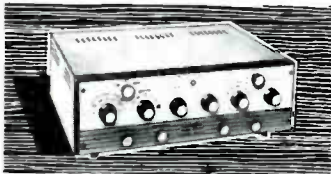

KT-600

### Professional Stereo Pre-Amp Master Control Center

"The Lafayette KT-600 is unquestionably one of the most flexible stereo control units available today. Its flexibility is complemented by overall performance comparable to manufactured units selling for far more than its modest price."

HIGH FIDELITY MAGAZINE—OCT. '59

### Stereo Tuner Kit

"The assurance of success lies in the excellent design of this Tuner, the thoughtful manner in which it was planned for assembly from a kit of parts, the use of RF and IF printed circuit boards in the FM sections, and the very complete illustrations and instructions. You will have reason to be proud and pleased with the results."

HI-FI MUSIC at HOME July-Aug 1958!

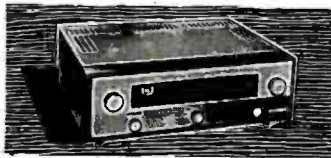

KT-500

### A 50 Watt Integrated Stereo Amplifier Kit

Simplicity, versatility and handsome styling have been integrated into this outstanding 50 watt stereo amplifier (25 watts each channel). A full range of controls and inputs assure complete flexibility. You build an amplifier comparable in every way to a factory wired unit.

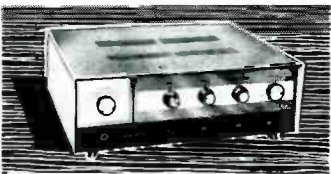

KT-250A

### NOW AT AUTHORIZED LAFAYETTE DISTRIBUTORS

**CALIFORNIA**  
**BERKELEY**  
 zackKIT Corp.  
**LONG BEACH**  
 Kierulff Sound Corp.  
**LOS ANGELES**  
 Kierulff Sound Corp.  
**LOS ANGELES—WEST**  
 Kierulff Sound Corp.  
**ORANGE**  
 Kierulff Sound Corp.  
**PALO ALTO**  
 Zaek Electronics  
**RIVERSIDE**  
 Kierulff Sound Corp.  
**SANTA BARBARA**  
 zackKIT Corp.  
**SAN FERNANDO VALLEY**  
 Kierulff Sound Corp.  
**SAN FRANCISCO**  
 Zaek Electronics  
**SANTA ANA**  
 Kierulff Sound Corp.  
**STUDIO CITY**  
 Kierulff Sound Corp.  
**DELAWARE**  
**WILMINGTON**  
 Almo Radio Co.  
**DISTRICT OF COLUMBIA**  
 Rucker Electronics  
**INDIANA**  
**FT. WAYNE**  
 Ft. Wayne Electronics Supply Co.  
**INDIANAPOLIS**  
 Graham Electronics Supply, Inc.

**INDIANA**  
**MUNCIE**  
 Muncie Electronics, Inc.  
**KENTUCKY**  
**LOUISVILLE**  
 The Golden Ear  
**MARYLAND**  
**BALTIMORE**  
 American Distributing Co.  
 The Hi Fi Shop  
**COLLEGE PK.**  
 Rucker Elec.  
**SALISBURY**  
 Almo Radio  
**SILVER SPRING**  
 Rucker Elec.  
**MASSACHUSETTS**  
**HOLYOKE**  
 KTC Electronics  
**GREENFIELD**  
 Del Padre Supply  
**PITTSFIELD**  
 Del Padre Supply  
**SPRINGFIELD**  
 Del Padre Supply  
**WORCESTER**  
 Del Padre Supply  
**MICHIGAN**  
**ALLEN PARK**  
 KLA Laboratories  
**BIRMINGHAM**  
 KLA Laboratories  
**DETROIT**  
 KLA Laboratories  
 Hudson's Northland  
 Hudson's Downtown

**MICHIGAN**  
**FLINT**  
 KLA Labs.  
**GROSSE POINT**  
 KLA Labs.  
**NEW JERSEY**  
**ATLANTIC CITY**  
 Almo Radio  
**CAMDEN**  
 Almo Radio  
**NEW YORK**  
**BINGHAMPTON**  
 Stack Electronics  
**ELMIRA**  
 Stack Electronics  
**ITHACA**  
 Stack Electronics  
**ROCHESTER**  
 Craig Audio Lab  
**SYRACUSE**  
 W.G. Brown Sound Co.  
**PENNSYLVANIA**  
**NORRISTOWN**  
 Almo Radio  
**PHILADELPHIA**  
 Almo Radio (3 Locations)  
**VIRGINIA**  
**ARLINGTON**  
 Rucker Electronics  
**CANADA**  
**MONTREAL P. Q.**  
 Electronic Tube Co.

# LAFAYETTE RADIO

JAMAICA, N. Y. • NEW YORK, N. Y. • BRONX, N. Y.  
 NEWARK, N. J. • PLAINFIELD, N. J. • BOSTON, MASS.

Circle 88

## ADVERTISING INDEX

Acoustic Research, Inc.	49
Acro Products Co.	2
Advanced Acoustics Corp.	79
AIWA Co., Ltd.	74
Allied Radio Corp.	84
Altec Lansing Corporation	36, 37, 38
American Electronics, Inc.	
American Concertone Division	71
Amperex Electronic Corp.	76
Apparatus Development Corporation	87
Audio Bookshelf	82
Audio Devices, Inc.	13
Audio Fidelity Records	61
Audion	87
Audio Unlimited	87
Bell Telephone Laboratories	18
Bogen-Presto Company	84
Bozak	55
British Industries Corporation	3, 47
Center Electronics Co., Inc.	87
Classified	86
Connoisseur	15
Dynaco, Inc.	78
EICO	11
Electronic Applications, Inc.	5
Electronic Organ Arts	85
Electro-Sonic Laboratories, Inc.	85
Electro-Voice, Inc.	59
Electro-Voice Sound Systems, Inc.	87
Ercona Corporation	15
Fairchild Recording Equipment Corp.	33
Ferrograph	15
Fisher Radio Corp.	9
Fukui Electric (Pioneer)	35
Fukuyo Sound Co., Ltd. (Coral)	87
General Electric	68
Gotham Audio Sales Co., Inc.	87
Grado Laboratories, Inc.	72
International Electronics Corp. (Mullard)	63
JansZen Loudspeakers	65
Jensen Manufacturing Company	57
Key Electronics	87
Kierulff Sound Corporation	87
KLH Research & Development Corporation	62
Koss, Inc.	80
Lafayette Radio	96
Lansing, James B., Sound Inc.	51
Madison Fielding by Crosby Electronics, Inc.	53
McIntosh Laboratories	45
Movie Company, Inc.	79
Neat Onko Denki Co., Ltd.	6
Neshaminy Electronic Corp.	65
Newcomb Audio Products Co.	75
North American Philips Co.	12
Paco Electronics Co., Inc.	83
Pickering & Company	17
Pilot Radio Corporation	7
Primo Company Limited	85
R&A	15
Radio Corporation of America	Cov. 11
Reslo	15
Rider, John F., Publisher	87
Roberts Electronics, Inc.	73
Sansui	80
Sargent-Rayment Co.	81
Scott, H. H., Inc.	69, 77
Sherwood Electronics Laboratories	1
Shure Brothers, Inc.	67
Sonotone Corp.	6
Stereo-Parti	87
Superscope, Inc.	29
Tannov (America) Ltd.	81
Transis-Tronics, Inc.	Cov. 1V
Tung-Sol	14
Uher	64
United Audio	70
University Loudspeakers, Inc.	31
Viking of Minneapolis	Cov. 111
Vitavox	15
Weiss, Warren, Associates	64





## NEW VIKING STEREO-COMPACT IS THE PERFECT MEMORY FOR YOUR HOME MUSIC SYSTEM

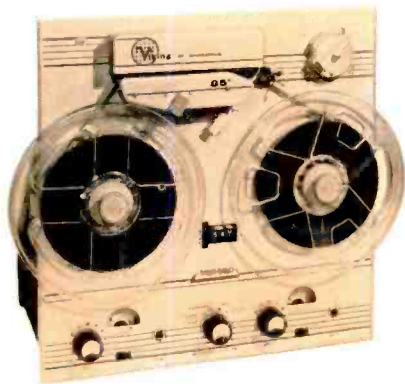

### AVAILABLE IN TWO MODELS:

**STEREO-COMPACT ESQ**—half-track erase and recording heads and short-gap quarter-track play models.

**STEREO-COMPACT RMQ**—Quarter-track recording model with exclusive wide-gap recording head and short-gap play heads.

Both models play  $\frac{1}{4}$  and/or  $\frac{1}{2}$  track stereo tapes.

Viking neatly combines its famous 85 tape deck with the superb RA72 recording amplifiers to give you a stereo unit unequalled for performance and quality.

The "STEREO-COMPACT" enables you to make stereo tapes from records . . . AM/FM broadcasts . . . and live program material with recording fidelity to satisfy the most demanding and simplicity of operation to delight even a beginner.

This package is designed for installation in wall or furniture, mounts in a 12 $\frac{1}{2}$ " square cutout.

Best of all, the Viking "STEREO-COMPACT" is yours at a surprisingly low price. Get complete information . . . visit your authorized Viking dealer or write Viking of Minneapolis.



**Viking** OF MINNEAPOLIS, INC.  
9600 Aldrich Avenue So., Minneapolis 20, Minnesota

*Sold exclusively through quality high-fidelity dealers.*

206600

*TEC has no tubes...TEC alone generates no tube heat, no hum, no microphonics.*

*TEC alone provides such superb transient response. Precision engineering permits TEC to make a two year guarantee on both parts and workmanship. See detailed specifications below and listen to a TEC all transistor amplifier*

*soon for unparalleled sound. General specifications: TEC S-25 stereo preamplifier-amplifier. Power rating: music power output each channel 34 watts.*

*Frequency response: 20-20,000 cps. Harmonic distortion: 0.7%.*

*Intermodulation distortion: 0.9%.*

*Power requirements: 117 vac or 12 to 18 volts dc. 70 watts maximum at full power, less than 15 watts at normal listening levels. Hum: inaudible.*

*16 inputs. Outputs: 4, 8, 16 ohm for each channel, tape recorder outputs for each channel, and a mixed A+B for a 3rd channel.*

*TRANIS-TRONICS INC. (TEC)*

*1650 21st Street, Santa Monica, California*



TEC S-25 STEREO AMPLIFIER 68 WATTS, 34 WATTS EACH CHANNEL

**TEC**

*unique all transistor high fidelity preamplifier-amplifier*

