

# AUDIO

NOVEMBER, 1957  
50¢

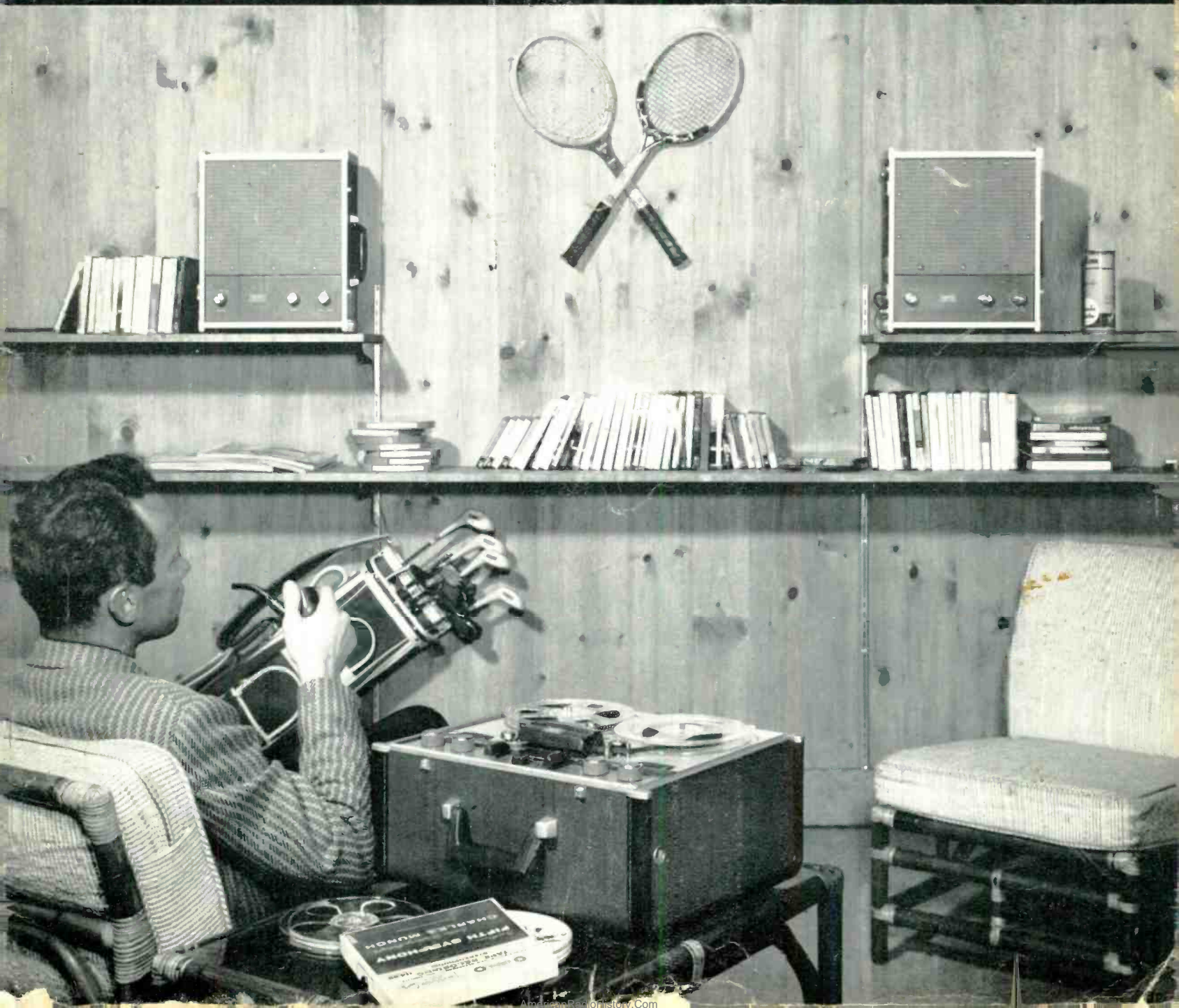

# BOGEN MEANS REALISM



**PR100A AUDIO CONTROL AND PREAMPLIFIER**

You are looking at an instrument so flawless and versatile that it is far ahead of its time. It incorporates every feature you will ever need . . . now or in the future. For instance, the PR100A has *eight* inputs and *two* cathode-follower outputs. Ganged volume controls simultaneously regulate two channels so that you can add "stereo" whenever you wish. Push-button switches permit the instantaneous selection and level adjustment of all program sources. Distortion? *Virtually unmeasurable*. Frequency response? Beyond anything you could ever use. Chassis: \$119.50. Blonde or mahogany-finished enclosure: \$7.50.

**SPECIFICATIONS:** Response: 10 to 100,000 cycles  $\pm 0.5$  db.  
**Front Panel Controls:** High-Frequency Roll-Off (6 positions); Low-Frequency Turn-Over (6 positions); Phono Selector (2 positions); Bass; Treble; Low Filter (5 positions); High Filter (5 positions); Volume; Loudness Contour Selector (5 positions); Input Selector (6 push-button switches): Off, Monitor, Phono, Radio, Tape, Aux.  
**Chassis Controls:** Level Adjust for Phono, Tape, Tuner, and Auxiliary Inputs. Unique Tape Monitor operates while recording.

Write for complete catalog and/or send 25c for 56-page book "Understanding High Fidelity" to Dept. G-11.

David Bogen Co., Paramus, N. J. • A Division of The Siegler Corporation.

**Bogen**  
 HIGH FIDELITY

... because it sounds better

# AUDIO

ENGINEERING MUSIC SOUND REPRODUCTION

**C. G. McProud, Editor and Publisher**

Henry A. Schober, Business Manager  
 Harrie K. Richardson, Associate Editor  
 Joan Dioguardi, Assistant Editor  
 Janet M. Durgin, Production Manager  
 Edgar E. Newman, Circulation Director

**Sanford L. Cahn, Advertising Director**  
 Special Representative—

*H. Thorpe Covington,*  
 814 Lincoln St., Evanston, Ill.,  
 Davis 8-8874

Mid West Representative—  
*Sanford R. Cowan, 300 W. 43rd St.,*  
 New York 36, N. Y.

West Coast Representative—  
*James C. Galloway*  
 6535 Wilshire Boulevard, Los Angeles 48, Calif.



## CONTENTS

Audioclinic— <i>Joseph Giovanelli</i> .....	2
Letters .....	6
Coming Events .....	7
Audio Techniques— <i>Joseph Giovanelli</i> .....	12
Editor's Review .....	16
Stereo Monaural Companion Amplifier for the "Preamp with Presence"— <i>Louis Bourget</i> .....	19
The Dubbings Duplicator— <i>Herman Burstein</i> .....	23
Which Tube Shall I Use?— <i>George Fletcher Cooper</i> .....	30
Two-Channel Mixer for Auricon Film Camera— <i>Donald K. Haahr</i> .....	36
Stereosonic Magnetic Recording Amplifier— <i>Part II—Arthur W. Wayne</i> .....	38
The Forbidden Fruit of Patent Pooling— <i>Albert Woodruff Gray</i> .....	42
Transformers in Transistorized Equipment— <i>Norman H. Crowhurst</i> .....	46
Loudness, Its Definition, Measurement and Calculation, Part I— <i>Harvey</i> <i>Fletcher and W. A. Munson</i> .....	53
Equipment Review— <i>Norelco "Continental" tape recorder—Wharfedale</i> <i>speaker systems—Radio Craftsmen's "Xophonic"—Improved BJ</i> <i>"Super 90" tangential phono arm.</i> .....	60
Record Revue— <i>Edward Tatnall Canby</i> .....	68
Jazz and All That— <i>Charles A. Robertson</i> .....	72
About Music— <i>Harold Lawrence</i> .....	78
New Products .....	80
New Literature .....	83
Audio ETC— <i>Edward Tatnall Canby</i> .....	84
Employment .....	98, 99
Advertising Index .....	100

COVER PHOTO—Donald Wolter, one of the West Coast's leading photographers, relaxed in full enjoyment of his Ampex Portable System A 122-P together with the two matching speaker-amplifiers, Model A692-P.

AUDIO (title registered U. S. Pat. Off.) is published monthly by Radio Magazines, Inc., Henry A. Schober, President; C. G. McProud, Secretary. Executive and Editorial Offices, 204 Front St., Mineola, N. Y. Subscription rates—U. S. Possessions, Canada and Mexico, \$4.00 for one year, \$7.00 for two years, all other countries, \$5.00 per year. Single copies 50¢. Printed in U. S. A. at Lancaster, Pa. All rights reserved. Entire contents copyright 1957 by Radio Magazines, Inc. Entered as Second Class Matter February 9, 1950 at the Post Office, Lancaster, Pa. under the Act of March 3, 1879.

**RADIO MAGAZINES, INC., P. O. Box 629, MINEOLA, N. Y.**



**GUY LOMBARDO**  
 makes his tape  
 recordings on



**That's not  
 the reason why  
 you should use**



**Here's why  
 you should use**



It's the best-engineered tape in the world ... gives you better highs... better lows... better sound all around! Saves your tape recorder, too—because the **IRISH FERRO-SHEEN** process results in smoother tape ... tape that can't sand down your magnetic heads or shed oxide powder into your machine. Price? Same as ordinary tape!



Available wherever quality tape is sold.  
**ORR**Radio Industries, Inc., Opelika, Alabama  
 Export: *Morhan Exporting Corp., New York, N. Y.*  
 Canada: *Atlas Radio Corp., Ltd., Toronto, Ontario*

# ● Are you Listening...

to full frequency range without getting what's really more important . . . definition?

Definition is that clarity of detail that enables the listener to identify, clearly and distinctly, all the instruments of a full orchestra even when played together in tumultuous crescendo.

Good definition depends upon good transient response, i.e. the instantaneous reaction of a speaker system to both the beginning and end of each signal impulse.

It is impossible for resonant speaker systems to produce good transient response because the resonances created by one signal overlaps, and blends with, succeeding ones, so that the result is a fusion of tones rather than distinct tonal entities.

Poor definition may be caused by a loudspeaker that does not respond quickly to signal impulses, or a resonant enclosure, or both.

The patented Bradford Baffle is non-resonant. Therefore, with a signal-responsive speaker, not only full range, but sharp definition . . . the true test of a superior speaker system . . . is obtained.

If you want definition as well as highs and lows, house your speaker in a Bradford Baffle. And remember, also, no boom . . . ever.

These better Baffles are available in two sizes: 12" x 12" x 9" for 8s and 10s; 17" x 17" x 14" for 12s and 15s. Finest construction and finish throughout. All panels ¾"; genuine mahogany, korina blond, walnut and ebony veneers, and unfinished birch. From \$34.50 to \$69.50.

Join the thousands of smug, sophisticated Bradford Baffle Fans who now dig definition as well as highs and lows. They know that if you don't get definition . . . you don't get real hi fi.

Write for literature . . .  
and become sound happy.

## Bradford & Company

27 East 38th St., New York 16, New York  
Circle 104A

# AUDIOCLINIC??

JOSEPH GIOVANELLI\*

## Microphone Phasing

*Q. I own a microphone mixer capable of handling the outputs of two microphones. The mixer is quite stable in that the channels do not interact with each other. I determined this by connecting a microphone to one channel and, while leaving the other input open, rotating the gain control to maximum while talking into the microphone. Rotating the control caused no change in the output of the driven channel. I checked the other channel with the same result. Yet, when I connect microphones into both channels and talk into both of them, increasing the gain of either channel causes the output to decrease. What would cause this undesirable effect? Raymond E. Leonard, Poughkeepsie, N. Y.*

*A. In all probability, the microphones are out of phase with each other. If this is so, output from both channels will combine in the output of the mixer in such a manner as to cancel each other partially. This condition is easily remedied by reversing the leads to one of the microphones. In the case of microphones which make use of two-conductor shielded cable, interchange the connections of the conductors, leaving the shield connected to its grounding point. If the microphones have selectable directional characteristics and are close enough to be in the same sound field, they should be set to have the same pickup pattern. When bidirectional microphones are employed, be sure that all action takes place on the same side of both microphones.*

## Delayed AVC

*Q. What is delayed AVC and what is its purpose? George Lystad, Lake City, Ark.*

*A. The purpose of AVC is to keep the audio output of the receiver relatively constant, regardless of the strength of the received signal. This is accomplished by rectifying the signal voltage and connecting it in such a manner as to make the grids of the r.f. and i.f. stages more and more negative as signal strength increases. Thus, the receiver is more sensitive to weak signals than it is to strong ones. No matter how weak the signal, some voltage is fed back, thereby reducing the sensitivity of the receiver. Obviously, when reception of weak signals is to be accomplished, the receiver must operate at maximum sensitivity. This cannot be done when the AVC is operating, as previously noted. Therefore, means must be provided to make the AVC operate only when signals reach at least a moderate strength. This can be done with a manual switch connected in the AVC bus which removes it from the tube circuits. There is also an automatic means for accomplishing this.*

\* 3420 Newkirk Ave., Brooklyn 3, N. Y.

Two diodes are needed for this circuit. One is connected in the conventional manner, and is used to demodulate the signal. The other is used only to develop AVC. The plate of this diode is biased negative with respect to its cathode by the desired amount. Weak signals will not develop sufficient voltage to overcome this bias but, as signal strength increases, the diode will conduct and form AVC in the usual manner. Since the AVC is not operative until the signal reaches a predetermined strength, this system is known as delayed AVC (DAVC). The use of two diodes is mandatory here, since if only one were used, it would fail to conduct at all on weak signals, and even when it did start to conduct, less than half of the cycle would be reproduced, leading to distortion.

## Aligning TRF Receivers

*Q. What is the procedure for aligning TRF receivers? John Maher, Canton, Ohio*

*A. TRF receivers consist of one or more tuned circuits, all of which are tuned to the same frequency, plus a detector and/or one or more r.f. stages. Usually there is a tuned circuit for each stage, including that of the detector. Sometimes, though, two tuned circuits are loosely coupled together directly, in which case there are more tuned circuits than there are amplifier and detector stages. The capacitors for each tuned circuit are mounted on a common shaft, so that when the shaft is rotated, the frequencies of all the circuits will be changed at the same time and by the same amount. Each tuning capacitor is fitted with a trimmer which exactly resonates it with its associated inductance. Some of the better circuits employ variable inductances or padder capacitors, so that the low-frequency end of the dial may be brought into exact resonance. (The trimmers are for resonating the high end of the dial.)*

Alignment, therefore, is simple. Set the tuning dial of the receiver at 1400 kc. Use a signal generator and set its frequency to 1400 kc also. Connect its output terminals to the antenna and ground terminals of the receiver. If the generator can be modulated, connect an output meter across the speaker terminals. If the receiver possesses AVC, you need not modulate the output of the generator, but instead, you may measure the AVC voltage with a d.c. VTVM. When adjusting tuned circuits, adjust for maximum reading on these meters. If no meter is available, output intensity may be noted aurally, since only relative strength, and not absolute signal strength, is of interest. Adjust all circuits for maximum output. Some sets possess no further means for adjusting resonance. For those of you whose receivers permit further adjustment, we continue as follows. Reset the signal generator and receiver tuning dial to 600 kc and adjust the proper circuit elements for maximum output. It will be

Garrard models change. Garrard ideals do not. Meaningful new features are added. Time-proven features are carefully retained. Gadgets, for the sake of gadgetry, are sternly rejected. The all-important fact to remember is that thirty-five years of experience in designing, testing, and building fine record players, guide us in offering you the present Garrard models.

# Garrard

**WORLD'S FINEST  
RECORD PLAYING  
EQUIPMENT**



*There's a Garrard for every high fidelity system*



**Model 301 PROFESSIONAL  
TRANSCRIPTION TURNTABLE**  
—Each speed variable!  
—Each unit with its own  
performance test report. \$89.00



**Model RC98 4-SPEED SUPER  
AUTO-MANUAL CHANGER**  
—Continuous + or — variable  
control on all speeds. \$67.50



**Model TPA/10 TRANSCRIPTION TONE ARM**  
—Professional performance,  
—Jewel-like construction  
—and exceptional  
—versatility. \$24.50



**Model RC88 4-SPEED DELUXE  
AUTO-MANUAL CHANGER**  
—Exclusive pusher platform  
protects your records. \$54.50



**Model T Mark II  
4-SPEED MANUAL PLAYER**  
—A superior unit for quality  
budget systems. \$32.50



**Model RC121 4-SPEED MIXER  
AUTO-MANUAL CHANGER**  
—Fine performance with economy  
and compactness. \$42.50

*For Information Write.*

**GARRARD SALES CORPORATION, Dept. GS-17, PORT WASHINGTON, N. Y.**

# COMING

## To Your City . . .

### HIGH FIDELITY SHOWS

**SEE and HEAR the latest in HIGH FIDELITY from leading high fidelity manufacturers . . .**

Don't miss these public showings of Hi-Fi Equipment . . . from the most economical units for the budget-minded to spectacular home music theatres . . . compare and enjoy them all.

\*Complete Hi-Fi Systems and Components.

\*Amplifiers — Pre-Amplifiers — FM-AM Tuners — Turntables and Record Changers — Phono Cartridges — Microphones — Music Control Centers — Speakers.

\*Speaker Enclosures and Equipment Cabinets — Finished and Assembled or Do-It-Yourself Kits.

**THREE FULL DAYS OF CONTINUOUS DEMONSTRATIONS FROM 1 P.M. TO 10 P.M. FOR EACH SHOW**

#### Rigo Shows 1957

Nov. 8, 9, 10	Seattle	New Washington Hotel
Nov. 22, 23, 24	St. Louis	Statler Hotel
Jan. 10, 11, 12	Minneapolis	Dyckmann Hotel
Jan. 31, Feb. 1, 2	Milwaukee	Pfister Hotel

**ADMISSION 50¢**

**RIGO Enterprises Inc.** 500 N. Dearborn, Chicago 10, Ill.

necessary to repeat both of these steps two or three times, since the adjustment of one end of the dial has an adverse effect upon that of the other. A point will finally be reached where further adjusting does not cause an increase in output.

If a signal generator is not available you may use broadcast stations whose frequencies are approximately those specified earlier. Of course, they must have sufficient strength to overcome the misalignment at least enough to be detectable.

Even though some sets do not have provision for tracking the low end, a certain amount may still be accomplished by bending portions of the rotor plates on the variable capacitor inward or outward so as to establish resonance.

#### Ghost and Echo

*Q. What are ghost and echo? Jay Sharpe, Oakland, Cal.*

A. These are annoying disturbances which can occur as over-recorded discs are played back. When an instantaneous lacquer disc is cut, a spiral is cut into the surface. As signal is fed into the cutting head, the cutting needle moves laterally in accordance with the frequency and amplitude of the program material. Because of this motion, the spiral generated is no longer uniform, so that at certain times the grooves are closer to each other than at other times. Lacquer is fragile, and so, if the sideward motion is made too great (over-recording), the wall of the preceding groove is broken through, or at least deformed slightly, and the playback stylus will not track properly. If the wall is not actually cut into, it can become distorted, with this distortion taking the form of the modulation envelope being impressed. In this manner, the groove immediately preceding the one in which over-recording occurred will have both the impression of the signal originally intended and that of the signal intended for the groove following. This latter impression is not as loud as the desired signal, but is nevertheless quite audible. These faint tracings are known as ghost.

*Echoes* are created as the cutting needle swings in the direction of what will be the succeeding groove. The needle hits the land on this half-cycle so violently that internal pressure is built up, whose amount varies in accordance with the modulation of the groove being recorded. Most of the time, this pressure is removed when the following groove is cut, but in some instances it remains and distorts the newly cut groove wall to the shape of its predecessor. Playing back such a groove reveals a faint trace of the material just heard. This faint after-sound is known as *echo*; it is necessarily far more rare than ghost, because of the tremendous force needed to distort uncut acetate or lacquer.

#### Low Filament Voltage

*Q. I have been interested in the reproduction of recorded music for many years and have recently begun to build amplifiers and preamplifiers for my use. A new project involves application of d.c. to filaments of the preamplifier stages. I have constructed a d.c. power supply which*  
(Continued on page 92)



*unquestioned masterpieces of precision*

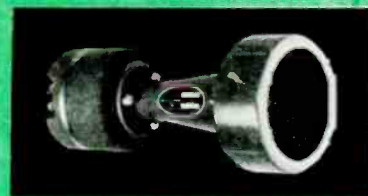

The 200 inch Palomar telescope weighs 425 tons. Yet the distribution of weight was so carefully calculated, the bearings so cleverly contrived, the parts constructed with such meticulous precision that this great mass is moved smoothly and accurately with a 1/12th horsepower motor. Realistic reproduction of music requires loudspeakers made with the greatest precision ... the kind of exquisite precision that distinguishes JBL Signature transducers. Carefully calculated tolerances, exacting assembly, original design concepts give JBL Signature speakers their extremely high efficiency, their smooth, clean sound. There is as much difference in precision between an ordinary loudspeaker and a JBL transducer as there is between a toy telescope and an astronomical observatory. For the name and address of the Authorized JBL Signature Audio Specialist in your community and a free copy of the new JBL catalog write ...

*"JBL" means* **JAMES B. LANSING SOUND, INC.**

*3249 Casitas Avenue, Los Angeles 39, California*

if  
you  
can  
press  
a  
button

you  
can  
enjoy  
the  
best  
in Hi-Fi

be sure your system includes

**MIRACORD  
XA-100**

THE ONLY 2-IN-1 FULLY AUTOMATIC  
CHANGER AND AUTOMATIC MANUAL PLAYER



MIRACORD XA-100 is the 4 speed record changer that makes Hi-Fi easy for everyone. It does everything *automatically*, at the push of a button . . . starts, stops, repeats, pauses, filters! It intermixes 10" and 12" records! It changes from automatic to manual in a moment. And it has the unique "free-wheeling" tone arm that *can't jam!* No other record-player has *all* these features! So get a MIRACORD XA-100, if you're assembling your own system . . . or having your dealer hook-up a system for you! **\$67<sup>50</sup>**

*...and for transcription quality  
in a 4-speed manual player...*

**MIRAPHON  
XM-110A**

at only **\$37<sup>50</sup>**  
complete with every feature to  
satisfy the most critical listener!

*ask your dealer for a demonstration*

FAR AHEAD THE FINEST BY FAR



**AUDIOGERSH CORP.** 514 BROADWAY, NEW YORK 12, N. Y.  
WORTH 6-0800 IN CANADA: Atlas Radio Corp., Ltd., Toronto

## LETTERS

### Transistor Symbols

SIR:

Although I have expressed myself on the transistor symbol question before (*Radio-Electronics*, January, 1957, p. 22) I feel a special responsibility to answer your editorial (September, 1957) since you have presented many of my articles on transistors.

Most criticism on the present symbol is not justified. If one were to start from scratch to think up a symbol for a three-terminal device which had to show polarity and differentiate between all the leads, he could hardly do better than select the present transistor one. It is simple, easy to recognize, hard to misunderstand, and easy to draw. Even when drawn quickly it is understandable. It has no intricate, small designs which would tend to reproduce poorly in a mimeograph or hectograph process, and it is easy to remember.

I have seen no better alternatives. Mr. Waldhauer's symbol takes about half again as long to draw, it has two small circles to fill up with ink being mimeographed, and it can be mistaken for a vacuum tube when drawn quickly. It does no good to argue that when drawn correctly it cannot be mistaken—all of us know how often important diagrams are scribbled on scraps of paper or restaurant napkins. And so it goes for the rest of the proposed symbols.

It is certainly a mistake to try to make the transistor symbol resemble the vacuum-tube one. This would not only lead to confusion between the two but would also beguile newcomers into thinking that there is a real similarity of action, which of course there is not.

Perhaps it is unfortunate that the point contact transistor has the same symbol, but point-contact transistors are virtually dead now, and if revived later could be given a new symbol. Certainly even now it would be easier to change the point-contact symbol than the junction transistor design.

And it is not quite right to imply (as in your editorial) that the present symbol is not standardized. Although not included in ASA Y32.2-1954 (same as 54 IRE 21.S1) the present symbol is listed by the military in MIL-STD-15A, dated 1 April 1954, and was further used (although not standardized) in the IRE Standards on Solid-State Devices: Methods of Testing Transistors 1956 (56 IRE 28.S2). With the notable exception of Mr. Waldhauer, his co-workers and followers, the industry is virtually solidly behind the present symbol.

For these reasons I believe it would be a real mistake for AUDIO to start using a different symbol, especially so without signs of co-operation from other magazines, authors, and standardization committees.

PAUL PENFIELD, JR.,  
269 Westgate West,  
Cambridge 39, Mass.

*(We'll go along with Mr. Penfield's recommendation, which expresses essentially the same opinion as that of many other readers. Ed.)*



**Addresses**

SIR:

Correspondence resulting from my article, "Two-channel remote mixer amplifier," in the September issue points out that International Instruments, Inc., P. O. Box 2954, New Haven 15, Conn., does not advertise adequately. Several letters have included a request for the address of this company. I have forwarded this information to them and suggested that AUDIO, because of this article, might be a good bet for them.

One card received said the following: "Re: Article in September AUDIO magazine. Can you supply address of International Instruments, or tell me where I can purchase VU meter made by I.I.?" Card was postmarked Elizabeth, N. J., but the inquirer did not include his return address. Perhaps he will read this and have his answer.

DONALD K. HAAHR,  
Liaison and Planning Engineer,  
Radio-Television Service,  
Iowa State College of Agriculture  
and Mechanic Arts,  
Ames, Iowa.

(Don't feel too bad, Mr. H. We get Reader Service Cards every month that have the numbers circled properly, but with no indication of who sent them. Ed.)

**Record Treatment**

SIR:

The charming lady pictured on the October cover of AUDIO has never been taught to handle records!

W. L. KNAUS,  
1299 Stratford Road,  
Schenectady 8, N. Y.

(Maybe she'll read this and take lessons. And if you don't want to teach her, we'll volunteer. Ed.)

**COMING EVENTS**

**HI FI SHOWS**

- Nov. 8-10—Seattle: New Washington Hotel (*Rigo*).
- Nov. 8-10—Detroit: Detroit-Leland Hotel (*IHF*).
- Nov. 15-17—Dallas: Statler-Hilton Hotel (*Independent*).
- Nov. 22-24—St. Louis: Statler Hotel (*Rigo*).
- Jan. 10-12—Minneapolis: Dyckmann Hotel (*Rigo*).
- Jan. 31-Feb. 2—Milwaukee: Pfister Hotel (*Rigo*).
- March 14-16, 1958—Washington: Shoreham Hotel (*Independent*).

**OTHER EVENTS**

- Nov. 11-13—Radio Fall Meeting, IRE, King Edward Hotel, Toronto, Canada.
- Nov. 13-14—Mid-America Electronic Convention, IRE, Municipal Auditorium, Kansas City, Mo.
- Nov. 15!16—New England Radio Engineering Meeting, IRE, Mechanics Bldg., Boston, Mass.
- Nov. 20—Chicago Acoustical and Audio Group. "Ultrasound: Biological Effects and Medical Applications," Jerome W. Gersten, M.D., Univ. of Colo. School of Medicine. Meeting at 8:00 p.m. at Stritch School of Medicine, Loyola University.

# MIRATWIN

world famous quality cartridge brings out  
**THE BEST IN ANY  
HI-FI SYSTEM!**

**MIRATWIN**

*mst-1 single*

with diamond stylus for LP  
or standard diamond stylus

Formerly \$34.50 **NOW \$26.50**



**MIRATWIN**

*mst-2 turnover*

with sapphire stylus  
for standard and diamond  
stylus for microgroove

Formerly \$45.00 **NOW \$31.50**



**NOW AT NEW LOW PRICES!**

If you have a hi-fidelity system, bring out its finest tonal values with MIRATWIN.

Because MIRATWIN is as smooth and sensitive a cartridge as man can make... faithfully transmits the *complete* recorded sound! Acclaimed by audio engineers and music appreciation enthusiasts alike, MIRATWIN fits *all* standard tone arms, has instant stylus replacement. Enjoy it in your hi-fidelity system for the *best* in recorded music! Recommended tracking force when used in separate tone arms 4 to 8 grams; in record changers 6 to 8 grams. Ask your dealer to give you an A-B Test today.

**MIRATWIN CARTRIDGES**

- MST-1D Single Diamond \_\_\_\_\_ \$26.50
- MST-1S Single Sapphire \_\_\_\_\_ 10.00
- MST-2D Dual-1 Sapph., 1 Diam. \_ 31.50
- MST-2A Dual Sapphire \_\_\_\_\_ 15.00

**REPLACEMENT STYLI**

- DM-2 Micro-Diamond \_\_\_\_\_ \$16.50
- DN-2 Standard Diamond \_\_\_\_\_ 16.50
- SM-2 Micro-Sapphire \_\_\_\_\_ 5.00
- SN-2 Standard Sapphire \_\_\_\_\_ 3.00

FAR AHEAD > THE FINEST BY FAR



**AUDIOGERSH CORP.** 514 Broadway, New York 12, N. Y.

WORTH 6-0800 IN CANADA: Atlas Radio Corp., Ltd., Toronto



*treat your family  
to all the fun and enjoyment  
of fine high fidelity at  
one-half the price you  
would expect to pay*

**HERE'S ALL YOU NEED**

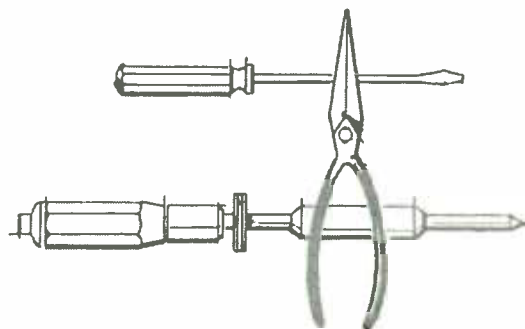

*to build your own*



**HI-FI**



**HEATHKIT  
HIGH FIDELITY FM TUNER KIT**

This FM tuner is your least expensive source of high fidelity material! Stabilized oscillator circuit assures negligible drift after initial warmup. Broadband IF circuits assure full fidelity, and 10 microvolt sensitivity pulls in stations with full volume. High-gain cascode RF amplifier, and automatic gain control. Ratio detector gives high-efficiency demodulation. All tunable components prealigned. Edge-illuminated dial for easy tuning. Here is FM for your home at a price you can afford. Shpg. Wt. 7 lbs.

**MODEL FM-3A \$25.95 (with cabinet)**

**HEATHKIT  
BROADBAND AM TUNER KIT**

This tuner differs from an ordinary AM radio in that it has been designed especially for high fidelity. The detector uses crystal diodes, and the IF circuits are "broadbanded" for low signal distortion. Sensitivity and selectivity are excellent. Quiet performance is assured by 6 db signal-to-noise ratio at 2.5 uv. All tunable components prealigned. Incorporates AVC, two outputs, and two antenna inputs. Edge-lighted glass slide rule dial for easy tuning. Your "best buy" in an AM tuner. Shpg. Wt. 8 lbs.

**MODEL BC-1A \$25.95 (with cabinet)**

**HEATHKIT "MASTER CONTROL"  
PREAMPLIFIER KIT**

This unit is designed to operate as the "master control" for any of the Heathkit Williamson-type amplifiers, and includes features that will do justice to the finest program material. Frequency response within  $\pm 1\frac{1}{2}$  db from 15 to 35,000 CPS. Full equalization for LP, RIAA, AES, and early 78's. Five switch-selected inputs with separate level controls. Bass and treble control, and volume control, on front panel. Very attractively styled, and an exceptional dollar value. Shpg. Wt. 7 lbs.

**MODEL WA-P2 \$19.75 (with cabinet)**

**HEATHKIT "BASIC RANGE"  
HIGH FIDELITY SPEAKER SYSTEM KIT**

The very popular model SS-1 Speaker System provides amazing high fidelity performance for its size because it uses high-quality speakers, in an enclosure especially designed to receive them.

It features an 8" mid-range-woofer to cover from 50 to 1600 CPS, and a compression-type tweeter with flared horn to cover from 1600 to 12,000 CPS. Both speakers are by Jensen. The enclosure itself is a ducted-port bass-reflex unit, measuring 11½" H x 23" W x 11¾" D and is constructed of veneer-surfaced plywood, ½" thick. All parts are precut and pre-drilled for quick assembly.

Total frequency range is 50 to 12,000 CPS, within ±5 db. Impedance is 16 ohms. Operates with the "Range Extending" (SS-1B) speaker system kit later, if greater frequency range is desired. Shpg. Wt. 30 lbs. **MODEL SS-1 \$39.95**

**HEATHKIT "RANGE EXTENDING"  
HIGH FIDELITY SPEAKER SYSTEM KIT**

The SS-1B uses a 15" woofer and a small super-tweeter, to supply very high and very low frequencies and fill out the response of the "Basic" (SS-1) speaker system at each end of the audio spectrum. The SS-1 and SS-1B, combined, provide an overall response of ±5 db from 35 to 16,000 CPS. Kit includes circuit for crossover at 600, 1600 and 4000 CPS. Impedance is 16 ohms, and power rating is 35 watts. Measures 29" H x 23" W x 17½" D, and is constructed of veneer-surfaced plywood, ¾" thick. Easy to build! Shpg. Wt. 80 lbs.

**MODEL SS-1B \$99.95**

*...and save!*

**HEATHKIT "LEGATO"  
HIGH FIDELITY SPEAKER SYSTEM KIT**

The fine quality of the Legato Speaker System Kit is matched only in the most expensive speaker systems available. The listening experience it can bring to you approaches the ultimate in esthetic satisfaction.

Frequency response is ±5 db 25 to 20,000 CPS. Two 15" theater-type Altec Lansing speakers cover 25 to 500 CPS, and an Altec Lansing high frequency driver with sectoral horn covers 500 to 20,000 CPS. A precise amount of phase shift in the crossover network brings the high-frequency channel into phase with the low-frequency channel to eliminate peaks or valleys at the crossover point. This is one reason for the mid-range "presence" so evident in this system design.

The attractively styled "contemporary" enclosure emphasizes simplicity of line and form to blend with all furnishings. Cabinet parts are precut and predrilled from ¾" veneer-surfaced plywood for easy assembly at home. Impedance is 16 ohms. Power rating is 50 watts for program material. Full, smooth frequency response assures you of outstanding high fidelity performance, and an unforgettable listening experience. Order HH-1-C (birch) for light finishes, or HH-1-CM (mahogany) for dark finishes. Shpg. Wt. 195 lbs.

**MODELS HH-1-C or HH-1-CM \$325.00 each**



A subsidiary of Daystrom, Inc.  
Benton Harbor 25, Mich.



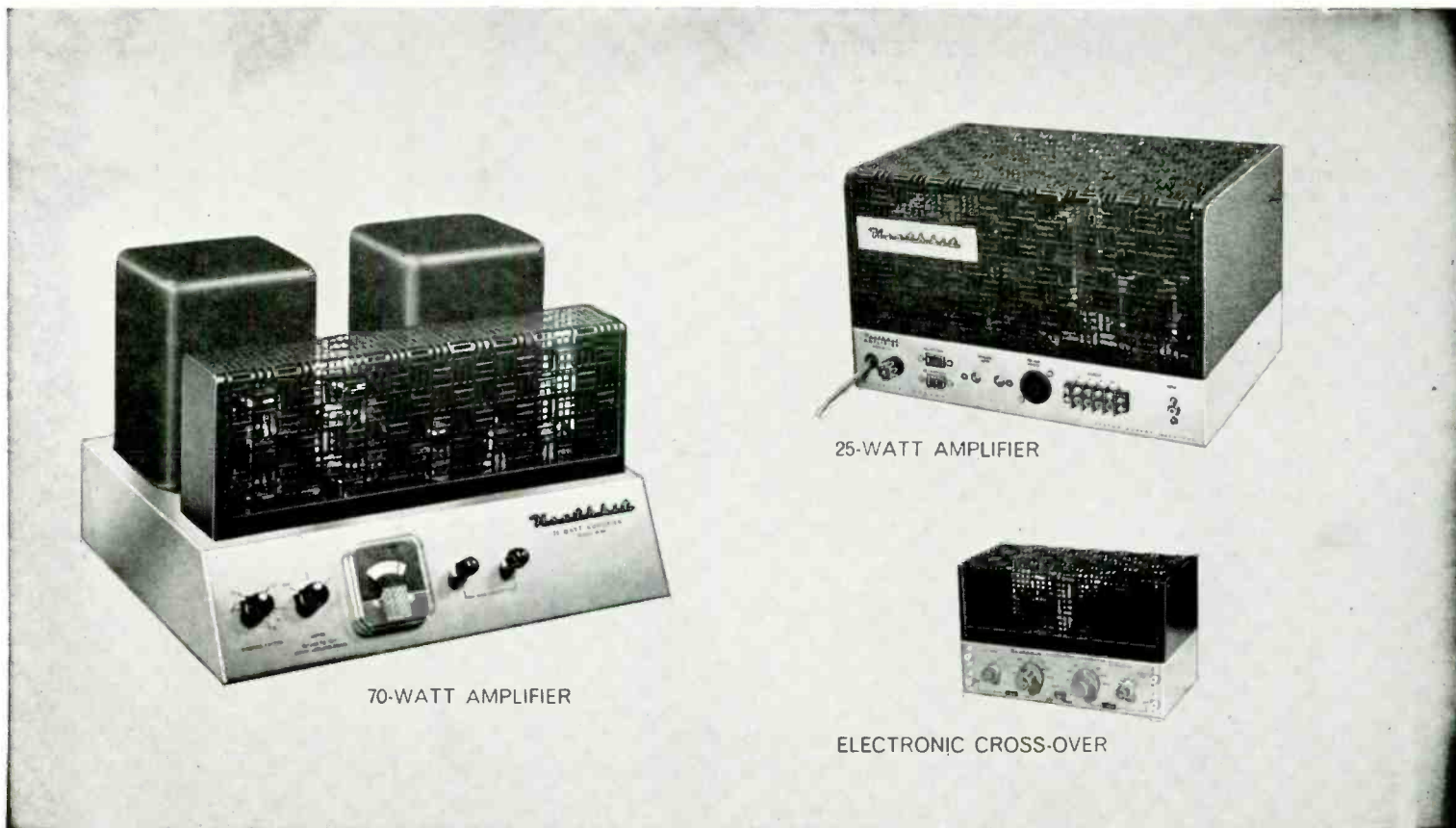

70-WATT AMPLIFIER



25-WATT AMPLIFIER

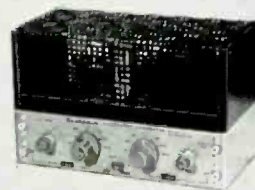

ELECTRONIC CROSS-OVER

*easy-to-build designs by* **HEATH** *insure*

You get more comprehensive assembly instructions, higher quality circuit components, and more advanced design features, when you buy HEATH hi-fi!

**HEATHKIT 70-WATT HIGH FIDELITY AMPLIFIER KIT**

This new amplifier features extra power reserve, metered balance circuit, variable damping, and silicon-diode rectifiers, replacing vacuum tube rectifiers. A pair of 6550 tubes produce full 70-watt output with a special-design Peerless output transformer. A quick-change plug selects 4, 8 and 16 ohm or 70 volt output, and the correct feedback resistance. Variable damping optimizes performance for the speaker system of your choice. Frequency response at 1 watt is  $\pm 1$  db from 5 CPS to 80 KC with controlled HF rolloff above 100 KC. Harmonic distortion at full output less than 2%, 20 to 20,000 CPS, and intermodulation distortion below 1% at this same level. Hum and noise are 88 db below full output. Variable damping from .5 to 10. Designed to use WA-P2 preamplifier. Express only. Shpg. Wt. 50 lbs. **MODEL W-6M \$109.95**

**HEATHKIT 25-WATT HIGH FIDELITY AMPLIFIER KIT**

The 25-watt Heathkit model W-5M is rated "best buy" in its power class by independent critics! Faithful sound reproduction is assured with response of  $\pm 1$  db from 5 to 160,000 CPS at 1 watt, and harmonic distortion below 1% at 25 watts, and IM distortion below 1% at 20 watts. Hum and noise are 99 db below rated output, assuring quiet, hum-free operation. Output taps are 4, 8 and 16 ohms. Employs KT66 tubes and Peerless output transformer. Designed to use WA-P2 preamplifier. Express only. Shpg. Wt. 31 lbs. **MODEL W-5M \$59.75**

**HEATHKIT ELECTRONIC CROSS-OVER KIT**

This device separates high and low frequencies electronically, so they may be fed through two separate amplifiers driving separate speakers. The XO-1 is used between the preamplifier and the main amplifiers. Separate amplification of high and low frequencies minimizes IM distortion. Crossover frequencies are selectable at 100, 200, 400, 700, 1200, 2000, and 3500 CPS. Separate level controls for high and low frequency channels. Attenuation is 12 db per octave. Shpg. Wt. 6 lbs. **MODEL XO-1 \$18.95**

**HEATHKIT W-3AM HIGH FIDELITY AMPLIFIER KIT**

Features of this fine Williamson-type amplifier include the famous Acrosound model TO-300 "ultralinear" transformer, and 5881 tubes for broad frequency response, low distortion, and low hum level. Response is  $\pm 1$  db from 6 CPS to 150 KC at 1 watt. Harmonic distortion is below 1% and IM distortion below 1.3% at 20 watts. Hum and noise are 88 db below 20 watts. Provides output taps of 4, 8 or 16 ohms impedance. Designed to use WA-P2 preamplifier. Shpg. Wt. 29 lbs. **MODEL W-3AM \$49.75**

**HEATHKIT W-4AM HIGH FIDELITY AMPLIFIER KIT**

A true Williamson-type circuit, featuring extended frequency response, low distortion, and low hum levels, this amplifier can give you fine listening enjoyment with a minimum investment. Uses 5881 tubes and a Chicago-standard output transformer. Frequency response is  $\pm 1$  db from 10 CPS to 100 KC at 1 watt. Less than 1.5% harmonic distortion and 2.7% intermodulation at full 20 watt output. Hum and noise are 95 db below full output. Transformer tapped at 4, 8 or 16 ohms. Designed to use WA-P2 preamplifier. Shipped express only. Shpg. Wt. 28 lbs. **MODEL W-4AM \$39.75**

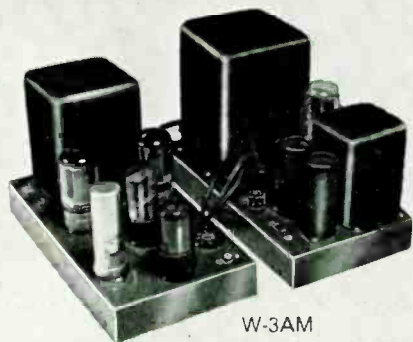

W-3AM  
20-WATT AMPLIFIER

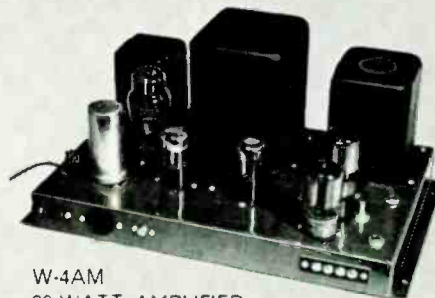

W-4AM  
20-WATT AMPLIFIER

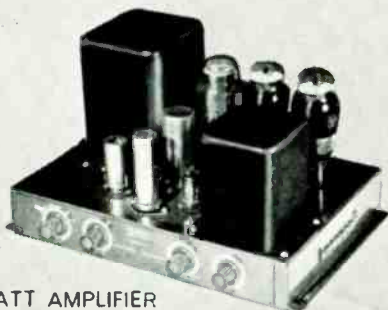

A-9C  
20-WATT AMPLIFIER



A-7D  
7-WATT AMPLIFIER

## HEATHKITS

*World's finest  
electronic equipment  
in kit form...*

*...top HI-FI performance*

### HEATHKIT A-9C HIGH FIDELITY AMPLIFIER KIT

This amplifier incorporates its own preamplifier for self-contained operation. Provides 20 watt output using push-pull 6L6 tubes. True high fidelity for the home, or for PA applications. Four separate inputs—separate bass and treble controls—and volume control. Covers 20 to 20,000 CPS within  $\pm 1$  db. Output transformer tapped at 4, 8, 16 and 500 ohms. Harmonic distortion less than 1% at 3 db below rated output. High quality sound at low cost! Shpg. Wt. 23 lbs. MODEL A-9C \$35.50

### HEATHKIT A-7D HIGH FIDELITY AMPLIFIER KIT

This is a true high fidelity amplifier even though its power is somewhat limited. Built-in preamplifier has separate bass and treble controls, and volume control. Frequency response is  $\pm 1\frac{1}{2}$  db from 20 to 20,000 CPS, and distortion is held to surprisingly low level. Output transformer tapped at 4, 8 or 16 ohms. Easy to build, and a fine 7-watt performer for one just becoming interested in high fidelity. Shpg. Wt. 10 lbs. MODEL A-7D \$17.95

**Model A-7E:** Same as the above except with extra tube stage for added preamplification. Two switch-selected inputs, RIAA compensation, and plenty of gain for low-level cartridges. Shpg. Wt. 10 lbs. \$19.95

#### HOW TO ORDER . . .

Just identify the kit you desire by its model number and send check or money order to address below. Don't hesitate to ask about HEATH TIME PAYMENT PLAN.

*Pioneer in  
"do-it-yourself"  
electronics*

### HEATH COMPANY

A subsidiary of Daystrom, Inc.  
Benton Harbor 25, Mich.

**FREE  
CATALOG**

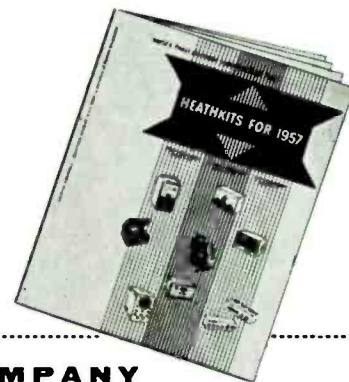

NAME \_\_\_\_\_

ADDRESS \_\_\_\_\_

CITY & STATE \_\_\_\_\_

*Please send FREE Heathkit Catalog*

# NEW STANDARD OF PERFORMANCE

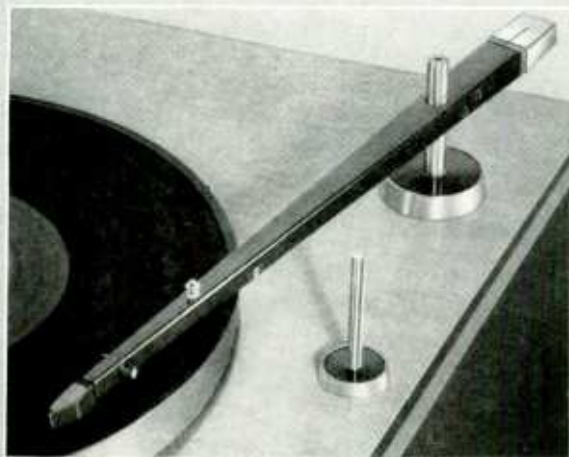

**SHURE**  
**STUDIO** *Dynetic*  
PHONO REPRODUCER

**IT TRACKS AT ONE GRAM!  
ITS FREQUENCY RESPONSE IS  
20 TO 20,000 CPS ( $\pm 2\text{db}$ )!**

## ONLY WITH THE STUDIO DYNETIC

- Record and needle wear are drastically reduced!
- You can completely avoid record scratches!
- You never have to level your turntable!
- You don't have to worry about groove-jumping!
- You can get superb fidelity, even from warped records!

You get the excellent response, low distortion and high compliance of dynamic cartridge construction, plus high output, minimum hum pick-up and the elimination of tone arm resonance and needle talk. There are also the additional benefits of the elimination of the pickup of low frequency rumble and motor noise. This superb unit sells for \$79.50 net. Your hi-fi dealer will be happy to arrange a demonstration.

**Write to Sales Department for reprints of informative, published articles.**

**SHURE** *The Mark of Quality*  
IN ELECTRONICS SINCE 1925

SHURE BROTHERS, INC., 216 HARTREY AVENUE, EVANSTON, ILL.

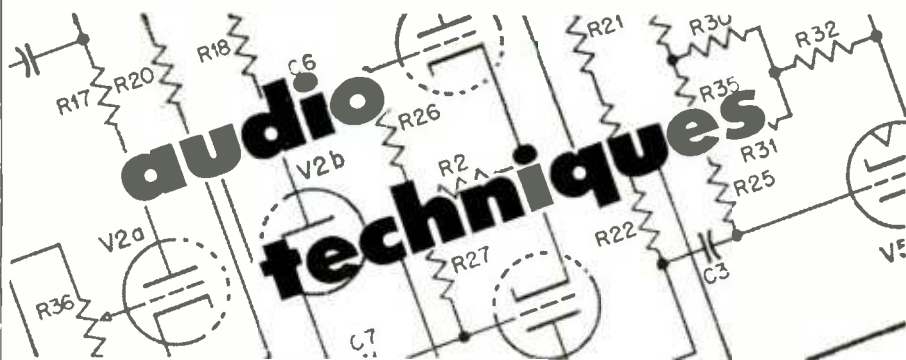

JOSEPH GIOVANELLI\*

This is the first in a new series intended to disseminate time-saving ideas to the experimenter. This is a how-to-do-it and how-I-solved-it kind of column, and will enable its contributors to share their experiences in a given field with others. We hope it can, in some small way, speed advances in the art of sound reproduction. *Audiotechniques* will not appear in each issue as does our other feature *Audioclinic*, but will appear only when we have received sufficient suggestions to warrant its preparation. The column will depend for its success upon you, the readers, and the contributions you make to it. Send your ideas and suggestions to me at the address given and not to *Audio Magazine*, since such mail would have to be forwarded.

units may be mounted inside the connector, with the leads brought through the base pins and soldered thereto. This gives a unit similar to the well-known four-diode quad, used for balanced modulators and other purposes. When wiring the circuits themselves, wires are soldered to their appropriate terminals on nine-pin female sockets which match the Amphenol male. This arrangement makes for both flexibility and safety. This latter is true since the heat from soldering is present only during the time when the transistors are first soldered into the connector, rather than the many times such heat would be present, were the transistors to be soldered directly into a circuit each time an experiment was to be tried. *Joseph Giovanelli, Brooklyn, N. Y.*

The following suggestions have been furnished by *Dr. L. J. Cote, Ottawa, Ont.*

### Protecting Transistors

How many transistors have you burned out because you accidentally connected them to the power source with the polarity of the leads reversed? Difficulties of this sort can be prevented by connecting a diode of sufficient current rating in series with one of the supply leads. It should be connected in such a direction that it will conduct only when the power leads are properly hooked up. When the leads are reversed, the diode will be biased in the reverse direction, so that practically no current flows, thereby protecting the transistor from damage. *Joel Shurgan, Brooklyn, N. Y.*

### Plug-In Transistors

Many of us are coming under the influence of the little devices known as transistors. When many experiments are to be conducted, it is convenient to be able to use the same transistors in various circuits. This can be done by simply plugging them from one circuit to another if the transistors are mounted in the following manner. When transistors with wire leads, such as the Raytheon CK722 are to be used, obtain an Amphenol 86PM9. This is a connector designed for attachment to a cable. It has a nine-pin base. There is sufficient space between the top of its metal shell and the connector proper to mount the transistors with plenty of clearance. Since there are nine pins and the transistors are equipped with three leads each, three such

### Shielded Wire Soldering

I push back the metal braid and expand it wide enough to insert a round piece of asbestos paper between it and the polyethylene. The purpose of the asbestos paper is to prevent the heat of the soldering iron from melting or distorting the polyethylene insulating core. If this core is distorted, the central conductor wire may unduly approach or touch the shielding braid. For a male phono jack, I flow solder for one-quarter inch at the tip end. I then put it in position of the plug and, temporarily, wrap a piece of wet asbestos around the exposed braid, to limit the flow of solder to a narrow ring or collar at the extremity of the braid. When using it for other purposes, I proceed as above but wrap a tinned #22 wire on the shielded braid, solder it, leaving a length of the wire for grounding and then cut off the excess. When using insulated polyethylene wire, such as microphone cable, I make a straight slit along the polyethylene, one inch in length, and roll it back. When through with the soldering, I roll the insulation forward, and tie it with #10 sewing thread. If a wire has been soldered to the braid, and it is desired to bring the insulation to cover the maximum area, then the insulation can be softened, pulled and stretched and tied around the braid.

### Bifilar Choke

My FM tuner is a Browning RB31. It is quite sensitive, 3 microvolts, and I easily pull in stations from Montreal, a distance

\* 3420 Newkirk Ave., Brooklyn 3, N. Y.

If it's worth engineers' time...

...it's worth engineered cable



## Belden

### TV CAMERA CABLE

Belden quality built to exacting specifications for black-and-white or color cameras. Harmonizing color—lightweight for easier handling.

### MICROPHONE CABLE

A type for every requirement, designed for highest efficiency, easiest use, longest service life.

"Items from the Complete Belden Line"



# Belden

WIREFORMER FOR INDUSTRY  
SINCE 1902  
CHICAGO

5-8

Magnet Wire • Lead and Fixture Wire • Power Supply Cords, Cord Sets and Portable Cord • Aircraft Wires  
Welding Cable • Electrical Household Cords • Electronic Wires • Automotive Wire and Cable

# THE NEW ALTEC 346A

20 watt amplifier

Ideal for small  
public address installations



Simple operating controls, attractive styling, full hi fidelity quality and power (20 watts), three inputs, ease of installation, and other outstanding features are offered by the compact new ALTEC LANSING 346A amplifier.

Ideal for use in smaller public address, paging and music systems such as restaurants, taverns, small stores and hotel lobbies, the 346A is amazingly low priced.

The 346A's controls include three separate volume controls which allow you to *pre-set* the level of any of the three inputs. Once you pre-set these volume controls, anyone can operate the 346A simply by turning it off and on. Push button channel selectors also are provided for ease of operation. Separate bass and treble tone controls provide perfect tonal balancing.

The three inputs are phono, microphone, and line for tuner, tape player, wired music or the like. A plug-in transformer can be used with the 346A for balanced lines.

Output taps for loudspeaker loads of 8 and 16 ohms, as well as a 70 volt line output for multiple speaker installations also are provided.

One of the special quality features of the 346A is its eyeletted printed circuit. Unlike common printed circuits, all components are attached through riveted eyelets making it possible to replace components without destroying the circuit.

Compare the features of the ALTEC 346A against any in its price range. You'll want its value and performance for your installation.

Specifications: Frequency Response:  $\pm 2$  db, 20-22,000 cps; Power Output: 20 watts @ less than 2% THD; Load Impedance: 8, 16, 250 ohms (70 V. Line); Output Impedance: Less than 20% of nominal load impedance; Controls: Push button switches select phono, mic, or line output; individual input volume controls; separate tone controls; power switch; Dimensions:  $4\frac{1}{8}$ "H x  $13\frac{3}{4}$ "W x  $7\frac{1}{8}$ "D.

Price: (less cabinet) \$114.00. Blonde or mahogany solid hardwood cabinet, \$18.00

Write for free catalogue



ALTEC LANSING CORPORATION  
Dept. AJ11, 1515 S. Manchester Ave.,  
Anaheim, Calif., or 161 Sixth Ave.,  
New York 13, N.Y.

12-16

of 120 miles, though at times there is not very good limiting. The tuner has so many images that I could pull in a local station at four spots on the dial. I could also hear a few AM stations. After experimenting for over six months, I finally came across the idea of introducing a bifilar choke in the filament leg of the cascode front end. I cut two 12-inch lengths of #26 enameled wire and twisted them together closely. Using a one-quarter inch diameter aligning tool shaft one and one-quarter inches long as a form, I wound sixteen turns of the wire on it and brought out the two wires separately at both ends. I then connected one of the wires to the 6.3 volt a.c. supply, and the other end of the same wire to pins 4 and 5 of the 12AT7. Pin 9 remained grounded. The other wire had one end connected to the bus ground, and the other to the center ground point of the socket. This improved matters to the extent that I have only one image and can now tune in stations from Watertown and Syracuse and other such places.

### Shielding and Tube Shields

When you need a tube shield, and the sockets will not permit the use of the regulation shield, form a piece of copper weatherstripping, one and one-half inches wide, into a shield. The copper is softened by heating it red hot in the flame of a gas stove. The weatherstripping can be obtained in any hardware store for approximately ten cents a foot. It is in a class by itself for making separate shielded compartments inside a chassis. For instance, I was plagued with hum in my preamplifier and never thought I could get rid of it. I wrapped some of this weatherstripping around two of the 0.05 coupling capacitors which were in the high-gain stages and grounded this shield to the chassis. This removed most of the hum.

### Record Changer Speed

Last week I was listening to a high-fidelity sound system in a friend's home when I noticed that the music in a selection that I knew well was very much off pitch and had very little bass. As his equipment is of very good quality, I was surprised at this lack of bass and that it was not more articulate. We checked everything to find where the trouble was, but found nothing. As the selection was off pitch, we checked the turntable speed with a stroboscope disc. It was very fast, somewhere in the vicinity of 40 rpm, instead of 33.33. (With such a wide deviation from the normal speed, it is probable that it was a 50-cps changer, connected to a 60-cps line, since  $6/5 \times 33.3 = 40$ . Ed.) We took the changer to my workshop and removed the speed turret from the motor shaft and put it on the lathe to true it up, and removed the excess of brass which caused the fast speed. Although this process took an hour, it was well worth the time and effort spent. It was remarkable to hear the improvement in bass response. Editor's note: Those of you who have no lathes can substitute this procedure: gently hold a piece of emery cloth against the proper portion of the motor shaft, checking from time to time to see that the correct speed

(Continued on page 92)





This is Mr. Briggs' great

# Wharfedale

SUPER 12/FS/AL  
FULL RANGE SPEAKER

...and the new enclosure  
designed specifically for it



*Together,  
they make one of  
the richest-sounding  
speaker systems you  
can buy, regardless  
of size or price!*

The Speaker (Super 12/FS/AL), warmly received by quality enthusiasts, has a remarkably level response between 25 and 18,000 cycles when adequately baffled. Foam suspension and low cone resonance reduce transient distortion to an absolute minimum and eliminates irritating "boom" associated with stiffly suspended cones. Critical listeners will hear the true bass which is so seldom heard. Wharfedale's exclusive cone and carefully wound aluminum voice coil achieve amazingly clean highs, without introducing peaks in the upper middle register.

The high quality of the speaker is uniformly maintained in production since it does not rely on subsidiary diaphragm resonances, which can cause intermodulation distortion. The Super 12/FS/AL has proved superior to many expensive combinations in general listening quality and pleasing sound.

**\$78.50**

The Enclosure (E/F/12) was also developed by Mr. Briggs . . . for the sole purpose of insuring full performance of the Super 12/FS/AL speaker. Gracefully styled, it incorporates one of the most respected of modern principles, the Acoustic Filter. It is built entirely of 3/4 inch hard wood and finished in fine Genuine Mahogany, Walnut or Blond (Limed Oak). Dimension: 30 3/4" x 23" x 15 3/8" deep

**\$94.50**

NOW ON DISPLAY AT YOUR DEALER

For full information on these and other Wharfedale speakers and speaker systems, write Dept. WS-17

**BRITISH INDUSTRIES CORPORATION**  
PORT WASHINGTON, N. Y.



# EDITOR'S REVIEW

---

## THE STEREO SHOW

**A**LTHOUGH the recently concluded IHFM show at the New York Trade Show Building was not billed as the "Stereo Show," it might just as well have been, since wherever one went, one was most likely to encounter stereo. Not only that, but during the show there were two demonstrations of stereo discs, of which more later.

By now, practically every tape recorder on the market is available with stereo playback facilities, although few are equipped with or can be modified for stereo recording without considerable trouble. We do not consider this much of a drawback, however, since it is quite unlikely that the average user of a tape recorder will have much opportunity for direct stereo recording. Only disadvantage we can think of offhand is that the somewhat illegal practice of dubbing a friend's stereo tape to save the cost of purchasing our own recorded tape will have to be foregone. Certainly there are not yet enough stereo broadcasts to warrant the additional expense of equipment necessary to tape them.

Among the new models shown were the Tandberg 3-Stereo, which included built-in power amplifiers for both channels, which is rather unusual. There is also a Pentron model which permits stereo recording on virgin or bulk-erased tape as well as normal monaural recording on any tape—no erase being provided in the stereo mode for the lower track. The A-series Ampex turned up in most of the rooms as the source of sound for the stereo systems, with Viking and Ferrograph running a close second.

New speaker systems shown ranged from the 18-foot Lansing stereo unit of ultra-modern design—so modern that we refrained from showing it to our vice-president in charge of decor—for two reasons. One—she might have wanted one, and two, just showing it to her might have given her the idea that we wanted one and thus have precipitated an argument. Pro-plane showed a relatively small cabinet—about 48 inches wide—with two complete speaker systems in it; considering the small spacing the stereo effect was excellent—easily suitable for the small living room. AMI showed matching speaker and equipment cabinets which spread out along one wall for an integrated effect—three cabinets being necessary.

Hartley showed a new speaker mechanism with a cast plastic cone basket and a solid—plastic stiffened—cone with high-compliance surround and spider. The stiff cone is intended to function as a true piston over the entire range, and regardless of theory the resulting sound was excellent.

Small speaker cabinets were in abundance—the most surprising being the Holland Standard with an 8-inch cone in an enclosure about 10 × 10 × 15. Performance in the low-frequency region was so surprising that at first we suspected there was a Klipschorn under the platform on which it was shown. Weathers showed a 10 × 20 by about 4-inch enclosure intended for wall mounting, in addition to a new single-play turntable so mounted that Mr. W himself regularly pounded the supporting table with a mallet without affecting the sound in the slightest.

Cabinart promoted a new approach in selling components—recommending that they be displayed already installed in a variety of cabinets. This is logical when demonstrating to non-do-it-yourselfers and others who would prefer packaged component system over a packaged system.

All in all, a good show.

## STEREO DISCS

Two systems of stereo discs were demonstrated during show week—London privately and Westrex at a session of the AES Convention. The former uses a combination of vertical and lateral recording, while the latter uses a combination of two hill-and-dale recordings, one on each face of the conventional 90-deg. groove. Both are said to be compatible and were so demonstrated, and both sounded excellent.

The Westrex system, developed in the U. S. with the knowledge and encouragement of the major record companies, seems to have the edge on the London system as to the possibility of final acceptance, and London spokesmen said that they were not touting their system to the exclusion of the other but that they would go along with whatever U. S. record companies wanted—they were only trying to prove that the stereo disc was practical and that it would work with quality equal to the standard LP. This they proved most satisfactorily, and so did Westrex.

It is probable, therefore, that we will have stereo discs within the next six months, even if only in limited titles. One thing is sure—with a stereo pickup and two amplifiers and speakers any lateral record is going to sound better than with a conventional monaural system, mainly because of the two sound sources in the listening room. True, it won't be stereo reproduction, but there is always some advantage to multispeaker operation for music. Then too, when we do have stereo records we will have the advantage of true stereo if we have the new pickup and the additional speaker and amplifier. But if we don't, our present monaural pickups will play them satisfactorily until we are ready for the new equipment.

Record companies are known to have been using stereo recording equipment for some time for all their master tapes, but even so it is not likely that the market will be flooded with stereo releases immediately—there just aren't enough stereo cutterheads available yet. Remember how long it took to build up a large collection of titles on LP when they were first introduced.

More and up-to-date information on this important development will be reviewed here as time goes on. While not stereo, Vox Productions announced the availability of 16 $\frac{2}{3}$ -rpm records of classical titles—a few to be ready by the time this is read. And to complicate the record situation still further, Dr. Goldmark of CBS announces 8 $\frac{1}{2}$ -rpm records—so far suitable only for speech, and developed for talking books. Time per record is of the order of 8 hours.

Where is the end? If we can be convinced that quality can be maintained by cutting speed in half and reducing stylus radius, we may next go to 4 rpm with no quality change, then 2 rpm ditto, and so on until finally we shall have a record the size of a quarter turning at 1/32 rpm and playing forever.

How many angels *can* there be on the head of a pin?

To keep your ears reliable, listen to live concerts occasionally—or, failing that, try a 78-microgroove record.

## ON AGAIN?

For what it's worth, the Mexico show is now said to be on again—Hotel Beverly, November 19–24. *We do not guarantee this information.*

Look... only the *FLUXVALVE*

has 100%

**IQF\***



Choice of the *best* phonograph pickup can *only* be resolved by comparison! What is the yardstick? . . . How can you tell? . . . What do you look for? . . . the answer is 100% **Important Quality Features\***!

PICKERING has had long experience in the cartridge field, supplying the finest quality products for recording studios, broadcast stations, wired music services, and high fidelity home music systems. As a result of this extensive experience, PICKERING has developed the **FLUXVALVE** . . . the *one* cartridge which incorporates *all* of the **Important Quality Features\*** so necessary for high fidelity reproduction from records.

Before you choose a cartridge . . .

LISTEN AND COMPARE . . . demand 100% IQF\*!

Feature	FLUXVALVE	Cartridge A	Cartridge B	Cartridge C
Frequency Response: Flat 20-20,000 cps $\pm$ 2 db (see curves on right)	YES 20 Points	NO 0 Points	NO 0 Points	NO 0 Points
Low Tracking Force, 2-4 grams	YES 20 Points	NO 0 Points	YES 20 Points	NO 0 Points
High Output, No Transformer Required	YES 10 Points	NO 0 Points	NO 0 Points	YES 10 Points
Replaceable Styli	YES 10 Points	NO 0 Points	NO 0 Points	YES 10 Points
1/2 Mil Stylus	YES 15 Points	NO 0 Points	NO 0 Points	NO 0 Points
One Cartridge For LP's and 78's	YES 5 Points	NO 0 Points	NO 0 Points	YES 5 Points
Anti-Hum Design	YES 10 Points	YES 10 Points	YES 10 Points	YES 10 Points
Hermetically Sealed	YES 10 Points	NO 0 Points	NO 0 Points	NO 0 Points
<b>TOTAL POINT VALUE</b>	<b>100%</b>	<b>10%</b>	<b>30%</b>	<b>35%</b>

**THE FLUXVALVE** . . . chosen time and again as the *top* cartridge solely on the basis of *listening quality* . . . by panels of qualified experts . . . tests which have proven that it is *actually* less costly to own a **FLUXVALVE**

The **FLUXVALVE** preserves the quality and prolongs the life of your record since there is complete absence of resonances throughout the audio frequency range.

It may interest you to know that the **FLUXVALVE**, because of its ability to make *precise* and *reproducible* record measurements, is used for calibrating recording channels and record masters.

Make the IQF\* test today . . . listen to your favorite record reproduced with a **FLUXVALVE** . . . the gentle pickup.

Series 194D UNIPULSE Pickup Arm with FLUXVALVE Cartridge.

Model 194D with 1 mil diamond "T-Guard" stylus \$59.85  
 Model 194D with 2.7 mil diamond "T-Guard" stylus 59.85  
 Model 194.5D with 1/2 mil diamond "T-Guard" stylus 65.85

**SERIES 370 SINGLE FLUXVALVE**  
 370-1S 1 mil Sapphire 17.85  
 370-2S 2.7 mil Sapphire 17.85  
 370-1D 1 mil Diamond 29.85  
 370-2D 2.7 mil Diamond 29.85  
 370-.5D 1/2 mil Diamond 35.85

**SERIES 350 TWIN FLUXVALVE\***  
 350-00 1 mil Diamond 36.00  
 350-500 1/2 mil Diamond 42.00  
 350-DS 1 mil Diamond/2.7 mil Sapphire 42.00  
 350-DD 1 mil Diamond/2.7 mil Diamond 54.00  
 350-D.5D 1 mil Diamond/1/2 mil Diamond 60.00

**SERIES 3500 "T-Guard" STYLI\*\***  
 S-3510 1 mil Sapphire 6.00  
 S-3527 2.7 mil Sapphire 6.00  
 D-3510 1 mil Diamond 18.00  
 D-3527 2.7 mil Diamond 18.00  
 D-3505 1/2 mil Diamond 24.00

\*Available in many other combinations of styli. \*\*Other stylus radii available on special order.

FREQUENCY RESPONSE CURVES

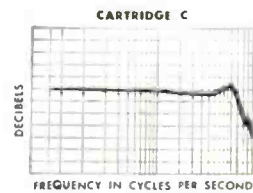
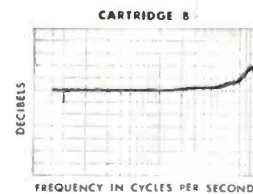
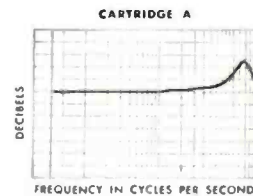
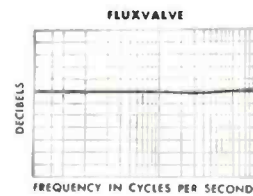

**IMPORTANT QUALITY FEATURES**  
 —so necessary for high fidelity reproduction from records.

Peaks and/or resonances in the stylus assembly at any recorded frequency will distort; and, damage the record groove. Therefore, any deviation from flat response over the recorded frequency band results in eventual breakdown of the groove wall. Deviations of from 3-6 db distort the record material as much as 60-100%.



*"For those who can hear the difference"* FINE QUALITY HIGH FIDELITY PRODUCTS BY  
**PICKERING & COMPANY, INC., Oceanside, N. Y.**



## A GREAT AMPLIFIER TUBE IS PERFECTED FOR TELEPHONY

A new transcontinental microwave system capable of carrying four times as much information as any previous microwave system is under development at Bell Laboratories. A master key to this development is a new traveling-wave tube of large frequency bandwidth.

The traveling-wave amplifying principle was discovered in England by Dr. Rudolf Kompfner, who is now at Bell Laboratories; the fundamental theory was largely developed by Labs scientist Dr. John Pierce. Subsequently the tube has been utilized in various ways both here and abroad. At the Laboratories it has been perfected to meet the exacting performance standards of long distance telephony. And now for the first time a traveling-wave tube will go into large-scale production for use in our nation's telephone systems.

The new amplifier's tremendous bandwidth greatly simplifies the practical problem of operating and maintaining microwave communications. For example, in the proposed transcontinental system, as many as 16 different one-way radio channels will be used to transmit a capacity load of more than 11,000 conversations or 12 television programs and 2500 conversations. Formerly it would have been necessary to tune several amplifier tubes to match each channel. In contrast, a single traveling-wave tube can supply all the amplification needed for a channel. Tubes can be interchanged with only very minor adjustments.

The new amplifier is another example of how Bell Laboratories research creates new devices and new systems for telephony.

*Left:* A traveling-wave tube. *Right:* Tube being placed in position between the permanent magnets which focus the electron beam. The tube supplies uniform and distortionless amplification of FM signals over a 500 Mc band. It will be used to deliver an output of five watts.

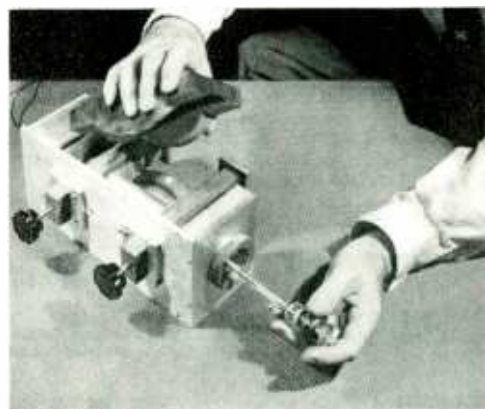

**BELL TELEPHONE LABORATORIES**

WORLD CENTER OF COMMUNICATIONS RESEARCH AND DEVELOPMENT



# Stereo Monaural Companion Amplifier for the "Preamp with Presence"

LOUIS BOURGET\*

Built around a new phase-splitter circuit, this stereo amplifier will provide adequate power for the average installation with better than average performance throughout the entire audio spectrum. The phase splitter itself is worthy of notice, also.

**M**OST OF US have heard the impressive stereo tape demonstrations given at virtually every audio exhibit held within the last two years. Those of us who have long dreamed of owning a *really complete music system* may now take heart. The cost is relatively modest for the features provided and the entire system may be assembled progressively so that you may start with any existing source—say a phonograph player or AM/FM tuner—and eventually have a complete high fidelity system accommodating the following input sources:

1. Phonograph
2. AM/FM tuner
3. Monaural tape
4. Stereo tape
5. AM tuner—for stereo AM/FM broadcasts in metropolitan areas.

The stereo amplifier with dual speakers or speaker systems is also very effective when used in parallel from a single preamp for "spreading out" the sound source. The music appears to emanate from an area centered between the two speakers when they are in phase and operated at the same intensity level. The bass range is considerably improved—from better speaker coupling to the room air and an apparent filling in of room nodes.

Once you become accustomed to the versatility and superior sound distribution of a twin-channel system it is unlikely that you will settle for less.

The dual amplifier, shown in *Fig. 1* with its power supply and the preamps, was designed to operate from two MeProud preamplifiers ("Miniaturized Preamp with Presence")<sup>1</sup> which have been modified for playback of commercially recorded tapes. The amplifier incorporates some features usually found

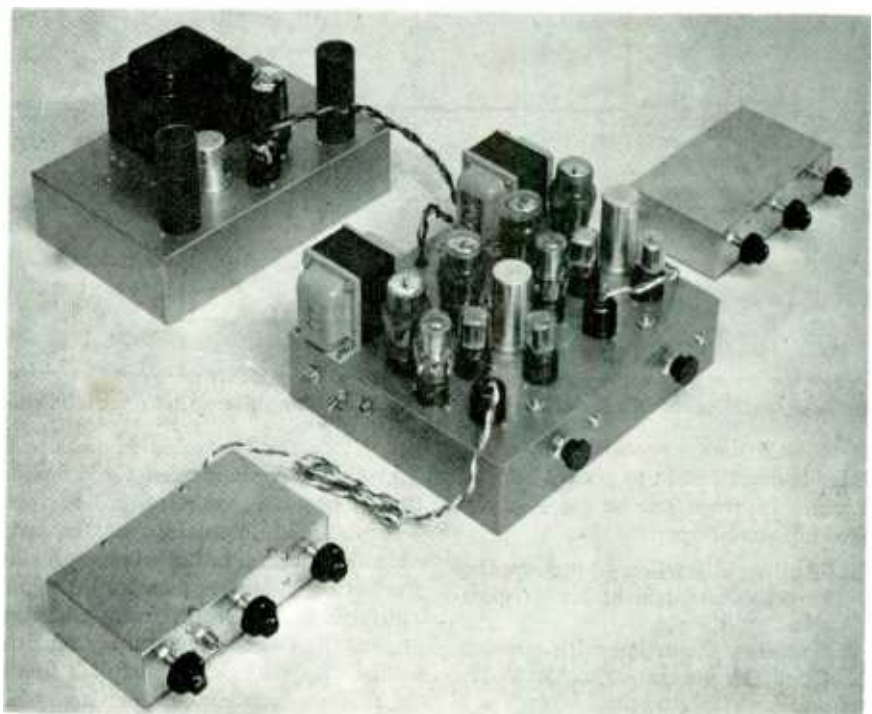

Fig. 1. The complete amplifier system, consisting of the stereo dual-channel power amplifier, two Miniaturized Preamps with Presence, and the power supply.

only in laboratory type equipment:

1. The output tubes are balanced for both dynamic and static conditions, sustaining full power delivery at low frequencies.
2. The phase splitter is balanced for both dynamic and static conditions. It is not frequency conscious. When balance is made at any audio frequency it will be correct for a frequency range wider than the audio spectrum.
3. Hum is of such low order that it becomes difficult to measure with accuracy.
4. Thermal hiss is low enough to permit the source material and preamp to act as the dominant influence without later stages causing masking of subtle high frequency detail.
5. The tube types used are moderate in cost and are operated under conditions which should give reasonably long life expectancy.

The amplifier power output (per channel) is based on the power requirements of the majority of existing speakers (or speaker systems) used in the home, to the extent that the speaker will reach excessive distortion limits ahead of the amplifier. Power beyond this requirement could well be a waste of money. To determine this power in watts for each half of the double amplifier led us to test a quantity of loudspeakers.

This study was made over a period of six months and included everything from eight-inch speakers to large three-way systems using fifteen-inch speakers for the woofer section. All of the speakers tested could be driven to excessive distortion levels before the amplifier capability was exceeded. It is interest-

\* 3996 McKinley Blvd., Sacramento 19, Calif.

<sup>1</sup> AUDIO, May, 1955.

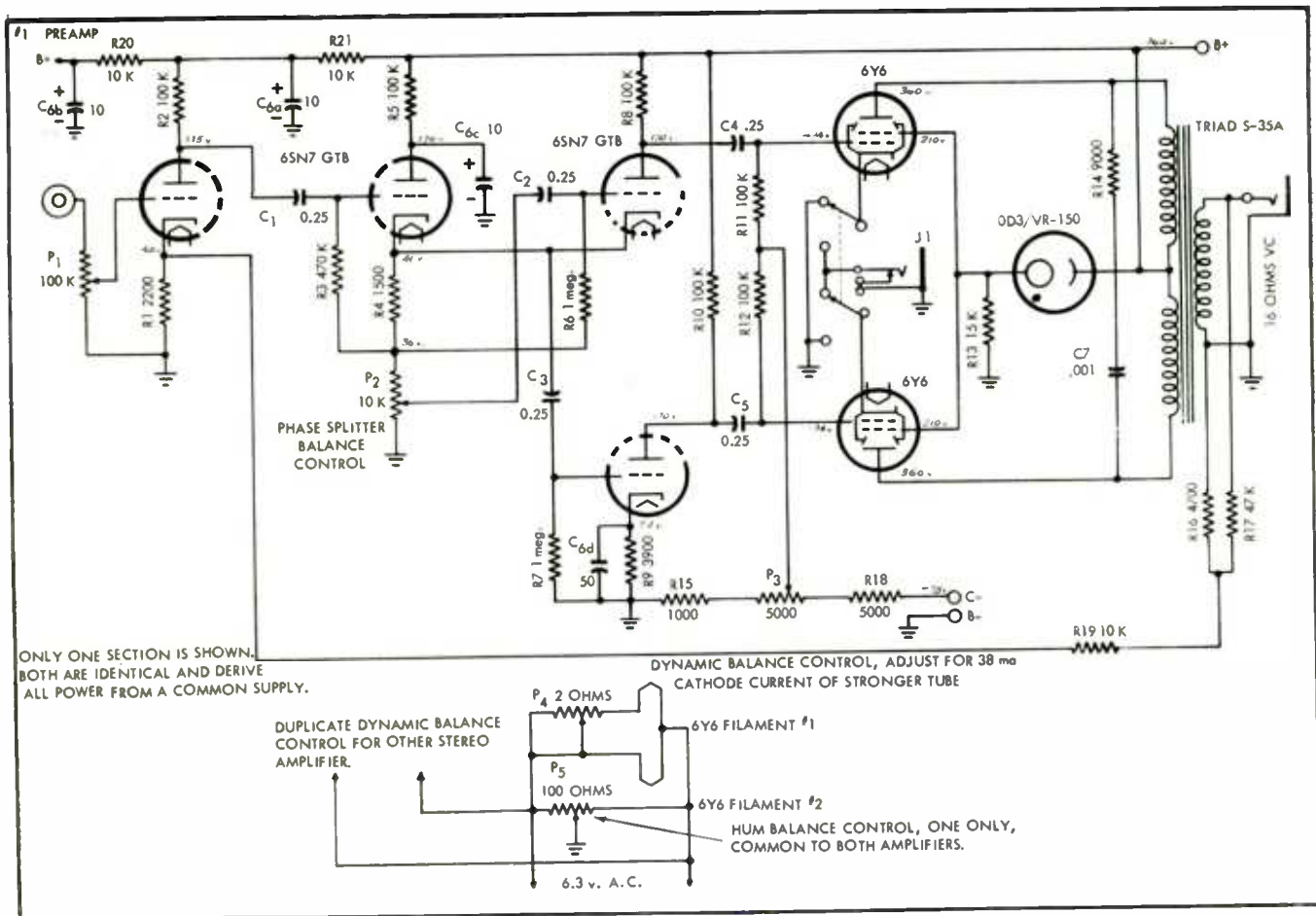

Fig. 2. Over-all schematic of one of the dual-channel amplifiers. Both sections are identical, and are built on a single chassis.

ing to note that ten *clean* watts when available down to 30 cps proved entirely adequate to reach one or more of the following conditions:

1. Limiting distortion of the speaker suspension system at low frequencies.
2. Excessive distortion with spurious frequency generation at the middle and high frequencies.
3. Loudness levels judged intolerable for home use.

The maximum power rating given by most speaker manufacturers is not intended as their recommended operating condition, but may preferably be interpreted in most cases as the danger level for the speaker mechanism. Fortunately the human hearing tolerance level is usually exceeded first except at extremely low frequencies and we are not often tempted to damage expensive reproducers.

To determine the power level at which suspension limiting takes place is fairly simple and makes use of a device frequently employed in the test laboratory. It consists of a dummy resistive load (of adequate power rating) mounted in a box with a quick changeover switch from voice coil to dummy load. Jacks are also provided for a calibrated oscilloscope and an a.c.-VTVM for rms val-

ues. These are connected in parallel so that they remain across the amplifier output on either resistive-load or voice-coil position. Comparison of the levels at which peak limiting occurs provides the answer at low frequencies. At middle and high frequencies a simple technique is used. The ear is remarkably sensitive to the apparent change in pitch due to frequency doubling or halving when overload point is reached for the loudspeaker from a sine-wave input source. Protective ear plugs are desirable here, as you may otherwise exceed the "threshold of pain" and this is as unwise as welding without goggles. The human hearing apparatus is also operating in a more discriminating manner when subjected to sound intensities well below the maximum tolerance level by the use of ear protective plugs.

All of this may seem a little beside the point in leading up to a description of the dual amplifier but if it were omitted many people might wonder about our manner of drawing such conclusions.

In this dual amplifier either side will deliver 20 watts before clipping. The extra power above 10 watts per side allows for tube aging and is considered an economy in terms of useful tube life at normal listening levels.

#### Voltage Amplifier and Phase Splitter

The voltage amplifier and three-tube phase splitter employ the newer 6SN7GTB which has been much improved for TV and governmental equipment. The circuit is shown in schematic form in Fig. 2.

The first stage is conventional except for the 0.1-meg. input potentiometers which are deliberately made less than the 0.5-meg. input commonly used in many amplifiers. This prevents the con-

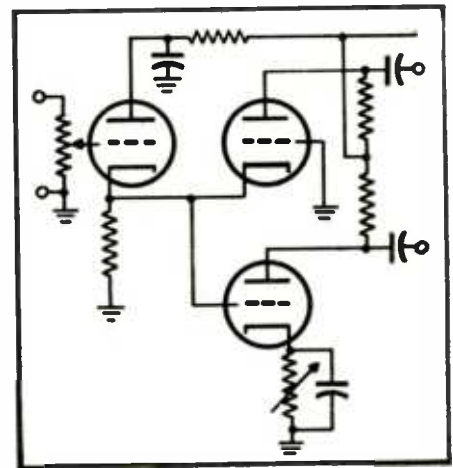

Fig. 3. Simplified schematic of the phase inverter circuit, which is capable of excellent balance throughout the entire audio spectrum.

control from becoming a differentiating circuit at middle and lower settings due to the RC network, formed by stray capacitance from wiring and terminals, which normally cause spiking of square waves on many amplifiers. The "Preamp with Presence" (like all modern preamps) has low output impedance and no difficulties are posed.

The phase splitter is an improved variation of circuitry used by the writer since the late 1940's.<sup>2</sup> A cathode follower provides simultaneous audio signal voltage to the cathode of one driver and the grid of the opposing driver, as shown in the simplified schematic, Fig. 3. Note the use of a plate-voltage dropping resistor—well bypassed—in the cathode-follower plate circuit. This is important to establish operation of the follower on the same part of the dynamic characteristic as the phase opposed drivers. Also observe that the energized-grid and cathode-circuit capacitances of the drivers (including strays) are effectively in parallel across the low input impedance of the cathode follower. This means that the shunt RC product is held to a small value and is virtually identical for the two drivers—a condition which makes it possible to obtain perfectly balanced driving voltages across more than the complete audio spectrum. The phase-splitter balance control is a 10,000-ohm wire wound potentiometer in the cathode-to-ground circuit of the follower. Balance will be obtained with the arm set about 1000 ohms up from ground.

#### Balancing the Phase Splitter

If you have no test equipment available, the phase splitter may be balanced as follows: connect a temporary short lead from grid to grid of the 6Y6 final—pull out one of the 6Y6 tubes and balance for null on low level music. Remove the short and plug the 6Y6 back in its socket.

While much has been written about two-tube "self-balancing" phase splitters, some rather important defects are generally ignored or glossed over. The phase-inverted side causes the signal to go through one more tube than the "direct side." This usually leads to higher distortion and unequal phase rotation with attendant balance difficulties at frequency extremes. No one would be so optimistic as to expect high-quality performance from a final stage with one flat tube. Obviously the same thing applies to the drivers. When one tube is badly off in a pair of phase-opposed drivers, a self-balancing circuit only insures that the flat tube will be driven harder, with inevitable increase of distortion. The answer is simple. Tubes in

<sup>2</sup> Patent 2,618,711 issued November 18, 1952.

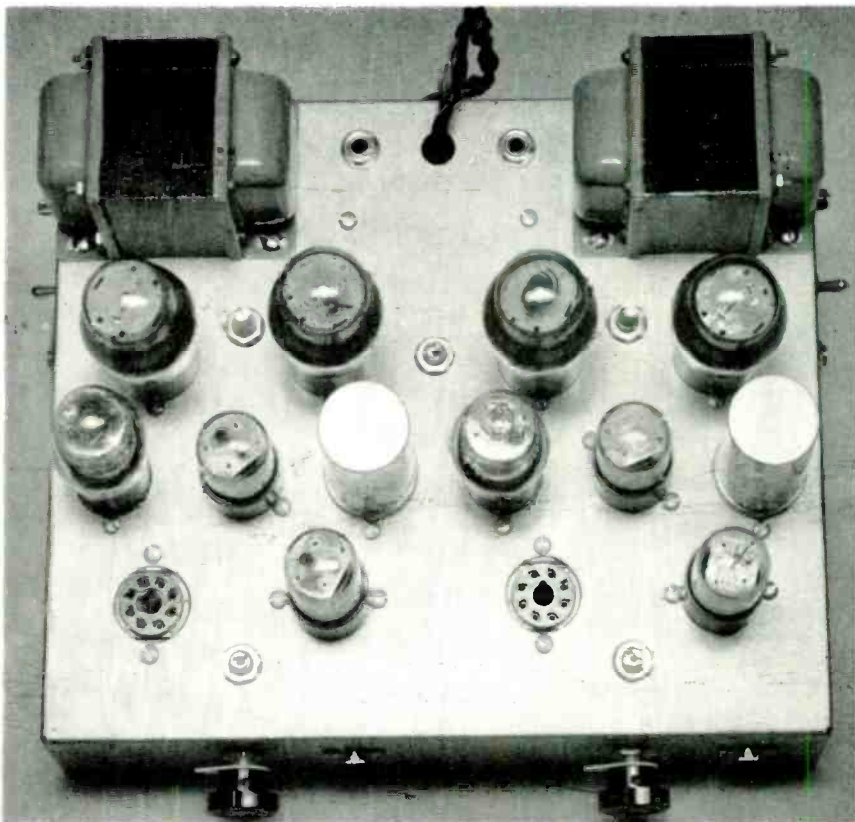

Fig. 4. Top view of the amplifier chassis. The jacks at the rear are for the outputs, while power is fed to preamps from octal sockets toward the front.

high class equipment should be tested periodically and replaced when necessary. In this amplifier the use of the improved 6SN7GTB tubes at plate cur-

rents of only 1.3 ma in each triode section serves to insure long trouble-free performance from a circuit which may be set precisely for balanced operation.

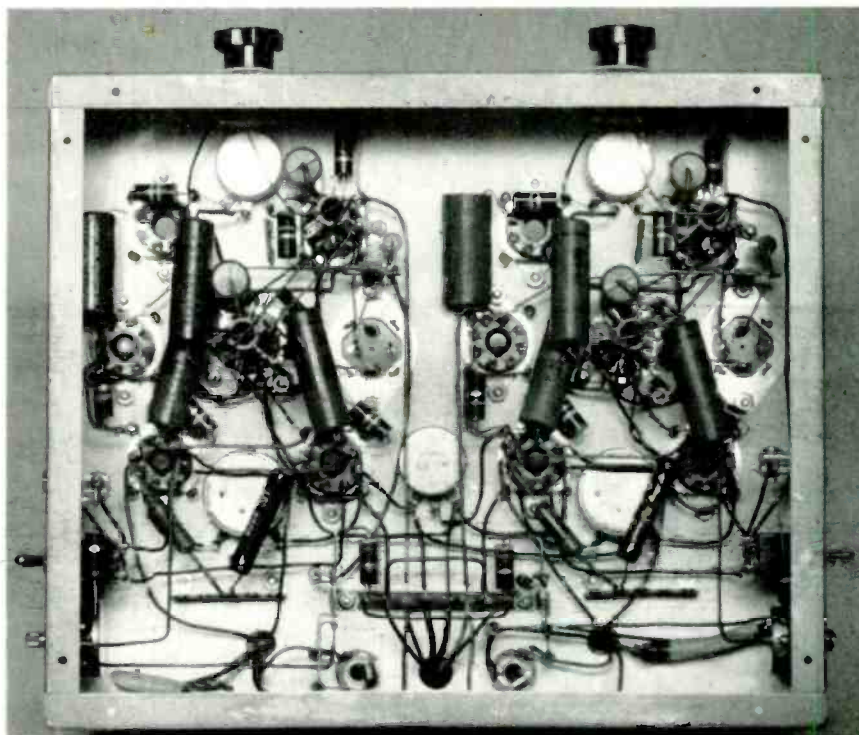

Fig. 5. Bottom view of amplifier chassis. Input controls are on front apron, with balance controls accessible from top of chassis just below them. Hum balance control is at center, individual bias controls are just above terminal strips. Filament emission balancing controls, plate current jacks, and toggle switch are on right and left aprons.

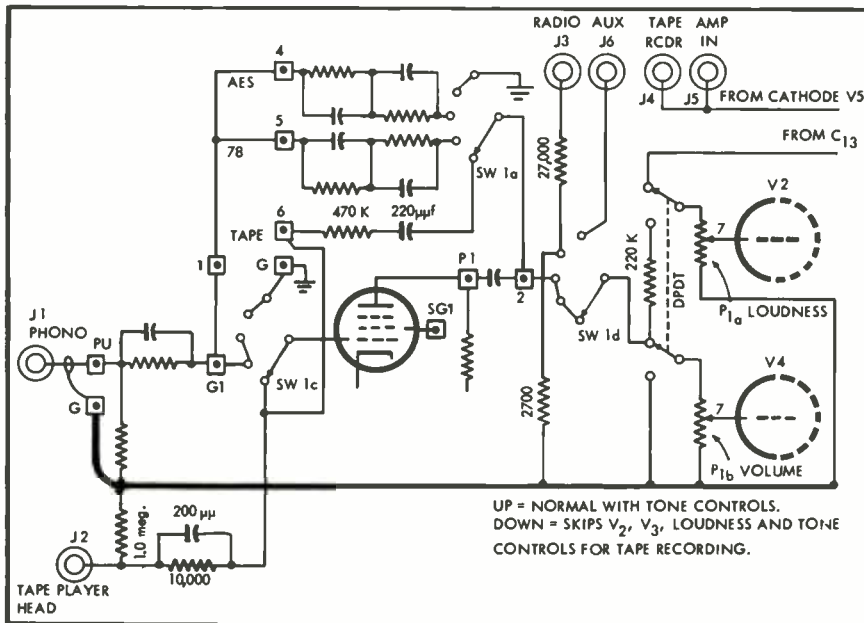

Fig. 6. Schematic of modifications to one of the preamps to permit direct connection from tape head as well as to eliminate tone and loudness controls from the circuit for recording.

### The Output Stage

The choice of 6Y6 output tubes was made after testing many different beam tubes in both triode and pentode connection. These tubes have the advantage of high power output at moderate plate supply voltages. In addition, the optimum plate to plate load impedance is lower than for most beam tubes and permits better low-frequency performance from a given amount of iron and copper in the output transformer.

The 6Y6 output tubes are operated at 300 to 325 plate volts and an OD3-VR150 gas tube is used as a *series* dropping device to maintain the screen voltages precisely 150 volts lower than the plate supply. The 15,000-ohm resistor from screen circuits to ground keeps

about 12 ma of gas-tube current flowing and stabilizes operation.

Improved low-frequency performance is assured by both dynamic and static balancing of the output stage. Most amplifiers—where balance adjustments are provided at all—permit balancing of only static cathode current values. This is usually arranged as either a variable cathode bias or grid bias circuit which permits reducing the plate current of the “high” tube to match the lower tube. Unfortunately this type of balancing generally leads to even poorer conditions of dynamic balance at medium and high level plate current excursions.

In the stereo/monaural amplifier, both output tubes in either push-pull pair have identical, fixed bias grid volt-

ages. A cathode current jack and switch permits comparing the cathode currents. The common bias control is adjusted to produce 38 ma of cathode current for the lowest tube's plate current with the filament control  $P_1$  set for zero resistance. If the “high” tube is in the socket which has the filament control, it is only necessary to reduce the filament voltage slowly until 38 ma plate current is obtained. If the high tube is in the wrong socket, merely interchange the output tubes and proceed as described. Obviously we are balancing by means of reducing the emission of the “hotter” tube. Extensive testing has verified that this method results in improved dynamic balance and sustains the delivery of full power at low frequencies.

Much credit for the high performance-vs.-cost ratio of the amplifier must go to Triad's Model S-35A output transformer. In this circuit the transformer holds up remarkably well, down to 20 cps and costs about half of what you might normally expect to pay for these results. Figure 4 shows the chassis layout and Fig. 5 shows the underside wiring.

### Equalization

The 9000-ohm wire wound resistor and .001- $\mu$ f capacitor from plate to plate of each output stage, serves to neutralize any ringing tendency with the value of negative feedback employed. Feedback is taken from a voltage divider across the voice-coil winding of the output transformer and is otherwise conventional.

The amount of inverse feedback used is deliberately held to about 10 db. The amplifier is easily driven to full output from less than one volt of input signal so the two volume controls serve mainly as “level-setting” devices. These are linear 0.1-meg. controls and are set about one quarter of full rotation when used with the Miniaturized Preamp with Presence.

### Preamp Modifications

While the Preamp with Presence kit is no longer available as a commercial unit, it is still possible to employ conventional construction practices and build the unit without the prefabricated etched wiring panel and the sheet-metal chassis parts, although there is more work involved. However, with a few modifications to the preamp circuit it may be made to operate directly from tape heads, and it is likely that other types of circuits could be modified similarly to obtain the same results. Figure 6 indicates the changes in the miniaturized preamp. The TAPE position replaces the FOR (foreign) phono position of the original circuit, and slight changes in the wiring of section C of  $Sw_1$  permits connecting both phono and tape head to in-

(Continued on page 88)

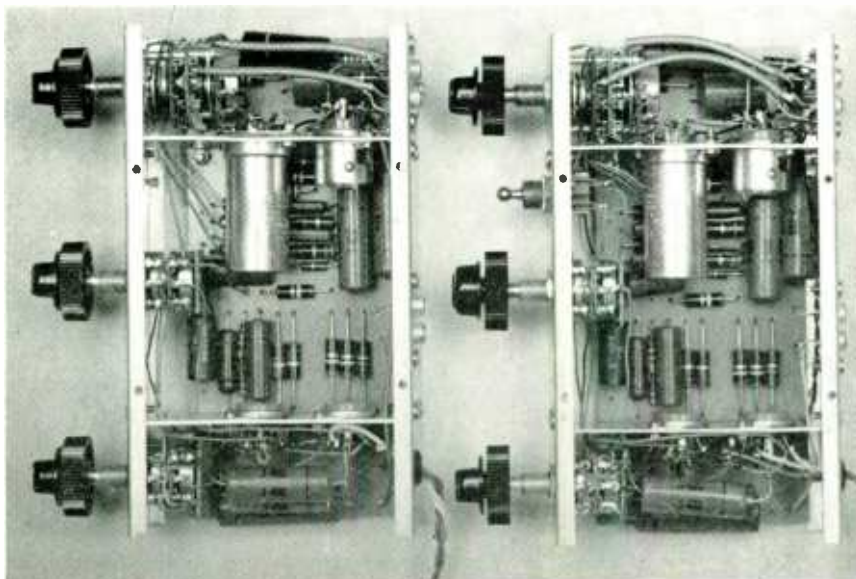

Fig. 7. View of two preamps showing modifications, including addition of toggle switch to the one at the right.



# The Dubbings Duplicator

While there is still a great difference between the time required to make a recorded tape and that for a finished phonograph record, this machine reduces the difference about as much as is practical at the present state of the art.

HERMAN BURSTEIN\*

**A**FTER quite a bit of dawdling around the corner, commercial recorded tapes are finally emerging as a serious contender for the high fidelity dollar. Generally available both at the 7.5 and 3.75 ips speeds, at the faster speed they can offer the musical ear almost everything it desires. Not that commercial tapes always live up to their potential, but the state of the art today permits the 7.5 ips progeny as well as their 15 or 30 ips forebears to possess a frequency range, signal-to-noise ratio, and freedom from distortion deserving the appellation "high fidelity." By dint of experience, technical skill, and care, some first-rate tapes are being released.

The delayed outpouring of recorded tape on a large scale can be attributed in part to the lack, until recently, of relatively low-priced home record-

ers with satisfactory electrical and mechanical performance. Today a fair number of such machines, including some priced under \$200, essentially fill the bill, although they may not all live up to exacting professional requirements.

On the other side of the coin, problems of tape duplication have had to be surmounted. To make a good copy at 7.5 ips has not been very difficult. To make a copy with reasonable economy has been more difficult. But to make a copy that is both cheap and good has been a task of altogether different magnitude.

As yet there is only one practical way of copying a tape for audio purposes. It must be played from beginning to end, and as this is done one or more copies are recorded from the playback signal. Ten or twelve copies are the practical limit during each run of the master. While the process can be accel-

erated a good deal by running master and copies faster than normal, technical factors set a bound to this speedup. Compare the situation in the disc recording field, where the better part of an hour of music may be stamped at once upon the vinylite platter, requiring only a few seconds.

If tape duplicates are to be satisfactory, everything must be just so, technically speaking, *throughout* the run. The playback signal must have proper frequency response and a minimum of hum and noise and distortion added by the duplicator. As the signal is transferred to the copies, all that is good must be preserved and nothing extraneous admitted. The copies must match the original in terms of accurate speed and uniform motion; also in terms of frequency response, noise, and distortion.

Two versions of the basic tape duplicating process exist at present. One is the slave system. As a master unit plays the tape, the audio output is fed simultaneously into a number of machines, slaves, designed expressly for recording. The other version is a single machine which drives both the master tape and the copies by means of a common capstan. This principle is embodied in the Dubbings duplicator.<sup>1</sup>

The latter is a more compact arrangement in regard to space and working steps. It insures close correspondence between speed of the master and speed of the copies. It serves to cancel out wow because the master and copy tapes are driven by the same capstan. And it is economical of components, particularly motors; the Dubbings unit, which makes twelve copies at a time, employs only two motors, whereas a 12-slave system, using two or three for each machine, would have a total of 26 or 39 (including the master playback unit).

Insofar as the special problems of tape duplication have given rise to a special form of tape recorder, the Dubbings machine is of interest in itself. On the other hand, since it utilizes the basic duplicating process, it is more or less reflective of tape duplicators as

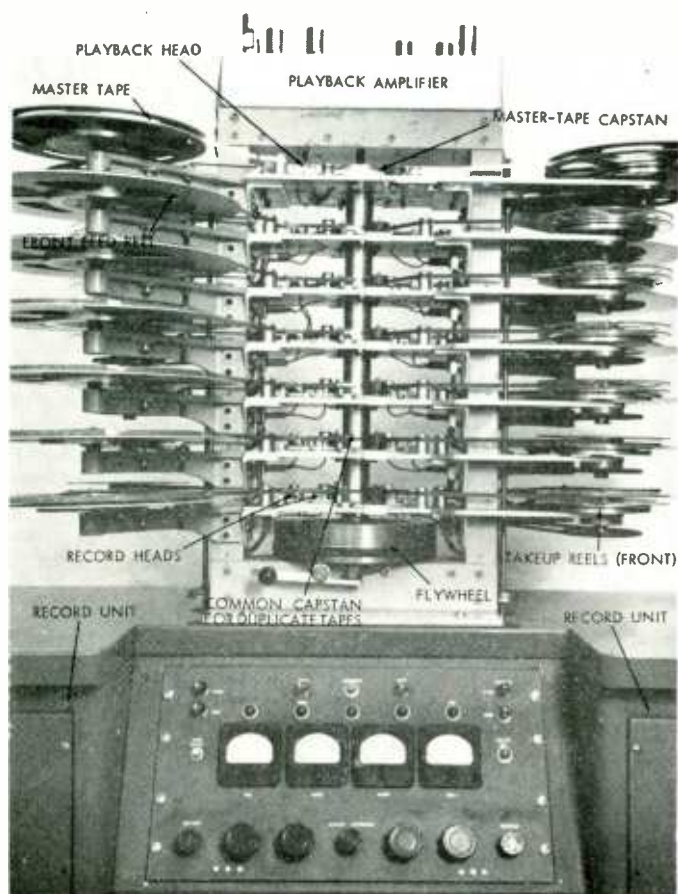

Fig. 1. Front view of the duplicator showing details of construction. The single capstan drives fourteen tapes simultaneously, and both tracks of the twelve slave tapes are recorded at the same time in absolute synchronism with the two masters.

<sup>1</sup> Developed by the Dubbings Sales Corporation, 41-10 45th Street, Long Island City, N. Y.

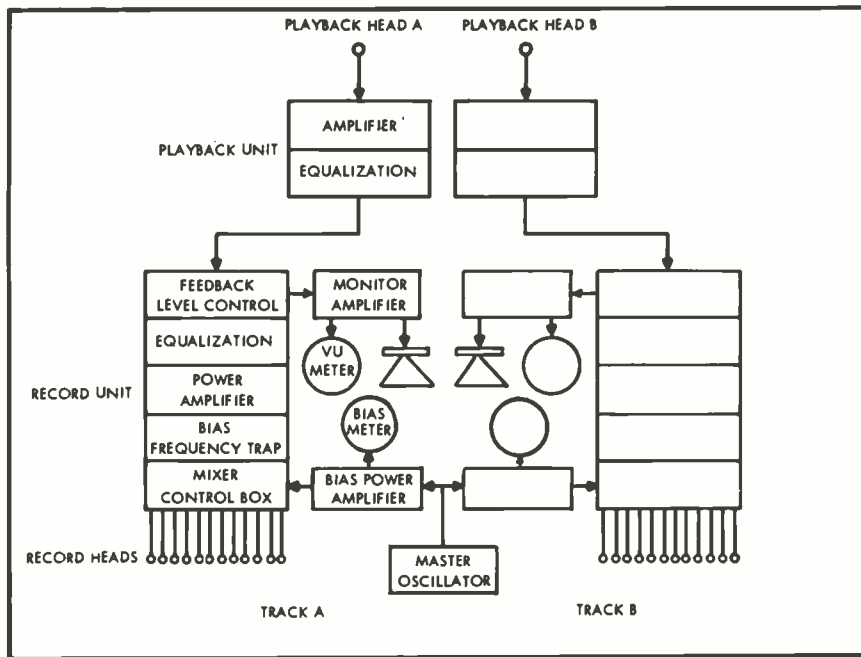

Fig. 2. Block diagram of the electronic circuitry employed in the duplicator.

a class of recorder. Furthermore, since the Dubbings duplicator is, after all, a tape recorder, a discussion of it should also be somewhat illuminating with respect to the general problem of obtaining top notch results in tape recording.

#### General Description

This article does not intend to burrow into the construction details of the Dubbings duplicator inasmuch as they are just that, details. On the other hand, there are enough facets of even a condensed treatment of the subject to require, for order's sake, some breakdown of the discussion. Therefore a distinction, an important one, will be made between the electronics and the transport mechanism. Yet it seems equally desirable, for the sake of perspective, to first present a bird's-eye view of the machine as a whole. So we shall start with a general description.

Figure 1 is a photograph of the duplicator. In the center, atop the cabinet, may be seen the shaft (common capstan) which drives two single-track master tapes and twelve dual-track copy tapes. One master is for track A and the other for track B of each copy. Both tracks are recorded simultaneously.

The top part of the capstan, which drives the master tapes, is twice the diameter of the rest of the shaft, which drives the copies. This permits use of 15 ips masters for making 7.5 ips copies. Similarly, 7.5 ips masters are used to make 3.75 ips copies. Inasmuch as better masters can be recorded at higher speeds, the 2:1 ratio between speeds of the master and the copy insures a superior source for making duplicates.

The electronics for playing back the

master tapes are located above the transport. The electronics for recording the 12 copies are contained in the large cabinet beneath the transport.

Looking at Figure 1, seven "shelves" may be seen on the near side of the transport. Each of the lower six shelves contains the reels, record heads, guides, and so on for making one copy. The top shelf accommodates the master tape for track A. A similar set of seven shelves is on the other side of the transport, in this case the master tape being for track B.

Since tape duplication is a relatively expensive and time-taking process, it may be questioned why the Dubbings machine does not contain more shelves of copying facilities. However, this would require a longer capstan, which might whip at the center instead of rotating truly. Moreover, seven shelves constitute a practical working height for the operators.

The A and B master tapes are scanned by A and B playback heads, and the signal from each goes into the playback electronics section for amplification and equalization. The resulting signals are fed into A and B record sections, where the necessary gain, equalization, and bias current are supplied. The A record electronics feeds twelve record heads in contact with the lower track of each copy. And the B electronics feeds twelve heads that are recording on the upper track of each duplicate.

Record level and bias current can be metered. A power amplifier and a speaker permit monitoring the master tapes to assure that the playback signal is satisfactory and to indicate when these tapes are about to run out. If desired, the duplicator can be made to

shut itself off when the masters have run out.

The Dubbings duplicator transports the master tapes at 60 ips and the copies at 30 ips; it should be remembered that the masters have a normal speed twice that of the duplicates. Thus a 7 in. reel of tape, 1200 feet long, with a playing time of one-half hour per track at 7.5 ips takes 7.5 minutes to record, one-fourth of normal playing time. Since two tracks are recorded at once, an hour of playing time is copied in 7.5 minutes. This is an 8-to-1 reduction in duplicating time. Adding about 1.5 minutes, on the average, for the time required to set up the reels and collect them after the duplicating run, twelve copies can be turned out every nine minutes, or about one in  $\frac{3}{4}$  minute. In the case of 3.75 ips tapes, two hours of playing time are recorded in 7.5 minutes, a 16-to-1 reduction in duplicating time.

While it is feasible to operate the duplicator at twice as fast a rate as above, for mechanical and electronic reasons this is not yet compatible with high fidelity requirements, although satisfactory for other duplicating purposes. However, it is expected that advances in the state of the art, including better tapes and better heads, will make it possible within a year or two to achieve high fidelity results while making 7.5 ips copies at eight times normal speed (16-to-1 reduction in duplicating time for dual-track tapes).

Part of the difficulty of duplicating at a higher speed is that this requires a higher bias-current frequency in order to avoid beats between harmonics of the audio signal and bias. But intertwining capacitance of the record head together with cable capacitance tend to act as a shunt as frequency goes up. If bias frequency is therefore kept constant as duplicating speed is increased, then the likelihood of audible beats becomes greater.

The Dubbings Sales Corporation, which makes the duplicator, is extensively engaged in copying tapes for recording companies, business houses, and others. It is interesting to note its basic check procedures for catching human and machine error. From each run of 12 copies, one reel is selected for a brief check of signal quality on each track. Approximately every twelfth run, one reel in the run is compared with the master for about 15 minutes on an A-B basis, the tapes being synchronized. These comparisons are by ear and performed by musically trained personnel. Every copy is serially coded so as to show when it was made and on what shelf of the duplicator, which facilitates detection of sources of malfunction.

#### The Electronics

Figure 2 is a block diagram of the

electronics, of which there are two virtually complete sets, one for track A and the other for track B, only the bias oscillator being shared in common. If separate bias oscillators were used and their frequencies were not identical, beat frequencies between the two might be recorded on the tape due to stray pickup.

Let us follow the signal for track A. Unless specifically stated otherwise, it should be understood that the copies are intended for operation at 7.5 ips.

A half-track playback head is used to scan the master tape, even though the master is full-track, for this makes azimuth alignment of the head less critical. This does not mean that less than maximum care is necessary in orienting the head with respect to the tape, but that such error as must inevitably be present has smaller effect upon high-frequency playback response.

The signal picked up by playback head A from the master tape is fed into a unit consisting of a high gain amplifier and equalizer. Output of the head is but a few millivolts, and considerable gain is needed to build this signal up to the level needed for recording purposes and to compensate for losses due to playback equalization.

The playback equalization and record equalization of the Dubbings duplicator are such that it makes a "one-to-one" copy of whatever frequency response characteristic is on the master. For reasons of convenience and because of its inherent advantages, NARTB equalization is used in playback.

NARTB playback equalization would normally call for a bass boost having a turnover frequency (3 db rise) of 3180 cps. But the master is moving at four times normal speed, so that each recorded frequency becomes a frequency four times as high in playback. Thus 3180 cps translates into 12,720 cps when the master is transported at 60 ips. Inasmuch as the high quality playback head used has but minor treble losses due to gap width and to iron losses (eddy currents and hysteresis), no treble boost is needed in playback.

Therefore, playback equalization consists only of bass boost, some 36 db of it. This much bass boost, it may be appreciated, together with the over-all gain required in playback, ordinarily necessitates extensive precautions against hum, usually a determining factor in a tape recorder's signal-to-noise ratio. However, in the case of the duplicator, this problem is mitigated because, since everything is operating at four times normal speed, any pickup of 60 cps is reduced to 15 cps when the copies are played by the user. This does not mean that the hum problem is non-existent, because any appreciable amount of hum fed to the record amplifier and to the

Fig. 3. Equalization curves required for playback of 7.5- and 3.75-ips tapes.

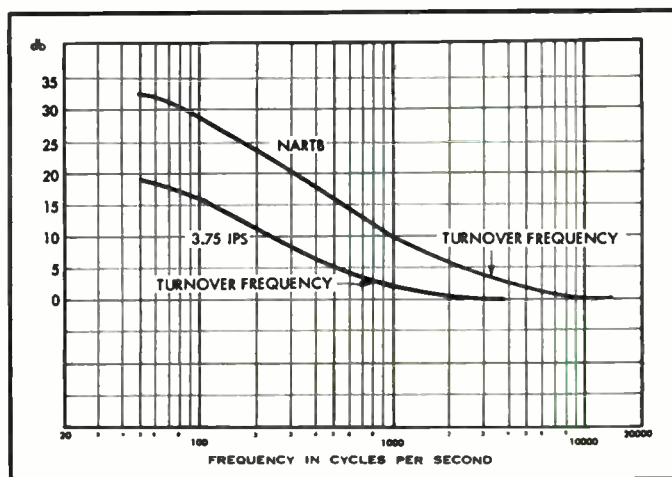

duplicate tapes can cause harmonic and intermodulation distortion, which have audible results. Therefore the duplicator employs the usual precautions against hum, such as careful shielding of the playback heads and use of d.c. on the heaters of the amplifier tubes.

Based on a master recording with a maximum of 2 per cent total harmonic distortion, the signal-to-noise ratio of the playback amplifier is over 75 db. As already indicated, this superior ratio (55 db is considered very good for ordinary tape recorders) is partly due to the absence of the usual hum problem. And partly it is due to the fact that, since the duplicator runs four times normal speed, output signal from the playback heads is increased by a factor of four since the head has an output directly proportional to velocity (rate of change) of the magnetic field on the tape.

Although in the usual tape recorder it is the playback process that determines the over-all signal-to-noise ratio, in the case of the Dubbings duplicator the determining factor is the record process, which results in an over-all signal-to-noise ratio of about 65 db. Essentially, the ratio is limited by the inherent noise in the tape, which is "developed" when bias current is applied.

This does not mean that duplicates come out with a 65 db signal-to-noise ratio. It simply means that the duplicator is sufficiently better than the master tapes so that it ordinarily does not cause a deterioration in signal-to-noise ratio. Thus the ratio on the copies is essentially governed by that on the master tape. On the other hand, it should be pointed out that if the master has a high hiss level, the duplicates may have about 2 db more hiss still. The reason for this is that the reproduced noise of the master tape in turn determines how much "modulation noise" is produced on the copy. Modulation noise, it may be explained, is inherent noise in the tape, due to magnetic or physical

irregularities, which is developed in the presence of a signal.

Physical location of the playback unit corresponds to the block diagram, close as possible to the playback head. This minimizes the cable run between head and amplifier and thereby reduces high-frequency losses due to cable capacitance.

From the playback unit the signal goes to the record unit, consisting of five sections. Some additional gain is provided by the first section, the level control stage, but its chief purpose is to serve as an attenuator, thereby bringing the record level down to the proper point. Ordinarily, the record level is set so that the signal on the copy will be of the same amplitude as that on the master. In this event the amount of distortion on the duplicate is usually no greater than on the master.

But if the master has been recorded at a relatively high level, the duplicates will be recorded at a lower level to avoid an increase in distortion. This is because the amount of treble boost required in recording is relatively great for the 7.5 ips copies, reaching in excess of 20 db at 15,000 cps; in the case of the 15 ips masters, only about 10 db emphasis is needed. The possibility of distortion owing to such emphasis is increased when the recording signal is of high amplitude. To avoid a perceptible increase in distortion over that on the master, the copies must therefore be recorded at a lower level than the original.

On the other hand, the master may have been recorded at too low a level. There is nothing to be gained by duplicating at a similar level. In fact, this would reduce the signal to noise ratio further. Therefore in this case the duplicates are recorded at a suitable higher level than the master.

The level control in the record unit attenuates by means of variable feedback over two triode stages. The reason for using feedback here is to cut down on noise, hum, and high-frequency losses associated with the volume control in

the ordinary voltage divider circuit.

Next the signal is equalized, which means for the most part application of a large amount of treble boost. A small amount of bass boost is also provided in conformity with NARTB equalization. Record treble equalization extends into the supersonic range because all frequencies have been multiplied by four. For example, if the copy tape were traveling at the normal 7.5 ips speed and 20 db of boost were required at 15,000 cps, then in the duplicator 20 db of boost would have to be applied at 60,000 cps.

A clearer picture of what is required in record equalization may be had by dwelling for a few moments upon the basic principles of NARTB equalization, which is generally used for commercial recorded tapes operating at 7.5 ips, although this standard officially applies only to 15 ips tapes.

NARTB specifies a definite playback bass boost curve, as shown in *Fig. 3*. Beginning with a 3 db rise (turnover frequency) at 3180 cps, the curve rises at the rate of 6 db per octave for a while as frequency declines, and then levels off so that at 50 cps it is 3 db below its maximum amplitude. Presuming this playback boost, it is then required that record equalization shall be such as to insure response no more than 1 db down from the average at 100 and 10,000 cps and no more than 4 db down at 50 and 15,000 cps, subject to one proviso: treble losses due to the playback head shall be compensated in playback rather than in record.

Digressing for a moment more, it should be borne in mind that the phenomena encountered in tape recording are for the most part wavelength effects. That is, they depend upon the wavelength recorded on the tape; wavelength (inches per cycle) equals tape speed (inches per second) divided by frequency (cycles per second). For example, the same problems exist when recording 15,000 cps at 15 ips as when recording 7500 cps at 7.5 ips. At a given tape speed, as frequency rises, that is, as recorded wavelength becomes shorter, the amount of signal recorded on the tape becomes less and less, for equal

amounts of audio current entering the record head. This loss is much more severe for a 15,000-cps frequency when recorded at 7.5 ips than when recorded at 15 ips because the corresponding wavelength is only half as long at the slower speed.

Accordingly, it is difficult but feasible to record out to 15,000 cycles at 7.5 ips. To do so requires a substantial amount of treble boost. The Dubbings duplicator provides record equalization such that, given NARTB playback equalization at normal playing speed, response is  $\pm \frac{1}{2}$  db between 50 and 15,000 cps and 1 db down at 30 cps. As stated before, the duplicator runs at four times normal speed, so that the record equalizer has reference to frequencies four times those just cited.

In order for record equalization to have the degree of precision described in the previous paragraph— $\pm \frac{1}{2}$  db between 50 and 15,000 cps, etc.—much more than the usual amount of flexibility is built into the Dubbings treble boost circuit. Three controls are used to shape this boost. One determines maximum gain. The second determines the frequency at which maximum gain occurs. The third determines the frequency at which response begins to rise; in other words, it governs the slope of the treble boost curve. Through careful adjustment of these controls, which are to some extent interdependent, treble boost can be shaped with desired exactness.

At this point it is appropriate to consider the problems of equalization at 3.75 ips. Beyond 7500 cps, the recorded wavelengths corresponding to such frequencies are so short that it is difficult to record them; i.e., they require an excessive amount of treble boost. Also it is difficult to play them back because of the critical nature of azimuth alignment at these frequencies and because the gap of the playback head in home tape machines (and professional ones as well) is ordinarily too wide compared with the recorded wavelength to afford the necessary resolution for reproducing the audio signal. On the other hand, a few machines do maintain fairly satisfactory response out to 10,000 cps at 3.75 ips.

The Dubbings duplicator presently equalizes 3.75-ips copies so that response is  $\pm \frac{1}{2}$  db between 50 and 7500 cps and 1 db down at 30 cps (although it is expected that improved heads, tapes, and azimuth alignment methods will soon increase the upper limit to 10,000 cps). This assumes a playback bass boost at normal speed similar to the NARTB playback curve, but having a turnover frequency two octaves lower, namely at 795 cps. Commercial 3.75 ips recorded tapes are generally predicated on this playback characteristic, which is shown in *Fig. 3*.

When switching from production of

7.5 ips duplicates to 3.75 ips duplicates, it is not desirable to alter the precisely adjusted record boost circuit of the duplicator. What is done instead is to make up the difference between 7.5 ips and 3.75 ips record equalization in the master tape used for producing 3.75 ips copies. Such masters are prepared on a standard high quality commercial tape recorder, with record equalization adjusted in accordance with the requirements of the Dubbings duplicator.

Following record equalization, the signal goes into a power amplifier inasmuch as there are twelve track-A record heads to be driven. The power amplifier uses a transformerless output stage in a push-pull single-ended circuit with very low distortion. The twelve heads, together with their constant-current resistors in series (to be discussed shortly), present a load impedance of several hundred ohms instead of the 4, 8, or 16 ohms usually presented by a speaker, so that it becomes practicable to omit the output transformer.

From the power amplifier the signal goes through a tuned trap, designed to keep the bias frequency out of the power amplifier and earlier stages, and into a mixer control box. Here the signal is apportioned among the twelve track-A heads, and at the same time a regulated amount of bias current is added to the signal for each head. *Figure 4* shows for two of the track A record heads how the audio signal and bias current are mixed. The purpose of the resistor between the power amplifier and each record head is to maintain constant current through the head at all audio frequencies for equal amounts of power. Impedance of the head rises with frequency, which tends to reduce current through the head. But the constant-current resistor in series with the head is sufficiently large compared with the head impedance so that it swamps out the latter over the audio-frequency range. In other words, it is essentially the resistor which determines the amount of current through the head.

As shown in *Figure 2*, there is a single master oscillator but separate bias power amplifiers for the A and B sections of the electronics. To prevent the bias frequency from straying into the record section and causing undesirable effects, a resonant trap consisting of an inductance and capacitance in parallel, is inserted between the mixer and audio power amplifier. Frequencies to 60,000 cps (corresponding to original audio frequencies of 15,000 cps at 7.5 ips and 7500 cps at 3.75 ips) easily pass through the coil. However, at the bias frequency, which is on the order of 500,000 cps, the trap presents a very large impedance.

This brings up the question as to why the bias frequency is so high. For satis-

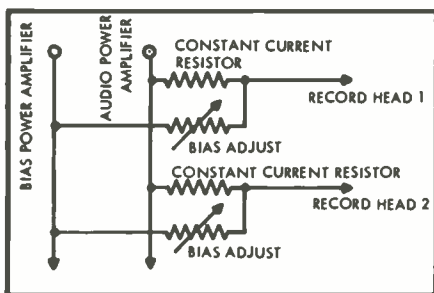

*Fig. 4.* Audio signal and bias current are mixed in this circuit individually for each recording head.

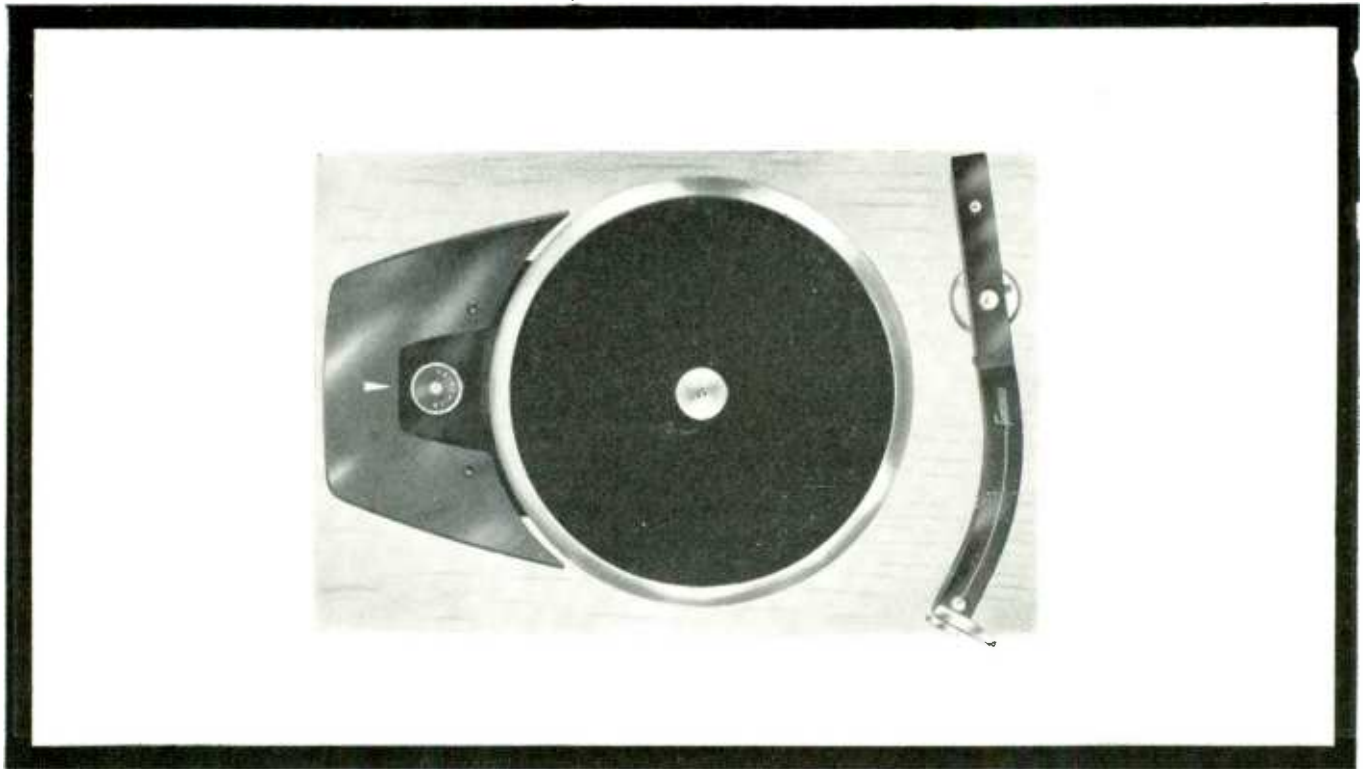

# ELECTRONICALLY OPERATED FAIRCHILD TURNTABLE SYSTEM

surpasses all industry performance standards by more than 100%

Unquestionably the most exciting high fidelity development of our time, the new Fairchild E/D Electronic Drive turntable brings us closer to the ideal of perfect record reproduction than we've ever been before. It is almost incredible — to think that rumble, wow and flutter have been so drastically reduced that if their presence is at all detected, they originate in the record or in the recording equipment.

The reason for this is clear when we realize that the performance ratings of the E/D actually surpass the critical standards adopted for primary professional recording equipment. And as for playback equipment, the Fairchild E/D shows improvements of more than 100% over standards prescribed by the NARTB.

The new Fairchild E/D is another miracle of modern electronics, brilliantly conceived and engineered. It has brought with it a new smooth simplicity of performance, completely eliminating the intricate mechanics, the multiplicity of moving parts upon which conven-

tional turntables depend for their operation. In so doing, the E/D has achieved an accuracy and constancy of speed, a quietness of operation beyond anything we have ever known. And this performance is independent of, and unaffected by any variations in power line voltage and frequency.



The Fairchild E/D is a complete 4-speed, electronically driven turntable with hysteresis-synchronous motor and built-in Electronic Control-Regulator, and can be operated from any AC line supplying 85 to 135 volts, or from a DC line with a convertor, or with storage batteries and a vibrator-inverter. Each speed has its own vernier adjustment. Without the ECR, the Fairchild E/D Turntable Unit serves as a high quality, single-speed  $33\frac{1}{3}$  rpm turntable that operates directly from a 60-cycle AC line. The ECR can be easily added at a later date.

Fairchild E/D complete 4-speed system \$186.50; Turntable Unit single-speed  $33\frac{1}{3}$  rpm turntable (less ECR) \$99.50; Electronic Control-Regulator (ECR) \$94.00; Hardwood Base (shock-mounted) walnut, mahogany or korina \$31.50.

See the new E/D at your Fairchild dealer. Literature on request.

**FAIRCHILD** RECORDING EQUIPMENT COMPANY  
10-40 45th Avenue, Long Island City 1, N. Y.

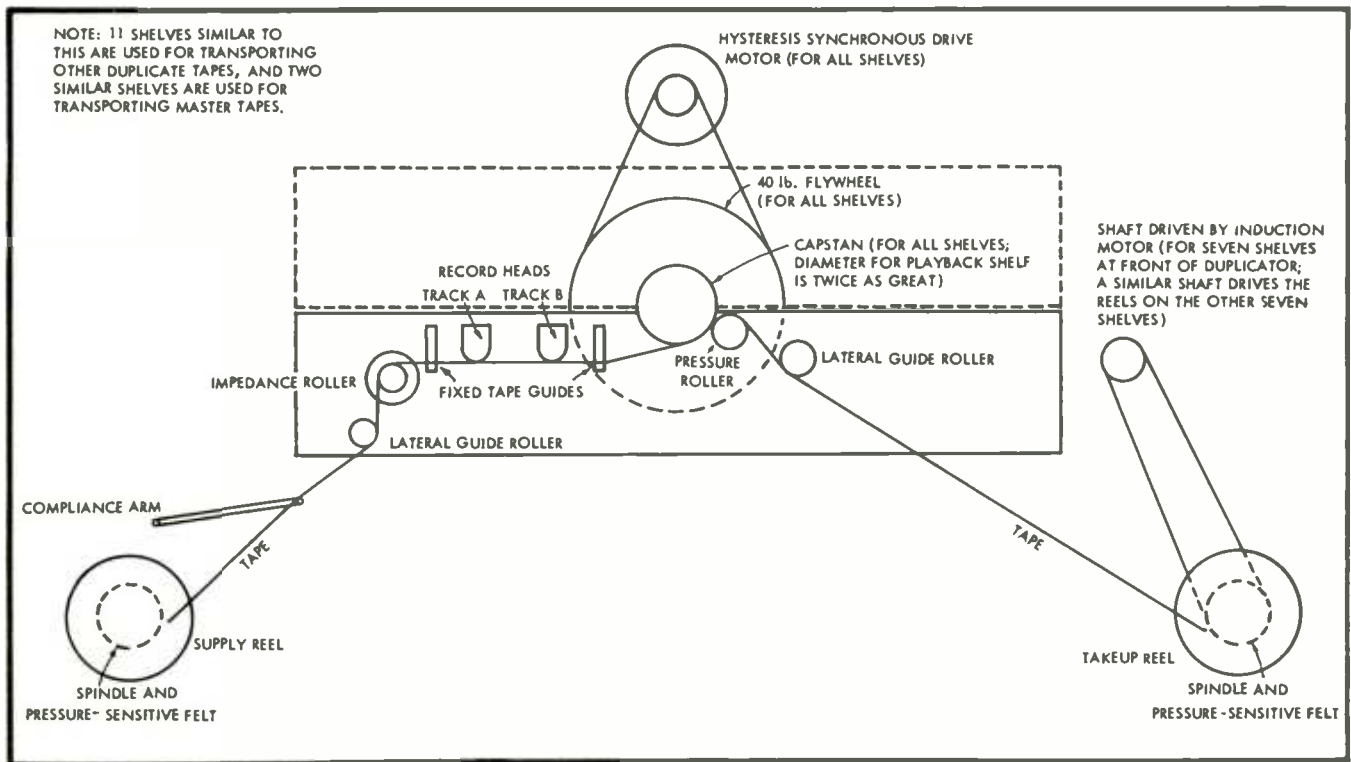

Fig. 5. Diagram of one record shelf of the duplicator transport mechanism.

factory recording results, the bias frequency should be at least five times the highest recorded audio frequency in order to prevent beats between harmonics of the latter and the bias frequency. For top quality recording, a higher factor—about 7 or 8—is even more desirable. Thus in conventional recorders of top caliber, it is not unusual to find bias frequencies of 100,000 cps or even more. Inasmuch as the duplicator's highest recorded frequency is 60,000 cps (four times 15,000 cps or eight times 7500 cps), the minimum required bias frequency is 300,000 cps. By going further up, even greater freedom from burps and squeaks due to the beat effect is assured. The record head used in the duplicator has a self-resonant frequency, due to interwinding capacitance, sufficiently high so that bias current is not significantly attenuated. The head has dual windings, and by connecting these in parallel, the capacitance of the head is relatively large (and the inductance correspondingly small); hence cable capacitance has a relatively small effect upon the head's resonant frequency.

The monitor audio amplifier and speaker are connected to the level-control stage, at a point following attenuation of the incoming signal. A VU meter is connected to the monitor amplifier so that record level may be set properly.

Meters are connected to each bias power amplifier in order to check on the total amount of bias power fed to the Track A heads and to the Track B

heads. If bias power should change by as little as one-half db, high-frequency response and distortion would be significantly affected. If bias increased, distortion would decline and so would treble response.

As was shown in *Fig. 4*, the amount of bias to each record head can be varied by means of an individual potentiometer. The technique used, for one at a time, is to feed in a 4000-cps tone (corresponding to 1000 cps at 7.5 ips) and monitor the tape output by means of a special playback head which can be swung into place. Bias is adjusted until playback response reaches a peak, and bias is then increased until response drops  $\frac{1}{2}$  db. This, on the basis of previous experience, provides the amount of bias consistent with desired high-frequency response and satisfactorily low distortion. After individual bias adjustments have been made for each head, total variations in bias current can be monitored by the meter connected to the bias power amplifier. And to the extent that variations are noted, the amount of bias current leaving the bias power amplifier can be increased or reduced as required.

#### The Transport Mechanism

*Figure 5* is a plan view of one of the twelve shelves used for recording a duplicate tape. Essentially the same arrangement is used for either master tape with the exception that the capstan diameter is twice as great and that only a single head, in this case a playback head, is used.

The tape travels from a supply reel at the left past several guides and rollers, past the track A and track B record heads, past another guide, past the capstan and pressure roller that drive the tape, past another roller, and onto the takeup reel at the right. In this arrangement there are features of interest and importance that do not immediately meet the eye, so it is worth considering each element separately.

In the conventional tape recorder, a motor applies torque, by means of a clutch, belt, or other slippage device, to the spindle on which the supply reel rests, so that the spindle tends to turn in a direction opposite to that in which the tape unwinds when driven by the capstan and pressure roller. This provides the back tension necessary to insure smooth operation and, where pressure pads are not used, good contact between the tape and the heads. In the Dubbing machine, however, back tension is supplied simply by friction between the supply reel and a felt pad on which it sits.

There is good reason for this, because it automatically adjusts back tension so that it is more or less uniform throughout the run of tape. When the reel is full, relatively little pull is needed to unwind the tape because the outer winding is a fair distance from the center of the hub; in other words, the distance between the outer winding and the center of the reel provides leverage for turning the reel, in effect reducing back tension. However, when the reel is full it is also

(Continued on page 97)

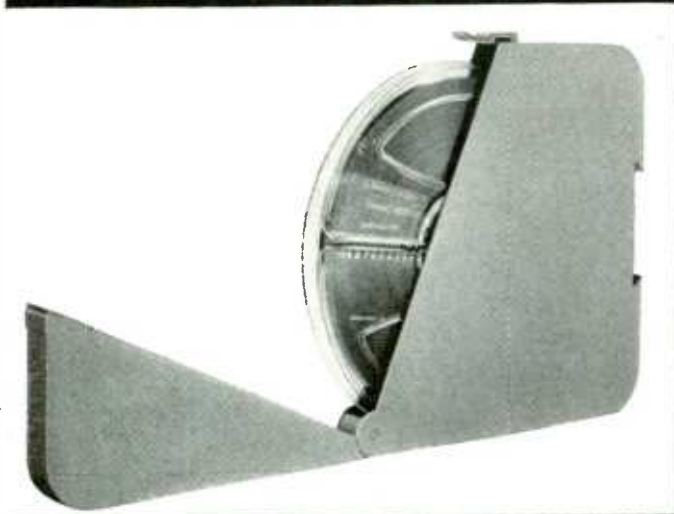

THE QUALITY  
RECORDING TAPE  
IN THE NEW  
PERMANENT  
PLASTIC CONTAINER

# SONORAMIC

Here is an extraordinary new product designed to protect, preserve and facilitate storage of your Sonoramic Wide Latitude Recording Tape. It's the exclusive NEW Sonoramic permanent plastic tape container. Sonoramic's fine quality magnetic recording tape PLUS the new container makes this your best buy in recording tape.

#### Here's the story on the container:

- Protects tape against dust and dirt.
- Made of high-impact, shatter-proof, polystyrene plastic in handsome decorator color.
- Opens at flick of finger pushing tape forward for easy access.
- Stacks neatly on shelf, bookcase, or table.
- Dovetail strip (available from company) lets you hang a row of tape containers on wall.
- Unique Sonoramic indexing system on pressure sensitive labels included free in every package. Permits you to keep tabs on all recordings.
- Tape time ruler on carton permits accurate measurement of elapsed and remaining time.

#### Inside the container...

...is Sonoramic Wide Latitude Recording Tape, a superb new miracle of recording tape engineering. From the selection of raw materials, to coating, slitting and packaging — this tape reflects the care and precision it takes to make a quality product. Here's the story on the tape:

\*A DuPont trade mark.

- Distortion-free recordings guaranteed by exclusive time-temperature dispersing techniques.
- Broad-Plateau Bias assures maximum performance regardless of make of recorder, line voltage fluctuations, tube age, head condition.
- High resistance to abrasion, print-through and cupping.
- Life-time lubrication eliminates squeal, layer-to-layer adhesion, and deposits on heads.

There are three tapes designed for all uses — all on 7" reels. These include: *Standard Play*, 1½ mil acetate, 1200 feet, meets rigid requirements for both professional and home use. *Long Play*, 1 mil mylar,\* 1800 feet, a premium quality tape designed for maximum strength and immunity against heat, humidity and other weather conditions. *Extra Long Play*, ½ mil mylar,\* 2400 feet, a high quality tape useful for extra recording time, and where tape tension is not excessive.

When you buy your next reel of tape remember these facts: not only do you get the excellent quality of Sonoramic Wide Latitude Recording Tape — but every reel comes in its own handsome permanent plastic container.

NOTE: To the first 50 people who write in requesting it — we'll be happy to send out a free Sonoramic tape container. Please remember: we can only do this with the first 50 requests: Write to Dept. A101, Ferrodynamics Corporation, Lodi, New Jersey.



Store on table...



...or on wall...



...or in bookcase.

SONORAMIC IS A PRODUCT OF THE



FERRODYNAMICS CORPORATION • LODI, NEW JERSEY

# Which Tube Shall I Use?

GEORGE FLETCHER COOPER\*

The author presents a lucid yet simplified description of the use of tube characteristic curves for the selection of the proper tube, from the standpoint of distortion, for a given application.

I AM ALWAYS READING, and for that matter writing, articles on how to design this and that, especially in the way of audio amplifiers. My staff of trained statisticians estimates that if all the audio amplifiers which have been designed were set to operate at full output simultaneously, one in four of the population would be off to have their eardrums pierced. One thing, however, is scarcely mentioned: although I explain why I take feedback round from end to beginning, and my friend X tells you why he uses only local feedback, we rarely explain why we chose to use a particular tube in a particular place. Oliver Heaviside said somewhere, "Even Cambridge mathematicians deserve justice," so I must rapidly plead that we do usually tell you why we chose our output stage tubes. My own personal choice for the 20-100 watt output stage is the 6L34, even if it is a little harder to get than old faithfuls like the 6L6, just because I have found it very easy to drive. Maybe some of the newer tubes are even easier, but at the moment I have no reason to try to find out.

The tube at the front end of the amplifier may choose itself, too, especially in portable equipment. My own personal feeling is that microphony is best treated by using the tube you like in its ruggedized version and providing some mechanical anti-shock system, while hum is rarely troublesome if the heater line is lifted up to about 20 volts above ground and is kept balanced. I am tempted to rectify the heater supply rather than use special tubes, but so far I have never been that desperate. As a result I am pretty free to choose the tubes right through the amplifier. There are some special considerations to be taken into account which will not affect most readers: when you are working on a whole range of equipment, spares inventories must be remembered or you find you need more space for spare tubes than for the operating installation.

Designers of studio-frequency amplifiers usually adopt a figure of merit based on the ratio of transconductance to capacitance. Just how you combine input and output capacitance depends on the interstage coupling circuit. This

is discussed in Terman and I do not propose to look it up and copy it down. A more sophisticated designer will go on to worry about grid-plate capacitance, the usual limiting factor in designing narrow-band r.f. amplifiers. And then—but we are, for now anyway, audio designers. What are we to do?

The basic problem of the audio designer is to get gain without distortion. As you all know, you can trade gain for distortion by using negative feedback and you can also trade distortion for gain by using positive feedback. Not surprisingly, the bigger the deal the bigger the headache. Ideally each stage of an amplifier could then be used to maximum effect, but this really does involve quite a design job.

## Tube Data

What we need in making our choice of tube type is some fairly simple criterion. In the old days the tube makers gave us a short set of tube data, curves and a couple of circuits all on a single small sheet of paper: now no self-respecting manufacturer would send out data sheets weighing less than the tube itself. What we need to do, therefore, is to find some way of summarizing this information into a form suitable for easy comparison between tubes.

Most of the vital statistics of a tube seem to be included, for our purposes, in a single curve. This is the curve of transconductance against bias. From this curve we can derive a whole mass of other information, and we can also just plot the curves for several different tubes on the same sheet of paper without getting into too much of a muddle. For some reason the textbook writers have never taken to this rather simple approach so that it is not nearly as widely known as it deserves.

First of all, let us assume that we are working with pentodes. Then the characteristics of the tube are, for all practical purposes, independent of plate load. We write down the plate current  $I_p$  as a function of grid voltage:

$$I_p = I_o + \alpha e_g + \beta e_g^2 + \gamma e_g^3 + \dots \quad (1)$$

In this expression  $e_g$  is measured from the normal working point and represents the input signal. This corresponds to the practical arrangement in which the cathode is biased positive by the drop

in the cathode resistor, the bias is held constant by a large decoupling capacitor and the grid is returned through a high resistance to ground.  $I_o$  is just the plate current with no signal applied. To find the transconductance we differentiate, giving

$$\frac{\alpha I_p}{\alpha e_g} = g_m = \alpha + 2\beta e_g + 3\gamma e_g^2 + \dots \quad (2)$$

Of course we normally consider the transconductance to be the limiting value for very small signals, so that actually  $\alpha$  is the transconductance given in tube data.

In Eq. (2) we have written down:

$$\frac{dI_p}{de_g} = g_m$$

This is just the same as writing down

$$I_p = \int g_m \alpha e_g$$

provided we put in the proper limits. We know that if  $e_g = e_{gc}$ , the cut-off voltage, we must have  $I_p = 0$  and if  $e_g = 0$  the plate current is  $I_o$ . Then

$$I_o = \int_{e_{gc}}^0 g_m \alpha e_g$$

As I hope you remember, this is just the area under the  $g_m - e_g$  curve, the area shown shaded in Fig. 1. Therefore we can tell the price we must pay in plate current for any particular transconductance, and thus for any particular gain. The area under the curve, if it is of the form shown in Fig. 1, is most

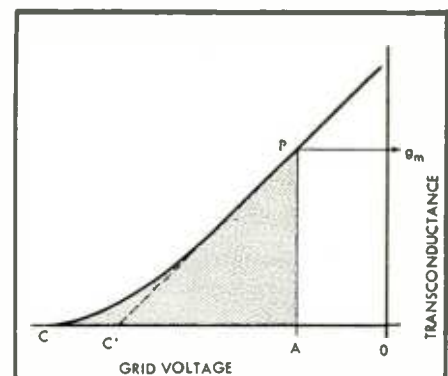

Fig. 1. A typical curve of transconductance against grid voltage. At P, the working point, the grid voltage is taken to be zero, AO being the voltage of the cathode above ground. C is the cutoff point. The area shaded is the standing plate current.

\* London, England.



# NEW G-E VR<sub>II</sub> CARTRIDGE

increased compliance...4-gram tracking force  
...frequency-range 20 through 20,000 cycles

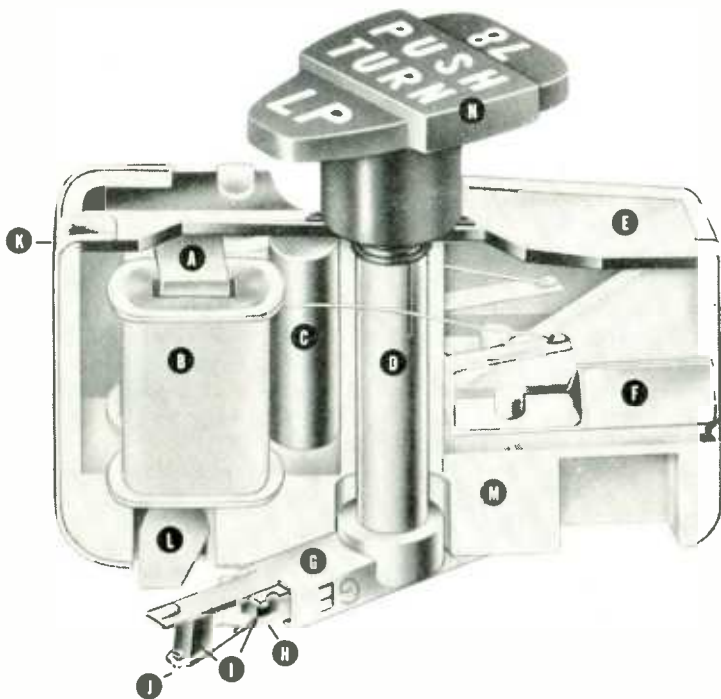

- A Highly permeable laminations
- B Hum-cancelling wound coils
- C Alnico V Magnet
- D Pivot Post
- E Electrostatic Shield
- F Plug-in Terminals
- G "T"-Channel
- H VR<sub>II</sub> Clip-In-Stylus
- I Special G-E Damping Blocks
- J Stylus Jewel
- K Mu-Metal Electromagnetic Shield
- L Magnetic Pole Pieces
- M Plastic Body
- N Triple Play Knob

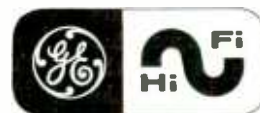

## A dramatic new design to bring out the best in every Hi-Fi system

**New Full-Range Reproduction.** General Electric's new VR<sub>II</sub> magnetic cartridge makes possible faithful reproduction from 20 through 20,000 cycles. Crystal clear reproduction from the lowest fundamental to the highest harmonics.

**New 4-Gram Tracking Force.** Lateral compliance of the VR<sub>II</sub> has been extended to  $1.7 \times 10^{-6}$  cm per dyne, permitting a tracking force of only 4 grams to minimize record and stylus wear.

**Instant CLIP-IN-TIP Stylus.** Stylus replacements can be made instantly at home without removing cartridge from tone arm. There is no need to discard an entire dual assembly when only one tip is worn.

**New Electrostatic Shielding.** In the VR<sub>II</sub> cartridge a new electrostatic shielding prevents pickup of electrostatic interferences and hum. This shield also grounds the stylus assembly, thus preventing the build-up of electrostatic charges from the surface of the record.

**New Lightweight Construction.** The new VR<sub>II</sub> has been reduced in size and weight, with a new stylus

guard. Terminals and knob have been improved. The G-E VR<sub>II</sub> is built to withstand continued usage under the most exacting conditions.

Frequency Response . . . . . See typical curve below.  
Output Voltage . . . . . Nominal, 22 millivolts at  
10 cm per sec. at 1000 cycles  
Horizontal Compliance . . . . .  $1.7 \times 10^{-6}$  cm per dyne  
Inductance . . . . . 520 millihenrys nominal  
Resistance . . . . . 600 ohms nominal  
Cartridge Weight . . . . . 8 grams (single type); 9.5 grams (dual type)

*For further information write to: Specialty Electronic Components Dept., Section HFA-1157 West Genesee Street, Auburn, New York.*

*In Canada: Canadian General Electric Company, 189 Dufferin Street, Toronto 3, Canada*

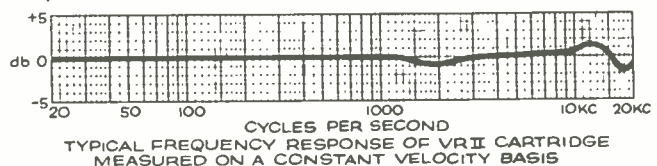

GENERAL  ELECTRIC

easily found by calculating the area of the triangle C'AP and then either counting squares or making a rough estimate of the area of the small wedge on the left. Remember, when doing this, that the average tube tolerances are quite large and do not, I beg you, try to work to 1 per cent, or even 5 per cent. It just doesn't mean a thing!

What else can we find out from this graph? Well, let us look again at Eq. (1), and assume that  $e_g = e \cos \omega t$ . It is, by the way, always a good thing to use  $\cos \omega t$  rather than  $\sin \omega t$  in harmonic calculations, because then there are no minus signs to make the expressions more awkward. Since  $e_g = e \cos \omega t$ , we have

$$e_g^2 = e^2 \cos^2 \omega t = \frac{1}{2} e^2 (1 + \cos 2\omega t)$$

and

$$e_g^3 = e^3 \cos^3 \omega t = \frac{1}{4} e^3 (3 \cos \omega t + \cos 3\omega t).$$

Equation (1) therefore becomes:

$$I_p = I_o + \frac{1}{2} \beta e^2 + \left( \alpha + \frac{3}{4} \gamma e^2 \right) e \cos \omega t + \frac{1}{2} \beta e^2 \cos 2\omega t + \frac{1}{4} \gamma e^3 \cos 3\omega t + \dots \quad (1a)$$

This equation is correct as long as we are justified in neglecting anything above the third power of  $e_g$ . Already, as you see, the steady component is affected by the  $\gamma$  term and the fundamental is affected by the  $\beta$  term. These interactions are actually intermodulation effects in which the signal mixes with its own harmonics to produce other harmonics. The more terms we take, the more likely the editor is to say he doesn't like mathematics!

If we simplify Eq. (1a) rather more by assuming that  $\gamma$  is zero, which means taking only second harmonic into account, and then turn to Eq. (2), we have

$$g_m = \alpha + 2\beta e_g. \quad (2a)$$

Now let us differentiate this, giving

$$\frac{dg_m}{de_g} = 2\beta$$

This means that  $\beta$  is a measure of the slope of the transconductance characteristic. The ratio of second harmonic to fundamental in the plate current is

$$\frac{1}{2} \beta e^2 / \alpha e = e\beta / 2\alpha$$

Let us look at Fig. 2, which is really only a part of Fig. 1 redrawn. The signal drives the grid alternately to the right and the left of A with a total range of  $2e$  (i.e. the peak-to-peak voltage). At P the transconductance is  $\alpha$ , but the range over which the transconductance varies is  $2g_p$ . The slope of the transconductance curve is thus  $2g_p/2e = g/e$ . But this, we have just seen, is  $2\beta$ . Hence we have  $g = 2\beta e$  and the ratio of

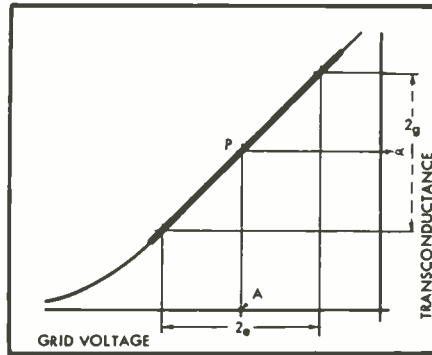

Fig. 2. A signal drives the grid to a peak distance of  $e$  volts on either side of A, the reference point. The transconductance varies from  $\alpha - g$  to  $\alpha + g$ .

the second harmonic to the fundamental becomes  $g/4\alpha$ .

It is, of course, very easy to find this just by looking at the tube characteristic.

We want to have the largest gain, that is the largest value of  $\alpha$ , for the smallest value of distortion, which in this case means the smallest value of  $g/4\alpha$ . If we take gain/distortion as a figure of merit we have  $\alpha^2/4g$ , or since we are always comparing tubes and need not keep dividing everything by 4, we have  $\alpha^2/g$  as a gain/distortion figure of merit.

#### Practical Example

At this point we should, I suppose, look at some typical tubes. Skimming through a tube handbook I have picked out three tubes and have replotted their characteristics on the same scale, together, in Fig. 3. Choosing a working point at a bias of  $-1.2$  volts and assuming a swing of  $\pm 0.4$  volts, we have for these three:

	$\alpha$ (transconductance)	$2g$ (see Fig. 2)	$\alpha^2/g$
1. 6AU6	3.5	1.4	17.5
2. 6BA6	4.0	1.0	32
3. 6BS7	2.0	0.55	14.5

It would appear, then, that the 6BA6 has the highest figure of merit, and that the low- $g_m$  tube, the 6BS7, although it produces less distortion than the 6AU6, does not pay off because it is better to accept the distortion for the sake of the extra gain.

One thing will be noted, however. The 6BA6 curve is everywhere above the 6AU6 curve and in fact the current taken by the 6BA6 is about twice that taken by the 6AU6. We really should carry out another check of this sort, based on equal plate currents. Then we look at our particular problem and decide whether economy in current is important. Very often it is, even if only because it becomes easier to decouple the early stages from the power-supply disturbance originating in the output stage. In portable equipment every milliamper adds ounces to the weight of the smoothing components.

It is worth while also working out what the distortion actually is: for our three tubes under the conditions given we have:

$$g/4\alpha \times 100 = \text{2nd harmonic distortion in per cent}$$

1. 6AU6  $(0.7/14) \times 100 = 5.0$
2. 6BA6  $(0.5/16) \times 100 = 3.12$
3. 6BS7  $(0.275/8) \times 100 = 3.44$

This shows us that we are favoring the 6BA6 for both distortion and gain. It also gives us some numbers to compare with the distortion in other parts of the amplifier, so that we can decide if this is our critical point or if we should be spending more time worrying about another stage.

#### Triode Considerations

We have now seen how to assess a pentode stage for its second harmonic distortion. Suppose, however, we are triode users. The answer then is, I'm afraid, it all depends on the tube maker. I have found one who provides me with curves of transconductance vs. grid voltage for three different plate loads, for the 12AT7, anyway. Sometimes you only get curves of  $\mu$  and  $r_p$ . When that happens you have to do rather more work.

The gain of a triode stage is

$$\mu R_L / (r_p + R_L)$$

so that the effective transconductance is  $\mu / (r_p + R_L)$ . It is tedious but not exhausting to tabulate  $\mu$  and  $r_p$  for different values of  $e_g$ , then add  $R_L$  to each  $r_p$  and then work out this effective transconductance. To bring triodes into our general net we must do this. I think it is worthwhile, just because one unified approach does save quite a lot of thought and effort in the long run.

While we are talking triodes let us deal with the effect of a local feedback loop. This is long-hair language for leaving the cathode resistance without decoupling. (By the way, just what is the difference between the long-hair ap-

(Continued on page 66)

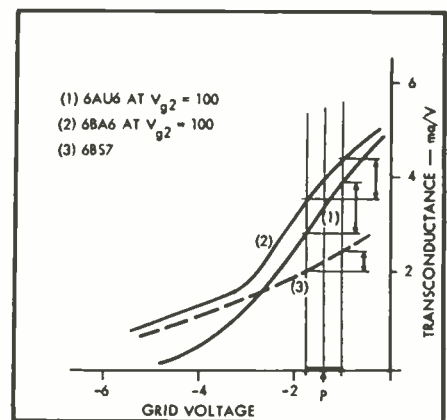
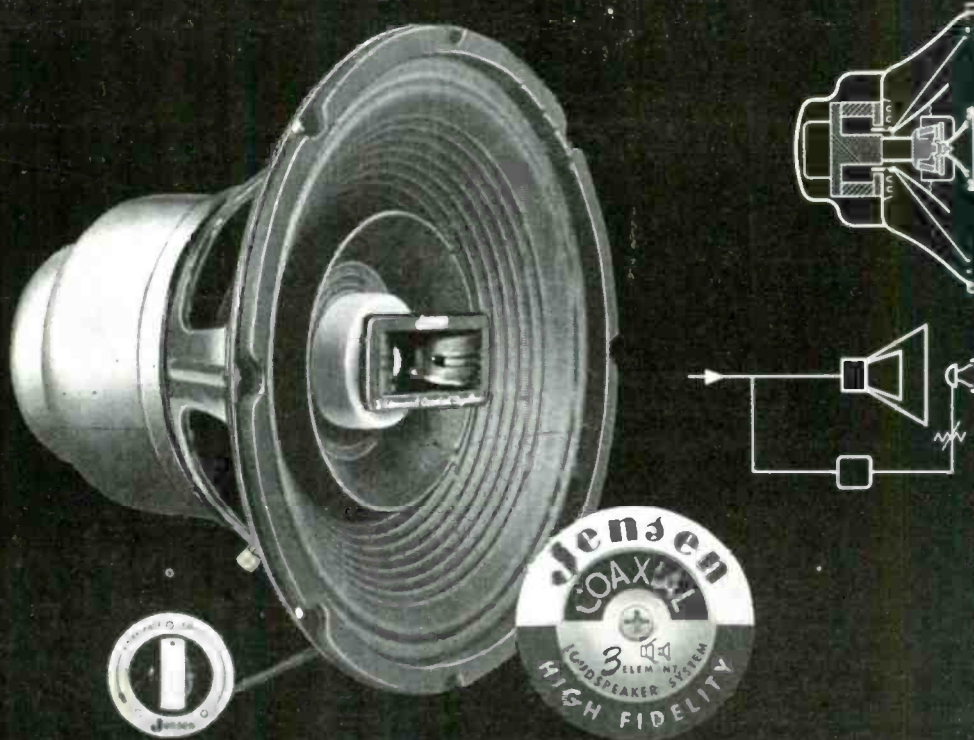

Fig. 3. Comparison of three tube types operating at  $-1.6$  v. bias with a grid swing of  $\pm 0.4$  volts.



# NEW Jensen COAXIAL 3-ELEMENT HI-FI LOUDSPEAKERS

You'll spend less for more performance  
... get traditional **Jensen** quality!

If you're looking for hi-fi performance outclassing anything remotely similar on the market today ... with more performance ... more easy-on-the-ears listening quality ... at less than you'd expect to pay, then don't fail to investigate Jensen's 4 new Coaxial 3-Element models.

There are three radiating elements driven by two voice coils. H-F unit is a compression driver supertweeter 4000-15000 cycles; woofer-midchannel is a separately driven dual cone unit, with the small cone dispersing and smoothing the 2000-4000 cps. region. The whole skillfully blended combination rates at 30-15000, low end depending on enclosure. H-F control tunes it up smoothly to suit the ear. Choice of 12-inch CX-120 (1 lb. magnet) at \$49.50 or CX-225 (1 3/4 lb.) at \$59.50; 15-inch CX-150 (1 lb.) is \$66.50, CX-255 (1 3/4 lb.) only \$76.50. Write now for free complete condensed Catalog 155-B.



### KTX-3 "STEP-UP" KIT

If you have the urge to improve your speaker later, you can have a full 3-way system by adding this compressor horn midrange unit (600-4000 cps). Net \$62.50.

# Jensen MANUFACTURING COMPANY

6601 South Laramie Ave., Chicago 38, Illinois

Division of The Muter Co. In Canada: J. R. Longstaffe Co., Ltd., Toronto  
In Mexico: Radios Y Television, S.A., Mexico D.F.



**UNAX**  
SINGLE ELEMENT

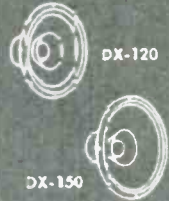

**DUAX**  
2-ELEMENT SYSTEMS

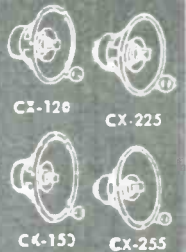

**COAXIAL**  
3-ELEMENT SYSTEMS

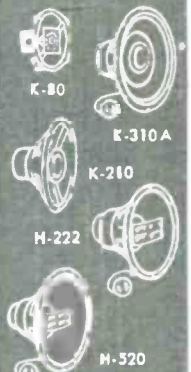

**COAXIAL**  
2-WAY SYSTEMS

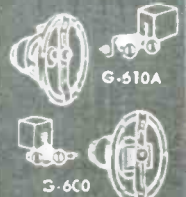

**TRIAxIAL** and  
**TRIAx**  
3-WAY SYSTEMS

THE  
WORLD'S  
MOST  
COMPLETE  
HIGH  
FIDELITY  
LOUDSPEAKER  
LINE

\*T. M. Reg.



# What makes **harman kardon** High Fidelity so special?

"We found the Harman-Kardon units we tested—the Theme, Trend, Festival and Solo to be honestly rated and living up to their specs in all ways. We were particularly impressed by the extreme stability of the FM tuners, particularly the Theme and Festival. Without AFC there was absolutely no discernible drift from a cold start. The Trend was also noteworthy for the power output it delivered over the full audio spectrum. The units were certainly an excellent value in their price class."

*From a report by the authoritative Audio League*

*What makes Harman-Kardon high fidelity so special?*

**1. The Way It's Designed:** Every Harman-Kardon tuner, including the relatively inexpensive Overture II (T-12), employs a full Armstrong circuit with Foster-Seeley discriminator and Automatic Frequency Control. Compare this with the less expensive, less effective ratio detector circuits used in so many tuners today. The remarkable new Harman-Kardon Inter-Mode FM front end (used in the T-1040 and TA-1010) achieves the practical limits of FM sensitivity; it provides more gain, eliminates fading, and is superior to other circuits in impulse noise rejection. Most installations will perform excellently with only a 48" lead for an antenna.

All Harman-Kardon amplifiers incorporate the H-K "Controlled H" output circuitry. This significant development in audio engineering makes it possible to house a powerful amplifier in a truly compact enclosure. Because "Controlled H" amplifiers draw power only in proportion to the requirements of the program material, they create less heat than conventional units of half their power. They are, therefore, less subject to component failure due to excessive heat. (Today's Recital II puts out 2½ more power than the first Recital, yet it draws 30% less power than the original.)

Consider the FM and AFC controls on an H-K tuner. When tuning FM, do so with the function selector switch in the "AFC-OFF" position. When the tuning meter indicates you've tuned as well as you can *manually*—snap on the AFC. *Automatically*, the accuracy of tuning is improved by a factor of 10 to 1. It's as though you had a magnifying glass in the tuning meter and could make the critical adjustment, which the AFC control makes *automatically*.

All Harman-Kardon instruments are extraordinarily sleek and handsome in appearance. The cage and control panel are finished in brushed copper; the knobs and escutcheon frame in matte black.

**2. The Way It's Made:** Printed wiring is used in every Harman-Kardon model. Eliminating human variables in production, this process literally prints the interconnecting wiring of the instrument by etching it on a laminated phenolic sheet. Electrical components are fastened to the sheet by automation equipment and the sheet is then dipped into a bath of solder. In this way, each element is locked into its one best position. This process, perfected and proven in the Guided Missile and Earth Satellite programs, places emphasis on precision, reliability and quality—an emphasis essential in genuine high fidelity.

The laminations in H-K's own specially designed output transformers are made of the most expensive grade of steel—grain-oriented XXX-P. This quality construction guarantees absolute stability and freedom from distortion.

Every Harman-Kardon unit must pass no less than 18 test and inspection stations during production. Our Quality Control group also runs exhaustive re-tests on no less than 10% of all completed units. This additional testing is further assurance of H-K quality and reliability. And Harman-Kardon backs this up with a full year's guarantee on each unit.

**3. The Way It Performs:** Here is the final test of a high fidelity instrument. And here is where Harman-Kardon is so demonstrably special: tuners which approach theoretical perfection; amplifiers which deliver audio power with startling ease, lack of distortion and freedom from hum.

Here's a dramatic indication of performance: Quality Control records indicate that in a recent production run of The Trend II (A-1010) amplifier, over 85% were 11 db better—that's five times better—than our advertised hum specs.

All H-K sensitivity specs are stated in "hard" microvolts. This means that our tuners are measured with an antenna connected to them (measured therefore under conditions of actual operation). Some companies publish sensitivity specs in "soft" microvolts. Such tuners are measured *without* an antenna connected and this process results in apparently more attractive—but *unreal* specifications.

Were H-K tuners measured in soft microvolts, the published specifications would read approximately twice as good as they now do. The T-1010, for example, would claim FM sensitivity of better than .95 microvolts instead of our conservative, published specification of 1½ microvolts. Consider this when next studying specifications on tuner sensitivity.

*The way it's designed; the way it's made; the way it performs. This, we think, merits the claim—"special."*

## THE CUSTOM LINE



THE TREND II amplifier delivers 40 watts (60 watt peak) of hum-free, distortion free power. Features include: speaker selector switch; rumble filter; loudness contour selector; variable damping factor control; separate record and tape equalization and enormously effective treble and bass tone controls.

The Trend II, Model A-1040 \$125.00



THE THEME II AM-FM tuner, ideal companion for the Trend II. Features: Armstrong FM with sensitivity at theoretical maximum; variable AFC; variable automatic interstation noise gate; illuminated tuning meter; FM rumble filter; dual cathode follower outputs with adjustable level control; only two simple front panel controls.

The Theme II, Model T-1040 \$140.00



THE FESTIVAL II combines the operating features and performance characteristics of the Theme II tuner and Trend II amplifier in one magnificent unit. Here is the finest expression of high fidelity thought and design in a graceful, compact instrument only 16 1/8" wide x 14" deep x 4-5/16" high—including runners.

The Festival II, Model TA-1040 \$250.00

## THE DELUXE LINE



THE COUNTERPOINT II, an FM only tuner, is an exact physical match for the Melody II amplifier. This highly sensitive new tuner includes a discriminator balance tuning meter; variable AFC; variable automatic interstation noise gate; FM rumble filter; cathode follower output with adjustable level control.

The Counterpoint II, FM-100 \$99.95



THE RECITAL II, selected as an outstanding example of American design for official U.S. exhibit at the Milan Triennale, world's most important exhibition of industrial design. Combines finest features of Melody II and Rondo. Represents the wisest balance of operating features, performance and price yet achieved in a single chassis receiver.

The Recital II, Model TA-120 \$189.95



THE MELODY II amplifier produces 20 watts of undistorted power from the exclusive "Controlled H" circuit. Despite its high power output, it runs cooler than a conventional 10 watt amplifier. Features: speaker selector switch; contour control; rumble filter; separate tape and record equalization.

The Melody II, Model A-120 \$99.95



THE RONDO tuner is the AM-FM tuner mate for the new Melody. Features: Armstrong FM with AFC and rumble filter; superheterodyne AM with 10 KC whistle filter; dual cathode follower outputs with adjustable level control; built-in ferrite loopstick antenna.

The Rondo, Model T-120 \$99.95

## THE STANDARD LINE

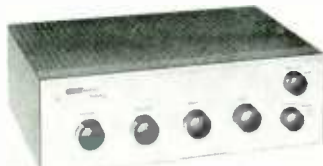

THE PRELUDE II all new, low cost, high quality 12-watt amplifier, provides remarkable performance for the price. Features: 4-position contour control; 3-position speaker selector switch; input for tape playback provides correct equalization without additional preamplifier.

The Prelude II, Model A-12 \$59.95

Prices slightly higher in the West



THE OVERTURE II AM-FM tuner, ideal mate for the Prelude II. Provides unusually fine performance at low cost. Printed wiring assures optimum front end performance, stability and quality control. Features: Armstrong FM with AFC; Broad-band Superheterodyne AM with AVC and Ferrite antenna. Flywheel tuning.

The Overture II, Model T-12 \$84.50



THE SOLO II, combined tuner-amplifier-preamplifier has the principal operating features and performance characteristics of the Prelude II and Overture II. A 3-position speaker selector switch permits choice of speaker A or B or both; The Solo II is styled in copper and black. It is 13 1/2" deep x 14 5/8" long x 4 1/2" high.

The Solo II, Model TA-12 \$139.50

**harman kardon**

INCORPORATED  
WESTBURY, L. I., N. Y.

# Two-Channel Mixer for Auricon Film Camera

DONALD K. HAAHR\*

An adaptation of a circuit previously described to make it possible to use two microphones readily with a recording amplifier designed for only one. Transistors are used to reduce size, weight and power consumption, yet with performance comparable to conventional equipment.

THE WOI-TV NEWS DEPARTMENT at Iowa State College of Agriculture and Mechanic Arts normally uses Auricon Cinevoice Camera, together with its Type RA-30-A7 amplifier. This amplifier has only one microphone input and a relatively high noise level at full gain. Because of a need to do off-camera interviews or to use a boom mike, it was considered necessary to develop a two-input transistor mixer amplifier with a low noise level and a gain of about 15 db. The mixer size was determined by available storage space in the carrying case—the space which would be occupied by four boxes of 100-foot 16-mm reels of film, or about 2 by 4 by 8 inches. A self-contained battery power supply allows this mixer to be completely independent of the Auricon amplifier so it can be inserted or removed from the existing system with no electrical or physical changes. The completed unit is shown in Fig. 1 alongside a box of film, and the internal construction is shown in Fig. 2.

## Circuit Details

Figure 3 shows the over-all schematic of the preferred form of the amplifier. 2N106 transistors were chosen basically because of their low noise level. To prevent loss of low-frequency response, all coupling and by-pass capacitors are 220- $\mu$ f, 6-volt units, which also reduces the number of different components used. All resistors are half-watt types, and the gain controls are 10,000-ohm, log-taper potentiometers which are isolated from d.c. voltages to ensure quieter operation. There is an interaction of 0.5 to 4 db between the two gain controls, depending on frequency and circuit, as is shown in Figs. 4 and 7. The two input circuits are identical, and are designed for low-impedance (50- to 600-ohm) microphones. 4 db of feedback results from

Fig. 1. External view of the two-channel sound-camera mixer unit—completely self contained, and suitable for employing two microphone inputs with a recording amplifier with only a single input.



the unbypassed emitter resistors  $R_5$  and  $R_7$ .

The shunt-fed output stage was

selected because the frequency response of small output transformers is greatly dependent on the amount of d.c. through

Fig. 2. Internal view of the amplifier of Fig. 1.

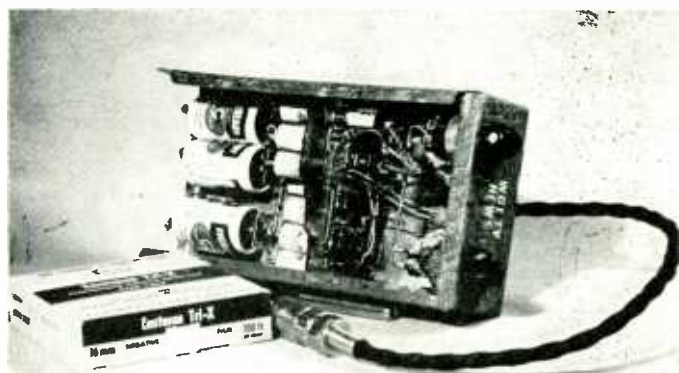

\* Liaison and Planning Engineer, Radio-TV Service, Iowa State College of Agriculture and Mechanic Arts, Ames, Iowa.

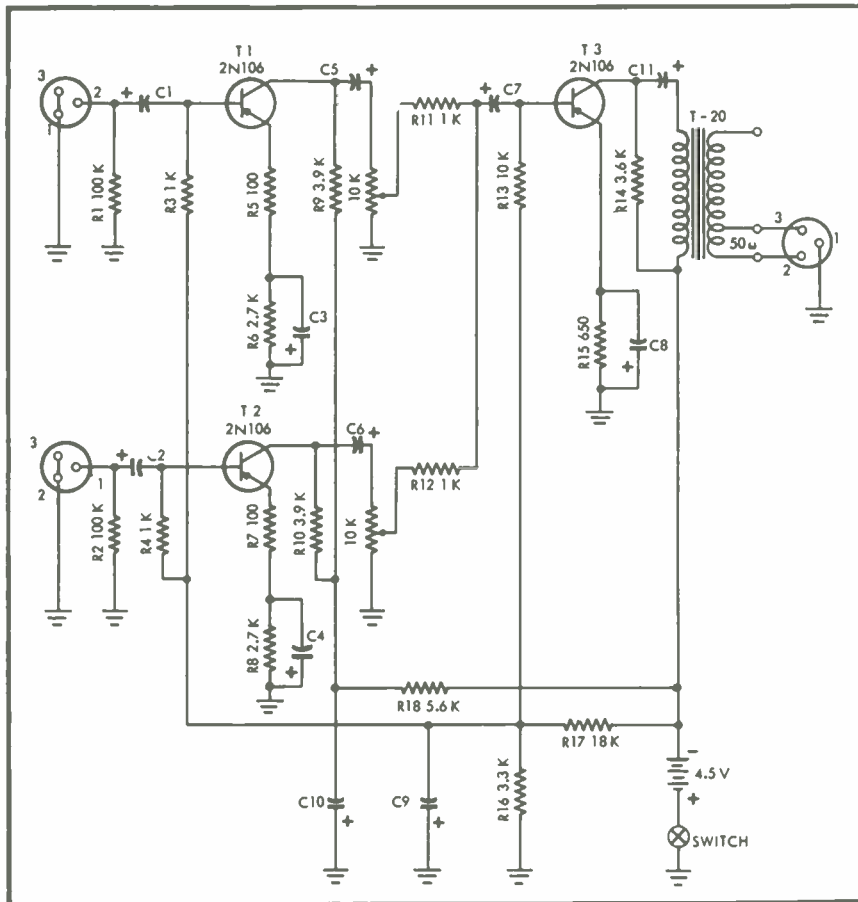

Fig. 3. Over-all schematic of the two-channel mixer adapter. Note the use of shunt feed for the output stage—which results in flat low-frequency response at the expense of some gain.

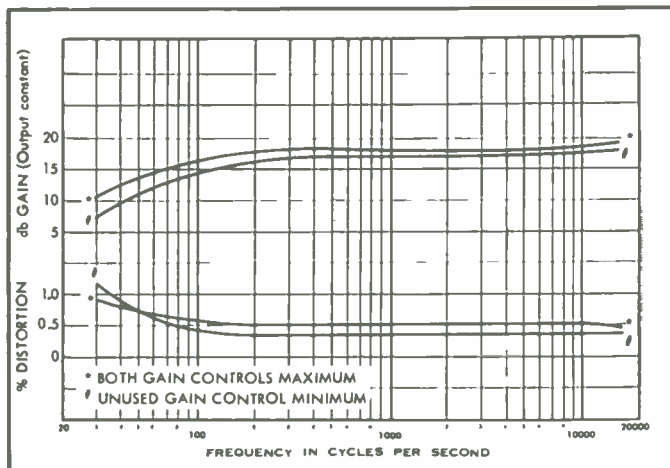

Fig. 4. Distortion and frequency response curves for the amplifier of Fig. 3.

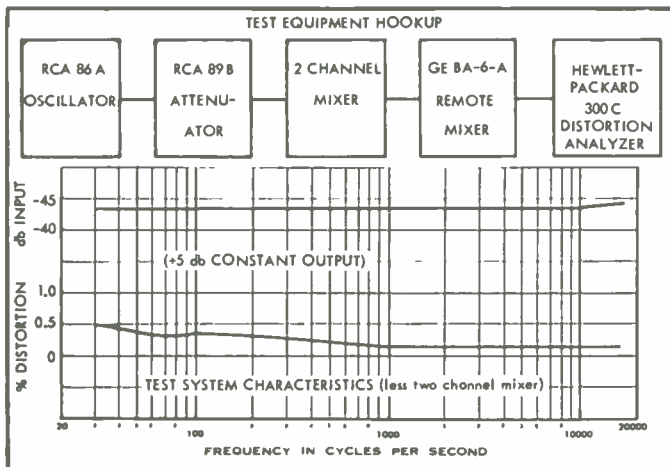

Fig. 5. Test equipment setup used to obtain curves of Figs. 4 and 7, together with distortion and frequency response curves.

the primary winding. At the expense of some gain—a maximum of 7 db—it was found possible to achieve a 1-db gain deviation from the 1000-cps reference point over the range from 30 to 17,000 cps, with an over-all gain of 9 db and distortion of less than 0.5 per cent, as shown in Fig. 4. The test circuit hookup is shown in Fig. 5, so the distortion and frequency response curves include that of the GE Type BA-6-A remote mixer amplifier. Noise level was 56 db below the -53.5-db input, or 109.5 db below zero-level output (0 dbm).

### Series-Fed Output

By modifying the output stage as shown in the schematic of Fig. 6, the remainder of the circuit being the same as in Fig. 3, the gain was increased over the shunt-fed circuit, resulting in a gain of 16 db over-all.  $R_{11}$  provides 11 db of feedback, and the emitter resistor was changed from 650 ohms to 2700. Response was down 3 db at 100 cps, but flat to 17,000 cps, and noise level was 47.5 db below the -61-db input, or 108.5 db below zero level output (0 dbm). Both response and distortion curves are shown in Fig. 7. Since this unit is normally used for film recording, the lower frequencies are not considered too important, but depending upon the requirements either circuit could be employed to give whichever response curve and gain combination was desired.

### Power Supply and Construction

For a power supply, three size "C" flashlight batteries are used. The Iowa Medical Society has been using one set of batteries for seven months and they still check at 1.6 volts each. This makes it reasonable to expect shelf life from this type of battery. Possibly a mercury

(Continued on page 96)

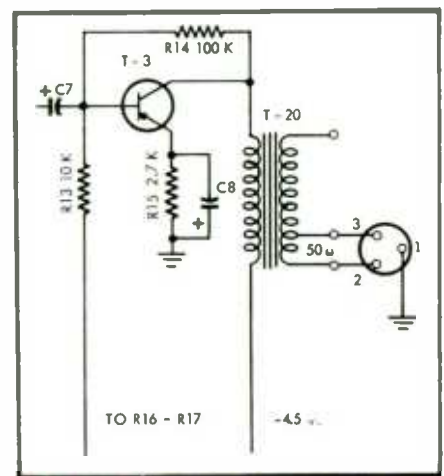

Fig. 6. Modifying the output stage as shown here results in slightly higher gain at the expense of low-frequency response.

# Stereosonic Magnetic Recording Amplifier

ARTHUR W. WAYNE\*

Concluding the description of a specific amplifier designed for a Ferrograph Tape Deck, but adaptable to accommodate any other type of stereo deck with heads of similar impedances and drive requirements.

## In Two Parts – Part II

THE FIRST INSTALLMENT of this article described the amplifier without showing the derivations of some of the statements made. Here in the Appendix the author indicates the direction to take in case further delving into performance and operation is indicated or desired, suggests suitable loudspeakers for use with the equipment, and offers some helpful hints about operation.

### APPENDIX 1

(1) Although the FS103 amplifier gives professional results, there is no reason why the experienced amateur should not do a little experimenting. After all, what is politely known as development work is really nothing more than the application of brute-force-and-ignorance methods to designs that look well on paper and satisfy the most esoteric manipulations of the slide-rule, but sound horrible when built, or just won't work at all.

One of the more interesting fields for experiment is in the matter of equalization, where many methods are in use, the applications of some being rewarding from the points of view of both interest and results. The twin-T feedback network is one of these, and the basic circuit is given in Fig. 8. The whole of the tone control network  $R_{21}$ ,  $R_{22}$ ,  $R_{23}$ ,  $P_7$ ,  $C_{11}$ ,  $C_{12}$ ,  $C_{13}$ ,  $C_{14}$ , and  $C_{15}$  is omitted, and in its place, on RECORD, a feedback network is applied between anode and grid of  $V_4$ .

The formula for "resonance," when the impedance of the network is at its maximum, is

$$f = \frac{159 \times 10^6}{K \times C}$$

where  $K$  is in thousands of ohms and  $C$  is in thousandths of microfarads (picofarads) and the amount of feedback may be varied by tapping off the anode load  $R_{11}$ . With  $K = 220K$  and  $C = 68$  pf (.068  $\mu$ f), the lift at around 10,000 cps is about 18 db; but in the author's opinion, it is too peaked, and more satisfactory aural results may be achieved with a bridged-T network. The reactance of  $CA$  gives the small bass boost, with  $RA$  responsible for the levelling-off.

Bass boost on replay is obtained by the substitution of a series feedback network consisting of 680K and 180 pf between anode and grid of  $V_4$ . However, the lift of about 25 db at 50 cps compared to 2,500 cps is perhaps too much for American replay standards, and 1.8 meg. will bring this down to approximately 18 db.

(2) The calculation of the coupling between the two channels, as represented by the impedance of the smoothing capacitor,

THE TRANSMISSION OF THE FEEDBACK NETWORK EXCEPT AT "RESONANCE" IS CONTROLLED ONLY BY THE REACTANCE OF  $CA$  AND THE RESISTANCE OF  $RA$  AND  $RB$ .

AT RESONANCE, THE IMPEDANCE OF THE NETWORK ALONE CAN BE VERY HIGH — "INFINITE ATTENUATION" — BUT IS MODIFIED BY THE SERIES RESISTORS AND ALSO BY THE SHUNT RESISTORS  $RC$  AND PART OF  $P_3$ .

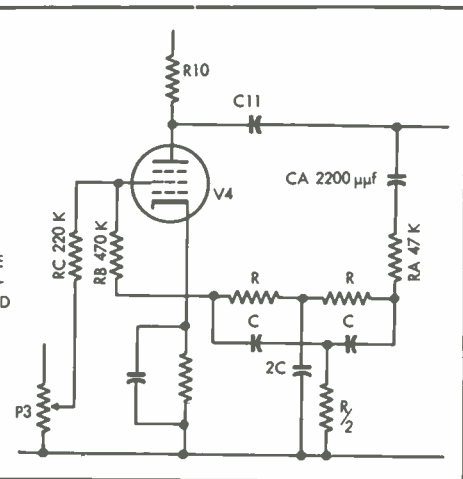

Fig. 8. The transmission of the feedback network except at "resonance" is controlled only by the reactance of  $CA$  and the resistance of  $RA$  and  $RB$ . At resonance, the impedance of the network is given by the formula

$$ZC = \frac{10^6}{2\pi \times f \times C(\mu f)}$$

In the FS103, the smoothing capacitor = 100  $\mu$ f. Common impedance =

$$\frac{10^6}{6.28 \times 50 \times 100} \text{ at } 50 \text{ cps} = 32 \text{ ohms approximately.}$$

Ripple current is approximately 1.4 times the load current. On RECORD, current = 230 ma; ripple current =  $230 \times 1.4$  ma = 322 ma, which figure must be borne in mind when choosing the reservoir capacitor.

An alternative power circuit, which avoids the difficulties associated with high ripple currents, as well as being cheaper and lighter than that of the FS103 is given in Fig. 9. The capacitors should have a working voltage of 450 although 350 wv is permissible.

alone can be very high—"infinite attenuation"—but is modified by the series resistors and also by the shunt resistors  $RC$  and part of  $P_3$ .

(3) Two out of the many possible oscillator circuits will be found in Fig. 10. In the oscillator of (A),  $V_{11}$  is omitted altogether, and  $V_{11}$  is a Mullard EL34.  $P_7$  is returned to ground through the Varite thermistor type V1011, adjustments being made as before. The EL34 is a power valve capable of a really remarkable r.f. output, and the thermistor stabilizes the drive to the grid, chiefly in the direction of bypassing it when the current increases beyond a predetermined level. In (B) of Fig. 10,  $V_{11}$  is again dispensed with, and a Mullard ECL82 is substituted for  $V_{11}$ . This is a combined triode-output pentode, the master oscillator being the triode section. Control is by grid-leak bias, and the circuit is largely self-regulating. As the amplitude of the oscillations increases, the grid capacitor charges and raises the negative bias, until a state of balance is reached in which the oscillations are the maximum

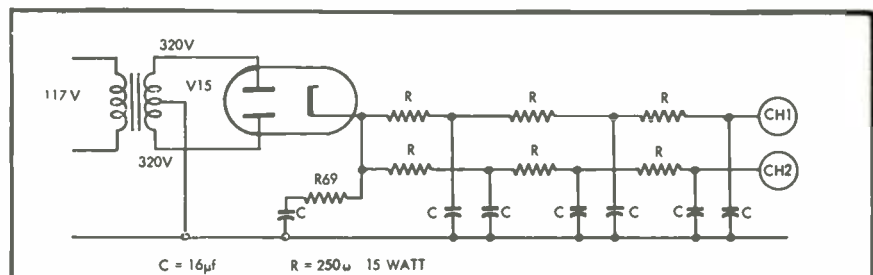

Fig. 9. Schematic of simple power-supply circuit which has a low ripple-current content.

\* Shirley Laboratories, Ltd., 3, Prospect Place, Worthing, Sussex, England.





This  
is where  
the music  
begins



Furniture By JENS RISOM DESIGN INC., N. Y.



## \* New Transcription-Type Tone Arm Makes Collaro World's First True High Fidelity Changer

Because the record player is so critical in a fine music system, you cannot afford to compromise with quality. Your loudspeaker may reproduce 20 to 20,000 cps; your amplifier may put out 50 watts of undistorted power—but the music begins at the record player. That's why today's high fidelity systems require the all new Collaro changer with the revolutionary transcription-type tone arm.

The new arm is one-piece, counter-balanced and will take any standard cartridge. Resonances are below the audible level. Between the top and bottom of a stack of records there's a difference of less than 1 gram in the tracking weight as compared with 4 to 8 grams on conventional changers. This insures better performance for your precious records and longer life for your expensive styli.

It's worth noting that Collaro quality is so well recognized that leading American manufacturers of fine console units incorporate Collaro into their instruments in order to achieve the best possible performance in a record player. Among these manufacturers are Magnavox, Stromberg-Carlson and Altec-Lansing.

In addition to the transcription-type arm, the Collaro Continental features:

Four speeds, manual switch that permits playing single record or portion of a record; jam proof mechanism, hold the arm in mid-cycle and it won't jam; automatic intermix, plays 7", 10"

or 12" records in any order; automatic shut-off after last record has been played; wow and flutter specifications,  $\frac{1}{4}$  (0.25%) RMS at 33 $\frac{1}{3}$  RPM, superior to any changer in the world; muting switch and pop filter to eliminate extraneous noises; extra heavy duty 4-pole induction motor; heavy rim-weighted, balanced turntable for fly wheel action; removable heavy rubber turntable mat; pre-wiring for easy installation; attractive two tone color scheme to fit any decor; factory custom-testing for wow, flutter, stylus pressure and correct set-down position. Reflecting their custom English craftsmanship Collaro changers are tropicalized to operate under adverse weather and humidity conditions. The base, in blond or mahogany, is optional at slightly extra cost and the Collaro mounts easily and quickly on a pre-cut mounting board or base.

When you buy your Collaro, you're buying professional quality equipment at a record changer price. Collaro prices start at \$37.50. The Continental, featured above, is \$16.50. (Prices are slightly higher west of the Mississippi.)



FREE: Colorful new catalog, containing guide on building record library plus complete Collaro line.

WRITE TO DEPT. A-011  
ROCKBAR CORPORATION  
MAMARONECK, N. Y.

Rockbar is the American sales representative for Collaro Ltd. and other fine companies.

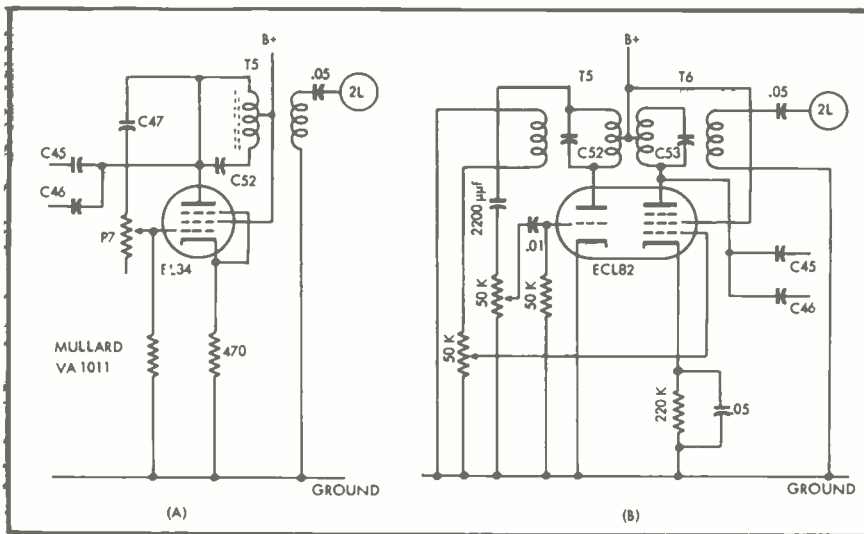

Fig. 10. Two possible circuits suitable for the bias/erase oscillator.

possible, taking into consideration the setting of  $P_7$ . The pentode section of the ECL82 is arranged as the slave oscillator, but with both bias and erase taken from it, leaving the master oscillator free from external influences.

(4) Some constructors may consider fitting bias traps in the head feed circuits, to keep r.f. off the output plates. It seems a rather unnecessary refinement, as bias and signal do go together, but two circuits for the purpose are given in Fig. 11.

#### APPENDIX 2.

The suggested choice for loudspeakers for use with the amplifier is the Goodmans Axiom 22 or Axiom 150 Mk. 2. There are, no doubt, equally good speakers on the market, but the author has yet to hear them. Their response is wide enough to dispense with crossover systems and tweeters—which can introduce serious problems in phase shift—and it is characterized by quite silky smoothness. These speakers have only one fault—if the amplifier is not of the best, they proclaim it to the world unhesitatingly and unequivocally. A resonant enclosure of the dimensions shown in Fig. 12 gives good results, the separation and definition being excellent. Note that, when making power measurements, a resistor as load will not give a picture of the true output. The amplifiers are designed expressly to work into a loudspeaker load, and the dummy should consist of a

reactance of 15 ohms total impedance at 400 cps. An inductor of  $3\frac{1}{2}$  mh in series with 10 ohms is about right.

#### APPENDIX 3

On the operation of stereosonic reproducers.

An operator, using this type of equipment for the first time, will almost certainly try to achieve perfect balance between channels. Indeed, he is exhorted to do so, more than one writer on the subject stating it is mandatory that the gain and tone controls be ganged for the very purpose. This, in common with many other pontifical pronouncements by the engineering and hi-fi fraternity, is nonsense. To forestall righteous anger and condemnation, the author proposes to make a slight digression.

As was suggested earlier in this article, engineers are, on occasion, apt to make definitive statements about subjective matters, without always considering all the available evidence. If this be not so, how can one account for the changing fashions in the Hi-Fi world? Each new circuit is equated with the "real thing," and each subsequent one is so much better than the last; but it is also the "real thing," a sort of ultra-real realism. At one time, 10 watts was ample for the average living-room; now, according to one concatenate authority admittedly not overmuch given to understatement, 100 watts is the figure. And, as mentioned before, we aren't really honest about it. We use co-ordinate geometry as proof of our statements, and raise Fourier analysis to the dignity of a gospel; but a Fourier series merely happens to be a convenient tool in the manipulation of partial differentials, while, for statements about problems in which subjective perception is an important factor, tensors appear to be the appropriate discipline. Whichever way the matter is viewed, the figures are merely a manipulative convenience, and not statements of fact.

Now, the author is a very ordinary engineer, busily engaged in scratching a modest living in a competitive business; but he is, also, a professional musician of vast, literally vast experience. This is not to say that he is anything but a mediocrity, even in that profession, but his first public appearance was at the age of 7, and he is not going to say how long ago that was: (off the record, he would be a grandfather now if his children weren't so lazy!) And on the strength of long acquaintance with hi-fi in the raw, his advice to the amateur

using stereo for the first time is to give up listening with the slide-rule but use, instead, certain rather old-fashioned instruments, a couple of which can be found in most well-appointed homes. They are known as ears, and their discrimination is remarkable—in fact, they are the standard by which all the other instruments are, or should be, judged. If stereo sounds better with one channel slightly louder than the other, play it so. If the performer seems to be in the room, with treble up on track 1 and bass up on track 2, that's where the controls should be. If it sounds right, it is right, and don't let any long-haired back-room boys—including the author—tell you it's not. Your ears aren't perfectly matched, neither are the two halves of your room, nor your tastes with the next man's, and all the controls are for use, not ornament.

In conclusion, acknowledgments are due to Charles H. Frank Jr. of the Ercona Corporation, without whose encouragement—not to say vigorous prodding—the original FS103 would probably never been built.

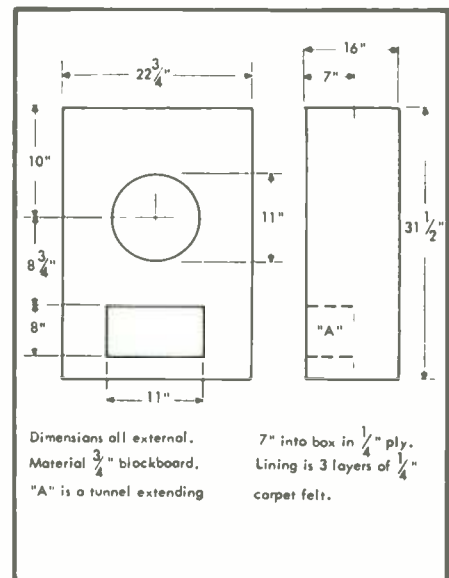

Fig. 12. Dimensions of a "resonant type" enclosure suitable for use with Goodmans Axiom 22 loudspeaker unit.

#### Errata to Part I

A few minor (?) errors crept into the drawing for Fig. 2 in Part I of this article, and at the end of Part II seems the most ideal place to bring them to the attention of readers who may have been particularly interested in this unit.

The jacks  $J_1$  and  $J_2$  were incorrectly drawn, and should have been shown as indicated here. The correct jack is typified by



Switchcraft MT-332C, although Mallory 4A, 704A, 5, and 705 may be wired to produce the same results. The lettering refers to the original diagram.

The resistor in parallel with  $C_{10}$  in the lower left corner of the drawing is  $R_{27}$ ; the voltage divider for the cathode of  $V_{11}$  consists of  $R_{14}$  at the top and  $R_{15}$  at the bottom; and the plate of  $V_{10}$  should be connected to the line leading from the primary of  $T_1$  to capacitor  $C_{10}$ .

It is suggested that you make these corrections on the original drawing.  $\text{Æ}$

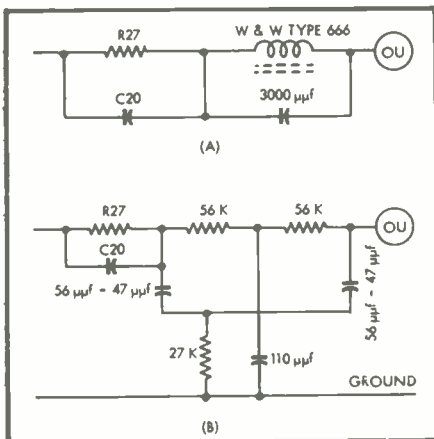

Fig. 11. Two types of bias-trap circuits which may be employed if considered desirable, although they are not absolutely necessary.

# All new ultra-compact amplifier SONOTONE HFA-150



## 15-WATT POWER AT A 10-WATT PRICE!

No amplifier on the market today can compare with the all-new Sonotone HFA-150. Full 15-watt power—superb sound—plus more new, useful “firsts” than any other amplifier at any price.

**ONLY 3” HIGH—12” WIDE!** For the first time, a complete power *and* control amplifier this compact... without an iota of performance being sacrificed to compactness. The ultra-smart cabinet cover is available in a *choice* of colors—another Sonotone first!

**SIX INPUTS!** Now, for the first time, you can buy a quality amplifier in this price range that gives you single switch choice of 6 inputs. Three of these in-

puts have *individual pre-set level controls!*

**SEPARATE CONTOUR CONTROL!** For the first time you get new, exclusive push-pull rumble and noise filters. Bass, treble and volume controls with a *separate* continuous contour control, infinitely variable from flat to 26 db of contour compensation.

The Sonotone HFA-150 is, unquestionably, the greatest value in *fine* high fidelity components in many years. Make seeing and hearing it a “must”!

**ONLY \$79<sup>50</sup> NET** Optional cover \$3.50 Net

Write for detailed information without obligation to:

Electronic Applications Division

**SONOTONE**<sup>®</sup> CORPORATION

ELMSFORD, N. Y.



# The Forbidden Fruit of Patent Pooling

In any subject there are bound to be rules—technical, moral, legal, or what not. In patents the rules are essentially legal ones, but they outline the rights and obligations of a patent holder.

ALBERT WOODRUFF GRAY\*

IN THE DECISION of a recent case before the United States Court of Appeals is suggested the long ago warning that of the fruits of the patents one may freely eat but of monopolies and of price fixing "Ye shall not eat of it, neither shall ye touch it."

Every benefit granted an inventor under the patent law he may freely enjoy but use of patents for the restraint of competition is condemned. Suit in this instance had been brought by Hazeltine Research for the infringement of a patent of a synchronizing system for electrical television receivers. In its defense the infringer urged that the patent owner had misused its patents and hence, not coming into the court with clean hands as demanded by the law, he should be denied a recovery.

It had, according to this defense "block booked" these patents, licensed them on the condition that the license be for a block of patents in addition to the one sought by the licensee. This patent, the infringer claimed, had been used to force this licensee and others to accept a license from Hazeltine Research of all its 600 radio and television patents and patent applications.

In its decision that the patent had been infringed, the Federal court said of the patent pool of the Hazeltine Research, "That company is in the business of research and selling patent licenses. It has licensed more than 150 manufacturers of radio and television receivers under its standard license form, each embracing all of that company's 600 patents. Under this form royalties are payable on total production of radio and television receivers, regardless of the extent to which the licensee uses any Hazeltine patent."<sup>1</sup>

Definition of this misuse of patent doctrine was made only a few months ago by a Federal court in Wisconsin in a suit for the recovery of royalties under a patent licensing agreement in which this same defense was interposed.

"It is the contention of the infringer," said the court in this instance, "that the contract is void because the patents were used to stifle or prevent competition, thereby extending the monopoly unlawfully. The basic principles of the doctrine of misuse of patents is that public interest is the dominant consideration. The doctrine denies to the patentee the power to use it in such a way as to acquire a monopoly which is not plainly within the terms of the grant.

"The patentee has the power to refuse a license but that does not enable him to enlarge the monopoly of the patent by the expedient of attaching conditions to its use."<sup>2</sup>

This definition followed as authority a similar statement of the law of this misuse of patents made by the Supreme Court of the United States a few years ago.

"The grant of a patent," said the court of that feature of the patent law, "is the grant of a special privilege to promote the progress of science and the useful arts. It carries, of course, the right to be free from competition in the practice of the invention. But the limits of the patent are narrowly and strictly confined to the precise terms of the grant.

"It is the public interest which is dominant in the patent system. It is the protection of the public in a system of free enterprise which alike nullifies the patent where any part of it is invalid and denies to the patentee after issuance the power to use it in such a way as to acquire a monopoly which is not plainly within the terms of the grant.

"The necessities or conveniences of the patentee do not justify any use of the monopoly of the patent to create another monopoly. The fact that the patentee has the power to refuse a license does not enable him to enlarge the monopoly of the patent by the expedient of attaching conditions to its use. The method by which the monopoly is sought to be extended is immaterial.

"The patent is a privilege. But it is a privilege which is conditioned by a public purpose. It results from invention and is limited to the invention which it defines. When the patentee ties something else to his invention he acts only by virtue of his right as the owner of property to make contracts concerning it and not otherwise. He then is subject to all the limitations upon that right which the general law imposes upon such contracts.

"The contract is not saved by anything in the patent laws because it relates to the invention. If it were the mere act of the patentee could make the distinctive claim of the patent attach to something which does not possess the quality of invention. Then the patent would be diverted from its statutory purpose and become a ready instrument for economic control in domains where the antitrust acts or other laws, not the patent statutes, define the public policy."<sup>3</sup>

## Patent Pool Not Necessarily Wrong

Disposition of the defense to this recent action by Hazeltine Research for infringement, that the owner of this patent pool might not ask the protection of the court against the violation of its patent rights by virtue of its conduct in creating this patent pool, had been substantially predetermined a few years before when this same contention, set up as a defense in another action by that company, ending in the grant of absolution by the Supreme Court of the United States, of the sin of monopoly and price fixing, with which it had been charged.

Suit in this instance had been brought to recover royalties due under these patent licensing agreements. Provision in such contracts was for the payment by the licensee of a specified percentage, approximately one per cent, of the selling price of the enumerated equipment manufactured and sold by the

\* 112-20 72nd Drive, Forest Hills, N. Y.  
<sup>1</sup> Hazeltine Research v. Avco Manufacturing Co., 227 Fed. 2d 137, Oct. 31, 1955; aff'g. 126 F.S. 595, June 29, 1954.

<sup>2</sup> Touchett v. E Z Painter Corp., 150 F.S. 384, March 14, 1957.

<sup>3</sup> Mercoid Corporation v. Mid-Continent Investment Co., 320 U.S. 661, January 3, 1944.

...the new dimension in sound

**tandberg**

**stereo**

**plus**

**plus** everything else you would want in a complete tape system...

Designed for the highest of reproduction standards... Scandinavia Styled from fine grain mahogany.

**Stereo 3-speed Tape Phonograph and Tape Recorder**—Tandberg Model 3-Stereo—for at home listening pleasure... or conveniently portable in luxury-styled, luggage-type carrying case for traveling enjoyment.

For the finest in sound reproduction, two extremely well-balanced power playback amplifiers are built-in with such efficiency of design that the distortion of each amplifier is under 1%. A specially manufactured in-line stereo head, unique in design and construction, provides a clarity of reproduction and a range of response heretofore unattainable.

The model 3-Stereo weighs 27 pounds, and is priced at \$369.50 Complete with microphone and carrying case.

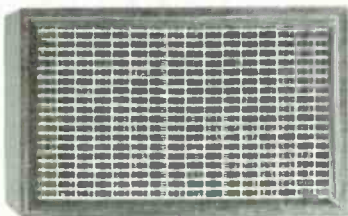

**stereo-trio**  
a complete home music system  
— perfectly matched

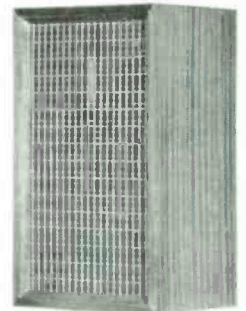
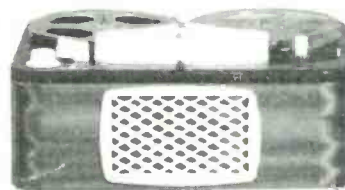

The Tandberg stereo-trio including model 3-Stereo recorder/reproducer and two perfectly matched 266 speaker systems furniture styled by Scandinavian craftsman in the same fine grain mahogany as the model 3-Stereo cabinet. Comparable to the finest—at almost half the price—\$469.95.

3-Speed Versatility—Records full-track... plays back half-track, full-track and stereophonic tapes. Frequency response at 7½ i.p.s. is within ± 2 DB from 30 to 17,000 cycles (± 1 DB from 50 to 10,000 cycles).

**tandberg has stereo — plus...**

To meet the highest professional standards of a recorder/reproducer for any application—commercial, broadcast or Hi-Fi.

- NARTB equalization at all speeds
- Microphone included has flat response within 3 DB to 13,000 c.p.s.
- No audible wow or flutter at any speed
- High quality Goodman speaker built-in for playback and monitoring
- Functional simplicity of styling, with minimum of controls.

Hear and See the Tandberg Stereo-Trio  
or write for full information to:

**Tandberg**

10 E. 52nd St., New York 22, N. Y.

licensee with a minimum royalty of \$10,000 a year.

In sustaining the contention of this patent owner and holding the pooling of the patents in this manner, at that time 500 radio and television patents and 200 patent applications, to be legal, the Supreme Court asserted,

"The mere accumulation of patents, no matter how many, is not in and of itself illegal. And this record simply does not support the incendiary yet vague charges that this company uses its accumulation of patents for the exaction of tribute and collects royalties by means of the overpowering threat of disastrous litigation.

We cannot say that payment of royalties according to an agreed percentage of the licensee's sales is unreasonable. Sound business judgment would indicate that such payment represents the most convenient method of fixing the business value of the privileges granted by the licensing agreement. We are not unmindful that convenience cannot justify the extension of the monopoly of the patent. But as we have already indicated there is in this royalty provision no inherent extension of the monopoly of the patent.

"This licensee cannot complain because it must pay royalties whether it uses Hazeltine patents or not. What it acquired by the agreement into which it entered was the privilege to use any or all of the patents and developments as it desired to use them. If it chose to use none of them it has nevertheless contracted to pay for the privilege of using existing patents plus any developments resulting from Hazeltine's continuous research.

"We hold that in licensing the use of patents to one engaged in a related enterprise, it is not in itself a misuse of patents to measure the consideration by the percentage of the licensee's sales."<sup>4</sup>

#### "Tie-in" Sales

Unreservedly condemned however, is the practice of "tie-in sales" in which patentees have all too frequently indulged, conditioning the sale of patented equipment on the use of specific unpatented products. Such an instance occurred when a manufacturer of solid carbon dioxide, "dry ice," invoiced its product with the notice, "The merchandise herein described is shipped upon the following condition: that DryIce shall not be used except in DryIce cabinets or other containers or apparatus provided or approved by the DryIce Corporation of America."

In its outlawry of this method of marketing the Supreme Court outlined

the underlying philosophy by which these methods stand condemned. "If the patent is valid the owner can, of course, prohibit entirely the manufacture, sale or use of such packages.

"It may charge a royalty or license fee. But it may not exact as the condition of a license that unpatented materials used in connection with the invention shall be purchased only from the licensor; and if it does so, relief against one who supplies such unpatented materials will be denied. The limited monopoly to make, use, and vend an article may not be expanded by limitations as to materials and supplies necessary to the operation of it.

"To permit the patent owner to derive its profit not from the invention on which the law gives it a monopoly, but from the unpatented supplies with which it is used, is wholly without the scope of the patent monopoly.

"If a monopoly could be so expanded, the owner of a patent for a product might conceivably monopolize the commerce in a large part of unpatented materials used in its manufacture. The owner of a patent for a machine might thereby secure a partial monopoly on the unpatented supplies consumed in its operation. The owner of a patent for a process might secure a partial monopoly on the unpatented material employed in it. The owner of the patent in suit might conceivably secure a limited monopoly for the supplying not only of a solid carbon dioxide but also of the ice cream and other foods, as well as the cartons in which they are shipped.

"The attempt to limit the licensee to the use of unpatented materials purchased from the licensor is comparable to the attempt of the patentee to fix the price at which the patented article may be resold. In both classes of cases courts deny relief against those who disregard the limitations sought to be imposed by the patentee beyond the legitimate scope of the monopoly."<sup>5</sup>

Contrary to this decision however, the Supreme Court twenty years before had held enforceable a restriction in the sale of a mimeograph machine, that, "This machine is sold by the A. B. Dick Company with the license restriction that it may be used only with the stencil paper, ink and other supplies made by the A. B. Dick Company," with a dissent to this decision by three of the justices of that court that tie-in sales, monopolies, and restraint of trade were the forbidden fruit of which the owner of the patent might not eat.

"Take a patentee selling a patented engine," said one of these dissenting Supreme Court justices, "he will now

have the right to bring under the patent laws all contracts for coal or electric energy used to afford power to work the machine or even the lubricants employed in its operation.

"Take a patented carpenter's plane. The power now exists in the patentee by contract to validly confine a carpenter purchasing one of the planes to the use of lumber sawed from trees grown on the land of a particular person or sawed by a particular mill.

"Take a patented cooking utensil. The power is now recognized in the patentee to bind by contract one who buys the utensil, to use in connection with it no other food supply but that sold or made by the patentee. Take the invention of a patented window frame. It is now the law that the seller of the frame may stipulate that no other material shall be used in the house in which the window frames are placed except such as may be bought from the patentee and seller of the frame.

"Take an illustration that goes home to everyone—a patented sewing machine. It is now established that by putting on the machine in addition to the notice of patent required by law, a notice called a license restriction, the right is acquired as against the whole world, to control the purchase by users of the machine, thread, needles and all lubricants or other materials convenient or necessary for operation of the machine."

"My mind," said this justice in his conclusion of this dissenting opinion, "cannot shake off the dread of the vast extension of such practices which must come from the decision of the court now rendered. Who, I submit, can put a limit upon the extent of monopoly and wrongful restriction which will arise, especially if by such power, a contract which would otherwise be void as against public opinion, may be successfully maintained."<sup>6</sup>

Five years after this decision was rendered a license restriction of this character on motion picture machines to specified films came before the Supreme Court for review. Under this earlier decision such a restriction would have been valid and enforceable. However, after that decision in the mimeograph license case, both Congress and the courts had seen a great light.

In 1914 was enacted the Clayton Act making it unlawful "to sell or make a sale or contract for sale of goods, machinery, supplies or other commodities, whether patented or unpatented, for use, consumption, or resale, or fix a price or charge therefor, on the condition, agreement, or understanding that the lessee or purchaser thereof shall not

*(Continued on page 67)*

<sup>4</sup> Automatic Radio Mfg. Co. v. Hazeltine Research, 339 U.S. 827 June 5, 1950.

<sup>5</sup> Carbice Corporation of America v. American Patents Development Corp., 283 U.S. 27, March 9, 1931.

<sup>6</sup> Henry v. A. B. Dick Co., 224 U.S. 1, March 11, 1912.

are you sure you have the best?

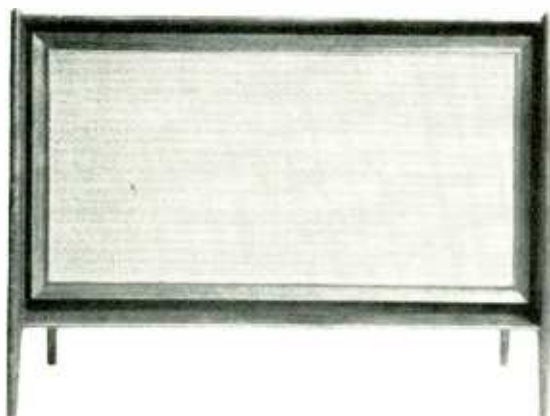

FRONT VIEW



SIDE VIEW

Consider the one forward step by which sound reproduction could be vastly improved:

*A servo-mechanism to feed data from speakers to amplifiers to correct distortion even before it begins.*

Even the finest conventional sound systems distort . . . the distortion coming from room acoustics, cabinet resonances, and especially the loudspeakers. All this could be dramatically reduced—actually, could have been reduced years ago—by this one change!

The servo principle has been used for years in automation, where servo-mechanisms check output to keep it correct. Obviously, audio engineers have recognized it too; some have even incorporated a few of the servo-speaker principles in their own sound systems. Yet the speakers and amplifiers available to you have continued to be offered in their conventional form, year after year. *Until Integrand.*

Just off the drawing board, the Integrand is the first complete amplifier — speaker system employing servo techniques. Distortion? The Integrand system permits less distortion in the overall sound than a good amplifier alone will produce under laboratory test conditions! Sound reproduction from the Integrand Servo-System is very, very near the ultimate . . . and very, very superior to any conventional system. Both stereo and monaural systems are available.

There are many other remarkable differences in the Integrand which contribute to superior sound reproduction. Integrand does far more than slash previous distortion levels. Among other new features: Original speaker design. Transformerless, direct coupled amplifiers, one to power each of the three matched speakers. Fully transistorized amplifiers and crossovers. Full stereo sound. And an unconditional guarantee for 2,000 hours of operation (about five years).

To get the whole story, you'll want to write for complete specifications, test data and a folder reprinting what the experts are saying about this new system. And you'll want to listen to the Integrand, so we'll send you the name of the audio dealer near you. Write to:

**BRAND PRODUCTS, INC.** Dept. A11, Westbury, New York • Marketing organization for Integrand Corporation

# INTEGRAND

## SERVO SPEAKER AMPLIFIER SYSTEM

*Technical details and specifications. Model 372 Stereo system.*

**Servo System** The unit employs 6 direct coupled transformerless transistor amplifiers feeding 6 specially designed loudspeakers. Information from each speaker is fed back to its own servo amplifier. This data continuously and automatically corrects for the effects of room acoustics, cabinet resonances and the distortion arising from amplifiers and the non-linearities of the magnetic structures and suspension devices inherent to any loudspeaker. The result is an acoustic output uniquely free of distortion. Distortion is guaranteed to be less than 1% over the entire audio range when operating at 1 acoustic watt (Radiating into a solid angle of  $\pi/4$  steradians; approximately 20 electrical watts).

**Loudspeakers** All speakers in the system are specially designed to produce piston operation over their operating ranges. Each voice coil is wound with rectangular wire and bonded with high temperature Epoxy to assure extreme rigidity and long life. The two 15" woofers are each equipped with a magnetic motor assembly weighing in excess of 12½ lbs. High and mid-range ring radiators are constructed coaxial and coplanar to each other and thus provide an unprecedented smoothness in the response at crossover. The mid-range ring radiator is foam rubber edge damped. The high frequency ring radiator features a new type of acoustic horn termination that completely eliminates the standing wave dip which exists on most high frequency radiators at about 12,000 cycles.

**Transistorized Amplifiers and Crossovers** Each of the 6 fully transistorized amplifiers contains its own crossover network. Crossovers are at 350 cycles for the woofers, 350 and 2500 cycles for the mid-range ring radiators and 2500 cycles for the high frequency ring radiators. All

crossovers attenuate at the rate of 12db per octave outside of their transmission band.

All servo amplifiers are coupled to their respective speakers without the use of output transformers.

An input signal of 1 volt is required for the full power output of 72 watts.

**Frequency Response** Each Integrand Servo-Speaker System is supplied with an individual calibration of its own pressure response from 35 to 16,000 cycles and is guaranteed to be  $\pm 3$ db over this range.

**General Specifications** The Model 372 Stereo Servo-Speaker System is housed in a handsome contemporary cabinet 44" w x 30" h x 20" d. Cabinets available in a selection of finely finished Walnut, Teak or Irimba.

Model 372 may be instantly changed from stereo to monaural operation by switching the two servo channels into parallel. Each system is guaranteed for 2000 operating hours (approximately 5 years). The system contains a built-in timing device to protect this guarantee.

*Model 372 Walnut \$595.00.* Monaural and other Integrand Servo-Speaker Systems from \$375. All prices and specifications subject to change without notice.

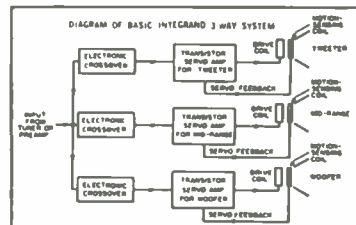

*Block diagram for basic Integrand three-way system. Model 372 Stereo Servo-system contains two (one for each channel).*

# Transformers in Transistorized Equipment

NORMAN H. CROWHURST\*

Transformers have long been eliminated from audio circuits as far as possible. However the advent of transistors introduces some new factors that make reconsideration—and reorientation—of audio transformer merits and demerits desirable, if not imperative.

SOME OF OUR READERS will be able to remember back about three decades to the time when radio receivers used battery operated triodes and there were only about two or three types of tube to choose from. Those early receivers employed at least two or three transformers, because, with those low-gain triodes a receiver without any transformers would have needed a phenomenal number of stages.

The fast buck boys saw their opportunity: all that was needed, to produce something that looked like—and to some extent behaved like—a transformer, was some kind of insulated wire, a means of winding it, such as a lathe, sewing machine, or any other device that rotated, and some sheet metal containing iron which could be cut up to make laminations for the core.

Radio was yet very young, so it is small wonder that most people came to the conclusion that the transformer in an audio amplifier is inherently the most likely cause of distortion. Because of this, improved tube types that rendered interstage transformers virtually unnecessary were accepted with acclamation.

We have now reached a stage where the transistor promises to revolutionize the design of electronic equipment in much the same way—if not to quite the same

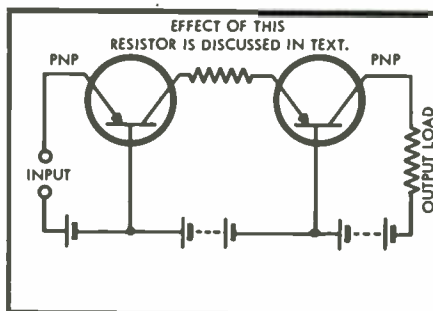

Fig. 2. Theoretical grounded-base "amplifier" discussed in the text.

extent—as the electronic tube did. Curiously enough, at the present stage of the art, it once again seems that transformers can serve a very useful purpose. It remains to be seen to what extent history will repeat itself with this new component and whether continued development will render interstage transformers virtually unnecessary again or whether improved technique in transformer design will this time land them a permanent place.

Until such time as an advanced physicist comes up with a revision to transistor construction that corresponds with the development of the tetrode and pentode in tubes, we have a situation where the transformer is definitely an asset if it is properly used. For this reason it

will be profitable to understand the features essential to a good transistor transformer and also to its proper application.

To do this we need first to have a clear picture of how a transistor works and then of the part that the transformer can play in improving the over-all performance of a transistorized device. First let's get the basic properties clear: when we analyze the behavior of a tube we use the cathode as a reference point and measure the voltage from grid to cathode and plate to cathode; from this basic concept and the tube characteristics we can then determine its behavior, even if the grid or plate is virtually grounded in place of the cathode.

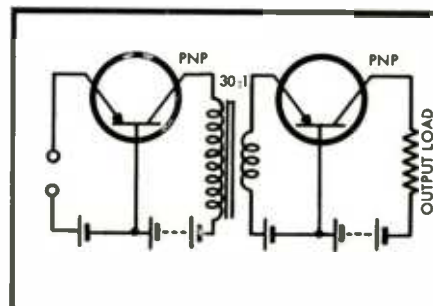

Fig. 3. Theoretical transformer-coupled grounded-base amplifier discussed in the text.

## Grounded Base

In the transistor the natural electrode to view as a reference is the base. But, instead of considering the voltages of the emitter and collector with reference to the base, in a transistor we consider currents, and Fig. 1 shows typical transistor characteristics where collector voltage and current are plotted for various values of emitter current. These characteristics may be regarded as the basic characteristics of a transistor, in much the same way that the plate current/plate voltage characteristics of a tube, plotted for different values of grid voltage, are considered as basic to the tube—except that it is not quite as easy as this.

In the case of the tube we only have

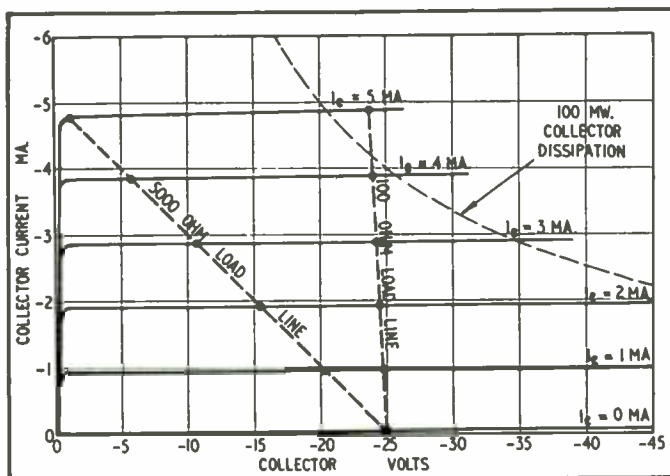

Fig. 1. Typical grounded-base characteristics for a pnp junction transistor, with collector-circuit resistance load lines drawn in. An npn transistor would have all the signs reversed.

\* 150-47 14th Road, Whitestone 57, N.Y.



**SPECIFICATIONS**

**ALL VIKING DECKS**

frequency response: 30 to 14,000 cps plus, at 7½ ips. 40 to 7,000 cps plus, at 3½ ips.  
 signal-to-noise: 55 db or better.  
 flutter: 0.2 percent average.  
 long term speed regulation: ½ of 1.0 percent.  
 tape speed: 7½ ips (3½ ips available by changing belt to smaller groove on motor pulley).  
 maximum reel size: 7"

record/playback head characteristics: track width .085 inch. Gap width .00016 inch. Impedance 2000 ohms at 1000 cycles. Double coil hum bucking winding. Mu-metal shielded. Output 2.5 mv.  
 recommended bias current: .8 ma. at 68 kc.  
 in-line head characteristics: (VIKING'S own in-line head) same as above.  
 erase head characteristics: track width .125 inch, double gap (each .005 inch), inductance 53 mh. at 1 kc, erase 60 db at 68 kc.

**MORE PERFORMANCE PER DOLLAR**  
**THESE ARE THE REASONS WHY:**



Ultra-linear transport . . . flutter and wow completely below audibility.

Short-gap record and/or playback heads for extended range . . . Double-coil (hum-bucking) record and playback heads for minimum hum. Double-gap erase heads for dead quiet erase.

The finest of bearings, and the ultimate in machining tolerances in capstan and drive members — where precision counts.

Rugged simplicity for enduring performance.

Physically independent amplifier components for increased flexibility and minimized hum pick-up

Very high erase-bias oscillator frequency permits extended range recording without bias intermodulation.

NARTB equalization. Physical separation of mechanical and amplifier components, plus clean design, eliminates need for roll-off of lower (*hum*) frequencies.

**SPECIFICATIONS**

**RF 61 SERIES PREAMPLIFIERS**

frequency response, playback: 30 to 14,000 cps ± 2 db.  
 frequency response, record-playback cycle: 30 to 12,000 cps ± 3 db.  
 distortion (tapes recorded 12 db below saturation): less than 2% within specified frequency range.  
 internal signal-to-noise ratio: 60 db minimum all units.  
 equalization: modified NARTB

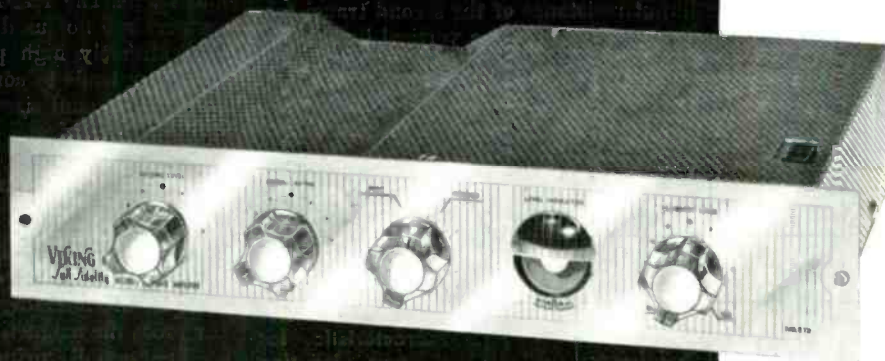

Ask your dealer for a Viking recording and playback demonstration before you buy any other recorder.

recording channel gain: low level input. Require: .002 volt rms at 400 cycles for recording level 8 db below saturation. (High level input, .3 volts rms.)  
 playback channel gain: 55 db.  
 recording inputs: high impedance microphone (62 db overall gain) and high impedance radio or phono input (32 db gain).  
 bias frequency: 68 kc.  
 output: 1 volt, high impedance.  
 tube complement: 1-12AX7, 1-12AU7A, 1-12AV6, 1-6X4, 1-6E5 Indicator.



**VIKING OF MINNEAPOLIS**  
 9600 Aldrich Avenue South, Minneapolis 20, Minnesota  
 EXPORT DIVISION: 23 Warren Street, New York City 7, New York  
 Cable: SIMONTRICE, NEW YORK (All Codes)

C  
O  
M  
P  
O  
N  
E  
N  
T  
S  
W  
I  
T  
H  
T  
H  
E  
H  
I  
G  
H  
R  
P  
F  
A  
C  
T  
O  
R.\*

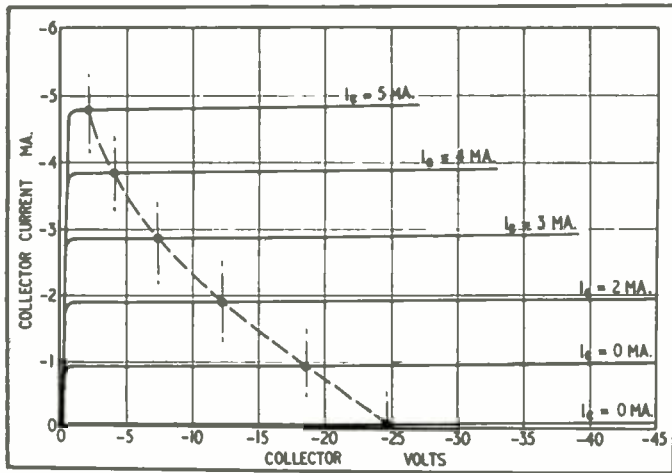

Fig. 4. The non-linear emitter/collector load, reflected through the transformer results in practically linear current-transfer characteristic, but quite non-linear voltage - transfer characteristic.

to consider grid voltage—the grid takes virtually no current and hence does not need to be considered as imposing a load upon the circuit providing that voltage. In the case of the transistor, the resistance between emitter and base varies with both emitter current and collector voltage. This means that the input resistance of a transistor in the grounded-

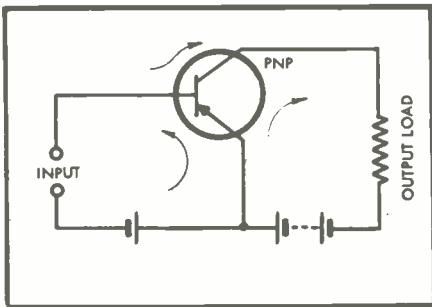

Fig. 5. The grounded-emitter configuration, showing the directions of current flow discussed in the text.

base connection looks like a nonlinear resistor, the non-linear characteristic of which depends upon the load connected in the collector circuit.

First let's consider the hypothetical two-stage transistor amplifier shown in Fig. 2. As we shall see in analyzing it, this circuit has little, if any, practical use, but it serves to show why transfor-

mers can prove useful in transistor amplifiers.

In a grounded-base circuit, the input resistance of a transistor, from emitter to ground, is quite low—in the region from 10 to 1000 ohms, according to transistor type. This resistance is nonlinear, as has already been mentioned. As the slope of the curves in Fig. 1 show, the a.c. resistance of the collector circuit is extremely high—in the region from 0.1 megohm to 1.0 megohm, according to transistor type.

First consider the input resistance: if the input used is basically a voltage generator, then the source resistance of the input, from which the emitter takes its current feed, should be considerably higher than the input resistance of the emitter, so as to swamp the nonlinear effect of the loading on the source voltage. In this way the current taken by the emitter will closely follow the waveform of the generator voltage. More of this another time.

Now look at the interstage coupling: the loading on the collector circuit, if no resistance is inserted between the first transistor collector and the second transistor emitter, is merely the emitter input resistance of the second transistor. This will be almost a vertical line on the characteristics of Fig. 1. The line can be made to slope by inserting resistance between the collector and emitter. But,

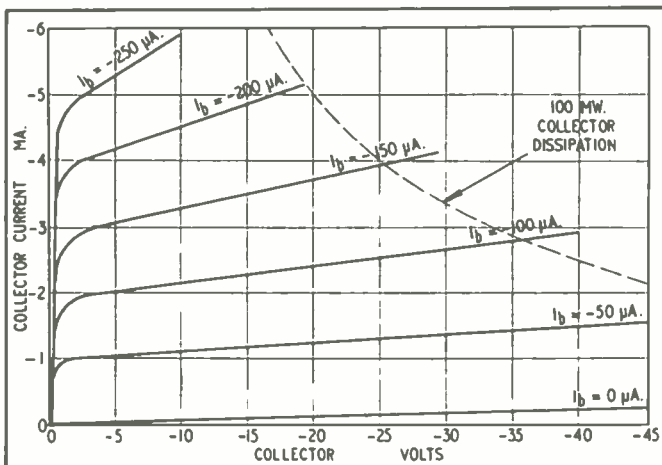

Fig. 6. A typical grounded-emitter characteristic for a pnp junction transistor. An npn type would have all the signs reversed.

as the load lines drawn on Fig. 1 show, this will not materially affect the current swing fed to the emitter of the second transistor.

Because the current-amplification factor, given the symbol  $\alpha$ , of all transistors, except the point contact type, is a value slightly less than unity—usually in the region of 0.95—the current fluctuation fed to the emitter of the second transistor will be slightly smaller than the current fluctuation fed to the emitter of the first transistor, whether or not resistance is inserted between stages.

From this it becomes evident that the gain of our hypothetical two-stage amplifier is very slightly less than the gain of a single transistor. The reason for this is the colossal mismatch between the collector of the first stage and the emitter of the second stage—the input emitter resistance, once again, is somewhere in the region from 10 to 1000 ohms, while the collector resistance is in the region from 0.1 to 1.0 megohms.

Considerable gain could be achieved in the grounded-base circuit by using a step-down transformer between stages, as shown at Fig. 3. This transformer would serve as a matching device between the high collector resistance and the low emitter resistance. A ratio of as much as 30 to 1 could be used here. If a transformer with satisfactory characteristics could be produced, this would step down the effective collector resistance, seen by the following stage emitter, from the region of 0.1 to 1.0 megohms to the region of 100 to 1000 ohms, which would result in a gain of 30 db.

Even though the emitter resistance reflected through the transformer, as a load for the collector, is nonlinear, it would not result in appreciable distortion, because we are feeding from a basic current generator—the collector of the first stage—into an input that requires a current drive—the emitter of the second stage. The reason why such transformers are not used in practice is that the extremely high primary impedance necessary leads to complications, especially in the small sizes in which they are constructed.

#### Transformer Requirements

However, before we pass to more complicated circuits let's see what would be the requirements of such a transformer. In the interstage transformer used for tubes the magnetizing current should be kept small, principally because its nonlinearity will cause distortion. At the same time leakage inductance together with winding capacitance can interact to upset high-frequency response. So these properties need special attention in design or selection of a transformer.

In the case of the transistor transformer, resistance in the winding is not

(Continued on page 93)



YOU HAVEN'T REALLY HEARD HIGH FIDELITY UNTIL YOU'VE HEARD

# UNIVERSITY

SPEAKER SYSTEMS



The DEAN

**MODEL S-8, "CLASSIC" DELUXE CONSOLE**

The highest achievement in audio engineering . . . *the ultimate in sound!* Each component of the CLASSIC has been designed with engineering inspiration and made with the meticulous care of a Swiss watchmaker. Three incomparable loudspeakers—each selected for perfect performance in its acoustic range—are integrated to give you silky smooth, incredibly realistic sound from the deepest organ tones to the most sparkling highs. And University's famed Acoustic Baton places at your fingertips natural, satisfying tonal balance, whatever the acoustics of your home. Here too is the finest in cabinet styling, a graceful, subtly proportioned console that will enhance your home whether traditional or modern. And the *exclusive* adjustable base permits conversion at any time from lowboy to highboy, the cabinet being finished on all four sides. Yes, when your taste and your home demand the finest, the CLASSIC is your choice.

**MODEL S-7, "DEAN" DELUXE CORNER CONSOLE**

This regal masterpiece of University speaker systems is the engineering and acoustic "twin" of the famed CLASSIC. Components are identical for equally breathtaking performance. Designed for those who prefer a corner installation, the DEAN, amazingly unlike other corner systems, is adaptable to any future decorating plans . . . as a *true* "cornerless-corner" system, it does not depend on either walls or floor for proper acoustic projection . . . actually performs with the same tonal perfection when placed against a wall. The warm hand-rubbed finish, the subtle rightness of its exquisite cabinet lines, will also make you proud to welcome the DEAN to your home. In the DEAN and CLASSIC you have the ultimate in high fidelity, the finest, at *any* price.

# HERE IS HIGH FIDELITY

reproduction as it should be—breathtakingly realistic—*natural*, warm, rich sound that assures delightful listening, hour after hour, without ear fatigue. These superlative units contain the most advanced loudspeaker components, perfectly matched to precisely crafted enclosures . . . for flawless reproduction that recreates every nuance of the original performance. Here, too, is graceful cabinetry in today's preferred wood finishes . . . superbly styled to enhance every home. For the very *best* in high fidelity, choose from this selection of the world's finest high fidelity speaker systems . . . designed by the world's premier custom loudspeaker manufacturer . . . *University*.



The CLASSIC

The MASTER



**MODEL S-6, "MASTER" MULTI-SPEAKER SYSTEM**

For those who demand music reproduction with full dynamic range, with tonal response from rich, clean bass to highs of bell-like brilliance . . . yet who must consider budget or space limitations . . . University presents the MASTER. It has long been a favorite in hi-fi circles . . . and understandably so. Incredibly efficient in acoustic performance, the MASTER provides top quality, full volume tone, even with amplifying equipment of modest price and power. And University's artistry with cabinet design and rich, hand-rubbed furniture finishes must be seen to be appreciated. Your MASTER is equally handsome, equally efficient acoustically, whether placed in a corner, or flat against a wall. Plan to listen to the MASTER, soon. You are due for a most delightful surprise.

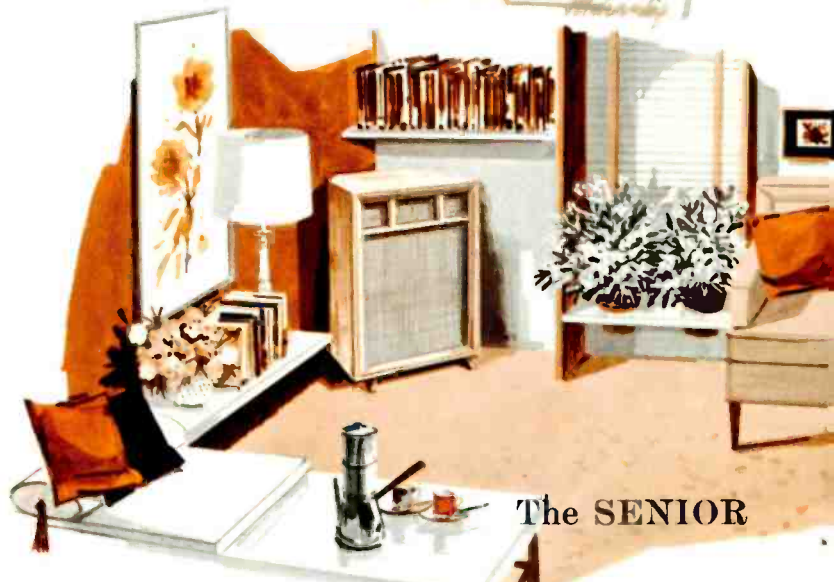

The SENIOR

**MODEL S-5, "SENIOR" MULTI-SPEAKER SYSTEM**

This model is truly a remarkable achievement in speaker system quality . . . and a revelation in practicality! For here is superb audio engineering that makes light of space and budget restrictions. Each component of the SENIOR has passed the most rigid tests and has earned its right to be part of this outstanding system. The result is a thrilling sensation of sound which seems to surround you . . . *amazing* in a system of this size. Treat yourself to its full-bodied, undistorted coverage of the acoustic spectrum, all kept in perfect balance by the Acoustic Baton. The SENIOR enclosure is a beautiful piece of furniture that will enhance any room . . . clean, easy-to-live-with lines characteristic of its careful craftsmanship. When you choose the SENIOR, you will be very pleased . . . and very proud.



## The ULTRA-LINEAR 15

### "ULTRA-LINEAR 15" CONSOLETTA Models S-11H and S-11L

The most recent addition to the University family, the ULTRA-LINEAR series offers you . . . for the first time . . . truly glorious, BIG sound from a small enclosure. Here is the "dream speaker" that brooks no compromise in bass range . . . that permits no distortion whatsoever throughout its entire response range . . . limitations that occur so disappointingly often in other small systems. With a good amplifier, delivering 20 to 60 clean watts—and the ULTRA-LINEAR 15—you'll literally revel in luxurious, smooth, theater-quality sound . . . from musical notes so low in frequency you feel as well as hear them . . . to highs beyond the limits of audibility. Yes, here is the "impossible" brought to miraculous tonal reality . . . performance comparable only with the finest speaker systems such as the DEAN and CLASSIC . . . for those who demand uncompromising musical reproduction, yet whose space is unusually limited. Balance controls permit tonal adjustment to suit individual preference or room acoustics. Graceful styling and fine, hand-rubbed finishes give the ULTRA-LINEAR 15 a character all its own, at harmony with any decor. Choose S-11H for upright use, S-11L as a lowboy. An ideal choice, too, for stereophonic installations. Hear it soon . . . and learn that finally there is a genuine answer to the small-space speaker problem.

### "ULTRA-LINEAR 12" CONSOLETTA Models S-10H and S-10L

Carrying forward University's significant breakthrough in acoustic design . . . providing authentic, distortion-free bass in limited enclosure volume . . . the ULTRA-LINEAR 12 has been scaled down to occupy the barest minimum of space, yet leaves nothing to be desired in tonal performance. Model S-10H is for applications where minimum width must be considered, Model S-10L where height must be conserved. Harmonious proportions, exceptionally interesting grill treatment and beautifully grained hand-rubbed finish make this consolette an admirable addition to any room. And without the removable base, either model is perfect for shelf, bookcase or "built-in" use. An adjustable control is provided for finger-tip correction to suit your taste or room acoustics. Requires 25 to 60 clean amplifier watts. You'll be thrilled with this incredible performer . . . listen, and see if you don't agree.

## The ULTRA-LINEAR 12



## The TINY MITE

## The COMPANIONETTE

### MODEL S-1, "COMPANIONETTE" 2-WAY SYSTEM

The ideal bookshelf or extension speaker. Make every room a music room with the COMPANIONETTE! This decorative, smartly styled cabinet easily fits into limited spaces, provides a beautifully efficient solution to the small-speaker problem, or when it is desired to bring music from an existing high fidelity installation to additional rooms. You'll be truly amazed at its excellent bass reproduction blended with clean highs. Inexpensive wrought iron legs, available at most furniture, department and hardware stores, convert the COMPANIONETTE into an attractive floor model.

### MODEL S-3TM, "TINY-MITE" SPEAKER SYSTEM

A moderately priced diminutive 3-way speaker combination providing exceptional high fidelity, the TINY-MITE is a veritable powerhouse of acoustic energy. You'll find it hard to believe such magnificent performance comes from an enclosure only  $21\frac{1}{2}'' \times 15\frac{1}{2}'' \times 12\frac{1}{2}''$ ! And so efficient, that a 5-10 watt amplifier is more than adequate. True "corner-corner" design enables the TINY-MITE to be used successfully in a corner, flat against a wall—even upside down, if you prefer! The clean-cut, handsome, go-anywhere console is beautifully "furniture" finished.

See Technical Specifications, Operational Data, Dimensions and Prices on Last Page

# TECHNICAL SPECIFICATIONS



## The CLASSIC and DEAN

The enclosure of the CLASSIC and DEAN is a true, front-loaded, self-contained, self-sufficient exponential horn terminating in a single mouth opening, there being no need to split the sound into two channels in order to use room walls, as is the case with most so-called "horn" enclosures.

University's single horn and mouth design delivers a superior acoustic performance for two major reasons: a) more accurate adherence to true exponential horn expansion is realized within a given physical volume if only one transmitting channel has to be fitted into it; b) a single horn terminating in a single larger mouth gives better radiation and smoother, fuller bass reproduction to the long wave lengths of the low frequencies than can be obtained from two separate smaller openings.

The horn of the CLASSIC and DEAN also takes full advantage of the matchless efficiency of the "compression-type" driver assembly principle. The rear chamber of the Model C-15W 15" woofer driving this horn is completely enclosed, thus producing a back compression during the rearward movements of the diaphragm. This compression is utilized as part of an acoustic network working with the cone speaker and matched to the throat opening of the horn directly at the front side of the diaphragm. The result is a maximum utilization of the full output capabilities of the driving loudspeaker.

To this woofer horn assembly is added the Cobreflex dual exponential mid-range horn driven by the heavy duty T-30 driver unit, and the HF-206 Hypersonic tweeter employing the "reciprocating-flare" wide-angle horn for clean, uniform high frequency response out to inaudibility. Thus, the CLASSIC and DEAN systems are actually true, triple, all-horn systems employing many exclusive and patented University design principles.



**MODELS 5-8, The CLASSIC and 5-7, The DEAN** Components for both comprise C-15W 15" theater woofer, Cobreflex wide-angle dual exponential horn with T-30 driver for mid-range, HF-206 Hypersonic Tweeter and N-3 Acoustic Baton network. Crossovers 350 and 5000 cps. Power capacity: 50 watts,\* room level approx. 2 watts. Impedance: 8 ohms. Sizes: CLASSIC—34½" x 40½" x 25½" deep; SHIPP. WT.: 225 lbs. DEAN—36½" x 37½" x 26½" deep; SHIPP. WT.: 208 lbs. User net: Mahogany—\$475, Blond—\$495, Walnut—\$520.



## The ACOUSTIC BATON

The Model N-3 Acoustic Baton tonal balance control is an outstanding University feature used in the Classic, Dean, Master and Senior speaker systems. The action of the Acoustic Baton differs from that of amplifier tone controls which is generally on a rate per octave basis and tends to change the character of the program material. However, by further being enabled to alter the relative level of the mid-range and tweeter with respect to the bass range, the user of the Acoustic Baton has at his command the aural sensation of "Presence" and "Brilliance." Hence, listening becomes far more pleasurable, and varying conditions of room acoustics, program source and personal taste may be accommodated without distorting the complex wave content of the original program.



## The MASTER and SENIOR

These new University "room-balanced" horn enclosures, combining direct radiation and rear horn loading, feature important improvements in design that permit more freedom in application and deliver completely balanced acoustical conditions in all frequencies. This design makes it possible to use integrated speakers such as coaxials or three-way speakers without dependency upon the walls or corner of the room for "completion" of the horn.

Components in these systems covered by patents 2,532,413; 2,532,414; 2,641,329; 2,690,231; 2,751,966 and other patents pending.

\*Integrated program

This has been achieved in two fundamental ways: 1) The low frequencies are directed through the horn to the floor and then out into the room through the base. Thus, the floor is able to act as a large baffle plane for the long wave lengths which then reach the listener through normal radiation and dispersion. (See Fig. 1.) Linearity in these low frequencies is preserved by a resistively padded vent placed near the bottom plate of the compression chamber. (Without this equalizing vent, the rearward motion of the diaphragm toward the compression chamber would produce higher acoustical impedance than would its forward motion toward the room.) The chamber is lined with a resistive material that damps wall plane reflections that normally occur in the mid-frequencies due to the spatial relationship of the back of an enclosure and the back of a speaker.

2) The middles and highs, meanwhile, are directed to ear level by the tilted baffle panel. Low frequencies blend perfectly with the middle and treble ranges for uniform response throughout the listening areas of the room. The result is a highly efficient "room-balanced" horn enclosure, completely independent of its location in the room.

**MODEL 5-6, The MASTER**—Components comprise C-15W 15" theater woofer, H-600 horn with T-30 driver for mid-range, HF-206 Hypersonic Tweeter and N-3 Acoustic Baton network. Crossovers 700/5000 cps. Power capacity: 50 watts,\* room level 2 watts. Impedance: 8 ohms. Size: 37" x 29" x 20" deep. SHIPP. WT.: 130 lbs. User net: Mahogany—\$310, Blond—\$320, Walnut—\$325.

**Enclosure only, Model EN-15**—For use with any University 12"/15" extended range speaker or multiple speaker combination. SHIPP. WT.: 96 lbs. User net: Mahogany—\$125, Blond—\$135, Walnut—\$139.50, Unfinished—\$102.



**MODEL 5-5, The SENIOR**—Components comprise C-12W woofer (minus response limiter), H-600 horn with T-30 driver for mid-range, UXT-5 "reciprocating-flare" wide-angle Super Tweeter and N-3 Acoustic Baton network. Crossovers 700 and 5000 cps. Power capacity: 30 watts,\* room level approx. 2 watts. Impedance: 8 ohms. Size: 30" x 21½" x 15¾" deep. SHIPP. WT.: 85 lbs. User net: Mahogany—\$200, Blond—\$205, Walnut—\$209.

**Enclosure only, Model EN-12**—For use with any University 12" extended range speaker or multiple speaker combination. SHIPP. WT.: 60 lbs. User net: Mahogany—\$76, Blond—\$79.50, Walnut—\$83.50, Unfinished—\$65.50.



## The ULTRA-LINEAR 12 and 15

The basic concept behind the Ultra-Linear systems begins with a woofer that responds to the very lowest of reproducible frequencies with the very flattest of response throughout its entire operating range. Then, the woofer in its new type acoustic enclosure smooths out whatever self-resonances may exist in the moving coil system. This enclosure is vented through a tubular duct toward the rear of the cabinet, accomplishing a phase inversion action without affecting its performance as a legitimate tuned circuit for the system's extremely low resonant woofer. By use of a duct of the proper cross section of area and proper length designed around the extreme low resonance of the woofer, the enclosure performs as if it were 30-40% larger. The venting of this cabinet toward the back of the enclosure serves two purposes: (1) it relieves the short-circuiting effect of a port upon the speaker by placing the opening as far away from the face of the speaker as possible; and (2) when placed against a wall, there is additional loading of this vent by proximity to the wall. This creates essentially two radiating surfaces and thus overcomes the diffraction effects of other types of small cabinets.

The woofer mechanisms that drive these enclosures were designed to have mechanically stable high compliances, and masses sufficient to give cone rigidity. Thus the woofer, when experiencing the large low frequency excursions of which it is capable, maintains its piston-like action over its entire operating range. The compliance designed into these speakers is a specially formed light fabric material impregnated with phenolics to give it stability and then treated with a newly developed plasticized rim treatment that will give lifelong protection to the very high compliance and yet maintain adequate acoustic sealing between the rear and the front of the speaker. Very low frequency cone resonances have been achieved by the combination of the high compliance and the mass relationships of the cones. This results in an exceedingly uniform frequency response characteristic which provides increased linearity throughout its excursion. In conjunction with the voice coil, designed to overhang the magnetic gap and thus produce a constant force factor over wide limits of coil amplitude regardless of coil position, this insures the preservation of ultra-linearity. To achieve maximum conversion efficiency without affecting response linearity, a new magnet material, Hi Flux UNIFERROX-7, is employed in a newly designed magnetic assembly. Truly team fundamental cone resonances as low as 15 cps are accomplished.

The systems may be classified in the low efficiency category. However, because matched components designed

to complement the woofer are used with it, greater efficiency may be obtained without sacrificing linearity than is possible with other low efficiency systems. Thus, for a given power input, reasonably high listening levels may be achieved. This is vitally important in the case of transients, where the peak power may at times severely exceed the average output power of an available amplifier. If an amplifier has to work too hard to drive a speaker of too low efficiency, the transient response will be deteriorated. Consequently, in the University design, the extra efficiency will provide excellent transient response with reasonable conversion efficiency.

For over-all linearity, these systems employ other complementary speakers to complete the mid and high frequency acoustic spectrums. In the Ultra-Linear 12, the response of the woofer extends to a point where it is possible to complete the system with simply one additional treble complementary reproducer. By molding the low frequency response of the tweeter to a level corresponding to the acoustic output level of the woofer, it is possible to obtain a completely "flat" system over the entire operating range. Although the system is normally connected for flat response, the over-all level of the tweeter can be slightly modified when it is desired to accentuate the high frequencies. Thus the system can be adjusted to suit both the user's preference and the particular acoustic environment.

In the Ultra-Linear 15, a 3-way system is employed, the upper end of the woofer being joined to the acoustic response of a high quality 8" mid-range speaker which, in turn, is complemented by a hypersonic tweeter. The mid-range speaker is necessary because the massive structure of the 15" basic woofer limits its upper frequency response. The mid-range is installed within its own rear compression chamber, which protects it from the low frequency pressures of the woofer. It also provides an acoustic crossover for the mid-range, determined by the internal volume of the chamber. The tweeter is balanced to be compatible with the level of the mid-range and woofer speakers. The matched-level network which integrates the three speakers is also adjustable to give a small but perceptible boost in the mid-frequencies and a similar boost to the high frequencies, if listening conditions warrant. However, this system is factory-connected for ultra-linear response.

Thus, high cone mass, high cone compliance, overhanging voice coil and complementary matched upper range units... plus the specially designed enclosure, all work together to produce original studio quality.



**The ULTRA-LINEAR 15, MODELS 5-11H and 5-11L** Components comprise new heavy duty high compliance 15" C-15HC woofer, Diffusicone-8 with its own compression chamber for mid-range (200 cps crossover), a special UL/HC Hypersonic Tweeter (15000 cps crossover) for response to beyond audibility and specially designed Model HC-3 matched-level network, with "Brilliance" and "Presence" controls. Operates with power input of 20-60 clean watts. Impedance: 8 ohms. Size: 26¾" x 19½" x 17½" deep; removable base adds 2". S-11H is upright model; S-11L is lowboy. SHIPP. WT.: 87 lbs. User net: Mahogany—\$245, Blond—\$249, Walnut—\$253.



**The ULTRA-LINEAR 12, MODELS 5-10H and 5-10L** Components comprise new C-12HC 12" high compliance, low resonance woofer, special 2500 cps crossover, wide-angle UL/HC tweeter and Model HC-2 matched level crossover network with high frequency adjustment for matching room attenuation characteristics. Operates with power input of 25-60 clean watts. Impedance: 8 ohms. Size: 25" x 14" x 14½" deep; removable base adds 1½". S-10H is highboy; S-10L is lowboy. SHIPP. WT.: 58 lbs. User net: Mahogany—\$139, Blond—\$143, Walnut—\$147.

**MODEL 5-3TM, "TINY MITE"**—Uses Model 308 8" 3-way Diffaxial speaker with University's exclusive true-axial construction and center-projected compression tweeter with "reciprocating-flare" principle, crossing over electrically at 5000 cps. Mid-range reproduced from patented deluxe multi-element Diffusicone section with 1000 cps crossover. Response to 15,000 cps. Power capacity: 25 watts,\* room level 3 watts. Impedance: 8-16 ohms. Size: 21½" x 15½" x 12½" deep. SHIPP. WT.: 30 lbs. User net: Mahogany—\$85, Blond—\$88, Walnut—\$89.50.

**Enclosure only, Model TM 812**—For use with any University 8" or 12" extended range speakers. SHIPP. WT.: 25 lbs. User net: Mahogany—\$43.50, Blond—\$46.50, Walnut—\$48.50, Unfinished—\$37.75.



**MODEL 5-1, "COMPANIONETTE"**—2-way speaker system using Model C-8W woofer and Model 4401 wide-angle tweeter. Response to 15,000 cps. Crossover 2500 cps. Power capacity: 25 watts,\* room level approx. 3 watts. Impedance: 8 ohms. Size: 10" x 24" x 10" deep. SHIPP. WT.: 21 lbs. User net: Mahogany—\$62, Blond—\$64, Walnut—\$65.75.

Hear magnificent University speaker systems at your dealer... soon!



UNIVERSITY LOUDSPEAKERS, INC., 80 SOUTH KENSICO AVENUE, WHITE PLAINS, N. Y.

# Loudness, Its Definition, Measurement and Calculation

HARVEY FLETCHER and W. A. MUNSON

In Two Parts — Part I

FROM THE ARCHIVES OF BELL TELEPHONE LABORATORIES

**L**OUDNESS is a psychological term used to describe the magnitude of an auditory sensation. Although we use the terms "very loud," "loud," "moderately loud," "soft" and "very soft," corresponding to the musical notations *ff*, *f*, *mf*, *p*, and *pp*, to define the magnitude, it is evident that these terms are not at all precise and depend upon the experience, the auditory acuity, and the customs of the persons using them. If loudness depended only upon the intensity of the sound wave producing the loudness, then measurements of the physical intensity would definitely determine the loudness as sensed by a typical individual and therefore could be used as a precise means of defining it. However, no such simple relation exists.

The magnitude of an auditory sensation, that is, the loudness of the sound, is probably dependent upon the total number of nerve impulses that reach the brain per second along the auditory tract. It is evident that these auditory phenomena are dependent not alone upon the intensity of the sound but also upon their physical composition. For example, if a person listened to a flute and then to a bass drum placed at such distances that the sounds coming from the two instruments are judged to be equally loud, then the intensity of the sound at the ear produced by the bass drum would be many times that produced by the flute.

If the composition of the sound, that is, its wave form, is held constant, but its intensity at the ear of the listener varied, then the loudness produced will be the same for the same intensity only if the same or an equivalent ear is receiving the sound and also if the listener is in the same psychological and physiological conditions, with reference to fatigue, attention, alertness, etc. Therefore, in order to determine the loudness produced, it is necessary to define the intensity of the sound, its physical composition, the kind of ear receiving it, and the physiological and psychological

conditions of the listener. In most engineering problems we are interested mainly in the effect upon a typical observer who is in a typical condition for listening.

In a paper during 1921 one of us suggested using the number of decibels above threshold as a measure of loudness and some experimental data were presented on this basis. As more data were accumulated it was evident that such a basis for defining loudness must be abandoned.

In 1924 in a paper by Steinberg and Fletcher<sup>1</sup> some data were given which showed the effects of eliminating certain frequency bands upon the loudness of the sound. By using such data as a basis, a mathematical formula was given for calculating the loudness losses of a sound being transmitted to the ear, due to changes in the transmission system. The formula was limited in its application to the particular sounds studied, namely, speech and a sound which was generated by an electrical buzzer and called the test tone.

In 1925 Steinberg<sup>2</sup> developed a formula for calculating the loudness of any complex sound. The results computed by this formula agreed with the data which were then available. However, as more data have accumulated it has been found to be inadequate. Since that time considerably more information concerning the mechanism of hearing has been discovered and the technique in making loudness measurements has advanced. Also more powerful methods for producing complex tones of any known composition are now available. For these reasons and because of the demand for a loudness formula of general application, especially in connection with noise measurements, the whole subject was reviewed by the Bell Telephone Laboratories and the work reported in the present paper undertaken.

<sup>1</sup>H. Fletcher and J. C. Steinberg, "Loudness of a complex sound," *Phys. Rev.* 24, 306 (1924).

<sup>2</sup>J. C. Steinberg, "The loudness of a sound and its physical stimulus," *Phys. Rev.* 26, 507 (1925).

This work has resulted in better experimental methods for determining the loudness level of any sustained complex sound and a formula which gives calculated results in agreement with the great variety of loudness data which are now available.

## DEFINITIONS

The subject matter which follows necessitates the use of a number of terms which have often been applied in very inexact ways in the past. Because of the increase in interest and activity in this field, it became desirable to obtain a general agreement concerning the meaning of the terms which are most frequently used. The following definitions are taken from recent proposals of the sectional committee on Acoustical Measurements and Terminology of the American Standards Association and the terms have been used with these meanings throughout the paper.

## Sound Intensity

The sound intensity of a sound field in a specified direction at a point is the sound energy transmitted per unit of time in the specified direction through a unit area normal to this direction at the point.

In the case of a plane or spherical free progressive wave having the effective sound pressure  $P$  (bars), the velocity of propagation  $c$  (cm. per sec.) in a medium of density  $\rho$  (grams per cubic cm.), the intensity in the direction of propagation is given by

$$J = P^2/\rho c \text{ (ergs per sec. per sq. cm.).} \quad (1)$$

This same relation can often be used in practice with sufficient accuracy to calculate the intensity at a point near the source with only a pressure measurement. In more complicated sound fields the results given by this relation may differ greatly from the actual intensity.

When dealing with a plane or a spherical progressive wave it will be understood that the intensity is taken in the direction of propagation of the wave.

Reprinted by permission from Bell Telephone System Monograph B-756. Originally presented in *J. Acous. Soc. Am.*, October, 1933.

## Reference Intensity

The reference intensity for intensity level comparisons shall be  $10^{-16}$  watts per square centimeter. In a plane or spherical progressive sound wave in air, this intensity corresponds to a root-mean-square pressure  $p$  given by the formula

$$p = 0.000207[(H/76)(273/T)^{3/2}]^{1/2} \quad (2)$$

where  $p$  is expressed in bars,  $H$  is the height of the barometer in centimeters, and  $T$  is the absolute temperature. At a temperature of  $20^\circ$  C, and a pressure of 76 cm. of Hg,  $p = 0.000204$  bar.

## Intensity Level

The intensity level of a sound is the number of db above the reference intensity.

## Reference Tone

A plane or spherical sound wave having only a single frequency of 1000 cycles per second shall be used as the reference for loudness comparisons.

*Note:* One practical way to obtain a plane or spherical wave is to use a small source, and to have the head of the observer at least one meter distant from the source, with the external conditions such that reflected waves are negligible as compared with the original wave at the head of the observer.

## Loudness Level

The loudness level of any sound shall be the intensity level of the equally loud reference tone at the position where the listener's head is to be placed.

## Manner of Listening to the Sound

In observing the loudness of the reference sound, the observer shall face the source, which should be small, and listen with both ears at a position so that the distance from the source to a line joining the two ears is one meter.

The value of the intensity level of the equally loud reference sound depends upon the manner of listening to the unknown sound and also to the standard of reference. The manner of listening to the unknown sound may be considered as part of the characteristics of that sound. The manner of listening to the reference sound is as specified above.

*Loudness* has been briefly defined as the magnitude of an auditory sensation, and more will be said about this later, but it will be seen from the above definitions that the *loudness level* of any sound is obtained by adjusting the intensity level of the reference tone until it sounds equally loud as judged by a typical listener. The only way of determining a typical listener is to use a number of observers who have normal hearing to make the judgment tests.

The typical listener, as used in this sense, would then give the same results as the average obtained by a large number of such observers.

A pure tone having a frequency of 1000 cycles per second was chosen for the reference tone for the following reasons: (1) it is simple to define, (2) it is sometimes used as a standard of reference for pitch, (3) its use makes the mathematical formulae more simple, (4) its range of auditory intensities (from the threshold of hearing to the threshold of feeling) is as large and usually larger than for any other type of sound, and (5) its frequency is in the mid range of audible frequencies.

There has been considerable discussion concerning the choice of the reference or zero for loudness levels. In many ways the threshold of hearing intensity for a 1000-cps tone seems a logical choice. However, variations in this threshold intensity arise depending upon the individual, his age, the manner of listening, the method of presenting the tone to the listener, etc. For this reason no attempt was made to choose the reference intensity as equal to the average threshold of a given group listening in a prescribed way. Rather, an intensity of the reference tone in air of  $10^{-16}$  watts per square centimeter was chosen as the reference intensity because it was a simple number which was convenient as a reference for computation work, and at the same time it is in the range of threshold measurements obtained when listening in the standard method described above. This reference intensity corresponds to the threshold intensity of an observer who might be designated a reference observer. An examination of a large series of measurements on the threshold of hearing indicates that such a reference observer has a hearing which is slightly more accurate than the average of a large group. For those who have been thinking in terms of microwatts it is easy to remember that this reference level is 100 db below one microwatt per square centimeter. When using these definitions the intensity level  $\beta_r$  of the reference tone is the same as its loudness level  $L$  and is given by

$$\beta_r = L = 10 \log J_r + 100, \quad (3)$$

where  $J$  is its sound intensity in microwatts per square centimeter.

The intensity level of any other sound is given by

$$\beta = 10 \log J + 100, \quad (4)$$

where  $J$  is its sound intensity, but the loudness level of such a sound is a complicated function of the intensities and frequencies of its components. However, it will be seen from the experimental data given later that for a considerable range of frequencies and intensities the intensity level and loudness for pure

tones are approximately equal.

With the reference levels adopted here, all values of loudness level which are positive indicate a sound which can be heard by the reference observer and those which are negative indicate a sound which cannot be heard by such an observer.

It is frequently more convenient to use two matched head receivers for introducing the reference tone into the two ears. This can be done provided they are calibrated against the condition described above. This consists in finding by a series of listening tests by a number of observers the electrical power  $W_1$  in the receivers which produces the same loudness as a level  $\beta_r$  of the reference tone. The intensity level  $\beta_r$  of an open air reference tone equivalent to that produced in the receiver for any other power  $W_r$  in the receivers is then given by

$$\beta_r = \beta_1 + 10 \log (W_r/W_1). \quad (5)$$

Or, since the intensity level  $\beta_r$  of the reference tone is its loudness level  $L$ , we have

$$L = 10 \log W_r + C_r, \quad (6)$$

where  $C_r$  is a constant of the receivers.

In determining loudness levels by comparison with a reference tone there are two general classes of sound for which measurements are desired: (1) those which are steady, such as a musical tone, or the hum from machinery, (2) those which are varying in loudness such as the noise from the street, conversational speech, music, etc. In this paper we have confined our discussion to sources which are steady and the method of specifying such sources will now be given.

A steady sound can be represented by a finite number of pure tones called components. Since changes in phase produce only second order effects upon the loudness level it is only necessary to specify the magnitude and frequency of the components.<sup>3</sup> The magnitudes of the components at the listening position where the loudness level is desired are given by the intensity levels  $\beta_1, \beta_2, \dots, \beta_k, \dots, \beta_n$  of each component at that position. In case the sound is conducted to the ear by telephone receivers or tubes, then a value of  $W_k$  for each component must be known such that if this component were acting separately it would produce the same loudness for typical observers as a tone of the same pitch coming from a source at one meter's distance and producing an intensity level of  $\beta_k$ .

<sup>3</sup> Recent work by Chapin and Firestone indicates that at very high levels these second order effects become large and cannot be neglected. K. E. Chapin and F. A. Firestone, "Interference of subjective harmonics," *J. Acous. Soc. Am.* 4, 176A (1933).





# THE NEW ALTEC

## Quartet 344A

*20-watt power amplifier and preamplifier*

**INVITES COMPARISON**

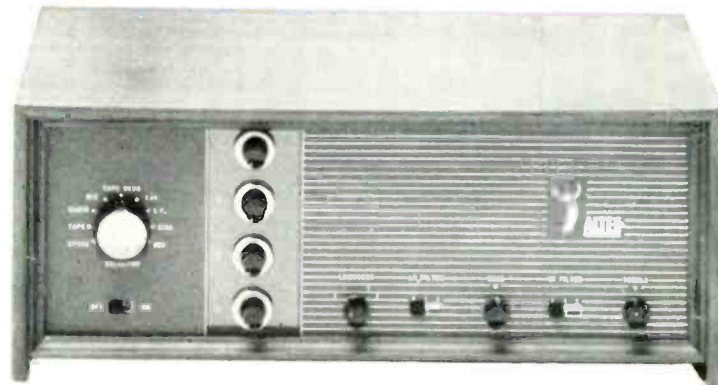

The new ALTEC "Quartet" (named for its unique 4 independent volume controls) is the only complete amplifier with all of the control features found in the best separate preamplifiers plus a full 20 watts of power.

*Compare* these outstanding features of the "Quartet":

*Six Inputs*—3 lo-level for magnetic phono pickup, microphone, and tape deck...3 hi-level for tuner, tape reproducer, and spare.

*Four Major Source Volume Controls* allow you to *pre-set* the level of any major program material and change from input to input or turn the power on and off without the necessity for readjustment. D. C. powered program indicator lights for completely hum-free operation.

*Guaranteed Performance Specifications:* 20-22,000 cps range, 20 watts (40 peak), 138 db gain, 32 db bass control range, 35 db treble tone control range.

*Four Position* loudness compensation control... continuously variable wide range bass and treble controls...*Three Position* independent rumble and scratch filters—all designed to give complete flexibil-

ity to suit reproduction quality of individual tastes and material.

*Tape Recording Output*—provided so material from any input may be selected for recording.

*Equalization*—4 phono compensation curves: European, LP, RIAA, and 78 rpm. 1 tape deck compensation.

*Quality Construction*—an example of the quality built into the "Quartet" is its "professional" printed circuit. Unlike common printed circuits, all components are attached through riveted eyelets making it possible to replace components without destroying the circuit.

*Extraordinarily Sleek Design:* Dimensions (less cabinet)—4-5/8" H, 13-3/4" W, 7-1/8" D... (with cabinet)—5-15/16" H, 14-5/8" W, 8-13/16" D.

Price: (less cabinet) **\$106<sup>00</sup>** Walnut, blond, or mahogany solid hardwood cabinet, \$18.00.

Write for free catalogue  
**ALTEC LANSING CORPORATION A-11**  
515 S. Manchester Ave., Anaheim, Calif.  
161 Sixth Ave., New York, N. Y.



12-4

In addition to the frequency and magnitude of the components of a sound it is necessary to know the position and orientation of the head with respect to the source, and also whether one or two ears are used in listening. The monaural type of listening is important in telephone use and the binaural type when listening directly to a sound source in air. Unless otherwise stated, the discussion and data which follow apply to the condition where the listener faces the source and uses both ears, or uses head telephone receivers which produce an equivalent result.

### FORMULATION OF THE EMPIRICAL THEORY FOR CALCULATING THE LOUDNESS LEVEL OF A STEADY COMPLEX TONE

It is well known that the intensity of a complex tone is the sum of the intensities of the individual components. Similarly, in finding a method of calculating the loudness level of a complex tone one would naturally try to find numbers which could be related to each component in such a way that the sum of such numbers will be related in the same way to the equally loud reference tone. Such efforts have failed because the amount contributed by any component toward the total loudness sensation depends not only upon the properties of this component but also upon the properties of the other components in the combination. The answer to the problem of finding a method of calculating the loudness lies in determining the nature of the ear and brain as measuring instruments in evaluating the magnitude of an auditory sensation.

One can readily estimate roughly the magnitude of an auditory sensation; for example, one can tell whether the sound is soft or loud. There have been many theories to account for this change in loudness. One that seems very reasonable to us is that the loudness experienced is dependent upon the total number of nerve impulses per second going to the brain along all the fibers that are excited. Although such an assumption is not necessary for deriving the formula for calculating loudness it aids in making the meaning of the quantities involved more definite.

Let us consider, then, a complex tone having  $n$  components each of which is specified by a value of intensity level  $\beta_k$  and of frequency  $f_k$ . Let  $N$  be a number which measures the magnitude of the auditory sensation produced when a typical individual listens to a pure tone. Since by definition the magnitude of an auditory sensation is the loudness, then  $N$  is the loudness of this simple tone. Loudness as used here must not be confused with loudness level. The latter is measured by the intensity of the equally loud reference tone and is expressed in

decibels while the former will be expressed in units related to loudness levels in a manner to be developed. If we accept the assumption mentioned above,  $N$  is proportional to the number of nerve impulses per second reaching the brain along all the excited nerve fibers when the typical observer listens to a simple tone.

Let the dependency of the loudness  $N$  upon the frequency  $f$  and the intensity  $\beta$  for a simple tone be represented by

$$N = G(f, \beta), \quad (7)$$

where  $G$  is a function which is determined by any pair of values of  $f$  and  $\beta$ . For the reference tone,  $f$  is 1000 and  $\beta$  is equal to the loudness level  $L$ , so a determination of the relation expressed in Eq. (7) for the reference tone gives the desired relation between loudness and loudness level.

If now a simple tone is put into combination with other simple tones to form a complex tone, its loudness contribution, that is, its contribution toward the total sensation, will in general be somewhat less because of the interference of the other components. For example, if the other components are much louder and in the same frequency region the loudness of the simple tone in such a combination will be zero. Let  $1-b$  be the fractional reduction in loudness because of its being in such a combination. Then  $bN$  is the contribution of this component toward the loudness of the complex tone. It will be seen that  $b$  by definition always remains between 0 and unity. It depends not only upon the frequency and intensity of the simple tone under discussion but also upon the frequencies and intensities of the other components. It will be shown later that this dependence can be determined from experimental measurements.

The subscript  $k$  will be used when  $f$  and  $\beta$  correspond to the frequency and intensity level of the  $k$ th component of the complex tone, and the subscript  $r$  used when  $f$  is 1000 cycles per second. The "loudness level"  $L$  by definition, is the intensity level of the reference tone when it is adjusted so it and the complex tone sound equally loud. Then

$$N_r = G(1000, L) = \sum_{k=1}^{k=n} b_k N_k = \sum_{k=1}^{k=n} b_k G(f_k, \beta_k). \quad (8)$$

Now let the reference tone be adjusted so that it sounds equally loud successively to simple tones corresponding in frequency and intensity to each component of the complex tone.

Designate the experimental values thus determined as  $L_1, L_2, L_3, \dots, L_k, \dots, L_n$ . Then from the definition of these values

$$N_k = G(1000, L_k) = G(f_k, \beta_k), \quad (9)$$

since for a single tone  $b_k$  is unity. On substituting the values from (9) into (8) there results the fundamental equation

for calculating the loudness of a complex tone

$$G(1000, L) = \sum_{k=1}^{k=n} b_k G(1000, L_k) \quad (10)$$

This transformation looks simple but it is a very important one since instead of having to determine a different function for every component, we now have to determine a single function depending only upon the properties of the reference tone and as stated above this function is the relationship between loudness and loudness level. And since the frequency is always 1000, this function is dependent only upon the single variable, the intensity level.

This formula has no practical value unless we can determine  $b_k$  and  $G$  in terms of quantities which can be obtained by physical measurements. It will be shown that experimental measurements of the loudness levels  $L$  and  $L_k$  upon simple and complex tones of a properly chosen structure have yielded results which have enabled us to find the dependence of  $b$  and  $G$  upon the frequencies and intensities of the components. When  $b$  and  $G$  are known, then the more general function  $G(f, \beta)$  can be obtained from Eq. (9), and the experimental values of  $L_k$  corresponding to  $f_k$  and  $\beta_k$ .

### DETERMINATION OF THE RELATION BETWEEN $L_k$ , $f_k$ AND $\beta_k$

This relation can be obtained from experimental measurements of the loudness levels of pure tones. Such measurements were made by Kingsbury<sup>4</sup> which covered a range in frequency and intensity limited by instrumentalities then available. Using the experimental technique described in Appendix A, we have again obtained the loudness levels of pure tones, this time covering practically the whole audible range. (See Appendix B for a comparison with Kingsbury's results.)

All of the data on loudness levels both for pure and also complex tones taken in our laboratory which are discussed in this paper have been taken with telephone receivers on the ears. It has been explained previously how telephone receivers may be used to introduce the reference tone into the ears at known loudness levels to obtain the loudness levels of other sounds by a loudness balance. If the receivers are also used for producing the sounds whose loudness levels are being determined, then an additional calibration, which will be explained later, is necessary if it is desired to know the intensity levels of the sounds.

The experimental data for determining the relation between  $L_k$  and  $f_k$  are given

<sup>4</sup> B. A. Kingsbury, "A direct comparison of the loudness of pure tones," *Phys. Rev.* 29, 588 (1927).

# Electro-Voice®

## NEW Ultra-Sonax and Super Sonax Very High Frequency Drivers, Diffraction Horns and Revolutionary E-V Avedon Throat Design

No other manufacturer gives you very high frequency drivers combining all the customer benefits of these unique new Electro-Voice models. Today's folded horn and phase loaded speaker systems with their low first-octave response require flat, extended high range response beyond the very limit of audibility if essential musical balance is to be achieved. These very high frequency drivers, employing the time-tested diffraction principle and the new Avedon throat design, overcome range and sensitivity limitations, function without distortion at the highest ranges.

All three models—T35, T35B and T350—have 180° dispersion patterns, program capacities of 50 watts, peak 100 watts, voice coils one inch in diameter and 16 ohms impedance. Chart shows other characteristics of each model.

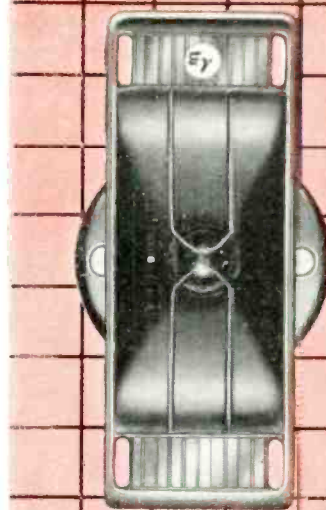

T350 Ultra-Sonax

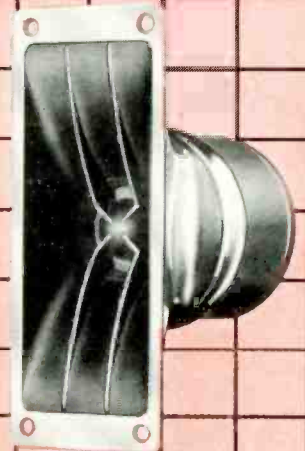

T35 and T35B Super-Sonax

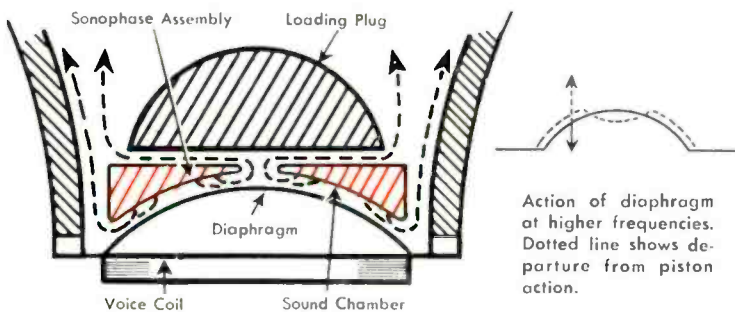

Specifications	T35	T35B	T350
Frequency Response:	± 2 db 2 kc—19 kc	± 2 db 2 kc—18 kc	± 2 db 2 kc—21 kc
RETMA Sensitivity			
Rating:	57 db	54 db	60 db
Magnet Weight:	7 oz.	4 oz.	1 lb.
Gauss	13,500	9,000	20,000
Size:			
Horn:	5 1/4 in. long x 2 in. wide		7 1/2 in. long x 2 1/2 in. wide
Pot Diameter:	2 1/4 in. maximum		3 1/2 in. maximum
Depth:	3 1/4 in. overall	3 in. overall	4 1/2 in. overall
Shipping Weight:	3 lbs.	3 1/2 lbs.	9 1/2 lbs.
Net Price:	\$35.00	\$22.00	\$60.00

### And These are the Reasons Why

#### The Avedon Throat Design

The unique throat design illustrated here overcomes a problem common in conventional high frequency drivers. This is diaphragm deformation at high velocities, occurring at frequencies above 5 kilocycles. Piston action is destroyed, the phase is shifted and the result is destructive interference.

These Electro-Voice VHF drivers solve the diaphragm distortion problem with a longer sound path from the center of the diaphragm. This restores proper phase relationship. This is important above 12 kilocycles, where sound must be taken from the center of the diaphragm and from the outer edge simultaneously. The diagram shows E-V's Avedon construction.

#### The Hoodwin Diffraction Horn

This is the Electro-Voice development which is used in all E-V horns to disperse sound equally in all lateral directions from a single point source. This is especially important in stereophonic reproduction to preserve the undistorted depth and width of the original sound. Diffraction horns insure balanced levels of both right and left stereo speakers. These drawings tell the diffraction horn story:

# Electro-Voice

**ELECTRO-VOICE, INC.** • **BUCHANAN, MICHIGAN**  
 Export: 13 East 40th Street, New York 16, U.S.A. Cables: ARLAB

Electro-Voice manufactures the most complete high-fidelity product family... speakers, speaker systems, speaker enclosures, amplifiers, preamps, tuners, phono cartridges, do-it-yourself enclosure kits and microphones. Available at leading high fidelity distributors.

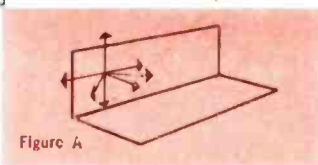
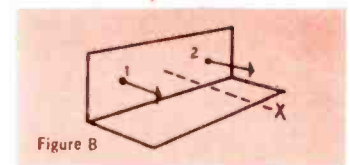
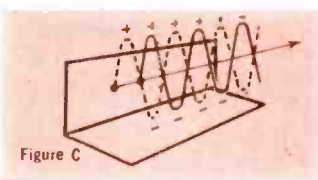

Figure A—This shows how sound disperses equally in all directions from a single point source.



In Figure B two sound sources are shown. On the axis, at point "x," double the sound power results as the resultant pressures are in phase.



But in Figure C, if the distance between the two sources is 1/2 wavelength or greater, the sound from the two sources will be considerably out of phase for points off the axis, resulting in decreased sound pressure.

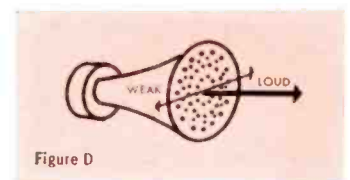

Figure D will show the deficiencies in horns of wide lateral dimensions compared to the wavelength being emitted. Any horn mouth can be considered as a group of small point sources of sound. They must beam the sound down the axis by their very nature.

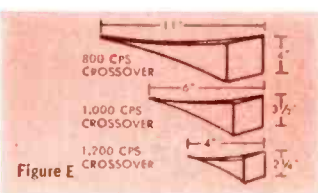

Figure E shows representative horns, illustrating that horns must have a certain length, as well as cross sectional area along their length and at the mouth to load the driver diaphragm down to the lowest frequencies to be reproduced. The lower we go, the longer must be the horn and the greater the mouth area.

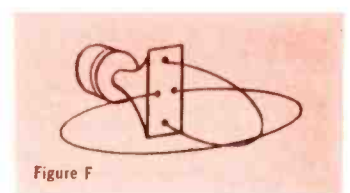

Figure F shows that narrowing the horizontal area and extending the vertical dimension of the horn mouth preserves the loading area necessary for good low end response, disperses the sound perfectly in the horizontal direction where it is so necessary, and keeps interfering reflections off the floor and ceiling.

TABLE I  
VOLTAGE LEVELS (DB) FOR LOUDNESS EQUALITY

Reference	62 c.p.s.	Reference	125 c.p.s.	Reference	250 c.p.s.	Reference	500 c.p.s.	Reference	2000 c.p.s.	Reference	4000 c.p.s.	Reference	5650 c.p.s.	Reference	8000 c.p.s.	Reference	11,300 c.p.s.	Reference	16,000 c.p.s.
-12.2	+ 9.8	- 4.4	+ 9.8	- 2.0	+ 6.6	- 2.2	+ 5.8	- 2.2	- 1.2	- 1.7	- 0.7	- 3.7	+ 0.8	-10.9	- 4.3	-20.2	+ 1.7	-50.2	+ 1.8
-17.2	+ 5.8	-10.2	+ 7.9	- 3.7	+ 5.7	- 4.2	+ 6.8	- 1.7	- 1.5	- 1.2	- 1.5	- 7.2	- 1.2	-12.2	-12.0	-22.2	+ 1.3	-66.2	-13.2
-19.2	+ 2.8	-13.3	- 0.8	- 5.2	+ 3.8	- 4.2	- 2.0	- 3.2	- 1.3	-23.2	-17.3	-28.2	-10.2	-26.2	-21.0	-38.2	-20.2	-77.2	-28.2
-15.7	+ 2.6	-18.0	- 3.2	- 6.7	- 2.2	- 7.2	- 2.3	-18.2	-13.4	-21.7	-16.7	-30.2	-19.2	-27.1	-21.3	-38.7	-20.3	-85.2	-38.2
-21.2	+ 0.8	-23.2	- 5.2	-12.2	- 2.2	-12.2	- 8.2	-21.2	-17.2	-44.7	-35.2	-53.2	-38.2	-46.2	-38.3	-55.2	-31.2		
-27.2	- 0.2	-27.9	-12.3	-25.5	-18.3	-21.2	-22.3	-22.2	-18.3	-47.7	-35.1	-54.7	-39.1	-48.2	-38.2	-55.7	-34.2		
-32.2	- 7.2	-31.0	-14.2	-32.2	-22.2	-21.7	-21.9	-40.2	-35.2	-63.2	-54.2	-72.2	-59.2	-64.2	-52.2	-72.2	-52.2		
-33.2	- 7.2	-35.2	-15.2	-32.2	-23.2	-32.2	-30.2	-41.2	-35.3	-65.2	-54.5	-72.7	-58.1	-70.2	-56.2	-78.7	-58.1		
-41.2	-10.2	-40.7	-23.6	-52.5	-40.4	-31.2	-31.2	-42.2	-35.4	-77.7	-72.2	-85.2	-71.2	-76.2	-72.2	-88.2	-72.2		
-35.4	-10.4	-66.6	-35.0	-72.9	-56.3	-41.7	-41.9	-59.2	-51.2	-80.2	-72.5	-92.7	-78.1	-82.6	-76.2	-90.7	-77.1		
-56.2	-15.2	-88.8	-46.5	-90.2	-68.3	-43.7	-42.2	-61.2	-57.5										
-67.2	-20.2					-63.7	-61.0	-64.2	-57.3										
-68.7	-20.3					-64.2	-61.2	-78.2	-77.3										
-97.2	-30.3					-83.2	-80.2	-78.2	-80.2										
						-83.7	-78.0	-81.7	-77.3										
-108.1	-39.8					-106.1	-102.6												
-108.3	-39.5	-108.1	-62.8	-108.1	-86.7	-108.3	-101.7	-108.3	-105.2	-108.3	-104.6								
-109.3	-42.4	-108.3	-60.7	-108.3	-86.4	-109.3	-99.7	-108.3	-109.0	-108.3	-105.7	-108.3	-101.9	-108.3	-108.1	-108.3	-93.7		
-113.1	-38.5	-113.1	-63.5	-113.1	-86.3	-113.1	-103.4	-109.3	-108.9	-109.3	-102.0	-109.3	-99.3	-109.3	-103.1	-109.3	-94.6		
							-103.0	-113.1	-111.4	-113.1	-108.1	-113.1	-102.3	-113.1	-106.6	-113.1	-93.7	-109.3	-57.3

in Table I in terms of voltage levels. (Voltage level = 20 log V, where V is the e.m.f. across the receivers in volts.) The pairs of values in each double column give the voltage levels of the reference tone and the pure tone having the frequency indicated at the top of the column when the two tones coming from the head receivers were judged to be equally loud when using the technique described in Appendix A. For example, in the second column it will be seen that for the 125-cps tone when the voltage is +9.8 db above 1 volt then the voltage level for the reference tone must be 4.4 db below 1 volt for equality of loudness. The bottom set of numbers in each column gives the threshold values for this group of observers.

Each voltage level in Table I is the median of 297 observations representing the combined results of eleven observers. The method of obtaining these is explained in Appendix A also. The standard deviation was computed and it was found to be somewhat larger for tests in which the tone differed most in frequency from the reference tone. The probable error of the combined result as computed in the usual way was between 1 and 2 db. Since deviations of any one observer's results from his own average are less than the deviations of his average from the average of the group, it would be necessary to increase the size of the group if values more representative of the average normal ear were desired.

The data shown in Table I can be reduced to the number of decibels above threshold if we accept the values of this

crew as the reference threshold values. However, we have already adopted a value for the 1000-cps reference zero. As will be shown, our crew obtained a threshold for the reference tone which is 3 db above the reference level chosen.

It is not only more convenient but also more reliable to relate the data to a calibration of the receivers in terms of physical measurements of the sound intensity rather than to the threshold values. Except in experimental work where the intensity of the sound can be definitely controlled, it is obviously impractical to measure directly the threshold level by using a large group of observers having normal hearing. For most purposes it is more convenient to measure the intensity levels  $\beta_1, \beta_2, \dots, \beta_k$ , etc., directly rather than have them related in any way to the threshold of hearing.

In order to reduce the data in Table I to those which one would obtain if the observers were listening to a free wave and facing the source, we must obtain a field calibration of the telephone receivers used in the loudness comparisons. The calibration for the reference tone frequency has been explained previously and the equation

$$\beta_r = \beta_i + 10 \log (W_r/W_i) \quad (5)$$

derived for the relation between the intensity  $\beta_r$  of the reference tone and the electrical power  $W_r$  in the receivers. The calibration consisted of finding by means of loudness balances a power  $W_i$  in the receivers which produces a tone equal in loudness to that of a free wave having an intensity level  $\beta_r$ .

For sounds other than the 1000-cps reference tone a relation similar to Eq. (5) can be derived, namely,

$$\beta = \beta_i + 10 \log (W/W_i) \quad (11)$$

where  $\beta_i$  and  $W_i$  are corresponding values found from loudness balances for each frequency or complex wave form of interest. If, as is usually assumed, a linear relation exists between  $\beta$  and  $10 \log W$ , then determinations of  $\beta_i$  and  $W_i$  at one level are sufficient and it follows that a change in the power level of  $\Delta$  decibels will produce a corresponding change of  $\Delta$  decibels in the intensity of the sound generated. Obviously the receivers must not be overloaded or this assumption will not be valid. Rather than depend upon the existence of a linear relation between  $\beta$  and  $10 \log W$  with no confirming data, the receivers used in this investigation were calibrated at two widely separated levels.

Referring again to Table I, the data are expressed in terms of voltage levels instead of power levels. If, as was the case with our receivers, the electrical impedance is essentially a constant, Eq. (11) can be put in the form:

$$\beta = \beta_i + 20 \log (V/V_i) \quad (12)$$

or

$$\beta = 20 \log V + C \quad (13)$$

where  $V$  is the voltage across the receivers and  $C$  is a constant of the receivers to be determined from a calibration giving corresponding values of  $\beta_i$  and  $20 \log V_i$ . The calibration will now be described.

(To Be Concluded)

TABLE II  
FIELD CALIBRATION OF TELEPHONE RECEIVERS

Frequency c.p.s.	60	120	240	480	960	1920	3850	5400	7800	10,500	15,000
Voltage level (20 log V <sub>i</sub> )	-13.0	-26.2	-38.5	-47.0	-48.2	-42.3	-36.3	-34.0	-39.1	-32.4	- 6.4
Intensity level (β <sub>i</sub> )	+79.3	+71.0	+67.4	+63.8	+65.3	+64.0	+62.2	+65.5	+74.0	+78.6	+75.0
C <sub>i</sub> = β <sub>i</sub> - 20 log V <sub>i</sub>	92.3	97.2	105.9	110.8	113.5	106.3	98.5	99.5	113.1	111.0	81.4
Threshold voltage level (20 log V <sub>0</sub> )	-48.0	-61.8	-86.2	-105.4	-110.7	-109.0	-104.0	-97.1	-100.5	-102.0	-74.0
Threshold intensity level (β <sub>0</sub> )	+49.3	+33.7	+19.7	+8.4	+5.4	-0.9	-4.2	+2.7	+10.6	+16.1	+22.0
C <sub>0</sub> = β <sub>0</sub> - 20 log V <sub>0</sub>	97.3	95.5	105.9	113.8	116.1	108.1	99.8	99.8	111.1	118.1	96.0
Diff. = C <sub>i</sub> - C <sub>0</sub>	-5.0	1.7	0	-3.0	-2.6	-1.8	-1.3	-0.3	+2.0	-7.1	-14.6

*Bozak...*  
*the very best in sound*



*The B-304 Stereo-Fantasy . . .  
one of nine distinguished  
Bozak Speaker Systems.  
Hear them at your Franchised  
Bozak Dealer.*

THE R. T. BOZAK SALES COMPANY • DARIEN • CONNECTICUT  
AUDIO • NOVEMBER, 1957

# Equipment Review

Norelco "Continental" tape recorder—Wharfedale 3-way speaker systems—Radio Craftsmen's "Xophonic" reverberation unit—ESL's improved BJ Series 90 tangential phono arm.

**N**ORELCO'S NEW "Continental" tape recorder brings some interesting constructional features into the tape recorder field and with them it brings performance that is exceptionally good for a machine intended for home use and with the consequent ease of operation not usually found in professional types of machines. But that might be expected from a Philips product.

The new unit, Fig. 1, operates by means of nine "piano key" controls—three of them (at the right) selecting the speed and turning on the power, the center three providing STOP, FAST FORWARD and REWIND functions, while the three at the left control the running of the machine. The left key is for PLAYBACK, the next, with an auxiliary protection button, is for RECORD, and the third is for momentary stop.

When the high-impedance dynamic microphone is plugged into the jack on the left of the top panel, the radio/phono input is disconnected. The latter input is located on a recessed panel at the left side of the case, which also mounts the two output jacks—one at high impedance and one at speaker impedance which cuts out the local speaker, a 5-inch twin-cone unit.

The recorder is provided with a program indicator, which is belt-driven from the supply reel. The level indicator for recording—and serving also as a pilot light—is a magic-eye tube with a fan-type pattern. The machine operates at three speeds— $7\frac{1}{2}$ ,  $3\frac{3}{4}$ , and  $1\frac{7}{8}$  ips—and records on the international standard, with the top track in use as the tape moves from left to right.

The tape handling mechanism is quite ingenious, using the same principle as the 3- or 4-speed record changer. The motor

shaft is stepped, and speed is changed by causing an idler to engage the large flywheel and the section of the shaft with the proper diameter at the same time. All of the drive mechanism seems unusually sturdy, and operation in all speeds and for both fast forward and rewinds is smooth, as is braking, which is sufficiently gentle that it does not damage "double-play" tape. One indication of the quality of construction may be observed in the slowing down of the flywheel when power is turned off—by actual timing, the flywheel "coasts" for 2 minutes and 44 seconds after power was turned off from a running

speed of  $7\frac{1}{2}$  ips.

The holdback takenup mechanism drives from a single belt on the motor shaft, and in the OFF position tension on the belt is released. Felt discs under the reels provide variable holdback and takenup tension depending on the amount of tape on the reels, and in the fast positions the drive is augmented by friction against rubber pads. Rewind time is just slightly under two minutes for a full 1200-foot reel.

The case is provided with a top which is attached by means of separable hinges, and provides storage space for two reels of tape (in addition to an empty reel and



Fig. 1. The new Norelco "Continental" three-speed tape re-

Fig. 2 (left). Performance curves for the Norelco "Continental." At the top is response from a standard tape, while the three lower curves show the playback output after recording from a constant-level signal input at the three speeds. Fig. 3 (right) Comparison of high-impedance output—which is unaffected by the tone control—and the output at the speaker jack with limiting values of tone-control action.

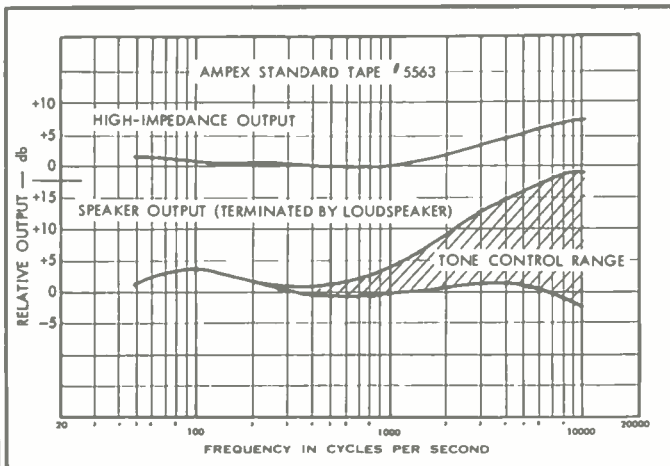
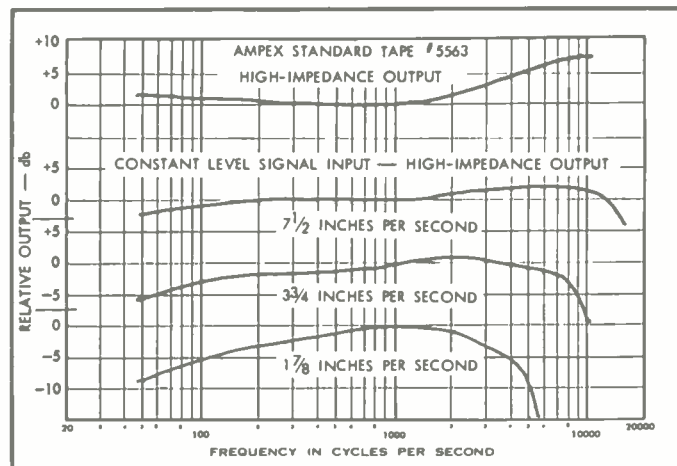



*forget turntable taboos*

## WEATHERS TECHNICAL MAGIC IS SOUND

Mystified by the gadgetry which attempts to charm turntables into proper balance, speed and smoothness? Weathers' revolutionary "Synchronomatic Drive" Turntable is truly *sound*. Only the record separates you from the perfection of sustained pitch! A small synchronous motor and an ingeniously designed bearing spin your records effortlessly and soundlessly... at ever constant speed. Weathers' *technical magic* has created a feather-weight turntable that is impervious to shock and the heaviest floor vibrations. A *plus* feature is a specially designed turntable pad which "floats" your records free of surface contamination.

Weathers new turntable operates at exactly 33 $\frac{1}{3}$  rpm on a 60 cycle power source. An electronic control is also available for continuous variable speeds from 10 to 80 rpm.

*Weathers amazing, revolutionary "Synchronomatic Drive" Turntable is worth a special trip to your dealer's today! Only \$59.95*



*A new free Weathers booklet is available to help you select your high fidelity components. Write for it today!*



# *Weathers*

WEATHERS INDUSTRIES  
DIVISION OF ADVANCE INDUSTRIES, INC.  
65 E. GLOUCESTER PIKE, BARRINGTON, N. J.

Export: Joseph Plasencia, Inc., 401 Broadway, N. Y. 13, N. Y.

a full one on the machine itself) as well as for the connecting cables. The power cord is stored in a compartment in the bottom cover, and a hinged door provides suitable protection when the cord is rolled up.

### Performance

Performance curves are shown in *Figs. 2 and 3*. The top curve in *Fig. 2* shows the output at the high-impedance jack from a standard Ampex #5563 tape at 7½ ips. This was measured using a 1-megohm termination and a low-capacitance connecting cable. With some rolloff set into the external playback amplifier, response would be completely flat up to the limits of the standard tape—10,000 cps. The three lower curves of *Fig. 2* show the output at the high-impedance jack for tapes made with constant-level signal inputs to the radio/phone jack at all three speeds, the signals being fed from a 600-ohm source.

The top curve of *Fig. 3* is the same as of *Fig. 2* and is shown for comparison with the output at the speaker jack, using the speaker itself at a termination for the amplifier—the latter being shown in the lower portion of the figure. The tone control affects only the speaker output, raising the output at 10,000 cps by some 20 db—making the output at 3¾ ips at the speaker jack almost flat up to 10,000 cps, while at 1¾ ips the output is relatively flat up to 5000 cps. The boost in the vicinity of 100 cps in the speaker-output curve is likely due to the resonant peak in the speaker load used during the measurements, as this hump does not appear when feeding into a resistance load.

No measurements of flutter were made, since it was not noticeable at all at the 7½-ips speed, which is a fair indication that it is below 0.25 per cent. Specifications for the unit indicate 0.2, 0.3, and 0.35 per cent for 7½, 3¾, and 1¾ ips respectively.

Physically, the recorder measures 15¾ by 13 by 8 inches, and it weighs approxi-

mately 30 pounds. As a portable machine for general use, the Continental is capable of excellent quality at 7½ ips, very good quality at 3¾ ips, and even passable quality on music at 1¾ ips, although we would prefer to use it for voice only at the lowest speed. On the whole however, we would classify it as an exceptionally good tape recorder in all particulars. **L-14**

## WHARFEDALE THREE-WAY SPEAKER SYSTEM—“WARWICK” AND “WINDSOR”

These two speaker systems represent a new approach to “enclosure” construction, since they are only enclosures in the sense that they provide a housing on which the speakers can be mounted—the backs of both models are open.

Designed by Gilbert A. Briggs, these models are relatively inexpensive when one considers the quality of performance. Three speakers are mounted in these cabinets, a 12-inch unit at the center near the bottom, a 10-inch above and to the left, and a 3-inch tweeter to the right of the 10-inch speakers. In the Warwick model—the less expensive—the 3-inch cone faces forward, while in the Windsor, *Fig. 3*, consists of the Warwick, *Fig. 3*, with a rectangular framing around it for the sake of appearance. Both employ a sand-filled baffle which damps all vibration very effectively. And with no cabinet to speak of, there can be no “cabinet resonance.”

The speaker and the housing were designed for one another, and neither speakers nor the baffle are available separately. The speakers employ plastic foam suspension, cast baskets, and the usually high flux density encountered in all Wharfedale speakers. No dividing networks—which are claimed by some to introduce their own forms of resonance—are used, the low fre-

quencies being excluded from the tweeter by a series capacitor. The bass resonance on the Windsor model observed was measured at 33 cps, and while no absolute output measurements were made, output up to 21,000 was definitely measurable.

The principal quality of this system is in its pleasant listenability. At first it might appear to offer nothing unusual in the way of quality, but it is the sort of sound reproduction which grows on one. It is never strident, and for this reason does not make the flamboyant impression on the listener that is usually encountered in an audio show. On the other hand, we have long insisted that while audio shows may be criticized for the quality of sound—along with the general loudness level—people just won't come into a room unless the sound is on the spectacular side. And we have always been willing to bet that the listener who takes home on the the more spectacular speakers will tire of the super-highs and super-lows quality within a few hours of listening.

Such is not the case with either of these models. When the speaker was first received, it was connected up to the office system, and—except for being taken out for a weekend to compare it in better known listening areas—it has been running practically all day long every day. It is for this reason that we can unqualifiedly recommend these models for their excellent listening quality—particularly for those who want to get away from the point-source quality of sound. Neither of these models is ever likely to be accused of causing “listening fatigue”—that elusive, but often present characteristic of some loud-speaker systems.

One of the unusual features of the reproduction quality of these speakers is that they are relatively unaffected by their position in the room, and the sound output appears to be about the same whether they are against a wall, in a corner, or free standing. Because of this quality, they are especially suited for use in pairs for a stereo system. **L-15**

The two new Wharfedale 3-way speaker systems: *Fig. 4* (left) shows the “Windsor” de luxe model while *Fig. 5* (right) shows the less expensive “Warwick” model. Both employ the same Components mounted on a sand-filled baffle, and both are open at the back.

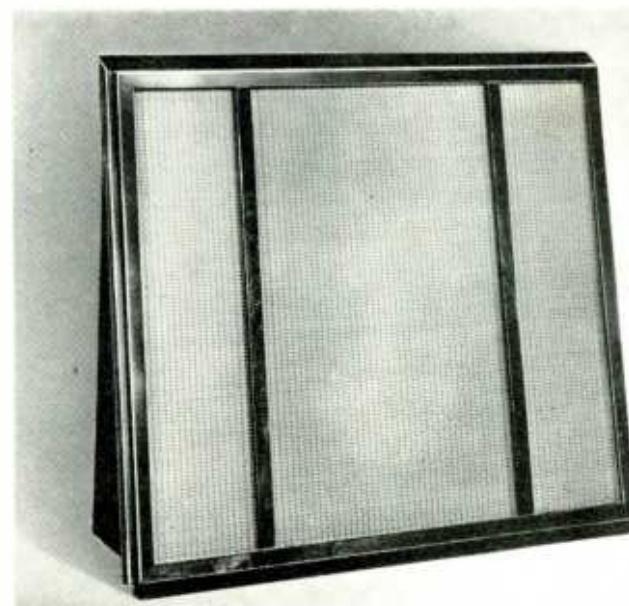
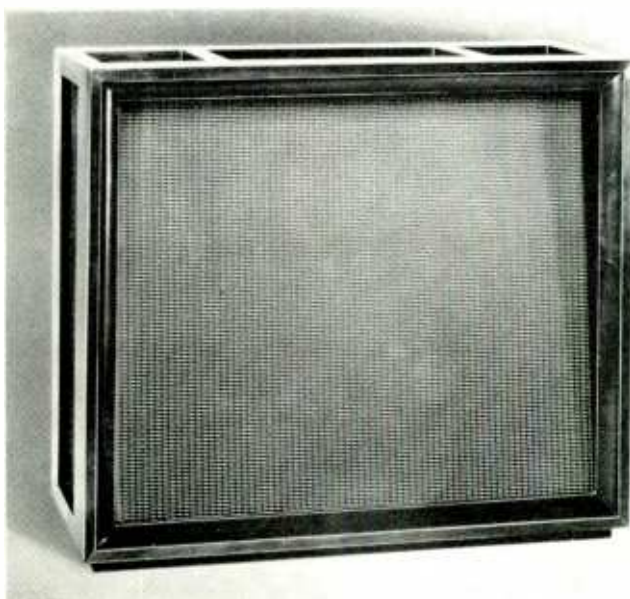



# ALTEC®



## SPEAKER COMPONENTS

*designed for the most natural...  
most faithful sound reproduction*

ALTEC LANSING speaker components exemplify the ALTEC tradition to give the most faithful reproduction of sound obtainable through the most natural means.

ALL of these ALTEC high frequency horns are of the sectoral, exponential type which provides a clear, mathematically calculated flow path to direct the sound waves into the proper distribution pattern without interfering with their natural propagation in the air. These sectoral horns provide efficient distribution control at all frequencies, unlike diffusion and other types which have wide distribution at the lower frequencies and become extremely directional and inefficient in the higher ranges.

These sectoral horns and their associated driving elements represent the only true method for obtaining high efficiency, full dynamic range, smooth frequency response and wide, regular distribution of high frequency sounds.

Have the pleasure of listening to a two-way speaker system of ALTEC LANSING speaker components at your dealer's. If your ear is in tune, you'll take ALTEC home.

### HORN 511B

This new ALTEC high frequency horn is the finest available for home use. When used with the ALTEC 802D high frequency driver the 511B gives amazingly smooth response throughout the range from 500 to 22,000 cycles, one-half octave above the range of the human ear. The ALTEC 803 bass speaker, either singled or paired, is recommended as a bass component for use with this horn. The 500D dividing network is needed to complete this system.

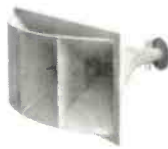

**PRICE: \$36.00**

### 811B HORN

This superb ALTEC horn is identical in design concept and quality with the 511B but is smaller and has a frequency range from 800 to 22,000 cycles. The 811B with the 802D driver can be used with the ALTEC 803A bass speaker or with the 415A Biflex to extend this wide range speaker to a full 22,000 cycle system.



**PRICE: \$27.00**

### HIGH FREQUENCY DRIVER 802D

Designed specifically for use with the 511B and 811B horns for smooth 500 to 22,000 cycle high frequency reproduction.

Power: 30 watts; Range: 500-22,000 cycles; Impedance: 16 ohms; Magnet Weight: 1.3 lbs



**PRICE: \$57.00**

### 3000B HIGH FREQUENCY SPEAKER AND NETWORK

This newly developed high frequency speaker and horn used with the 3000B network is the ideal unit to extend the range of the ALTEC 412A and 415A Biflexes or of any efficient 12" or 15" cone speaker to a full 22,000 cycles. The dividing network separates high and low frequencies at 3000 cycles, crossing over at a smooth 12 db per octave curve.

Speaker—Power: 20 watts; Impedance: 8 ohms; Range: 3,000-22,000 cycles

**PRICE: \$39.00**

Network—Impedance: 8 ohms; HF Attenuation: 10 db continuously variable; Crossover: 3000 cycles

**PRICE: \$21.00**



### 500D

#### DIVIDING NETWORK

For use with the 802D h.f. driver and 511B horn. Has smooth 12 db per octave slope and detented high frequency shelving control designed for external mounting with 4 steps of 1½ decibels each for precise adjustment to individual rooms.

Impedance: 16 ohms; HF attenuation: 6 db, 1½ db steps; Crossover: 500 cycles

**PRICE: \$54.00**

### 803A

#### BASS SPEAKER

The 803A is used as the bass component in many of ALTEC's larger theatre speaker systems. Since it is intended for use with the 802D high frequency driver and either the 511B or 811B horn its efficient frequency range is limited to 30-1600 cycles. This 1600 cycle upper range assures a smooth crossover at any frequency up to 800 cycles. As a result the 803A has a bass performance far superior to that of loudspeakers designed to operate over a wider frequency spectrum.

Power: 30 watts; Impedance: 16 ohms; Range: 30-1600 cycles; Magnet Weight: 2.4 lbs

**PRICE: \$60.00**



### 800E

#### DIVIDING NETWORK

Has the same characteristics as the 500D but with 800 cycle crossover for use with the 811B horn and 802D h.f. driver.

Impedance: 16 ohms; HF Attenuation: 6 db, 1½ db steps; Crossover: 800 cycles

**PRICE: \$42.00**



# ALTEC®

LANSING CORPORATION

#### ALTEC LANSING CORPORATION

1515 S. Manchester Avenue, Anaheim, Calif.

161 Sixth Avenue, New York 13, N.Y.

Write for free catalogue Dept. A11-A

Ad #12-11

## RADIO CRAFTSMEN'S "XOPHONIC" REVERBERATION UNIT

When we first read about this device prior to publishing the story about it in the September issue, we were slightly skeptical about its ability to do all that was claimed for it. Having the curiosity of the proverbial cat, we requested one for examination and in due time it arrived. Like the small child with a new toy, we could hardly wait to try it out.

Suffice that we did get it in operation about 11:00 p.m. one evening and had one of the more pleasant surprises of our long—and in many ways, dull (though not all)—life. Turning the Xophonic on with our eyes shut, the walls of the room seemed to recede about 25 feet on all sides. In short, the room just about doubled in size.

The Xophonic reverberation unit, Fig. 6, resembles one of the conventional bookshelf speakers, except that it has a control and a pilot light on it, and in addition, a 10-foot cord extends from it and terminates in a pendant switch. This switch is in series with the driver unit and a resistor, located in the unit, and a line connecting to an existing speaker. When the switch is closed, the driver unit in the Xophonic is thus connected across the speaker line in series with a resistor (7.5 ohms) so as to avoid loading the speaker circuit. The driver unit—which, in the model we had was simply a 2-inch speaker—was coupled by means of a fibreboard funnel to a 50-foot length of plastic tubing about  $\frac{3}{4}$  in. outside diameter. At the other end of the tube, which was coiled around a compartment left for the unit's 6x9 speaker and a small AC-DC amplifier, the earpiece of a crystal hearing-aid receiver was inserted. All of the parts were held in place with masking tape, and both speaker and receiver were well insulated with rock wool batting. The output from the receiver was fed to the amplifier, which was connected to the speaker.

The 1/20 second delay caused by the sound passing through the length of the tube is sufficient to create the illusion of a listening room much larger than the eyes



Fig. 6. Radio Craftsmen's "Xophonic," an artificial reverberation unit to increase the effective size of the listening room.

tell us it is. Granted that the frequency response of the system was not particularly flat nor of extended range, the effect was still there. It is not good on speech, as would be expected, but on music the effect is most interesting and, often, delightful.

The entire system caused us to go back to May, 1948, issues of *AUDIO ENGINEERING* to refresh our memory about a reverberation unit described by D. W. Curran, then of KFI, Los Angeles. He used a similar principle multiplied by four—with tube lengths of 25, 50, 75, and 100 feet, and with the 100-foot delayed signal fed back in adjustable amounts into the driver unit again, thus giving a wide range of reverberation time with complete control. He used 1-inch aluminum tubing, broadcast microphones, and high-quality driver units, and equalized the response up to some 8000 cps. Very interesting, and for those inclined to experiment it gives an idea of where to begin.

For those that aren't, however, the Xophonic serves a similar purpose with considerably less effort. We like the effect very much. L-16

## NEW BJ PHONO ARM

When we reviewed the original BJ arm (April, 1955) we presented a diagram that we had made for our own edification to show just how the arm worked. By this diagram we showed ourselves that the arm did just what it claimed—it held the pickup cartridge in a position which was at all times tangent to the groove at the point of contact. While it is possible that the graphical diagram may not have been entirely accurate, it still showed that the maximum deviation from tangency from a radius of 6 inches to a radius of 2 inches was not over 2 deg., and that only at the extremities. Between radii of 3 and 5 inches, there was no deviation whatever.

The new Super 90 has all the advantages of the earlier model, and in addition has readily adjustable counterweights, plug-in cartridge shells—two being supplied with each arm—and a movable base which permits a slight adjustment to compensate for the position of the stylus in the shell, although this dimension is supposed to be standardized.

The new arm is of vastly improved finish, both in the molded plastic parts and in the satin-finished anodized aluminum tubes. Bearings consist of tiny balls which seat adjustably into steel inserts in the aluminum arms, resulting in greater freedom of movement—a desirable feature because of the use of the four pivot points, two on each of the tubes. Vertical pivot bearings are similarly adjustable, as is the height of the support tube.

The Super 90 is now available in two lengths—12 $\frac{1}{2}$  in. over-all for use with up to 12-inch records, and 14 in. over-all for use up to record diameters of 16-inches. The shells will accommodate practically any cartridge, and they are provided with a removable plate on top for use with cartridges of the GE type, and with a thin section at the front which may be cut out readily with a knife for use with turnover cartridges actuated by a knob at the front. The counterweights permit more than adequate adjustment for any currently available cartridges, and with two different lengths of tubes employed, resonances are claimed to cancel out. The new model is a distinct improvement over the original.

L-17



Fig. 7. The new BJ "Super 90" tangential phono arm offers a number of novel features.

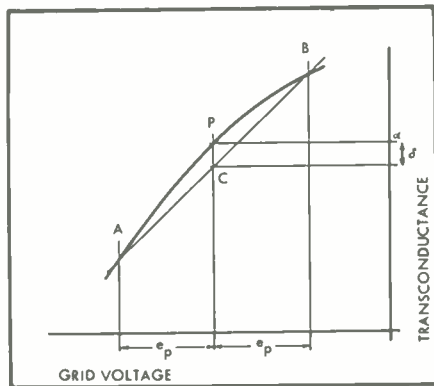

Fig. 5. From the deviation of the transconductance curve from a straight line—the chord AB—we can find the third harmonic distortion.

viously, the third harmonic.

The transconductance curve contains information about this third harmonic. I am not going through the mathematics in detail, because it is rather lengthy and can be regarded as an exercise for the enthusiast. The practical result requires us to refer to the idealized characteristic of Fig. 5. Having chosen our working point P and the maximum signal amplitude  $\pm e_p$  we draw the chord AB across the transconductance curve. At P the transconductance is  $\alpha$ . We measure the distance PC which we call  $\delta$ . For any input of less than  $e_p$ , say  $e$  volts, the third harmonic distortion is

$$\frac{3\delta}{\alpha} \cdot \left(\frac{e}{e_p}\right)^3$$

I am not going to apply this to the curves of Fig. 4, because it takes pretty accurate drawing. Looking back to our second harmonic expression  $g/4a$  we see that if  $\delta = g/12$  the second and third harmonics will be equal. You need to look pretty closely to check on the third harmonic.

I think we can now get a rough idea of when local feedback will really be profitable. Most tubes tend to have transconductance characteristics which sag below the straight line I have been drawing so glibly. A little cathode feedback produces a curvature in the opposite direction. By careful choice of the cathode resistor you can get a pretty good linear characteristic and then, going push-pull, balance out the second harmonic. I remember that this worked out very well indeed with the 5763, though I have no figures at hand now to show the improvement.

Some readers may feel that all this is just a paper exercise. Maybe so, if you can afford to buy the wrong tubes. But if you want to get the best performance out of something you design yourself it is worth-while to sit down for a few hours and think before you put your money on the counter. **Æ**

## PATENTS

(from page 4f)

use the goods, machinery, supplies or other commodities of a competitor or competitors of the lessor or seller, where the effect of such lease, sale or contract for sale or such condition, agreement, or understanding may be to substantially lessen competition or tend to create a monopoly in any line of commerce."

In holding such restrictions no longer lawful or enforceable the Supreme Court said of the law as it is today, "It is not competent for the owner of a patent by notice attached to its machine

to, in effect, extend the scope of its patent monopoly by restricting the use of it to materials necessary in its operation but which are no part of the patented invention, or to send its machines forth into the channels of trade of the country subject to conditions as to use or royalty to be paid, to be imposed thereafter at the discretion of such patent owner.

"The patent law furnishes no warrant for such practice and the cost, inconvenience and annoyance to the public which the opposite conclusion would occasion, forbid it."

<sup>7</sup> Motion Picture Patents Co. v. Universal Film Mfg. Co., 243 U.S. 502, April 9, 1917. **Æ**

# AMPEX STEREO

SIGNATURE OF PERFECTION IN SOUND



takes you  
**BEYOND THE HI-FI BARRIER!**

Add Ampex Stereo to *your* system, and you've pierced the last barrier that stands between you and the long-sought goal of actually experiencing the complete realism of the original performance. Hear it once, and you'll never be satisfied with anything less.

Ampex is most-wanted because it is best-engineered. You can install this precision tape-deck in the secure knowledge that it is not only the finest equipment available *today*, but *years from now* will still be outperforming everything in the field.

In addition to the Ampex Model A124-U recorder-stereophonic reproducer shown here, there are portables, modular units, and consoles complete with their own AM-FM tuners and record changers.

## AMPEX

CREATORS OF THE VIDEOTAPE TELEVISION RECORDER; MAKERS OF AMERICA'S BEST-ENGINEERED, MOST-WANTED AUDIO EQUIPMENT



**AMPEX AUDIO INC.**  
1036 KIFER ROAD, SUNNYVALE, CALIFORNIA  
Please rush free Ampex Stereophonic Sound brochure to:

NAME \_\_\_\_\_  
ADDRESS \_\_\_\_\_  
CITY \_\_\_\_\_

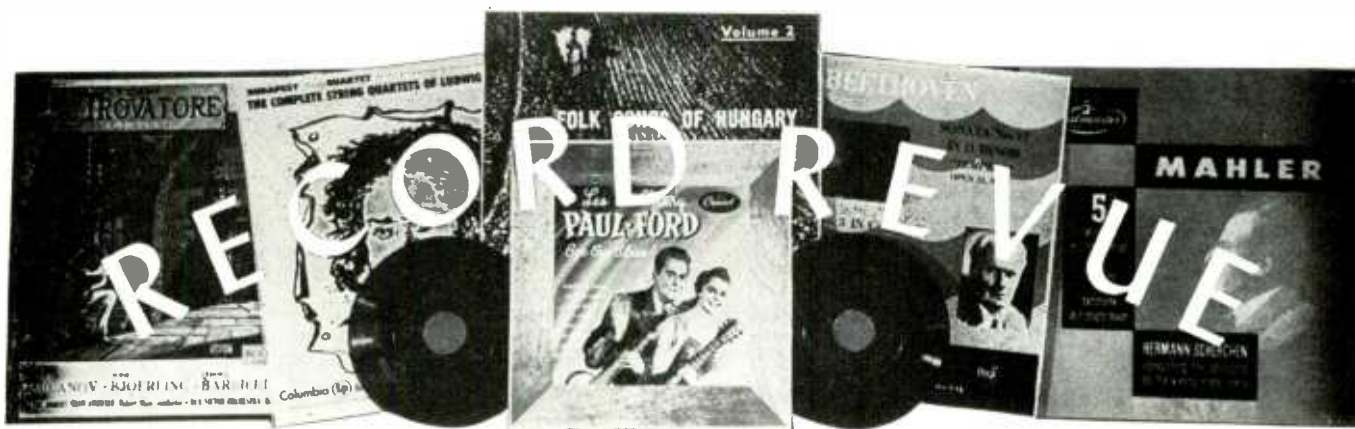

EDWARD TATNALL CANBY\*

## 1. BIG STUFF

**Brahms: Symphony #2.** Berlin Philharmonic, Karl Bohm. Decca DL 9933

This is a sweet, natural, unassuming Brahms Second, neither pompous nor over-tense but of a happy-medium cast.

Is it innate conservatism in German musical circles that allows these big Romantic works to stay alive so easily and pleasantly—where in other climates they seem more and more strained as we progress away from Brahms' own time? Well, perhaps not; but at least the music is on home ground here and can be claimed as a "natural" for German performers in a way that it can never quite be for our own.

The symphony is taken rather slowly (as compared to some of our own noteworthy performances), with much relaxation—as fits this Second—but it is not in the slightest degree heavy and it does not drag. Bright orchestral colors, clear, transparent playing, a lovely, plastic rhythm, make the whole thing a pleasure to hear.

With so many recorded versions of this music available it would be foolish to say this is "it"—but if you're looking for a new Second or would like to try it for the first time, this is a can't-lose bet. Nice, conservative hi-fi, too, as good as it comes.

**Dvorak: Violin Concerto.**

**Glazounov: Violin Concerto.** Nathan Milstein; Pittsburgh Symphony, Steinberg. Capitol P8382

The Milstein-Steinberg-Pittsburgh team is one of the very finest concerto playing combinations on records and Capitol is lucky to have it. Here, the list of concertos grows by one very worthwhile work, the Dvorak, and another, Glazounov, that is a good colorpiece for easy listening, if not much more.

The Beethoven Violin Concerto as played by these artists (Capitol P8313) is to my mind the noblest of all recorded versions, bar none, though others have their points and there can be no single, ultimate interpretation. Noblest because it achieved, between soloist, conductor, and orchestra, a higher plane of architectural sublimity than any version I can remember, without in the least sacrificing the melodic beauty and relaxation of the work. There are the Mendelssohn and Bruch concertos on still another record and Brahms on a third—all are of the same high calibre, along with this new disc.

The Dvorak concerto is for some reason seldom heard. It's a delight, of its type, and played here with splendid verve and an acute sense of the Central European style, half joyous Brahms (this was an early Dvorak), half Czech peasant dance. There is the usual impeccable teamwork here, too, and Milstein's wonderfully pure tone has his ineffably perfect sense of pitch, as always.

**Tchaikowsky: Violin Concerto.** (A) Heifetz; Chicago Symphony, Reiner.

RCA Victor LM 2129

(B) Campoli; London Symphony, Argenta. London LL 1647

There are too many recordings nowadays for us ear-weary souls to make comparisons, but these came along at the same time and curiosity got me started sampling first one and then the other. . . .

Well, old Heifetz still is king of the fiddle though Campoli, with a somewhat more impetuous approach, is not so far behind. Heifetz still can rise to higher flights of sheer technical mastery, even though there are easy passages that begin to sound very slightly tired—surely he has played this often enough to warrant it. And as for the orchestra, Argenta plays remarkably beautifully, but Reiner, too, is king of the orchestra when it comes to making clear the somewhat turgid and complicated harmonies of the big *tutti* passages in this work. As usual, Reiner's is taut, marvelously disciplined and understood, and perhaps a bit chilly, Argenta sounds more youthful and warm and the British orchestra responds with very good will.

As to sound, I must report that on quick comparison London has it all over RCA. The London orchestra is huge, immediate, impressive, on an equal with the big violin sound. RCA's orchestra is pinched and distant in comparison, and at a remarkably low volume in relation to the solo violin—which is close and dry, though faithfully recorded. Matter of style, for RCA and London have always gone these two ways, RCA for many decades. Some will still prefer the RCA solo approach and find the big London sound too stagey. Take your choice.

**Rachmaninoff: Piano Concerto #3.**

Rachmaninoff; Phila. Orch., Ormandy. RCA Victor LM 2051

RCA Victor recorded the entire Rachmaninoff repertory for piano and orchestra with the composer at the piano; this one was made in the winter of 1939-40 and is patched together from the 78 masters, with the usual large reduction in surface noise. The quality is good, considering—no highs, of course, and there is fuzziness now and then in the old 78 inside grooves, but the piano is remarkably good and the orchestra is clear enough.

What is amusing technically is the difference in mike technique between then and now. The piano is virtually at stage distance and it seems possible that there was but one mike for the session. No close-up effect at all. And, though the place is the Academy of Music in Philadelphia where a thousand more recent recordings have been made, the audible acoustics here are dry and not very live. Probably indicates no "presence" mikes, no over-all livensome mike in the background. Interesting.

Rachmaninoff's music is awfully long-winded, but his pianism is something to hear—unbelievable. There has not been a pianist with such sheer brilliance and power since.

His style of playing already sounds old-fashioned, but you'll recognize a now-familiar night club piano habit in the way he lunges forcefully at the first few notes of each melodic phrase, then dies away. It's a mannerism that has been copied a million times since!

Too bad the old man couldn't have heard himself here, joined in one piece on long-play discs. He's mighty impressive as an LP artist.

**The Sea. (Debussy: La Mer Ibert: Ports of Call.)** Boston Symphony, Munch.

RCA Victor LM 2111

Two sea-works, both French and very reasonably combined in this album, which has bound in it a series of sea pictures and quotations on the subject. (The Rachel Carson notes used on the Toscanini version of La Mer are quoted here too.)

It's a big, sensuous, sweeping recording, this of the Boston Symphony in all its majesty. The playing is smooth as silk and as perfectly coordinated as the work of a machine. How come, then, that the entire thing leaves me lukewarm? If the playing is beyond criticism, how can the performance pall?

I dunno. Might be Debussy's fault, and Ibert's; but I have thrilled to Toscanini's La Mer, even without Enhanced Sound. I can only suggest that the whole thing lacks warmth, lacks humanity—and thereby I leave myself wide open, for such things can't be explained. It's all just too perfect, too polished. (And yet I would not have it even a shade less polished. . . .)

If you want to follow my reasoning, compare this with the Monteux Stravinsky playings, below. The Monteux recordings just reek with humanity.

(P.S. in small type: the loudest parts sound a wee bit distorted to my ear.)

**Stravinsky: Petrouchka; Firebird Suite.** Paris Conservatory Orch., Monteux.

RCA Victor LM 2113

Pierre Monteux conducted the very first performance of Petrouchka, back in 1911—but even if he had not, this recording would command plenty of attention. To hear this familiar music—familiar from many recordings, broadcasts, concerts and ballet productions—done with such a vast range of new and unexpected effects, yet done so naturally, musically and with such musical enthusiasm, is really a listening experience. Old Monteux is quite a conductor.

I wonder whether this is the way it sounded that first time, almost a half century ago? In any case, this Petrouchka (complete) is taken on the slow side and with an astonishing wealth of inner detail brought out, as I never remember hearing it before. It's partly in the recording, which is ultra transparent and crystal sharp, with accurate detail in a very natural big liveness. But it's also in the interpreting—which is both Monteux and French.

For this is the kind of music Frenchmen love to play (wasn't it first performed in Paris?). Music of enormous complexity, yet

\* 780 Greenwich St., New York 14, N. Y.

<p><b>ON BOURBON STREET WITH THE phenomenal DUKES OF DIXIELAND</b> Vol. 4—Memories of Bourbon Street! The most popular requests of the patrons of THE FAMOUS DOOR from 1950 thru '55. Includes New Orleans Function, St. James Infirmary, etc. AFLP 1860</p>	 <p>ON BOURBON STREET WITH THE... <b>phenomenal DUKES OF DIXIELAND</b> VOLUME 4 A STUDY IN HIGH FIDELITY SOUND</p> <p>YOU HAVE TO HEAR IT TO BELIEVE IT!</p>	<p><b>SULTAN OF BAGDAD</b> — Mohammed El-Bakkar and the Oriental Ensemble take you to Bagdad — the city of intrigue . . . mystery . . . and romance — with exciting, sensuous Music of the Middle East. Volume 2 AFLP 1834</p>	 <p><b>SULTAN OF BAGDAD</b> Mohammed El Bakkar and his Oriental Ensemble Music of the Middle East Vol. 2</p>
 <p><b>BULLRING!</b> MUSIC OF THE BULL FIGHTING LA FIESTA Vol. 4</p>	<p><b>BULLRING!</b> — La Fiesta Brava! Vol. 4 — Exciting traditional music from an afternoon at the Bull-fights. Luxuriously packaged with four color illustrated book of Bullfight scenes. AFLP 1835</p>	 <p><b>Linda's Player Piano</b> Linda Carillon Berry and her Player Piano</p> <p>A STUDY IN HIGH FIDELITY SOUND</p>	<p><b>LINDA'S PLAYER PIANO</b> A charming little girl at her Player Piano. Old-Time favorites as played (or pumped) by Linda Carillon Berry. Includes: Alexanders Ragtime Band, South Rampart Street Parade, etc. AFLP 1846</p>
<p><b>RAILROAD SOUNDS . . .</b> Steam and Diesel — Lend an ear to some of the most thundering, earth-shaking sounds ever recorded! Here, in dazzling Hi-Fi, are the romantic, nostalgic sounds of the railroads of yesteryear—Sounds of a Vanishing Era! AFLP 1843</p>	 <p><b>RAILROAD SOUNDS</b> The Sounds of a Vanishing Era STEAM AND DIESEL</p> <p>A STUDY IN HIGH FIDELITY SOUND</p>	<p><b>TROPICAL CRUISE</b> — A "potpourri" of Latin tempos to fill your sunbeam days . . . your star-filled nights, played by Pedro Garcia and the Del Prado Orchestra. Includes: Quireme Mucho, Rico Mambo and Begin the Beguine, etc. AFLP 1841</p>	 <p><b>TROPICAL CRUISE</b> Pedro Garcia and the Del Prado Orchestra</p> <p>A STUDY IN HIGH FIDELITY SOUND</p>

# AUDIO FIDELITY

the highest quality records ever made!

Whether you're a musical connoisseur, hi-fi expert or you just plain enjoy good music . . . AUDIO FIDELITY TFRR\* brings you unsurpassed sound reproduction — with startling clarity and brilliance, purest definition, widest dynamic and frequency ranges

Here are some of the most earth-shaking sounds and musical effects ever recorded! . . . and the Fi is *fantastically* high! These are not just records . . . each is a wonderful emotional experience.

recorded in brilliant High Fidelity Sound . . . \$5.95 each 12 inch LP



**AUDIO FIDELITY INC.**  
770 ELEVENTH AVENUE • NEW YORK 19, N. Y. • CIRCLE 7-5533

\*total frequency range recordings

<p><b>LEON BERRY ON THE GIANT WURLITZER PIPE ORGAN</b> Vol. 2—Favorite "Pop" standards on the most brilliant Theatre Organ in the Western Hemisphere. AFLP 1829</p>	 <p><b>GIANT WURLITZER PIPE ORGAN</b> Vol. 2 <b>LEON BERRY</b></p>	<p><b>AMERICAN MILITARY MARCHES</b> — Let's go to a parade! America's most famous marches brilliantly and excitingly performed by the <b>BANDA TAURINA</b>. AFLP 1836</p>	 <p><b>AMERICAN MILITARY MARCHES</b> Banda Taurina</p>
---	---	---	---

ultra-transparent, full of fabulous virtuoso orchestral solo parts, and notably the razor-edged woodwind and brass effects that have always been a French speciality. This is old home week for these Frenchmen, including Monteux himself, and they obviously take delight in bringing through everything that can be made to sound—which, the music being Stravinsky, means every last note.

A lot of changed emphasis in various spots may surprise some listeners; it is mostly a consequence of this passionate interest in the innumerable inner byplays of the complex score. The big moments are less prominent, the obvious tunes less obvious, the myriads of little canons, duets, trios, very much played-up and the tricky orchestral effects performed each one to the hilt.

The Firebird Suite gets an analogous treatment, equally arresting but different; here, Monteux speeds things up, where older performances unmercifully flogged the old-gray-mare climaxes of the big, juicy tunes, left-overs from an earlier era. This was young Stravinsky and, as Monteux hears it, the significant parts of the score were the new and unusual modernisms; these he brings forth, and he plays down the sentimental parts with reason and restraint. Big improvement, I say, and the piece sounds as modern as Petrouchka. It's as hi in the fi, too, for the more modern approach.

**Vienna (Waltzes by the Strausses, Weber). Chicago Symphony, Reiner.**

**RCA Victor LM 2112**

Well, yes—it's true that Fritz Reiner did conduct in Vienna 'way back, as it says here, and that some members of the Chicago band are Viennese-trained. But my ear says that maybe this isn't quite as Viennese as the notes would make it. No great matter, to be sure, for Reiner is a potent and precise conductor who wastes nobody's musical time. But I'd say these were cranked-up Viennese, about 20 per cent higher in tension than anybody in Vienna would ever play them. That's Reiner, and you can still enjoy them to the full, if not more.

The range covers the Blue Danube (of course), the lovely Village Swallows, the Emperor, and that odd one, Morning Papers, plus a very fine playing of Weber's "Invitation" and an equally nice version of the Richard Strauss Rosenkavalier waltzes. Big, live sound and hi fidelity.

**Stravinsky: Le Sacre de Printemps. Paris Conservatory Orch., Monteux.**

**RCA Victor Stereo Tape ECS 67**

This one I listened to in the stereo tape form. (Check with your dealer as to which RCA releases are available in which form—the company hasn't sent us a cross-indexing yet.) It makes a perfect third to the two early Stravinsky works above—Petrouchka and Firebird—and has the same probing, highly musical aural penetration into the details of a complex score.

Le Sacre can be a pretty rough piece and is often so played. (Cf. the Mercury recording with Antal Dorati.) True, the subject matter and the expression were scandalously wild and woolly in 1913 and can still do a bit of mild shocking today. Yet, as you might guess, old Papa Monteux, in his eighties, is able to make this score more musical, more interesting as an orchestral *tour de force*, than any recent version I can think of and without sacrificing any of the legitimate drive and fury of the music. This, then, is the version for you if you have a hankering to hear more musical sense out of these rites of springtime in Russia. It's a glorious stereo, too.

**Shostakovich: Symphony #7 ("Leningrad"); Symphony #1. Leningrad Philharmonic, Mravinsky.**

**Vanguard VRS 6030/1 (2)**

There was a tremendous fuss about the "Leningrad" Symphony when it first came out; conductors practically fought over it and, as I remember, somebody put out an enormous white-elephant of a 78 rpm album of it, weighing around fifty pounds. The fuss was under-

standable considering the times and the situation. Now, a good while later, the huge symphony sounds pretty tame. Just more Shostakovich—and more and more and more; the thing is just too long for any coherent grasping of structure. One can always suggest that "parts of it are nice," but this surely damns it with faint praise. In short, I opine that it would make a reasonable and interesting symphony at one half the length or maybe a third.

Incidentally—to my amusement I suddenly recognized the passage which Bartok makes ribald fun of in his well-known Concerto for Orchestra; I had been told by Peter Bartok that the quoted passage (with the hyena instrumental laughs after it) came from Shostakovich—but I didn't know where. It's the main theme of a huge, cumulative march-of-war here, intended to be solemn and terrifying. I'm afraid that Bartok, sensitive musician that he was, just didn't think it musically up to its grisly task of war-depicting. I don't either, and that goes for the rest of the symphony.

I've always thought Shostakovich's First, with its odd, quizzical, chicken-like themes at the beginning, was his most original and best symphony; I still think so. It's long, but long within bounds, and it said remarkable things for a composer in his teens. This is a singularly unhumorous playing of it, as though the shadow of the later symphony had turned the earlier one's bright melodic colors to wartime gray. Nothing wrong with the Russian recording at all. They're doin' fine these days.

**Hoffnung Music Festival Concert. Gerard Hoffnung, assorted players.**

**Angel 35500**

This was a musical spoof to end all spoofs, presented (Nov. 1956) in the Royal Festival Hall in London to a huge audience, played by a symphony orchestra and various celebrated soloists—the horn player, Dennis Brain, for instance (solo on a vacuum cleaner tube)—and it practically split the British musical gut for good and all. Judging by the recording, people laughed until they could laugh no more.

Well, I suppose I'm a humorless old so-and-so, but I found it, at least in recorded form, only occasionally really funny in a musical way. The rest seemed to me to be corny and overblown, the musical jokes not very good and, indeed, rather amateurish. The whole thing has that atmosphere of hysterical hilarity that goes with our own Christmas-vacation office spoofs and the high school take-offs that grace our holidays every year, when everybody is ready to laugh his head off at any old thing, regardless, until the laugh-muscles ache and you wish it were all over. . . .

I'm critical, I suppose, because this was a Big Thing and involved top British musicians and compositing talent. Surely, the musical take-offs are cute and tricky, but not enough so. A piano concerto that combines Gershwin, Tchaikovsky, and Rachmaninoff in one piece is uproarious for a few moments, but goes on and on and on, to no great musical point, funny or otherwise. Too much of a muchness. A couple of very slight references to an amateurish sort of Latin-American rhythm provoke absolute howls of glee from the audience, as though this were something extraordinary. Where do these Britishers live—in a vacuum?

The vacuum cleaner tube solo (speaking of vacuums) is fine, as much of it as can be heard, and an even better item involves several doughty ladies who turn on and off vacuum cleaner motors, in various keys. A group of tuba players who produce grunting ("hopin are sure fire, for a while. A musical take-off of the Haydn "Surprise" Symphony starts positively brilliantly with some excruciatingly twisted changes of key—but peters out into silliness and longwindedness. So it goes.

What gets me about all of this is its sterile, old-fashioned quality, out of the 'Eighties maybe, but unintentionally. A lot has happened in music since Sir Arthur Sullivan (who wrote *real* musical satire) but you wouldn't know it here. There are surely dozens of British composers, not necessarily classical, who could write rings around any of this pretentious stuff any day. The lowliest jazz player in high school could improvise a better piece on any of these ideas (Auld Lang Syne,

etc.) than these self-consciously arch bits of written-out humor.

Real musical satire—really funny—must always be good music in itself as well as clever take-off. It always has been, whether by Orlandus Lassus, Mozart, or Anna Russell. I am fairly sure that anybody with a musical ear—jazz or classical—will find this disc quite side-splitting for a once-through and decidedly boring thereafter. No modern spice.

## 2. INTIMATE

**Schubert: Sonata in A, Op. 162; Sonatas #1 in D, #3 in G Minor. Jos. Fuchs, violin, Arthur Balsam, piano.**

**Decca DL 9922**

This recording of more Schubert for piano and violin overlaps the Martzy-Antonielli disc in one work, the first Sonatina. These two players are crackerjack artists—see Balsam below in Beethoven—and their Schubert is powerful. But it comes out too much like Beethoven—there is a curious lack of that feminine quality that is so vital to Schubert. This Schubert drives ahead, and in those parts which suit the drive it is excellent, as in the quite fierce beginning to the third Sonatina, in G Minor, or the jolly scherzo of the same work.

But, even so, there is an unbecoming hardness that is the more apparent when the comparison is made with Johanna Martzy's much gentler approach. And another fault, for my ear more serious, is a curious disregard for those extraordinary sudden modulations to distant keys that abound in Schubert—these men play them as though they weren't even there. Nothing so insults the true Schubertian ear! (But, then, such greats as Rudolph Serkin show the same odd quirk. It's quite common.)

Even so, on straight points this comes out a good recording that stresses the strongest element in the composer.

**Beethoven: Works for Cello and Piano. Zara Nelsova, cello; Arthur Balsam, pf. London LLA 52**

A very satisfying cello recording, this, and your first feeling I think, will be that here is cello music played for "everybody"—not merely for that specialized tribe, cello lovers! This is first of all good Beethoven—the best. There are none of those trade-tricks that mark the virtuoso cellist in his show-off moments; Nelsova plays beautifully, musically, and in style. Beethoven style, not cello style. Arthur Balsam is an excellent Beethoven player and sensitive accompanist. And as important as all this, the "frrr" engineers have balanced the two instruments perfectly, with an exactly equal impact, in the usual "frrr" warm liveness.

If you have tried the above violin recording with piano somewhat in the background, you'll be interested in this job, which has the ideal solo-piano balance for the type of music. And, I should say hastily, this cello music of Beethoven, played so warmly, is well worth anybody's musical time. Four Sonatas and three sets of Variations.

**Schubert: Sonatinas for Violin and Piano #1 in D, #2 in A Minor. Johanna Martzy, Jean Antonietti. Angel 35364**

There's no music so disarmingly touching as these medium-size works of Schubert—such marvelously fresh, warm melodies, such scintillating piano. What an honest, real, straightforward person was Schubert! No pretence, no bombast, no self-consciousness (not even as much as Beethoven)—just pure musical expression, which means pure human expression.

This is one of a recorded series that will take in all the Schubert music for violin and piano. The playing is thoroughly fresh and musical at all times and a pleasure to hear, though I have some very slight reservations. Miss Martzy's violin technique is of a sort not very common, in these days of mechanical perfection, a strong rather nasal and somewhat unsteady sound, very human and expres-

(Continued on page 99)

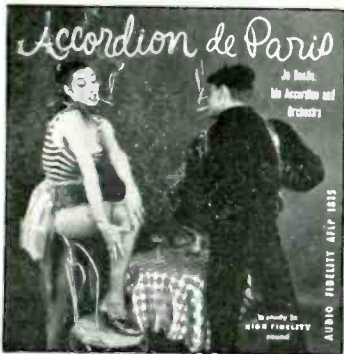

AFLP 1815

AFLP 1830

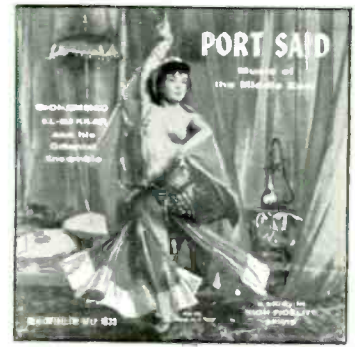

AFLP 1333



AFLP 1838

AFLP 1837

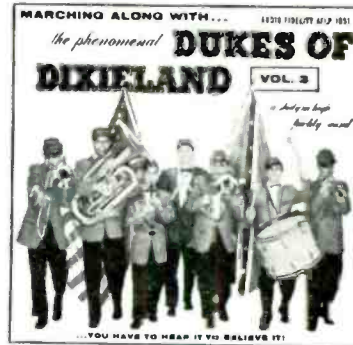

AFLP 1851

the finest in *HIGH FIDELITY* Sound...

# AUDIO FIDELITY

TOTAL FREQUENCY RANGE RECORDINGS

AFLP 1824

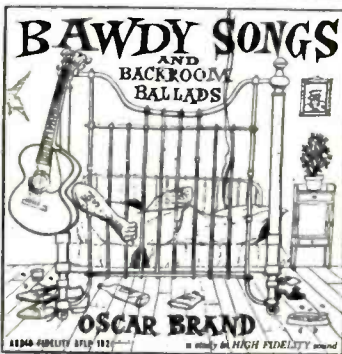

AFLP 1814



AFLP 1825



AFLP 1821

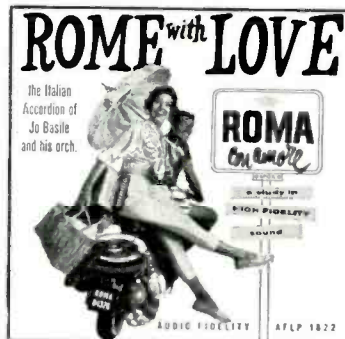

AFLP 1822

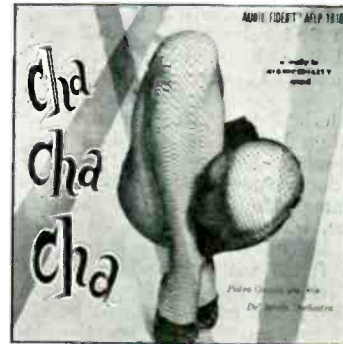

AFLP 1810



AFLP 1801

in Brilliant  
High Fidelity Sound  
\$5.95 each 12 inch LP

## AUDIO FIDELITY INC

Nationally Distributed by:  
DAUNTLESS INTERNATIONAL  
766 Eleventh Ave., New York 19, N. Y.  
Write for FREE Catalog





CHARLES A. ROBERTSON\*

### Primitive Piano

Tone 11P

A composite effort by several enthusiasts who believe it important to search out and conserve examples of early blues piano, a fast-vanishing folk art form native to the United States, is represented on this album. Four of its legendary practitioners, none of whom has appeared on a record date since 1938, are heard in the numbers made under home-recording conditions. One of them, the "ear player" Doug Suggs, long a resident of Chicago's South Side and an early associate of Clarence Lofton and Jimmy Yancey, is previously unknown except through respectful mention by men who played with him in the twenties.

The task of tracking them down and enlisting the aid of other jazz historians fell largely to Erwin Helfer, a student at Tulane University, who also teaches in secondary school during the school year. He plays barrelhouse piano in any odd moments and has occasionally found a place in a group headed by trumpeter Punch Miller. This gave rise to a determination to record some of the early blues pianists. All the production problems of preparing a first release by a small company, based at his home at 234 Maple Hill Road, Glenocoe, Ill., were undertaken by him.

Like Frederic Ramsey, Jr., who has done field recordings in the South on a Guggenheim Fellowship, Helfer feels this is a job to be done immediately or it will be too late. James Robinson, one of the men on this disc, was born in 1903, he notes, and is no longer among the living. He hopes that funds will be made available to the Institute of Jazz Studies for such work, or that some university will be encouraged to conduct research into the origins of jazz. Until that time he sees a large area, untouched by the commercial record companies, open to the knowledgeable amateur willing to explore it with a tape recorder.

Rufus Perryman, better known as "Speckled Red," is the most recently recorded of the four, having received \$125 for a day's work in 1938 when Walter Davis took down a series of sides for Bluebird. Now sixty-five, he was located working as a porter in St. Louis, through Dick Allen and Bob Koester. A session was set in the home of John Phillips, and taped by Helfer on a newly-acquired Concertone 1601 and a Shure unidirectional microphone. A good piano and a well-

damped room help as Red plays and sings *Dad's Piece*, *Early in the Morning* and *Oh, Red*, all his own compositions. His voice has taken on a trace of hoarseness over the years, but his touch is as sure as ever.

James Robinson, known as "Bat the Hummingbird" from his habit of humming during a blues, was found in St. Louis and recorded at the St. Louis Jazz Club by Ralph Hitt. The only one not self-taught, he received instruction on piano and drums from his father. Some of his now unobtainable records appeared on Vocalion and Gennett and he played drums with Louis Armstrong at the Sunset Cafe. He is heard in *Four O'Clock* and *Bat's Blues*, which are a splendid instance of the type of showpiece such pianists carried in their repertoire to display their individual blues feeling and pianistic prowess.

That such numbers were passed from hand to hand, always with credit given to the originator, is shown by Doug Suggs on *Sweet Patootie*, a number he introduced to the Chicago men after picking it up from its composer Doug Brown. His firm left hand is also heard in *Doug's Jump*. As was Jimmy Yancey, he is employed at the White Sox Ball Park and was recorded by Helfer.

At the age of fifteen, Billy Pierce accompanied Bessie Smith when that great blues singer visited her hometown of Pensacola, Florida. *Get a Working Man* is her version of the tune Bessie did as *Pinchbacks*, *Take 'Em Away*. She plays *Panama* as it is rarely heard today and sings her original *I'm in the Racket*. Bill Russell, one of the authors of "Jazzmen" and a leading authority in the field, contributed this section. It was made on a Magnecord with a Stephens microphone, under the handicap of a bare room and sorry piano. But the brassy plaint and unfettered shading of her voice are not obscured, as she delivers the hearty axioms and earthy symbols which enrich the language of the blues.

As nearly twenty years have elapsed since any of these performers were previously recorded, the sound is a great improvement on what they were given then. It does not match good professional work, but there are seemingly better qualified professional sources which do worse. Some of the sections were recorded at 7½ ips, and the Pierce is only a little above the 1938 level. Considered as an example of what the amateur in sympathy with his subject can do on moderately-priced equipment, it should be an encouragement to the documentary use of the tape recorder.

Never before has so much unadulterated blues piano been placed on a disc that is

not a reissue. And not since Yancey died in 1951, has an artist of similar abilities been recorded. For this is the blues unclothed by the sophistication and urbanization which has colored the work of so many musicians. Because these players learned the piano to express deep personal emotion, even Jelly Roll Morton and the Meade Lux Lewis of today, seem polished and self-conscious in comparison. It is a valuable record and evidence that its powerful message is not lost is to be found in the work of pianists Mose Allison, Thelonious Monk, and Horace Silver. Helfer hopes to issue albums of "Ragtime Reconsidered," and unrecorded New Orleans musicians.

Herbie Mann: Sultry Serenade  
Riverside RLP12-234

In a searching scrutiny of the inner workings of a mood, Herbie Mann employs flute, alto flute, and bass clarinet for varied tonal coloration to sustain a vernal theme. In five numbers of the sextet, they are voiced with the unusual combination of the bass clarinet and baritone sax of Jack Nimitz and Urbie Green's trombone. The flexible guitar lines of Joe Puma are featured on his *Professor* and his arrangement of *One Morning in May*. Bassist Oscar Pettiford adds his pulsing *Swing Till the Girls Come Home* and Charlie Smith's well-paced drumming has the same tasteful contrasts in dynamics as excelled in by Shelley Manne. Nat Pierce scored Tyree Glenn's *Sultry Serenade* and Mann contributes a waltz in *Let Me Tell You*. The engineering by Jack Higgins, especially on the three quartet numbers for flute and rhythm, strikes an excellent balance. The richly-flavored instrumentation has much to offer in the way of diverting sound.

Music To Listen To Red Norvo By  
Contemporary C3534

A member of the music department of the University of Southern California and holder of a Prix de Rome award, Bill Smith is also at home in a jazz setting and his composition, the twenty-minute *Divertimento* in four movements, is the highlight of this album. It is delicate chamber music, with the scope of classic form and the impetus of jazz improvisation. Arranged passages are traversed with such fluid ease by the skilled sextet that it is often not immediately apparent when an improvised section is underway. The tone of Buddy Collette is a ready complement to Smith's clarinet, as they are nudged along by Red Norvo's vibraphone and Barney Kessel's guitar. Bassist Red Mitchell and drummer Shelley Manne are invaluable in preventing stiffness from creeping into the ensembles. Five shorter pieces are distinguished by the free-swinging originals of Kessel and Norvo. *Poeme* by Jack Montrose is a development of a *Sweethearts On Parade* theme, and Lenny Niehaus adds a sensitive blues.

Blowing In From Chicago  
Blue Note 1549

During the past few years, Chicago has gained a reputation as an incubator for promising young tenor sax men. While filling his last engagement there, Horace Silver heard and liked two twenty-five-year-old practitioners well enough to promote their appearance on this disc. He added support to his first judgment by hiring Cliff Jordan for his quintet, and backs them on piano in a rhythm section of curly Russell, bass, and Art Blakey, drums. John Gilmore was introduced to records as a mainstay of the Sun Ra group.

There is a jam session flavor throughout, and it is lessened only slightly by the arrangements of *Blue Lights* and Silver's functional *Everywhere*. Jordan contributes a blues and the Latin-tinged *Bo-Till*. Both men have more than a decade of playing behind them and are ready for a forward step. They show a creative force and raw emotion that can be drawn to a fine temper, a fascinating process now well underway.

\* 732 The Parkway, Mamaroneck, N. Y.



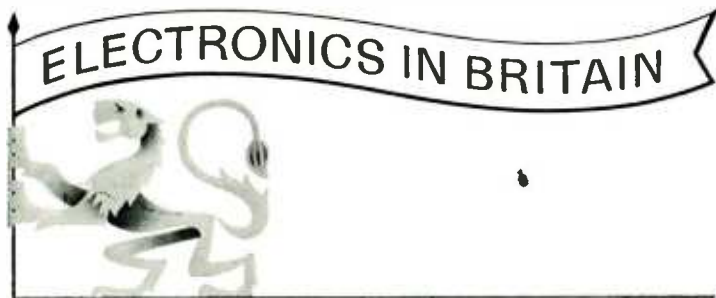

## Six sound investments...



### EF86

6267

Exceptionally low hum, low microphony and low noise tube. Specially designed for input stages of high sensitivity in high quality equipment.

The Mullard range of audio tubes has won universal acclaim among high fidelity sound experts: and it is easy to understand why. Every single tube in this range has been specially developed to meet the exacting needs of sound reproduction.

Read the specifications here; see for yourself what makes each tube such a sound investment.

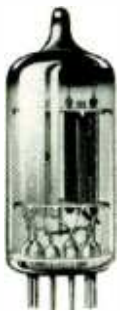

### ECC83

12AX7

Double triode with especially good microphony performance and high gain. Used in equipments where utmost versatility is required.



### EL84

6BQ5

Economical, high sensitivity output pentode. Of miniature all-glass construction on the novai base. Two tubes in push-pull can provide 17W output for only 20V drive (grid-to-grid).



### EL34

6CA7

High sensitivity 25W pentode. Two tubes in ultralinear push-pull provide up to 40W output. For public address work, two tubes in push-pull can supply up to 100V o. audio power.

Supplies available from:  
in the U.S.A.  
International Electronics Corporation,  
Dept. A11, 81, Spring Street, N.Y. 12,  
New York, U.S.A.

in Canada  
Rogers Majestic Electronics Limited,  
Dept. MK, 11-19 Brentcliffe Road,  
Toronto 17,  
Ontario, Canada.



### EZ81

6CA4

Compact full-wave rectifier of miniature all-glass construction on novai base. Provides up to about 350V output at 150mA with good regulation.



### GZ34

5AR4

Modern full-wave rectifier supplying up to 600V at 160mA, or 450V at 250mA with good regulation. Recommended for the larger type of Hi-F equipment.

# Mullard

## ELECTRONIC TUBES

*used throughout the world*



MULLARD OVERSEAS LTD., MULLARD HOUSE, TORRINGTON PLACE, LONDON, ENGLAND

Mullard is the Trade Mark of Mullard Limited and is registered in most of the principal countries of the world.

MEV 52

An announcement we hope  
will gladden some very  
patient people . . .

HERE IS THE NEW

**JansZen**  
DYNAMIC

PRECISION-DESIGNED WOOFER

From the day designer Arthur Janszen finished the production prototypes of the JansZen 130, the electrostatic loudspeaker was here to stay. Such true, transparent, trouble-free treble had not been heard before from a loudspeaker. Music lovers succumbed at once, in delight, and demand ran away from supply.

This was gratifying, especially so because there had been strong misgivings here about marketing the tweeter without a woofer to match. (Not that we had any choice. It is almost axiomatic among small manufacturers of precisely crafted devices that you must sell one product to pay for the development of the next.) Worthy woofers existed, but they had been carefully designed—good woofers do not just happen—to complement tweeters of operating principle similar to their own: a moving coil driving a cone or diaphragm. Most of them, when teamed with electrostatic tweeters, showed irreconcilable variances of phasing, midrange roll-off, transient attack, impedance, and efficiency.

A few, fortunately, worked rather well, earning our recommendation, and it must be said here, with profound respect, that certain ingenious home sound experimenters managed with multiple woofers and special enclosures, to produce sound with which we could find no fault at all, except that it cost them more hours and/or dollars than most people can afford.

Obviously, we still had an obligation, but we had not been delinquent about it. As soon as the 130 was launched, Mr. Janszen and his staff had gone back to work designing a bass speaker to complement it. Silence was imposed until he could be reasonably sure of success; premature mention would have been unfair both to prospective buyers and to other manufacturers. Early last summer he admitted he had something satisfactory, which is for him a wildly enthusiastic statement. We present this product to you, as the JansZen DYNAMIC woofer. It consists of one cone in a special cabinet. It is unique in some particulars. It had to be, because it was conceived, designed, and empirically crafted to work in seamless sonic unison with the 130 tweeter. It does. Expert listening juries have been (happily) unable to detect its point of crossover. Further, it is small, hearteningly inexpensive, and capable of clean, solid bass down to a measured 30 cycles per second. You will be able to buy it either by itself or in a common enclosure with the 130.

Write for literature and the name of your nearest dealer

Product of NESHAMINY ELECTRONIC CORP., Neshaminy, Pa.

Export Division: 25 Warren Street, N. Y. C. 7, Cable Simontrico, N. Y.

#### Mohammed El-Bakkar: Port Said

Audio Fidelity AFLP1833

The plaintive, almost primitive, music of the Middle East is heard in a dozen plastic evocations of the ritual of the dance in this excellent recording by Mohammed El-Bakkar and his Oriental Ensemble. As a featured star in the cast of the Broadway hit "Fanny," he provided the stimulus for the gyrations of Nejla Ates. As a singer and entertainer, he has made a long list of concert appearances in the Orient and this country, in addition to acting in thirty-two motion pictures. Now a United States citizen, he seems destined to carve a permanent place for his provocative group and its sensuous music.

Egyptian music has a simple beauty and the earthy charm of antiquity, for the favorite airs are handed down from the remote ages. It makes use of a large variety of unusual instruments and the quarter-tone scale. Their distinctive sounds are heard in authentic melodies which recall the enchantment of a native festival. The singing and dancing reaches an abandon that, need it be said, makes it hard to sit still. And it is not meant to speed the parting guest.

#### John La Porta: Three Moods

Debut 122

A continuing examination of a bright blues theme, in which the tempo is doubled and then doubled again, is the subject of John La Porta's *Three Moods*. To the neglect of his clarinet, the twelve-minute composition features him as a writer, arranger and able altoist. A rhythm section of Barry Galbraith on guitar, Richard Carter on bass and drummer Charles Perry also supports him on *Don't Blame Me* and *All the Things You Are*. Included are three brief but inclusive duets with trumpeter Louis Mucci. La Porta's musings are apt to be cerebral and may, as he notes on the liner, take more than one hearing to assimilate. A better justification for a re-hearing is that they are also absorbing and uncontrived.

#### The Third Festival Of British Jazz

London LL1639

London's Royal Festival Hall was the scene last November of the National Jazz Federation's third concert presentation. This recording by London's capable engineers is a debut for all six groups, presenting on the modern side drummer Phil Seaman's Quintet on *Manteca*, pianist Alan Clare's Quartet on *Satin Doll* and his original *Walk Easy*, and the Courtney-Seymour Orchestra on an arranged *Struttin' With Some Barbecue*. Sponsored by the Federation throughout the year to present various sidemen in concert, The Jazz Today Unit swings the Basie favorites *Swingin' the Blues* and *Doggin' Around*. Jimmy Walker, an eloquent Scotsman on the soprano sax, leads his quartet through *East of the Sun*. A climax is reached when trombonists George Chisholm and Keith Christie show where it all began in an exchange of righteous solos on *Ja-Da*.

#### Henry Miller Recalls and Reflects

Riverside RLP 7002/3

In nearly two hours of stimulating conversation recorded on a series of afternoons during a visit to New York, Henry Miller recounts to Ben Grauer, himself an old Paris hand and bibliophile, many of the early events in his career, dwelling most lingeringly on the vital, formative years in Paris. He tells of how he determined to write and began his struggles by severing his ties with New York. When he is engrossed in a narrative, he falls into present tense, and the voice and manner of an articulate Humphrey Bogart, caught up in the drama of a detective story. It becomes evident that he has not lost the love of freedom which led him to beg in the streets when his friends were too broke to help him.

As the patriarch of Big Sur, Miller is still not reluctant to make an economic plea for younger artists. But he can now reflect with utter candor on the philosophy and choice of life which shaped the man. On these two

valuable discs he shows a personality that can be regarded with admiration and a certain affection. There is, wisely, no attempt to make him a lovable character. Perhaps, if a survey of his days at Big Sur is made as a sequel, he will seem even that.

**Lord Foodoos: Calypso**

**Elektra 127**

**Frank Holder Sings Calypso**

**London LL1712**

One benefit of the passing calypso craze was the recording of a few reasonably authentic examples of the genre. For those collectors who seek out the one or two discs ordinarily produced in a year, it is a bonanza which should last until the next revival. Lord Foodoos and his band are a suitably inspired native group recording in Jamaica. Formerly vocalist with Johnny Dankworth and Ted Heath, Frank Holder hails from British Guiana, with Trinidad as a way station, and is the English answer to Belafonte, even down to the echo. Of the fourteen songs on each disc, *Jamaica Farewell* is the only duplication, a fact which points to the riches to be gathered in the West Indies.

**King Oliver's Creole Jazz Band: Louis Armstrong, 1923** **Riverside RLP12-122**

In the belief that those who wish to explore the history of jazz will find their way without concern for sound quality, I have purposely neglected the many valuable reissues on L.P. Among the hardest records to reclaim are those issued by Gennett and Paramount on gritty surfaces in acoustical days. As the original masters were destroyed, the process involves a long search for undamaged copies with little-worn grooves for dubbing. Even in their pristine state, they were hardly an accurate reproduction of King Oliver's Creole Jazz Band at its peak in 1923.

To fully appreciate what Jack Mathews of Reeves Sound Studios, working with perhaps the only Fairchild lathe rebuilt to be fully automatic, has accomplished with these eleven sides, it is necessary to be acquainted with the originals and some of a long series of dubbings. As one who has listened to them in various versions on and off for twenty years, I can say their first appearance on a 12-inch L.P. comes as a pleasant surprise. With no more distortion or surface noise than found on the original, it is possible to listen at a realistic volume level and not be driven from the room. In fact, I find it easier really to hear a faded recording, be it opera or jazz, from an adjoining room, when conditions permit the volume to be turned up, than in the same room at a comfortable listening level. Try it sometime—when your conditions permit.

Each of these sides previously appeared on obsolescent 10-inch L.P.'s, and are released as part of Riverside's program of restoring its early reissues to the catalogue. Improved techniques now permit them to be remastered at a greater volume level and Armstrong's first recorded solo on *Chimes Blues* is at last available with some of the luster present in the studio. The growing series features the encyclopedic *History of Jazz* and includes albums by Jelly Roll Morton, Blind Lemon Jefferson, and Bix Beiderbecke.

**The Dartmouth Indian Chiefs: Chiefly Jazz**  
**Transition 23**

In the latter half of their four years together, the Indian Chiefs gained an enviable reputation among college bands for their deft handling of traditional numbers and a repertoire which included worthwhile originals in the idiom. Of greater significance is their development of tunes usually not done by groups regarded as dixieland. Four of these are found among the ten numbers on their recording debut: Cole Porter's *Begin the Beguine* and *It's All Right With Me*, Lerner and Loewe's *I Could Have Danced All Night*, and a *Body and Soul* played at its original danceable tempo. As none of the band members hails from a point closer to New Orleans

# JansZen Electrostatic



Model 130

THE MOST  
NEARLY PERFECT  
LOUDSPEAKER

# JansZen DYNAMIC



Model 25D measures only 18 3/4" high (exclusive of legs) by 24 3/4" wide by 14" deep

A NEW  
STANDARD  
IN CONE  
WOOFERS



Model Z-200 measures only 32" high (including 4" legs) by 24 3/4" wide by 14" deep

A COMPLETE  
RANGE  
LOUDSPEAKER  
SYSTEM

**NOW more than ever...**  
**Hear the Music, not the Speaker**

Write for literature and the name of your nearest dealer

Products of **NESHAMINY ELECTRONIC CORP.**, Neshaminy, Pa.

Export Division: 25 Warren Street, N.Y.C. 7 • Cable *Simontrice*, N.Y.

# HARTLEY MAKES SPEAKER HISTORY

1926

VARIOUS MODELS

1939

MODEL 215

1955

NEW IMPROVED  
MODEL 215

1957

MODEL  
217 with  
POLYMERIZED  
CONE

AND IN

1958

## MODEL 220

WITH

### "LINEAR SOUND"

DESIGNED FOR THE

## HARTLEY LUTH

"HOLTON"

SPEAKER SYSTEM

Ask for descriptive folder on  
model 220 "Linear Sound"

## HARTLEY PRODUCTS CO.

Dept. 9 521 East 162nd Street  
New York 51, N. Y. • LUdlow 5-4239

than South Orange, N. J., they grew up on this material and have absorbed it more completely than the traditional. They treat it with robust freshness and musical sophistication.

Trumpetist Larry Elliott, of Port Chester, N. Y., leads the band and does most of the writing and arranging, contributing *Barbados*, *Blues of the Emperor Jones*, and *The Joyous Advent of the Adding Machine*. He is also the most secure soloist in a front line of trumpeter Al Shapiro and clarinetist Dave Cook, who supplies a moody blues. The rhythm section of pianist John Berge, bassist Barry Bockus and drummer Cliff Olds is helped by Pete Bull on banjo, but would be more flexible after a few lessons from Baby Dodds. Also the band follows the dynamics of some revivalist groups by playing in two ranges—loud and louder. This might be an asset on the college circuit, but not at a recording date at M.I.T.'s Kresge Auditorium. Engineer Tom Fasset gives them the best sound yet to come from this label. In all, a happy event, and it is to be hoped the Chiefs will be heard from again.

### Thelonious Monk: Monk Himself Riverside RLP12-235

With a style designed for the support of bass and drums, few pianists of today are willing to venture into a studio and record a series of solos. Even before the rise of the trio, sessions of the intimate, searching sort found on this adventurous LP by Thelonious Monk, were all too rare. His reflective and unconventional improvisation is that of a man alone with his thoughts in a darkened room. There is none of the commercial bravura usually sought by record companies. There is a tantalizing and effective use of the instrument to convey deep feeling in a highly personalized way. As an example of a creative force at the keyboard playing not only by himself, but for himself, it will be cherished by all devotees of jazz piano.

Because Monk's playing is spare and pithy, critics have pointed out a parallel in the piano pieces of Satie. It should also be remarked that it is a style shaped by pressures similar to those bearing on many other pioneers in modern art. An inability to be trite and derivative leads to new forms and time values. As these often seem destructive and disturbing, public understanding is usually tardy. Technique is never an end in itself, but a means to confess the discoveries of a probing mind. On five popular tunes and three originals, Monk still shows a genius for the unexpected, tempered by the strength of maturity.

His treatment of *April in Paris* is a satirical gem to dismay all rococo pianists who make a forte of stunning arpeggios. *All Alone* becomes an epitome of pathetic barroom emotion. *Ghost of a Chance* and *I Should Care* are awarded more respect and he is at his lyrical best on *I'm Getting Sentimental Over You*. Extended performances are given his classic originals *Round Midnight* and *Functional*, a ten minute avowal of his ties with blues tradition and his kinship with the sources of jazz. On *Monk's Mood*, a revealing illustration of how his solo ideas are worked into a group, he is joined by John Coltrane, tenor sax, and Wilbur Ware, bass. It presages the work he is doing with Coltrane in person. Excellent piano sound.

### Lee Morgan, Vol. 3 Blue Note 1557

The new Lee Morgan disc is to be heralded equally as a glowing example of his progress as a new trumpet star, and as a fulsome expression of Benny Golson's talents on tenor sax and as a composer. Of even greater note is that it serves to forecast the rise of a small group from within a big band on a par with the various units formed over the years from the Count Basie organization. Both men find regular employment, along with pianist Wynnton Kelly and drummer Charlie Persip, under the banner of Dizzy Gillespie, and all deserve considerable credit for the reinvigorating breezes which have recently wafted his band to greatness.

In his five originals for the sextet, Golson confines himself to a subtle and lyric under-

pining of a stronger melodic theme. He often has two or more lines going at once as he provides a meaningful harmonic background. He belongs to the mainstream school of jazz writers which began with Don Redman and Benny Carter and has had too few qualified graduates. He brings to it a present-day freshness which extends to his tenor sax playing, a thoughtful consolidation of Hawkins' style as forwarded by Don Byas and Lucky Thompson. It has a big, round-toned sound and is used with restraint as a precise instrument for his musical ideas.

Included is Golson's moving tribute *I Remember Clifford*, dedicated to his friend the late trumpeter Clifford Brown, and sensitively played by an inspired Morgan. *Hasaan's Dream* has an oriental cast and *Domingo*, a South American touch, both reminiscent of trips with the Gillespie band. *Mesabi Chant* has a 34 bar chorus and was written in Minnesota. But *Tip-Toeing* is a clever exposition of a rhythmic figure which comes from no greater distance than Persip's drums.

Gigi Gryce, who is the altoist on the date, speaks of his admiration for Golson in the liner notes and shows an affinity for his work in his playing. Bassist Paul Chambers completes the rhythm section. If you have not yet made the acquaintance of such valuable new voices as Morgan and Golson in their penetrating contributions to a small group, there is no better starting point than this recording by Van Gelder.

### Cookin' With The Miles Davis Quintet Prestige 7094

During its nearly two years as a unit, the Miles Davis Quintet achieved a tensile strength and a command of its repertoire which gave it a spirit and sureness seldom surpassed in jazz. The unhappy circumstances of its disbanding last Spring makes this disc an imperative to any inclusive collection. For it is the most complete representation of that memorable organization at its pulsating best yet released. A free flowing session with none of the stiffness of a studio performance, it has Miles calling the tunes just as he would at a club date and his men respond with the relaxed drive which comes when everyone is in top form. It is what you might hope to hear when the players are suitably warmed up at about the third set of an evening. But such live sessions are all too rare.

Though there are three or four LP's made by the group at about the same time still in the files, it will be difficult to select a program more fully indicative of its remarkable quality in all its aspects. *Avegin* and *Tune Up* are swift moving pyrotechnical displays, firmly knit together by the consistent empathy of the musicians. *When Lights Are Low*, Benny Carter's marvelous tune which somehow is mislabeled as *Just Squeeze Me*, is given a glorious swing and a detailed examination it has never enjoyed before. *My Funny Valentine* begins with a calm trumpet statement by Davis in low register and gradually grows in intensity as the rhythm nudges it along. *Blues By Five* is a ruminative original by Davis which fades out on Red Garland's supple piano solo.

Long hours spent together on the stand enable them to give a deceptive ease to the session. Davis is master of his horn in every instance, making it speak with soulful conviction. And John Coltrane has progressed so rapidly on tenor sax in the past year that his recorded work is just beginning to approach the way he now sounds in person. Bassist Paul Chambers and drummer Philly Joe Jones always keep something going in the rhythm and Garland is an equal front line voice so skillfully does he move into his solos. All are suitably recorded by Van Gelder.

### Zen: The Music of Fred Katz Pacific Jazz PJ1231

Anyone who is vague as to the true meaning of the principle of Zen is not going to be enlightened by this album of the music of that discerning cellist Fred Katz. But as a combination of his working knowledge of several opposite forms, it strikes out along uncharted lanes and is far enough removed from hum-drum affairs to supply a meditative source for

the subconscious. All it needs is a listener willing and able to abandon himself to the muse which guides Katz in his explorations. As principal writer and arranger for the Chico Hamilton Quintet, a group which admits to no boundaries in its music or use of instruments, he has an ideal outlet for his individualistic concepts.

It is augmented by three trombones, flute, bassoon, clarinet, and oboe for the three movements of the *Suite For Horn*, consisting of a pastoral *Allegro*, the *Zen* section and a zooming embodiment of *Science Fiction*. Gongs and oriental effects give *Zen* a sense of early Grauman's Chinese Theater mysticism. As that is also still a flourishing Hollywood cult, it seems completely valid. Trombone Quartets and Sextets will do well to study Katz's trio scoring for that instrument.

In six other unorthodox studies by Katz, the Quintet copes unaided with some of the knotty problems he poses. The ballad *Lord Randall* begins with a folk music tenderness and ends in a bacchanalian fury with Hamilton flailing away on the tympani. *Pluck It* and *Granada* are show cases for guitarist John Pisano. Carl Fischer's *Loma*, an Indian theme, becomes a vehicle for Paul Horn's sensitive flute. Hamilton gives a florid rhythmic base to *Montana* and *Classical Katz* is a witty use of the devices of chamber music. Bassist Carson Smith contributes *Katz Up* on which the cellist swings with the sound of the violin of Stephane Grappelly of the Quintet of the Hot Club of France. If you like his scoring of "Sweet Smell Of Success," you will be appreciative of this well-recorded post graduate course in Katz's work.

#### Tony Kinsey: Kinsey Comes On

London LL1672

One of Britain's foremost modern jazz groups, the Kinsey quintet features orderly ensembles and careful arrangements which spot the soloists in the best light. Don Rendell, tenor sax, and Ronnie Ross, baritone sax, are both of the Lester Young school and blend well in adroit unison passages, notably on a breakneck *Love For Sale*. In *A Mellow Tone*, and *Caravan*. Pianist Bill Le Sage is responsible for the arranging and *Cambridge Blue*, a full-textured original. He turns to vibes to make a driving solo vehicle of *Vice Work If You Can Get It*.

Kinsey propels the group from the drums and is at his best when giving constructive aid to the soloists. He solos on *Sweet and Lovely* and provides *No Name Flyer*, a tightly constructed original. At times there seems to be a grim determination to outdo their American colleagues in technical brilliance. This is offset by a relaxed *4" Train* and a lingering solo by Ross on *You Are Too Beautiful*. Bert Steffen is credited with the exceptional engineering.

#### Ray Bryant Trio

Prestige LP7098

With a background of six years of professional playing, gained in his hometown of Philadelphia since he was 20, Ray Bryant became pianist this year in the trio accompanying the singer Carmen McRae. Bassist Ike Isaacs and drummer Specs Wright form the balance of that unit and give him admirable support on the eight numbers in his first album as leader. His firm, unerring touch brings forth a pearly-toned sound which he employs with taste on standards and dramatic impact on such modern originals as Clifford Brown's *Duhoud*.

Bryant accepts the challenge of *Diango*, an exacting work by John Lewis, and makes it a personal tribute to the French guitarist by some of his most satisfying playing on the date. *Angel Eyes*, *Golden Earring*, and *The Thrill Is Gone* have not been overdone and are suited to his temperament. As one of a number of promising young pianists coming on the scene, Bryant is fortunate in a full left hand and his choice of companions. His originals *Splittin'* and *Blues Changes* are fine group efforts and raise this well-produced LP above the general level. Quite a few more established artists have not been as lucky on records.

(Continued on page 89)

## 245-Mile FM Reception!

THE FABULOUS FISHER 90-X FM TUNER

Fred W. Scholl, Jr. of Lancaster, Ohio, reports:

### "My FISHER FM-90X Regularly Receives a 245-Mile Signal!"

■ "My 90-X is the most astounding FM tuner I have ever had the pleasure to own or operate, including the best to date. WWJ, Detroit, is our usual station for listening—air line about 245 miles!"

FM reception at distances over 200 miles, terrain permitting, is a *regular occurrence* if you own a FISHER FM-90X. There has never been a tuner like it in radio history. Such performance is no accident, for the key to the unequalled reputation of the FM-90X is the exclusive FISHER Gold Cascade RF amplifier, plus companion circuitry that takes full advantage of the Gold Cascade. Some evidence of the precision-jeweler characteristics of the Gold Cascade's internal construction will be found in the simple fact that we guarantee this tube for *two* years. With its half-micro-volt sensitivity, THE FISHER FM-90X has, in one sweep rendered all other FM tuners in its price range obsolete. **Chassis, \$169.50**

*Mahogany or Blonde Cabinet, \$17.95*

WRITE TODAY FOR COMPLETE SPECIFICATIONS



**FISHER RADIO** Corporation • 21-29 44th Drive, Long Island City 1, N. Y.

at  
**LEONARD RADIO**

IT'S  
the PICKERING

*fluxvalve*

for  
IQF\*

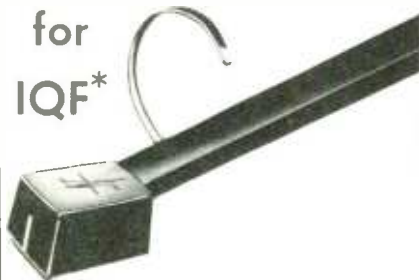

PICKERING has had long experience in the cartridge field, supplying the finest quality products for recording studios, broadcast stations, wired music services, and high fidelity home music systems. As a result of this extensive experience, PICKERING has developed the **FLUXVALVE** . . . the one cartridge which incorporates all of the Important Quality Features\* so necessary for high fidelity reproduction from records.



FREQUENCY RESPONSE CURVE

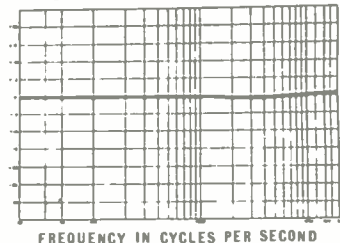

**SERIES 370 SINGLE FLUXVALVE**

370-1S	1 mil Sapphire	17.85
370-2S	2.7 mil Sapphire	17.85
370-1D	1 mil Diamond	29.85
370-2D	2.7 mil Diamond	29.85
370-5D	1/2 mil Diamond	35.85

**SERIES 350 TWIN FLUXVALVE\***

350-00	1 mil Diamond	36.00
350-500	1/2 mil Diamond	42.00
350-DS	1 mil Diamond 2.7 mil Sapphire	42.00
350-DD	1 mil Diamond 2.7 mil Diamond	54.00
350-0.5D	1 mil Diamond 1/2 mil Diamond	60.00

**SERIES 3500 "T-Guard" STYLII\*\***

S-3510	1 mil Sapphire	6.00
S-3527	2.7 mil Sapphire	6.00
D-3510	1 mil Diamond	18.00
D-3527	2.7 mil Diamond	18.00
D-3505	1/2 mil Diamond	24.00

Mail & Phone Orders, 25% Deposit  
Balance C.O.D.

**LEONARD RADIO, INC.**  
69 Cortlandt St., New York 7, N.Y. COntlandt 7-0313

# ABOUT MUSIC

HAROLD LAWRENCE\*

## Splitting the Tone

**T**O THE AVERAGE MUSIC LOVER, the world of electronic music is as puzzling as the schematic of an amplifier circuit is to the person whose only contact with electronics is the light switch and wall plug. *Musique Concrète*, microtonal writing, and Ondes Martenot are all somehow lumped together in his mind. In the same way, the label, "modern," though covering a multitude of styles and approaches, is still employed by writers of popularized books on music to describe anything composed after 1900.

Fortunately today's public is more sophisticated than in pre-World War II days. It recognizes the fact that there are many varieties of "modern" music, ranging from the exotic impressionism of Debussy, the neo-classicism in Bloch's *Concerti Grossi*, the echoes of Tin Pan Alley in Gershwin's symphonic output, and the latter-day romanticism of Barber's *Symphony No. 1*.

"Electronic" is no less vague a term than "modern" in the world of music. To the technician-composers of the West German Radio in Cologne, it means one thing: in the studios of La Radio Télévision Française, another. The word, "electronic" is rejected by the protagonists of Concrete Music. Actually there is no universal name for the many diversified experiments in sound. For the sake of this article, and at the risk of offending the French, the writer will refer to that music whose creation depends wholly or in part on electronic devices, as "electronic music."

Electronic music has been with us for a number of years. Hawaiian melodies are inconceivable without the electric guitar, the Hammond Organ appears to be ubiquitous, and the Theremin has been used in film sound tracks and popular discs. Such primitive forms of electronic music date back to 1906 when Thaddeus Cahill invented his Telharmonium. This granddaddy of electrophonic instruments comprised a series of sine-wave generators whose tones were synthesized into notes with partials and overtones. Since then, scores of electrophonic instruments have been invented. The majority of these merely echoed the harmonic and melodic idiom of traditional composition, just as

early instrumental works of the 15th century mirrored the *chansons* and other vocal music of the age. The leading exponents of electronic music maintain that their work can only reach maturity when liberated from imitative influences. In other words, only when the art is based on sounds which cannot be produced by the human throat or by standard musical instruments.

Within this new musical framework, the performer would be totally eliminated (except in cases where live and electronic music are performed simultaneously). New works would be recorded on magnetic tape at the time of their creation. Banished would be the concept of "interpretation," since each composition would be analogous to a book or a painting, self-contained and permanent. Musical notation as we know it would be replaced by figures and diagrams resembling nothing less than a Martian blueprint. (The frequency generator alone makes normal notation impossible, since it can split tones with mathematical precision.) Timbres can be varied at will by means of control of partials and overtones. Speeds beyond the capabilities of a Heifetz or a Horowitz would be possible. Through amplification, dynamics would take on new meaning as music shifts from a whisper to an awesome outpouring.

Of all the various experiments in the world of electronic composition, the most widely publicized are those conducted in Paris by Pierre Schaeffer and Jacques Henry. Their "Concrete Music" is a mélange of electronics, mechanics and field recording. Their basic materials are real sounds, altered in pitch, "mounted" in provocative juxtapositions, filtered, provided with echo, or broken down into their various components.

Concrete Music's artistic counterpart is surrealism. Both transform recognizable subject matter into unrecognizable forms. *Trifle in C*, an object lesson in Concrete Music, "manipulates" a C major piano chord. The moment of impact, for example, is separated from the total sonic picture, thus producing an organ-like effect. Anyone who has operated a tape machine knows how reversed music sounds: a piano chord played backwards ends in a percussive snap; accelerated, it results in a whining glissando. Through filters, various parts of

\* 26 W. Ninth Street, New York 11, N.Y.

the chord's frequency makeup can be isolated and put through the same motions as the full chord. Like numerical combinations, the possibilities offered by this simple chord are almost limitless. In a sense, Concrete Music is an extension of John Cage's work with the "prepared piano," applied to all sound sources from a leaking faucet, to a whirligig, subway turnstile, or traditional instrument.

As distant as is Concrete Music from sound as we know it, electronic music from Cologne is even farther removed. Bypassing "live" sound entirely, its creative alphabet is supplied by a frequency generator which can produce sine-tones from 16 to 20,000 cps. These pure tones are recorded and filed. When needed for a certain composition, they are re-recorded with specified duration, intensity, echo, superimposition, etc. A painstaking operation. Germany's leading electronic composer, Karlheinz Stockhausen, took a year and a half to write a 17-minute work.

Obviously the methods of electronic composition are still too intricate and time-consuming to attract any but a handful of intrepid composers. It is significant that this new world of sound appeals strongly to twelve-tone composers like Ernst Krenek, who was invited in 1955 to write a piece in this idiom in the Cologne laboratories. Igor Stravinsky too is more than casually interested in the field and said that if he were young he would explore the world of electronic music.

It is safe to say that electronic music by itself is a long way from capturing the attention of the general public. However, in combination with other forms, it has already come into its own. The entire musical sound track of the science-fiction movie, *Forbidden Planet*, for instance, was composed and recorded by Louis and Bebe Barron using special electronic circuits as background "music" to different characters, moods and events. These effects included, as *Time* magazine reported (July 2, 1956), "a kind of trickling-water sound; a zipping effect, as if somebody were running his thumbnail along a comb; a high, ominous thrumming, something like the sound telegraph wires make when the pole is struck; a frightful, featureless roaring; and an effect that repeatedly swoops up to a point of release and then breaks and starts over."

The Barrons do not regard their "score" as musically fit because they could never predict exactly what would result from their circuit dexterity. But both they and their vast audiences splashed happily in the sonic bath to the accompaniment of whooshing rocket ships and astral explosions.

Electronic composition has not yet made its mark except as a sort of intellectualized "sound effect." But like the earth satellite, it is definitely of this era and may well find its true orbit. Æ



**three  
little\*  
speakers  
went  
to  
market**

**without  
price  
tags!**

\*Actually they are big speakers and they DO have price tags . . . but we want you to hear the speaker without the influence of price. All R & A speakers deliver brilliant performance and are low priced. Many audiophiles feel that a high-priced speaker must be good merely because it costs so much. Detach yourself completely from this theory and listen only for pure sound reproduction. You will be convinced that the R & A design and construction surpasses many of the most costly that you've heard . . . in any price range . . . a thrilling experience which can be yours for less than the cost of 2 good seats at the Met!



Made in England

**New R & A Coaxial 700 Series Mark III**

Model	Size	Voice Coil	Fundamental Resonance	Voice Coil Impedance	Magnet Strength	Handling Power Capacity
780	* 8"	1"	80 cycles	8 ohms	12000 Gauss	15 Watts
7100	* 10"	1"	65 cycles	8 ohms	12000 Gauss	20 Watts
7120	* 12"	1"	60 cycles	8 ohms	12000 Gauss	25 Watts

Buy it . . . try it . . . we back our claims with a money back guarantee!

**ERCONA CORP.** (Electronic Division)

551 Fifth Ave., Dept. 17, New York 17, N. Y.

In Canada: Astral Electric Co. Ltd., 44 Danforth Road, Toronto 13

# NEW PRODUCTS

● **Weathers Speaker System.** Six moving-coil speakers—two 12-in. full-range units and four 3-in. tweeters—are incorporated in the "Monte Carlo," a new speaker system recently announced by Weathers Industries, Barrington, N.J. Featuring a number of advancements developed by Weathers to achieve professional "laboratory" sound within the home, the sys-



tem has a continuous power handling capacity of 20 watts and a frequency range of 25 to 20,000 cps. Among its unique features are "radial damping" backwave control for the elimination of low-frequency build-up, a new and exclusive multiple-octave crossover, and a new type of cone-edge treatment which enhances middle-range performance. Impedance is 4 ohms. Heavily constructed, the Monte Carlo measures 36½" h x 33½" w x 11½" d. **L-1**

● **Stereophonic Tape Recorder.** The "Sterecorder" is a complete package in the moderate price range that both records and plays back stereophonic sound from a single compact unit. It may also be used for dual-track monaural operation when desired. Although designed to meet professional requirements, the Sterecorder



offers a degree of operating simplicity which makes it entirely suitable for home use. Included among its features are a hysteresis synchronous motor, two VU meters, cueing and editing facilities, and two self-contained independent channels of amplification, including power output. Available with the record-playback unit are two separately-enclosed Type D123 Signature 12-in. speakers and two high-impedance microphones. The Sterecorder is manufactured by the developers of the SuperScope motion picture process and lenses. For further information write SuperScope, Inc., Audio Electronics Division, 780 Gower St., Hollywood 38, Calif. **L-2**

● **Collaro Record Changers.** A new transcription-type tone arm is foremost among the advanced features which are included in the new 1958 line of Collaro record changers. A one-piece, spring-damped, counterbalanced unit, the new arm will accept any standard high-fidelity cartridge. Tracking pressure variation is less than one gram between the first and last records in a stack. The new arm is incorporated in two of the three new Collaro changers, namely, the Continental Model TC-510, and the Conquest Model TC-310. The Continental is a deluxe changer



which meets rigid requirements for high fidelity reproduction. The Conquest is a modestly-priced changer whose many precision features afford excellent hi-fi performance. The third new Collaro changer, the Coronation Model TC-410, combines the custom quality of the Continental with the flexibility of a standard plug-in arm and universal head shell. All models are equipped with 4-pole shaded-pole induction motors, heavy rim-weighted balanced turntables, and muting switch. Wow and flutter are stated to be less than 0.25 per cent at 33½ rpm. American sales representative for Collaro, Ltd., is Rockbar Corporation, 650 Halstead Ave., Mamaroneck, N. Y. **L-3**

● **Tape Editing Device.** Completely non-magnetic in construction, this device has been designed to meet the need for a fast, simple means of cutting and splicing quarter-inch magnetic recording tape. Cutting is accomplished by a center blade which pivots and can be set for precision cuts at 90°, 67½°, and 45-degree angles. An engraved center line marks the point of the cut and an index marker indicates



a point 1½ inches from the center as a reference in editing and marking. In splicing, the splicing tape is laid over the recording tape and the splice is achieved in a single downward stroke of the cutting arm. Two side knives cut the splicing tape to the exact width of the recording tape, while the two tapes are pressed together for a firm bond. The compact unit measures only 1½ x 3½ x 2½ ins. and weighs less than one pound. Inquiries should be addressed to Alonge Products, Inc., 165 W. 23rd St., New York 11, N. Y. **L-4**

● **Rek-O-Kut Portable Turntable-Tone Arm Unit.** Developed for finest possible reproduction of records, this new Rek-O-Kut unit combines the company's well-known A-120 tone arm with a choice of the L-31, L-37 and CVS-12 turntables. It is available with dual-sapphire stylus and



either ceramic or magnetic cartridge. The L-31 plays at 33½ and 45 rpm, while the CVS-12, illustrated, permits continuous speed variation from 25 to 100 rpm. Designed for feeding into any high-quality amplifier, it is especially well-suited for use in schools, churches, dance pavilions, and other spots where professional audio quality and mechanical dependability are of equal importance. It is mounted in a sturdy plywood leather-tie-covered case with detachable cover. Further information may be obtained from Rek-O-Kut, Inc., 38-19 108th St., Corona 68, N. Y. **L-5**

● **Sine-to-Square-Wave Converter.** Although extremely compact, this instrument will find many uses as an accessory in connection with test instruments of conventional size, operating from 5 to 100,000 cps, the unit is capable of 17 volts



peak-to-peak output when driven by almost any conventional oscillator. The novel circuit utilizes the signal from the driving oscillator to provide operating power for the transistor "squaring" circuit. Rise time for the square wave produced is 0.5 per cent of the period with a symmetry of 50 per cent ± 2 per cent. Further information may be had by writing Mandrel Industries, Inc., P. O. Box 13243, Houston 19, Texas. **L-6**

● **Improved Tape Reel.** Developed primarily to permit users of tape recorders to realize the full potential of their ma-





# Our 30th Year in Business Brings Bigger and Better Hi-Fi Values at HARVEY'S



**the place to buy HI-FI!**

Since HARVEY'S started in business 30 years ago, their buyers have been in the market place seeking out the finest audio equipment available. They have searched everywhere, often going abroad, examined and tested equipment thoroughly, and scrutinized performance characteristics of all manufacturers' products. As a result of this approach, there's not a customer who leaves HARVEY'S who is not completely satisfied with the merchandise.

From buyer to seller, everyone at HARVEY'S believes there's nothing better than a satisfied customer. From skilled buyers who haven't lost their touch, to the experienced sales personnel in Harvey's famous Hi-Fi AUDITORIUM, they will all be pitching in to make HARVEY'S 30th Anniversary celebration one you'll never forget.

With every hi-fi component worthy of note in stock for immediate delivery, look to HARVEY'S to bring you bigger and better values.

## CONNOISSEUR Turntable



The hush of an empty church, even though the synchronous motor is running—this is the Connoisseur, crafted in traditional English quality. Precision machining assures pure sound reproduction.  $\pm 2\%$  variation provided for all 3 speeds; hysteresis motor ..... **\$11000**

## Sherwood S-3000B High Fidelity FM Tuner



A combination of fine design, superior listening quality and clean, modern styling. No trouble with interstation interference — special local-distance switch suppresses cross-modulation response. Intermodulation distortion is less than 1.5% — harmonic distortion less than 1% meaning very superior sound indeed ..... **\$9950**

## GRAY "Micro-Balanced" Dual Viscous—Damped



### TONE ARM—MODEL 212

The Gray "Micro-Balanced" arm offers a maximum of compliance and responsiveness with all popular cartridges that is beyond the experience of most High Fidelity enthusiasts. Maximum tracking stability is guaranteed because of sealed viscous-damping on BOTH vertical and horizontal pivots, and complete static balance around the vertical pivot ..... **\$3400**

## PICKERING 350



### Twin Fluxvalve Cartridge

A product of perfection that was designed for use in only the finest professional equipment. It provides a flat frequency response beyond 20 kc. Tracking distortion, record and stylus wear are reduced to new low levels. Recent production techniques now place a Series 350 model within reach of the budget buyer. Model 350-DS (Diamond and Sapphire) ..... **\$4200**

## Electro-Voice®

MODEL KD 5 EMPIRE KIT



Capable of handling an entire speaker system, the KD 5 is an economical enclosure kit incorporating unique, E-V designed bilinear-lenticular-slot rear loading principle. A smart, distinctive furniture piece and a highly efficient loud-speaker enclosure. Size 29 1/2" h., 32" w. and 16" d. .... **\$5100**

## Tandberg MODEL 3



3-Speed Tape Recorder

Designed and built in accordance with the most advanced European engineering techniques, this fabulous little portable tape recorder crashes through the price barrier between home equipment and professional machines. Its specifications and performance are comparable to those of the finest available tape recorders ..... **\$29950**

## HARMON KARDON

TA1040 Festival II



The Festival combines a highly sensitive AM-FM tuner, a complete preamplifier and a 40 watt hum-free, distortion-free, power amplifier. It features: magnificent Armstrong FM with Automatic Frequency Control to insure accurate tuning automatically. Price complete ..... **\$25000**

## Pilot AA-903B

Williamson-Type Amplifier



Employing specially wound output transformers to insure absolute stability and lowest distortion, the rated output of the Pilot AA-903B is 14 watts (25 watts peak) with less than 1% distortion. Frequency response is 20-20,000 cycles,  $\pm 1$  db at rated output. Has built-in preamp and audio control facilities. Complete ..... **\$7995**

## Speaker Systems by

**BOZAK**

... Unsurpassed Realism



Typical of "The Very Best in Sound" is the Bozak model B-302A, a three-way system ideally suited for 20-watt amplifier package. Wide frequency response of 40-16,000 cps assures the listener of the finest in reproduction. Handsomely styled, the Bozak 302A blends perfectly with any decor. **\$23560**

Listen to "ADVENTURES IN SOUND" on WQXR Every Sunday Night at 7:05

# HARVEY RADIO CO., INC.

Established 1927

1123 Avenue of the Americas (6th Ave. at 43rd St.) New York 36, N. Y.

**JUDSON 2-1500**

Excerpts from **PRESS COMMENT** on the

# AR-2

## High Fidelity *(Tested in the Home)*

"...With the (tweeter) control set to suit my taste (best described as row-M-oriented), oscillator tests indicated that bass was smooth and very clean to below 40 cycles, was audibly enfeebled but still there at 35, and dropped out somewhere around 30 cycles. No doubling was audible at any frequency.

From 1,000 to 4,000 cycles there was a slight, broad dip in the response (averaging perhaps 2 db down), a gradual rise to original level at 8,000 cycles, and some minor discontinuities from there out to 12,000 cycles. Then there was a slow droop to 14,000 cycles, with rapid cutoff above that.

Because of its slightly depressed 'presence' range, the AR-2 has what is to me a refreshingly sweet, smooth, and highly listenable sound. Music is reproduced transparently, and with very good detail. Its high end is unobtrusive, but its ability to reproduce the guttiness of string tone and the tearing transients of a trumpet indicate that it is, indeed, contributing highs when needed. This, I feel, is as it should be.

Its low end is remarkably clean and, like the AR-1, prompts disbelief that such deep bass could emanate from such a small box.

"...Like the AR-1, the AR-2 should be judged purely on its sonic merits... not on the theoretical basis of its 'restrictive' cabinet size. When so judged, it can stand comparison with many speakers of considerably greater dimension and price.—J.G.H."

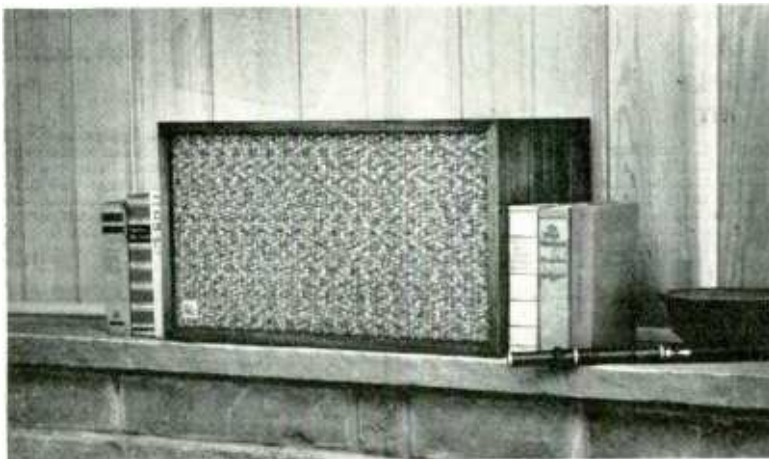

## AUDIO *ETC.*

"...I find the AR-2 remarkably like the AR-1 in over-all sound coloration. Its cone tweeter is not the same, but there isn't much difference in sound. (It costs less, but that doesn't prove much.) On direct comparison, given a signal with plenty of bass component in the very bottom, you can tell the difference between the two in bass response. Most of the time, in ordinary listening, I am not aware of it at all.

"...I find AR-2, as with AR-1, remarkably clean and unobtrusive in its sound, easy on the ears for long-period listening, easy also to ignore in favor of the music itself. Either speaker has a way of simply fading into the surroundings (the size helps) leaving the music unattached and disembodied in the room. Excellent illusion!..."

Prices for Acoustic Research speaker systems, complete with cabinets, (AR-1 and AR-2) are \$89.00 to \$194.00. Size is "bookshelf." Literature is available from your local sound equipment dealer, or on request from:

**ACOUSTIC RESEARCH, INC.** 24 Thorndike St., Cambridge 41, Mass.

chines, the new Bel-Cleer tape reel is molded with extra-heavy flanges which are claimed to give a balanced flywheel-like action to tape transport, thus minimizing wow. Precision-molded of opaque gray plastic which is warp-proof, the reel virtually eliminates wobble and eccentricity. Frosted areas are provided on each flange for labeling or written identification of program material. Threading of the new reel represents a distinct advance both in ease and security. Tape is easily fitted into place around a molded-in anchor, with only a simple movement of the fingers necessary to secure against slippage. Although prices will remain unchanged, all Bel-Cleer magnetic tape will be shipped on the new reel within the near future. The Saint Cecilia Company, Ltd., Westwood, N. J. **L-7**

• **Miniature R.F. Tube With Internal Shield.** Developed specifically for use in FM-AM tuners and receivers as a grounded-grid or grounded-cathode r.f. amplifier, and as a self-oscillating fre-



quency converter or cascode amplifier, the new Amperex Type ECC85/6AQ8 is a high-mu high-transconductance twin triode with a number of unique qualities. Through the use of an internal shield which separates the triode sections, the ECC85/6AQ8 reduces oscillator radiation from the antenna of the receiver to an extent not possible with earlier twin triodes. Higher transconductance permits increased front-end gain and lower noise. Detailed data and applications engineering information are available from Special Purpose Tube Division, Amperex Electronic Corporation, 230 Duffy Ave., Hicksville, N. Y. **L-8**

• **JansZen Woofer.** New materials and unique design features are combined in the new JansZen cone woofer to produce a speaker of exceptional smoothness and with extremely low distortion over its



entire band pass. Called the JansZen Dynamic, the new woofer is available either

as a separate unit or in combination with the JansZen tweeter. It is a low-frequency direct radiator in a 2.5-cu.-ft. enclosure, designed to produce a response specifically tailored to complement the JansZen Model 130 electrostatic tweeter. Upper frequency response of the woofer has been extended so that proper blending with the tweeter is effected without the use of a crossover network. Rigid manufacturing tolerances are enforced and each JansZen woofer is given a final series of tests. For full details, write Neshaminy Electronic Corporation, Neshaminy, Pa. **L-9**

• **Test Records.** All aspects of turntable operation can be checked without the use of additional test instruments by means of six records which have been released by Components Corporation, Denville, N.J. Instructions for use are given verbally on each disc. Measurements are made purely by listening. Novel titles indicate the functional test afforded by each record. "Wow, and Flutter, Too!" is, as might be expected, a check for wow and flutter. "How's Your Stylus?" checks stylus wear. "Quiet Please" is a test for rumble. Pickup arm resonance is checked by "Tracking Special," while "Vertical/Lateral Response" checks cartridge frequency range. Location, measurement and cure of hum is determined by "What? No Hum?" **L-10**

## NEW LITERATURE

• **Allied Radio Corporation,** 100 N. Western Ave., Chicago 80, Ill., announces the release of its new 1958 catalog. Consisting of 404 pages, including 192 pages in rotogravure, this latest Allied catalog lists more than 27,000 items and is by far the electronic industry's leading retail buying guide. Featuring extensive listings of high-fidelity components and systems, the catalog includes a selection of 66 complete systems chosen on the judgment of music lovers, technicians, and research organizations. A full presentation of hi-fi components in all leading makes includes amplifiers, tuners, speakers, cabinets, record changers, styli and other accessories. There is an entire section devoted to tape recorders, including the latest stereo models. The new Allied 1958 catalog will be mailed free upon written request. So what are you waiting for? **L-11**

• **Electronic Instrument Co., Inc.,** 33-00 Northern Blvd., Long Island City 1, N. Y., has available free a colorful new catalog describing and illustrating the EICO line of high-fidelity equipment in both kit and factory-wired form. Catalog A5 contains full specifications, features and prices of all EICO amplifiers, preamps, and the HFSI two-way speaker system. Copy will be mailed free on request. **L-12**

• **Centralab, A Division of Globe-Union Inc.,** 900 E. Keefe Ave., Milwaukee 1, Wis., announces Pocket Control Guide No. 6, a 121-page book containing hundreds of new listings on replacement controls, as well as a great deal of information of value in the selection of controls where type numbers have been obliterated. A special feature of the guide is the complete line of carbon and wire-wound controls which are listed by ratings and part numbers, together with handy taper curves and other data to assist the service man. These guides are priced at 20 cents each.

• **Dry Screen Process, Inc.,** 1016 Madison Ave., Pittsburgh 12, Pa., is offering to electronics manufacturers a booklet which delineates the company's methods for reconciling high quality, high volume, and low unit cost in the production of printed circuitry. The dry screen process, introduced to the industry less than a year ago, is a step forward in solving this major problem as well as many minor ones which have plagued manufacturers. It also gives research and developmental engineers a fast, proved method for carrying out work identical to that which will be done later on a production basis. Requests for copies of this booklet must be written on company letterhead. **L-13**

# PILOT and only PILOT

*offers you peak performance  
in high fidelity at low cost*

## TUNERS

Traditional Pilot engineering and quality assure optimum performance. All Pilot tuners feature *Beacon* tuning for precise station selection. All Pilot tuners are also fully shielded to conform with FCC radiation specifications.



### FA-550 FM-AM

Has tuned RF stage and dual cascade limiter-discriminator FM circuit for maximum sensitivity; — perfect quieting even with fringe signals; AFC with disabling switch; 10 KC filter for AM; flywheel tuning; built-in FM and AM antennas. Features preamp-audio control with five input channels; hum-free DC on tube heaters; tape head and phono inputs with separate equalization; bass and treble controls; separate cathode follower outputs for tape recorder and power amplifier. Housed in handsome enclosure finished in brushed brass and burgundy.

Dimensions: 4 3/4" h x 14 1/2" w x 10 1/4" d.

**\$159.50 Complete**



### FA-540 FM-AM

Has tuned RF stage for high sensitivity — perfect quieting even with fringe signals; AFC with disabling switch 10KC filter for AM; cathode follower output; phono and auxiliary inputs; flywheel tuning; built-in FM and AM antennas. Housed in handsome enclosure finished in brushed brass and burgundy.

Dimensions: 4 3/4" h x 13" w x 8 3/4" d.

**\$109.50 Complete**



### FM-530 FM Only

Has tuned RF stage for high sensitivity — perfect quieting even with fringe signals; AFC with disabling switch; cathode follower output; phono and auxiliary inputs; flywheel tuning; built-in antenna. Housed in handsome enclosure finished in brushed brass and burgundy.

Dimensions: 4 3/4" h x 13" w x 8 3/4" d.

**\$89.50 Complete**

Make your own performance test of these tuners at your Pilot dealer.  
For complete specifications, write to Dept. AW-11

Prices slightly higher west of Rockies.

**Pilot**

**RADIO CORP., 37-06 36th St., Long Island City 1, N. Y.**

Over 38 years leadership in electronics.

# pioneer

## TWEETERS

help to give you real

PRESENCE!

with frequency range extending up  
to 16,000 cps.

### PT-1

(CONE TYPE)



Popular type  
tweeter. Covers  
3,000 to 16,000  
cps without peaks  
or dips. Driven impedance, 8 or 16  
ohms; power input, 20 watts.

### PT-1C

(CONE TYPE WITH  
SIMPLE NETWORK)



A simple dividing network that is  
matched to the optimum crossover  
frequency is built in the unit. Covers  
1,000 to 16,000 cps; power input, 15  
watts; impedance, 8 or 16 ohms.

### PT-2

(HORN TWEETER)



PT-2 is the horn type  
tweeter designed for  
use in two or three way  
system. The moving coil  
is wound with aluminum  
wire in order to improve the response.  
Frequency range, 2,200 to 16,000 cps;  
power input, 20 watts above 4,000 cps;  
impedance, 8 or 16 ohms.

### PT-3

(RECTANGULAR  
HORN  
TWEETER)



By adoption of a rectangular horn, the  
dispersion characteristics are extremely  
good. Frequency range, 1,700 to 16,000  
cps; power input, 20 watts above 2,800  
cps; impedance, 8 or 16 ohms.

Write for catalog to \_\_\_\_\_



5 Otowacho 6-chome, Bunkyo-ku, Tokyo  
**FUKUIN ELECTRIC**

# AUDIO ETC.

Edward Tatnall Canby

## Three-Way Stereo—The Center Carrier. 1.

**O**N THE FACE OF IT you might think stereo recording had gone daffy these last days. Many stereo recording companies are now taking down all their material on three tracks, dividing the sound into thirds (special half-inch tape)—and releasing the results on two tracks, dividing it half-and-half. Do you get two-thirds of a recording, with one track eliminated? No, it's whole, in spite of the 3:2 reduction. You don't even get 1.333 tracks in each speaker.

As I see it, you get all three, complete and virtually unabridged, and one of them is in the center, too, all by itself and unattached.

A short while ago I listened to my first Mercury Living Presence stereo tapes and it was then that a great white light dawned upon me, I found—or so I think—that I was in literal fact hearing not two, but three channels, though my home system still is strictly dual, not triple. Mercury uses the triple-track recording technique, as do other companies, and makes quite a bit of reasonable fuss about the filling-out of the problematical middle area in its tapes, via the third track. That's what got me thinking. How?

Well, I've got my own theory, after the fact. No doubt I have been anticipated, in the technical literature, by a quarter century or so—I wouldn't attempt to deny it. Even so, I'm going to toss off my own ideas as to how this might happen, and how "ordinary" stereo, on two tracks, is related to it, in order to cast a bit of Canbyese light on a subject that can easily bog down in polysyllaby. Borrowing unscrupulously from the engineering department, I'm calling that third-track effect the center carrier, and I'll explain why in strictly layman terminology.

But before I get to all that, allow me to discuss old fashioned stereo recording. The kind that uses only two tracks—in the recording itself as well as the finished commercial tape record. We still have a lot of it around.

### Farsighted Two-Track

There are a number of quite different ways in which two tracks can be put to use for stereo entertainment. They overlap and blend, of course, but we can look at them separately.

The basic two-track technique for big-scale stereo sound—bringing a whole orchestra into your living room—is what I call "farsighted." I don't mean wise, intelligent, long-range. I mean simply a mike technique that picks up the sound far enough away so you don't have to listen cross-eyed. An over-all pickup that takes in the whole expanse of the music in its viewpoint, so that your ears merge the

stereo parts into one continuous side-to-side sound picture. Farsighted. If the mikes are put too near, you'll get a shortsighted double image and an unnatural, "out-of-focus" effect.

It isn't difficult to achieve this merging of a whole orchestral sound, across your living room evenly from one side to the other, without double images and without a "hole" in the middle. It is done every day. But it is definitely tricky. It often fails to come off. A slight miscalculation, in the recording, at home in the listening, and things go haywire. The fusion just won't fuse and all you have are two speakers, playing two separate recordings. The farsighted kind of mike technique is one way to help the desired fusion, and as I say, it works beautifully, when it works. I wouldn't be in there rooting for stereo if I didn't know this from long personal experience.

But if your mikes are too shortsighted for the music in front of them, if they are too close to the orchestra on each side, the middle area simply will not register, between the speakers, when you play the tape at home. The side instruments will be in close enough to put their music almost "inside" your speakers, right at their location or close behind it. Only a few feet away from you on each side. It is impossible, then, for you to cram the rest of a large orchestra into the intervening space; your ears and mind are confused by the conflicting indications. They refuse to cooperate in making a "picture" of the music and instead, present you with the naked truth which, alas, is no more than two speakers with a hole in between. Lost illusion.

As you can see, the fusing of a good middle out of two stereo tracks is a matter of mental image-making. Not that the effect must be strictly logical—the whole thing is an illusion. But it must be consistent, especially as to apparent distance from you to what you hear, both the sides and the middle. They must seem to be related in respect to distance.

Therefore—you must be farsighted. You must keep your mikes back, to take in the whole scene without favoring any small areas of the orchestra. You must record so that the listening ear can imagine the whole orchestra in all its vastness spread out from one side of a living room to the other and this means—not too close. It means it, anyhow, with two-track recording.

### Doubling

When the stereo sound-picture goes wrong the worst and most troublesome result is the phenomenon of doubling, two-channel stereo's biggest plague. Two images, one in each speaker, where you should be hearing only one. Two solo pianos in a

piano concerto and you can't tell which side is "it." Two huge fiddles, both played by the same famous violinist, split and doubled. A solo singer who stands stage-left and stage-right at the same time. A double chorus that ought to be single.

The over-all two-track image is like a flimsy sound-cobweb spun across from one speaker to the other; tamper with it even a bit and the thing parts in the middle, instantly pulls itself over to the sides. A doubled stereo image is listenable of course, since the "two" sounds agree; but the effect nevertheless is musically distressing as well as spatially confusing. (It's even worse when the image periodically jumps from one side to the other.) Stereo engineers don't exactly relish doubling either, if only because it so clearly indicates a miscalculation somewhere along the line. Everybody tries to get rid of it, but not everybody succeeds.

And so the first and best way to dodge doubling and lack of middle fusion is to be farsighted. Keep back. Don't be cross-eyed. Don't try so hard to get the trumpets on the right and the fiddles on the left that you kill the center. Note that sharp directionality isn't really important anyhow in most music. All we need is a relatively slight and vague suggestion, that so-and-so instrument is over to one side, another instrument in a different location. It's that way in the concert hall.

The urge to get super-right-handed and ultra-left-handed effects leads to the most trouble, the worst doubling. Too close.

At its best, "farsighted" miking is amazing. You can, for instance, place a single solo instrument, say a solo guitar, right between two speakers, without a trace of doubling in them. Mike him too close and you'll have two guitars. One of them will be in each of your speakers, and plenty far apart. But if you have recorded the guitar back ten or fifteen feet in a nice and helpful liveness, so that your mental ears and eyes can "see" him farsightedly, quite a ways off—then you'll focus on the center, you'll hear one guitar. And it won't be near either speaker.

I might add (as has been expressed in my stereo reviews) that a big, resounding hall liveness does wonders for this type of big-expanse, farsighted stereo pickup—in fact it is almost obligatory. Liveness, remember, is the factor that allows us to judge distance and so place sounds in perspective. The better the hall liveness, the easier it is for you to push a big orchestra back away from your speakers and hear it in its own space, out beyond them.

Even more particularly, the fabulous "wall bounce" of many big concert halls can give stereo sound a fantastic extra realism. Especially for percussive sounds that die away quickly and reveal the echo on its own. Drum sounds. In such sudden musical explosions, the almost-instantaneous back-and-forth bounce of the echo is caught literally by the two mikes and projected, wall for wall, right out of your two speakers. Marvellous! It is one of the big thrills of stereo sound and a kind of realism that is impossible in any monaural reproduction, no matter how hi the fi.

(In fact, the wall-bounce effect is so grateful to the ears that big drum sounds in this sort of stereo are startlingly realistic even via small speakers that technically don't reproduce the bass end at all. The bouncing side-to-side echo easily makes up for the lack of real lows.)

#### Nearsighted Stereo

But there are other ways to use two-channel stereo recording. Big classical orchestras aren't the only sound for the

# spectacular...new Tape System Components PENTRON

• STEREO • MONAURAL

Select the Tape units to meet your needs

Pentron combines professional features and custom styling with building-block flexibility. You buy what you want and add to your system when you require—from the simplest monaural system to the all inclusive stereo systems.

#### PENTRON LEADERSHIP FEATURES

- Precision made and tested professional head assembly with Aznar-X spring loaded screw adjustment.
- Simple single rotary control.
- Four outputs plus two AC convenience outlets.
- Mounts VERTICALLY, horizontally, or at any angle.
- Speed change lever at front panel.
- Removable pole pieces in heads, as easy to change as a phono needle.
- Automatic self-energizing dither for braking.

#### Basic specifications FM series mechanisms

**COMBINATION HEAD:**  
Frequency response: 40-14,000 cps with proper equalization. Signal-to-Noise: 55 db with CA units.  
Track width: .093" gap width: 1/4 mil impedance of record section: 6000 Ohms; inductance of erase section: 60 mH • **STACKED HEAD:** track width .060" gap width: 15 mil impedance: 3500 Ohms • **FILTER:** under 0.3% at 7 1/2 lps; under 1% at 3 1/4 lps. • **CAPSTAN OR VE:** drier driven • **MOTOR:** 8 pole inductance type, individually balanced • **OUTPUTS:** 4 standard pin jack outputs to accept shielded phono plug • **CONVENIENCE OUTLETS:** two auxiliary AC outlets controlled by mechanism power switch. Supplied with removable mounting brackets with shock mounts.

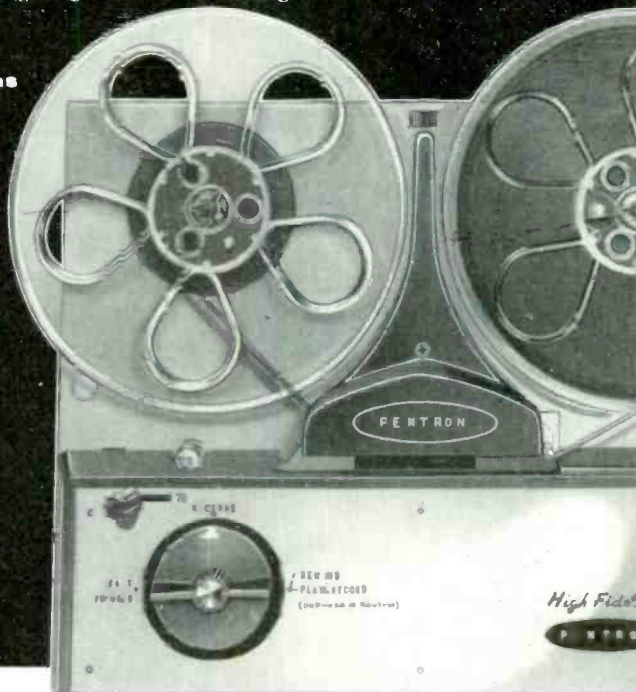

#### preamplifiers



CA-11

Tape Playback only. Response: 20-20,000 cps. Signal-to-Noise: 55 db



CA-13

Tape playback preamp and record amplifier. Response: 20-20,000 cps. Signal-to-Noise: 55 db



CA-15

Stereo dual channel playback. Response: 20-20,000 cps. Signal-to-Noise: 60 db

ALL CA UNITS HAVE SAME PHYSICAL DIMENSIONS AND REQUIRE SAME CUTOUT.

HEAR PENTAPE RECORDED TAPES—"GREATEST SOUND EVER FOUND"

**PENTRON**

776 S. Tripp Avenue  
Chicago 24, Illinois  
Canada: Atlas Radio Ltd. Toronto

Send brochure on tape components

Name \_\_\_\_\_

Address \_\_\_\_\_

City & State \_\_\_\_\_

# At Last! Tape-Indx

\*Patent Applied For

**THE PERFECT TAPE INDEXING SYSTEM**

- Simple
- Accurate
- Economical

Now—at last—you can index your recorded tape accurately—and as easily as you apply a postage stamp. Index as many as five reels with 6 tabs each for only \$1.00. Companion product to Tape Indx, "Perma-File" to identify your tabs and catalog your titles only \$1.00.

**Tape-Indx**  
DATREL COMPANY  
520 Fifth Ave., New York 36, N. Y.

Circle 86A

stereo medium. There is plenty of stuff that can be recorded two-track (I'm still not ready for three-track), close-up with excellent results. You may not even need to bother with the middle. You don't need it, often enough. Given the right kind of music, it is often a good idea deliberately to put your music right into your loudspeakers, at only a few feet distance. Not a full orchestra, but small ensembles.

Much excellent popular stereo is done in this way. An accordion right at one speaker—not more than a foot from the mike as you listen—and, maybe, a crooning vocalist two inches from the voice coils on the other speaker. Interesting. In less extreme cases you can place a couple of individual sounds on each side without appreciable pickup at the other side; a piano and drums on one mike (and in one speaker), a guitar and a trumpet on the other. Each speaker has its own small space around it; the middle is simply not there at all or so slight as to be unimportant. Why not?

Two-point recording can be very effective. I tried it once (1952) with spoken drama—two people conversing, one in each speaker; then three people, two in one speaker and one in the other. (The mikes were placed fifty feet apart so that the cross-pickup was virtually nil.)

Modifying this "shortsighted," close-up stereo technique, you can introduce a limited and rather close middle, if you are careful, that still avoids doubling, yet joins together the close-up sides. It's a matter of proportion, again. If you have your vocalist at one mike and your accordion at the other, then without disturbing these two points you can place a third instrument in between, in the background at a reasonable distance. Say ten or fifteen feet at the most. Reasonable, in that your ears can easily make a sensible room-space out of such a total sound, placing the side sounds at the mikes (speakers) and spreading the middle back a short distance, via a mild, not-too-big liveness. Done rightly, this shortsighted kind of miking is just as good, in its sphere, as the farsighted kind that keeps all the sound back from the two speakers.

But done wrongly, the bogey of doubling will spoil this type of stereo just as quickly as the other. Put your "middle" instrument too close to the mikes and it splits in two, one half migrating to each speaker.

You can see how this business of middle is related to and opposite to the phenomenon of doubling. Good middle, no doubling. Lack of middle, unpleasant doubling of sounds that ought to be in the middle. In other words, doubling relegates the middle to the sides—both sides.

### Third-Track Substitutes

Now this, you see, is where the third track comes in. A third track solves in one fell swoop the whole problem of missing or falsified middle. Put in a third mike, a third channel and a third functioning loudspeaker and you have your middle literally, not by mental reconstruction.

Given a true third track, our stereo problems would fade to the vanishing point! If every home stereo system had three channels and three loudspeakers, stereo engineers would stop growing gray hairs overnight. (And the servicemen would start. Ed.) Anything can be done with three tracks. Ask the movie people.

Most of all, three tracks provide for two sides and a real, live, actual middle. With three tracks, doubling is enormously reduced in virtually every circumstance where it is a problem in two-channel stereo. You can have all sorts of cakes and eat them too. You can pick up a huge, wide orchestra at a "nearsighted"

"Abdul's really living since he got his United Speaker System"

**HI, FI and HANDSOME**

New decorator designed, precision crafted cabinet and speaker system in selected woods, hand-rubbed to a glowing patina. Choose rich African Mahogany, Swedish Birch or Pewter Walnut. SPECIFICATIONS: 8½" AccuSonic Woofer and 3" integral cone Tweeter, 45-16,000 cycle freq. resp.; resistance loaded enclosure for maximum bass. DIMENSIONS: 24" x 24" x 15½" deep. Write for literature.

**AccuSONIC SERIES X-100.... 99.50**  
in Walnut 104.50

the X-200 horn-loaded speaker system \$198.

**United SPEAKER SYSTEMS**

**34 NEW STREET • NEWARK, N. J.**

Circle 86B

quired, except for the chassis.)

$C_1, C_2, C_3$	0.25 $\mu$ f, 400 v. paper
$C_4$	10-10-10-50/450-450-450 25, electrolytic; Sprague TVL-4723
$C_7$	.001 $\mu$ f, 1000 v. paper; Sprague 10TM-D1
$J_1, J_2$	Closed circuit phone jacks
$P_1$	0.1-meg potentiometer, linear; IRC Q11-128
$P_2$	10,000-ohm potentiometer, audio taper, IRC Q13-116
$P_3$	5000-ohm potentiometer, linear; IRC Q11-114
$P_4$	2-ohm potentiometer, wire wound; IRC W-2
$P_5$	100-ohm potentiometer, wire wound; IRC W 100
$R_1$	220 ohms, $\frac{1}{2}$ watt
$R_2, R_3, R_8, R_{10}$	100 K ohms, 2 watts, 5%
$R_5$	470 K ohms, 1 watt
$R_6$	1500 ohms, $\frac{1}{2}$ watt
$R_7, R_9$	1.0 megohm, $\frac{1}{2}$ watt
$R_{11}$	3900 ohms, 1 watt, 5%
$R_{12}, R_{13}$	100 K ohms, 1 watt, 5%
$R_{14}$	15,000 ohms, 2 watts
$R_{15}$	9000 ohms, 10 watts, wire wound
$R_{16}$	1000 ohms, 1 watt
$R_{17}$	4700 ohms, 1 watt
$R_{18}$	47,000 ohms, 1 watt
$R_{19}$	5000 ohms, 5 watts
$R_{20}, R_{21}, R_{22}$	10,000 ohms, 1 watt
$Sw_1$	DPDT toggle switch
$T_1$	Output transformer, Triad S-35A
$V_1, V_2$	6SN7GTB
$V_3, V_4$	6Y6
$V_5$	01B/YR-150
Chassis	10-12-3 in.

Sockets for 6SN7's are Vector 10MB12T (4 required)

POWER SUPPLY PARTS LIST

$C_1, C_2$	80-40/475, electrolytic; Sprague TVL-2850
$C_3$	30 30/150 electrolytic; Sprague TVL 2422 (insulated from chassis)
$C_4, C_5$	.01 $\mu$ f, 400 v. paper
$L_1, L_2$	Choke, 3 Hy, 160 ma, 75 ohms; Triad C13-X
$R_1, R_2$	100 K ohms, 2 watts
$R_3$	47 ohms, 2 watts
$R_4$	2400 ohms, 2 watts
$Sw_1$	DPST toggle switch
$T_1$	TV power transformer for 300/325 volts d.c. output at 300 ma; 6.3 volts at 12 a; 5 volts at 3 a.
$T_2$	Filament transformer, 6.3 v at 1 a.
$V_1$	5U4GB
Rect.	50-ma, 130-volts selenium rectifier
Chassis	7-11-3 in.

**JAZZ**

(from page 22)

**Doug Watkins: Watkins At Large Transition 20**

The continuing evolution of the jazz rhythm section into a fluid and musically engrossing team of virtuosos is reflected in this LP, the first to bear the name of Detroit's Doug Watkins, a cousin of Paul Chambers, and a mercurial bass player in his own right. With drummer Art Taylor, he paces guitarist Kenny Burrell and pianist Duke Jordan in bounteous solos and comes to the fore on resonant choruses from a stalwart seven foot



to be listened to

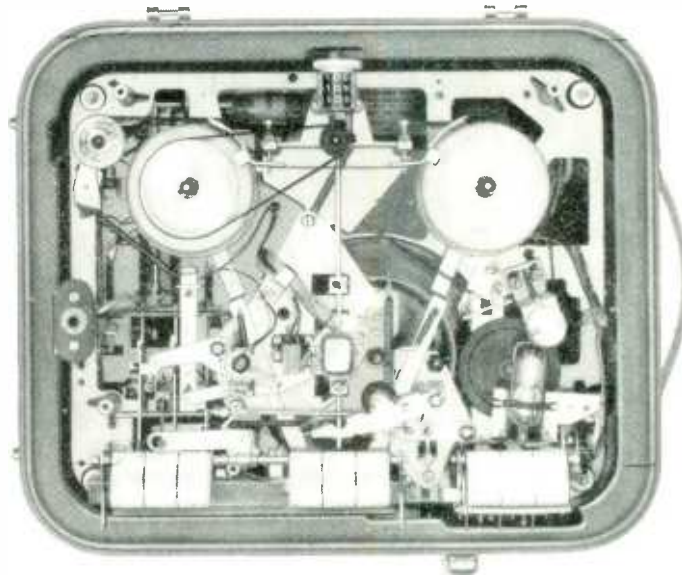

introducing the

**NORELCO** 'CONTINENTAL'  
three-speed portable  
**TAPE RECORDER**

Above is a technician's-eye view of the new Norelco 'Continental.' It is a reassuring picture to tape recorder mechanics - many are even calling the 'Continental' the most advanced machine of its type. But most of the readers of this magazine are not tape recorder mechanics - they are seekers of good sound. It is to these readers that we say - the specifications of the 'Continental' are great...but that's beside the point! We won't tell you about them yet - because we first want you to listen to the sound! Go to your dealer and ask for a demonstration. Then just listen. The Norelco 'Continental' will convince you with sound - not with cycles and decibels. Don't say we didn't tell you in time for Christmas!



Engineered by Philips of the Netherlands, world pioneers in electronic design

Precision-crafted by Dutch master technicians

Styled by the Continent's top designers

Three speeds (7 1/2, 3 3/4 and 1 3/4 ips)... twin tracks... pushbutton controlled

Special narrow-gap (0.0002 in.) magnetic head for extended frequency response

Built-in wide-range Norelco speaker

Lightweight... easily portable... rugged

Can also be played through external hi-fi system



For the name and address of your nearest Norelco dealer, write to Dept. 24.

NORTH AMERICAN PHILIPS CO., INC.  
High Fidelity Products Division  
230 DUFFY AVENUE,  
HICKSVILLE, L. I., N. Y.

# The Presence of a Queen



# Stentorian

## LOUDSPEAKERS



Royal Sound at POPULAR PRICES

### 10" Stentorian Universal Impedance Loudspeaker Model HF 1012U

Response: 30-14,000 cps.  
 Bass Resonance: 35 cps.  
 Power Rating: 10 W.  
 2 lb. Alcomax magnet system:  
 12,000 gauss  
 1" Universal Voice Coil for 4, 8, or  
 16 ohm use  
 W/B Cambric cone with mid-range  
 stabilizers  
 Die-cast chassis  
 Loudspeaker cutout 9 1/4"  
 List Price: \$31.60  
 Special Audiophile Net: \$18.95

How is such high fidelity possible at so low a price? Simple. The Whiteley Electrical Radio Co., manufacturer of Stentorian products, is the world's hi-fi pioneer, having made the first commercial permanent magnet speakers in 1927. They manufacture all speaker components from permanent magnet systems to cambric cones, and can therefore assemble and sell their speakers with maximum economy.

Such regal presence . . . such "live performance" sound . . . worthy of a queen! W/B Stentorian speakers are part of the high fidelity equipment on the Royal Yacht, Britannia, of Her Majesty Queen Elizabeth II.

Stentorian Tweeter Model T-10 2,000-16,000 cps., 5 watts, 2 1/2 lb. Alcomax Magnet System. List: \$35.00. . . . .	Special Audiophile Net
8" Stentorian Loudspeaker Model HF 812U Same specifications as Model HF 1012U except 8" speaker with 50-12,000 cps. response and bass resonance of 65 cps. List: \$25.00. . . . .	\$20.95
Stentorian Crossover Unit Model CX3000 Input and output impedances: 16 ohms. Cross-over at 3,000 cps. List: \$16.60. . . . .	\$ 9.95

\* T M Whiteley Electrical Radio Company

For complete details on these and other superior Stentorian loudspeakers and audio accessories, see your dealer or write:

## Barker Sales Company

996-8 Edgewater Avenue, Ridgefield, N. J., U.S.A.

Exclusive Sales Agents for U.S.A. and South America  
 Charter Member: Inst. of High Fidelity Mfrs., Inc.

Italian bass. The sextet is completed by Hank Mobley, tenor sax, and Donald Byrd, trumpet, who comport themselves well, but this session belongs to the rhythm men.

They offer a preview of Dimitri Tiomkin's theme *Return To Paradise*, which is played by a 110-piece orchestra in the latest Cinerama opus. The success of Shelly Manne's album of songs from "My Fair Lady" has led jazz groups to pay more attention to show tunes, but this is the first to be released before the public has had a chance to become acquainted with the original version. It is highlighted by Burrell's distinctive solo, followed by Jordan, who surprisingly adopts a sound and phrasing much like that of the guitarist Django Reinhardt, and Burrell returns to back Watkins on unamplified guitar. Tiomkin has modestly stated that his film music is not of concert caliber. As jazz it does not pull in thirteen minutes of playing time, and it will be interesting to see if the orchestral rendition stands up as well. Burrell shines again on his original *Phinupi*, and Jordan contributes *Pannonica*. There is a bedrock blues in *Phil T. McNasty's Blues*, followed by *More of the Same*, on a good recording by Bob Guy.

### Hank Mobley Quintet Blue Note 1550

When an observant musician has taken part in a number of recording sessions, he begins to have a notion of how to program an absorbing album. And along the way he may pick up a few ideas which deserve development. If he is lucky enough to attain some stature as a soloist, he may eventually use what he has learned as does Hank Mobley on his eight originals on this disc, which stems from just such experience. That his writing is full of accents and insight into things often overlooked is best illustrated on *Base On Balls*. Quite a few blues depend on bass figures of varying complexity as a motivating force, but Mobley takes the simplest of them all, as delivered by bassist Doug Watkins, and brings it to the fore to wrap up a few telling comments on the blues so well that one can only wonder why it was never done before.

Not only does Mobley enhance his standing as a writer and soloist, but he shows that he possesses a goodly share of the qualities which go to make a leader. As a result, trumpeter Art Farmer has seldom performed better, and his muted solo on *Fin de L'Affaire* is one of his most moving and inspired. Art Blakey is suitably restrained and exhibits the more tasteful side of his drumming. Pianist Horace Silver solos strongly as always, and adds gently to the spirit and drive behind Mobley's uptempo numbers.

### Gil Melle: Quadrama Prestige 7097

Except for two tunes by Duke Ellington, the seven numbers on this album are all originals by Gil Melle, one of the few baritone sax players who owes little to Gerry Mulligan in the way of style or provocative ideas. Much of the difference lies in his warmer, rounder tone and a more subtle use of humor and satire. He also has enjoyed a working partnership for the past year with Joe Cinderella, whose lyric guitar becomes an equal voice in the quartet. Interweaving with the horn or backing Melle in his solos, Melle passes a most rigid test when he quietly underlines the guitar choruses with long, lithe lines.

For the most part Melle's writing consists of lively, well-thought exercises, sometimes of great technical difficulty, designed to show his versatility. But not to the neglect of the dramatic climax on *Rush Hour In Hong Kong*, *Full House*, and *Quadrama*. Dedicated to his wife, *Jacqueline* is a slow ballad, full of tenderness, and able to hold its own in such excellent company as *Sentimental Mood* and *It Don't Mean a Thing*. Bassist George Duvivier shines on *Walter Ego* and Shadow Wilson, on drums, fills in with expert brushwork.

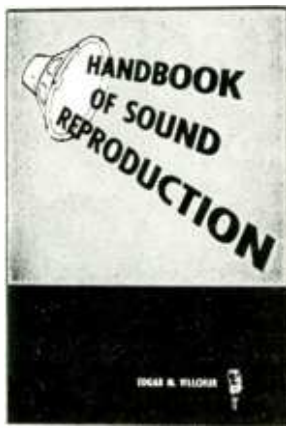

## AT LAST!

The book you have waited for so long —

EDGAR M. VILLCHUR'S

## HANDBOOK OF SOUND REPRODUCTION

For over two years, this material ran in consecutive issues of AUDIO and was followed avidly by every reader. Now available in

book form, with corrections and minor revisions, this material will be recognized as the basis of a thorough course in sound reproduction. Covers the subject from the elements of sound to individual chapters on each of the important components of a sound reproducing system. Ready for immediate delivery, \$6.50 postpaid.

Customary discounts to dealers and distributors

RADIO MAGAZINES, INC., Book Division  
 P. O. Box 629, Mineola, N. Y.

Please send me . . . . . copies of Villchur's HANDBOOK OF SOUND REPRODUCTION. I enclose check  money order  for \$6.50 each.

Name . . . . .  
 Address . . . . .  
 City . . . . . Zone . . . . . State . . . . .



**The Jazz Messengers: Ritual**  
Pacific Jazz M402

After recording for Elektra, Columbia and Victor, the new edition of the Messengers now turns up on a West Coast label. The album derives its title from one of Art Blakey's descriptive drum suites, in this case executed with only the members of the quintet doubling as percussionists. It consists of three short sketches of life in an African Village, the last being a well-punctuated tale of the momentous arrival of the first motor car, a noisy and aptly rhythmic beast. It is a charming representation of the humor the group might put into a nightclub performance.

The five other numbers are mostly distinguished by a waltz theme in Mal Waldron's *Touche*, and rampant bagpipes in *Scotch Blues*, a joint effort by Duke Jordan and Blakey. Pianist Sam Dockery's plunging *Sam's Tune* sets the loosely-swinging mood of the session. On the liner, trumpet Bill Hardman's name is misspelled and Jackie McLean, alto sax, turns up on tenor.

**Mood In Blue** Urania UJ1209  
**Anthology Of California Music, Vol. 3**  
Jazz West Coast JWC507

Those who number themselves among what have been called the "fringe listeners" to jazz, a large group wanting to own a cross section of the best in the idiom, will make no mistake in acquiring either of these albums. Urania selects from sessions made for its Jazz Series eight superior mood pieces, each featuring an artist of supreme talent such as Coleman Hawkins, Jack Teagarden, Lucky Thompson, Ernie Royal, and Willie "The Lion" Smith, playing numbers such as *Where or When*, *Taking a Chance on Love*, *Stars Fell on Alabama* and *I'll String Along With You*.

A healthy sampling of ten numbers by units appearing on Pacific Jazz at a higher price is assembled in the third volume of a continuing anthology of musicians based in California. All are picked from performances recorded in the past year by groups under Gerry Mulligan, Chico Hamilton, Chet Baker, Art Pepper, Bud Shank, Russ Freeman, Phil Urso, or Bill Perkins. Realizing the value of this disc as promotion, the company puts its best foot forward and offers some previously unreleased tracks.

**Railroad Sounds: Steam And Diesel**  
Audio Fidelity AFLP 1843

Some of the powerful sounds still to be heard on the New Orleans Division of the Illinois Central Railroad are documented, with the benefit of expert microphoning, on this tribute in sound to the steam and diesel engine. At times, the vantage point is so close that escaping live steam, and the slow creak of steel relaxing from the strain of its exertion, make the machinery seem wholly animate. At others, a distant whistle mournfully heralds the thunderous approach of a laboring mammoth. More than one microphone is employed to gather both the impact from the ground and the soundwaves traveling through the air. Not only are the more obvious effects captured, but careful mike placement brings out the fainter more subtle vibrations which are necessary to make a complete auditory picture of a locomotive.

Almost as much attention is paid to the diesel as to steam, and the low throb of its mighty powerhouse at rest resembles the heartbeat of a slumbering prehistoric beast. A comparison with the two discs on the disappearing steam locomotive of the West, prepared by Vinton Wight for Folkways, shows them to be documentation for the railroader. This record is for the sound enthusiast. The liner could use more descriptive notes, but even the detailed explanations provided by Wight were not much help when it came to sorting out the actual sounds—a real test for the perceptive ear. As a warning note: there are two earsplitting whistles in the opening grooves, and the volume should be set accordingly.

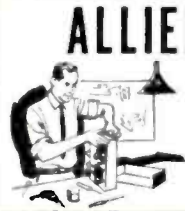

**ALLIED knight-kit HI-FI EQUIPMENT**

EASY-TO-BUILD HI-FI EVERYONE CAN AFFORD

- ★ World's Finest Hi-Fi in Kit Form
- ★ Beautiful Custom-Styled Line
- ★ Advanced, Easiest-to-Build Design
- ★ Money-Saving Hi-Fi At Its Best

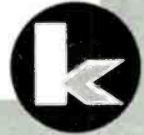

EASY TERMS AVAILABLE



Model Y-786 **\$3995**

Only \$3.99 down

**NEW knight-kit 18-Watt Complete Hi-Fi Amplifier Kit**

featuring:

- Latest Custom Styling
- Full 18 Watts Hi-Fi Output
- 8 Inputs • Full Equalization
- New Printed-Circuit Switch
- 2 Printed-Circuit Boards
- True Hi-Fi at Lowest Cost

Here's easiest-to-build hi-fi at a price that defies comparison. Features 8 inputs for every possible signal source, including NARTB equalized tape head input. Response is  $\pm 1$  db, 20-30,000 cps. At full 18 watts output, distortion is only 0.5%. Tape head and magnetic cartridge sensitivity, 5 microvolts. Uses new RCA 6973 output tubes. Output: 4, 8 or 16 ohms. Full equalization for all records; separate Bass and Treble controls. Beautiful custom-styled case, 4 x 13 x 8". Ready for easy, money-saving assembly. Shpg. wt., 15 lbs.

Model Y-786. Net, F.O.B. Chicago, only **\$3995**

**NEW knight-kit FM Hi-Fi Tuner Kit**

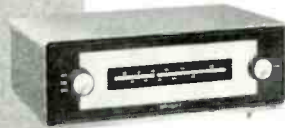

Model Y-751

**\$3895**

Only \$3.89 down

- Authentic Hi-Fi Response
- Flywheel Tuning • AFC
- Pre-Adjusted Coils and IF's
- Printed Circuit
- 4  $\mu$ v Sensitivity Guaranteed

You'll be proud to build and own this top value tuner. Covers 88 to 108 mc. Sensitivity is 4 microvolts for 20 db of quieting. "Lock-in" (AFC) tuning holds stations. Extra features: cascode broad-band RF amplifier; drift-compensated oscillator; cathode follower output; output jacks for amplifier and tape; neon bulb pointer. Beautiful "space-saver" case, 4 x 13 x 8". Wt. 12 lbs.

Model Y-751. Net, F.O.B. Chicago, only **\$3895**

THERE IS AN EASY-TO-BUILD knight-kit FOR EVERY HI-FI NEED



18-Watt Hi-Fi Amplifier Kit **\$3995**



FM Hi-Fi Tuner Kit **\$3895**



30-Watt Hi-Fi Amplifier Kit **\$7695**



FM-AM Hi-Fi Tuner Kit **\$4995**



Deluxe Hi-Fi Preamp Kit **\$3995**



25-Watt Basic Amplifier Kit **\$4450**



20-Watt Complete Amplifier Kit **\$3575**



10-Watt Hi-Fi Amplifier Kit **\$2350**



2-Way Hi-Fi Speaker Kit **\$4995**

**FREE!**

404-PAGE  
1958  
ALLIED  
CATALOG

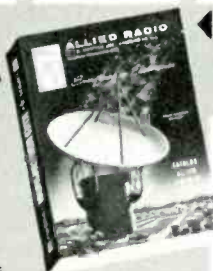

Send for this value-packed catalog featuring the world's largest selection of Hi-Fi Kits, components and complete music systems. Including Everything in Electronics. Send for your FREE copy today.

See our 1958 Catalog for full details

**ALLIED RADIO**  
America's Hi-Fi Center

ALLIED RADIO CORP., Dept. 17-L7  
100 N. Western Ave., Chicago 80, Ill.

Ship the following Hi-Fi KNIGHT-KITS:

\_\_\_\_\_ \$ \_\_\_\_\_ enclosed

Send FREE 1958 ALLIED 404-Page Catalog

Name \_\_\_\_\_

Address \_\_\_\_\_

City \_\_\_\_\_ Zone \_\_\_\_\_ State \_\_\_\_\_

our  
37th  
year

# PROOF OF Excellence

**EICO**

**HF-61A  
MASTER-CONTROL PREAMPLIFIER**



**KIT \$24.95  
WIRED \$37.95**  
(powered by any  
EICO power  
amplifier)

**HF61 KIT \$29.95  
(with Power Supply) WIRED \$44.95**

"...the HF-61's performance rivals that of the most expensive preamps. There are inputs for several types of phono cartridges; five phono-equalization curves; a tape output which follows the filters but precedes the tone-control stages; inputs for tape recorder, tuner, TV, and an auxiliary; AC sockets for four other pieces of equipment; the Compentrol type of loudness control with a separate level control; the excellent tone-control action of the Baxendall circuit; a hum adjustment; and low-impedance main output. All in all, here is an example of a high level of engineering skill, which has managed to achieve fine performance with simple means and low cost."

Joseph Marshall - AUDIOCRAFT, April, 1957

**HF60 60-WATT Ultra-Linear POWER  
AMPLIFIER with  
ACRO TO-330  
Output Xfmr  
KIT \$72.95  
WIRED  
\$99.95**

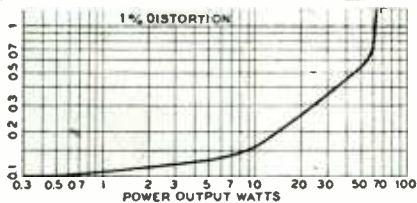

1M distortion vs. power output as measured by AUDIOCRAFT.

"As far down and as far up as we are equipped to measure, the frequency-response specifications were met easily. Square-wave response was nearly perfect with any kind of load: resistive, inductive, or capacitive. The only way we could make the amplifier show noticeable high-frequency ringing was to operate it with NO load at all. Low-frequency stability was excellent also... Listening tests confirmed the fine instrument test results without question. Our HF-60 produced firm, well-defined bass and clear, sweet treble on the finest speaker systems available. It clipped momentary overloads very well and recovered quickly, and this gave listeners the impression of tremendous reserve power. In our opinion, it is one of the best-performing amplifiers extant; it is obviously an excellent buy."

AUDIOCRAFT Kit Report, July, 1957.

**Also Available:**

**HF50 50-WATT Ultra-Linear Power Amplifier** with extremely high quality Chicago Standard Output Transformer. Identical in every other respect to HF60 and same specifications up to 50 watts.

**KIT \$57.95 WIRED \$87.95**

**HF52 Integrated 50-WATT Ultra-Linear Amplifier and Preamplifier-Control Section** on one chassis. All preamp features of HF61 less scratch and rumble filters. Power amplifier section essentially identical to HF50.

**KIT \$69.95 WIRED \$109.95**

Prices 5% higher on West Coast  
**IN STOCK at your neighborhood distributor**  
Write for free Catalog A-11.



33-00 NORTHERN BLVD.  
LONG ISLAND CITY 1, N. Y.

## AUDIO TECHNIQUES

(from page 11)

is being approached. We have done this with good results.

### Clearing Solder Lugs

We have all experienced much difficulty in removing excess solder from components such as RETMA skirted plugs, coaxial fittings and the like. To accomplish this removal quite simply, straighten a paper clip (leaving one bend to be used as a handle) and insert the tip of the clip as far as it will go into the hole to be cleared. Heat the solder and, at the same time, apply pressure to the clip. Presto: one cleared plug! *Janice Zacker, Sacramento, Cal.*

### Amplifier Output Tubes

When building experimental audio amplifiers, you can substitute transmitting tubes for those normally used in the output stage. Surplus 1625's are available for 29 cents each. 837's can be had for a dollar and a half each. For that big 150 watter, try a pair of surplus 811's. All of these tubes are known to be linear, since they are used in class B r.f. amplifiers for single sideband applications, where non-linearity causes serious alteration of the modulation envelope and consequent distortion. *Oscar J. Hendriksson, Madison, Wis.*

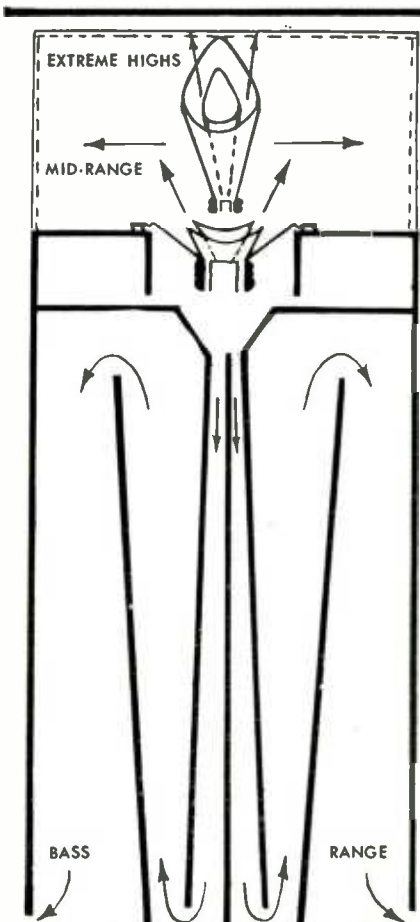

**EICO**® proudly presents...  
a major break-through in  
speaker system development



a new combined horn and direct-radiator system having uncolored transient response, superb damping, and non-directional sound distribution. Includes built-in LC dividing network and balance control.

- Frequency Response:** essentially flat 45-20,000 cps; useful response 30-40,000 cps.
- Rated Impedance:** 16 ohms.
- Efficiency:** can be driven satisfactorily from good amplifiers having a power output as low as 10 watts.

**Rated Power Handling:** 30 watts integrated program material.  
**Dimensions:** 36" high, 15 1/4" wide, 11 1/2" deep. Weight 45 lbs.  
**Finishes:** hand-rubbed mahogany, walnut, or blonde.  
**Price:** \$129.95 net

If you appreciate the difference between artificial "hi-fi" and truly natural sound, listen to the EICO New Standard Speaker System at your local distributor. For complete data, write for free Bulletin AX-11.

**EICO**® 33-00 Northern Blvd.  
Long Island City 1, N. Y.  
Prices 5% higher on West Coast

## AUDIOCLINIC

(from page 1)

consists of a bridge rectifier and a capacitor input filter. Input to the bridge is obtained by connecting the two six-volt secondaries of a TV power transformer in series. Connecting the 12 volts d.c. to the preamplifier filament string causes the voltage to drop to less than 1.5 volts, and of course, the filament fails to glow. Can you offer an opinion as to what I have done wrong? *George W. Helms, Kansas City, Kansas*

A. Several factors can cause low filament voltage. 1. Diodes can be defective or of insufficient current ratings. 2. The choke or resistor in the filter may be of too high a value. 3. Perhaps the transformer windings were connected out of phase. If possible, check the forward resistance of the diodes. It should be as low as possible. Measure the voltage at the input of the filter and at its output. The measurement should be made under load. If the voltage is normal at the input of the filter, but low at the output, the value of the resistor or choke is too high. The value of the choke does not refer to its inductance in this case, but rather, to its d.c. resistance. To determine whether the power transformer is defective, or has been wired out of phase, measure the a.c. voltage at the input terminals of the bridge. Under normal operation it should be about 12 volts. **Æ**

a high quality system at low cost... from **EICO**



**NEW!**  
**FM TUNER**  
**HFT90**

**KIT, less cover** ..... \$39.95\*  
**WIRED, less cover** ..... \$65.95\*  
**Cover** ..... \$ 3.95  
\*excise tax incl.

Newly-designed, extremely sensitive, low-noise "front end", supplied in a cast housing completely pre-wired, pre-aligned, ready to use. Employs temperature-compensated components and advanced circuitry to completely eliminate need for AFC. Drift less than 2 parts in 10,000 from cold start. Radiation suppressed far below FCC standards. Also features new DM-70 traveling tuning eye. Sensitivity, unapproached among FM tuner kits, of 1.5 uv for 20 db quieting\*. Input 300 ohms, 17 bandwidth 260 kc, detector peak separation of 600 kc. Freq. resp. 20-20,000 cps  $\pm 1$  db. Audio output 1 V for 10 uv input with 75 kc deviation. Hum 60 db below 1 V. Cathode follower and multiplex outputs. Flywheel slide-rule tuning, AGC, stabilized low limiting threshold for excellent performance from weaker signals, broad-band ratio detector for improved capture ratio and easier tuning, full-wave rectifier and heavy filtering, very low distortion. Uses 1-ECC85/6AQ8, 3-6AU6, 1-6AL5, 1-6C4, 1-DM70, 1-6X4. Flexible "low silhouette" design adaptable to any panel thickness for console installation; optional cabinet. HWD: 3 3/4" x 12" x 8 1/2". Operates from 110-125 VAC, 60 cps line.  
\*\*Typical unit, measured with Marconi TF 955A/2 FM-AM signal generator.



**12-WATT**  
**Williamson-Type**  
**HIGH FIDELITY**  
**INTEGRATED AMPLIFIER HF12**  
with Preamplifier, Equalizer and Control Sec  
**KIT \$34.95**      **Wired \$57.95**

Compact, beautifully packaged and styled. Provides complete "front-end" facilities and true high fidelity performance. Direct tape head and magnetic phono inputs with NARTB (tape) and RIAA (phono) feedback equalizations. 6-tube circuit, dual triode for variable turnover bass and treble feedback-type tone controls. Output Power: 12 w cont., 25 w pk. IM Dist. (60 & 6000 cps @ 4:1): 1.3% @ 12 w; 0.55% @ 6 w; 0.3% @ 4 w. Freq. Resp.: 1 w:  $\pm 0.5$  db 12 cps-75 kc; 12 w:  $\pm 0.5$  db 25 cps - 20 kc. Harmonic Dist: 20 cps: 2% @ 4.5 w; 1/2% @ 2.5 w; 30 cps: 2% @ 11 w; 1/2% @ 6 w; 40 cps: 1% @ 12 w; 1/4% @ 9 w; 2000 cps: 1/2% @ 12 w; 10 kc: 1% @ 10 w; 1/2% @ 4 w. Transient Resp: excellent square wave reproduction (4 usec rise-time); negligible ringing, rapid settling on 10 kc square wave. Inverse Feedback: 20 db Stability Margin: 12 db. Damping Factor: above 7, 20 cps - 15 kc. Sensitivity (input for 12 W): Max. Phono. - 9 mv; Tape Head - 6 mv; Tuner, Aux - 0.5 v. Hum & Noise Level (below 12 W): Max. Phono -  $\pm 60$  db; Tape Head -  $\pm 55$  db; Tuner, Aux - 75 db. Speaker Connections: 4, 8, 16 ohms. Tone Control Range: @ 10 kc, +13 db; @ 50 cps,  $\pm 16$  db. Tubes: 2-ECC83/12AX7, 1-ECC82/12AU7, 2-EL84, 1-EZ81. Mounts in or out of cabinet. Size: HWD: 3 3/4" x 12" x 8 1/2", 13 lbs.  
\*includes effect of compensation.

**TWO-WAY**  
**SPEAKER SYSTEM**  
**HFSI \$39.95**  
complete with  
**FACTORY-BUILT**  
**CABINET**

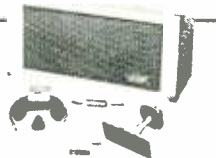

Jensen heavy-duty 8" woofer & matching Jensen compression-driver exponential horn tweeter. Smooth clean bass & crisp, extended neutral highs. Overall response:  $\pm 6$  db 70-12,000 cps. Power-handling capacity: 25 w. Impedance: 8 ohms. Bookshelf size: 23" x 11" x 9". 25 lbs. Wiring Time: 15 min.

**IN STOCK** at your neighborhood distributor.  
Write for free catalog **A-11.**

**EICO** 33-00 NORTHERN BLVD.  
LONG ISLAND CITY 1, N. Y.  
Prices 5% higher on West Coast

## TRANSFORMERS

(from page 18)

detrimental because it helps stabilize current. Leakage inductance will not materially affect the current transfer, any more than the nonlinearity of the emitter resistance used as a load. However, winding capacitance can prove to be a detrimental factor because it provides a current bypass between the collector and the following-stage emitter. Also, core losses can be detrimental even if special core material is used that does not produce nonlinear distortion in the transformer itself.

In transistor circuits, the current transfer is linear while the voltage transfer is nonlinear. This is illustrated in Fig. 4, where the curved load line represents the load reflected through the transformer by the following stage emitter resistance. Spacing vertically between intersection points is almost uniform, while horizontally, on the voltage scale, the nonlinearity shows up.

This means that any magnetizing current taken by the transformer would also be nonlinear, following the nonlinear voltage, and hence would produce a nonlinear bypass for the current. For this reason a transistor transformer should be designed to have a very small magnetizing current and its principal losses should be due to the series resistance in the winding. Similarly, capacitance, as well as causing loss of high frequencies, will introduce nonlinear distortion at those frequencies.

### Grounded Emitter

Now let's turn the transistor round to the grounded emitter position, more commonly used for practical amplifiers, shown in Fig. 5. Starting from our original concept of the grounded base, the input current in this case will be the difference between the collector and emitter current. The collector current fluctuations (except in point contact types) are usually a fraction,  $\alpha$  of the emitter current fluctuations, where  $\alpha$  approaches unity. This means that, for the same voltage swing between base and emitter as in the grounded base connection (it will be a nonlinear voltage compared with the current waveform), the input current will be  $(1 - \alpha)$  times the emitter current.

Using 0.95 as a typical value of  $\alpha$ , this means that the input resistance of a transistor in the grounded-emitter connection is about 20 times its input resistance as a grounded-base amplifier.

It will have a current amplification of about 20, which would be a gain of 26 db, if the input and output circuit resistance were the same.

Looking at the output circuit, the current and voltage swing, measured between collector and base, can be the same

two more **BEST BUYS...**  
from **EICO**



**20-WATT**  
**Ultra-Linear**  
**Williamson-Type**  
**INTEGRATED**  
**HIGH FIDELITY**  
**AMPLIFIER HF20**

complete with Preamp-Control Section

**KIT \$49.95**      **WIRED \$79.95**

During its first year, the HF20 has received consistently high praise from users - has become established as the outstanding value in amplifiers of this power class. Employs an output transformer capable of handling far in excess of its rated 20 watts, a full Ultra-Linear Williamson power amplifier, and the finest pre-amplifier-control facilities. Rated Output: 20 w (34 w pk.) IM Distortion (60 & 7,000 cps @ 4:1): 1.3% @ 20 w. Harmonic Distortion: below 1% from 20-20,000 cps within 1 db of 20 w. Freq. Resp.:  $\pm 0.5$  db 15-30,000 cps at any level from 1 mw to 20 w; no peaking or raggedness outside audio range. Square Wave Resp.: 20-20,000 cps essentially undistorted. Sens.: 4 mv on mag phono & .4 v on tuner, etc., for 20 w output. Hum & Noise: 60 db below 20 w on mag phono, 75 db below 20 w on tuner, etc. 5 feedback equalizations for LPs & 78s, 4 hi-level switched inputs (tuner, tv, tape, crystal), unused inputs grounded to eliminate cross-talk; 2 low-level inputs for proper loading with all cartridges. Low distortion variable crossover feedback tone controls:  $\pm 15$  db @ 50 cps &  $\pm 15$  db at 10 kc, with mid-freqs. & volume unaffected. Hum bal. control. DC superimposed on tube filaments to eliminate cathode-heater leakage as hum source. Centralab printed circuit "Compentrol." Loudness control & separate level set control on front panel. Extremely fine output transformer: interleaved windings, tight coupling, careful balancing, grain-oriented steel. Speaker Connections: 4, 8 & 16 ohms. HWD: 8 1/2" x 15" x 10". 24 lbs. Matching Cover E-1, \$4.50.



**NEW! 30-WATT**  
**High Fidelity**  
**POWER**  
**AMPLIFIER HF30**

**KIT \$39.95**      **WIRED \$62.95**

Four EL84 output tubes in push-pull parallel; high power sensitivity eliminates need for extra driver stages, permitting Williamson-type circuit with large inverse feedback and high stability margin. 6 lb. output transformer, extensively interleaved windings & grain-oriented steel laminations. Surge-free, high reliability power supply using two EL81 full-wave rectifiers. Power take-off socket for EICO HF61A Preamplifier. Rated Output: 30 w (47 w pk.) IM Distortion: (60 & 7,000 cps @ 4:1) 2% @ 30 w; 0.83 @ 20 w; 0.35% @ 10 w. Harmonic Distortion: below 1% from 20-20,000 cps within 1 db of 30 w. Freq. Resp.:  $\pm 0.1$  db 15-30,000 cps &  $\pm 1.5$  db 15-100,000 cps, at any level from 1 mw to 30 w; no peaking or raggedness outside audio range. Square Wave Resp.: 20-20,000 cps essentially undistorted. Inverse Feedback: 20 db. Stability Margin: 15 db. Damping Factor: above 10, 20 cps to 20 kc. Sens.: 1.24 V for 30 w. Hum: 80 db. below 30 w. Speaker Connections: 4, 8, and 16 ohms. HWD: 5" x 12" x 7". 17 lbs. Matching Cover E-3, \$4.50.

**EICO** 33-00 NORTHERN BLVD.  
LONG ISLAND CITY 1, N. Y.

Please send **FREE** catalog and name of neighborhood distributor or high fidelity specialist.

Name.....

Address.....

City.....Zone.....State.....

Prices 5% higher on West Coast A-11

*Superb Craftsmanship*  
*Magnificent Performance*

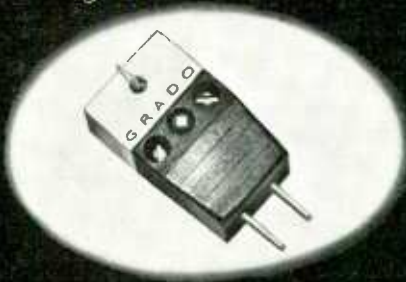

quality designed by **GRADO**

We announce with pride the development of a custom crafted phonograph cartridge of revolutionary design ...*THE GRADO CONSTANT IMPEDANCE MOVING COIL TRANSDUCER*. This unit for the first time reproduces the peerless quality of the master tape. The Grado is precision made by master watchmakers to the highest electronic standards.

Used by leading audio manufacturers and research technicians as a laboratory standard.

Audiophile Net Price \$45.00

GRADO LABORATORIES • 4614 SEVENTH AVENUE • BROOKLYN 20, NEW YORK  
EXPORT DIV. • 25 WARREN ST. • NEW YORK 7, N. Y.

**STATEMENT REQUIRED BY THE ACT OF AUGUST 24, 1912, AS AMENDED BY THE ACTS OF MARCH 3, 1933, AND JULY 2, 1946 (Title 39, United States Code, Section 233) SHOWING THE OWNERSHIP, MANAGEMENT, AND CIRCULATION OF**

AUDIO, published Monthly at Lancaster, Pa., for October 1, 1957.

1. The names and addresses of the publisher, editor, managing editor, and business managers are: Publisher: Charles G. McProud, 204 Front St., Mineola, N. Y.; Editor: Charles G. McProud, 204 Front St., Mineola, N. Y.; Managing editor: none; Business manager: Henry A. Schober, 204 Front St., Mineola, N. Y.

2. The owner is: Radio Magazines, Inc., 204 Front St., Mineola, N. Y.; Henry A. Schober, 204 Front St., Mineola, N. Y.; Charles G. McProud, 204 Front St., Mineola, N. Y.

3. The known bondholders, mortgagees, and other security holders owning or holding 1 per cent or more of total amount of bonds, mortgages, or other securities are: none.

4. Paragraphs 2 and 3 include, in cases where the stockholder or security holder appears upon the books of the company as trustee or in any other fiduciary relation, the name of the person or corporation for whom such trustee is acting; also the statements in the two paragraphs show the affiant's full knowledge and belief as to the circumstances and conditions under which stockholders and security holders who do not appear upon the books of the company as trustees, hold stock and securities in a capacity other than that of a bona fide owner.

(Signed) HENRY A. SCHOBBER, Business Manager

Sworn to and subscribed before me this 9th day of September, 1957.

(Seal) GEORGE W. SCHULT, Notary Public.

State of New York. No. 30-8856885. Qualified in Nassau County. Term expires March 30, 1958.

as they were in the grounded base circuit. The current swing will be the same in the grounded emitter arrangement, because the collector circuit is common to both arrangements, but the voltage swing will differ because it is measured from collector to emitter instead of from collector to base. As the voltage fluctuations from emitter to base are in the same phase as the fluctuations from collector to base, the emitter-to-base voltage swing is deducted from the swing available in the grounded base circuit.

The voltage developed from emitter to base—or, in this case, from base to emitter—is dependent upon the input resistance of the transistor and, as stated earlier, this in turn is dependent upon the collector voltage. Thus the loading in the collector circuit of the grounded emitter stage will affect the voltage between base and emitter. This, in turn, will modify the input to the transistor and thus reduce the current swing available at the collector.

This is a complicated and quite involved sequence to trace out. For this reason separate characteristics for the grounded emitter condition are published for most transistors. A sample set are shown at *Fig. 6*. From these curves it is evident that the effective output resistance, represented by the slope of the characteristics, is nowhere near so constant as in the grounded-base stage. Linear amplification will be much more critically dependent upon the slope of the load line.

In some transistors the spacing of the lines is such that the current amplification will be nonlinear at whatever slope the load line is drawn. In these instances the matter can usually be rectified to some extent by utilizing the nonlinear loading of the input resistance, either of this stage on the preceding stage or of the following stage on this stage, according to which way the spacing becomes nonlinear, i.e. whether the cramping occurs at the top or bottom.

In a stage of this kind the output resistance is a little more than 10 times the input resistance. This means that the active power gain, when the current gain is 26 db, becomes 36 db or more.

In tube amplification we have become used to speaking of voltage gain, so, to complete the picture, we will consider the effective voltage amplification. The current gain is 26 db, or 20 to 1, and the resistance of the output circuit is in the region of ten times the resistance of the input circuit. So this means the output voltage is more than 200 times the input voltage, or that the transistor gives a voltage gain of 46 db or more.

In a direct- or R/C-coupled amplifier, however, only 26 db per stage could be realized, because the transistor is a current operated device. To improve coupling efficiency in a multistage amplifier, we

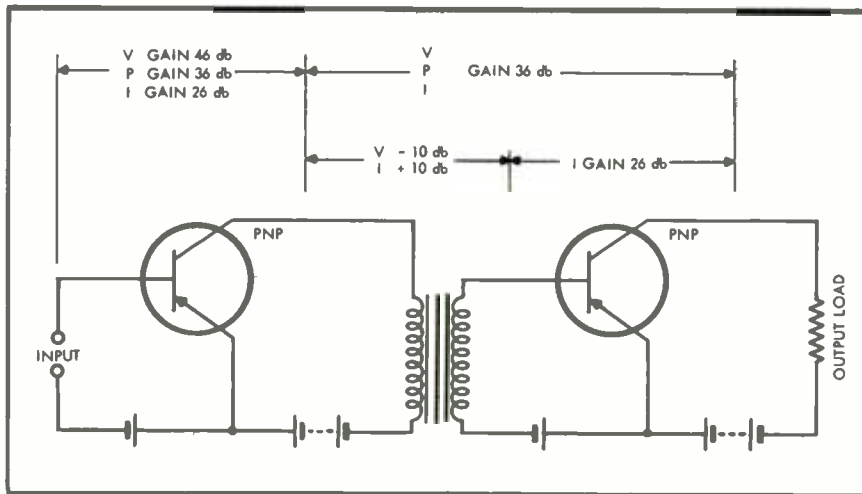

Fig. 7. A practical transformer-coupled grounded-emitter two-stage amplifier, showing distribution of gain—see text.

can again use transformers to match output to input, using this time a step down in the region of 3 to 1 (or maybe a little more). This will enable each transistor, with its associated interstage transformer, to yield a power (or voltage gain) of better than 36 db, or about

resistances which would result in undesirable high frequency roll-off. In transistor circuitry, using grounded emitter or grounded collector, all the impedances are of a reasonable order and so capacitances do not assume important proportions. Leakage inductance is relatively

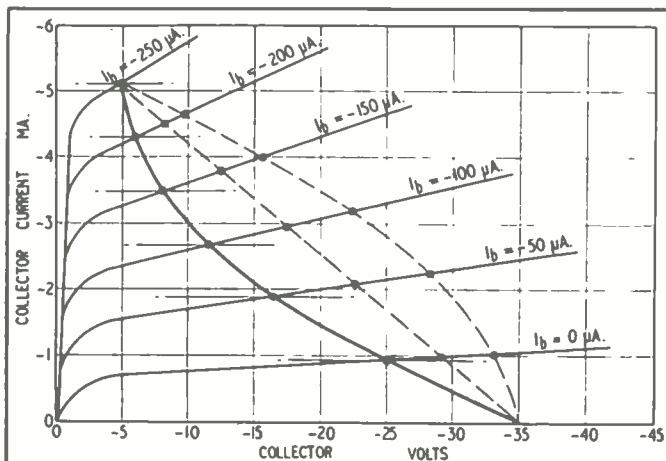

Fig. 8. How the non-linear load reflected through the interstage transformer of Fig. 7 can result in linear current amplification (solid curve); dotted are a linear resistance load, and the same non-linear load with transformer phasing reversed, showing greater distortion.

half as much again as without the transformer. The input stage achieves a voltage gain of more than 46 db, as illustrated in Fig. 7.

In tube circuits, to achieve gain in excess of 40 db from a single tube would necessitate the use of high plate circuit

unimportant too. This is why it proves possible to apply feedback over several transistor stages, even when they are transformer coupled.

A convenient feature of feedback over transformer coupling is the ease with which correct phase can be obtained by

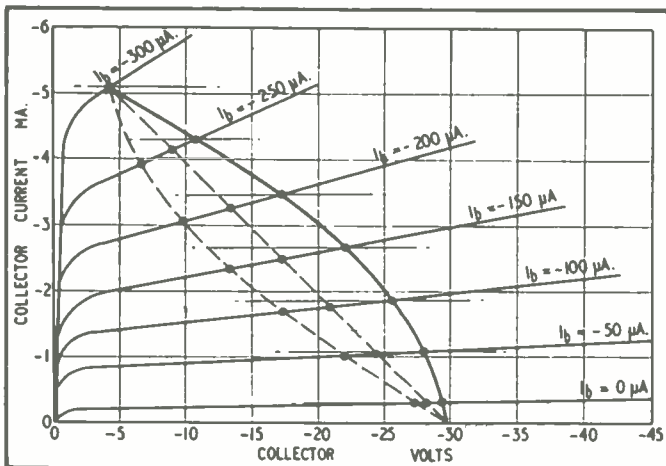

Fig. 9. Different transistor characteristics require phasing opposite from that of Fig. 8 to give best linearity of current amplification.

**NEW!**



**RACON  
18" WOOFER**

for a new high in lows

The new Racon 18" woofer, model 18-HW, is truly the Goliath of the bass family in its reproduction of extremely low frequencies. Deep fundamentals to the sub-audible area are rendered with precision and freedom from boom.

The 18-HW uses the Racon patented design of floating cone which results in low fundamental resonance, high compliance and low mass. The plastic foam surround which supports the cone, provides pneumatic self-damping to smooth out the resonant peak. Optimum performance is assured without recourse to expensive amplifiers having special output circuitry or high damping factors.

A series of feather-weight stiffening struts are cemented radially to the back of the cone to add rigidity, preventing "breakup" at high volume levels.

The 18-HW is of the high efficiency type and does not require abnormally large amplifiers. Any conventional 10-20 watt amplifier will supply more than adequate drive for the most exacting home use. The magnetic structure uses a 20 lb. chemically pure iron "keeper" which encloses an Alnico 5 DC slug magnet weighing 5 lbs.

To assure maximum rigidity and maintain voice coil concentricity at all times, the supporting basket is a one-piece massive aluminum alloy sand casting.

WRITE FOR FREE LITERATURE

**SPECIFICATIONS**

<b>FREQUENCY RESPONSE:</b>	10 to 1500 cps
<b>FUNDAMENTAL RESONANCE:</b>	19 c.p.s.
<b>POWER:</b>	25 watts
<b>WEIGHT:</b>	38 lbs.
<b>DIMENSIONS:</b>	18 1/4" dia, 10" d
<b>AUDIOPHILE NET:</b>	\$150.00



Export: Joseph Plasencia  
401 Broadway, New York, N. Y.  
Canada: Dominion Sound Equipments Ltd.  
4040 St. Catherine St., West-Montreal 6, Que.

# FULL FIDELITY MUSIC ENJOYMENT

TWIN-CONES IN A SINGLE

*F.R.S.* SPEAKER  
COVER THE  
AUDIBLE RANGE



Norelco®

TWIN-CONE \*FRS  
\*FULL RESONANCE  
SPEAKERS

In a single speaker, Norelco has created an unusually efficient sound radiator. These twin-cone speakers incorporate a small cone for reproducing high frequencies and a large cone for lower frequencies. Both cones operate in conjunction from a single voice coil—producing balanced sensitivity and uniform sound for all ranges. Arrangement of both cones reflect and diffuse the sound while moving in phase to provide even sound distribution.

A deep air gap within a homogeneous magnetic field provides unusually large movement of the voice coil resulting in distortion-free reproduction over the entire frequency range. Impedance does not diminish with higher frequencies and volume is practically constant throughout the whole audible range.

Send today for your catalog on Norelco \*FRS Twin-Cone Speakers. It contains specification data, sound distribution curves, frequency characteristics on these speakers as well as the new Norelco Speaker Enclosures.



Send to Dept. A11 for more details

NORTH AMERICAN PHILIPS CO., INC.  
High Fidelity Products Division  
230 Duffy Ave. Hicksville, L. I., N. Y.

the reversal of any winding on one of the transformers. But in transformer coupling transistors, phasing is important for another reason, illustrated in Figs. 8 and 9. The input resistance of the following stage is nonlinear. But with transformer coupling, the direction of nonlinearity can be reversed simply by reversing connections in one winding. Figures 8 and 9 show two different sets of grounded-emitter characteristics. As these load lines show the desirable phasing of an interstage transformer is reversed, as they "like" opposite varieties of curvature. For comparison, a pure

resistance, and nonlinearity in opposite phase is shown in each case, dotted.

It is not impossible that, with careful design, a transistor amplifier using these small transformers may yet yield a frequency response and distortion figure comparable with a high-quality tube amplifier. But to achieve these results it will be necessary to see that the transformers have satisfactory characteristics and also that the transistor circuits are correctly adjusted to obtain maximum linearity at each stage. A further article will describe in detail simple practical methods of working to this end **Æ**

## TWO-CHANNEL MIXER

(from page 37)

cell would be in order to eliminate even this limitation. The total current drain is 1.5 ma at 4.5 volts. The output signal available across a 50-ohm load is approximately .053 volts, which is sufficient to feed into the normal microphone input of the Auricon amplifier.

As in a similar amplifier previously described<sup>1</sup> a plexiglass chassis was used

through for support without the need of additional insulation or support mountings. Labels and markings can be seen from both sides during the construction, which was basically completed before mounting in the aluminum case—made from an old recording disc. Transistor sockets mount nicely after a pilot hole is drilled and the plastic softened with a soldering gun or small iron, then inserting the socket while the plastic is still soft. The plexiglass drills and taps easily for mounting the transformer and for attaching to the cabinet.

Typical voltage readings obtained from this amplifier are as follows:

	Emitter	Base	Collector
V <sub>e</sub>	-0.65	-0.78	-0.84
V <sub>b</sub>	-0.70	-0.78	-0.85
V <sub>c</sub>	-0.94	-1.04	-4.05

Supply voltage - 4.5 v.

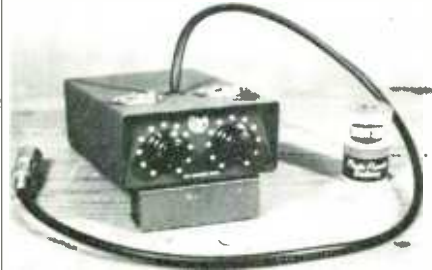

Fig. 8. Commercially available model of the amplifier described by the author in the September issue.

for this unit. It allows the components to be mounted with leads feeding directly

<sup>1</sup> Donald K. Haahr, "Two-channel transistor remote amplifier," *Armo*, Sept, 1957.

The amplifier of similar type that was described previously is now available commercially, and is built in the form shown in Fig. 8.

The writer wishes to acknowledge his indebtedness to the Colling Radio Company, Keith Ketcham, Mel Haas, and Merv Gardner for their valuable assistance in design, development, and construction. **Æ**

Fig. 7. Distortion and frequency response curves of the amplifier modified as in Fig. 6.

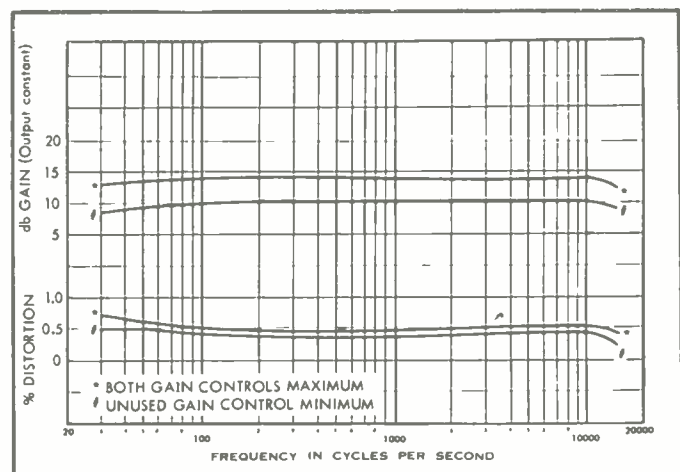

## TAPE DUPLICATOR

(from page 28)

heaviest, which means greater friction between reel and felt and therefore increases back tension. On the other hand, when the reel is nearly empty, it is more difficult to unwind because the outer layer of tape is close to the hub and affords little pulling leverage. But now the reel is lighter, there is less friction between it and the felt, back tension is therefore reduced. In sum, the weight sensitive felt cloth automatically adjusts the back tension due to friction so as to maintain total back tension nearly constant. This is an important factor in obtaining the uniform motion required for good recording results. Relatively constant back tension, together with other measures to be described, keep flutter below 0.15 per cent.

The compliance arm is a spring-mounted affair and is free to move in an arc. It serves as a mechanical filter which smoothes out variations in back tension, thus reducing flutter.

The guide roller is just that. The impedance roller has a relatively large and heavy base, which provides inertia to keep the tape moving at a constant rate; it, too, is a form of mechanical filter.

On either side of the two record heads are fixed guides made of glass for smoothness and resistance to wear. The left guide roller and the impedance roller are positioned so that the tape makes firm contact with the heads.

The record heads are full-track, but are positioned so as to cover only half a track inasmuch as the copies are dual track. Use of full-track heads is an advantage in that they enable relatively wide tracks to be recorded, insuring that in playback the head of the customer's machine will span a recorded signal throughout the vertical dimension of its gap. The record heads are of low impedance so that the bias frequency will not be attenuated by interwinding and cable capacitance. The head at the left in *Fig. 3* is the A head, which is operated by the A electronics section and records on the lower half of the tape. The head at the right is driven by the B electronics section and records on the upper half of the tape.

The copies are recorded so that the finished reel, at the right, is ready for playback. Therefore track A, the lower track, must be recorded backward. This means in turn that the master for track A must be played backward. On the other hand, the upper track must be recorded forward; when the takeup reel is fully wound, track B is backward, but after track A is played by the user, then track B is forward once more.



Is your pickup a  
**GROOVE DIGGER?**

Ordinary hi-fi pickups—even new models—are often highly destructive to records and styli. The chief reason is their poor compliance and large dynamic mass.

ESL electrodynamic cartridges can greatly prolong the life of your valuable records—and styli, too. Minimum lateral compliance is  $6.8 \times 10^{-6}$  cm/dyne (two to seven times that of most leading pickups), and dynamic mass is only one one-thousandth of a gram.

Not only does the ESL in this way save many times its own cost, but it also sounds better—far better. It can reproduce your records with a naturalness and clarity you've never before experienced. Hear its superiority at your dealers, and write for details.



FOR LISTENING AT ITS BEST

*Electro-Sonic Laboratories, Inc.*

Dept. A • 35-54 Thirty-sixth Street • Long Island City 6, N.Y.

Concert Series cartridge \$35.95 • Professional Series arm and cartridge \$106.50 • Dust Bug \$5.95

*New*

REVISED EDITION AVAILABLE ABOUT  
December 1, 1957

# ELECTRONIC MUSICAL INSTRUMENTS

By Richard H. Dorf  
(AUDIO Library — Vol. 1)

Up-to-date information about:

- SCHOBER
- CONN
- MINSHALL
- THOMAS
- KINSMAN
- ORGAN TUNING

**\$7.50**  
Postpaid

Customary discounts to dealers and distributors

If you missed the first edition, you're sure to want this new and revised second edition. And even if you have the first edition you are sure to want the latest information about the newest instruments. Order direct, Dept. E2, Radio Magazines, Inc., Mineola, N. Y.

SAVE 1/2 — PAY PART-BY-PART — HAVE FUN  
Assembling the **SCHOBER**  
**ELECTRONIC**  
**ORGAN** in KIT form



**NO SPECIAL SKILLS NEEDED!**

Now you can afford a real, full concert organ, just like those made by the foremost organ manufacturers. Because over 1/2 the cost is saved when you assemble it yourself. And it's REALLY EASY: only 24 separate units, all with printed circuits, and detailed-to-the-smallest-step instructions. In addition, you purchase each of the 24 kits when you are ready for it — and can afford it.

You'll get a real kick out of putting the Schober Electronic Organ\* together — and then sitting down and pulling the stops for Strings, Trumpets, Clarinets, Diapasons, Flutes, etc. Electronic Percussion optional; chimes available.

**Compact CONSOLE**

One of the many exclusive features of this exceptional organ is the handsome console, in a wide variety of finishes. It is equally at home in a traditional or modern setting, and takes little more space than a spinet piano.

**Free Literature**

Complete descriptive booklet and price list are available on request. And, if you wish to hear the glorious pipe organ tone of the Schober Electronic Organ, a 10" long-playing demonstration recording is available for \$2. This is refundable when you order. Write today and see what a fine instrument you can get at such a great saving!

**The SCHOBER ORGAN CORP.**

2248-K Broadway, New York 24, N. Y.

\*Designed by Richard H. Dorf

Circle 98A

**ELECTRONIC ENGINEERS**

Broaden your engineering experiences. Are you chained to the same narrow scope of engineering?

Challenging opportunities are available in design and development work in Audio, TV or High Frequency, AM Broadcast Transmitters, and Communications.

Advancement. Complete benefits. Send details and Photo to Department A-1.

**GATES RADIO COMPANY**  
Quincy, Illinois

As can be seen more clearly in *Fig. 1*, the lower end of the capstan is a large flywheel. It weighs forty pounds and provides the inertia required for uniform driving motion. The flywheel is belt-driven by a synchronous motor for accurate speed. The capstan shaft diameters, which drive the master and copy tapes, are ground so that the 2:1 relationship between these diameters is accurate to .0001", which assures less than one second deviation per hour between the playing time of the master and of the copies.

The position of the capstan and pressure roller with respect to each other and the course of the tape is of fundamental importance. The capstan and pressure roller are so located that the tape first makes contact with the capstan and then comes off the roller. The function of the capstan is not only to press the tape tightly against the pressure roller; it also serves to impart smooth motion to the tape in much the same way as does the impedance roller. Therefore it is desirable that the tape maintain contact with a fairly large portion of the capstan circumference.

The spindle on which the takeup reel is mounted is "over-driven" by an induction motor via a belt drive system; that is, the spindle turns more rapidly than the reel. The takeup reel, as in the case of the supply reel, rests on a weight sensitive felt. As the reel grows heavier, friction between reel and felt increases, so that the reel exerts more drag on the spindle. On the other hand, as the radius of the tape being wound on the reel grows larger, the leverage effect previously described increases, so that the spindle exerts more pulling force. The greater pulling force and the increased drag on this force tend to compensate each other so as to maintain nearly constant forward tension on the tape.

A single induction motor drives all the takeup reels via two shafts. Seven reels, including one for the master tape, are belt driven by one shaft; and seven others are driven by the second shaft. **Æ**

**CLASSIFIED**

Rates: 10¢ per word per insertion for noncommercial advertisements; 25¢ per word for commercial advertisements. Rates are net, and no discounts will be allowed. Copy must be accompanied by remittance in full, and must reach the New York office by the first of the month preceding the date of issue.

THE AUDIO EXCHANGE has the largest selection of new and fully guaranteed used equipment. Catalog of used equipment on request. Audio Exchange, Dept. AE, 150-19 Hillside Ave., Jamaica 32, N.Y. AXtel 7-7577; 367 Mamaroneck Ave., White Plains, N.Y. WH 8-3380; 836 Flatbush Ave., Brooklyn, BUCKminster 2-5300.

HIGH FIDELITY SPEAKERS REPAIRED  
Amprite Speaker Service  
70 Vesey St., New York 7, N.Y. BA 7-2580

LOOKING FOR CLEAN RESPONSE TO 20 CYCLES? Listen to the radically new Racon "Hi-C" 15" foam suspension speaker. Racon Electric Co., Inc., 1261 Broadway, New York 1, N.Y.

LONG-PLAYING records 20 to 50% discounts; brand new; factory fresh; unplayed; all labels. Send 20¢ for catalog to Record Discount Club, 1108 Winbern, Houston 4, Texas.

FOR SALE: AMPEX 300, 350, 350-2, 601, 601-2 8c A-Series, available at Grove Enterprises, Roslyn, Pa., Turner 7-4277.

WANTED: Records and Transcriptions, 1930 40, \$5. James Orlando, Box 78, Dickerson Run, Pa.

Wanted: Limiter or compressor amplifier; state age, make, specifications, and price. H. White, 2124 W. Broad St., Bethlehem, Pa.

STEREOPHONIC recorded tapes: "Of Sound and Light" 1/2 hour introductory tape, \$4.95; Music and fun for all the family! Unusual demonstration tape, \$2.50. Stacked or staggered. (Check or COD) John Paul Jones, 655 Main, Lafayette, Indiana.

UP TO 50% DISCOUNT on brand new Hi-Fi speakers, components, amplifiers and tuners, tape recorders etc. Write for individual quotations on your specific needs. Classified Hi-Fi Exchange, AR, 2375 East 65 St., Brooklyn 34, N.Y.

SELL: Ampex 4-channel mixer, Model 3701, like new and guaranteed, two months old. \$195. H. White, 2123 Kenmore Ave., Bethlehem, Pa.

Presto Model 8-K disc recorder complete with microphone and speaker. Perfect condition, \$125. Sheldon T. Gardner, 1513 Cleveland Ave., Evanston, Illinois.

MANUFACTURERS REPRESENTATIVE, specializing in Hi-Fi looking for new items. NY, NJ area. Audio, Box CL-1.

WANTED: Good condition Altec Lansing 604-C speaker and network in lined oak 606 enclosure or enclosure alone. J. C. Locke, 639 Mattison Ave., Sumter, S.C.

Neat, alert young man (29) desires placement with opportunities in audio field. Holds management and Hi-Fi consulting position with large service organization. Strong experience in customer relations and policy adjustments requiring quick, positive decisions.

Highly active audio fan dating to pre L.P. era, technical training, veteran. An asset to any firm. Minimum salary, \$7,000. Audio, Box 901.

CUSTOM HIGH FIDELITY systems designed and installed. Equipment expertly serviced and repaired. Free pickup and delivery in New York City area. Eastern Audio Co., 6139 Tyndal Ave., Bronx, N. Y. KI 9-8134.

Write us before you buy any hi-fi, you'll be glad you did. Immediate replies. Key Electronics, 120 Liberty St., New York, N. Y. EV 4-6071.



**TELEFUNKEN**  
*indisputably...*

**THE WORLD'S BEST MICROPHONES**

Ask about the new CM-61 (only 7 7/16" long), and the famous U47M shown here. Write for complete details. Professional Instrument — \$390.00

Please ask about our dynamic microphones from \$40.00 to \$90.00

Sole U.S. Importers

**AMERICAN ELITE, INC.** Dept. AA  
7 Park Ave.  
New York 16, N.Y.



Circle 98B



## PROFESSIONAL DIRECTORY

*"Continuously Since 1944"*  
**HOLLYWOOD ELECTRONICS**  
DISTRIBUTORS OF HI-FI COMPONENTS  
EXCLUSIVELY



7460 Melrose Ave. - Los Angeles 46, Calif. WEbster 3 8208

Circle 99C

CANADA  
High Fidelity Equipment  
Complete Lines • Complete Service  
Hi-Fi Records — Components  
and Accessories

**ELECTRO-VOICE  
SOUND SYSTEMS**  
141 DUNDAS ST. WEST, TORONTO, CANADA.

Circle 99D

*the finest in Hi-Fi*  
featuring **Electro-Voice**®  
HIGH FIDELITY COMPONENTS



**SOUND  
CORPORATION**  
820 W. Olympic Blvd. - L.A. 15, Calif. - RI 7-0271

Circle 99E

## HIGH-FIDELITY HOUSE

Most complete stock of Audio  
components in the West

Phone: RYan 1-8171

536 S. Fair Oaks, Pasadena 1, Calif.

Circle 99F

**FM/Q**  
**antenna systems**

High gain Broadband Yagi for max. sensitivity to both  
72 and 300 ohm input. Designed for fringe FM.  
APPARATUS DEVELOPMENT CO.  
Dept. C Wethersfield 9, Connecticut

Circle 99G

**IF YOU ARE MOVING**  
Please notify our Circulation Department  
at least 5 weeks in advance. The Post Office  
does not forward magazines sent to wrong  
destinations unless you pay additional post-  
age, and we can NOT duplicate copies sent  
to you once. To save yourself, us, and the  
Post Office a headache, won't you please  
cooperate? When notifying us, please give  
your old address and your new address.  
Circulation Department  
**RADIO MAGAZINES, INC.**  
P. O. Box 629, Mineola, N. Y.

## EMPLOYMENT

HI-FI TECHNICIAN-SALESMAN wanted  
to enter partnership with record specialist in  
Hi-Fi and Record Shop in wealthy, progres-  
sive San Juan, Puerto Rico. Some investment  
required, opportunity unlimited. Audio, Box  
CL-2.

## RECORD REVIEW

(from page 70)

sive (which is good) but also occasionally  
lacking the purity of line and pitch that Schu-  
bert needs. For old violin habitues—Martyz  
sounds curiously like the latter-day Szigeti,  
whose fiddle tone is also rather nasal and big,  
with a pronounced wobble.

The Antonelli piano is excellent, but in  
the miking is placed a bit in the shadow;  
these are strictly equal partners. Perhaps, I  
should say, it is the fiddle that is too promi-  
nent, and this applies, oddly, more to the first  
than the second sonatina; in the second the  
fiddle tone is gentler, less wiry, more even.

If you have ever watched an active fiddler  
swaying hither and yon to his music, you'll  
understand that a variations in close-to-mike  
pickup is only too easy from one session to  
another, if not from one instant to the next!  
It seems likely that, here, the engineers just  
plain got Miss Martyz on a better spot for  
Number Two than Number One. Interesting  
difference. In both, there is a nicely full live-  
ness.

### 3. ODDITIES

**Highland Pageantry. Pipes and Drums  
and Regimental Band of the Black Watch  
(Royal Highland Regiment).**

RCA Victor LPM 1525

Sometimes I'm glad I'm on the RCA Black  
Label list for occasional releases—for it  
brings me items like this, which is a superb  
record.

No country mentioned but, natch, the music  
is of British-Scotch origin; the outfit is pres-  
ently on tour in the U.S., and this is a tie-in.

Tie-in or no, I haven't heard such a stirring  
band-and-pipes record since I began operations.  
What a sense of pageantry the British (and  
Scotch) have! They put our bumbling, good  
natured parades, our football soullés with  
their twirlers, our Army-Navy-Marine musical  
shows, into a gentle shade, or so I think after  
listening to the Black Watch.

An alternation between brass and bagpipes,  
with drums going along with the whole show,  
and each change from one to the other is so  
dramatic you will jump with surprise. Just  
good playing plus careful calculation of effect.

Old duffers will drop a tear during a very  
long pot-pourri on tunes of Sir Harry Lauder  
—I recognized a few of them m'self ("Stop yr  
Tiekin', Joek!")—played by the band. The  
rest of us will thrill to the simpler and shorter  
items. Fine, big arena-style sound.

**Wishing You an Old Fashioned Merry  
Christmas. Regina 15" Music Box; Mills  
Violino.**

Golden Crest CR 4006

Oof, what a corny title, but the contents are  
as subtitled above and that spells pleasure for  
many of us. The Regina is the fanciest and  
biggest sort of music box and any musical ear  
can derive satisfaction from the peculiarly  
complex counterpoint and melisma that the  
music box "composers" worked out mechani-  
cally in their arrangements. (Melisma? Orna-  
mentation, elaborate decoration of a simple  
melodic line.) The Regina, after all, could  
play as many notes as a couple of dozen  
human fingers on a keyboard and it never got  
tired, as long as the motor was wound up.

The Mills Violino was both diabolically in-  
genious and a spine-chilling parody—because  
it came so close to the real thing. A mechani-  
cal violin played by rollers across the strings,  
complete with vibrato and lots of double  
stops. Accompaniment from a player piano with  
the bass strings in the middle and treble on  
the two sides—I'd hate to play on that one.  
I get a perverse pleasure listening to it, espe-  
cially since I remember putting nickels in one  
when I was a child and loving it. (The mech-  
anism, I think, not the music.)

## the Magnificent Ferrograph



Model 3A/N  
(portable)  
with built in  
speaker.  
3¾-7½ ips  
\$379.50

### The world's finest hi-fi tape recorder

The ultimate in high-fidelity tape  
recorders for home and professional use.  
Dual-speed, dual-track FERROGRAPH  
recorders are also available in custom  
models (tape decks available,  
from \$195.) and with 7½  
and 15 ips speeds. Independent field  
performance tests rate Frequency  
Response at ± 2 db between 50 and  
10,000 cycles with wow and flutter  
less than 0.2% at 7½ ips.

Quality standards have restricted our  
production and unforeseen demand may delay  
delivery, write TODAY for literature.

**ERCONA CORPORATION**  
(Electronic Division)

551 Fifth Ave., Dept. 15, New York 17, N. Y.  
In Canada: Astral Electric Co. Ltd.  
44 Danforth Road, Toronto 13  
Circle 99A

### Capps HOT-STYLUS UNIT



LONGER STYLUS LIFE  
REDUCES LOADING ON CUTTING  
HEAD  
IMPROVES FREQUENCY RESPONSE  
IMPROVES SIGNAL TO NOISE RATIO  
FACILITATES PROCESSING  
EASILY INSTALLED AND OPERATED

The CAPPS HOT-STYLUS UNIT is  
used for applying heat to disc recording styli,  
softening the disc material at the point of  
contact thereby producing smoother, more  
accurate grooves. This results in a substantial  
reduction in surface noise, especially at the  
inner diameters and minimizes the mechani-  
cal load on the cutting head increasing its  
efficiency and frequency response.

When ordering specify make  
and model number of cutter  
head and stylus requirements.

Model No.  
CU-1 Supplied without stylus . . . \$60.00 net  
CU-1R Supplied with regular duty stylus,  
1P or 78 . . . . . 66.50 net  
CU-1C Supplied with custom made stylus to  
customer's specification . . . . . 70.50 net

This complete unit may be obtained  
at your nearest dealer

**Capps & CO., INC.**

20 Addison Place • Valley Stream, N. Y.

Circle 99B

# This We Know

a speaker system does not have to be **BIG** or **COSTLY** to reproduce clean balanced sound from  
**30-15,000 cps.**

Now you can prove this to yourself  
Listen to



Speaker Systems  
Available at Your  
Distributor

\$99.50

**I**NTERNATIONAL  
**S**CIENTIFIC  
**I**NDUSTRIES CORP.

COLORADO SPRINGS, COLORADO

Address inquiries to:  
SALES OFFICE, 15 ELLIS ROAD  
WESTON, MASS.

Circle 100A

Better Results With  
**ROBINS' AUDIO ACCESSORIES!**

**GIBSON GIRL® TAPE SPLICERS**

1. Semi-Pro	SP-4	\$ 3.50
2. Junior	TS-4JR	6.50
3. Standard	TS-4STD	8.50
4. De luxe	TS-4DLX	11.50
5. Industrial (5 sizes to 1")	(net)	55.00

**ROBINS PHONO AND TAPE ACCESSORIES**

6. Splicing tape	ST-500	\$ .39
7. Jockey Cloth for Tapes	JCT-2	1.00
8. Tape Threader	TT-1	.75
9. AUD-O-FILE	AF-50 (net)	23.99
10. Changer Covers	CC 1, 2	2.00
11. Turntable Covers	CC 3	2.50
12. DisClosures	E10, 12 (pkg)	1.20
13. Jockey Cloth for Records	JC-1	1.00
14. KleeNeedLE	NB-1	1.50
15. Phono-Cushion, 10", 12"	PC-10, 12	1.50
16. Atomic Jewel	SE-90	5.00

At Dealers Everywhere

**ROBINS INDUSTRIES CORP.**  
BAYSIDE 61, NEW YORK

Circle 100B

## ADVERTISING INDEX

Acoustic Research, Inc. ....	82
Allied Radio Corporation .....	91
Altec Lansing Corporation .....	14, 55, 63
American Elite, Inc. ....	98
A M I, Inc. ....	65
Ampex Audio, Inc. ....	67
Apparatus Development Company .....	99
Audio Fidelity, Inc. ....	69, 71
Audiogersh Corporation .....	6, 7
Barker Sales Company .....	90
Belden .....	13
Bell Telephone Laboratories .....	18
Bogen, David Co., Inc. ....	Cov. 11
Bozak, R. T. Sales Company .....	59
Bradford & Company .....	2
Brand Products, Inc. ....	45
British Industries Corporation	
facing p. 1, 3, 15	
Capps & Co., Inc. ....	99
Classified .....	98
Connoisseur .....	100
Dattel Company .....	86
E I C O .....	92, 93
Electro-Sonic Laboratories, Inc. ....	97
Electro-Voice, Inc. ....	57
Electro-Voice Sound Systems .....	99
Ercona Corporation .....	79, 99, 100
Fairchild Recording Equipment Co. ....	27
Ferrodynamics Corporation .....	29
Ferrograph .....	99
Fisher Radio Corporation .....	77
Fukuin Electric (Pioneer) .....	84
General Electric .....	31
Grado Laboratories .....	94
Harman-Kardon, Inc. ....	34, 35
Hartley Products Co. ....	76
Harvey Radio Co., Inc. ....	81
Heath Company .....	8-11
High Fidelity House .....	99
Hollywood Electronics .....	99
Hycor Division of International	
Resistance Corporation .....	88
International Scientific Industries Corp. ....	100
JansZen Speakers (Neshaminy Electronic	
Corp.) .....	74, 75
Jensen Manufacturing Company .....	33
Kierulff Sound Corporation .....	99
Lansing, James B. Sound, Inc. ....	5
Leonard Radio, Inc. ....	78
McIntosh Laboratory, Inc. ....	Cov. 111
Mullard Overseas, Ltd. ....	73
North American Philips Co., Inc. ....	89, 96
Orradio Industries, Inc. ....	1
Pentron .....	85
Pickering & Company .....	17
Pilot Radio Corp. ....	83
Professional Directory .....	99
Racon Electric Company, Inc. ....	95
R & A .....	79
Rauland-Borg Corporation .....	100
Rigo Enterprises .....	4
Rebins Industries Corp. ....	100
Rockbar Corporation .....	39
Schober Organ Corporation .....	98
Scott, H. H., Inc. ....	87
Shure Bros., Inc. ....	12
Sonotone Corporation .....	41
Stephens Tru-Sonic Inc. ....	Cov. 114
Tandberg .....	43
Tung-Sol Electric Inc. ....	66
United Speaker Systems .....	85
University Loudspeakers, Inc. ....	49-52
Viking of Minneapolis .....	47
Weathers Industries, Inc. ....	61

## startling silence for the perfectionist *Connoisseur* TURNTABLE



The hush of an empty church, even though the synchronous motor is running—this is the Connoisseur, crafted in traditional English quality. Precision machining assures pure sound reproduction. Non-magnetic, 12" lathe-turned table; precision ground spindle; phosphor bronze turntable bearing;  $\pm 2\%$  variation provided for all 3 speeds; hysteresis motor. **\$110.00**

**TURNTABLE:** Rumble—better than 50 db down; Wow—less than 0.15% of rated speed; Dimensions: 13½x15¼".

**PICKUP:** Frequency Response — 20-20,000 cps  $\pm 2$  db at 33½ rpm; Effective Mass—4 mg; Impedance—400 ohms at 1000 cps.

"Dynabanced" tone arm with Mark II super-lightweight pickup w/diamond stylus **\$49.50**  
w/sapphire stylus **\$34.50**

Write today for literature.

### ERCONA CORPORATION

(Electronic Division)  
651 Fifth Ave., Dept. 16., New York 17, N. Y.  
In Canada: Astral Electric Co. Ltd.  
44 Danforth Road, Toronto 13

Circle 100C



## 'Golden Series' HI-FI



The "GOLDEN ENSEMBLE"...  
Tuner, Preamp and Amplifier  
in a single, compact, balanced  
unit...complete Hi-Fi at  
extremely low cost...

one of a complete line of  
advanced design high fidelity  
tuners, amplifiers and components...

hear these quality RAULAND units at  
your Hi-Fi dealer or write for details...

### RAULAND-BORG CORPORATION

3515 W. Addison St., Dept. G, Chicago 18, Ill.

Circle 100D

# FLEXIBILITY GUARANTEED

## McIntosh

**C-8 Professional  
Audio Compensator and Pre-Amplifier**

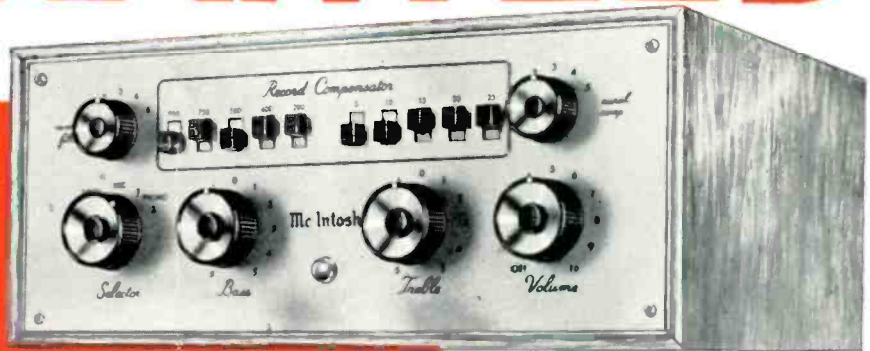

C-8 (Less Cabinet) \$88.50



### *Record Compensator*

Reproduction to satisfy the novice or the most critical listeners is achieved by the more than 500 compensation positions on these unique bass and treble switches. Room acoustics and electrical characteristics are completely controlled only in the flexible C-8.

### *Rumble Filter*



A five position control designed to eliminate the annoying mechanical rumble inherent in turntables and record changers. A narrow band suppression that rejects noise not music.

### *Aural Compensator*



Five fixed positions of balanced volume reduction with equalization for the hearing losses experienced at low volumes. Greatest flexibility for greatest enjoyment.

Here is the only compensator designed to critically balance electrical playback of records plus the flexibility to correct for all listening room acoustics. McIntosh, creators of the world's finest amplifiers and pre amplifiers *guarantees* 1 Flexibility, 2 Specifications, and 3 Craftsmanship. Hear McIntosh today at your favorite dealer.

*Send for complete information  
or visit your nearest  
Franchised McIntosh Dealer.*

In Canada manufactured under license by McCurdy Radio Industries, Ltd.  
22 Front Street W., Toronto, Canada

AE-11-57

**McIntosh**  
LABORATORY, INC.  
4 Chambers St., Binghamton, N. Y.  
Export Division: 25 Warren St., New York 7, N. Y.  
Cable: SIMONTRICE N. Y.



# THE NEW TRUSONIC EIGHT-INCH SPEAKER

*8 inches big!*

*8 inches small!*

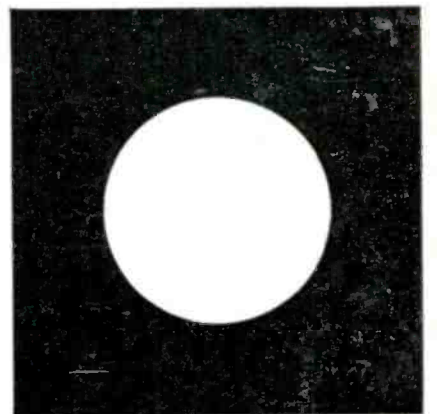

Not an acoustical illusion, this new full range speaker has big-speaker response designed into a rugged, compact unit. It establishes a new standard for clarity, power-handling capacity, presence and lack of distortion in an eight-inch speaker. Like all TRUSONIC speakers and audio equipment, the new eight-inch 80 FR speaker is produced from the finest materials and engineered for a lifetime of faithful performance. Net Price: \$31.50

*Listen... you'll always hear more from:*

**STEPHENS TRUSONIC INC.**  
8538 Warner Dr., Culver City, Calif. Cable Address: "MORHANEX" Export Address: 450 Broadway, New York 13, N.Y.