

AUDIO

ENGINEERING MUSIC SOUND REPRODUCTION

NOVEMBER, 1956

50¢

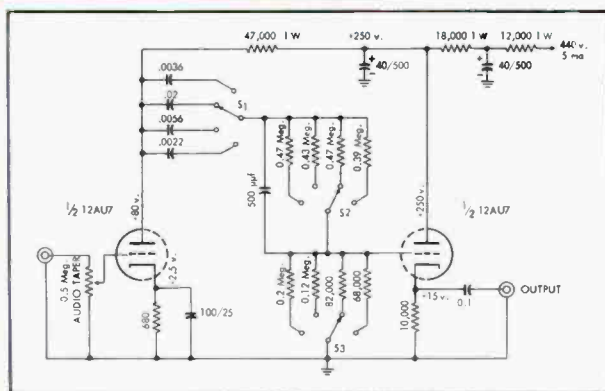

Amplitude-sensitive pickups must be compensated properly if they are to reproduce records as we want to hear them. The system described will give excellent results. See page 26.



Tired of commercials? Push a button and this device silences the speaker for a time, then turns it on again. See page 24.

INTERFERENCE EFFECTS WITH CROSSOVER NETWORKS
DESIGN CONSIDERATIONS FOR HUM REDUCTION
CONFERENCE AMPLIFIER FOR HARD-OF-HEARING EXECUTIVES
NOISE—ENEMY OF NORMAL HEARING

AMPEX Approves



FERRO-SHEEN TAPE

for Revolutionary VIDEOTAPE* Recorder

A full hour's TV program—picture and sound—on a single 12½-inch reel of magnetic tape, ready for instantaneous playback . . . that's the electronic miracle made possible by the epoch-making Ampex Videotape Recorder unveiled last spring. The television industry immediately bought up the available prototype models of the amazing new machine, and one of the first questions to come up was, of course, "Which tape?" The Ampex Videotape Recorder records on a special 2-inch wide tape, which must be made to the most rigid specifications to capture fre-

quencies as high as 4,000,000 cycles per second. All along, Orradio Industries, manufacturers of the famous **irish FERRO-SHEEN** process tapes, had been working with Ampex, so they were ready for the question. Now **irish FERRO-SHEEN Videotape** is available in production quantities, and delivery has just been completed on the television industry's first full-scale commercial order.

The successful adaptation of the exclusive **irish FERRO-SHEEN** process to the extraordinarily exacting requirements of commercial Videotape production is the culmination of a long-term research and development program—implemented by the same staff and facilities responsible for the development and current production of the five famous **irish FERRO-SHEEN** tapes for audio tape recorders: Shamrock, Green Band, Long Play, Double Play and Sound Plate.



*Reg. T.M. Ampex Corp.

ORRADIO INDUSTRIES, INC.
OPELIKA, ALABAMA

World's Largest Exclusive Magnetic Tape Manufacturer
Export: Morhan Exporting Corp., 458 B'way, New York 13, N.Y., U.S.A.
Canada: Atlas Radio Corp., Ltd., Toronto, Ontario

cut along dotted line and save

MISSIONARIES WANTED

No pay. Long hours. Working conditions sometimes quite irritating. Applicants must be prepared to argue with the misguided as well as to instruct those truly desiring to become converts.

The

Board



(over)

Who wants to be a MISSIONARY?



If you believe that:

JUSTICE
WILL TRIUMPH
and
VIRTUE IS
ITS OWN REWARD

then this is a great job for you!

We had originally intended to run our advertisement in a local newspaper but we were frightened of being overwhelmed by applicants. Consequently, we are running it in this relatively pristine column.

You may not like the sound of this job, but you ought to take it anyway. Here's why:

The mere fact that you subscribe to "Audio" is in itself sufficient evidence of your interest in, and knowledge of, good sound and high fidelity equipment. That puts you ahead of about 95% of the American public, and many members of that public are just aching to become converts. The only trouble is that it is difficult to bring them the true faith. Heathen idols are being planted in large numbers amongst them. Two good examples are: (1) those Super High-Fidelity, Superb-Quality, Multiple Speaker, Concert-Hall-Type Record Players for \$49.50, and (2) those opportunist components which loudly proclaim themselves as bringing "necessary improvements" to audio products but which, in fact, add nothing really worth having and which in no way contribute to the art and science which *you*, by your knowledge and support, have advanced.

Men, this has got to stop and you have to help us stop it! We have got to bring light to the uninitiated. You should *want* to help with this job, because you know something about this. You should *want* to help protect the innocent from falling prey to the flossiest, loudest promoters.

It isn't specific brand names we expect you to "sell" to your friends and acquaintances; it's the *concept* of high fidelity. You *know* the quality merchandise from the pretenders. So teach them to beware of the gimmicks, the gadgets, the so-called "features" which do nothing for good sound reproduction and which, in fact, make them needlessly costly.

The natives are restless! The drums are beginning to sound, asking a lot of questions. The time has come to separate the wheat from the chaff and carry it forward on high until it extinguishes the fires of the false prophets. (And if you think you can write a more mixed metaphor than that, I'd like to see you try!)

That is why missionaries are needed and why *you* ought to take the job!

Leonard Carduner

The Sounding Board

AUDIO

ENGINEERING MUSIC SOUND REPRODUCTION

C. G. McProud, Editor and Publisher

Henry A. Schober, Business Manager
 Harrie K. Richardson, Associate Editor
 Joan Dioguardi, Assistant Editor
 Janet M. Durgin, Production Manager
 Edgar E. Newman, Circulation Director

Sanford L. Cahn, Advertising Director

Special Representative—
H. Thorpe Covington,
26 East Pearson Street, Chicago 11, Ill.,
DEL 7-0506

Mid West Representative—
Sanford R. Cowan, 67 West 44th St.,
New York 36, N. Y.

West Coast Representatives—
James C. Galloway and J. W. Harbison,
6535 Wilshire Boulevard, Los Angeles 48, Calif.



CONTENTS

About Music— <i>Harold Lawrence</i>	2
Letters	3
Editor's Report	12
Crossover Networks— <i>Charles P. Boegli</i>	15
Noise—Enemy of Normal Hearing— <i>Charles E. White</i>	18
70.7-Volt Speaker Impedance Chart	22
Loss of Patent— <i>Albert Woodruff Gray</i>	23
Time-Delay— <i>Ronald L. Ives</i>	24
Amplitude-Responsive Phono Pickups— <i>R. H. Brown</i>	26
A Survey of Crossover Networks— <i>Richard C. Hitchcock</i>	28
Interaction Concept in Feedback Design— <i>Part 2—Norman A. Crowhurst</i>	32
Hum Reduction— <i>Oliver Berliner</i>	38
Microphone Placement— <i>James Cunningham and Robert Oakes Jordan</i>	43
Conference Amplifier— <i>Robert M. Mitchell</i>	46
Audioclinic— <i>Joseph Giovannelli</i>	53
The Briggs Concert— <i>U. S.—1956</i>	54
Equipment Report— <i>General Electric Model XA1-320 20-watt amplifier and preamplifier, the "Convertible"—General Apparatus Company's "Van Amp" electronic crossover network—Observations on loudspeaker systems</i>	58
Record Revue— <i>Edward Tatnall Canby</i>	66
New Literature	71
New Products	72
Audio ETC— <i>Edward Tatnall Canby</i>	76
Coming Events	95
Industry Notes	97
Employment Register	98
Advertising Index	100

AUDIO (title registered U. S. Pat. Off.) is published monthly by Radio Magazines, Inc., Henry A. Schober, President; C. G. McProud, Secretary, Executive and Editorial Offices, 204 Front St., Mineola, N. Y. Subscription rates—U. S., Possessions, Canada and Mexico, \$4.00 for one year, \$7.00 for two years, all other countries, \$5.00 per year. Single copies 50¢. Printed in U. S. A. at Lancaster, Pa. All rights reserved. Entire contents copyright 1956 by Radio Magazines, Inc. Entered as Second Class Matter February 9, 1950 at the Post Office, Lancaster, Pa. under the Act of March 3, 1879.

RADIO MAGAZINES, INC., P. O. Box 629, MINEOLA, N. Y.

AUDIO • NOVEMBER, 1956

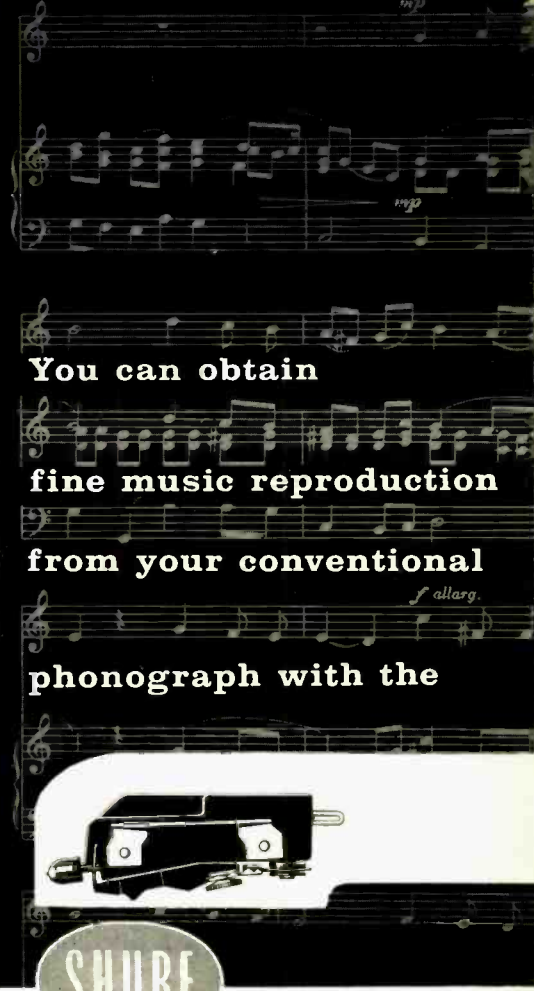

"Twin Lever" Ceramic Phono Cartridge

The WC10 "Twin-Lever" Improvement Cartridge will dramatically improve the tone quality of your conventional home phonograph—will actually make it better than new! The low price of the "Twin-Lever" permits anyone to enjoy the luxury of faithful reproduction of recorded music.

This remarkable cartridge replaces practically all three-speed, plastic-cased cartridges, crystal or ceramic, turnover or single needle.

It is easily installed in any tone arm with standard 1/2" mounting centers. Needle replacement can be accomplished in seconds—without tools—with the cartridge in the arm.

MODEL WC10

List Price **\$9.50**
 with two sapphire needles

MODEL WC10D

List Price **\$34.00**
 with a 1-mil diamond and
 a 3-mil sapphire needle

SHURE *The Mark of Quality*
 "IN ELECTRONICS SINCE 1925"
SHURE BROTHERS, INC.
 Microphones—Electronic Components
 216 HARTREY AVENUE • EVANSTON, ILLINOIS

IMPROVE your AMPLIFIER In 5 ways



with the

Amperex®

GZ34 RECTIFIER

A LOW-IMPEDANCE, INDIRECTLY HEATED, FULL-WAVE RECTIFIER WITH 250 MA OUTPUT CAPACITY

The unique AMPEREX GZ34 replaces without circuit changes, in the majority of amplifier circuits, an entire line of popular, heavy-duty 5-volt rectifiers—5U4G, 5V4G, 5T4, etc.

— with the following benefits:

- Better voltage regulation due to lowered power supply impedance;
- Higher power supply output voltage for more power;
- Added filter condenser protection due to reduced ripple;
- Cooler operation due to lower voltage drop;
- Protection of costly power output tubes through delayed warm-up.

OTHER Amperex TUBES FOR HIGH-FIDELITY AUDIO APPLICATIONS:

EL84/6B05	9-pin power pentode; 17 W PP
6CA7/EL34	High-power pentode; 100 W PP
EF86/6267	Low-noise high- μ pentode
ECC81/12AT7	Low-noise medium- μ dual triode
ECC82/12AU7	Low-noise low- μ dual triode
ECC83/12AX7	Low-noise high- μ dual triode
EZ80/6V4	9-pin rectifier; cathode; 90 ma.
EZ81/6CA4	9-pin rectifier; cathode; 150 ma.

At All Leading Electronic Parts Distributors



Amperex
ELECTRONIC CORP.
230 Duffy Ave., Hicksville, Long Island, N.Y.

ABOUT MUSIC

HAROLD LAWRENCE*

Jazz Infections and Inflections in the Concert Hall

BY NOW, THE SMOKE over Henry Pleasants' attack on contemporary composers, *The Agony of Modern Music* (Simon & Schuster, 1955), has blown away. Angry letters are no longer being sent to the music editors of *The Musical Quarterly*, *The Saturday Review* and *The New York Times*; the author is not invited to battle with his enraged opponents over a microphone; and sales of the book (never spectacular) have dwindled to those of an old newspaper. In the beginning of his book, Pleasants outlined the "argument" that he planned to elaborate upon in the ensuing pages. He did the prospective reader a favor: if you didn't like the theme you knew you'd be missing very little by not reading the development. The theme is stated in no uncertain terms: "Modern music is not modern and is rarely musical. . . . There is more real creative musical talent in the music of Armstrong and Ellington, in the songs of Gershwin, Rodgers, Kern and Berlin, than in all the serious music composed since 1920."

After he stirred up his musical nest, critical hornets seemed to swarm over every point in Pleasants' book, every point, that is, except one. In his concluding chapter, the author makes the very flat statement that, whereas "jazz can absorb any of the technical devices of modern music without seeming to imitate, modern music can absorb none of the musical characteristics of jazz without immediately sounding like an imitation of jazz." Mr. Pleasants has overlooked the fact that a master musician thoroughly integrates into the fabric of his composition those jazz rhythms and devices he chooses to employ, unless the purpose is one of parody.

As in other portions of this agonizing reappraisal of modern music, the author makes a broad assertion and blithely skips to the next stage of his argument. But before he does, let's examine the question of jazz influences on modern music a bit more closely.

The first two decades of the twentieth century comprised the heyday of the ragtime, with its pluck-and-twang character. Probably the most famous work inspired by this ancestor of postwar jazz is Debussy's "Golliwog's Cake-walk" from *Children's Corner* (1908). The rhythms are plainly those of the ragtime, jerky and with unexpected accents, and yet there is no doubt as to who is in control. The total impression is that of a Gallicized, subtle,

and world-wide minstrel. Two years later, Debussy was still intrigued with the naive ragtime rhythms and used them again in "Minstrels" from his *Piano Preludes*, Book I.

Ragtime also fascinated Igor Stravinsky with what he called "its truly popular flavor, its freshness and the novel rhythm which so clearly reveals its negro origin." The outcome of this interest was a remarkable *Ragtime* scored for the unusual combination of flute, clarinet, horn, cornet, trombone, cymbalom, first and second violins, viola (no cello), double-bass and percussion (1918). He wrote a less successful follow-up piece, *Piano-Rag-Music*, in 1919.

In 1923, a year before Gershwin's *Rhapsody in Blue* was first performed, Milhaud composed one of the first orchestral works based on the jazz idiom: *La création du monde* (*The Creation of the World*). Milhaud's initial encounter with this new musical language took place in London when he heard Billy Arnold and his band, "straight from New York." "The new music," Milhaud wrote in *Notes Without Music* (Alfred A. Knopf, 1953), "was extremely subtle in its use of timbre: the saxophone breaking in, squeezing out the juice of dreams, or the trumpet, dramatic or languorous by turns, the clarinet, frequently played in its upper register, the lyrical use of the trombone, glancing with its slide over quarter-tones in crescendos of volume and pitch, thus intensifying the feeling; and the whole, so various yet not disparate, held together by the piano and subtly punctuated by the complex rhythms of the percussion, a kind of inner beat, the vital pulse of the rhythmic life of the music."

When Milhaud visited America in 1922 he spent part of his time in Harlem at Negro theatres and dance halls, absorbing as much jazz as he could. After his return to France, he "never wearied of playing over and over, on a little portable phonograph shaped like a camera, Black Swan records I had purchased in a little shop in Harlem. More than ever I was resolved to use jazz for a chamber work."

La création du monde was the product of Milhaud's jazz immersion. At first hearing, this score would appear to fit into the category of Pleasants' "jazz imitators." The music alternates between two contrasting moods: the first is quiet, lyrical and introspective; the second, boisterous, syncopated and percussive. But even to the casual listener, there is real continuity of musical thought from beginning to end, with the "jazz sections" not intrusions,

* 26 West Ninth Street, New York 11, N. Y.

*A beautiful home for your
high fidelity components*

WITH THE NEW
"100" MODULAR SERIES

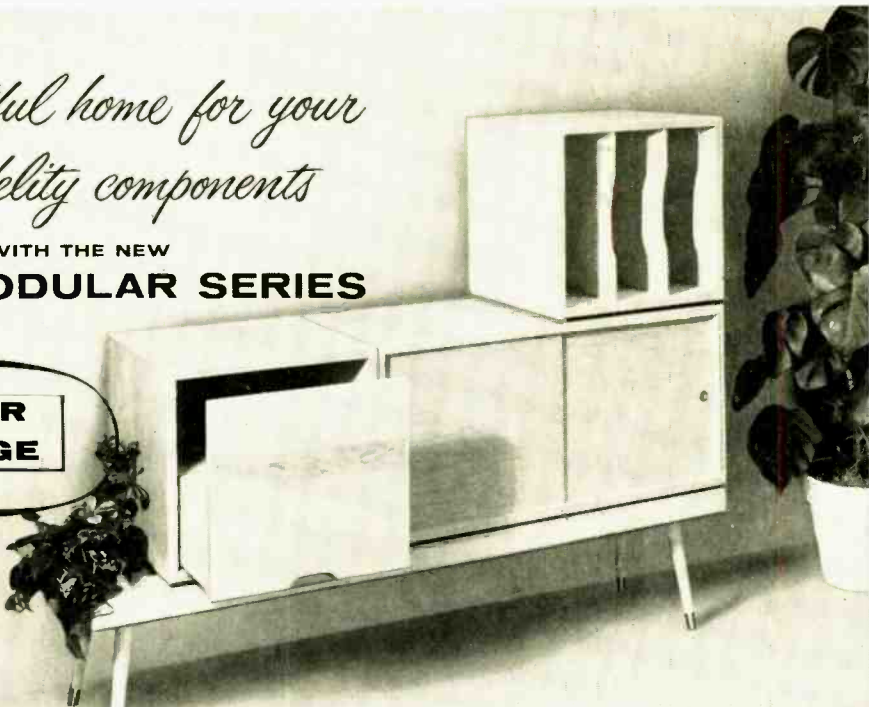
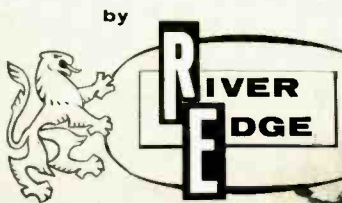

Now River Edge brings you fine modular hardwood furniture in kits, or as assembled units ready to finish... planned to go together in dozens of interesting ways. Equipment cabinets are engineered by audio experts to protect high fidelity mechanisms. The speaker enclosure is acoustically right, artistically in keeping, and mechanically correct. Start now to build your own grouping with River Edge modular units. You'll have a custom-look job that will fill you with pride.

EQUIPMENT CABINET



Model 100. Holds record player, tuner, amplifier. Drawer takes any standard changer and many tape decks.
36" w., 16" d., 16" h.

SPEAKER ENCLOSURE



Model 110. Bass reflex type for full range speaker to 12"; woofer up to 12" with tweeter to 9" x 12".
36" w., 16" d., 16" h.

RECORD CABINET



Model 120. Three separated storage sections.
18" w., 16" d., 16" h.

PLAYER CABINET

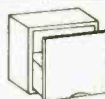

Model 130. Holds record changer, transcription turntable with 12" arm; many tape decks.
18" w., 16" d., 16" h.

60" BENCH



Model 140. Supports the units shown. 4 wooden legs with brass ferrules.
16" w., 16" d., 14" h.

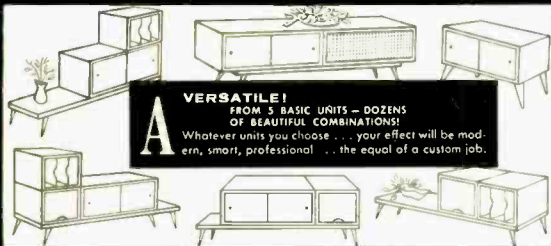

A **VERSATILE!**
FROM 5 BASIC UNITS - DOZENS OF BEAUTIFUL COMBINATIONS!
Whatever units you choose... your effect will be modern, smart, professional... the equal of a custom job.



C **FINE FURNITURE!**
The wood is birch hardwood which accepts a finish to match your fine furniture.

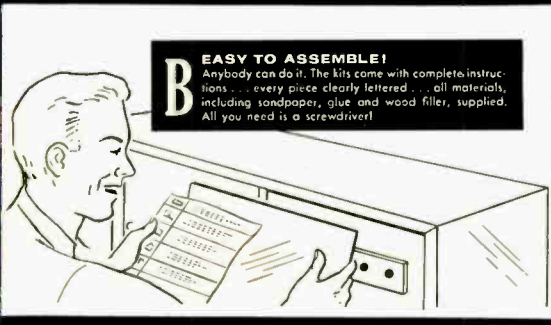

B **EASY TO ASSEMBLE!**
Anybody can do it. The kits come with complete instructions... every piece clearly lettered... all materials, including sandpaper, glue and wood filler, supplied. All you need is a screwdriver!



(Quality-endorsed product of the R.I.C. Group)

SEE your high fidelity dealer. WRITE for the useful River Edge Customized Cabinet Guide.

RIVER EDGE SALES CORP. Dept. VS-16
Port Washington, N. Y.
Please send Customized Cabinet Guide.

Name: _____
Address: _____
City: _____ Zone: _____ State: _____

but rather logical stages in the work's growth.

The Blues attracted the attention of another Frenchman, Maurice Ravel, in his violin and piano sonata (1927). And, in the same year, Ernst Krenek's successfully scandalous jazz opera *Jonny Spielt Auf* (*Johnny Strikes Up*) received its world premiere at the Leipzig Opera. Kurt Weill's still popular *Three-Penny Opera* followed Krenek's now forgotten work a year later, while in England, Western Europe and, of course, America, other composers dipped into the jazz reservoir.

Works like *La création du monde*, Ravel's Piano Concerto in G, *The Three-Penny Opera*, Stravinsky's *Ragtime*, and

L'Histoire du soldat, could only have survived because jazz elements were made to serve the composer's personal expression and style. A superb illustration of the creative use of jazz in post-World War II music is the *Turandot* movement of Hindemith's *Symphonic Metamorphosis on Themes by Weber*, in which the composer combines his uncanny gift of counterpoint with syncopated rhythms. The result is a delightful toe-tapping jazzy fugato utilizing trombone glissandi and unusual percussion effects.

So far, the serious composer has synthesized ragtime, blues, swing, and other jazz forms. Now the question is: Will anyone take on Rock 'n Roll?

LETTERS

The Other Side—presented by This Side SIR:

I am in general accord with Mr. Briggs' avowed purpose of redressing the balance with electrostatics in his letter to the editor in the September 1956 issue, since most of the recent articles on electrostatic loudspeakers have extolled their virtues and ignored their shortcomings. Let me be among those who agree that at least one article was amusingly and transparently intemperate in its ecstatic pronouncement that moving coil manufacturers might as well close up shop. I have no wish to join the prophets, and I have no quarrel with subjective judgments, whether they are expressed by Mr. Marsh or Mr. Briggs. In those areas, every man is his own expert, and any comment on my part could justifiably be construed as another volley of grapeshot in the imaginary "battle of the loudspeakers" or the "electrostatic revolution." There are several instances, however, in Mr. Briggs' letter in which he touched upon the objective performance and engineering design of electrostatic loudspeakers. In some of these, his statements seem to be at variance with demonstrable fact, and I would like to chide him gently about them.

1) and 2). All materials are affected to some degree by variations in temperature and humidity. What is important is that changes in performance caused by such variations be rendered innocuous. Through the use of appropriate plastic materials, an electrostatic loudspeaker can be stabilized for operation in at least most of the areas mentioned. Many JansZen electrostatics have been in operation for a year or more in the Gulf Coast region of the U.S.A., under conditions that are at least as unfavorable as in most of the areas mentioned by Mr. Briggs. The incidence of failure has been extremely low, and has not been detectably higher than in other regions in which ambient conditions are more favorable. It seems to me that the use of plastics in loudspeakers is not analogous to the use of grease in pickup damping, as Mr. Briggs suggests. I think it sufficient to point out that some of the most durable loudspeakers that were built for use aboard warships during the 1940's were equipped with plastic diaphragms. I do not know of any reason why a properly designed electrostatic loudspeaker should be more susceptible to changes in temperature and humidity than well designed moving coil types.

3). While it is true that in general the diaphragm of electrostatic loudspeakers do not move with uniform amplitude over their entire areas, they can be so constructed that they approach this ideal so closely that the imposition of constraints at the points of support cannot be detected in acoustic measurements. They can be so designed that no undamped diaphragm resonances are present in any portion of the frequency range over which they radiate. Instead of relying on electrical damping, the resistive component of the air-load impedance is made to constitute the predominant component of the total mechanical impedance of the diaphragm up to approximately 10,000 cps. Electrical



What we're driving at is the simple fact that Tung-Sol Audio Tubes are preferred by makers of the finest Hi-Fi equipment.

TUNG-SOL ELECTRIC INC.
Newark 4, N. J.



TUNG-SOL®
AUDIO TUBES

Only "Scotch" Magnetic Tape was sensitive enough to capture

a madman's madrigals



Don Carlo Gesualdo

In 1613 the psychotic Italian nobleman and composer Don Carlo Gesualdo died.

To us he leaves a magnificent bequest—the brilliant Gesualdo madrigals. "A collection of marvels," Igor Stravinsky describes these musical masterpieces.

Many of these ingenious *a cappella* compositions are now superbly recorded in the highly acclaimed new Sunset Records album, "Aldous Huxley Presents the Madrigals of Gesualdo."

To reproduce the mad composer's subtle dynamic changes and harmonic progressions, Sunset Records made its original master recording on a magnetic tape with an international reputation for highest fidelity. Their choice—"Scotch" Magnetic Tape—because it "assured us perfect reproduction in recording our album."

"Scotch" Magnetic Tape is *always* first choice where superior sound reproduction is essential. Try it on your machine and you'll hear why.



ALDOUS HUXLEY AND IGOR STRAVINSKY at the Gesualdo madrigals recording session.



The term "SCOTCH" and the plaid design are registered trademarks for Magnetic Tape made in U. S. A. by Minnesota Mining and Mfg. Co., St. Paul 6, Minn. Export Sales Office: 99 Park Avenue, New York 16, N. Y. © 3M Co., 1956



no other Quality Speaker offers so much for so little



World Famous for consistent good sound
...unequalled Quality features and LOW COST!



LORENZ LP 312
12" WIDE-RANGE LOUSPEAKER

A quality, dual-purpose speaker. Can be used as wide-range reproducer or woofer unit in expanding system. **FEATURES:** EXTRA heavy magnet, long magnetic path, small air gap, long voice coil, non-resonant frame, perfect gap alignment and multi-parameter, tropicalized cone.

SPECIFICATIONS: Impedance — 16 ohms at 800 cps; Response — below 20 to above 14,000 cps; Output — 25 w average, 35 w peak; Magnet Wgt. — 61.5 ozs; Voice Coil Diam. — 1 1/2"; Baffle Opening — 10 3/4"; Depth — 6 3/4"; Frame — heavy duty cast aluminum girder construction. net **39.50**



LORENZ TB-1 and TB-2
TWEETER COMBINATIONS
For all 12" speakers.

Completely assembled and ready for installation. Fits across 12" speakers with out projecting beyond front of speaker mounting baffle. Specially designed steel bracket supports tweeter(s) coaxially. Rigid metal construction discourages resonance in speaker or tweeter.

TB-1 (bracket with single tweeter) net **11.85**
 TB-2 (bracket and two tweeters) net **21.69**



LORENZ LP 208
8" WIDE-RANGE LOUSPEAKER

Versatile, 3-purpose reproducer. Designed as wide-range speaker alone or in groups, as high or low end of 2-way system, or as mid-range unit in 3-way system. **FEATURES:** extra heavy AlNi magnet, perfect gap alignment, tropicalized cone, oversized voice coil, small air gap, non-resonant frame. **SPECIFICATIONS:** Impedance — 8 ohms at 800 cps; Response — 35 to 14,000 cps; Output — 15 w average, 21 w peak; Magnet Wgt. 28.5 ozs; Voice Coil Diam. — 1"; Overall Diam. — 8 1/2"; Baffle Opening — 7 1/4"; Depth — 4"; Frame — heavy duty cast aluminum girder construction. net **19.95**



LORENZ LP 312-1 and LP 312-2
12" COAXIAL AND DIALXIAL SPEAKERS

Extended response coaxial or dialxial speakers are obtained by adding Lorenz TB-1 or TB-2 Tweeters to Lorenz 12" wide-range reproducers.

SPECIFICATIONS	LP 312-1	LP 312-2
Impedance (at 800 cps):	16 ohms	16 ohms
Response:	20-17,000	20-17,000
Output:	27 w	27 w
Overall Diam.:	12 3/4"	12 3/4"
Baffle Opening:	10 3/4"	10 3/4"
Depth:	6 3/4"	7 1/4"

Price: net **49.50** net **59.50**
 (includes HP-1 Hi Pass Filter)



LORENZ LP 65
HORN-TYPE TWEETER

Fits any enclosure or speaker without the usual interaction. **FEATURES & ADVANTAGES:** solid back permits wide application; round cone design assures even sound dispersion; soft plastic construction prevents metallic overtones. **SPECIFICATIONS:** Impedance — 5.5 ohms at 800 cps; Response (with High Pass Filter HP-1) — 2,000 to 17,000 cps; Sound Dispersion — 120° (in all directions); Output — 2 w; Outside Diam. — 2 1/2"; Cone Diam. — 2 1/4"; Baffle Mounting Hole — 2 1/8" fared to 2 1/2" or more. net **8.50**

LORENZ HP-1
HIGH PASS FILTER

For use with any tweeter. Introduces highs at rate of 3 db per octave starting at 2,000 cps, with nominal crossover at 5,000 cps. Effect increases smoothly to limit of audibility. Installed within speaker enclosure. **DIMENSIONS:** Overall height 2 3/4"; Mounting (square base) — 1 1/2" between hole centers. net **4.95**



Exclusive U.S. Distributors

See and Hear Them At Your Hi-Fi Dealer Now!
Kingdom PRODUCTS, Ltd.
 514 Broadway, New York 12, N. Y. • WOrth 6-0800

damping under such conditions would be superfluous.

4). Since there is really no such thing as a perfectly rigid structure, I must agree with Mr. Briggs that the stationary electrodes must vibrate, just as the frame of a moving-coil loudspeaker must vibrate. The important thing here is to make certain that the electrodes are stationary enough. Such a degree of "stationariness" can be achieved.

5). Some types of electrostatic loudspeakers are very directional. But some moving-coil type speakers are also very directional. In both electrostatic and moving-coil types, the directional characteristics can be made to correspond to what seems to be optimum for the greatest percentage of rooms. No manufacturer can provide enough models to meet exactly the requirements of every listening room.

6). Of all of the high-quality power amplifiers that have been used with the Janszen electrostatic, only two have displayed a tendency toward instability. Through cooperation with the manufacturers of power amplifiers, and through the introduction of a resistive component into the electrical load seen by the power amplifiers above 3000 cps, the probability of instability in amplifiers is being reduced rapidly, and is approaching zero.

7). In saying that American manufacturers of electrostatic loudspeakers always recommend grossly inefficient bass speakers as low-frequency counterparts because of the low sensitivity of the electrostatics, Mr. Briggs errs. In at least one case, the Janszen, the sensitivity was set to match that of two brands of woofers that were found through extensive listening tests to provide the most pleasant over-all performance two years ago. Presumably because of their uniform power response from the low frequencies up to the frequency at which the tweeter can take over the acoustic load, the efficiency of these woofers is not as high at any frequency as that of other woofers at specified frequencies. I suspect that their hand-pass efficiency product might well be on a par with most other woofers that have a nominally higher efficiency or sensitivity rating.

8). It is true that higher voltages are required for the reproduction of low frequencies from electrostatic loudspeakers. But the listener need not be exposed to these voltages. As was demonstrated in the production prototype of the Janszen wide-range electrostatic at the New York High Fidelity Show, the electric fields can be entirely enclosed and all high voltages confined to the interior of the loudspeaker structure. The chance of exposure to high voltages can be made to be as low as in the case of a television receiver.

ARTHUR A. JANSZEN,
 48 Stone Road,
 Belmont, Mass.

SIR:

With reference to the letter by G. A. Briggs in the September issue of AUDIO: If one calculates the power of the amplifier necessary to drive a speaker system which is 5 per cent efficient, and requires that the speaker system develop the power of a 15 piece orchestra, it turns out that the power required for peak passages is 50 to 250



LA GIOCONDA



stereophonic sound **by Ampex** brings you up to date

Once you've heard music reproduced stereophonically, you'll always be aware of the disappointing flatness of sound from a single source system. And once you've heard Ampex stereophonic sound, you'll never be satisfied with less.

Now, the magnificent new Ampex A series brings you stereophonic sound — and a complete tape recorder too. "A" series recorders capture all the natural depth, clarity and realism of the original performance, record on half-track with true professional quality and achieve vivid reproduction of half- and full-track, single channel tapes. New features include: tape position indicator, simple tape speed selector for 3% and 7% ips

speeds, and recording volume indicator. Ampex A series recorders, and their amplifier-speakers are available in elegantly designed table-top cabinets or handsome portable cases. The ultimate in a complete home music system is the Ampex Console Model A 423. The system contains: stereophonic player-tape recorder, AM-FM tuner, 3 speed record changer, and two complete amplifier-speaker systems.

Whether you choose the table-top, portable, or complete console system, your Ampex will put you years ahead in high fidelity — will add a wonderful touch of perfection to your listening enjoyment. See and hear them today at your Ampex dealer's.

Ampex Corporation • 984 Charter Street • Redwood City, California

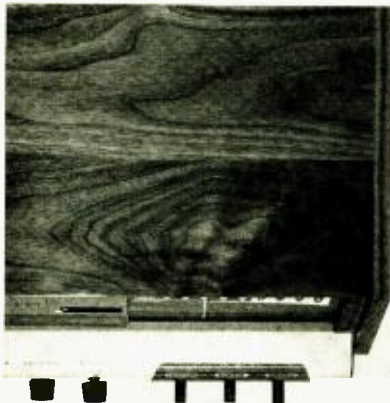

Even though our name is steeped in the tradition of the high fidelity field, we would now like to introduce ourselves as the newest and freshest face around. We still hold tenaciously to our tradition, but a few new ingredients have been added.

Progressive styling for one thing. Our styling department was given full rein on these new models and what has evolved is simply exhilarating. A form that is freshly alive, rich warm woods, fine finishing, extremely functional—an incredibly handsome line, indeed.



Engineering, too, was given the full treatment. Some old hands in high fidelity circuitry shut themselves in the lab for months looking for something new. One day they walked out of the lab with some prototypes brimming over with new circuit ideas. We didn't feel that we could keep them a secret for long, so we've used them in all of our new models.

You will want to see and hear our new models when they start gracing the shelves of our dealers. In the meantime, we've reserved a brochure for you giving full details on all of our new tuners and amplifiers. Just drop us a note with your name and address and the word "brochure" to

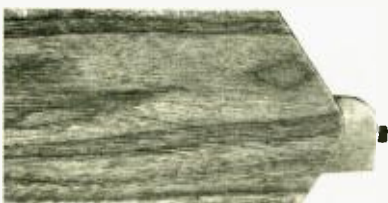

SARGENT-RAYMENT CO.

4926 East 12th Street, Oakland 1, California

watts. The power of various instruments and orchestras in peak passages and on an average basis may be found in the *Journal of the Acoustical Society of America*, April, 1931.

If one uses the data for power level measurements given in *Proceedings of the Institute of Radio Engineers*, for March, 1949, or the data in *AUDIO*, for January, 1953, p. 32, it is found that a power amplifier of about 100 to 200 watts is necessary to reproduce this orchestra in a room the size of Mr. Nunn's listening room.

Mr. Briggs indicates that much less power is required for music reproduction. He uses 60 watts to fill Festival Hall which would by the above standards require 2000 watts. There is an explanation for this difference of opinion between Mr. Briggs and the American literature. The three suggestions which Mr. Briggs proposes are all incorrect and incomplete as well.

I propose the following possible explanation. The amount of power required for high-quality reproduction depends very strongly upon the acceptable level of distortion. Mr. Briggs says that only the wind quintet sounded perfectly reproduced. Also, several critics have been very cool about the quality of the Briggs concerts. It is possible to conclude then that the lower power level required by Briggs is due to the clipping of the peaks and the consequently poorer quality which he finds acceptable. One may note that according to the more rigorous standards used in America, (? Ed.) only the wind quintet music lies within the power capabilities of Mr. Briggs equipment. I would not suggest that the Briggs equipment is not acceptable but only that it is not used in such a way as to give the very highest quality reproduction, such as has been attained in America by Mr. Nunn and others. (*He'll bet this draws a reply.* Ed.)

RICHARD A. GREINER,
The University of Wisconsin,
College of Engineering,
Madison, Wis.

SIR:

All of this argument about power output and loudspeakers in audio systems among the Hi Priests of Hi Fi is fascinating, but one point is being overlooked, it seems to me.

Isn't the final judgement of a rig whether or not it satisfies its owner? If Ewing Nunn feels he needs 20 speakers and 180 watts of output power, can anyone call him wrong if he's happy with it, and his neighbors are either far away or tolerant? On the other hand Paul Klipsch once said 10 watts are enough, if they are flat to 16 cps. If that satisfies him, doesn't that make him right? I happen to like moderate amplification combined with the best speakers I can afford. As long as I am aware of the sound of big powered amplifiers and like what I have, am I in error?

In fact, aren't the opinions of these audio professionals colored by what they're trying to sell? Mr. Nunn makes records with frequency response far above the level at which the hearing cuts off for the average guy who has reached the economic state where he can afford audio as a hobby. But he needs equipment that can reproduce the full 20 to 20,000 cps range, Briggs.

the
perfect complement
to the finest
High Fidelity System!



MST-1 *Single*



MST-2 *Turnover*

MIRATWIN Cartridges

No Hi-Fi System is better than its pickup cartridge . . . and no cartridge excels the clarity and brilliance of the *Miratwin*. Its unusually wide range and extreme sensitivity brings out the very best in any Hi-Fi System. Fits all standard tone arms . . . permits instant fingertip stylus replacement.

MST-1D—Single Diamond Stylus	\$34.50
MST-1S—Single Sapphire Stylus	\$12.50
MST-2D—Turnover Diamond Stylus and Sapphire Stylus	\$45.00
MST-2A—Turnover Sapphire Styli	\$22.50

Stylus Replacements Available from Stock



At All Hi-Fi Dealers • Write for Complete Brochure

AUDIOGERSH CORPORATION

514 BROADWAY, NEW YORK 12, N. Y. • WORTH 6-0800

In Canada: Atlas Radio Corp., Ltd., Toronto



FAR AHEAD > THE FINEST BY FAR



MIRACORD XA-100

Pushbutton changer and Manual
Player in ONE Precision
Instrument!



MIRAPHON XM-110A

Manual Player

A New Concept in Speaker Design

...FROM ALTEC LANSING LABORATORIES

Exceeding the expectations of even those engineers who worked on the design and development of Altec Lansing's new Biflex speakers, the principle of "multiple concentric compliances" has provided almost unbelievable new performance at very nominal cost. By separating a single cone into two segments with a flexible connection, Biflex speakers achieve a smoother and more extended frequency range than any other single cone loudspeaker.

To convince yourself of the truly remarkable performance of Biflex speakers selling for as little as \$27.00, you have only to listen for yourself. Only by hearing the Biflex can you believe that so much high fidelity can be yours for so little.



415A
15", 25 watts, 30-14,000 cycles, \$63.00



412A
12", 20 watts, 40-15,000 cycles, \$48.00

408A
8", 15 watts, 60-16,000 cycles, \$27.00



These guaranteed frequency responses, measured in Altec's anechoic chamber, are minimum specifications and will be met or exceeded by the Biflex speaker you buy.



ALTEC[®]
LANSING CORPORATION

ALTEC FIDELITY IS HIGHEST FIDELITY

Dept. 11 - A
9356 Santa Monica Blvd., Beverly Hills, Calif.
161 Sixth Avenue, New York 13, N. Y.

Still the finest!

**...DUPLEX SPEAKERS
BY ALTEC LANSING**

Duplex speakers by Altec Lansing are still the finest loudspeakers made—still the outstanding choice of professional engineers. Without truly outstanding performance, their long record of leadership could not be maintained.

Duplex speakers are the finest because they represent the ultimate development from the sound laboratories that are responsible for the famous stereophonic speaker systems of Cinerama, Cinemascope and Todd-A-O. Until you hear the efficient reproduction of sound throughout the frequency range of 30 to 22,000 cycles which is available only in tested and guaranteed Duplex speakers by Altec Lansing, you have not realized the true potential of your high fidelity installation.

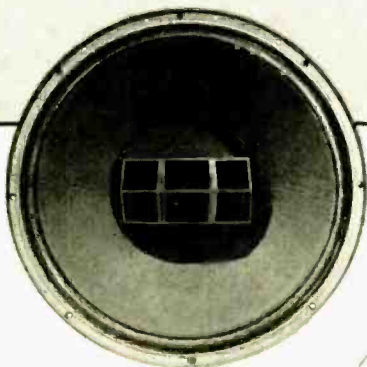

604C
15", 35 watts (50 peak), 30-22,000 cycles,
\$165.00 incl. network

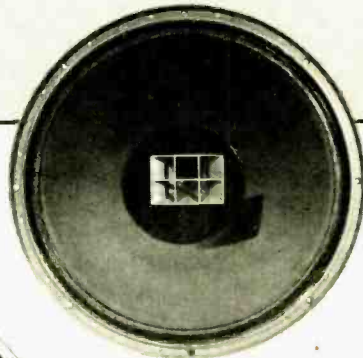

602A
15", 25 watts (35 peak), 30-22,000 cycles,
\$126.00 incl. network

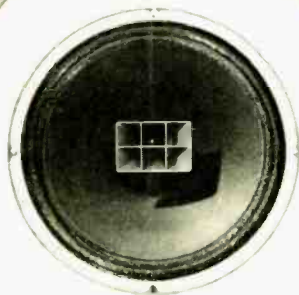

601A
12", 20 watts (30 peak), 30-22,000 cycles,
\$106.00 incl. network

These guaranteed frequency responses, measured in Altec's anechoic chamber, are minimum specifications and will be met or exceeded by the Duplex speaker you buy.



ALTEC FIDELITY IS HIGHEST FIDELITY

Dept. 11- A
9356 Santa Monica Blvd., Beverly Hills, Calif.
161 Sixth Avenue, New York 13, N. Y.

EDITOR'S REPORT

NEW YORK HIGH FIDELITY SHOW

ACCORDING TO CUSTOM, the lead-off spot for the issue following the Fall audio show in New York is devoted to a discussion—Monday-morning quarterbacking, so to speak—of the event, and this is no exception. Everyone who attended will agree that it was the greatest show that has ever been held in New York, and with one or two minor squawks every exhibitor holds the same opinion. To be sure, the intermediate walls were not as soundproof as everyone would have liked, but the flow of traffic, the lightness and cleanliness of the building itself, and the presence of an air conditioning system—which was slightly over-loaded, perhaps, during the peak hours of each day—make the New York Trade Show Building an ideal place for the show.

During the four days, a total of 28,880 paid admissions were recorded, and with the additional attendance of the press, manufacturer's representatives, trade, and the members of the Audio Engineering Society, the over-all total was just under 40,000—a real record for any audio show (except in Tokyo, where attendances of over 50,000 were racked up on two occasions).

An hour before opening time on Thursday, September 27th, a line formed along the front of the building to 35th Street, down the subway stairs, and extended for several hundred feet in the subway arcade. This didn't last for long, for with the aid of a number of gentlemen in blue the line reconstituted itself along 35th Street. By 45 minutes after opening time the paid attendance had reached 1511, exactly half the total attendance of the first audio show in 1949.

The event proved several things about how to run an audio show—not the least important was dispelling any doubts of the advantage to be obtained by charging a nominal admission fee, although this was fairly well proved in Philadelphia last year and in Los Angeles in February. Adequate advance publicity is an absolute necessity for a successful show, and there was plenty of that this year. The Brass Rail restaurants—one of which is located in the Trade Show Building—carried a story about and served "Hi-Fi" cocktails, and a few of the papers mentioned it. There were streamers and window cards in record and hi-fi stores. There was good coverage with advertisements in the metropolitan newspapers and several well timed publicity stories. The show was announced on several radio stations—either as an appendage to exhibitors' commercials or on special programs. The net result was that the crowds came, which was the object of all the advance effort.

From a bird's eye view of the exhibits, it would seem that the accent was on loudspeaker enclosures, with many new types being shown for the first time. We can well remember the introduction of the first widely received television set—RCA's 630—at the relatively high price of three hundred and seventy five dollars, and for a 10-inch picture tube, too. Then as refinements were made and manufacturing processes simplified—as were the circuits—the price grad-

ually came down, perhaps with a diminution of quality with each step, for the 630 and its many successors that are still available in kit form or completely finished by several smaller producers of sets still rank as among the best TV sets ever made. It would appear that we are witnessing a similar progress in loudspeakers. We still have the acknowledged leaders with fairly expensive speaker systems, and we have many less expensive models which achieve their own degrees of acceptance by what might be called an extraordinary exercise of engineering. If the greatest number is to be served with quality hi-fi equipment, the trend toward lower prices is desirable—even if only to get people interested enough to "get the bug."

DIAMOND STYLI

In general, we try to follow a policy of "live and let live," assuming that the customer will find out about unsatisfactory merchandise or advertising and selling practices by himself and be guided by what he learns. But occasionally it appears that there are some "sharpies" in the business who live by trying to put one over on the customer. The sort of thing that couldn't possibly happen in a small town, where a merchant of any type has to rely on his old customers for his livelihood because there are only so many people in the town altogether and he can't afford to take advantage of any one of them. But in a city the size of New York—or any of a dozen or more others—the sharp-practicer can pull a fast one on a hundred customers each day and scarcely run out of customers in a lifetime.

In particular, we are talking about diamond styli. Not that we have anything against diamond styli, for we wouldn't use anything but a diamond, but we do have something against the idea of selling diamond "replacement styli" that are not exactly in accordance with the manufacturer's specifications. In fact, we are firmly of the belief that when it is necessary to procure a replacement stylus, it should be obtained from the pickup manufacturer and not from some other source that claims to have one which is just as good and five dollars—or more or less—cheaper. The design and construction of the small and extremely delicate parts of a pickup have considerable influence on the performance of the finished product, and if brass is used instead of aluminum, for example, the performance may suffer very greatly. We have heard numerous complaints about replacement styli which did not fit properly, were longer than the original, and which weren't satisfactory for a variety of reasons. One way of avoiding this kind of trouble is to make sure that the replacement stylus is made either by the manufacturer of the pickup, which is the preferred way, or at least that the manufacturer of the replacement is equally reputable. We do not mean to imply, of course, that all manufacturers of replacements are not as capable of making just as good a stylus as the original manufacturer, but we caution readers to make sure before buying a "bargain."

**you
wouldn't
buy**



Half a record

yet that may be all your present system reproduces!

Recent improvements in high-fidelity recording have captured the full tonal color of every instrument in the orchestra . . . every subtle shading from the brilliance of the violins to the deep roll of the kettle-drums is impressed on discs made with the latest recording techniques. Yet this dazzling other-world of sound may be *beyond the capacity* of your present high-fi equipment . . . in terms of sound reproduction, *you may be buying only half a record!*

PICKERING professional-quality components—*the best that money can buy*—recreate *all* of the music on fine microgroove recordings—give you the richness of reality that makes listening the extreme pleasure you have dreamed about . . . but never experienced.

PICKERING components include the world-renowned "FLUXVALVE" magnetic cartridge with one-mil or half-mil diamond styli . . . the Pickering 410 Audio Input System, combining preamplifier, record compensator, and equalizer network (each of which is available separately) . . . the famed Pickering Model 190-D distortion-free tone arm . . . and the revolutionary new PICKERING ISOPHASE electrostatic SPEAKERS, which reproduce music so faithfully *they must be heard to be believed!*

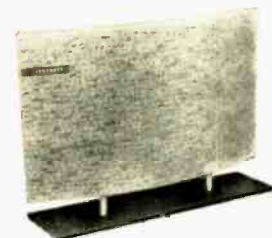

PICKERING & CO., INC. OCEANSIDE, N.Y.

Professional Audio Components

"For those who can hear the difference"

... Demonstrated and sold by Leading Radio Parts Distributors everywhere. For the one nearest you and for detailed literature: write Dept.A-12
EXPORT: AD. AURIEMA, INC., 89 BROAD ST., NEW YORK / CANADA: CHARLES W. POINTON LTD., 6 ALCINA AVE., TORONTO

A TRIUMPH OF TELEPHONE TECHNOLOGY

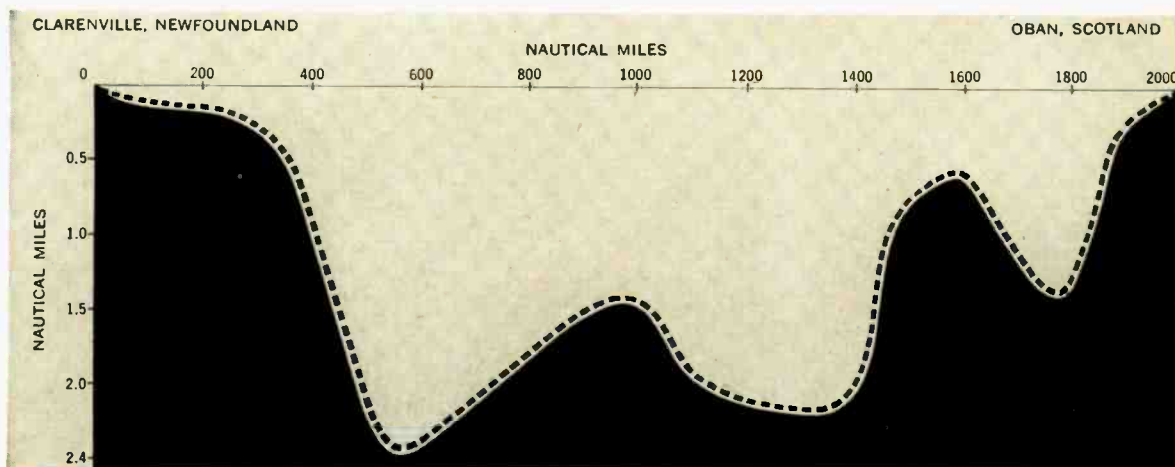

Contour of ocean bed where cable swiftly and clearly carries 36 conversations simultaneously. This is deep-sea part of system — a joint enterprise of the American Telephone and Telegraph Company, British Post Office and Canadian Overseas Telecommunications Corporation.

A great new telephone cable now links North America and Europe—the first transoceanic cable to carry voices.

To make possible this historic forward step in world communications, Bell Laboratories scientists and engineers had to solve formidable new problems never encountered with previous cables, which carry only telegraph signals.

To transmit voices clearly demanded a much wider

frequency band and efficient ways of overcoming huge attenuation losses over its more than 2000-mile span. The complex electronic apparatus must withstand the tremendous pressures and stresses encountered on the ocean floor, far beyond adjustment or servicing for years to come.

Here are a few of the key developments that made this unique achievement possible:

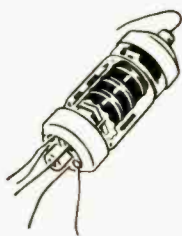

More than 300 electron tubes of unrivaled endurance operate continuously, energized by current sent from land.

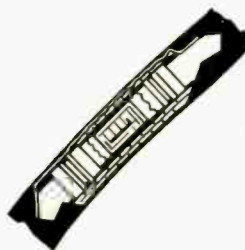

Precisely designed equalizing networks and amplifiers compensate for the loss in the cable every 40 miles and produce a communication highway 144 kc. wide.

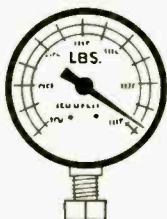

A unique triple watertight seal protects the amplifiers from pressures as high as 6500 pounds per square inch.

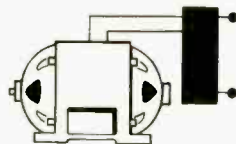

Power supplies of exceptional reliability send precisely regulated current along the same coaxial that carries your voice to energize the amplifying units.



BELL TELEPHONE LABORATORIES

World center of communications research and development

Interference Effects with Crossover Networks

CHARLES P. BOEGLI*

Placement of the two speakers of a two-way system is important in over-all reproduction quality since it may result in lack of smoothness over the frequency spectrum. The author covers one of the finer points of multiple-speaker system construction.

THE MOST CRITICAL single part of an audio-frequency reproducing system is the loudspeaker. Microphones and phonographs have been perfected to the point where they are ceasing to be serious problems, and amplifiers are available with performance which leaves nothing to be desired. On the other hand, speaker systems still remain a source of considerable concern, for it is here that large amounts of distortion and frequency nonlinearity are often introduced.

Efforts to reduce the shortcomings of speakers take a number of paths. Very frequently the audio spectrum is divided into several sections, each of which is assigned to an individual speaker designed to handle that section best. This division of the audio spectrum is carried out principally by means of crossover networks, for which several designs are available.

The problem of phasing in coaxial speaker networks is one which has not received too much attention until recently. It has, however, often been noticed that reversing the connections to one speaker of a two-speaker array causes an audible change in over-all results.

For the most part, it has been assumed that when the crossover network is carefully designed and constructed, the response of the system is practically flat. That this is not necessarily the case will be demonstrated in this paper. A preference has existed in the audio field for 12 db/octave crossover networks as opposed to the simpler 6 db/octave type. It will be shown that under some circumstances the 6 db/octave network is superior to the 12 db/octave type, at least from the frequency-response standpoint. It has been common practice to choose the crossover frequency by considering only the frequency over which the individual speakers function most effectively. The subsequent work will show that the flattest response will re-

sult if the crossover frequency is also chosen with a view toward the mechanical spacing between the speakers.

Analysis of Special Cases

12-db/octave constant-resistance networks

Let us assume that the sound output of a speaker is in phase with, and has a magnitude directly proportional to, that of the electrical input. Although at first glance it may seem to be rather presumptuous to ascribe such perfection to any speaker, this assumption nevertheless leads to results at the crossover frequency that have been experimentally observed in a number of cases. It is probably justified over at least a limited frequency range, so long as that range is sufficiently removed from points at which the speakers' responses are seriously affected by principal resonances.

We shall further assume that the two speakers, of equal efficiencies, are connected by means of a constant-resistance parallel-type 12 db/octave crossover network to a constant-voltage source of signal (e.g., an amplifier with zero output resistance). The crossover frequency will be considered unity with no loss of generality.

A third and temporary assumption is that the sound-generating elements of both speakers occupy the same space; that is, they are not only coaxial but also coplanar. Strictly speaking, this is an impossible condition, but it forms a special case which is more easily handled than the general case, which will be discussed later. The results of this analysis will also be found useful in the more general work.

An analysis of the 12-db/octave crossover network (Fig. 1 shows the parallel type, but the series type gives the same results) leads to the following expressions for the voltages fed to the individual speakers, in Laplacian notation:

$$E/E_i = \frac{1}{s^2 + \sqrt{2}s + 1} \quad (\text{low-range speaker}) \quad (1)$$

$$E/E_i = \frac{s}{s^2 + \sqrt{2}s + 1} \quad (\text{high-range speaker}) \quad (2)$$

The two speakers can be connected in either of two ways: in-phase or out-of-phase. "In-phase" connection means that if a battery is connected to the corresponding terminals of each speaker, the diaphragms will move in the same direction. In this case, the sound output from the speakers (which is assumed the same as the electrical inputs) is simply the magnitude of the sum of the two transfer functions just derived:

$$V_s' = \text{sum output} = \sqrt{\frac{u^4 - 2u^2 + 1}{u^4 + 1}} \quad (3)$$

the quantity u being used because the frequencies are referred to the crossover frequency as 1.0.

If the speakers are connected out-of-phase, the over-all sound output is the magnitude of the difference of the two transfer functions:

$$V_d' = \text{difference output} = \sqrt{\frac{u^4 - 2u^2 + 1}{u^4 + 1}} \quad (4)$$

The primes in Eqs. (3) and (4) indicate that these equations are for the special case.

It is interesting to note the shapes of the frequency-response curves in Fig. 2. That for V_s' has a point of zero response just at the crossover frequency. The curve for V_d' is much more uniform, al-

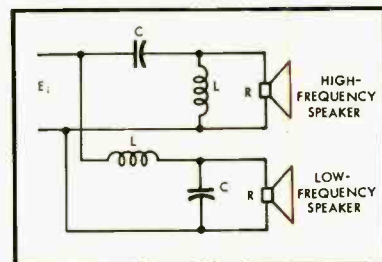

Fig. 1. Typical 12 db/octave constant-resistance crossover network, in the parallel configuration.

* Cincinnati Research Company, 2209 Losantville Road, Cincinnati, Ohio.

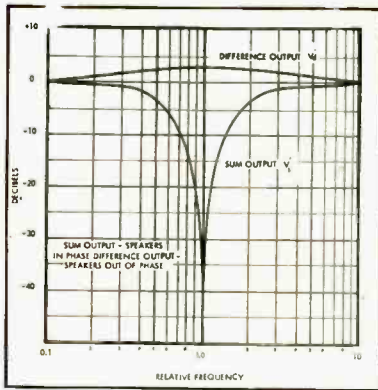

Fig. 2. Frequency responses of 12 db/octave constant-resistance networks and coaxial coplanar speakers in and out of phase.

though it is not flat. It may be inferred that the tacit assumption that the response of an in-phase multiple-speaker system is flat at the crossover frequency is often very far from being true, and that in the present case better results are obtained if the speakers are connected out-of-phase. Frequency-response curves of coaxial speakers sometimes show sharp dips at the crossover frequency. This evidence appears to favor the first assumption.

6 db/octave constant-resistance networks

Figure 3 shows a typical 6-db/octave crossover network. With the same assumptions as were used previously, and by performing the same sort of analysis, we obtain

$$E/E_t = \frac{1}{s+1} \text{ (low-range speaker) } \quad (5)$$

$$E/E_t = \frac{s}{s+1} \text{ (high-range speaker) } \quad (6)$$

In this case, it is interesting to note that the magnitude of both the sum V_s and difference V_d outputs are the same, independent of frequency, and equal to 1.0. This means that with two coaxial and coplanar speakers connected by a 6-db/octave constant-resistance network, there is no peak or dip at the crossover frequency; the response is perfectly flat. Unfortunately, it does not imply that peaks or dips will be absent when the speakers are not coplanar.

General Analysis

The logical extension of the preceding analysis is to find what happens when the two speakers are coaxial but not coplanar, as is usually the actual case with coaxial speakers. Under these circumstances, at a reasonable distance from both units, there is a short time delay between the outputs of the speakers. For example, if the separation were six inches the delay would be of the order of 0.0005 second. A nonreactive cable

85 miles long would be required for the one speaker, if they were both coplanar, for a comparable electrical delay.

The existence of this time delay has the effect of multiplying the Laplace transform of the output of the speaker, whose sound is delayed by the term ϵ^{-st} , where t is the time delay. The time delay can be expressed in terms of the crossover frequency as follows: If the speakers are mechanically spaced n wavelengths apart at the crossover frequency ω_0 , the time delay is $\frac{2\pi n}{\omega_0}$ seconds, and the time-delay term becomes $\epsilon^{-2\pi n s/\omega_0}$. When ω_0 is arbitrarily considered to be 1.0, this delay term degenerates to $\epsilon^{-2\pi n s}$.

12-db/octave constant-resistance networks

For the 12-db network, the individual speaker outputs are the same as previously found, equations (1) and (2). The sum response V_s , when the signal from the low-frequency speaker is delayed with respect to that from the high, is then

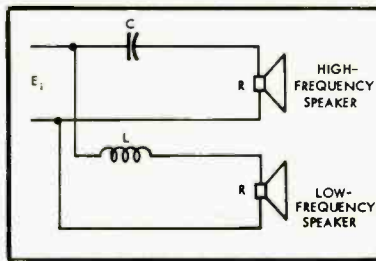

Fig. 3. Constant-resistance 6 db/octave crossover network.

$$V_s(s) = \frac{s^2}{s^2 + \sqrt{2}s + 1} + \frac{\epsilon^{-2\pi n s}}{s^2 + \sqrt{2}s + 1}$$

This equation can be rearranged to

$$V_s(s) = \frac{s^2}{s^2 + \sqrt{2}s + 1} + \frac{1}{(\cosh 2\pi n s - \sinh 2\pi n s)(s^2 + \sqrt{2}s + 1)}$$

When s is set equal to ju ,

$$V_s(ju) = \frac{-u^2 + \cos 2\pi n u - j \sin 2\pi n u}{1 - u^2 + j\sqrt{2}u}$$

The magnitude of this expression is found in the usual way to be

$$V_s = \sqrt{\frac{u^4 - 2u^2 \cos N + 1}{1 + u^4}} \quad (7)$$

¹ This terminology may be clarified by an example. Let the speakers be six inches apart and the crossover frequency be 550 cps. With a sound velocity of 1100 feet/second the wavelength is 2 feet, and 6 inches equals $\frac{1}{4}$ wavelength.

By the same method, the difference output is

$$V_d = \sqrt{\frac{u^4 + 2u^2 \cos N + 1}{1 + u^4}} \quad (8)$$

In Eqs. (7) and (8),

$$N = 2\pi n u$$

Certain observations can be made by comparing Eqs. (7) and (8) to (3) and (4):

- (1) $V_s = V'_s$ when $\cos N = 1$; that is, when $nu = 0, 1, 2, 3, \dots$
- (2) $V_s = V'_d$ when $\cos N = -1$; that is, when $nu = 1/2, 3/2, 5/2, \dots$
- (3) $V_d = V'_s$ when $\cos N = 1$; that is, when $nu = 0, 1, 2, 3, \dots$
- (4) $V_d = V'_d$ when $\cos N = -1$; that is, when $nu = 1/2, 3/2, 5/2, \dots$
- (5) $V_s = V_d$ when $\cos N = 0$; that is, when $nu = 1/4, 3/4, 5/4, 7/4, \dots$

These are also the points where the magnitude of the response is 1.0.

Since the expressions for V_s and V_d contain only $\cos N$ terms, and since $\cos N = \cos(-N)$, the frequency-response equations remain unchanged when the sound from the low-frequency speaker is advanced (instead of delayed) with respect to that of the high-frequency speaker. In other words, the response is the same for a given separation irrespective of which speaker is in front of the other.

With this information it is easy to sketch the response curve for two coaxial but not coplanar speakers connected through a 12 db/octave constant-resistance network, given the response curves for the special cases V'_s and V'_d . As an example, let us assume the speakers are spaced one wavelength apart at the crossover frequency and connected out of phase. Then $V_d = V'_d$ when $u = 0, 1, 2, 3, \text{ etc.}$; $V_d = V'_s$ when $u = 1/2, 3/2, 5/2, \text{ etc.}$; and $V_d = 1$ when $u = 1/4, 3/4, 5/4, 7/4, \text{ etc.}$ The resulting curve is shown in Fig. 4, sketched on the curves previously calculated for V'_s and V'_d . The response

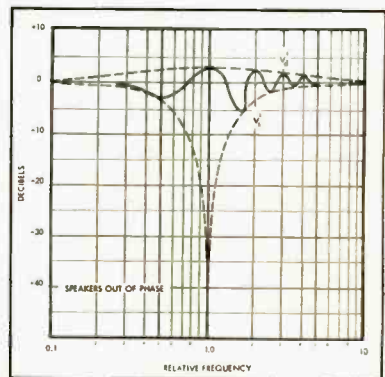

Fig. 4. Frequency response of a 12 db/octave constant-resistance network with out-of-phase coaxial speakers one wavelength apart at crossover frequency.

SEE OTHER
SIDE FOR
CHRISTMAS
GIFT
ORDER
BLANK



the V'_s and oscillation placed further when the wavelengths vary and the frequency is as

which one the other require-crossover departure of phase. The flat zero response, the two even number or out-of-half-wave-over fre-

networks db/octave equations none:

$$(9)$$

$$(10)$$

in the was flat speakers. As the used for does not illustrate be- $\frac{2u}{1+u^2}$ and $+u^2$ oscillation

ribed as

$$\sin N = \dots, 9/4, \dots$$



12 db/octave network with one wavelength at the crossover frequency.

$$(2) V_s = \sqrt{1 + \frac{2u}{1+u^2}} \text{ when } \sin N = -1; \text{ that is, when } nu = 3/4, 7/4, 11/4, \dots$$

$$(3) V_d = \sqrt{1 + \frac{2u}{1+u^2}} \text{ when } \sin N = 1; \text{ that is, when } nu = 1/4, 5/4, 9/4, \dots$$

$$(4) V_d = \sqrt{1 - \frac{2u}{1+u^2}} \text{ when } \sin N = -1; \text{ that is, when } nu = 3/4, 7/4, 11/4, \dots$$

$$(5) V_d = V_s = 1 \text{ when } \sin N = 0; \text{ that is, when } nu = 0, 1/2, 2/2, 3/2, \dots$$

The maximum possible variation from flat response occurs at $u=1$, for which the value of $\frac{2u}{1+u^2}$ is a maximum, and this peak is 3 db above or below the flat response. As an example, we may work out the previous problem, where the speakers are connected out-

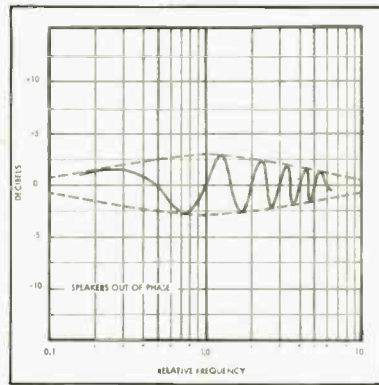

Fig. 6. Frequency response of a 6 db/octave constant-resistance crossover network with out-of-phase coaxial speakers one wavelength apart at crossover frequency.

of-phase and are separated by one wavelength at the crossover frequency. Then $V_d = 1$ when $u = 0, 1/2, 2/2, 3/2, \dots$;

$$V_d = \sqrt{1 + \frac{2u}{1+u^2}} \text{ when } u = 1/4, 5/4, 9/4, \dots; \text{ and } V_d = \sqrt{1 - \frac{2u}{1+u^2}} \text{ when } u = 3/4, 7/4, 11/4, \dots$$

The curve is sketched in Fig. 6, along with those representing its envelope.

The equations for the 6-db/octave network contain a term in $\sin N$. Since $\sin N = -\sin(-N)$, the expressions for V_s and V_d —Eqs. (9) and (10)—are interchanged when the low-frequency speaker is forward with respect to the high.

Practical Results

12-db/octave constant-resistance networks

When two coaxial speakers, connected in phase through a constant-resistance 12-db network, are located so that the sound-producing elements are one wavelength or more apart at the

TABLE I
VARIATIONS IN RESPONSE WITH OPTIMUM SPEAKER LOCATIONS

	n (approx.)	Response db range (approx.)
SPEAKERS OUT OF PHASE	0.866	7
	1.94	13
	2.96	16
	3.97	19
SPEAKERS IN PHASE	1.41	10
	2.45	14.5
	3.46	17.5
	4.48	20

crossover frequency; or if the two speakers are out of phase and one-half wavelength or more apart at the crossover frequency, then the combined response curve will show two major dips, located each side of the crossover frequency. This is true because, as has been shown in the previous section, $V_s = V'_s$ when $nu = 0, 1, 2, 3, \dots$; hence, if n is greater than 1.0, at least one dip will occur at u less than 1.0 and some succeeding dips will exist at u greater than 1.0. The same considerations for V_d lead to the other conclusion.

The flattest response results approximately when the two most prominent dips are located equidistantly (on the logarithmic frequency plot) each side of $u=1.0$. In other words, $u=1.0$ should be the geometric mean of the two principal dip frequencies to attain the flattest response. This statement is an approximation because (a) the curve for V'_d is not a straight line, and (b) the lowest point of the dip is not necessarily the point at which the response curve coincides with V'_s . Nevertheless, the approximation is quite good.

For out-of-phase speakers, therefore, the flattest response results about when $u=1.0$ is located at the geometric mean between two dips at which $V_d = V'_s$; that is, at the geometric mean of any pair of successive $nu = 1/2, 3/2, 5/2, \dots$. This relationship is conveniently given by the expression

$$n = \sqrt{\frac{x^2 + 2x}{2}} \quad (11)$$

where $x = 1, 3, 5, 7, \dots$. On the other hand, for in-phase speakers, $u=1.0$ should be located at the geometric mean between two dips at which $V_s = V'_s$; that is, at the geometric mean of two adjacent values of $nu = 1, 2, 3, 4, \dots$. The relationship is given by the equation

$$n = \sqrt{x^2 + x} \quad (12)$$

in which $x = 1, 2, 3, 4, \dots$. The value $x=0$ cannot, of course, be substituted into this equation with meaningful results.

With these relationships established, it is possible to gain an idea of the departure from flat response that results with various optimum placements.

(Continued on page 92)

Noise—Enemy of Normal Hearing

CHARLES E. WHITE*

Noise is an ever-increasing problem in industrial, commercial, and military life. The symptom of the problem—hearing loss—is a serious disability which creeps upon many workers undetected. The author describes the requirements for audiometric testing areas and the need for frequency analysis of noise disturbances.

During attendance at several conferences intended as indoctrination for medical personnel and audio technicians who were concerned with loss of hearing in industrial, commercial, and military establishments brought about by the presence of noise, the writer observed a great need for further information regarding noise measurement and the effect of noise upon hearing. Questions such as the following were typical:

1. How are noise levels in working areas and audiometric testing areas measured?
2. What are noise limits in working areas and audiometric testing areas?
3. Of what value is a knowledge of the frequency spectrum of the noise?
4. How can soundproofed rooms for audiometric testing be constructed?

With the feeling that audio personnel in general are interested in the same problem, this article presents information which may be applied to answering the questions raised and supplies a reference list wherein is contained further information.

* P.O. Box 137, New London, Conn.



Fig. 2. Scott Sound Level Meter demonstrates portability of well-designed equipment.



Fig. 1. General Radio Company's latest design of sound level meter.

Measurement of Noise Levels

Noise levels are measured simply, by employment of instruments such as:

1. General Radio Sound Level Meter, Type 759 or 1551A—Fig. 1
2. H.I. Scott Sound Level Meter, Type 410C—Fig. 2
3. General Radio Sound Survey Meter, Type 1555-A—Fig. 3
4. General Radio Vibration Meter, Type 716B
5. General Electric Sound Level Meter, No. 5122145G1
6. General Electric Vibration-velocity Unit, No. 5993801G1

It should be stressed that these meters are not complicated in operation. The instructions supplied with each unit are complete and clear. But, there are certain measures which should be observed before the instruments are employed in a noise area. These precautions are presented clearly in a publication supplied by the General Radio Company at a nominal cost.¹ It is strongly urged that anyone interested in the subject of noise measurements obtain a copy.

Briefly, the precautionary measures are:

1. The measuring instrument should

be placed in a location such that the sound reaching the microphone is at the ear level of the worker who would be affected by the presence of the noise.

2. Be certain that the instrument is not located in a null position—it is often found that the acoustical environment in the area being treated is such as to produce standing waves. Under these circumstances it will be found that moving the microphone position



Fig. 3. Versatile pocket-size sound level meter made by General Radio.

¹ *Handbook of Noise Measurement*. General Radio Co., Cambridge, Mass. April, 1953.

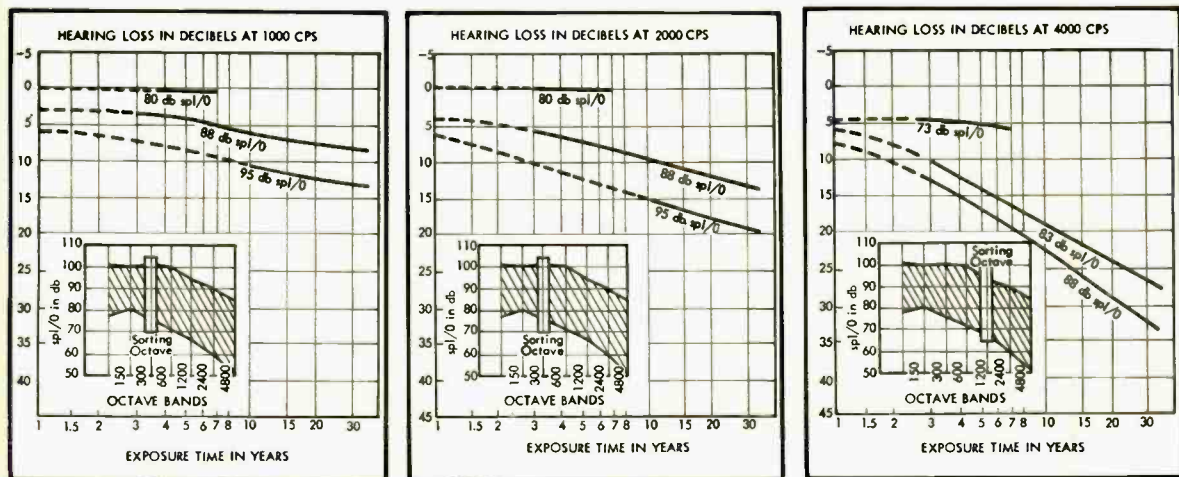

Figs. 4, 5, and 6 (left to right). Estimated average trend curves for net hearing loss at 1000, 2000, and 4000 cps, respectively, after continuous exposure to steady noise; corrected for presbycusis; not corrected for temporary threshold shift. (From ASA Report²)

will result in a series of maximum and minimum deflections of the indicating meter. If this situation is encountered, it should be borne in mind that it is the maximum deflection which should be recorded.

3. When testing suitability of a location to be employed in audiometric testing the measuring instrument should be placed in a number of positions within the room to determine the average noise level. If it should be determined that readings differ by more than 10 db, a check should be made for the cause of the deviation. There is a distinct possibility that noises generated locally may be offending and that elimination is a simple matter. Heating and ventilation systems are highly suspect, also high-speed rotating devices which are not treated for sound isolation.

4. It is of primary importance when making sound level measurements that the microphone pickup be monitored with a good set of earphones. In this way a check is maintained continuously that the microphone is actually picking up the noise which would be heard by the ear when at the same location, and not hum, microphonics, or other undesirable electrical effects.

Working Area Noise Limits

During the past ten years impetus has been given to the study of the effect of noise upon hearing. Research in acoustics during World War II encouraged studies of the effect of noise upon communications, of noise upon working-man output, and the physiological effect upon man of high-intensity noises such as jet engine exhausts, and so on.

In general it is appreciated that the problem of limiting noise in working

areas is complicated by factors such as the type of work being conducted, extent of communications required, the physical well-being of workers, and the like. If it is essential that communication be maintained during work, a lower level of noise is tolerable than if communication was not required. Kryter² reports that under conditions where communication is required to a small extent, the maximum safe intensity for exposure for *indefinite periods* is approximately 85 db above .0002 microbar for single tones, or for critical bands if noise is a disturbing factor. He allowed this level of tolerance to be raised for frequencies below 1000 cps and above 3000 cps. Where communication was not essential critical band noise levels as high as 100-110 db above .0002 microbar could be tolerated with no detrimental physiological or psychological effect, provided the worker had sufficient time for adaptation.

Stevens *et al*³ reported that intermittent exposure to airplane noise of a sound pressure level approximating 115 db over a period of sixteen experimental days revealed that as a subjective experience, noise is disagreeable and tiring but that most types of mental, motor, and physiological activity are affected only to a slight degree by noise. This conclusion is substantiated

² K. K. Dryter, "Noise safety criteria." *AMA Archives of Industrial Hygiene and Occupational Medicine*. Feb. 1952, pp. 117-120.

³ S. S. Stevens *et al*, "I. The effects of noise on psychomotor efficiency II. Noise reduction in aircraft as related to communication, annoyance, and aural injury." OSRD 274, Dec. 1941. Office of Scientific Research and Development, Washington 25, D. C.

also by Corso,⁴ whose report contains an excellent and complete bibliography as of the date of the report.

An excellent report is obtainable which treats of the biological effects of noise on man which brings to date all material known on the subject. This is the report issued by BENOX,⁵ a group of scientists "organized to make a survey of existing information, to conduct preliminary experiments, and to make recommendations as to the course of action to be followed in order that men can continue to perform effectively in situations where intensity levels of noise are very high." The reader's attention is directed to the report for a detailed discussion of the high-intensity noise problem, details of the efficacy of protective devices, physical disabilities which are encountered under exposure to high-intensity noise levels, and the psychological and neuropsychological effects after exposure to intermittent noise.

In May, 1951, the American Standards Association Sectional Committee Z24 on Acoustics, Vibration, and Mechanical Shock authorized its chairman, Dr. L. L. Beranek, to appoint an exploratory group to study "permissible, objectionable, and injurious noise levels" and to report back to Committee Z24 within the year. Action was delayed for one year but in May, 1952, the sub-committee on "Bio- and Psycho-Acoustic Criteria for Noise Control" was established. The efforts of the committee were limited to an investigation

⁴ J. F. Corso, "The effects of noise on human behavior." *WADC Technical Report 53-81*, Dec. 1952. Wright-Patterson Air Force Base, Ohio.

⁵ *An Exploratory Study of the Biological Effects of Noise*. BENOX, University of Chicago, Dec. 1953.

of the relations between hearing loss in industrial workers and exposure to industrial noise. The report of their investigation is published under the title "The Relations of Hearing Loss to Noise Exposure."⁶

From this report, several items of importance are presented here. A study of the effects upon hearing of continuous exposure to steady noise was made; curves were presented which allow for estimation of the hearing losses at 1000, 2000, and 4000 cps. These are shown as Figs. 4, 5, and 6. It must be made clear at this point that the reader should not interpret the curves in any manner other than as they are presented. It should be borne in mind that these curves show trends in hearing losses at certain specified frequencies and under the conditions of exposure to certain specified noise bands designated as "sorting octaves."

It was pointed out in the same report that the average hearing loss resulting from intermittent exposure to noise was much less than hearing loss encountered under the condition of continuous exposure to the same noise. Further on, the report showed that the average threshold shift (hearing loss) sustained by mechanics and riveters in the aircraft industry was very small after a period of exposure of three to six years. Note that noise encountered by workers in this category is of an intermittent type. Furthermore, workers were required to use ear defenders as routine measure of protection. Noise levels at the workers' ears were meas-

⁶ *The Relation of Hearing Loss to Noise Exposure.* American Standards Association, Inc., 70 E. 45th St., New York 17, N. Y.

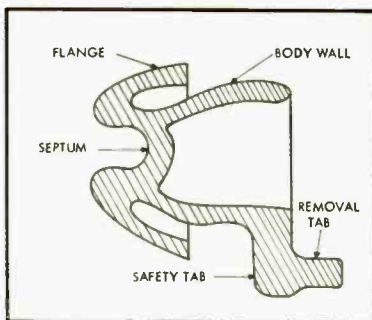

Fig. 7. Cross-sectional view of V-51R Ear Defender.

ured as high as 107 db above .0002 microbar in the frequency band from 1200-2400 cps.

The report showed that definite hearing losses resulted when workmen were exposed to impulsive-type and impact-type noises. The former is represented by that generated during proof-firing of gun barrels, and the threshold shift at 4000 cps was shown to be 15 db. The latter type of noise is well represented by the drop forge, whose impact generates sound pressure levels above 130 db. Threshold shifts after a period of two years exposure were shown as follows—1000 cps, 12 db; 2000 cps, 20 db.

Ear Protection

At this point, it might be well to mention the subject of ear defenders or ear wardens. These devices, ingeniously contrived to fit within the ear canal and form as nearly perfect an acoustic seal as is possible, have been instrumental in protecting the hearing of thousands of men in the armed

forces. C
tenus in
the stud
laborator
model V
popular
of its st
defender
by holdi
flange e
tion. Th
illustrate

From
Békésy
that the
vice such
only to
which th
sound e
waves to
duction
by Zwisl
the absol
at the e
well as
in Fig.

The g
ear defe
as soft
is the li
pressure
of the e
tensive e
a unit v
compara
unit, ma
is made
latex wh
perature
canal. O
to fit its
fitting s
is one c
the comj
such as
shape or
unit is r
of the ja
ered, sir
will not
remoldin

Recovery

Very
with reg
posure t
are:

A. Rawm
plete v
posure
as 70
employ

⁷ Zwisl
phone so
1955, pp.

⁸ Rawm
short dur
ery time.
pp. 138-1

⁹ Sensa
decibels t
of hearin

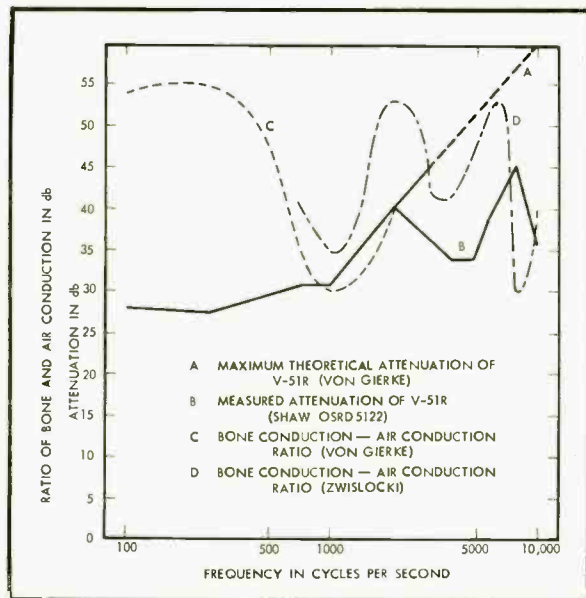

Fig. 8. Ratio of thresholds of hearing and attenuation of ear defender.

B. Kelsey and Harris¹⁰—series of tests conducted on 50 subjects. Thresholds were obtained at 2048 and 4096 cps, after which a stimulus tone of 2048 cps at a sound pressure level of 100 was presented to the ear for a period of five minutes. Immediately after the presentation of the stimulus, threshold measurements were conducted at 4096 cps. It was found that all but 10 per cent of the subjects were completely recovered within 8 minutes. An important conclusion made in the report was that recovery time was dependent upon the sensation level of the signal applied rather than upon absolute sound pressure, since it was shown that for the group of subjects to whom the stimulus signal appeared as a sensation level of 85-90 db, recovery time was 360 seconds; for the group to whom the stimulus signal appeared as a sensation level of 77.5-82.5 db, recovery time was 212 seconds; a third group to whom the stimulus appeared as a sensation level of 70-75 db had a recovery time of 80 seconds.

C. McCoy¹¹—the hearing loss of men working at metal chipping with a noise level of 110-130 db, after an exposure of 7 hours and after one month, was investigated with results given in Table I. It is evident that some form of adaptation sets in after the initial exposure, with a resultant decrease in hearing loss.

TABLE I

Frequency	Loss after 7 hours	Loss after 1 month
512 cps	8 db	0 db
1024	50	0
2048	43	25
4096	48	35
8192	38	5

¹⁰ J. D. Harris, "The roles of sensation level and of sound pressure level in producing reversible auditory fatigue." *The Laryngoscope*. Feb. 1954, pp. 89-97.

¹¹ D. A. McCoy, "The industrial hazard." *Archives of Otolaryngology* 1944. Vol. 39, pp. 327-330.

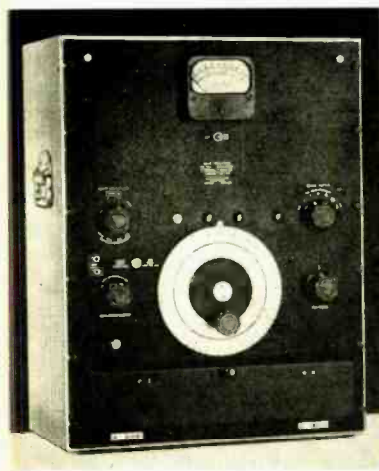

Fig. 10. Precise detection of noise components is simple with the General Radio Co. Wave Analyzer.



Fig. 9. Illustrating ease of interconnecting octave band wave analyzer to noise level meter. (General Radio Co.)

D. Boehmer¹²—recovery may take place during a period as long as 2 months.

E. Parraek, et al¹³—using a turbo-jet engine and a special siren capable of emitting sounds greater than 150 db sound pressure level, found hearing losses of 60 db for periods between three and ten minutes, but hearing returned to normal after one to seven days rest.

From the foregoing, it will be evident to the reader that research personnel are in agreement that much more work is required to determine the long-term effects of noise upon hearing. Also, it must be understood that results mentioned previously are an expression of average results. Individuals differ to a considerable extent in reaction to noise exposure and for that reason, more attention must be paid to the distribution of data around the median figure for maximum protection to all workmen.

In concluding this section, it is reiterated that the establishment of noise limits is quite complicated, requiring extensive study of each circumstance. Noise levels above 120 db for any critical band, must be regarded as potential hazards. Adaptation may take place in most workers within a short time after initial exposure but this does not mean that recovery is complete after cessation of contact. The maximum intensity to which a worker may be exposed safely for prolonged periods with no deafening effect is approximately 85 db for single tones or critical bands of noise.

¹² J. C. Boehmer, "Acoustic trauma." *Annals Otol. Rhin. and Laryng.* 1945. Vol. 54, pp. 513-517.

¹³ Parraek et al, *Physiological Effects of Intense Sound*. Engineering Division, Air Materiel Command, May 24, 1948. T.I.P. U:2571.

Noise Limits in Audiometric Testing Areas

The noise level requirements for audiometric testing areas which will supply dependable test-retest data, are fairly stringent. Experience dictates that a maximum background noise level of 25 to 35 db is required. This evolves from the fact that average attenuation of noise in the speech frequency range by the typical ear cushion used in conjunction with the earphone, does not exceed 15 to 18 db. Since minimum threshold pressure on good ears is found between 5 to 15 db, it is apparent that any extraneous background noise in the test area which exceeds 30 db within the most critical frequency band (1000 to 3000 cps) may serve to mask the threshold of hearing of the sensitive

(Continued on page 85)

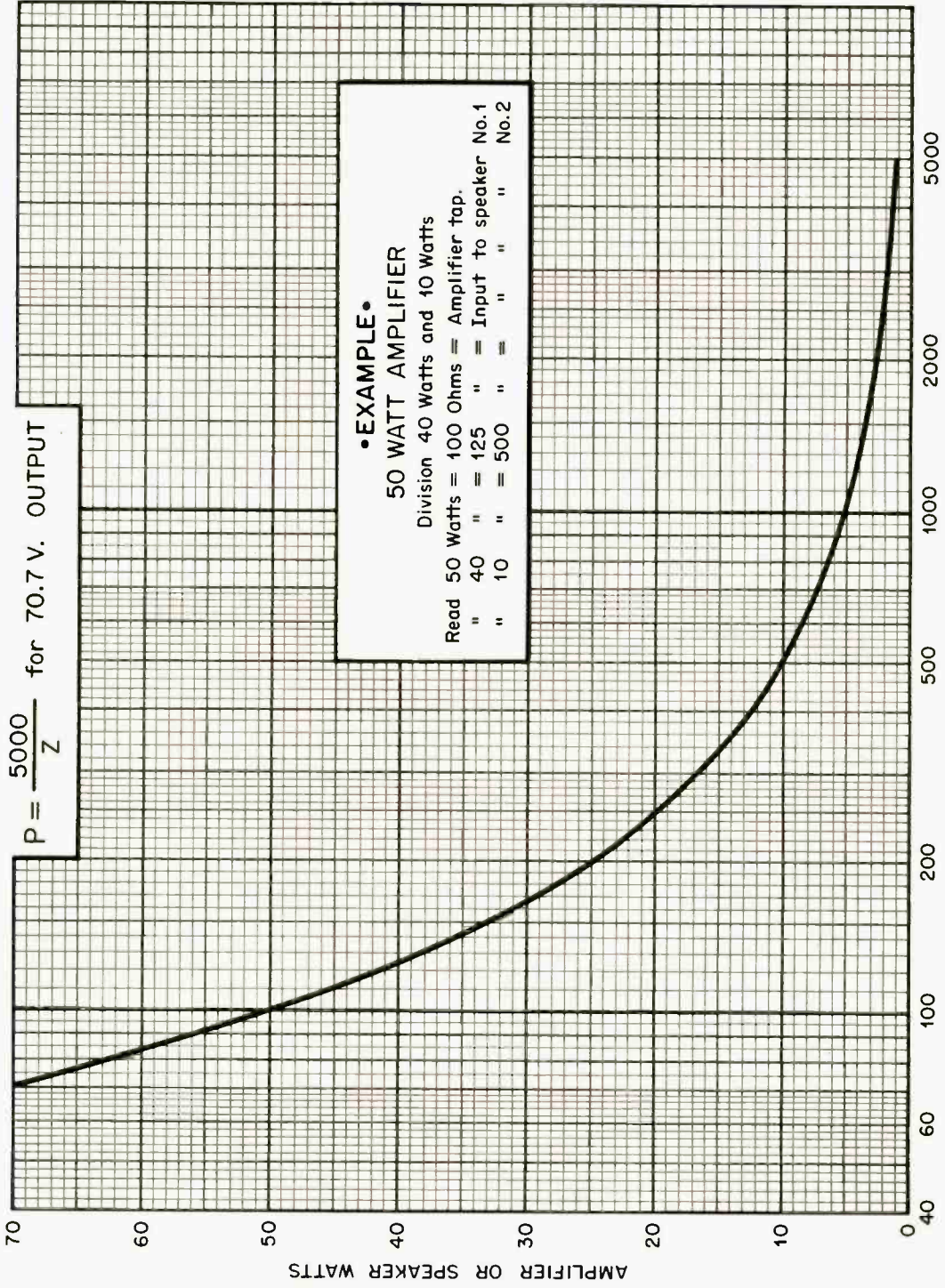

Fig. 11. Scott Sound Analyzer uses half-octave band pass widths.

AUDIO DESIGN CHART

AMPLIFIER OR LOUDSPEAKER IMPEDANCE

$$P = \frac{5000}{Z} \text{ for } 70.7 \text{ V. OUTPUT}$$



•EXAMPLE•
50 WATT AMPLIFIER
 Division 40 Watts and 10 Watts
 Read 50 Watts = 100 Ohms = Amplifier tap.
 " 40 " = 125 " = Input to speaker No.1
 " 10 " = 500 " = " " " No.2

Loss of Patent by Delayed Application

ALBERT WOODRUFF GRAY*

The principle of "due diligence," as applied to the prosecution of a patent application, can often operate to deny an inventor the issuance of a patent or to prevent him from claiming infringement.

A PPLICATIONS FOR PATENTS were filed several years ago by two inventors for a rheostat-snap switch, the first on March 30th and the second on April 2nd of the same year.

The invention was described by a Federal Court in the litigation that followed, as, "In combination a volume control comprising a circular resistance, a contact arm for varying said resistance, a rotatable actuator shaft on which said contact arm is mounted, a projecting pin eccentrically mounted on said shaft, a casing enclosing said volume control, an aperture in said casing, an auxiliary recessed casing closing said aperture, a snap-switch contained in said auxiliary casing and an actuating arm for said snap-switch operable by said projection at one extreme of its cycle."

Suit was brought by the inventor in the second application, filed on April 2nd, for a determination of his right to a patent for the invention. The first applicant fixed the date of his conception of the discovery on April 18th, four years before, while the second applicant conceived his invention in September of the following year. The first inventor had delayed his application approximately four years after his discovery while the second applicant had delayed approximately two and a half years.

The Federal appellate court, in awarding the patent for this invention to the second applicant said of circumstances that impel the imposition of penalties for delays in patent applications after a discovery for which the patent is sought.

"As in other fields of private endeavor there is keen competition in the art to which these inventions belong. In the beginning radio sets were equipped with separate volume controls and switches. The first step in combining these separate devices was taken in the outtrigger type of combination unit, featuring the external bracketed switch

and covered rheostat. The second step was taken in the built-in unit here in question, featuring the internal or barnacle switch and covered rheostat.

"It is an elementary proposition that a first conceiver must use reasonable diligence in reducing his idea to practice, in order to entitle him to a patent against a subsequent conceiver who has first produced the concrete art. The law however has not established a general standard by which diligence can be measured. All that can be said on the subject is that the conceiver's conduct between the conception and the reduction must be reasonable under all the circumstances of the particular case in question.

"Modern industry being what it is, the first applicant to file his application for a patent was fairly chargeable with knowledge that other inventors would be striving to discover the next improvement demand of the trade and that other inventive efforts were very likely to result in the same built-in unit which he had already conceived.

"Under these circumstances his long inactivity is inexcusable. He is certainly not entitled at this time, on any theory of fair play to urge a superior right against these later inventors, who have expended their time, money and energy in endeavors which would have been abandoned had he reduced his conception to practice within a reasonable time after the date he first conceived this idea.

"To hold that this inventor's conduct is proof of diligence is to reward indolence and encourage laxity on the part of the first conceiver and to deter inventors in that their endeavors may prove worthless upon the discovery of any prior unembodied conception. Justice requires that the public reward only those who keep faith with it and who, having conceived ideas, reduce them as quickly as possible, to practical public use."¹

A Similar Case

Another action of this character before this court two years before emphasized a further feature of this rule of law that denies an inventor the right to a patent when his discovery has been in use by the public before the application for the patent is made.

The present patent law provides, "A person shall be entitled to a patent unless the invention was patented or described in a printed publication in this or a foreign country or in public use or on sale in this country more than one year prior to the date of the application for patent in the United States," and a further provision that, "In determining priority of invention there shall be considered not only the respective dates of conception, but also the reasonable diligence of one who was first to conceive and last to reduce to practice, from a time prior to conception by the other."²

In this instance suit had been brought against the RCA-Victor Company for infringement of a patent for, "The combination of a standard form of variable resistance or rheostat used as a volume control in radio receiving sets, with a known form of snap-switch, for making and breaking the power circuit of such sets."

In the defense of this action it was shown that not only had a description of this invention been published in a magazine devoted to the radio industry over two years before but that a number of these receiving sets had been sold and delivered by the inventor. In its absolution of this company from the charge of infringement the court said,

"While it is true that to establish public use or sale the evidence must be convincing beyond a reasonable doubt, it has been held that a single sale of an article more than two years prior to the application for a patent is all that is

(Continued on page 90)

* 3712 Seventy Fifth St., Jackson Heights, L.I., New York.

¹ Globe-Union, Inc. v. Chicago Telephone Supply Co., 103 Fed. 2d 722.

² 35 U.S.C.A. 102.

A Time-Delay Commercial Suppressor

RONALD L. IVES*

One method of solving the age-old problem of cutting out the commercials while leaving the musical program untouched. This may be killing the goose that lays the golden eggs, since it is the commercial that makes the music possible, but so long as only a small percentage of the listeners practice "commercial killing" the broadcasting industry is not likely to fall apart completely.

BACK IN THE "good old days" of radio broadcasting, announcements were short, simple, and terse, such as "This is WAAM, the I. R. Nelson Co., One Bond St., Newark, N. J." Today, the *vox locutor* has degenerated into the *vox loquacitor*, and programs of classical music are too often interrupted to bring us the rasping tape-recorded voice of Madame Perra, who this week is plugging Barreiform Girdles. These, we learn while getting up to shut the blasted thing off, come in all sizes, from 38 "petite" to 80 "grande dame."

The problem of passing instrumental music, while squealing unwanted chin music and singing commercials is quite complicated. One device, consisting of a flashlight and a photoelectric control on the receiver, is quite effective on TV, but is not of much use on an ordinary broadcast receiver, as there is no clue to the end of the announcer's gabfest. Shutting the receiver off when Abdul the Neeromancer starts plugging used Volks-

* 251 Lincoln Ave., Palo Alto, Calif.

wagens is very effective, but on forgetting to turn the receiver on again, we miss the wanted time, weather, and news announcements.

An electric discriminator, sometimes called the VOCK (voice-operated commercial killer), has appeared in several different forms, and can be so adjusted that it will distinguish between most music and most voices. It can be set to differentiate between Walter Winchell and Gabriel Heatter, but cannot distinguish between "HMS Pinafore" and the "Burpy-Cola Song." It also takes the surprise out of the *Surprise Symphony*, and develops acute schizophrenia with piano solos. In addition, it eliminates both the wanted announcements and the lectures on how to borrow your way out of debt with the Stoneheart Finance Company. Additional problems are introduced by the differences between languages; a VOCK cannot be made to work as well for Spanish as for English, and fails completely for Burmese, Bantu, and Yucateca.

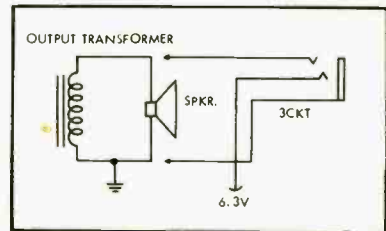

Fig. 2. Receiver connections for time-delay suppressor.

Some study of the nature of commercials, made with a radio receiver, a stopwatch, and some blood-pressure medicine, shows that the length of the commercial at most stations is fairly constant, and seldom exceeds 80 seconds. Thus, a device which will shut off the audio output of the receiver for 80 seconds plus a margin of safety, will eliminate the major part of most commercials. Such a device is easily made from a self-holding relay, a push button, and a time-delay unit, necessary power being supplied by the receiver. The circuit of such a time-delay commercial suppressor is shown in Fig. 1 and the method of connecting this device to the receiver is shown in Fig. 2.

How it Works

In operation, when the push button is pressed the relay closes, shorting the speaker terminals, and also shorting the push button through the contacts of the time-delay relay, which are normally closed. The heater of the time-delay relay, being in shunt to the coil type relay, begins to heat. After a finite time interval (here 90 seconds), the time-delay contacts open, opening the current supply to the relay, which opens and de-energizes the time-delay unit, removing the short from the speaker. The switch is available for use when the announcer is extremely longwinded. Any

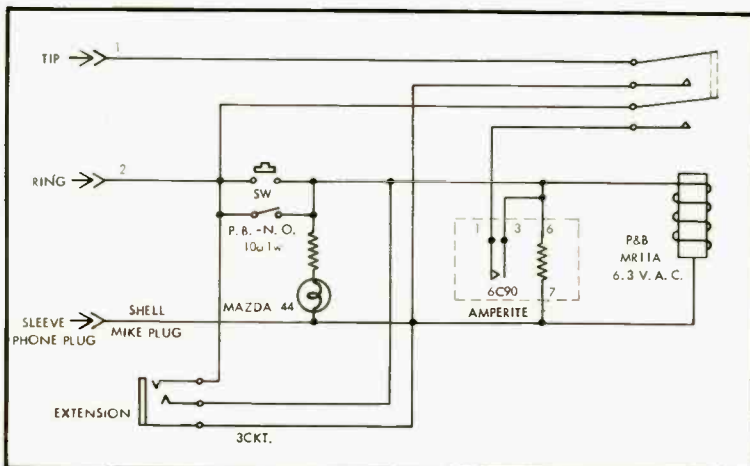

Fig. 1. Schematic of time-delay commercial suppressor.

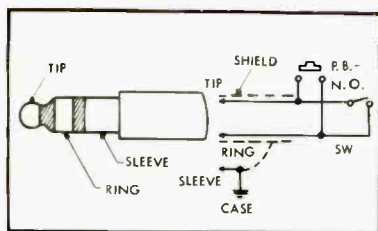

Fig. 3. Schematic of extension control.

number of extensions may be used, and extension lead length may be as much as 50 feet, if desired. The circuit of the extension is shown in Fig. 3. Shielded cable may be necessary from the extension to the main control box if high sensitivity a. f. equipment is used in its vicinity.

The general appearance of the time-delay commercial suppressor is shown at the right side of Fig. 4; the extension, designed to mount on the wall next to the telephone is shown at its left. Several alternate designs are possible, and present no technical problems, there being no high frequencies or critical adjustments involved in its construction.

In an experimental form assembled by the author, the housing for the main suppressor is a 4x6x2 in. SeeZak expandable chassis, with the corner bosses replaced by machine screws, as are the sheet metal screws holding the top and bottom plates in place. The main cord

connection, on the rear, Fig. 5, is an Amphenol three-terminal mike fitting, terminal 3 being connected to the shell. The other end of the connecting cord, which is a two-wire shielded microphone cable, terminates in a three-circuit plug (Switchcraft #267), which engages the receiver jack (Fig. 2). The front jack, for the extension, is a narrow-gauge type (Switchcraft JJ-033) to engage a like three-circuit plug (Switchcraft P.J-068). The use of unlike connectors here is intentional, as components are not interchangeable.

The case for the extension is an aluminum box chassis 13 $\frac{3}{8}$ " by 13 $\frac{3}{8}$ " by 2 $\frac{1}{4}$ " (IMB-M00). The connecting cord is run through a grommet on one end, and the shield is anchored to a soldering lug held under the switch.

Internal construction of the main control is shown in Fig. 6. The bracket for mounting the time-delay-unit socket is made from part of a SeeZak rail; the pilot light is mounted in a Dialco #705 socket, with the web bent at right angles and soldered to a threaded spacer. The bulb passes through a grommet in the top plate, and a screw through this top plate holds the socket in place. No special care, other than good workmanship, is needed in assembly.

Although not electrically necessary, a bottom plate on the case is most desirable to keep grubby fingers out of the mechanism, and to permit mounting four rubber feet on the bottom. These prevent skidding and scuffing. The bottom



Fig. 5. Rear view of suppressor chassis shows use of Amphenol plug for connection from amplifier.

screws are 4-10 binding heads, tapped into the case rails.

In actual use, the radio is left on until the announcer winds up with "—and now, friends, we bring you—" Press the button, and enjoy 90 seconds of blessed silence. If the announcer talks overtime, you may catch the final "—Del Rio, Texas, and don't forget to put the dollar

(Continued on page 81)

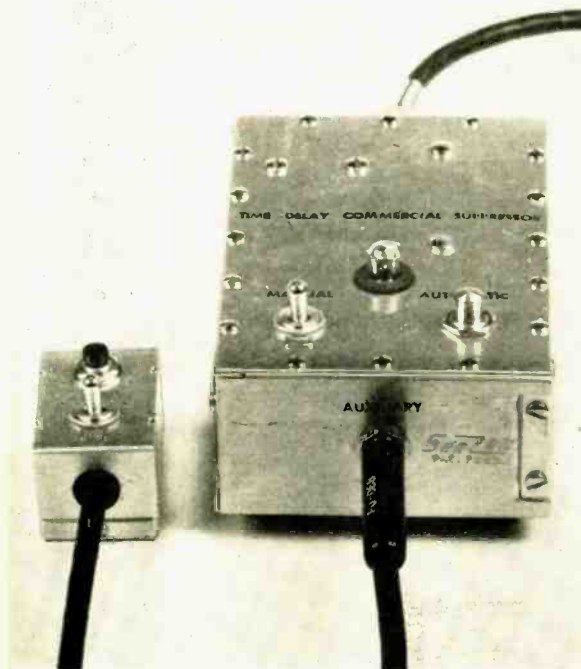

Fig. 4. External appearance of commercial suppressor (right) and the extension control unit.

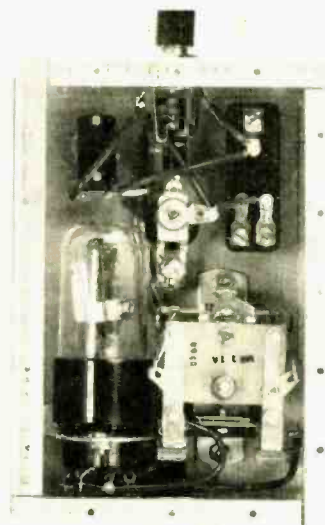

Fig. 6. Interior view of main control chassis. Amperite time-delay unit is the tube-like device at lower left.

Compensation for Amplitude-Responsive Phono Pickups

R. H. BROWN*

Because of different internal impedance and a different method of generating the output voltage, compensating circuits used with capacitance, crystal, and ceramic pickups differ from those used with magnetics. Before designing networks for crystal and ceramic types, however, make sure that they need compensation—most are designed with correct characteristics to feed into "flat" amplifier.

RECORD WEAR soon becomes a matter for grave concern to many owners of high-fidelity phonograph equipment. When the crisp clarity of a favorite recording gives way to a comparative dullness aggravated by high-frequency distortion, components of the playback system are sometimes suspected of dereriation before record wear is discovered to be the cause of the difficulty. Some hi-fi fans would be unwilling to face up to the cost per play based on the number of times a record can be played before high-frequency loss and distortion due to wear become appreciable. An increase in record life of six times, or better, is possible with use of a capacitance pickup, for capacitance pickups are available which require somewhat less tracking force than some magnetic cartridges and have less than one-sixth as much dynamic mass as the stylus tip.

The compensation required for a capacitance pickup, or any other amplitude-sensitive type, is considerably different from that required for the more popular velocity-sensitive pickups. Consider the problem of obtaining correct compensation for the RIAA recording character-

istic shown by the solid line, A, in Fig. 1. This characteristic approximates that shown by the dashed line, B, which is constant velocity up to 50 cps, constant amplitude from 50 cps to 500 cps, constant velocity between 500 cps and 2120 cps. The dotted curve, C, shows the output that would be obtained from an RIAA test record with an uncompensated amplitude-responsive pickup. Each of these curves has been arbitrarily adjusted to zero level at 1000 cps. The inverse of C is the frequency characteristic of an appropriate amplitude compensation circuit for RIAA recordings. This characteristic has a 12.5 db treble boost to compensate for the constant-velocity recording between 500 cps and 2120 cps, and it also has a 6-db-per-octave

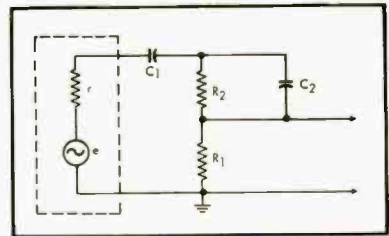

Fig. 2. Amplitude compensation circuit. *e* is open-circuit output voltage of generator supplying signal to compensation circuit. *r* is internal series resistance of generator output. *C*₁ is bass pre-emphasis compensation capacitor. *C*₂ is crossover control capacitor. *R*₁ and *R*₂ provide treble boost.

cut below 50 cps to compensate for the constant-velocity recording below that frequency. One half of the maximum treble boost is required at 1028 cps, which is the frequency at the center of the constant-velocity portion of the recording characteristic. By making a similar analysis for the other important recording characteristics one obtains the data given in the first four columns of Table 1.

Figure 2 shows a schematic of a circuit which will provide correct compensation for an amplitude sensitive pickup. In this circuit, *e* represents the audio output signal of the pickup, or a subsequent amplifier stage. With a capacitance pickup *e* comes from the associated oscillator-converter, or a subsequent stage; *r* represents the internal resistance in series with *e*. For the Weathers oscillator-converter *r* is about 45,000 ohms. *C*₁ in connection with the resistance (*r* + *R*₁ + *R*₂) provides 6-db-per-octave compensation for bass pre-emphasis. The maximum treble boost ratio *G* is equal to (*r* + *R*₁ + *R*₂) / (*r* + *R*₁), from which it follows that *R*₂ / (*r* + *R*₁) is equal to (*G* - 1). Values of this parameter for the important record-

TABLE 1 AMPLITUDE PICKUP COMPENSATOR DESIGN PARAMETERS							
Curve	<i>G</i>	<i>f</i> ₀	<i>f</i> ₁	<i>f</i> ₂	<i>f</i> ₃	<i>f</i> ₄	<i>f</i> ₅
	db	cps	microseconds	μs/(<i>r</i> + <i>R</i> ₁)	4πk	<i>J</i>	<i>f</i> ₅ <i>C</i> ₂
London	6.00	15.6	1225	1590	5.00	.800	1.452 189
ALS (40)	6.27	15.9	1000	510,000	5.27	.758	1.462 233
RIAA	4.24	12.5	1029	3180	3.24	1.233	1.376 213
LP	3.18	10.0	892	1590	2.18	1.835	1.305 233

G = Maximum treble boost ratio. *f*₀ = Maximum treble boost in decibels, 20 Log *G*.
*f*₁ = Frequency at which treble boost is half maximum. *f*₂ = Time constant for bass pre-emphasis compensation. *k* = (*r* + *R*₁) / *R*₂. *J* = √[(*G* - 1) / (1 + *G*)]. For *r*, *R*₁, *R*₂, *C*₁, and *C*₂, see Fig. 2.

* 302 S. E. Second, College Place, Wash.

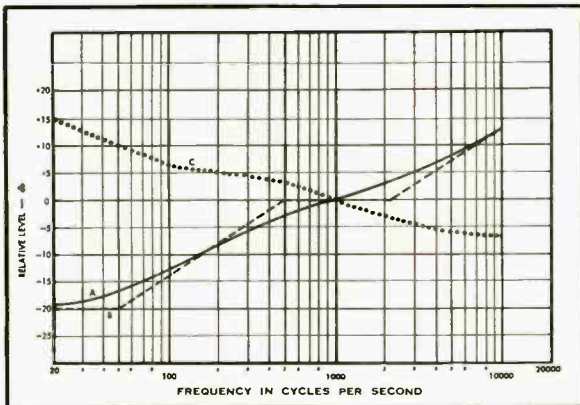

Fig. 1. A—RIAA recording characteristic (velocity presentation). B—velocity characteristic approximated by A. C—output from an uncompensated amplitude-responsive pickup on an RIAA test record.

ing characteristics are given in column five of Table I.

C_2 controls the frequency at which the treble boost reaches half its maximum value. To obtain a design equation for C_2 one may express the parallel combination of R_2 and C_2 in terms of its series equivalent and then determine the value of C_2 for which the total impedance in series with e is midway between the low-frequency value ($r + R_1 + R_2$) and the high-frequency value ($r + R_1$). Using the abbreviation K for $(r + R_1) / R_2$, one obtains for the condition on C_2 which provides that one-half

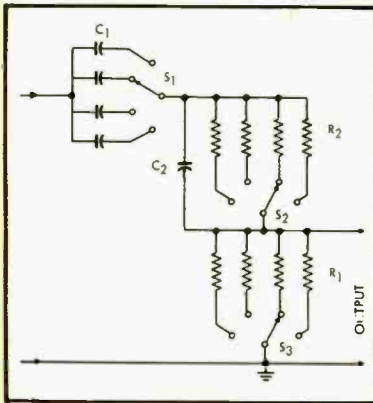

Fig. 3. Basic amplitude compensator. S_1 is a three-gang, four position, shorting-type selector switch. See Table II for values of C_1 , C_2 , R_1 , and R_2 .

of the maximum treble boost occur at the frequency f_m

$$R_2 C_2 = \frac{1}{2\pi f_m} \sqrt{\frac{3 + 4K}{1 + 4K}}$$

By abbreviating the radical with the symbol J one obtains the following simple expression for the time constant of R_2 and C_2 in terms of f_m :

$$R_2 C_2 = \frac{J}{2\pi f_m}$$

Values of J and $R_2 C_2$ are tabulated in columns seven and eight of Table I.

Table II gives representative values for compensation circuit components as determined from the design parameters of columns four, five, and eight of Table I. A fixed value for C_2 gives the compensation circuit of lowest cost and also the greatest ease of construction. A design should be chosen for which R_1 is always at least three times r to avoid loss of signal within the source of e .

Complete Circuit

A suggested compensator circuit is shown in Fig 3. In this circuit S_1 controls the bass pre-emphasis compensation. S_2 and S_3 , together control the

treble compensation. If any resistance is placed across the output of the compensator, the values of the resistors connected to S_3 must be chosen so that their parallel combinations with this load resistance are equal to the design values for R_1 . To avoid a high-frequency loss of more than one db at 15,000 cps, the total of the capacitance to ground (1) at the output of the source of the signal fed to the compensator, (2) in the compensator itself, (3) at the input of the load connected to the compensator, and (4) in any connecting cables, must not be greater than $5(r + R_1) / r R_1 \mu\text{f}$ (time constant of five microseconds). Where short leads are possible the compensator could in some cases be connected directly between an amplifier input and the oscillator-converter of a capacitance pickup. The insertion loss of the compensator is given by B in column two of Table I.

A completely isolated amplitude compensator with level control and cathode follower output is described in Fig. 4. The output from this circuit is ample to drive power amplifiers requiring a high-level input. The decoupling filter in the circuit allows $B+$ to be taken from an associated power amplifier without motorboating difficulties. Provision for tone controls could be made by adding another stage of amplification, or by

using a high- μ twin triode with the tone control circuit between the two amplifier sections and the compensator circuit between the input connection and the level control. For the latter arrangement the values of the resistances connected to S_3 would need to be redetermined. It is evident that the capacitance pickup offers advantages of simplified compensation and preamplification circuitry in addition to the advantage of greatly reduced record wear.

Ceramic Pickup Compensation

The ceramic (and crystal) pickups are also amplitude-responsive, but in most instances they are designed to work into specific load impedances which result in a close adherence to the current standard recording characteristic, the RIAA. However, it may be that the user wishes a different curve from his equipment. The same circuits that work with the capacitance pickups will also work with ceramics, but it must be remembered that the latter already have built into them the rolloff characteristics of the RIAA curve. Thus while the low-frequency response may be corrected as shown, the user should remember that there is already some rolloff, and that if he wishes less rolloff than this he will need to provide high-frequency boost; conversely, for more rolloff, he will need to provide additional losses.

The same circuitry will obtain with both types of pickups, but it is only important that the "built-in" rolloff be kept in mind. Considerable experimentation may be required to end up with the desired result, but the principles are the same and the final response can be tailored to suit without much trouble.

TABLE II
AMPLITUDE COMPENSATOR CIRCUIT COMPONENT VALUES

Curve	C_2 μf	R_2 Kilohms		R_1 Kilohms		C_1 Microfarads	
		Design Value	Nearest 5% RIAA Component	Design Value	Nearest 5% RIAA Component	Design Value	Nearest 5% RIAA Component
London	750	252	240	50.5	51	.00276	.0051
AES (old)		310	300	58.8	56	.027	.03
RIAA		284	270	67.4	91	.00858	.0082
LP		310	300	143	150	.00351	.0036
London	900	378	390	75.6	75	.00331	.0036
AES (old)		465	470	88.3	91	.018	.02
RIAA		429	430	131	130	.00872	.0084
LP		465	470	214	220	.00234	.0022

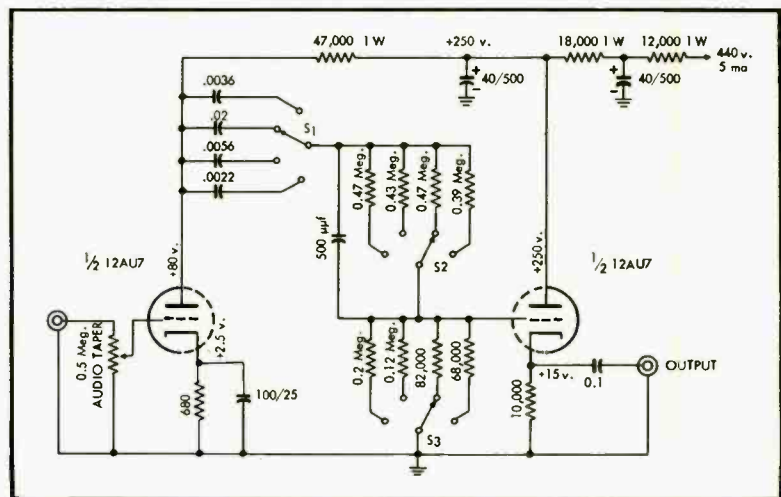

Fig. 4. Compensator preamplifier for amplitude-responsive pickups. S should be a three-gang, four-position shorting switch. Compensator switch positions are: (1) LP; (2) RIAA; (3) AES; (4) London. All components in the compensator circuit (connected to terminals of S) should be ± 5 per cent.

A Survey of Crossover Networks

For moving coil loudspeakers, including coil design data.

RICHARD C. HITCHCOCK*

The calculations for crossover networks can be reduced to simple reference to a number of diagrams; once having determined the constants for the coils and capacitors, the coil dimensions and wire size can also be determined from charts.

THE PURPOSE OF A CROSSOVER NETWORK¹ is twofold; to divide up the ranges of audio frequencies, presenting the proper ones to the intended loudspeakers,² and to provide a reasonably constant output load on the amplifier at all frequencies.³

Paper capacitors and air-cored coils are the usual components for a crossover network. At an earlier period, most electrical experimenters had on hand various sizes of magnet wires. That was the "wireless" day of hand-wound tuning coils. Today's experimenters seldom need magnet wires, and when they do, they prefer to buy just what is needed, in this case to wind crossover coils. For this practical reason the charts of Figs. 7, 8, and 9 are based on "pounds of coil wire."

* Syntro Company, Homer City, Pennsylvania.

¹ J. P. Wentworth, "A discussion of dividing networks." *AUDIO*, Dec. 1952, p. 17.

² C. G. McProud, "Practical dividing networks." *AUDIO*, May 1947; also *Audio Anthology* (book), Radio Magazines, Inc., 1950, pp. 101-4.

³ B. H. Smith, "Constant resistance dividing networks." *AUDIO*, Aug. 1951; *Audio Anthology* (book), Radio Magazines, Inc., 1950, pp. 107-8.

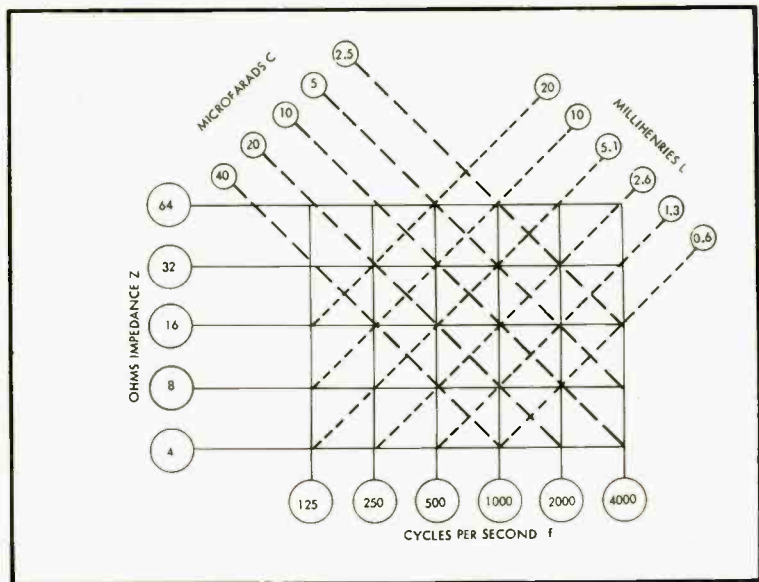

Fig. 1. Chart for determination of L and C for crossover networks when impedance L and frequency of crossover f are known.

Fundamental equations

$$X_{coil} = 2\pi fL \quad (1)$$

$$X_{capacitor} = 1/(2\pi fC) \quad (2)$$

The basic equations for the inductive reactance of a coil and the capacitive reactance of a capacitor are:

where X in each case is in ohms, f is in cycles per second (cps), L in henries,

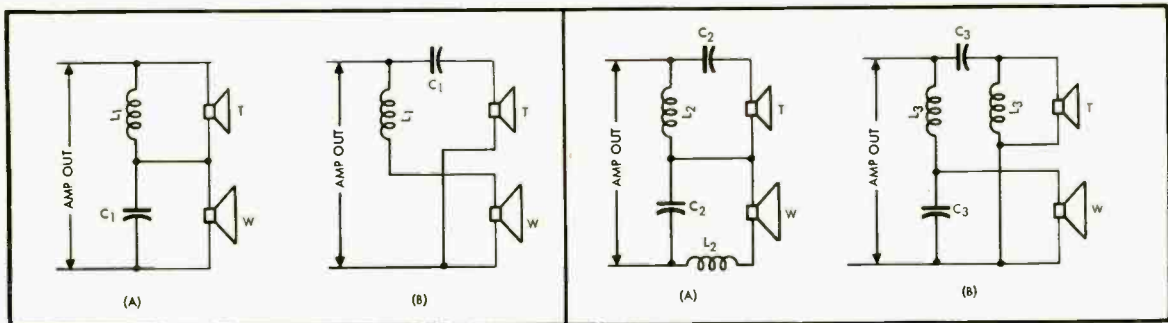

Fig. 2 (left). Two-way crossovers with a slope of 6 db per octave. $X_c = X_L = Z_w = Z_T$ at crossover frequency. C_1 and L_1 are found from Fig. 1. Fig. 3 (right). Two-way crossovers with a slope of 12 db per octave. Find C and L from Fig. 1. $C_2 = 1.41 C$; $L_2 = 0.71 L$; $C_3 = 0.71 C$; $L_3 = 1.41 L$.

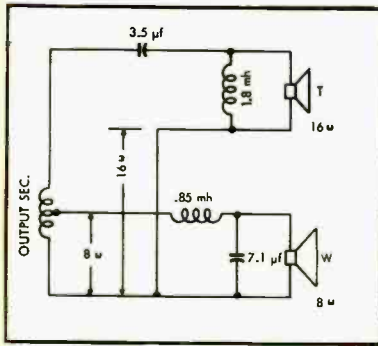

Fig. 4. Typical unequal voice-coil crossover circuit for a 16-ohm tweeter and an 8-ohm woofer at a crossover of 2000 cps.

and C in farads. Aside from the fact that we are interested in millihenries, mh, (thousandths of a henry) and microfarads, μf , (millionths of a farad) the factor 2π is unhandy to work with. Hence these equations are put in more convenient form in Fig. 1. The scale on the left is ohms impedance Z ; across the bottom is the frequency of f cps. The capacitor lines C are dashed and slope up to the left. The inductor lines L are dotted and slope up to the right.

For example, take a 0.6-mh coil: at 1000 cps it has a reactance of 4 ohms; at 2000 cps, 8 ohms; and at 4000 cps, 16 ohms. Now for a 40- μf capacitor: it has, at 1000 cps, a reactance of 4 ohms; at 2000 cps, 2 ohms; and at 4000 cps, 1 ohm. From this it is clear that as the frequency doubles, the inductive reactance also doubles. This is 2:1 in ohms per octave⁴ and also 3 db in power per octave.⁵ Conversely, for the capacitor, as the frequency doubles, the reactance decreases to one-half for each octave increase, again 1:2 in ohms, and again 3 db in power per octave. For the simpler circuits in (A) and (B) in Fig. 2, the frequency at which both the coil and the capacitor have the same reactance in ohms is the crossover frequency.

Two-way crossovers, 6 db per octave

The most popular use of crossovers is for two-way systems; a woofer for low tones, and a tweeter for high tones. Figure 2 shows two typical two-way crossovers.⁶ These networks are 6-db-per-octave crossovers, since coil and ca-

⁴ An octave is a 1:2 range in frequency. Standard A is 440 cps. The next octave above it is A' at 880 cps. The octave next below standard A is A₁ at 220 cps. Decades are sometimes used, a range of 1:10 for frequency ranges, but octaves are very familiar, being the basis of musical instrument scores.

⁵ F. Langford Smith, "Octaves and decades," *Radiotron Designer's Handbook*, 4th Ed., 1953, R. C. A., p. 368.

⁶ *Ibid.* pp. 184-5.

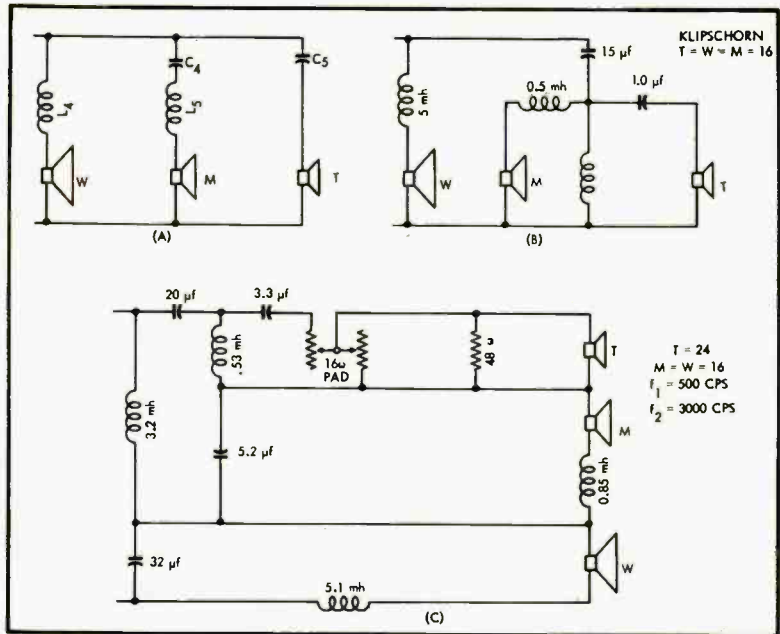

Fig. 5. Three-way crossovers. See text for full description.

pacitor contribute 3 db each. The L_i coils and C_i capacitors are found from Fig. 1 and apply to either of the circuits in Fig. 2. Both the series circuit, (A), and the parallel circuit (B) employ woofer W and tweeter T with the same rated ohms, which also is the ohm tap of the output transformer.

As an illustration, what values are needed for 16 ohms at 500 cps? On Fig. 1 follow 16 ohms from the left until it crosses the 500 cps line straight up from the bottom; then follow up left along the dashed line to find $C_1 = 20 \mu\text{f}$. Return and follow up right along the dotted line to find $L_1 = 5.1 \text{ mh}$.

Sharper crossovers, 12 db per octave

The two circuits of Fig. 3 have two coils and two capacitors each, giving a sharper crossover of 12 db per octave, which is also safer as it protects the driver units against damage.⁶ This is 4:1 in ohms per octave. Here a caution should be mentioned: there is a distinct difference between the coils and capacitors used for the series circuit (A), and the parallel circuit (B) in Fig. 3.

For the series circuit of (A) both speakers have the same ohms, but the coils and capacitors have 0.71 times the reactance values shown in Fig. 1. These values are still readily obtained from Fig. 1 by simply multiplying the coil L by 0.71, and the capacitor value C by 1.41 [remember the capacitor ohms are less for increased capacitance, Eq. (2)]. Take, for instance, a crossover frequency of 500 cps, and two 16-ohm speakers. The coil values from Fig. 1 are 5.1 mh

and we want $L_2 = 5.1 \times 0.71 = 3.6 \text{ mh}$. The capacitor values are $20 \mu\text{f}$ from Fig. 1, and the values we want are $C_2 = 20 \times 1.41 = 28.2 \mu\text{f}$.

For the parallel 12-db circuit of (B) in Fig. 3, we need to exchange the factors for L and C as compared with the accompanying series circuit. It really is simple; use Fig. 1 to get L and C for the required speaker ohms and crossover frequency, then $C_3 = 0.71 C$, and $L_3 = 1.41 L$. For a crossover frequency of 500 cps, and two 16-ohm speakers (B): $C_3 = 0.71 \times 20 = 14.2 \mu\text{f}$, and $L_3 = 1.41 \times 5.1 = 7.2 \text{ mh}$.

Unequal voice coil crossovers, two-way

Figure 4 shows⁷ a parallel 12-db crossover for an 8-ohm woofer and a 16-ohm tweeter, which requires a three terminal 8/16 ohm output transformer. The L and C values are calculated the same as

⁷ W. F. Walker, "Crossover network for unequal v.c. impedances," *AUDIO*, July 1950; 2nd *Audio Anthology* (book), Radio Magazines, Inc., 1953, pp. 106-7.

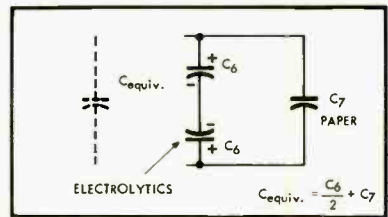

Fig. 6. Two electrolytic capacitors may be used "back to back" aided by a smaller value of paper capacitor.

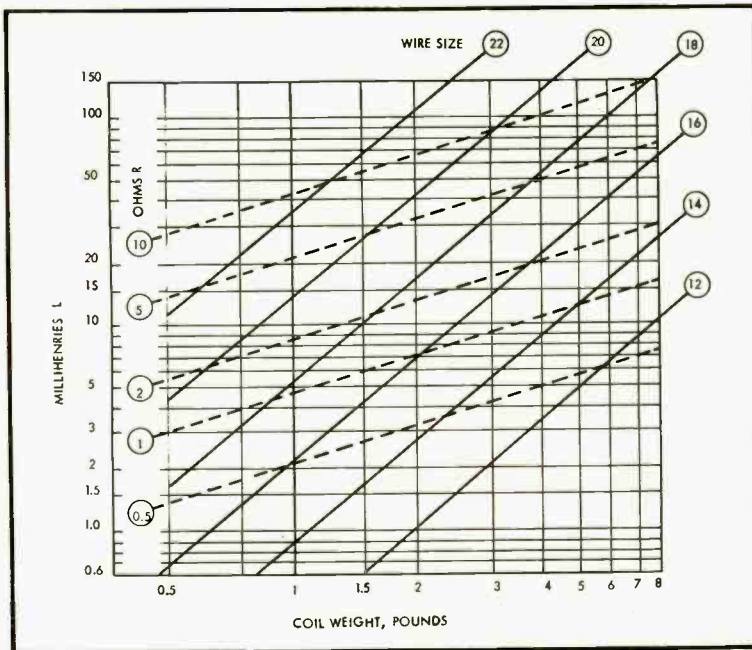

Fig. 7. Inductance and resistance of coils of the proper form factor at given weights of coil and sizes of wire.

for the parallel circuit of (B) in Fig. 3, making sure to connect the proper speakers on the respective output taps. This method is restricted to parallel crossover circuits, such as those in (B) of both Fig. 2 and Fig. 3, when using the usual 3-terminal output transformer secondary.

Three-unit crossovers

There are more possibilities in three speaker crossovers, but the basic ideas are the same as before. Coils increase their inductive reactance with rising frequency, capacitors decrease their capacitive reactance with rising frequency. To start, we need to decide the frequencies for the crossovers. Low frequencies must go to the woofer *W*, so it needs a series coil which stops the increasing frequencies at a faster and faster rate. The tweeter *T* has a series capacitor, which allows higher frequencies to pass, and blocks the lower ones. The mid-range speaker *M* needs both *L* and *C*, with a sharp crossover. One scheme is shown at (A) in Fig. 5 where the woofer *W* and tweeter *T* are much the same as previous examples. The mid-range speaker *M* has a twice-capacitance capacitor (half reactance) and a half-inductance coil (half reactance) in series with it. At the crossover frequency between *W* and *M*, the two units C_4 and L_5 of (A) together have a reactance equal to that of *M* the mid-range speaker.

As a typical example for (A) in Fig. 5: suppose for 16-ohm speakers that the crossovers are 500 cps where *W* starts to cut out; and 4000 cps where *T* starts to

cut in. The L_4 for the woofer has a reactance of 16 ohms at 500 cps, and Fig. 1 shows 5.1 mh. For the tweeter, C_5 has 16-ohms at 4000 cps and Fig. 1 shows 2.5 μ f. For the mid-range, where C_4 has half the reactance shown by Fig. 1, at 500 cps for the 16-ohm *M* we want 8 ohms for C_4 , or 40 μ f. The coil L_5 at 500 cps has half the value of 16 ohms, and at 8 ohms on Fig. 1 we find 2.6 mh for L_5 .

The Klipschorn (trademark) crossover⁸ is shown at (B) of Fig. 5. This

⁸ P. W. Klipsch, Hope, Ark., private communication.

network uses two coils of 5 mh each, and another of 0.5 mh in series with the mid-frequency driver, plus a 1.0- μ f capacitor in series with the tweeter (University 4401).

For the circuit of (C) in Fig. 5 the values are a bit more complicated⁹ and include a 16-ohm L-pad for the tweeter. This *L* is unrelated to the *L* used for coil values. Incidentally, this feature can be used in other circuits; replace the tweeter *T* with a potentiometer, or with an L-pad, to control the volume of the tweeter independently.

Capacitors

Paper capacitors are readily secured from radio parts houses. In some cases, paper capacitors are still available from surplus, at reduced prices. It is possible to use electrolytic capacitors, back-to-back¹⁰, as shown in Fig. 6. This is not the best idea, but they work satisfactorily at least for a time. However, a paper capacitor must be added in parallel¹¹ as shown in Fig. 6, to give good high tone response, which is not good with electrolytics alone. If C_6 is the value of each of the two electrolytics, and C_7 that of the parallel paper capacitor, the combination has

$$C_{equiv} = \frac{C_6}{2} + C_7 \quad (3)$$

⁹ G. A. Douglas, "Three-way speaker system," *AUDIO*, June 1948; *Audio Anthology*, (book), Radio Magazines, Inc., 1950, pp. 86-87.

¹⁰ G. A. Briggs, "Loudspeakers" (book), 4th Ed., 1955, Wharfedale Wireless Works, Ltd., p. 65.

¹¹ R. C. Hitchcock, "Two-way loud-speaker system," *Popular Mechanics*, May, 1952, p. 214, Fig. 10.

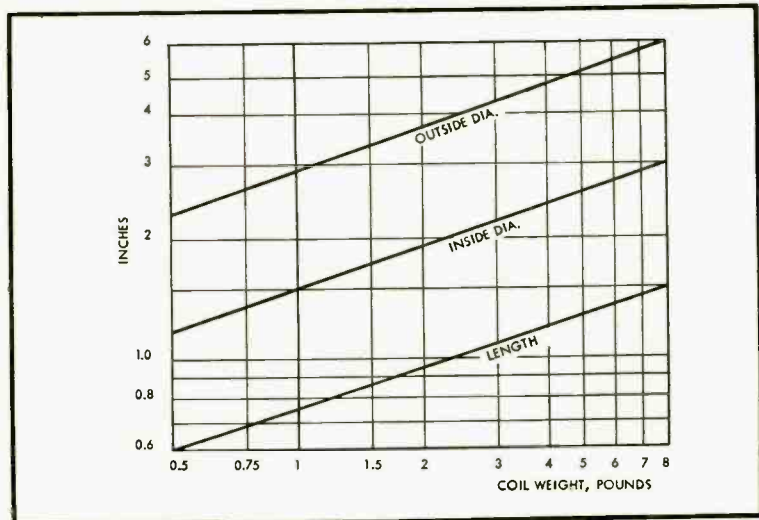

Fig. 8. Chart of coil dimensions vs. weight.

Since the paper capacitor is the most expensive, usually C_7 is the starting point, and the required C_6 calculated. For example, if C_7 is 2 μf , and 40 μf is needed. Eq. (3) shows that each C_6 is 76 μf (two are required, see Fig. 6). Exact capacitor values are not required, and 80 μf will be close enough. Furthermore, the actual value of electrolytic capacitors is likely to be as much as 20 per cent off from the rated value, and it would be best practice to measure the capacitance on a bridge. The working voltage rating of the capacitors should be 25 to 50 volts d.c. for 20-watt amplifiers. Any paper capacitor will have more than this rating, but electrolytics are made with lower d-c ratings.

Inductance Coils

The rest of this article will deal with coils and their calculations. It is not at all difficult to wind coils by hand, when a few design facts are available. The charts given will allow coils to be made the first time, with a minimum of cut and try for accurate values, when required. At the outset it should be said that neither L nor C is critical as to exact value. A variation of 10 per cent in L , or in C , with a total of 20 per cent, when both are in the same direction, will hardly be noticed in the usual loud-speaker system crossover, for the actual numerical value of the crossover.

Inductance and Resistance

All coil design data given here are

based on the newer wire coatings; heavy enamel, formvar, nylelad, and so on. These make neat and compact coils. Double-cotton or single-cotton-enamel wire makes good coils, but their variable space factor does not lend itself to over-all design information. Figure 7 has the coil weight in pounds as the horizontal scale. The vertical lines refer to the same coil weight. The inductance L is the left scale; it applies to all the horizontal solid lines. The slanting upward solid lines are magnet wire sizes, from AWG 12 to 22; the dotted lines are d.c. ohms.

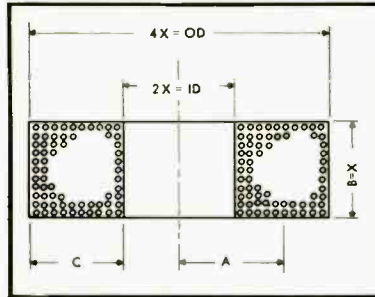

Fig. 10. Coil design dimensions.

Example: a 5-mh coil wound with 1 pound of No. 18 wire has about 1.2 ohms d.c. resistance. As a rule of thumb, this ratio of millihenries to d.c. ohms should be about 5:1, though this is a matter of opinion.

Figure 8 shows coil dimensions, and as before this is for the heavy enamel-type

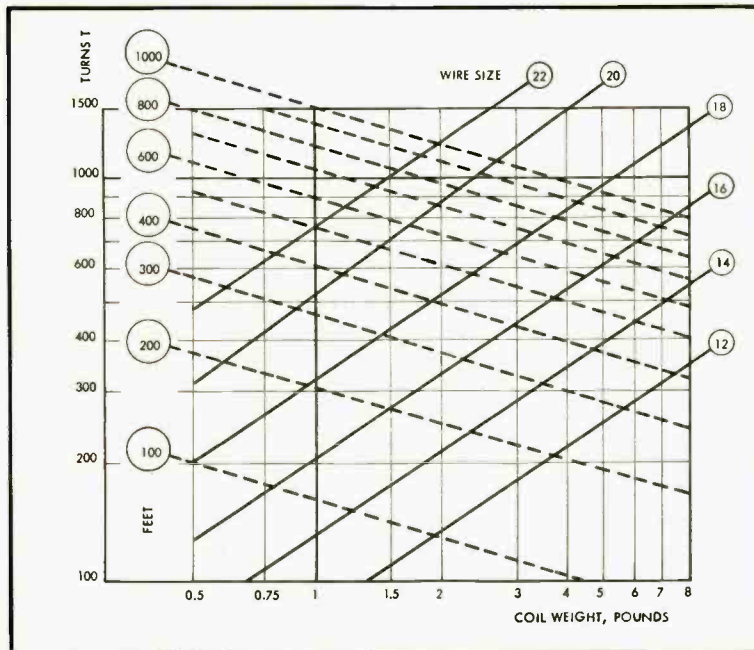

Fig. 9. Chart showing number of turns and length of wire for coils of given weight and of usual wire sizes.

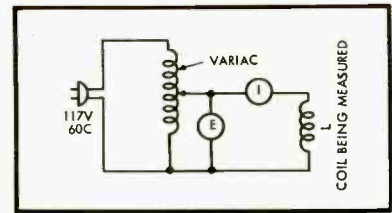

Fig. 11. Circuit used to measure inductance of coils in the millihenry range.

magnet wires, for specified weights. The weights from 0.5 to 8 pounds are shown, with outside diameters, inside diameters, and axial lengths. Figure 10 shows the dimensions referred to.

Turns and Length of Wire

Figure 9 gives additional information. The slanting dotted lines indicate feet of wire, and the solid lines are wire sizes. If the coil is wound by weight, say 1 pound, and the dimensions of Fig. 8 are used, Fig. 9 need not be considered. However, if a different covering—such as single cotton enamel—is used, the turns shown in Fig. 9 can be followed, and the resulting inductance L , pound for pound, will be very close to that indicated in Fig. 7. Usually this makes a coil (same weight) with a slightly lower inductance, and a somewhat larger outside diameter.

How to Measure Coils

If you have an impedance bridge, you don't need any suggestions. But for the accuracies needed for crossover coils, the circuit can be much simpler. A quite satisfactory result can be obtained by using an a.c. ammeter, an a.c. voltmeter, and a variable-voltage transformer, such as a Variac, in the circuit of Fig. 11. The d.c. resistance R is measured first with an ohmmeter. Then the a.c. impedance at 60 cps is found by

$$Z_{ac} = E/I. \quad (4)$$

Convenient values of I will be 1 to 3 amperes for coils in the millihenry range. Then calculate the reactance by

$$X_L = \sqrt{(E/I)^2 - R} = \sqrt{(Z_{ac})^2 - R^2} \quad \text{ohms.} \quad (5)$$

Finally, find the inductance by

$$L_{mh} = 2.65 X_L \quad (6)$$

How to use crossover coils

When two or more coils are used, they should be mounted at right angles to each other to prevent interaction. All coils should be kept away from power transformers and other sources of a.c. fields. Use insulating cores and mountings; wood, molded insulation, plastics.

(Continued on page 96)

The Interaction Concept in Feedback Design

NORMAN H. CROWHURST*

Part II. Concluding the discussion of the problems of visualizing the behavior of feedback amplifiers and the presentation of a new attack which enables these circuits to be better understood and more easily predicted.

Three-Stage Case

But amplifiers often have more than two rolloffs contributing to the over-all response throughout the loop. This considerably complicates the consideration because, as shown in an earlier article, the number of combinations when three or more different rolloffs can be combined becomes very much more complicated to consider. However there are certain optimum arrangements and it will be assumed that these are followed, or at least approximately followed.

For a loop containing three rolloffs the optimum arrangement for achieving the maximum amount of feedback without running into peaking utilizes two rolloffs at a higher frequency and one at a lower frequency, the ratio between the frequencies being designated n , illustrated diagrammatically at Fig. 11.

The chart of Fig. 12 shows the progress of the boundary between peaking and instability for this arrangement for different values of n between 1 and 100. This is extracted information from Fig. 6 of a previous article (Ref. 3). In that

article a graph was also given for the identical stage case of the frequency of peak and height as feedback is increased. In the appendix to this article a relationship is deduced for the frequency and height of peak as the feedback is increased beyond the point where peaking commences, designated by the factor F_p , and given the name "excess feedback." This signifies the amount of feedback in excess of that required to produce the maximal flatness curve for the arrangement.

The amount of feedback required to produce the maximal flatness curve is given by the line between the nonpeaking and peaking boundaries in Fig. 12. The behavior at amounts of feedback exceeding this is represented by the graph of Fig. 13. Here the original curve of Fig. 5 in the previous article is re-plotted together with a further one which represents the limiting case when n is made large.

When the three networks are identical the ultimate frequency of instability is 1.732 times the rolloff frequency of all the networks. When one network is brought nearer the band than the other two, the ultimate frequency of instability

is the same frequency as the rolloff of the two networks.

Notice that the feedback margin between maximal flatness and instability with identical networks is a little over 15.5 db and when the separation between the rolloffs is made very great the margin increases to 18 db.

There is also some difference between the shape and position of the maximal flatness curve. This is represented in Fig. 14. Notice that the maximal flatness curve for the identical stage configuration has a sharper rolloff, indicated by the construction lines for the 6-db and 12-db-per-octave slope points. For the widely spaced case the 6-db-per-octave slope point is almost 3 db down and the 12-db-per-octave slope point is more than 10 db down. The 6-db-per-octave slope point, which is an important reference in design, falls to approximately 0.4 times the upper rolloff frequencies.

Four-Stage Case

Passing on to the four-stage case, there are two possibilities: either a single rolloff may take effect first while three are removed to a much higher frequency; or two rolloffs may operate first

* 150-47 14th Road, Whitestone 57, N.Y.

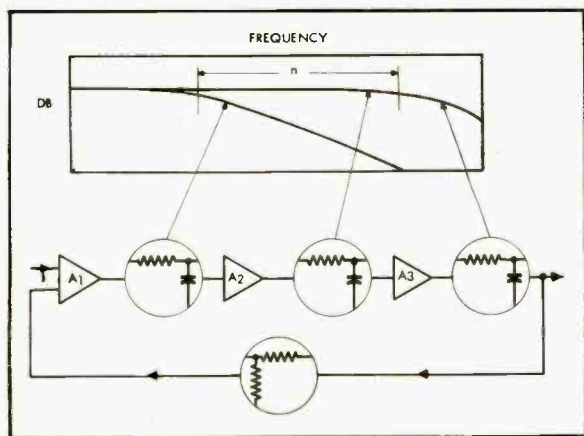

Fig. 11. Illustrating the response relations for a three-stage feedback design.

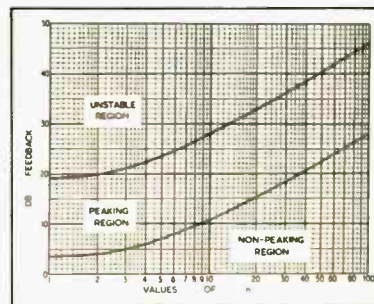
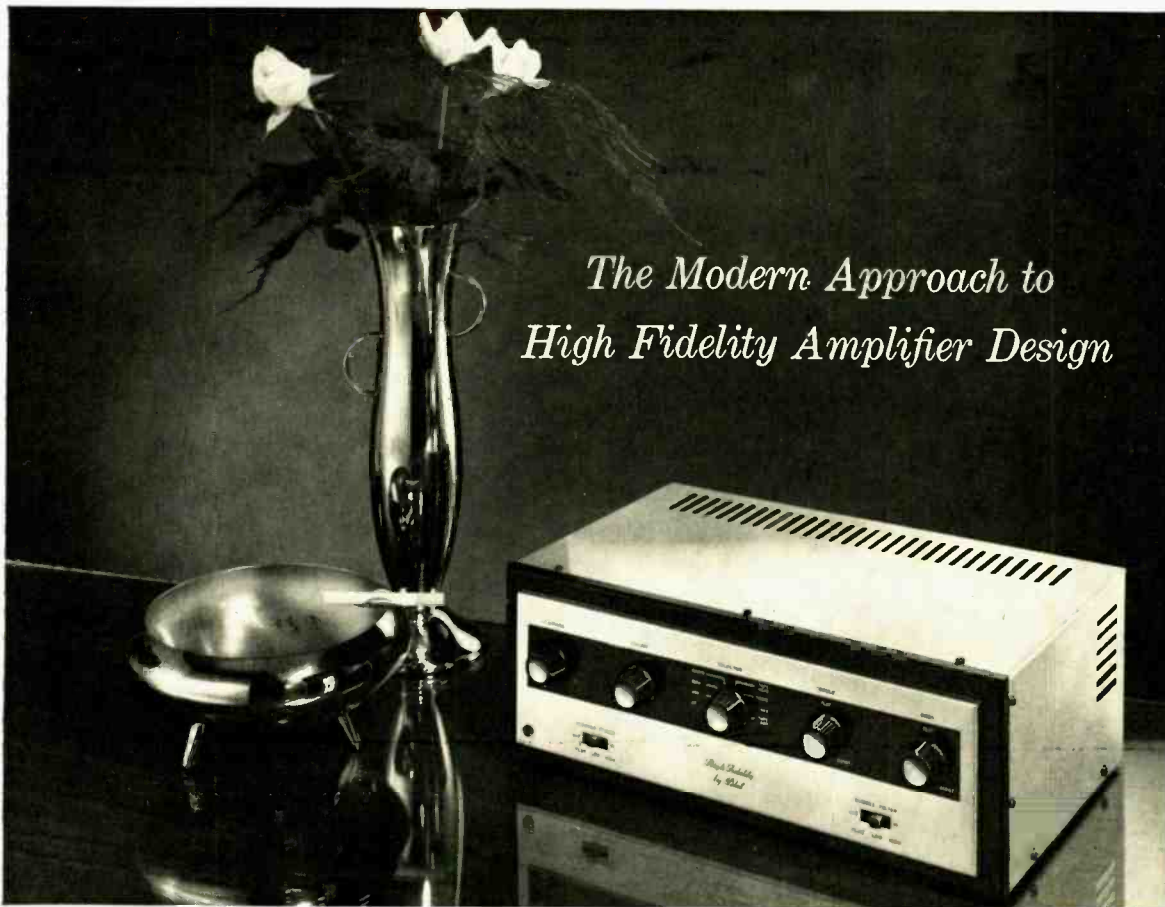

Fig. 12. Limit chart for three-stage case, using one early and two remote rolloffs, separated by a ratio n , showing the boundary at which peaking and instability occurs. The peaking boundary is also the maximal flatness condition for that rolloff ratio.



*The Modern Approach to
High Fidelity Amplifier Design*

the NEW **Pilot** AA-920 \$99.⁵⁰ slightly higher
West of Rockies
Power Amplifier and Audio Control System

**Here—in one handsome, convenient enclosure—is
the immediate answer to all your amplifier needs.**

There is hardly a high fidelity feature you can name that has not already been included in the AA-920. First, it delivers up to 20 watts of undistorted audio power with a frequency response that is flat from 20 to 20,000 cycles ± 1 db. Even at its peak output of 40 watts, distortion is surprisingly low.

Second, the AA-920 also incorporates a high quality preamplifier and a versatile audio control system. In addition to phono, tuner, tape amplifier and auxiliary channels, the AA-920 also has provision for operating directly from the playback head of a tape deck or tape recorder. The necessary tape equalization is included.

The phono input impedance is continuously variable, and may be adjusted for the optimum value prescribed for your favorite cartridge. There are four record equalization positions, as well as independent, full-range bass and treble tone controls, effective on all inputs.

Sharp-cut rumble and scratch filters are also included in the AA-920. Each is operated by a separate switch which may be set for either mild or extreme conditions. To give full effectiveness to the loudness control, the AA-920 is also equipped with a volume or level-setting control.

The AA-920 employs the new rugged 6L6GB output tubes in push-pull. Use of DC on all tube heaters in the preamp and other low level circuits has brought hum to 80db below full output—practically hum-free performance.

The all-metal enclosure of the AA-920 is luxuriously finished in deep burgundy and burnished brass. Styling and design make it the perfect match for the Pilot FM-530 and the Pilot FA-540, companion FM and FM-AM tuners to the AA-920.

the **Pilot**

See and hear the Pilot AA-920 at your hi-fi dealer or
write for complete specifications to Dept. YH-1

RADIO CORPORATION 37-06 36th STREET, LONG ISLAND CITY 1, N. Y.



from this as,

$$db = 10 \log_{10} [F^2 + \{(n+1)^2 - 2Fn\}x^2 + n^2x^4] \quad (15)$$

Differentiating the expression in the square bracket with respect to x and equating to zero gives the frequency of peak as,

$$x_p^2 = \frac{F}{n} - \frac{(n+1)^2}{2n^2} \quad (16)$$

From this point two special cases will be introduced for each formula, representing the limits to the range of behavior. These will be identified by using the same formula number with the suffix a or b . The first is obtained by the substitution $n=1$, while the second is an approximation when $n \gg 1$.

$$db = 10 \log_{10} [F^2 + (4-2F)x^2 + x^4] \quad (15a)$$

$$db = 10 \log_{10} [F^2 + (n^2 - 2nF)x^2 + n^2x^4] \quad (15b)$$

$$x_p^2 = F - 2 \quad (16a)$$

$$x_p^2 = \frac{F}{n} - \frac{1}{2} \quad (16b)$$

Substituting values of x_p^2 from (16) into (15) and normalizing for level by extracting the factor F^2 , the expressions for peak height are,

$$db_{peak} = -10 \log_{10} \left[\frac{(n+1)^2}{nF} - \frac{(n+1)^4}{4n^2F^2} \right] \quad (17)$$

$$db_{peak} = -10 \log_{10} \left[\frac{4}{F} - \frac{4}{F^2} \right] \quad (17a)$$

$$db_{peak} = -10 \log_{10} \left[\frac{n}{F} - \frac{n^2}{4F^2} \right] \quad (17b)$$

The 90-deg or unity (6-db/octave) slope point is given by equating the real part of (14) to zero, or

$$x_{\phi}^2 = \frac{F}{n} \quad (18)$$

That these frequencies coincide for this case can be checked by evaluating the differential $\frac{d \log A}{d \log x}$ and equating to unity, which also produces expression (18).

Substituting (18) into the general expression (14) and normalizing for level, the attenuation at f_{ϕ} is given as

$$db \text{ at } f_{\phi} = 20 \log_{10} [n^2 + n^2] - 10 \log_{10} F^2 \quad (19)$$

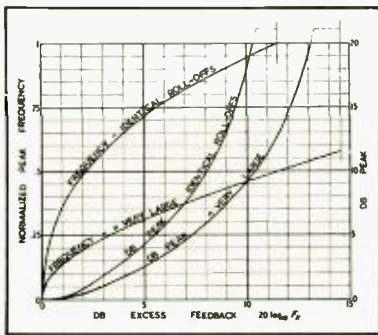

Fig. 16. Limit chart showing the behavior of the four-stage one-and-three case for amounts of feedback causing peaking but not instability. For explanation see Fig. 13.

This forms the basis of the abac of Fig. 8.

In the three-stage case, shown at Fig. 11, where one rolloff occurs at a frequency nearer the pass band by a ratio n than the other two, the complex attenuation factor can be written

$$A = F - (2n+1)x^2 + j(2+n)x - jnx^4 \quad (20)$$

From this the attenuation response is deduced,

$$db = 10 \log_{10} [F^2 + \{(2+n)^2 - 2F(2n+1)\}x^2 + (2n^2+1)x^4 + n^2x^6] \quad (21)$$

$$db = 10 \log_{10} [F^2 + (9-6F)x^2 + 3x^4 + x^6] \quad (21a)$$

$$db = 10 \log_{10} [F^2 + (n^2 - 4nF)x^2 + 2n^2x^4 + n^2x^6] \quad (21b)$$

Feedback for the peaking boundary is given by equating the coefficient of x^2 in (21) to zero:

$$\text{General case, } F_p = \frac{(2+n)^2}{2(2n+1)} \quad (22)$$

$$\text{for } n=1, \quad F_p = 1.5 \quad (22a)$$

$$\text{for } n \gg 1, \quad F_p = n/4 \quad (22b)$$

The stability boundary is obtained by equating both imaginary and real parts of (20) to zero, giving the frequency of oscillation,

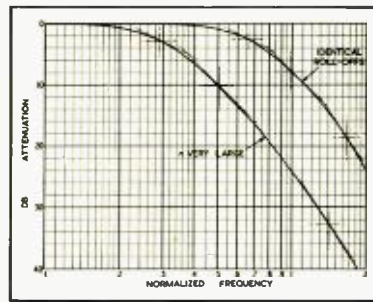

Fig. 17. Limiting responses for maximal flatness case in four-stage one-and-three feedback arrangements. The construction lines identify the unit slope points on the curves, 6, 12 and 18 db/octave. The reference frequency is the remote rolloff for the case $n \gg 1$.

$$x_n^2 = \frac{2+n}{n} \quad (23)$$

$$x_6^2 = 3 \quad (23a)$$

$$x_{12}^2 = 1 \quad (23b)$$

and the feedback necessary,

$$F_n = \frac{(2+n)(2n+1)}{n} \quad (24)$$

$$F_6 = 9 \quad (24a)$$

$$F_{12} = 2n \quad (24b)$$

The range of feedback between the peaking and stability boundaries is given by,

$$\frac{F_n}{F_p} = \frac{2(2n+1)^2}{(2+n)n} \quad (25)$$

$$\frac{F_n}{F_p} = 6 \quad (25a)$$

$$\frac{F_n}{F_p} = 8 \quad (25b)$$

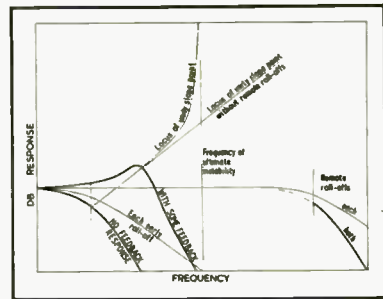

Fig. 18. Approximate behavior of the two-and-two combination in a four-stage arrangement. Slightly less than 6 db of feedback produces the maximal flatness (not shown, but similar to the 6-db feedback curve of Figs. 6 and 7) condition. From here the response follows a unity slope variation similar to that shown in Fig. 7, until the mid-frequency (of ultimate instability) is approached. Then, as shown, it begins to rise more rapidly. This is not convenient to show in detail, because the shape varies with the value of n indefinitely, and does not approach an ultimate condition, as in the other cases considered.

For the intermediate range, the frequency of peak is given by differentiating (21) and equating to zero, giving the only real root,

$$x_p^2 = \sqrt{\frac{(F_x - 1)(2+n)^2}{3n^2} + \frac{(2n^2+1)^2}{9n^4}} - \frac{2n^2+1}{3n^2} \quad (26)$$

$$x_p^2 = \sqrt{3F_x - 2} - 1 \quad (26a)$$

$$x_p^2 = \sqrt{\frac{F_x + 1}{3} - \frac{2}{9}} - \frac{2}{3} \quad (26b)$$

where $F_x = F/F_p$.

Expressions for peak height are deduced for the limiting cases by substituting (26) into (21), normalizing for level.

$$db_{peak} = -10 \log_{10} \left[1 - \frac{2}{3F_x} \right] \times \left[1 + \frac{14}{3F_x} - \frac{8}{3F_x} \sqrt{3F_x - 2} \right] \quad (27a)$$

$$db_{peak} = -10 \log_{10} \left[1 - \frac{32}{27F_x^2} + \frac{32}{3F_x} - \left\{ \frac{32}{3F_x} + \frac{32}{9F_x} \sqrt{\frac{F_x + 1}{3} + \frac{1}{9}} \right\} \right] \quad (27b)$$

The response characteristic at the peaking boundary is obtained by substituting (22) in (21), which, normalized for level, gives,

$$db = 10 \log_{10} \left[1 + \frac{4(2n+1)^2(2n^2+1)}{(2+n)^4} x^2 + \frac{4(2n+1)n^2}{(2+n)^4} x^4 \right] \quad (28)$$

$$db = 10 \log_{10} \left[1 + \frac{4}{3} x^2 + \frac{4}{9} x^4 \right] \quad (28a)$$

$$db = 10 \log_{10} [1 + 3.2x^2 + 16x^4] \quad (28b)$$

For the four-stage feedback arrangement, where one stage has a rolloff n times

FOR THE FIRST TIME IN HI-FI HISTORY...

cabinart

pfK

pre-finished Kits!

That's right! Now you can buy a loudspeaker enclosure in kit form whether you are a do-it-yourselfer or a don't-do-it-yourselfer. No more messing with shellac, furniture stain, varnish, wood putty, rags and the rest of the gookum... this time you really need only a screwdriver to assemble a superb piece of cabinet-work with that supremely professional "CABINART" finish. Each enclosure comes with every outside piece pre-finished in beautiful hand-rubbed korina or mahogany veneers. The assembled kits are absolutely indistinguishable from their world-famous factory-assembled "CABINART" counterparts. Best of all, the money you would otherwise spend on finishing tools and materials more than makes up the price difference between a pre-finished kit and an unfinished kit.



Model PFK-120/150

(pfK=Pre-Finished Kit)
Pre-finished kit version of the REBEL 4, Paul Klipsch-designed CABINART corner horn for 12" or 15" speaker systems.

PFK-120, for 12" woofer drivers:
Shipping Weight 42 lbs. \$48.00 net
Model K-12, unfinished kit \$36.00 net
Model KR-4/12, factory-assembled and finished version of same \$69.00 net

PFK-150, for 15" woofer drivers:
Shipping Weight 48 lbs. \$58.00 net
Model K-15, unfinished kit \$42.00 net
Model KR-4/15, factory-assembled and finished version of same \$87.00 net

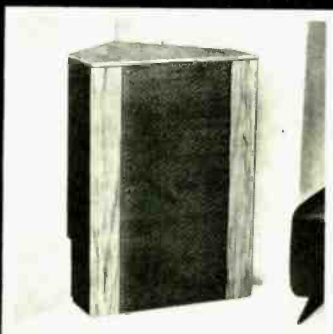

Model PFK-300

(pfK=Pre-Finished Kit)
Pre-finished kit version of the REBEL 3, CABINART's famous Klipsch-designed corner horn for 15" speaker systems. Response down to nearly 30 cps.

Shipping Wt. 61 lbs. \$72.00 net
Model K-3, unfinished kit version of same \$49.50 net
Model KR-3, factory-assembled and finished version of same \$99.00 net

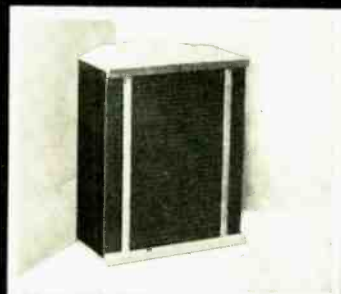

Model PFK-500

(pfK=Pre-Finished Kit)
Pre-finished kit version of the REBEL 5, the extra-compact CABINART corner horn designed by Paul Klipsch for 8" and 12" speaker systems.

Shipping Weight 34 lbs. \$36.00 net
Model KR-5, factory-assembled and finished version of same \$48.00 net
Model K-5, unfinished kit version of same \$24.00 net

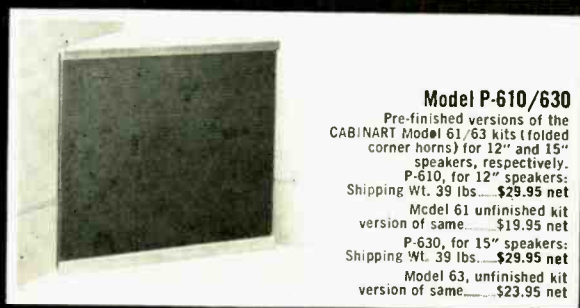

Model P-610/630

Pre-finished versions of the CABINART Model 61/63 kits (folded corner horns) for 12" and 15" speakers, respectively.

P-610, for 12" speakers:
Shipping Wt. 39 lbs. \$29.95 net
Model 61 unfinished kit version of same \$19.95 net

P-630, for 15" speakers:
Shipping Wt. 39 lbs. \$29.95 net
Model 63, unfinished kit version of same \$23.95 net



... and don't forget—

CABINART can supply you with 16 other hi-fi kits, 29 kinds of equipment cabinets, 4 matched speaker systems and 20 different hi-fi accessories.

Write For Complete cabinart '57 Catalog

cabinart

CABINART FURNITURE IS MANUFACTURED BY G & H WOOD PRODUCTS COMPANY, 99 NORTH 11 ST., BROOKLYN 11, N. Y.

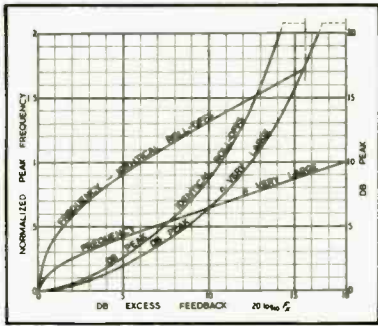

Fig. 13. Limit chart showing the behaviour of three-stage feedback arrangements for amounts of feedback causing peaking but not instability. The curves give the peak frequency and height for limiting cases, $n = 1$ and $n \gg 1$. Frequency is normalized to the remote rolloff in the latter case. The dotted construction at the top shows the limit where oscillation occurs. Excess feedback refers to feedback in excess of that producing the maximal flatness characteristic.

and the other two be removed to the higher frequency. The boundaries for both cases are illustrated in Fig. 15. In this case the margin of stability very slightly favors the use of two and two; however peaking commences at only a maximum of 6 db feedback with this arrangement. The use of the one-and-three configuration results in practically the same margin before instability is reached, but allows much more feedback before the maximal flatness case.

Figure 16 shows the frequency and peaking characteristics for the identical rolloff case and also the ultimate condition where n is very large for the three-and-one arrangement.

Figure 17 shows the limits of maximal flatness response for these arrangements. Once again the shape of the rolloff for the identical time constant case is much sharper than when n is made large. The 6-db-per-octave slope is reached with the attenuation rather less than 3 db. The 12 db per octave slope is reached for less than 8 db of attenuation while 18 db per octave is reached at about 18.5 db attenuation. When n is made quite large the 6-db-per-octave point is at approximately 3 db attenuation, the 12-db-per-octave point is just over 10 db attenuation and the 18 db-per-octave-point is almost 33 db down.

Here the point of interest is the 6 db per octave point which falls to an ultimate of 0.29 times the upper rolloff frequency.

For the two-and-two case the first 6 db of feedback reaches maximal flatness very much like the two-stage identical, and more than 6 db feedback causes peaking in a similar fashion too, until instability is approached at a frequency which is a geometric mean between the

two rolloff frequencies. This is illustrated at Fig. 18.

From this general presentation it is hoped that a better understanding of the performance of feedback networks will be achieved and that the effect of closing the feedback loop will be more readily visualized as well as more easily calculated.

REFERENCES

- 1 H. Nyquist, "Regeneration theory," *B.S.T.J.*, Jan. 1932.
- 2 B. W. Bode, "Network Analysis and Feedback Amplifier Design," D. Van Nostrand Company.
- 3 N. H. Crowhurst, "A new approach to negative feedback design," *AUDIO ENGINEERING*, May, 1953.
- 4 N. H. Crowhurst, "Unique relationships," *AUDIO*, Oct. 1955.

APPENDIX

In the circuit of Fig. 1, write a for time constant R_1C_1 , b for R_2C_2 , and k for the ratio R_1/R_2 ; and e for $R'C'$, f for $R''C''$. Then the complex attenuation factor for (A) in Fig. 1 is

$$A = 1 - \omega^2 ab + j\omega [a + (k+1)b] \quad (1)$$

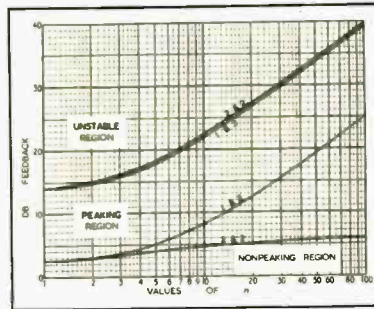

Fig. 14. Limiting responses for maximal flatness case in three-stage feedback arrangements. The construction lines identify the unit slope points on the curves, 6 and 12 db/octave.

and for (B) in Fig. 1

$$A' = 1 - \omega^2 ef + j\omega (e + f) \quad (2)$$

Equating the real parts of (1) and (2),

$$ab = ef \quad (3)$$

and the imaginary parts,

$$a + (k+1)b = e + f \quad (4)$$

Writing $\frac{a}{b} = n^2$ and $\frac{e}{f} = m^2$, and removing $(ab)^{\frac{1}{2}} = (ef)^{\frac{1}{2}}$ as a factor from both sides of (4) this reduces to,

$$m + \frac{1}{m} = n + \frac{k+1}{n} \quad (5)$$

Attenuation at f_ϕ of components in (A) of Fig. 1 as separate networks:

$$db \text{ at } f_\phi = 20 \log_{10} \left(n + \frac{1}{n} \right) \quad (6)$$

when combined, due to interaction factor k :

$$db \text{ at } f_\phi = 20 \log_{10} n + \left(\frac{k+1}{n} \right) \quad (7)$$

$$= 20 \log_{10} \left(m + \frac{1}{m} \right) \quad (7a)$$

In the circuit of Fig. 3, write the following:

$$a = \frac{L}{\sqrt{r(r+K)}} \quad b = \frac{CrK}{\sqrt{r(r+K)}} \\ k = \frac{r}{R} \quad e = \frac{L'}{I+K'} \quad f = rC'$$

Then the complex attenuation factor for (A) in Fig. 3 is,

$$A = (1+k) \left[1 - \omega^2 ab + j\omega \right] \sqrt{\frac{k}{1+k}} (a+b) \quad (8)$$

and for (B),

$$A' = 1 - \omega^2 ef + j\omega (e+f) \quad (9)$$

Equating the real parts of the frequency discriminating factor of (8) and (9),

$$ab = ef \quad (10)$$

and the imaginary parts,

$$\sqrt{\frac{k}{1+k}} (a+b) = e+f \quad (11)$$

Writing $\frac{a}{b} = n^2$ and $\frac{e}{f} = m^2$, and removing

$(ab)^{\frac{1}{2}} = (ef)^{\frac{1}{2}}$ as a factor from both sides of (11), this reduces to

$$\sqrt{\frac{k}{1+k}} \left(n + \frac{1}{n} \right) = m + \frac{1}{m} \quad (12)$$

The attenuation at f_ϕ is then given by

$$db \text{ at } f_\phi = 20 \log_{10} \left(n + \frac{1}{n} \right) \\ - 10 \log_{10} \left(\frac{1+k}{k} \right) \quad (13)$$

In the two-stage feedback arrangement of Fig. 5 the complex attenuation factor can be written

$$A = F - nx^2 + j(n+1)x \quad (14)$$

where F is the ratio by which feedback reduces gain, and x is the ratio ω/ω_0 , ω_0 being the frequency at which one reactance produces 3 db rolloff with its associated circuit, while the other occurs at ω_0/n .

So the attenuation response is deduced
(Continued on page 80)

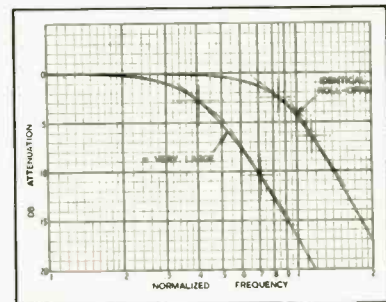

Fig. 15. Limit chart for four-stage case, show limits with either one early and three remote or two early and two remote rolloffs, separated by a ratio n , showing the boundaries where peaking and instability occur. The two-and-two case never allows more than 6 db for maximal flatness, and closely resembles the two-stage identical in many respects.



in Britain

The British Electronics Industry is making giant strides with new developments in a variety of fields. Mullard tubes are an important contribution to this progress.

**Britain's
foremost pentode
for 25W high
fidelity equipment**

The Mullard EL34 can be rightly acclaimed as the most efficient high fidelity output pentode tube yet produced in Britain. It is being fitted in many of the British sound reproducing equipments which are becoming increasingly popular in the United States and Canada.

Used in push-pull ultra-linear operation (distributed load), two EL34 tubes will give 32 watts output at a total distortion of less than 1%. The application of negative feedback reduces distortion even further.

The EL34 is equally capable of supplying higher power outputs where an increased distortion level is acceptable. Under class B conditions, 100 watts are obtainable from a pair of EL34 tubes in push-pull for a total distortion of 5%.

Another significant feature of this tube is its high transconductance value of 11,000 μ mhos, resulting in high power sensitivity and low drive requirements.

Supplies of the EL34 are now available for replacement purposes from the companies mentioned below.



Principal Ratings

- Heater 6.3V, 1.5A
- Max. plate voltage 800V
- Max. plate dissipation 25W
- Max. screen voltage 425V
- Max. screen dissipation 8W
- Max. cathode current 150mA
- Base** Octal 8-pin

Available in the U.S.A. from:—
International Electronics Corporation,
Dept. A11, 81 Spring Street, N.Y. 12,
New York, U.S.A.

Available in Canada from:—
Rogers Majestic Electronics Limited,
Dept. HN, 11-19 Brentcliffe Road,
Toronto 17, Ontario, Canada.

Mullard

ELECTRONIC TUBES

used throughout the world

MULLARD OVERSEAS LTD., CENTURY HOUSE, SHAFTESBURY AVE., LONDON, ENGLAND

Mullard is the Trade Mark of Mullard Ltd., and is registered in most of the principal countries of the world.



Design Considerations for Hum Reduction

OLIVER BERLINER*

Some helpful hints in designing and building wide-range audio equipment that will be hum-free from the start.

EVEN THE EXPERIENCED BUILDER of radios, televisions, transmitters and other electronic gear will often be in for a surprise when he attempts to build a "simple" audio amplifier. In fact, the more experienced he is with the others, the more he may foolishly minimize the problems in the design and construction of high-grade audio equipment. Amplifier problems may be divided into three categories: frequency response, distortion, and noise. As the scourge, hum, is the most prominent portion of the latter, it will be attempted to point out methods of locating, eliminating, and—most important of all—avoiding it.

Hum is a low-pitched composite tone which may include a component at any integral multiple of the a.c. power-supply frequency, and is usually due to a direct or inductive pickup from that source. Before going further, it is best to point out that for our purposes here, we will assume that there are no defective components (certain defective items will cause hum), and that the audio and power-supply basic circuitry is correct. Upon this assumption we may now take up the considerations involved in laying out and constructing a proposed audio amplifier.

Probably the greatest amount of attention to hum avoidance can be given to the simple matter of the metalware contained in every piece of audio equipment, the chassis being the prime piece, of course. A steel chassis has a number of advantages: it is available in plated or painted form; it is cheaper; it is rigid; it reduces hum pickup from other adjacent chassis; and it minimizes the hum radiated by the components contained within or upon it. But unfortunately, its great disadvantage, besides those of greater weight and far more difficult drilling and punching, is that it provides an unrestricted path for the hum radiated by any power transformer located on it to be carried to the other components upon or within itself.

This difficulty often completely destroys all of the advantages of the steel

chassis. An aluminum chassis, or one of some other non-ferrous metal, will generally serve to reduce the flow of hum that is transferred through the metal itself. The addition of a chassis bottom plate will serve to "ground out" the radiation into the underside of the chassis from other external electronic gear. Of course, an amplifier can be built on a wooden box or a "breadboard," but all the shielding advantages would be lost, as would the inherent electrical ground return and some component mounting facilities.

Certain pieces of radio-frequency equipment, particularly FM tuners, use interstage shields to eliminate oscillation, hum pickup, and frequency drift due to inductive coupling between two or more components or stages. In some high-gain amplifiers, these metal shields are attached either above or below the chassis, depending upon the locations of the components requiring separation, and serve to reduce effectively the radiated hum potential.

Choice of Tube Types

The ever widening use of miniature glass tubes has made hum avoidance in low-level stages a difficult matter. Tubes like the 12AU7, 12AX7 and 12AY7 should have removable metal shields when used as preamplifiers or low-level voltage amplifiers. Wherever possible, though, tubes like the 6J7, 6SJ7, 6SC7, 6PF5, and 6SF5 are more advisable. Not only do they have a built-in shield, which is effectively connected to ground by terminal #1 on the base (connect it to the chassis or to the "ground buss"); but being larger, the chances of microphonics—a ringing amplified sound due to the rubbing or knocking together of adjacent elements within the tube, caused by aging or vibration—is minimized.

Tubes in these and similar series that do not contain the letter "S" in the type number, utilize grid caps located in the top of the tube envelope. Since the grid terminal is so far away from the filament and plate terminals (which are at

the base of the tube) the chances of hum pickup from them by the grid terminal is considerably reduced. A detachable grid-cap shield is also available to shield against hum radiated towards the grid cap. Be certain that a solid connection between this shield and the grounded metal tube envelope is effected.

Rectifier tubes placed too close to above-chassis low-level audio circuits will generate ripple-like hum. If it cannot be kept away from these points, a metal tube with terminal #1 grounded (such as the 5T4) should be used instead of a 5U4G for high current applications, or if a 5Y3GT, 6X5GT, or miniature 6X4 rectifier is used, a properly grounded tube shield should be placed over it. Be careful to keep adequate ventilation in the neighborhood of these rectifiers.

Physical Construction

Wires carrying audio voltages should be kept as short as possible, to maintain high frequency response and to keep hum to a minimum. Where there is any appreciable length, or where the leads pass a hum source, it is wise to use

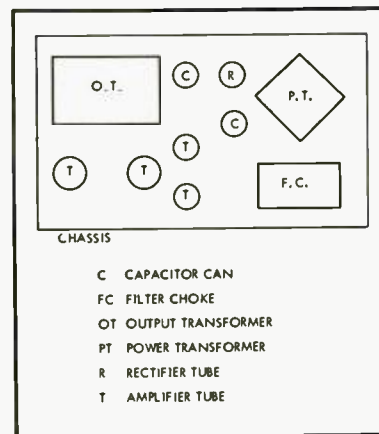
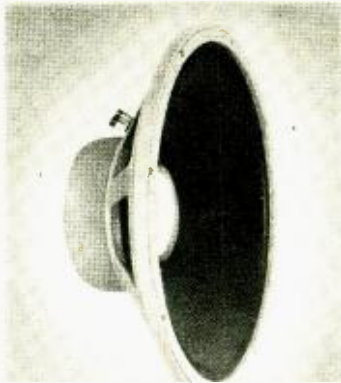
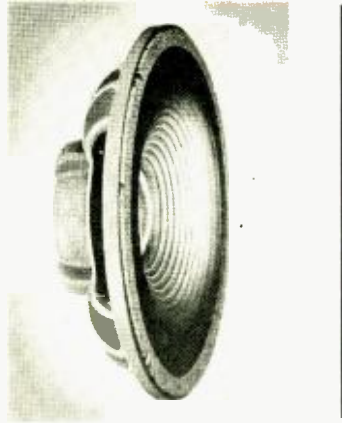

Fig. 1. Diagram of a typical power amplifier with the power transformer mounted at an angle to both choke and output transformer for minimum hum.

* P.O. Box 921, Beverly Hills, Calif.



Model D130 JBL Signature Extended Range Loudspeaker has cast frame, 15" diameter shallow curvilinear cone, 4" voice coil and dural dome.



Model D123 JBL Signature Extended Range Loudspeaker has shallow cast frame, 12" diameter very shallow cone, 3" voice coil and dural dome.

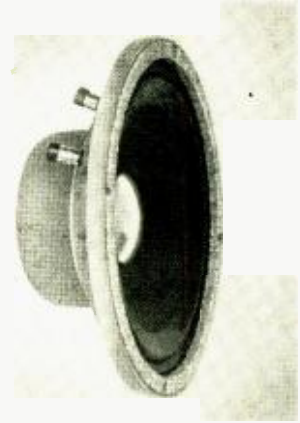

Model D208 JBL Signature Extended Range Loudspeaker has cast frame, 8" diameter shallow curvilinear cone, 2" voice coil and dural dome.

HOW TO RECOGNIZE A TOP QUALITY

HIGH FIDELITY LOUDSPEAKER

every note a perfect quote



"JBL" means James B. Lansing Sound, Inc.

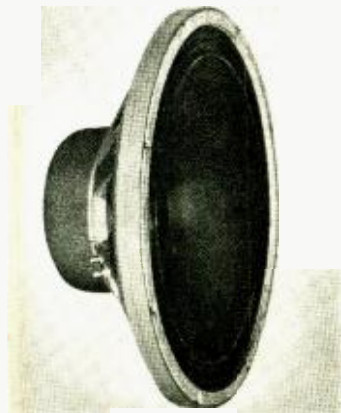

Model 150-4C JBL Signature Low Frequency Driver has cast frame, 15" extremely rigid, straight-sided cone, 4" voice coil. This is a fine theater speaker and is also used in the Hartsfield.

It has been said repeatedly that the way to select a loudspeaker for your high fidelity music reproduction system is to listen carefully and choose the one your ears like best. This is a good way. When you have learned to listen objectively and have sharpened your hearing by attentive listening to live music, then you are able to appreciate smooth, accurate coverage of the complete audio range when you hear it. You can recognize honest bass reproduction — bass notes that are musical tones, crisp, not boomy. High frequencies that are smooth way on up to the very limits of audibility; treble tones that are clean and clear, not shrill or squeaky. You can appreciate a full mid-range reproduced with unflinching precision. You can admire the performance of a speaker system that reproduces sudden, sharp peaks of sound without distortion. When reproduced music is true high fidelity, you can listen for hours on end without feeling listening fatigue, devoting all of your attention to the music itself.

Listening, when you know how, is a good way to judge a loudspeaker. Fortunately, there are other "earmarks" of a top quality loudspeaker that can be seen quickly by the eye. First of all, consider the frame, sometimes called the "basket." Since it must hold the edge of a rapidly vibrating cone, the prime requirement of a frame is that it be extremely rigid. If the frame vibrates with the cone, it will contribute unwanted sound. A cast frame, rather than one that is stamped out of sheet metal, is by far to be preferred.

If you plan to install, initially, an extended range loudspeaker, such as the JBL Signature D130 or D123, look for a shallow cone. This permits maximum dispersion of high frequency radiations. If you are selecting a low frequency driver which will be used primarily for reproducing notes below middle C, look for a straight-sided, funnel-shaped cone. This type provides a more rigid acoustic piston. The JBL Signature 150-4, used in the mighty Hartsfield, is an outstanding example of straight-sided cone construction.

Look for a loudspeaker with a large voice coil. The JBL Signature D130 15" Extended Range Speaker is made with a 4" voice coil. The JBL D123 12" Extended Range Speaker has a 3" voice coil. The D208 8" unit has one that is 2" in diameter. This 1 to 4 ratio between voice coil and cone diameter is unique in JBL Signature Speakers. It results in cleaner bass and smoother treble. The visible evidence of a large voice coil is the silvery dome in the center of the cone. But be sure this dome is attached directly to the voice coil as it is in JBL Signature units.

The magnet assembly is not visible in most speakers, and even if it were, you probably would have difficulty assessing its value. But there is a simple demonstration you can perform. Dangle an iron key near the "pot" which covers the magnet. If the pot exerts little or no magnetic influence on the key, you can be sure there are no stray magnetic fields present. This is an indication of excellent, efficient magnetic circuitry. Try this test with a JBL Signature Speaker.

The precision and care which have gone into a JBL Signature Speaker can almost be felt when you lift and examine one of these sturdy units. It is easy to see in your mind's eye the voice coil of fine aluminum ribbon which has actually been wound on its narrower edge. This is but one example of the meticulous craftsmanship, the close tolerances, the hundreds of refinements that go into every JBL Signature Speaker. Doing everything just right is responsible for the lifelike qualities of JBL Signature High Fidelity Music Reproduction.

Listen to JBL Signature Speakers in the component demonstration room of the Authorized JBL Signature Dealer in your community. He is the expert who is waiting to introduce you to the miracle of true high fidelity sound. He is the specialist who will help you plan improvements for the system you may now own. For his name write to James B. Lansing Sound, Inc., 2439 Fletcher Drive, Los Angeles 39, California.



Fig. 2. Mixer amplifier with power supply on separate chassis (right) for minimum hum transfer to preamplifiers and input transformers. Note use of metal tubes and also that the power transformer is set at an angle. (Photo by Frank Aiello through courtesy of Oberline, Inc.)

shielded hookup wire. This consists of an inner conductor which carries the desired signal, an insulating cover, a braided shield, and (preferably) a plastic or cloth covering over the shield. Ground the shield at *one* point, and you will find that it will effectively carry off the adjacent hum field to ground. The cloth cover on the shield serves to insulate the shield so that it does not touch ground at any other points so as to cause a ground loop, and it prevents shorting any signal or supply-voltage points to ground.

The physical location and orientation of the power transformer are of great consequence, even in amplifiers of relatively low gain yet high power output. It should be kept as far away as possible from other transformers and tubes carrying audio voltages. It is highly desirable to mount the power transformer at an angle to the other transformers, rather than parallel to them; that is, in such a way that the corner of the power transformer points, say, towards the side of the output transformer, or even the filter choke, as in Fig. 1. It is also wise to use an above-chassis mounting power transformer, for it has been found that some of the radiated hum is carried off through the laminations and grounded into the chassis, rather than carried by the chassis as a continuation of the laminations, which is the case with flush-mounting transformers (which are much more difficult to install, anyway).

It is sometimes advisable to place the power supply of an audio amplifier on a separate chassis, especially in equipment containing preamplifiers and/or input transformers, such as the unit shown in Fig. 2. The purpose of this isolation is two-fold: it puts the power transformer on a separate chassis, thus

eliminating hum transfer through the chassis; and it allows the power supply to be located at some distance from the audio stage, resulting in minimum radiation pickup. All this is desirable due to the limited hum-bucking abilities of some components. With miniaturiza-

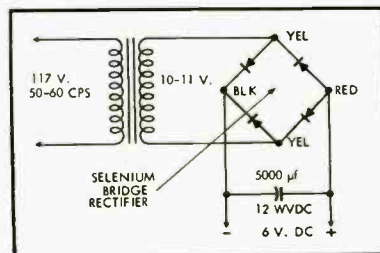

Fig. 3. Spare 5-volt winding may be placed in series with 6.3-volt winding to obtain sufficiently high input voltage to rectifier for d.c. filter supply.

tion demanding compactness, we can group the components more closely because of our greater knowledge of hum prevention and elimination and because of the existence of better hum-bucking materials and procedures. In all cases, though, it is wise to keep low-level stages away from those carrying high audio levels; that is, have the signal amplified progressively as it moves from one side of the chassis to the other.

When using input transformers, units having heavy shielding—60 db or more—should be used, price permitting. If possible, input transformers that can be rotated after installation to the point of minimum hum pickup should be employed. Hum level may be changed greatly by rotating the transformer because the physical direction of the transformer's laminations (or core) de-

termines the hum radiation or pickup pattern. Mounting the power transformer on brass bushings will also eliminate the common-core aspect of the chassis.

Ground Loops

One of the most exasperating sources of hum is the *ground loop*, because it can appear in many different forms and because it is often created inadvertently. The best way to describe a ground loop is by example: A mixer amplifier is connected to a power amplifier by means of a single-conductor shielded cable. Accidentally, the two chassis are pushed together so that they touch. Instantaneously a ground loop is formed in that the ground circuit goes from one chassis to the other through the wire shield, and then back to the first chassis from the second which is touching it, with the result that hum currents may circulate through the loop. This arrangement will often result in hum being introduced to the circuit that is part of this ground loop.

Ground loops can also occur within a chassis, especially where shielded wire is used. To avoid this, the shield should be grounded at only one point, and this point should preferably be at the output end of the wire for better hum reduction. That is, if the wire is going from the plate circuit of one tube to the grid of the next stage of amplification, the shield of that wire should be grounded as close to the grid end as possible. Of course, where a high-impedance circuit is being carried from one chassis to another, the shield must be grounded at both ends (to both chassis, that is) because it acts to complete the two-wire electrical interconnection. (Actually there are some exceptions to this rule, especially when several chassis are fed from the same power supply.) This is known as an *unbalanced* line; but if the circuit should call for a low-impedance *balanced* line using two-conductor shielded wire, you should ground

(Continued on page 82)

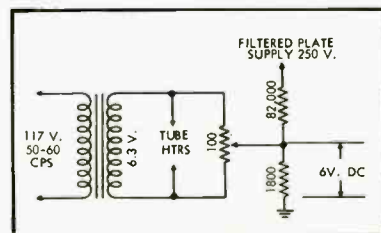
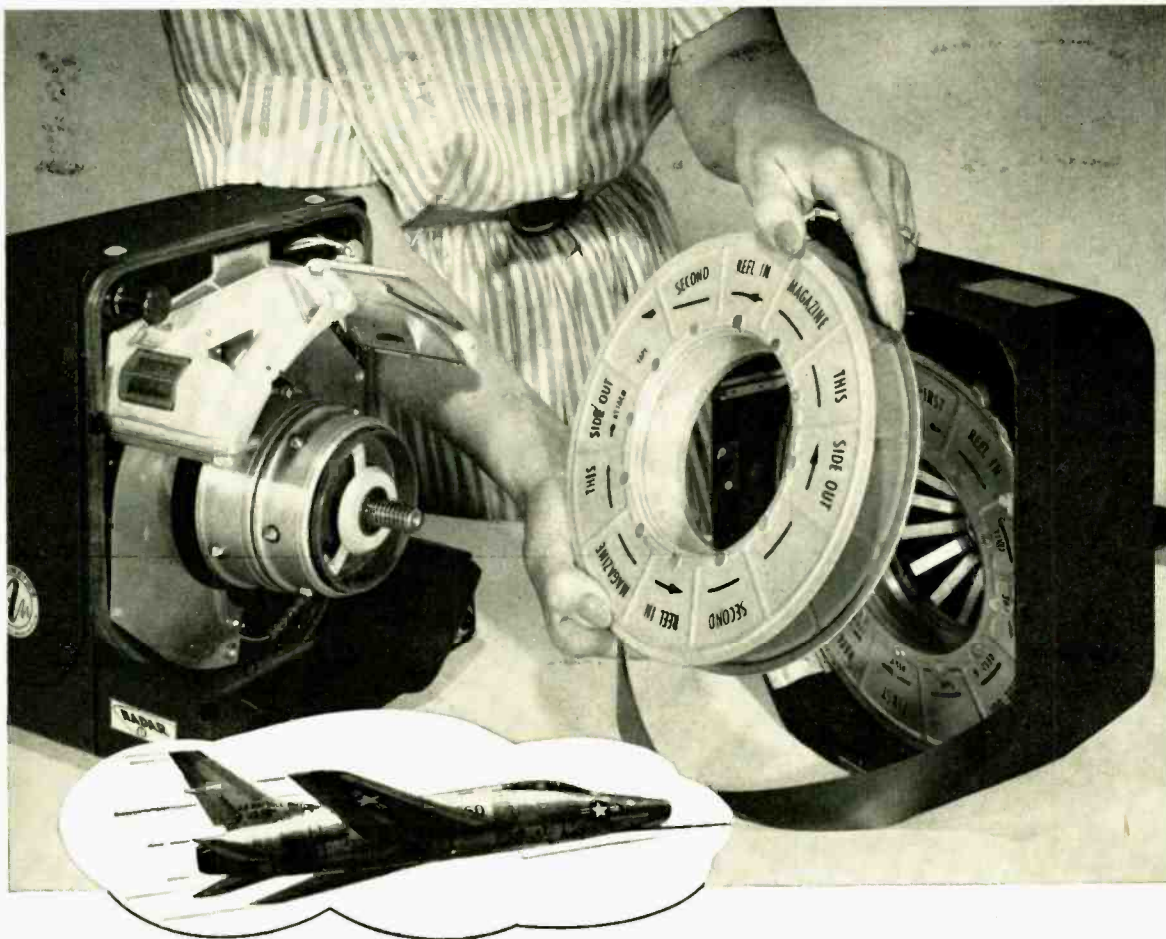

Fig. 4. When properly adjusted, the potentiometer balances out the capacitive coupling effects between the heaters and control grids of the tubes.



New airborne equipment records vital supersonic data on tapes made with **MYLAR***

Lightweight airborne recorder developed by the Autometrics Division of North American Aviation requires high-strength recording tapes that can operate over a wide range of altitudes . . . in extremes of weather and temperature. Tapes made with "Mylar" polyester film meet *all* these rugged conditions of use. "Mylar" gives recording tapes lasting strength never before available in ordinary tapes—plus these important performance benefits:

NO BREAKAGE PROBLEMS: "Mylar" is the toughest of all plastic films . . . tapes made with "Mylar" are unbreakable under normal operating conditions.

NO STORAGE PROBLEMS: Tapes are unaffected by extremes of temperature, humidity . . . no special storage care needed.

EXTRA ECONOMY, LONGER RECORDING TIME: Because "Mylar" is strong, thinner gauges are used. This means 50% more tape on the same size reel.

LONGER LIFE: "Mylar" contains no plasticizer—will not dry out or become brittle with age . . . today's recordings can be faithfully played back many years from now.

Tapes made with Du Pont "Mylar" are ideal for home use, industrial, religious, legal and professional recording. Next time you see your supplier, pick up a reel or two of your favorite brand of tape made with "Mylar".

Du Pont manufactures the base material, "Mylar"—not finished recording tape.
* "Mylar" is Du Pont's registered trademark for its brand of polyester film.



REG. U.S. PAT. OFF.

BETTER THINGS FOR BETTER LIVING...THROUGH CHEMISTRY

DU PONT

MYLAR®

POLYESTER FILM



Chopin played for Liszt

... and spoke of fidelity

Liszt had embellished Chopin's nocturnes as he played one night in a Paris *salon* for the composer . . .

Chopin said: "I beg you my dear friend, when you do me the honour of playing my compositions, to play them as they are written, or else not at all."

Then *Chopin* played Chopin . . .

Why not give yourself the pleasure of hearing *your* musical recordings as they *should* be heard?

EXCLUSIVE THREE-CHANNEL FRONT-LOADED EXPONENTIAL HORN SYSTEM: Below 45 cps to 16,000 cps flat with usable response in excess of those frequencies. Exceptional transient response. Three-way frequency dividing network with cross-over at 550 cps and 4,000 cps. High output 22 watt amplifier with preamp. 20 to 20,000 \pm 1.5 db. Less than 2% IM distortion (60 cps and 7,000 cps; 4::1 ratio signal). Precision calibrated bass and treble tone controls for definite stops in cut and boost; separate continuously variable volume control; professional three-step loudness control; 12 db/octave high frequency roll-off control (scratch filter) with 3-6-10 "KC" and "Flat" positions. Other input selector positions: "Mic," "Tuner," "Tape," and "TV." AM-FM tuner with AFC; 4-speed precision intermix changer of advanced design; G-E variable reluctance cartridge with 1 mil diamond and 3 mil sapphire styli.



AMI CHOPIN ENSEMBLE

Control unit, corner horn enclosure, and record storage console. Corner horn enclosure couples acoustically with floor and walls of your listening room to extend the bass horn within the enclosure. One of six fully integrated sound systems as well as remote control console models and wall and corner horn enclosures for a variety of combinations. Light or dark Honduras mahogany, satin finish hand rubbed by Grand Rapids fine furniture craftsmen.

...the Precision  Instruments of High Fidelity

1500 Union Avenue, S. E.
Grand Rapids 2, Michigan

Engineers, Designers and Manufacturers of
Professional and Commercial Sound Systems Since 1909



Stereophonic Microphone Placement

JAMES CUNNINGHAM* and ROBERT OAKES JORDAN**

The authors, who have had considerable professional experience in stereo recording, present the theory behind the practical solution of microphone placement for optimum results. But in the long run, after you determine scientifically exactly where the mike should be hung, you may decide to move it to somewhere else that sounds better.

STEREOPHONIC SOUND, in limbo during the past sixty years, is now emerging as a home entertainment medium. This development is due to a combination of events, the latest of which is the introduction of stereophonic home playback equipment by Ampex, Livingston, Ereona, and others. Concurrently, many recording companies are rapidly building libraries of stereophonic tapes.

It is obvious that these tapes must be truly stereophonic if this medium is to succeed—that is, microphone placement and other influencing factors must be employed to produce the maximum stereophonic effect. Not so obvious, however, is how to accomplish this effect, since any evaluation of stereo involves many individual psycho-acoustic differences.

Before making any specific statements concerning stereophonic microphone placement, it is advisable to review the literature to discover what previous experimenters have found this stereophonic effect to be. In this review one fact should be kept in mind: the human binaural hearing mechanism is exceedingly complex, and therefore any lucid analysis involves consideration of one part of this process at a time. The importance of each part, however, must still be considered only in relation to the complete hearing process.

Unfortunately, no complete theory of hearing exists, but a great deal of worthwhile research has been done, much of it relating to stereophonic sound. Snow¹ has pointed out that humans do not use their directional sense in the normal way to perceive the stereophonic effect. This can be seen by comparing *Figs. 1* and *2*. Let us first examine *Fig. 1*, which represents normal directional hearing. The subject localizes sound source *A* using at

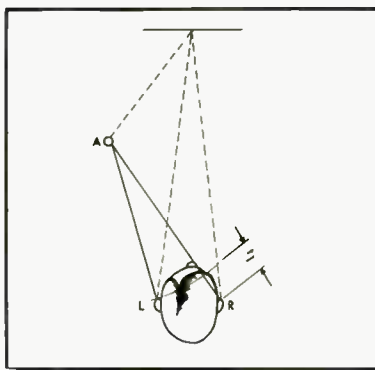

Fig. 1. Sound source *A* is heard by the listener's ears *L* and *R* at different times. The time difference t_1 equals $AR-AL$. Sound travels about one millisecond per foot.

least four means: (1) time differences at the two ears for sounds of a transient nature; (2) phase differences for steady state below 1000 cps; (3) intensity differences; and (4) quality differences due to attenuation of higher frequencies by the head itself. Of course, all of these factors are used simultaneously to localize a complex sound. Mention must also be made of the mind's ability to weigh the direct sound and suppress those reflections of a sound

source which arrive from other directions and at varying times, thus localizing on the direct sound. This is shown by the dotted lines of *Fig. 1* and will be discussed later.

Often it is incorrectly assumed that a complex plane wave, such as that produced by an orchestra, can be reproduced almost exactly by a stereophonic system of two or even five channels. If this were true the analysis of stereophonic sound would be much the same as that given for *Fig. 1*; in other words, we would use our normal directional hearing sense to localize a sound. Examination of *Fig. 2* shows what actually happens, at least as far as time differences are concerned.

The sound source *A* is now heard as two sets of eues (incident sounds) reaching the ears in rapid succession. Experiment has shown that we localize on the first set of eues in the normal way and "ignore" the second set (similar to the dotted lines in *Fig. 1*) as long as their time difference t_2 is roughly 3 to 50 milliseconds. In the case of *Fig. 2*, the total sound would seem to come from the left loudspeaker. This analysis applies only to sounds of a transient nature since, of course, the ear must have sharp wave fronts on which to judge time differences.

This ability to localize only on the first arriving sound is called the prece-

Fig. 2. W_1 and W_2 each represent a microphone - amplifier - speaker combination. *A* is the sound source while *L* and *R* represent the listener's ears. The sound is heard first from W_1 then from W_2 . Their time differences t_2 is equal to $AW_2 - AW_1$.

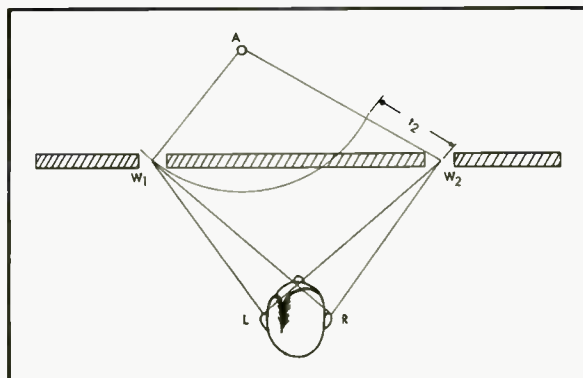

* National Broadcasting Co., Chicago, Ill.

** Robert Oakes Jordan & Associates, Highland Park, Ill.

¹ W. B. Snow, *J.S.M.P.T.E.*, Nov. 1953.

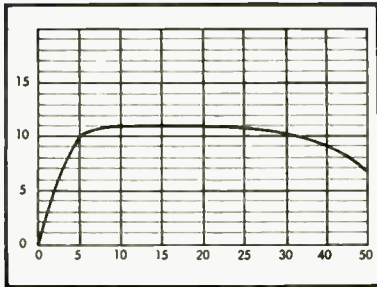

Fig. 3. The Haas curve. See text.

dence effect and has been studied first by Haas² and later by Wallach, Newman, and Rosenzweig.³ Haas used the following technique: setting up two loudspeakers, he seated a subject midway between them. Recorded speech was fed to each loudspeaker, with a variable delay in one circuit. The subject was given a level control and asked to equalize the levels of the two loudspeakers as different amounts of delay were introduced by a movable playback head on a tape recorder. As Fig. 3 illustrates, the delay can be offset by increasing the intensity of the delayed loudspeaker. After 50 milliseconds an echo is distinguished. If the intensity is not increased the total sound will seem to come from the loudspeaker radiating the direct sound. A different approach was taken by Wallach *et al* in that they studied this effect, using two pairs of audible clicks in earphones, as shown in Fig. 4. The first pair of clicks represents the direct sound, while the second pair represents the reflected or delayed sound. The subject heard the four clicks as a fused sound apparently coming from the right or left depending on which ear heard the first click of the first pair. The second pair of clicks appeared to pull the first pair along with it, but this effect was rather slight.

If the precedence effect were the only means by which we were able to hear stereophonic sound, a sound source would appear exclusively in one speaker or the other and not in the area between the two speakers, except for a small central area. But this is only part of the story; imagine a complex sound source, such as a speaking voice, as in Fig. 2. The listener would, as has been explained, use the sharp wave fronts in the sound to identify the left loudspeaker as the source. At the same time, intensity differences at the loudspeakers which produce intensity differences at

the ears will influence the apparent position of the sound source, perhaps "pulling" it to the right toward its natural position. Outside of Steinberg and Snow⁴, little experimentation has been done with the effect of intensity differences in stereo, but a simple experiment, which can be duplicated with stereophonic equipment, shows that with sustained tones even a 2 db difference in loudspeaker intensity can produce a shift in the apparent position of the sound source. Evidence that phase or quality differences at the loudspeakers contribute to the stereophonic effect is lacking, except for a report by Bekecsy⁵ that loudspeakers of widely different quality will tend to produce a separate localization and thus have a tendency to destroy the precedence effect.

One of the most often mentioned advantages of stereophonic sound is a spatial feeling or a transferral of the

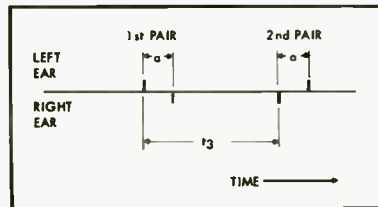

Fig. 4. The precedence effect is illustrated by the vertical lines which represent clicks in earphones worn by a listener. Within certain limits, the four clicks are heard as a fused sound and the apparent location of the source is almost totally determined by the time difference, a .

acoustics of the concert hall into the listening room. A partial explanation of this can be offered by again applying the precedence effect. As an example, suppose we are standing in the concert hall, and a sound occurs; our ears are struck by the reflections of this sound from all directions, with the direct sound accounting for only a small percentage of the total sound energy reaching the ears. Of course, we localize on the direct sound, but the mind integrates the reflected energy and forms an impression of the size of the hall, perhaps roughly similar to the way in which bats use the reflective radar principle to perceive obstructions. In any case, it is known that if the reflected energy did not reach our ears we would have the

⁴J. C. Steinberg and W. B. Snow. "Physical factors in auditory perspective." *BSTJ*, 13, 1934, pp. 246-259.

⁵G. V. Bekecsy. "Zue Theorie des Hörens, Über das Richtungshören bei einer Zeitdifferenz oder Lautstärkenungleichheit der beiderseitigen Schalleinwirkungen." *Physikal. Zsch.* 31, 1930.

impression of being in an open field. In fact, reversing the situation, it has been proposed that an outdoor concert hall could be roughly effected if loudspeakers were placed at intervals on imaginary walls and fed delayed sound appropriate to the energy that would ordinarily be reflected at these points. Thus the direct sound would emanate from the orchestra in the usual outdoor shell and the "reflected" sound from the loudspeakers. This illustrates an important point: if the direct and reflected sound arrive at the ears from different directions and at different times a spatial feeling will result. Stereophonic sound, with its two speakers in a fairly sound-absorbent listening room, can produce this illusion, as Fig. 2 illustrates. For simplicity, we have not considered reverberation in this discussion. But it can be shown that a low ratio of direct to reverberant sound, which produces the well known "off mike" condition in monaural sound, will not cause as much loss of intelligibility and definition in stereophonic as in monaural sound. This again is due to the mind's ability to suppress or integrate the reflected energy arriving from a direction other than the direct sound.

In the light of the preceding evidence, we are now ready to draw some conclusions as to what is good or bad stereophonic microphone placement. There are many variables in every stereo setup, such as the size and physical characteristics of the hall or studio, the included angle of the pickup area, individual judgement, equipment, etc. Therefore it is not advisable to set rigid standards of practice. Just as in monaural, the final excellence of the product will be subject to the artistry of those directing the setup. Actually, there are certain limits within which it is possible to achieve the stereophonic effect, but

(Continued on page 82)

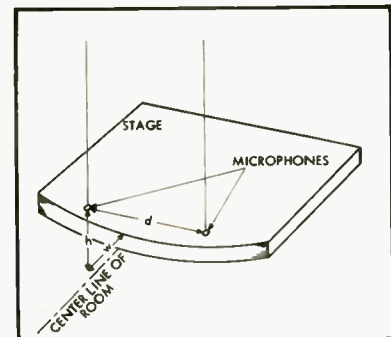

Fig. 5. The three dimensions governing stereophonic microphone placement. The actual dimensions will depend on the size of the pickup area and the factors discussed in the text.

²H. Haas. "Über den Einfluss eines Einfaachechos und die Hörsamkeit von Sprache." *Acustica No. 2*, 49-58 1951.

³H. Wallach, E. Newman, M. Rosenzweig. "The Precedence Effect in Sound Localization." *Amer. J. Psych.* July, 1949.



Belden 8411

If it's worth Engineers' time . . .



Belden 8422

. . . It's worth Engineered Cable



Belden 8412

Belden
microphone
cables

Whatever the installation,
 whatever the requirements,
 there is an accurately
 rated Belden Microphone
 Cable built for the job.



Belden
 WIREMAKER FOR INDUSTRY
 SINCE 1902
 CHICAGO

4-8

1001 WIRES FOR EVERY ELECTRONIC NEED

Conference Amplifier for the Hard-of-Hearing Executive

ROBERT M. MITCHELL*

When it is necessary for a person who wears a hearing aid to follow the discussion around a director's table, for example, some means must be provided to supplement his usual equipment. The system described here will make it possible for the user to follow every word readily. Furthermore, for making a complete recording of the proceedings, such a system would improve the results.

ELECTRONICS PLAYS AN EVER INCREASING part in the development of medical science and knowledge, and nowhere have its particular advantages of miniaturization, reliability and economy been put to better use than in the modern hearing aid. The application of electronic circuits, and more especially the introduction of transistor circuitry, have brought about reductions in size and operating costs virtually unparalleled in other fields.

Today it is possible for the hearing aid consultant to provide units with maximum sound pressure levels ranging from about 115 to 140 db. This is accomplished by selecting amplifiers having power outputs ranging from about 1 milliwatt to about 100 milliwatts. Even the largest of these weighs only six ounces—including batteries. In addition these instruments are capable of being

"fitted" electro-acoustically to the particular user's hearing loss as it varies with frequency. The availability of such extensive variation in power, frequency response, size, and so on, makes it possible to design and fit hearing aids to take care of virtually every possible situation.

There are certain situations, however, where the regular hearing aid does not provide optimum performance due to the large variation in physical distances involved. Such a situation arises in the case of a conference or meeting, for example, where some speakers may be directly adjacent to a listener, while others are as much as twenty or thirty feet away from him. Even a normal-hearing person will often experience difficulty at such a conference, since nearby noises tend to mask the distant speaker, and neither the directivity nor the sensitivity of one's hearing can be significantly adjusted to compensate for the

differences. The hearing aid user can adjust his directivity to a slight degree and his sensitivity to a large degree. However, since the variation in directivity is small, any increase in sensitivity will only result in the nearby noise becoming louder, and the over-all result can be worse than the original condition.

This particular problem arises many times in the life of the busy industrialist who has to sit at board meetings and conferences or attend hearings and inquiries a good deal more frequently than the average businessman. One nationally prominent industrialist, a long-time hearing-aid user, faced just such a situation, and it was for his particular use that the conference amplifier described in these pages was designed. Although designed for a hearing aid user, it is evident that this conference amplifier could be of equal value to the normal-hearing businessman as well.

The requirements for the amplifier were as follows:

- (1) Power output sufficient to drive a bone conduction receiver to full output.
- (2) Frequency response equivalent to that of the user's hearing aid.
- (3) Exterior Master gain control.
- (4) Five input channels, with gains adjustable in groups by interior controls.
- (5) Five microphones with cables up to 30 feet.
- (6) One special close-talking microphone, with press-to-talk switch and relay control to disable other circuits.
- (7) Suitable cases so that the entire equipment can be carried by one person easily.

Since the amplifier was intended to be portable, but was not intended to be carried on the person, neither miniaturization nor battery-powered operation was required. This meant that conventional tubes drawing their power from the a.c. line could be used. It also meant that a specific carrying case of proved

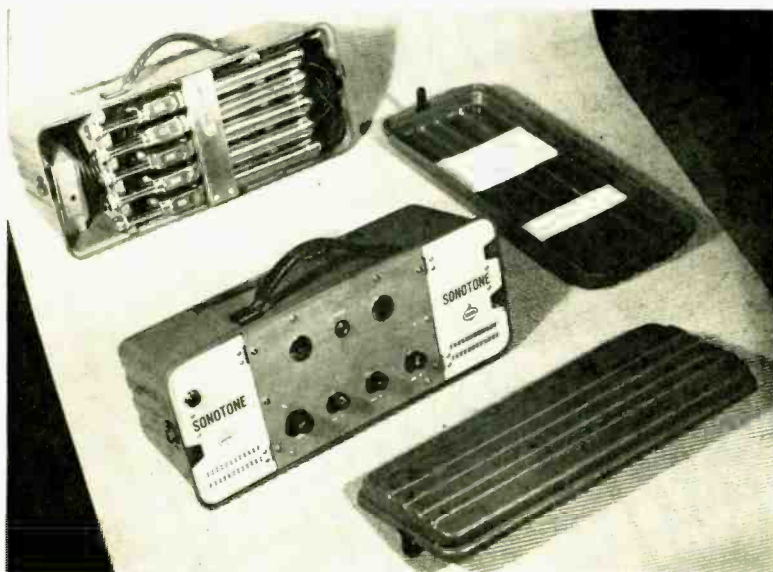

Fig. 1. The Sonotone Conference Amplifier is housed completely in one case, while the microphones and cables are carried in another of identical size and appearance.

at last!

Engineering
Artistry
Craftsmanship
Systems Concept



Catenoid®

The famous Catenoid now offered by its originators with new improved speakers
Response from below 30 to beyond 18,000 cps

Three-way system with full bass horn and electrical crossovers of 300 and 5,000 cps
Power 30 watts, dimensions 37½" H x 29" along wall from corner
Net Price \$395.00

FROM THE AUDIO LEAGUE—"We have never heard a smoother overall sound. The balance of lows, middles, and highs, was well-nigh perfect."

All LEE speakers available in mahogany, blonde and walnut pressure laminate finishes



Chordale

New three-way speaker system with 15 inch resistance damped enclosure
Response from 40 to 18,000 cps
Electrical crossovers of 300 and 5,000 cps, Power 30 watts
Net Price \$249.00



Fantasia

New three speaker system incorporating a resistance controlled enclosure
Response from 50 to 15,000 cps,
Power 20 watts
Net Price \$129.50



Trio

New corner system utilizing three speakers and a resistance controlled enclosure
Response 50 to 15,000 cps,
Power 20 watts
Net Price \$119.95



Musette

Two-way bookshelf speaker utilizing an isothermal backvolume
Response from 70 to 15,000 cps,
Power 15 watts
Net Price \$69.95



L. E. E. INCORPORATED

The laboratory of electronic engineering

625 NEW YORK AVENUE, N.W., WASHINGTON 1, D. C. • NA. 8-3225



Fig. 2. The Conference Amplifier set up for use at a small meeting, with the five Electro-Voice microphones in typical locations.

ruggedness could be used for the amplifier as well as the microphones. This particular case is made of Royalite, a special plastic material highly resistant to scuffing and virtually immune to breakage. The entire unit consisting of the complete amplifier and five desk stand type dynamic microphones with cables fits into two of these cases as shown in Fig. 1. The plastic covers snap in place with luggage type hasps, giving complete protection in transit. The amplifier is not removed from the case when in use, since all controls necessary to its operation are available from the front panel.

There are five speaker microphones and one "adviser" microphone. The microphones used for the speakers are high-

quality dynamic microphones of slender shape, mounted on desk stands, so that they may be conveniently placed around the conference table. The adviser's microphone is a dynamic type of the close-talking variety with a press-to-talk switch. This switch activates a relay in the amplifier which silences all the other microphones and lets only the adviser's voice come through. In this way it is possible for the adviser to have the user's full attention and speak with the same privacy as if he were whispering directly in his ear.

The conference amplifier as set up for actual use is shown in Fig. 2. In this photo only the five desk microphones are shown. The small rectangular object at the end of the table is the master volume

control. This consists of a wire wound volume control mounted in a hardwood block. The block is weighted with a brass plate and equipped with rubber feet so that it cannot be easily dislodged. The input of the volume control is fed with the amplifier output. Because this output voltage is at low impedance the volume control can be a considerable distance away from the amplifier. The arm of the volume control feeds directly into the user's bone conduction receiver (shown on table near volume control). In this way the user has complete control of all channels, and also has the benefit of a virtually constant signal-to-noise ratio.

The circuit diagram of the prototype conference amplifier is shown in Fig. 3. The inputs are arranged in three groups. Group A consists of three speaker's microphones, Group B of two speaker's microphones while the last group consists of the adviser's microphone only. Each dynamic microphone is fed into the primary of a UTC O-16 input transformer, via a short circuiting jack. The secondaries of Group A and B are mixed by means of the 0.1-megohm isolating resistors and fed to the grids of the first 12AX7 tube. In this way unused microphone inputs are shorted out, without significantly affecting the gain from the other inputs. The secondary of the adviser's microphone transformer feeds a divider of two 0.1-megohm resistors which brings its gain down to the same level as the other inputs. The two 12AX7 tubes have fila-

(Continued on page 88)

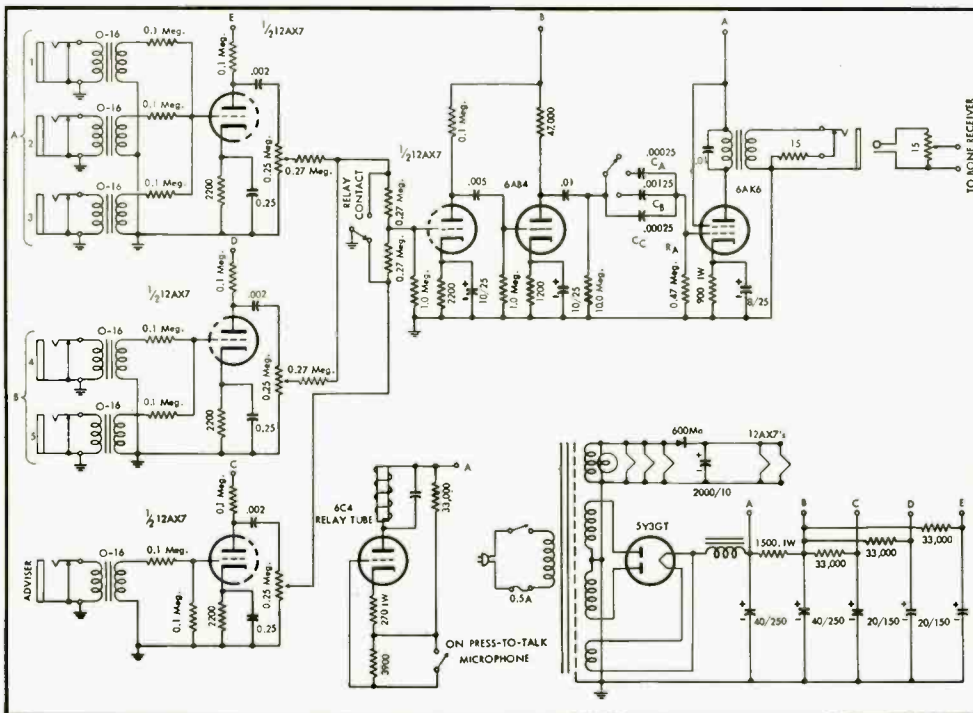

Fig. 3. Complete schematic of the Sonotone Conference Amplifier. This circuit shows the relay for use by an "adviser" to cut out all but his own microphone.

AUDIOCLINIC ? ?

JOSEPH GIOVANELLI*

Linearity

Q. As applied to electronics, what is meant by linearity? John Carlson, Bronx, New York

A. As you know, a microphone (or phonograph pickup) converts mechanical motion into electrical voltages. These are a.c. voltages whose instantaneous value depends upon the amount of mechanical motion, and whose frequency depends upon the number of vibrations imparted to it. These voltages are then applied to the grid of a tube. At the output of the tube, the voltage is larger by an amount equal to the gain of the tube. If the signal in the output circuit is perfectly linear, the relationship between the voltages in the output circuit should be equal to all the voltage relationships in the input circuit. This is the same as saying that when we copy a small picture by means of using an enlarger, the picture is made bigger; although all parts of the picture are larger than in the original, their relative sizes remain unchanged. Not only must the relationships between instantaneous voltage peaks be maintained, but the tube must not add any voltages of its own. Of course, there is a 180 deg. phase shift in the plate circuit of a vacuum tube, so that all voltages are now of opposite sign from those originally applied to the grid circuit. This is of no importance. What is important is that any phase change should affect voltage at all frequencies to an equal extent. Phase changes which vary with frequency do occur and are unwanted. Ask anyone who has attempted to design negative feedback circuits about this.

If an amplifier is perfectly linear, and if the microphone or phonograph pickup has properly interpreted the mechanical motion supplied to it, good sound reproduction should be had, again assuming that the loudspeaker can accurately reconvert the electrical voltages and currents into mechanical motion, and if the room acoustics do not alter the phase relationship between the soundwaves transmitted from the speaker or otherwise alter the relative magnitude of the soundwaves.

If some frequencies are stronger than they were in the original signal, or if some are weaker than they should be for good linearity, we have another way of saying that the amplifier in question suffers from a poor frequency response, or at least that the response is not flat. If there are voltages added other than any present in the original signal, the amplifier is said to have harmonic or intermodulation distortion, depending upon the means by which they were introduced.

Speaker Phasing

Q. I am completing a speaker system which employs two woofers. How can I determine when they are properly phased? W. Benson, Newark, New Jersey

A. It should be pointed out that proper phasing of the speakers means that their cones are both travelling in the same direction; that is, when one is travelling out-

ward, so is the other. The first step in determining whether this condition exists is to connect the speakers in either series or parallel, depending on the needs of the system. Before proceeding, be sure that the speakers are not baffled, so that their performance can be observed. Connect a flashlight battery to the speakers and you will be able to see whether the speakers are moving in the same or opposite directions. If the speakers are not in phase, reverse the connections to one of the speakers (not both). The two woofers are now properly phased and ready to be baffled.

Triode

Q. What is a triode? Philip Hartman, Shreveport, Louisiana

A. A triode is a vacuum tube consisting of three elements: a cathode (directly or indirectly heated), a plate, and a grid which is actually a plate with holes in it. Constructionally, the cathode is at the center with the grid concentrically surrounding it and with the plate concentrically surrounding the grid.

A diode (see AUDIOCLINIC, Oct., 1956.) can either conduct or not conduct, depending upon whether the plate is positive or negative with respect to its cathode. The only way the conductivity in a diode can be controlled depends upon the amount the plate is positive with respect to the cathode. In a triode, the grid is introduced, providing us with another means of controlling the conductivity between cathode and plate. To illustrate the way in which this is accomplished, let us assume that the tube is connected as a diode, so arranged that its plate is more positive than its cathode. The grid is so connected as to be slightly positive with respect to the cathode. The grid attracts electrons from the cathode. Because of the high velocities at which the electrons are travelling, most of them do not strike the grid but rather pass through the holes and continue on until they reach the plate. Because of the fact that the grid is somewhat positive, the motion of the electrons from the cathode toward the plate has been accelerated, increasing the plate current. Obviously, if the grid were made more positive than the plate, the plate would tend to repel the electrons back toward the grid.

Let us assume that the grid is made negative with respect to the cathode. In this case, electrons leaving the cathode are repelled by the more negatively charged grid. Some electrons will probably still find their way to the plate because of the holes in the grid, but their number is considerably reduced from that observed when the grid was made positive or when the same tube was connected as a diode, assuming no grid. Very little change in grid voltage is needed to effect a large change in plate current. When the plate circuit is properly arranged, large voltage changes can be observed in the output. Therefore, such a tube has the ability to magnify signals or voltages connected between its plate and cathode. In practice, most vacuum tube circuits have their grids somewhat negative with respect to their cathodes. For further discussion of this, see AUDIOCLINIC, Aug., 1956.

Ohm's Law

Q. What is Ohm's law? Fred Dirkman, Tulsa, Oklahoma

A. Ohm's law states the relationship of voltage, current, and resistance. This is a basic concept in electronic work.

In order for a stream of electrons to flow through a circuit, pressure must be exerted upon it. This pressure is known as voltage. The stream of electrons is the current. The unit of current is the ampere which represents the flow of one coulomb or 6.28×10^{18} electrons past a given point in one second. There is opposition to the flow of such current. If there were not, the least pressure would cause an infinite current to flow, but this is not the case. This opposition, known as resistance, can vary from practically zero to infinity, depending upon the material making up the circuit. The amount of such resistance offered to the flow of electrical current is measured in ohms. If the resistance is infinite, no current can flow, no matter how great the voltage applied. If the resistance approaches zero ohms, very little voltage will be needed to produce a large flow of current. If the resistance is not infinite but still is high, large current can be made to flow by using tremendous voltage. To determine exactly the amount of voltage which will be needed to push a given amount of current through a given amount of resistance, multiply the resistance and the current. Algebraically, this is stated:

$$E = IR, \quad (1)$$

where E is the voltage (which is also known as electromotive force), I is the current in amperes, and R is the resistance in ohms. This is the standard notation used when discussing these quantities. When the multiplier is divided into the product, the result is the multiplicand. If the multiplicand is divided into the product, the result is the multiplier. This is the basis for our being able to find the resistance or current when the other two are known. Algebraically they may be expressed as follows, with the meanings for each letter being the same as those for equation 1:

$$R = E/I, \quad (2)$$

$$I = E/R \quad (3)$$

and

If the current is multiplied by the voltage, the product is the power needed to overcome a specific resistance. A resistance is being overcome, so that work is being done; therefore, the word *power* can be used. Electrically, this is measured in watts, indicated by the symbol W . Hence:

$$W = EI \quad (4)$$

From Eq. (1), $E = IR$. Since this is so,

$$W = IR \cdot I \text{ or } W = I^2R \quad (5)$$

Therefore, $W = I^2R$ (6)

From Eq. (3), $I = E/R$

Therefore, $W = EE/R$ (7)

Hence, $W = E^2/R$ (8)

These formulas hold for a.c. or d.c., although they will definitely not be applicable to alternating current if there is any inductance and/or capacitance present, as they offer opposition to the flow of alternating current other than that of their d.c. resistances. They must, therefore, be taken into account when making calculations such as those above.

(Continued on page 99)

* 3420 Newkirk Ave., Brooklyn 3, N.Y.



Left, Mr. Briggs during the introductory remarks before the concert, and right, a portion of the audience in Carnegie Hall.

The Briggs Concert—U.S.—1956

Carnegie Hall is again the scene of a presentation of what sound reproducing equipment designed for the home can do in a large auditorium, and which compares live and recorded performances.

GILBERT BRIGGS is a man who has the courage of his convictions, and who—while fully cognizant of the fact that reproduced sound is not a complete substitute for the original—is still willing to present the two on the same program to show just how far we have come in home equipment.

And while the entire concert was completely new as compared to the event of 1955, there was considerable to be observed and learned by the serious audio engineer, the hi-fi technician, and the music lover whose interest lies in good reproduction. Actually, it is rare that any of us ever get an opportunity to hear ordinary home equipment under concert-hall conditions, and while we may attempt to reproduce our favorite records at what we think is concert-hall level, the conditions are so different that we can learn but little.

Music critics were not wholeheartedly in favor of the concert, but this observer feels that there is a lot more to a demonstration of this type than a simple presentation of live and recorded music solely for the purpose of making a direct comparison.

Acoustic Conditions

No one questions the fact that there is considerable difference between the acoustic conditions in the home and in such an auditorium as Carnegie Hall. For example, the large space tends to integrate the over-all volume of sound, effectively smoothing out the instantaneous peaks so that the average level is acceptable to the human ear. If the same level of sound were reproduced in the average living room, the dynamic range would be entirely too great.

No one will say that the reproduced sound was identical with the live—least of all Mr. Briggs. There were certain parts of the program which compared very favorably, others which did not. But in reality that is not what anyone was trying to prove. And if we take a completely honest view of the comparisons, we are forced to say that we are quibbling over fairly small differences in many cases, so small that it indicates that we have ceased to remember that the sound was reproduced.

Description

For the benefit of those who may not

have heard of the "Briggs Concerts" before, let us take a few moments for a brief description. In preparation for the concert, the selected artists are assembled in the hall some two months before the event. Along with them are their producers from the record companies which are cooperating, and the recording engineers with their equipment. The artists are recorded on tape, using the best quality of broadcast equipment and standard studio techniques as far as possible within the limitations of the hall in comparison with the usual recording studio.

At the concert, the artists and the recorded tapes are presented together—in most instances by means of simple "switching" between live and reproduced sounds. The tape is started and a few phrases are played, sound is cut off and the artist carries on. At a signal the tape takes over again, and so on throughout the particular number. Thus the artist is playing a selection at the concert with another playing that was recorded many weeks before, with possibilities of variations in tempo, touch, and the many other characteristics which make the differences between one artist and another.

It is not as simple as a direct comparison from one "take" to the next, as one might hear in a recording studio.

The stage presentation commences with Mr. Briggs giving a short introduction in which he describes the equipment, the intent of the whole performance, and the program itself. In the concert just concluded, Mr. Briggs was assisted by Harold Leak, who officiated at the controls of the amplifiers of his own manufacture, and who gave a short semi-technical talk to open the third segment of the show.

Three 25-watt amplifiers were used, all fed from one Leak control unit. The tape equipment was Ampex, and the loudspeakers—quite naturally—were Wharfedale products. For those portions of the concert which consisted of phonograph records, a Leak moving-coil pickup was used, together with a Garrard 301 transcription turntable. To complete the credits, the two pianos used were Steinways.

The live artists appearing on the program were the dual piano team of Teicher and Ferrante, who were sponsored by Westminster; E. Power Biggs, sponsored by Columbia Records; and Morton Gould, conducting the Percussion Ensemble, and Danny Daniels, tap dancer, both sponsored by RCA Victor Records.

For loudspeakers, Mr. Briggs used three of his three-way systems and two smaller units not yet available in the U.S. The large models are, however, and each consists of a corner cabinet made with sand-filled panels and containing a 15-inch woofer, together with a superstructure which houses an 8-inch mid-range cone unit and a 3-inch high-frequency cone unit. Normally these are used in the home with the smaller cones directed upward to give adequate diffusion in the room; in Carnegie Hall they were tilted forward so as to direct the sound toward the audience—a necessity, since they did not have the advantage of a low ceiling to aid in diffusion.

The program consisted of 18 numbers (19 were shown on the printed program, but the 16th was omitted on account of time). Different combinations of speakers were used as the material demanded—where the original source was small, such as a soloist, only one or two speakers were used; when the original source was large, all five were used at once.

The live-vs.-tape portions of the program were limited to five of the numbers, the remainder being simple demonstrations of selected records and—in two cases—recorded tapes.

The program opened with a record of a guitar solo, reproduced on two small speakers, and our reaction was that the sound was natural and in good balance—which would be expected from a single



Morton Gould conducting the Percussion Ensemble during the presentation of this group with tap dancer, Danny Daniels, at the right.

instrument. This was followed by a comparison between a tape and the two pianists playing Brahms' *Variations on a Theme by Haydn*. This, we felt, was reproduced at a lower level than the two artists played, with the result that the tape sounded thin and not as "round" as the live pianos. These were reproduced on two of the large speakers.

The next three numbers offered, in order: jazz, a soprano with orchestra, and a full symphony orchestra.

These numbers were followed by another live-vs.-tape selection with the two pianists in *African Echoes* (also available in Westminster WN-6014) in which some hanky-panky with the pianos resulted in most unusual music which was hardly distinguishable from the records.

After a record of Erica Morini playing *Chant Sans Paroles* from a record, we heard Soler's *Concerto for Two Organs*, with one part recorded and one part played live by E. Power Biggs. Purcell's *Trumpet Voluntary* followed, played comparatively by Biggs on the organ. In both of these numbers we felt that the speakers were not capable of handling the power level required for the organ, but aside from some rattle the quality was adequate.

Several other records were played, with varying acceptance. This observer thought that Debussy's *Afternoon of a Faun* (RCA Victor LM-1984) was one of the best heard during the evening, although disagreements have been heard from other listeners.

The differences in recording technique and the live performance were shown up most noticeably in the three original pieces by Morton Gould, who conducted the Percussion Ensemble in the comparison. This, we felt, was recorded with the microphone so positioned that while the

orchestra bells were most prominent in the live presentation, the xylophone was predominant in the recording. This is no criticism of the playing nor of the quality of the recording, but only of the microphone placement during the recording.

The outstanding part of the program was, to this observer, the demonstration of the tap dancer with the Percussion Ensemble under the masterful direction of Mr. Gould. Here we heard the reproduction of the previously recorded tape with the tap dancer along with the same percussion group, but the effect of the interchange between orchestra and dancer and the recording—all of it under the very definite control of Mr. Gould—was striking. The conductor demonstrated how thoroughly he was in control of the entire performance, making the transitions between tape and live with ease and efficiency.

We then heard two more records, the last being the *Hallelujah Chorus* of Handel. Again we felt that there was not enough amplifier power or power-handling ability in the speakers for the high levels of this sort of material. But it was still good.

So on the whole we enjoyed the evening. We feel that we have learned more about the performance of home equipment in a critical environment and to a critical audience. And we came away with a good feeling, because those of us who live in this business always have the feeling that we do a fairly good job of reproducing music, and we would say that Mr. Briggs did a most creditable job of presenting sound equipment under difficult conditions and still came out with at least a B for performance and certainly with an E for effort.

—C. G. McP.

Fine High-Fidelity is for you too . . .



You can enjoy savings without sacrificing quality—if you “build-it-yourself” and eliminate labor charges; and if you buy direct from the manufacturer and eliminate extra profit.



MODEL BC-1

Here's what you get:

High-fidelity amplifiers, tuners, and speakers that you assemble yourself, from the step-by-step instructions furnished. You get, top-quality parts at lower cost through Heath mass purchasing power. You get the equivalent of systems costing approximately twice the Heathkit price.

MATCHING CABINETS

The Heathkit AM tuner, FM tuner, and preamplifier kits may be stacked one on the other to form a compact “master control” for your hi-fi system.

BC-1
FM-3A
WA-P2



MODEL WA-P2



MODEL W-5M

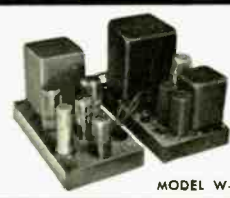

MODEL W-3M



MODEL FM-3A

HERE'S WHY A Heathkit[®] IS FUN TO BUILD:

Instructions are *complete*, and our amazing step-by-step method, tied-in with large pictorial illustrations, guide the beginner through each stage of assembly. If you can follow directions you can succeed, and can build high-fidelity equipment you will be proud to show off to your family and friends.



Here's the proof:

Thousands of Heathkits have been built at home by people just like yourself, and you should treat yourself to this same experience by dealing with the world's largest manufacturer of top-quality electronic kits for home and industry.

Heathkit Model FM-3A High Fidelity FM Tuner Kit

Features A.G.C., and stabilized, temperature-compensated oscillator. Ten uv sensitivity for 20 DB of quieting. Covers standard FM band from 88 to 108 mc. Ratio detector for efficient hi-fi performance. Power supply built in. Illuminated slide rule dial. Pre-aligned coils and front end tuning unit.

\$26⁹⁵*

(With Cabinet)
Shpg. Wt. 7 Lbs.

Heathkit Model BC-1 Broadband AM Tuner Kit

Special AM tuner circuit features broad band width, high sensitivity and good selectivity. Employs special detector for minimum signal distortion. Covers 550 to 1600 kc. RF and IF coils pre-aligned. Power supply is built in.

\$26⁹⁵*

(With Cabinet)
Shpg. Wt. 8 Lbs.

Heathkit Model WA-P2 High Fidelity Preamplifier Kit

Provides 5 inputs, each with individual level controls. Tone controls provide 18 DB boost and 12 DB cut at 50 CPS and 15 DB boost and 20 DB cut at 15,000 CPS. Features four-position turnover and roll-off controls. Derives operating power from the main amplifier, requiring only 6.3 VAC at 1 a. and 300 VDC at 10 ma.

\$21⁷⁵*

(With Cabinet)
Shpg. Wt. 7 Lbs.

Heathkit Model W-5M Advanced-Design High Fidelity Amplifier Kit

This 25-watt unit is our finest high-fidelity amplifier. Employs KT-66 output tubes and a Peerless output transformer. Frequency response \pm 1 DB from 5 to 160,000 CPS at one watt. Harmonic distortion less than 1% at 25 watts, and 1M distortion less than 1% at 20 watts. Hum and noise are 99 DB below 25 watts. Output impedance is 4, 8 or 16 ohms. Must be heard to be fully appreciated.

\$59⁷⁵

Shpg. Wt. 31 Lbs.
Express Only

MODEL W-5: Consists of Model W-5M above plus Model WA-P2 preamplifier. Shpg. Wt. 38 Lbs. **\$81.50*** Express only

Heathkit Model W-3M Dual-Chassis High Fidelity Amplifier Kit

This 20-watt Williamson Type amplifier employs the famous Acrosound Model TO-300 "ultra linear" output transformer and uses 5881 output tubes. Two-chassis construction provides additional flexibility in mounting. Frequency response is \pm 1 DB from 6 CPS to 150 kc at 1 watt. Harmonic distortion only 1% at 21 watts, and 1M distortion only 1.3% at 20 watts. Output impedance is 4, 8 or 16 ohms. Hum and noise are 88 DB below 20 watts.

\$49⁷⁵

Shpg. Wt. 29 Lbs.
Express only

MODEL W-3: Consists of Model W-3M above plus Model WA-P2 preamplifier. Shpg. Wt. 37 Lbs. **\$71.50*** Express only

HEATHKIT SPEAKER SYSTEM KITS

These speaker systems are a very vocal demonstration of what can be done with high-quality speakers in enclosures that are designed especially to receive them. Notice, too, that these two enclosures are designed to work together, as your high-fidelity system expands.

Heathkit Model SS-1 High Fidelity Speaker System Kit

Employing two Jensen speakers, the Model SS-1 covers 50 to 12,000 CPS within \pm 5 DB. It can fulfill your present needs, and still provide for future expansion through use of the SS-1B. Cross-over frequency is 1600 CPS and the system is rated at 25 watts. Impedance is 16 ohms. Cabinet is a ducted-port bass-reflex type, and is most attractively styled. Kit includes all components, pre-cut and pre-drilled, for assembly. **\$39⁹⁵** Shpg. Wt. 30 Lbs.



Heathkit Model SS-1B Range Extending Speaker System Kit

This range extending unit uses a 15" woofer and a super-tweeter to cover 35 to 600 CPS and 4000 to 16,000 CPS. Used with the Model SS-1, it completes the audio spectrum for combined coverage of 35 to 16,000 CPS within \pm 5 DB. Made of top-quality furniture-grade plywood. All parts are pre-cut and pre-drilled, ready for assembly and the finish of your choice. Components for cross-over circuit included with kit. Power rating is 35 watts, impedance is 16 ohms. **\$99⁹⁵** Shpg. Wt. 80 Lbs.

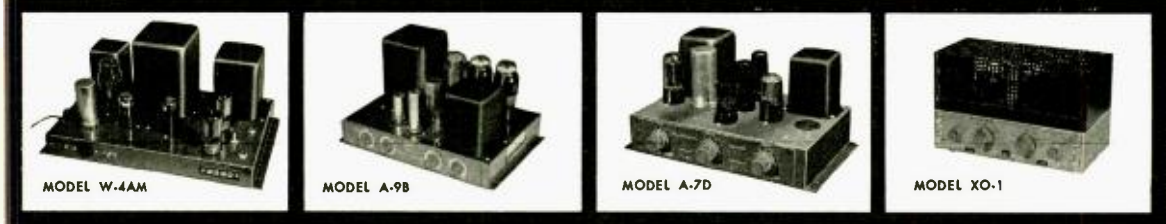

Heathkit Model W-4AM Single-Chassis High Fidelity Amplifier Kit

The 20-watt Model W-4AM Williamson type amplifier combines high performance with economy. Employs special-design output transformer by Chicago Standard, and 5881 output tubes. Frequency response is \pm 1 DB from 10 CPS to 100 kc at 1 watt. Harmonic distortion only 1.5%, and 1M distortion only 2.7% at this same level. Output impedance 4, 8 or 16 ohms. Hum and noise 95 DB below 20 watts.

\$39⁷⁵

Shpg. Wt. 28 Lbs.

MODEL W-4A: Consists of Model W-4AM above plus Model WA-P2 preamplifier. Shpg. Wt. 35 Lbs. **\$61.50*** Express only

Heathkit Model A-9B 20-Watt High Fidelity Amplifier Kit

Features full 20 watt output using push-pull 6L6 tubes. Built-in pre-amplifier provides four separate bass and treble tone controls provided, and output transformer is tapped at 4, 8, 16 and 500 ohms. Designed for home use, but also fine for public address work. Response is \pm 1 DB from 20 to 20,000 CPS. Harmonic distortion less than 1% at 3 DB below rated output.

\$35⁵⁰

Shpg. Wt. 23 Lbs.

Heathkit Model A-7D 7-Watt High Fidelity Amplifier Kit

Qualifies for high-fidelity even though more limited in power than other Heathkit models. Frequency response is \pm 1 1/2 DB from 20 to 20,000 CPS. Push-pull output, and separate bass and treble tone controls.

\$18⁶⁵*

Shpg. Wt. 10 Lbs.

MODEL A-7E: Same, except that a 12SL7 permits preamplification, two inputs, RIAA compensation, and extra gain. **\$20.35*** Shpg. Wt. 10 Lbs.

Heathkit Model XO-1 Electronic Cross-Over Kit

Separates high and low frequencies electronically, so they may be fed to separate amplifiers and separate speakers. Selectable cross-over frequencies are 100, 200, 400, 700, 1200, 2000, and 35,000 CPS. Separate level control for high and low frequency channels. Minimizes inter-modulation distortion. Attenuation is 12 DB per octave. Handles unlimited power.

\$18⁹⁵

Shpg. Wt. 6 Lbs.

*Price includes 10% Fed. Excise tax where applicable.

HOW TO ORDER:

It's simple—just identify the kit you desire by its model number and send your order to the address listed below. Or, if you would rather budget your purchase, send for details of the HEATH TIME-PAYMENT PLAN!



HEATH COMPANY

A Subsidiary of Daystrom, Inc.

BENTON HARBOR 25 MICHIGAN



HEATH COMPANY A Subsidiary of Daystrom, Inc.

BENTON HARBOR 25 MICHIGAN

Please send Free HEATHKIT catalog.

Name _____

Address _____

City & Zone _____ State _____

Equipment Report

General Electric Model XA1-320 20-watt amplifier and preamplifier, the "Convertible"—General Apparatus Company's "Van Amp" electronic crossover network—Observations on loudspeaker systems.

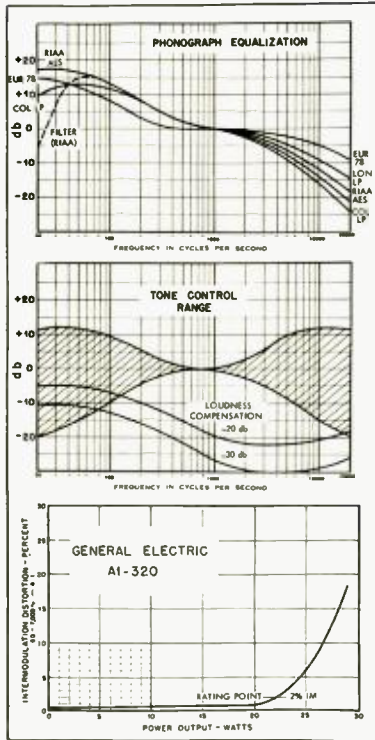

Fig. 1. Performance curves for the XA1-320 "convertible" amplifier.



Fig. 2. General Electric Model XA1-320 in metal "table-top" housing.

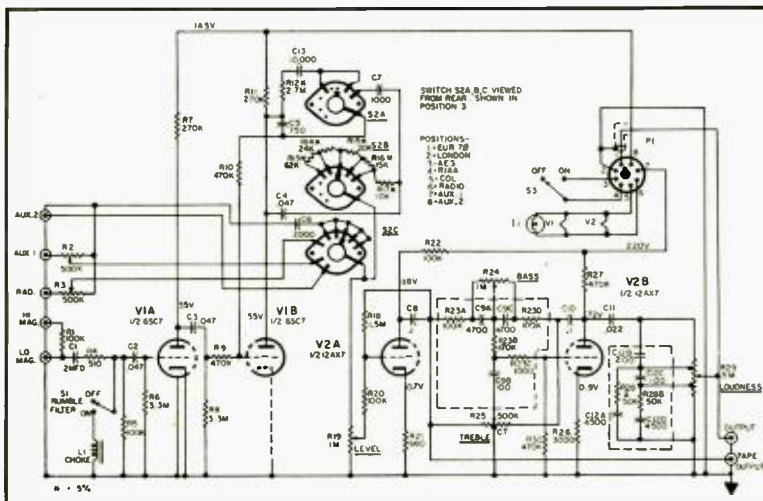

Fig. 3. Schematic of the preamp section of the XA1-320 amplifier.

PROVIDING IN ONE instrument the advantages of a single-unit amplifier in which the preamp and the power amplifier are combined and the advantages of a preamp which may be mounted in one place and a main amplifier which may be located in another, the General Electric Model XA1-320 deserves considerable attention. And while this "Convertible" may not have wheels in the accepted sense, it rolls through its paces on the test bench with flying colors.

Considering first the mechanical features, the amplifier is normally housed in a metal case 15 in. wide, 13 1/4 in. deep over the knobs, and 5 5/8 in. high, and is designed for horizontal mounting when used in the case—in fact, the instructions specifically state that the unit must be used in a horizontal position. When it is desired to mount the amplifier in an equipment cabinet, it may be removed from the case and placed on a sturdy shelf with the knob shafts projecting through the panel, transferring the escutcheon plate to the cabinet. Because of the heat of the output tubes and the rectifier, the amplifier must be

mounted horizontally when used in this fashion.

However, by separating the preamp and the power amplifier, the former may be mounted with the panel up, if desired—a position favored when the installation is made in an end table, for instance. The power amplifier may then be mounted at a short distance from the preamp, using an accessory connecting cable between the two units. This observer has long wondered why both sides of the escutcheon panel could not be finished with two separate patterns—one for the customary horizontal mounting of the unit, and another for mounting with the long dimension vertical, so as to be read from one of the short ends rather than from the long side. However, it is of some advantage to be able to mount the preamp with the panel in a horizontal plane, and users can arrange the mounting so that the escutcheon labeling is not inconvenient.

As seen in Fig. 2, the amplifier is fitted with five major controls and two small knobs controlling switches—the one at the left being the rumble filter, while that at the right is the power switch. From left to right the controls are: selector switch, level control, loudness control, bass tone control, and treble tone control. Below the spaces to the right and left of the loudness control will be seen two small holes—these are screwdriver-actuated level-set controls for the RADIO and AUX I inputs.

The selector switch has eight positions: the first five are phono, with equalizations for EUR 78, LONDON LP, old AES, RIAA (marked "STD" and framed in a white sector), RADIO, AUX I, and AUX II. As seen in Fig. 3, LEVEL control is a "flat" volume control ahead of the tone-control amplifier tube; the LOUDNESS control follows the entire preamp; BASS and TREBLE tone controls employ the preferred Baxandall arrangement, using a "bullplate" with all of the compensating capacitors and resistors in a single unit. A similar bullplate is used with the loudness control. The rumble filter functions only with the phonograph input, and cuts response drastically below about 40 cps so as to remove any trace of rumble from faulty record players.

The preamplifier section consists of a single 6SC7 with frequency-selective feedback around the second stage to provide the low-frequency boost required for the various curves, and a variable series resistor followed by a shunt capacitor for the rolloffs. The tone-control amplifier employs feedback around the first stage, with the control elements connected between the output of the second stage and the plate circuit of the first. A tape output jack connects to the output of the first stage of the tone-control section, and the recorder is thus fed from ahead of the tone controls, although its signal output is con-

For HIM for HER for you

**GENERAL ELECTRIC HI-FI MEANS
ENDURING MUSICAL ENJOYMENT!**



**G-E
GOLDEN CO-AX
12-inch
Dual Coaxial
Loudspeaker**

Combines a 12-inch woofer, a 2 $\frac{3}{4}$ -inch tweeter, and built-in electrical-mechanical crossover system. Handles 25 watts of power. Distortion free response—40 to 15,000 cycles... **\$44⁹⁵**



**G-E CONVERTIBLE
20-watt Amplifier and Pre-Amp**

Dual chassis design for independent installation or use as a complete unit. This flexible, low-cost component provides 7 panel-mounted controls. **\$99⁹⁵**



Loveliest of all—the gift of great music through the years. Awakened for you now in new splendor by the magic wand of General Electric Hi-Fi. Here are components for a lifetime of superb musical enjoyment. Ideal for anyone who appreciates the finest.

The incomparable General Electric cartridge puts new brilliance in your favorite recordings at modest cost. Ranging upward, you'll find General Electric speakers, the sensational 20-watt Amplifier and Pre-Amp, and other superb components each adding in its unsurpassed way to a quality of reproduction famous in professional circles. Fortunately, all General Electric components are sensibly priced. Examine them at your local dealer's, or write today for our free booklet of new Hi-Fi ideas. *General Electric Company, Special Products Department, Section R44116, Electronics Park, Syracuse, New York.*

Progress Is Our Most Important Product

GENERAL  ELECTRIC

trolled by the LEVEL control. However, in normal operation it is likely that the user would employ the LOUDNESS control to adjust listening level, leaving the LEVEL control fixed. Performance of the preamp section is shown in the two upper sections of Fig. 1. Careful check of the phono curves with the standard values will show that they are quite accurate in comparison with many such units, and the effect of the rumble filter—shown as it would appear with the RIAA curve—is sufficiently sharp as to be very effective, yet without much audible effect upon any but the best loud-speaker systems.

Tone controls are smooth in operation, and designed with a relatively wide flat portion in the center so it is not necessary to be exact in centering the controls when "flat" response is desired. The effect of the loudness control is shown at 20 and 30 db down from maximum, with close approximation to the Fletcher-Munson curves. Subjectively, the control "sounds" satisfactory.

Power Amplifier Section

The power amplifier, Fig. 4, is essentially a Williamson type in the first three stages, but uses the 6L6GB output tubes as pentodes, with 400 volts on the plates and 290 on the screens. The d.c. feed to the preamp section is especially well filtered, with one resistance-capacitance network ahead of the 220-volt feed to the tone-control amplifier, and a second RC network for the 145-volt feed to the phono preamp stages. Outputs of 4, 8, and 16 ohms are provided, being accessible on a terminal strip on the bottom of the amplifier unit. Two a.c. receptacles are located on the power amplifier chassis, one being controlled by the power switch, the other remaining on all the time. Only the amplifier itself is fused—a desirable practice, since the fuse may thus be chosen closer to the amplifier's requirements than if it had to accommodate any unspecified additional equipment that might be plugged into the accessory receptacles.

Performance of the output amplifier is better than the specifications, since it is

rated at 2.4 per cent IM distortion at 20 watts, while our measurements show it to be 2 per cent at 22 watts—the 2-per-cent point being that at which AUDIO rates amplifiers.

Signal Voltages

With LEVEL and LOUDNESS controls at maximum and both tone controls in the flat position, a signal of .048 volts is required at the RADIO and AUX jacks for the usual 1-watt output, which is considered by AUDIO as the normal average level likely to be used by the listener for the average living room. At the LO MAG input, a signal of 2.6 mv is required for the same output, and at HI MAG the required signal is 6.5 mv. Under average playing conditions, levels from both radio and phono are likely to be considerably higher than these minimums, so hum-and-noise measurements are made with phono inputs of 30 mv and with radio inputs of 0.5 volts, and with loudness control set for a 1-watt output. On phono, the measured hum and noise was 57 db below rated output, on radio, 68 db. While these figures are not especially low—being 32 and 43 db, respectively, below 1 volt, they are at least realistic and, in our opinion, all hum-and-noise figures should be stated in "db below 1 volt" or below some other standard, rather than "db below rated output," since this gives a statistical advantage to the higher powered amplifiers; inasmuch as the user is not likely to run his system at any higher level with a 50-watt amplifier than he is with a 10-watt unit—in the same room, of course—the higher figure for the 50-watt amplifier may appear to be in its favor. However, this amplifier does not have noticeable hum or noise in its output, so most of the foregoing discussion is largely academic.

On the whole, this amplifier performs quite satisfactorily, provides sufficient flexibility for almost any record equalization requirements, provided the user is willing to employ the tone controls to accommodate any unusual characteristics, and has sufficient power output to ensure comfortable listening levels.

The following Berlant-Concertone distributors invite you to visit their store to see the new TRIPLE PLAY RECORDERS and/or get your free \$50.00 tape library or Concertone Custom Microphone for \$20.00 with purchase of any Berlant-Concertone recorder.

- AKRON**
Audio Hall
326 W. Bowers St.
Olson Radio Warehouse Inc.
733 E. Mill Street
- ALBUQUERQUE**
Hi Fi Equipment Inc.
816 San Mateo S.E.
Sound Engineering & Equipment Co.
3011 Monte Vista, N.E.
- BEVERLY HILLS**
Crafts of Beverly Hills
485 N. Rodeo Drive
- BINGHAMPTON**
Morris Distributor Co.
1101 Center Street
- BROADVIEW, ILLINOIS**
Hi-Fi Unlimited
1305 Roosevelt Road
- BUFFALO**
Buffalo Audio Center
Arrowhite Co. Inc.
1501 Genesee Street
- CANTON, OHIO**
Burrough's Radio, Inc.
2705 Fulton Road
The Camera Center
431 Cleveland Ave., N.W.
- CENTRAL CITY, NEBR.**
Sampson Electronics
102 S. 2nd Street
- CHICAGO**
Allied Radio Corporation
111 N. Campbell
Continental Corporation
3239 W. North
Electronic Exeditors, Inc.
294 W. Devon
Newark Electric Company
223 West Madison Ave.
Voice & Vision
5201 W. Walton Place
- CINCINNATI**
Customcrafters Audio Inc.
2259 Gilbert Avenue
Schilder's Inc.
433 Walnut Street
- CLEVELAND**
Dyna Radio Co.
2915 Prospect Ave.
National Manufacturing Co.
1006 Hamilton Ave.
The Progress Radio Supply Co.
413-415 Huron Rd.
Shaffer Music Company
849 North High Street
- DAYTON**
Custom Electronics Inc.
1000 South Main St.
- DENVER**
Electric Accessories
Stier and Frank Co.
1201 20th Street
- DETROIT**
Haro Distributing Co.
9730 Birmele
K. A. Laboratories, Inc.
737 Woodward Ave.
Tohys Hobby Inc.
1730 Woodward Ave.
- EAST CHICAGO, IND.**
J. N. E. Television
2013 Broadway
- HEMPSTEAD, L. I.**
Island Audio & Hi Fi Center, Inc.
441 Fulton Avenue
Newark & Lewis
43 Main Street
- HOLLYWOOD, CALIF.**
Hollywood Electronics
7460 Melrose Ave.
Magnetic Recorders
7115 Melrose Ave.
Pacific Hi-Fi House
1320 Caluenga Blvd.
- HOUSTON**
Busaker Electronic Equipment Co., Inc.
1216 West Clay
- LAFAYETTE, INDIANA**
Lafayette Radios
408 North Street
- LAKESIDE, OHIO**
Music Unlimited
13410 Detroit Ave.
- LAS VEGAS**
Neveba Book & Sound
300 E. Charleston
Radio and Sound Supply Co.
25 E. California St.
- LONG BEACH, CALIF.**
Dunkey Electronics
343 East Market Street
Scott Radio Supply Inc.
2166 Alameda Avenue
- LOS ANGELES**
Beverly Hi-Fi
498 So. Robertson Blvd.
Buchheit Electronics
12028 Wilshire
Gateway to Music
30895 Wilshire Blvd.
Blissway Electronics
2817 Crenshaw Blvd.
L. A. Portable Recorders
521 N. La Clemea Blvd.
Sound Unlimited
6320 Commodore Sloat Dr.
- MIAMI**
Hi-Fi Encaseler
3888 Biscayne Blvd
- MILWAUKEE**
Hi-Fi House, Inc.
24336 N. Dowmar Street
Photostat Visual Service
840 No. Plankinton Ave.
- Wark Sales
3131 W. North Avenue
- MINNEAPOLIS**
Electronic Industries, Inc.
2451 Hennepin Avenue
Paul Schmitt Music Co.
68 South Teuth Street
- NEWARK**
Hi-Fi Radio & Television Corp.
35 William Street
- NEW YORK**
Atrex Radio Corporation
64 Cortlandt St.
Audio Unlimited, Inc.
119 East 59th Street
Goody Audio Center, Inc.
235 W. 49th St.
250 W. 49th St.
Grand Central Radio
1224 East 44th Street
Halls & Balet
65 Cortlandt Street
Hudson Radio & Television Corp.
48 W. 48th Street
212 Fulton Street
1 Hunt Audio Signs
450 Madison Ave.
Peerless Camera Stores
138 East 44th Street
Radio Wire Television Inc.
100 Sixth Avenue
Recording Wire & Tape Co.
163 East 87 Street
Southern Corporation
115 West 45th Street
Sun Radio & Electronics
190 Madison Ave.
- 50 W. 20th Street**
Terminal Radio Corp.
85 Cortlandt Street
- ONTARIO, CALIFORNIA**
Raul Book—The Original
Hi-Fi Shop
604 S. Euclid
- PALMDALE**
Audio Associates
689 So. Fair Oaks
Dyna Radio Co.
1759 E. Colorado
High Fidelity House
536 So. Fair Oaks
- PHOENIX**
Audio Specialties
333 E. Camelback Road
- PITTSBURGH, PENNA.**
Pittsburgh Radio, Inc.
642 Grant St.
M. N. Mansfield Co.
637 Liberty Avenue
Radio Parts, Inc.
6339 Penn Ave.
- PORTLAND, OREGON**
Stier and Frank Co.
Sandy's Camera Stores
714 S.W. Washington St.
- RED HOOK, NEW YORK**
10 South Broadway
- RIVERSIDE, CALIF.**
Custom Music
341 Main Street
- SACRAMENTO**
Hi-Fi Sound Supply
1910 E. 18th Street
- ST. LOUIS, MO.**
Van Sickle Radio
113 Time Street
- SALT LAKE CITY**
Sound by Craftsmen
378 South 4th East
- SAN DIEGO**
Hofner Sound
3781 Fifth Street
Recording Center
1342 S. 5th Avenue
Wright's House of Hi-Fi
5140 El Canon Blvd.
- SAN FRANCISCO**
San Francisco Radio & Supply Co.
1280-84 Market Street
- SAN MARINO, CALIF.**
E. O. Bulky Co.
2543 Mission St.
- SAN PEDRO**
Bower's Music
810 So. Gaffey
- SANTA BARBARA**
Pacific Audio Supply
29150 La Vina Street
- SEATTLE**
Tall
1415 Third Ave.
Seattle Radio Supply Inc.
2117 2nd Avenue
- STOCKTON, CALIF.**
Quality Sound Service
1217 North Wilson Way
- TOLEDO**
Josephs High Fidelity
840 W. Central Ave.
Torrance Radio, Inc.
1314 Madison Avenue
- TOPEKA, KANSAS**
Piata Television
140 S. Houston
- TUCSON**
Art Electronic Supply Co., Inc.
145 South Park Ave.
- VAN NUYS**
Valley Electronic Supply Co.
13417 Sherman Way
- YONKERS**
Westlab
2475 Central Park Ave.

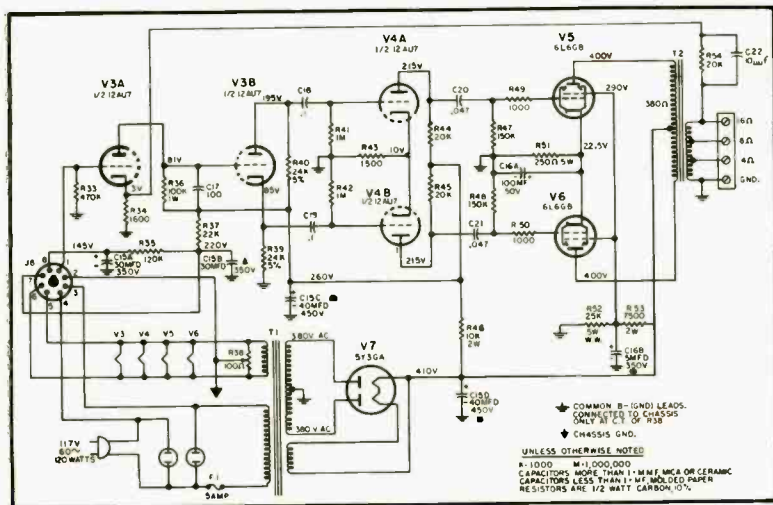
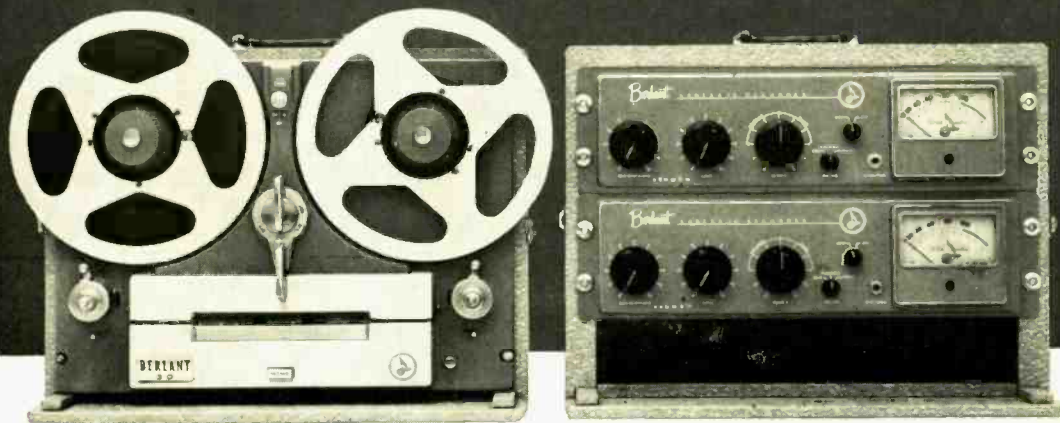

Fig. 4. Schematic of the power amplifier section.

Now! **ONE** *Berlant-Concertone Recorder*
does the work of **THREE**



The 36ST Berlant Deluxe Recorder is ideal for radio station use. Delivers performance characteristics for the most exacting quality use. Hysteresis synchronous drive model - (99.8% timing accuracy). Frequency response 40 to 15,000 cps at 15 ips \pm 2db. Save the cost of a second recorder plus savings in space, operator time and tape. Perfect for the station planning stereo tape broadcasts on AM and FM simultaneously.

For the Advanced Audiophile

the Concertone Custom Recorders answer recording and playing needs for years to come. Full professional features include use of 10½ reels, editing and cueing, 4½ signal level meter, 3 motors, monitoring from tape while recording, 2 channel input mixer.

Take Time to Pay...

Terms to meet your budget on all models. (Model 22) As low as \$49.50 down, \$7.50 per week, 24 months to pay.

**THIS NEW STEREO TRIPLE PLAY HEAD DOES IT—
Plays Full Track, Half Track, Stereo**

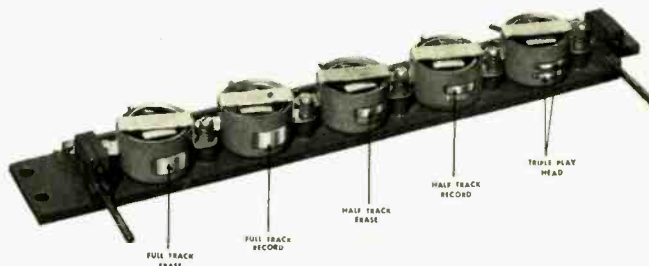

Head Compliment Model 265T and Model 365T. Another exclusive development of the superb engineering laboratories of American Electronics—America's foremost manufacturer of electronics for military, home and industrial use.

**TWO SPECIAL OFFERS
FEATURED NOW
BY YOUR
BERLANT-CONCERTONE
DISTRIBUTOR**

1. **FREE**—\$50.00 worth of recorded tape with the purchase of any B-C recorder.
2. **SAVE**—\$73.50 on a new \$93.50 Concertone Custom Microphone.

Offers limited and may be withdrawn without notice. See your Berlant-Concertone distributor today for your **FREE** tape library or for the microphone savings... featured at the dealer stores listed on opposite page. Write for new 6-page brochure No. 18-N.

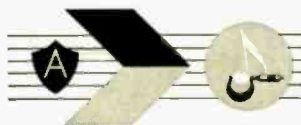

Audio Division,
AMERICAN ELECTRONICS, INC.
655 West Washington Blvd.
Los Angeles 15, California

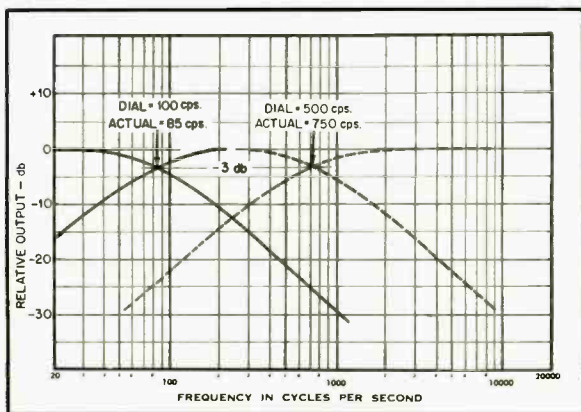

Fig. 5. Typical response curves on the Van-Amp, made at two frequencies.

VAN-AMP ELECTRONIC DIVIDING NETWORK

Considerable interest has been shown in the past year or so in the use of electronic crossover networks preceding two separate power amplifiers—one for the low-frequency speaker and one for the tweeter. Some articles have appeared in these pages in the past months describing such equipment, and at least one kit has been shown for several months.

Another product which is available either as a kit or as a finished unit is the Van-Amp, a small separate chassis, self powered, which may be employed between a preamplifier-control unit and two power amplifiers. By this means, the low driving

impedance of the two individual amplifiers is "seen" by the two loudspeakers, with whatever attendant advantages may be gained by such direct drive of the speakers without any intervening networks of the conventional type. Furthermore, with the electronic crossover it is possible to change the frequency of crossover at will, within the limits of the device, allowing the user to adjust this frequency to obtain the most satisfactory performance from the two speakers used in his system.

To be correct, a system of this type should offer curves that are inversely symmetrical, as shown in Fig. 5, which shows measured response for two settings of the frequency control. When set at 100 cps,

the actual crossover was 85 cps; when set at 500 cps, the crossover was 750. This is of no importance, however, since the curves are of the proper shape in either case. To make measurements of this type it is necessary to adjust the "flat" portion of the curves to the same level; then the point where each is down 3 db is the crossover frequency, since each speaker is delivering one half of the power, and the two together are delivering full power, resulting in a curve which is flat throughout.

The Van-Amp consists essentially of a voltage amplifier which drives two cathode followers with intervening volume controls, and the outputs of the two cathode followers are fed through RC filters—the one in the low-frequency circuit consisting of two series resistors and two shunt capacitors, while that in the high-frequency circuit consists of two series capacitors and two shunt resistors. The resistors are the variable elements, and all four are gauged together.

The lowest frequency reached by the unit tested was 69 cps, which corresponded to a dial indication of 90 cps; the highest was 1200, corresponding to a dial indication of 1100. But throughout the band, the curves were uniform and followed the desired shape. Since the two sections of each filter are composed of different RC ratios, the slope of the curves above and below crossover is adjusted to approximately 8 db per octave.

When supplied in kit form, the constructor assembles the potentiometers from standard IRC multisection controls, with linear tapers being used in each case. For accuracy in crossover frequency and in complete symmetry of the curves it is necessary that the capacitors be held to a tolerance of, say, 2 per cent.

Measured distortion at 400 and 4000 cps (above and below the crossover point) is less than 0.5 per cent at any normal signal level. The unit has some residual gain, since with the output controls set to maximum a signal of 0.2 volts at the input gave an output on the low channel of 1.52 volts and on the high channel of 1.73 volts. Thus the preamp may be used at a very low output signal, making up the additional gain necessary in the Van-Amp—a practice which might well result in a reduction in the over-all hum level at the speakers. Power consumption at 117 volts a.c. was measured at 8 watts.

The ability to change crossover frequency and to adjust the levels of the two channels independently has many advantages provided the user exercises some caution in making the adjustments. It is, for example, possible to make a "shelf" setting wherein the level is constant up to the crossover frequency and several db higher or lower above that point. This would result in an apparent imbalance in the response from the speaker system. It would seem to this observer that the two level-adjusting controls might better be of the screwdriver-set type, and fitted with locking nuts to resist unwanted tampering once the correct adjustment was made. However, in the hands of an intelligent user who knows what he wants and is able to recognize it when he hears it, the Van-Amp would certainly offer considerable flexibility.

V-25

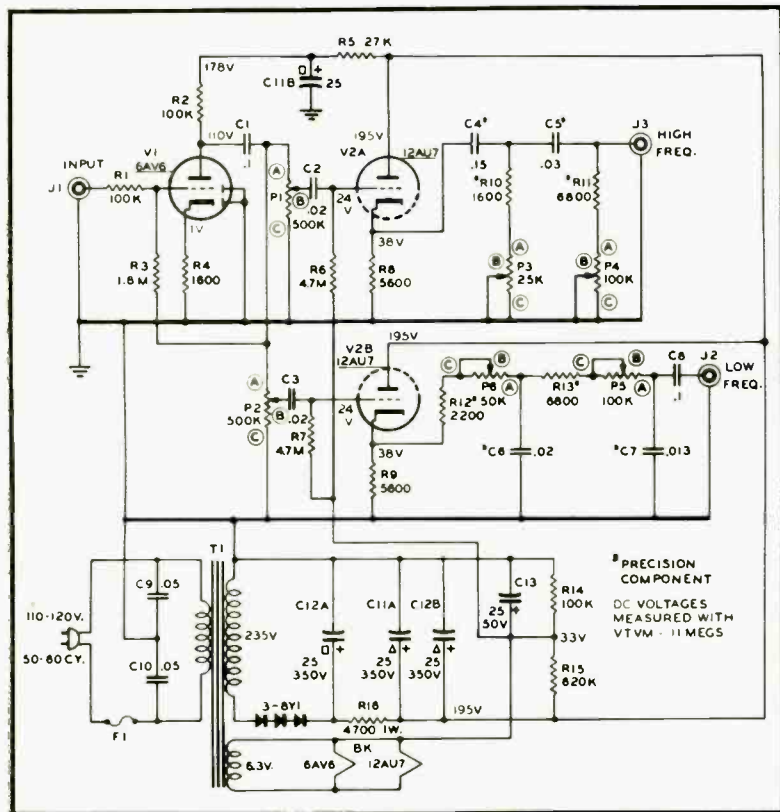

Fig. 6. Complete schematic of the Van-Amp electronic crossover unit.

NOW...

ASSEMBLE YOUR OWN CONVERTIBLE GOODMANS friction loaded LOUDSPEAKER SYSTEM

New, prefabricated

ARU ENCLOSURE KITS

can be started as a
single channel system
and converted to 2-way and 3-way
without modification



Recent articles in technical and hobby magazines have extolled the performance of Goodmans loudspeakers in friction-loaded enclosures. The advantages discussed are now all available in the new friction-loaded ARU Enclosures: small size—bass response to 20 cycles—elimination of peaks—effective loading to zero cycles. The quality of sound obtainable with Goodmans speakers in these new ARU Enclosures is absolutely superb—comparable to the most costly systems available today.

One of the most desirable, practical features of these enclosures is the ease with which a modest single-channel system can be built up to a 2-way and 3-way system without modification. For example: the Model B-1200 ARU Enclosure is designed for use with a 12-inch Goodmans full range Axiom 22, Axiom 150 or Axiom 100 as a single-channel system. The front panel is also pre-cut to accept the Goodmans Midax and Trebax, mid-range and high frequency pressure-type reproducers—these openings being covered with temporary, easily removable panel blocks.

By simply mounting and connecting a Trebax and 5000-cycle crossover unit, you

convert your full-range Axiom system into a 2-way with frequency response extended to 20,000 cycles. Then, by adding a Midax and 750-cycle crossover unit, this 2-way converts into a Goodmans 3-way system. In this instance, the 12-inch Axiom may be replaced with a 12-inch Goodmans Audiom 60 or 70 woofer, if desired. ARU Enclosures are also available for use with the 15-inch Audiom 80 and 18-inch Audiom 90 woofers in 2-way and 3-way systems.

Another type of ARU Enclosure is designed to use 8-inch Goodmans Axiote speakers as tweeters with Audiom woofers. Three special ARU Enclosures have also been developed for use with one, two or four of the famous Axiom 80 'free suspension' speakers as wide-range single-channel systems exclusively.

Each ARU Enclosure Kit is complete in every detail: supplied with selected 3/4-inch, birch-faced plywood, cut to fit and sanded smooth for finishing, all screw-holes pre-drilled—plus grille cloth, acoustical damping material, glue, hardware, instructions and the ever-important ARU Acoustical Resistance Unit. Only a screw-driver is needed to assemble this kit.



AXIOM



AUDIOM



MIDAX



TREBAX

ARU ENCLOSURE KIT prices range from \$59.25 to \$79.30 less speakers and crossover units.
prices slightly higher west of Rockies



For complete details, see your hi-fi dealer or write Dept. VL-1
ROCKBAR CORPORATION 650 Halstead Avenue, Mamaroneck, N.Y.

In Canada: A. C. Simmonds and Sons, Ltd., Toronto, Ontario





HUDSON offers
exciting listening at
savings to you

SPEAKER SPECIAL



ELECTROVOICE SP12B
Radax Twelve 12-inch Coaxial
Speaker. Response: 10-13,000
cps. RETMA Sensitivity Rating
46.5 db. Resonance 40-50 cps.
Program material capacity 20
watts, peak 40 watts. Critical
Damping Factor in Aristocrat
enclosure 4, in an infinite baffle
2.5. Impedance 16 ohms. Me-
chanical crossover 3500 cps.
1-lb. magnet. Size: 12 1/4-inch
diameter x 6-inch overall depth.
Baffle opening 10 3/4-inch.

**SEEBURG S35 ULTRA HIGH FRE-
QUENCY DRIVER.** Response 3500 cps
to beyond range of audibility. Impedance
16 ohms. Polar pattern dispersion 180.
RETMA Sensitivity Rating 56 db. Diffraction
horn cutoff 1500 cps. 6.8 oz. magnet.
Horn size 4 1/2" x 1 1/4". Pot size:
2 5/16" diam. x 3 1/4" deep. Included
with driver are the SEEBURG DIVIDING
NETWORK and BALANCE CONTROL.



**ELECTROVOICE KD6 ARIS-
TOCRAT KIT.** Folded-horn
corner enclosure designed for
12-in. speakers and separate 2-
and 3-way systems. For use
with Electro-Voice SP12 or
SP12B coaxial speakers,
12TRX or 12TRXB triaxial re-
producers, and 108, 111 2-way
and 108A, 111A 3-way systems.
Smooth reproduction down to
35 cps, with remarkable purity
and efficiency. Finished size:
29 3/4 in. high, 19 in. wide, 15 3/4
in. deep.

These components make up the
famous Electrovoice 12 TRXB
speaker system.—A \$112 value—

at HUDSON only \$79⁹⁵

37 W. 65th St., N. Y. C. 7, N. Y.

- Please send me your new High Fidelity Catalogue
 Please send me your new Record Catalogue

NAME _____

ADDRESS _____

CITY _____

STATE _____

YOU'RE THE ONLY ONE...

who can select the proper high fidelity system for you. Our job is to present all of the many combinations available, discuss their strong points and their weak points, make it as easy as possible for you to select your own personal high fidelity system,— and see that you get the best value for your money.

HUDSON'S 3 audio showrooms are ideal for browsing, so come on in, relax in one of the easy chairs, and listen to HI-FI at its best.

illustrated below is a typical HUDSON
CERTIFIED high fidelity system



HARMON KARDON "SOLO" TA 10.
A complete high fidelity system in one chassis, the "SOLO" is an extremely sensitive AM-FM tuner AND a 10 watt amplifier. RF section features an Armstrong circuit with Limiter, and Foster-Seely Discriminator. Frequency Range: FM, 88-108 MC; AM 530-1650KC. Frequency Response: FM, $\pm 1/2$ db 20-20,000 cps (including standard 75 micro-second deemphasis); AM, 3 db 20-5,000 cps. Audio section Frequency Response: ± 1 db 20-20,000 cps at 5 watts, ± 1 db 30-10,000 cps at 10 watts. Has 9 controls, a total of 12 tubes. Control panel is copper, case and knobs are matte black.



GARRARD RC98 "CROWN II" 3-speed super-auto-manual record changer featuring full automatic and manual operation. An outstanding feature, continuous + or - variable control on all 3 speeds with which the RC98 can be "tuned" to match a musical instrument, or for perfect pitch. Entirely new 4-pole shaded-pole motor. "Simpli-Mix" permits 12, 10 & 7" records to be mixed and played at one time. Pusher platform. True-Turret drive.

ELECTROVOICE 12TRXB.
12" speaker with Radax principle and 2000 cps first cross-over for exceptional bass and mid-range response. 3500 cps built-in electrical cross-over feeds to the T35B VHF driver for reproduction beyond the range of audibility. With brilliance control, wired with 5-ft. cable. Power handling, 20 watts.



G.E. RPX 052A. Famous magnetic cartridge, requires only 6-8 grams tracking pressure. Newly designed "clip-in" stylus. .001" diamond tip for microgroove. .003" sapphire tip for standard.

Write or come into any of our showrooms. See and hear the system shown here for which many people would expect to pay \$285 See how inexpensive Hudson makes getting high, high fidelity style.



DOWNTOWN 212 Fulton St. New York 7, N. Y. Digby 9-1192
UPTOWN 48 West 48th St. New York 36, N. Y. Circle 7-4907

NEWARK, N. J.
35 William St.
Newark 2, N. J.
Market 4-5154

OBSERVATIONS ON LOUSPEAKERS

During the recent months, we have had an opportunity to witness many new and interesting arrangements of loudspeakers and their enclosures and to listen to the various descriptions by their proponents. Not all of the ideas are world-shaking, but there are many points of interest in some of the models that have been shown—either privately or at the recent New York High Fidelity Show.

We have long held the opinion—which we have been at pains to pass on to the many inquirers as to what is the "best" speaker system—that what the individual listener likes best is the one he should buy, assuming, of course, that he is intending to purchase the product of a reputable manufacturer. Fortunately most of the manufacturers in the high-fidelity field fall in this classification, and by and large their products are of uniformly high quality.

But if we may assume that each of the manufacturers of speakers and their enclosures wishes to produce the best unit that he possibly can within the cost bracket, (presumably those who have the responsibility of making the final decision as to sound quality all have considerable experience in the art and can be said to be "trained listeners.") we might be expected to assume similarly that each of their products would sound like the original, and consequently all of them would sound alike. Anyone who has ever listened to a number of loudspeakers and enclosures in a sound show room knows that this is most definitely not the case. Therefore the admonition that the potential purchaser should select the speaker which sounds best to him is reasonable and is, in the long run, one which is most likely to result in satisfaction on his part.

Speaker Systems

In an effort to employ smaller speakers or ones with lesser magnetic structures, many ingenious enclosure designs have appeared over the last year or so. In most instances these units have succeeded in attracting their own followings, and in all fairness it must be said that many of them turn out remarkably good sound for their size. It is not hard to smooth out the peaks of a bass-reflex enclosure so that the reproduction is smooth over the lowest two or three octaves, and unless the speaker magnet is far too small the overall effect may be excellent. Most cabinets of a given type have their own particular coloration, and one listener may like one while another likes a different type of sound.

Strangely enough, with many of the smaller structures, or those which rely on unique features to enhance the performance of a speaker mechanism beyond that which it might reasonably be expected to have, there does not seem to be as much care in phasing as would be desirable. While the phase shift in the dividing network is readily calculable, or at least is obtainable from the same source as the formulas, the designer has the problem of deciding the

exact point which may be considered the sound source for the frequency of crossover, which is where the phasing is important. With a horn-loaded driver, it is reasonable to consider the diaphragm as the sound source, but where is it on a 12-inch cone, for example? Certainly it is not at the plane of the voice coil, nor is it at the rim of the cone. It is most likely to be somewhere between these two points, depending upon the frequency. Thus when the designer makes a cabinet of a certain type, he places the cone on the front panel, let us say, and then he mounts the high-frequency horn or cone with its front at the same place, which may or may not be the best place for it.

In professional two- or three-way installations, great care is exercised in the phasing of the separate units. Not only with respect to the actual connections to the voice coil, but also as to the relative location of the units. This is not easy to determine, particularly without some suitable equipment, and we have often seen systems in use in which the lows were good and the highs were good, but the over-all sound quality left something to be desired. An out-of-phase condition is particularly noticeable on male speech when the crossover is in the vicinity of 700 to 1000 cps, for the sound seems to jump from one section to the other. For those who may have some doubts as to phasing of their two-way systems, it is suggested that they secure a sound source of the same frequency as the crossover—possibly a frequency test record if an oscillator is not at hand, although a very simple audio oscillator fixed at one frequency would serve satisfactorily—and feed its signal to the system. By moving one's ear from directly in front of one unit to the other at a distance of only a few inches from the front of the speaker, either a smooth tone of constant level will be heard, or at some place between the two units there will be a definite null, caused by cancellation of the two out-of-phase tones reaching the ear at the same time. If such a null is heard, simply reverse the leads to the voice coil of either of the speaker units—never both.

Physical Positioning of Units

When the system is so constructed that the physical positioning of the two units can not be changed, there is little else that the user can do to improve the system. However, if the high-frequency unit can be moved backward or forward slightly, try having someone move it while listening at some distance in front of the speakers. If measuring equipment is available—a microphone, amplifier, and indicating meter—the procedure is as follows:

Feed a signal at the crossover frequency to the amplifier. Alternately terminate the high- and low-frequency outputs of the dividing network and note the level of the signal from the two speakers individually, adjusting the loss in the high-frequency channel until the sound level is the same for both. Then with both speakers connected normally, try moving the high-frequency unit backward and forward a little at a time until a point is found where the output is at a maximum, which should be exactly 3 db higher than that from either

speaker alone. If the high-frequency speaker is too far in front or too far in back of the plane of the low-frequency speaker, reverse the voice-coil leads to one of the units and try again. A distance of 7½ inches will be approximately equal to a half-cycle at 800 cps, for example, so with a given connection it may be found that the tweeter is 8 inches back of the plane of the woofer, reversing the connections to one of the units will cause the optimum position to be shifted forward by 7½ inches, approximately, which is only one-half inch back of the woofer.

In many instances a long tweeter horn is used, placing the sound source (the diaphragm) at some distance behind the front of the horn. While it is possible to phase such a combination satisfactorily on a constant tone, it is possible that the system will not sound "right" on transients, such as a piano or snare drums, for example. In such cases it might be desirable to move the woofer back into the cabinet slightly, using some form of "fairing" in front of the cone to provide smooth access to the air in front.

Psychological Effects

One apparent fallacy that is observed with a two-way system is the result of the listener being able to see both high- and low-frequency sound sources at the same time. This is likely to occur during construction when the final grille-cloth covering has yet to be put in place. If one can see both of the units at the same time, he is likely to feel that the two sources do not blend together as they should, even though they are perfectly adjusted and phased. This effect is dispelled immediately by placing a sheet or other light material in front of the system so that both units can not be seen by the listener, and the moment that they are covered up the sound will appear to blend and to come from one source.

None of the points brought out here has sufficient importance to be the subject of specific instructions on loudspeaker systems, but it is hoped that as "hints" toward choosing, adjusting, and operating a speaker they may be found interesting and helpful to readers who may encounter some of the same problems. We believe that there are many excellent loudspeakers, enclosures, and complete systems, and we believe that a speaker should be equipped with such controls to enable it to be adjusted once for a given environment and then left alone—we do not believe that operating controls should be a part of the speaker system, since adjustment of the level of any particular speaker of a two-, three-, or even four-way system can be correct only at one point. Acoustic environments in listening rooms are not likely to be subject to sudden discontinuities or steps, which is the type of correction offered by adjustments of the various sections of a multispeaker system. Such controls should be set for flat response through the frequency junction between their respective ranges, and once so adjusted should be left alone; any necessary tone compensating adjustments made by the conventional tone controls.

—C. G. McP.+

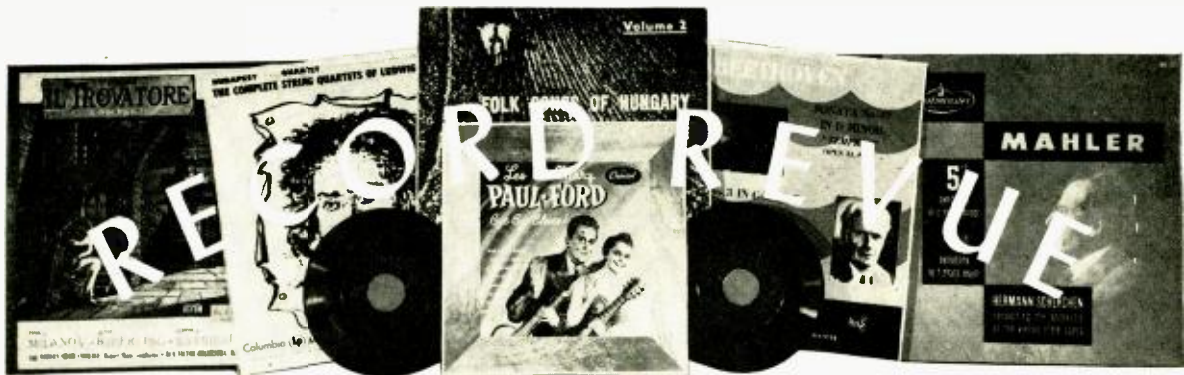

EDWARD TATNALL CANBY*

The Mozart Year

Mozart: Two-Piano Concerto in E Flat, K. 365; Three-Piano Concerto in F. Helen and Karl Ulrich Schnabel, Ilse von Alpenheim, Vienna Symphony, Paumgartner. Epic LC 3259

It's likely that this department will still be reviewing Mozart Year records when the little man's Tercentenary rolls around ("Tercentenary"? in 2006 A.D. Certainly there won't be an end to the new Mozart when his 251st birthday arrives, come January; there are enough worthy items from these last months to keep us all busy for as long as the 60-cycle AC holds out, which we trust will be until eternity.

The Two-Piano Concerto is often heard and for clear enough reasons—every duo piano team jumps for it as a fine reason for playing in public with orchestra, something not all of them get to do. But the Concerto for Three Pianos is something heard heavily involved. Nobody ever heard of three pianists who could get along together on a stage—well hardly ever—and so nobody gets to listen here to some very fine music that ought to be heard a lot. (Mozart didn't write it for the stage, of course; he tossed it off for the private use of a countess and her two aspiring daughters; but they never got around to it, so he did it himself with one of his lady friends. The third pianist? A piano manufacturer? See how tactful Herr Mozart was?)

Anyhow, the Concerto for *two* pianos has suffered desecrations by the dozen at the hands of pianists who play it because it is a repertory piece which all duo-piano teams are supposed to know, rather than because they love it and understand it. This applies to great as well as lesser pianistic names. I must refer sadly to the version—versions, I guess—by the Iturbis, brother and sister, which remain among the ugliest, most unfeeling examples of Mozart playing I remember having heard. In this new recording there is, miraculously, hardly a trace of the all-too-familiar virtuoso approach, the easy "tossing-it-off" that spoils many a performance. Here the music is taken seriously, and so is light, fanciful, graceful and utterly beautiful. Herr Paumgartner keeps his reputation for excellent concerto accompaniments; those who know the concerto will find merely that his tempi are rather fast and light. The two pianists play their big instruments lightly, too, avoiding the elephant effects that are only too easy with the modern grand, so much bigger than the piano Mozart intended.

The Concerto for the three pianos offers more of the same kind of playing, and the fact that you won't really be able to distinguish between the two Schnabels (he's the

son of the famous Artur S.) and Ilse of the Alpine Home (well, that's what her name means) merely indicates that there is excellent musical ensemble and agreement in the playing. Team work. The usual very nice and natural Mozart recording from Philips—that is, Epic.

Mozart: Piano Concerti #13 in C, K. 415, #14 in D minor, K. 466. Julius Katchen; New Symphony of London, Peter Magg. London LL 1357

Immediately, what a surprising difference in approach! After the above recording of the concerto for two and three pianos in an impeccably musical and carefully styled manner, this one is roughly dramatic, and at first I didn't like it. But as the music went on I changed my mind, and so will you, I think.

This is, undeniably, a strong, virtuoso kind of Mozart, a concert-performance kind, of the sort that is good before large audiences. Moreover, it is dramatic to the full, emphasizing—and correctly—each turn of drama in the melody and harmony of these fairly late Mozart works, the second of them perhaps the most famous of all Mozart concerti, that in D minor.

The D minor was singled out far back in the 19th century as an unusually Romantic work, and has been so played for a century, on and off, by most of the big pianists of history—who never so much as looked at the other concerti, the "delicate," ethereal ones, or so they thought. They were wrong about the others, but right about this one; it *is* Romantic, and it can be played with Romantic drama, if done musically. Katchen and Magg together have worked out a Romantic-slanted performance that does about as well as any I've heard recently in underlining the Romantic details of the work, phrase by phrase, harmony by harmony, mood by mood. Though a good many will find it too rough and strong, too prone to rubato, slowing-down, speeding-up, and though the loud enclaves tend to become noisy and to pound, I still think that of its type this is an unusually good performance, to be set alongside others of a different emphasis, notably the marvellous job done by Clara Haskil.

The preceding concerto, one number earlier, is outwardly a much lighter and airier piece, the sort that one day would have been thought trifling. Not here! For though it faithfully reflects the wide-open and forthright key of C major, it is full of emotional tricks. The last movement gives Mozart's real seriousness away, as so often happens; it begins unexpectedly with a profound slow-speed introduction in dramatically strong harmonies, followed by a superbly light-footed fast ending, of the sort that always indicates great underlying seriousness on Mozart's part.

Excellent recording, quite dry in the acoustics and rightly so, but brilliant and full. This could be in a large music room of the princely sort, rather than in some spacious concert hall, and that is precisely the sort of room for which it was intended.

Mozart: Piano Concerto #19 in F, K. 459; Symphony #29 in A. Clara Haskil; RIAS Symphony of Berlin, Ferenc Fricsay. Decca DL 9830

Here is the divine Clara herself, the princess (for my ears) of Mozart concerto players, but the recording is inexplicably disappointing in the orchestra.

A reviewer, hearing a disc like this, can only guess what happened or didn't happen in the complex business of getting music down on LP records. Clara herself is fine, but the orchestra here—a good orchestra generally, and an excellent conductor in many other releases—is dead, dull, mushy, hesitant. There is a noticeable and most unpleasant softness and vibrato in the first violins, where there should be clarity and brilliance of line. The beginning of the concerto (orchestra alone) seems to fade in, as though an engineer had forgotten to open up his mikes. The tempo seems slow, the rhythm weak and undecided. Impossible! But it's there. Just listen for yourself.

One must always keep engineering in mind and remember that acoustics and mike placement can sometimes trick the finest ear into hearing what isn't there. It might be in the recording—who knows? But I don't think so. On the other hand—how could it be in the orchestra? A bad day, the morning after the night before? Too many recording sessions in a row? . . .

Turn it any way you will, the sound is there for you to try, and it's possible you may not go along with my ears. But the solo symphony (for orchestra "solo," that is) seems also lousy and slowish. However, here I make a mental reservation; this early symphony is usually done as a kind of trifling show piece, tossed off with extreme brilliance and at excessive speed as a sort of curtain raiser, to show off the power of so-and-so orchestra to an appreciative audience. The fact that this recorded performance strictly avoids all trace of that sort of silly business is in its favor, and it may be that my ears are simply too well adjusted to the usual frothy playing of the music to absorb a slow, quiet performance. And so the question remains—pending six months' or so of playing and re-appraisal—is it a tired, half-hearted performance, or a good, quiet, serious one without show-off brilliance? As of now, I say it's tired, but I'm open to further persuasion (by the music itself).

Mozart: Sonatas for Organ and Orchestra, complete. (K. 67 through K. 336.) Richard Ellsasser; Hamburg Chamber Orch., Winograd. M-G-M E 3363/4 (2)

Here's one of those complete collections that are like books of essays, collected works, poems—not to be absorbed all at a sitting. In fact it is a crime to play more than two or three of these marvelous little pieces at a time, since they were intended to be heard

* 780 Greenwich St., New York 14, N.Y.

for those who can **HEAR** the difference!

AUDIO FIDELITY
THE DUKES OF DIXIELAND
HEAR the difference!
A STUDY IN HI-FIDELITY SOUND



Fiesta en Mexico
Mariachis Miguel Dias

A rich, colorful variety of traditional rhythmic music that expresses the heart and soul of Mexico. Played by authentic Mexican Mariachi Musicians... recorded in magnificent Hi-Fidelity sound. Features: Jarabe Tapatio; Guadalajara; El Rancho Grande; etc.
AUDIO FIDELITY AFLP 1816
12-in. \$5.95



PATACHOU
Songs from Her Hit Shows

All the vibrance and warmth of this famous French personality is brought to life in this magnificent new Hi-Fidelity recording. Patachou sings your favorites: Le Fiacre; Paris; C'est une Blonde; Autumn Leaves; Sous Le Ciel de Paris; etc.
AUDIO FIDELITY AFLP 1814
12-in. \$5.95



PLAZA DE TOROS
La Fiesta Brava, Vol. 2
Music of the Bullfight Ring

Again the "Banda Taurina," of the Plaza Mexico, presents, in brilliant Hi-Fidelity, traditional music of another afternoon at the bullfights. Complete with portfolio of full-color reproductions of bullfight paintings by world-famous artists, suitable for framing.
AUDIO FIDELITY AFLP 1817
12-in. \$5.95



Unparalleled Recordings in New HIGH FIDELITY SOUND



ACCORDION DE PARIS
Jo Basile & Orchestra

Mysterious, romantic, French cafe music that wraps you in rhythms now passionate... now gay... with that enchanting nostalgic Paris magic. Brilliantly recorded in true High Fidelity.
AUDIO FIDELITY AFLP 1815
12-in. \$5.95



CHA-CHA-CHA

Here, for the first time, superbly recorded in Hi-Fidelity, is the pulsating tropical magic of the foremost Cha Cha orchestra in the world... Pedro Garcia his Del Prado Orchestra and the captivating Latin beat of the Cha-Cha-Cha. Complete with illustrated dance instructions.
AUDIO FIDELITY AFLP 1810
12-in. \$5.95



THE BRAVE BULLS!

Music of the Bullfight Ring, Vol. 1
Featuring the "Banda Taurina" of the Plaza Mexico world's largest bullfight arena. A Hi-Fi presentation of an afternoon at the bullfights. Complete with book of 24 full color Bullfight Poster Reproductions. "Brilliant engineering!" -HIGH FIDELITY MAGAZINE.
AUDIO FIDELITY AFLP 1801
12-in. \$5.95



THE DUKES OF DIXIELAND

Hot trumpets, cool clarinets, low-down trombones and a big fat tuba in the most exciting performance of true New Orleans Dixie ever recorded! The "MOST" in Hi-Fidelity... you've got to Hear It to Believe It!
AUDIO FIDELITY AFLP 1823
12-in. \$5.95

AUDIO FIDELITY Recordings are NOT ordinary recordings - but guaranteed total frequency range recordings with absolute musical range... perfect pitch... perfect tempo - this is high fidelity as you always want it to sound! These are the records audio manufacturers themselves use to demonstrate their electronic equipment and hi-fi components!

Here then, is the Most in Sound, brought to you by **AUDIO FIDELITY**, in some of the most delightful and unusual music ever heard on records...



BAWDY SONGS and BACKROOM BALLADS

Oscar Brand, noted balladeer sings Folk-Americana often heard but never recorded. Rollover songs for people with lusty appetites and strong musical tastes.
Vol. 1 - **AUDIO FIDELITY AFLP 1906** 12-in. \$5.95
Vol. 2 - **AUDIO FIDELITY AFLP 1806** 12-in. \$5.95
Vol. 3 - **AUDIO FIDELITY AFLP 1824** 12-in. \$5.95

RECORD PREVIEWS

NEW OCTOBER RELEASES

- **CHA CHA CHA**, Salamanca Orch. **AFLP 1813** 12-in. \$5.95
 - **TROMBONE**, Davis Shuman Trombonist Concerto with Orch. - Serly **AFLP 1811** 12-in. \$5.95
 - **TORERO - La Fiesta Brava, Vol. 3** **AFLP 1818** 12-in. \$5.95
 - **FIESTA EN ESPANA**, Flamenco Guitar **AFLP 1819** 12-in. \$5.95
 - **GRAILVILLE SINGS**, Music of Advent & Christmas **AFLP 1820** 12-in. \$5.95
 - **ACCORDIONISTE DE FRANCE**, Jo Basile & Orch. **AFLP 1821** 12-in. \$5.95
 - **ROME... WITH LOVE!** Italian Accordion **AFLP 1822** 12-in. \$5.95
- other studies in HIGH FIDELITY sound on **AUDIO FIDELITY**
- **TALBOT BROS. of BERMUDA, Vol. 2** **AFLP 903** 10-in. \$4.00
 - **TALBOT BROS., Vol. 3** **AFLP 1807** 12-in. \$5.95
 - **TRINIDAD STEEL BAND** **AFLP 1809** 12-in. \$5.95
 - **LORD INVADER: CALYPSO** **AFLP 1808** 12-in. \$5.95
 - **MERRY GO ROUND MUSIC** **AFLP 901** 10-in. \$4.00
 - **DRUMS OF THE CARIBBEAN** **AFLP 902** 10-in. \$4.00
 - **CIRCUS CALLIOPE MUSIC** **AFLP 904** 10-in. \$4.00
 - **MERENGUES** **AFLP 905** 10-in. \$4.00
 - **MARIMBA MAMBO Y CHA CHA CHA** **AFLP 1802** 12-in. \$5.95
 - **KATHERINE DUNHAM, DRUMS OF CUBA-HAITI-BRAZIL** **AFLP 1803** 12-in. \$5.95

These records are available at your favorite Audio or Record Shop

WRITE FOR FREE CATALOGUE

NATIONALLY DISTRIBUTED BY

DAUNTLESS INTERNATIONAL

750 TENTH AVENUE NEW YORK 19, N. Y.

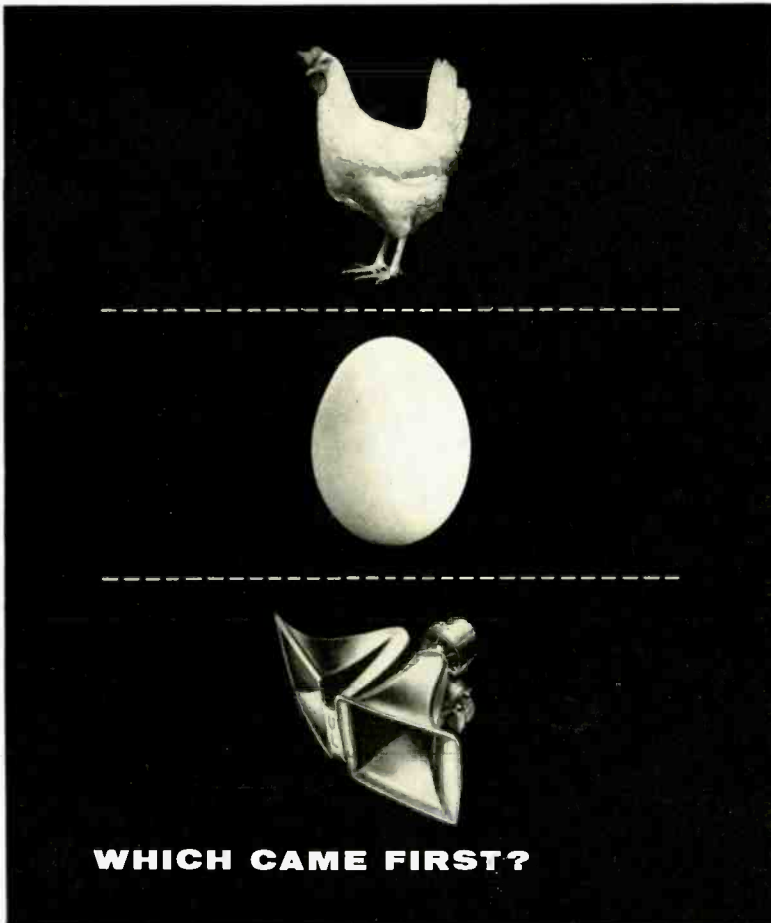

WHICH CAME FIRST?

There's a lot of controversy about which came first, the chicken or the egg . . . but there's no question about the fact that University has been first with many of the most sensational developments in the loudspeaker field.

Merely being first is not enough. We, at University, subject every new product to the most rigorous laboratory tests, placing it on the market only when it has been brought to the peak of perfection. (Our customers have felt it was worth waiting for these "proven-firsts").

We've always enjoyed the challenge of finding new answers to old problems as well as exploring entirely new fields in audio engineering. Perhaps that's the reason University has become the leading manufacturer of specialized loudspeakers and components.

For the record—here are some of the "firsts" which we have engineered.

University was the FIRST to . . .

Pioneer high power reflex trumpets . . . now the industry standard

Introduce radial projectors . . . making full coverage still more economical

Achieve the one-piece integrally cast tone arm, reflector and bell Cobreflex—permitting durable construction of intricate designs

Offer wide-range response, breakdown and weatherproof driver units . . . bringing the best in Sound to public address

Devise "rim-centered" diaphragm/voice coil and magnet assemblies . . . eliminating need for slims and guides, ensuring shock and vibration-proof reliability

Depart from obsolete, erratic-performing

multi-cellular and slit type diffraction projectors . . . by introducing the still superior "reciprocating flare" principle for uniform wide-angle dispersion of high frequencies

Make available high efficiency blast and submergence-proof speakers for p.a. and industrial applications . . . opening new markets to Sound installations

Combine driver and multi-match transformer in one unit . . . substantially increasing versatility of application and flexibility of operation

Conceive "progressive speaker expansion" (PSE) . . . together with specially designed components such as adjustable impedance voice coils, adjustable response woofers, adjustable crossover networks

and others too numerous to mention

UNIVERSITY LOUDSPEAKERS, INC., 80 SOUTH KENSICO AVENUE, WHITE PLAINS, N. Y.

LISTEN

University sounds better



strictly one by one, each for a church service of its own. So—turn your changer to the manual position and make use of those convenient separation bands on the record.

The sonatas are each a single movement, only a few minutes long, not very much longer than the somewhat similar Scarlatti sonatas for harpsichord. Each is like the first movement of a little symphony—like the beloved "Eine Kleine Nachtmusik." The thinking is concentrated, the movement lively and utterly melodious, and there is, for our ears, not a trace of stuffy churchiness in any of them.

In music of this sort it's important to remember that our present concept of "heavy" or solemn church music, uplifting but sanctimonious, simply did not exist in the 18th century. These works were commissioned for the Archbishop's own service, than which there could hardly be anything more official. But music for church service then was conceived in what seems to us a worldly style, though it didn't to the participants—not for a while. (Later on, this instrumental kind of music was banned; but choral music with orchestra of an equally light and spontaneous nature was put in its place and can still delight us.) And so, forget about the more forbidding aspects of "church music" here, and remember, if you will, that this music too was composed to the glory of God, churchy or no.

The organ, I hasten to add, is practically inaudible in the sonatas. It serves mainly as a sort of figured bass accompaniment, filling out the strings' lightfooted harmonies, and as a solo *obbligato* voice, playing some of the tunes by itself but simply as a part of the ensemble, without concerto-style effects. Definitely not for organ bugs. I add, too, that the playing is excellent in the orchestra and tastefully registered on the part of the organist, with just the right balance of forwardness and backwardness, so to speak, according to the style of the music. Fine job, and take them one a day—they'll last for months.

Mozart: Serenade for 13 Wind Instruments in B Flat, K. 361. L'Orch. de la Suisse Romande, Ansermet.

London LL 1274

This towering pinnacle of Mozart's wind music, the grandpapa, of all the Divertimenti and Serenades and other delights that we've been hearing hi-fi these last years, joins a whole host of performances on London by this now familiar musical performing combination, and the recording of the winds, though not of a big-bass man's sort (there is merely the normal bottom) will send the higher-minded hi-fi enthusiasts into tizzies. Superbly edged, clean wind sound with all the color, the timbre, preserved, yet the ensemble of thirteen instruments blends beautifully into an orchestral ensemble. Right—for this is one of those works that hits the border between close-up chamber music and at-a-distance-orchestral music.

Ansermet consumers will know the sort of performance to expect: beautifully, carefully tailored and planned, most musically phrased, balanced, but somehow just a wee, wee bit on the un-light side. Nor heavy so much as lacking in drama, in places that can take it, if ever so subtly. In a lesser performance we would use that devastating term "consciousness." Ansermet is much too good for that, but I find it hard to pull out a word that gives a slight bit of the same idea, without detracting from the splendidly careful job these players do.

Mozart: Divertimenti in D, K. 136; B Flat, K. 137; F, K. 138. Solisti di Zagreb, Janigro. Vanguard 482

And here are the Divertimenti themselves, three of them, with a new playing group that intrigues by its very title. I bethought me—where in Heaven is Zagreb? Yugoslavia, isn't it? Haven't yet gone to the proper authorities to find out (maybe I'll have to see the State Department), but musically I can identify the group immediately. It is one of the now highly popular small ensembles of a dozen carefully picked strings, that have been springing up mainly in Italy in the last few years, of which "I Musici" is perhaps the best known. "I Musici" includes

eleven players, this group has thirteen. Janigro is already familiar to us for his performances on Westminster records.

I detect a difference, I think, between this group and the Italian groups already heard: this one plays with a softer, more lyric touch, more in the Austrian manner than in the Italian. Good, very good, for Mozart, and moreover, the size of the group is superbly suited to this in-between music, composed not as chamber music (one to a part) nor again as orchestral music (a larger ensemble) but for the borderline area, semi-solo, semi-ensemble, that was one of Mozart's most prolific kinds of endeavor. I like this playing a lot, and I find the close-up blend of the two or three leading violins, quite near the mike, exactly in the tradition and precisely as it should be—almost as a solo part though audibly played by more than one fiddle. First rate job, musically and in the recording.

MISCELLANEOUS

Bartok: The Six Quartets. Vegh Quartet.
Angel 35240/41/42
(Available separately.)

The six Bartok quartets are as big musically, for our day, as the nine symphonies of Beethoven. In them there is not only his most breath-taking music, his most extreme dissonance, but also an almost miraculously skillful revolution in quartet expression. Strings never were made to do such wild things before—and they do them with ease, at least in the effectiveness of the sound. The Quartets vary from the late-Romantic beginnings in the First through the incredible dissonant complexities (perfectly understandable) of the raucous, marvelous Fourth of 1928. A world of music here and it's surprising how quickly Bartok makes sense, today, to many an untrained ear.

This new recording invites comparison with the complete set by the Juillard Quartet on Columbia. As I remember it, and speaking very generally, the Juillards had a steely and intense precision, a razor-edge, a cold heat that, nevertheless, struck me as a trace academic; the feeling was not as big as that in the music. The rather dead recording went well with the performances themselves.

This new version is much warmer, I think, if perhaps not as high in tension. Both tension and warmth are in Bartok and both aspects can be evident in the performance. In the Vegh performance the musical teeth don't grate so violently, the dissonance seems milder, the fury less barbaric.

Is it merely a lack of intensity? Or is it, rather, a deeper understanding of the music, that makes it seem more natural, more plausible as we listen, and so less dissonant? I suspect it is this. The huge recorded sound, in an almost orchestral liveness, adds more plausibility, makes for easier listening, and at no point do I have other than the feeling that the players are thoroughly at home with the sense of the music they are playing. It even sounds easy—which it definitely is not!

Try the Third and Fourth, with their raucous cat-calls, their slides, swoops, screeching dissonances—and see how easily they glide into your ear. You never know, these days, who is going to like Bartok.

Schoenberg: Pierrot Lunaire (1912). Ethel Semser, recitation; ensemble conducted by Rene Leibowitz.

Westminster WN 18143

Not the first recording of this extraordinary work for seven instruments (more or less) and a voice that half speaks, half sings a German text that was originally French; but this version is outstandingly well done and it has a feature that all the others should have had. The speaking-singing voice (Sprechgesang) is correctly treated as but one element in the ensemble, along with others and equal to them, no more. Miss Semser is thus somewhat in the background and on occasion is almost drowned out by other sounds. That is exactly as it should be and, actually, makes the work far more listenable.

This is, oddly enough, almost Schoenberg's most popular piece (next to Verklarte Nacht) in spite of its radical aspects. The answer is that, first, its chamber music language is

NOW FOR BOTH 12" AND 8" SPEAKERS

The NEW *Tiny Mite*
Model TM-812

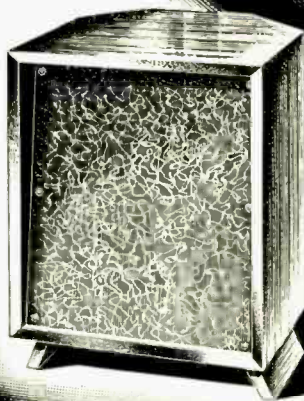

A TINY GEM WITH MIGHTY PERFORMANCE
AT AN UNBELIEVABLY LOW PRICE

It is hard to describe "sound." The picture above gives a pretty good idea of what a TINY-MITE looks like, but what it sounds like... that's not so easy.

If we used words like "beautiful," "sonorous," "rich-bodied," you'd conjure up some sort of mental auditory response. But at best it wouldn't be accurate. You have to actually listen with your own ears to know what "sound" really sounds like. You'd have to look twice to believe that the magnificent sound produced by the TINY-MITE was emanating from an enclosure only 21" h. x 15½" w. x 12" d.

It's no trick to achieve good results with a large enclosure, but realizing the great need for limited space enclosures, we set ourselves the goal of producing the finest small enclosure possible... *This is it!*

JUST LOOK AT THESE FEATURES:

1. The *only* cornerless-corner enclosure for both 12" and 8" extended range speakers, employing highly efficient University horn-loaded phase-inversion principle.
2. Versatile design permits use in room and ceiling corners or along flat wall. All exteriors, including the back, are beautifully finished, permitting unlimited decorating possibilities.
3. Construction equals the finest cabinetry. Full ¾" wood used throughout, thoroughly braced.

4. Supplied with mounting board cut out for 12" speaker; adapter for 8" speaker with ample space for tweeter opening is available.
5. No more struggling to install speakers. Baffle board is easily removed at front of cabinet.

The TINY-MITE makes any speaker sound its best. Matching the superb quality of the TINY-MITE, University offers the largest selection of 8" and 12" 2- and 3-way Diffusals... to meet any budget requirement. Visit your favorite Hi-Fi center and listen for yourself!

Mahogany ... \$39.75
Blond 42.25
Unfinished ... 34.00

UNIVERSITY LOUDSPEAKERS, Inc., 80 South Kenisco Ave., White Plains, N.Y.

LISTEN

University sounds better





CHAMPION CARTRIDGE

There is only one champion in the fine phono cartridge field: the ESL. After impartial testing of nineteen leading pickups, the authoritative Audio League continues to report:

"By a practically unanimous decision, our listening panel considers the ESL Professional and Concert Series cartridges to be by far the finest phonograph reproducing instruments we have heard.

"In A-B comparisons with its closest competitors, even persons who had never previously been exposed to high fidelity reproduction were struck by the superior definition of the ESL."

"The smoothness and clarity of these cartridges are unique. . . For sheer naturalness and undistorted ease, ESL has no peer."

Is your pickup obsolete? No matter how respected nor how recent it may be, you're missing plenty if you don't have the world's most advanced cartridge: the ESL. Write today for free information.

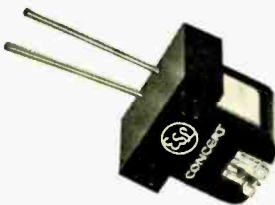

FOR LISTENING AT ITS BEST
Electro-Sonic Laboratories, Inc.
Dept. A, 35-54 Thirty-sixth St. • Long Island City 6, N. Y.

Soloist Series from \$14.95 • Concert Series \$35.95 • Professional Series arm and cartridge \$106.50

* Authorized quotation No. 51. Please consult *The Audio League Report*, Vol. 1, No. 6-7 (March-April 1955) for the complete technical and subjective report. Additional information in Vol. 1, Nos. 10 & 12. Subscriptions: 12 Issues \$4, from P. O. Box 262, Mt. Vernon, N. Y.

now not unfamiliar to the average ear thanks to a thousand and one derivatives, and moreover, the fact that the somewhat impractical singing-speaking is actually very close to the heart of the principle of musical expression via the human voice—expression that is always a cross between music and speech.

And, a still further reason, the Surrealistic text, so incomprehensible in 1912, is of the sort that has now entered fully into popular favor, and is echoed in the movies, TV and in a million advertisements.

The Songs of Insects. Recorded by R. D. Alexander and Donald J. Borror, Ohio State Univ. Prod. by P. P. Kellogg and A. A. Allen, Cornell.

Cornell Univ. Records (1)
(124 Roberts Pl. Ithaca, N.Y.)

This belongs in the now well known Cornell series of bird songs and other natural sounds—frogs, for instance. But the Kellogg-Allen team didn't do this one directly; it has been taken over from Ohio State. And the work, allowing for impressive technical difficulties in the recording, is not as good as that in the bird and frog Cornell discs.

The insects, for one thing, sound very much alike; most are simply buzzings and sawings. Dozens of crickets "sing" and the sound might well have been faked up by three or four decrepit door bells, for all most of us can tell. No exotic charm, no semblance, as with the birds, of musicianship!

Moreover, on my player at least, there is much extraneous blasting noise, sputtering sounds as of an overworked mike. It could be in my equipment—if so, it will show up in others' too. The sound is too close, generally, for a naturalistic effect, as heard (at a distance) in the field, though I grant that this may have been technically necessary. Finally, the narration is of that excessively scientific sort, humorless, dry, unexpressive (though the content is good in itself), which too often gets into the communication fields in situations like this. Speak up, man! Talk like a human being.

However, the mere prolificity, if such a word can be used, of crickets and grasshoppers with incredible names (the Slightly Musical Conehead, *Neococephalus exilicanturus*, or the Short-legged Shield-Bearer, *Atlantius testaceus*, for example) will provide enough interest for many of us to make the disc worth investigating. Available through Cornell University, as indicated.

In His Shadow. (Contributing artists: Fisk Choir, James Melton, Norman Cordon, Dinah Shore, Snooky Lanson, etc.) To Preserve the Old Downtown Church, Nashville, Tenn.

Vance Memorial Music
154 Fifth Av. North, Nashville

This one is mentioned here for those who are interested in this church and as an interesting commentary on the advance of LP as a means for fund raising of many sorts. Instead of a benefit performance, now you put out a benefit record. Same idea, and the cost of this one is five bucks, address as shown.

Less said the better about the contents, which make, alas, a commentary on the musical tastes of some church members. The popular items, borrowed with permission from already issued standard releases, are actually the best. The Fisk Choir does its stuff and a number of soloists provide a choice of fare, mostly sticky and sentimental. (But Sylvia Stahlman's Mozart, with organ, is surprisingly competent vocally.) Recorded quality is mediocre, of the home-tape-recorder sort. No excuse for that.

A Practical Course in Hypnosis. Prof. Jonathan B. Sokol.
University Workshop UW 1001 (2 10")

I received these two ten-inch LP's (no album to go with them) before I had stumbled upon the name of a certain lady, one Bridley Murphy, and so I was slightly astonished that such a lengthy discourse as this should be put on records. I am no longer.

Bridey isn't mentioned, of course, and theoretically she has nothing to do with it. She is merely the economic impetus, shall we say.

The lecture, for the layman, is spoken slowly and with an announcer-style voice (presumably the Professor himself) that is easy to understand. The text itself is a bit on the impersonal side; the white-coated doctor of the ads is speaking here. Warnings against incautious use of hypnotism are given in several places and there is no invitation to dangerous experiments. Nevertheless, I somehow wonder whether even the implication that the amateur can play around with hypnotism should be passed along this freely. True—he can. True, the warnings are correctly present here. Nevertheless, I should suppose this disc would be best used as an adjunct to instruction classes, etc.

**Joe Enos Plays Two Pianos.
Hifirecord R 201**

You may have overlooked this—if you are interested in recording technique, don't. The man plays two pianos, of course, in sequence, first recording on one, then recording more music as the first one plays back. In fact, the two pianos are the same one. This sort of double recording is now becoming standard practice in the pops field and it's spreading gradually into other areas as the possibilities are realized. (Note an Alec Templeton recording, Remington 199-158, of similar double-provisations.)

But the more interesting facet of this record is the change in mike technique, from take to take, to alter the sound of the single piano in quite an amazing way. Sometimes it's near, sometimes far, sometimes it is big and full and grand, then again it is thickly and thin, or hard and percussive. And, of course, these effects are combined, two at a time. An interesting study in microphoning.

The music? Varied, from pops to classics, and Mr. Enos is a fluent player and a good improviser-embroiderer, not being confined at all to the printed notes. But, in the classics, he shows up as a gifted amateur; he has little sense for the careful shading and phrasing that belongs in that music. Doesn't matter much in this context.

NEW LITERATURE

● **International Instruments, Inc., P. O. Box 2954, New Haven, Conn.**, announces publication of a new engineering data sheet covering its line of miniature expanded-scale a.c. voltmeters. Combining small size and light weight with excellent accuracy, these meters provide more precise readings of voltages at critical points on the scale than conventional types of voltmeters. They are exceptionally well-suited for monitoring a.c. line voltages where variations will affect the operation of X-ray machines, TV cameras, and other electronic equipment. Will be mailed free on request. **V-1**

● **Plant Equipment Sales Department, Corning Glass Works, Corning, N. Y.**, has available a new general information bulletin on radiation shielding windows. Charts, graphs, and sketches help explain shielding, transmittance, and radiation-darkening characteristics of Corning's 2.7, 3.3 and 6.2 density shielding glasses. Three pages are devoted to window design considerations, with sketches of typical window installations to aid the reader. Bulletin PE-51 will be sent free of charge. **V-2**

● **Electronic Components Division, Stackpole Carbon Company, St. Marys, Penn.**, gives dimensions, mounting styles, ratings, standard modifications, and performance characteristics for its complete line of variable composition resistors and snap switches in a new Bulletin RC-10B. A convenient fold-out chart at the rear of the bulletin serves as a quick guide to the most important features of each unit shown on the inside pages. Available upon request. **V-3**



*Friction
free
as a
feather
in air*

In the new Rek-O-Kut Turntable Arm . . . something exciting has taken place! Here at last is lateral and vertical freedom-from-friction achieved by no other . . . distortionless tracking . . . and an exclusive micrometer-action counterweight allowing easier, more accurate stylus pressure adjustment!

A-120 for records up to 12" \$26.95

A-160 for records up to 16" \$29.95

slightly higher West of Rockies

REK-O-KUT
TURNTABLE ARM
Pat. Pending

- Friction-free lateral motion achieved by unitized sealed-in twin-bearing pivot.
- Friction-free vertical suspension between 1mm chrome-steel bearings . . . sealed in the cross-shaft!
- No need for a stylus pressure gauge! With cartridge mounted and arm in state of balance . . . turn micrometer-action counterweight to build up stylus pressure.



See your dealer. Write for Catalog and **FREE** strobe disc

REK-O-KUT COMPANY, INC.

38-01 Queens Blvd., Long Island City 1, N. Y.

EXPORT: Morhan Exporting Corp., 458 Broadway, N. Y. 13, N. Y.
CANADA: Atlas Radio Corp., 50 Wingold Ave., Toronto 10, Ontario

NEW PRODUCTS

• **Ferroglyph Tape Recorder.** Ideal for custom installation as part of a complete high fidelity music system, the new Ferroglyph Series 66 dual-speed dual-track tape recorder includes a power amplifier which also permits its use alone, when desired, to feed any high quality 15-ohm speaker. The Ferroglyph is also available with stereo heads, either playback only or both record and playback. A synchronous hysteresis motor drives the tape capstan and two shaded-pole motors are



provided for takeup and rewind. Separate bass and treble tone controls, a combination gain-volume control for recording and playback, and a recording level meter are incorporated in the sloping control panel. The recorder is finished in attractive Venetian bronze, with contrasting cream-colored knobs and accessories. Manufactured by British Ferroglyph Recorder Co., Ltd., London, the Series 66 recorders are distributed in the United States by the Ercona Corporation, 551 Fifth Ave., New York 17, N. Y. **V-5**

• **Brociner 20-Watt Amplifier.** Newest addition to the Brociner line of audio amplifiers is the Mark 20, which makes use of the printed-circuit techniques pioneered by Brociner in the earlier Mark 12 and Mark 10 models. A notable feature of the Mark 20 is a tape monitor switch, located on the front panel, which permits simultaneous tape recording and monitoring of the program material; recording level is unaffected by the position of the volume control. Also mounted on the front panel are rumble filter and loudness compensation switches. A combined program-selector and phono-turnover switch, a phono roll-off switch, continuously variable tone controls providing boost, cut and calibrated flat position, and a volume control with on-off switch complete the front



panel control complement. At the rear of the housing are input jacks, tape-feed jack, output terminals, and signal-to-noise adjustment. Frequency response of the Mark 20 is 15 to 25,000 cps within ± 1 db, and intermodulation is under 2 per cent at full rated output. Dimensions are 13" w x 9 1/4" d x 4 1/4" h. Brociner Electronics Corporation, 344 E. 32nd St., New York City, N. Y. **V-6**

• **Bogen Transistor Amplifier.** Said to be the first practical transistor public-address amplifier, the new Bogen Model BT12 is an ideal unit for emergency cars,

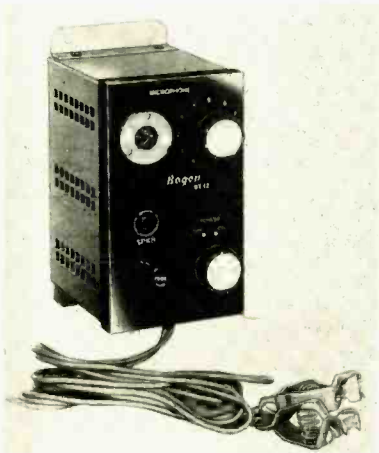

buses and portable p. a. systems. Designed to operate from a 12-volt battery, the 4-watt mobile unit draws very little current. It is remarkably compact in size, light in weight, and mounts easily under a dashboard. The front panel contains a microphone connector, speaker socket, fuse, volume control, and on-off switch. The BT12 comes with 6-ft. battery cable and clamps, ready for immediate use. David Bogen Company, Inc., P. O. Box 500, Paramus, N. J. **V-7**

• **Oscillator Wand.** Designed as a maintenance tool for magnetic recording equipment, the Stancil-Hoffman Oscillator Wand will thoroughly check a recording channel in a matter of seconds. The wand is a source of either a 1000-cps or 8000-



cps tone. When it is held close to a playback head, a note of either frequency will be introduced into the system to check operation of the playback amplifier. Held close to a dynamic microphone or any other moving-coil pickup, the wand will induce the same tones. It weighs only 9 ounces and is 8 ins. long and 1 1/2 ins. in diameter. For more information write Stancil-Hoffman Corporation, 921 N. Highland Ave., Hollywood 38, Calif. **V-8**

• **Control Console.** The new RCA low-cost single-channel audio-control console has been engineered for the budget and coverage requirements of schools, hospitals, and industrial plants requiring an economical intercommunication system which can also be used for program

distribution. The unit measures only 22 inches wide and can be mounted on a desk. A self-contained instrument, the console features a 10-watt amplifier with frequency range of 50 to 15,000



cps, a balanced 70-volt output, and a monitor speaker which also functions as a microphone. Program distribution is controlled by a single three-position switch which includes an all-call position to provide automatic cut-off of programs for priority announcements. Further information on the Type MI-14980 console can be obtained from the Theatre and Sound Products Department, Radio Corporation of America, Camden, N. J. **V-9**

• **Altec Lansing High-Power Amplifier.** Intended for public-address and industrial control applications where long life and minimum maintenance are paramount, the 260A is a 260-watt amplifier with exceptionally low distortion and wide frequency range. Full rated power is available con-



tinuously at 2 per cent or less distortion over a frequency range of 40 to 15,000 cps. Output connections provide for low-impedance speaker loads and a 70-volt line. Also provided is a 65-ohm tap for a 140-volt line or 117-125 volts to operate motors at various frequencies. Protection is supplied by thermal cutout. Filament warm-up period is controlled by a time-delay relay, permitting remote on-off control. Altec Lansing Corporation, Dept. AE-7, 9356 Santa Monica Blvd., Beverly Hills, Calif. **V-10**

• **Explosion-Proof Speakers.** Approved for service in contaminated atmospheres by Underwriters Laboratories, several sizes and types of explosion-proof high-efficiency public-address speakers have been introduced by Atlas Sound Corp., 1451 39th St., Brooklyn 18, N. Y. The speakers are available in Class I, groups C and D, and

HARVEY Reports on HI-FI

November-December, 1956



The hi-fi sets ought to outnumber the neckties under the Christmas trees this year — if we can judge at all from the phenomenal crowds and the alternately rapt and hungry looks we observed at the recent New York High Fidelity Show. That HARVEY's will be the chief supply depot for Santa's hi-fi-bearing reindeer is another pretty safe prediction. As for specific recommendations in the way of components for yuletide electronic cheer, here is a particularly rich harvest of current developments:

Possibly the biggest news is the appearance of the Ampex A series tape recorders and matching amplifier-speakers — a dramatic bid for the home hi-fi market by the most renowned name in strictly professional tape recording equipment. The A series, featuring two-track stereophonic playback in addition to monaural recording and reproduction, is definitely designed and priced for home music systems, but a lot of the famous engineering finesse of the Ampex professional line has rubbed off on it. The newly developed 7½ and 3¾ ips tape transport is very rugged, smooth and accurate, despite its simplicity, and there is no audible flutter or wow at either speed. There is a tape position indicator of novel and foolproof design; a volume level meter as on all Ampexes; mixer-fader controls; and a positive record safety button. The amplifier-speakers are of the already celebrated Ampex design that achieves genuinely wide-range, distortion-free response in a little less than 1½ cubic feet — speaker, tubes, resistors, capacitors, box, air and all . . . The A122 tape recorder (that's the portable, stereophonic model in the A series) sells for \$449.50 less microphone. The A692 amplifier-speakers, in two-tone grey portable cases that match the A122, are priced at \$199.50 apiece — and you'll need two of them for stereo, alas . . . But wait till you hear the sound!



There is great news on the tuner front, too. The two new Sherwood tuners are just about "it" (that elusive "it" pursued by the vanguard of audiophiles and high-fidelity manufacturers) — unless, of course, your quest for quality won't stop short of broadcasting-type equipment, multiple meters and multiple zeros after the price. Both the new Sherwood S-2000 FM-AM tuner (which has been around for some months but is now even further improved in sensitivity) and the even newer S-3000 FM-only tuner have been designed by sound-conscious engineers with particular attention to audio quality. This is uncommon in the tuner field, where the emphasis has consistently been on RF circuit refinements. It so happens, though, that the S-2000 and S-3000 are just as great RF-wise as they are smooth in sound — with an FM sensitivity of 0.95 μ v for 20 db quieting; special 6BS8 cascode RF amplifier stage; balanced FM input transformer (for maximum noise rejection); super-stable FM oscillator circuit using mixer cathode injection; and an advanced extra-wide-band AM circuit in the S-2000. The S-3000 has, in addition, the most accurate and easy-to-read tuning eye we have seen — it's an entirely new type — and a special switch for suppressing cross-modulation images on strong local signals. But we must come back to the sound: The specified intermodulation distortion on FM in either tuner is less than 1½% at 100% transmitter modulation (most tuner manufacturers are rather vague on this point), and harmonic distortion is less than 1% at 400 cps with 100% modulation. You can hear it, too . . . Best of all, the S-2000 costs only \$139.50 (slightly more for special decorator styles) and the S-3000 only \$99.50.

Speaking of small speaker systems, the brand-new L.E.E. 'Trio' 2-way system is about the finest thing we could name at the moment in the under-\$125 category. It is the fourth in size and price of a new line of five speaker systems headed by an improved version of the already famous 'Catenoid' corner horn. The 'Trio' is definitely your meat if you're looking for a speaker of reasonable but not diminutive size that can approximate that smooth, authoritative sound of the genuinely big systems and will also acquit itself as a handsome piece of furniture in any living room setting. It incorporates a single woofer, partly horn-loaded and partly resistance-controlled by friction loading; two cone-type tweeters (very smooth); and crossover at 6500 cps. It fits nicely into almost any corner, measuring only 19" along the wall and less than 34" from the floor. It covers the 50 to 15,000 cps range without peaks or that cramped, constrained effect — a very rare virtue among smallish systems; handles 20 watts continuous power; is finished in nearly indestructible formica; and costs just \$119.95.



The Christmas shopping season is also a particularly good time to remember that you can always save time and avoid the crowds by taking advantage of HARVEY's famous mail order service. Shop from these pages, lookout some of our older ads, enclose a postage allowance with your payment (excess will be promptly refunded), and have faith in our recommendations and our money-back guarantee. Between the two, you can't lose . . .

HARVEY RADIO CO., INC. 1123 Avenue of the Americas (6th Ave. at 43rd St.), New York 36, N.Y. JUDSON 2-1500

A N O T H E R
BOZAK
 F I R S T . . .

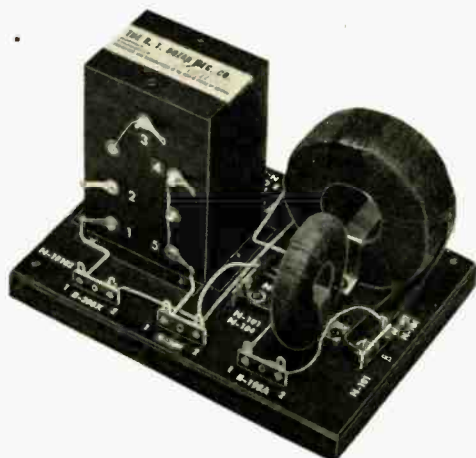

the N-10102 Convertible Crossover Network

Grows with your Bozak Speaker System

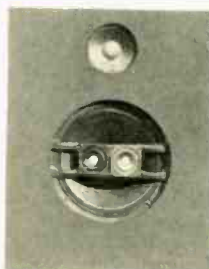

Wired as an N-101 it has an 8-Ohm Impedance and the slow 6-db-per-octave Crossovers at 800 and 2500 cycles for the one-woofer Bozak B-302 Speaker System.

when your B-302 grows into a two-woofer B-305

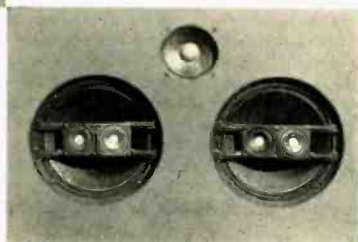

just remove two leads and transfer two others, and you have the 16-Ohm Impedance and the same slow Crossovers at 800 and 2500 cycles needed for this outstanding System.

For the magnificent four-woofer B-310 and B-400 . . . add a condenser bank and change four leads for the 8-Ohm Impedance and slow Crossovers at 400 and 2500 cycles.

The N-10102 Crossover Network, like Bozak Loudspeakers, is never outgrown . . . never becomes obsolete. Together they mean

The Very Best in Sound

THE R. T. BOZAK SALES COMPANY



BOX 966 • DARIEN • CONNECTICUT
 EXPORTS: ELECTRONICS MANUFACTURERS' EXPORT COMPANY, PLAINVIEW, NEW YORK

Class II, groups D, E, and F. All models are available with built-in line matching



transformers. Free catalog description will be mailed upon written request. **V-11**

• **Turntable Base.** Beauty of appearance and scientific design are combined in the new turntable base recently introduced by Ingalls Electronics Company, 30 W. Putnam Ave., Greenwich, Conn. The mounting board is float-mounted on specially-developed latex-impregnated felt,



which reduces the effects of feedback to a negligible minimum. Adjustable inserts (also available separately) in each leg provide accurate levelling. The base is available in a wide range of hand-rubbed finishes. Dimensions are 20" x 20" x 5"d. Deluxe in every respect, it will enhance the performance of any turntable with which it is used. **V-12**

• **Goodmans Mid-High and High-Frequency Speakers.** Designed for use with the Goodmans Audion woofer to form a three-way speaker system, the Midax and Trebax drivers cover mid-high and high frequencies, respectively. The Midax is a pressure-type unit with frequency range extending to 8000 cps. The Trebax, illustrated, is equipped with a built-in horn and extends the range of the system to

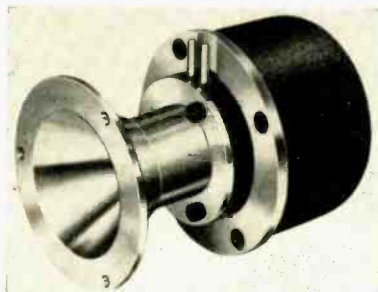

15,000 cps. Recommended crossover frequencies are 750 and 5000 cps. Impedance of each unit is 15 ohms. The Trebax may be used with any Goodmans full-range Axiom speaker to form a two-way system. In conjunction with the new speakers Goodmans has also introduced matching crossover networks. For complete information write Rockbar Corp., 650 Halstead Ave., Mamaroneck, N. Y. **V-13**

• **G-E Transistorized Preamplifier.** Using a tube-transistor combination, the new General Electric Model A1-203 preamp is believed to be the first in the industry to combine the economy of tube-designed circuitry with the low-hum performance of transistors. A self-powered unit designed for operation from regular house current, the preamp will operate with all types of standard magnetic pickups, and is equipped with a slide switch to convert from phono to microphone operation. It is provided with full RIAA equalization for phono playback. Frequency range is 30 to 20,000 cps. The unit is



described as "supersensitive" with an 8 millivolt input and a 1-volt minimum output. Three input jacks are provided: one for low sensitivity, one for medium sensitivity, and another for high sensitivity, to match the voltage output of various cartridges. A high-gain double-triode voltage-amplifier tube is used following the input transistor to provide output level in keeping with the input sensitivity of most standard amplifiers. Also shown in the photo is the new G-E high-frequency speaker and its associated dividing network. General Electric Company, Electronics Park, Syracuse, N. Y. V-14

• **Heathkit Audio VTVM.** This new VTVM kit emphasizes stability, broad frequency response, and sensitivity. It is intended especially for audio measurements and for measuring low-level a.c. in such circuits as power-supply filters. Circuit design employs a cascade amplifier with cathode-follower isolation between the in-

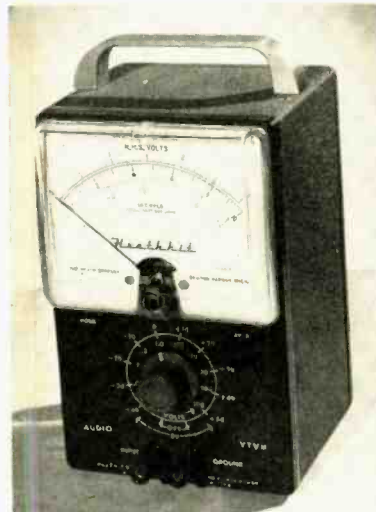

put and the amplifier, and between the output stage and preceding stages. Input impedance is 1 megohm at 1000 cps. The extremely wide voltage range covered by the Model AV-3 makes it particularly valuable for experimental laboratories as well as for service work. A.C. rms ranges are 0-.01, .03, .1, .3, 1, 3, 10, 30, 100, and 300 volts. VU ranges cover -52 to +52 db. Multiplier resistors with tolerance of 1 per cent are employed for maximum accuracy. The Heath Company, Inc., Benton Harbor, Mich. V-15

**the professional tape recorder
that eliminates
every editing and cueing problem!**



magnecord P-60-AC

The magnificent new Magnecord P-60-AC is designed for the perfectionist and the professional as the ultimate in durability, frequency response and ease of operation.

This sensational new recorder has justly been named "The Editor" because it meets every professional requirement for simplicity, speed and versatility in editing, programming and cueing. For example, with the machine in the "edit" position and the head cover open, the tape is easily moved for marking or cueing because of the free floating reels. For perfect cueing, you merely grasp each reel and glide the tape over the heads while the tape lifter knob is in manual cueing position. There's also an ideally easy way to cue up the spot—just another proof that "The Editor" will set new standards of excellence in broadcasting studios!

Conforming with all NARTB characteristics, the P-60-AC rack-mount recorder is powered by 3-motor direct drive, with two-speed hysteresis synchronous drive motor. All controls are swiftly operated by push button. Tape speeds of 7½ and 15 IPS are instantly changed by switch. Deep slot loading and automatic tape lifter for fast forward and rewind.

Solenoid brake control automatically prevents tape spillage. Takes 10½"

NAB reels; automatic shutoff at end of reel prevents thrashing, tape breakage.

Separate erase, record and playback heads allow simultaneous record and playback. The new P-60-C amplifier makes perfect equalization simplicity itself; the result is lifelike sound from every recording you make!

The P-60-AC has potted laminated heads which give the longest head life possible. Frequency response 40 to 15,000 cycles at 15 IPS; 40 to 12,000 cycles at 7½ IPS. Signal to noise ratio, 55 db. at 3% THD full track. Wow and flutter, .2% at 15 IPS; timing accuracy, 3 sec. ± in 30 minutes.

The P-60-AC can be serviced on the spot; all motors and controls are on separate easily removable assemblies. Rewinding time of a 10½" NAB reel is under 100 seconds! Never before has a professional tape recorder offered such precision features at such low cost!

Full track heads are standard; half-track heads may be specified.

FREE BROCHURE — Get all the facts. Use the convenient coupon today! You'll be glad you did!

magnecord, inc.

1101 S. Kilbourn Ave.
Chicago 24, Illinois

MAGNECORD, INC. Dept. AUD. 11
1101 S. Kilbourn Ave., Chicago 24, Ill.
Please send me your illustrated folder on the new Magnecord P-60-AC.

Name _____
Address _____
City _____ Zone _____ State _____

AUDAX TONE-ARM NOW IN KIT FORM

Anyone can assemble it in about 10 minutes—and save 50%. Exactly duplicates Audax "Compass-Pivoted" transcription arm long recognized as top "blue chip". "Selector-Index" permits instant adjustment for any stylus pressure. Newly-designed cartridge housing permits all-important stylus-to-groove alignment at a glance. Accommodates ANY cartridge.

KT-12 \$14.55 NET;
factory-assembled
\$24.00 NET.



KT-16 \$17.55 NET;
factory-assembled
\$30.00 NET.

LISTENING QUALITY

is everything

Impartial Lab reports on the new Audax Hi-Q7 magnetic cartridge:

A leading recording studio:

"Because readings showed an amazing total lack of distortion, check tests were repeated 3 times."

Consumer sheet:

"Good frequency and transient response. Practically no high frequency distortion. Low intermodulation distortion."

Listening quality is

everything — and the new Audax Hi-Q7 has it to a degree not equalled by any other pickup. But — HEAR it yourself — there is no other way! Net \$47.70 with 1 Chromatic Diamond and a Sapphire. Other models as low as \$20.70 Net.



STYLUS-BALANCE

"... this really works..." Canby

Stop deformation of record grooves! Only Audax Stylus-Balance can give you the all-important certainty of correct stylus pressure—ALWAYS. Precision-calibrated like a pharmacist's balance. Works with any arm and cartridge. Gold Finish. Net \$4.80 (add 25¢ if shipped from N. Y.).

LISTENING QUALITY CUTTERS

Flat to 14,000 cps. Distortion 0.6% at 1000 cps. Fully modulates groove with input of about 16 db with 220 lines. Z's up to 500 ohms. Two models:

H-5 Net \$111.00
H-4 Net \$75.00



FREE copy of \$1.00, 22-page, 1956 reference guide, "ELECTRONIC PHONO FACTS" — by pioneer Maximilian Weil — at your dealer, or write us.

AUDAK COMPANY

500 Fifth Ave., dept. A, New York 36
Fine audio-electronic apparatus over 30 years

AUDIO ETC.

Edward Tatnall Canby

Audio for 1957 —The Pep and the Push

THE VERY FIRST serious article I ran into after coming home last fall was a piece in *Scientific American* that hit my fine, objective, distant-view mood exactly, though it was pessimistic. It told, in chilling understatement, of the very likely disappearance of our fossil fuel reserves—coal, oil, gas—in the near future; it extrapolated curves and quoted detailed studies that show our production flattening off and beginning to drop in just a few years from now. What! The world practically runs on such fuel. What of our 250 hp autos? (And, in very small letters, what of audio and hi-fi?) Merely a long-range look, a dozen or so years hence, this.

"We have based a major part of our existence on liquid fuel. And yet we must face the prospect that supplies will soon be inadequate even for our present population. We can look forward to a profound revolution in automotive transportation within the next two decades." Our huge demand for oil, the article says, will still be "on the rise when production begins its inexorable decline," a few short short years hence. "There are important political and economic implications in the prospect that serious shortages will come to the U. S. before they are felt abroad." (Take that.)

Doesn't it give you the willies? What of audio 1967, in the face of this sort of sober prophecy? Well, you'll be thinking, we'll have nuclear energy by then, and all the power we can use, so why worry about audio 1967 when you've got 1957 right in front of you. Oh yeah? Read this: "If all our present electrical power were generated by nuclear reactors, this would save only 12 per cent of our fossil fuel." If you question it, look into the article yourself. But, you thought (and I'm still dragging you away from audio, 1957), we're bringing in huge new oil reserves all the time, so why worry. "Since consumption is rising so rapidly" (and hi-fi takes its share, remember), "even a 50 per cent increase would postpone the peak dates (in our oil production capability) only a few years."

The thing, it seems, is inevitable. "We would be pleasantly excited by a new 100-million-barrel oil field in the U. S., but such a field would amount to only a 12-days' supply at our current rate of con-

sumption."

Hey, you're thinking, let's get back to important business, to Audio 1957. Well, let's, and I won't quote more oil statistics. Look in the October *Scientific American* if you feel like being further disturbed. I'll only suggest that when you've been away from home long enough to see America from a wee bit of a distance, you'll fall hard for that sort of article simply because it lifts you out of the microscopic present into a very near future.

The finest thing, you see, about a leisurely trip away from one's own country is that it makes one pause, so to speak, to think. Who are we? Where are we? Where are we going, at such breakneck speed? It makes one look hard at things as they are, as they are taken for granted, here in our hectic life at home. Such a trip gives any observant traveler who stops long enough to let his surroundings sink in upon him a kind of objectivity that he can rarely acquire at home, in the middle of things. That's how I felt last month.

Well, from oil to audio. I zoomed straight from London right square into the midst of the New York High Fidelity Show. What an experience! What a jolt, to find one's self in two such different worlds within hours. I wouldn't have missed it for anything.

Now don't get me wrong. I'm not about to issue a complaint against hi-fi shows. As a matter of fact, after a summer of no audio at all I found the whole show stimulating and exciting and I noticed with pleasure a raft of things that I probably wouldn't have been aware of if I hadn't come back suddenly, from such a distance. That, you see, is why I travel away, every so often. Not (as the boss said) to see what's doing in European audio, nor to follow the music festivals (I didn't hit even one of them), but simply to be able to come back and look at the home situation with fresh ears. It's worth a lot of money and time.

I dreaded the hi-fi show. I hated to get myself en route to it, and I almost swore I just wouldn't go, this time. But I hadn't yet realized how neatly I'd opened my ears and eyes during three months of absence. Instead of hating the show, I liked it a lot. I didn't even mind the racket, and I found the music good every time I got to hear any by itself. I liked the fast-

* 780 Greenwich St., New York 14, N. Y.

stepping bustle of a typical wild-and-woolly American commercial exposition. I thrilled to the action, the pep, the enthusiasm, the get-it-done push. That's US, I thought, and I was glad it was US.

And so, while the oil still holds out, while there's still a bounteous supply of that extremely dubious and complex commodity, 117-volt a.c., nuclear or otherwise—what's new in Audio for 1957? What'll we have for this next year, as the oil-less millenium gets closer and closer?

Solid Art, Real Hi-fi

Before you start buying up battery portables, you might as well indulge one last ten-year fling in power consumption out of our present unrationed wall sockets. Audio for 1957 is all set to burn up the power, just as the autos for 1957 are set to dispose of another chunk of our oil reserves. Things are booming along towards an ever-expanding audio market and I was honestly astounded at the scope and size of hi-fi production outlined for this coming year, after the long summer of audio parsimony I experienced elsewhere.

What a genius we have for sheer production. What a gorgeous, wasteful, wide-open people we are, compared with so many others who have equally fine brains, equally good engineering, but who are geared to caution, who build not for the gorgeous today but for the doubtful tomorrow, who are more interested in making things last than in making them obsolete. Our audio, like everything else here, rushes giddily ahead and—if anything visible or audible is left of it in a thousand years—I'm sure we'll be the wonder of future historians and archaeologists.

First, I found that the area of hi-fi consolidation is still very much with us for 1957. Not really very much that is radically new. No terrific sensations, no violently new principles. Even the electrostatic speaker was with us last year, though not in production, and the noblooming stereo tape field was incipient a good many seasons back, though it reaches practicability this year for the first time. As in the last several years, we are polishing off audio for the Larger Public, advancing on a million secondary fronts of importance, from the convenience of better control systems to the beauty of finer looking exteriors. Big emphasis on this last. This year, for the first time, the hi-fi show was fully as visual as it was audible. There are things to look at, and not merely the slick paper flyers either. The stuff itself is getting to be both handsome and really original in sheer outward design.

We're a dizzy people in some ways and no wonder the Europeans don't always understand us. I think I do, a bit. We are the most illogical souls on earth. We never approach a new subject, a new development, a new field, with the sort of sensible, careful planning that Europeans expect. We jump in with all four feet. We yell our heads off, we commit every excess in the book, we produce horrible junk, we go off the beam in every way imaginable. We blow up the virtues of everything via the printed and spoken word until what we say makes no more sense than monkey gib-

**New Styling...
New Features...
A Completely New Line
from H. H. Scott**

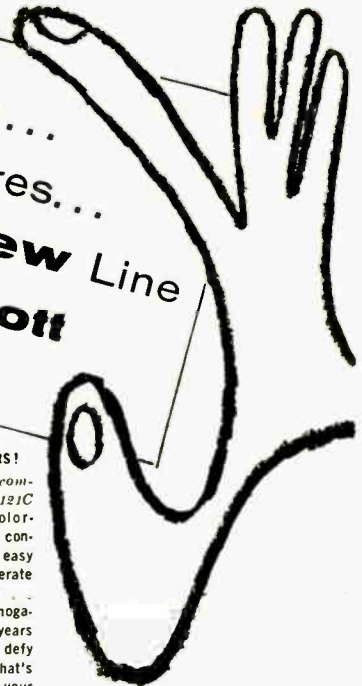

210E

3 NEW FEATURE-PACKED AMPLIFIERS!

(Models 210C, 210E complete amplifiers, 121C preamplifier) Color-marked Green Dot controls that make it easy for your family to operate your hi fi system... smartly designed mahogany cabinets... years ahead features that defy obsolescence... that's H. H. Scott for '57, your best dollar investment. See for yourself!



330B

4 NEW SUPER-SENSITIVE TUNERS!

(Models 330B, 331B AM-FM tuners; 311B, 310B FM tuners) For the first time AM that gives you audio response beyond 10 kc... FM with new wide-band circuitry that makes drift a thing of the past... AM-FM tuners equipped for Stereophonic (binaural) operation. That's H. H. Scott for '57. Hear for yourself!

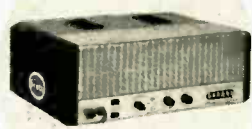

280

2 COMPLETELY REDESIGNED POWER AMPLIFIERS!

(Models 240, 280) Exclusive Dynamic Power Monitor on Model 280 affords full output on music, yet protects expensive speakers against burnout... variable damping controls for perfect speaker matching... new exterior styling... clean distortion-free performance typical of all H. H. Scott components. Judge for yourself!

ALSO SEE THE NEW 710A TURNTABLE

Visit your dealer or write today for complete technical specs.

H. H. Scott Inc.
385 Putnam Ave.
Cambridge, Mass.



Please rush me your new catalog A-1 and complete technical specifications on H. H. Scott components for '57.

Name

Address

City

State

Export Dept: Telesco International Corp., 270 Park Ave., N. Y. 17

The magic word in speakers!

ELECTROSTATIC

...product of 9 years

of **JansZen**

research

and backed by an unprecedented



The JansZen Electrostatic speaker brings laboratory-perfect sound into your living room! Unlike paper-cone speakers, the Electrostatic transforms electrical energy directly into sound, through four electrostatic radiators arranged to give 500-30,000 cps. response at 120 degree dispersion.

Each of these four radiators is actually a condenser-type unit with a virtually massless diaphragm stretched between the plates . . . driven over its entire surface by variations in the electrostatic field. This diaphragm is so light, it acts like just a layer of air . . . thereby giving a perfectly flat response, free from breakup and resonances in the audible range. An additional advantage of the JansZen Electrostatic is that its radiators remain unaffected by changes in humidity and temperature . . . so stable and dependable are these radiators that we guarantee them for two full years!

*Radiators guaranteed 2 years;
Balance of speaker guaranteed 1
year. Based on a remarkable new
principle in the transmission
of sound.

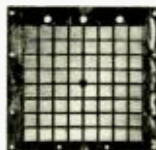

Mahogany,
Birch, Walnut
and Utility
finishes available
on request.

JansZen ELECTROSTATIC

Loudspeaker



Send for complete literature on the JansZen 1-30 Electrostatic
as well as the name of your nearest dealer!

Product of **NESHAMINY ELECTRONIC CORP.** Neshaminy, Pa.
Export Division: 25 Warren St., New York 7, N. Y. Cable: Simonrice, N. Y.

berish. Claims! Exaggerations! Half-truths!

And yet, in the long run, we end up having *done* something. We come through, in the end, with as much serious, practical, beautiful progress as could possibly be desired, by the most logical and planned development you could ask for. We are a people of action, and though I would hardly suggest we are of the old sort, of few words and much action, I do suggest that it's our actions, our accomplishments, that are our measure, not our billions of words. And so, with audio.

My feeling is that this year the outward design of audio components really begins to approach the beautiful, the artistic, to compete in good looks and in originality with any craft art of any time in the world's history. A big statement, and there's plenty of junky, foolish, ugly, un-aesthetic audio still around. Yet on the whole the stuff is impressive for sheer good looks this year, and I don't refer only to the new Eames speaker systems, designed by the man who makes the fabulous Eames furniture.

I mean this quite seriously. I think we can now begin to look upon the audio product in terms of solid, artistic endeavor, to compete with anything, anywhere. And the punk stuff will get less, the good stuff better, if this year's designs are any indication. That's point Number One for 1957, in my book.

Secondly, I distinctly felt, at this year's big hi-fi show, that the quality of sound was improved—*really* improved. There was less of that dreadful noise that has been known as hi-fi sound these last few years. Less of the tinny, screeching exaggerations of metallic high tones, less of the earth-shaking pounding bass, that have lately been all the rage, though about as unnatural as any sounds imaginable.

Maybe it was the new and much better location of the show that made the difference. We did have much better acoustics, better sound proofing in the corridors, a system of windows looking into each exhibit, that gave visitors a preview of what was inside and so made the wide-open door a bit less mandatory. More of the sound was kept inside the show rooms than in any year I can remember.

Even so, I couldn't help feeling that moderation was in order, with only a few glaring exceptions. The sound was everywhere quieter, more musical, less exaggerated. Which reflects, I trust, a solid advance this year towards the growing-up of big-time hi-fi. We are now beginning to have *real* hi-fi, at last, good sound reproduction for the sake of the sense of the sound itself, rather than as sheer electronic power. You see, we do come out on a straight and even keel, we Americans, after we've had our fling at zaniness. We always do.

I was astonished to hear in a large number of exhibits a really good low-bass sound, quiet and natural. True low bass, remember, is largely unobtrusive and very seldom overpowering. It should always be audible, and even feelable, but it practically never should threaten to knock you over. Low bass is mostly just a subtle, all-important coloration, a little bit going a

long, long, way. That's what we're beginning at last to realize, in a grown-up sort of way.

I was equally pleased to hear any number of hi-fi demonstrations at the show where the high end of the spectrum was smooth, clean, and natural, without undue loudness. Hard to believe, but there it was.

Somehow I feel that the mere fact of this sensible moderation is much more important than the technical details of how it was achieved. We've had available good, natural highs and clean, natural low bass for some years now—if and when we wanted it. Mostly we didn't, and former hi-fi shows have merely shown the world that the hi-fi movement was still, willfully, in the dizzy, all-out, nutty stage. As long as people wanted it that way, as long as the demonstrations had it that way, you could expect to find the internal design of many of our components slanted towards the zany kind of sound. But now, it seems, we're beginning to want the real thing, even if it is less spectacular. And for that very reason, equipment this year is better, can produce better and more natural sound more easily.

Good looks. Better sound. Hi-fi is growing up. This is the big news of 1957. The rest, mainly, is a matter of refinements. There really was remarkably little of startling newness to be seen. Good! The hi-fi area of dizzy sensations is narrowing down. The business is getting itself onto a more reasonable and more solid footing, with standards that become more trustworthy, each of these years.

The fact that hi-fi as a whole is still growing bigger is an even more pleasant sign. Hi-fi can grow, and at the same time consolidate in more permanent, more sensible form. Good prognosis. Expansion and consolidation, both at once.

I'll only mention a couple of continuing trends that showed up well in the exhibits. The biggest were the electrostatic speakers and the stereo tape players. In both cases there is concrete evidence this year of practicality, where in the past we've seen mainly stuff for the Few, at a price.

There were enough new small stereo tape phonographs shown this year to make it clear that two-channel stereo tape is here in a practical way for plenty of people. Not cheap yet, not by any means a mass product. But there are players, quite reasonably priced, and there are tapes, dozens and dozens of them of all types. Big progress in practicality over last year.

The several full-range electrostatic loudspeakers demonstrated this year were strictly for practice, and not for home consumption. But the electrostatic principle is now solidly established in its most useful area, the upper range of musical tones. The commercial electrostatic's tweeter and mid-range coverage while still expensive is now definitely within reach of anybody, and well worth it too. A lot of that new and beautifully natural high-range sound I heard was due to the electrostatics that were on hand throughout this year's show.

Indeed, I suggest, the purity of good electrostatic highs has had much to do with showing up the tinny deficiencies of a lot of our recent "hi-fi" sound. Once the all-potent public gets its ears on really clean

(Continued on page 98)

MAGIC

BELT-DRIVE FOR

FREE HI-FI

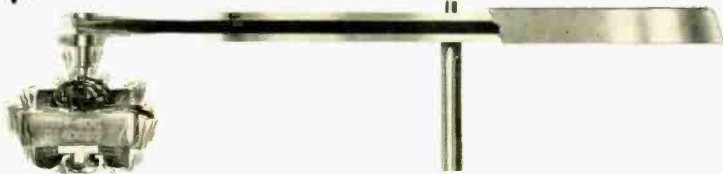

- FACT 1:** all motors vibrate more than the groove amplitude, necessitating isolation.
- FACT 2:** motor vibration never reaches the turntable in Components Professional Junior because its belt-drive is engineered to isolate the motor from the turntable.
- FACT 3:** only a belt-driven turntable can achieve rumble-free performance.

Compare the Professional Junior with five other makes for rumble-free performance at a budget price.

Features	Professional Junior	Brand A	Brand B	Brand C	Brand D	Brand E
Belt Driven	Yes	Yes	No	No	No	No
4-Speed	Yes*	No	No	No	No	Yes
Noise Level 60 DB/7 cm	Yes	No	No	Yes	Yes	No
Wow & Flutter 0.1% r.m.s.	Yes	Yes	Yes	?	Yes	No
Eliminates noisy idlers	Yes	No	No	No	No	Yes
Price Under \$40	Yes	No	No	No	No	No

THE "PROFESSIONAL"

"Junior"

Your Best Turntable Buy

For Only \$39.50



Hi-Fi Do-It-Yourself Records 89¢ at your dealer, or \$1.00 postpaid from Components Corp.

*Accessory for Extra Speed \$2.50 each

Components Corporation

DENVILLE, NEW JERSEY

BEST BUY
IN HI-FI
Grommes



The Grommes Premier 212

A deluxe equalizer pre-amplifier control center, the Grommes Premier 212 provides the ultimate in high fidelity performance. Featuring exceptional flexibility with 14 controls including 6 position turnover and roll-off record compensators, bass, treble, presence and low frequency balance controls. 8 inputs with 2 phono channels and equalized tape head input. Freq. Response: +0.1 DB, 10 to 20,000 CPS. Distortion: 0.5% harmonic and 0.1% intermodulation at 10V output. Finish: Charcoal Gray and Brass. For tabletop or cabinet installation.

Net Price \$129.50

Grommes Premier 260. 60 Watt Basic Amplifier. New advanced high fidelity circuitry. Featuring direct coupling, cathode coupled phase inverter, feedback cathode follower drivers and push pull 6650 tubes. Premier fidelity assured when combined with the Grommes 212.

Net Price \$169.50

Ask your Dealer to demonstrate the Premier 212 and 260, or write for complete specifications.

Grommes
Division of Precision Electronics, Inc.
Dept. A-11, 9101 King St.,
Franklin Park, Ill.

Send complete specifications.

Name

Street

City Zone State

INTERACTION CONCEPT

(from page 36)

nearer the response band than the other three, the complex attenuation factor may be written,

$$A = F - 3(1+n)x^2 + nx^3 + j(3+n)x - j(3n+1)x^2 \quad (29)$$

The attenuation response then becomes,

$$db = 10 \log_{10} [F^2 + \{(n+3)^2 - 6F(n+1)\}x^2 + (3n^2 - 2n + 3 + 2nF)x^3 + (3n^2 + 1)x^4 + n^2x^5] \quad (30)$$

$$db = 10 \log_{10} [F^2 + (16 - 12F)x^2 + (4 + 2F)x^3 + 4x^4 + x^5] \quad (30a)$$

$$db = 10 \log_{10} [F^2 + (n^2 - 6nF)x^2 + (3n^2 + 2nF)x^3 + 3n^2x^4 + n^2x^5] \quad (30b)$$

$$F_x = \frac{3(4x_p^2 + 1)(x_p^2 + 1)^2}{3 - 2x_p^2} \quad (36b)$$

The height of the peak can be determined by using the same value of x_p and F_p substituted into (30), normalized to zero level for the amount of feedback used (F_{xp}).

$$db_{peak} = -10 \log_{10} \frac{16(1+x_p^2)(1-x_p^2)^2}{(4+2x_p^2+3x_p^4+x_p^6)^2} \quad (37a)$$

$$db_{peak} = -10 \log_{10} \frac{(1-3x_p^2)^2(1+16x_p^2)}{(1+x_p^2)^2(1+4x_p^4)^2} \quad (37b)$$

The response characteristic at the peaking boundary, also normalized for level, is

$$db = 10 \log_{10} \left[1 + \frac{36(n+1)^2(3n^2-2n+3) + 12n(n+1)(n+3)^2}{(n+3)^4} x^2 + \frac{36(3n^2+1)(n+1)^2}{(n+3)^4} x^3 + \frac{36n^2(n+1)^2}{(n+3)^4} x^4 \right] \quad (38)$$

Feedback for the peaking boundary is given by equating the coefficient of x^2 in (30) to zero:

$$F_p = \frac{(n+3)^2}{6(n+1)} \quad (31)$$

$$F_p = 4/3 \quad (31a)$$

$$F_p = n/6 \quad (31b)$$

$$db = 10 \log_{10} \left[1 + \frac{15}{4}x^2 + \frac{9}{8}x^3 + \frac{9}{16}x^4 \right] \quad (38a)$$

$$db = 10 \log_{10} [1 + 120x^2 + 108x^3 + 36x^4] \quad (38b)$$

When the four-stage arrangement is changed to two rollofs at each of the alternate values, the complex attenuation factor may be written,

$$A = F - (n^2 + 4n + 1)x^2 + n^2x^3 + j2x(n+1)(1-nx^2) \quad (39)$$

The attenuation response then becomes

$$db = 10 \log_{10} [F^2 + \{4(n+1)^2 - 2(n^2 + 4n + 1)F\}x^2 + \{2n^2F + (n^2 + 1)^2\}x^3 + 2n^2(n^2 + 1)x^4 + n^4x^5] \quad (40)$$

$$db = 10 \log_{10} [F^2 + (16 - 12F)x^2 + (4 + 2F)x^3 + 4x^4 + x^5] \quad (40a)$$

which is the same as (30a) as rollofs are identical.

$$db = 10 \log_{10} [F^2 + 2n^2(2-F)x^2 + n^2(n^2 + 2F)x^3 + 2n^2x^4 + n^4x^5] \quad (40b)$$

Feedback for the peaking boundary is given as,

$$F_p = \frac{2(n+1)^2}{n^2 + 4n + 1} \quad (41)$$

$$F_p = 4/3 \quad (41a) = (31a)$$

$$F_p = 2 \quad (41b)$$

The frequency of stability boundary oscillation is,

$$x_s^2 = 1/n \quad (42)$$

$$x_s^2 = 1 \quad (42a) = (32a)$$

$$x_s^2 = 1/n \quad (42b)$$

and the feedback necessary,

$$F_s = n + 3 + \frac{1}{n} \quad (43)$$

$$F_s = 5 \quad (43a) = (33a)$$

The stability boundary is obtained by equating both imaginary and real parts of (29) to zero, giving the frequency of oscillation,

$$x_s^2 = \frac{3+n}{3n+1} \quad (32)$$

$$x_s^2 = 1 \quad (32a)$$

$$x_s^2 = 1/3 \quad (32b)$$

and the feedback necessary,

$$F_s = \frac{(n+3)(8n^2+9n+3)}{(3n+1)^2} \quad (33)$$

$$F_s = 5 \quad (33a)$$

$$F_s = 8n/9 \quad (33b)$$

The range of feedback between the peaking and stability boundaries is given by,

$$\frac{F_s}{F_p} = \frac{6(n+1)(8n^2+9n+3)}{(n+3)(3n+1)^2} \quad (34)$$

$$F_s/F_p = 15/4 \quad (34a)$$

$$F_s/F_p = 16/3 \quad (34b)$$

The relation between feedback and frequency of peak can be plotted by differentiating (30) and solving for F ,

$$F_{xp} = \frac{x_p^6 + 3x_p^4 + 2x_p^2 + 4}{3 - x_p^2} \quad (35a)$$

$$F_{xp} = n \frac{(4x_p^2 + 1)(x_p^2 + 1)^2}{2(3 - 2x_p^2)} \quad (35b)$$

or, normalized to "excess feedback," by dividing by (31),

$$F_x = \frac{3(x_p^6 + 3x_p^4 + 2x_p^2 + 4)}{4(3 - x_p^2)} \quad (36a)$$

$$F_s = n \quad (43b)$$

The range of feedback between the peaking and stability boundaries is

$$\frac{F_s}{F_p} = \frac{(n^2 + 3n + 1)(n^2 + 4n + 1)}{2n(n+1)^2} \quad (44)$$

$$F_s/F_p = 15/4 \quad (44a) = (34a)$$

$$F_s/F_p = n/2 \quad (44b)$$

The response characteristic at the peaking boundary, normalized for level, is

$$db = 10 \log_{10} \left[1 + n^2 \left(1 + \frac{n^2}{4} \right) x^4 + \frac{n^4}{8} x^8 + \frac{n^4}{16} x^8 \right] \quad (45b)$$

This is normalized to the remote frequency. Normalizing the same response to the early rolloff frequency,

$$db = 10 \log_{10} \left[1 + \left(\frac{1}{4} + \frac{1}{n^2} \right) y^4 + \frac{1}{8n^2} y^8 + \frac{1}{16n^2} y^8 \right] \quad (46b)$$

Or, to the mean frequency, which is the ultimate frequency of instability,

$$db = 10 \log_{10} \left[1 + \left(1 + \frac{n^2}{4} \right) z^4 + \frac{n}{8} z^8 + \frac{1}{16} z^8 \right] \quad (47b)$$

TIME-DELAY

(from page 25)

in the envelope"; but the intervening vocabulation, extolling the supposed merits of "real, genuine, simulated diamonds," has been harmlessly dissipated as millicolories of heat, instead of raising your blood pressure by millimeters of mercury.

PARTS LIST

Main Control

- 1 SeeZak expandable chassis, 4 x 6 x 2, with bottom plate
- 4 1/8" rubber feet, with mounting screws
- 1 Amphenol 91MC3F female cable connector
- 1 Potter & Brumfield MR-11A relay, DPDT, 6.3 v. a.c. coil.
- 1 10-ohm 1-watt carbon resistor
- 1 Dialco 705 socket
- 1 #44 pilot lamp
- 1 Amperite 6C90 time-delay unit
- 1 Switchcraft JJ-033 jack, 3-ct.
- 1 Toggle switch, SPST
- 1 Unimax MXJ-1 push button, SPDT

Main Cord

- 1 Amphenol 91MC3M cable connector
- 1 Switchcraft 267 phone plug
- Desired length of 2-wire shielded mike cable (limit 50 ft.), Belden 8414

Extension

- 1 Aluminum box chassis, 1 1/2 x 1 1/2 x 2 1/4 in.
- 1 Switchcraft PJ-068 phone plug
- 1 Rubber grommet, to fit mike cable
- 1 Switchcraft 201 push button, SPST, N. O.
- Desired length of 2-wire shielded mike cable (limit 50 ft.), Belden 8414

NEW!



Altec's sensational 260A amplifier delivers the most undistorted power per dollar!

Altec Lansing engineers invite you to check carefully the amazing specifications of the new 260A amplifier. They believe you will agree that 260 watts of power available throughout the extended frequency range of 40 to 15,000 cycles sets the 260A apart as an outstanding development in the field of heavy duty amplifiers for public address, industrial and laboratory use. The fact that this entire power output is available at less than 2% distortion also indicates the high quality of this highest power Altec amplifier.

Regardless of whether your amplifier needs dictate a power output of 10 watts or 260 watts, an Altec Lansing amplifier is your best choice to deliver the most undistorted power per dollar.

Altec Lansing also manufactures a complete line of high quality microphones, control consoles, loudspeakers, horns, tuners, scientific instruments, theatre systems, public address systems, high fidelity systems and transformers.

SPECIFICATIONS:

Gain: 50 db; 30 db, bridging 600 ohm line
 Input Sensitivity: 1.2 v rms/600 ohms
 Power Output: 260 watts @ less than 2% thd, 45 cycles-15 KC
 Frequency Response: @ 10 watts, ± 0.5 db, 20-20,000 cps; ± 3 db, 5-70,000 cps
 Source Impedance: 500/600 ohms and 5,000 ohms bridging
 Load Impedance: 8, 19 (70 v line), 65 (130 v line) ohms
 Output Impedance: Less than 12% of nominal load impedance
 Noise Level: -16 dbm; 70 db below rated output
 Controls: Meter switch—Plate current balance
 Power Supply: 105/117/125 volts, 60 cycles, 600 watts
 Tubes: 2-6AU6, 2-813, 2-3B2B, 1-5R4GYA
 Dimensions: 18" H x 19" W x 14-1/4" D
 Color: Blue gray
 Weight: 186 lbs.
 Accessories: #12156 wall mounting assembly



loudspeakers • amplifiers • preamplifiers • tuners • enclosures

Dept. 11-AP
 9356 Santa Monica Blvd., Beverly Hills, Calif.
 161 Sixth Avenue, New York 13, N. Y.

Hi . . . Mr. Hi Fi
This is It . . .

The BRADFORD Perfect BAFFLE*



Radically new idea in loudspeaker enclosures. Not a bass reflex or folded horn.

The primary purpose of a loudspeaker enclosure is to prevent destructive sound cancellation that takes place at low frequencies, when the front and rear waves, emanating from both sides of the speaker cone, merge.

It is obvious that no rear waves can escape through a totally enclosed cabinet, and it would be the perfect baffle, except for one reason. The air pressure within the cabinet acts as a cushion upon, and therefore restricts, cone movement. This causes loss of life and color.

The BRADFORD Perfect BAFFLE is totally enclosed, yet it relieves cone pressure by an ingenious device that operates in unison with cone movement.

Since this action conforms to an ultimate scientific principle, the BRADFORD Perfect BAFFLE is the only enclosure that can give you the utmost in sound reproduction.

And that, specifically, is . . .

ALL THE BASS. Full, rich, clean bass, clearly distinguishing each contributing instrument, down to the lowest speaker frequency.

NO BOOM. Absolutely no boom. Boom, or "one note" bass, is not high fidelity.

NO FALSE PEAKS. Does not "augment" bass by false peaks that are really distortions.

ANY SPEAKER. Accommodates any speaker . . . any size, weight, shape or make.

NO TUNING. No port tuning or speaker matching.

ANY POSITION. Operates in any room position.

NO RESONANCES. No false cabinet or air resonances.

COMPACT. Sizes for 8" & 10" speakers, 12" x 12" x 9"; 12" & 15" speakers, 17" x 17" x 14". Prices: finished \$39.50 & \$69.50 respectively. Unfinished Birch \$34.50 & \$59.50.

REAL HARDWOODS. In all popular finishes . . . mahogany, blond, ebony, walnut.

INCOMPARABLE CONSTRUCTION. Hand made, hand finished . . . by master craftsmen. All walls 3/4" thick.

GUARANTEED. Unconditionally guaranteed to out-perform any other enclosure now available regardless of size, weight or price.

If you want the very best speaker enclosure and will not be misled as to real performance by deceptive size or price, see your audio dealer at once. A demonstration will convince you. Or write for literature.

BRADFORD

Perfect **BAFFLE**

BRADFORD & COMPANY

27 E. 38th St. NEW YORK 16, N. Y.

MICROPHONE PLACEMENT

(from page 44)

only experiment can determine the best placement, within these limits, in each individual case.

Figure 5 illustrates the three dimensions to which these limits can be applied. First, the microphones should be the distance d apart; that is, not so great as to give a 40-50 millisecond delay between channels on the most distant sound source, and not so small as to give less than about 3 milliseconds delay. This is in accordance with the Haas curve of Fig. 3. Second, the microphones should be a distance w from the subject. This distance is a function of d , since it is a compromise between having the microphones close enough to get adequate separation between channels, yet not so close as to lose "balance" or the reverberation of the hall. This will, in most cases, avoid the possibility of being so far away that the time differences between channels are equalized. It is also evident, then, that w is also related to h , which is the height of the microphones above the floor. The limits are clearly the same as for w . The hope of a derived formula, empirical or otherwise vanishes when we consider the number of additional variables. The size and characteristics of the hall or studio will be a consideration since, just as in monaural, there will still be standing waves, flutter echoes, irregular reverberation, and so on, to contend with, and therefore careful attention must be given to the microphone placement that produces the best "sound." If the subject of the stereo pickup is an orchestra, the individual musicians may be placed to produce time differences according to the Haas curve of Fig. 3, ignoring intensity differences until the final "adjustment" of the apparent location is considered. Since musicians understandably take a dim view of being moved too far from their standard orchestral

setup, flagrant abuses of this are unlikely to occur.

Perhaps the best stereophonic recordings in existence have been made in large concert halls, where conditions—such as large time differences not easily overcome by movement in the listening room—are generally favorable to the stereophonic illusion. The situation is not the same, however, with so-called "popular" music. Due to the nature of the music, the monaural microphone technique generally in use is a "close to" pickup in order to obtain presence and intimacy, then artificial reverberation is added to replace that which is lost in the close microphone placement. If this technique were employed in stereo the result would be two-channel monaural sound with no spatial effect, since the isolation of the instruments on each channel would be more or less complete, and there would be no chance for the precedence effect to operate. One solution of this problem is to use a separate pair of directional microphones for the soloists, allowing the regular microphones to pick up the ensemble. A good test for the spatial effect is, using one instrument or section at a time, to shut off the channel with the indirect sound and notice how much of the "room sound" is lost. The placement which gives the maximum loss of "room" will be optimum. More difficult problems can be expected when both monaural and stereophonic recordings must be made at the same time, but if the principles of stereophonic sound are kept in mind, the best possible solution should be attained.

The reader is strongly urged to study the references cited in this article, since what has been presented here is no more than an elementary review of a complex and still largely unexplored subject.

HUM REDUCTION

(from page 40)

the shield only at the chassis that is receiving the signals, because it acts only as a hum shield and is not carrying the signal currents.

Over the years, use of the ground buss has become more and more universal. It is virtually a requirement when using aluminum chassis, since it is terribly difficult to make solder connections to the chassis, because of the inherent oxidation of aluminum. With the

ground-buss system, all circuit, electrolytic-capacitor-can, and tube-shield grounds are made to a relatively heavy (#16 or larger) bare wire. In turn, this ground buss wire is connected to the chassis at only one point. For best hum reduction, this connection point should be physically located at the point of lowest audio level; which usually is the input jack of the amplifier. If there is available no input jack which has a

solidly grounded frame, a large lug may be soldered to the buss wire and then bolted to the chassis at the actual point where the audio signals are at their lowest level.

Filament Circuits

Alternating current taken from the 6.3-volt winding of the power transformer for use on the filaments of low-level, high-gain preamplifiers will frequently be amplified along with the audio voltages passing through the tubes if there is any capacitive coupling to the input-grid circuit. This can be overcome completely in one way, *Fig. 3*, and possibly several others. By applying direct current to the filaments of the low-level tubes they will be hum free. When using a full-wave bridge selenium rectifier, a high-value electrolytic filter capacitor will be needed to raise the d.c. output voltage to the required amount, as well as for hum filtering.

Where this arrangement is not possible, a low d.c. bias voltage applied to the center top of the 6.3-volt a.c. circuit, as in *Fig. 4* prevents heater emission to the other tube elements. Any point in the circuit where approximately 250 volts d.c. is available may be tapped to provide the low d.c. voltage needed. Since this drains only about 3 milliamperes of current, there is no problem of overloading the power supply. If a hum-balancing potentiometer is not being used, the same d.c. bias should be introduced into the center-tap of the 6.3-volt winding. Do not connect the center-tap at all when using a balancing potentiometer or when one side of the 6.3-volt winding is grounded, a practice that is not recommended.

If you must use a plain unmodified a.c. filament-voltage source, always use a hum-balancing control and adjust for minimum hum on the loudspeaker or observed on an output meter. This is needed because the center tap of the transformer winding is not always exactly at the center. Finally, twisting the a.c. filament leads, rather than running them parallel to each other, effects an important hum cancellation.

Other and more complete articles have been devoted to the matter of plate supply hum filtering. However, more filter capacitance is necessary for low-level audio stages than for high-level ones, but that the effect of this capacitance is fully realized only when it is added in successive isolated power supply stages, rather than all "tacked on" at just one point. A filter choke is, now-

WORLD PREMIERE



A king can have no better than this "2300" . . . the newest look and performance in High Fidelity amplifiers.

Pictured above is the *new* Bell "2300", twenty watt.

Other *new* designs are available in 10 to 40 watts.

The specifications of these *new* Bell amplifiers are the best in the world today.

The controls, all closely grouped in the center panel, present conveniences you've always longed for.

You cannot buy a better engineered or better styled High Fidelity amplifier . . . anywhere.

**NOT JUST NEW VERSIONS OF OLD MODELS
but . . . COMPLETELY NEW DESIGNS**

For "Operation 2300", Bell assembled a group of electronic engineers with knowhow . . . a group of designers with imagination . . . and gave them an order—"Create a line of High Fidelity Amplifiers that will produce breathtakingly-realistic sounds—and will be styled for traditional, contemporary and modern living."

The "2300" line is the result of this far-reaching project. You should see and hear it. Your nearest Bell dealer will gladly demonstrate, for you, a remarkable "2300". Write us for his name and detailed "2300" literature. Bell Sound Systems, Inc., (A subsidiary of Thompson Products, Inc.) 559 Marion Road, Columbus 7, Ohio.

Bell "World Renowned For the Best in Sound"

the Magnificent Ferrograph

The world's finest hi-fi tape recorder

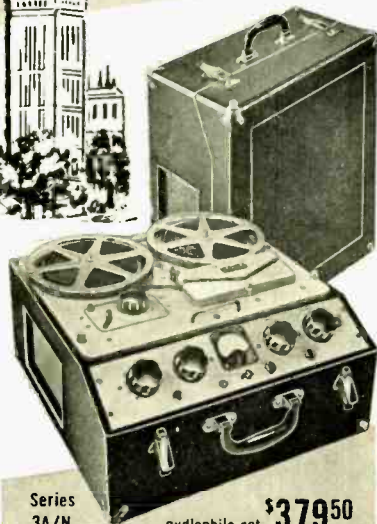

Series 3A/N

audiophile net \$37950

professional quality at nominal cost

The world-famous FERROGRAPH magnetic tape recorder, designed and developed primarily for professional use, has been re-styled for YOU — the discriminating audiophile, the progressive educator, the efficient businessman, the music lover.

Standard equipment with the British Broadcasting Corporation, it is a byword with cultural, educational and scientific users throughout Europe. The FERROGRAPH is unconditionally guaranteed to meet the most critical performance requirements.

Two models of this versatile dual-speed, dual track recorder are now available in LIMITED QUANTITIES, with tape speeds of 3 3/4" and 7 1/2" or 7 1/2" and 15" per second. Both models feature the employment of a synchronous hysteresis capstan motor providing unparalleled long-term speed stability, thus avoiding pitch errors on playback.



ALL FERROGRAPH RECORDERS AND TAPE DECKS have three motors. Custom installation models with tape speeds of either, 7 1/2 and 15 ips, or 3 3/4 and 7 1/2 ips are available. (Custom model 66/H illus. at left).



Write for performance specifications and the name of the franchised dealer in your area.

ERCONA CORPORATION

(Electronic Division)

551 Fifth Ave., Dept. 30, New York, N. Y.

Canada: Astral Electric Co., Ltd.,
44 Danforth Rd., Toronto 13

days, normally needed only in power amplifiers having large differences between no-signal and peak-signal current drains if the d.c. voltage is to remain essentially constant during these current swings.

Line Cords

Some consideration must be given to the 117-volt line cord. Naturally, it should be kept far away from audio components after entrance to the chassis. If this is impossible, a #18 2-conductor shielded wire may be used as a line cord, with the shield grounded to the chassis or ground buss at one point. After the amplifier has warmed-up, disconnect the power plug, turn it 180 deg. and reinsert. Leave the plug inserted in the way that yields the least audible hum.

Insertion of a low-value paper capacitor (.05 to 0.1µf) between one "leg" of the a.c. line and ground, (the outside foil of the capacitor should be connected to ground) frequently serves to reduce hum. Experiment to see which of the two wires should be filtered, for although both will accept a capacitor, usually only one will be effective, regardless of the way the plug is inserted. The only difficulty with this arrangement is that a potential equal to half the line voltage now exists between the line and the chassis. If the power plug is improperly inserted, it will be possible to get a slight electric shock should you touch this chassis and another one simultaneously. This danger often far outweighs the advantages of using the capacitor.

It has been customary for many years to combine the a.c. power switch with a volume or tone control. The critical user will want to avoid this close association of relatively high current and high voltage with low-level audio. Use a separate switch for the main power. Keep all capacitors and resistors carrying audio voltages as close to the chassis as possible, for the chassis serves to "catch" the hum directed towards these components. All transformers which have frames bolted to the chassis could have the paint removed from the points that touch the chassis, in order to preclude the possibility of a high-resistance ground.

No attempt has been made here to explain the theoretical reasons for these ailments and their cures. Merely to point them out takes considerable space, and serves to lead the constructor toward careful and effective practices.

Your friends will admire
HOW you use to advantage

TRANSISTORS

in your *HI-FI*
hook-up . . .

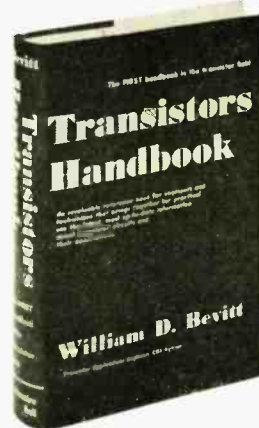

This ENTIRELY NEW Transistor Handbook will give you KNOW-HOW about this miracle midget of electronics. It analyzes different types of transistors and their specific applications . . . shows what they can do for you . . . and how you can make them do it. Reveals how to make hi-fidelity circuits more compact—how it makes new circuits possible.

Easy to understand, no major math or physics needed. Material organized so that professional engineer, radio-TV technician or Hi-Fi experimenter can learn how to make compact receivers, oscillators, basic amplifier circuits. Describes point-contact and junction transistors . . . P-N-P and N-P-N tetrode and pentode transistors. Covers ENTIRE FIELD!

\$9.50

including postage.

21 Illustrated Sections

Fundamental Definitions and Concepts • Point-contact • Junction • Power • Measurements of Characteristics • Analysis of Transistors and Transistor Circuits • Photodiodes and Photo-transistors • Tetrode and Pentode • Practical Considerations in Circuits • Noise and Temperature Effects • Audio Frequency and Power Amplifiers • Radio Frequency Amplifiers • Audio Frequency Oscillators • Radio Frequency Oscillators • Amplitude Modulation and Detection • Frequency Modulation and Demodulation • Radio and Television Receivers • Relaxation Oscillators • Computer Applications • Miscellaneous Applications.

COMPLETE DATA ON 56 TRANSISTORS MADE BY THESE MANUFACTURERS: Amperex Electronic • Bell Telephone • CBS Hytron • General Electric • Germania Products • Minneapolis-Honeywell • RCA • Radio Receptor • Raytheon • Sylvania Electric • Texas Instruments • Transistor Products • Western Electric.

A condensed complete transistor Library and detailed INDEX in 410 information packed pages . . . 380 illustrations.

Order your copy today from

AUDIO

P. O. Box 629 Mineola, N. Y.

NOISE

(from page 21)

car. However, if the testing area is to serve merely as a location for screening personnel—the concern merely being to detect subjects whose hearing is worse than normal by 20 to 25 db, then a background level as high as 50 db is acceptable.

Noise Spectrum

There are several reasons for considering noise in terms of frequency bands. The frequency composition of a noise will determine among other things, its loudness, its annoyance value, and its ability to interfere with speech. However, the sound level meters listed previously supply information which is pertinent only to the broad frequency spectrum picture. In no way does the operator of the instrument learn the exact extent of the contribution of any single frequency or narrow frequency band to the general over-all noise level. In the final analysis the contribution of the individual frequencies, or of narrow frequency bands, is of the utmost importance. For that reason, it is advisable to utilize one of the following types of instruments in conjunction with one of those listed earlier, in order to obtain a true perspective of the frequency composition of the noise:

1. General Radio Octave Band Analyzer Type 1550-A—Fig. 9
2. General Radio Sound Analyzer Type 760-B
3. General Radio Wave Analyzer Type 736-A—Fig. 10
4. H.H. Scott Sound Analyzer Type 420A—Fig. 11
5. Hewlett-Packard Harmonic Wave Analyzer Model 300A
6. Western Electric Wave Analyzer Model 3A
7. Electrodyne Wave Analyzer Model 4801.
8. Panoramic Sonic Analyzer Model AP-1

Why is the contribution of single frequencies or of narrow frequency bands of such importance in studying the effects of noise? The answer appears in the results of work done by Fletcher and Munson of the Bell Telephone Laboratory in the early 1930's. Figure 12 is a plot of tones heard, using earphones, which are equal in loudness to the standard reference tones of 1000 cps. The frequency response plotted against sensation level illustrates the nonlinearity of the function of hearing. The parameters are the various loudness-levels associated with the reference-tone signal intensities. All other frequencies are equated for equal loud-

Save Money
BUILD YOUR OWN
Hi-Fi

get custom quality at low cost in
ALLIED'S own HIGH FIDELITY

knight-kits

KNIGHT-KITS give you the last word in HI-FI design, performance and value...and they're easy to build from crystal-clear manuals featuring "Step-and-Chek" assembly. Save money—get true Hi-Fi quality with these custom-designed KNIGHT-KITS.

BUILD THE BEST... AND SAVE!



knight-kit LINEAR DELUXE

**25-WATT BASIC HI-FI
AMPLIFIER KIT**

Model 5-755 **\$44.50**

Williamson-type Circuit
Printed Circuit Board
Chrome Plated Chassis

Designed to satisfy the most critical listener. Intended for use with tuners incorporating built-in preamp or with separate preamp. Uses latest Williamson-type circuit. Has potted, matched transformers. Output: Maximum, 45 watts; undistorted, 25 watts. Frequency response: ± 0.5 db, 10 to 120,000 cps, measured at 20 watts. Harmonic distortion is only 0.15% right up to 30 watts. Intermodulation is only 0.27% at 17 watts and only 5% at 20 watts, using 60 cps and 7 kc, 1:4 ratio. Hum level is 85 db below rated output. Output impedance, 4, 8, 16 ohms. Uses two 12AU7's, two 6881's, and a 5V4G. Printed circuit is utilized in voltage amplifier and phase inverter stages. Has output tube balancing control, variable damping control, and on-off switch. Handsome chrome-plated chassis, 14" x 9" x 2". Overall height, 7". Complete with all parts, tubes and construction manual. Shpg. wt., 27 lbs.

Model 5-755. Basic 25-watt Hi-Fi Linear-Deluxe Amplifier Kit. Net **\$44.50**
S-759. Metal enclosure for above amplifier. Black finish. Shpg. wt., 3½ lbs. Net **\$4.25**



knight-kit 10-WATT HI-FI AMPLIFIER KIT

Model 5-753 Famous for wide response and smooth reproduction at low cost. Only 0.5 volt drives amplifier to full output. Response: ± 1 db, 30-20,000 cps at 10 watts. Harmonic distortion less than 0.5% at 10 watts. Intermodulation is less than 1.5% at full output. Controls: On-off volume, bass, treble. Input for crystal phono or tuner. Chrome-plated chassis is punched to take preamp kit (see below) for magnetic cartridges. Matches 8 ohm speakers. Shpg. wt., 14 lbs. Complete; ready to build.

Model 5-753. Amplifier Kit. Net **\$23.50**
Model 5-235. Preamp Kit for above. Net \$3.10
S-757. Enclosure for above. Net **\$3.95**

ALL PRICES NET F.O.B. CHICAGO



knight-kit 20-WATT HI-FI AMPLIFIER KIT

Model 5-750 True Hi-Fi for less! Response, ± 1 db, 20 to 20,000 cps at 20 watts. Distortion, 1% at 20 watts. Hum and noise level: Tuner input, 90 db below 20 watts; magnetic phono, 72 db below 20 watts. Sensitivity: Tuner input, 0.6 volt for 20 watts output; magnetic phono, .007 volts. 4 inputs: Magnetic phono, microphone, crystal phono or recorder, and tuner. Controls: Bass, Treble, Volume. Selector with compensation positions for 78 and LP records. Handsome chrome-plated chassis. Shpg. wt., 23 lbs. Complete; ready to build.

Model 5-750. 20-Watt Kit. Net **\$35.75**
S-752. Chrome control panel. Net **\$1.40**
S-758. Enclosure for above. Net **\$4.15**

ORDER FROM

ALLIED RADIO

America's Hi-Fi Center

OUR
36th
YEAR



FREE

ALLIED'S
1957
CATALOG

Send for this 356-page value-packed catalog covering everything in Electronics. Complete sections featuring world's largest selection of Hi-Fi components and music systems, many more famous KNIGHT-KITS, recorders, P.A. systems, Amateur gear, parts, tubes, tools and books. Send for your FREE copy today.

ALLIED RADIO CORP., Dept. 17-L-6
100 N. Western Ave., Chicago 80, Ill.

Ship the following: _____ \$ _____ enclosed

Send me your FREE 1957 ALLIED 356-Page Catalog

Name _____

Address _____

City _____ Zone _____ State _____

AR-1

Report from the
LABORATORY
The Audio League Report*

Fig. 5
Acoustic Output at 30 CPS

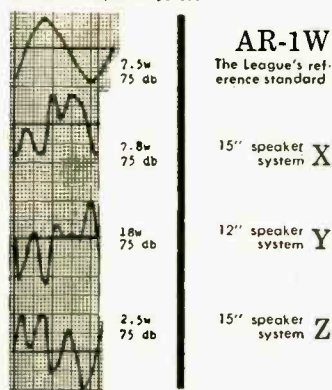

*Vol. 1 No. 9, Oct., '55. Authorized quotation #28. For the complete technical and subjective report on the AR-1 consult Vol. 1 No. 11, The Audio League Report, Pleasantville, N. Y.

Report from the
WORLD OF MUSIC



The Aeolian-Skinner Organ Co. uses an AR woofer (with a Janszen electrostatic tweeter) in their sound studio. Joseph S. Whiteford, vice-pres., writes us:

"Your AR-1W speaker has been of inestimable value in the production of our recording series 'The King of Instruments'. No other system I have ever heard does justice to the intent of our recordings. Your speaker, with its even bass line and lack of distortion, has so closely approached 'the truth' that it validates itself immediately to those who are concerned with musical values."

AR speaker systems (2-way, or woofer-only) are priced from \$132 to \$185. Cabinet size 14" x 11 1/2" x 25"; suggested driving power 30 watts or more. Illustrated brochure on request.

ACOUSTIC RESEARCH, INC.
24 Thorndike St., Cambridge 41, Mass

Fig. 12. Contours of equal-loudness versus sensation-level. Parameters are loudness levels. (Fletcher and Munson)

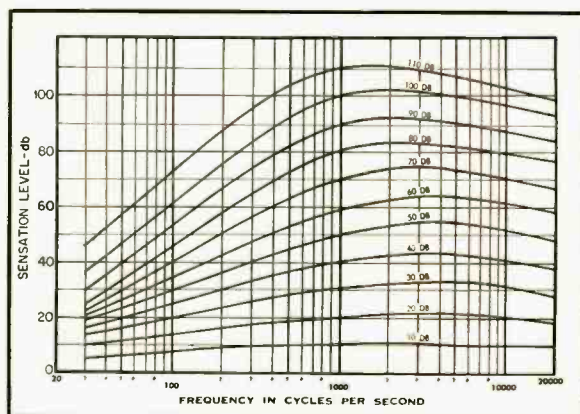

ness as heard by the observers, the level above the threshold is determined, and the resultant plot gives the contour of the response for any one loudness level at 1000 cps. These curves are the average of many measurements made by the experimenters. Since threshold levels and loudness levels are subjective measurements, it is important that we be able to express such results in terms of sound pressure level at the eardrum. A replotting of the results of the experiments gives the more familiar curves of Fig. 13 wherein are plotted the same equal-loudness contours but they now appear as functions of intensity level at the eardrum. Note that the contour of the curve at zero intensity level—threshold of hearing—is of different shape than that at a level of 110 db loudness level. This signifies that given a noise whose frequency spectrum is substantially flat (i.e. containing equal amplitude signals from lowest to highest frequency detectable by the ear), the ear is affected in different ways by different intensity levels of the noise. Assume as an example that the noise is composed of frequencies whose individual sound pressure level is 50 db. The ear will detect the various frequency components of the noise in the relationship given in Table II.

Now, if the amplitude of the noise frequency components is raised to 110 db re .0002 microbar, the relationship between the frequency components is shown in Table III.

Note that the ear would detect the lower level signal as a complex sound predominating in the frequency range from 500 to 4000 cps whereas the higher level signal is heard as a sound of broader frequency spectrum from 125 to 7200 cps.

Tests made of the annoyance value of noise² reveal that noise which is composed of higher frequencies is more annoying than that which is composed of lower frequencies—assuming both noises to be at the same sound pressure level. This explains in part why greater effort is expended in noise reduction effort to reduce the higher frequency components of noise.

Further tests² reveal that noises which occur continuously or periodically are much less annoying than sporadic or unanticipated noises. Adaptation to the continuous type of noise takes place very quickly unless the sound pressure level is greater than 120 to 125 db.

Speech is composed of varying frequency and energy spectra, consequently the effect of noise upon speech will depend entirely upon the loudness of the various frequency components of the

¹⁴ (Phon—a measure of loudness level. Defined as the intensity-level of a 1000-cps tone which sounds equal in loudness to the given tone. The phon is measured and expressed in decibels above the threshold at 1000 cps.)

¹⁴ Shafer *et al.*, "Frequency selectivity of the ear as determined by masking experiments." *J. Acous. Soc. Am.*, Vol. 22, pp. 492-493, 1950.

TABLE II

Noise Level	Frequency — cps						
	125	250	500	1000	2000	4000	8000
50 db SPL	25	40	48	50	50	53	38 Phons

TABLE III

Noise Level	Frequency — cps						
	125	250	500	1000	2000	4000	8000
110 db SPL	109	108	108	110	115	120	106 Phons ¹⁴

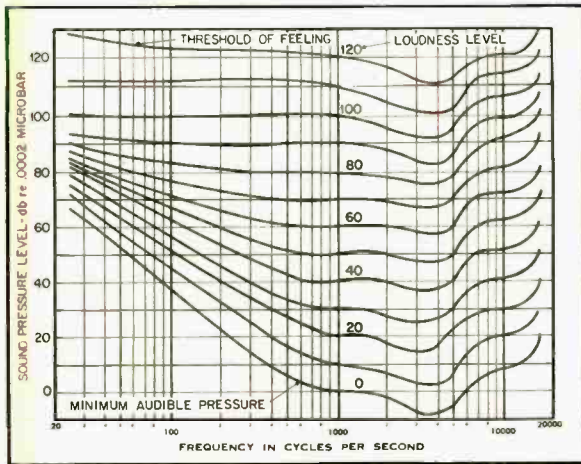

Fig. 13. Contours of equal-loudness versus sound pressure level. (Fletcher and Munson)

noise spectrum in relation to the loudness of the spoken words. It is possible to have high sentence intelligibility but word dropouts or failures occur frequently. It should be apparent therefore, that forms of communication are carefully studied to determine whether coding of speech or normal conversation will be practicable under noise conditions.

In order to express more clearly the effects of noise frequency components upon speech, the audio spectrum is divided into bands of frequencies which are of equal value in their contribution to speech.¹⁴ By comparison of the noise spectrum and the speech spectrum, it is possible to determine the information which an ear will receive, expressed as "articulation index". It has been determined further that a simple three-band frequency analysis—600-1200, 1200-2400, 2400-4800 cps—will give a quantity referred to as "speech-interference level." This form of analysis, because of its simplicity, is suitable for classifying communication in the presence of noise as "easy, difficult, or impossible".

Most noise encountered in military or industrial establishments is seldom of the broad band type, usually it is predominant in low, middle, or upper fre-

quency range. Noises of this sort are best analyzed for their possible damaging effects by use of the Sound Analyzer which measures sound levels in terms of frequency octaves or partial octaves. In addition to the analysis mentioned, it is often of great importance where vibrating or rotating machinery is employed to make another noise level check by means of the Vibration Meter and Analyzer Fig. 14, to determine if the unit is properly fastened or mounted. This last test is invaluable in determining the efficiency of shock or vibration mounts.

Design and/or Treatment of Audiometric Testing Areas

In erecting audiometric testing spaces it is vitally important that reference be made to building practice as employed in radio and television sound studio construction. For satisfactory attenuation of noises originating outside the structure, it is necessary to consider the use of room-within-room construction. In this, the inside room is "floated" with no supporting members making direct con-



Fig. 14. General Radio Company's Vibration Meter is useful in isolating machinery noise.

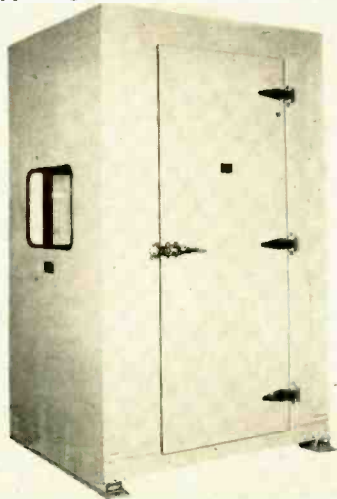

Fig. 15. Industrial Acoustics company supplies a portable Audiometric Test Room.

AR-2

The AR-1 acoustic suspension[®] speaker system is now widely recognized as reproducing the cleanest, most extended, and most uniform bass at the present state of the art. It is employed as a reference testing standard, as a broadcast and recording studio monitor, as an acoustical laboratory test instrument, and in thousands of music lovers' homes.

The AR-2, our second model, is a two-way speaker system (10 in. acoustic suspension woofer and newly developed tweeter assembly), in a cabinet slightly smaller than that of the AR-1—13½"x24"x11¾". It is suitable for use with any high quality amplifier which supplies 10 or more clean watts over the entire audio range.

AR-2

The price of the AR-2 in hardwood veneer is \$96.00, compared to the AR-1's \$185.00. Nevertheless we invite you to judge it directly, at your sound dealer's, against conventional bass-reflex or horn systems. The design sacrifices in the AR-2, comparatively small, have mainly to do with giving up some of the AR-1's performance in the nether low-frequency regions, performance which is most costly to come by. The AR-2 can radiate a clean, relatively full signal at 30 cycles.

The AR-2 speaker was designed as the standard for medium-cost high fidelity systems. Our tests have shown it to be so far ahead of its price class that we think it will come to be regarded as such a standard within its first year.

AR-2

Literature, including complete performance specifications, available on request from:

ACOUSTIC RESEARCH, INC.
24 Thorndike St., Cambridge 41, Mass.

* Pat. pending and copr., Acoustic Research, Inc.

the cartridge that scores **100%**

The Recoton-Goldring cartridge was acclaimed the best by a national independent research organization, because it passed all tests with flying colors!



- Performance uniformly excellent.
- Cantilever · stylus · armature construction capable of rougher treatment than most moving-coil mechanisms.
- Will fit just about any American-made arm.
- Smooth and free of strain even on heavily recorded passages.
- Gives you more for your money. (Only \$9.90 including 2 synthetic sapphire styli)

Recoton-Goldring

Model 500 SD—Sapphire Diamond
Model 500 DD—Diamond/Diamond

**"500" MAGNETIC TURNOVER
CARTRIDGE**

At leading hi-fi distributors,
write for descriptive literature to

RECOTON CORPORATION, 52-35 Barnett Ave., Long Island City 4, N. Y.
Manufacturers of World-Famous Phonograph Styli.

THE QUESTION: Do you know where you can find information about the current articles in magazines about microwaves, loudspeakers, television repairing, electronic musical instruments, traveling-wave tubes, transistor amplifiers, oscilloscopes, or any other electronic subject?

THE ANSWER:

LECTRODEX

FORMERLY
RADIOFILE

Not a new publication, but one which for over ten years has served engineers, libraries, experimenters, researchers, hobbyists, radio amateurs, radio and TV repairmen, and anyone else connected with radio or electronics. Covers radio, television, electronics, and related subjects, and published bi-monthly as a cumulative index throughout the year, with the last issue of the year an Annual which may be kept as a permanent record of all electronic periodical literature.

LECTRODEX—the electronics index—is now published by Radio Magazines, Inc., and has been expanded to include the contents of twenty magazines in the radio and electronics fields. Sold by subscription only, \$3.00 for one year, \$5.50 for two years. Back Annual issues are available from 1946 through 1955, 50¢ per copy. Subscribe now and know where to find the information you often need so badly.

RADIO MAGAZINES, INC.
P. O. Box 629, Mineola, N. Y.

tact with the outside room members. Instead, support is given by means of sound isolating structural members. In addition, acoustical treatment of the inner room is a standard procedure. Such construction is referred to and illustrated in various technical publications^{15, 16} and data sheets supplied by manufacturers of components.

Another way to supply testing facilities is by employing prefabricated soundproof rooms. Such rooms, Fig. 15, are easily set up in place and just as easily moved to another location as the need arises. Typical attenuation characteristics of such rooms are given in Table IV.

TABLE IV

Octave Band — cps	Attenuation — db
20-75	20
75-150	27
150-300	39
300-600	49
600-1200	53
1200-2400	56
2400-4800	56
4800-9600	54

(Photo Credits: Figs. 1, 3, 9, 10, and 14, General Radio Co.; Figs. 2 and 11, Herman Hosmer Scott, Inc.; Fig. 15, Industrial Acoustics Company.)

¹⁵ Handbook of Noise Control, Vol. I, WADC Technical Report 52-204, Dec. 1952, Chapter 11.

¹⁶ Acoustical Designing in Architecture, Knudsen and Harris, New York: John Wiley & Sons, 1950.

CONFERENCE AMPLIFIER

(from page 48)

ments heated by d.e. to keep hum (and modulation distortion) down to a low value.

Each of the three input groups has a separate volume control so that proper balancing adjustments can be made in each new location. The outputs of the three volume controls are mixed through the 0.27-megohm isolating resistors and fed to the second section of V_2 . The 0.27-megohm resistor in the Adviser channel has a dual function, since it also serves as isolating resistor for the short circuit action of the relay keyed by the press-to-talk switch.

In normal operation the relay contact is in the "open" position (as shown in the diagram.) In this position the adviser channel is shorted out. When the press-to-talk switch is closed, the relay is energized and the contact shorts out both channels A and B. The two 0.27-megohm resistors feeding the grid prevent the relay contact from shorting out all channels simultaneously. Because both resistors are always in the circuit, however, they cause a constant 6 db loss in gain from any channel.

The relay tube consists of a 6C4 triode with a 5000-ohm 7.5-ma plate-type multi-contact relay in its plate circuit. The 33,000- and 3900-ohm resistors form

Rauland

"GOLDEN SERIES"

HIGH FIDELITY

Custom
Quality
Hi-Fi
Components



Sensibly
Priced
for
Everyone

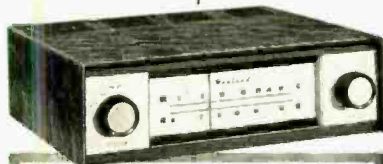

Golden Star MODEL HF255
AM-FM TUNER

Provides exceptional AM-FM reception, true high fidelity realism with "space-saver" convenience and beauty at remarkably low cost. FM response, ± 0.5 db, 20 to 20,000 cycles; AM, ± 4 db, 20 to 5,000 cycles. Sensitivity: FM—5 microvolts for 20 db of quieting; AM—20 microvolts for 1 volt output. Includes AFC, drift-compensated circuits, FM di-pole antenna. AM ferrite loop, etc. Only $3\frac{1}{2}$ " high. Ideal for use with amplifier below.



MODEL 1512
Golden Chief 12-WATT
HIGH FIDELITY AMPLIFIER

True hi-fi performance at moderate cost. Full 12 watts output; response, ± 0.5 db, 20 to 20,000 cps. Features 5 inputs; separate bass, treble controls; equalization for EUR, frr, RIAA, Quiet; variable damping control, choice of volume control or loudness control. In compact cabinet, only $3\frac{1}{2}$ " high.

BEAUTIFUL "SPACE SAVER" DESIGN

RAULAND matching Hi-Fi units are decorator-styled in handsome charcoal black with marbled gold finish, control panels in soft brushed brass. Designed to fit anywhere—no cabinets required. (Extension shafts available for behind-panel mount.)



Hear these RAULAND units at your
Hi-Fi dealer, or write for details

RAULAND-BORG CORPORATION
3515 W. Addison St., Dept. C, Chicago 18, Ill.
Circle 89A

a bleeder which under normal conditions raises the cathode potential to +20 volts. Since the grid is directly grounded, the tube is biased to cut-off and the relay is open. When the press-to-talk switch is closed, the 3900-ohm resistor is shorted, removing the 20-volt bias. The 270-ohm resistor then biases the tube to about 2.5 volts, allowing 10 ma of plate current to flow, and energizing the relay. When the switch is opened, the tube is again cut off, and the relay opens. By operating the channel-switching feature through a relay, no signal voltages need be run through the press-to-talk switch.

The two voltage amplifier stages V_{2b} and V_3 are entirely conventional. The coupling networks have been chosen to give 3 db points at approximately 250 cps to cut low-frequency noise and hum. If special response-shaping circuits are desired, they can be easily inserted after each of these voltage amplifier stages, such as the low cut network C_{11} , C_{12} , C_{13} and R_{11} .

The output stage has been designed to produce 4 volts with low distortion across the 15-ohm secondary load and to clip cleanly and evenly 3 db above that level. The capacitor across the output-transformer primary is chosen to give a high-frequency cutoff which fits the user's required frequency characteristic. By placing the high-frequency cutoff at the end of the amplifier the best signal-to-noise ratio is obtained.

Output Circuits

The secondary load is formed by the 15-ohm potentiometer and the bone conduction receiver. Since the receiver impedance is about 100 ohms at 1000 cps, the load is formed entirely by the potentiometer. Furthermore, since the potentiometer impedance is very low compared to the receiver, the frequency response does not vary with settings of the volume control.

While designed specifically for a hearing-aid user, this equipment can also be used to feed a recorder when it is desired to make a tape of the entire proceedings. The proximity of each microphone to the individual speaker will ensure less "roominess" to the recording, with the result that everything said can be understood readily—something which is not always the case with single-microphone recordings under similar conditions.

The success of this Sonotone Conference Amplifier is due in large part to the work of Martin Molloy, who was responsible for the mechanical design, wiring layout, testing and final adaptation of the unit. Acknowledgment is also made for considerable work in the construction and planning of the amplifier to Mr. L. Z. Sajor and Mr. Harold Barbagallo.

WIGO

The ULTIMATE In HIGH FIDELITY SPEAKERS

Combining
Outstanding
Tone Quality
and Economy



UNITED AUDIO PRODUCTS
(Div. of United Optical Mfg. Corp.)
202 East 19th St., N. Y. C. 3, N. Y.

Dual

REVOLUTIONARY
NEW

Automatic, Precision
RECORD
CHANGER

No.
1003



Exclusive!

Tone Arm scans records automatically for starting groove. Automatic tone arm locking device prevents styli damage when not in use. An Automatic Record Changer or a fully Automatic Record Player, as desired.



Changing Cycle
and pause timer
are independent
of changer speeds.

See these products in room 303
N. Y. High Fidelity Show

UNITED AUDIO PRODUCTS
(Div. of United Optical Mfg. Corp.)
202 East 19th St., N. Y. C. 3, N. Y.

Circle 89B

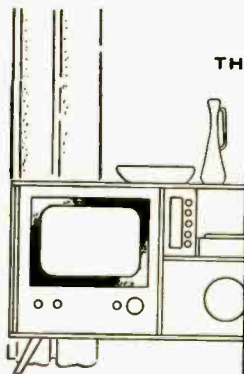

THE VERY BEST IN CUSTOM TELEVISION

BY **TECH-MASTER**

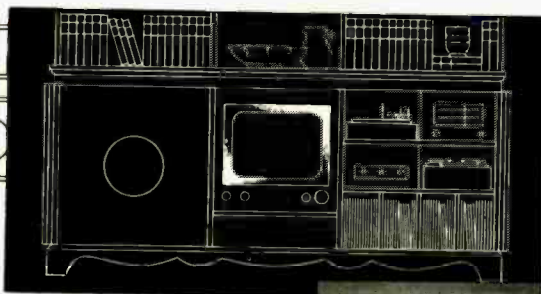

FOUND IN THE FINEST OF INTERIORS

As the custom installation signifies the ultimate in well-chosen decor... so the name Tech-Master stands for the utmost in Custom television. The reputation established with the manufacture of the renowned Model 630 chassis is further enhanced by the outstanding Tech-Master Audiophile and Sound Theatre.

See your Custom hi-fi dealer today... or write
TECH-MASTER CORPORATION
 75 FRONT STREET, BROOKLYN, NEW YORK

ONLY TECH-MASTER HAS THESE OUTSTANDING PLUS FEATURES:

- World-famous 3 tube synchrolok picture circuit for constant picture stability. • 30 tubes fully used. • "Full Frame Mounting" ... just a simple cutout is required for installation.
- High fidelity picture as well as exceptional audio reproduction.

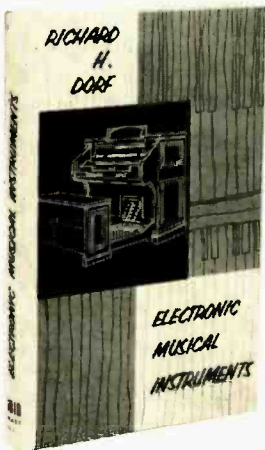

Keep informed—read
ELECTRONIC MUSICAL INSTRUMENTS

By
Richard H. Dorf

In one big volume, you can now learn all about the intricacies of commercial electronic organs, including the Allen, Baldwin, Connsonata, Hammond, Minshall-Estey, Lowrey Organo, and others, together with many smaller instruments. Constructional details on the author's Electronorgan and the simpler Thyratone show you how to build one of these fascinating instruments for yourself. A compilation in book form of the author's articles in *Radio Electronics*, brought up to date and with many additions. Price \$7.50 (Foreign, \$8.00).

Customary discounts to dealers and distributors

RADIO MAGAZINES, INC., Book Division
 P. O. Box 629, Mineola, N. Y.

Please send me copies of Dorf's ELECTRONIC MUSICAL INSTRUMENTS. I enclose check money order for \$7.50 each (Foreign, \$8.00).

Name
 Address
 City Zone State

PATENTS

(from page 23)

required by the statute."³

Two applications for the same television invention were filed, one on September 8th, 1940, and the other on the following day. The inventor filing the first application had conceived his invention on March 25th of that year, the second applicant on May 28th, two months later.

The Federal Court sustained the award of the patent to the inventor who had filed the later application, since the delay between his conception of the invention and the application for a patent had been approximately three months while the delay of the earlier applicant was two months greater.

"One who is first to conceive will not be permitted to lay his conception aside, take up and experiment with many other problems and devices and then be permitted to defeat the inventor who enters the field and reduces to practice, while the one first to conceive is engrossed with other devices."⁴

Secret Can't be Held Indefinitely

The injustice that would be effected by permitting the inventor to hold his invention as a secret indefinitely and subsequently in his own good time, seek a patent when the security of his secret was threatened, appeared in a famous case with circumstances of this character before the Federal Courts many years ago.

In the fall of 1903 the inventor in this instance discovered a formula and process for the manufacturing of illuminating glass that he held as a secret. Glass was manufactured and sold throughout the country by this inventor under this process until 1910, when an employee entrusted with the secret disclosed it to a competitor and within a few months this competitor was manufacturing and marketing the glass.

Three years later the original owner of this secret process secured a patent and sued an electrical manufacturer for infringement. The Federal appellate court in sustaining the defense that the patent was invalid for the delay between the concept of the invention and the application for the patent, said,

"When this inventor perfected his invention in 1903 he and his company evidently concluded to control and use it for purposes of profit and to work these ends by practicing the invention in secret and placing the product on

³ *Maibohm v. RCA-Victor Co.*, 89 Fed. 2d 317; 13 F.S. 901.

⁴ *Wilson v. Goldmark*, 172 Fed. 2d 575.

public sale. The plain object of such a course was to exclude others from using the invention and to secure these benefits for themselves.

"When a patent expires the right to practice the invention thus becomes available to everybody. The object of such a limitation and disclosure was to secure to the public the full benefit of patented objects as speedily as was consistent with reasonable stimulation of invention. If then we assume that the course adopted by the present inventor did not contemplate and intend to abandon the right to secure a patent, it certainly did contemplate and indefinitely delay any disclosure of the invention and a practical and substantial enlargement of any period of monopoly recognized by the statute. Can it be added that this was opposed to a declared and subsisting public policy?"

"Enough however has been shown of the practical construction and effect of the right to practice an invention in secret and for profit and the right to obtain a patent on the invention, fairly to test the soundness of the claim that the rights are not inconsistent. They, of course, are now to be considered with reference to a scheme which includes an effort to secure a patent. And so regarded, the first is in its nature and essence susceptible of exercise only in a way to evade, or at least unduly to delay a disclosure of the invention in the interest of science and the useful arts and with an intent to expand the statutory period of monopoly and thereby reap additional profits.

"The second is a means simply to acquire a monopoly subject to all the conditions and limitations of the patent laws. Such rights, in our opinion, are inconsistent in themselves—notably in the matter of profits available through use as distinguished from sale of the invention and in their respective relations to the patent laws.

"It is not conceivable that an inventor can consistently hold both rights throughout the same period of time, where the design is to use them for purposes and with results all or similar to those here shown."⁵

The decision in this instance rested on a case decided by the Supreme Court nearly a hundred years ago. A delay of seven years had occurred between the invention of "an improvement in the art of making tubes or hose for conveying air, water and other fluids," and the issuance of the patent. When suit was brought later for infringement the defense that the patent was invalid by reason of this delay was sustained by the Supreme Court.

"If the inventor," said that court, "should be permitted to hold back from

⁵ Macheth-Evans Glass Co. v. General Electric Co., 246 Fed. 695.

the most perfect...

FOR
YOUR
RECORDS

RECOTON

*Diamond
Styli*

Your record collection
deserves the very best...
RECOTON DIAMOND STYLII
... top performance
from your recordings!
Before you play another
record—see your dealer
and ask for a Recoton
Diamond Styli!



RECOTON CORPORATION

52-35 Barnett Avenue
Long Island City 4, N. Y.

TAPE RECORDERS AND TAPE RECORDING



Just Out!

TAPE RECORDERS AND TAPE RECORDING

By

Harold D. Weiler

Author of
"High Fidelity Simplified"

The first complete book for the home recordist. Tells why, how, and what in easily understood language—not too technical, yet technically accurate. Covers sound, room acoustics, microphones, microphone techniques, editing and splicing, sound effects and how to make them, maintenance, and adding sound to slides and home movies.

Board Cover .. \$3.95

Paper Cover .. \$2.95

Use Book Order card on insert at back of this issue

LEONARD RADIO, INC.
 49 Cortland St., New York 7, N.Y. COntland 7-0313

AT LEONARD RADIO HIGH-FIDELITY'S GONE STEREO!

Now in stock . . . complete tape stereo library. Livingston . . . A-V . . . Bel Canto . . . Concert Hall Society . . . Stereotapes . . . Concertapes . . . HiFi Tapes . . . Jazztape . . . Omega-tape . . . RCA Victor . . . EMC . . . many others . . . and NOW! ! !

SONOTAPE

Never before have you heard such frequency response, especially in the highs. Made from **WESTMINSTER MASTERS** which are unsurpassed in fidelity . . . and SONOTAPE'S copying technique admits no loss, or distortion! You can't get closer to an actual performance than a SONOTAPE stereo-phonics . . . listen to just a single measure, and compare!

IMMEDIATE DELIVERY!

SWB 8001-BACH: Toccata and Fugue, D-min; Passacaglia and Fugue, C-min. Carl Weinrich, organ of Varfrukyrka, Skanninge Sweden

SWB 8002—BEETHOVEN: Moonlight and Pathetique Sonatas; Raymond Lewenthal, piano

SWB 8003—STRAVINSKY: L'histoire Du Soldat; Ars Nova, Mandell, cond.

SWB 8004 — WIDOR, MULET, VIERNE, BOELLMAN, and others: Toccatas For Organ; Robert Owen, Aeolian Skinner organ, Christ Church, Bronxville, N. Y.

SWB 8005—Latin American Adventure; Ferrante and Teicher, duo-pianos.

SWB 8006—Leibert Takes Richmond; Dick Leibert, Mighty Wurlitzer organ, Byrd Theatre, Richmond, Va.

SWB 9001 — TCHAIKOVSKY: Quartet No. 1; Curtis String Quartet.

SWB 8000 series (approx. ½ hr.) \$9.95

SWB 9000 series (approx. ¾ hr.) \$15.95

Mail Orders Filled Within 24 hrs. 25% deposit balance C.O.D. Postage Pre-Paid on all orders accompanied with payment in full.

Complete listing of Stereo Tapes in stock for immediate delivery available on request.

LEONARD RADIO, INC.
 49 Cortland St., New York 7, N.Y. COntland 7-0313

Circle 92A

the knowledge of the public the secrets of his invention; if he should for a long period of years retain the monopoly and make and sell his invention publicly and thus gather the whole profits from it, relying upon his superior skill and knowledge of the structure; and then, and then only, when the danger of competition should force him to secure the exclusive right, he should be allowed to take out a patent and thus exclude the public from any further use than what should be derived under it during his fourteen years, it would materially retard the progress of science and the useful arts and give a premium to those who should be prompt to communicate their discoveries."⁶

⁶ Penneck v. Dialogue, 27 U.S. 1.

CROSSOVER

(from page 17)

For example, the first distance given by equation (11) for out-of-phase speakers is $n=0.866$. If the response curve for this value of n is sketched, it will be found that the response remains flat within a range of 7 db. This does not mean, however, it will be flat within ± 3.5 db; the highest peak is +3 db and the deepest dip is -4 db. As a matter of fact, in all cases the response cannot rise more than 3 db above flatness, since the V^2 envelope does not exceed this value.

Table I shows various values of the approximate best placements for the two speakers, together with the minimum range of the response (maximum value minus minimum value) in decibels. Evidently, placing the speakers very far apart amounts to inviting the response to leave the straight-and-narrow path of flatness. To the extent that these calculations predict the actual state of affairs, a good rule in speaker design would be to use the lowest feasible crossover frequency, locate the speakers as close together as possible, and attempt to avoid certain previously-defined highly-disadvantageous combinations.

When the two speakers are closer together than three-quarters wavelength and properly connected, the response no longer touches the V^2 curve each side of $u=1.0$, and the previous rule breaks down. There will be, as a matter of fact, only one principal dip, whose minimum does not coincide with the V^2 curve at all. Although, with a bit of study, one can easily gain a general idea of the response with close spacings, recourse must be made to more detailed calculation to find its precise nature.

The calculations have been performed

FULL FIDELITY MUSIC ENJOYMENT

TWIN-CONES IN A SINGLE

F.R.S. SPEAKER
 COVER THE
 AUDIBLE RANGE

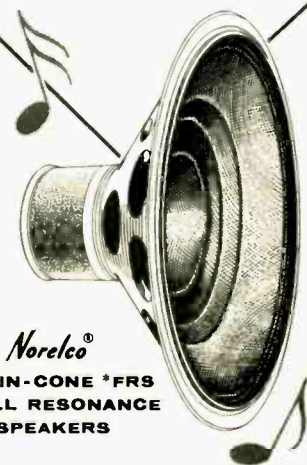

Norelco®
 TWIN-CONE *FRS
 *FULL RESONANCE
 SPEAKERS

In a single speaker, Norelco has created an unusually efficient sound radiator. These twin-cone speakers incorporate a small cone for reproducing high frequencies and a large cone for lower frequencies. Both cones operate in conjunction from a single voice coil—producing balanced sensitivity and uniform sound for all ranges. Arrangement of both cones reflect and diffuse the sound while moving in phase to provide even sound distribution.

A deep air gap within a homogeneous magnetic field provides unusually large movement of the voice coil resulting in distortion-free reproduction over the entire frequency range. Impedance does not diminish with higher frequencies and volume is practically constant throughout the whole audible range.

Send today for your catalog on Norelco *FRS Twin-Cone Speakers. It contains specification data, sound distribution curves, frequency characteristics on these speakers as well as the new Norelco Speaker Enclosures.



Send to Dept. A-11 for more details

North American Philips Co., Inc.
 100 East 42nd Street
 New York 17, N. Y.

Circle 92B

Simplify design and calculation

practical
ELECTROACOUSTICS

M. RETTINGER

The keynote of the book is **UTILITY** in a practical coverage of the rapidly developing field of electroacoustics.

Electroacoustics is presented in the light of the most recent developments. The modern methods and devices discussed in the book are those used at present in radio, sound-film recording, and allied arts.

Special emphasis is placed on the relatively new and promising field of magnetic recording.

Many tables and curves show at a glance the required quantities, reducing calculations to a minimum. The diagrams in the book are useful not only for lessening figure work but also for checking calculations and illustrating relationships.

CONTENTS

FOREWORD. MICROPHONES: Anecdotal History of Microphones—General Aspects—Types of Microphone—Microphone Technique. **LOUDSPEAKERS: Direct-Radiator Loudspeaker—Loudspeaker Enclosures—Loudspeaker Cabinets—Corner Cabinet for Loudspeakers—Horn Loudspeakers—Directional Radiation—Damping Loudspeaker-Cabinet Panels—Speaker Measurements—Speaker Distortion. CIRCUITS: Constant-Resistance Crossover Networks—Impedance-Measuring Networks—Mixers. MAGNETIC STRUCTURES: General Aspects—Permanent Magnet Public-Address Systems: General Aspects—Outdoor Loudspeaker Output-Power Requirements—Specifications—Testing Public-Address System Installations—The Hollywood Bowl Sound-Reinforcement System—Loudspeaker Matching. VIBRATIONS: Transients—Vibration Isolation. ARCHITECTURAL ACOUSTICS: Dynamic Symmetry—Convex Wood Splays for Broadcast and Motion-Picture Studios—Recording Studios—Television Studios—Home Acoustics—Sound-Absorptivity Measurements—Acoustic Measurement Facilities. MAGNETIC RECORDING: Ring-Type Magnetic-Recording and Reproducing Heads—Front Gap—Back Gap—Alternating-Current Magnetic Erase Heads—Frequency Response—Experimental Results. APPENDIX: Octaves—Decibels, Volume Units. Dbm versus Watts—Dbm versus Voltage—Bibliography—Index.**

—271 pages • 1955 • \$10.00

Order your copy today from

AUDIO

P. O. Box 629 Mineola, N. Y.

but, because of their length (a matter more of tedium than difficulty) are not reproduced here. They show that below three-quarters wavelength there is no optimum spacing; at spacings of from zero to 0.255 wavelength with out-of-phase connection, the response will always lie within a range of 4 db; and the same figure applies to the in-phase connection from 0.255 to about 0.75 wavelength. The dividing figure, 0.255 wavelength, was determined graphically and one might, with greater convenience, consider the dividing line to be 1/4 wavelength (the chances are that this figure is just as accurate as 0.255 wavelength).

Without paying attention to the question of optimum spacing, where it exists, then, the dividing points between regions in which the various connections are desirable are where $n = 1/4, 3/4, 5/4, \dots$; that is where $V_n = V_d$, at $n = 1.0$. Following this rule, the out-of-phase connection is preferable from $n = 0$ to $1/4$; the in-phase connection from $n = 1/4$ to $3/4$; and the out-of-phase again from $n = 3/4$ to $5/4$, and so on. And although Table I lists certain optimum spacings between some of these limits, a much better response is attained, with less attention to accurate measurement, by keeping the spacing below three-quarters wavelength at the crossover frequency.

A multiple-speaker (not coaxial) system should be arranged so the sound paths from all speakers to the listener are of identical length, and this consideration is particularly important at higher frequencies. While it may be difficult, this objective is by no means impossible to achieve; in this manner, a multiple-speaker installation can be made to correspond closely to the ideal coaxial, coplanar case. Of course, if 12 db/octave networks are used, the speakers should be out of phase.

6 db/octave constant-resistance networks

With 6-db networks, the frequency range over which interference occurs is much greater than with 12-db networks. Where, however, the frequency-adjacent speakers must be placed a great distance apart, the 6-db network is likely to lead to a response that varies less from flatness than that with a 12-db network. In certain special cases, therefore, the 6-db network may show some advantages over the 12-db circuit; in general, the 12-db arrangement will be preferable in a well-engineered system. With the 6-db network, it makes no difference whether the speakers are in- or out-of-phase, except where a preference exists for a peak over a dip of the same size, at some particular frequency.

NEW! COMPACT
Ortho-sonic V/4
TONE ARM



MODEL #100 NOW only \$35.95

BY insistent demand of audiophiles and dealers, comes the new, *abridged* ORTHO-SONIC V/4. This new model retains all of the 10 incomparable features of the professional ORTHO-SONIC V/4 transcription model. While the arm measures only 7 1/4", it plays all recordings up to and including the 12".

OVERSIZED TRANSCRIPTION ARMS UNNECESSARY

Awkward, oversized arms are a thing of the past! The purpose served by these conventional "Transcription" arms was to minimize distortion due to tracking error. This is automatically accomplished by the revolutionary ORTHO-SONIC V/4 principle, which eliminates tracking error by following the course of the original cutting stylus.

UNMATCHED PERFORMANCE ACCLAIMED

The cartridge carrier is supported on a multiple ball bearing trolley... lateral friction is virtually eliminated. While the conventional arm, due to inertia, throws the stylus against the side of the groove, ORTHO-SONIC V/4 keeps the stylus in the center of the groove. This adds up to perfect, distortion-free reproduction so that worn records sound like new. Resonance below audible range. Fits all popular cartridges.

Testing laboratories, audio engineers and hi-fi editors attest to the superiority of the ORTHO-SONIC V/4; users rave about its unequalled performance. (Original quotes on request.)

MODEL #100\$35.95
MODEL #200 (Transcription) \$44.50
MODEL #300 (Binaural)\$59.50

AT BETTER DEALERS EVERYWHERE

If your dealer cannot supply your needs, send your order direct to...

Hi-Fi on Low Budgets

Electro-Voice®

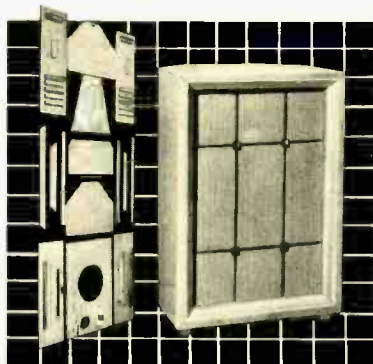

DO-IT-YOURSELF SPEAKER CABINET KITS

Assemble the Electro-Voice Aristocrat KD 6 corner folded horn cabinet. Factory assembled and finished, it retails for \$72.00. It's yours in kit form for just \$39.00!

Your Aristocrat enclosure comes pre-cut, partially-assembled. You get glue, illustrated step-by-step instructions, *everything you need.*

Finish your Aristocrat cabinet in cherry, cordovan mahogany, walnut, golden oak, fruitwood or ebony. Finishing kits, \$5.

Build Your Speaker System One Economical Step at a Time



Start with the Electro-Voice Model SP12B coaxial loudspeaker — just \$29.70.

Step up your enjoyment by adding E-V Model T35B VHF driver, AT37 level control, X36 crossover for those silky highs.

Or step up with T10A HF driver, 8HD horn, AT37 level control and X825 crossover for more mid-range response.

Complete your integrated Electro-Voice system by adding *all* the above to your basic speaker. You'll have a custom 3-way hi-fi system.

Hear the Difference

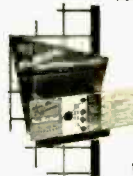

See your Electro-Voice dealer TODAY! Use the Electro-Voice Speaker Systems Selector to hear the difference as you dial from a single speaker to a multi-way system.

Write for Bulletin 211-A611

ElectroVoice®

ELECTRO-VOICE, INC. • BUCHANAN, MICHIGAN

Export: 13 East 40th Street, New York 16, U.S.A.

Cables: ARLAB
Circle 94A

Further considerations

In the preceding work, there has been a tacit assumption that the sound-generating element can be located with at least a fair degree of accuracy. While this may be fairly easy with horns, in which the element is a relatively small diaphragm, it is by no means so simple with cone units. As a matter of fact, the active portion of the cone may vary for different frequencies. Even when the entire cone is moving, it does not necessarily follow that an "equivalent diaphragm location" exists. Were the cone an ideal piston, of course, the problem would be easy; the failure in this case consequently arises from the departure of the cone's action from that of an ideal piston. This departure may cause mechanically-produced interference peaks and dips in the cone-speaker's response similar to those observed with crossover networks and ideal speakers, particularly at points where cone breakup occurs. If such nonlinearities do not occur very close to the crossover point, it should be possible to gain an idea of the response at the crossover frequency from the foregoing calculations. On the other hand, when mechanical speaker resonances occur near the crossover frequency, the picture becomes very complicated indeed, and attempting to perform calculations on the system becomes a very short and fast road to insanity, ulcers, or both.

Conclusion

It is evident that one cannot assume the response of a multiple-speaker system is flat no matter how meticulously the crossover networks are designed or constructed. Careful selection of the crossover frequency, once the system is designed, will assure a response of optimum flatness.

From the frequency-response standpoint alone, it appears that with a well-engineered system a good 12 db/octave network is to be desired over its simpler 6-db counterpart. The interference effects between speakers with the 12-db network extend over a sufficiently wide frequency range so that a variation of more than ± 1 db from flatness can be expected from 1/3 to 3 times the crossover frequency, a range of 9 to 1—over three octaves. On the other hand, the 6-db network causes a similar variation over a range of 40 to 1. When the speakers must be placed far apart, however, so that the sound paths to the listeners are widely different, the 12-db network gives rise to violent variations in response, a trait not shared by the 6-db network, which may consequently be preferred in such cases.

The results of the calculations pre-

Now—your practical guide to high-fidelity amplifier design!



HIGH-FIDELITY CIRCUIT DESIGN

Gernsback Library
Book No. 56. By
Norman H. Crow-
hurst and George
Fletcher Cooper.
304 pages. Deluxe
stamped gold-leaf
hard cover edition
only. \$5.95.

Here's one of the most unique and helpful books ever written on audio amplifier design. A practical, common-sense approach which eliminates hit-or-miss, trial-and-error experimenting in favor of logical planning. Shows you how to design the best amplifier for your needs.

Two of England's top hi-fi experts show you the secrets of successful circuit design.

Includes the Famous Cooper Feedback Series High-Fidelity Circuit Design

includes the noteworthy and often requested series of hi-fi articles "Audio Feedback Design" which originally appeared as a series in RADIO-ELECTRONICS Magazine, now augmented with additional material and detailed explanations. The two eminent authors answer all the questions you yourself would ask. Here are just a few of the points they cover: — Where to apply feedback; Circuit refinements; Design comparison and procedures; Eliminating filter hum; Phase difference; Hook-up problems; and many more subjects than can be mentioned here. Look over the partial list of contents and see for yourself how much HIGH-FIDELITY CIRCUIT DESIGN has to offer you.

15 BIG CHAPTERS

- Negative Feedback effects
- Analysis and design
- Response and stability
- Distortion
- Extending design factors
- Drivers and inverters
- Power supplies
- Attenuators
- Filters and equalizers
- Scope test procedures
- Speaker systems
- Advanced techniques
- High-power amplifiers
- Test equipment design
- Improving your amplifier

OTHER GERNSBACK HI-FI BOOKS

MAINTAINING HI-FI EQUIPMENT—No. 58. Hi-fi expert Joseph Marshall shows you the techniques necessary to service hi-fi equipment. Covers acoustical and mechanical as well as electronic faults. 224 pages. Paper cover \$2.90. Hard cover \$5.00.

HIGH-FIDELITY—Design, Construction, Measurements—No. 48. New 3-way approach to top hi-fi performance. Covers amplifier construction. 128 pages. \$1.50.

BASIC AUDIO COURSE—No. 66. Fundamentals from the theory of sound to advanced techniques. 224 pages. Paper cover \$2.75. Hard cover \$5.00.

PRICES 10% HIGHER IN CANADA

Visit our display in Room 523 at the NEW YORK HIGH-FIDELITY SHOW in the New York Trade Show Building, September 26-30.

See your distributor — or mail this coupon

GERNSBACK LIBRARY, INC. Dept. A116
154 West 14th St.
New York 11, N. Y.

Enclosed is my remittance of \$.....

Please send me the following books postpaid:

56 High-Fidelity Circuit Design.

Hard cover \$5.95

58 Hard cover \$5.00 58 Paper cover \$2.90

66 Hard cover \$5.00 66 Paper cover \$2.75

48 Paper cover only \$1.50

Name Please Print

Street

City State.....

Circle 94B

sented here should be viewed in the light of the assumptions that the capacitances and inductances are pure, the speaker can be represented as a resistance, and the amplifier has a negligible internal impedance. The presence of resistance in the inductance or amplifier may moderate the curves somewhat and render the variations in response less severe.

The calculations performed in this paper, and the resulting curves, all apply to *axial* response; that is, the sound level along the axis of the co-axial speakers. To each spacing there corresponds a particular pattern of off-axis responses, which have not been considered. The possibility that a speaker spacing having an inferior axial response may nevertheless yield a good off-axis response must be admitted. That a desirable spacing, having a good axial response, should at the same time present an undesirable off-axis response does not seem to be possible, particularly with the more desirable close spacings. Irrespective of the arguments that may arise regarding the value of the optimum spacings in Table I, there can be no dispute about the value of spacings so close that the two speakers act essentially as a single unit.

COMING EVENTS

Nov. 8-9—IRE Technical Conference, Town House Hotel, Kansas City, Kansas.

Feb. 7-10, 1957—Los Angeles High Fidelity Show, presented by the Institute of High Fidelity Manufacturers, Ambassador Hotel, Los Angeles, California.

Feb. 15-18, 1957—San Francisco High Fidelity Show, presented by the Institute of High Fidelity Manufacturers, Hotel Whitecomb, San Francisco, California.

March 18-21, 1957—IRE Annual Convention and Radio Engineering Show, The Coliseum, New York City.

Apr. 9-11, 1957—Fourteenth Annual British Radio Component Show, Great Hall, Grosvenor House, Park Lane, London, W.1, England. Admission by ticket only, obtainable from the Radio and Electronic Component Manufacturers' Federation, 21, Tothill Street, London, SW. 1.

Apr. 12-15, 1957—The London Audio Fair, 1957, Waldorf Hotel, Aldwych, London, W.C. 2.

... the ultimate goal
of the
critical listener

Audio Console
pre-amplifier with cabinet \$168*

Power Amplifier
\$198*

*slightly higher west of the Mississippi

write for literature

marantz company
44-15 Verdon Boulevard, Long Island City 1, N. Y.

And now . . .

the 3rd audio anthology

Reprints of articles which appeared in AUDIO from July 1952 to June 1955. 124 pages of articles of greatest interest to the serious hobbyist.

The AUDIO ANTHOLOGY and 2nd AUDIO ANTHOLOGY are no longer in print.

CUT OUT — MAIL TODAY!

Book Division, Dept. 10
Radio Magazines, Inc.,
P. O. Box 629, Mineola, N. Y.

Gentlemen: Enclosed is check money order for \$..... Please send me

..... copies of the 3rd audio anthology (paper cover) @ \$2.50 each
..... copies of the 3rd audio anthology (board cover) @ \$3.50 each

Name (please print)

Address

City Zone State

...any arm can reach
for good music
but...

A good arm delivers . . . and that's what audiophiles, audio-engineers, and music lovers are saying in words and by their purchases of Fairchild's excellent Model 280A plug-in transcription arm. The beauty of the finest recorded music stays in deep-freeze if the pickup arm is poorly designed. Check these points—they spell out the meaning of arm excellence, performance, of rugged construction.

- Fundamental resonance below audibility with any high quality cartridge.
- Perfect tracking on all records—arm offset and overhang carefully calibrated.
- No groove jumping, no skidding—arm laterally balanced.
- No delicate leveling required.
- Quick cartridge change. ('Less than 5 seconds dead interval'—Audio League.)
- Uses all standard cartridges including GE turnaround.
- No hum—remove cartridge slide, leave volume full on. Hum automatically cut out.

Net Prices: 280A (12") \$33.95
281A (16") \$35.95

For further information on Fairchild professional arms or other High Fidelity components, write to:

FAIRCHILD RECORDING EQUIPMENT CO. 9th AVE. & 154 ST., WHITESTONE 57, N. Y.

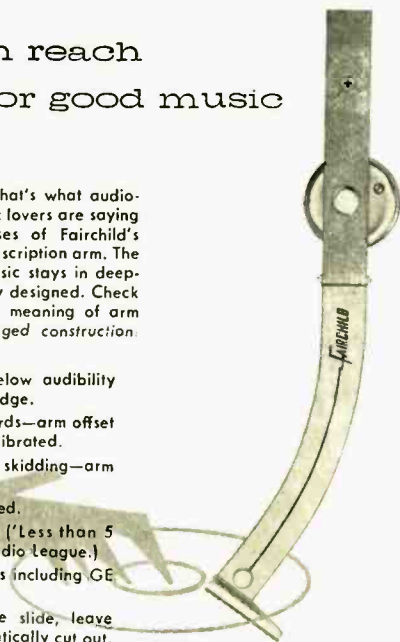

CROSSOVER NETWORKS

(from page 31)

Do not mount coils against a metal chassis, either aluminum or steel. Space the coil at least an inch, and preferably two inches away from any metal. A good place to mount crossover coils is on the wooden back of a loudspeaker cabinet. Use a $\frac{1}{4} \times 1$ inch piece of wood to hold it in place. Fasten it by means of a brass wood screw through the wood piece and the center of the coil.

APPENDIX—Calculations

One of the simpler formulas for multi-layer coils of wire¹¹ is;

$$L_{\text{microhenries}} = \frac{0.8 a^2 n^2}{6a + 9b + 10c} \quad (7)$$

where a is the mean radius of the coil, b the axial length of the coil, and c the radial depth, all in inches as in Fig. 10, and n is the number of turns. To simplify this and make a compact coil put

$$2a = 3b = 3c = 3x \quad (8)$$

and the working formula reduces to

$$L_{\text{microhenries}} = 0.043 a n^2 = 0.064 x n^2 \quad (9)$$

where a is the mean radius of the coil, and x is the axial length. This means that for each coil;

$$\text{outside diameter} = 2a + c = 2.67 a = 4x \quad (10)$$

$$\text{inside diameter} = 2a - c = 1.33 a = 2x \quad (11)$$

$$\text{axial length } c = 0.67 a = x. \quad (12)$$

In words, the length x is half the inside diameter, and the outside is twice the inside diameter.

The density of solid copper is 0.318 lb/in^3 . The density of fully packed round copper wires, without insulation, is $\pi/4$ times this value, or 0.249 lb/in^3 . For the different sizes of heavy enamel copper wire of interest for crossover coils the densities are;

No. 12— 0.237 lb/in^3

No. 18— 0.230 lb/in^3

No. 22— 0.222 lb/in^3 .

Thus, by using No. 18 as the design center, at 0.230 lb/in^3 the No. 12 wire will be 3 per cent high, and the No. 22 $4\frac{1}{2}$ per cent low. These data are the bases of Figs. 7, 8, and 9.

¹¹ Pender and McIlwain, "Elec. Engg. Hbk., Vol. 5," 3rd Ed., 1936, Wiley, p. 4-14.

STATEMENT REQUIRED BY THE ACT OF AUGUST 24, 1912, AS AMENDED BY THE ACTS OF MARCH 3, 1933, AND JULY 2, 1946 (Title 39, United States Code, Section 233) SHOWING THE OWNERSHIP, MANAGEMENT, AND CIRCULATION OF

AUDIO, published Monthly at Lancaster, Pa., for October 1, 1956.

1. The names and addresses of the publisher, editor, managing editor, and business managers are: Publisher: Charles G. McProud, 204 Front St., Mineola, N. Y.; Editor: Charles G. McProud, 204 Front St., Mineola, N. Y.; Managing editor: none; Business manager: Henry A. Schober, 204 Front St., Mineola, N. Y.

2. The owner is: Radio Magazines, Inc., 204 Front St., Mineola, N. Y.; Henry A. Schober, 204 Front St., Mineola, N. Y.; Charles G. McProud, 204 Front St., Mineola, N. Y.

3. The known bondholders, mortgagees, and other security holders owning or holding 1 per cent or more of total amount of bonds, mortgages, or other securities are: none.

4. Paragraphs 2 and 3 include, in cases where the stockholder or security holder appears upon the books of the company as trustee or in any other fiduciary relation, the name of the person or corporation for whom such trustee is acting; also the statements in the two paragraphs show the affiant's full knowledge and belief as to the circumstances and conditions under which stockholders and security holders who do not appear upon the books of the company as trustees, hold stock and securities in a capacity other than that of a bona fide owner.

(Signed) HENRY A. SCHOBEL, Business Manager.

Sworn to and subscribed before me this 26th day of September, 1956.

(Seal) HERMAN J. KNOPH, Notary Public.

State of New York. No. 30-7316875. Qualified in Nassau County. Term expires March 30, 1958.

HI-FI
Fen-tone
IMPORTS

The finest professional mikes
used in Broadcast and TV
Studios the world over

The new
MULTI-IMPEDANCE
Fen-tone Dc 53



Blue Ribbon Studio-Type
Velocity Mike.

With the flip of a
switch, you can choose
50 ohms - 250 ohms or
HI-Z.

Frequency range: ex-
tremely flat — 30-
15,000 cps ± 2½ db.
Hum pickup (Gh) 139.8
db at 50 ohms.

AVAILABLE MODELS:
With 20 feet of shielded
balanced cable and
connections to stand
and microphone.

B&O-53 Multi-imp-
edance List \$105.00
B&O-50 50 ohm im-
pedance only 89.95
B&O Desk Stand 5.50

THE NEW Dc STEREO
MICROPHONE RIG

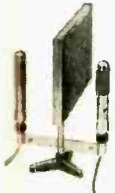

For the first time you can
set up mikes for stereo record-
ing as you would for mono-
aural. **ONE STAND, ONE**
POSITION. Perfect polar pat-
tern for large or small groups.

Rig alone (without mikes and
stand) List \$38.95

And for more rugged
use—indoor or out-
door, the triple blast
screened

Reslo "CELESTE"



Deal impedance 50 ohms/
HI-Z. Proper impedance sel-
ected by plugging in proper
cable. With two cables and
mating switch—List \$89.95



FENTON COMPANY
15 Moore Street, New York 4, N. Y.

Sold through better
Audio Distributors.
See yours today!

West of Rockies,
prices slightly higher.



Circle 97A

Industry Notes . . .

BELL RE-ASSIGNS PERSONNEL. Re-
flecting the company's broadening sales
and marketing program, a number of per-
sonnel changes have been made within the
sales department of **Bell Sound Systems,**
Inc. H. H. Seay, former vice-president and
sales manager, has terminated his active
association with the company in order to
represent Bell as a factory representative.
Seay's successor as sales manager is Earl
V. Sala, Jr. Also joining the Bell sales
group is Don Brink, formerly with the
Electronic Division of **Thompson Pro-
ducts, Inc.,** of which Bell is a wholly-owned
subsidiary. Brink's responsibilities will
deal primarily with advertising and sales
promotion. Rounding out the picture, K.
M. Bishop, Bell president, announced the
retention of **Advertising Council, Inc.,** Co-
lumbus, Ohio, as the company's new adver-
tising agency.

JENSEN RETURNS TO ONE-STEP
DISTRIBUTION. Terminating its experience
with two-step distribution as a "mobile
experiment which did not work," **Jensen**
Manufacturing Company has eliminated
the wholesaler-to-dealer segment of its
distribution of high fidelity items. "After a
more than two-year trial, it is plain that
the method is not workable in the distribu-
tion nationally of high-fidelity loud-
speakers," announced Ralph P. Glover,
vice-president. Jensen is now following
the conventional distribution pattern
which has been evolved by component
manufacturers. "We are convinced that
the future of component high fidelity is
closely linked with specialized selling op-
erations," Glover said.

PENTRON RECAPITALIZED. Sound,
Incorporated and its wholly-owned sub-
sidiaries, **The Pentron Corporation** and
Star Products Company, all located in Chi-
cago, have recapitalized and added six new
members to the board of directors of the
parent organization, according to Theo-
dore Rossman, president. Members of the
board, in addition to Rossman, are: Irving
Rossman, vice-president, Sound, Inc.; Ber-
nard Sahllins, treasurer, Sound, Inc.; Rich-
ard Dooley, formerly vice-president of
Admiral Corporation; Henry Straus, vice-
president of Inland Steel Company;
Jerome Kahn, formerly president of
Standard Transformer Corporation; Ken-
neth G. Prince, attorney; Alex Gianaras,
president of Raynar Corp., and I. Ben
Berger, industrialist.

The company is now completing develop-
ment of a tape-cartridge recorder. The ma-
chine utilizes a one-reel cartridge of tape
feeding in a continuous loop. It is operated
by sliding a flat plastic cartridge into a
slot and turning a knob to select Play,
Record, Stop, or Automatic Eject.

AES ELECTS OFFICERS FOR COMING
YEAR. Walter O. Stanton, president of
Pickering & Company, and secretary of the
Institute of High Fidelity Manufacturers,
has been elected president of the **Audio**
Engineering Society to succeed Colonel
Richard H. Ranger. Sherman M. Fairchild,
president of Fairchild Recording Equip-
ment Company, was chosen executive vice-
president in the election which was by
mail ballot.

BOGEN IN NEW PLANT. Lester Bogen,
president, **David Bogen Company, Inc.,** in
announcing the firm's occupation of its
new manufacturing plant in Paramus,
N. J., terms the new quarters "the most
spacious and best equipped in the sound
reproduction equipment industry." The
new facilities are in addition to the com-
pany's present plant in New York. Under
a new marketing and sales realignment,
Lawrence LeKashman has been appointed
vice-president in charge of sales for both
David Bogen Company, Inc., and **Presto**
Recording Corporation, a wholly-owned
subsidiary which was acquired last July.
Also announced was the promotion of
David Pear to manager of advertising and
sales promotion for both Bogen and
Presto.

Your answer
to a low-cost,
well designed speaker!

NEW! Isophon
ELECTROSTATIC
TWEETERS

- ★ Better performance in higher frequencies (7000-20000 cycles)
- ★ Extremely low cost
- ★ Compact, space-saving
- ★ Easy Installation for single output and push-pull amplification
- ★ Remarkable brilliancy of sound

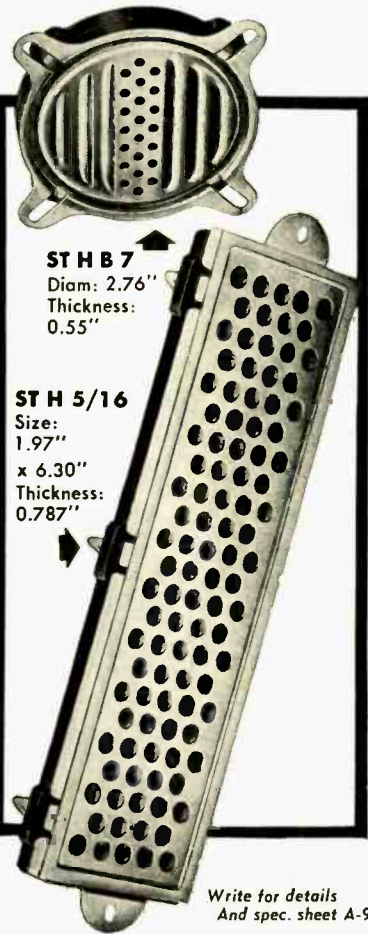

STHB 7
Diam: 2.76"
Thickness:
0.55"

STH 5/16
Size:
1.97"
x 6.30"
Thickness:
0.787"

Write for details
And spec. sheet A-9

Arnhold **ARNHOLD**
CERAMICS, INC.

1 E. 57th Street, New York 22, N. Y.
Circle 97B

And the night shall be filled with music... Longfellow



Heavenly music . . . with all its rich color and original lustre . . . as it flows through the faithful reproduction channels of

Custom-Built HI-FI AMPLIFICATION SYSTEMS by Rogers of England

You capture all the thunder of the pure bass . . . all the shimmer of the high treble—virtually flat frequency response from 20 to 20,000 cycles with minimum distortion and phase shift. Modest in size as well as price.

Cambridge Preamplifier Control Unit \$49.95 net



Cambridge 15-watt Amplifier \$89.95 net

Higher powered models available. Write for unbiased performance reports and literature.

AT LEADING HI-FI MUSIC CENTERS
ERCONA CORPORATION
(Electronic Division)

551 Fifth Ave., Dept. 31, New York, N. Y.

Circle 98A

IF YOU ARE MOVING

Please notify our Circulation Department at least 5 weeks in advance. The Post Office does not forward magazines sent to wrong destinations unless you pay additional postage, and we can NOT duplicate copies sent to you once. To save yourself, us, and the Post Office a headache, won't you please cooperate? When notifying us, please give your old address and your new address

Circulation Department
RADIO MAGAZINES, INC.
P. O. Box 629, Mineola, N. Y.

AUDIO ETC.

(from page 79)

highs, it will lose its taste, but fast, for the scratchy sort. The emphasis among the other types of hi-fi upper range speakers will accordingly shift towards essentially better sound, and has already. Maybe you won't even have to buy an electrostatic; the other tweeters are going to do some fast catching up, towards better sound.

“Is it electrostatic?”, I heard again and again; and the defensive answer was often “well no, but . . .” and then on to explain that the new non-electrostatic driver was nevertheless improved, cleaner, better. Probably true. If you took all the electrostatics off the market right now, we'd still have improved highs this year.)

‘Nuff said. If you think this constitutes a fine passel of generalizations, you're entirely right. Somehow, sometime we've got to get away a bit from hi-fi details for a bit of medium-range foresight. I hate to think of where hi-fi and audio in general may be in ten years. Ever onward and upward? Who knows. Next May this department will be celebrating its Tenth Anniversary along with the magazine itself, and maybe at that time we'll dare take a look at what we were saying ten years ago. Ten years right now seems an awful long time, looking forward. If in ten years there won't be enough oil to go around and the internal combustion V-8 engine will be a thing of the past, as is now suggested, then where in Heaven will the 117-volt a.c. amplifier be by the same token? Where will WE be?

Let's hope not in eternity, anyhow.

P. S. This department, while hedging a bit, hasn't given up on new product discussion. It's just that, first, I find the best way to judge usefully the new stuff that comes my way is to put it to use, not overnight, but for a solid period of time. And secondly, I was away for some months and I left much of my going equipment to the ever-so-tender mercies of numerous of my friends, typical amateurs with a vengeance. We shall see what has happened, in future issues! Pardon me, I have to go fix a phono player that went dead on my friend who borrowed it. . . .

CLASSIFIED

Rates: 10¢ per word per insertion for noncommercial advertisements; 25¢ per word for commercial advertisements. Rates are net, and no discounts will be allowed. Copy must be accompanied by remittance in full, and must reach the New York office by the first of the month preceding the date of issue.

THE AUDIO EXCHANGE has the largest selection of new and fully guaranteed used equipment. Catalog of used equipment on request. Audio Exchange, Dept. AE, 159-19 Hillside Ave., Jamaica 32, N. Y. AXtel 7-7577; 367 Mamaroneck Ave., White Plains, N. Y. WIJ 8-3380.

AUDIO EXCHANGE EXCHANGES AUDIO

HIGH FIDELITY SPEAKERS REPAIRED
Amprite Speaker Service
70 Vesey St., New York 7, N. Y. BA 7-2580

WANT A VERY LOW RESONANCE SPEAKER?

Ask your dealer to demonstrate the Racon floating cone, foam-suspension loudspeaker. Or write for literature and prices. Racon Electronic Co., 1261 Broadway, New York 1, N. Y.

FREE monthly Hi-Fi bulletin. Write for quotation on any components. Sound Reproduction, Inc., 34 New St., Newark, N. J. Mitchell 2-6816

6-Element BROAD-BAND FM ANTENNAS. All seamless aluminum. \$10.95 ppd. Wholesale Supply Co., Lunenburg 10, Mass.

Long Playing records 20 to 50% discounts; brand new factory fresh; unplayed; all labels. Send 20¢ for catalog to Record Discount Club, 1108 Winbern, Houston 4, Texas.

Wanted—Western Electric model 594-A loud-speaking telephone, with or without field supply or horn, also Western Electric model 713 driver. R. E. Murphy, 6413 Stoneham Rd., Bethesda, Maryland.

FOR SALE: Control units with cabinets: Scott 121-B, \$100. McIntosh C-8P, \$60. Fisher 80-AZ amplifier, \$55. All are in excellent condition. John Haner, 815 N. Henderson, Galesburg, Ill.

Magnecord M-90-AC in portable cases. New condition. Operated less than 25 hours. \$850. Roland S. Bond, Jr., 2600 Republic National Bank Building, Dallas, Texas.

HEATH and Dynakit custom built. Reasonable price. Catalog 25¢, refundable. Bednar Electronic Services, 24 Sickles St., New York 40, N. Y.

Employment Register . . .

Positions Wanted and Positions Open are listed here at no charge to industry nor to individuals who are members of the Audio Engineering Society. Positions Wanted listings from non-members are handled at a charge of \$1.00, which must accompany the request. For insertion in this column, brief announcements should be sent to AUDIO, P. O. Box 629, Mineola, N. Y., before the fifth of the month preceding the date of issue.

• Lawyer, with academic and practical training in electronics and ten years general legal practice desires position requiring his diverse qualifications. Box 1101, Audio.



TELEFUNKEN
INDISPUTABLY...
the world's best
microphones

Ask about the new CM - 51 shown here (only 4 1/2" high), and the famous U47M. Write for complete details. Professional Instrument — List Price \$390.00

Sole U.S. Importers

AMERICAN ELITE, INC.

Dept. A
7 Park Ave.
New York 16, N. Y.



Circle 98B

PROFESSIONAL DIRECTORY

"Continuously Since 1944"
HOLLYWOOD ELECTRONICS
 DISTRIBUTORS OF HI-FI COMPONENTS EXCLUSIVELY
 7460 Melrose Ave. Los Angeles 46, Calif. Webster 3-8208

Circle 99D

HIGH-FIDELITY HOUSE

Most complete stock of Audio components in the West
 Phone: RYan 1-8171
 536 S. Fair Oaks, Pasadena 1, Calif.

Circle 99E

the finest in Hi-Fi featuring Electro-Voice®
 HIGH FIDELITY COMPONENTS

SOUND CORPORATION
 820 W. Olympic Blvd. - L.A. 15, Calif. - RI 7-0271

Circle 99F

CANADA
 High Fidelity Equipment
 Complete Line • Complete Service
 Hi-Fi Records — Components and Accessories
ELECTRO-VOICE SOUND SYSTEMS
 141 DUNDAS ST. WEST. TORONTO, CANADA.

Circle 99G

YOUR TAPE RECORDER CAN MAKE MONEY FOR YOU

Make tape recordings of
 PARTIES • MEETINGS • SCHOOL
 CONCERTS & EVENTS • WEDDINGS
 and transfer to high-fidelity permanent records for very little cost. Then resell at your own price!

- Records Imprinted With Your Copy
 - Large or Small Quantities
 - Exceptionally Low Rates
 - All Speeds and Sizes

CREST RECORDS, INC.
 220 Broadway, Huntington Sta. 8, N. Y.
 Please send me brochure and rates on transferring tape to records.
 NAME
 ADDRESS
 CITY ZONE STATE

Mail TODAY for Brochure and Rates

Circle 99C

AUDIOCLINIC

(from page 53)

Hiss

Q. The quality of my record reproduction has deteriorated. I notice considerable hiss, especially during loud passages wherein the brass section is prominent. The difficulty does not lie with my amplifier, as tape and radio reproduction are as good as ever. It seems, then, to be coming from my cartridge. Is there any way you can suggest to get rid of this distortion?
 S. F. Saiya, Brooklyn, New York

A. First, check the stylus. If it is worn, considerable distortion can be introduced. From your description of the trouble, however, I suggest that you remove the stylus and examine the now exposed interior of the cartridge for any dirt which may have collected there. Such particles will impede the motion of the stylus.

LETTERS

(Continued from page 8)

Klipsch, et al, sell speakers to a public among which there are individuals whose hearing may well extend above 20,000 cps. They would favor equipment reproducing to that level.

Like you say, there is no high finality. But its much like the argument about the correct amount of vermouth to put into a martini. (If any. Ed.)

TOM G. SMITH,
 422 Champine Place,
 Grosse Point Farms 36, Mich

ATOMIC JEWEL RADIOACTIVE STATIC ELIMINATOR



- Reduces Record Wear
- Reduces Needle Wepr
- Improves Fidelity

At Your Dealer

ROBINS INDUSTRIES CORP. Bayside 61, N. Y.

Circle 99K

If You're a Connoisseur... you'll want a Connoisseur TURNTABLE



\$110.00

Compare the Connoisseur with any turntable and you'll marvel at its performance. Non-magnetic, 12" lathe-turned table; precision ground spindle; phosphor bronze turntable bearing. ±2% variation provided for all 3 speeds; hysteresis motor.

TURNTABLE: Rumble—better than 50 db down; Wow—less than 0.15% of rated speed; Dimensions: 13½x15¾".

PICKUP: Frequency Response — 20-20,000 cps ±2 db at 33½ rpm; Effective Mass—4 mg; Impedance—400 ohms at 1000 cps.



"Dynabanced" tone arm with Mark II super-lightweight pickup w/diamond stylus \$49.50... w/sapphire stylus \$34.50.

ERCONA CORPORATION

(Electronic Division)
 561 Fifth Ave., Dept. 32, New York 17
 In Canada, write Astral Electric Company Limited, 44 Dunforth Road, Toronto 12

Circle 99H

GIBSON GIRL TAPE SPLICERS

splices in a wink!
 NO SCISSORS!
 NO RAZOR BLADES!
 Duplicated run tape ends and from splice edges.
 At Your Dealers
 ROBINS INDUSTRIES CORP. Bayside 61, N. Y.

Circle 99H

DO YOU WANT A BETTER AMPLIFIER? Build a 50 watt DYNAKIT MARK II



\$69.75 net

A premium kit for the audio perfectionist, the Dynakit sounds better because it is designed for outstanding transient response and stability, for higher power at low distortion, and for complete and accurate reproducibility. The improvement over conventional circuits is immediately apparent to the discriminating listener. The Dynakit combines unequalled quality with economy and simplicity. It features the finest of parts, like the superb Dynaco A-430 output transformer. At the same time construction is greatly simplified by the Dynaco pre-assembled printed circuit unit which includes the major portion of the wiring. The Dynakit is sold complete with all parts and the pre-wired printed circuit assembly. Complete specifications are available on request. Available from electronic parts and audio distributors

USE A DYNACO TRANSFORMER TO MODERNIZE YOUR PRESENT AMPLIFIER

Dynaco super-fidelity transformers are a new design which permits lower distortion and wider frequency response in high fidelity amplifiers. Models are available from 10 to 100 watts including the 50 watt A-430 transformer which can be used to increase the power of Williamson Amplifiers to 50 watts.

MODELS

A-410	10 watts 6V6, EL-84	\$14.95
A-420	25 watts KT-66, 5881, EL-34	19.95
A-430	50 watts 6550, EL-34 (6CA7)	29.95
A-440	100 watts 6550	39.95
A-450	100 watts PP par 6550, EL-34	39.95

(all with tapped primaries except A-440 which has tertiary for screen or cathode feedback)

Full data and details of Williamson Amplifier conversion available on request.

DYNA COMPANY, Dept. A, 5142 Master St., Phila. 31, Pa.

Circle 99A

**SAVE
25%**



This is our
GROUP SUBSCRIPTION PLAN

Now you, your friends and co-workers can save \$1.00 on each subscription to **AUDIO**. If you send 6 or more subscriptions for the U.S., Possessions and Canada, they will cost each subscriber \$3.00 each, 1/4 less than the regular one year subscription price. **Present subscriptions may be renewed or extended as part of a group. Remittance to accompany orders.**

AUDIO is still the only publication devoted entirely to

- Audio
- Broadcasting equipment
- Acoustics
- Home music systems
- Recording
- PA systems
- Record Revues

(Please print)

Name

Address

New Renewal

Name

Address

New Renewal

Name

Address

New Renewal

Name

Address

New Renewal

Name

Address

New Renewal

Name

Address

New Renewal

U. S., Possessions, and Canada only

RADIO MAGAZINES, INC.
P. O. Box 629, Mineola, N. Y.

**ADVERTISING
INDEX**

Acoustic Research, Inc.	86, 87
Allied Radio Corporation	85
Altec Lansing Corporation	10, 11, 81
American Electronics, Inc.	60, 61
American Elite, Inc.	98
Amperex Electronic Corporation	2
Ampex Corporation	7
AMI Incorporated	42
Arnhold Ceramics Inc.	97
Audak Co.	76
Audiogersh Corporation	9
Belden Manufacturing Co.	45
Bell Sound Systems, Inc.	83
Bell Telephone Laboratories	14
Bozak, R. T. Sales Co.	74
Bradford & Company	82
British Industries Corporation	9
facing Cov. 2, 3	
Cabinart	35
Collaro Record Changers	Cov. 3
Components Corporation	79
Crest Records, Inc.	99
Dauntless International	67
du Pont de Nemours, E. T. & Co. (Inc.)	41
Dyna Company	99
Electro-Sonic Laboratories, Inc.	70
Electro-Voice, Inc.	94, Cov. 4
Electro-Voice Sound Systems	99
Ercona Corporation	84, 98, 99, 100
Fairchild Recording Equipment Co.	96
Fenton Company	97
Fisher Radio Corporation	49-52
General Electric Company	59
Gernsback Library, Inc.	94
Goodmans Industries Ltd.	63
Harvey Radio Co., Inc.	73
Heath Co.	56, 57
High Fidelity House	99
Hollywood Electronics	99
Hudson Radio and Television Corp.	64
JansZen Speakers (Neshaminy Electronic Corp.)	78
Kierulff Sound Corporation	99
Kingdom Products, Ltd. (Lorenz)	6
Laboratory of Electronic Engineering ..	47
Lansing, James B., Sound, Inc.	39
Leonard Radio, Inc.	92
Magnecord, Inc.	75
Marantz Company	95
Minnesota Mining & Mfg. Co.	5
Mullard Overseas Ltd.	37
Niblack Thorne Co.	100
North American Philips Co., Inc.	92
Orradio Industries, Inc.	Cov. 2
Ortho-Sonic Instruments, Inc.	93
Pickering & Company	13
Pilot Radio Corp.	33
Precision Electronics, Inc.	80
Rauland-Borg Corporation	89
Recoton Corporation	88, 91
Rek-O-Kut Company	71
Robins Industries Corp.	99
Sargent-Rayment Co.	8
Scott, H. H. Inc.	77
Shure Brothers, Inc.	1
Tech-Master Corporation	90
Tung-Sol Electric, Inc.	4
United Audio Products	89
University Loudspeakers, Inc.	68, 69

QUOTE

"Startling, full-bodied bass . . .
crisp, clear mid-range . . .
vibrant shimmering treble."
Leading Hi-Fi Magazines, May 1956

**NEW! TRI-CHANNEL
HI-FI Sound System**

Frankly, only about 12 people who read this ad will be interested enough in the majestic sound reproduction to plunk down \$795.00 for the unit. You are one of them . . . only if you sincerely want the truest depth and dimension possible in an audio system. This is a radical departure from conventional Hi-Fi . . . featuring a 3 channel Tone Colour mixer (preamp) feeding 3 separate amplifiers and driving 4 speakers—all acoustically matched! Flat frequency response from below 25 to above 25,000 cycles. Distortion below recordable measurement.

Don't get excited about it unless you can afford the price. Have your sound specialist arrange a demonstration . . . write today for independent, unbiased performance test reports.

ERCONA CORPORATION
(Electronic Division)
561 Fifth Ave., Dept. 33, New York 17

Circle 100A

**Keep your Recording Tape
From Time-Wasting
Spilling with**

New "Magi-Clip" for

Any Size Reel!



Whether you're a professional or record at home, you know how often tape spills out from a reel you're ready to use. That wasted time may mean missing the very crux of what you want to record.

Magi-Clip,® an ingenious brass, non-magnetic clip, holds tape securely on the reel till ready for use. It snaps over flange of any size reel, holds even a partial reel. Lasts indefinitely. Ideal for mailing or storing!

INTRODUCTORY OFFER!

20 for \$2.00 (postage paid) Magi-Clip is not sold in stores. Send cash, check or money order to:

NIBLACK THORNE COMPANY
DEPT. AV
BOX 86, SCOTTSDALE, ARIZONA

Circle 100B

why the Collaro RC-456

is today's outstanding
HIGH FIDELITY RECORD CHANGER



Minimum Noise and Distortion

Balanced, heavy 4-pole motor . . .
balanced pulley and coupler reduce
rumble to an inaudible minimum.
Automatic muting switch and R/C
network eliminate 'clicks.'

Accurate Speed & Pitch

Collaro quality control limits for the
RC-456 are .25% wow and flutter
. . . unmatched by any other
record changer.

Jam-Proof

Collaro safety-clutch prevents
damage even if tone-arm is held
or moved during change cycle.

Four Speeds

Plays all 78, 45 and 33 $\frac{1}{3}$ rpm
records . . . plus new types designed
for 16 $\frac{2}{3}$ rpm speed.

Automatic Intermix

Plays 7, 10 and 12-inch records
stacked in any order —
automatically.

Manual Operation

For playing records individually or
for selecting and playing specific
bands and parts of a record.

Simple Installation

Prewired power and audio connections
eliminate soldering. Pre-cut
mounting board available.

Plus

- ★ Rapid change cycle independent of record speed.
- ★ Automatic 'shut-off' after last record.
- ★ Simple, one-knob speed selection.
- ★ Gentle, straight-spindle record handling.
- ★ Interchangeable, plug-in cartridge shells.
- ★ Heavy, rim-weighted turntable for flywheel action.
- ★ Automatic idler-disengage prevents idler flats.

At leading sound dealers, or write Dept. WL-1

ROCKBAR CORPORATION • 650 Halstead Avenue, Mamaroneck, N. Y.



...STOP UNWANTED SOUNDS

with the NEW **664** VARIABLE D*



CARDIOID for P.A.

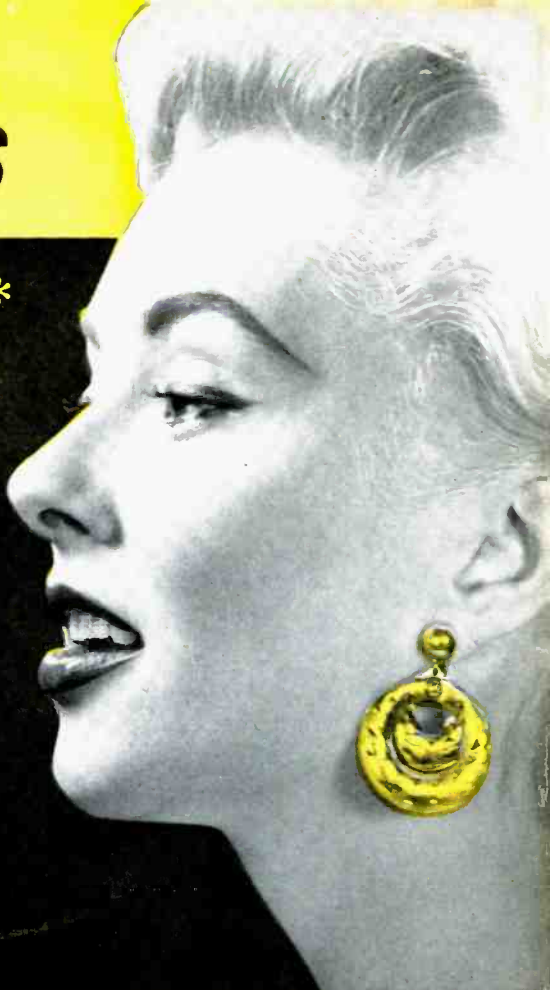

Now... Broadcast Performance Designed for Public Address

**COMPLETELY NEW ALL-PURPOSE CARDIOID DYNAMIC MICROPHONE
BRINGS NEW EFFICIENCY OVER WIDE FREQUENCY RANGE**

All the advantages of the E-V Variable D* are now available in the new high-fidelity "664"... for public address, recording, communications and similar applications. Uniform cardioid polar pattern provides high front-to-back discrimination against unwanted sounds, without close-talking boominess. Easily solves sound pick-up and reproduction problems under a great variety of conditions. Gives distinct, natural reproduction of voice and music. Increases working distance from microphone. Gives greater protection against feedback. Especially useful where ambient noise and severe reverberation exist. Pop-proof filter minimizes wind and breath blasts. E-V Acoustalloy diaphragm guarantees smooth wide-range reproduction. Can be used on a floor or desk stand or carried in the hand. No finer microphone for performance and value! Write for Technical Specification Sheet A1611.

®EV Pat. Pend.

Model 664. Variable D* Super-Cardioid Dynamic Microphone. Uniform response at all frequencies from 40 to 15,000 cps. Output level -55 db, 150 ohm and high impedance. Impedance changed by moving one connection in connector. Line balanced to ground and phased. Acoustalloy diaphragm, shielded from dust and magnetic particles. Alnico V and Armco magnetic iron in non-welded circuit. Swivel permits aiming directly at sound source for most effective pick-up. Pressure cast case. 5/8"—27 thread. Satin chrome finish. 18 ft. cable with MC4M connector. On-Off switch. Size: 1 7/8 in. diam. 7-3/16 in. long not including stud. Net wt.: 1 lb. 10 oz. List Price \$82.50

Model 419 Desk Stand for use with the "664". List Price \$10.00



Electro-Voice®

ELECTRO-VOICE, INC. • BUCHANAN, MICH.

Export: 13 East 40th Street, New York 16, N. Y. U. S. A. Cables: Arlab
Canada: E-V of Canada Ltd., 1908 Avenue Rd. Toronto, Ontario

HIGH-FIDELITY MICROPHONES • SPEAKER SYSTEMS • PHONO-CARTRIDGES • AND OTHER ELECTRO-ACOUSTIC PRODUCTS