

it CAN be ATTRACTIVE - See page 30

NOVEMBER
1953
35c

AUDIO ENGINEERING

and *Audio in the Home*

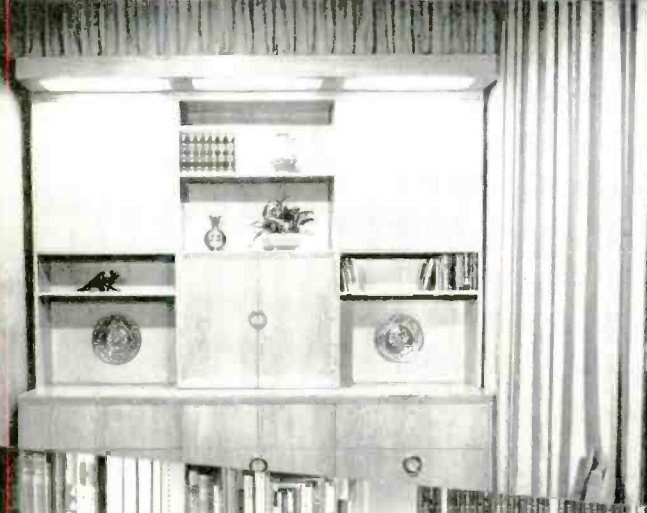

THE WORLD OF SOUND

only



offers you all this valuable new information

... and it doesn't cost you a cent!

20 PRIZE-WINNING ARTICLES from Audio's International Sound Recording Contest

Here's a wealth of new ideas on how to use tape and disc recordings to achieve greater economy and efficiency in radio, TV and sound studio operation.

With reference to these articles, one of the contest judges commented as follows: "I have never received so much information which was new and exciting in such

short time in all of my years in the business." And another judge stated that "the information and descriptions of recording operations conducted in small radio stations and recording studios throughout the country has been quite an education."

Contest winners include entries from 11 different States, as well as from Canada

and Switzerland. The 20 best articles, which were awarded cash prizes totaling \$1400, will be published in the pages of Audio Record. The information thus made available to the industry will be of real value to sound recordists everywhere.



QUICK FACTS ON MAGNETIC TAPE RECORDERS

Each year, Audio Record brings you a complete, up-to-date listing of all makes and models of tape recording machines—with conveniently arranged price and performance data. This directory issue,

published in September, is the most complete and authoritative compilation of tape recorder information available to the industry. Over 75,000 copies of the last issue were distributed.

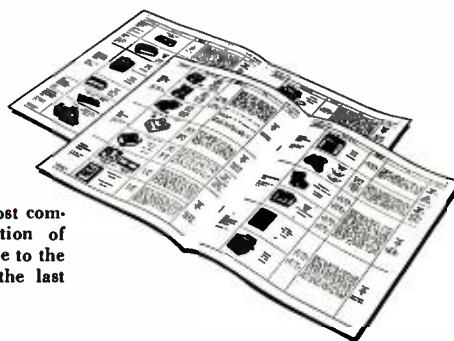

... plus many other articles of timely interest to the sound recordist

Audio Record keeps you well informed on all the latest trends and technical developments in all phases of tape and disc recording. It is not an advertising publication and its sole purpose is to render a needed and useful service to the industry.

Audio Record, published 8 times a year, is currently distributed free of charge to a request mailing list of about 35,000 sound recordists in broadcasting stations, recording studios, schools and colleges throughout the country.

IT'S YOURS FOR THE ASKING

A letter or post card will add your name to the Audio Record mailing list. And if you would like to have others in your organization read it also, send their names along, too. Just write to Audio Devices, Inc., using the Dept. No. listed below. All requests addressed to this Dept. will be started with the July-Aug., 1953 issue, so you will be sure to get all the prize-winning articles, as well as the 1953 Tape Recorder Directory Issue.

AUDIO DEVICES, Inc.

Dept. AR-1, 444 Madison Ave., New York, N. Y.

Export Dept.: 13 East 40th St., New York 16, N. Y. Cables "ARLAB"



audiodiscs
audiotape
audiofilm
audiopoints

PLEASE SEND

CHRISTMAS GIFT SUBSCRIPTIONS

FOR **AUDIO ENGINEERING** TO



First Fold

— POSTAGE WILL BE PAID BY —

BUSINESS REPLY ENVELOPE

No Postage Stamp Necessary if Mailed in The United States

AUDIO ENGINEERING

P. O. BOX 629

MINEOLA, N. Y.

FIRST CLASS
Permit No. 142
Sec. 34.9, P. L. & R.
Mineola, N. Y.

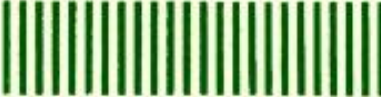

Third fold

Second fold

SEND TO

ADDRESS

CITY STATE
(Zone)

1 Year, 2 Years

Gift card from

SEND TO

ADDRESS

CITY STATE
(Zone)

1 Year, 2 Years

Gift card from

Christmas Gift Order Form

Please enter gift subscriptions to Audio Engineering and send notice thereof on gift cards to the following persons:

(PLEASE PRINT)

SUBSCRIPTION RATES

TWO YEARS	\$5.00
ONE YEAR	\$3.00
TWO YEARS (Foreign)	\$8.00
ONE YEAR (Foreign)	\$4.00

Foreign includes subscriptions addressed to Europe, Asia, Africa and Oceania.

NO ENVELOPE OR POSTAGE NEEDED
Just Fold, Seal and Mail

.....

SEND TO

ADDRESS

CITY STATE

(Zone)

1 Year, 2 Years

Gift card from

.....

SEND TO

ADDRESS

CITY STATE

(Zone)

1 Year, 2 Years

Gift card from

.....

SEND TO

ADDRESS

CITY STATE

(Zone)

1 Year, 2 Years

Gift card from

.....

SEND TO

ADDRESS

CITY STATE

(Zone)

1 Year, 2 Years

Gift card from

.....

SEND TO

ADDRESS

CITY STATE

(Zone)

1 Year, 2 Years

Gift card from

.....

SEND TO

ADDRESS

CITY STATE

(Zone)

1 Year, 2 Years

Gift card from

MY NAME (please print).....

ADDRESS

CITY STATE

(Zone)

Enter my subscription in my name 1 Year, 2 Years

Extend my subscription 1 Year, 2 Years

I ENCLOSE \$..... in full payment

Successor to **RADIO** —Established 1917

AUDIO ENGINEERING

INCLUDING



C. G. McProud, Editor and Publisher

Henry A. Schober, Business Manager

Harrie K. Richardson, Associate Editor Edgar M. Villchur, Contributing Editor
Robin Melton, Production Manager S. L. Cahn, Advertising Director
Edgar E. Newman, Circulation Director H. N. Reizes, Advertising Manager

Representatives

H. Thorp Covington, Special Representative
7530 North Sheridan Road, Chicago 26, Ill.
Sanford R. Cowan, Mid-West Representative
67 W. 44th St., New York 18, N. Y.

West Coast

James C. Galloway J. W. Harbison
816 W. 5th St., Los Angeles 17, Calif.



CONTENTS NOVEMBER, 1953 Vol. 37, No. 11

Audio Patents—Richard H. Dorf	2
London Letter	8
Audiology—W. R. Ayres	12
Editor's Report	16
Make Your Own Woofer—Curtiss R. Schafer	19
Housing and Finishing Equipment—William H. Burke	20
The Piano—Part II—Albert Preisman	22
Handbook of Sound Reproduction—Chap. 14—Edgar M. Villchur	25
Audio Fair and AES Convention	29
it CAN be ATTRACTIVE	30
The White Powrtron Amplifier—Stanley White	32
Audio ETC—Edward Tatnall Canby	34
Record Revue—Edward Tatnall Canby	38
New Literature	43
Book Review	49
New Products	50
Technica	57
Radio's Master Reports	70
Industry Notes and People	71
Advertising Index	72

COVER

This montage picturing installations made by Kierulff Sound Corporation, Los Angeles distributor and custom builder, just goes to show how the home music system—even including television—can be made to fit into the general decor of the home. Note that there are no unsightly wires, and that each of the systems appears to fit into its surroundings. *Æ's* pages are always open to individuals and professionals who have attractive and novel installations that might lead newcomers into the hi-fi fold without upsetting decoration plans.

RADIO MAGAZINES, INC., P. O. BOX 629, MINEOLA, N. Y.

AUDIO ENGINEERING (title registered U. S. Pat. Off.) is published monthly at 10 McGovern Avenue, Lancaster, Pa. by Radio Magazines, Inc., Henry A. Schober, President; C. G. McProud, Secretary, Executive and Editorial Offices: 204 Front St., Mineola, N. Y. Subscription rates—United States, U. S. Possessions and Canada, \$3.00 for 1 year, \$5.00 for 2 years; elsewhere \$4.00 per year. Single copies 35c. Printed in U. S. A. All rights reserved. Entire contents copyright 1953 by Radio Magazines, Inc. Entered as Second Class Matter February 9, 1950, at the Post Office, Lancaster, Pa. under the Act of March 3, 1879.

Engineering

WRITERS

ENGINEERS, E. E. or PHYSICS GRADUATES, for preparation of technical manuals...

HUGHES RESEARCH AND DEVELOPMENT LABORATORIES' expanding program for production of radar, electronic digital computers, guided missiles and other military advanced electronic systems and devices requires the following:

1 ELECTRICAL ENGINEERING AND PHYSICS GRADUATES to prepare operating, servicing and overhauling instructions for complex electronic equipment. Those with previous maintenance experience on military equipment preferred. Writers will participate in a three-month program in our technical training school to become familiar with the latest Hughes equipment prior to writing assignments.

2 ENGINEERS EXPERIENCED in the writing and preparation of maintenance manuals for electronic equipment or guided missiles. These specialists will work step-by-step with the people designing, developing and manufacturing the products involved. Experience in the writing of engineering reports is of value.

HOW TO APPLY

Write full details of your qualifications to

HUGHES

Research and Development Laboratories

SCIENTIFIC AND ENGINEERING STAFF

Culver City, Los Angeles County California

Assurance is required that relocation of the applicant will not cause disruption of an urgent military project.

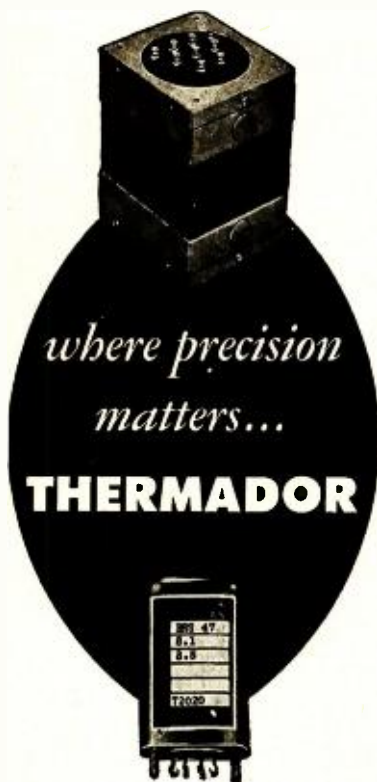

where precision matters...

THERMADOR

Transformers for Television
... Radar ... Aircraft ...
Geophysics ... Radio

You will find Thermador ready, willing and fully qualified to handle your transformer requirements. Engineering experience and manufacturing know-how, developed over a period of 35 years, form the hard core that makes Thermador today's largest West Coast manufacturer of electrical appliances and transformers. We would like to work with you on your next project involving the design and production of transformers for specific requirements...including joint Army-Navy specifications.

transformers:

- Audio Auto Geophysical
- Driver Filament High-Fidelity Audio
- Input-Output Midget Plug-In
- Plate Power Television
- Tube to Line

...also Chokes and Reactors



THERMADOR ELECTRICAL MANUFACTURING CO.

3-320

5110 District Boulevard • Los Angeles 22, Calif.

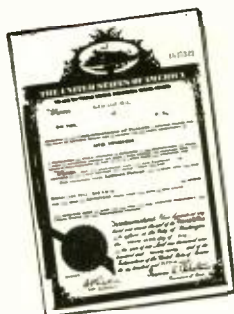

AUDIO PATENTS

RICHARD H. DORF*

AS MANY READERS KNOW, the writer has done considerable research in the field of electronic musical instruments. One product of this research has been articles such as the one on the Hammond Chord Organ which appeared in the September issue of *Æ*.

Another product of the research is a large collection of U. S. Patents covering electronic music. Such patents, whether or not they describe circuits and devices which have reached the commercial market (most have not), serve the researcher-designer with ideas, schemes, germs of solutions, angles of approach. He may pick the brains of a hundred inventors for the kindling which his own match may set afire with a new and brilliant design. Or, if he is not an original designer by skill and temperament, he may use the same hundred inventors' ideas to piece together his own musical instrument with individual circuits lifted bodily from the patents.

A good deal of mail has indicated the interest in electronic music. To serve readers in that category, this month's patent article gives a selected list of patents on the subject. They are arranged in groups, covering the important aspects of electronic music. Almost every patent, however, treats of more than the subject under which it is listed. The patents are listed by year, to give the reader an idea of their "freshness."

In each category there are listed first what the writer considers the most interesting and useful, with a brief descriptive comment on each; following that others, less important are listed by number only. To conserve space we have not followed standard bibliographic procedure, but give only the information on each patent likely to convey a message to the reader.

A copy of any patent may be obtained for 25¢ from The Commissioner of Patents, Washington 25, D. C. The large public libraries also contain excellent patent files, as well as copies of the Patent Office Gazette, issued weekly and containing a summary of all patents issued.

Tone Generators

1931

- 1,817,704. Phonograph records contain tones, with pickups keyed to reproduce them.
- 1,823,716. Charles J. Young, assigned to General Electric. Polyphonic instrument using heterodyne principle.
- 1,823,724. Wendell L. Carlson, assigned to GE. Heterodyne instrument with r.f. harmonic filters to select tone structure.
- 1,837,144. French inventor. Heterodyne instrument capable of plucked-string effects.

1932

- 1,865,428. Same inventor. Damped oscillations started by capacitor discharge give piano-harp effect.

1933

- 1,937,021. John Hays Hammond, a prolific inventor, not connected with Hammond Organ. Photoelectric instrument.
- 1,937,389. Nicholas Langer, well known primary worker with relaxation-oscillator organs. A gas-tube design.
- 1,940,093. Bell Labs. Heterodyne instrument with pitch controlled by a "trolley-car motorman's" handle.

1935

- 1,993,890. Langer. Monophonic neon-lamp instrument.
- 2,014,741. Photoelectric organ, timbres generated directly.
- 2,017,542. Langer. Synchronizing octave strings of neon oscillators from a master oscillator.

1936

- 2,035,238. Langer. Plucked-string effect with neon lamps.
- 2,039,651. Langer. Improvement on 1,993,890, allows fine tuning of individual notes.
- 2,044,360. Langer. Another method of syncing neons.
- 2,046,463. Dr. Winston Kock, assigned to Baldwin, whose organ he mainly designed. Various neon oscillators including inductors.

1937

- 2,070,344. Harry F. Waters. Neon instrument with continuous-tuning device mounted on replica of a violin neck.

1938

- 2,128,367. Kock. Thyatron octave strings.

1939

- 2,148,166. Tones generated by cathode-ray tube.
- 2,171,936. More of the same by the same inventor.

1940

- 2,185,635. Kock. Improvement on 2,128-367.
- 2,221,097. James A. Koehl, v.p. of Central Commercial Industries, maker of Lowrey Organo. Photo organ using film strips which start moving on keying, then rewind when key is released.

1942

- 2,276,389. Laurens Hammond. This is the organ man. Octave divider strings using hard (vacuum) tubes as relaxation oscillators.
- 2,293,499. Western Electric. Instrument using just rather than tempered scale but allowing playing in any key. Interesting discussion of temperament.

1949

- 2,472,595. J. T. Kunz, Schulmerich (important electronic chime manufacturer). Capacitive pickups for bar chimes.
- 2,473,897. British inventor. Photo organ.
- 2,474,847. E. M. Jones, Baldwin. Photo organ with light-interrupter disc. Not similar to present Baldwin photoelectric.
- 2,476,607. E. L. Kent, Conn. Consonata oscillator.
- 2,480,131. Laurens Hammond. Struck coil-springs with magnetic pickups.
- 2,481,693. Spencer McKellip. Oscillators with two tone qualities.
- 2,484,914. Photo organ.
- 2,485,829. Dutch inventors. Photo organ with stationary short film wave tracks scanned by light from cathode-ray tube.
- 2,486,039. Langer. Aperiodic flip-flop dividers.
- 2,489,857. Singers' voices recorded optically and pitches played back selectively.

* 255 W. 84th St., New York 24, N. Y.

Another "Scotch" Brand Development!
First in the industry...



2 1/4-inch
HUB!

- ⊕ Stops Tape Spillage
- ⊕ Minimizes Timing Errors

Exclusive design of this first *truly functional* large hub reel accommodates standard lengths of all magnetic tapes regardless of date of manufacture... stops tape spillage on take-up reels... minimizes timing errors. Get it today from your electronic parts distributor.



**It's the "SCOTCH" Brand
"V" SLOT 7" PLASTIC REEL**

- ⊕ "V" SLOT offers easiest, quickest threading device available
- ⊕ WIDE SPOKES give extra rigidity, true balance
- ⊕ TAPERED FLANGES eliminate frayed tape edges
- ⊕ COSTS NO MORE than ordinary reels

REG. U.S. PAT. OFF.
SCOTCH Magnetic Tape
BRAND



The term "SCOTCH" and the plaid design are registered trademarks for Sound Recording Tape made in U.S.A. by MINNESOTA MINING & MFG. CO., St. Paul 6, Minn.—also makers of "Scotch" Brand Pressure-Sensitive Tapes, "Underseal" Rubberized Coating, "Scotchite" Reflective Sheeting, "Safety-Walk" Non-slip Surfacing, "3M" Abrasives, "3M" Adhesives. General Export: 122 E. 42nd St., New York 17, N.Y. In Canada: London, Ont., Can.





North American F-86F Sabre Jet

VIBRATION DATA recorded by

14-channel Brush Magnetic Head

A precision Brush multichannel head assures faithful reproduction in the Davies magnetic tape data recorder, used to record vibration in jet aircraft and shock waves in seismic and oil field exploration.

This head has one synchronizing channel and 13 data channels, all of which record on a single tape 1 3/4" wide. *Precision gap alignment* permits recording on one machine and playback on another machine with all signals in perfect time-phase relationship—an exclusive advantage of Brush multichannel heads.

For complete information, write Brush Electronics Company, Dept. ZZ-11, 3405 Perkins Ave., Cleveland 14, Ohio.

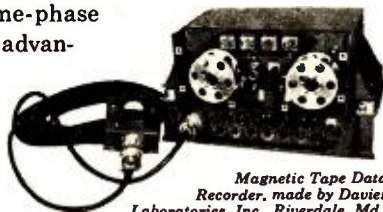

Magnetic Tape Data Recorder, made by Davies Laboratories, Inc., Riverdale, Md., uses Brush Magnetic Heads for Accurate Recording.

BRUSH ELECTRONICS

INDUSTRIAL AND RESEARCH INSTRUMENTS
PIEZO-ELECTRIC MATERIALS • ACOUSTIC DEVICES
MAGNETIC RECORDING EQUIPMENT
ULTRASONIC EQUIPMENT



COMPANY

*formerly
The Brush Development Co.
Brush Electronics Company
is an operating unit of
Clevite Corporation.*

2,492,919. Cornell-Dubilier. Vibrating reeds, magnetic pickups.
2,494,943. British inventor. Photo organ.

1950

2,496,367. Laurens Hammond and John M. Hanert, Hammond's Research Chief. Chorus generator for Hammond Organ.
2,500,820. Hanert. Tube generators with chorus effect.
2,509,923. Hanert. Chorus and vibrato effect for generators initially incapable of varying frequency.
2,513,109. Photo organ.
2,522,923. L. E. A. Bourn of British Compton. Electrostatic generator.
2,533,461. Magnetic tone recordings.

1951

2,539,130. Magnetic tone recordings.
2,539,826. Frequency-doubler strings.
2,542,611. V. I. Zuck, Wurlitzer. Capacitive reed pickups.
2,559,276. Photo organ.
2,561,349. Tones from acoustic bass instrument picked up and brought down an octave lower.
2,568,862. Constant Martin, France. Struck strings with magnetic pickups.
2,573,975. Rotating magnetic tone generators.
2,574,577. RCA. Electronic generation of bell tones.
2,576,760. Baldwin. Means for stabilizing speed of rotating photoelectric generator.

1952

2,588,680. Photo organ with single high-speed rotating disc.
2,601,265. Tones generated with cathode-ray tube.

Miscellaneous

1,782,542	1,832,402
1,847,119	2,036,691
2,340,001	2,480,945
2,500,947	2,508,514
2,535,323	2,540,285
2,543,629	2,544,722
2,569,521	2,570,178
2,576,759	2,581,653
2,636,989	

Keying Envelope Control

1936

2,043,828. Coupleux, France. Delay by reducing momentarily the heater voltage in filament-type tube.

1939

2,161,706. Laurens Hammond. Delay suitable for but not used on Hammond Organ.
2,173,888. Gilbert Smiley, Hammond. Grid-bias keying.

1940

2,215,709. Benjamin F. Meissner. Key contacts capacitive so tone transmission varies with key position.
2,216,513. Laurens Hammond. Slow decay with capacitors.
2,224,729. Laurens Hammond. Improved grid-bias keying.

1941

2,266,030. Laurens Hammond. Envelopes affected by rate at which key is pressed.

1942

2,287,105. Walter F. Kannenberg, Bell Labs. Envelope control by d.c. applied to rectifier bridge. See 2,025,158 for more complete theory of rectifier bridge.
2,296,125. Pressure-sensitive keys.

1948

2,452,307. Koehl, Central Commercial. Key contracts unshort several resistors for step-type tone rise.

1949

2,482,548. Dutch inventor. Struck-string envelope keying.
2,483,823. Thomas J. George. Delay circuit with diodes; produces string and flute tones from sine generator.

1950

2,497,331. Several busses, swept by each key contact, give step-type tone onset and decay.
2,500,821. Hanert, Hammond. Pedal generators with slow decay.

1951

2,543,628. Hanert, Hammond. Envelope control for monophonic instrument; legato

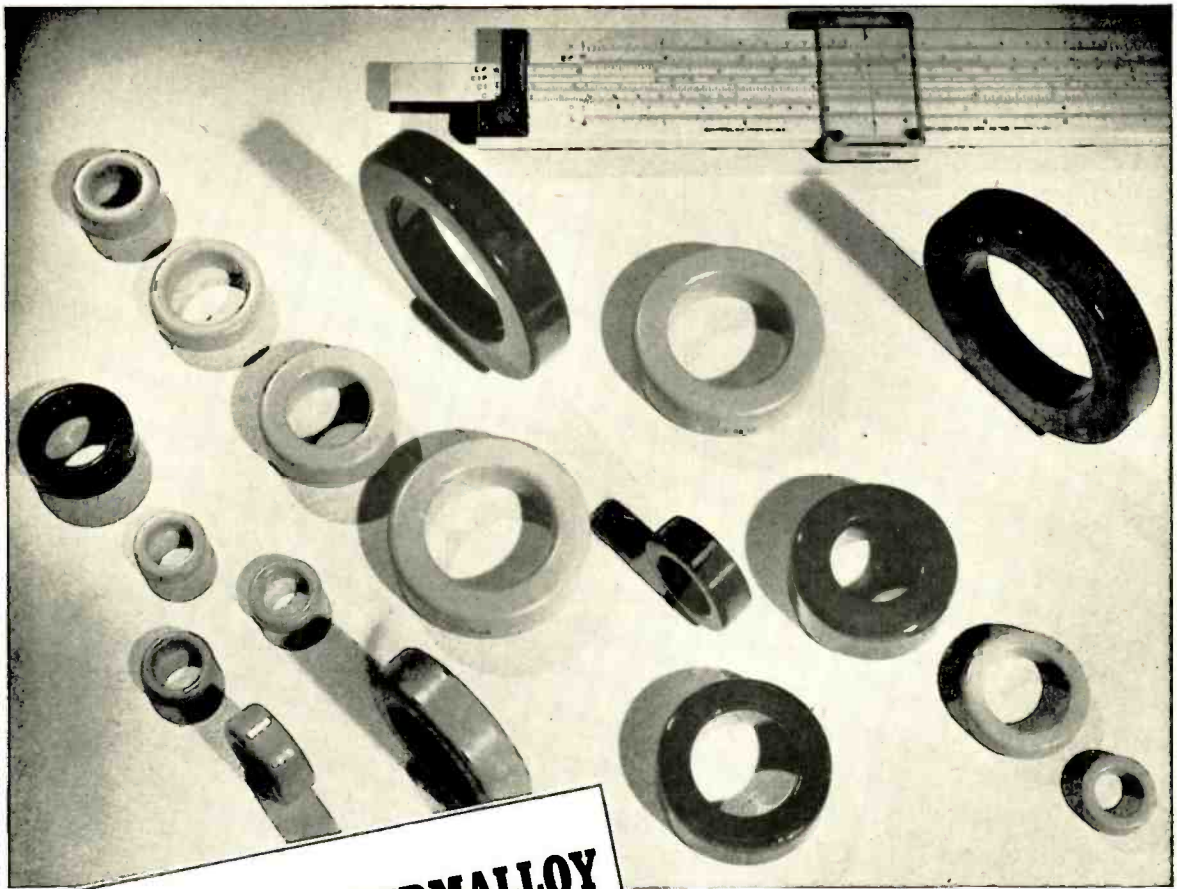

MOLYBDENUM PERMALLOY POWDER CORES*

(New technical data now available)

HIGH Q TOROIDS for use in
**Loading Coils, Filters, Broadband
Carrier Systems and Networks—
for frequencies up to 200 KC**

COMPLETE LINE OF CORES TO MEET YOUR NEEDS

- ★ Furnished in four standard permeabilities—125, 60, 26 and 14.
- ★ Available in a wide range of sizes to obtain nominal inductances as high as 281 mh/1000 turns.
- ★ These toroidal cores are given various types of enamel and varnish finishes, some of which permit winding with heavy Formex insulated wire without supplementary insulation over the core.

For high Q in a small volume, characterized by low eddy current and hysteresis losses, ARNOLD Moly Permalloy Powder Toroidal Cores are commercially available to meet high standards of physical and electrical requirements. They provide constant permeability over a wide range of flux density. The 125 Mu cores are recommended for use up to 15 kc, 60 Mu at 10 to 50 kc, 26 Mu at 30 to 75 kc, and 14 Mu at 50 to 200 kc. Many of these cores may be furnished stabilized to provide constant permeability ($\pm 0.1\%$) over a specific temperature range.

*Manufactured under license arrangements with Western Electric Company

W&O 4744

THE ARNOLD ENGINEERING COMPANY

SUBSIDIARY OF ALLEGHENY LUDLUM STEEL CORPORATION

General Office & Plant: Marengo, Illinois

DISTRICT SALES OFFICES: . . . New York: 350 Fifth Ave.

Los Angeles: 3450 Wilshire Blvd.

Boston: 200 Berkeley St.



Wing blade handle on threaded center shaft for easy connecting and disconnecting. Stronger—the center post is inserted after molding operation.

Watertight and pressurized, note rubber bushings and sealing rings.

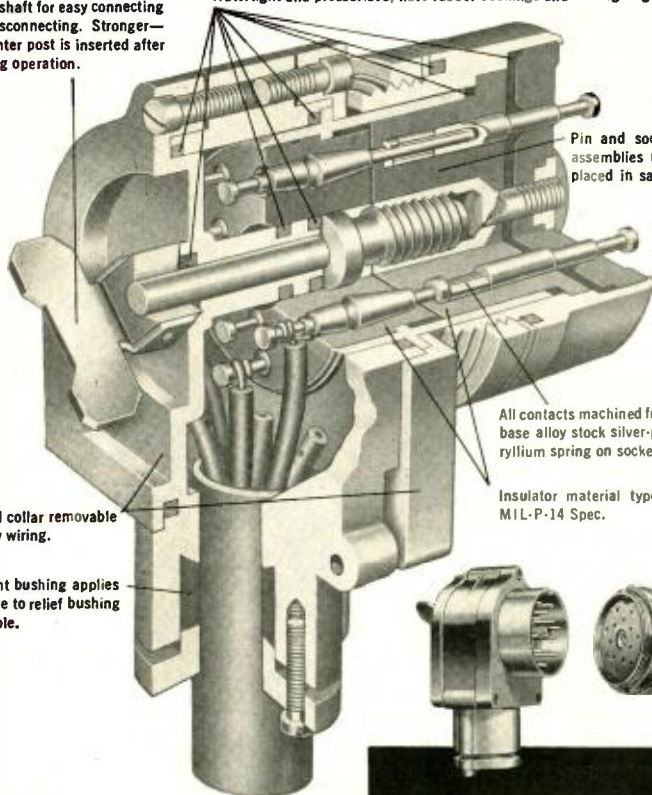

Cap and collar removable for easy wiring.

Resilient bushing applies pressure to relief bushing and cable.

**Here's why those
in the know demand —**

**CANNON
PLUGS**

TYPE 2E Sealed Power Connector (Signal Corps numbers U-112/U to U-118/U) is typical of Cannon's foresighted engineering to do a better job. The 2E Series is designed for heavy duty service on Signal Corps power units for audio equipment.

Features:

- Longer contact engaging length.
- Thicker inserts of greater tensile strength to reduce breakage.
- Closed entry socket contacts.
- Special sealing rings which do not require sealing compound or gaskets.
- Efficient neoprene clamp gland.

Manufactured in accordance with Specification MIL-C-1252 (Sig. C) the 2E Series Plug has cable clamping provision from 0.205 to 0.770 inclusive. Quick connect and disconnect

are accomplished by a wing handle and threaded center screw that can be operated by gloved hands in extreme climatic conditions. Two shell sizes accommodate four insert arrangements of 4, 9, and 19 contacts. Watertight and pressurized, with rugged construction, Cannon's 2E Sealed Power Connectors are built for long life and trouble-free service and are adaptable to industrial application. Write for Advance Bulletin No. 2E-1.



CANNON ELECTRIC

Since 1915

CANNON ELECTRIC COMPANY, LOS ANGELES 31, CALIFORNIA
Factories in Los Angeles; New Haven; Toronto, Canada; London, England.
Representative in principal cities. Address inquiries to Cannon Electric
Company Dept. L-109, Los Angeles 31, California.



playing still retains separate envelope for each note.

2,575,230. Baldwin. Resistive key contacts (not used in present Baldwins).

2,576,758. E. M. Jones, Baldwin. Envelope control for photoelectric instrument; shutters.

2,577,753. Hanert, Hammond. Sustaining means for pedal tones.

Special-Purpose Keying Schemes

1931

1,824,402. Maurice Martenot, France. Pitch determined by amount of wire unwound from spool.

1936

2,045,172. Baldwin. 13 oscillators for entire organ.

2,048,610. Kock, Baldwin. Highest note of any chord struck sounds loudest.

1940

2,203,432. Thomas J. George, Hammond. Use of 6 oscillator strings on premise adjacent notes never used together.

1941

2,241,363. Laurens Hammond. Single pedal provided, sounds note determined by lowest note being played on manual.

1943

2,323,242. Bell Labs. All notes of instrument produced by harmonics filtered from 6 generators tuned below lowest octave.

1949

2,484,930. Black keys eliminated. Selector set at key of composition and white keys automatically provide correct scale.

2,492,320. Bendix Aviation. Practice instrument, with many keyboards connected to single generator system; headphones.

1951

2,549,697. Bendix Aviation. Key switches operated by piano-like hammer action, remain for time depending on player's stroke.

2,577,493. Dutch inventor. Fewer generators than keys, on premise that only limited number of keys can be struck at once.

1952

2,581,680. Maurice Martenot, France. Capacitor varied by movable tape, as used in the Ondes Martenot.

Tone Color

1925

1,530,498. Harmonic outputs of oscillators controlled.

1932

1,877,317. Westinghouse. Each note has fundamental oscillator and also harmonic oscillators as required.

1933

1,933,299. German inventor. Modifying tone qualities of standard instruments.

1934

1,947,020. Richard H. Ranger. Generators provide all harmonics. Filters for each note subtract those not wanted.

1936

2,035,836. Richard H. Ranger. Tones distorted by circuit to provide complex structure.

2,039,201. Friedrich Trautwein, Germany. Generation of tone accompanied by shock-excitation formants.

1938

2,139,023. Kock, Baldwin. Shock-excitation formants furnished by neons just short of oscillation.

1940

2,227,100. Central Commercial. Harmonic synthesis.

1941

2,251,061. Laurens Hammond. Several generators for each note, each with different tone quality.

1949

2,474,380. Tone-shaping with cathode-ray tube.

(Continued on page 58)

Choose the right Presto disc for your job

Orange
Green
Brown
and now **White label**
Presto
discs



The choice of the right recording disc for every job is not difficult if you'll stop reading conflicting claims and listen to the experts. The nation's top recording engineers say PRESTO discs are best for performance, permanence and price.

After you have made the important choice of *brand*... select the proper *grade* PRESTO disc for your use. See the box on this page for a ready reference guide. And, be sure to consider the advantages of the new PRESTO White Label disc!

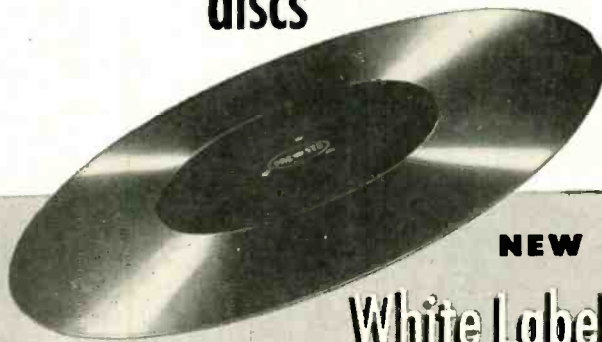

NEW

White Label

The newest addition to the Presto line. Both surfaces are warranted to be useable without breaking sapphire cutting stylus. Ideal all-purpose disc.



Green Label

As Presto's finest disc, the Green Label offers consistently high quality. Virtually no surface noise even after repeated playbacks. Both sides warranted flawless.



Orange Label

A lighter aluminum base, but the same high quality lacquer makes the Orange Label disc popular as a "playback" where good quality at low cost is desired.



Brown Label

Identical to Green Label except only *one* side is warranted flawless. Ideal for high specification recording where only one side is to be used.



PRESTO

RECORDING CORPORATION

PARAMUS, NEW JERSEY

Export Division:
Canadian Division:

25 Warren Street, New York 7, N. Y.
Walter P. Downs, Ltd., Dominion Square Bldg., Montreal

WORLD'S LARGEST MANUFACTURER OF PRECISION

RECORDING EQUIPMENT AND DISCS

HAVE YOUR OWN COMPLETE HiFi SYSTEM

AT MODERATE COST

START NOW WITH THE

Crestwood 400's

At right—Model 401
(Recorder-Preamplifier) \$199.50*

Not shown—Model 402
(Power Amplifier-Speaker) \$100.00*

*Taxes not included. Prices slightly higher
in Mountain and West Coast States.



AVAILABLE NOW!

HERE'S HOW! The Crestwood 401 is an extremely stable tape recorder (wow and flutter less than 0.3%) with a full fidelity preamplifier (frequency response 30-13,000 cycles \pm 2db). It has separate inputs for microphone, radio-TV and phonograph, which are connected to a selector switch.

The Crestwood 402 is a high impedance input, 10 watt power amplifier (frequency response 20-20,000 cycles \pm 2db) with an 8" extended range dynamic speaker, specially housed to produce exceptional frequency response for a compact unit.

IT'S EASY! With Crestwood models 401 and 402, here's all you do to complete your HiFi system:

1. AM-FM tuner (of your choosing)** is plugged into radio-TV input.
2. Record changer (of your choosing)** is plugged into phono input.

Both may be permanent installations because of the selector switch, which allows choice of inputs or tape playback.

**Certain AM-FM tuners and magnetic pickups may require special handling. Information supplied on request.

YOUR HI-FI SYSTEM IS READY TO USE! By use of the selector switch you can listen to either radio or records. And, by merely pressing the Record button, whatever you're listening to will be instantly recorded on tape—accurately, faithfully, just as you're hearing it! The same selector switch controls microphone input, allowing your own program arrangement.

CAN BE USED WITH PRESENT SYSTEM, TOO! The Crestwood 401 is an excellent unit to fit into your present HiFi system. Full fidelity and complete dependability.

FEATURES INCLUDE

Full Fidelity • Two Speeds • Two-Track Recording
• Separate Monitor and Record Volume Controls •
Exceptionally Sharp Magic Eye Record Volume Indicator •
Simplicity of Operation • 10 Watt Power Amplifier •
Precision Engineering • Modern Styling

**SEE YOUR DEALER
FOR FULL INFORMATION
OR
SEND COUPON TODAY**

Crestwood
BY DAYSTROM
TAPE RECORDERS
Open a Brand New
World of Recorded Sound

Crestwood Division of Daystrom Electric Corp.
Dept. AE-11, Poughkeepsie, N.Y.

Please send complete information on the new Crestwoods.

Am interested in setting-up my own HiFi system.

Am interested in HiFi tape recorder only.

Name

Address

City.....Zone.....State.....

Awarded MEDAL OF MERIT for: Excellence of Product, Quality of Engineering,
Beauty of Design—by International Sight and Sound Exposition, Chicago, 1953.

LETTERS

(Because of the information offered in the following letter from *Æ's* London correspondent, its publication herein replaces the usual LETTERS column—for this month only. Beginning in January a London Letter will be a monthly feature.)

About this time last year we published our first report on Britain's Annual Radio Show, which is held in September each year at Earls Court, the largest exhibition hall in England.

This is a public exhibition, organised by the Radio Industry Council, and has an annual paid attendance exceeding a quarter of a million. The centre of the hall is occupied by the leading TV and Radio manufacturers, who have large booths often exceeding in cost of space and construction £20,000, on which are displayed the latest models of TV and sound receivers. In addition, many of the leading firms have elaborate demonstration rooms and suites in which the public can see and hear their products under home conditions.

Apart from manufacturers' exhibits, the main feature of interest in this year's Show (which ran from September 2nd through September 12th) was a television studio, built by the Radio Industry Council, to accommodate an audience of 1,000 per session, from which most of the B.B.C.'s National network of programmes were transmitted during the time the Show was open. A novel feature of the auditorium this year was the provision of a cinema sized screen, 21-ft. wide, above the proscenium upon which visitors saw the programme as it went out on the air. The number of performances and rehearsals per day were much increased over last year, and in addition to TV programmes a number of sound programmes were being rehearsed, broadcast, or recorded for subsequent transmission. I noticed, incidentally, that Leak amplifiers are used by the B.B.C. for all their monitoring loudspeakers.



Viscount Montgomery, who opened Britain's Radio Show, with Richard Arbib, Managing Director of Multicore Solders at the Multicore booth, where Philips projection television receivers were assembled and soldered.

A smaller studio, with glass walls, run by the Radio Industry Council staff themselves was used for more intimate TV programmes which did not require the spectacular stage of the B.B.C. studio. The output from either of these studios was transmitted to about 400 television receivers situated either on manufacturers' stands or booths, demonstration rooms, or Television Avenue where 40 different manufacturers' receivers were seen operating side by side. A completely separate camera channel



jumps are for Horses
... NOT *for magnetic tape*

That's why you need SOUNDCRAFT Micro-Polished Tape.
 No Raised Spots! No Roughness! No Jumps!
 It's S m o o t h right from the start!*

Under the microscope, magnetic tape may look like a steeplechase—replete with all the “jumps.” As you record, these jumps—minute raised spots characteristic of all coating processes—momentarily separate large enough areas of the tape from the recording head to appreciably interrupt high-frequency response. On some equipment, they may even cause signal dropouts.

The Answer Is Micro-Polish

But Reeves SOUNDCRAFT eliminates the “jumps” with its exclusive Micro-Polish process, assuring the most complete head contact possible right from the start. That’s because Micro-Polish smooths off the microscopic nodules by

subjecting the ferrous oxide coating to high-precision polishing. It leaves the surface mirror-smooth, and preconditioned for immediate, stable, high-frequency response.

Breaking in tape by running it through the recorder, with accompanying head wear and waste of time, is a thing of the past.

Other SOUNDCRAFT Advantages

In addition, SOUNDCRAFT Recording Tapes are pre-coated with a special formulation to give utmost oxide adhesion, and prevent curling and cupping.

All tape is dry-lubricated to eliminate squeals and carries a splice-free guarantee on all 1200- and 2500-foot reels.



REEVES

SOUNDCRAFT

CORP.

**10 East 52nd Street, Dept. B
 New York 22, N. Y.**

*Pat. Applied For.

Precision Prints

**YOUR PRODUCTIONS
BEST REPRESENTATIVE**

CLOSE CHECK ON PROCESSING

Picture and sound results are held to the closest limits by automatic temperature regulation, spray development, electronically filtered and humidity controlled air in the drying cabinets, circulating filtered baths, Thymatrol motor drive, film waxing and others. The exacting requirements of sound track development are met in PRECISION'S special developing machinery.

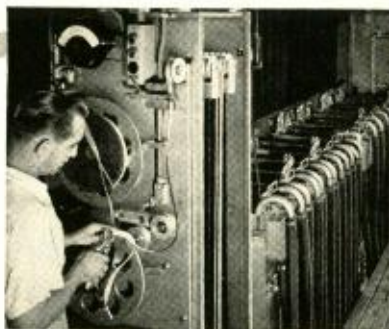

YOUR ASSURANCE OF BETTER 16mm PRINTS

16 Years Research and Specialization in every phase of 16mm processing, visual and aural. So organized and equipped that all Precision jobs are of the highest quality.

Individual Attention is given each film, each reel, each scene, each frame — through every phase of the complex business of processing — assuring you of the very best results.

Our Advanced Methods and our constant checking and adoption of up-to-the-minute techniques, plus new engineering principles and special machinery enable us to offer service unequalled anywhere!

Newest Facilities in the 16mm field are available to customers of Precision, including the most modern applications of electronics, chemistry, physics, optics, sensitometry and densitometry — including exclusive Maurer-designed equipment — your guarantee that only the *best* is yours at Precision!

Precision Film Laboratories — a division of J. A. Maurer, Inc., has 16 years of specialization in the 16mm field, consistently meets the latest demands for higher quality and speed.

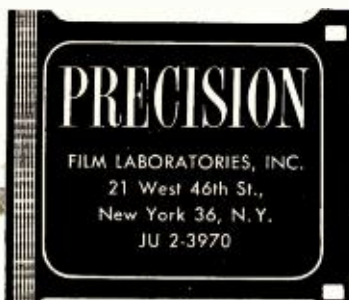

was installed in another part of the hall where celebrities visiting the exhibition were interviewed. Besides being able to pick up programmes from these three channels the sets in the exhibition could also receive the B.B.C. National Programme transmitted from Alexandra Palace, or a film programme from a "flying spot" scanner installed in the R.I.C. Control Room. This elaborate suite housing the amplifiers and associated equipment had glass windows so that the public could see the engineers at work.

The trend in television development this year appeared to be the use of larger screens, but the general highest British standard is still only 17 in., and the increased popularity of projection television—the sales of which probably amount to about 15 per cent of the total sales of receivers for the domestic market.

Included in the exhibits in connection with projection television was the installation on the Multicore Solders' stand of a factory production line where projection television receivers were assembled and soldered by factory operatives from the Philips' Works at Mitcham, Surrey. This demonstration was probably the most popular working exhibit in the Show. Crowds twelve feet deep could be seen throughout the day around the line, marvelling at the rapid soldering operations which can now



An all-wave 3-speed radiogram—H.M.V.'s Model 1507—one of the most compact and lightest units of its type ever made.

be undertaken with Multicore Solder.

Practically all the projection sets sold for domestic use employ rear projection, size of screens varying from between 21 and 48 inches in width. Owners of hotels, schools, and clubs were being offered front projection receivers, constructed in two units, the screen and loudspeaker being in a separate cabinet. Practically without exception all these projection outfits were based on the same optical unit which employs a 2½ in. tube.

The most outstanding exhibit of interest to Hi-fi enthusiasts was the new Garrard Model R.C.90 Record Changer. This unit, having the same physical size as earlier models incorporates many additional most useful features. The change cycle is now the same for records of all three speeds, and amounts to only six seconds. A variable speed control is provided so that absolute accuracy of pitch is assured with old records or uneven electricity supplies. An additional lever now enables the user to play records individually, and thus the unit is virtually a single record player and a record changer combined.

Now that E.M.I. are marketing in Britain 45 r.p.m. records, TV manufacturers seem to feel that the American trend of increased

(Continued on page 57)

*The Greatest Name
in Turntables*

designed for Quality in Record Reproduction

REK-O-KUT



Record Reproduction begins with the rotating motion of the record! This motion expresses passage of time. And each rotation is an interval or segment of that time. This important function is entrusted to the turntable.

The faithfulness with which the turntable, a purely mechanical device, can perform this task, is related entirely to its design and construction. It is pretty generally known that any mechanical vibration will impose itself as undesirable elements of distortion in the reproduced sound, and that speed deviation will result in a variation in time or tempo, and in undulating pitch.

There is no compromise with turntable quality if the best in sound reproduction will be had. Engineers know this, and the name of REK-O-KUT is a byword in professional circles as the standard of turntable quality. But whether professional sound engineer or simply a lover of good sound, only a fine turntable can justify the fine equipment of a modern high fidelity system.

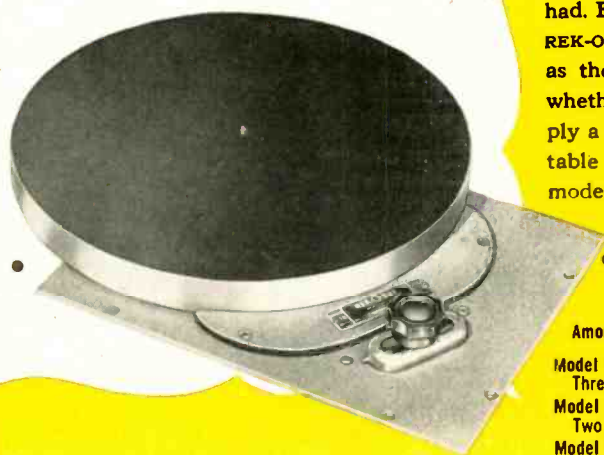

*At Leading Radio Parts Distributors
and at Sound and Music Dealers*

Among the seven REK-O-KUT Turntables available are:

Model LP743 — Induction Motor Three Speeds, 33 $\frac{1}{3}$, 45 and 78.....	\$ 59.50
Model T-12H — Hysteresis Motor Two Speeds, 33 $\frac{1}{3}$ and 78.....	119.95
Model T-43H — Hysteresis Motor Two Speeds, 33 $\frac{1}{3}$ and 45.....	119.95

REK-O-KUT CO. 38-03B QUEENS BOULEVARD • LONG ISLAND CITY 1, NEW YORK

Export Division: 458 Broadway, New York 13, U. S. A. Cables: Morhanex
In Canada: Atlas Radio Corp., Ltd., 560 King Street W., Toronto 28

20-20 PLUS!

S-268-Q
Output
Transformer

±1 db 8—80,000 cycles
80 watts 30—40,000 cycles

20 watts at 10 cycles
40 watts at 15 cycles

Insertion loss
0.3 db

NOW IN STOCK

Primary impedances
8,000CT & 2,000CT

Connected between halved impedances, frequency response is extended at each end; between doubled impedances, ±1 db 15—45,000 cycles.



Write today for the 1953 Peerless Catalog

Perfect with KT-66 and 6146 tubes



PEERLESS
Electrical Products

A DIVISION OF



9356 Santa Monica Blvd., Beverly Hills, Calif.
161 Sixth Avenue, New York 13, New York

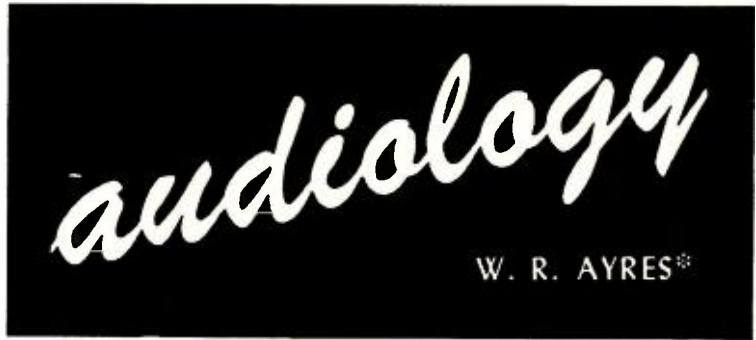

Precision Phase Splitting

THE GRIDS OF PUSH-PULL TUBES require signals of equal amplitude and opposite phase. For generally improved performance, as well as reduction in size, weight, cost and hum-pickup, push-pull input transformers are now almost entirely replaced by vacuum tube phase splitters. Notable exceptions to this rule are cases in which driving power for the following stage is required, and in circuits where very large output voltage requirements are beyond economical realization with R-C coupling.

Many popular splitting arrangements pass one output signal straight through, and divert the other through a phase inverting stage of unity gain. Since unity is an inconveniently low amplification at which to operate common tube types, a signal voltage divider is customarily used in the grid circuit. *Figure 1* is an example of this plan, grid resistances R_1 and R_2

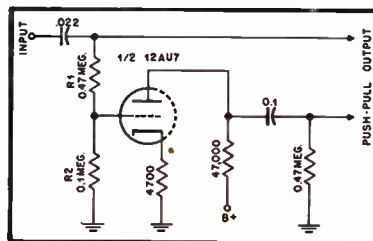

Fig. 1.

chosen to cause attenuation complementary to the tube amplification.

Perfection of balance obtained depends upon closeness of these resistances to required values, and constancy of amplification exhibited by the phase inverting tube. Close-tolerance divider resistors are readily obtainable, but fine stabilization of tube amplification is not readily accomplished without added complication and additional close-tolerance components.

Another principle of operation is that of making the grid signal of the inverting tube automatically adjusted by the extent of unbalance. The "floating paraphase" of *Fig. 2* is example of this technique, grid signal for the inverting tube being proportional to the difference between the opposed output voltages. Obviously with identical grid resistances the output voltages must be unbalanced in order for the circuit to function at all; however, the fractional unbalance is the reciprocal of the inverter tube amplification, and may be made small through use of high amplification.

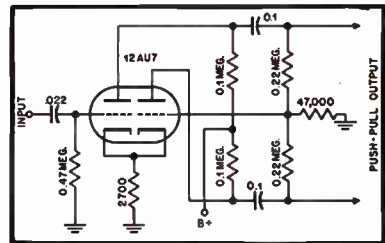

Fig. 2.

While many improved variations on self-balancing phase splitters have been devised, one of the simplest and yet most practical methods is the cathodyne or split-load circuit of *Fig. 3*. Here the tube is equally divided between the plate and cathode circuits. In practice there are additional capacitive loads due to input capacitance of the following tubes, wiring capacitance to ground, etc. If the complex plate and cathode loads are exactly equal, then since they are in series and carry the same current, the voltages across them are exactly equal and in phase (proceeding from ground to B+). Relative to ground, the a.c. plate and cathode voltages are equal in magnitude and opposite in phase to the same degree of exactness that the complex plate and cathode impedances are alike.

It will be seen that this type phase splitter is unique among popular circuits in that precision mid-frequency balancing requires matching of only two components, and is unaffected by tube gain variations. Amplification from input to either output is a little less than unity due to the high cathode-circuit degeneration, but that same degeneration makes nonlinear distortion in the output extremely low. In *Fig. 3* the load resistances, which may be closely matched, are low enough to permit satisfactory operation with quite high capacitive

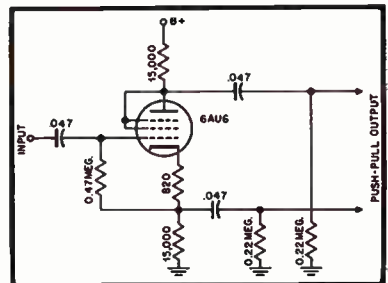

Fig. 3.

* RCA Victor, Camden, N. J.

IN EVERY FIELD

There is a Leader!



—and following every leader are those who would rather copy than create!

Substitutes are not acceptable where precision instruments are required, that is why engineers the world-over specify the MEASUREMENTS line. They know that—

STANDARDS ARE ONLY AS RELIABLE AS THE REPUTATION OF THEIR MAKER



Model 65-B
STANDARD SIGNAL GENERATOR

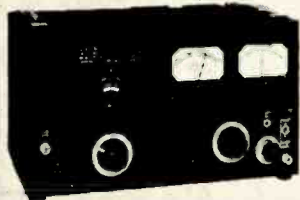

Model 80
STANDARD SIGNAL GENERATOR

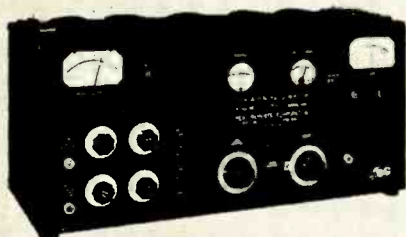

Model 84
STANDARD SIGNAL GENERATOR

**MEASUREMENTS
CORPORATION**

BOONTON • NEW JERSEY

**MEASUREMENTS
"FAMOUS FIRSTS"**

in
Laboratory Standards

1939 MODEL 54 STANDARD SIGNAL GENERATOR—Frequency range of 100 Kc. to 20 Mc. The first commercial signal generator with built-in tuning motor.

MODEL 65-B STANDARD SIGNAL GENERATOR—This instrument replaced the Model 54 and incorporated many new features including an extended frequency range of 75 Kc. to 30 Mc.

1940 MODEL 58 UHF RADIO NOISE & FIELD STRENGTH METER—With a frequency coverage from 15 Mc. to 150 Mc. This instrument filled a long wanted need for a field strength meter usable above 20 Mc.

MODEL 79-B PULSE GENERATOR—The first commercially-built pulse generator

1941 MODEL 75 STANDARD SIGNAL GENERATOR—The first generator to meet the need for an instrument covering the I.F. and carrier ranges of high frequency receivers. Frequency range, 50 Mc. to 400 Mc.

1942 SPECIALIZED TEST EQUIPMENT FOR THE ARMED SERVICES.

1943 MODEL 84 STANDARD SIGNAL GENERATOR—A precision instrument in the frequency range from 300 Mc. to 1000 Mc. The first UHF signal generator to include a self-contained pulse modulator.

1944 MODEL 80 STANDARD SIGNAL GENERATOR—With an output metering system that was an innovation in the field of measuring equipment. This signal generator, with a frequency range of 2 Mc. to 400 Mc. replaced the Model 75 and has become a standard test instrument for many manufacturers of electronic equipment.

1945 MODEL 78-FM STANDARD SIGNAL GENERATOR—The first instrument to meet the demand for a moderately priced frequency modulated signal generator to cover the range of 86 Mc. to 108 Mc.

1946 MODEL 67 PEAK VOLTMETER—The first electronic peak voltmeter to be produced commercially. This new voltmeter overcame the limitations of copper oxide meters and electronic-voltmeters of the r.m.s. type

1947 MODEL 90 TELEVISION SIGNAL GENERATOR—The first commercial wide-band, wide-range standard signal generator ever developed to meet the most exacting standards required for high definition television use.

1948 MODEL 59 MEGACYCLE METER—The familiar grid-dip meter, but its new design, wide frequency coverage of 2.2 Mc. to 400 Mc. and many other important features make it the first commercial instrument of its type to be suitable for laboratory use.

1949 MODEL 82 STANDARD SIGNAL GENERATOR—Providing the extremely wide frequency coverage of 20 cycles to 50 megacycles. An improved mutual inductance type attenuator used in conjunction with the 80 Kc. to 50 Mc. oscillator is one of the many new features.

MODEL 112 U.H.F. OSCILLATOR—Designed for the many applications in ultra-high frequency engineering that require a signal source having a high degree of frequency accuracy and stability. Range: 300 Mc. to 1000 Mc.

1950 MODEL 111 CRYSTAL CALIBRATOR—A calibrator that not only provides a test signal of crystal-controlled frequency but also has a self-contained receiver of 2 microwatts sensitivity.

1951 MODEL 31 INTERMODULATION METER—With completely self-contained test signal generator, analyzer, voltmeter and power supply. Model 31 aids in obtaining peak performance from audio systems, AM and FM receivers and transmitters.

1952 MODEL 84 TV STANDARD SIGNAL GENERATOR—With a frequency range of 300-1000 Mc., this versatile new instrument is the first of its kind designed for the UHF television field.

PROOF of PERFORMANCE

Shure slender Gradient¹ Microphones solve difficult acoustic problem

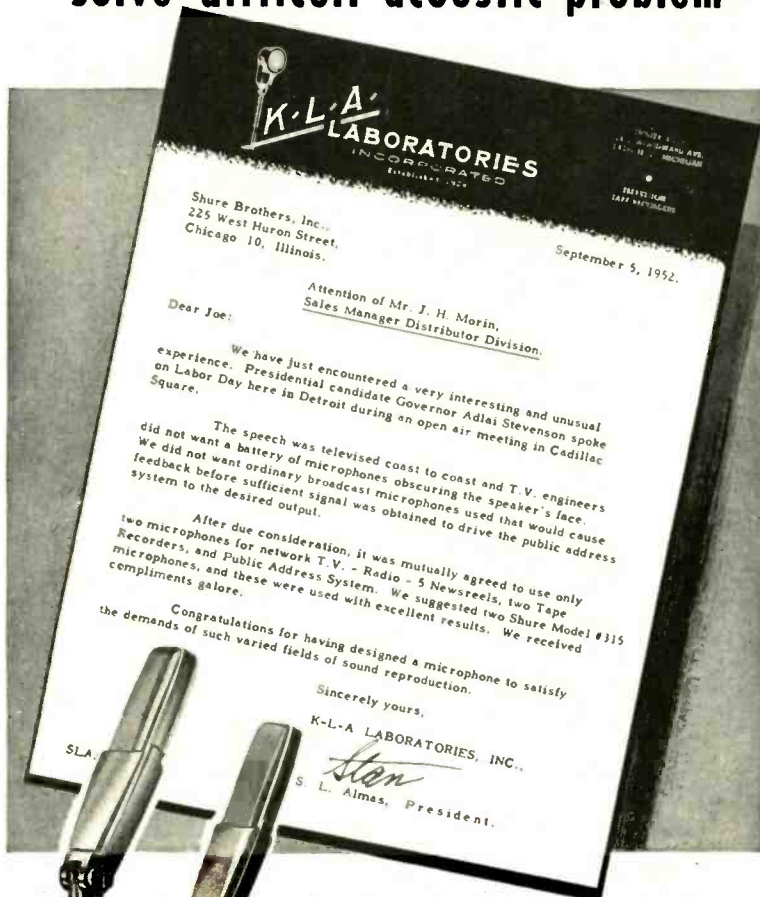

"315"
GENERAL PURPOSE
List Price \$79.50

"300"
BROADCAST
List Price \$135.00



Former Governor Stevenson of Illinois, pictured as he addressed Detroit audience on Labor Day, during the 1952 presidential campaign.



Shure Patents Pending

SHURE BROTHERS, Inc. ★ Microphones and Acoustic Devices
225 West Huron Street, Chicago 10, Illinois • Cable Address: SHUREMICRO

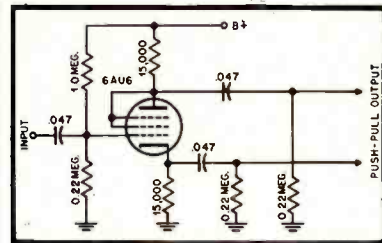

Fig. 4.

loading, yet with 270 supply volts the harmonic distortion at 30 peak volts output (per side) is only one-quarter per cent. When phase splitting or cross-coupling is accomplished within a feedback loop, there is rarely need for balance closer than one per cent, particularly since the following power amplifier tubes probably have power sensitivities differing by ten per cent or more.

Due to negative feedback in the cathode circuit, the output impedance is low at the cathode and high at the plate. Therefore, the stage amplification is less affected by changed cathode loading than by changed plate loading. Nevertheless, the two output voltages still differ only to the extent that the cathode and plate load impedances differ, since they are series elements carrying the same alternating current. Balance, of course, is the greatest single requirement of a phase splitter. If necessary to preserve it with loads of widely different capacitance on the two outputs, one simply uses suitably low plate and cathode resistances.

Cathode potential at no-signal in a phase splitter is commonly one-fifth to one-third of B+. Bias may be obtained with a series bias resistance, and cathode signal output may be taken directly at the cathode, with the total resistance from cathode to ground arranged to equal the plate-load resistance. But this would appear to be a relatively fruitless complication, besides not being adaptable to the use of matched pairs for plate and cathode load resistances.

An arrangement requiring no additional resistances, yet avoiding need for a tie-point in construction, is that of Fig. 4. Here the grid potential is elevated adequately by voltage-divider action, and suitable tube operating conditions prevail.

Usually at some expense of large-signal handling capability, the preceding amplifier stage may be direct-coupled to the phase-inverter grid. There is the basic objection of operating conditions in one stage being subject to component tolerances and tube variations in another stage. However, aside from the advantage of saved components, direct coupling here simplifies the application of overall feedback by avoiding troublesome phase shift at sub-audio frequencies.

With relative simplicity, the cathodyne phase-splitter offers low harmonic distortion and a known high standard of balance. One per cent matched resistance pairs now available at nominal cost permit preciseness of balance not always realizable with even elaborate self-balancing splitter circuits. Further, since the degree of balance is set only by the ratio of two circuit impedances, precision performance continues throughout useful tube life.

GO WEST!
Audio Fair—Los Angeles

Feb. 4, 5, 6, 7, 1954
Alexandria Hotel
Los Angeles, California



Have you heard *the latest...* IN BACKGROUND MUSIC?



An atmosphere to relax and enjoy—or the stimulation to work, to think, to play or buy—these are the benefits of background music. And background music is now practical *anywhere*, even beyond the reach of present wired services.

With the announcement of the new AMPEX 450, magnetic tape, musical wonder of a coming era, has become the ideal medium for background music. Hourly cost drops to a new low; quality rises to an all-time high. A wide variety of music for every purpose is now available on pre-recorded tape (see your Ampex distributor). Tape recordings eliminate needle scratch and their fidelity is permanent. They last for any conceivable number of plays.

On the AMPEX 450, up to eight hours of unrepeatd music is available from one 14-inch reel of tape, and fully automatic repetition is available. The troubles and complexities of record changers are eliminated. And the AMPEX requires no standby attention from an operator.

AMPEX background music has a place in your business.

For further information, write to Dept. B-1218A

AMPEX

MAGNETIC RECORDERS

THE NEW AMPEX 450

- 8 hours of uninterrupted music (rest periods as desired)
- Usable on land, sea or air
- No standby operator required
- Lowest cost per hour

AMPEX ELECTRIC CORPORATION
934 CHARTER STREET • REDWOOD CITY, CALIF.

EDITOR'S REPORT

THE AUDIO FAIR

EVERY year about this time, this page devotes some space to comments about the Fair just closed, with orchids where deserved, and an occasional thorn to another deservée. Fortunately very few of the latter await distribution this year. On the whole, the Audio Fair has appeared to settle down for a long stay—exhibitors have learned quite successfully what will attract the public and keep them interested. But a few comments may touch a responsive chord among those who were fortunate enough to attend—or may cause a shudder, depending upon how the Fair affected the individual.

One fact has been observed from the beginning—if you want people in your exhibit room, you must make noise of some sort. Even *Æ* itself—never before with any type of sound creator (except subscription and Anthology hawkers) burst forth this year with a hill and dale phonograph, circa 1905, of the Edison cylinder variety. While this observer well remembers such devices while a youth—"The Preacher and the Bear" being most outstanding in his memory—dozens of visitors came and stared and listened to hi-fi of half-a-century ago, and then told us that this was the first instrument of that type they had ever heard. Paraphrasing an early Latin expression, they came, they heard, and they bought (subscriptions). But the lesson was well learned. Next year we shall have a collection of cylinders and we shall reproduce them electrically. This will probably surprise lots of people, including ourselves. But we'll wager it will attract visitors.

The opposite side of the picture is that when one exhibitor makes *too much* sound—the Hotel New Yorker not being thoroughly treated acoustically—it often offends adjacent exhibitors, even making it difficult for them to demonstrate their own equipment adequately.

It is beginning to look as though *no* hotel is going to be big enough to hold Audio Fairs of the future. When the third largest hotel in the country has to use the service elevators to handle the crowds, one thing is certain—Audio has arrived. And to think that in 1949 exhibitors were elated at an attendance of 3022! Four years later we had at least 25,000. Some exhibitors have been known to claim that all of them were in their rooms at one time.

The old-timers in the hi-fi field have been concerned about the entry of the commercial set manufacturers into the competition. We cannot agree that this represents any sort of threat to the present hi-fi manufacturers. Let us compare audio with auto for a moment: In this country there is a well developed cult of sport car fans—enough that publications covering this field have circulations of around half a million—and these people wouldn't be caught driving a standard commercial-type automobile such as Ford, Dodge, or Cadillac. They'd be much more likely to have a Ford chassis with a Cadillac engine and a home-made body. Undoubtedly there are many who would be completely satisfied with a factory-assembled "package" hi-fi set—chances are such a set would be greatly superior to the present sound reproduc-

ing equipment in their homes. There are probably many who would be satisfied by adding a simple change—perhaps by adding feedback or controllable phono equalization. But the real music lover will undoubtedly continue to prefer his personal selection of components, put together by an expert or by the owner himself. And so long as these music lovers continue to increase in numbers, our hi-fi manufacturers have no worry.

We have been amused the past few days by endorsements by famous persons for certain types of factory-assembled sets. The biggest smile comes when one of the more famous names in the music-broadcasting business claims to have heard realistic reproduction for the first time. Where can this man have been not to have attended an Audio Fair or even to have investigated some of the finer equipment demonstrated by the Audio Salons all over the country? No, we're not bitter—it's just funny, that's all.

MAGNETIC RECORDING INDUSTRY ASSOCIATION

We welcome the formation of the Magnetic Recording Industry Association, another event coincident with the 1953 Audio Fair. Joseph R. Hards, vice president of A-V Tape Libraries, New York, was elected president of MRIA at its organization meeting on October 15. Nineteen members met to vote in the constitution and by-laws of the new group and to elect officers and board members.

"With magnetic recording now a \$100 million industry, there is a need for a representative and lasting group to exchange ideas and information among its members and with the public, and to promote good relations between the industry, government, the public, and business concerned with magnetic recording," said Mr. Hards, who is largely responsible for organizing the group. Other officers elected were Russell Tinkham of Ampex Corporation as vice president; Herman Kornbrodt of Audio Devices, Inc. as secretary; and Victor Machin of Shure Brothers, Chicago, as treasurer. The Board of Directors will include two members—Paul Jansen of Minnesota Mining and Manufacturing Company, and Everett Olson of Webster-Chicago Corporation, in addition to the four officers. Membership is expected to double within the next month. We wish them all success in their avowed aims.

NEW MAGAZINE

In a welcoming mood, we also take pleasure in greeting *Tape and Film Recording*, a new bi-monthly magazine devoted to all aspects of magnetic recording. The first issue should be out by now, and judging from the past performance of its editor, Mark Mooney, Jr., formerly with *Camera* magazine in the same capacity, the new book should have the right slant for the movie maker who wants to add sound, in addition to the amateur tape recordist. Best of luck, *T & F R*.

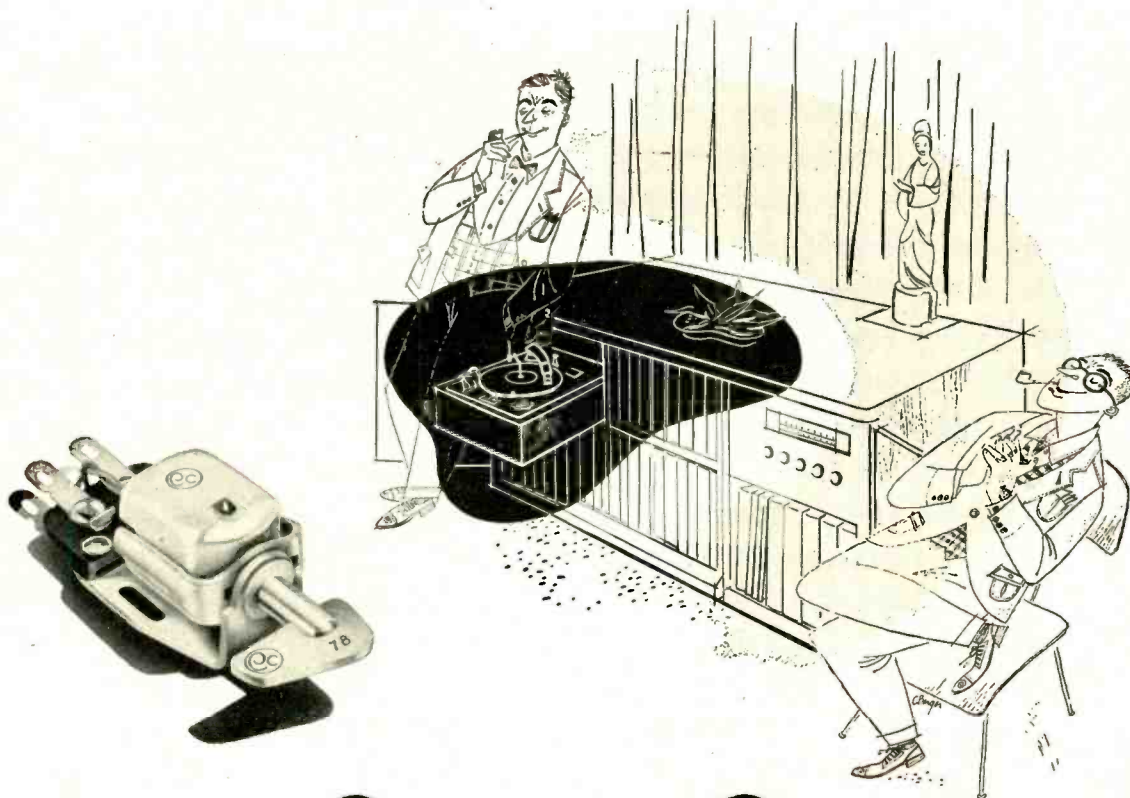

“I’m glad I waited...”

Here’s how I solved a problem that bothered me . . . and may be bothering you.

Many of my favorite recordings happen to be 78’s. They mean as much to me as any of my newer LP’s or 45’s. Changing pickups was often a real nuisance—and yet I wasn’t willing to give up the superior quality of my two Pickering cartridges.

Last fall my dealer offered a suggestion. “Wait a little longer,” he said. “You’ll be glad you did.”

He was right. I now have Pickering’s new turn-over cartridge. A simple flip of the handy lever and I’m ready to play any favorite that fits my mood—whether it’s standard or microgroove. *More than that, I’d swear my recordings sound better than ever.*

I’m glad I waited . . . but you won’t have to.

Ask your dealer to show you this convenient new turn-over cartridge. Have him demonstrate it. See if you, too, don’t hear the difference!

PICKERING and company incorporated • Oceanside, L. I., New York

PICKERING PROFESSIONAL AUDIO COMPONENTS

“For those who can hear the difference”

...Demonstrated and sold by Leading Radio Parts Distributors everywhere.
For the one nearest you and for detailed literature, write Dept. A-3



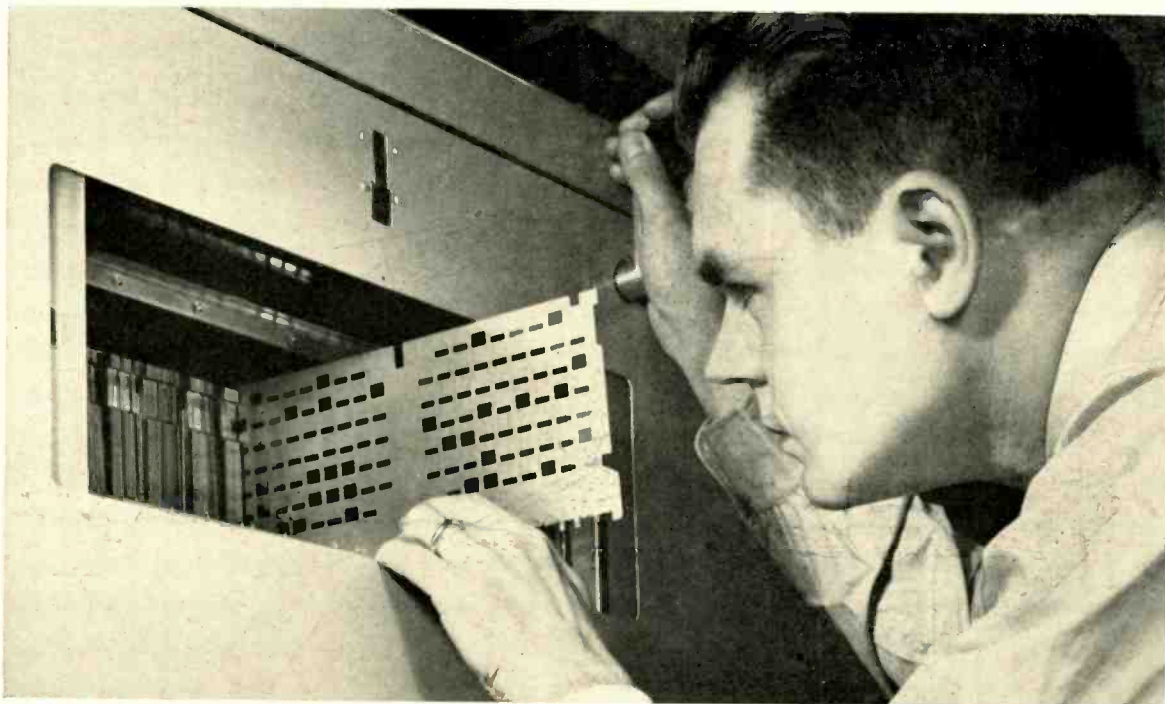

CARDS FOR CONVERSATION

To find out how to route Long Distance calls a dial system needs lots of information—fast. To provide it Bell Laboratories engineers developed a new kind of card file—one that dial systems can read.

Punched holes on metal cards tell how calls should be handled. When a call arrives the dial system “asks” the “card file” how to proceed to a particular area. Instantly the appropriate instruction card is displaced so that its pattern of holes is projected by light beams on a bank of Phototransistors. In a flash the Phototransistors signal switches to set up the best connection. Cards are quickly changed when new instructions are needed.

The “card file” will have its widest use in speeding Long Distance calls that are now dialed by a telephone operator and may one day be dialed by you personally. It is another example of how Bell Telephone Laboratories helps telephony to grow, as costs are kept down.

Checking perforated metal card in Bell's new “card file” which uses Phototransistors to help route Long Distance telephone calls along the best routes. If the first voice-way is in use, a “detour” is swiftly found. The equipment is known in telephony as a “card translator.”

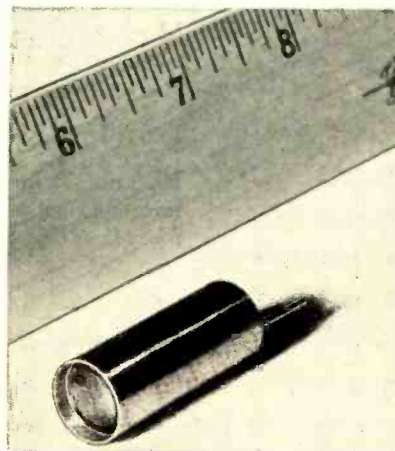

New Phototransistor unit. Light entering the cylinder is focused by the lens on a piece of germanium that responds by generating current. Like the Transistor, the Phototransistor was invented in Bell Telephone Laboratories.



BELL TELEPHONE LABORATORIES

IMPROVING TELEPHONE SERVICE FOR AMERICA PROVIDES CAREERS FOR CREATIVE MEN IN SCIENTIFIC AND TECHNICAL FIELDS

Make Your Own Woofer

CURTISS R. SCHAFER*

For a minimum expenditure of money and a modest expenditure of time, anyone can easily convert an old-model speaker into a modern 18-inch woofer.

EXCELLENT DESIGN DATA for several types of loudspeaker enclosures have recently appeared in technical publications. Most of these designs—whether for corner horns or four-way bass-reflex cabinets, will give their best performance when used with a good, heavy-duty theatre-type woofer. The actual use of such woofers has been restricted because most of them carry a list price tag reading around \$250. It is the purpose of this paper to enable anyone really interested in obtaining such a speaker to assemble it himself for a net cost of between \$30 and \$35, depending on whether or not he has a friend who can operate a lathe.

Most of us like to know exactly what we are going to get out of a construction project before we start it. Therefore Fig. 1 shows the free-field response of the unit when mounted in a true infinite baffle, at a 20-watt electrical input level. Figure 2 shows the impedance characteristic at various frequencies. Figure 3 shows the completed speaker, ready for installation.

Caphart used a 14-inch Jensen "Auditorium" speaker in many of their larger models, from 1933 to about 1942. These may be purchased from many radio and phonograph repair shops at a nominal price. The aluminum basket and cone for the current models of 18-inch theatre woofers (Jensen PMJ-18 and PLJ-18 will, with a very little bit of lathe work, fit the magnetic structure of the old 14-inch unit, and it is this con-

Fig. 3. Early model of 14-inch Jensen speaker modified by substituting a new 18-in. basket and cone to make modern high-quality woofer.

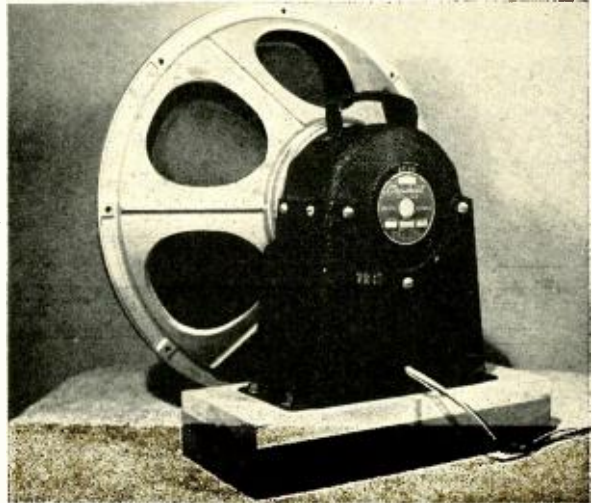

version that is the basis of the speaker described here.

There are also many 18-inch Jensen speakers, of the electromagnetic type with built-in field exciters, available at theatre supply houses, and these may be converted by changing only the cone and adding the spider clamping ring shown in Fig. 4.

This is the procedure, starting with disassembly of the 14-inch unit:

1. With a 7/16-in. open end wrench, remove the four 1/4-in. bolts that secure the basket to the magnetic structure.

2. Separate the basket and cone assembly from the magnetic structure.

3. Tear out the old cone, voice coil, and centering spider.

4. Remove the three heavy screws that fasten the iron ring to the aluminum basket, and separate the ring from the basket.

5. Drill out the riveted brass studs that supported the spider.

6. Chuck the iron ring in a good lathe and turn down the outside diameter of the ring so that it will fit snugly into the new basket; the new outside diam-

(Continued on page 69)

* Route 4, Ridgefield, Conn.

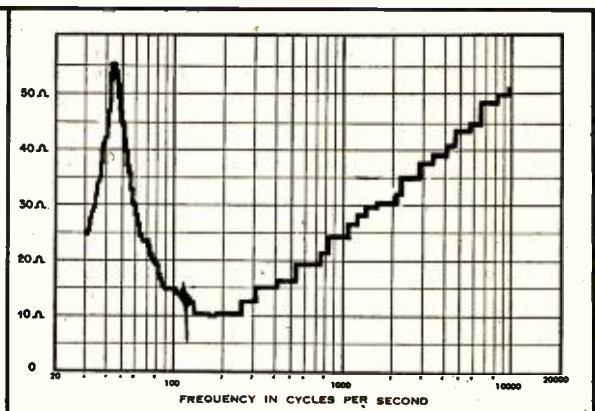
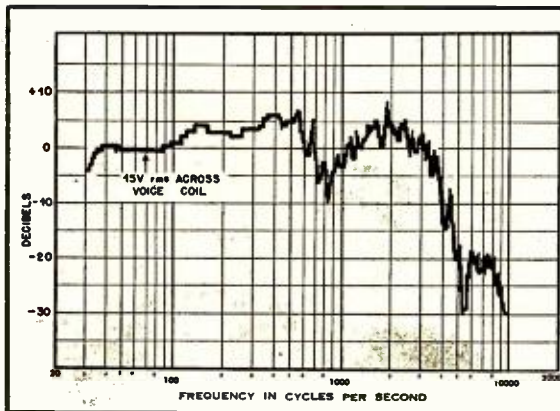

Fig. 1 (left). Free-field response of modified 18-inch woofer mounted in a true infinite baffle. Fig. 2 (right). Impedance characteristic of the woofer—nominal value being 10 ohms.

Making a "Front End" Handsome

WILLIAM H. BURKE*

Most articles discussing the preamplifier and control unit are concerned principally with electronic circuitry, with very little attention being paid to construction, or to making it look "professional." This author takes the other slant.



Fig. 1. The "Front end" unit in place in the author's phonoradio cabinet. Note the neat appearance of the decal labels.

IN AN ARTICLE on converting their Musician's Amplifier to Ultra-Linear operation, the authors¹ explained that they had not described a "front end" for their amplifier for several reasons, a major one being "the almost unsurmountable obstacle to the amateur constructor in achieving the appearance of a factory-built unit." With all due respect to those eminent gentlemen, I wish to dissent. That obstacle is nowhere near insurmountable. I am an amateur constructor—as amateur as they come—but I built a front end that is handsome and professional in appearance. And so can you, if you have the equipment and know-how to build a Williamson in the first place. I had never tried anything like it before. I have no unusual talent for that sort of thing; neither am I all thumbs. In short, I am just like you.

There was a time when, exhibiting a normal degree of timorousness, I agreed with Messrs. Sarsar and Sprinkle. When I began to plan for the construction of the Ultra-Linear version of the Williamson,² I decided that for the sake of appearance I had better buy a manufactured front end. I priced the adequate ones; I consulted the budget; the bubble burst. If I was to have a good front end I was going to have to build one. So I

resolved to have my cake and eat it too, or to perish in the attempt. Having picked a design that seemed to offer everything that I could want in a front end,³ I lit my pipe and curled up with a good catalogue. What I learned then and in the subsequent construction of my front end unit is applicable to the housing of any unit, and this article will be concerned primarily with the problem of attractively housing whatever circuit the constructor prefers to build. Figures 1 and 2 show the resulting equipment.

As a housing for my unit I chose a two-section aluminum case, accurately formed and attractively finished in gray

³ Arthur J. Rose, "Front-end control unit for Williamson amplifier." *Radio and Television News*, June 1952.

hammertone. To achieve a pleasing color combination, I chose red bar-knobs for the controls. Anyone whose interior-decoration requirements are more chaste and austere will find that black bar-knobs will also make a handsome job. In any event, the gray hammertone of the case will harmonize with any color scheme. The solution to the labeling problem was provided by the "audio" series of "Tekni-Cals," easily applied water-transfer decals available only in white. Another type—"Tekni-Labels"—is also available in black, gold, and red. The combination of gray, red, and white proved to be a most attractive one.

The complexity of the front end which I built dictated the choice of the 4 x 5 x 17 in. case; smaller sizes are available to fit other requirements. The materials once acquired, the procedure for completing the control panel is as follows. Lay out symmetrically the holes through which the control shafts will protrude, using a soft lead pencil whose marks can be easily rubbed off later. Drill holes comfortably larger than the diameter of the shafts, for a reason which will be stated later. Then rule guide lines for the labels, after careful consideration, of course.

Procedure

Now apply the decals. Read the directions over several times before doing anything, and follow them carefully. If you do, you will have no difficulty, even though you have never applied a decal before. Once you have applied a decal to the panel, you can move it around to your heart's content with a wet camel's hair brush. When it is in exact position,

Fig. 2. The completed control unit together with the Ultra-Linear amplifier used with it. Heater current for the control-unit tubes is drawn from the cathode circuit of the KT-66's.

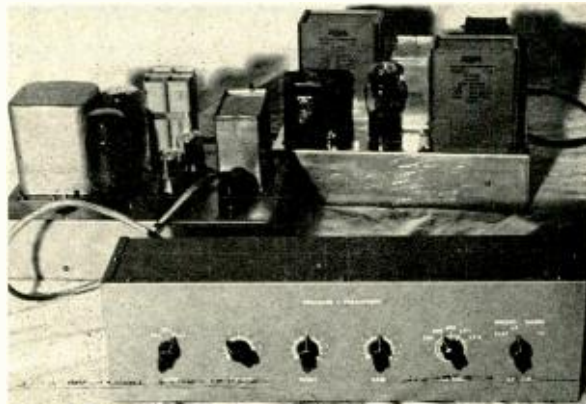

* 611 Stuart Ave., Kalamazoo 48, Mich.

¹ Sarsar and Sprinkle, "Gilding the lily," *AUDIO ENGINEERING*, July 1952.

² Hafler and Keroes, "Ultra-linear operation of the Williamson amplifier," *AUDIO ENGINEERING*, June 1953.



Fig. 5. Chassis of front-end unit further disassembled to show construction.

fix it there in the following manner: place over the decal one thickness of soft, dry cloth (soft thin cotton is best; a piece of an old T shirt is ideal) and press your forefinger gently but firmly upon the decal. If you inadvertently move the decal in the process, work water under the edges with the wet brush, push the decal back into exact position, place the cloth over it again, and once more apply even, gentle pressure. Do this as many times as you have to; whatever you do, don't lose patience and don't be satisfied with *almost* good enough. Once the decal is fixed in exact position, wrap a single thickness of the cloth around the tip of your forefinger and go over the entire decal, flattening out any small wrinkles. Dials are available in a separate Tekni-Cals booklet, which offers a good variety of attractive dials. Choose the ones you wish to use, trim them closely and carefully, and center them around the shaft holes with care. Take all the time you need, and you will wind up with a professional-looking job. It took the writer an entire evening, and it was an evening well spent. One further step remains, and a word of caution concerning it must be added. After the decals have dried for twenty-four hours, the directions tell you to brush over them lightly with a camel's hair brush moistened with lacquer solvent. When they say "moistened," they mean "barely moistened." Dip the brush into the lacquer solvent (available at any paint store) and then dab the brush repeatedly upon a piece of absorbent paper until you can see that the brush is barely moist. Then brush over one label or dial and repeat the process.

You will find that the audio series of "Tekni-Cals" contains just about every label you could want, and what isn't available can easily be made from what is. **TURNOVER, ROLLOFF, FLAT**—they're all there (but be sure to get the *fifth* edition of the audio series; the fourth edition, which I had to use for the first unit I built, lacked many useful labels



Fig. 4. Front section of case removed to show method of mounting sub-assembly.

and made much patching together necessary). If you want to label the top of your panel with **EQUALIZER-PREAMPLIFIER**—and it does add a professional touch—the legend can be made up of **EQUALIZER**, a minus sign, and **PREAMPLIFIERS**, cutting off the final s. If you prefer **CONTROL UNIT**, **CONTROL** is available and **UNIT** can be taken from **VOLUME UNITS**. Neither **RADIO** nor **TUNER** is available, oddly enough, for both **AM** and **FM** are on hand; and, if desired, **RADIO** can be made from **AUDIO** and **GENERATOR**. Incidentally, *Figs. 1 and 2* show the first unit; *Fig. 3* shows the second unit with different dials.

Protection

An important question which now arises is: How do I keep that handsome control panel from getting marred while I have it on the bench mounting parts on it? The answer is inescapable: mount nothing on it. I mounted everything except the input and output sockets and jacks on the sub-assembly shown in *Figs. 4 and 5*. Not only did this pro-

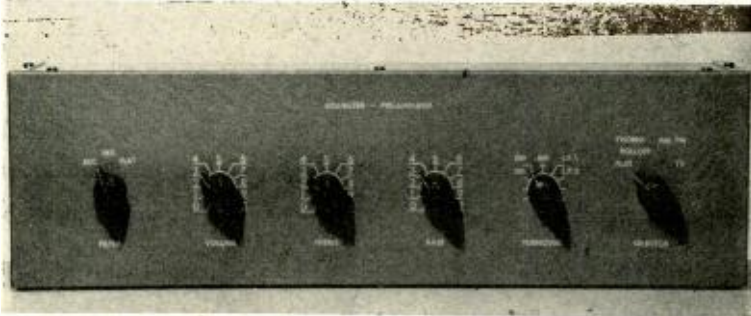

Fig. 3. Second model of the author's unit to show new type of dials used on the panel.

cedure spare the finish of the control panel; it also made wiring simple because everything is in the open and easy to get at. While the details of a sub-assembly may vary widely in accordance with the circuit being built, some basic principles might be applied to any. The first requisite is an aluminum strip about three inches wide and about as long as the case is. If such a strip cannot be bought or liberated, other materials than aluminum will do. One-eighth-inch Masonite could even be used, with the ground bus connected then to one of the brackets mounting the strip to the case. First lay out the holes for the controls by placing the strip against the back of the control panel in the appropriate position and marking the centers of the holes through the holes in the panel. Then drill the holes, making them slightly larger than the threaded bushings of the controls—a 7/16-in. hole is fine for 3/8-in. bushing. The reason for this is that it will probably prove desirable, when the final touches are being put on the unit, to move one or more of the shafts sidewise slightly in order to center the pointer of the knob on the top center index line of a dial. A matter of neatness.

For the tubes and the can electrolytic, I used two 1 × 3 1/8 × 4-in. open-end aluminum chassis, each fastened to the alu-

minum strip with two small right-angle brackets and metal screws. Suitable brackets might be purchasable; I made mine. Whether you use miniature chassis or just metal or Masonite squares for the tube mountings, it is a good idea to mount them about a quarter of an inch out from the aluminum strip, so that wiring may be passed between tube mount and strip. Mount at each end of the aluminum strip a screw-type terminal strip, such as the Jones barrier-type strips. All leads into and out of the unit can be connected to these terminals with solder lugs; this will simplify removing the sub-assembly for servicing. With reference to *Fig. 4*, the terminal strip on the left end of my assembly handles the three inputs and their common ground; the terminal strip on the right end handles B-plus, filament supply, output, and ground (the output and filament-supply conductors can be cablefellows, because the filaments are operated from d.c. drawn from the cathodes of the Williamson output stage via the arm of the balance pot. This also accounts for the

relatively informal wiring: since there is no a.c. in the unit, there is no need to worry about lead dress. There is no hum whatsoever, either). After you have mounted the terminal strips, connect the lower terminals with a ground bus, which is grounded to the chassis at one point only. The rest of the construction is *ad lib*. When the sub-assembly is completed, mount it in the rear section of the case with three right-angle brackets and metal screws. Machine screws and nuts will not do here, for obvious reasons.

When you have finished, you will have a unit which really has that "factory-built" appearance about which Messrs. S. and S. were so bearish. In fact, this very evening an audio engineer walked into my living room, saw my unit, and said: "Who makes that front end? I thought I'd seen all the ones on the market." Of course, if your taste will settle for nothing less than hand-rubbed hardwood, you probably ought to spend your eighty or ninety dollars and be done with it. But many readers will be interested to know that my unit, which involves about as complex and expensive a circuit as one could want to build, cost me about thirty-two dollars. I might add that its performance is magnificent. All this and handsome appearance, too. It can be done.

The Piano

ALBERT PREISMAN*

In Two Parts—Part 2

Continuing the description of the most universal of the musical instruments with a presentation of the technical considerations in the production of tones and their related harmonics.

IN THE FIRST PART of this paper the piano was described from its constructional standpoint. This section is devoted to a discussion of the technical characteristics of tone production and the elements which contribute to the quality of tone obtained from the instrument.

The String as a Transmission Line

Mention was made that the vibrating string behaves like an electrical transmission line. Besides the pioneer work of Rayleigh, Helmholtz and many others, Winston E. Kock³ has analyzed the behavior of the vibrating string according to this analogy, and has taken the displacement of the string, rather than its velocity, as analogous to current in the line. In this manner he obtains similar boundary conditions: at the ends of the open-circuited line the current is zero, and at the ends of the rigidly held string (nodal points) the displacement is zero.

Suppose the hammer strikes the string. The result is an impulse force, similar to an impulse voltage, and it can be analyzed into a series of sinusoidal or pendular components. The string, like the line, will respond to a maximum degree to those components for which it is resonant, which means to frequencies for which it is a half wave length, whole wave length, one and one-half wave lengths, etc. Some of the different types of vibration are illustrated in Fig. 12; we say that the string generates a fundamental tone plus various harmonic overtones, such as the second, third, and so on.

All this is on the assumption that there is no dissipation in the string. So far as internal friction is concerned, this is generally very small. It can be reduced very markedly by increasing the string tension. In the electrical transmission line the analogous effect is to reduce the unit shunt capacitance, and thus raise the Q of the line with respect to the series resistance of the line.

What is intended to be brought out here is that the effect of resistance is to raise the velocity of propagation along the line as one goes up in frequency. Since the length of the segments in which the string can vibrate, as illustrated in Fig. 12, is fixed, and each segment represents a half wave-length at the frequency in question, then if the

*Capitol Radio Engineering Institute, Washington, D. C.

³W. E. Kock, "Vibrating string considered as an electrical transmission line," *J. Acous. Soc. Am.*, Vol. 8, p. 227, 1937.

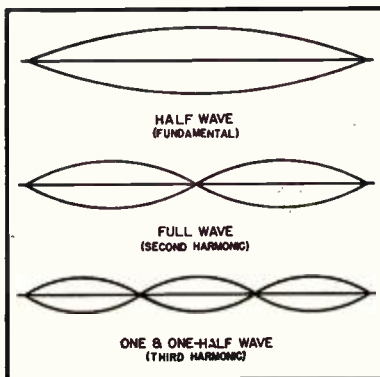

Fig. 12. Different modes of vibration of a string.

velocity is greater, the frequency must be higher, because frequency is equal to the velocity divided by the wave-length.

As a result of all this, resistive or frictional damping makes the overtones slightly higher in frequency than true harmonic values (integer values); i.e., the overtones are somewhat sharpened. This effect is known as inharmonicity, and is deemed undesirable, particularly in the bass strings. Here it is found that the soundboard can radiate the fundamental tone only feebly as compared to the overtones. The ear, owing to its non-linearity, can take the overtones—such as, for example, the fourth and fifth—and obtain a difference beat frequency. If the fourth and fifth and all other overtones are true harmonics, the difference beat between adjacent overtones will in every case be the fundamental frequency, and the difference beats will all blend harmoniously.

But if the overtones are not harmonic, the difference beats will not be all of exactly the same frequency as the fundamental nor of each other, and a jangling sound will result. It is for this reason that the bass strings of a concert grand

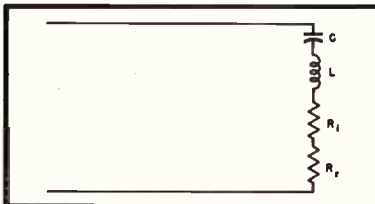

Fig. 13. Equivalent terminating impedance of a piano string.

yield more pleasant tones; the strings are longer and consequently under greater tension for a given pitch and mass, and hence the inharmonicity is less. Furthermore, if a string is under greater tension, its amplitude of vibration for a given output is less. This in itself reduces the inharmonicity, as will be shown.

The ends of the vibrating portion of the string, particularly the bridge, are not absolutely rigid. Indeed, it is by virtue of the "give" in the bridge and connected soundboard that vibrational energy is transferred to the soundboard and thence radiated into the air. Such "give" is equivalent, in the electrical line, to a finite rather than infinite impedance termination. The elasticity C and mass L of the bridge and soundboard, and the radiation resistance R_r of the system and internal friction R_i , may all be represented electrically as illustrated in Fig. 13. Such a termination tends to limit useful radiation of the low bass frequencies, because of the high reactance of C , although the step extension on the bass bridge (Fig. 8) tends to increase C (reduce the stiffness) by coupling the bridge to the more compliant central section of the soundboard.

At the higher frequencies the impedance of L (mass of bridge and associated portion of the soundboard) limit the amount of radiated energy. This is perhaps an even more serious limitation than the lack of radiation of the bass tones; the highest notes of a piano are particularly undistinguished in character. Although people, even artists, accept the tone of the top strings, they are more nearly a thud than a tone. More will be said about this later.

Effect of Stiffness

There is another effect that can be ascribed to damping, and that is the lack of suppression of certain harmonics. Piano strings are struck at approximately one-seventh of their vibrating length. This is therefore a point of maximum displacement or a loop rather than a node. For the seventh harmonic, every seventh interval of the string should be a node.

Hence, it can be expected—and it was so argued by Helmholtz—that if the hammer strikes the string at one-seventh of its length, the seventh harmonic will be suppressed. It has even been argued that this is an undesirable harmonic!

However, actual tests show that there is a very appreciable amount of seventh harmonic present in the output of the

piano. This can be explained on the basis of dissipation. If the string has losses or damping, then there are no true nodal points along the string, but rather points of rapid change in phase; from transmission-line theory it can be shown that the impedance at such points is finite rather than infinite, and that therefore some seventh harmonic will be generated.

Piano manufacturers make a great point of choosing the point at which a string or tri-chord is struck, and undoubtedly it affects the tone quality. The highest treble strings are generally struck nearer to the end, in an apparent effort to augment the harmonic output of these strings. The usual striking distance for a string varies from about one-seventh to perhaps one-ninth of its length.⁴

Although frictional damping in a string can cause inharmonicity, apparently at the tensions employed today, this is not a serious factor. There is, however, another factor that is definitely appreciable, and that is the stiffness of the string.

The elementary theory of the vibrating string involves a linear differential equation; one obtains such an equation by assuming only first-order effects, such as no change in tension of the string with amplitude (because the amplitude is small), and no internal stiffness in the string. This means that if the tension is removed, the string hangs limply; i.e., in its unstressed state it can be bent without any effort.

Actual strings, however, do have some internal stiffness, especially if they are relatively short and thick. They then begin to behave like bars, which can resist bending stress just like a beam. For example, a beam anchored firmly at both ends, vibrates in modes, some of which are shown in Fig. 14. They are not harmonically related to the fundamental vibration, but are appreciably higher.

In Fig. 14 the restoring force is due solely to the internal stiffness of the members; the tension is assumed zero. In an actual string, the tension is the main restoring force, but in a short, thick string the stiffness may be an appreciable contributing factor. In this case the inharmonicity may be appreciable, and the overtones will be definitely sharp compared to the true harmonics.

Even in the ordinary middle register the inharmonicity may be measured quite readily with a sensitive frequency meter known as a Conn Stroboscope.

Tests made by O. H. Schuck and R. W. Young,⁵ as well as more recently by R. W. Young,⁶ indicate that the increased frequency of the overtones, or inharmonicity, can be entirely explained

on the basis of stiffness of the strings, rather than frictional damping. The measured results agree very satisfactorily with the more advanced theory of the vibrating strings that takes stiffness as well as tension into account.

Most pianos have the same length of strings in the middle and upper registers, hence most exhibit about the same amount of inharmonicity in that range. This is most pronounced for the highest and shortest strings, and this is to be expected, since these strings approach short stiff bars in their properties.

It is in the extreme bass strings that inharmonicity becomes prominent once again, and moreover, is more pronounced for small pianos of the spinet type than for large grand pianos, particularly concert grands, which in addition radiate appreciable sound at fundamental frequencies. R. W. Young suggests that the lack of inharmonicity may well indicate what is considered a desirable tone quality, and that furthermore a uniform change in inharmonicity from string to string may be more desirable than an abrupt change at any point in the scale.

There is another fact that may be

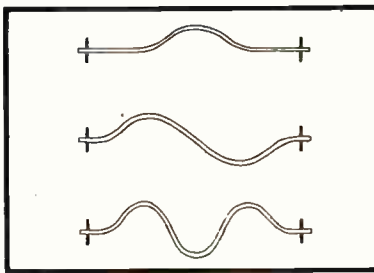

Fig. 14. Different modes of vibration of a bar clamped at both ends.

explained in terms of inharmonicity. Piano tuners tune a piano so that it becomes progressively sharper than the equally tempered scale as one goes up the scale. Lack of space precludes any discussion of piano tuning, or of the equally tempered scale, for that matter, but mention will be made of the fact that a tuner tunes two strings by measuring and adjusting the beats between the harmonic of the one note with the appropriate harmonic of the other.

For example, to tune one string so that it is four whole tones above that of another (fifths), it is necessary to tune to zero beat the third harmonic of the lower tone with the second harmonic of the upper tone. The two tones will then be five whole tones apart.

But if there is inharmonicity, the overtones will be inherently more sharpened, the higher they are. Thus, the third overtone of the lower note will be relatively higher compared to the third harmonic than the second overtone of the higher note is compared to the second harmonic. Hence, when the two are tuned to zero beat,⁷ the second harmonic and also the fundamental of the higher note will both be somewhat sharpened.

The opposite result occurs when the

lower strings are tuned to the standard A, 440 cps. Thus the piano is tuned so that it becomes progressively flatter than the equally tempered scale A-440 and progressively sharper above A-440. Such "stretching" of the scale actually occurs; inharmonicity may wholly account for it, and a small spinet may be flattened more in the low register than a concert grand.

Steinway once tuned one piano exactly right to the equally tempered scale by means of a Conn Stroboscope, and another with a stretching of the pitch. The former piano sounded dead and lifeless in comparison with the latter; no one failed to detect the difference.

In passing, it is to be noted that if the amplitude of vibration is large, the tension will vary periodically, and thus in itself produce inharmonicity. However, this is apparently not appreciable for strings under the tension used today in a piano. Thus, the inharmonicity does not appear to vary with the loudness of the tone.

A solution to the inharmonicity of strings owing to their stiffness has been suggested by Franklin Miller.⁸ The idea is to attach a small mass, of the order of 0.1 gram, within a few centimeters of the end of the string. This is sufficient to correct for the first eight overtones to within a few hundredths of a semitone. Theoretically, a large mass near one end of the string would correct for a large number of overtones.

A small mass, when attached to a string, lowers each nodal frequency except those for which the mass is located at a node. A mass distributed in sinusoidal manner along the string would correct for ten or twenty partials, but is much too complicated. A practical mathematical solution is possible for one mass used to make the first overtone harmonic with the fundamental, but other overtones remain inharmonic. Hence, a somewhat larger mass closer to the end of the string is preferred; this more nearly harmonizes a greater number of overtones.

Although a two-mass correction renders the first four overtones exactly harmonic, it does not improve the higher overtones, and does not appear to warrant the extra complication. It is pointed out that for a string 120 cm. long and a mass of 7.2 g., a mass of 0.133 g. placed 3.33 cm. from one end of the string, or half the mass placed that distance from each end of the string, would be sufficient. Gold plating might be a solution to the problem, but it would be better to have an adjustable mass, since the string stretches when tuned. However, so far

⁷ Actually, owing to the equally-tempered scale, the two are tuned to a certain number of beats per second rather than to zero beat, except in the case of octaves. However, starting about 1½ octaves from the top of the scale, a tuner may sometimes even deliberately sharpen the octaves to a slight extent.

⁸ Franklin Miller, Jr., "A proposed loading of piano strings for improved tone," *J. Acous. Soc. Am.*, Vol. 21, No. 4, p. 318, 1949.

⁴ Steinway strikes at less than one-seventh throughout, more so in the treble.

⁵ O. H. Schuck and R. W. Young, "Observations on the vibrations of piano strings," *J. Acous. Soc. Am.*, Vol. 15, No. 1, p. 1, 1943.

⁶ R. W. Young, "Inharmonicity of plain wire piano strings," *J. Acous. Soc. Am.*, Vol. 24, No. 3, p. 267, 1952.

this solution still awaits adoption by a manufacturer.

Effect of the Hammer

The effect of the impact of the hammer on the string has been investigated by many, starting perhaps with Helmholtz. Recently R. N. Ghosh^{9,10} has written two articles on this subject which are interest and significance.

For a hammer that has certain amount of elastic "give," such as in the case of a felt hammer, there is first a tiny interval of time (investigated by Helmholtz) in which the hammer felt becomes compressed, but the string does not as yet move. Then follows a period of time during which the string begins to move and two waves travel in opposite directions along the line from the point of contact between the hammer and the wire.

These pulses, upon reaching their respective ends, are reflected therefrom in opposite phase, and return to the hammer. Upon reaching the hammer, at least some of the energy of each pulse is reflected back to the end it came from, and the action is repeated.

Since the hammer in a piano is about $\frac{1}{8}$ of the distance from one end, it turns out that the pulse from that near end reaches the hammer, is reflected from it back to the end, undergoes another reflection, and so on several times before the other pulse reaches the farther end and finally comes back to the hammer. By that time the hammer has received enough energy from the near end to rebound from the string and permit standing waves to be set up in it.

Hence, the analysis concerns itself with the reflections from the near end, only, and is therefore considerably simplified. Nevertheless the mathematics (Heaviside's Operational Calculus) is fairly involved, but indicates that there is built up by the string against the hammer a pressure that varies, for certain constants, as shown in Fig. 15. Here the ordinates represent pressure and the abscissa represent (vt/α) , where v is the velocity of propagation along the string, t is the time measured from the instant the standing waves are formed, and α is the distance of the hammer from the near end. Also, $\chi = T_s/\mu\alpha$, where T_s is the tension in the string and μ is the coefficient of elasticity of the felt; and $\beta = \rho\alpha/M$, where ρ is the mass of the string per cm. and M is the mass of the felt hammer. The values for χ and β shown are typical for a piano for α lying between 1/7 and 1/9.

The interesting thing about this curve is that it is continuous. If the hammer were perfectly hard and inelastic, the pressure curve would be discontinuous in shape. Owing to the elastic quality of the felt and even that of the hammer shank, the curve is smooth albeit undulating, as in Fig. 15.

⁹R. N. Ghosh, "Elastic impact of a pianoforte hammer," *J. Acous. Soc. Am.*, Vol. 7, No. 4, p. 254, 1936.

¹⁰R. N. Ghosh, "Elastic impact of pianoforte hammer," *J. Acous. Soc. Am.*, Vol. 20, No. 3, p. 324, 1948.

The tone quality of the string depends upon the pressure curve. From Ghosh's analysis, only α and β are involved in the time-variable terms of the formula for the pressure, and the initial velocity with which the hammer strikes the string merely determines the amplitude but not the shape of the curve.

Hence it would appear that assuming the elastic limit, μ , of the felt is not exceeded, the tone quality of the string should not change with amplitude. Yet tests by White¹¹ and Hart, Fuller and Lusby¹² indicate that the tone quality

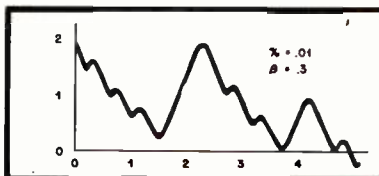

Fig. 15. Variation in pressure on a pianoforte hammer by the reaction of the struck string.

or wave shape does change with the loudness.

One possibility is that nonlinearities in the soundboard may change the wave shape with amplitude. Another possibility mentioned by Hart, Fuller, and Lusby and taken up by Ghosh is that of vibratory motion set up in the hammer. If the hammer is given a high velocity, appreciable energy from the key may be stored in elastic deformation of the hammer shank, weighted as it is with the large mass of the hammer it is driving. This may set up a vibratory motion in the hammer owing perhaps to air friction as it comes in contact with the string, and thus alter the pressure characteristic from that shown in Fig. 15. This may in turn explain the difference in wave shape with amplitude.

Touch vs. Tone Quality

We now come to a rather old but still controversial question, namely, can the tone quality of a piano note be altered by the manner in which the key is depressed, without the loudness being changed?

The answer, in the form of scientific tests or experiments,^{11,12,13} is in the negative. William Braid White tested many artists with regard to this theory, and in every case where the tone color was different, the amplitude of the wave was different, too, as revealed on an oscillograph.

Ortmann obtained the same results after an elaborate series of tests that form the basis of an entire book.¹³ Thus, he attached a stylus to the hammer and moved a piece of smoked paper past it so as to trace out a line on the paper. From this the hammer velocity as a

¹¹W. B. White, "The human element in piano tone production," *J. Acous. Soc. Am.*, Vol. 1, No. 3, p. 357, 1930.

¹²Hart, Fuller, and Lusby, "A precision study of piano touch and tone," *J. Acous. Soc. Am.*, Vol. 6, No. 2, p. 80, 1934.

¹³Otto Ortmann, "The Physical Basis of Piano Touch and Tone," a book.

function of time could be ascertained. Ortmann believes that the chief difference between two types of tones is the amount of noise that accompanies the sound. Thus, a "good", "sympathetic", or "beautiful" tone means, in part, a sound-complex with a maximum of tonal elements and a minimum of noise elements. Conversely "poor", "shallow", or "dry" tone means a minimum of tonal elements and a maximum of noise elements. The noise comes from the key striking its stop, and the clicks and thuds of the other parts of the action. The most characteristic difference in touch, when measured in terms of the noise element, is that between percussive and non-percussive touch.

Hart, Fuller, and Lusby constructed a device that could strike the string in a variety of ways. An oscillograph revealed the wave shape picked up by a microphone, and the hammer motion was recorded optically. The object of these tests was to see if the possible whipping or vibratory action of the hammer, when its shank is elastically deformed, could possibly have an effect on the tone. Owing to the bulk of the equipment, 50 hammers had to be removed, and middle C was the only tone checked.

It was found that only when the hammer velocity was changed by 35 per cent could a difference in loudness and quality of the tone be perceived. In all cases where the hammer velocity, as it left the fly, was the same, the wave shape was identical, regardless of whether the striking mechanism struck the key with increasing, constant, or decreasing force.

Apparently there was no whipping or vibratory action of the hammer ordinarily to alter the nature of the contact of the hammer with the string, at least for a given hammer velocity. However, the striking mechanism could be adjusted so that when the key was struck once, the hammer would strike the string twice in very rapid succession—within 0.035 second—something quite impossible for a human performer to accomplish ("ricochet"). This is called a "repetition," and the second impact produces a marked jangling effect in the tone. However, this is an effect that every action builder carefully seeks to avoid; as proof is the fact that a performer never produces a repetition in normal playing.¹⁴

In view of this, it is somewhat ludicrous to see a piano player impart a vibrato motion to the key, after the hammer has struck the string and produced the tone. Furthermore, as Ortmann says, "—so far as effect on the tone is concerned, it is useless to write 'religioso,' 'pietoso,' or 'mesto' for a piano passage since the keyboard cannot be influenced thereby." To which the major piano builders add a fervent "Amen."

(Continued on page 64)

¹⁴Top speed for a human being is about 600 to 700 notes per minute. Action makers and regulators aim for ability to handle this speed, and succeed in obtaining it. No greater speed is necessary.

Handbook of Sound Reproduction

EDGAR M. VILLCHUR*

Chapter 14. Tone Control and Equalization.

A description of the simpler methods of obtaining frequency response equalization by the use of resistors and capacitors. The author also touches on expander circuits.

THE AMPLIFIER CIRCUITS that have so far been discussed are designed for a "flat" frequency characteristic within the signal band—the output signal voltages are ideally independent of frequency. Certain stages of an amplifier are purposely designed to introduce frequency discrimination, in compensation for conditions that exist elsewhere. These frequency discrimination circuits are either fixed or variable; the fixed circuit is usually referred to as an equalizer, and the variable circuit is called a tone control. Automatically variable circuits may be considered a special case of the variable circuit.

Fixed equalizers are used to compensate for:

1. Treble pre-emphasis in FM broadcasting. This is a standard and uniform broadcast practice required by the Federal Communications Commission, for the purpose of improving the signal-to-noise ratio of the FM signal. A 75-microsecond¹ de-emphasis network is inserted at the audio output of the tuner detector.
2. Constant-amplitude bass recording (bass attenuation) and treble pre-emphasis in records. Several circuits may be provided for the various recording curves, or a single compromise circuit may be used, and its corrective action augmented by variable tone controls.
3. Non-uniform frequency characteristics of a pickup cartridge, especially of the piezo-electric type. A circuit used for this function is a bridge between the characteristics of the pickup and those of the record being played.

Tone controls are used to compensate for:

1. Frequency irregularities of associated reproducing equipment.
2. Acoustical conditions of the listening room, including the masking effects of background noise and the frequency *vs.*

*Contributing Editor, AUDIO ENGINEERING.

¹A resistor-capacitor network may be described quantitatively by its "time constant," in seconds which is equal to the product of the resistance in megohms and the capacitance in microfarads.

Fig. 14—1. Combined effect of the response of a high-quality speaker and of a treble-boost control with a transition frequency which is too low.

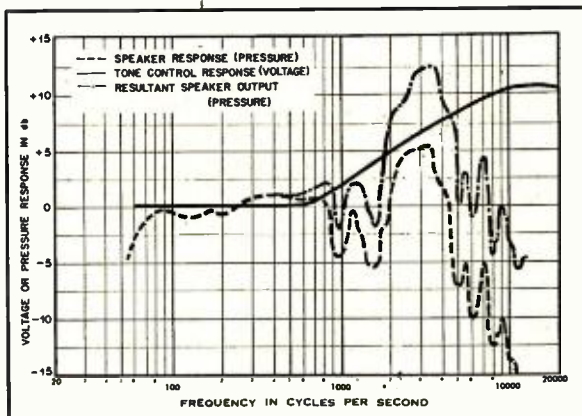

absorption characteristics of the room surfaces.

3. Tonal imbalance caused by a generally weak treble or weak bass.
4. Reduced hearing sensitivity at bass frequencies when the intensity level of the program material is reduced.

(Compensation may be accomplished by an automatic bass boost circuit synchronized with the volume control.)

Tone Control Curves

The type of frequency discrimination required of fixed equalizers is normally exactly determined by the problem; the transition frequency and rate of boost or cut corresponds to the particular condition for which equalization is introduced. Variable tone controls, on the other hand, must furnish the means for correction, by the same circuit, of all sorts of signal aberrations. The designer of such controls can create a complex circuit which furnishes the means for any and all types of frequency variation, or he can limit circuit flexibility, and furnish the means for approximate correction of those conditions most likely to be encountered. The latter is the practical procedure.

Most modern tone-control systems in high-quality amplifiers consist of two controls, allowing independent, variable, and progressive boost or cut of either bass or treble from relatively fixed transition frequencies. This scheme is largely

based upon design convenience, but also corresponds fairly well to the needs of the situation. The transition frequencies must be chosen as a suitable compromise between the requirements of the various types of correction that will probably be called for.

The geometric mean of the audible frequency spectrum—about 800 cps—is also its perceptible mid-point. (There are about $4\frac{1}{2}$ octaves of useful frequencies on each side of 800 cps.) This frequency region is commonly selected as the transition hub of all tone control correction. The writer, however, holds the view that the selection of the psychological mid-point of the spectrum as a transition point is arbitrary, and does not fulfill the needs of a properly designed tone control. The function of such a control, it is felt, is to make the perceived frequency distribution of the reproduced music correspond as closely as possible to the perceived distribution at the original source. Tone control then becomes tone compensation, and the problem of response-curve characteristics revolves about the question of what the controller must be equipped to compensate for. The following transition frequency regions are recommended on the basis of a survey² of the purposes for which tone control is most likely to be used:

²E. M. Villchur, "The selection of tone control parameters," AUDIO ENGINEERING, March, 1953, p. 22.

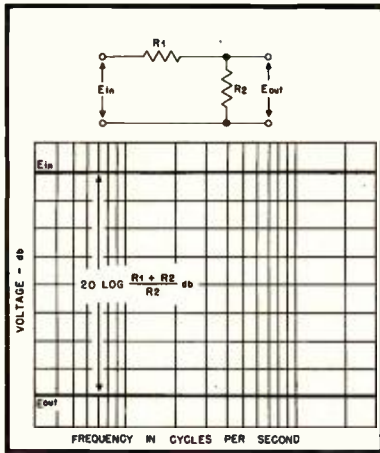

Fig. 14-2. Uniform attenuation over the frequency spectrum produced by purely resistive voltage divider.

Treble boost—3,200 cps
 Treble cut—2,000 cps
 Bass boost—400 cps
 Bass cut—500 cps

The high treble-boost transition frequency is chosen not only on the basis of predicted compensatory functions, but because most speakers introduce treble accentuation in the first few octaves above 800 cps, due to cone break-up resonances. The unhappy effect of using too low a treble-boost transition frequency in conjunction with such a speaker is illustrated in Fig. 14-1. The two curves in this graph are taken from manufacturers' published data for high-quality equipment currently on the market, and are by no means atypical.

The Frequency Discriminative Circuit

The basis of the common frequency discriminative circuit is the voltage divider. There are three types in use: the resistive-capacitive, or R-C circuit, the resistive-inductive, or R-L circuit, and the resistive-inductive-capacitive, or R-L-C circuit. R-L-C circuits have an

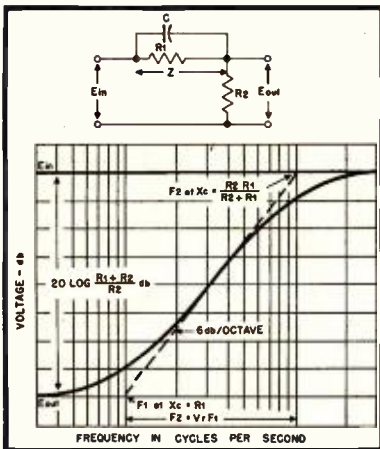

Fig. 14-3. Frequency discrimination of voltage divider with reactive element for one arm. This circuit may be used for treble boost or bass cut.

advantage in that they can provide steeper rates of boost or cut and a disadvantage in that they have a resonant peak. Coils also increase the danger of inductive hum pick-up, and are not as readily available in the required values as capacitors. In any case the R-C circuit is by far the most common, being smooth, simple, inexpensive, and entirely satisfactory. Although the maximum rate of boost or cut can at best approach 6 db per octave, steeper rates can be achieved by using more than one R-C stage of frequency correction, cascaded.

In Fig. 14-2 the input signal is attenuated uniformly over the entire frequency spectrum. If one of the arms of this voltage divider is now made reactive instead of purely resistive, however, the attenuation will no longer be uniform. Consider the circuit of Fig. 14-3. The reactance of Z varies radically with frequency: at the upper end of the spectrum C furnishes an effective short circuit across R_1 , and at the lower end C is effectively open. The result is that at the upper end of the spectrum there is very little attenuation through the circuit, and at the lower end almost the full attenuation of the resistive voltage divider, $R_2/(R_1 + R_2)$, is applied.

All tone control networks are basically attenuating circuits. Their effect, however, may be an apparent boost. This is so because the attenuation on one side of the transition frequency is almost uniform up to the end of the spectrum, while attenuation on the other side of the transition frequency can become progressively less. The process may be thought of as a uniform depression of the entire band of frequencies, followed by a progressive re-opening of the attenuator gate to one part of the band only.

The circuit of Fig. 14-3 will be analyzed descriptively in order to provide a physical picture of how equalizers work. The reader may wish to use the same type of analysis for the circuit of Fig. 14-2.

At low frequencies the reactance of C is so high that the capacitor may be considered open. Transmission through the circuit is therefore attenuated by the factor $R_2/(R_1 + R_2)$, as represented by the lower horizontal line in the graph. Since C is never actually open the true transmission curve does not join the horizontal line, but approaches it asymptotically.

As the frequency is raised, a point will be reached at which the reactance of C is numerically equal to the resistance of R_1 . C now becomes a significant element in the network. If C were not a vector quantity the impedance of the upper arm of the voltage divider would be halved, but as it is the impedance is reduced by a considerably smaller factor, and voltage transmission through the network is increased by a maximum of about 3 db. (The exact amount of increase depends upon the ratio between the values of R_1 and R_2 .) The total transmission increase over all the lower octaves has thus been only 3 db at most.

Above the transition frequency f_1 the net impedance of the upper arm of the voltage divider undergoes large changes. X_c is halved with each octave, and the impedance of the parallel combination of R_1 and C is correspondingly reduced, by a larger factor with each octave, although never at as great a rate as the change in X_c . Transmission through the network therefore increases with each octave, at a rapidly increasing rate which can approach the unobtainable limit of 6 db/octave.

The greater the attenuation of the resistive part of the network the closer the rate of boost can come to this ideal. The curve of voltage output *vs.* frequency cannot continue to increase its slope toward the 6 db/octave line indefinitely, however, because as the frequency continues to be raised we approach maximum or complete transmission. The output curve must therefore undergo a change from increasing slope to decreasing slope (at its point of inflection), and then flatten out again as ceiling

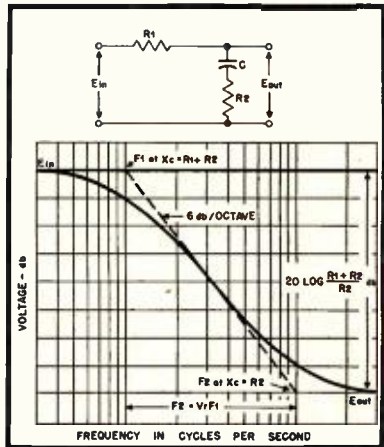

Fig. 14-4. Frequency response of circuit suitable for treble attenuation or bass boost.

transmission is approached. When the reactance of C , now the main element of Z , is approximately equal to the resistance of R_2 , the output voltage is, at most, 3 db from maximum. (A more rigorous determination of f_2 appears in the following indented section.) At higher frequencies the curve, which has only 3 db to go, is raised very gradually.

The circuit of Fig. 14-3 is thus suitable for either treble boost or bass cut, depending upon what part of the frequency band it is applied to. As a treble boost circuit the transition frequency is considered to be f_1 ; as a bass attenuator the transition frequency is f_2 .

The following expressions concerning circuit characteristics neglect the effect of vacuum-tube plate resistance, but are sufficiently accurate.^{3,4} Units are ohms and farads, or megohms and microfarads.

³ Holger Marcus Dahl, "R-C circuits as equalizers," *AUDIO ENGINEERING*, June, 1942, p. 16.

⁴ Charles J. Merchant, "Simple R-C equalizer networks," *Electronics*, Feb., 1944, p. 146.

The transition frequencies for the circuit of Fig. 14-3 are determined as follows:

$$f_1 = \frac{1}{2\pi R_1 C} \quad (\text{The frequency at which } X_C = R_1)$$

$$f_2 = \frac{1}{2\pi R_2 C} \quad (\text{The frequency at which } X_C = \frac{R_1 R_2}{R_1 + R_2})$$

where f_1 = Transition frequency for treble boost

f_2 = Transition frequency for bass cut

$$R_T = \frac{R_1 R_2}{R_1 + R_2}$$

The total amount of boost or cut is equal to:

$$20 \log V_B = 20 \log \frac{R_1 + R_2}{R_2} \quad \text{db}$$

where V_B = Ratio between maximum voltage transmission (C shorted) and minimum voltage transmission (C open)

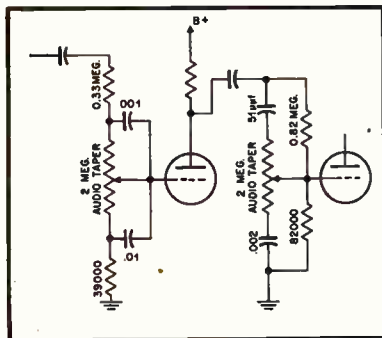

Fig. 14-5. Variable bass and treble tone control with values assigned for approximate transition frequencies recommended in text.

The maximum slope of the curve (at the point of inflection) is equal to:

$$6 \frac{V_R - 1}{V_R + 1} \quad \text{db/octave}$$

Thus when V_R becomes very large the slope of the equalization curve is almost 6 db/octave.

The frequency spread of the curve may be expressed as the ratio between f_1 and f_2 as:

$$f_2 = V_R f_1$$

If a resistor R is inserted in series with C the effect is to reduce the total boost or cut, and the slope.

In Fig. 14-4 the transition frequencies are determined as follows:

$$f_1 = \frac{1}{2\pi R_1 C} \quad (\text{The frequency at which } X_C = R_1 + R_2)$$

$$f_2 = \frac{1}{2\pi R_2 C} \quad (\text{The frequency at which } X_C = R_2)$$

where f_1 = Transition frequency for treble cut

f_2 = Transition frequency for bass boost

$$R_2 = R_1 + R_2$$

The total amount of boost or cut is equal to:

$$20 \log V_B = 20 \log \frac{R_1 + R_2}{R_2} \quad \text{db}$$

The maximum slope (at the inflection point) is equal to:

$$6 \frac{V_R - 1}{V_R + 1} \quad \text{db/octave}$$

The frequency spread of the equalization curve is expressed as:

$$f_2 = V_R f_1$$

If a resistor R is added in parallel with C the effect is to reduce the total boost or cut and the slope.

Frequency discriminative circuits may be inserted directly into interstage coupling networks of the signal channel, in which case they act as simple attenuators. They may also be used in feedback return loops. In the latter case the effect of the circuit on the signal is reversed—for example, a bass-boost circuit increases the relative amount of bass fed back degeneratively and takes on a bass cut function. In both cases the *insertion loss* refers to the number of db of attenuation at minimum transmission.

The basic principles of R-C circuits described above may be applied to various types of tone controls. One popular circuit configuration⁵ is illustrated in Fig. 14-5, with values assigned to approximate the transition frequencies recommended earlier in the chapter. Varying the potentiometer sliders changes the rate of boost or cut and to a lesser extent shifts the transition frequencies (towards the ends of the band for shallower slopes).

Another circuit has been described^{6, 7} in which the R-C networks are part of a negative feedback loop, and where the transition frequencies are varied with only minor changes of slope. The compromise involved here is the relinquishing of control over the rate of boost or cut.

The phase shifts introduced by R-C tone equalization networks are very large. The graph of Fig. 14-6 shows that 6 db of attenuation through the

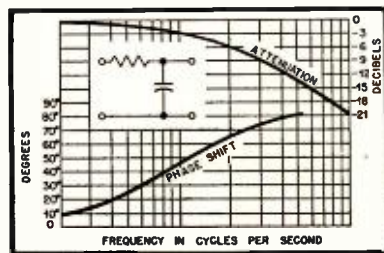

Fig. 14-6. Phase shift in relation to attenuation of an R-C network. (After F. Langford Smith.)

circuit of the inset diagram introduces approximately 60 deg. of phase shift. To the knowledge of the writer, such phase shift has not, up to the present, been demonstrated to have significant undesirable effects in monaural reproduction, whether the conditions which are being compensated involve an opposite phase shift, no phase shift, or phase shift in the same direction.

Loudness Controls

A "loudness" control is a tone-compensated volume control which varies the average intensity of program material without appreciably changing the perceived frequency distribution. To keep the loudness, or apparent intensity, of the different frequency elements in the same proportion, it is necessary to compensate for normal perceptual illusions that occur when the over-all intensity level of the sound is raised or lowered. The need for such compensation is probably almost universally agreed upon; the type of compensation which is most desirable, and the question of whether to make the compensation automatic, semi-automatic, or manual, is sometimes a subject of contention.

Certain facts relative to the problem have been experimentally established, and may be stated without the qualification of presenting them as a point of view. The Fletcher-Munson curves of equal loudness over the frequency spectrum, at different over-all loudness levels (see Chapter 6), may be used to calculate the required compensation for the Fletcher-Munson effect. Figure 14-7 plots the difference in perceptive sensitivity, over the frequency band, for the

⁵ Howard T. Sterling, "Flexible dual control circuit," *AUDIO ENGINEERING*, Feb., 1949, p. 11.

⁶ P. J. Baxandall, "Negative-feedback tone control," *Wireless World*, Oct., 1952, p. 402.

⁷ Basil T. Barber, "Flexible tone control circuit," *AUDIO ENGINEERING*, Sept., 1953, p. 29.

Fig. 14-7. Differences in hearing sensitivity over the frequency spectrum. The 50-phon and 80-phon equal loudness contours (from Fletcher and Munson) superimposed.

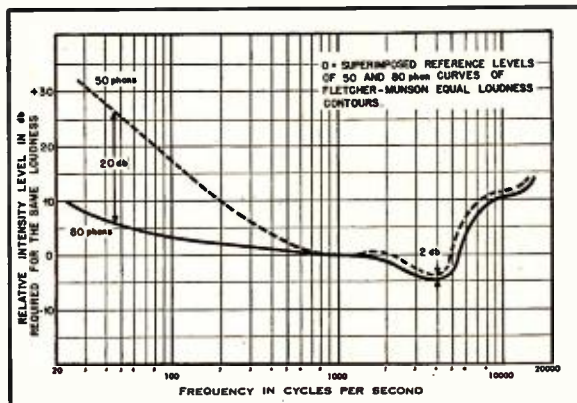

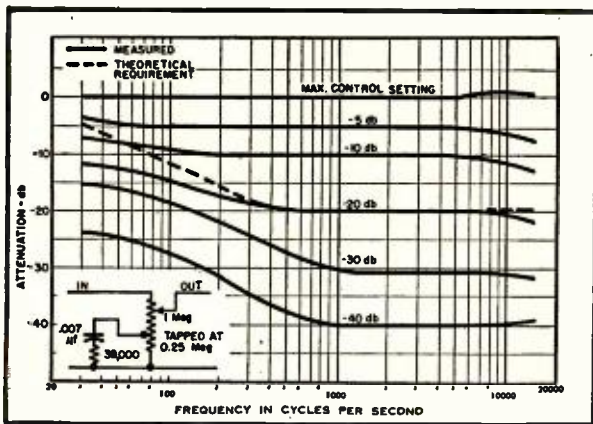

Fig. 14—8. Simple loudness control. The potentiometer uses a logarithmic taper. (After Toth.)

80 phon and 50 phon loudness contours.⁸ The maximum boost required for the Fletcher-Munson effect will be seen to be about 20 db at 50 cps, and 2 db from about 1500 cps and up. The treble boost is, even at maximum, insignificant, since the curves are essentially identical above about 1000 cps.

The bass boost may be applied automatically by a circuit such as appears in Fig. 14—8. The difficulties in using this circuit are that the degree of bass boost is tied only indirectly to the intensity level of the program material, through the physical position of the volume control slider. Different program sources may require entirely different settings of the slider for the same average signal intensity. One solution to this problem is to provide an additional potentiometer before the loudness control. This is used for initial adjustment of the input signal (with the loudness control all the way up), to an intensity level judged to be approximately equal to the original level of sound at the point of origin. The loudness control will then be more or less properly calibrated and will provide approximately correct tone compensation when varied. The complexity involved, however, may be considered an argument for completely manual compensation—that is, the use of bass control until the program timbres sound natural.

It has been suggested that since the Fletcher-Munson curves have been plotted on the basis of pure tones they do

⁸ As pointed out in Chapter 6, 80 db above threshold is the order of average sound intensity of a 75-piece orchestra heard from a front row seat, and 50 db is the minimum intensity level at which this music is likely to be reproduced with a legitimate interest in quality.

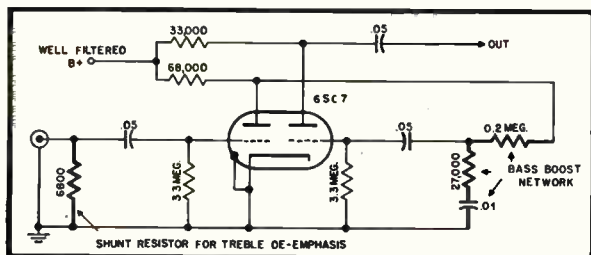

Fig. 14—10. GE-type preamplifier. Equalizing circuit elements are shown in heavy line.

not accurately predict the compensation required for the complex sounds of normal program material, and that specifically, when the intensity of sound is reduced, a significant treble boost is required by such effects as masking. In the absence of quantitative data paralleling that of the Fletcher-Munson study, however, this writer knows no accurate basis for designing an automatically variable treble boost circuit. The effects of room noise on masking higher frequency sound will of course vary in different locations.

Phonograph Preamplifiers and Compensating Networks

The circuits immediately following the pickup are used to compensate for recording characteristics and for any frequency discrimination in the pickup itself, if such exists. The compensation is applied at these low-level stages so that the required bass boost does not accentuate hum introduced by previous voltage amplifiers.

Piezo-electric pickups have relatively high signal outputs, usually between one-half volt and several volts. Compensation must be based upon the characteristics of the pickup unit itself, and designed to correct the curve of pickup output *vs.* frequency towards the reciprocal of the desired recording curve (not towards "flat" output). Certain crystal pickups have been specifically designed to match a particular recording characteristic when connected to the proper load resistance. Any crystal pickup, however, provides bass boost and treble droop automatically, so that the use of an uncompensated crystal cartridge tends to be fairly acceptable.

Figure 14—9 illustrates a circuit that can be used for semi-variable crystal

pickup equalization. The load resistor across the pickup has the effect of reducing bass response—the lower the resistance the less the response—while the parallel R-C network corrects treble droop.

The magnetic pickup has a much lower output than the piezo-electric—for some types the signal voltage is no greater than 10 millivolts or so—and additional voltage amplification is required. Frequency compensation for recording characteristics are included in the added amplifier stages; these stages make up the *preamplifier*. The compensation may be introduced by an attenuating network, as in Fig. 14—10, or by a feedback network, as in Fig. 14—11.⁹ The latter circuit includes alternative equalization circuits which provide approximate compensation for most recording curves. The circuit may be simplified by limiting the number of choices and by combining the treble and bass switch controls, as in Fig. 14—12.

Exact compensation cannot be expected in any case, because the published recording characteristic of a manufacturer does not take into account addi-

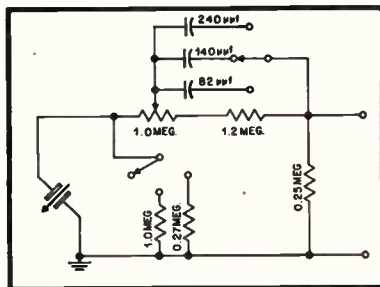

Fig. 14—9. Crystal pickup amplifier (After McProud.)

tional factors such as microphoning and recording studio acoustics. The variable tone control can be used to supplement the preamplifier switch control.

The use of feedback methods for preamplifier equalization has the advantage of decreasing distortion, especially in the unequalized portions of the band, but it does not improve the signal-to-noise ratio over that obtained with an attenuating network. This is because the noise and signal are both attenuated by the same factor, and the input signal to the preamplifier cannot be increased to improve the ratio between the two, as with other feedback amplifiers.

The load resistor across a magnetic pickup may serve the purpose of high-frequency equalization, since the lower the value of this resistor the greater the high-frequency roll-off. Such a method of high-frequency equalization has the disadvantage of attenuating the high-frequency signal from the pickup (as a matter of fact the over-all pickup output is also reduced) while leaving the high-frequency noise output of the pre-

(Continued on page 61)

⁹ George Ellis Jones, Jr., "Two preamplifiers for magnetic pickups," *AUDIO ENGINEERING*, Jan., 1952, p. 24.

Audio Fair and AES Convention Reach New Heights

Record attendance at New York event fulfills pre-Fair estimates—four floors of exhibits crowded throughout entire four-day period indicate full acceptance of hi-fi by the “man on the street.”

WITH OVER 24,000 registered visitors and Friday night influx delivered by service elevators direct to the eighth floor where no registration facilities were available, there can be no doubt that the total attendance at the 1953 Audio Fair exceeded the 25,000 figure estimated by both exhibitors and Fair management. Exhibits were open for a total of 37 hours, and allowing each visitor a minimum of three hours—little enough to see the 117 rooms—it would figure out to indicate that at least 20 people were in each exhibit all the time. And that makes no allowance for the repeaters—those who came two, three, or even all four days. Those who have been around the previous Audio Fairs will remember many of the same faces that have attended every day of every Fair in New York. But this year there was a considerable change in the character of the crowds. While heretofore most of those in evidence were the dyed-in-the-wool hobbyists, this year's crowd was augmented by those who had no previous experience with hi-fi, but who were looking and learning for the first time. Particularly notable were the many young couples—new homemakers who were looking for something better in the way of music in the home. They found it in abundance at this year's show. Because of the dates of the 1953 Fair, a full description of the exhibits must be delayed until the December issue.

AES Convention

The Convention papers of the Audio Engineering Society were well attended, and many new members were enrolled during the event. Full texts of all the papers presented will appear in the coming issues of the *Journal of the A. E. S.*, but are not



New Emile Berliner Award was delivered to the Society by grandson Oliver Berliner, above. Award is in form of plaque.

Dr. Edward W. Kellogg, left, receives the John H. Potts Memorial Award from Arthur W. Schneider at AES Banquet. Incoming president Jerry B. Minter, lower left, looks on, while Col. Richard H. Ranger studies notes.



readily available for prior publication by other media.

The Fifth Annual Banquet, held on Thursday evening in the Grand Ballroom, was also well attended—many coming to witness the presentation of the Awards which are given annually. The first of these—the John H. Potts Memorial Award for outstanding achievement in the field of audio engineering, and given by $\mathcal{A}\mathcal{E}$ —was received by Dr. Edward W. Kellogg, who retired from RCA in 1947. His work began with telephone engineering, continued with submarine detection during the first World War, veered into antenna design, and then settled for audio. Among other important contributions to the field, Dr. Kellogg, with Chester W. Rice, developed the dynamic paper-cone loudspeaker which is the father of most speakers in use today. In his later years with RCA, Dr. Kellogg was engaged principally in the development of equipment for sound motion pictures.

Given for the first time this year, the Emile Berliner Award for an outstanding development in audio engineering was presented to Henry C. Harrison. Oliver Berliner—grandson of inventor Emile Berliner for whom the Award is named—was present to transmit the first plaque to the Society. Berliner will be remembered as the man who perfected the first successful microphone using variable contact resistance, providing a low-cost unit which gave the Bell System a head start in the telephone business over Western Union. He is probably best known for having developed the lateral cut disc record which is the basis for all modern phonograph records.

Mr. Harrison, who received the award, was a member of the technical staff of Bell Laboratories throughout most of his working life, having retired in 1952. The development for which he was chosen to receive the award was the rubber-line recorder, which was one of the first electrical record-

ing units used in the industry. This application of mechanical damping to an electrical device marked one of the first marriages of electrical and mechanical engineering—a basic fundamental research problem well solved. Mr. Harrison and the group under his supervision are also credited with the development of a vertical-cut or “hill and dale” recording which for many years established the basis for sound reproduction of high quality.

Dr. Edward C. Wente joined a distinguished group consisting of Dr. Harvey Fletcher, Prof. Frederick V. Hunt, and Prof. Vern O. Knudsen by being chosen the fourth honorary member of the Society. Dr.

(Continued on page 58)



Henry C. Harrison, recipient of Berliner Award, is responsible for development of the “rubber-line” recorder for disc recording.

it CAN be

ATTRACTIVE

it all depends on you!

ONE OF THE CRITICISMS of the average hi-fi system is that it is likely to represent a maze of units, unsightly connecting wires, and plywood housings that wouldn't be included in the specifications for a decorator-planned home. And in many instances, that criticism is deserved. All of us have seen installations that have no more place in a home than a laboratory-type breadboard has in a Lord & Taylor window. Without attempting to delve into the psychological reasons for such unsightliness, let it be said that there is no valid excuse for a system remaining in that

and a phonograph turntable in the same cabinet, for example, which often requires that more housing units must be supplied than for a simple radio-phonograph combination. In this, however, lies much of the advantage of the separate-unit construction, for housing may be split up between cabinets and built-in units. In some houses, for example, there is a place where a divided-entry structure can be used for the tuner, record player, and amplifier, in a manner similar to that shown at the left. Those who own their own homes would want to make such an installation a permanent

fixture, but those who are renting could easily arrange such a cabinet to be movable—being attached to the floor as close to the wall as possible. Such a dividing wall often adds to the convenience of living—separating an entryway from the room perhaps, or by making the room somewhat more livable by providing a feeling of intimacy.

In the installation shown—as conceived by Kierulff Sound Corp. of Los Angeles—the radio tuner is located in the top compartment, the phono equipment in the center, and the amplifier in the lower section. Ventilation is provided by the grille shown at the bottom and by vents into the adjacent wall. For a non-permanent installation, suitable grilles might be provided above the tuner panel or even on the top of the entire cabinet. Some form of ventilation is a necessity, and each installation may need to be designed specifically to include this much-needed feature in one fashion or another.

To go along with the divider installation, the owners wanted loudspeakers installed in the ceilings of their living and dining rooms, and in the breezeway to provide for summer evening dancing music. There is an axiom among custom installers that goes something like this—"Tell us exactly the facilities you require and we will build them for you." Occasionally, however, the owner will offer to provide an outlandishly small space for the loudspeaker—perhaps half a cubic foot—or he may want the equipment installed in built-in bookshelves that are simply too shallow for the required components. Here, again, one of the problems is that of ventilation, but it is usually possible to employ the walls to channel out some of the heat. One must remember that even the smallest amplifier-preamplifier combination will consume at least 60 watts, and it could range up to 200 watts in the largest models; the average tuner will consume around 75 watts, and a turntable from 15 to 50. Since little actual power is put out in



condition after the electrical performance has been perfected to the satisfaction of the owner. Not everyone can qualify as a furniture designer, and not everyone is adept enough to perform some of the modern miracles of cabinetry, but everyone does have access to a few of the home magazines—such as *House Beautiful*, *Better Homes and Gardens*, *House and Garden*, and so on. From those sources can be obtained many ideas which can be adapted to the specific needs of the individual. Fortunately the actual construction of modern furniture and cabinetwork is considerably more simple than that required for traditional decor, and modern is currently very much in vogue.

One of the virtues of the usual hi-fi system is that it is quite flexible. Few devotees will hold still for a loudspeaker

the form of acoustic energy, most of that drawn from the power line is dissipated in the form of heat. Thus a typical installation will radiate about as much heat as a 250-watt lamp—easily enough to keep a pot of coffee hot even though it might not be sufficient to make the coffee in the first place.

At the right is shown an installation which is ideal for the small apartment where the addition of any more cabinets would seriously reduce the living space. Here the tuner and the record changer have been placed in a convenient bookcase, and the speaker has been installed in the three shelves above the tuner. This installation—by Electronic Workshop, New York—is somewhat deceptive to the eye, for it appears that these three shelves contain books. Such is not the case, however, for upon further inspection it will be seen that the books are false, and that the speaker is directly behind the space where the books aren't—at the center of the middle shelf of the three indicated by the arrows. In this instance, two of the shelves have been removed, a baffle board mounted at the front, with suitable grill-cloth covering, and then false shelves and book-backs have been applied. (Since seeing this photo, the writer has been curious as to what would happen if a guest decided to read one of the "books" in the speaker section.) The power amplifier for this installation is located in one of the built-in cabinets below the bookcase, and all necessary controls are on the tuner.

At the lower left is another arrangement which can be adapted in many types of homes. This installation, also by Kierulff, is in a den which adjoins an outdoor patio, reaffirming the importance that Californians place on outdoor living. The dwelling is a beautifully decorated home in San Marino, California, and all the components are clearly seen as regards their mounting and operation, with the exception of the main amplifier which is under the changer drawer. The tuner and changer are readily accessible, and the speaker is housed in another portion of the built-in section, at the left. The television set, just barely visible at the top, is not connected to the music system, but could be



All too often the home music system is anything but
a delight to the eye. Whether built-in or housed in conventional
cabinetry, there is no good
reason why the home-assembled system should not be planned to
provide both high-quality sound and eye-quality sight
to please everyone in the home.

if it were deemed desirable. With the changer drawer closed, and with the doors over the tuner and the speaker closed, the existence of the system need not even be suspected—as though anyone might be ashamed of having a music system in his home.

Just how does one go about making such an installation? The easiest way is to outline the requirements to any of the specialists in custom building throughout the country. That way is likely to cost more than if the work is done by the owner himself, but there are many who shy away from cabinet work because of a lack of experience or the absence of adequate tools for the work. But nowadays there is so much information available in the "How to Do It" category that anyone with the desire and a slight amount of skill can turn out an acceptable job. Perhaps perfection

(Continued on page 44)

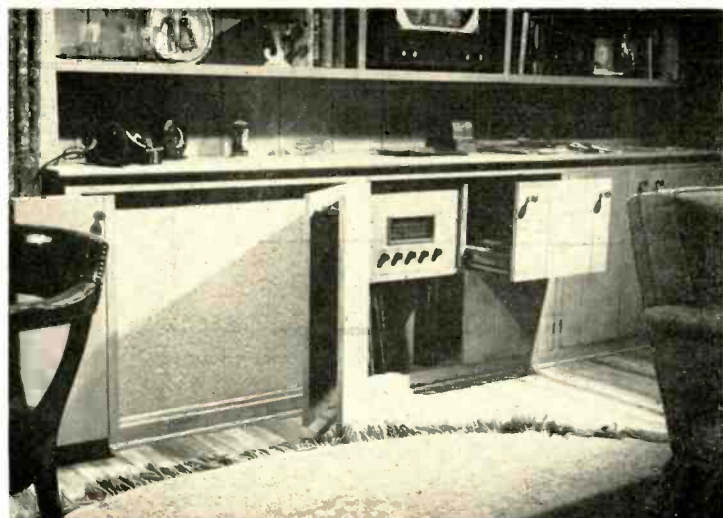

The White POWRTRON Amplifier

STANLEY WHITE*

A discussion of one possible cause of power distortion and a description of a circuit developed to eliminate it. The author also describes his method of dividing the frequency spectrum ahead of the power amplifier. This unit has been popular with listeners at recent demonstrations.

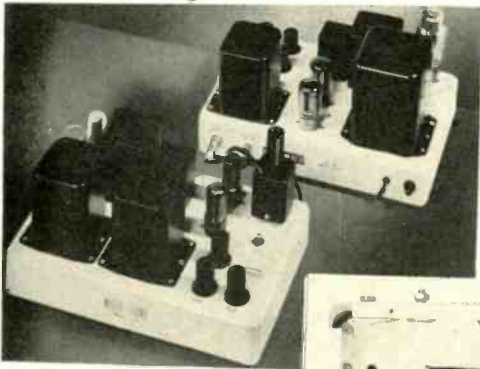

Fig. 1 (left). Top view of 10- and 20-watt White amplifiers with filter network plugged into the 10-watt unit. Fig. 3 provides for network to be plugged into the 20-watt low-frequency amplifier.

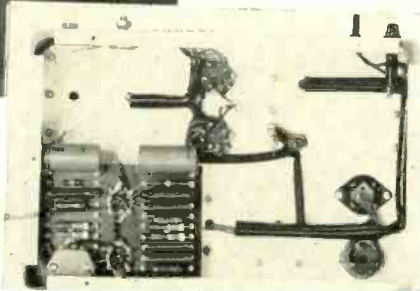

Fig. 2 (right). Underside view of the 20-watt amplifier. Large mica capacitor at lower left is C_1 .

MOST AMPLIFIERS are developed and tested using pure resistive load impedances across the secondary of the output transformer. Determination of intermodulation distortion, harmonic distortion, and power performance are based upon results obtained using these resistive loads although it is well recognized that speakers do not present a constant load impedance over the entire frequency spectrum. However, for want of a better method, resistive loads have been retained as a standard procedure in determining the performance and operating characteristics of amplifiers.

This paper proposes a basic change in amplifier circuitry that is inevitable if amplifiers are to perform their basic function—that of presenting an electrical power waveform to a speaker in such a manner that the acoustical wave radiated from the surface of the speaker is a

(Continued on page 52)

*White Sound, Inc., 105 W. Madison Street, Chicago 2, Ill.

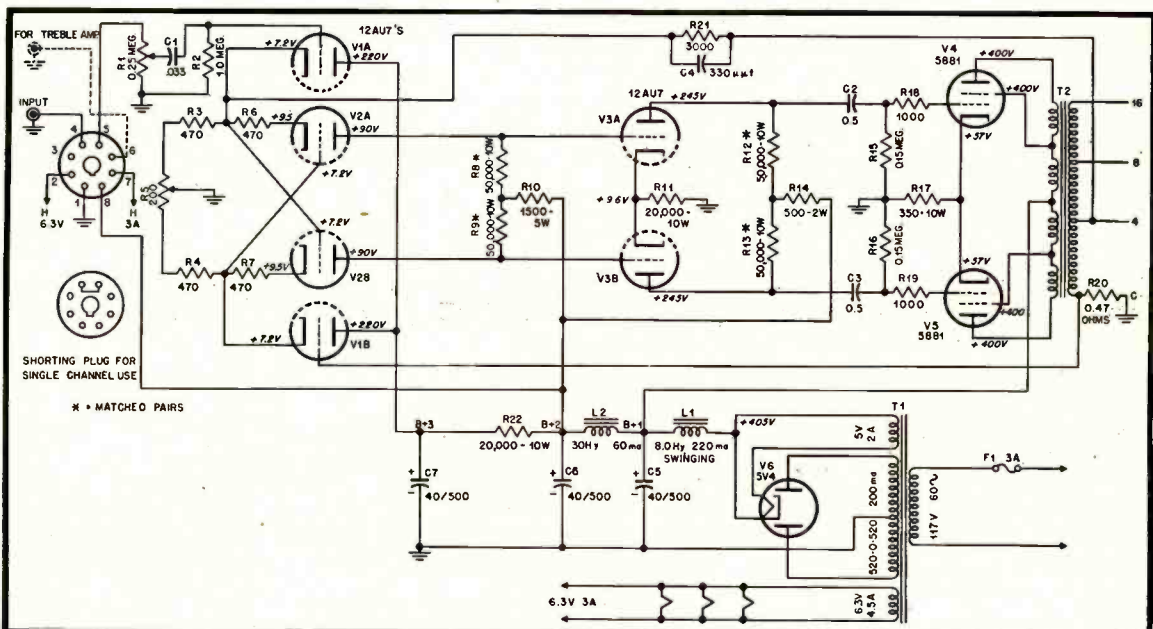
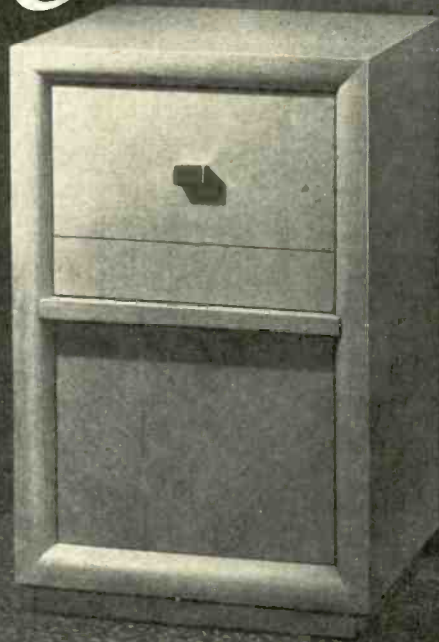

Fig. 3. Complete schematic of the 20-watt White amplifier arranged for plugging in the electronic filter network. 10-watt model is identical except for output tubes, which are 6V6's, and the output transformer.

the beautiful *Peerage*



sound equipment console
for music lovers!



Pivoted, tilting top panel opens with brass pull and mounts all conventional tuners. In open position, controls are at easy-to-read 65 degree angle. Amplifier is mounted on back panel which is readily removed. Changer drawer is directly below tuner panel and is mounted on roller slides for smooth operation.

Note how the PEERAGE complements the famous E-V Aristocrat folded-horn enclosure (below). Its simple, graceful lines harmonize with other E-V enclosures as well and lend themselves to any contemporary setting.



Now, for the first time, a truly beautiful and practical console expressly designed to house virtually any combination of the popularly-known tuners, amplifiers and record changers! Made by furniture craftsmen, the PEERAGE is so cleverly planned that it is a simple task to install—at home, with ordinary tools—all the components needed for High Fidelity sound reproduction. The PEERAGE is made of sturdy, kiln-dried veneers and is available in lustrous Tropical Mahogany or sparkling Blond Korina.

Write for complete brochure No. 192 showing mounting arrangements, internal compartment sizes, and tuner-amplifier and changer combinations which fit the PEERAGE—or see your local E-V distributor.

DIMENSIONS:
29 $\frac{3}{4}$ " high, 20 $\frac{1}{4}$ " wide, 18 $\frac{3}{4}$ " deep.
WEIGHT: Net, 43 lbs. Shipping, 52 lbs.
PRICE (less tuner, amplifier and changer):
MAHOGANY, List, \$160.00, Audio-ophile Net, \$96.00;
BLONDE, List, \$170.00, Audio-ophile Net, \$102.00.

Electro-Voice Inc., Buchanan, Michigan

Export: 13 E. 40th St., New York 16, U. S. A. Cables: Arlab

Audio ETC

EDWARD TATNALL CANBY*

THERE'S NOTHING like a good trip away from home. In those few short weeks last summer when I was neatly isolated in Europe from audio and hi-fi and new records alike everything popped; plans secretly afoot for years burst forth in public announcements, audio prepared for its biggest "fall opening" yet—but the most important thing that happened was not in the audio field itself at all but outside, for it marked, by the most rigorous of American business judgments, at long last, Audio's Coming of Age. Suddenly, completely, audio was publicly recognized by the commercial radio-phono-TV industry! Recognized both in the heady persuasion of big-time publicity and in the fact of newly announced commercial phonographs, designated for the first time with the magic words, *high-fidelity*. So the fat's in the fire—and where, pray tell, do we stand now? A very interesting question.

I'd sort of expected, at this point, to quote a bit of chapter-and-verse indicating how much evidence we've been offering here, right along, that all this was bound to happen. My eyes gave out on me too soon—we've covered a lot of fine print in this department in six years—and so I'll do no more than remind you of that continuing cycle of development in the audio field, described intermittently in this space, which has led straight to the present point: the discovery, a long while back, that home record playing equipment made from separate units, sold "wholesale," offered unusual advantages; the gradual exploitation of this in a business way by the erstwhile wholesalers, now become audio men; the increasing concessions made to the needs of the buying amateur public—plug-together, pre-wired components, pre-chosen "package" systems, retail-style sales rooms with comparison facilities, increasingly wide advice service, and all the rest. This department has been all for it right along, and can claim a fairly remarkable coincidence between its suggestions and subsequent events, whether it be accidental or not. But let's look closer.

*780 Greenwich St., New York 14, N. Y.

Ultimate Step

It was a year and some months ago that, under title of "Hi-Fi for Aunt Minnie" (*Æ*, August, 1952, p. 30) I described what seemed to be the last and ultimate step in this cycle that audio-for-the-amateur could take—the one-piece separate-unit "system," completely assembled in a cabinet and ready to play. This was the end-product, in a sense, of all that development that had begun with the strictly professional radio parts dealer and worked itself by degrees—still at wholesale or "net" prices—right up into a new major consumer's sales area. Having gone this far—what next? What more could audio do, with respect to merchandizing? The circle was almost complete. We had progressed back to the single phonograph again.

Would hi-fi next try to invade the mass market itself, in direct competition? Or, alternatively and perhaps simultaneously, would the big commercial concerns come the other way, and take over high fidelity for their own? If so, wouldn't there be a sort of final merging of the two, inevitably, so that the long-strict distinction between what we've come to call "hi-fi" equipment (leaving standards aside for the moment) and "commercial" equipment might begin to disappear? Worst of all (for us, in the hi-fi area), would Big Industry take over, and swallow up hi-fi with one vast gulp, when the time was ripe?

Until Columbia's "360" phonograph came out last year, the commercial industry had acted in just about every way as though hi-fi (and its wholesale system) didn't exist, or wasn't big enough to be noticed. With commendable discretion the industry avoided even the terms "hi-fi" and "high fidelity;" the nearest approach was an occasional modest (relatively) "fine" or "full" fidelity. The separate-parts audio field had hi-fi to itself, outwardly, without interest from the mighty on high. Children must play and (so one might have guessed) the "parents"—those radio-phono makers who, after all, had been supplying the nation's record playing equipment and radios for as long as most of us can remember—went about their business, occasionally denying with some asperity (through their

retail dealer-representatives, when questioned) that this new upstart business really counted.

The asperity increased, quite naturally, as "net" price hi-fi mushroomed and it became increasingly difficult for retail radio-phono dealers to slough off hi-fi. Outwardly, there was no change, but we may now be sure that behind the scenes wheels began to turn, in secret, to meet the growing competition. It takes a mass industry a long time to get set for a major policy break; those wheels no doubt have been running faster and faster these last several years. How could it be otherwise, with the once baby hi-fi industry growing apace? Just a matter of time before things would bust wide open . . . right now.

What Favors Mass Production?

But before we carry this little narrative into a hypothetical future, look with me at the basic differences which have separated the two areas of home sound reproduction up to the present. What does "hi-fi" or "audio" (there isn't any official name for it) have to offer, that has boomed it so rapidly in the very face of commercial production?

In reverse order, more or less, we might say (a) higher sound quality for the dollar—the end-product; (b) separate units, out of numerous specialized makers—with attendant flexibility of choice and application; (c) the "net" price system of sales, which narrows the spread between manufactured cost and final cost—cuts out the middlemen, as the old saying goes; (d) (from the buyer's viewpoint) an entirely separate and distinct sales outlet mechanism, rigidly set apart from the retail dealerships.

The commercial phonograph (and radio-TV) is a mass produced unit, geared in its total existence to the typically complex American production system, from raw materials right through to sales. That system has enormous potentialities, as is obvious to anyone. But it has weaknesses, too. It is too big for quick change, and must depend largely on superficial modernizations, year by year, bolstered by all the arts of publicity.

TANNOY

(CANADA) LIMITED



Brings You the Improved DUAL CONCENTRIC LOUDSPEAKER SYSTEM



Modern Craftsmanship of Old England

"TANNOY" 12-INCH DUAL CONCENTRIC LOUDSPEAKER

The introduction of a "TWELVE" Inch Version of the now famous "Tannoy" Dual Concentric "Fifteen" enables reproduction of a standard hitherto associated only with the research laboratory, to become a reality in the smallest living room, from a relatively small enclosure. An even wider frequency response stretching smoothly upwards well into the ultra-sonic band, is attained with wide angle high frequency distributions.

Accurate translation of these upper frequencies gives unrivalled presence and great musical charm, which can be enjoyed NOW at comparatively low costs by high fidelity enthusiasts everywhere. Place your order NOW to secure early delivery and a new conception of listen ability!

Price only \$130

Amazing
Presence
Smooth and
Very wide
Frequency
Response

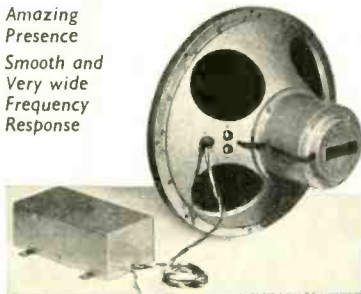

15"

"TANNOY" 15-INCH DUAL CONCENTRIC LOUDSPEAKER

Already acclaimed throughout the world by high fidelity enthusiasts, the "Tannoy" Dual Concentric System "FIFTEEN" now embodies a number of improvements and so maintains established leadership. There is no doubt that where the input source is of sufficiently high quality, this Loudspeaker is well in advance of ANY hitherto commercially available.

Send today for handsome brochure which contains the authentic testimony of happy Dual Concentric owners and describes in detail the twelve star features of this wonderful example of the "Modern Craftsmanship of Old England".

Price only \$159

THE NEW "TANNOY" 12-INCH DIRECT RADIATOR

General Details.

A general purpose Loudspeaker with a difference. Highly efficient, reasonable in price, yet unique in performance.

Ideal where the widest response of the Dual Concentric is not practicable but accurate interpretation of a more conventional frequency band is important.

Price only \$47.50

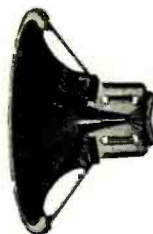

DID YOU HEAR THE
GIANT GUY. R. FOUNTAIN
AUTOGRAPHED ENCLOSURE
AT THE AUDIO FAIR

Registered Office: TANNOY (CANADA) LIMITED, Suite 2,200, 25 KING STREET WEST, TORONTO 1, ONTARIO, CANADA
And 475 FIFTH AVENUE, NEW YORK 17, N.Y.
Telephone: Empire 6-1151
LONDON OFFICES & SHOWROOMS: TANNOY LIMITED WEST NORWOOD LONDON, S.E.27 ENGLAND

The mass product system, moreover, depends on the complex, many-stepped distribution arrangement and the huge mark-up—and exists mainly because in so many cases it can make the basic product so incredibly cheaply, in quantity, that a large mark-up is possible.

More specifically we, in our own field, must understand that mass industry depends on two big factors for success—large-scale heavy operations, like the stamping-out of auto bodies and fenders, and/or the high-speed automatic machine production of small parts, by the millions, and the high-speed assembly of same, often automatic. A large-scale production job is successful in these terms above all, and those products which are best adapted to this kind of production are the ones where big industry has expanded most successfully. Note, indeed, that products formerly hand-made, after a fashion, that can be newly adapted to mass production suddenly take on new business potentialities—I think at once of shipbuilding and pre-fab housing as recent examples. In the old days, the conversion of the auto industry was a celebrated case in point.

Now I ask you, is audio a "natural" for mass production in this sense? First, is there heavy work—large-scale casting, foundry stuff and the like—where big industry can get its grip for fair? No! Second, can small parts be turned out by the millions and assembled at high speed? No! Parts, yes—but not assembly. You can't whip amplifiers and pickups and speakers together. Lined up against thousands of other American products, the phonograph-radio and its component sections makes a relatively poor subject for mass production, and this in spite of the best that ingenuity has devised, to date.

The plain fact is that the sound reproduction mechanism is favorable to mass production only in its simpler, cheaper, and cruder aspects—small radios, portable phonos, and their equivalents hidden inside the fancier consoles.

As quality increases in audio equipment, susceptibility to mass production goes down. Not all the king's horses, nor the biggest producer in the industry, can change this. Quality audio is basically a craft industry.

Craft Industry

It's not hard to see, then, why in our particular area there has grown up a craft-based business to compete in the home with mass-made products and give a better value for the money in pure sound. We don't find that sort of development in areas where mass production is really at home. Who ever heard of a "craft" washing machine—a better bargain than a mass-made one? That's heavy industry. There are "craft" autos, to be sure, but only at a high price dictated directly by the unfavorable economics—in that area—of the craft system.

You can count on your fingers and toes those products which occur to you as basically of a craft nature, where mass production is at a natural disadvantage. You can count on your thumbs, I'll bet, those where a big business has been built on a craft basis offering values to compete directly with a parallel (more or less)

mass industry. That's us. That's audio!

By "craft," I mean, of course, the modern equivalent of the old hand-made, one-at-a-time fabrication. In today's relative terms a craft industry is one where product runs are small, attention individual, flexibility in design change very great, where there is relative specialization as in our component construction. There is no exact dividing line, naturally, but the distinction holds in general and is, indeed, vitally important for us to understand.

Never the Twain Shall Meet?

And here we had better glance quickly at some interesting associations. In general, craft industry is associated in most minds with "small business." There are plenty of natural affinities. But audio is now straining its whole might towards being a collection of large businesses. Larger than small, anyhow. How big can a craft business be and still be craft? That is a vital point, in the present set-up.

Another association, in the audio field, is that of the craft-type industry as above described with the wholesale or "net" sales set-up—and this is an even more pertinent matter. For here are the two really basic divisions between the new audio industry, or "hi-fi," and the old "commercial" industry. Are the two necessarily tied together? Must craft hi-fi necessarily be sold through the new "net" sales system and its newly grown outlets? And vice-versa?

At this moment, the tie-up is extraordinarily potent and, indeed, it would seem to me that the entire basic set of differences between commercial and craft audio has now been externalized into a straight fight between the two existing types of sales outlets—and never the twain shall meet. The situation is the more exciting right now because of numerous forays from one side to the other at present going on. Maybe the net price itself no longer has much meaning, literally, but until the day when a product—whatever product—can be sold at one and the same price in all of the present sales outlets, both the "retail" dealers and the new hi-fi stores, the basic difference continues.

Now the odd thing is that in all the present excitement over big-company entrance into the hi-fi field, the big-time confusion, even the delicately balanced in-between operations of the makers of true separate-unit one-piece hi-fi phonographs—I know of no case yet where the two sides have actually been bridged. Every product, from whatever source and however ingeniously compromised between craft and commercial, however deviously advertised, finds its sales place definitely on one side or the other of the Great Dividing Line—or if not, then it sells at two prices, list and net. (At the moment the only way to avoid this inexorable law of the times is to issue two models virtually identical but with a different title or name. Price them differently, channel them to different sales areas. So, I gather, has one of the big component makers recently solved his manufacturers' price vs. net price problem—the same thing on another level.)

The complexities of the great list-and-net problem are more than I dare explore further at this point, but we have enough here to take a good look again at the pres-

ent explosive situation, as of this article's opening.

Commercial audio has at last announced its entrance in the "hi-fi" area, with publicity and with machines. Do these machines compete directly with present craft hi-fi equipment?

It would certainly seem that competition is wide-open—the ads say so and the public undoubtedly thinks so. Indeed, the public is not really aware that there are two sides of this question, two kinds of "hi-fi". Without the slightest doubt, then, the commercial machines that claim hi-fi will compete directly with craft audio *on paper and in the public mid*. This we must face, as soberly as we can, for the ad money is back of the commercial machines. The war of words is on.

But how do these commercial hi-fi machines stack up directly against their craft-type opposite systems, roughly cost for cost? Put aside the AB comparisons until we get two vital points absolutely straight.

First, however radical and ingenious and commendable the changes are towards adapting some of the principles of hi-fi to the commercial machine (and they are often to be admired), these new models are still mass-produced. They still must take along with them the whole of the baggage of the mass production system, the millstone of a basically unfavorable product in the mass-produced field. That basic situation cannot be quickly changed.

I say plainly, then, that no mass-produced machine coming from the present manufacturing set-ups is going to compete in sound value, dollar for dollar with the craft type of sound system, nor can, except in the very low priced categories, where craft hi-fi has never claimed a place. The differences in convenience of operation and attractiveness, of ease of purchase (at the local retail outlet) and all the rest are another matter and continue legitimate, as before. We must remember that vast numbers of people still preferred even the old commercial machines to anything that craft hi-fi could offer. Present basic differences between commercial-type and craft-type equipment then will continue very much as they have been, in spite of the new models and the new advertising. *This we must not forget.*

Secondly, don't for one moment forget that the new commercial machines continue to sell strictly on a retail basis through retail outlets—and therefore on the sales floor they are in competition *only among themselves*, never directly with craft hi-fi products. The separation is extraordinarily complete, as far as I can see. (Except of course in the ads, on paper, and occasionally in the home.) There aren't any AB tests between the two types, because they never are found in the same place! I can't say what'll happen in the near future in the general fracas, but as of this writing I'll bet you can't locate any sales floor in the country where a true craft-type hi-fi system is in direct audible competition with any one of the new retail commercial machines. It won't happen if the makers can help it.

(Continued on page 59)

NEVER SUCH **EXTRAVAGANT** MUSIC
 SO **MISERLY** IN SPACE AND COST
 WITH THE NEW JENSEN *Duette*

Here's a specially designed unit, coordinating speakers and small enclosure . . . "presence" you never dreamed you'd get in such a compact, inexpensive unit . . . two speakers in a true 2-way system for real high fidelity performance. Ideal for small space hi-fi, as a second or extension speaker, or in a pair for binaural sound.



Use on table bookshelves or on floor standing on side or end
 The "Duette" gives clean, smooth reproduction with the unmistakable "presence" of the 2-way hi-fi reproducer. Uses special heavy duty 8" "woofer" and multicell horn "tweeter" like expensive speaker systems. Impedances: 4 and 8 ohms. 20 watt power rating.



Only 11" high, 23½" wide, 10" deep. Mahogany toned pigskin plastic finish with contrasting front.
 Net price . . . \$69.50

Jensen

Jensen Manufacturing Company : Division of the Muter Company
 6601 S. Laramie Ave., Chicago 38, Illinois
 In Canada: Copper Wire Products, Ltd., Licensee



Listen to the new **H-530 Coaxial Loudspeaker (15")** . . . it is an advanced design coaxial with new compression-driver horn-loaded "tweeter" with the smoothest reproduction you've ever heard from a 2-way system! Sets a totally new standard of coaxial performance. Furnished with H-F Balance Control. \$129.50 net



Hear the **H-520 Coaxial Loudspeaker (15")** . . . big brother to the famous H-222 (12") with all of the good listening qualities of a finely balanced compression-driver tweeter coaxial. Furnished with H-F Balance Control. \$79.50 net

Burton Browne Advertising



EDWARD TATNALL CANBY*

PINES AND FOUNTAINS

Respighi: The Pines of Rome; The Fountains of Rome. NBC Symphony, Toscanini. Album booklet.

RCA Victor LM 1768

The most striking thing about this album, as everyone knows by this time, is the thirty-page bound-in collection of art photos in deep green of scenes of Rome—the fountains and the pines. (Having just come from there I marvel at the photographer's ingenuity in avoiding even so much as a trace of the teeming modern life of Rome—the autos, sightseeing busses, bicycles, trucks, trolley busses, trams, and, of course, city people, that normally throng about the scenes depicted! But that is perhaps the very art of it; the pictures are superb.) There is just the one record, and it's Toscanini through and through, though hitherto we have not found him often among "hi-fi" conductors.

Frankly, I never could like this music enough to enthuse over its undoubted hi-fi potentialities. But anyone with an ear can understand the Toscanini intensity, that taut, rapid, almost breathless super-control, those strangely whanging kettledrums (they sound the same, hi-fi or no), the steely potency of the climaxes that are so typically his. Nobody, but nobody, as Gimbels says, can beat the Old Man at this, nor at bringing out the most in Respighi. Not either of the other recent conductors who have taken a wham at the music for hi-fi, Dorati (Mercury) or Quadri (Westminster).

How is this as hi-fi? RCA's manual click-type groove pitch control ("margin control") gives the disc a very odd banded appearance and provides beautifully for the climaxes, at wide groove spacing, notably the final March. The New Orthophonic technique does all it should and the expanse of highs and lows is gratifying—but I suggest that one aspect beyond the control of any recording curve or cutting technique—the microphoning—is not quite ideal here. The sound is a bit narrow, not as full as it might be, and the lower end seems somewhat at a distance. Not, I am sure, a matter of curve or distortion at all but merely one of those subtleties of mike acoustics. Also, possibly a question of opinion rather than fact—better listen to the Westminster and Mercury versions (the latter definitely one-mike) for comparison. (See also Berlioz' Romeo and Juliet, below.)

THE SPOKEN WORD

John Brown's Body. Tyrone Power, Judith Anderson, Raymond Massey, adapted and directed by Charles Laughton; choral music and effects by Walter Schumann.

Columbia SL 181 (2)

Shakespeare: Macbeth. Old Vic Company. RCA Victor LM 6010 (2)

Today, some five years after LP's debut, we are finally beginning to realize the full power of the new medium. Back in the late 40's, LP was still merely a new way to issue old-style

*780 Greenwich St., New York 14, N. Y.

records, though we all hailed the convenience of its length, sound quality, freedom from rhythmic background noise, unbelievably small bulk and gratifyingly low cost. LP was then a kind of adhesive tape with which short discs were stuck together into long discs, the breaks more or less concealed. And as long as the 78 kept alive as a parallel to LP, so long were we tied to the short slices, whether we heard them or not, and to the patch-it system.

Not now! Such ventures as the above, not to mention a gross of complete operas and no end of other large-scale endeavors, are inconceivable on the old discs. Of these two, "John Brown's Body" perhaps shows the most radical expansion of the recording technique, (speaking dramatically) but the rendering of Macbeth is surely as significant in its way.

"John Brown's Body" as a narrative poem was extraordinary in 1928; in the present adaptation by Laughton, equally valid on the stage (with modern dress and no scenery) or on records, the same sort of free-verse word-painting is as challenging as it ever was on white paper.

Three principal voices, speaking in rapid and easy alternation, share between them in the most impartial way both the continuing "role" of narrator or story teller and the actual voices of specific characters; the ancient and honorable tradition of the drama whereby each person in the play is represented by a specific body, a voice who speaks directly in his words, is thus blithely put aside and with the easiest charm you can imagine. Direct "quotes" change off with indirect narrative, as though the speaker were reading a novel out-loud; sentences are broken up between the contrasting voices even though the indirect narrative continues its familiar "he said" and "she said" pattern—and not a particle of sense is lost in the process.

In between, in the long-familiar technique of radio dramatics, serving as bridge and mood and background, as commentator and scene-shifter, is an a cappella chorus, without instruments. The music, as such, is conventional, out of a hundred similar dramatic works of a patriotic nature. But surely the choral medium has never been carried so far, the technique so expertly managed, as here. The chorus sings (with solos), hums, chants, shouts, makes sound effects—even the sound of a banjo—and bursts out periodically with that old piece of ham, "Glow-ry, glow-ry halleluoyah," sung in the best Broadway manner; a strange mixture of superb singing-acting technique and strictly big-time show stuff.

"Nuff said. A remarkable job and the words and story are absorbing and in plenty of spots superbly beautiful. The three voices are recorded with unbelievable clarity and without bottom-heavy tubbiness, even on large speakers. Hi-fi fans will exult. (Somebody did some good thinking on the problem of mixing voices for close-to effect; as we all know it's not easy. Was there perhaps a low frequency cut-off?)

"Macbeth" is done straight, with few sound effects and those few of the cornier sort—thunderclaps and low-fi rain (probably from some clderly 10-inch 78), trumpet fanfares, studio-style crowds hailing the king—but what carries this recording to immense success is Shakespeare, and the excellent speakers who record his words. Note the Old Vic's modesty in billing no names, above, but Alec Guinness, Pamela Brown, Anthony Service and others of similar ability do the job. Acting is in the usual Shakespeare tra-

dition of high-flying oratory, but these people know how to keep it within bounds (except for a few minor characters).

As an experiment—and not having read Macbeth for any number of dogs' ages—I listened to this "cold," without so much as a look at the labels, booklet, dramatis personae or anything else, to see whether it might by itself make sense. It did, by golly, and remarkably well, though the voices and characters and the places were strictly unidentified for me. The truth is, as I had hoped, that Shakespeare's own texts take care of a surprisingly large part of the background information, and necessarily so since his plays were originally acted with virtually no scenery, in then "modern dress," with only the barest of hints here and there as to armies, balls, kings' courts. What could be better for the new recorded medium!

It's perhaps not so odd, in view of this, that there isn't a vestige of the "story" included in RCA's accompanying booklet, which treats mainly of the Old Vic company. Macbeth is left strictly to its own devices, and does royally by itself.

Berlioz: Romeo and Juliet. Complete Dramatic Symphony, op. 17. Boston Symphony, Münch; Harvard Glee Club, Radcliffe Choral Soc., solos.

RCA Victor LM 6011 (2)

It's not too strange to find this under the two above items, classed as "The Spoken Word." Of all musicians of his day, Berlioz came nearest to expressing the sense and the feeling of spoken intimacy via a large orchestral aggregation. Not Wagner, not Verdi, not even Brahms, came near to this strange vocal power; perhaps Schumann came closest in his orchestral works.

Last spring we had a semi-complete orchestral version of this music, filling out the familiar excerpts with new ones; this at last, is "the works" and for the first time we can see the whole plan. It's no symphony, nor an opera; the Berlioz methods of story-telling are as unorthodox as those of "John Brown" above. There is no Juliet, nor any Romeo though there are solos—a tenor and a contralto; the climaxes of the story are told through the orchestra alone, the actual voices silent. At times, Romeo and Juliet converse in the plainest and most moving tones—via cellos and violins. The chorus is more than Montagus and Capulets, its obvious background role—it echoes tirelessly the narration of the solo singers and of the orchestra itself.

You'll find this a superb piece of big-scale listening, except perhaps for the last side, where Shakespeare's wisely simple ending for a tragedy of two very young people is blown up by Berlioz into a French-opera climax of noise and exultation. The chorus, college-age, makes it wonderfully clear that Romeo and Juliet were indeed youthful, in spite of the middle-aged and well padded people who generally take their roles on the stage! The singing is lean, accurate, enthusiastic and the very spirit of youthfulness. Note especially the Funeral March for Juliet with its sharp exultation of "Jetez des Fleurs" and the lovely wordless twining of the women's parts, soon after, as the men take up the narration. (Side 3, band 2.)

I had heard complaints that this recording was difficult to equalize satisfactorily; I don't seem to have any trouble. Again, I suspect that the seeming thinness of the highs in a few spots and a fairly unobtrusive bass end are merely acoustical

now YOU can tell when to change Stylus



STYLUS-DISK

Pat. Pend.

A microscope will show flats after 40 or so hours of play (diamond), but it is actual cutting edges that ruin records. This makes a microscope (\$15.00 to \$100.00) almost useless to an untrained observer. He can see, but he cannot judge.

1. Just as a fuse protects an electrical circuit, the STYLUS-DISK protects your records against ruination by a worn stylus. It acts only when a stylus BEGINS to wear or is defective in any way.
2. Gives VISUAL indication whether or not the stylus is in playable condition.
3. Will test any type of stylus, in any type of pickup—in a jiffy—33-1/3—45—78 rpm.
4. Neither the stylus nor the cartridge need be removed for the test.
5. The grooves may be used over and over again, until finally a worn or defective stylus scrapes the groove-walls. You can be sure with STYLUS-DISK!
6. Should last for years **\$3.90 net** at your dealers, add 25¢ if shipped from NYC.

STYLUS DISK—is a *MUST* for any music system

T.M.

Of the thousands of letters received, some ask, "Will the Audax cartridge fit into my enclosed arm?" "Is the Audax a crystal pickup?" etc. The first is answered below. The Audax is neither a Rochelle-Salt nor a Ceramic-Crystal. The Audax is the highest quality MAGNETIC pickup, with NO HANGOVER or PHASE-LAG.

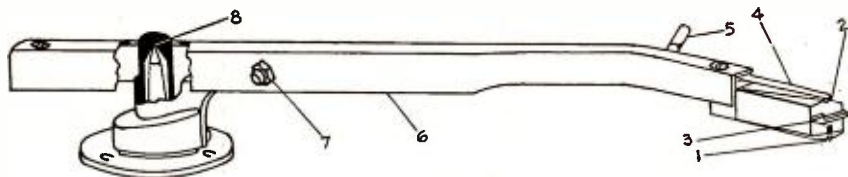

1. Stylus point at extreme front, in full view, a MUST for maintaining proper alignment, (stylus square to the groove). Both styli replaceable at home—of course. Note the cartridge itself is mounted in the open, in full view.
2. Second stylus (ready for instant play) which may be any radius.
3. Key for switching from one stylus to the other—instantly.
4. Guard for second stylus.
5. Finger Lift.
6. Featherweight Aluminum Tone-Arm balanced by fixed counterweight (not affected by climatic changes, no springs, no fatigue).
7. Needle-pointed pivots for frictionless up and down movement of tone-arm. Note! Pivots far to the rear as required in professional arms.
8. Compass-point—Total weight of arm and cartridge rests on the compass-needle. No ball bearings.

Audax pickups available for the higher quality record changers

Be sure to obtain free descriptive literature on STYLUS-DISK — also obtain copy of 1953 "ELECTRONIC PHONO FACTS" at your favorite store, or from us direct if your store is out of stock.

AUDAK COMPANY

500 Fifth Avenue

Dept. A

New York 36, N. Y.

Creators of Fine Music reproducers for over 25 Years

"The Standard by Which Others Are Judged and Valued"

the **AUDIO "BUGS"** know best

they're using

CHICAGO

for quality



Audio Amplifier with "Presence"
Described in Radio News, Nov. 1951. Heart of the amplifier is the CHICAGO full-frequency BO-6 output unit, with other "Sealed-in-Steel" transformers incorporated in the separate power supply chassis for top audio results.



An Unusual P.A. Amplifier
An unusually compact 20-watt P.A. amplifier of exceptional audio fidelity. CHICAGO full-frequency range transformers are used exclusively for exceptional audio quality coupled with small size and light weight.



Audio Modulator
Described in Radio News, June 1951. An efficient audio testing instrument suitable for precise lab analysis or for subjective quality tests. CHICAGO "Sealed-in-Steel" input, output and power transformers are incorporated.

Wherever audio quality is a "must"—the experts specify and use
CHICAGO "Sealed-in-Steel" Transformers



talk about full frequency—
CHICAGO Output Transformers
really deliver for you...

.2 db 30-20,000 CPS

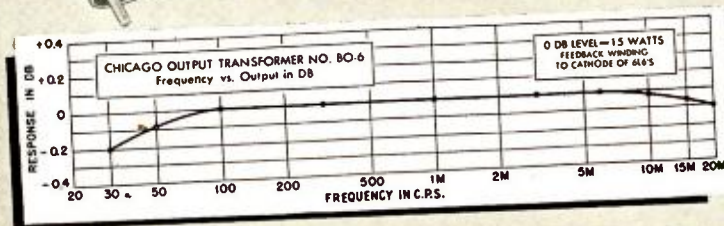

No. BO-6

For use in high fidelity amplifiers. Couples push-pull 6L6's (7500 ohms, C-1) to 6/8 or 16/20-ohm voice coil. Center-tapped tertiary winding provides 15% inverse feed-back to reduce harmonic distortion to a minimum. In drawn steel case, 4 3/4" x 3 3/4" x 3 1/4", with mounting studs and convenient pin-type terminals.

No. BO-7

For matching 600 or 150-ohm line to a 6/8 or 16/20-ohm voice coil. Frequency response within plus or minus 1 db. at full rated output—maximum power level, 30 watts. Mounted in compound-filled drawn steel case, 4 1/4" x 3 3/4" x 3 1/4". Mounting studs and pin-type terminals same as No. BO-6 illustrated above.

There's a **CHICAGO** Transformer for Every Audio Application

CHICAGO "Sealed-in-Steel" Transformers (the world's toughest) are available in 3 complete ranges for every type of audio requirement: Full Frequency, Public Address, and Communications. Whatever the application, it's wise to choose CHICAGO audio transformers for that extra margin of dependability under all operating conditions.

Free CHICAGO Complete Line Catalog

You'll want the full details on all CHICAGO Transformers—"Sealed-in-Steel" New Equipment Transformers, ML-T-27 Transformers, Television Replacement Transformers, General Replacement Transformers and Control and Power Circuit units. Write for your free copy today, or get it from your electronic parts distributor.



CHICAGO STANDARD TRANSFORMER CORP.

3501 W. ADDISON ST., CHICAGO 18, ILL.



tricks of the miking. It is conceivable, after all, that the bass end actually sounded that way—or the bass instruments were not as immediately close to the mikes as we are accustomed to. The recording was evidently multimiked and I feel that perhaps the sound ensemble is a bit "off-mike" ideally speaking, a shade less full and round than it could have been. And at one point what seem to be very close-by solo breathing sounds introduce a false "note" that indicates a possibly over-complex mike set-up. Speculation on my part; I wasn't there, and as always, opinion—any listener's—weighs heavily in such evaluations. Try a bit of Columbia's orchestral version (Mitropoulos, New York Philharmonic) for a valid comparison.

SPANISH

De Falla: Pièces Espagnoles, Ritual Fire Dance. Turina: Ninerias. Jesus Maria Sanroma, piano.

Polymusic PRLP 1011

Granados: 12 Spanish Dances. Jose Echaniz, piano.

Westminster WL 5181

Piano Music of Spain. Leonard Pennario, piano.

Capitol P-8190

Three dishes of Spanish tid-bits and entrées and I'd choose from them in the order listed. Sanroma, long-time official pianist of the Boston Symphony, has always been a strong-arm pianist—I remember calling him "the Powerful Sanroma" (after the Powerful Katrinka of comic fame) as far back as before the war. In the ready classics interpretations which most official pianists must turn out on order, I'd place Sanroma's in the hard-boiled category—note-perfect but often nerve wracking. However, he is of Catalan blood, born in Puerto Rico, and as one can instantly sense here in spite of some very loud sounds, the 19th century Spanish idiom is completely natural for him. I like particularly what may at first seem a too-great use of the pedal, in contrast to the drier technique of the other listed gentlemen. Here, it serves for color and atmospheric veiling and, in the last analysis, is not overdone in the sense of creating tonal confusion. Altogether a brilliant and essentially musical record, the seldom-heard Hurinas and De Fallas an excellent addition to the repertory. Good, middle-distance piano recording, some bad crackles on my copy.

José Echaniz, born in Cuba, seems to have different inclinations in regard to the Latin-Spanish idiom. His material, to be sure, is of less intrinsic interest, to my ear at least. The twelve dances, recorded complete and "for the record," are pleasant but not very strong music, semi-salon stuff, and the few famous ones do, for once, seem to be the best of the lot. The Echaniz technique, for a Latin, is strangely Bach-like; the inner accompaniment lines, which can add so much atmosphere, are here played loudly, clearly, dogmatically, the lilt of them is missing and the pianistic shadings of color and level and mood and phrasing seem weak. Ingratating playing, even so, and there is a feeling of sincerity that is good.

Leonard Pennario has what is far from uncommon these days, a fabulous finger technique that can and will tackle virtually anything for his instrument. The present recording confirms my reluctant feeling that there is more fingership than musicianship in his performance. A hard, staccato technique, a cold (to my ear) approach, a lack of phrasing and shaping, go along, unfortunately, with a rather chilly and dry sort of piano recording, without liveness, that will sound fine if you can provide your own concert hall but may smack too much of wires and hammers in a small room.

Albeniz-Arbo: Iberia. Turina: Procession del Rocío. Granados: Intermezzo ("Goyescas"). De Falla, Interlude and Danza ("La Vida Breve"). London Symphony, Gaston Poulet.

M-G-M E3073

Side 1 of this disc makes an immediate hi-fi impression—the "Iberia" suite—but side 2, with the rest of the items, has a better musical sound for me at least. The Arbo's orchestration of "Iberia" is fussy, complex, full of hi-fi noises but too involved in its own fancy trimmings to come through well musically—or at least not in a brilliant, close-to recording of this sort, which accentuates the orchestral colors and the solo

HARVEY the House of Audio



The NEW BROOK AMPLIFIER Model 22A

An entirely new concept in amplifier design and construction. Combines the main amplifier, the front-end control system, and record pre-amp equalizer in one functional compact unit. Nominal power is 10 watts with less than 1% harmonic, and less 2% intermodulation distortion.

Main amplifier section employs all-triode circuit. Pre-amp equalizer section has 6-position switch for matching to record characteristics. Independent controls provide extreme boost or attenuation for treble and bass.

Channel selector permits switching to FM, AM, TV, tape, magnetic or crystal pickups. Frequency response: 20 to 20,000 cps, ± 1 db. Matches speakers: 2, 4, 8, or 16 ohms. Complete with tubes. **\$119.95**

PILOTUNER

Model AF-824 FM-AM TUNER



A sensitive, selective, and stable tuner designed for high fidelity applications. FM section is provided with temperature compensation against drift, as well as AFC which can be cut out by means of front panel disabling switch. Effects 20db quieting with only 10 microvolt signal. AM section employs separate tuning condenser. Output is .2 volts with 10 microvolt signal.

Model AF-824 has built-in preamp-equalizer for LP, NAB, AES, and Foreign recordings. Frequency response is $\pm 1/2$ db from 20 to 20,000 cycles. Separate bass and treble control circuits permit up to 19db boost or attenuation of 20 and 20,000 cps. Cathode follower provides low impedance, permitting long line to main amplifier without high frequency loss, and without hum pickup. Power supply is self-contained. Complete with Tubes and Front Escutcheon. **\$119.50**



TELEFUNKEN Mighty Midget CONDENSER MICROPHONE complete with power supply

Easily switched from non-directional to cardioid use. Uniform frequency response and wide dynamic range in the cardioid pattern, as well as a slight rise in the upper range in non-directional operation, make this the world's most advanced transducer. Not affected by changes in temperature and humidity. Response: ± 4 db, 30 to 16,000 cps. Output impedance, 30/50, 200/250 ohms, balanced. Only 7 3/4" long, 7/8" wide. Weighs only 4 ounces.

Microphone 201 M complete with Portable Power Supply Unit ELA M 910, Cable and Plugs. **\$49.00**

R. C. A. MICROPHONES

Broadcast quality units of tested and proven performance ideal for on-the-air and recording studio applications. Known to, and preferred by leading sound engineers.

- Model 44-BX (Ribbon) **\$129.00**
- Model BK-1-A (Pressure) **79.50**
- Model 77-D (Poly-Directional) **175.00**

Visit the HARVEY AUDIOtorium

If you want to See and Hear the finest . . . the widest selection of high fidelity equipment . . . be sure to visit the HARVEY AUDIOtorium. It will thrill you.

NOTE: Prices Net, F.O.B., N.Y.C. Subject to change without notice.



ELECTRO-VOICE 'GEORGIAN' 4-WAY LOUDSPEAKER SYSTEM

An integrated reproducer utilizing the Klipsch "K" horn with the 15WK driver in the bass section. First crossover point at 300 cps removes "dual source" effects. Compression-type, horn-loaded mid-low frequency driver has 68" path length. From 1,000 to 3,500 cps, a diffraction horn presents smooth, augmented treble tones.

The E-V T-35 Super Sonax VHF Driver takes over extended high frequencies to and beyond the range of audibility.

- Georgian, complete (Mahogany) **\$495.00**
- Georgian, complete (Korina) **\$15.00**

AMPEX

#350 TAPE RECORDER

One of the leading tape recorders designed for broadcast, recording studio and other critical professional applications. Provides 15,000-cycle response at 7 1/2 in/sec as well as 15 in/sec. Signal-to-noise ratio over 60db; flutter and wow well under 0.2% rms at 15 in/sec and under 0.25% rms of 7 1/2 in/sec. Playback output: Plus 4 VU output into 600 ohms, balanced or unbalanced; will feed a high output impedance amplifier directly with approximately one volt. Three-motor tape transport mechanism assures accurate timing and fast response. New design gives convenience and precision in operating, cueing and editing.



- #350 Tape Recorder **\$1195.00**
- Also available in two-case portable model. **\$1175.00**

Write to Harvey for full details.



BROCINER Model A100-CA2 CENTRALIZED CONTROL UNIT

A compact combination of Preamplifier-Equalizer and Control Amplifier which together give a range and accuracy of control not to be compared with ordinary "front ends". Model A100S Preamplifier-Equalizer, amplifier-powered, offers separate Turnover and Roll-Off controls with a choice of 24 different record characteristics. Model CA2 Control Amplifier, self-powered, has a separate tape recorder output, the level of which is not affected by the setting of the volume control. A treble cut-off filter permits playing old and feebly records with minimum noise and distortion; an adjustable loudness control of exclusive design increases the degree of bass boost as volume is decreased, if desired. Response and signal-to-noise ratio of each unit meets the highest standards.

- Complete with tubes **\$99.00**
- TCM Cabinet for both (mahogany) **11.00**
- TCB Cabinet for both (blonde) **13.00**

TRIMM



EQUIPMENT For Audio Applications

JACK PANELS Provide maximum operating convenience and control. Terminating program lines, microphones, amplifiers, preamplifiers, equalizers, and a variety of other audio elements can be easily and quickly inter-connected and interchanged. Broadcast quality construction throughout.

Series 96 - Uses standard twin-type patch cords. Has reinforced, solid bakelite panels. Dimensions: 18" long and 3 1/4" deep (height shown below).

- | No. | No. of Jacks | Height | Net |
|-----------|--------------|--------|---------|
| No. 96-01 | 12 pairs | 1 1/4" | \$27.00 |
| No. 96-02 | 24 pairs | 2 1/4" | \$49.20 |

PATCH CORDS AND PLUGS IN STOCK



HARVEY RADIO COMPANY, INC.

103 W. 43rd Street, New York 36, N. Y. JUdson 2-1500

A WORLD OF WONDERFUL MUSIC FOR YOU

and what
a "sound"
gift!



for finest high fidelity

magne
Cordette

World's Finest Professional Tape Recorder

Use this magnificent recording instrument to make dramatic, full-range recordings in your home — and play them back a thousand times! The MagneCordette is the same tape recorder chosen 3-to-1 by radio engineers, elegantly restyled in blond, mahogany, and black lacquer cabinets. Priced lower than any other professional tape recorder!

the new PORTABLE

magne
Cordette

It's a complete record-playback-P.A. system—
combined for the first time in a single carrying case!



Look in the phone book under
"recorders" for your dealer.

MagneCord, INC.

225 West Ohio Street, Dept. AE-11, Chicago 10, Illinois



voices at the expense of over-all ensemble. The second side features more conservative orchestration and what seems to be the better ensemble. Was there a different mike arrangement, or is the difference purely in the texture of the music itself? Some crackles in my copy.

FRENCH

Ravel: *Valses Nobles et Sentimentales; Le Tombeau de Couperin.* L'Orchestre de la Suisse Romande, Ansermet.

London LL-795

Here's one of the most satisfying Ravel discs for a long time, combining two works that have often eluded the right combination of recording technique and interpretation in performances hitherto released. The most shimmering of *fff* sound is beautifully applied here, the sharp, clean texture of close-up highs well balanced by the feeling of over-all liveness and atmosphere. The Ansermet interpretations are notably high-level, done with the exacting care that is required for every Ravel score, that each phrase, each shadow of tone color be in precise proportion, modelled, polished to a shine. To be sure, there are other and radically different approaches to the music of both pieces. Here, the Waltzes are relatively slow, much of the implied violence and frenzy is put aside in favor of their equally implied graciousness and color. *Le Tombeau*, which too often is tossed off with all its minuets and rigaudons as a piece of minor frippery, here finds its own best dignity as one of the very finest pieces in the Ravel literature. A wonderful record to complement the big hi-fi noise makers in your demonstration pile.

Ravel: *Tzigane.* Chausson: *Poème.* Honnegger: *Concertino.* Milhaud: *Piano Concerto #1.* Eliz. Lockhart, London Symphony; Fabienne Jacquinot, Philharmonia, Fistouleri.

M-G-M E3041

Just skip the jargon printed above—this is surely one of the oddest collections of French music yet compounded on a single disc. Lockhart is a violinist and plays Chausson and Ravel; Jacquinot is a pianist and does the Honnegger and Milhaud opuses; the whole, with two orchestras, is led by Fistouleri.

Gem of the collection is the late-Romantic *Poème* for violin and orchestra of Chausson, who was a close follower of César Franck. Ordinarily the Franck satellites show up as pretty windy and overblown beside their master, who could blow a long tune himself, but in this performance, at least, Chausson comes through with sincerity and a very moving simplicity. A good deal must be credited to the performers; there is an unusual sense of quiet restraint here, a long-breathing, sustained line that is not too often heard on records.

The other items are of another world, the jazz epoch of the 20's. The Honnegger *Concertino* followed right upon Gershwin and Milhaud (*La Création du Monde*) as an early try at "classical jazz"; today it is a feather-light bit of expert orchestral whimsy which is too heavy here for my taste—the whipped cream has gone flat. The Milhaud concerto, of the same snazzy period, has more to it, yet perhaps is actually less expertly molded as we now hear it.

Ravel's strange "Tzigane," an evocation of Gypsy improvisation, is almost entirely prelude—for the unaccompanied solo violin; the orchestra (in another version, the piano) doesn't appear until almost the end. The gypsy-like tunings-up, the dark and foreboding runs, double stops, harmonics, constitute a fiendishly difficult exercise for the player, though hardly a display-piece in the usual sense. Lockhart's playing is the sort that takes extreme liberties with pitch, en route, so to speak. I can appreciate her desire to make this music guttural and stringy, in the gypsy manner, but even a gypsy would find ways towards more accurate playing than this! Maybe you have the very early 7-inch LP of the same by Szigeti (with piano); if so, you'll know the way it should sound.

Speaking of gypsies—

Gypsy Music, vol. III. Antal Kocze, King of the Gypsies, and His Band.

Westminster WL 3002 (10")

I'll have to admit that this gypsy, nominal prizewinner and hence "king" among gypsy players, swoops about the pitch much as does Lockhart, above, in these semi-improvised café pieces from Vienna. But on close listening, I think you'll find a basic steadiness beneath the

Koche playing that belies its strangely drunken sound. Even so, steady or no, I'm afraid I'm no gypsy fan; the stuff on this record (and earlier ones in the series) puts me to sleep at once. Maybe the Duke of Windsor and Toscanini'd like it. . . .

The miking has something to do with my feeling. The solo violin is very close, very loud, the handful of other strings virtually inaudible, only the accompanying cymbalom (like an old upright piano with the pedal stuck) comes through for harmony. That, too, may be quite proper and in the tradition, for all I can say. . . . come to think of it, you'd better tear right out and get the record for yourself. You'll probably enjoy it, as a lot of people undoubtedly have.

NEW LITERATURE

• **CBS-Hytron**, Danvers, Mass., fills the need for a practical manual of basic information on transistors in a new eight-page booklet which is offered free of charge. Well-illustrated, the booklet is in three parts—Theory, Data, and Application. Problems which remain to be overcome before the transistor can find universal application are described, as are those which were solved to bring the device to its present stage of usability.

• **Automatic Electric Company**, 1033 W. Van Buren St., Chicago 7, Ill., has produced a helpful guide to engineers in a new catalog of "telephone-type" components for industrial use. Illustrated with scores of photographs and diagrams, it contains specifications and general data on key switches, impulsing devices, switchboard lamps, jacks, plugs, etc. Copy will be supplied on request.

• **Miniature Precision Bearings, Inc.**, Keene, N. H., has just completed an exceptionally fine catalog which tells just about all there is to know about the design and application of miniature ball bearings. Two-and-a-half years in preparation, the 20-page three-color booklet is a veritable encyclopedia of practical information, with all technical data liberally supported by drawings, graphs, tables, and photographs. If you use tiny ball bearings, you have a distinct need for this publication.

• **Radio Shack Corporation**, 167 Washington St., Boston 8, Mass., is now distributing free the largest catalog in the firm's 31-year history. Containing 224 pages in all, the catalog includes a 32-page rotogravure section devoted solely to high-fidelity audio equipment and custom-built home music systems. Highlighted in the general equipment section are extensive listings of transistors and germanium diodes, converters and test equipment for UHF-TV, printed circuit components, and radiation detection apparatus.

• **Hammarlund Manufacturing Company, Inc.**, 460 W. 34th St., New York 1, N. Y., describes equipment for the remote control of broadcast transmitters—a type of operation only recently made possible by an FCC directive—in a new brochure which will be mailed on request. The equipment makes use of audio tones for complete control and metering of the remote transmitter. It requires only a single circuit which may be wire or microwave. This publication will be of distinct interest to station managers.

• **American Standards Association**, 70 E. 45th St., New York 17, N. Y., emphasizes the economic importance of standardization in a new 24-page booklet titled "Standards Are Your Business." The booklet gives the philosophy and objectives of the voluntary standards movement in this country, and includes specific examples of recent savings effected through standardization by leading corporations. Copies are available without charge.

• **G & H Wood Products Company**, 75 N. 11th Street, Brooklyn, N. Y., has just issued a new catalog on its Cahinart line of custom-styled hi-fi cabinets and kits. Small enough to carry around while on a shopping tour for comparison purposes, this brochure describes the entire line, including the recently added Klipsch Rebel IV series. Complete specifications and choice of woods and finishes are given for each cabinet. Copy may be obtained from your local parts distributor or by writing the company direct.

You don't have to
spend a lot

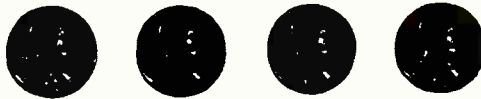

to get a high
quality dynamic

like this....

TURNER'S New ADA 95D Dynamic gives performance you've always wanted at a price you've only hoped for. This slim beauty is equipped with such quality features as Alnico V Magnets and moving coils for maximum sensitivity to voice and music. The wide response range and excellent sound characteristics of the ADA 95D make it ideal for use with tape recorders, PA or commercial broadcasting.

Its amazing performance—its graceful, satin-chrome beauty—its low, low price have won the acclaim of microphone users everywhere. Frequency response, 70 to 10,000 cps; output level, -58 db; 20 ft. removable grey plastic cable set; standard 5/8"-27 coupler; high impedance wired single ended (single conductor shielded cable); 50, 200 or 500 ohms wired for balanced line (two conductor shielded cable). About 8 1/2" high.



The TURNER ADA 95D

List price.... only \$35.

TURNER ADA S95D, with slide switch.....\$38.50

The TURNER Company

929 17th Street N.E., Cedar Rapids, Iowa

IN CANADA: Canadian Marconi Co.,
Toronto, Ont. and Branches

EXPORT: Ad. Auriema, Inc., 89 Broad Street,
New York 4, N. Y.



ENJOY RECORDS AT THEIR BEST!



Model AI-900



RECORD COMPENSATOR

EFFECTS FLAT RESPONSE



General Electric engineered to bring you as close to the beauty of the original orchestration as possible when used with standard type G-E variable reluctance cartridges.

ADJUSTABLE PLAYBACK



Five selective settings which include two scratch filter positions for noisy records.

NEW RECORD LIFE



Noticeable high frequency distortion and background noise on old 78 records is greatly reduced. Your favorite collector's items take on a new, magic quality that rivals the original.

EASILY MOUNTED



Compact design permits mounting in any position. Easily connected between the pickup cartridge and the pre-amplifier input.



SEND FOR THIS NEW BULLETIN...

General Electric Company, Section 44113
Electronics Park, Syracuse, New York

Please send me the G-E Record Compensator Bulletin with Playback Curves.

NAME.....

ADDRESS.....

CITY..... STATE.....

GENERAL  ELECTRIC

it CAN be ATTRACTIVE

(from page 31)

may not be attained, but unless the job is inspected with a magnifying glass, most of the slight imperfections may not be noticed by the average person. The fact that the builder knows about a joint that is not exactly square or a crack between a door and the adjoining jamb is not uniform will not make any difference in the way it sounds, and such imperfections can usually be found in even the best-built homes. The most important considerations are those relating directly to the quality of the sound coming out and those are dependent on design rather more than upon the execution of the original plans of the owner.

Basic Requirements

A number of questions have to be asked—and answered—before a complete plan can be laid out for a home installation. For a built-in system, the space requirements must be considered. Listed in the next few paragraphs are the most important points that have to be covered before starting the actual work.

Loudspeaker. Whenever possible, the loudspeaker should be located in a corner. For built-in installations, this gets somewhat difficult, for very few storage-wall or conventional built-in cabinets provide a space suitable for a speaker enclosure across the corner of a room. But it should be considered if at all possible. This writer does not prefer that a speaker be mounted high up—such as a ceiling corner or above the television screen as on this month's cover, but in many instances no other solution is possible. In any case, adequate room must be provided—preferably six to eight cubic feet, although there are some very satisfactory enclosures that may simply be made a part of the built-in units, and which are of the order of two to three cubic feet. The interior walls of the enclosure must be well braced, and should be lined thoroughly with Ozite, Kimsul, or some other sound absorbing material. Needless to say, the back and side walls should be airtight.

If a two- or three-way system is planned, it is generally thought best to place the low-frequency unit at the lowest part of the enclosure, with the high-frequency unit(s) above.

Many installers use a piece of plywood for the speaker baffle—usually 3/4-inch material—without any paint or staining prior to covering with the grille cloth. This usually results in dark circles where the speakers are

mounted, for most speakers have dark gray cones, which reflect little light. One of the "tricks of the trade" is to paint or stain the front of the baffle board black or dark gray before mounting the speaker so that the entire front will appear the same color. Lumite grille cloth is recommended because of the firmness of its strands. Most cloth materials have progressively greater absorption of sound at the higher frequencies, with the result that the system is likely to sound dull unless suitable compensation is made in the tone control section.

Amplifier. A space 18 in. wide, 12 in. deep, and 10 in. high will provide for practically any of the power amplifiers on the market. Some of the McIntosh models—20W2 and 50W2—require more height, but if necessary they can be installed with the tubes horizontal. The control unit—or the entire amplifier in a single-unit system—should be located so as to be readily accessible to the user. Some installations require that the control unit be mounted vertically, and many of those on the market are arranged so as to have escutcheons that may be used either way. Ventilation is the big problem for the power amplifier, for it is the greatest radiator of heat. In cabinets of the type shown here, ventilation is best obtained by leaving the back off, or at least by providing large openings at both the top and bottom of the back, and preferably by providing several large holes in the bottom.



Typical cabinet housing the power amplifier in the lower portion, with a turntable and pickup and arm in the top along with the controls for the preamplifier which is custom-built and mounted directly on the motor board. (Courtesy Kierulff Sound Corp.)

Phono Equipment. Whether the user employs a changer or a single-play turntable, it should be mounted in accordance with its instructions. Most changers are designed to mount with springs, furn-



MODEL RP-1

\$59⁵⁰

SHIPPING
WT. 30 LBS.
Shipped
Express
Only

Here is a new introduction to quality record reproduction. A simple to operate compact table top model with none of the specialized custom installation problems usually associated with high fidelity systems. Two matched speakers mounted in an acoustically correct enclosure reproduce all of the music on the record, reproduction with the unique sensation of being in a halo of glorious sound. This spectacular characteristic is possible only because of the diffused non-directional properties of the matched speakers. The performance level of the Heathkit Dual is easily superior to that of the ordinary phonograph or console selling for many, many times the price of the Dual.

Automatic record changer plays all three sizes at all three speeds with automatic shut off for both changer and amplifier after the last record is played. A wide range ceramic cartridge features an ingenious "turn-under" twin sapphire stylus for LP or 78 records without turning the cartridge. Simplified easy to assemble four tube amplifier featuring compensated volume control and separate tone control. Proxilyn impregnated fabric covered cabinet supplied completely assembled. You build only the amplifier from simple detailed step-by-step instructions. No specialized tools or knowledge required.

If a kit project has ever tempted you here is the perfect introduction to an interesting and exciting pastime. The Heathkit Dual Kit includes cabinet, record changer, two 6" speakers, tubes and all circuit components required for amplifier construction. Build the Heathkit Dual and enjoy unusually realistic room filling reproduction of fine recorded music.

OTHER *Famous*
HEATHKIT AMPLIFIERS

THE HEATHKIT 6 WATT
AMPLIFIER KIT



Model A-7B

\$15⁵⁰

Ship. Wt. 10 lbs.

The Heathkit Model A-7B Amplifier features separate bass and treble tone controls — two compensated inputs — three output impedances 4, 8, and 16 ohms — frequency response $\pm 1\frac{1}{2}$ db from 20 to 20,000 cycles — push pull beam power output at full 6 watts.

Heathkit Model A-7C with preamplifier stage..... **\$17.50**

HEATHKIT *High Fidelity*
AMPLIFIER KIT



\$35⁵⁰

Model A-9A

Ship. Wt. 17 lbs.

A 20 watt high fidelity amplifier especially designed for custom installations. Low hum and noise level 9 pin miniature dual triodes in pre-amplifier and tone control circuits. Four switch selected inputs. Frequency response ± 1 db 20 to 20,000 cycles. Output impedances of 4, 8, and 16 ohms.

Write For Free
CATALOG

New 32 page 1953 Catalog lists all kits, specifications, schematics and latest price information.

HEATH COMPANY
BENTON HARBOR 25
MICHIGAN

YOU SAVE BY ORDERING DIRECT FROM FACTORY

*A New Standard
in Listening Satisfaction*



BEAM

QUAD

Amplifier and Control Unit

- Full Range Fidelity
10 to 60,000 cps—
(Attenuated 20 to
20,000 cps)
- Built-In Pre-Amp.,
1.5-40 mV. Inputs
- Push-Button Recording
Equalization and
Program Selection
- Plug-In Matching to
Pick-Up Type
- Automatic Circuit
Correction
- Unique Stability, with
Less Than 0.03%
Distortion
- Beautiful Styling to
Match Any Decor

The finest in contemporary amplifiers, brought to an even *finer* point by the most versatile control instrument ever designed—this is the new Beam QUAD Amplifier and Control Unit.

Every care has been taken to assure complete operating facilities and faultless reproduction in this superb amplification system. Relatively perfect technically, the Beam QUAD is also relatively perfect *audibly*. And your thrill at its sound is enhanced by the ease of its operation—by the fact that guesswork and effort on your part are eliminated. Push-button controls, automatic circuit correction, harmonic filtering and other built-in devices make your listening enjoyment *absolute*. Audition the QUAD Amplifier and Control Unit at your audio dealer's *today*. Prove to yourself that this is the world's finest amplification system, that here truly is a *new standard in listening perfection*. Complete data sheet on request. Also send for free brochure on revolutionary new Beam "Sientorian" full-range loudspeakers.

QUAD II Amplifier and QC II Control Unit
System Complete. \$237.50 net
QC II Control Unit Only \$120.00 net
QUAD II Amplifier Only \$130.00 net

BEAM

QUAD

BEAM INSTRUMENTS CORPORATION

U. S. Agents

350 FIFTH AVENUE • NEW YORK, N. Y.

ished with the unit, and this simplifies the installation. When necessary to use slides, it is suggested that heavy-duty types be employed so the changer may be pulled out or pushed back with a minimum of disturbance to the pickup on the record. A 6-c.p. bulb in a small fixture arranged to light up as the drawer is pulled out is a convenience.

If the system is to include a tuner mounted side by side with the changer, it is best to locate the changer on the right and the tuner on the left so that the pickup is as far as possible from the power transformer on the tuner. If crystal or ceramic cartridges are used, this caution may be overlooked, but with some magnetic pickups the field from a power transformer twelve inches away is sufficient to introduce so much hum into the system as to make it impossible to use the phonograph equipment with the tuner power turned on. And when the tone controls of the tuner are employed with the phonograph equipment, it is important that the power be turned on. This same problem must be considered in the installation of the power amplifier. One other hum-producer is the electric clock, which may be a convenience on the control panel. Make sure, however, that it is checked for hum before installing it permanently. A few inches one way or another may be sufficient to eliminate the hum problem entirely.

Tuners. The location of the tuner depends greatly upon the listening habits of the user and his household. Many families rely on the radio more than they do on records—there are others who are just the opposite. One will occasionally see an installation in which the tuner is almost inaccessibly mounted below the record player, making it necessary to get down on hands and knees to see the tuning indicator—if any. Of course, if records are the main source of entertainment, it may be more convenient to have the phonograph equipment above the tuner. The logical solution is to place them side by side, if at all possible.

Ventilation is important for the tuner, although it is not a great heat producer. With FM tuners in particular, there is likely to be considerable drift—even though most commercially built tuners have temperature compensating capacitors in the oscillator circuits so as to minimize drift, but too much heat will cause these circuits to exceed their limits and make retuning necessary at intervals. This caution applies even to those tuners which have a.f.c. circuits, for there are limits to how far these arrangements will work satisfactorily.

Preliminary Work

Once the various units of equipment are selected—their choice is not the

province of this article—the first step is to plan for the installation of each unit. The space available must be considered in the selection of the units because one should not purchase a 15-in. dual loudspeaker to put in a 11-in. bookshelf, for example, and one should not choose an amplifier with a separate preamplifier-control unit unless he is choosing a tuner that is stripped of all controls except tuning and FM-AM selector. Other than making such decisions, it is desirable to obtain all of the components before starting any of the work of installation—or even of the actual planning. Place all of the units where they are to be located finally, hook up the system, and then try every possible listening combination. Try out the tuner—both AM and FM if you have them; try out the phonograph, then without a record on the turntable, turn the gain up to maximum and listen for hum. Move the pickup over the turntable and see if there is any hum at any point the pickup can traverse. If television is to be connected to the music system, try that out too. It may be that the illusion of sound coming from the picture will be destroyed if the loudspeaker is too far from the picture tube. A few hours spent in this work will result in greater satisfaction with the finished installation, and may save more hours of work in setting the system right after it is all finished. The front panels are not necessary just to determine how it will sound—except for the loudspeaker. After being thoroughly satisfied with the performance of the system in the location planned for it there is time for starting the actual construction.

All modern hi-fi components come with adequate templates for installation. One must make sure that the hole for the changer is laid out on the top of the motor board, for example. While it is often safer to work from the back or the



For the installation where a speaker can not be accommodated as a built-in enclosure, it is often desirable to utilize some form of ready-built cabinet, such as this one which houses two 15-in. woofers and a 2x4 multicellular horn. Properly designed, this type of cabinet can produce good sound.

(Courtesy Kierulff Sound Corp.)

Everything in hi-fi always in stock at ALLIED



NEW RELEASES—IMMEDIATE DELIVERY

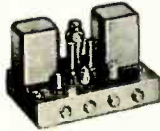

New Knight 24-Watt Amplifier
Brilliant performance: Response, ± 0.75 db, 20-20,000 cps; less than 1% harmonic distortion at 24 watts rated output. Features: separate bass and treble controls; 4 inputs; record compensator; 8 and 16 ohms speaker output imp. Size: 8 x 14 x 9" deep. Shpg. wt., 30 lbs. A wonderful value in quality Hi-Fi.
93 SX 321. Net. \$79.50



New Knight 727 FM-AM Tuner
Value that's in a class by itself. Fit for the finest hi-fi systems. RF stage on FM; drift-compensated; built-in antennas; phono input for crystal cartridge or magnetic preamp; hum-balance adjustment. Handsome gray panel, edge-lighted dial. 7 1/2 x 10 x 13 1/2" wide. Top tuner buy of the year. Shpg. wt., 16 lbs.
5X8 L 727. Net. \$52.80



Jensen "Duette" Speaker
New "presence" 2-way speaker system in ultra-compact cabinet. Uses special 8" woofer and separate multicell horn tweeter; with frequency dividing network. Imp.: 4 and 8 ohms. 20 watt power rating. 11 x 10 x 23 1/2" wide. Mahogany toned pigskin plastic finish. Wt., 24 lbs.
82 DX 035. Net. \$69.50



H. H. Scott 99-A High Fidelity Amplifier
Ultra-compact, ultra-quality. Response flat 20-30,000 cps. Harmonic distortion less than 0.5% at 10 watts. Features 4-position input selector, separate turnover and rolloff record equalizers, treble and bass controls, adjustable loudness compensation and pickup level control. Handsome aluminum case, 13 1/4 x 9 3/4 x 3 1/4". Shpg. wt., 15 lbs.
93 SX 994. Net. \$97.95

Garrard Deluxe RC-90 3-Speed Changer

Ultra-fast change cycle for all speeds. Plays all speeds, all sizes. Two plug-in heads take any modern cartridge. New pulley-drive and flywheel for wow-free operation. Rugged 4-pole motor. Shuts off after last record is played; new type manual play position. Special muting switch. Large spindle for 45 rpm records. Less cartridge, cord and output cable. Shpg. wt., 18 lbs.
96 RX 720. Net. \$64.68



Low Cost "Studio Presence" Phono System

Best buy in a full-fidelity record-reproducing system recommended by *Saturday Review's* E. T. Canby and associates. Complete system includes: Bogen DB-10-1 High-Fidelity Amplifier, Garrard RC-80 3-Speed Changer with two G.E. cartridges and diamond stylii, Electro-Voice SP12B Coaxial Speaker. Complete with cables (no soldering required), hardware and full instructions. Shpg. wt., 65 lbs.

93 SX 572. Only \$167.75

93 SX 911; BOGEN R604 FM-AM TUNER. High Fidelity tuner for above system.

Only. \$97.35



FREE 1954 268-PAGE Buying Guide

Write today for the complete guide to the world's largest selection of High Fidelity systems, amplifiers, tuners, speakers, changers and accessories. If it's anything in Hi-Fi, it's in stock at ALLIED. Send for our FREE Catalog today.

ALLIED RADIO
Everything in High Fidelity

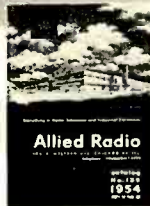

ALLIED RADIO CORP., Dept. 17-L-1
100 N. Western Ave., Chicago 80, Illinois

Send FREE 1954 Catalog.

Ship the following:

.....\$.....enclosed

Name.....

Address.....

City.....Zone...State.....



the Moderns
Model UR-312 Available in Cherry
Mahogany, Blond Mahogany,
or Lined Oak.
User Net: \$ 64.50
Blond and Lined Oak—10% extra

LOOK at the styling . . .
LISTEN to the reproduction . . .

the new *Musicorner*

the Provincial
Model UR-310.
In Maple
or Fruitwood.
User Net: \$ 64.50

by **UNIVERSITY**



the Traditional
Model UR-311.
In Cherry or
Cordovan Mahogany.
User Net: \$ 64.50

Now you can have good "looking" with good listening! Each University MUSICORNER design is authentic in every detail, and reflects the traditions of the old masters of fine furniture. All genuine woods—hand rubbed! Designed to flatter the decor with stylings that smartly blend with any existing interior.

University Musicorner gives you wide angle coverage, clarity and brilliance with its full front radiation. High power handling ability and distortion control, with an internal and extended horn. And, boosted low frequency response with high efficiency, from its unique integral bass reflex system.

THE HEART OF THE *Musicorner*

Model 6201, 12" coaxial speaker system. A TRUE coaxial dual range system, with woofer, and driver type tweeter, built-in crossover network, and "balance" control. Finest to be had! User Net: \$ 45.00



The exclusive University Diffusicone-12 speaker is acclaimed by experts everywhere! Here, in the economy of one speaker you get dual-horn loading, radial projection, and diffraction—to give unsurpassed fidelity, range, and uniform sound distribution. User Net: \$ 27.00



Model 6200, 12" extended range speaker. Gives highly efficient full-bodied response throughout the operating spectrum. User Net: \$ 21.00



FREE BOOKLET!

describing these
wonderful enclosures in
greater detail.

University **LOUDSPEAKERS, INC.**
80 SOUTH KENSICO AVENUE • WHITE PLAINS, N. Y.

underside of a panel, it will be found that templates are designed for marking on the front of the panel.

Panels for tuners and preamps may be made from 1/4-in. hardwood veneer, and many units require that the panel be no thicker than 1/4 in. When possible, it is preferred to use 3/8- or 1/2-in. panels to reduce the chance of warping, but if 1/4-in. panelling must be used, be sure to provide means for attaching the panel firmly on all four sides. To cover the mounting screws, triangular moulding strips may be used—put together in the form of a picture frame, and fitting firmly in the opening provided. Felt washers around knob shafts will reduce light leakage from pilot lamps.

Slides for phonograph equipment are somewhat difficult to mount, but if one works slowly and carefully it should not be too difficult to end up with a smoothly operating job. It is important to keep the turntable level—whether for a changer or for a single-play turntable. Sufficient freedom must be allowed for the connecting cables from any equipment that is mounted on a slide drawer, and it is desirable to attach the cables to a hook at the top of the compartment at a point where they are just free when the drawer is pulled out as far as possible.

Electrical Connections

When separate units are installed in a system that envisages loudspeakers in several rooms; the problem of making the interconnections is sometimes frightening. In a single-story house, it is usually easy to gain access to the basement, or at least to the space under the floor. If so, holes in the floor may be employed to pass the wires. It is much neater to cut slightly larger openings and install some connecting receptacle—Cannon or Jones being recommended. For example, if speakers are to be located in three rooms in addition to the living room, an 8-terminal receptacle would be installed in the floor near the main amplifier, with leads running to the other locations where 2-terminal receptacles would be mounted, if for separate cabinets, or directly to the speakers, if built in. Some form of detachable connection is desirable in any case, so as to avoid the need for unsoldering in case any servicing becomes necessary.

In some instances there is no space under the house, and it may be necessary to do all the wiring in the attic. This is not a disadvantage, for built-in speakers are often located near a ceiling, which makes access from the attic quite simple. Leads from the amplifier can usually be snaked up through the wall (unless there is a fire stop) to the attic, but one method of getting from the basement to the second floor (or the attic) is quite ingenious. This method involves removing.

the door-stop strip from any convenient doorway and routing a groove on the underside of the strip. A hole from the bottom of the doorway—where it would be covered by the strip—leads to the under side of the floor, and a long electrician's drill will permit making an opening from the top of the doorway up to the second floor—through the wall and flooring. For such an operation it is well to choose the location carefully, but if the proper place is selected, the result is completely satisfactory.

For long runs, as may occasionally be encountered, there is no harm in running the wiring outside the house, if necessary to get the job done at all. Obviously it is much easier to make the installation of all interconnecting wires at the time the house is built, but the vast majority of installations will have to be made in houses that are already existent, and one must make the best of the facilities at hand.

With a little thought, a little care, and a little ingenuity, a built-in hi-fi installation can be just as attractive as the owner desires. There is no need for exposed chassis, unsightly wires, or unfinished cabinetry any more than there is any need for unsatisfactory performance. We would not buy an automobile that does not perform to our satisfaction, but we also make sure that it looks as good as we'd like. But with the home music system, the appearance depends entirely on the user.

—CGMcP

BOOK REVIEW

THERMIONIC VACUUM TUBES, by W. H. Aldous & Sir Edward Appleton. New York: John Wiley & Sons. vii+160 pages. A "Methuen Monograph on Physical Subjects."

In this the sixth edition of this vest-pocket sized text, the authors present a completely revised and rewritten approach to the operation of the thermionic vacuum tube, from the simple diode through the latest reflex klystron and wave guide tubes. Naturally, in so small a book—and it is indeed a pocket edition—the coverage is brief, and extremely compressed. Relying upon the classical mathematical presentation, this is a book not for the student starting off in vacuum tube theory, but rather for one with the help of classroom presentations and tutorial guidance. Designed for the "student of general physics, who has not made a special study of radio-frequency phenomena" the book amply fills its destiny. But the serious student who wishes a more complete presentation, with descriptive explanation as well as mathematics will do well to look elsewhere in the technical literature.

Well annotated and with a good subject index, the format is annoying to the reader for there being nearly as many reference footnotes as pages, these have been collated at the end of the book, rather than placed at the specific page to which they pertain. For a quick refresher, or for reference purposes when seeking a specific formula, this book takes up little shelf space for the scope of its contents.

—L. B. Keim.

POWRTRON*

by

WHITE SOUND

*New Revolutionary
Amplifier Circuit*

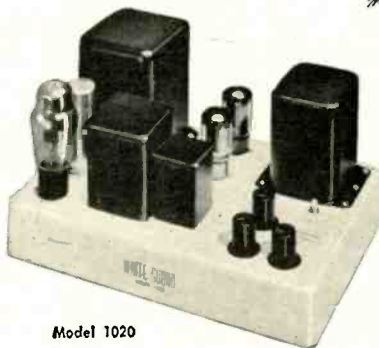

Model 1020

Ultra High Fidelity

Which gives you for the first time an output power wave form which is the same as the input voltage waveform, regardless of changing load impedance.

No More

- Pentode Operation
- Triode Operation
- Voltage Feed back

Now

- Power Control with Powrtron

WHITE SOUND AMPLIFIERS

White Sound's new circuit has established a New High in the realistic reproduction of music. The finest electronic components, precision engineering and White's new design combine to give you Ultra High Fidelity.



Model 3422
15-18,000 cps.

*Copyrighted

Exclusive! Non-resonant Cross-Over Circuit • Cross-Over (24db./ Octave) at the Input of Dual Channel Amplifier.

Model 1010, 10 watts Model 1020, 20 watts. Model 2010, Dual Channel Amplifier with the Model C-101, Cross-Over Network.

WHITE CABINET SPEAKERS

• A True Exponential Horn (within 1%)... Coupled to Speaker through a New Unique Phasing Device and Sound Trap • Nine foot Horn compactly Curled into Non-Resonant Cabinet • Response: 15-18,000 cps • White Cabinet Speakers offered in 5 Sizes... 3 Finishes... 5 Prices.

For Complete Information, see your Distributor
or Write to Department H-9

105 W. MADISON ST.

WHITE SOUND, INC. CHICAGO 2, ILLINOIS

NEW PRODUCTS

• **Small Hi-Fi Speaker System.** The new Jensen "Duetta" meets the needs of the hi-fi enthusiast for whom space is a problem. Ideally constructed to be placed on a bookshelf, end table, or desk, it is a complete two-way speaker system with a

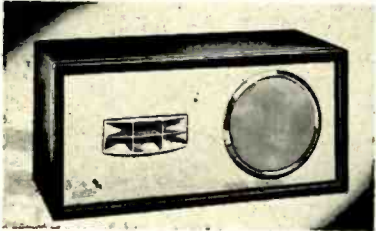

heavy-duty eight-inch woofer and a multicellular horn-type tweeter. The unit is attractively finished with a two-tone pigskin plastic covering accented with burnished copper trim. Although only 11" h x 23 1/2" l x 10" d, the Duetta affords excellent low-frequency response due to coordination in design of the woofer and the acoustic characteristics of the housing. Jensen Manufacturing Company, 6601 S. Laramie Ave., Chicago 38, Ill.

• **Record Changers.** Two new 3-speed record changers, differing only in the fact that one intermixes 10- and 12-in. records, while the other is of the non-intermix type, having recently been introduced by the Collaro Division of Rockbar Corporation, 211 E. 37th St., New York City. Both units are equipped with automatic shut-off. Turntables are precision-machined and

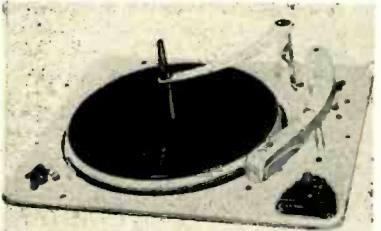

made of drawn steel, with top and sides covered with rubber. Designed for use with all standard magnetic or crystal pickups, the changers are supplied with plug-in shells. Among mechanical features are a jam-proof mechanism which permits handling of the tone arm even during a changing cycle without damage, a muting switch, and a 4-pole motor with self-aligning Oilite bearings.

• **Three-Channel Magnetic Playback Head.** Designed primarily for use on motion picture projectors which reproduce stereophonic sound, the new Tri-Di magnetic playback head is capable of exceptionally high quality sound reproduction. Advanced manufacturing techniques permit virtually perfect gap alignment. Comprising three separate heads in a single shielded

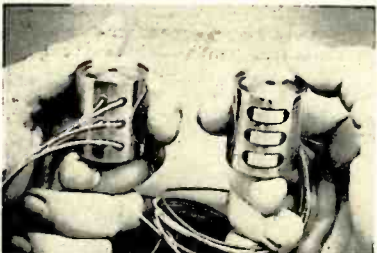

housing, the unit is machined to extremely high tolerances and is subject to rigid quality control. It has been tested to severe shock, vibration, and humidity conditions without apparent effect on audio characteristics, and conforms to requirements of the Academy of Motion Picture Arts and Sciences. Full technical details will be supplied to manufacturers of projection equipment by Tri-Di Sound Corporation, 4913 W. Jefferson Blvd., Los Angeles 16, Calif.

• **High Quality Audio Amplifier.** Push-button switching for three separate inputs and up to eight equalizing combinations for phonograph reproduction are included among the features of the new Q.C. II preamplifier-control unit intro-

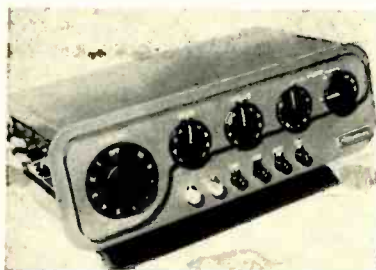

duced recently in this country in conjunction with the new Acoustical Q.U.A.D. II 15-watt power amplifier. Although manufactured in England, both units are designed specifically for the U. S. market. In addition to volume and tone controls,

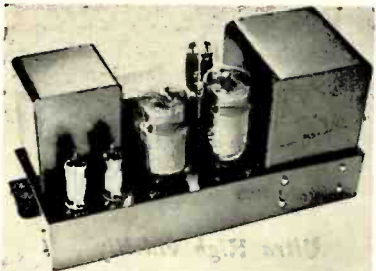

the preamp includes a continuously variable audio harmonic filter. Input sensitivity is three mv. Frequency response of the Q.U.A.D. is 20 to 20,000 cps within ± 0.2 db and 10 to 50,000 cps within ± 0.5 db. For complete information and literature, write Beam Instruments Corporation, 350 Fifth Ave., New York 1, N. Y.

• **Square-Wave Generator.** Extremely short rise time of approximately 30 millimicroseconds makes the new SKL Model 504 square-wave generator ideal for testing the response of audio, i. e., r.f., and video amplifiers. Producing a square-wave voltage without tilt or overshoot, the 504 offers continuously variable calibrated voltage from 0 to 11 volts. The



unit is equipped with a 9-position frequency switch, the first position of which permits operation at any frequency as determined by an external capacitor; the remaining positions afford frequencies from 0.5 cps to 500,000 cps in decade steps. The decade steps provide a convenient source of time bases from one second to one microsecond. The 504 and its self-contained regulated power supply are mounted in a compact, lightweight aluminum cabinet suitable for bench use. Further information can be obtained from Spencer-Kennedy Laboratories, Inc., 186 Massachusetts Ave., Cambridge 39, Mass.

• **Inverters.** Improved models of ATR inverters for operation from 6- or 12-volt storage batteries in automobiles, trucks, boats, and busses, have recently been introduced by the American Television and Radio Company, 300 E. 4th St., St. Paul,

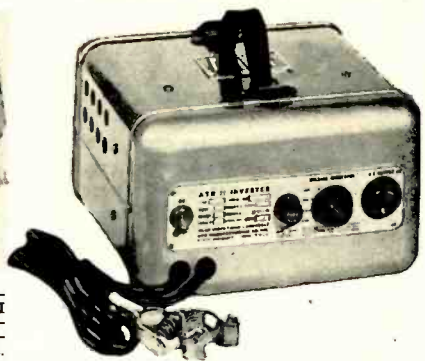

Minn. Standard models provide 110-volt 60-cycle a.c. in various wattage capacities for the operation of dictating machines, tape recorders, radio receivers, and other equipment with similar power requirements. Special models are available for operation from other d.c. input voltages. Complete descriptive literature will be supplied on request.

• **Stylus-Check Disc.** Made of a specially-compounded soft material which is highly sensitive to erosion, the new Audak Stylus Disk provides a simple, yet effective means of home-testing jeweled stylus for excessive wear. Grooves are recorded eccentrically in such a manner that the stylus under test is subjected to considerable thrust—first on one side, then on the other—with each revolution of the turntable. A worn or defective stylus will scrape the delicate surface of the grooves, leaving a visible indication of its condition. In normal use the disc should have a life span equal to that of about 20 styli. Audak Company, 600 Fifth Ave., New York 36, N. Y.

• **Transcription Console.** Every recording requirement of broadcast stations is filled by the new Rek-O-Kut Model B-16H three-speed turntable and matching console Model C-7B. Made of cast aluminum, the turntable exerts no pull on magnetic cartridges. It is rim-driven through idlers by a hysteresis motor, and reaches operating speed with one-half revolution at



33-1/3 and 45 r.p.m. A permanent built-in 45-r.p.m.-record bushing is flush-mounted around the spindle; a slight twist extends it above the table surface. When used with the C-7B console, the turntable is floated on felt; no bolts or screws are used. The cabinet stands on adjustable leveling casters and is attractively finished in metallic gray. An electrical outlet is built-in. Dimensions are 33" h x 22" w x 20" d. Additional information will be supplied by Rek-O-Kut Company, 38-01 Queens Blvd., Long Island City 1, N. Y.

• **Test Level Indicator.** Operating on the principle that the loudspeaker of a home music system is driven by a potential that is measurable in volts, the new Dubbings Test Level Indicator may be used with any frequency test record to determine the frequency characteristics of the system, also to adjust the system for optimum performance. The device consists of



three low-current low-voltage bulbs so calibrated as to light up at 3-db intervals when connected across the output terminals of an amplifier. Although extremely low in cost, the indicator is an effective substitute for much more expensive equipment in checking frequency response. Manufactured by The Dubbings Company, 41-10 45th St., Long Island City 4, N. Y.

• **Stereophonic Amplifier.** Expanding its line of audio equipment for stereophonic reproduction, Livingston Electronic Corporation, Livingston, N. J., has recently announced a twin-channel amplifier designed specifically to take full advantage of the multidimensional sound sources currently available. Consisting of two



complete 10-watt hi-fi channels, the amplifier contains a stereophonic-monaural selector, a speaker reversal switch, with separate bass and treble controls for each channel. Control panel is edge-lighted Lucite. Amplifier and power supply are in separate matching cabinets, each measuring 9 1/2 x 8 1/2 x 5 1/2". Interconnection is by means of a 3-ft. plug-in cable. Three twin inputs are provided for dual-channel discs, tape, and broadcast programs.

• **Portable Recorder-Playback System.** The new Masco Model RK6 is a portable three-speed disc recorder, record player, and five-watt public address system. Available with or without built-in AM tuner, the unit both records and plays back 45- and 33-1/3-r.p.m. microgroove discs, as well as standard-groove 78's. At 33-1/3 r.p.m. 15 minutes of recording can



be made on one side of a 10-in. record at 160 lines/in. Speed change switch affords automatic equalization for various recording speeds. Recordings may be made from microphone, tuner, tape or wire recorder, or from another phonograph. Output jack is provided for feeding an external speaker. Attractively styled, the RK6 is self-contained in a two-piece luggage-type carrying case. Additional specifications are available from Mark Simpson Mfg. Co., 32-28 48th St., Long Island City 3, N. Y.

• **Low-Cost Mobile Amplifier.** Sturdily built but readily portable, the new Bell Model 3717-MB mobile amplifier is a 15-watt unit housed in a rugged steel cabinet with a sloping, indirectly lighted control panel. A built-in 78-r.p.m. rim-drive phono is easily accessible for mobile operation. Separate volume controls are provided for phono and microphone inputs. A stand-by switch affords power economy by removing plate voltage while keeping filaments hot. The unit may be operated on either



117 volts a.c. or 6 volts d.c., and is supplied with cables for both types of connection. Microphone and phono channels have 115 and 80 db gain, respectively. Output impedances are 25, 4, 8, 16, 250, and 500 ohms, and in addition there is a 70-volt constant-voltage tap. Where a complete range of turntable speeds is required, a deluxe model with 3-speed phono and turnover-type pickup is available. Bell Sound Systems, Inc., Columbus, Ohio.

• **Miniature Delay Relays.** Amperite Company, Inc., 561 Broadway, New York 12, N. Y., now has available its regular line of delay relays in 9-pin miniature bulbs. They can be supplied in all standard heater voltages such as 6.3, 26, and 115 volts, and with delays from 2 to 90 sec-



onds. Power consumed by the heater is approximately 2 watts, and contact rating is 115 v, 2 amp, non-inductive. Further information may be obtained from the manufacturer.

• **Thermo-Tip Soldering Pencil.** A soldering tool for miniature and subminiature work has been introduced by Ideal Industries, Inc., 4487 Park Ave., Sycamore, Ill. The new device features rapid heating, light weight, and small size. It consists of a step-down transformer connected to a

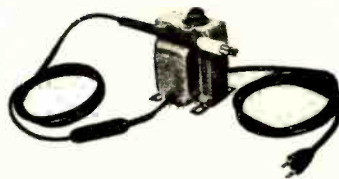

small soldering pencil and utilizes the principle of resistance heating with the soldered part becoming a part of the electrical circuit. Passage of a high current at harmless low voltage causes rapid heating, thus eliminating the possibility of poorly soldered joints. A variety of tips and attachments are available for specialized requirements.

LEONARD RADIO

One of America's
Leading Audio
Distributors

"First With the Finest"

NATIONALLY AUTHORIZED DISTRIBUTORS OF:

Acro Trans.	Livingston
Altec Lansing	Markel
Atlas	Masco
Audio Devices	Meissner
Audak	Newcomb
Bell Sound	Pederson
Bogen	Pentron
Brociner	Pilot
Browning	Pickering
Brush	Presto
Concertone	Q. U. A. D.
Cook	Radio
Dubbings	Craftsmen
Electro-Voice	Rek-O-Kut
Fairchild	River-Edge
Fisher	R-J
Garrard	Scotch Tape
G & H Wood	Shure
Prod.	Stephens
General Electric	Super-Horn
Grey Research	Tannoy
Grommes	University
Hallicrafter	V-M
H. S. Scott	Weathers
Jensen	Wharfedale
Leak	ETC.

Write Leonard TODAY
for Your FREE 1954
HI-FI CATALOGUE

Manufacturer's Specific-
ation Sheets Available

Visit Leonard NOW!

Famous for

- Competitive Prices
- Personal Attention
- Immediate Delivery

Your mail inquiries welcomed and
will receive immediate attention

LEONARD RADIO, INC.

69 CORTLANDT ST.
NEW YORK 7, N. Y.

COrtlandt 7-0315

Fleetwood

The Finest in
Remote Control

Television Receivers

with High Fidelity Audio Output

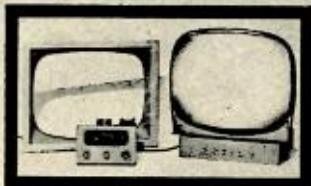

Complete 2-chassis system featuring the New 27" Rectangular Picture Tube

ALSO AVAILABLE FOR 21 AND 24 INCH PICTURE TUBES

For the finest in television picture quality, with the convenience of electronic remote control, enjoy the many features of the Fleetwood. A complete two chassis, full remote control television system, built to professional standards which provides high fidelity audio outputs to match the finest home music systems.

The separate tuner chassis, with edgelit dial and individual channel pilot lamps, includes off-on, volume, picture channel selection and fine tuning controls. The tuner is

of the Super Cascode type, completely adaptable to UHF by simple interchange of strips. UHF provision on tuner dial. Four I. F. Stages and full 4 megacycle band-pass. Separate cathode followers for audio and video. Audio Outputs: 4 watts for loudspeaker; both high impedance and cathode follower for connection to existing amplifier. Both Tuner and Picture Chassis attractively finished in gray and black baked enamel.

Also available without remote control.
SEE YOUR LOCAL JOBBER OR WRITE

CONRAC, INC. Since 1939 • Glendora, California

Nearly everybody reads the audio anthology and the 2nd audio anthology

The original audio anthology is still being ordered by people who have worn out their first copy or who have just learned about the book. Contains reprints of 37 articles which appeared in AUDIO ENGINEERING from May 1947 through December 1949. An invaluable reference work on audio in the home.

The 2nd audio anthology continues from where the first left off and contains reprints of articles from January 1950 through July 1952. In both books the articles were brought up to date, corrected where necessary, and assembled by subject. The 2nd a may still be had with board cover.

-----CUT OUT----- MAIL TODAY -----

Book Division, Dept. 3V,
Radio Magazines, Inc.,
P. O. Box 629, Mineola, N. Y.

Sirs: Enclosed is check money order for \$..... Please send me
..... copies of audio anthology (paper cover) @ \$2.00 each
..... copies of the 2nd audio anthology (paper cover) @ \$2.00 each
..... copies of the 2nd audio anthology (board cover) @ \$3.00 each

Name (please print)

Address

City Zone State

The POWRTRON

(from page 32)

transformed replica of the voltage waveform at the input to the audio amplifier. It will be shown that present audio amplifiers create a power distortion of a magnitude of 6 to 8 db, and this type of distortion is not discernible by present day testing procedures.

Definition 1. Power distortion: A power waveform generated by an audio amplifier that deviates in any manner whatsoever from the form of the input voltage waveform is distorted with respect to power to the extent of the deviation.

From this definition, it can be seen that any distortion measurement of an audio power amplifier is, in fact, a measurement of power distortion. That is, power distortion is a generalized form covering intermodulation distortion, harmonic distortion, and so on. Any amplifier that changes its power output with changing load impedance suffers from power distortion to the extent that the power output is altered. It is recognized that the relationship between power, voltage, and impedance can be expressed by the formula

$$P = \frac{E^2}{Z} \quad (1)$$

where P = power output,
 E = voltage, and
 Z = load impedance.

In test procedures using resistive loads, it can be seen that if E remains constant, the power output will remain constant. However, with variable load impedances the power output will bear an inverse relationship to the impedance.

From transducer theory, there are certain relationships between the electrical and acoustical characteristics of any speaker, and such factors as the resistance of the suspension system, the resistance of the air load, the reactance of the voice coil and cone, the reactance of the air load, and the reactance of the suspension system must be considered as affecting the total impedance of the speaker, in addition to the pure electrical impedance of the voice coil itself.

Effect of Feedback

The majority of hi-fi amplifiers employ some form of voltage feedback, but a study of equation (1) will show that if voltage remains constant there will be considerable power distortion, and it is agreed that voltage feedback tends to hold the voltage constant regardless of the load across the amplifier terminals. Thus any change in load impedance results simultaneously in an inverse power change. If electrical impedance characteristics and acoustical output characteristics of a given speaker were related in such a manner that electrical impedance peaks occurred simultaneously with acoustical peaks, the decrease in power response at the point of maximum acous-

tical output would be beneficial. However, in real speakers this condition seldom occurs.

The Powrtron circuit, Fig. 3, differs from conventional amplifiers in that it adds a small amount of negative current feedback to a usual amount of negative voltage feedback, with the result that over a reasonable range of load variations the power distortion is held to 1 db, whereas without the Powrtron feature the same amplifier shows a distortion of as much as 8 db.

Careful consideration of this will show that it is useless to attempt to control the behavior of a loudspeaker by means of a device that will sense impedance changes in the speaker, and this is exactly what is done with voltage feedback. Many other effects of voltage feedback are definitely beneficial, as is well known, but the effect on power distortion is to increase instead of decrease it.

Negative power feedback results in much less power change over a range of output loads than the other methods of operation. Positive current feedback reduces the internal impedance of power amplifiers to zero, but by so doing it increases power distortion.

The Complete Circuit

While the Powrtron circuit refers only to the addition of a single resistor in the output circuit and the connection back to a suitable point for the introduction of feedback, there are some advantages to the complete White amplifier and the method of introducing two separate kinds of feedback is simplified greatly. In Fig. 3 it will be noted that R_s and C_s constitute a usual form of negative voltage feedback. The negative current feedback is obtained from R_{g0} in the return leg of the secondary of the output transformer. The cross-coupled phase inverter, together with the direct-coupled driver stage make it possible to introduce the two different types of feedback with considerable ease. Furthermore, if a direct A-B test is desired, it is only necessary to short out R_{g0} .

Since the circuit is somewhat unique, it may bear explanation. The input is fed into a level-adjusting potentiometer and thence to the grid of V_{1a} through C_1 and the grid resistor R_g . (The use of the octal socket will be described later.) C_1 and R_g may appear unnecessary, but the slightest amount of d.c. on the grid of V_{1a} is sufficient to unbalance the operation of the entire system so C_1 is a mica capacitor—.033 μ f or larger—which has been found to be completely free from leakage. The cathode of V_{1a} is directly coupled to the grid of V_{2b} and a tap on the cathode resistor string of V_{2a} . R_s provides for a balance of d.c. voltages throughout the first three tubes—the method of adjustment being to set R_s at a point where the voltage between the plates of V_{1a} and V_{2b} is zero. The negative current feedback is connected to the grid of V_{1b} —directly out of phase with the input section—and the output of V_{1b} is fed into the phase splitter in a manner similar to that from V_{1a} . The direct coup-

Here's how to make
HIGH FIDELITY
mean what it says!

JUST OUT!



A COMPLETE GUIDE TO BETTER HIGH-FIDELITY EQUIPMENT, CIRCUITS, CONSTRUCTION, SERVICE and better results!

Get better results from "hi-fi" by having all of the facts and latest ideas at your fingertips!

This big new book by one of the nation's acknowledged experts brings you the complete "low-down" on modern sound reproduction methods and equipment. It shows exactly how to get best results at minimum cost; discusses all details of circuitry, components and equipment; covers the service angles; compares the different methods—and is chock full of how-to-do-it tips and ideas.

HIGH FIDELITY TECHNIQUES

by John H. Newitt
Staff, Mass. Inst. of Technology
494 pages, 203 illustrations
Price \$7.50

ANSWERS YOUR QUESTIONS ABOUT HI-FI

Chock full of how-to-do-it tips and ideas

Here are just a few of the subjects covered: What to look for in high-fidelity equipment—what to avoid • Getting reproduction to suit your taste • Some unusual "hi-fi" combinations • Hi-fi vs. P.A. type speakers • Matching the reproducer to its environment • Loudspeaker construction and performance • Adjusting bass-reflex cabinets • Controlling distortion • A novel horn system • Baffles • Getting rid of "overhang" • The best reproducer enclosure • Choosing a reproducer • Selecting a woofer-tweeter combination • Sound-proofing materials • How grillwork affects attenuation • Output transformer specifications and what they mean • Special hi-fi circuits • Proper crossover frequencies • Do's and don'ts of volume expansion • Practical ways to suppress noise • A good tone control • Negative feedback and how to use it • Pre-amps and equalizers • Amplifier construction hints • Judging commercial amplifiers • F-M tuners • Minimizing tuner distortion • Avoiding chatter and crosstalk • Limiter-discriminator vs. ratio detector FM circuits • All about records and record players • Selecting turntables and pick-up cartridges • Avoiding record wear • A comprehensive course in magnetic recording • Pick-up resonance, its cause and cure • Choosing a recorder • Tips for custom builders • Special installation problems • Typical "hi-fi" installations • Bass-reflex calculations and design charts • Acoustical horn design data . . . and dozens of other subjects.

Read it for 10 days AT OUR RISK! Use coupon.

**10-DAY
FREE
EXAMINATION**

Dept. AE-113, Rinehart Books, Inc., Technical Division
232 Madison Ave., New York 16, N. Y.

Send HIGH FIDELITY TECHNIQUES by Newitt for 10-day FREE examination. If I decide to keep the book, I will then remit \$7.50 plus postage. Otherwise, I will return book postpaid promptly and owe you nothing. (If you send cash with order, we pay postage—same return privilege with money refunded.)

Name

Address

City, Zone, State

OUTSIDE U.S.A.—Price \$8.00, cash only. Money back if book is returned postpaid in 10 days.

HYCOR TYPE 4201 PROGRAM EQUALIZER



- Features . . .**
- **LOW HUM PICKUP** through the use of toroid coils.
 - **Switch contact noises** are inaudible even at microphone levels.
 - **Low-frequency equalization** peaked at 40 cycles and 100 cycles in 2 db steps up to 12 db.
 - **High frequency equalization** peaked at 3 kc, 5 kc and 10 kc in 2 db steps up to 12 db.
 - **Low frequency attenuation** in 2 db steps at 100 cycles and has a maximum attenuation of 16 db.
 - **High frequency attenuation** in 2 db steps at 10 kc and has a maximum attenuation of 16 db.

\$195.00

General Specifications . . .

- DIMENSIONS:** Standard rack panel, slotted, 3½" high. Maximum depth 7½".
- CIRCUIT:** Bridged, constant impedance.
- IMPEDANCE:** 500/600 ohms, in-out.
- INSERTION LOSS:** 14 db constant.
- CONTROLS:** Low and high frequency selector switches. Low and high frequency controls in 2 db steps, in-out key.
- FINISH:** Engraved panel, medium gray baked enamel. (Special colors and finishes upon request.)

Send for Bulletin E

HYCOR SALES COMPANY
of California

11423 VANOWEN STREET
NORTH HOLLYWOOD, CALIF.

Representatives:
BEEBE ASSOCIATES
5707 W. Lake St., Chicago, Illinois
BURLINGAME ASSOCIATES
103 Lafayette St., New York City
HARRISON J. BLIND
1616 Card St., Indianapolis 24, Ind.

**STATEMENT OF THE OWNERSHIP, MANAGEMENT, AND CIRCULATION
REQUIRED BY THE ACT OF CONGRESS OF AUGUST 24, 1912, AS
AMENDED BY THE ACTS OF MARCH 3, 1933, AND JULY 2, 1946**

(Title 39, United States Code, Section 233)

of AUDIO ENGINEERING, published monthly at Lancaster, Pa., for October 1, 1953.

1. The names and address of the publisher, editor, managing editor, and business managers are: Publisher: Charles G. McProud, 204 Front St., Mineola, N. Y.; Editor: Charles G. McProud, 204 Front St., Mineola, N. Y.; Managing editor: none; Business manager: Henry A. Schober, 204 Front St., Mineola, N. Y.

2. The owner is: Radio Magazines, Inc., 204 Front St., Mineola, N. Y.; Henry A. Schober, 204 Front St., Mineola, N. Y.; Charles G. McProud, 204 Front St., Mineola, N. Y.

3. The known bondholders, mortgagees, and other security holders owning or holding 1 per cent or more of total amount of bonds, mortgages, or other securities are: none.

4. Paragraphs 2 and 3 include, in cases where the stockholder or security holder appears upon the books of the company as trustee or in any other fiduciary relation, the name of the person or corporation for whom such trustee is acting; also the statements in the two paragraphs show the affiant's full knowledge and belief as to the circumstances and conditions under which stockholders and security holders who do not appear upon the books of the company as trustees, hold stock and securities in a capacity other than that of a bona fide owner.

(Signed) HENRY A. SCHOBER, Business Manager.

Sworn to and subscribed before me this 14th day of September, 1953.

(Seal) WILLIAM E. STOLT, Notary Public.

State of New York, No. 30-9205000. Qualified in Nassau County. My term expires Mar. 30, 1954.

ling between the phase splitter section and the driver is made possible by the use of a very large cathode resistor for V_2 . It will be noted that these cathodes are about 96 volts above ground, resulting in a potential of approximately 90 volts on the plates of V_2 —this same voltage being applied to the grids of V_3 , which results in a bias of around 6 volts.

The output stage is the Ultra-Linear, which has been described heretofore.¹ In the 20-watt White amplifier, 5881's are used; in a very similar design for 10 watts output, 6V6's are used—this

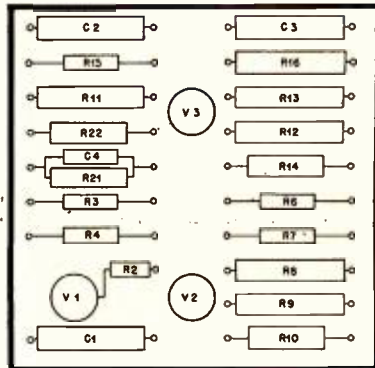

Fig. 4. Arrangement of parts on terminal board shown in Fig. 2.

latter amplifier being used with the 20-watt model to make the two-way amplifier system to be described.

The current feedback is developed across R_{20} , shown as 0.47 ohms. In construction, it is suggested that this value be obtained by the use of a 1-ohm 10-watt adjustable resistor. Slight variations in the power response characteristics may be had by changing the value of this resistor, with corresponding changes in the tonal quality of the output.

Figure 2 shows the underside of the White amplifier. Note that most of the components ahead of the output stage are located on the terminal board, which is laid out as in Fig. 4. The parts list indicates the wattages of the various resistors, as well as the types recommended.

In construction, it is suggested that the amplifier be assembled with semi-permanent connections between the driver stage and the output-tube grids, and with the negative-voltage feedback circuit— R_{21} , C_4 —disconnected. Then pass a signal through the amplifier and note whether the signal increases or decreases when R_{20} is shorted. If the signal decreases, the leads to the two output grids should be reversed, since the feedback voltage developed across R_{20} should reduce the gain, and shorting the resistor eliminates the feedback. After the correct polarity is determined, the voltage-feedback circuit R_{21} - C_4 may be connected.

¹ David Hafner and Herbert I. Keroes, "The Ultra-Linear amplifier." AUDIO ENGINEERING, Nov. 1951.

The Octal Socket

The octal socket previously mentioned provides for the insertion of an electronic dividing network ahead of the power amplifiers. With the shorting plug in place, the amplifier functions normally, and may be used to feed a single speaker, or to feed a two- or three-way system with a conventional dividing network. However, one of the advantages of the White system is that the dividing network is used ahead of the amplifiers, providing the advantage of low source impedance for the speakers. The principal disadvantage is the need for two power amplifiers, it being quite usual to use the 20-watt model for low frequencies and the 10-watt model for high frequencies.

The shorting plug simply connects the incoming signal to the input of the amplifier. However, when it is desired to use two amplifiers, the shorting plug is removed and an electronic filter unit is inserted in the socket. *Figure 5* is the schematic of the filter network, which consists of a dual triode connected as two cathode followers. Each follower feeds a filter circuit—one of low-pass configuration, and one of high-pass configuration. The low-pass output is fed to the associated amplifier, and the other output is fed to the treble amplifier. In the commercially available model, the treble output is fed through a pigtail cable, which is plugged into the second amplifier. As shown in *Fig. 3* the treble output is channeled to another phono jack, which is connected by a jumper to the second amplifier. The terminals shown are not those used in the commercial version, but are indicated for study of the circuit.

Filter-Network Advantages

The most recent trend in amplifier design has been toward increased negative feedback, using output transformers of wider and wider range and placing more and more stages inside the feedback loop. For optimum operation, all of the push-pull stages should be balanced, and maximum phase shift must be kept to less than 180 deg. inside the feedback loop if oscillation is to be avoided.

The two regions in which phase shift will occur and oscillation becomes a problem are at the extreme ends of the audio spectrum. The ideal way to design an amplifier is to keep the phase shift through the electronic section of the amplifier limited to less than 5 deg. and allow the electrical characteristics of the output transformer to determine the operating frequency of the amplifier. Unfortunately this ideal is seldom achieved.

It is well known that the reactive filter networks cause substantial distortion in the process of sound reproduction. However, the manner in which it is caused is not nearly as well known. The design of filter sections of constant-valued elements of resistance, capacitance, and inductance is standard engineering practice. However, the design

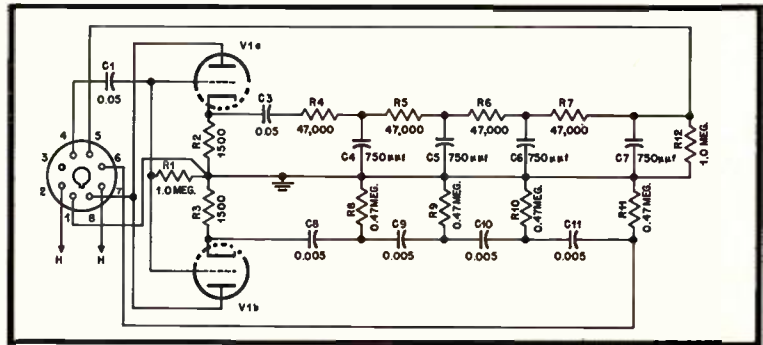

Fig. 5. Electronic filter network using a single 12AU7 as two cathode-follower sections to drive the R-C filters which comprise the dividing network ahead of the power amplifiers.

From
Station Break
to Feature ...
the NEW
"BALANCED"
TV Tripod
is doing a
whale of a job
every day!

"BALANCED"
TV TRIPOD
mounted on
3-wheel
portable
collapsible
dolly
illustrated.



We THREW THE book away and engineered a brand new "BALANCED" Tripod for every photographic and video need. The result—a revolution in effortless operation, super-smooth tilt and 360° pan action.

PERFECT BALANCE prevents mishap if the lock lever is not applied. Quick release pan handle locks into desired position. Mechanism is enclosed, rustproof, needs no lubrication. Tension adjustment for Camera Man's preference. Built-in spirit level. Telescoping extension pan handle. We defy you to get anything but the smoothest, most efficient operation out of this tripod beauty.

WE CALIBRATE LENSES . . . Precision "T" STOP CALIBRATION of all type lenses, any focal length. Our method is approved by Motion Picture Industry and Standard Committee of SMPTE. Lenses coated for photography. Special TV coating.

WE DESIGN and manufacture Lens Mounts and camera equipment for 16mm — 35mm and TV cameras.

WE RENT AND SERVICE

CAMERAS * MOVIOLAS *

DOLLIES . . . Complete line of 35mm and 16mm equipment available for rental.

MITCHELL: Standard, Hi-Speed, BNC, NC, 16mm. Bell & HOWELL: Standard, Shiftover, Eyamos. MAURER: 16mm Cameras. ARRIFLEX. MOVIOLA: Editing machines, Synchronizers.

FRANK C. ZUCKER
CAMERA EQUIPMENT CO.
1600 BROADWAY NEW YORK CITY

IF YOU WORK WITH FILM . . .

It will pay you to get to know us. The country's foremost professionals depend upon our portable, versatile, adaptable equipment.



Broadcast Utility AMPLIFIER

FOR USE AS:
Microphone Pre-Amplifier
Booster Amplifier
Cuing Amplifier, etc.

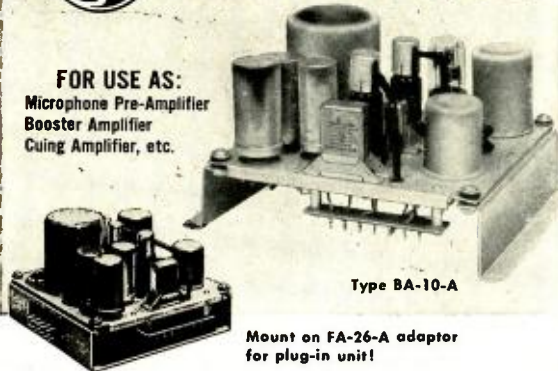

Type BA-10-A

Mount on FA-26-A adaptor
for plug-in unit!

- GAIN 50 db maximum
- FREQUENCY RESPONSE ± 1 db, 50 to 15,000 cps
- OUTPUT LEVEL -2 dbm, with $\frac{1}{2}\%$ or less distortion
- COMPACT AC operated, self-contained power supply

For information write: General Electric Company
Section 44113, Electronics Park, Syracuse, New York

GENERAL ELECTRIC

ENJOY THE FULL RICHNESS
OF FULL FREQUENCY RECORDING...

The
FAIRCHILD

SERIES 215

HIGH-COMPLIANCE

Diamond Cartridge



NOW ONLY
\$37.50

WITH FINEST
DIAMOND STYLUS

This amazing new cartridge, a radical departure from ordinary cartridge design, achieves near-zero mass of stylus assembly. The result is **HIGH COMPLIANCE**—accurate, distortion-free tracking which reproduces without listening fatigue the full, rich tonal qualities of the most sensitive recordings.

"Amazed at new purity of sound... clarity... distinctness of orchestral texture... which all add up to something fabulously beautiful!" says B. H. Haggin, noted Record Reviewer.

FAIRCHILD RECORDING EQUIPMENT:

9th Ave. & 154th St.,
Whitestone, N. Y.

Manufacturers of the World's Finest Professional Sound Equipment

ORDER FROM YOUR
AUDIO DEALER
or mail coupon for
FREE folder

Without obligation, please mail FREE folder, "HI-FI FACTS for the Music Lover"

Name.....
Address.....
City..... State.....



of filter sections capable of dealing with the variable impedance presented by a speaker is a problem of serious magnitude. The use of a dual-channel amplifier using electronic filter sections at the input of the system is deemed the best solution.

The crossover filter is constructed in a standard Vector CO-10-N turret can, making it readily interchangeable. Thus the experimenter can construct several different filter networks to determine the best operating crossover frequency for the speakers used, or by removing the network can restore the amplifier to normal operation with a minimum of effort. For the constants shown, the crossover frequency is approximately 560 cps.

In the hi-fi field the final judgement is always that of the listening test. In the case of amplifiers it is difficult to achieve a distinct improvement, but it is felt that a listening test with the crossover amplifier will give the listener just such a distinct improvement.

PARTS LIST (Fig. 3)

- C_1 .033 μ f, 1200 v. mica
- C_2, C_3 0.5 μ f, 600 v. paper
- C_4 330 μ f, 500 v. mica
- C_5, C_6, C_7 40 μ f, 500 v. elect.
- L_1 8 H, 220 ma, swinging choke
- L_2 30 H, 60 ma, smoothing choke
- R_1 0.25 meg potentiometer, audio taper
- R_2 1.0 meg, $\frac{1}{2}$ -watt, deposited carbon
- R_3, R_4, R_5
- R_6 470 ohms, 1-watt, wirewound
- R_7 200 ohms, 4-watt potentiometer, linear
- R_8, R_9 50,000 ohms, 10-watt, wirewound, matched pair
- R_{10} 1500 ohms, 5-watt, wirewound
- R_{11} 20,000 ohms, 10-watt, wirewound
- R_{12}, R_{13} 50,000 ohms, 10-watt, wirewound, matched pair
- R_{14} 500 ohms, 2-watt, wirewound
- R_{15}, R_{16} 0.15 meg, 1-watt, deposited carbon
- R_{17} 350 ohms, 10-watt, wirewound
- R_{18}, R_{19} 1000 ohms, $\frac{1}{2}$ -watt, deposited carbon
- R_{20} 1.0 ohms, 10-watt, adjustable, wirewound
- R_{21} 3000 ohms, 1-watt, wirewound
- R_{22} 20,000 ohms, 10-watt, wirewound
- T_1 Power transformer, White Sound or Chicago PCR-200, 520-0-520 v at 200 ma; 5.0 v at 2.0 a; 6.3 v at 4.5 a; potted.
- T_2 Ultra-Linear output transformer, Acro TO-300, or White Sound
- V_1, V_2, V_3 12AU7
- V_4, V_5 5881 or KT66
- V_6 5V4

PARTS LIST (Fig. 5)

- C_1, C_2 .05 μ f, 600 v. paper
- C_3, C_4, C_5
- C_7 750 μ f, 500 v. mica
- C_8, C_9, C_{10}
- C_{11} .005 μ f, 500 v. mica
- R_1, R_{11} 1.0 meg, $\frac{1}{2}$ -watt, deposited carbon
- R_2, R_3 1500 ohms, 10-watt, wirewound
- R_4, R_5, R_6 47,000 ohms, $\frac{1}{2}$ -watt, deposited carbon
- R_7 carbon
- R_8, R_9, R_{10} 0.47 meg, $\frac{1}{2}$ -watt, deposited carbon
- R_{11} carbon
- V_1 12AU7

TECHNICANA

Diagnosis of Distortion

An article with the above title, written by E. R. Wigan, appears in the June, 1953, *Wireless World*. The article is not concerned with distortion measurement but with methods of diagnosis of audio distortion, and describes a technique for such diagnosis.

A pure sine-wave signal is applied to the apparatus being tested, and is also applied simultaneously to the horizontal plates of an oscilloscope. The output signal of the tested unit is passed through a network which deletes the fundamental wave, leaving only distortion, noise and hum modulation terms. This residual signal from the network is amplified, from 30 to 100 times, and then applied to the vertical oscilloscope plates.

When the relative phase of the vertical signal is properly adjusted, the trace resulting from horizontal and vertical inputs becomes a graphical representation of the transfer characteristic of the tested apparatus, with its defects enormously magnified. The author calls this trace the "difference diagram." Although the method is not proposed as a measuring technique it is stated that the magnitude of distortion can be read with useful accuracy, and that distortion components as small as 0.1 per cent can be recognized under good conditions.

The primary use of the difference diagram, however, is in enabling the operator to diagnose the source of distortion, from direct observation of the type of non-linearity of the transfer characteristic.

Loudspeaker Efficiency

The February, 1953, issue of *Wireless World* reports on a method of calculating loudspeaker efficiency, a method which is described as simpler and more closely related to conditions of actual use than the usual techniques. The normal figures for loudspeaker efficiency are derived from free-field measurements of output sound pressure, on axis and at selected angles off the axis. For each frequency, it is stated, eighteen separate measurements are usual. Even ignoring the physical difficulties involved in taking such measurements (which include the expense of anechoic chambers), once the figures have been recorded there remains the problem of how to integrate the results. The distribution of radiated power over different axes varies with frequency and is affected by diffraction.

The new technique places the speaker in a reverberation chamber instead of in an echo-free space, the speaker and microphone situated at opposite corners of the chamber. With a known power input to the speaker (produced by a warble-tone generator), the total sound output is calculated. The integration is thus performed automatically. Corrections are applied for room absorption and for the characteristics of the microphone.

LONDON LETTER

(from page 10)

interest in radio-phonograph combinations is likely to spread across the Atlantic. Most of the larger TV manufacturers were showing radio-phonograph console units. Probably 50 per cent of these units still have the controls on the top with the lid opening

upwards. There were very few models incorporating TV.

The success of the Trix Portable Record Player has apparently encouraged many other manufacturers to bring out similar equipment, some of which now have a radio section as well as sound amplification. Probably the most novel in design was the H.M.V. portable three-speed radiogram which has three wavebands with the player section pivoted so that it is carried in a vertical position and of course played in a horizontal one. Alba showed a portable radiogram which could be operated from either batteries or Mains, a spring-driven motor being used.

Although a few tape recorders were on show, the interest in tape in Britain has not yet reached the proportions it has in the U.S.A.

For the first time at the exhibition, the E.M.I. Group devoted a large stand exclusively to records featuring the H.M.V., Columbia, Regal, Parlophone and M.G.M. brands. Thousands of photographs of recording stars were sold during the Show and record fans could hear many of their favorite artists by plugging earphones into sockets which were connected by line to 40 record changers housed in another part of the exhibition.

Although the exhibition had not the same technical interest as the British Radio Components Show which is held in April each year, it is indeed remarkable that more than a quarter of a million of the British public pay nearly 40 cents (which to them is equivalent to a dollar) to visit a public exhibition of TV, radio and records. There is nothing like this Radio Show in the U.S.A.



V-M 935HF Record Changer
936HF on metal pan
"all the music is all you hear"



LAMINATED TURNTABLE WITH PRECISION-FORMED CONCENTRICITY! (Exclusive in this price range!) Assures constant-speed operation, eliminates WOW.



FOUR-POLE, FOUR-COIL MOTOR! Another V-M exclusive feature.



TWO PLUG-IN TONE ARM HEADS! of die cast aluminum, are adaptable to these leading cartridges, GE "turn about" RPX050, GE RPX040, GE RPX041, Pickering single-play and turn-over, and Clarkstan.



triomatic®

935HF

HIGH FIDELITY RECORD CHANGER

WRITE FOR COMPLETE DATA ON THESE EXCITING, NEW, 935HF FEATURES!

PLEASE MAIL COUPON TODAY!

Learn how the V-M 935HF meets your personal and professional specifications.



GENTLE TRI-OMATIC SPINDLE! Lowers records to spindleshelf, holds them flat for silent, air-cushion drop to turntable.



V-M 45 SPINDLE included!

* Pre-amplification stage required.

ALUMINUM DIE CAST TONE ARM! a V-M exclusive, is resonance-free, counter balanced.



MUTING SWITCH for silence during change cycle.

V-M CORPORATION, BENTON HARBOR 6, MICHIGAN

Please send me all data and illustrated literature on the new V-M 935HF high fidelity record changer.

Name _____

Address _____

City _____ State _____

A NEW PRINCIPLE IN TURNTABLES! OUTSIDE IDLER DRIVE

***NON-METALLIC TABLE**
—Solid, 3/4" thick, dimensionally stable die stock—cork latex covering
—non-bell-like—never needs litting from well.

***CONSTANT SPEEDS**

33.33, 45, 78.26 — "Floating Idler" decouples motor vibration from chassis — sturdy, micro-balanced 4-pole induction motor on isolation mountings, carefully positioned for minimum hum.

Complex mechanisms are eliminated in the NEW D & R DR-12, the most significant advance in turntable design in 17 years!

A new magnitude in low noise level and IM distortion due to minimum flutter and vibration . . . all parts easily

See the NEW DR-12 at leading HI-FI dealers, or write for descriptive literature to . . . Audio Equipment Division, D & R, Ltd., 402 E. Gutierrez St., Santa Barbara, California

THE D & R DR-12, a completely new design, allowing improvements in basic engineering never before possible!

Turntable only, with standard panel mounting . . .

\$78.50

mahogany box mounting, extra

accessible, machined to professional tolerance . . . especially designed for the more exact requirements of LP record reproduction.

Acclaimed by HI-FI experts and broadcasters as the ideal combination of laboratory quality and moderate cost.

d & r LTD.

FAIR and CONVENTION

(from page 29)

Wente—for nearly 40 years with Bell Laboratories—has been in the forefront of development of sound equipment from the beginning, one of the first and most important contributions being the condenser microphone. His work with the ribbon-type light valve and many hundreds of other improvements in the sound recording field brought him the first progress medal of the Society of Motion Picture and Television Engineers.

The Society's Award, presented for meritorious service to the Society, was given to C. G. McProud, *Æ* Editor, and Fellowships were presented to C. J. LeBel, Howard A. Chinn, Chester A. Rackey, and H. E. Roys.

And with the conclusion of the 1953 Audio Fair and AES Convention, all eyes are now turned hopefully to October 13, 14, 15, and 16, 1954, for the Sixth Audio Fair—which will probably be bigger and better than the one just closed.

Colvin Joins Gates



John D. Colvin, former president of the AES, has been appointed director of engineering of Gates Radio Company, Quincy, Ill., manufacturers of broadcast equipment. Prior to joining Gates, Mr. Colvin was chief engineer of Commercial Radio Sound, Inc., New York, chief audio engineer for ABC, and systems engineer for RCA.

PATENTS

(from page 6)

2,486,208. Addition of transients—breath effects, etc. 1950

2,506,723. Mervin J. Larson, Stromberg-Carlson. Sine waves distorted for tone variations.

2,533,821. Langer, Central Commercial. Conversion of square to sawtooth waves.

Tremolo, Vibrato, etc. 1932

1,853,630. Maurice Martenot, France. Whole keyboard is slightly movable; vibration of hand on key produces vibrato.

2,040,439. Langer. Neon-lamp vibrato circuit. 1936

2,466,306. Tremolo by varying speaker field current. 1949

2,485,538. Paul H. Rowe, Mass-Rowe. Tremolo by oscillator varying grid bias of push-pull amplifier output stage.

Why LAMBDA laboratory power supplies are among the most FREQUENTLY RECOMMENDED



RACK MODEL 28
Standard rack mounting.
Panel size 5 1/4" x 19".
Weight 16 lbs.

SPECIFICATIONS:

Input: 105-125 Volts AC, 50-60 cycles, 120 watts.

DC Output: Continuously variable from 200 to 325 Volts DC regulated from 0 to 100 ma max. Either positive or negative side of supply may be grounded.

DC Voltage Regulation: Output constant to better than 1% for loads from zero to full load and line voltage variations from 105 to 125 volts.

Noise and Ripple Output: Less than 10 millivolts rms for above ratings.

AC Output: 6.3 Volts AC at 3A unregulated.

ALSO AVAILABLE NOW:
Model 28-M, with voltmeter and milliammeter.

Lambda power supplies are made by engineers who pioneered in this field and have continued to specialize in it. Used by many of the country's leading laboratories, Lambda units are recommended by them for value, versatility and dependable performance. Models for many purposes. Conservatively rated, constructed for long, trouble-free service, priced moderately. Fully guaranteed.

LAMBDA ELECTRONICS CORP.

103-02 NORTHERN BOULEVARD
CORONA 68, NEW YORK



SEND FOR NEW CATALOG. Comprehensive, authoritative, up-to-the-minute. An important addition to your powersupply reference library.

2,489,653. Donald J. Leslie. Rotating vanes in front of speaker.

1950

2,503,352. Electronic variation of tube gain.
2,534,342. Same idea as 2,485,538.

1951

2,542,065. Baldwin. Separate tremolo for each manual.
2,565,033. Played back film track has vibrato added by cyclically moving scanning light or varying speed of film.
2,580,217. French inventor. Adding "movement" to tones to simulate random frequency variations of organ pipes.

1952

2,600,870. RCA. Synthetic reverberation with stretched string and magnetic transducers.

Complete Instruments

Photoelectric
1,980,292 2,169,842

Acoustic with Pickups
1,705,395 1,901,985
2,069,204 2,300,609
2,486,545

Electromagnetic
380,035 (1897) 1,956,350

Electrostatic
Re. 21,554 Re. 22,321

Magnetic Recordings
2,549,145

Electron-tube Designs
1,190,332 1,661,058
1,911,309 Re. 20,831
2,211,540 2,233,258
2,245,337 2,254,284
2,276,390 2,294,178
2,295,524 2,301,871
2,310,429 2,478,867
2,439,497 2,497,661
2,540,727 2,544,466
2,545,665 2,562,908
2,563,477 2,568,644

Miscellaneous Patents

2,475,742. John Hays Hammond. Production of reentrant magnetic recordings.
2,491,189 and 2,491,190. Thomas H. Long, Conn. Harmonic wave analyzer.
2,538,184. Wurlitzer. Electronic pickup for piano tuning; eliminates need for rubber wedges.

AUDIO ETC.

(from page 36)

Big-Company Craft Hi-Fi

And the pay-off of this whole extraordinary situation—two water-tight lines of goods, absolutely separated in their physical existence, yet in hot competition on paper and via words—is that many of the large commercial companies have entered both sides of the Big Divide, offering lines of true craft-type equipment in the "net" or wholesale dealer area simultaneously with their commercial-type lines in the retail dealer field! This is an entirely reasonable procedure, as things now stand. There are true hi-fi component lines from GE, Stromberg Carlson, RCA and more. Some of these concerns, of course, have long been in the component business at net prices where conditions were favorable, notably GE with its reluctance pickup and the line of GE speakers. RCA's speakers have been on the net market too, though until now the fine Olsen LCIA has not been officially available through net dealers and was not seen in most hi-fi catalogues. Now, these lines have been rounded out into full-fledged craft-type hi-fi systems.

**A
CREDIT
TO YOUR
HIGH
FIDELITY
SYSTEM**

Collaro
for 7, 10, and 12
INCH RECORDS *Fully Automatic*
3-SPEED RECORD CHANGERS



Model 3/532
Intermixes 10 and 12 inch records.
List Price \$65.00

Model 3/531
Non-intermix.
List Price \$54.50

Model 3/534
Single record player.
List Price \$33.60

WOOD BASE
Mahogany Finish.
Specify Changer or Player.
List Price \$9.50

Available at
Radio Parts Jobbers,
Distributors, and
Hi-Fi Dealers

Write for complete details to:
ROCKBAR CORPORATION • 215 East 37th Street, New York 16, N. Y.

NEW WILLIAMSON TYPE

Heathkit
AMPLIFIER KIT

FEATURES

- Practically disturbanceless. Harmonic and intermodulation distortion both less than one half of 1% at 5 watts.
- Frequency response ± 1 db from 10 cycles to 100 kilocycles.
- Alter Lansing PEERLESS or ACROSOUND transformers available.
- First Williamson type Amplifier supplied with matching preamplifier.

When selecting an amplifier for the heart of a fine high-fidelity audio system, investigate the outstanding advantages offered by the Heathkit Williamson type Amplifier. Here is an amplifier that meets every high-fidelity audio requirement and makes listening to recorded music a thrilling new experience through naturally clear, lifelike reproduction of sound at all tonal levels. Wide acceptance of the Heathkit Williamson type Amplifier by the most critical purchasers clearly demonstrates that high-fidelity can be coupled with low cost. For factual information regarding the Heathkit Williamson type Amplifier, consult "CONSUMERS RESEARCH ANNUAL CUMULATIVE BULLETIN 1952-53."

This outstanding amplifier is offered with the optional choice of the ACROSOUND output transformer or the PEERLESS output transformer. ACROSOUND features ULTRA-LINEAR circuitry, which is the exclusive development of the Acro Products Company and provides a greater margin of reserve power efficiency and increases power output. PEERLESS features additional primary taps to permit the optional choice of either the extended power circuitry, now enjoying current popularity, or all of the advantages of the original Williamson type circuit.

The construction manual has been simplified to the point where even the complete novice can successfully construct the amplifier without difficulty. Write for a free catalogue containing complete specifications and schematics of the Heathkit Williamson type Amplifier.



PRICES OF VARIOUS COMBINATIONS

- W-2 Amplifier Kit (Incl. Main Amplifier with Peerless Output Transformer, Power Supply and WA-P1 Preamplifier Kit) Shipping Weight 39 lbs. Shipped express only. **\$69.50**
- W-2M Amplifier Kit (Incl. Main Amplifier with Peerless Output Transformer and Power Supply) Shipping Weight 29 lbs. Shipped express only. **\$49.75**
- W-3 Amplifier Kit (Incl. Main Amplifier with Acrosound Output Transformer, Power Supply and WA-P1 Preamplifier Kit) Shipping Weight 39 lbs. Shipped express only. **\$69.50**
- W-3M Amplifier Kit (Incl. Main Amplifier with Acrosound Output Transformer and Power Supply) Shipping Weight 29 lbs. Shipped express only. **\$49.75**
- WA-P1 Preamplifier Kit only. Shipping Weight 7 lbs. Shipped express or parcel post. **\$19.75**

HEATH COMPANY
BENTON HARBOR 25, MICH.

**For Precision Sound Measurement . . .
or High Quality Recording . . .**



- Gives You—Uniformly Dependable Response • Exceptional Calibration Stability • Laboratory-Industry Proved Performance

Wherever quality recording or accurate measurement of sound is important, Kellogg Midget Condenser Microphone meets the most exacting standards set by research and industry. For more than sixteen years its superiority has been proved through consistently reliable and stable ser-

vice. Users include sound studios, industrial plants manufacturing sound equipment, audio development laboratories, government laboratories and universities.

• Send for Full Information
—Write Dept. 27-K Today!

RESPONSE CHARACTERISTICS		
	Model A	Model B
Response Referred to 1 volt /dyne/cm ²	— 59 db	— 55 db
Flat to Within	±3 db from 20 to 11,000 cps, for closed cavity without grille.	±4 db from 20 to 15,000 cps with or without grille for perpendicular incidence in free field.



KELLOGG SWITCHBOARD AND SUPPLY COMPANY
A Division of International Telephone and Telegraph Corporation
Sales Offices: 79 W. Monroe St., Chicago 3, Illinois

Flexible! Complete. Ready-to-Use!
MASCO INTERCOM SYSTEMS

for OFFICES • HOMES • FARMS • FACTORIES
U. I. and CSA Approved • Natural Voice Reproduction
AC-DC Operation • Unbreakable Cast Aluminum Housing

ALL MASTER SYSTEMS
Up to 11 Stations
The JM-5 Master may be connected to a maximum of 5 other Masters for a total of 6 in the system, each \$45.90 List
The JM-10 may be used with up to 10 other Masters, or 11 stations in one system, each \$53.75 List

MASTER-TO-REMOTE SYSTEMS
Single Masters for Up to 10 Remotes
A JM-5 Master may be connected to a maximum of 5 JR Remotes. A JM-10 Master may be connected to up to 10 JR Remotes.
Model JM-5 Master \$45.90 List
Model JM-10 Master \$53.75 List
Model JR Remote Station \$16.20 List
Write to Factory for Catalog on Complete Line of Intercommunication Systems

MASCO SOUND EQUIPMENT
MARK SIMPSON MANUFACTURING CO., Inc.
32-28 49th Street, Long Island City 3, N.Y.

They are strictly isolated from the retail products of the same makers, from start to finish, manufacturing to final sale, nor could it be otherwise at present.

How, some who haven't heard may ask, can the companies produce craft hi-fi? The answer should delight every hi-fi maker's soul, of course, for it proves the validity of the whole craft hi-fi movement and at the same time is the best augury for its future. The big companies do set up certain sub-departments, operating on a smaller, craft-style arrangement, to make these more careful products in the craft manner. But not all. A major portion of at least one new famous-name component line is farmed out—to none other than those very concerns who have been building the craft-hi-fi business right along! No secret—you can guess the makers by the products' looks; nor is it any criticism of the big companies in question—rather, it is a tribute to their astuteness in recognizing the permanent values of craft-type small business. Again, that's us. That's audio.

It remains to tackle the question in all minds—how best can craft hi-fi meet the new barrage of commercial "hi-fi"? How can it exploit the virtues of its position?

The problem is not as simple as a plain AB. Do we need AB tests, for ourselves? They will only confirm what is inevitable—and remember that the public is not going to be able to make AB tests on present sales floors. Not without traipsing all over town, to encompass the two types of dealerships. We know, without prejudice to the commercial manufacturers, that their product is bound, under the circumstances, to be a commercial compromise with hi-fi quality. I was enthusiastic about the first such compromise, last year's pioneer Columbia 360 (E, March 1953, p. 46) because one could easily see in it imagination, enterprise and a high order of gadget-thinking, to meet the challenge of craft hi-fi in mass-product terms. The Columbia 360 started the avalanche. The others waited—and saw.

What To Do?

What is needed is not a narrow insistence on AB testing, but a clarification, for the public, of the true situation, and that by every bit of advertising and promotional persuasion that the collective audio business can summon to its aid. This is fair and honest competition—clarification vs. confusion! I'm not the one to write promotion, but these would seem to be the points that must be made, with honesty:

A. The public must understand that there are two types of equipment, representing two fundamentally unlike industrial systems. (Put it in your own words.) Without this understanding, craft hi-fi can't even begin to make its own position clear to the uninitiate. It will truly be swallowed—in confusion. What names, slogans, titles, are used to make this clear will depend on the status of the terms hi-fi and high fidelity. Up until now, that terminology has made the basic distinction—"hi-fi" equipment (craft) and "standard commercial."

B. There must be a vigorous attempt to keep the term hi-fi or high fidelity



HEAR the difference, SEE the difference
in the *Rauland* model 1826
ultra-fidelity ensemble

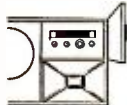

The proof of unprecedented superiority of the new RAULAND Ultra-Fidelity Ensemble is in its unmatched performance. That proof awaits you now at your Hi-Fi dealer. The Master Amplifier is of matchless quality. The unique self-powered "Libretto" Remote Control-Preamplifier, with its amazing flexibility, is an ingenious innovation. The laboratory tests are a revelation, but the ultimate proof of superiority is in the thrilling listening and operating experience. The specifications summarized below can only hint of the quality of this new dimension in sound.



the master amplifier

A truly superb instrument with frequency response of ± 0.3 db, 20 to 40,000 cps at rated 20 watts output. Harmonic distortion less than 0.5% at rated output, less than 0.3% at 10 watts. Intermodulation distortion less than 0.4% at 1 watt (home level), 0.7% at rated output (measured at 60 and 7,000 cycles 4 to 1 ratio). Output imp., 8 and 16 ohms. 4-position input selector—for magnetic pickup, crystal pickup and 2 auxiliary. Dimensions: 14" x 9" x 8" high.



the LIBRETTO remote control

A true remote control, completely self-powered and capable of operation several hundred feet from amplifier. Uniquely fashioned in the form of a luxuriously bound book (only $8\frac{3}{4}$ x 11 x 2" thick). Backbone lifts to provide easy access to tuning controls. Operates flexibly in either horizontal or vertical positions.

CONTROL FUNCTIONS

1. 6-position crossover control (flat, 150, 300, 450, 700, 1000 cycles).
2. 6-position roll-off control (flat, -5, -8, -12, -16, -24 db at 10,000 cps).
3. Volume Control—instant choice of conventional control or loudness control.
4. Bass Tone, +24 db to -20 db at 20 cps (db calibrated).
5. Treble Tone, +18 db to -30 db at 10,000 cps (db calibrated).

Custom-Engineered, Custom-Styled
For Audio Connoisseurs

See the RAULAND 1826 Ultra-Fidelity ensemble at your Hi-Fi dealer, or write for full details.



RAULAND-BORG CORPORATION
3515 W. Addison St., Dept. AD, Chicago 18, Ill.

within reasonable technical standards—though I fear it will be but partially successful; things have already gone too far. Nevertheless, the use of that term to cover sound quality that clearly is far below previously accepted standards is something we all must fight as well as we can, if only in the interests of intelligibility. Words can be killed as dead as any animal by gross mis-use.

I refer you to the statement last July from Leonard Carduner, of British Industries Corporation, headed "Let's keep the 'high' in 'high fidelity.'"* I agree entirely with his sentiments and admire the catchphrase as a good one; but I am sure that in addition to publicising hi-fi standards (granted we can reach rough agreement, which we should), there must also be a frank explanation, as in A. above, of the existence of two kinds of equipment, or—

C. It might be better policy, asserting only the affirmative values, to stress the virtues of craft hi-fi and the industrial methods behind it, leaving the existence of a competing commercial-type of equipment to clear inference.

I propose, seconding our editor, that the word craft be associated as often as possible with the use of high fidelity in the previously accepted sense. The combination of the two is surely in the way of honesty and towards the actual virtues of the hi-fi movement as it has thus far developed.

It occurs to me, on re-reading this, that it may seem a bit odd for this department to recommend steps for promotional procedure! It's not, really, for promotion when it is devoted to the propagation of the truth and to the clarification of same, is everybody's interest. The present situation is a touchy one, and any idiot—even a record reviewer—can see that its outcome depends about 90 per cent on the battle of words. I have as great an interest in good audio and, specifically, in craft-type audio, as any maker in the business, though I have no commercial connection with any of them; I'm a word-monger myself and you can't expect me to stand aside when it comes to a good fight—right in my own medium! And so—on to the battle.

* See EDITOR'S REPORT, AUDIO ENGINEERING, Sept. 1953.

SOUND HANDBOOK

(from page 28)

amplifier tubes unaffected, thereby involving a poorer signal-to-noise ratio.

Special Phonograph Circuits

Surface noise from the record, which is most annoying at the higher frequencies, may be suppressed by several methods in addition to application of the proper de-emphasis. These methods include:

1. The introduction of relatively steep cut-offs above selected frequencies. This makes it possible to reduce noise and distortion in a frequency band

MUSIC COMES ALIVE
WITH
LORENZ SPEAKERS
Matched With **KINGDOM** Cabinets



**LP-215
LORENZ
'WOOFER'
LOUDSPEAKER**

Made expressly for Kingdom Products by LORENZ, leading European Audio Manufacturer. A truly magnificent speaker and a worthy complement to the finest equipment. Performs smoothly over the full range. Natural, clean tonal quality assures complete listening pleasure at any loudness level. Features a heavy rigid frame, thick felt flange (no cardboard) to seal and damp out undesirable resonances. Response: 40—13,500 Cycles. Power: 8 watts. Impedance: 4 ohms. Size $8\frac{1}{2}$ ". Its faithful reproduction is as amazing as its exciting low price.
Net **\$22.50**

LP-65 LORENZ TWEETER

Here is the tweeter to complement any Woofer. This high frequency speaker will carry the "highs" as you want it—Clean, Clear and Crisp up to 16,000 Cycles. Power: 2.5 watts. Impedance: 5.5 ohms. Size: $2\frac{1}{2}$ " dia.
Net **\$8.50**



**HP-1 KINGDOM
HIGH PASS FILTER**
Used with the LORENZ LP-65 TWEETER it will extend the range of any speaker to the limit of human audibility, going smoothly from 4,000 CPS up to 16,000 CPS.
Net **\$4.95**



**KINGDOM
SOUND
COMBINATION**
Cabinet With
Speaker System

Illustrated is the popular KINGDOM CABINET. Small, Smart, Versatile and Decorative. Made of $\frac{3}{4}$ " thick hardwood, acoustically correct and completely assembled with LORENZ LP-215 speaker, LORENZ LP-65 TWEETER and KINGDOM HP-1 HIGH PASS FILTER (shown above). All perfectly matched to give you maximum listening pleasure at all levels. Complete Kingdom Sound Combination. Cabinet with speaker system. Size 13" x 16" x 19". Available in colors to harmonize with the following finishes:
Mahogany or Blonde...Net **\$69.50** Unfinished...Net **\$47.00**

KINGDOM CABINETS ONLY
Mahogany or Blonde...Net **\$26.95** Unfinished...Net **\$24.45**
CHAIRSIDE STAND...NET **\$6.95**

Write for Detailed Specifications

KINGDOM PRODUCTS, Ltd.
23 Park Place, New York 7, N. Y. • WOrth 4-8585
Specify Emitron KT-66

NEW SOUND SENSATION

BELL Model 3-D BINAURAL High Fidelity Amplifier



Another Bell "first"—a single high fidelity amplifier for full, masterful rendition of the new *binaural sound*! Pre-amps and special controls are all included in Model 3-D, along with three *dual* inputs for radio, tape, and hi-or-lo mag pickups (equalized for present binaural records).

Function switch lets you select operation you want—monaural (it's a conventional amplifier, too), binaural, or reverse binaural, each with or without loudness compensation. Balance control affords correction for variations from the original in pickups, speakers, or acoustics. A host of other quality features too numerous to list!

Power: 20 watts (10 watts each channel) at less than 1/2 of 1% total distortion; peak 35 watts. Freq. Response: 20 to 20,000 cycles plus or minus 1/2 db (controls set flat). Hum Level: 70 db below rated output. Dual Output Imp.: 4, 8, 16 ohms plus dual Hi-Z jacks for tape recorder. Controls: 3-position selector; 6-position function switch; balance; gain; bass; treble with AC switch. Tone controls have boost and cut.

THERE'S A LOT MORE!
WRITE FOR FREE DETAILS.



BELL SOUND Systems, Inc.

559 Marion Rd., Columbus 7, Ohio
Export Office: 401 Broadway, N. Y. 13.

IN ORDER TO FIND IT— WHY NOT BIND IT?

Your reference library of AUDIO ENGINEERING can be up-to-the-minute by ordering your binder now

APPEARANCE • CONVENIENCE
WORKMANSHIP

For only \$2.75 (Foreign orders add 50¢ per binder)

RADIO MAGAZINES, INC.
P. O. Box 629
Mineola, N. Y.

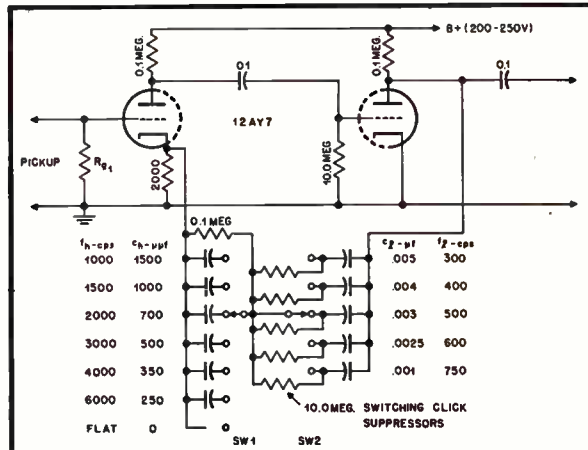

Fig. 14—11. Feedback preamplifier with variable characteristics. (After Jones.)

where there is little recorded signal. In any case the high-frequency noise reduction is achieved with minimum penalty to the signal. Steep attenuation slopes may be provided by L-R-C networks, by R-C parallel T networks,¹⁰ or by the simpler circuit of Fig. 14—13,¹¹ in which advantage is taken of the inductance of magnetic pickups.

2. "Dynamic" noise suppression.^{12, 13, 14} Here the high-frequency content of the recorded signal controls frequency discrimination, so that with little or no high-frequency signal the transmission channel is severely attenuated in the treble, while with normal high-frequency signal content the treble attenuation is instantaneously removed. In most circuits of this type the user is able to determine the amount of treble signal required to open the attenuator gate,

¹⁰ D. T. N. Williamson, "High-quality amplifier—new version," *Wireless World*, Oct., 1949, p. 365, and Nov., 1949, p. 423.

¹¹ C. G. McProud, "High-frequency equalization for magnetic pickups," *AUDIO ENGINEERING*, Sept., 1947, p. 13.

¹² H. H. Scott, "Dynamic suppression of phonograph record noise," *Electronics*, Dec., 1946, p. 92.

¹³ H. F. Olson, "Audio noise-reduction circuits," *Electronics*, Dec., 1947, p. 119.

¹⁴ C. G. McProud, "Simplified dynamic noise suppressor," *AUDIO ENGINEERING*, Aug., 1948, p. 17.

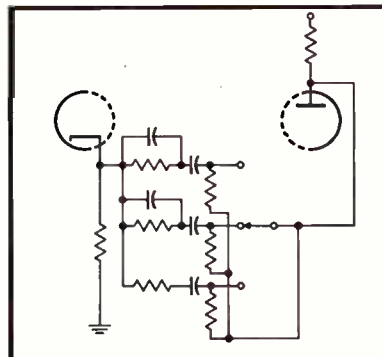

Fig. 14—12. Simplified feedback circuit for preamplifier of Fig. 14—11.

that is, to control gate sensitivity.

3. Use of a recently developed squelch circuit,¹⁵ which momentarily cuts off the signal channel when stimulated by the "pops" and "clicks" of modern plastic record surfaces. The noise pulses are distinguished from signal pulses by the fact that they have a higher energy content above about 20,000 cps. They are segregated from the signal by a high-pass 20,000-cps filter, and used to trigger the squelch circuit. It is stated that the ear is tolerant of momentary silences of less than 250 microseconds duration, and that the cumulative time taken up by the cut-off periods may be as great as one-tenth of the total program time.

Low-frequency noise from the turntable may also be a source of trouble, not only for its intrinsic annoyance, but because of the intermodulation products that may be formed with signal frequencies. A sharp cut-off high-pass filter¹⁰ may be used to attenuate low-frequency response below the useful limit of 40 cps or so.

The dynamic range of recorded or broadcast music may be increased with a *volume expander*. Use of this circuit

¹⁵ "Suppressing gramophone surface noise," (Report on a lecture by D. T. N. Williamson) *Wireless World*, July, 1953, p. 298.

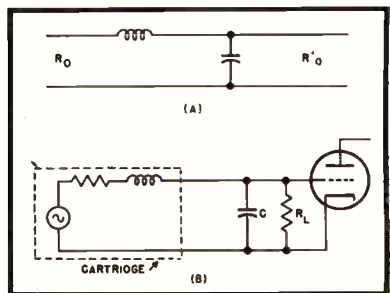

Fig. 14—13. An R-L-C filter for the price of a capacitor. Method of introducing relatively sharp high-frequency cut-offs for magnetic pickups. Design data can be found in footnote reference 11. (After McProud.)

Stereo-Magnemite*



New Portable Battery Operated STEREO-PHONIC Tape Recorder

Stereophonic field recordings can now be made with ease and assured professional results using a choice of three models operating at tape speeds of 15, 7½ and 3¾ ips. to provide frequency responses up to 15,000, 7,500, and 5,000 cycles respectively. 15 and 7½ ips. models meet primary and secondary NARTB standards for flutter, frequency response and dynamic range.

Enables stereo-enthusiasts, sound engineers, researchers, broadcasters and motion-picture producers to economically experiment and efficiently produce ideal recordings with optimum stereophonic effect.

All models measure 8½ x 11 x 10 in. and weigh 17 lbs. Employ two completely isolated channels for recording and playback. Utilize 60 kc ultrasonic bias oscillator. Provide 50 hours of operation from one economical set of standard dry cell batteries.

Incorporates governor-controlled constant speed spring-motor. Stereo-headphone monitoring while recording and playback. Overall dynamic range 50 db. Flutter less than ± 0.1%.

Stereo-cephaloid crystal or dynamic microphone available to produce diffraction and acoustic pickup pattern simulating human stereophonic hearing.

Completely battery-operated stereophonic recording-playback system easily carried and operated anywhere. Uses standard ¼ in. tape on 5 in. reels.

Write for complete technical literature and direct factory prices to Dept. AE



AMPLIFIER CORP.
of AMERICA
398 Broadway, N. Y. 13, N. Y.
*T.M. Reg. U.S. Pat. Off.

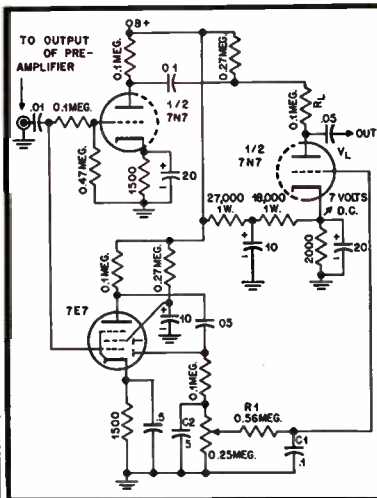

Fig. 14—14. Variable-plate-resistance volume expander. The attack time, in seconds, is the time constant ($R \times C$) of R_1 and C_1 , and the release time is the time constant of the potentiometer and C_2 plus R_2 . The potentiometer controls the amount of expansion, to a maximum of about 7 db. (After McProud.)

has declined greatly with the advent of modern LP records and FM broadcasting.

Volume expanders make use of a d.c. control voltage whose instantaneous value is a function of the average signal amplitude over a small period of time. This voltage is obtained by tapping off a part of the signal energy, amplifying and rectifying it, and then passing it through smoothing or delay networks. The delay networks are necessary so that the control voltage does not vary with individual cycles or does not respond to pulses of very short duration.

The control voltage may be used as bias for a variable μ stage, thereby causing the amplification of the tubes to increase with increased signal amplitudes, and to decrease with decreased signal amplitudes. Such a circuit has the disadvantage of introducing distortion unless the input signal is limited to very small values, of the order of 0.1 volt.

The circuit of Fig. 14—14¹⁶ illustrates a volume expander which has limited expansion but low distortion. The d.c. control voltage varies the plate resistance of V_L , a tube which acts as the lower arm of a voltage divider across which the signal is applied. Thus the signal does not actually pass through V_L , but only appears across it, with an amplitude dependent upon the instantaneous value of R_p in relation to R_L .

The delay networks for attack and decay can be made variable, although the compromise values shown are generally satisfactory. Expansion may produce very unpleasant effects when it is applied to unsuitable program material. In voice, for example, an artistic vibrato may be converted to a coarse tremolo.

¹⁶ C. G. McProud, "Experimental volume expander and scratch suppressor," AUDIO ENGINEERING, Aug., 1947, p. 13.

What's NEW in AUDIO ?



If it's NEW... TERMINAL has it! SEE! HEAR! and COMPARE! the Finest Audio Equipment at TERMINAL Completely Equipped Sound Studios...

Featuring The World's Leading Makes of High Fidelity Equipment.

- Audio Devices
- Acro • Ampex
- Astac • Altec
- Atlas Sound
- Amplifier Corp of America
- Audak • Amphol
- Brociner
- Browning
- Brook • Bell
- Bogen • Brush
- Cabnet • Centralab
- Clarkstan • Crescent
- Concertone
- Cook • Conrac
- DuoTone • Espey
- Electro-Voice
- Fisher • Fairchild
- General Electric
- General Industries
- Garrod • Gray
- Grommes
- Hallcraft
- I.R.C. • Jensen
- Karlson • Leah
- Lowel • Livingston
- Market
- McIntosh
- Minnesota Mining
- Masco • Meissner
- Magnecore
- Newcomb
- Dradio • Pickering
- Presto • Pentron
- Permoaux • Pilot
- Reeves Soundcraft
- R-J • Rex-O-Kut
- Rautand • Revere
- River Edge • R.C.A.
- Radio Craftsmen
- Recotron • Racon
- Stephens
- Stromberg Carlson
- H. H. Scott
- Sonotone • Shure
- Standard Wood
- Products
- Tech Master • Thorens
- Tapemaster
- University
- Ultrasonic
- U.T.C. • V.M.
- Webster Chicago
- Webster Electric
- Wharfedale
- Weathers



FISHER FM-AM Tuner Model 50-R



BOGEN High Fidelity Amplifier Model DB 20



GARRARD 3 Speed Automatic Record Changer Model RC-90



CONCERTONE Recorder 1502 D

The TERMINAL WAY is THE SOUND WAY to Your Audio Satisfaction!

FREE! NEW 1954 AUDIO GUIDE



Over 130 pages packed with everything you want to know about all the latest High Fidelity Audio, P. A., and Sound Equipment... The most Complete Buying Guide of its kind for Music Lovers, Audio Engineers, Professional and Industrial users of Sound Equipment. Send for Your FREE Copy NOW... Write (Dept. AE-11)

Visit Our Sound Studios

Phone: WOrth 4-3311

Terminal
RADIO CORP.
85 Cortlandt St. • New York 7, N. Y.

THE PIANO (from page 24)

What, then, determines the difference between an artist's and a tyro's interpretation of a piece? Besides a vast difference in technique, particularly as regards rapid passages, there are those subtle variations in timing that break up an otherwise machine-like procession of tones; there is the variation in loudness between successive tones and between those forming a chord, between the loudness of the right hand and the left hand.

In short, there are many ways in which an artist can vary a rendition of a piece, even though variation in tone color independent of loudness is denied to him.

Nevertheless, many pianists still believe that they can vary the tone color and not the loudness by varying the touch, although others, notably the late Paderewski, did not think so.

It is not to be inferred from the foregoing that the stance of the player, the way he holds his hands and arms and fingers, is not important. It is important in that it determines the facility with which his muscles can act; the speed with which he can play, and the length of time he can play, particularly rapidly, without tiring. But so far as touch is concerned, it appears that once a certain final velocity has been imparted to the

hammer, both the loudness and tone quality are determined; how you impart that final velocity (how you strike the key) is immaterial.

The Pedals

There is one method of affecting the tone quality that appears valid, and that is by means of the pedals. Pianos have at least two, and usually three in the case of a grand piano. These pedals have the following functions:

(1) The left pedal—the so-called soft pedal—shifts the entire action mechanism so that the hammers strike only two strings of a trichord, in the case of a grand piano. In the case of an upright piano, including the spinet, the hammers are moved closer to the strings, so that they do not acquire as high a velocity by the time they strike the strings, and thus produce a softer tone. Some grands do this too; a short cut that is considered bad practice.

A question that arises in connection with this, and that has not been investigated, is the effect of the coupling of an unstruck string or strings upon the struck string or strings. Ordinarily, when the three strings of a trichord are struck, they act like three electrical generators in parallel. Hence, they are three tuned systems coupled together through the bridge and they act as a single generator and tuned system.

When, however, only two of the three strings are struck, the effect of these two strings coupled to the third, unstruck, string may be noticeably different. In this case we have two resonant systems coupled together, and there should be a transfer of energy from one system to the other, just as in the case of that favorite physics experiment of the two pendulums both suspended from a horizontal string that serves to couple them together. If one pendulum is swung, its motion soon dies out, but at the same time the other pendulum begins to swing and attain full amplitude, while the other apparently comes to rest. Then the latter begins to swing, and the other comes to rest, and so on until all the energy is dissipated.

In the case of the strings, we might expect some similar effect, and perhaps a change in pitch. If so, the effect is very small, but may nevertheless have some effect on the tone quality.

However, another effect can be expected, and that is a diminution in sound intensity owing to the transfer of energy from the struck strings to the unstruck string, accompanied by the inevitable losses that attend such transfer. This may account in part for the lower volume when the left pedal is used, although the major reason must be the fact that only two instead of three strings were struck by the hammer. Some experiments by F. A. Saunders¹⁵ on the violin seem

¹⁵ F. A. Saunders, "Recent work on violins," *J. Acous. Soc. Am.*, Vol. 25, No. 3, 1953.

Authoritative and Enlightening . . .



*Acknowledged the Leading Publication
in the Field of Sound Reproduction*

If you are novice, hobbyist, experimenter, or engineer . . . if you are a lover of music . . . and in pursuit of sound, undistorted . . . Audio Engineering will be your faithful, reliable companion all the way. You will find no more pleasureable and stimulating reading than there is in AE; absorbingly interesting material, valuable and authentic data, workable detailed instructions . . . all comprehensively and yet practically presented.

"What to Do" and "How to Do" will guide your every move through this thrilling experience we call Audio.

Each new issue brings New Ideas, New Slants, and Latest Developments . . . month in and month out . . . twelve times a year.

BE SURE to get your copies REGULARLY.

MAIL this Coupon NOW

AUDIO ENGINEERING

Box 629, Mineola, N. Y.

Enclosed is Check Money Order for \$ _____
Please send a copy of each new issue of Audio Engineering for the next
 12 months; 24 months to:

Please Print

Name _____

Address _____

City _____ Zone _____ State _____

Subscription Price: U.S.A., possessions, and Canada: 1 year. .\$.30.00.
2 years. .\$.50.00. All other countries: 1 year. .\$.40.00. 2 years. .8.00.

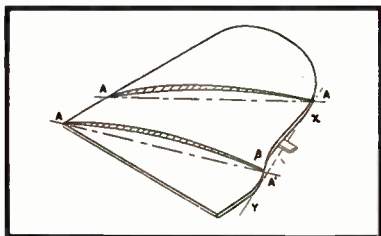

Fig. 16. Showing curvature of soundboard and taper toward edges. (Courtesy J. Acous. Soc. Am.)

to bear this out.

(2) The right pedal—sometimes erroneously called the loud pedal—is the sustaining pedal. It lifts up *all* the dampers, thus allowing lower strings to vibrate at some higher mode in sympathy with the struck string.

The effect is some change in tone quality, although not in a sense of the nature just discussed, because the coupling of remote strings via the bridge is probably negligibly small. However, the primary function of this pedal is to tie the notes of a phrase together by slurring one into the other, somewhat like playing all the notes in one bow in the case of a violin. An objection is that earlier notes still continue to be heard, so that much pedal may blur the passage. Certain pieces, like those of Bach, are often played without the use of this pedal.

(3) The middle pedal is seldom used, and often omitted in the case of an upright. Yet it can produce certain desirable effects, if the artist will only avail himself of it. If *first* a key (or keys) are struck, and then this pedal is depressed before the key is released, it will take over the function of holding that particular damper away from the string as long as it is depressed.

This is the true sostenuto pedal. In many pianos the third pedal is often the damper pedal for the bass, only. This is useful, say, in dance music, where the left hand can first play a chord in the bass, which is then sustained, while the same hand shifts to play what may be considered the second-violin part, while the right hand plays the first-violin part.

But keys struck *after* this pedal has been depressed will act in the normal manner. Hence, a tone or chord can be sustained while a phrase of notes following it is played. The latter stand apart from one another, while the first tone or chord remains sounding in the background.

Thus, besides dynamic and agogic (timing) emphasis, the performer has the pedals as an aid in interpreting the selection.

Although the music literature demands the sostenuto pedal, many of today's artists never use it, so that the importance of this pedal is decreasing. This may represent a trend that began years ago. In the Victorian era, pianos had cymbal and mandolin attachments, as well as cannon booms for playing the "Battle of Prague," as described by Mark Twain.

The Soundboard

Since the soundboard radiates the acoustic energy and helps to determine the tone quality, it can be expected that it would be the subject of much investigation. Although soundboards are normally made of spruce, they have been constructed of steel, aluminum, plywood and other woods, such as mahogany, and these materials should not be dismissed from future consideration. Much nonsense has been written in the past about the noble qualities of wood, its mellow effect upon the tone, and so on. Nevertheless, spruce does seem to be as desirable a material as any for this purpose.

An improvement in soundboard construction that has been made in the last ten years or so, is the diaphragmatic soundboard of Steinway.¹⁶ The experiments and changes were made by Paul H. Bilhuber of Steinway in collaboration with C. A. Johnson of the E. E. Free Laboratories.

Briefly, the three main changes were as follows:

(1) The soundboard was made thinner at the edges in accordance with a parabolic curve, as shown in Fig. 16 at AA. This increased the compliance at the edges about 20 per cent, and caused the soundboard to vibrate more nearly like a diaphragm, hence the term *diaphragmatic soundboard*.

(2) Owing to the crown in the soundboard after it is glued to the ribs, the portion between X and Y is in a plane higher than the rest of the edge. In the past the entire edge was glued to the top of the inner rim of the casing, which all lay in one plane. Hence, the soundboard was subjected to considerable buckling strain. The remedy was to raise the top gluing edge of the inner rim to meet the contour of the soundboard.

(3) The crown in the soundboard causes the bridge to raise the strings up at that point above a straight-line path between the agraffe and the hitch pins. This in turn causes the string to press down on the bridge and hence transmit its vibration to the bridge and associated soundboard, just like the violin and other string instruments.

However, investigation showed that the downward pressure varied from one set of strings to the next, and thus unequal buckling stresses were set up in the soundboard owing to strain. The downward pressures were accordingly readjusted in terms of a pre-determined optimum. However, this is a matter of soundboard bearing, and is no part of the diaphragmatic claims. All piano makers plane the bridges to the proper height to adjust the tone.

Tests were made with a vibration pickup set at the center of each of small squares into which the soundboard was marked off. For all notes the intensity of vibration was found to be greater, and in general a greater area of the

¹⁶ P. H. Bilhuber and C. A. Johnson, "Influence of the soundboard on piano tone quality," *J. Acous. Soc. Am.*, Vol. 11, No. 3, p. 311, 1940.

ASCO Offers Finest Professional Audio Equipment at LOW COST



FISHER HI-LO FILTER SYSTEM

America's first electronic sharp cut-off Filter System. Suppresses turntable rumble, record scratch and distortion, etc., with absolute minimum loss of frequency response. Separate low and high frequency cut-offs. Can be used with any tuner, preamplifier, amplifier, etc. No insertion loss. Uniform response. Self-powered. Beautiful plastic cabinet. Shipped prepaid.

Only \$29.95

Another FISHER FIRST PREAMPLIFIER-EQUALIZER

Same size and appearance as the Filter System above. Top-quality record equalization within every reach. Independent switches for low-frequency turnover and high frequency roll-off. 16 combinations. Handles any low level magnetic pickup. Uniform response. Two triode stages. Full low frequency equalization. Output lead any length up to 50 feet. Beautiful plastic cabinet. Shipped prepaid.

Only \$19.95



FREE! NEWEST BOOK ON HI-FI

Come in and get your copy of "Sound Advice," 148 Pages of up-to-date Hi-Fi data, by Irving Greene, famous audio-engineer . . . or send coupon enclosing 10c (or stamps) for handling.

ASCO SOUND CORP., 115 W. 45 ST., N.Y. City

Please send me copy of "SOUND ADVICE". Enclosed 10c for handling.

— FISHER HI-LO FILTER SYSTEM @ 29.95

— FISHER PREAMPLIFIER EQUALIZER @ 19.95

Total Amount Enclosed _____

NAME _____

ADDRESS _____

soundboard was set into vibration. The high notes were also benefited by this treatment, although it admittedly did not affect the radiation characteristic of the cast-iron plate.

An interesting feature was that although the tones were on the average 1.6 db louder, showing that the acoustic radiation resistance was higher, nevertheless the tones did not die out as rapidly. This indicated that the over-all damping, probably frictional within the soundboard, had been lowered to an extent that more than compensated for the increase in the (desirable) radiation resistance.

Today the soundboard is constructed by placing the spruce assembly, of initially uniform thickness, on a table that

is dished out by the proper amount. The center of the board is pressed down into the hollow of the table, so that it is now lower than the edges. The top of the board is now planed flat; this obviously produces a cross-section which tapers from the center to the edges.

The soundboard is now turned over and the process repeated. The result is that now both surfaces taper equally toward the edges. For the larger concert grands only, the area near the edges is thinned down, since this larger soundboard has inherently less stiffness and therefore tends to vibrate more freely. The soundboard, in any case, is then glued to the ribs in another specially dished out table to give it the crowned shape desired.¹⁷

It is felt that the bridge should be more closely coupled to the ribs than through the compliance of the intervening spruce soundboard. Hence, where the bridges cross each rib, a hole is drilled through the bridge, soundboard, and rib, and a maple dowel, covered with glue, inserted in this hole. Also, Baldwin uses a maple disc or grommet, which is glued into the soundboard at this point, and the dowel actually glues into it. The dowel thus acts as a pin that ties the three components together even more closely. This maple-dowel extension of the bridge, it is felt, transmits more effectively the vibrations via the ribs to all parts of the soundboard, and thus tends to make it vibrate more uniformly.

FM - TV - HI-FI



The C-12 Microphone consists of a cylindrical metal shell approximately 1 3/8" in diameter and 15-3/16" long including the connector, and contains the condenser head, a 12AY7 tube, and an output transformer, being connected to the power supply by a 65-ft. multi-conductor cable which may be extended to 600 ft. if necessary. Another cable leads from the power supply to the switch box.

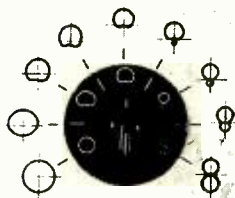

A NEW ERA IN PICKUP TECHNIQUE

The polydirectional characteristics of the microphone are controlled by a separate switch box which may be located in the control room. The sound engineer can select the most suitable pattern for each phase of the program in progress. Changes may be made during program pickup so as to adjust the microphone to the reverberation of the individual studio, or for such effects as varying the apparent distance of the artist from the microphone. Frequency response—30-15,000 cps \pm 3 db. Front-to-back discrimination (cardoid pattern)—15 db. Output level — 34 dbm for a sound field of 10 dynes per square centimeter.

Akustische und Kino-Geräte

Ges. m. b. h.

Nobilegasse 50, Vienna XV, Austria

Sole U. S. Agents

Electrovert, Inc., 489 Fifth Avenue, New York 17, N. Y.

Miscellaneous Considerations

We come now to the questions, "What are the characteristics of the piano tone?" "What is the range of audio frequencies encompassed?" and "What is the volume range?" Some work has been done on this, as might be expected.

First, some tests were made on the decay rates of piano tones by Dr. D. W. Martin¹⁸ while at RCA. The tests were made in relation to some experiments on an electronic piano, and indicated that when the soundboard was removed, there was still acoustic radiation, but it was 14 db lower. This indicates a surprising efficiency for the soundboard as a radiator. The rate of decay is approximately halved by removal of the soundboard; the effect is somewhat greater on the low tones.

A piano tone normally decays at two rates; an initially rapid rate of from 4 1/2 to as high as 80 db per sec., increasing with the pitch, and a slower decay rate after the first few seconds of tone that is normally of significance only in sustained passages and particularly where the sustaining pedal is used. The method of measurement is to employ the average rate of decay to determine the time required for the sound to decay 60 db.

Thus, for the initial slope, the time may be anywhere from 12 to 3.5 sec. for a baby grand piano, and 11 to 3.5 sec. for an upright piano, depending upon the pitch of the note. For the final decay time, the values may be from 30 sec. to 5 sec. for the baby grand piano, and 25 to 7 sec. for the upright. Above about F₅₇ (the 57th key from the bass end), the two rates merge, i.e., the initial and final rates of decay become identical.

In listening to a tone, one can note the initial and final rates of decay, and there is also noticeable an accompanying change in tone quality. This is due to different rates of decay of the partials

¹⁷ Other makers make the soundboard thinner at the edge by planing on one side, but Steinway uses straight rather than crowned ribs, which do not perhaps strain the soundboard's undersurface unduly in gluing in spite of it also being planed.

¹⁸ D. W. Martin, "Decay rates of piano tones," *J. Acous. Soc. Am.*, Vol. 19, No. 4, p. 535, 1947.

AN ACOUSTIC ACHIEVEMENT!

The incomparable

ISOTONE

Acoustic Spiral Speaker System
(patented)

Conceived and designed with imagination.

- Absolute listenableness—for the musically meticulous.
- Acoustic damping down to unity, with perfect definition throughout the entire tonal range (20 to 22,000 cps).



"THE BAROQUE"

- No mid-range boom; solid, vibrationless construction, no ringing, no hang-over whatever; just clear, smooth, natural reproduction. The ISOTONE definitely sets the limit to the approach to tonal perfection.
- Patrician cabinetry, hand-rubbed; Blonde Oak (9 cu. ft.) or polished mahogany (15 cu. ft.).



"THE RONDINO"

See your distributor or write for information to:

ISOTONE

Acoustic Spiralways, Inc.,
666 East 164th Street, Suite 10,
New York 56, N. Y. Phone: ORegon 3-0283

or overtones in the notes; they are greater for the higher partials. In general, the partials of the higher notes decay much more rapidly than those of the lower notes, thus giving rise to the less pleasing tones of the higher notes.

Similar results were noted by Schuck and Young.⁵ There are also fluctuations in the amplitudes of the partials with time which may be due to rotation of the plane of vibration of the string, as well as possible transfer of energy from one mode to another. It was also noted that the initial build-up of the tone exceeded the speed of recording of the high-speed level recorder, which is nominally 50 db/sec., and is of course due to the sudden impact of the hammer.

A series of tests were made by Sivian, Dunn and White,¹⁹ of the Bell Telephone Laboratories, to determine the peak amplitudes of various musical instruments, and also their combination in an orchestra, both over the entire range, and in different parts of the spectrum.

We are particularly interested in the results obtained for the piano. An average of three different methods of calculation would indicate a peak power output of 267 milliwatts, taken from measurements made at 1/8-second intervals. This corresponds roughly to a short musical note, the "musical syllable." These tests were made using a reproducing mechanism and a music roll. Further tests using an actual artist showed a maximum peak output of about 2 watts.

Most of the peaks are concentrated in the 250 to 500-cps band, of practically the same amplitude as those of the whole spectrum. Furthermore, peak power—as measured over the entire spectrum—occurs for about 16 per cent of the measuring intervals. Peak power—as measured over the 250 to 500-cps band—occurred in one measurement for 7 per cent of the time; in another measurement, for 14 per cent of the time.

There are, of course, components in the higher and lower ranges of the spectrum. For example, in the 4000 to 5600 cps band, some energy is present, but it is about 55 db down as compared to the average value. Similarly, in the 5600 to 8000-cps band, the energy is about 55 db or so down compared to the average value, and occasionally, in the 8000 to infinity band, energy but 40 db down may be encountered. Nevertheless, in recording, quite satisfactory results can be obtained using a band width of but 6000 cps or so; the piano does not seem to require the extreme frequency range that, say, the cymbals or even a violin might require.

What about the character of the piano tone itself? An interesting discussion by Fletcher²⁰ has bearing on this ques-

¹⁹ L. J. Sivian, H. K. Dunn, and S. D. White, "Absolute amplitudes and spectra of certain musical instruments and orchestras." *J. Acous. Soc. Am.*, Vol. 2, No. 3, 1931.

²⁰ Harvey Fletcher, "The pitch, loudness, and quality of musical tones," *Amer. J. Phys.*, Vol. 14, pp. 215-225, July-August 1946.

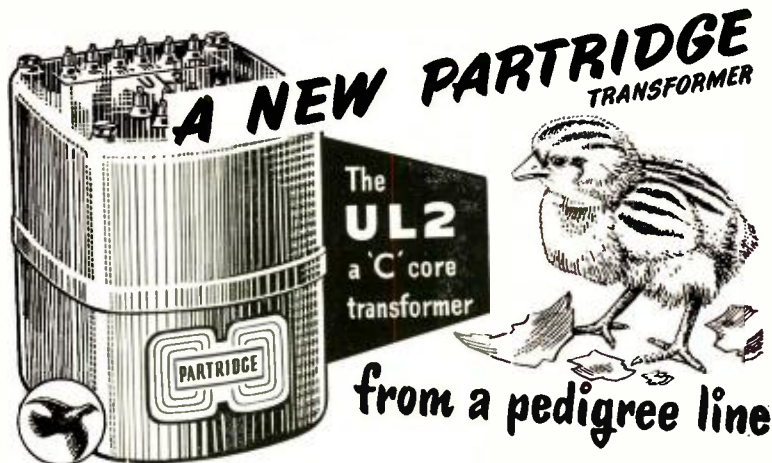

A NEW PARTRIDGE TRANSFORMER

The **UL2** a 'C' core transformer

from a pedigree line

Some salient characteristics:—

REFERRED PRIMARY LOADING. The standard models cover the requirements of all popular tubes. Each half primary is brought out separately to posts and is tapped at 43% of the turns.

POWER RATING. Peak 50 watts at 60 c.p.s. or 14 watts at 30 c.p.s. for less than 0.5% harmonic distortion without feedback.

LEAKAGE INDUCTANCE . . . 10 mH. SELF CAPACITY . . . 500 pF. full primary.

. . . and it's **AVAILABLE NOW!** from your usual jobber; if in difficulty write direct—we'll see you are supplied without delay.

NOW for \$25 duty paid you can have this p.p. transformer specifically designed for really high-quality audio equipment. Having an extended frequency range and low harmonic distortion it enables a large measure of N.F.B. to be taken from the secondary circuit and applied three or four stages back. The superlative properties of the latest strip wound grain orientated material are used to the maximum advantage. The unit is hermetically sealed in a deep drawn case of purposeful design.

Ask for Technical Data . . . mailed free on request.

PARTRIDGE TRANSFORMERS LTD
TOLWORTH . . . SURREY . . . ENGLAND

the people who know
come to **LAFAYETTE**
PILOT CUSTOM COMPONENTS IN STOCK!

FM-607 FM PILOTUNER

\$59.50



8 tubes incl. Rectifier with two stage audio Amplifier and Cathode Follower Output for use with up to 100 feet of connecting cable. Audio Distortion .2% at 1 volt output, Frequency Response ± .5DB, 20 to 20,000 cycles. Sensitivity 5 microvolts for 20DB quieting with hum level 70DB below 1 volt. Slide Rule dial with illuminated scale and self-contained front panel assembly with beautiful gold finish enables unit to be left open on shelf or easily mounted in cabinet. Three simple controls: On-Off Volume; Selector Switch for FM, FM with AFC, or Phono; and Tuning. Built-in line cord antenna.

Famous Williamson type MODEL AA-903 AMPLIFIER

with built-in pre-amplifier

\$69.50

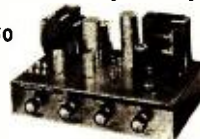

Williamson type 10 watt Amplifier. 7 tubes including Rectifier with push-pull output tubes. Controls are mounted behind decorative front panel which may be easily removed for cabinet installation, and include On-Off Volume, separate Bass and Treble Controls and Equalizer selector switch for LP, NAB, AES and Foreign Recordings. Frequency Response ± 1DB 15 to 40,000 cycles. Distortion less than 1%. Hum level 70DB below 1 volt. Three inputs are provided for Radio and Auxiliary equipment and one input is provided with adjustable impedance for matching the various magnetic cartridges.

Lafayette
RADIO
HIGH FIDELITY HEADQUARTERS

NEW YORK 13, N. Y., 100 Sixth Ave., REctor 2-8600
BOSTON 10, MASS., 110 Federal St., HUbbard 2-7850
NEWARK 2, N. J., 24 Central Ave., MArket 2-1661
PLAINFIELD, N. J., 139 W. 2nd St., PLainfield 6-4718
BRONX 58, N. Y., 542 E. Fordham Rd., FOrdham 7-8813

SAVE
33 1/3%



This is our
GROUP SUBSCRIPTION PLAN

You and your friends and co-workers can now save up to \$1.00 on each subscription to AUDIO ENGINEERING. The more men in a Group, the more each saves. If you send 6 or more subscriptions for the U.S.A., and Canada, they will cost each subscriber \$2.00, 1/3 less than the price of a regular 1-year subscription. Present subscriptions may be renewed or extended as part of a Group.

AUDIO ENGINEERING is still
the only publication devoted
entirely to

- Audio
- Broadcasting equipment
- Acoustics
- Home reproduction systems
- Recording
- PA systems
- Psychoacoustics

(Please print)

Name
Address
Position Company

Name
Address
Position Company

Name
Address
Position Company

Name
Address
Position Company

Name
Address
Position Company

Name
Address
Position Company

U. S., Possessions, and Canada only.

RADIO MAGAZINES, INC.
P. O. Box 629, Mineola, N. Y.

Fig. 17. Build-up and decay characteristics of organ and piano tones.

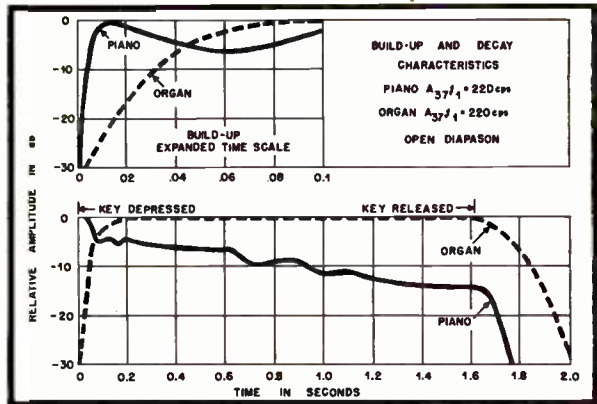

tion. The six physical aspects of a musical tone are its intensity, its fundamental frequency, its overtone structure, its duration, its growth and decay time pattern, and its vibrato. The latter is of no concern in the case of the piano.

In Fig. 17 is shown the manner in which a piano and an organ tone build up and decay. The upper graph shows that the piano tone builds up to its maximum in about 0.01 sec., whereas the organ tone takes about 10 to 100 times as long to build up. The decay time for the piano, or rather the time required to extinguish the tone after the key is released, is about 0.1 sec. or about the same as the organ build-up time. Hence, it is not surprising to find that a recording of a piano tone, when played in reverse, sounds like an organ tone. The abrupt build-up now becomes the decay time, and merely makes the tone sound like an organ played staccato.

The loudness of a musical tone, such as that of the piano, depends upon the duration, if it is less than 1/4 sec. For tones of longer duration than this, the loudness is unaffected. Since most musical tones have durations in excess of 1/4 sec., we can expect the loudness to be independent of the duration for most tones that are used in music.²¹

It will be of interest to conclude this discussion with the overtone structure for the piano tone C_{28} for which the frequency is 131 cps. Fletcher gives it the notation shown

$$S \rightarrow \frac{1}{0}, \frac{2}{3}, \frac{3}{10}, \frac{4}{9}, \frac{5}{17}, \frac{6}{5}, \frac{7}{17}, \frac{8}{10}, \frac{9}{19}, \frac{10}{19}, \frac{11}{15}$$

The top number in each case represents the overtone: 1 is the fundamental; 2 is the second harmonic and so on. The corresponding lower number represents the number of db this overtone is below the fundamental. Thus, the second harmonic is 3 db below the fundamental (which is of course 0 db below itself); the third harmonic is 10 db below the fundamental, and so on. Actually, however, the structure changes to an appreciable degree with the intensity.

²¹ However, some of Chopin's Etudes, such as Op. 10 and Op. 75, have a sequence of from 400 to 600 notes per minute, so that each note lasts but 1/10 second.

Acknowledgements

In concluding this article, it is a pleasure to acknowledge the help and cooperation of several people. Mr. Theodore D. Steinway, Chief Engineer, not only took the writer through the Steinway factory and showed him the various processes, but discussed very frankly some of their manufacturing techniques and thoughts about piano design and construction. He also suggested some of the books mentioned in the bibliography, and kindly agreed to read this article for accuracy of technical content, particularly where it concerned the Steinway piano.

The rather complete bibliography of articles from the *Journal of the Acoustical Society of America* was very generously furnished by Dr. D. W. Martin, Supervisor of Acoustical Engineering for the Baldwin Company. He and Mr. J. F. Jordan, Chief Engineer of the Baldwin Company, also discussed many of the technical problems involved, and furnished the writer with many interesting and pertinent technical concepts concerning the piano, as well as agreed to review this article for technical soundness of presentation. In addition, Mr. J. M. E. Mixter and Mr. T. M. Wulsin were very cooperative in furnishing the literature and illustrations so necessary for this exposition. Finally, acknowledgment must be made of the many helpful discussions the writer had with Mr. Walter A. Anderson, who must be an excellent piano tuner, since he knows so much about the piano.

BIBLIOGRAPHY

C. H. Hickman, "A spark chronograph developed for measuring intensity of percussion tones," *J. Acous. Soc. Am.*, Vol. 1, p. 138, 1929.
C. E. Seashore, "The piano camera," *J. Acous. Soc. Am.*, Vol. 2, p. 76, 1930.
G. F. H. Harker, "Principles underlying the tuning of keyboard instruments to equal temperament," *J. Acous. Soc. Am.*, Vol. 8, p. 243, 1937.
W. B. White, "Practical tests for determining the accuracy of piano tuning," *J. Acous. Soc. Am.*, Vol. 9, p. 47, 1937.
J. DeBremaeker, "A new method for tuning pianos," *J. Acous. Soc. Am.*, Vol. 10, p. 155, 1938.
Shankland and Coltman, "Departure of the overtones of a vibrating wire

from the true harmonic series," *J. Acous. Soc. Am.*, Vol. 10, p. 161, 1939.
 W. B. White, "New system of tuning pianos," *J. Acous. Soc. Am.*, Vol. 10, p. 246, 1939.
 C. Williamson, "Design for a keyboard instrument in just intonation," *J. Acous. Soc. Am.*, Vol. 11, p. 216, 1939.
 W. B. White, "Mean-tone temperament," *J. Acous. Soc. Am.*, Vol. 15, p. 12, 1943.
 Schuck and Young, "Observations on the

vibrations of piano strings," *J. Acous. Soc. Am.*, Vol. 15, p. 1, 1943.
 R. W. Young, "Influence of humidity on the tuning of a piano," *J. Acous. Soc. Am.*, Vol. 21, p. 580, 1949.
 von J. Goebel, "*Grundzüge des Modernen Klavierbaues*," 4th Ed., Leipzig, 1952: Fachbuchverlag G.M.B.H.
 Herbert Junghanns, "*Der Piano-und Flugelbau*," Berlin, 1952: Otto Krause, W 30 Lindauer, Strasse II.

MAKE YOUR OWN WOOFER

(from page 19)

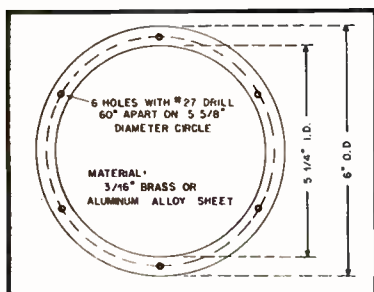

Fig. 4. Details of spider clamping ring.

eter will be approximately $6\frac{7}{8}$ in.

7. With the ring still in the lathe, enlarge the center hole to $2\frac{5}{8}$ in. inside diameter.

8. Transfer the terminal strip for the voice-coil leads to the new basket.

9. Press the iron ring into the circular groove in the new basket, making sure that the four $9/32$ -in. holes near the periphery of the ring line up with the corresponding holes in the basket.

10. Apply a coating of good speaker cement to the back rim of the new cone and the recessed rim of the new basket.

11. Set the cone into the basket, in approximately its normal position. Quickly assemble the spider and its clamping ring, with the six $6/32$ screws. Insert the screws so that the heads are in the recesses in the rear surface of the basket. Use a split lock-washer and nut on the threaded end washer under each screw head. Put a of the screw after it is in place.

12. Insert the fishpaper shims, provided with the new cone assembly, into the gap between the iron ring and the outside of the voice coil. With the voice coil thus roughly centered, tighten the screws that hold the clamping ring and spider.

13. Press the edge of the cone into place around the edge of the basket. Allow the cement to dry for about ten minutes; then smear on another layer of cement and add the felt quadrants which are also provided with the new cone assembly.

14. Lay the new cone and basket assembly face down on a flat surface, put a few books on top of it, and allow the cement to dry for at least four hours. Remove the fishpaper shims.

15. Slide the cone and basket assembly

into the magnetic structure, being careful to retain the brass spacer in place around the center polepiece. Insert and tighten the four $1/4$ -in. bolts, which were removed in step 1.

16. Solder the voice coil leads to the terminals on the terminal strip, using care to keep the soldering iron away from the cone.

17. Loosen the six screws holding the spider clamping ring, insert three of the shims 120 deg. apart in the gap between the voice coil and the center polepiece, and tighten the screws holding the clamping ring.

18. Set the speaker on the wood block; mark, drill, and countersink (from the bottom) the four holes required, and attach the unit to the wood base. The speaker is now ready to be mounted in its enclosure.

The field coil requires 35 watts of well-filtered d.c. The Capehart units were usually wound to 400 ohms resistance, and a selenium or germanium diode full-wave bridge rectifier, operating without a transformer directly across the 115-volt line, together with a choke coil and two 80 - μ f electrolytics, will make a good field exciter for a 400-ohm field.

The efficiency of this speaker is high. It is about 2 db lower than the current model Jensen units using these cones, but it is several db higher than other 15- and 18-inch woofers now available.

This unit should be used only as the low-frequency radiator in a 2-, 3-, or 4-way system. The frequency response curve, Fig. 1, indicates an optimum crossover frequency of 400 cps, for the cone is working as a piston only up to this point. A crossover frequency as high as 800 cps may be used, but in general this is not desirable, for frequencies above 400 cps begin to give "presence" and localize the source.

PARTS LIST

- 1 Capehart (Jensen) 14-inch speaker
- 1 Jensen 18-inch cast aluminum basket
- 1 Jensen 18-inch woofer cone, #2248-2
- 1 spider clamping ring, made as per Fig. 4
- 1 hardwood block, approx. $14 \times 6\frac{1}{2} \times 2\frac{1}{2}$ in. thick
- 6 RHNP brass machine screws, $6/32$ by $1/2$ in. long, with 1 nut and 2 split lock-washers each
- 4 steel hex head bolts, $1/4$ -28, $2\frac{1}{2}$ in. long, with nuts and split lockwashers
- 1 tube speaker cement

RIDER'S "BEST SELLERS" for SOUND from A to Z

GUIDE TO AUDIO REPRODUCTION

by David Fidelman

Here's an a to z explanation of the reproduction of sound . . . from the fundamentals to all phases of audio reproduction systems. Design, construction and assembly of these systems and their components. Comprehensive methods for testing individual units. Explanation of circuitry of pre-amplifiers and amplifiers. Complete discussion of pick-up devices (phono cartridges, tuners and microphones), loudspeakers and enclosures. Charts, tables and graphs keep mathematics to a minimum. Engineers will value the book for design charts and testing methods. Practical circuits for home or custom construction enable building of systems tailor-made to individual needs. **ONLY \$3.50**

HIGH FIDELITY SIMPLIFIED

by H. D. Weller

LIFE magazine's June 15, 1953 issue reported enthusiastically how "High Fidelity Simplified"—the only book quoted—explains the complete HI-FI story. RADIO-Television News stated: "Those planning high fidelity music systems for their homes will save themselves time, money and trouble by reading this first, then making purchases.

Typical Chapters: Sound!; Acoustics, Electronics and Music; The Simple Loudspeaker; The High-Fidelity Loudspeaker; Loudspeaker Enclosures; The Basic Amplifier; The Amplifier—Part 2; The Record Player; The Tuner; Use of the Music System; Tape Recorders.

ONLY \$2.50

OBTAINING AND INTERPRETING TEST SCOPE TRACES

by John F. Rider

People interested in audio will welcome this book which shows over 500 actual photographs of test scope traces. Complete explanation of how to use scopes and what test traces mean. Valuable for audio systems and test equipment and also for TV receivers, and FM and AM receivers. Specific test equipment set-ups are shown with each application. There is no other book like it! Typical Chapters: What's in a Scope; Getting Familiar with the Scope; Auxiliary Test Equipment for the Scope; Using the Scope for Checking Test Equipment; Checking Audio Systems With the Scope; the Scope's use in Checking Components, and four other chapters. **ONLY \$2.40**

Buy these books now from your Jobber, local bookstore or, if unavailable from these sources, write to:

JOHN F. RIDER
 PUBLISHER, INC.

480 Canal Street, New York 13, N. Y.

Altec — V-M — Brook — Bell — Jensen
 Fairchild — Hi-Fi — Electro-Voice — Parlo — Scott — Stephens — McIntosh — Pilot — Weathers — Tannoy
 Melaner — Superhzer — Rek-O-Kut — Hollywood — National — Fisher — Reciner — IzapMaster — Garrard

TEXAS-TV

"Southwest Sound Hp."



FISHER 50F CUT-OFF FILTER
 First all-electronic sharp cut-off filter system. Suppresses rumble, surface noise, frequency distortion. Self-powered, all triode, can be used with any magnetic cartridge. Two independent high- and low-frequency cut-off's with 16 possible combinations net **\$29.95**

FISHER 50PR PRE-AMP EQUALIZER
 First low-cost high-quality equalizer for use with any low-level magnetic cartridge. Self-powered, all triode. Has two independent switches for low-frequency turnover and high-frequency roll-off, offering 16 possible combinations. net **\$19.95**

KLIPSCH CORNER HORN ENCLOSURE
 A true Klipsch Rebel IV Corner Horn kit for single or two-way systems. Everything included. Easily assembled in a few minutes. For 12-inch speakers, net **\$38.85**

For prompt personal attention, write Jeff Smith at

TEXAS-TV

506 W. Hildebrand Avenue
 San Antonio 12, Texas

Clarkstan — University — Ampex — Cabinet

Demand for Jim Lansing High Fidelity Sound Systems greater than supply

If you have tried to purchase a Jim Lansing High Fidelity Sound System recently, you know that many models are not currently available. There are two good reasons for this situation. (1) More and more people are learning to appreciate true high fidelity music reproduction, resulting in greater demand for Jim Lansing systems, and (2) the motion picture industry has tremendously increased its demand for Jim Lansing equipment for use in the new 3-D stereophonic sound systems.

Fortunately, the shortage is temporary. Production schedules have been trebled on all Jim Lansing equipment. Knowing your patience will be rewarded, we urge you not to accept a substitute. Your favorite Jim Lansing system will soon be available.

William H. Thomas
 William H. Thomas, President,
 James B. Lansing Sound, Inc.

Jim Lansing

2439 FLETCHER DRIVE
 LOS ANGELES 39, CALIF.



A MONTHLY SUMMARY of product developments and price changes of radio electronic-television parts and equipment, supplied by United Catalog Publishers, Inc., 110 Lafayette Street, New York City, publishers of Radio's Master. These REPORTS will keep you up-to-date in this ever-changing industry. They will also help you to buy and specify to best advantage. A complete description of most products will be found in the Official Buying Guide. Radio's Master—available through local radio parts wholesalers.

Recording Equipment, Speakers, Amplifiers, Needles, Tape

ALTEC LANSING—Decreased price on Model "800" speaker system to \$340.00 net.

ELECTRO-VOICE—Increased price on model 848 Compound Diffraction Projector Loudspeaker System to \$39.00 net.

HALLICRAFTERS CO.—Increased price on Model SX-71 Double Conversion Receiver to \$249.95 amateur net.

KARLSON ASSOCIATES—Added Model 15PU rough plywood loudspeaker enclosure at \$75.00 net. Discontinued Model 15P rough plywood loudspeaker enclosure.

PACIFIC TRANSDUCER—Model 271 sapphires needle decreased to \$0.75 net.

PAR METAL PRODUCTS—Discontinued transmitter chassis Models 20183, 20184, 26222, 26223, 26224.

PENTRON—Increased price on Model 9-73C portable multiplex tape recorder to \$139.50 net.

PERMOFLUX CORP.—Added new series of Super-Royal speakers.

RECORDING WIRE & TAPE—Added Jiffy Tape Base at \$21.60 net. Increased prices on 7-in. Magna-Reel Chest to \$4.02 net; 5-in. Magna-Reel Chest to \$3.36 net.

V-M CORP.—Discontinued Model 150 manual 3-speed phonograph.

Test Equipment

INDUSTRIAL TELEVISION—Increased price on Model IT-105RB field strength meter to \$114.95 net.

RADIO CITY PRODUCTS—Added Model 655 electronic peak-to-peak vacuum-tube voltmeter at \$59.50 net.

TELCOA (Professional Audio Equipment Exchange Division) We sell all types of new guaranteed audio equipment. Highest trade-in values throughout the world. Increasingly liberal trade-in allowances with cumulative purchases. Azurelee Dome, Malibu, California. GLOBE 6-2611.

FOR SALE: Altec-Lansing 602A. used one month, \$90. C. W. Ostenburg, 1925 Lowell, Butte, Montana.

MAGNECORD PT7-P three-channel amplifier with PT63-AH mechanism, \$800 value, excellent condition. \$525. Russell Burnett, P. O. Box 3571, Miami, Florida.

SELL: Altec 604C speaker, network, original crate, new \$130. Wm. Tannenbaum, 160 Bennett Ave., New York 33, N. Y. TOMPKINS 7-1698.

FOR SALE: Meissner 9-1091 AM-FM tuner in excellent condition. Cost \$205: best offer. S. Kalman, 95 W. Palisade Ave., Englewood, N. J.

FOR SALE: Concertone 1401 tape recorder including footage counter, console tray with built-in 6 x 9 oval speaker and cooling fan, and reel adaptors. Pete Helfrich, Wescoesville R. # 1, Pa. \$245, or best offer.

FOR CANADIANS
FISHER model 60-R tuner, 60-A amplifier, 60-AP power supply; recently overhauled, adjusted and new tubes by Fisher factory service, \$275. **JENSEN** model G-610 15-in. triaxial speaker installed in Jensen back-loading folder horn cabinet; as good as new, \$300. **ALTEC-LANSING** model 604 15-in. coaxial speaker in their bass-reflex cabinet, \$150. All securely crated, FOB my express office. Donald Ellis, Port Williams, Nova Scotia.

CLASSIFIED

Rate: 10¢ per word per insertion for noncommercial advertisements; 25¢ per word for commercial advertisements. Rates are net, and no discounts will be allowed. Copy must be accompanied by remittance in full, and must reach the New York office by the first of the month preceding the date of issue.

THE AUDIO EXCHANGE INC. buys and sells quality high-fidelity sound systems and components. Guaranteed used and new equipment. Catalogue, Dept. AE, 159-19 Hillside Ave., Jamaica 32, N. Y. Telephone OL 8-0445.

Audiophiles wanted for part or full time work. Technical or secretarial experience desirable. Location: North Suburban Philadelphia. Send resume of education and experience to Box CV-1, AUDIO ENGINEERING.

RECORDS 25% OFF

All long plays and 45 r.p.m. Albums new. No exceptions. Order records wanted, mailed C.O.D. Or write for free catalog. Mail Order Record Company, Studio B-13, 570 N. Gay St., Baltimore 2, Md.

ATTENTION Custom Installers, Servicemen. Buy Diamond styl direct from manufacturer. Other interesting items. Write on business letterhead. Box A, 217 Riverdale Ave., Yonkers, N. Y.

FOR SALE: Stephens driver 216, latest model, like new. Box CV-2, AUDIO ENGINEERING.

STEPHENS P-63HF-SD speaker unit, 600 cps crossover, 40-watt capacity, perfect condition, mahogany period cabinet, \$325. 106A3 like new, \$100. Hammond Novachord Electronic Organ, perfect, \$750. Roland Bond, 6255 Desco Drive, Dallas 25, Texas.

RCA Folded Low-Frequency Horn. If you want the best bass reproduction in town (down to 16 cps) that will make any speaker under \$1000 sound sad and you have the room (I don't)—this is it. Size 30" x 40" x 8 ft. This is a true folded horn—not bass reflex. Made for movie studio monitoring. Must sell, either horn alone or with two RCA 15" woofers. Make offer. CANAL 6-3284 (N. Y.)

SELL: MINIFON pocket wire recorder, brand new, accessories, Net \$315, will sell for \$200 or exchange for '53 Revere Tape Recorder. Soehngen, B-465, RRR, Dayton 3, Ohio.

SELL: New Western Electric 728B speakers \$38, express extra. Dwight Pentecost, 826 Cricket Ave., Ardmore, Pa.

EXPERIMENTER'S LIQUIDATION

Shalleross 638-1 Kelvin-Wheatstone bridge. .0001 to 11,110,000 ohms with power supply like new; cost \$200, take \$100. RCA 170A Audio Chanalyst, d.c. and a.c. volts, electronic volt-ohm meter, variable and sweep oscillator, impedance measurement, 4-stage amplifier, speaker, etc. Finest and most complete audio checking instrument on the market, like new; cost \$450, take \$125. RCA WV-70A Audio Voltmeter, NEW, 1 millivolt to 1000 dc volts in 11 ranges, db range 0-120 in 11 ranges; frequency response of built-in amplifier flat ± 0.5 db from 20-20,000 cps; accuracy better than 5% over entire voltage range; cost \$165, take \$65. RCA MI-12188 70-watt power amplifier, virtually flat 20-20,000 cps, distortion less than 3% from 50-15,000 cps at 70 watts output; built for hard usage. Cost \$185; take \$90. Any of the above shipped prepaid to you anywhere in the U.S.A. Adolph Hoefler, 8330 Kingsbury, Clayton 24, Mo.

WILLIAMSON Amplifiers—buy direct from factory and save 50%. Prices start at \$66. Send postcard for list. Long Island Sound Co., 19 Bennett Place, Amityville, N. Y.

WANTED: Presto 10A turntable mechanism. Schneider, 592 Corsicana Dr., Oxnard, Calif.

REK-O-KUT G-2, 16" transcription turntable, brand new, never used, \$85. Call NY-BURG. PLAZA 9-5726 (N. Y.)

HEAVIEST DUTY of all Williamson Amplifiers, now with the Pedersen PRT-1 Preamp. Nicely Associates, Kenton, Ohio.

30% DISCOUNT on factory-fresh, guaranteed LP records. Send card for catalogue and literature. SOUTHWEST RECORD SALES, Dept. AE, 4710 Caroline, Houston 4, Texas.

PROFESSIONAL DIRECTORY

Custom-Built Equipment

U. S. Recording Co.

1121 Vermont Ave., Washington 5, D. C.
LIncola 3-2705

"EVERYTHING IN HIGH FIDELITY"

From Primary Components
to Completed Custom Audio Equipment

KIERULFF

Sound Corp.

820 West Olympic Blvd. • Los Angeles 15, Calif.
Richmond 7-0271 Zenith 0271

"WE HAVE IT"

HI-FI COMPONENTS EXCLUSIVELY

HOLLYWOOD ELECTRONICS

7460 MELROSE AVE.
HOLLYWOOD 46
CALIFORNIA
WEBSTER 3-8208

FULL DIMENSIONAL SOUND



THE ULTIMATE IN

HIGH FIDELITY RECORDING



Look for this symbol on record albums you buy

IF YOU ARE MOVING

Please notify our Circulation Department at least 5 weeks in advance. The Post Office does not forward magazines sent to wrong destinations unless you pay additional postage, and we can NOT duplicate copies sent to you once. To save yourself, us, and the Post Office a headache, won't you please cooperate? When notifying us, please give your old address and your new address.

Circulation Department
RADIO MAGAZINES, INC.
P. O. Box 629 Mineola, N. Y.

You got troubles? Let us fix them!

COMPETENT ENGINEERS
FULLY-EQUIPPED AUDIO
LABORATORY

Distortion, frequency-response, and other measurements; hum elimination, correction of faulty operating conditions, performance improvement to your requirements. Write, describing your problems for estimate.

Box PV-1, AUDIO ENGINEERING

Industry People...

AUDIO FAIR REMINISCENCE: Art Odgers, president, Northern Radio Company, Inc., entertaining friends and associates in the New Yorker's lavish 38th-floor penthouse suite. Gene Smith, high-fidelity expert of The New York Herald Tribune, mixing business with pleasure as he ogles exhibits with one eye while keeping the other on his watch—deadlines. Ditto John Briggs, Murray Schumach and Harold Schoenberg of The New York Times, Al Hughes of The Christian Science Monitor, Arthur Bronson of Variety, Iz Horowitz of The Billboard, Charles Sinclair of Sponsor, Guy Shipley of Business Week, Norman Weiser, Nat Kentoff and Bob Parent of Downbeat, Stanley Krigfeld of The Wall Street Journal, Bill Herrman of Retailing Daily, Neil Harrison and Ralph Freas of Record Retailing, K. Inoue of Asahi—Japan's largest newspaper, Martin Mayer of Esquire, William Lansdale of House and Garden, J. P. Urban of Musical America, Rocco Famighetti of Broadcasting-Telecasting, and many, many others.

Lewis Goodfriend, prominent audio consultant, receiving congratulations on birth of a new baby girl. Arthur H. Miller, public relations consultant, displaying supreme grace in the face of unfortunate cancellation of TV broadcast he had planned. Nat and Chuck Mendelsohn getting acquainted with major manufacturers as the final step in opening their new high-fidelity studios and sales room located eight miles from George Washington Bridge in Paramus, N. J.—company name will be Music Age, Inc.

NEWS FROM HERE AND THERE: Edwin C. Roworth, secretary of Stromberg-Carlson Company, retired recently after 43 years of continuous service. Phillip B. Williams has been named chief engineer of Jensen Manufacturing Company, according to word from Thomas A. White, president. Appointment of Charles B. Denton as market manager has been announced by Weston Electrical Instrument Corporation. Melvin C. Sprinkle has been named audio sales manager of the Ampex Corporation's Washington, D. C. district office—formerly chief engineer for Shrader Manufacturing Company and for many years in sales engineering department of Altec Lansing Corporation. Raymond S. Perry is the new president of Federal Telephone and Radio Company—succeeds Henry C. Roemer who returns to IT&T as administrative vice-president. Donald LeRoy is new advertising manager of Raytheon Manufacturing Company's Television and Radio division.

John S. Margolin, Sales Manager, and Will Brooks, Chief Engineer, respectively, of tapeMaster, Inc., have both resigned to become full partners in the Chicago Rep. firm of J.K.M. Inc., according to R. M. Karet, president of the Rep. firm. William W. Garstang moves from position as Works Manager for Television and Radio Division of the Raytheon Manufacturing Company to Assistant Vice-President in charge of manufacturing.

Industry Notes...

Bell Sound Systems, Columbus, Ohio, has been purchased by Thompson Products, Inc., Cleveland, and will be operated as a subsidiary of the Thompson electronics division. Floyd W. Bell, founder, will remain with the organization. Pyramid Electric Co., North Bergen, N. J., is planning January 1 occupancy of a new 160,000 sq. ft. plant in Gastonia, N. C.—will eventually employ nearly 1000 persons. American Institute of Management has awarded associate membership to Miryam Simpson of the Mark Simpson Mfg. Co., manufacturers of Masco sound equipment.

The National Tax Association has elected as president for 1954 John L. Connolly, secretary and general counsel of Minnesota Mining & Manufacturing Co. International Standard Trading Corporation, New York, announces the appointment of Kingdom Products, Ltd., also New York, as exclusive distributors in this country for Loreux high-fidelity speakers. Capitol Commodities Company, Inc., and Radio Surplus Corporation, both Chicago, have merged under the name Capitol Commodities, Inc.—street address is 1229 W. Washington Blvd.

VERSATILITY

Sine & Square Wave
AUDIO GENERATOR KIT



EICO Model 377K

- Extremely stable Wien bridge oscillator
- Sine waves from 20 to 200,000 cps in 4 bands
- Square waves from 60 to 50,000 cps
- Response flat ± 1.5 db from 60 to 150,000 cps
- Calibration accuracy $\pm 3\%$ or 1 cps, whichever is greater
- Improved cathode follower output circuit for high output over wide load range
- 10V out at 1K Ω load (rated), 14V at 10K Ω , 8V at 500 Ω
- Continuously variable output attenuator
- Distortion only 1% of rated output
- Hum less than 0.4% of rated output
- 1% bridge resistors, 4 gang tuning condenser
- Rugged steel case, deep-etched panel

KIT \$31.95

WIRED \$49.95

LOWEST COST

See it at your Jobber!

Write for FREE Cat. AA-11



Electronic Instrument Co., Inc.
84 Withers St., Brooklyn, N. Y.

for every application...



ATLAS MIKE STANDS

most complete—
most diversified
line in the world!



From a professional boom stand to a flexible goose neck to a tiny, fitting—whatever your need in mike stands and accessories—depend on it, ATLAS has it for you. Designed and manufactured for highest stability, quiet, ease of operation, durability. And backed up 100% by ATLAS—world leader in mike stands, public address loudspeakers and accessories for 21 years.

Compare them all at your distributor—You'll make your next mike stand an ATLAS.



ATLAS SOUND CORP.

1448-39th Street, Brooklyn 18, New York
In Canada: Atlas Radio Corp., Ltd., Toronto, Ont.



A PERSONAL MESSAGE FROM THE MAN WHO HAS LIVED HIGH FIDELITY

The Hartley 215 is the refined product of a quarter century's striving for perfection, a striving that has never ceased. I have been working hard in my laboratory to develop further improvements and the result of that work was demonstrated at the Audio Fair for you to hear.

While the Hartley 215 has, in only four years, created an almost legendary reputation among audio connoisseurs as being the ultimate in fine design and craftsmanship, I wasn't satisfied (I never will be). I wanted to make it still better, and this I firmly believe I have done.

The new 215 will cost a little more—\$65.00—but compare this modest price with what you are asked to pay for complicated speaker systems embracing techniques I abandoned twenty years ago. Remember also that the unique Hartley Baffle enclosure solves all your problems of mounting, and it is now available from our New York factory in various styles.

You may not believe that a professedly nearly perfect reproducer can be bought for so low a price as \$65.00, but I give you my assurance that my sole aim through all these years has been to recreate music. That is why there has always been just one Hartley model—the very best that could possibly be produced. The low price results from long experience in eliminating those aspects of design that make no real contribution to the final result—high fidelity.

Fine music needs handling by agents who understand music. The 215 is now being carried by discriminating retailers in various districts, but these take time to find. Do not, therefore, be put off by someone who doesn't hold our agency. It is your pleasure that matters, and we shall always be happy to go to any trouble to see you are satisfied.

From now on most of my time will be spent in the U. S. A. Although the speakers are still coming from London, you do not suffer from the interposition of unnecessary middlemen. For help, guidance, and criticism, you can deal with the man who designed the job, in person.

H. A. Hartley

H. A. HARTLEY CO., INC.

521 East 162nd Street, Bronx 51, N. Y.

LUdlow 5-4239

ADVERTISING INDEX

Allied Radio Corp.	47
Akustische und Kino-Gerate	66
Ampex Corp.	15
Amplifier Corp. of America	63
Arnold Engineering Co.	5
Asco Sound Corp.	65
Atlas Sound Corp.	71
Audak Co.	39
Audio Devices, Inc.	Cover 2
Beam Instruments Corp.	46
Bell Sound Systems, Inc.	62
Bell Telephone Laboratories	18
Brush Electronics Co.	4
Camera Equipment Co.	55
Cannon Electric Co.	6
Capitol Records, Inc.	71
Chicago Transformer Division	40
Classified Ads	70
Commissioned Electronics Co.	72
Compco Corp.	72
Conrac, Inc.	52
Crestwood Div., Daystrom Elec. Corp.	8
D & R, Ltd.	58
Electron Instrument Co., Inc.	71
Electro-Voice	33
Fairchild Recording Equipment Co.	56
General Electric Co.	44, 56
Hartley, H. A., Co., Inc.	72
Harvey Radio Co., Inc.	41
Heath Co.	45, 59
Hollywood Electronics	71
Hughes Aircraft Co.	1
Hycor Sales Co.	54
Isotone Acoustic Spiralways, Inc.	66
Jensen Mfg. Co.	37
Kellogg Switchboard & Supply Co.	60
Kierulff Sound Corp.	71
Kingdom Products, Ltd.	61
Lafayette Radio	67
Lambda Electronics Corp.	58
Lansing, James B., Sound, Inc.	70
Leonard Radio, Inc.	51
Magnecord, Inc.	42
Measurements Corp.	13
Minnesota Mining & Mfg. Co.	3
Orradio Industries, Inc.	Cover 3
Partridge Transformers, Ltd.	67
Peerless Electrical Products	12
Pickering and Co., Inc.	17
Precision Film Laboratories, Inc.	10
Presto Recording Corp.	7
Professional Directory	71
Rauland-Borg Corp.	61
Reeves Soundcraft Corp.	9
Rek-O-Kut Co.	11
Rider, John F., Publisher, Inc.	69
Rinehart Books, Inc.	53
Rockbar Corp.	59
Shure Brothers, Inc.	14
Simpson, Mark, Mfg. Co., Inc.	60
Tannoy, Ltd.	35
Terminal Radio Corp.	63
Texas TV	70
Thermador Electrical Mfg. Co.	2
Turner Co.	43
U. S. Recording Co.	71
United Transformer Co.	Cover 4
University Loudspeakers, Inc.	48
V-M Corp.	57
White Sound, Inc.	49

RECORDING TAPE (PLASTIC BASE)

at NET PRICES
in Cartons of 12

WASHINGTON, D. C.: ^{Magnetic} WHERE ELSE WOULD THERE
BE MORE RED ^ TAPET

- 1200 ft. plastic tape with plastic reel included.
- Each reel individually boxed.
- Choice of nationally famous top quality brands such as:
 - Webcor (2906) 3.20; Reeves (SPN-12) 3.20;
 - Audio (1251) 3.23; Scotch (111-A) 3.25;
 - Panacoustic (711-A) 3.25; Irish, Professional grade (211 RPA) 3.30.
- Recording studios, schools, radio stations and other large quantity users—write for bulk price.

USED RECORDING TAPE (PLASTIC BASE)



1.99 for 7"—1200 foot
.99 for 5"—600 foot
.59 for 4"—300 foot
.29 for 3"—150 foot
Plastic reels included with all above sizes.

Money cheerfully refunded if you do not find this tape clearly erased and as good as new. (If you are skeptical and from Missouri send us 12¢ in stamps and we'll roll you a sample.)

New empty plastic reels in boxes for easy labeling. 3" 10¢; 4" 22¢; 5" 24¢; 7" 30¢; 7" Professional reel (2 1/4" hub) 45¢ ea. EMPTY BOXES: 3" 3¢; 4" 5¢; 5" 5¢; 7" 10¢ ea.

We carry new recorders, recording blanks, tape, tape recorders, etc. at large savings. PLEASE INCLUDE SUFFICIENT POSTAGE.

COMMISSIONED ELECTRONICS CO.
2503 Champlain St. N.W., Washington 9, D. C.

Compeo EASY-HANDLING MAGNETIC TAPE REELS

Precision manufactured in accordance with the exacting standards set by the N.A.B.



- Easy to handle because:
1. Burrs and sharp edges are smoothed away.
 2. Components assemble quickly, easily.
 3. Aluminum flanges stay flat. Eliminate tape rubbing.
 4. Hubs are die-cast to close tolerance.
 5. Grey, "write-on" finish available for editing notes.

TAPE REELS, STORAGE CANS, AND SHIPPING CASES FOR EVERY PROFESSIONAL REQUIREMENT ALWAYS IN STOCK.

Write for descriptive literature and Price list

COMPCO CORPORATION

Manufacturers of fine products for the Audio-Visual Industry.

2251 W. St. Paul Ave. Chicago 47, Illinois

PLEASE SEND

CHRISTMAS GIFT SUBSCRIPTIONS

FOR **AUDIO ENGINEERING** TO



First Fold

BUSINESS REPLY ENVELOPE
No Postage Stamp Necessary if Mailed in The United States
— POSTAGE WILL BE PAID BY —

AUDIO ENGINEERING

P. O. BOX 629

MINNEOLA, N. Y.

Third Fold

FIRST CLASS
Permit No. 142
Sec. 34.9, P. L. & R.
Minneola, N. Y.



Second Fold

SEND TO SEND TO

ADDRESS ADDRESS

CITY STATE CITY STATE

(Zone) (Zone)

1 Year, 2 Years 1 Year, 2 Years

Gift card from Gift card from

Christmas Gift Order Form

Please enter gift subscriptions to Audio Engineering and send notice thereof on gift cards to the following persons:

(PLEASE PRINT)

SUBSCRIPTION RATES

TWO YEARS	\$5.00
ONE YEAR	\$3.00
TWO YEARS (Foreign)	\$8.00
ONE YEAR (Foreign)	\$4.00

Foreign includes subscriptions addressed to Europe, Asia, Africa and Oceania.

NO ENVELOPE OR POSTAGE NEEDED
Just Fold, Seal and Mail

.....

SEND TO

ADDRESS

CITY STATE

(Zone)

1 Year, 2 Years

Gift card from.....

.....

SEND TO

ADDRESS

CITY STATE

(Zone)

1 Year, 2 Years

Gift card from.....

.....

SEND TO

ADDRESS

CITY STATE

(Zone)

1 Year, 2 Years

Gift card from.....

.....

.....

SEND TO

ADDRESS

CITY STATE

(Zone)

1 Year, 2 Years

Gift card from.....

.....

SEND TO

ADDRESS

CITY STATE

(Zone)

1 Year, 2 Years

Gift card from.....

.....

SEND TO

ADDRESS

CITY STATE

(Zone)

1 Year, 2 Years

Gift card from.....

.....

MY NAME (please print).....

ADDRESS

CITY STATE

(Zone)

Enter my subscription in my name 1 Year, 2 Years

Extend my subscription 1 Year, 2 Years

I ENCLOSE \$..... in full payment

irish

ORRADIO makes a grade of
SOUND RECORDING TAPE
for your *SPECIFIC* Requirements



If your tape recorder is intended for home or office use . . . we recommend:

IRISH Brown Band, No. 195 RPA

High quality, plastic-base tape, specially developed to reproduce with extreme fidelity, the frequency range between 100 and 8000 cps.

1200 Feet on plastic reel.....\$3.50



If your tape recorder is designed for professional application, you should use . . .

IRISH Green Band, No. 211 RPA

Super-sensitive, long-life, professional tape, offering greater output volume, greater amplitude constancy and greater signal to noise ratio. Manufactured to exact standards set by NARTB and RTMA.

1200 Feet on plastic reel.....\$ 5.50

2400 Feet on metal reel..... 13.85



If your tape recorder is intended for broadcast programming, professional dubbing, or any application where physical strength is an important consideration, ORRADIO offers you . . .

IRISH "Sound Plate," No. 220 RPA

New, revolutionary BREAK-PROOF tape. Will not tear or break at speeds up to 500 feet per second. Has the same high quality magnetic and audio features that have made IRISH 211 RPA the byword among professional tape users.

1200 Feet on plastic reel.....\$15.50

2400 Feet on metal reel..... 33.85



There are differences in magnetic oxides! Irish molecular lubricated oxides are more stable to coating conditions and turn out more uniform dispersions . . . that is one of the reasons for the growing acceptance of Irish Tape . . . for domestic, professional and broadcast applications.

SOUND RECORDING



REC. U. S. PAT. OFF.

Available at All Leading
Radio Parts Distributors and Photo Dealers

Manufactured in U.S.A. by
ORRADIO INDUSTRIES, INC.

OPELIKA, ALABAMA

World's Largest Exclusive Magnetic Tape Manufacturer



COMPONENTS FOR EVERY APPLICATION



LINEAR STANDARD
High Fidelity Ideal



HIPERM ALLOY
High Fidelity . . . Compact



ULTRA COMPACT
Portable . . . High Fidelity



OUNCER
Wide Range . . . 1 ounce



SUB OUNCER
Weight 1/2 ounce



COMMERCIAL GRADE
Industrial Dependability



SPECIAL SERIES
Quality for the "Ham"



POWER COMPONENTS
Rugged . . . Dependable



VARITRAN
Voltage Adjustors



MODULATION UNITS
One watt to 100KW



VARIABLE INDUCTOR
Adjust like a Trimmer



TOROID HIGH Q COILS
Accuracy . . . Stability



TOROID FILTERS
Any type to 300KC



MU-CORE FILTERS
Any type 1/2 - 10,000 cyc.



EQUALIZERS
Broadcast & Sound



PULSE TRANSFORMERS
For all Services



HERMETIC COMPONENTS
Ceramic Terminals



PLUG IN ADAPTER
Impedance Matching



FOSTERITE
Grade 3 JAN Components



CABLE TYPE
For mike cable line



VERTICAL SHELLS
Husky . . . Inexpensive



REPLACEMENT
Universal Mounting



STEP-DOWN
Up to 2500W . . . Stock



LINE ADJUSTORS
Match any line voltage



CHANNEL FRAME
Simple . . . Low cost

United Transformer Co.
150 VARICK STREET NEW YORK 13, N. Y.

EXPORT DIVISION: 13 EAST 40th STREET, NEW YORK 16, N. Y., CABLES: "ARLAB"